

36" Built-In Custom Panel French Door

Benchmark® Series – Custom Panel B36IT905NP



B36IT905NP
Custom Panel

The 36" Custom Panel French door built-in refrigerator works efficiently to keep food fresh longer, and prevent the transfer of flavors and odors.

Features & Benefits

Remotely monitor and control your refrigerator with the Home Connect™ app.

Bright LED lighting illuminates the entire interior.

Dual evaporators prevent odor transfer and optimize freshness.

Optiflex® hinge allows for flush-mount doors, without damaging surrounding cabinetry.

ENERGY STAR® qualified for energy efficiency.

General Properties	
Home Connect™ (Wi-Fi Enabled)	Yes
Reversible door hinge	No
Water filter	UltraClarityPro™
Lighting	LED side wall theater
Defrost process refrigerator section	Frost-free
Number of shelves - refrigerator	3
Adjustable shelves - refrigerator	2
Shelf material - refrigerator	Glass w/ metal trim
Type of shelves - refrigerator	Full width
Gallon storage bins	2
Humidity control drawer	Yes - 1
Defrost process freezer section	Automatic
Number of drawers - freezer	2
Ice maker	Yes
Quick ice	No
Capacity	
Total capacity	19.4 cu. ft.



Technical Details	
Watts (W)	350 W
Current (A)	15 A
Volts (V)	120 V
Frequency (Hz)	60 Hz
Power cord length (in.)	118"
Plug type	120V-3 prong
Dimensions & Weight	
Appliance dimensions (H x W x D) (in.)	84" x 35 3/4" x 24"
Required cutout size (H x W x D) (in.)	84" x 36" x 25"
Net weight (lbs)	540 lbs
Efficiency	
ENERGY STAR® qualified	Yes
Energy consumption (kWh/yr)	579 kWh
Accessories	
UltraClarityPro™ Water Filter	BORPLFTR55
Heater Kit may be required when two columns are installed side-by-side. See next page for details.	HEATKITB82



Accessories: To purchase Bosch accessories, cleaners & parts please visit www.bosch-home.com/us/store or call 1-800-944-2904 (Mon to Fri 5 am to 6 pm PST, Sat 6 am to 3 pm PST).

Notes: All height, width and depth dimensions are shown in inches. BSH reserves the absolute and unrestricted right to change product materials and specifications, at any time, without notice. Consult the product's installation instructions for final dimensional data and other details prior to making cutout.

Warranties: Please see Use & Care manual or Bosch website for statement of limited warranty.

For more information on our entire line of products, go to www.bosch-home.com/us or call 1-800-944-2904

© BSH Home Appliances Corporation. All rights reserved. Bosch is a registered trademark of Robert Bosch GmbH.

36" Built-In Custom Panel French Door

Benchmark® Series – Custom Panel B36IT905NP



Installation Details

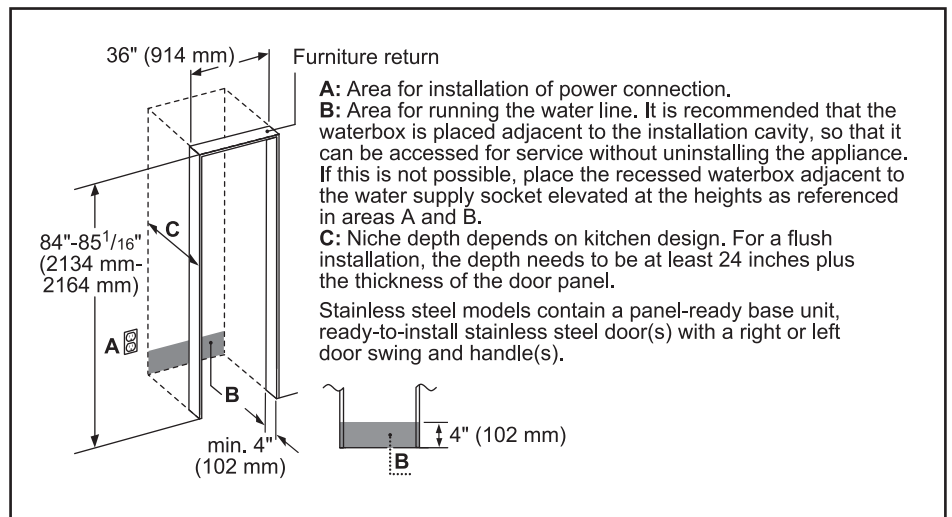
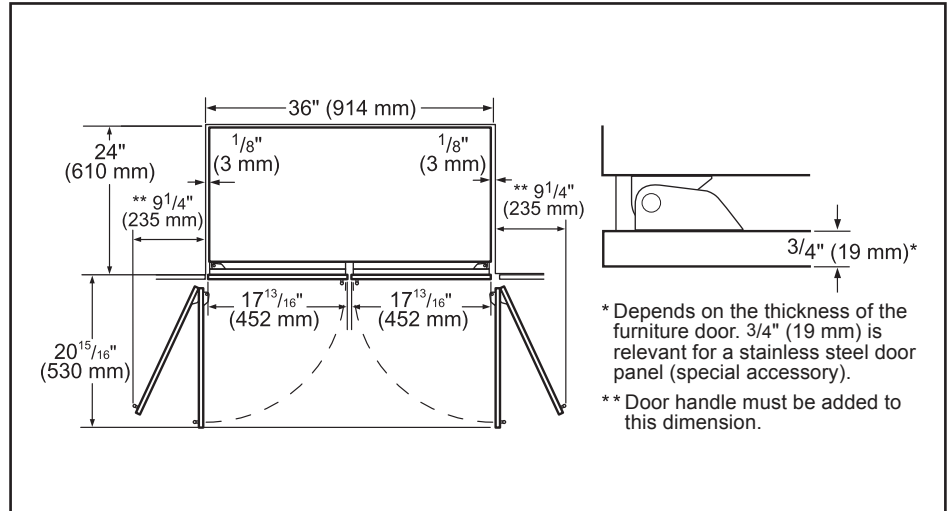
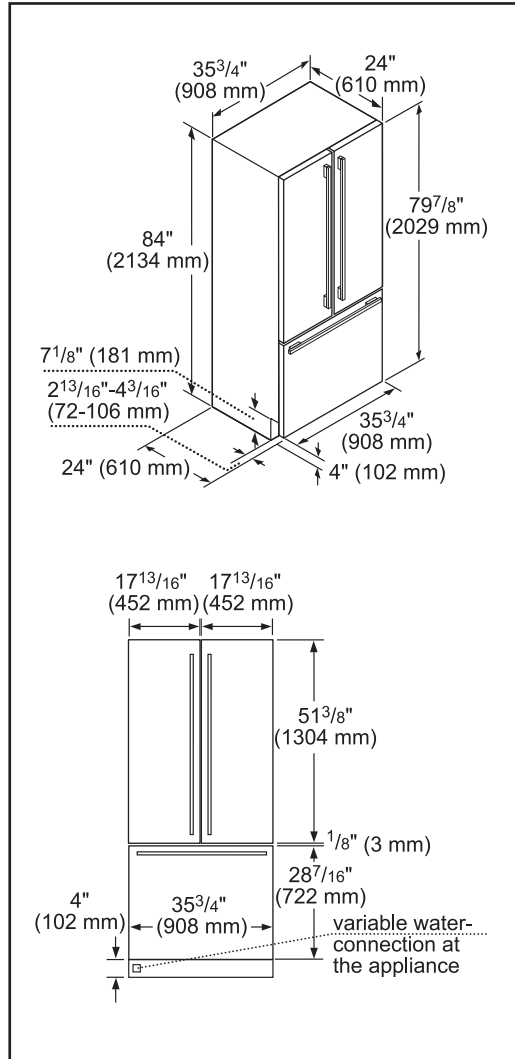

HEATKITB82 Heater Kit
When two appliances are installed side-by-side a sealing kit must be used. For combinations that involve a freezer column, this kit is included. For all other (non-traditional, i.e. two bottom freezers) side-by-side combinations or instances where any appliances are installed less than 6" (152 mm) apart from one another but not connected side-by-side, purchase this kit. This kit is also recommended for use with any installation in areas that are subject to humidity, or located next to an outside wall.

IMPORTANT: Handleless Panels should not be installed on units without the soft close capability. If you are uncertain if you have a refrigeration unit with soft close capability please contact our customer team by calling 1-800-944-2904.

Accessories: To purchase Bosch accessories, cleaners & parts please visit www.bosch-home.com/us/store or call 1-800-944-2904 (Mon to Fri 5 am to 6 pm PST, Sat 6 am to 3 pm PST).

Notes: All height, width and depth dimensions are shown in inches. BSH reserves the absolute and unrestricted right to change product materials and specifications, at any time, without notice. Consult the product's installation instructions for final dimensional data and other details prior to making cutout.

Warranties: Please see Use & Care manual or Bosch website for statement of limited warranty.

For more information on our entire line of products, go to www.bosch-home.com/us or call 1-800-944-2904

© BSH Home Appliances Corporation. All rights reserved. Bosch is a registered trademark of Robert Bosch GmbH.