

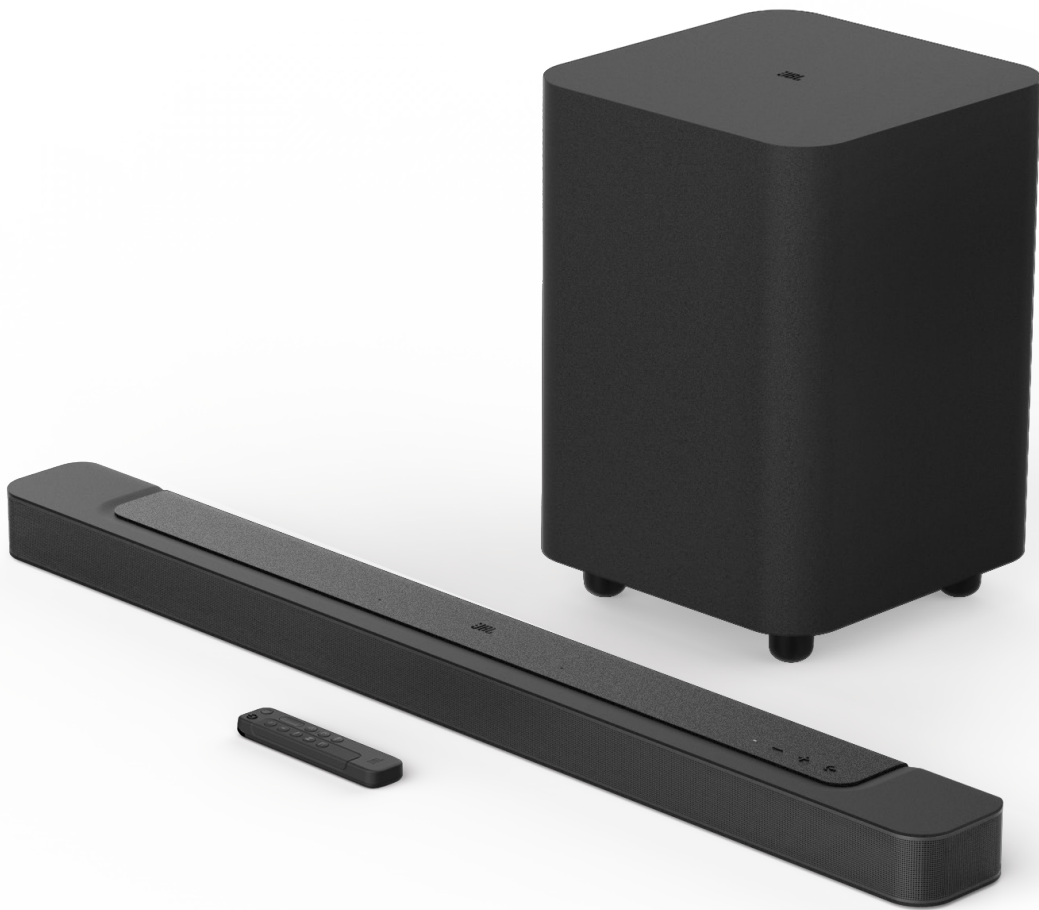

# BAR 500



**OWNER'S MANUAL**

---

## **IMPORTANT SAFETY INSTRUCTIONS**

### **Verify Line Voltage Before Use**

The JBL BAR 500 (soundbar and subwoofer) has been designed for use with 100-240 volt, 50/60 Hz AC current. Connection to a line voltage other than that for which your product is intended can create a safety and fire hazard and may damage the unit. If you have any questions about the voltage requirements for your specific model or about the line voltage in your area, contact your retailer or customer service representative before plugging the unit into a wall outlet.

### **Do Not Use Extension Cords**

To avoid safety hazards, use only the power cord supplied with your unit. We do not recommend that extension cords be used with this product. As with all electrical devices, do not run power cords under rugs or carpets, or place heavy objects on them. Damaged power cords should be replaced immediately by an authorized service center with a cord that meets factory specifications.

### **Handle the AC Power Cord Gently**

When disconnecting the power cord from an AC outlet, always pull the plug; never pull the cord. If you do not intend to use this speaker for any considerable length of time, disconnect the plug from the AC outlet.

### **Do Not Open the Cabinet**

There are no user-serviceable components inside this product. Opening the cabinet may present a shock hazard, and any modification to the product will void your warranty. If water accidentally falls inside the unit, disconnect it from the AC power source immediately, and consult an authorized service center.

# TABLE OF CONTENTS

---

## **IMPORTANT SAFETY INSTRUCTIONS 2**

---

## **1. INTRODUCTION 4**

---

## **2. WHAT'S IN THE BOX 5**

---

## **3. PRODUCT OVERVIEW 6**

- 3.1 SOUNDBAR 6
  - 3.2 SUBWOOFER 6
  - 3.3 REMOTE CONTROL 7
- 

## **4. PLACE 8**

- 4.1 DESKTOP PLACEMENT 8
  - 4.2 WALL-MOUNTING 8
- 

## **5. CONNECT 9**

- 5.1 CONNECTION WITH YOUR TV AND DIGITAL DEVICES 9
  - 5.2 BLUETOOTH CONNECTION 11
  - 5.3 CONNECTION WITH YOUR HOME NETWORK 11
- 

## **6. SETUP 12**

- 6.1 CONNECT THE SUBWOOFER 12
  - 6.2 3D SURROUND SOUND 13
- 

## **7. PLAY 14**

- 7.1 POWER-ON/AUTO STANDBY/AUTO WAKEUP 14
- 7.2 PLAY FROM THE TV SOURCE 15
- 7.3 PLAY FROM THE HDMI IN SOURCE 15
- 7.4 PLAY FROM THE BLUETOOTH SOURCE 16
- 7.5 PLAY THROUGH THE JBL ONE APP 16
- 7.6 PLAY THROUGH CHROMECAST BUILT-IN 17
- 7.7 PLAY THROUGH AIRPLAY 17
- 7.8 PLAY THROUGH AMAZON MUSIC 17
- 7.9 MULTI-ROOM PLAYBACK 18

---

## **8. SOUND SETTINGS 19**

- 8.1 AUDIO SYNC 19
  - 8.2 SMART MODE 19
  - 8.3 PUREVOICE DIALOGUE ENHANCEMENT TECHNOLOGY 19
- 

## **9. RESTORE FACTORY SETTINGS 20**

---

## **10. SOFTWARE UPDATE 20**

---

## **11. RE-CONNECT THE SUBWOOFER 21**

---

## **12. PRODUCT SPECIFICATIONS 22**

---

## **13. TROUBLESHOOTING 23**

---

## **14. TRADEMARKS 24**

---

## **15. OPEN SOURCE LICENSE NOTICE 25**

---

---

## 1. INTRODUCTION

Thank you for purchasing the JBL BAR 500 (soundbar and subwoofer) which is designed to bring an extraordinary 3D sound experience to your home entertainment system. We encourage you to take a few minutes to read through this manual, which describes the product and includes step-by-step instructions for setting up and getting started.

**To make the most of product features and support, you may need to update the product software through the Internet or the USB connector in the future. Refer to the software update section in this manual to ensure that your product has the latest software.**

Designs and specifications are subject to change without notice. If you have any questions about the soundbar, installation or operation, please contact your retailer or customer service representative, or visit our website: [www.jbl.com](http://www.jbl.com).

### JBL One app

With the JBL One app, you can

- easily complete product setup;
- connect \*music streaming services;
- discover new music with integrated music services;
- use one button to access your preset playlist and speaker settings;
- access software updates when they are available.



For more information, see [“5.3 Connection with your home network”](#) and [“7.5 Play through the JBL One app”](#).

#### NOTES:

- \*Subscription may be needed and not provided by the JBL One app.

## 2. WHAT'S IN THE BOX

Unpack the box carefully and ensure that the following parts are included. If any part is damaged or missing, do not use it and contact your retailer or customer service representative.

### Soundbar

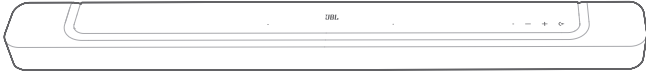

### Subwoofer

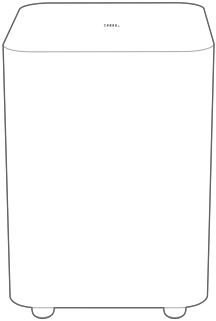

### Remote control (with 2 AAA batteries)

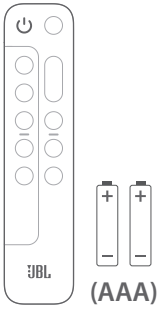

### Power cord\*

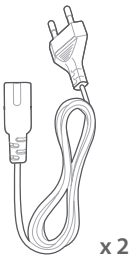

\* Power cord quantity and plug type vary region.

### HDMI cable (1.2 m/3.9 ft.)

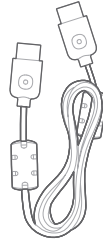

### Wall-mounting kit



### Product information & wall-mounting template



## 3. PRODUCT OVERVIEW

### 3.1 Soundbar

#### 3.1.1 Controls

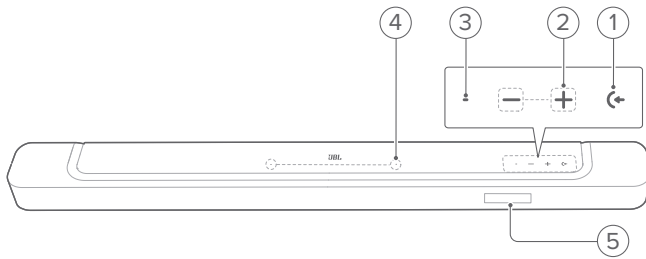

#### 1) Source

- Switch on
- Select a sound source: TV (default, for audio input from TV connection where the **HDMI OUT (TV ARC/ TV eARC)** connector is prioritized over the **OPTICAL** connector), Bluetooth or HDMI IN

#### 2) +/- (Volume)

- Switch on
- Decrease or increase the volume
- Press and hold to decrease or increase the volume continuously
- Press the two buttons together to mute or unmute

#### 3) Status indicator

System:		
⦿	Regular flashing (white)	System startup
⦿	Fast flashing (white)	Software updating in progress
●	Solid (amber)	Restoring factory settings
Network connection:		
⦿	Slow breathing (white)	Entering Wi-Fi setup mode, or network disconnected
●	Solid (green)	Soundbar discovered by the JBL One app
○	Solid (white)	Network connected
●	Solid (yellow)	Weak Wi-Fi connection

#### 4) Microphone

- For sound calibration

#### 5) Status display

### 3.1.2 Rear connectors

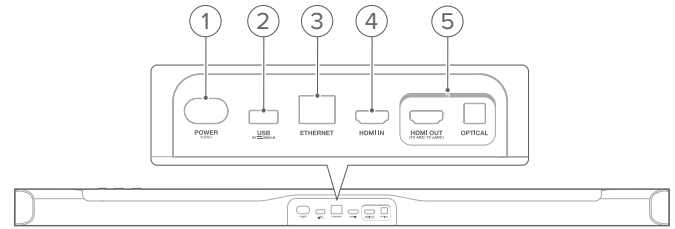

#### 1) POWER

- Connect to power (with the supplied power cord)

#### 2) USB

- USB connector for software update
- Connect to a USB storage device for MP3 file playback (for US version only)

#### 3) ETHERNET

- Connect to your home network through an Ethernet cable

#### 4) HDMI IN

- Connect to the HDMI output on your digital device

#### 5) TV connectors

##### HDMI OUT (TV ARC/ TV eARC)

- Connect to the HDMI ARC / HDMI eARC input on your TV

##### OPTICAL

- Connect to the optical output on your TV or digital device

### 3.2 Subwoofer

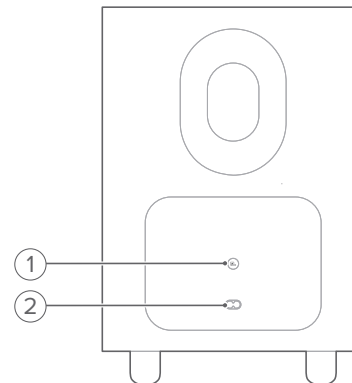

#### 1) Connection status indicator

- Connection status indicator

○	Solid (white)	Connected to the soundbar
⦿	Fast flashing (white)	Pairing mode
⦿	Slow flashing (white)	Reconnecting or exiting the pairing mode
●	Solid (amber)	Standby mode

#### 2) Power connector

- Connect to power (with the supplied power cord)

### 3.3 Remote control

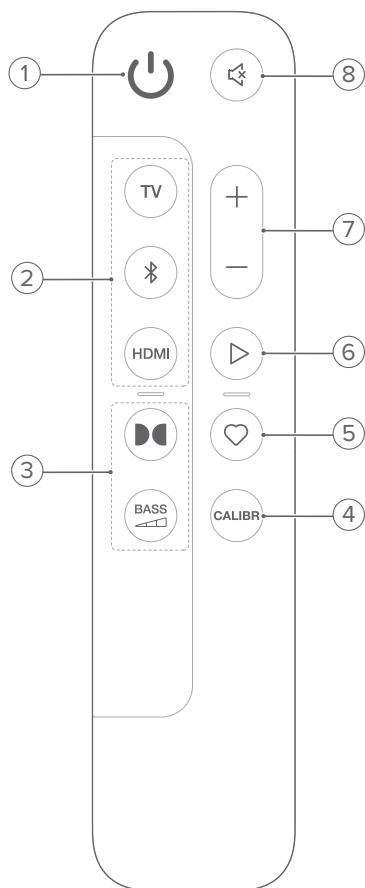

#### 1)

- Switch on or to standby

#### 2) Source selectors

##### TV

- Select the TV source (default, for audio input from TV connection where the **HDMI OUT (TV ARC/ TV eARC)** connector is prioritized over the **OPTICAL** connector)

##### (Bluetooth)

- Select the Bluetooth source
- Press and hold to connect a Bluetooth device

##### HDMI

- Select the **HDMI IN** source

#### 3) Sound effect buttons



- Switch the virtual Dolby Atmos® sound effects on or off (Default: on)

##### BASS



- Select the bass level for subwoofer: 1/2/3 (default)/4/5

#### 4) CALIBR

- Press to start sound calibration

#### 5) (Moment)

- Press to directly access the playlist or speaker settings that you have personalized in the JBL One app

#### 6) (Playback controls during the music streaming over JBL One app, Chromecast built-in™, AirPlay, Alexa or Bluetooth)

- Single press: Pause or resume playback
- Double press: Next track
- Triple press: Previous track

#### 7) + / -

- Increase or decrease the volume
- Press and hold to increase or decrease the volume continuously.

#### 8) (Mute)

- Mute/unmute

### 3.3.1 App-enabled control

With the JBL One app on your Android and iOS device, you can do the following:

- Wi-Fi setup;
- Audio calibration & demo;
- Personalize audio settings;
- Manage and control device;
- Music service integration;
- Additional features.

## 4. PLACE

### 4.1 Desktop placement

Place the soundbar and subwoofer on a flat and stable surface. Make sure that the subwoofer is at least 3 ft (1 m) away from the soundbar, and 4" (10 cm) away from a wall.

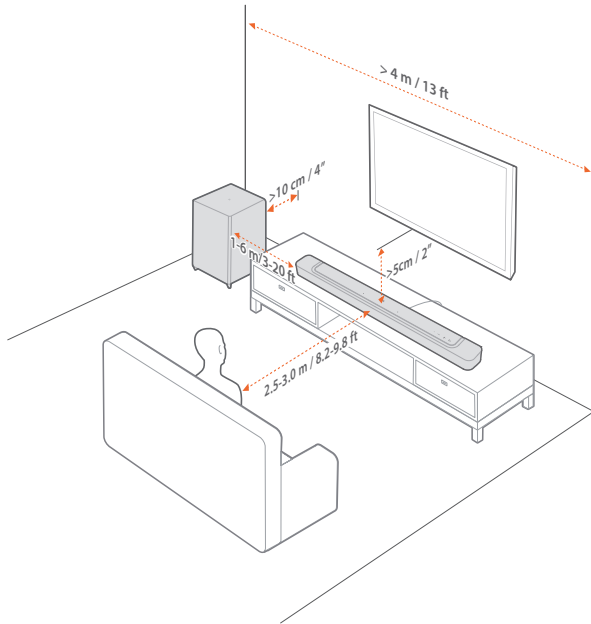

#### NOTES:

- The power cord shall be properly connected to power.
- Do not place any objects on the top of the soundbar or subwoofer.
- Make sure that the distance between the subwoofer and the soundbar is less than 20 ft (6 m).

### 4.2 Wall-mounting

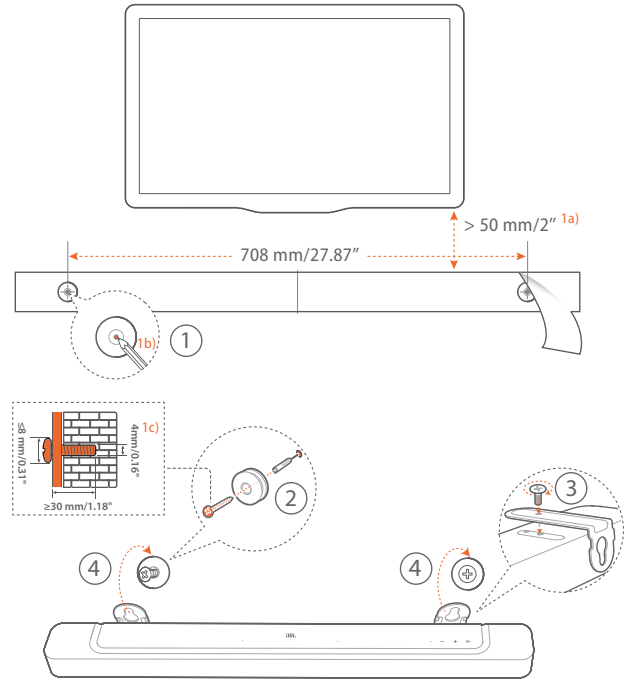

#### 1. Preparation:

- a) With a minimum distance of 2" (50mm) from your TV, stick the supplied wall-mounting template to a wall by using adhesive tapes.
- b) Use your ballpen tip to mark the screw holder location. Remove the template.
- c) On the marked location, drill a 4 mm/0.16" hole.

#### 2. Install the support for wall-mounting bracket.

3. With the screw, fasten the wall-mounting bracket onto the bottom of the soundbar.

#### 4. Mount the soundbar.

#### NOTES:

- Make sure that the wall can support the weight of the soundbar.
- Install on a vertical wall only.
- Avoid a location under high temperature or humidity.
- Before wall-mounting, make sure that cables can be properly connected between the soundbar and external devices.
- Before wall-mounting, make sure that the soundbar is unplugged from power. Otherwise, it may cause an electric shock.



## 5. CONNECT

### 5.1 Connection with your TV and digital devices

For audio playback through the soundbar, connect the soundbar with your TV through the supplied HDMI cable or an optical cable (sold separately).

An HDMI connection supports digital audio and video with a single connection. HDMI connectivity is the best option for your soundbar.

#### 5.1.1 TV (HDMI ARC / eARC)

(Recommended connection for the best Dolby Atmos experience)

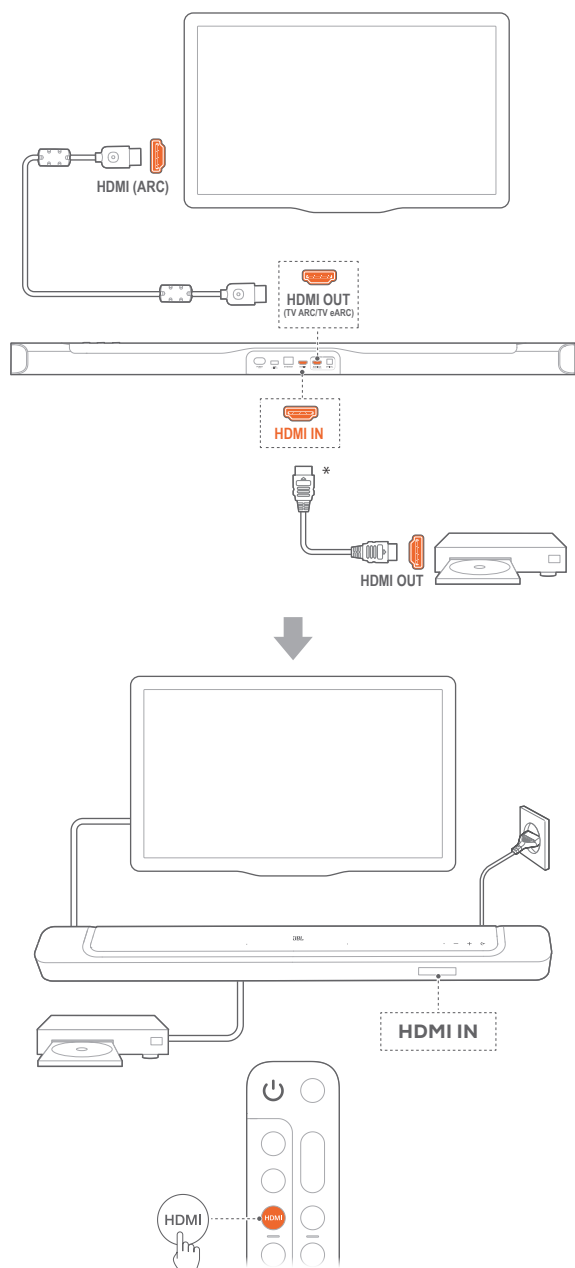

1. Connect the soundbar with the **HDMI IN (ARC / eARC)** connector on your TV by using the supplied HDMI cable.
  - On your TV, check that HDMI-CEC and HDMI ARC have been enabled. Refer to the owner's manual of your TV for more information.
2. Use an HDMI cable (V2.0 or later) to connect the soundbar with your digital device, such as a set-top box, DVD/Blu-ray player or game console.
  - On your digital device, check that HDMI-CEC has been enabled. Refer to the owner's manual of your digital device for more information.
  - On your digital device, select "Bitstream" or "Raw data" in the audio output settings for the best Dolby Atmos experience.
3. To play audio from the digital device connected to the soundbar, select **HDMI** on the remote control.

#### NOTES:

- If your TV does not support HDMI eARC, make sure that you connect your digital device through the HDMI IN connector on the soundbar instead of your TV. Otherwise, the Dolby Atmos information cannot pass through the HDMI (ARC) connectors from the TV to the soundbar.

## 5.1.2 TV (HDMI eARC)

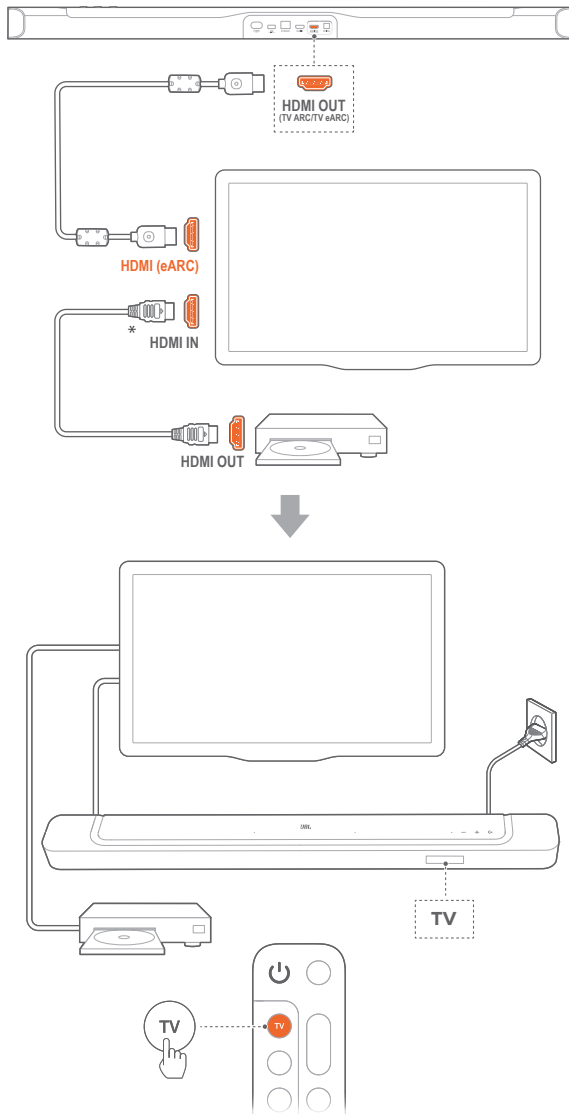

1. Connect the soundbar with the **HDMI IN (eARC)** connector on your TV by using the supplied HDMI cable.
  - On your TV, check that HDMI-CEC and HDMI eARC have been enabled. Refer to the owner's manual of your TV for more information.
2. Use an HDMI cable (eARC compatible, V2.0 or later) to connect your TV with your digital device, such as a streaming device, set-top box, DVD/Blu-ray player or game console.
  - On your digital device, check that HDMI-CEC has been enabled. Refer to the owner's manual of your digital device for more information.
  - On your TV and digital device, select "Bitstream" or "Raw data" in the audio output settings for the best Dolby Atmos experience.
3. To play audio from the digital device connected to your TV, select **TV** on the remote control.

## 5.1.3 OPTICAL

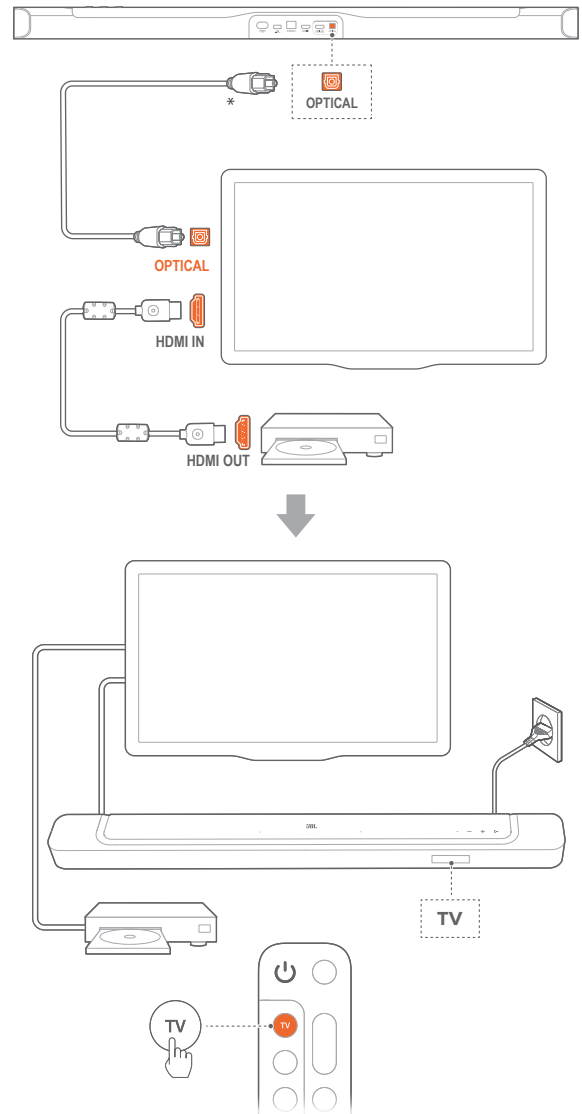

### NOTES:

- With the Virtual Dolby Atmos design, the Dolby surround upmixer of the soundbar can expand the legacy channel-based audio of Dolby Digital format, including 5.1 and 7.1 content, and provide an immersive 3D Atmos experience.

1. Connect the soundbar with your TV by using an optical cable.
2. Use an HDMI cable (V2.0 or later) to connect your TV with your digital device, such as a streaming device, set-top box, DVD/Blu-ray player or game console.
3. To play audio through the optical cable, select **TV** on the remote control.

### NOTES:

- \* The HDMI cable (for digital device connection) and the optical cable are sold separately.
- Full compatibility with all HDMI-CEC devices is not guaranteed.
- When both HDMI ARC and optical cables are connected to the soundbar for audio input from TV connection, the HDMI ARC connection is prioritized.

## 5.2 Bluetooth connection

Through Bluetooth, connect the soundbar with your Bluetooth device, such as a smartphone, tablet and laptop.

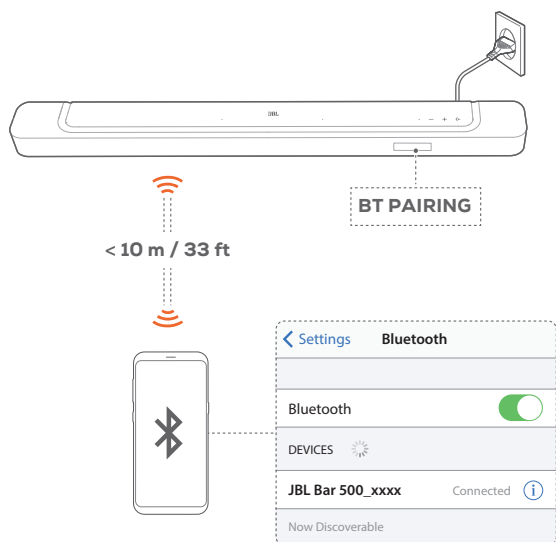

### 5.2.1 Connect a Bluetooth device

- To select Bluetooth source, press **⏪** on the soundbar or **⏪** on the remote control.
  - **"BT PAIRING"**: Ready for BT pairing
- On your Bluetooth device, enable Bluetooth and search for **"JBL BAR 500\_xxxx"** within three minutes.
  - **Successful connection**: The device name is displayed if your device is named in English. A confirmation tone is heard.

### 5.2.2 To reconnect the last paired device

Your Bluetooth device is retained as a paired device when the soundbar goes to standby mode. Next time you switch to the Bluetooth source, the soundbar reconnects the last paired device automatically.

### 5.2.3 To connect to another Bluetooth device

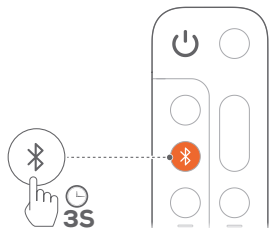

- In the Bluetooth source, press and hold **⏪** on the soundbar or **⏪** on the remote control until **"BT PAIRING"** is displayed.
  - The soundbar enters the Bluetooth pairing mode.
- Follow the Step 2 under ["5.2.1 Connect a Bluetooth device"](#).
  - If the device has ever been paired with the soundbar, first unpair **"JBL BAR 500\_xxxx"** on the device.

## NOTES:

- The Bluetooth connection will be lost if the distance between the soundbar and Bluetooth device exceeds 33 ft (10 m).
- Electronic devices may cause radio interference. Devices that generate electromagnetic waves must be kept away from the Soundbar, such as microwaves and wireless LAN devices.

## 5.3 Connection with your home network

Through Wi-Fi or an Ethernet cable, connect the soundbar to your home network. With the JBL One app and the supported streaming services (Chromecast built-in, AirPlay and Alexa), the soundbar allows you to stream audio on smartphones or tablets through the soundbar speakers.

- On the soundbar, enter the Wi-Fi setup mode:
  - Press any button to switch on (See ["7.1 Power-on/Auto standby/Auto wakeup"](#)).
    - If the soundbar has not been connected to a network, the screen shows **"HELLO"** and then, **"SETUP WIFI"**.
    - To re-enter the Wi-Fi setup mode, press and hold **+** and **-** until **"SETUP WIFI"** is displayed.
- On your Android or iOS device, add the soundbar to your home Wi-Fi network.
  - Connect your Android or iOS device to your home Wi-Fi network. Download the JBL One app.
  - Follow the app instructions to complete setup.

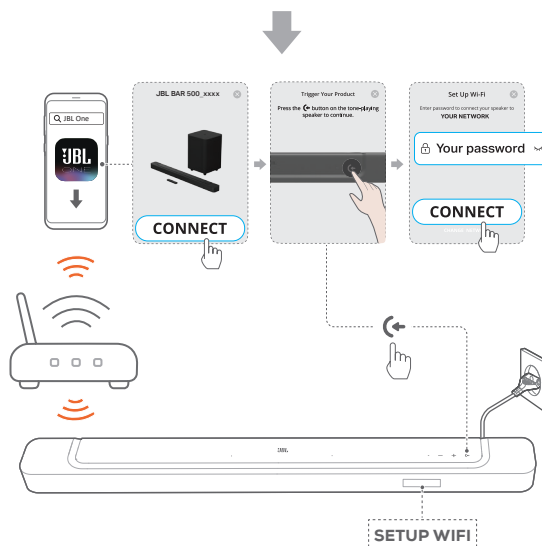
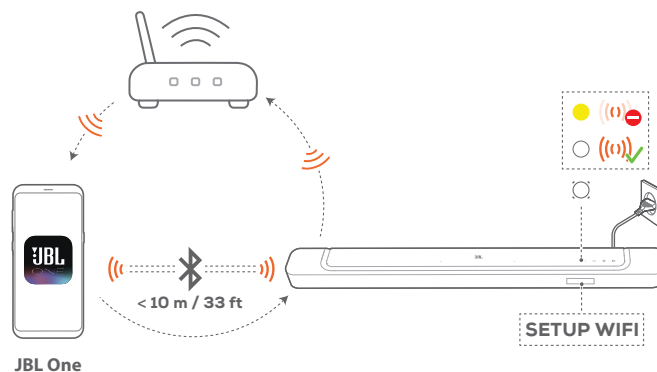

3. If necessary, use an Ethernet cable to connect the soundbar to your home network.
  - Make sure that you connect to the same network as you did during the setup.

**NOTES:**

- On your Android or iOS device, you can name the soundbar in the JBL One app.
- On your iOS device, add the soundbar to the Apple Home app and manage it together with other AirPlay 2-compatible speakers.
- On your iOS device, if the soundbar has been added to your home Wi-Fi network, you can start AirPlay streaming from an AirPlay-compatible app (See “7.7 Play through AirPlay”).
- Availability of online music streaming services varies by country.
- Some features require subscriptions or services not available in all countries.

## 6. SETUP

### 6.1 Connect the subwoofer

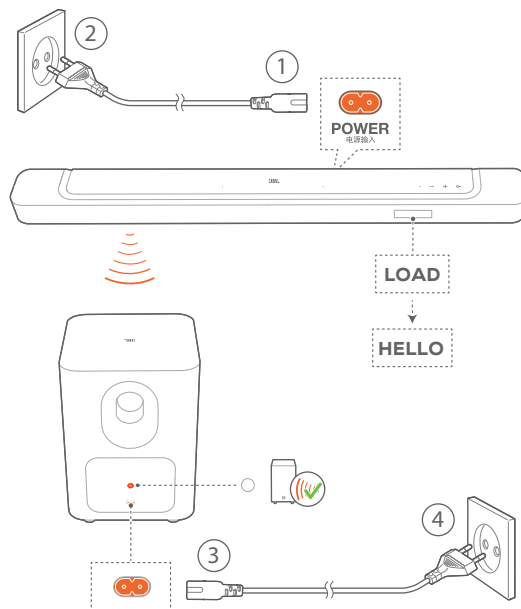

1. Connect the soundbar to power by using the supplied power cord.
  - The screen on the soundbar shows “LOAD” and then, “HELLO”.
2. Connect the subwoofer to power by using the supplied power cord.
  - The subwoofer is connected to the soundbar automatically.  
**Connected:**  turns solid white.

**NOTES:**

- Use the supplied power cords only.
- Before connecting to power, make sure that you have completed all other connections (See “5.1 Connection with your TV and digital devices”).

## 6.2 3D surround sound

### 6.2.1 Sound calibration

Optimize your 3D surround sound experience for your unique listening environment.

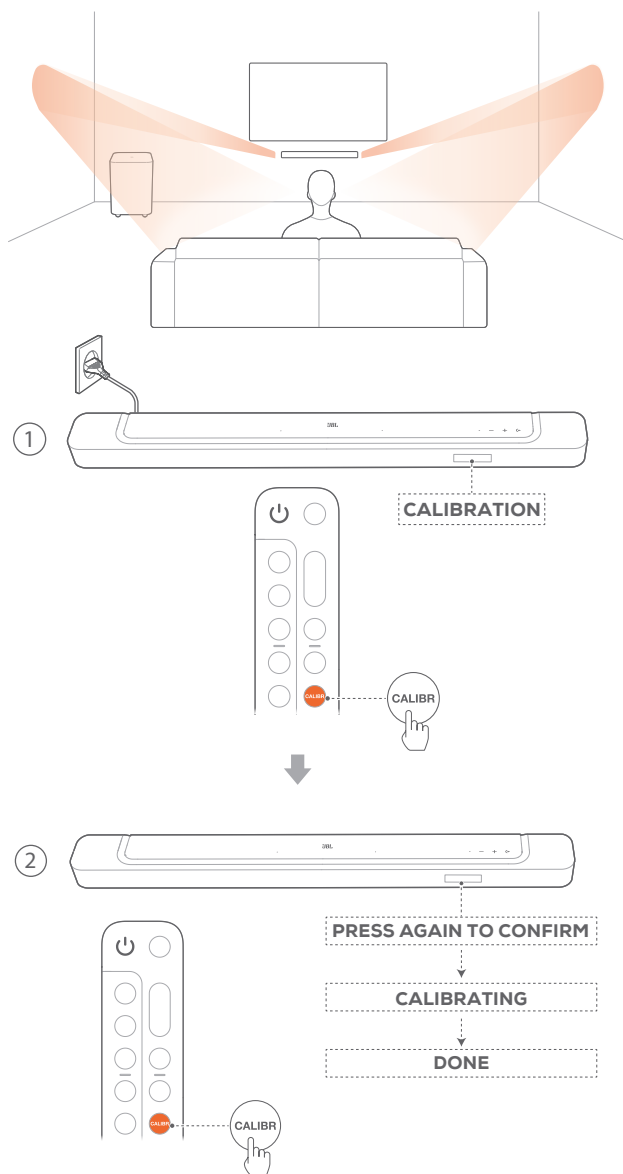

1. On the remote control, press **CALIBR** to start calibration.  
→ “**CALIBRATION**” is displayed on the soundbar.
2. When “**PRESS AGAIN TO CONFIRM**” is displayed, press **CALIBR** again.  
→ Countdown starts from 5 to 1.  
→ Calibration tone is heard. Audio calibration starts.  
“**CALIBRATING**”: Calibration in progress  
“**DONE**”: Calibration completed successfully

#### NOTES:

- During sound calibration, all buttons on the remote control are disabled except for **⏻**.

### 6.2.2 Dolby Atmos®

With the virtual Dolby Atmos, enjoy height sound effects when you play movies in the TV/HDMI IN source.

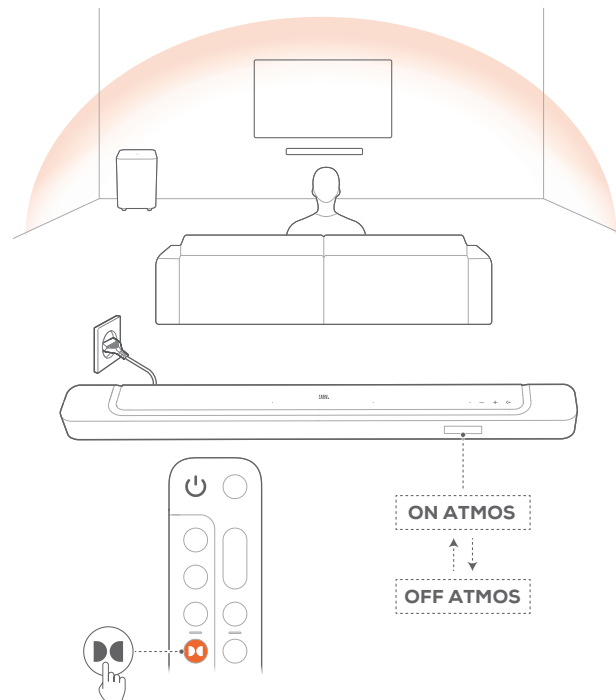

1. Connect and play your Blu-ray player or streaming device through the HDMI ARC/HDMI eARC connector and the HDMI connector. (See “[5.1 Connection with your TV and digital devices](#)”).
2. Press **Ⓜ** on the remote control to switch on or off the height sound effects (Default: on).  
→ The screen on the soundbar shows “**ON ATMOS**” or “**OFF ATMOS**”.

#### NOTES:

- Switch off the ATMOS effects, if you prefer not to have any height sound effects during your viewing or listening.
- The ATMOS effects are available in Dolby audio content only.

### 6.2.3 Bass adjustment

You can make bass adjustment as needed.

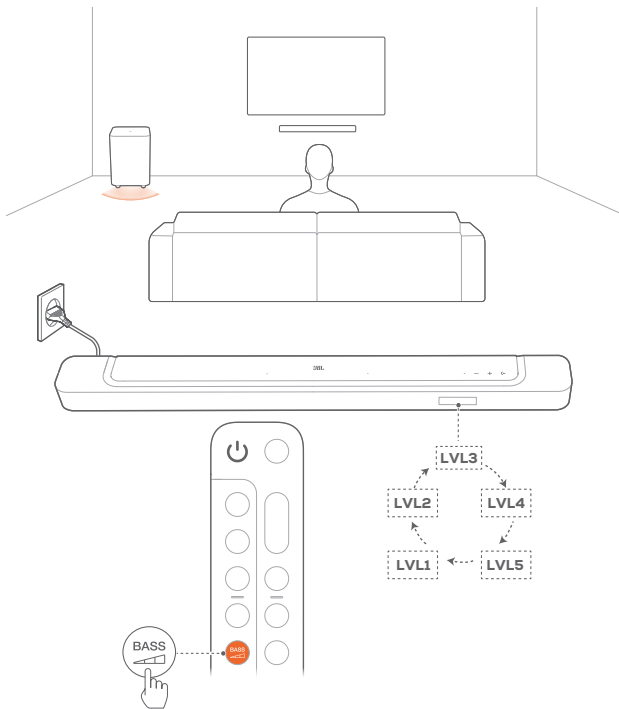



- On the remote control, press **BASS** to switch between bass levels.  
→ “LVL1” to “LVL5” is displayed (Default: “LVL3”).

## 7. PLAY

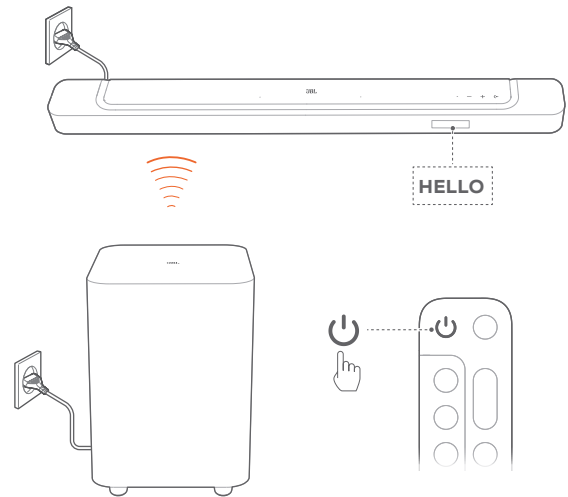
### 7.1 Power-on/Auto standby/Auto wakeup



#### 7.1.1 Switch on

- To switch on, press any button on the soundbar, or  on the remote control.  
→ “HELLO” is displayed.  
→ The subwoofer is reconnected to the soundbar automatically. **Connected:**  turns solid white.

#### 7.1.2 Auto standby

If the soundbar is inactive for more than 10 minutes, it will switch to standby mode automatically. “STDBY” is displayed. The subwoofer also goes to standby, and  turns solid amber. Next time you switch on the soundbar, it returns to the last selected source.

#### 7.1.3 Auto wakeup

In standby mode, the soundbar will wake up automatically when

- the soundbar is connected to your TV through the HDMI ARC/eARC connection and your TV is switched on;
- the soundbar is connected to your TV through the HDMI ARC/eARC connection and through the HDMI connection, is also connected to your digital device such as a set-top box, DVD/Blu-ray player or game console, and your digital device is switched on;
- the soundbar is connected to your home network and audio is streamed to the soundbar through the music streaming services over JBL One app, Chromecast built-in, AirPlay or Alexa.

## 7.2 Play from the TV source

With the soundbar connected, you can enjoy TV audio from the soundbar speakers.

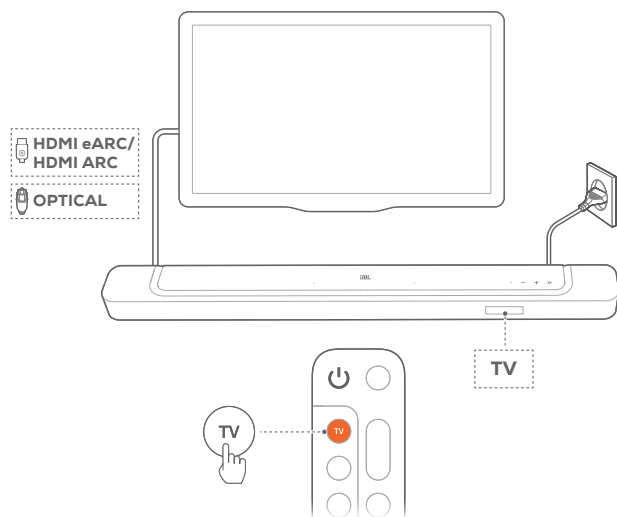

1. Make sure that your TV is set to support external speakers and the built-in TV speakers are muted. Refer to the owner's manual of your TV for more information.
2. Make sure that the soundbar has been properly connected to your TV (See "[5.1 Connection with your TV and digital devices](#)").
3. To select the TV source, press **TV** on the soundbar or **TV** on the remote control.
  - **"TV"**: The TV source is selected.
  - In the factory settings, the TV source is selected by default.

### NOTES:

- If the soundbar is connected to your TV through both an HDMI cable and an optical cable, the HDMI cable source is selected for the TV connection.

### 7.2.1 TV remote control setup

To use your TV remote control for both your TV and the soundbar, check that your TV supports HDMI-CEC. If your TV does not support HDMI-CEC, follow the steps under "[TV remote control IR learning](#)".

#### HDMI-CEC

If your TV supports HDMI-CEC, enable the functions as instructed in your TV user manual. You can control the volume +/-, mute/unmute, and power on/standby functions on your soundbar through the TV remote control.

#### TV remote control IR learning

Through IR learning, your Infra-red TV remote control can learn some commands of the soundbar.

1. On the soundbar, press and hold **TV** and **+** until **"LEARNING"** is displayed.
  - You enter the TV remote control learning mode.

2. Point your TV remote control at the soundbar. Follow the screen instructions to operate the buttons on your TV remote control:

- When any one of **"POWER"**, **"VOL+"**, **"VOL-"**, or **"MUTE"** is displayed on the soundbar, press the desired button on your TV remote control.
  - **"DONE"**: The functions of the soundbar button are learnt by your TV remote control buttons.
  - The soundbar returns to the last selected source.
- To stop and exit the TV remote control learning mode, press and hold **TV** and **+** on the soundbar until **"EXIT LEARNING"** is displayed.
  - The learnt functions are discarded.

### NOTES:

- The soundbar will exit the TV remote control learning mode automatically if no action is taken for 30 seconds. The learnt functions are discarded.

## 7.3 Play from the HDMI IN source

With the soundbar connected as shown, your digital device can play video on your TV and audio from the soundbar speakers.

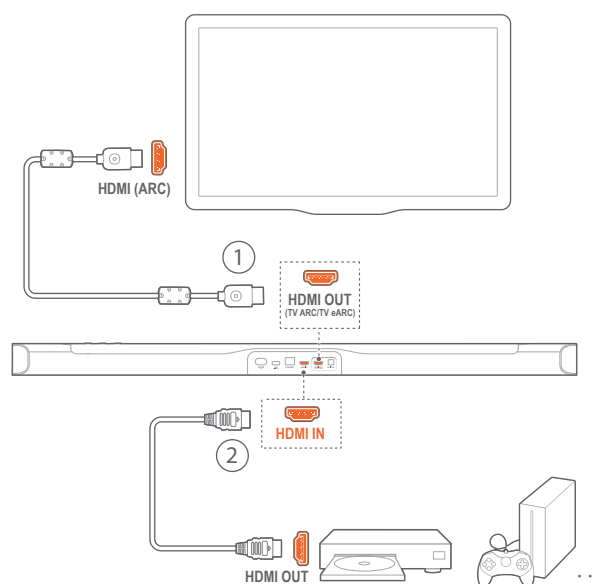

1. Make sure that the soundbar has been properly connected to your TV and digital device (See "[5.1 Connection with your TV and digital devices](#)").
2. Switch on your digital device.
  - Your TV and the soundbar wake up from standby mode and switch to the input source automatically.
  - To select the **HDMI IN** source on the soundbar, press **HDMI IN** on the soundbar or **HDMI** on the remote control.
3. Switch your TV to standby mode.
  - The soundbar and source device are switched to standby mode.

### NOTES:

- Full compatibility with all HDMI-CEC devices is not guaranteed.

## 7.4 Play from the Bluetooth source

Through Bluetooth, stream audio play on your Bluetooth device to the soundbar.

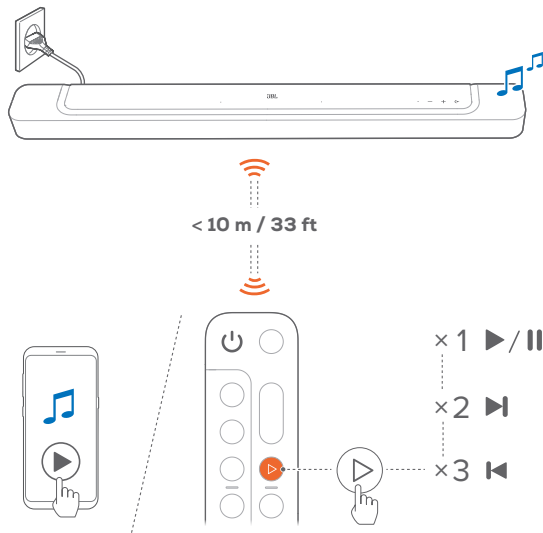

1. Check that the soundbar has been properly connected to your Bluetooth device (See “[5.2 Bluetooth connection](#)”).
2. To select the Bluetooth source, press on the soundbar or on the remote control.
3. Start audio play on your Bluetooth device.
  - Alternatively, press on the remote control to control playback.
4. Adjust the volume on the soundbar, remote control or your Bluetooth device.

## 7.5 Play through the JBL One app

Through the JBL One app, stream audio from online music services to the soundbar.

1. On the soundbar,
  - Check that the soundbar has been properly connected to your home network (See “[5.3 Connection with your home network](#)”).
2. On your Android or iOS device,
  - a) Check that your Android or iOS device has been connected to the same network as the soundbar.
  - b) Launch the JBL One app, browse available \*music streaming services to select music, and then, start music streaming to the connected soundbar.
    - Use the search box to discover music with the integrated music library of available music services.



3. To exit from the music playback, switch to other sources.

### NOTES:

- \*Subscription may be needed and not provided by the JBL One app.

### Access your presets with the (Moment) button

By pressing on the remote control, you can access the playlist and speaker settings that you have personalized on the JBL One app.

1. On the JBL One app,
  - personalize the (Moment) feature.

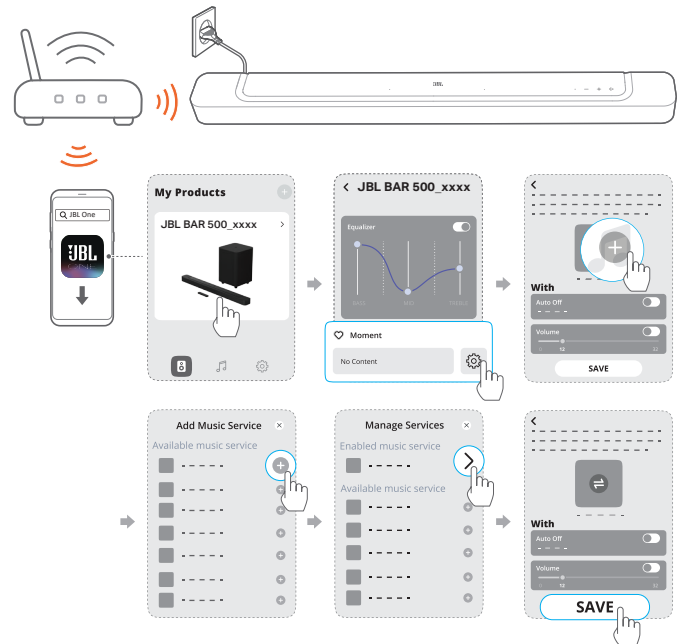



2. On the soundbar,
  - Press  on the remote control to access the personalized playlist and speaker settings.

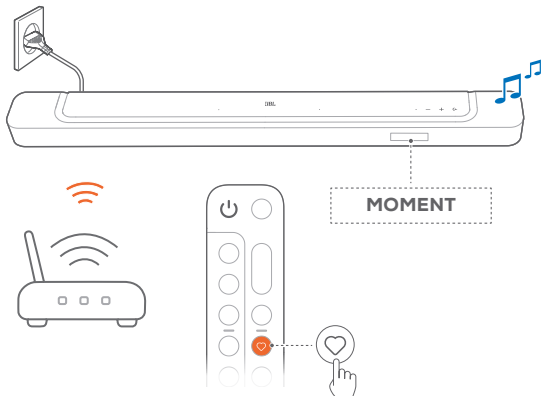

## 7.6 Play through Chromecast built-in

Through Chromecast built-in, stream audio on your Android or iOS device to the soundbar.

1. On the soundbar,
  - Check that the soundbar has been properly connected to your home network (See [“5.3 Connection with your home network”](#)).
2. On your Android or iOS device,
  - a) Check that your Android or iOS device has been connected to the same network as the soundbar.
  - b) Launch the JBL One app, and check that you have enabled the streaming service of Chromecast built-in.

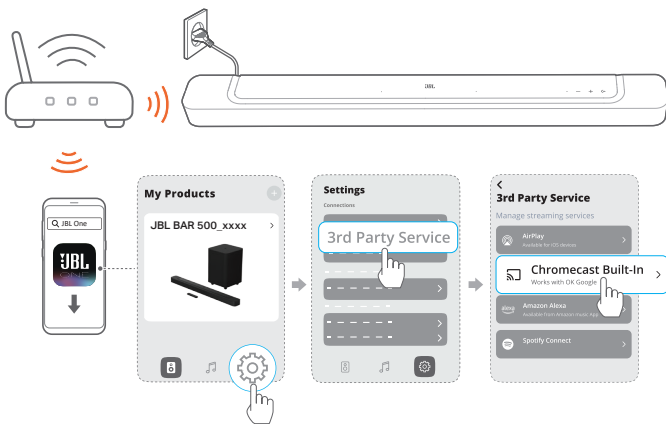

- c) On a Chromecast-enabled app, play music, tap the cast icon  and select the connected soundbar.



3. To exit from the music playback, switch to other sources.

## 7.7 Play through AirPlay

Through AirPlay, stream audio on your iOS device to the soundbar.

1. On the soundbar,
  - Check that the soundbar has been properly connected to your home network (See [“5.3 Connection with your home network”](#)).
2. On your iOS device,
  - a) Check that your iOS device has been connected to the same network as the soundbar.
  - b) To enter the Control Center on an iOS device, swipe down from the upper right corner. Tap  to select the connected soundbar and then, start audio streaming from an app.

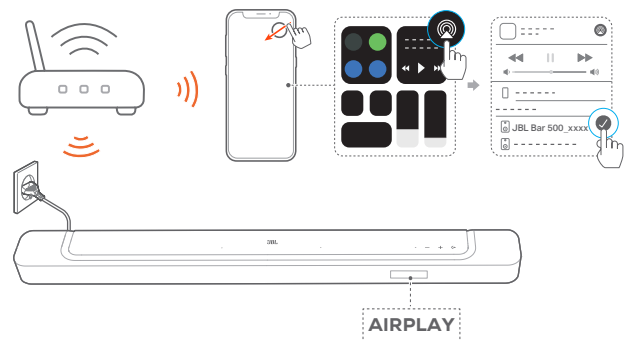

3. To exit from the music playback, switch to other sources.

## 7.8 Play through Amazon Music

With the soundbar connected to Alexa, you can stream music from the Amazon Music library to the soundbar.

1. On the soundbar,
  - Check that the soundbar has been properly connected to your home network (See [“5.3 Connection with your home network”](#)).

2. On your Android or iOS device,
  - a) Check that your Android or iOS device has been connected to the same network as the soundbar.
  - b) Launch the JBL One app, and check that you have enabled the streaming service of Amazon Alexa.



3. Launch the Amazon Alexa app to start music playback.



- Open the Amazon Music app to access the Amazon Music library.
- Make sure that you start music playback from the same Alexa account that you have enabled in the JBL One app. Refer to the Amazon Alexa app for more details.

#### NOTES:

- The soundbar can support audio streaming and cannot support video streaming.
- During playback through Chromecast built-in, AirPlay or Alexa, music playback pauses on the current connected device when you start music playback on a second connected device.
- When the soundbar switches between your home Wi-Fi and wired network during AirPlay, music playback pauses and will resume in a few minutes, depending on the bandwidth condition of broadband. For the connection to your home wired network, see [5.3 Connection with your home network](#).

## 7.9 Multi-room playback

With the multi-room playback, you can stream music on your Android or iOS device to multiple Chromecast-enabled/ AirPlay / Alexa speakers.

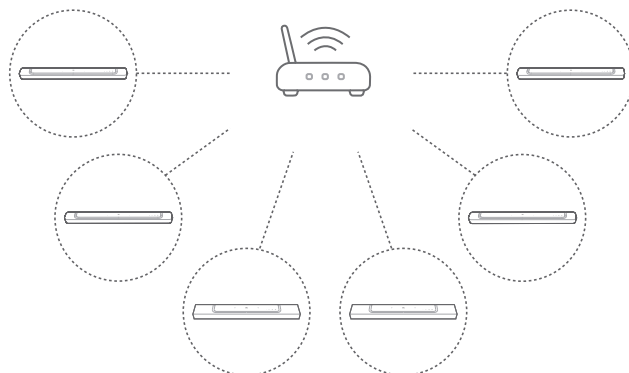

### 7.9.1 Chromecast built-in

1. Through the Google Home app, connect multiple Chromecast-enabled speakers to the same network, assign them to multiple rooms, and create groups as needed.
2. Run a Chromecast-enabled app on your smartphone or tablet.
3. Play music. Press and select the grouped speakers.

#### NOTES:

- To create a multi-room speaker group in the Google Home app, make sure that you have connected all the speakers to the same home network and have used the same Google login account. Refer to the Google Home app for more details.
- Depending on the bandwidth of your local network, you can stream music to up to 6 Chromecast-enabled speakers.

### 7.9.2 AirPlay

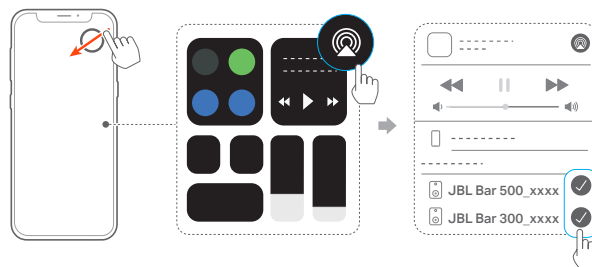

1. On an iOS device, enter the Control Center.
2. Tap to select multiple connected speakers as needed.
3. Start music streaming from an app.

### 7.9.3 Alexa MRM: Multi-Room Music

1. Check that you have enabled the streaming service of Amazon Alexa on the soundbar through the JBL One app.



2. Through the Amazon Alexa app, create a Multi-room Music group for the soundbar. Refer to the Amazon Alexa app for more information.

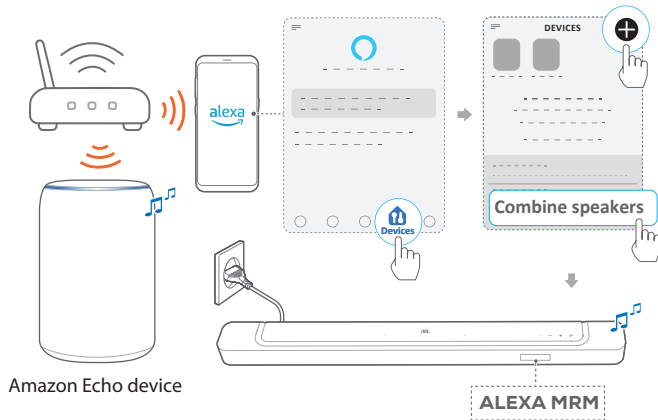

#### NOTES:

- To create a multi-room music group in the Amazon Alexa app, make sure that you have connected all the devices to the same home network and have used the same Alexa login account. Refer to the Amazon Alexa app for more details.

## 8. SOUND SETTINGS

### 8.1 Audio sync

With the audio sync function, you can synchronize audio and video to make sure that no delay is heard from your video content.

1. On the remote control, press and hold **TV** for more than three seconds and then, press **+**.  
→ “**SYNC**” is displayed.
2. Within five seconds, press **+** or **-** on the remote control to adjust the audio delay and match with video.  
→ The audio sync timing is displayed.

### 8.2 Smart mode

With the smart mode enabled by default, you can enjoy TV programs with rich sound effects. For TV programs such as news and weather forecasts, you can reduce sound effects by disabling the smart mode and switching to the standard mode.

**Smart mode:** EQ settings and JBL Surround Sound are applied for rich sound effects.

**Standard mode:** The preset EQ settings are applied for standard sound effects.

To disable the smart mode, do the following:

- On the remote control, press and hold **⏮** for more than three seconds and then, press **+**.  
→ You switch to another mode. “**OFF SMART MODE**”: The standard mode is enabled.  
→ Next time you switch on the soundbar, the smart mode is **enabled again automatically**.

### 8.3 PureVoice dialogue enhancement technology

By taking advantage of the PureVoice dialogue enhancement technology, the PureVoice allows you to enhance vocal clarity and easily hear and understand speech.

By default, the PureVoice is enabled if you play movies from the TV/ HDMI IN source; and the PureVoice is disabled if you stream music over Bluetooth, Chromecast built-in, Alexa and AirPlay.

To disable or enable the PureVoice mode,

- On the remote control, press and hold **⏮** for more than five seconds and then, press **BASS**.  
→ “**OFF PUREVOICE**”: The Purevoice is disabled.  
→ “**ON PUREVOICE**”: The PureVoice is enabled.  
→ Next time you switch on the soundbar, the Purevoice is **enabled again automatically**.

---

## 9. RESTORE FACTORY SETTINGS

By restoring the default settings defined at factories, you remove all your personalized settings from the soundbar.

- On the soundbar, press and hold **↶**, **+** and **-** for more than 5 seconds.
  - **“RESET”** is displayed.
  - The soundbar restarts.

---

## 10. SOFTWARE UPDATE

For optimal product performance and your best user experience, JBL may offer software updates for the soundbar system in the future. Please visit [www.jbl.com](http://www.jbl.com) or contact JBL call center to receive more information about downloading update files.

### Updating online



- Connect the soundbar to your home network. Updating online happens automatically if software updates are available.
  - **“WAIT”**: Software updating in progress
  - **“DONE”**: Software updating completed

## Updating through a USB storage device

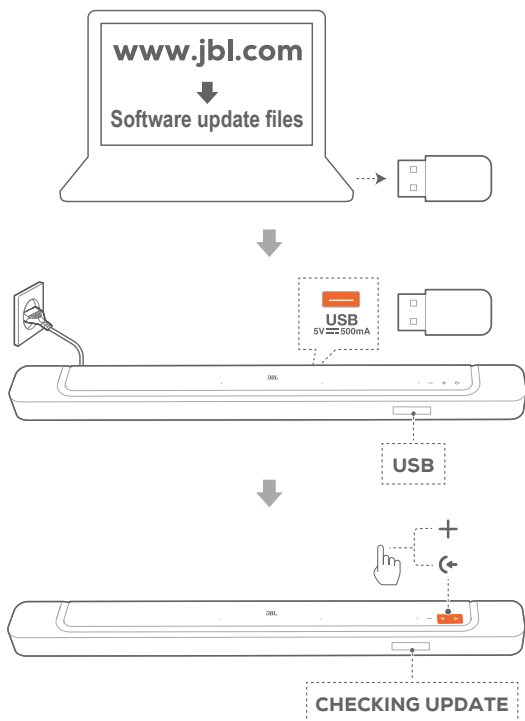

1. Check that you have saved the software update file to the root directory of a USB storage device.
  - Make sure that your USB storage device meets the following requirements:
    - Maximum capacity: 64 GB
    - File system: FAT32
2. Connect the USB device.
  - “USB” is displayed.
3. To enter the software update mode, press and on the soundbar.
  - “CHECKING UPDATE” is displayed.
  - “WAIT”: Software updating in progress
  - “DONE”: Software updating completed

### NOTES:

- Keep the soundbar powered on and the USB storage device mounted before software updating is complete.

## 11. RE-CONNECT THE SUBWOOFER

The soundbar and subwoofer are paired at the factory. After power-on, they are paired and connected automatically. In some special cases, you may need to pair them again.

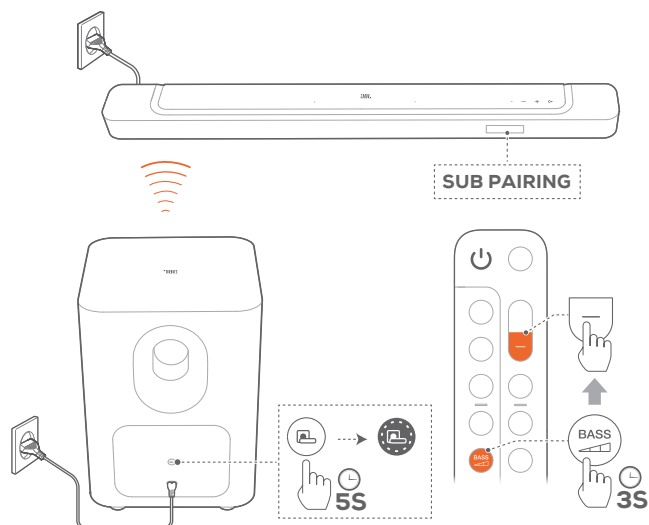

### To re-enter the subwoofer pairing mode

1. On the rear panel of subwoofer, press and hold until it turns fast flashing white.
2. To enter the subwoofer pairing mode on the soundbar, press and hold on the remote control for more than three seconds. Then, press on the remote control.
  - “SUB PAIRING”: The subwoofer is ready for pairing.
  - “SUB PAIRED”: The subwoofer is connected.

### NOTES:

- The subwoofer will exit the pairing mode in three minutes and go to standby, if pairing is not completed. turns from fast flashing white to off. To return to the pairing mode, press .

---

## 12. PRODUCT SPECIFICATIONS

### General specification:

- Model: BAR 500 (soundbar unit)  
BAR 500 SUB (subwoofer unit)
- Sound system: 5.1 channel
- Power supply: 100 - 240V AC, ~ 50/60 Hz
- Total speaker power output (Max @THD 1%): 590W
- Soundbar output power (Max @THD 1%): 290W
- Subwoofer output power (Max. @THD 1%): 300 W
- Soundbar transducer: 4x (46x90)mm racetrack drivers,  
3x 0.75" (20mm) tweeters
- Subwoofer transducer: 10" (260mm)
- Networked standby power: < 2.0 W
- Operating temperature: 0°C - 45°C

### HDMI specification:

- HDMI video input: 1
- HDMI video output (with Enhanced Audio Return Channel, eARC): 1
- HDMI HDCP version: 2.3
- HDR pass through: HDR10, Dolby Vision

### Audio specification:

- Frequency response: 35Hz - 20kHz (-6dB)
- Audio inputs: 1 Optical, Bluetooth, USB (USB playback is available in US version. For other versions, USB is for Service only.)

### USB specification (Audio playback is for US version only):

- USB port: Type A
- USB rating: 5V DC, 0.5A
- Supporting file formats: mp3
- MP3 codec: MPEG 1 Layer 2/3, MPEG 2 Layer 3, MPEG 2.5 Layer 3
- MP3 sampling rate: 16 - 48 kHz
- MP3 bitrate: 80 - 320 kpbs

### Wireless specification:

- Bluetooth version: 5.0
- Bluetooth profile: A2DP 1.2, AVRCP 1.5
- Bluetooth transmitter frequency range: 2400 MHz – 2483.5 MHz
- Bluetooth transmitter power: <15 dBm (EIRP)
- Wi-Fi network: IEEE 802.11 a/b/g/n/ac/ax (2.4GHz/5GHz)
- 2.4G Wi-Fi transmitter frequency range: 2412 - 2472 MHz (2.4 GHz ISM Band, USA 11 Channels, Europe and others 13 Channels)
- 2.4G Wi-Fi transmitter power: <20 dBm (EIRP)
- 5G Wi-Fi transmitter frequency range: 5.15 - 5.35GHz, 5.470 - 5.725GHz, 5.725 - 5.825GHz
- 5G Wi-Fi transmitter power: 5.15 - 5.25GHz <23dBm, 5.25 - 5.35GHz & 5.47 - 5.725GHz <20dBm, 5.725 - 5.825GHz <14dBm (EIRP)

- 2.4G wireless transmitter frequency range: 2406 - 2474 MHz
- 2.4G wireless transmitter power: <10 dBm (EIRP)

### Dimensions

- Soundbar dimensions (W x H x D): 1017 x 56 x 103.5 mm / 40" x 2.2" x 4"
- Subwoofer dimensions (W x H x D): 305 x 440.4 x 305 mm / 12" x 17.3" x 12"
- Soundbar weight: 2.8 kg / 6.2 lbs
- Subwoofer weight: 10 kg / 22 lbs
- Packaging dimensions (W x H x D): 1105 x 370 x 475 mm / 43.5" x 14.6" x 18.7"
- Packaging Weight: 16.2 kg / 35.6 lbs

## 13. TROUBLESHOOTING

Never try to repair the product yourself. If you have problems using this product, check the following points before you request services.

### System

#### The unit will not turn on.

- Check if the power cord is plugged into power and the soundbar.

#### The soundbar has no response to button pressing.

- Restore the soundbar to factory settings (See "[9. RESTORE FACTORY SETTINGS](#)").

### Sound

#### No sound from soundbar

- Make sure that the soundbar is not muted.
- Select the correct audio input source on the remote control.
- Connect the soundbar to your TV or other devices properly
- Restore the soundbar to its factory settings by pressing and holding **⏪**, **+** and **-** on the soundbar for more than 5 seconds.

#### Distorted sound or echo

- If you play audio from your TV through the soundbar, make sure that your TV is muted or the built-in TV speaker is disabled.

#### Audio and video are not synchronized.

- Enable the audio sync function to synchronize audio and video (See "[8.1 Audio sync](#)").

#### No height sound effects of Dolby Atmos

- If your TV supports HDMI ARC only, make sure that you have connected your digital device to the soundbar through the **HDMI IN** connector on the soundbar (See "[5.1.1 TV \(HDMI ARC / eARC\)](#)").
- Enjoy the sound effects of Dolby Atmos when you play movies from the TV / HDMI source. For audio streaming over Bluetooth or casting apps (enabled by Chromecast built-in, AirPlay or Alexa), Dolby Atmos is not supported.

### Bluetooth

#### A device cannot be connected with the soundbar.

- Check if you have enabled Bluetooth on the device.
- If the soundbar has been paired with another Bluetooth device, reset Bluetooth (see "[5.2.3 To connect to another Bluetooth device](#)").
- If your Bluetooth device has ever been paired with the soundbar, reset Bluetooth on the soundbar, unpair the soundbar on the Bluetooth device, and then, pair the Bluetooth device with the soundbar again (see "[5.2.3 To connect to another Bluetooth device](#)").

#### Poor audio quality from a connected Bluetooth device

- The Bluetooth reception is poor. Move the source device closer to the soundbar, or remove any obstacle between the source device and the soundbar.

#### The connected Bluetooth device connects and disconnects constantly.

- The Bluetooth reception is poor. Move the source device closer to the soundbar, or remove any obstacle between the source device and the soundbar.

### Wi-Fi

#### Failed to connect to Wi-Fi.

- Make sure that Wi-Fi is turned on.
- Make sure that you have selected the right network and entered the correct password.
- Make sure that your router or modem is turned on and within the range.
- In your router settings, make sure that you have set the security type to WPA2 or auto.
- Make sure that your soundbar is connected to the same wireless LAN as your smartphone or tablet.
- If you have difficulties in setting up Wi-Fi, hold **+** and **-** on the soundbar until "**SETUP WIFI**" is displayed.

### Playback

#### AirPlay cannot find the soundbar as an AirPlay speaker for music streaming.

- On your Apple device, update the software to the latest version: iOS 13.4 and later, macOS 10.15.4 and later, or tvOS 14.3.
- Make sure that your Apple device has been connected to the same network as the soundbar.
- For a PC running iTunes for Windows, you can stream music from your PC to the soundbar through Bluetooth.

#### Music playback does not work smoothly when the sound source switches from Bluetooth to Chromecast built-in, AirPlay or Alexa.

- The quality of audio casting and playback are dependent on the traffic and coverage of the network that connects the soundbar and your casting devices, such as phones, tablets and PCs.

#### Music playback does not resume when the sound source switches from Bluetooth to TV/HDMI IN, and then back to Bluetooth.

- The music playback in the Bluetooth device stops when the sound source switches from Bluetooth to TV / HDMI IN. When you switch back to the Bluetooth source, start music playback in the Bluetooth device again.

#### The soundbar is in the "Offline" status in the Amazon Alexa app or issues happen to Alexa MRM-related playback.

- To recover the soundbar, restore the soundbar to its factory settings by pressing and holding **⏪**, **+** and **-** for more than 5 seconds.

## Remote control

### The remote control does not work.

- Check if the batteries are drained. If so, replace them with new ones.
- Reduce the distance and angle between the remote control and the main unit.

### Failed to complete the TV remote control learning.

- Check if you are using an infra-red TV remote control. The IR learning is not supported by a Bluetooth TV remote control.

## 14. TRADEMARKS



The Bluetooth® word mark and logos are registered trademarks owned by Bluetooth SIG, Inc. and any use of such marks by HARMAN International Industries, Incorporated is under license. Other trademarks and trade names are those of their respective owners.



The terms HDMI, HDMI High-Definition Multimedia Interface, HDMI trade dress and the HDMI Logos are trademarks or registered trademarks of HDMI Licensing Administrator, Inc.



Wi-Fi CERTIFIED 6™ and the Wi-Fi CERTIFIED 6™ Logo are trademarks of Wi-Fi Alliance®.

COMPATIBLE WITH



Dolby, Dolby Vision, Dolby Atmos, and the double-D symbol are registered trademarks of Dolby Laboratories Licensing Corporation. Manufactured under license from Dolby Laboratories. Confidential unpublished works. Copyright © 2012–2021 Dolby Laboratories. All rights reserved.



Google, Android, Google Play and Chromecast built-in are trademarks of Google LLC.



Use of the Works with Apple badge means that an accessory has been designed to work specifically with the technology identified in the badge and has been certified by the developer to meet Apple performance standards.

Apple, and AirPlay are trademarks of Apple Inc., registered in the U.S. and other countries.

To control this AirPlay 2-enabled speaker, iOS 13.4 or later is required.





Amazon, Alexa, and all related logos are trademarks of Amazon.com, Inc. or its affiliates.



Use your phone, tablet or computer as a remote control for Spotify. Go to [spotify.com/connect](https://spotify.com/connect) to learn how.

The Spotify Software is subject to third party licenses found here: <https://www.spotify.com/connect/third-party-licenses>.

---

## 15. OPEN SOURCE LICENSE NOTICE

This product contains open source software licensed under GPL. For your convenience, the source code and relevant build instruction are also available at [https://harman-webpages.s3.amazonaws.com/JBL\\_BAR\\_Gen3\\_package\\_license\\_list.htm](https://harman-webpages.s3.amazonaws.com/JBL_BAR_Gen3_package_license_list.htm).

Please feel free to contact us at:

Harman Deutschland Gmb

HATT: Open Source, Gregor Krapf-Gunther, Parking 3  
85748 Garching bei Munchen, Germany

or [OpenSourceSupport@Harman.com](mailto:OpenSourceSupport@Harman.com) if you have additional question regarding the open source software in the product.



HARMAN International Industries,  
Incorporated 8500 Balboa Boulevard,  
Northridge, CA 91329 USA  
[www.jbl.com](http://www.jbl.com)

© 2022 HARMAN International Industries, Incorporated.

All rights reserved.

JBL is a trademark of HARMAN International Industries, Incorporated, registered in the United States and/or other countries. Features, specifications and appearance are subject to change without notice.



# QUICK START GUIDE

## BAR 500

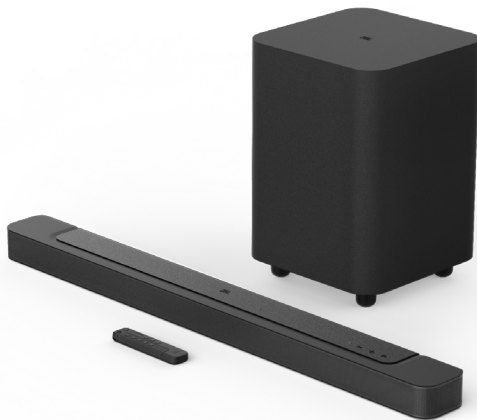





- EN** Before using this product, read the safety sheet carefully.
- FR** Avant d'utiliser ce produit, lisez attentivement la fiche de sécurité.
- DA** Læs sikkerhedsarket omhyggeligt, før du bruger dette produkt.
- DE** Lies vor der Verwendung dieses Produkts das Sicherheitsdatenblatt sorgfältig durch.
- ES** Antes de usar este producto, lee la hoja de seguridad atentamente.
- ES-MX** Antes de usar este producto, lea la hoja de seguridad con atención.
- FI** Lue käyttöturvallisuustiedote huolellisesti ennen tuotteen käyttöä.
- IT** Prima di utilizzare questo prodotto, leggere attentamente la scheda di sicurezza.
- NL** Lees het veiligheidsblad voordat u dit product gebruikt.
- NO** Før du bruker dette produktet, må du lese sikkerhetsbladet nøye.
- PL** Przed użyciem produktu, przeczytaj uważnie arkusz dot. bezpieczeństwa.

- PT** Antes de usar este produto, leia cuidadosamente as instruções de segurança.
- PT-BR** Antes de usar o produto, leia cuidadosamente esta ficha de segurança.
- SK** Pred použitím tohto výrobku si pozorne prečítajte bezpečnostný hárok.
- SV** Läs säkerhetsbladet noggrant innan du använder produkten.
- RU** Перед использованием изделия внимательно прочитайте инструкцию по безопасности.
- ZH-TW** 在使用本產品前，請仔細閱讀安全說明書。
- ID** Sebelum menggunakan produk ini, bacalah lembar panduan keselamatan dengan cermat.
- JP** この製品を使用する前に、安全シートをきちんとお読みください。
- KO** 제품을 사용하기 전에 안전 관련 주의사항을 자세히 읽으십시오.

**AR** قبل استخدام هذا المنتج، اقرأ صحيفة بيانات السلامة بعناية.

**HE** לפני השימוש במוצר זה, קרא בעיון את גיליון הבטיחות.



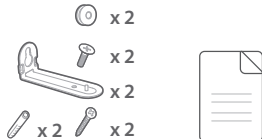
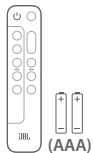
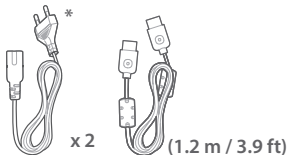

- EN** \* Power cord quantity and plug type vary by regions.
- FR** \* Le nombre de cordons secteur et les types des prises varient selon les régions.
- DA** \* Strømledningens længde og stiktype varierer efter region.
- DE** \* Anzahl und Steckertyp des Netzkabels weichen je nach Region ab.

**ES** \* El número y el tipo de cables de alimentación puede variar según la región.

**ES-MX** \* La cantidad de cables de alimentación y el tipo de enchufe varía según la región.

**FI** \* Virtajohtojen määrä ja liitäntätyyppi vaihtelevat alueittain.

**IT** \* Il numero dei cavi di alimentazione e il tipo di spina variano da regione a regione.

**NL** \* Aantal netsnoeren en type stekker is afhankelijk van de regio.

**NO** \* Antall strømkabler og kontakter varierer mellom områder.

**PL** \* Ilość przewodów zasilających i rodzaj wtyczki różnią się w zależności od regionu.

**PT** \* Os cabos de alimentação e o tipo de tomada variam de região para região.

**PT-BR** \* O cabo de alimentação e o tipo de tomada variam de região para região.

**SK** \* Špecifikácia napájacieho kábla a typ zástrčky sa líšia podľa regiónov.

**SV** \* Antalet strömkablar och kontakttyp varierar i olika regioner

**RU** \* Длина шнура питания и тип вилки зависят от региона.

**ZH-TW** \* 電源線數量 and 插頭類型因區域而異。

**ID** \* Jumlah kabel daya dan jenis steker berbeda-beda tergantung wilayah.

**JP** \* 電源コードの本数とプラグタイプは地域によって異なります。

**KO** \* 전원 코드 수량 및 플러그 유형은 지역별로 다릅니다.

\* تختلف كمية كبل الطاقة ونوع القابس حسب المناطق. **AR**

\* כמות כבלי החשמל וסוג התקע משתנים בהתאם לאזור. **HE**

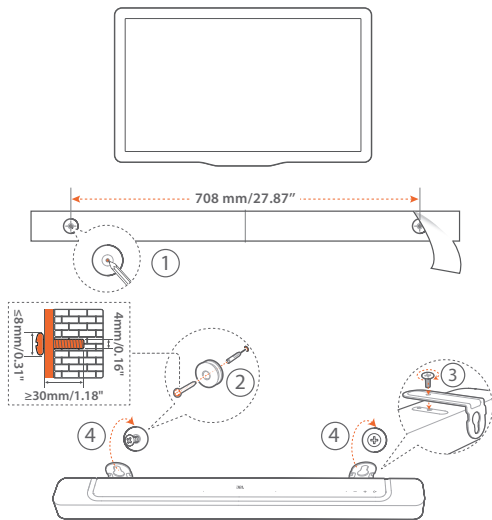
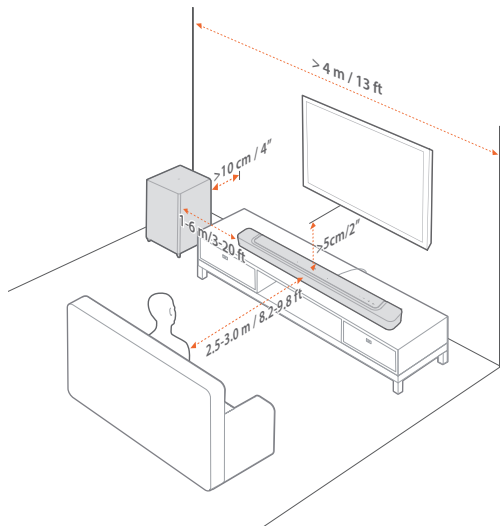



## TV (HDMI ARC)

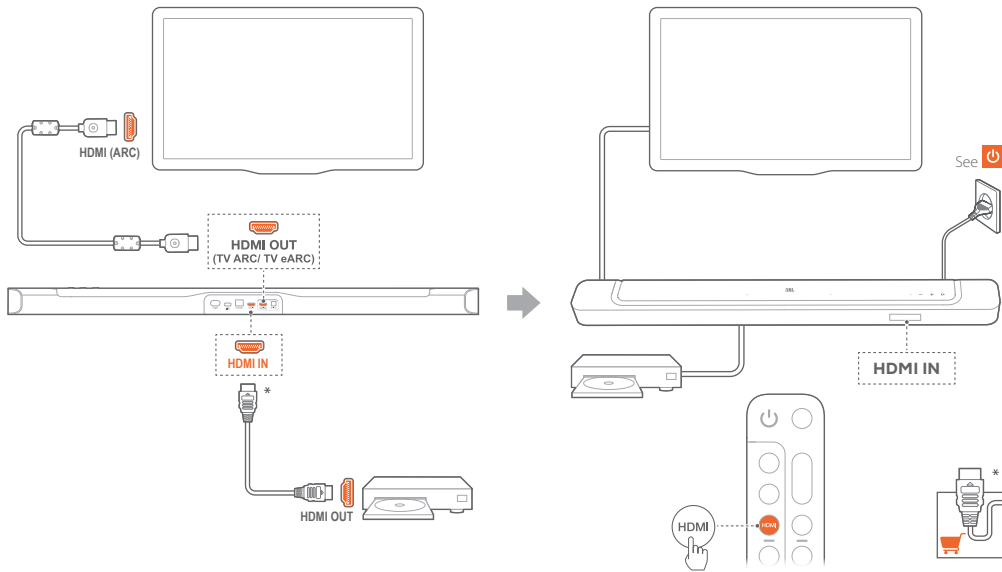





## TV (HDMI eARC)

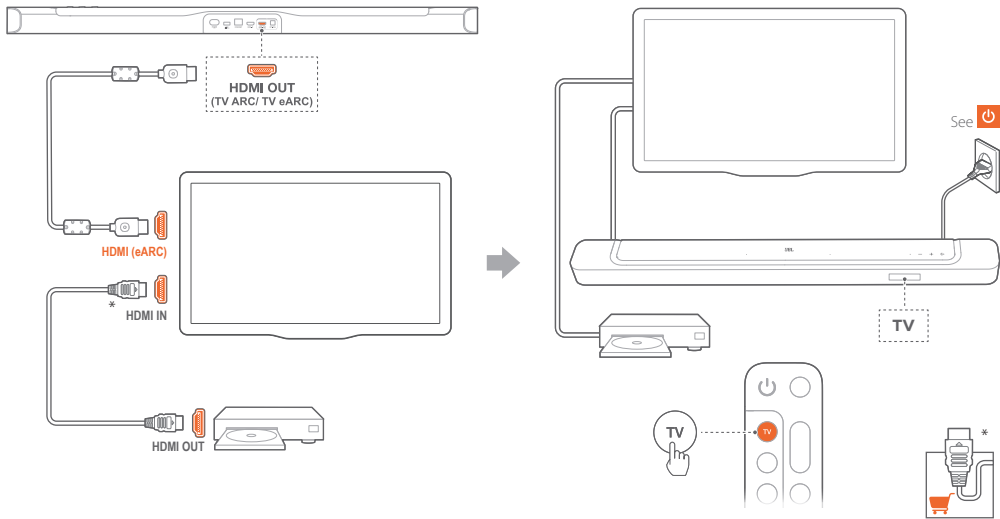

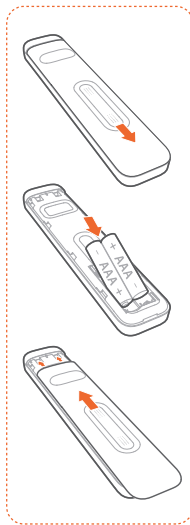
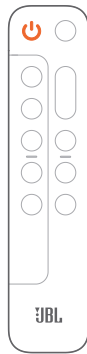
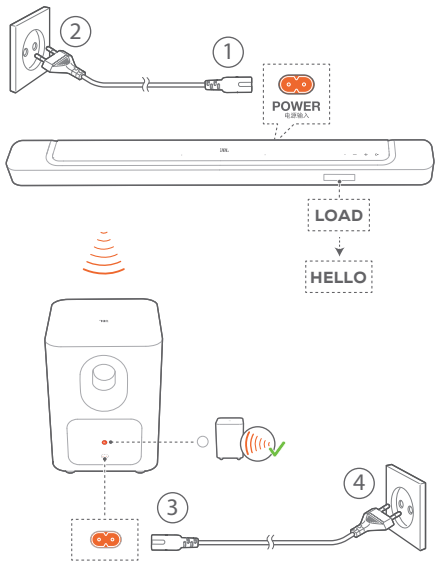



CALIBRATION



PRESS AGAIN TO CONFIRM

CALIBRATING

DONE

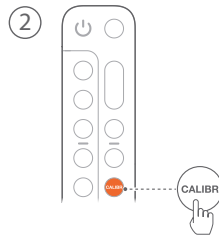
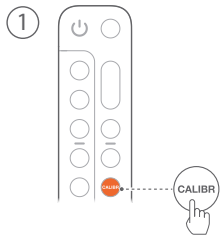

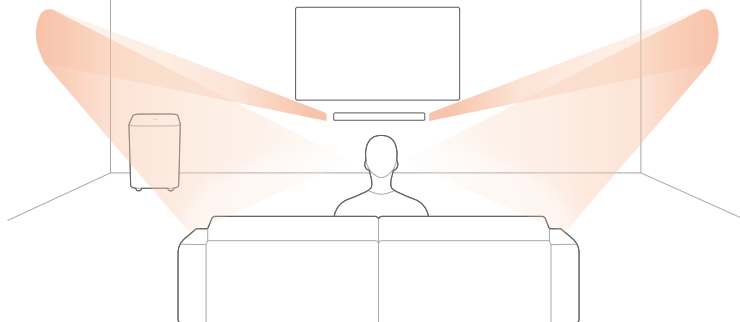

**EN** **Sound Calibration**

Optimize your 3D surround sound experience for your unique listening environment.

**FR** **Étalonnage du son**

Optimisez votre expérience de son surround 3D dans votre environnement d'écoute spécifique.

**DA** **Kalibrering af lyd**

Optimer din 3D-surroundlyd-oplevelse til dit unikke lyttemiljø.

**DE** **Sound-Kalibrierung**

Optimiere das 3D-Surround-Sound-Erlebnis für deine bevorzugte Hörposition.

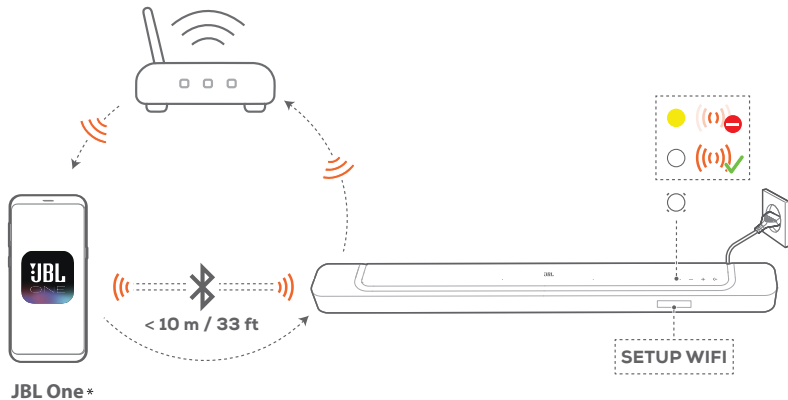

**EN** On an Android™ or iOS device, add the soundbar to your home Wi-Fi network through the JBL One app. Follow the app instructions to complete setup.

\* Some features require subscriptions or services not available in all countries.

**FR** Sur un appareil Android™ ou iOS, ajoutez la barre de son au réseau Wi-Fi de votre domicile via l'application JBL One. Suivez les instructions de l'application pour terminer la configuration.

\* Certaines fonctionnalités nécessitent des abonnements ou des services non disponibles dans tous les pays.

EN

**General specification:**

- Model: BAR 500 (soundbar unit)
- BAR 500 SUB (subwoofer unit)
- Sound system: 5.1 channel
- Power supply: 100 - 240V AC, ~ 50/60Hz
- Total speaker power output (Max @THD 1%): 590W
- Soundbar output power (Max @THD 1%): 290W
- Subwoofer output power (Max @THD 1%): 300W
- Soundbar transducer: 4x (46x90)mm racetrack drivers, 3x 0.75" (20mm) tweeters
- Subwoofer transducer: 10" (260mm)
- Networked standby power: < 2.0 W
- Operating temperature: 0 °C - 45 °C

**HDMI specification**

- HDMI video input: 1
- HDMI video output (with Enhanced Audio Return Channel, eARC): 1
- HDMI HDCP version: 2.3
- HDR pass through: HDR10, Dolby Vision

**Audio specification**

- Frequency response: 35Hz - 20kHz (-6dB)
- Audio inputs: 1 Optical, Bluetooth and USB (For playback is available in US version. For other versions, USB is for Service only)

**USB specification**

- USB port: Type A
- USB rating: 5V DC, 0.5A
- Supporting file formats: mp3
- MP3 codec: MPEG 1 Layer 2/3, MPEG 2 Layer 3, MPEG 2.5 Layer 3
- MP3 sampling rate: 16 - 48 kHz
- MP3 bitrate: 80 - 320 kbps

**Wireless specification**

- Bluetooth version: 5.0
- Bluetooth profile: A2DP 1.2, AVRCP 1.5
- Bluetooth transmitter frequency range: 2400 MHz - 2483.5 MHz
- Bluetooth transmitter power: <15 dBm (EIRP)
- Wi-Fi network: IEEE 802.11 a/b/g/n/ac/ax (2.4GHz/5GHz)
- 2.4G Wi-Fi transmitter frequency range: 2412 - 2472 MHz (2.4 GHz ISM Band, USA 11 Channels, Europe and others 13 Channels)
- 2.4G Wi-Fi transmitter power: < 20 dBm (EIRP)
- 5G Wi-Fi transmitter frequency range: 5.15 - 5.35GHz, 5.470 - 5.725GHz, 5.725 - 5.825GHz
- 5G Wi-Fi transmitter power: 5.15 - 5.25GHz <23dBm, 5.25 - 5.35GHz & 5.470 - 5.725GHz <20dBm, 5.725 - 5.825GHz <14dBm (EIRP)
- 2.4G wireless transmitter frequency range: 2406 - 2474 MHz
- 2.4G wireless transmitter power: <10 dBm (EIRP)

**Dimensions**

- Soundbar dimensions (W x H x D): 1017 x 56 x 103.5 mm / 40" x 2.2" x 4"
- Subwoofer dimensions (W x H x D): 305 x 440.4 x 305 mm / 12" x 17.3" x 12"
- Soundbar weight: 2.8kg / 6.2 lbs
- Subwoofer weight: 10 kg / 22 lbs
- Packaging dimensions (W x H x D): 1105 x 370 x 475 mm / 43.5" x 14.6" x 18.7"
- Packaging Weight: 16.2 kg / 35.6 lbs

FR

**Spécifications générales :**

- Modèle : BAR 500 (unité barre de son)
- BAR 500 SUB (unité caisson de basses)
- Système audio : 5.1 canaux
- Alimentation électrique : 100 - 240 V CA, ~ 50/60 Hz
- Puissance de sortie totale des enceintes (max. à 1 % DHT) : 590 W
- Puissance de sortie de la barre de son (max à 1 % DHT) : 290 W
- Puissance de sortie du caisson de basses (max. à 1 % DHT) : 300 W
- Haut-parleurs de la barre de son : 4 haut-parleurs oblongs (46x90 mm), 3 haut-parleurs hautes fréquences 20 mm (0,75")
- Haut-parleur du caisson de basses : 260 mm (10")
- Consommation en veille réseau : < 2,0 W
- Température de fonctionnement : 0 °C - 45 °C

**Spécification HDMI**

- Entrée vidéo HDMI : 1
- Sortie vidéo HDMI (avec canal de retour audio amélioré (eARC, Enhanced Audio Return Channel)) : 1
- Version HDCP HDMI : 2.3
- Transfert HDR : HDR10, Dolby Vision

**Spécifications audio**

- Réponse en fréquence : 35 Hz - 20 kHz (-6 dB)
- Entrées audio : 1 optique, Bluetooth, USB (la lecture USB est disponible sur la version US. Sur les autres versions, l'USB est réservé au service.)

**Spécification USB**

- Prise USB : Type A
- Caractéristiques USB : 5 V CC, 0,5 A
- Formats de fichiers supportés : mp3
- Codec MP3 : MPEG 1 Layer 2/3, MPEG 2 Layer 3, MPEG 2.5 Layer 3

- Taux d'échantillonnage MP3 : 16 - 48 kHz
- Débit de bits MP3 : 80 - 320 kbit/s

**Spécifications radio**

- Version du Bluetooth : 5.0
- Profils Bluetooth : A2DP 1.2, AVRCP 1.5
- Bande de fréquences de l'émetteur Bluetooth : 2400 MHz - 2483,5 MHz
- Puissance de l'émetteur Bluetooth : < 15 dBm (PIRE)
- Réseau Wi-Fi : IEEE 802.11 a/b/g/n/ac/ax (2,4 GHz / 5 GHz)
- Plage de fréquences de l'émetteur Wi-Fi 2.4G : 2412 - 2472 MHz (bande ISM 2,4 GHz, USA 11 canaux, Europe et autres 13 canaux)
- Puissance de l'émetteur Wi-Fi 2.4G : < 20 dBm (PIRE)
- Plage de fréquences de l'émetteur Wi-Fi 5G : 5,15 - 5,35 GHz, 5,470 - 5,725 GHz, 5,725 - 5,825 GHz
- Puissance de l'émetteur Wi-Fi 5G : 5,15 - 5,25 GHz < 23 dBm, 5,25 - 5,35 GHz et 5,470 - 5,725 GHz < 20 dBm, 5,725 - 5,825 GHz < 14 dBm (PIRE)
- Gamme de fréquence de l'émetteur sans fil 2.4G : 2 406 - 2 474 MHz
- Puissance de l'émetteur sans fil 2.4G : < 10 dBm (PIRE)

**Dimensions**

- Dimensions de la barre de son (L x H x P) : 1017 x 56 x 103,5 mm / 40" x 2,2" x 4"
- Dimensions du caisson de basses (L x H x P) : 305 x 440,4 x 305 mm / 12" x 17,3" x 12"
- Poids de la barre de son : 2,8 kg / 6,2 lbs
- Poids du caisson de basses : 10 kg / 22 lbs
- Dimensions de l'emballage (L x H x P) : 1105 x 370 x 475 mm / 43,5" x 14,6" x 18,7"
- Poids emballé : 16,2 kg / 35,6 lbs

**EN**

## 1. Information on power consumption

This equipment complies with European Commission Regulation (EC) No 1275/2008 and (EU) No 801/2013.

- Off: N/A
- Standby (when all wireless connections are deactivated): < 0.5 W
- Networked standby for Soundbar: < 2.0 W

## 2. The period of time after which the power management function switches the equipment automatically into:

Off	N/A	
Standby	When all wired ports are disconnected and all wireless network connections are deactivated	Switched to standby mode after 10 minutes.
Networked standby	When any wireless network connection is activated	Switched to networked standby mode after 10 minutes of inactivity in operational mode

## 3. If this equipment has the wireless network connections:

How to activate wireless network connections:

- Set up the equipment properly;
- Switch into wireless mode (Bluetooth, Chromecast built-in™, AirPlay 2 casting audio, Alexa Multi-Room Music & etc);
- Connect with energy using products (e.g. players/ game consoles/ STB (Set-Top Boxes)/ phones/ tablets /PCs).

How to deactivate wireless network connections:

- Press and hold  on the remote control for more than 5 seconds firstly;
- Then long press  on the remote control for more than 5 seconds.

**FR**

## 1. Informations sur la consommation électrique

L'équipement est conforme au règlement de la Commission européenne (CE) n° 1275/2008 et (UE) n° 801/2013.

- Off : S. O.
- Veille (lorsque toutes les connexions sans fil sont désactivées) : < 0,5 W
- Veille en réseau pour la barre de son : < 2,0 W

## 2. La durée après laquelle la fonction de gestion de l'énergie commute automatiquement l'équipement dans l'état :

Éteint	S. O.	
Veille	Lorsque tous les ports câblés sont déconnectés et que toutes les connexions réseau sans fil sont désactivées.	Mise en veille après 10 minutes.



Veille en réseau	Lorsqu'une connexion réseau sans fil est activée.	Passage en veille en réseau après 10 minutes d'inactivité en état opérationnel.
------------------	---	---

## 3. Si cet équipement a des connexions réseau sans fil :

Activation des connexions réseau sans fil :

- Installez l'équipement correctement ;
- Sélectionnez un mode sans fil (Bluetooth, Chromecast built-in™, diffusion audio AirPlay 2, Alexa MultiRoom Musique et autres) ;
- Connectez-vous avec les produits consommateurs d'énergie (par ex. lecteurs / consoles de jeux / récepteurs/décodeurs / téléphones / tablettes / PCs).

Désactivation des connexions réseau sans fil :

- Appuyez d'abord pendant plus de 5 secondes sur  de la télécommande ;
- Appuyez ensuite pendant plus de 5 secondes sur  de la télécommande.

**DA**

## 1. Oplysninger om strømforbrug

Dette udstyr er i overensstemmelse med Europa-Kommissionens forordning (EF) nr.1275/2008 og (EU) Nr. 801/2013.

- Slukket: Ikke relevant
- Standby (når alle trådløse forbindelser er deaktiveret): < 0,5 W
- Netværksstandby for Soundbar: < 2,0 W

## 2. Den periode, hvorefter strømstyringsfunktionen automatisk skifter udstyret til:



Slukket	Ikke relevant	
Standby	Når alle kabelforbundne porte er frakoblet, og alle trådløse netværksforbindelser er deaktiveret	Skiftede til standby efter 10 minutter.
Netværksstandby	Når enhver trådløs netværksforbindelse er aktiveret	Skiftede til netværksstandbytilstand efter 10 minutters inaktivitet i driftstilstand

## 3. Hvis dette udstyr har de trådløse netværksforbindelser:

Sådan aktiveres trådløse netværksforbindelser:

- Sæt udstyret korrekt op.
- Skift til trådløs tilstand (Bluetooth, Chromecast built-in™, AirPlay 2 casting audio, Alexa Multi-Room Music & etc);
- Opret forbindelse til energiforbrugende produkter (fx afspillere / spillkonsoller / tv-bokse / telefoner / tablets / pc'er).



Sådan deaktiveres trådløse netværksforbindelser:

- Tryk og hold  på fjernbetjeningen i mere end 5 sekunder først;
- Hold derefter  inde på fjernbetjeningen i mere end 5 sekunder.

FCC RF Radiation Exposure Statement Caution: To maintain compliance with the FCC's RF exposure guidelines, place the product at least 20cm from nearby persons.

Cet équipement est conforme aux limites d'exposition aux radiations FCC/ IC CNR-102 établies pour un environnement non contrôlé. Cet équipement doit être installé et utilisé avec une distance minimale de 20 cm entre le radiateur et votre corps.

**Use Restriction:** This device is restricted to indoor use when operating in the 5150 to 5350 MHz frequency range in following countries:

	BE	EL	LT	PT	
	BG	ES	LU	RO	
	CZ	FR	HU	SI	UK
	DK	HR	MT	SK	
	DE	IT	NL	FI	
	EE	CY	AT	SE	
	IE	LV	PL	UK(NI)	

Belgium (BE), Greece (EL), Lithuania (LT), Portugal (PT), Bulgaria (BG), Spain (ES), Luxembourg (LU), Romania (RO), Czech Republic (CZ), France (FR), Hungary (HU), Slovenia (SI), Denmark (DK), Croatia (HR), Malta (MT), Slovakia (SK), Germany (DE), Italy (IT), Netherlands (NL), Finland (FI), Estonia (EE), Cyprus (CY), Austria (AT), Sweden (SE), Ireland (IE), Latvia (LV), Poland (PL) and Northern Ireland (UK).

This product contains open source software licensed under GPL. For your convenience, the source code and relevant build instruction are also available at [https://harman-webpages.s3.amazonaws.com/JBL\\_BAR\\_Gen3\\_package\\_license\\_list.htm](https://harman-webpages.s3.amazonaws.com/JBL_BAR_Gen3_package_license_list.htm)

Please feel free to contact us at:

Harman Deutschland GmbH

ATT: Open Source, Gregor Krapf-Gunther, Parking 3

85748 Garching bei Munchen, Germany

or [OpenSourceSupport@Harman.com](mailto:OpenSourceSupport@Harman.com) if you have additional question regarding the open source software in the product.





The Bluetooth® word mark and logos are registered trademarks owned by Bluetooth SIG, Inc. and any use of such marks by HARMAN International Industries, Incorporated is under license. Other trademarks and trade names are those of their respective owners.



The terms HDMI, HDMI High-Definition Multimedia Interface, HDMI trade dress and the HDMI Logos are trademarks or registered trademarks of HDMI Licensing Administrator, Inc.



Wi-Fi CERTIFIED 6™ and the Wi-Fi CERTIFIED 6™ Logo are trademarks of Wi-Fi Alliance®.

COMPATIBLE WITH



Dolby, Dolby Vision, Dolby Atmos, and the double-D symbol are registered trademarks of Dolby Laboratories Licensing Corporation. Manufactured under license from Dolby Laboratories. Confidential unpublished works. Copyright © 2012–2021 Dolby Laboratories. All rights reserved.



Google, Android, Google Play and Chromecast built-in are trademarks of Google LLC.



Use of the Works with Apple badge means that an accessory has been designed to work specifically with the technology identified in the badge and has been certified by the developer to meet Apple performance standards. Apple, and AirPlay are trademarks of Apple Inc., registered in the U.S. and other countries.

To control this AirPlay 2-enabled speaker, iOS 13.4 or later is required.



Amazon, Alexa, and all related marks are trademarks of Amazon.com, Inc. or its affiliates.



Use your phone, tablet or computer as a remote control for Spotify. Go to [spotify.com/connect](https://spotify.com/connect) to learn how. The Spotify Software is subject to third party licenses found here: <https://www.spotify.com/connect/third-party-licenses>.



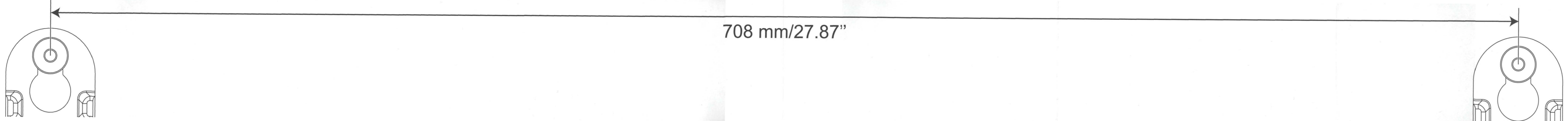

708 mm/27.87"



BAR500-WALL-V1



## Safety Instruction and Warranty Card

### PRODUCT REGISTRATION

[register.jbl.com](http://register.jbl.com)

---

#### SIGN UP & STAY TUNED

Register your product • Registriere dein produkt • Registro del producto •  
Enregistrez votre produit • Registro de Produto • 製品登録 •  
Registrer dit produkt • Rekisteröl tuotteesi • Rejestracja produktu •  
Registrera din produkt • Registreer je product

---

\*Product registration may not be available for all countries



SCAN ME



### ENGLISH

Download the full warranty Card and safety information and other helpful information from our website: [www.jbl.com/warrantyandsafetybooks](http://www.jbl.com/warrantyandsafetybooks)

### ČEŠTINA

Úplný záruční list, bezpečnostní pokyny a další užitečné informace lze stáhnout z našeho webu: [www.jbl.com/warrantyandsafetybooks](http://www.jbl.com/warrantyandsafetybooks)

### DANSK

Hent det komplette garantiark og sikkerhedsoplysninger og andre nyttige oplysninger fra vores hjemmeside: [www.jbl.com/warrantyandsafetybooks](http://www.jbl.com/warrantyandsafetybooks)

### DEUTSCH

Lade die vollständige Garantiekarte und Sicherheitsinformationen sowie weitere hilfreiche Informationen von unserer Website herunter: [www.jbl.com/warrantyandsafetybooks](http://www.jbl.com/warrantyandsafetybooks)

### EESTI

Laadige alla täielik garantiikaart, ohutusteave ja muu kasulik teave meie veebisaidilt: [www.jbl.com/warrantyandsafetybooks](http://www.jbl.com/warrantyandsafetybooks)

### ΕΛΛΗΝΙΚΑ

Κατεβάστε την πλήρη κάρτα εγγύησης και πληροφορίες ασφαλείας και άλλες χρήσιμες πληροφορίες από τον ιστότοπό μας: [www.jbl.com/warrantyandsafetybooks](http://www.jbl.com/warrantyandsafetybooks)

### ESPAÑOL

Descarga la tarjeta de garantía completa, la información de seguridad y otra información útil de nuestro sitio web: [www.jbl.com/warrantyandsafetybooks](http://www.jbl.com/warrantyandsafetybooks)

### SUOMI

Lataa täydellinen takuukortti ja turvallisuustiedot, sekä muut hyödylliset tiedot verkkosivuiltamme: [www.jbl.com/warrantyandsafetybooks](http://www.jbl.com/warrantyandsafetybooks)

### FRANÇAIS

Téléchargez la carte de garantie et les informations de sécurité complètes ainsi que d'autres informations utiles sur notre site Web : [www.jbl.com/warrantyandsafetybooks](http://www.jbl.com/warrantyandsafetybooks)

### HRVATSKI

Preuzmite punu jamstvenu karticu, sigurnosne informacije i ostale korisne informacije s našeg web mjesta: [www.jbl.com/warrantyandsafetybooks](http://www.jbl.com/warrantyandsafetybooks)

### MAGYAR

Töltse le a teljes garanciakártyát, a biztonsági információkat és egyéb hasznos információkat a weboldalunkról: [www.jbl.com/warrantyandsafetybooks](http://www.jbl.com/warrantyandsafetybooks)

### ITALIANO

Scarica la scheda di garanzia completa, le informazioni sulla sicurezza e altre informazioni utili dal nostro sito Web: [www.jbl.com/warrantyandsafetybooks](http://www.jbl.com/warrantyandsafetybooks)

### LIETUVIŲ KALBA

Atsisiųskite visą garantijos kortelę ir saugos informaciją bei kitą naudingą informaciją iš mūsų svetainės: [www.jbl.com/warrantyandsafetybooks](http://www.jbl.com/warrantyandsafetybooks)

### LATVISKI

Lejupielādējiet pilnu garantijas karti, informāciju par drošību un citu noderīgu informāciju mūsu vietnē: [www.jbl.com/warrantyandsafetybooks](http://www.jbl.com/warrantyandsafetybooks)

### NEDERLANDS

Download de volledige garantiekaart en veiligheidsinformatie en andere nuttige informatie van onze website: [www.jbl.com/warrantyandsafetybooks](http://www.jbl.com/warrantyandsafetybooks)

### NORSK

Last ned det komplette garantikortet, sikkerhetsinformasjon og annen nyttig informasjon fra nettstedet vårt: [www.jbl.com/warrantyandsafetybooks](http://www.jbl.com/warrantyandsafetybooks)

### POLSKI

Prosimy pobrać kartę gwarancyjną, informację o bezpieczeństwie oraz inne przydatne informacje z naszej strony internetowej: [www.jbl.com/warrantyandsafetybooks](http://www.jbl.com/warrantyandsafetybooks)

### PORTUGUÊS

Descarregue por completo o Cartão de garantia e informações de segurança e outras informações úteis no nosso site: [www.jbl.com/warrantyandsafetybooks](http://www.jbl.com/warrantyandsafetybooks)

### PORTUGUÊS (BRASIL)

O Cartão de Garantia, informações de segurança e outras informações úteis estão disponíveis no site [www.jbl.com/warrantyandsafetybooks](http://www.jbl.com/warrantyandsafetybooks)

### ROMÂNĂ

Descărcați fișa completă de garanție, informații de siguranță și alte informații de ajutor de pe site-ul web: [www.jbl.com/warrantyandsafetybooks](http://www.jbl.com/warrantyandsafetybooks)

### SLOVENŠČINA

Prenesite celoten garancijski list in varnostne informacije ter druge koristne napotke z naše spletne strani: [www.jbl.com/warrantyandsafetybooks](http://www.jbl.com/warrantyandsafetybooks)

### SVENSKA

Ladda ner hela garantikortet och säkerhetsinformation och annan användbar information från vår webbplats: [www.jbl.com/warrantyandsafetybooks](http://www.jbl.com/warrantyandsafetybooks)

### TÜRKÇE

Komple garanti kartını ve güvenlik bilgilerini ve yardımcı bilgileri websitemizden indirin: [www.jbl.com/warrantyandsafetybooks](http://www.jbl.com/warrantyandsafetybooks)

### БЪЛГАРСКИ

Изтеглете пълната гаранционна карта и информация за безопасност и друга полезна информация от нашия уебсайт: [www.jbl.com/warrantyandsafetybooks](http://www.jbl.com/warrantyandsafetybooks)

### РУССКИЙ

Загрузите полностью гарантийный талон, информацию по технике безопасности и другую полезную информацию с нашего веб-сайта: [www.jbl.com/warrantyandsafetybooks](http://www.jbl.com/warrantyandsafetybooks)

### 简体中文

请登录我公司网站下载完整的保修卡和安全信息及其他有用信息: [www.jbl.com/warrantyandsafetybooks](http://www.jbl.com/warrantyandsafetybooks)

### 繁體中文

從我們的網站下載完整的保固卡和安全資訊及其他有用資訊: [www.jbl.com/warrantyandsafetybooks](http://www.jbl.com/warrantyandsafetybooks)

### 日本語

下記のウェブサイトから保証書、安全情報、その他の役立つ情報をダウンロードしてください: [www.jbl.com/warrantyandsafetybooks](http://www.jbl.com/warrantyandsafetybooks)

### 한국어

전체 품질보증서와 안전 정보를 비롯해 기타 유용한 정보를 다음 당사 웹사이트에서 다운로드하십시오. [www.jbl.com/warrantyandsafetybooks](http://www.jbl.com/warrantyandsafetybooks)

### العربية

قم بتنزيل بطاقة الضمان الكاملة ومعلومات السلامة وغيرها من المعلومات المفيدة عن على موقعنا على الإنترنت: [www.jbl.com/warrantyandsafetybooks](http://www.jbl.com/warrantyandsafetybooks)

### עברית

ניתן להוריד את הנוסח המלא של תעודת האחריות ומידע בנושא בטיחות, כמו גם מידע שימושי נוסף, מאתר האינטרנט שלנו: [www.jbl.com/warrantyandsafetybooks](http://www.jbl.com/warrantyandsafetybooks)





## ENGLISH

### IMPORTANT SAFETY INSTRUCTIONS

#### For all products:



1. Read these instructions.
2. Keep these instructions.
3. Heed all warnings.
4. Follow all instructions.
5. Clean only with a dry cloth.
6. Do not block any ventilation openings. Install this apparatus in accordance with the manufacturer's instructions.
7. Do not install this apparatus near any heat sources such as radiators, heat registers, stoves or other apparatus (including amplifiers) that produce heat.
8. Do not defeat the safety purpose of the polarized or grounding-type plug. A polarized plug has two blades with one wider than the other. A grounding-type plug has two blades and a third grounding prong. The wide blade or the third prong is provided for your safety. If the provided plug does not fit into your outlet, consult an electrician for replacement of the obsolete outlet.
9. Protect the power cord from being walked on or pinched, particularly at plugs, convenience receptacles and the point where they exit from the apparatus.
10. Use only attachments/accessories specified by the manufacturer.
11. Use only with the cart, stand, tripod, bracket or table specified by the manufacturer or sold with the apparatus. When a cart is used, use caution when moving the cart/apparatus combination to avoid injury from tip-over.
12. Unplug this apparatus during lightning storms or when unused for long periods of time.
13. Refer all servicing to qualified service personnel. Servicing is required when the apparatus has been damaged in any way, such as when the power-supply cord or plug is damaged, liquid has been spilled or objects have fallen into the apparatus, or the apparatus has been exposed to rain or moisture, does not operate normally or has been dropped.
14. To disconnect this apparatus from the AC mains completely, disconnect the power-supply cord plug from the AC receptacle.
15. The mains plug of the power-supply cord shall remain readily operable.
16. This apparatus is intended to be used only with the power supply and/or charging cable provided by the manufacturer.



The following instructions may not apply to waterproof devices. Refer to your device user manual or quick start guide for more waterproof instruction if any.

- Do not use this apparatus near water.
- Do not expose this apparatus to dripping or splashing, and ensure that no objects filled with liquids, such as vases, are placed on the apparatus.

**WARNING: TO REDUCE THE RISK OF FIRE OR ELECTRIC SHOCK, DO NOT EXPOSE THIS APPARATUS TO RAIN OR MOISTURE.**

CAUTION	
RISK OF ELECTRIC SHOCK. DO NOT OPEN.	
	THIS SYMBOL ON THE PRODUCT MEANS THERE IS UNINSULATED, DANGEROUS VOLTAGE WITHIN THE PRODUCT ENCLOSURE THAT MAY PRESENT A RISK OF ELECTRICAL SHOCK.
	THIS SYMBOL ON THE PRODUCT MEANS THERE ARE IMPORTANT OPERATING AND MAINTENANCE INSTRUCTIONS IN THIS GUIDE.

**CAUTION FCC AND IC STATEMENT FOR USERS (USA AND CANADA ONLY)**  
This device complies with part 15 of the FCC Rules. Operation is subject to the following two conditions: (1) This device may not cause harmful interference, and (2) this device must accept any interference received, including interference that may cause undesired operation.  
CAN ICES-3(B)/NMB-3(B)

#### FCC SDOC SUPPLIER'S DECLARATION OF CONFORMITY

HARMAN International hereby declares that this equipment is in compliance with the FCC Part 15 Subpart B.

The declaration of conformity may be consulted in the support section of our Web site, accessible from [www.jbl.com](http://www.jbl.com)

#### Federal Communication Commission Interference Statement

This equipment has been tested and found to comply with the limits for a Class B digital device, pursuant to Part 15 of the FCC Rules. These limits are designed to provide reasonable protection against harmful interference in a residential installation. This equipment generates, uses and can radiate radio frequency energy and, if not installed and used in accordance with the instructions, may cause harmful interference to radio communications. However, there is no guarantee that interference will not occur in a particular installation. If this equipment does cause harmful interference to radio or

television reception, which can be determined by turning the equipment off and on, the user is encouraged to try to correct the interference by one or more of the following measures:

- Reorient or relocate the receiving antenna.
- Increase the separation between the equipment and receiver.
- Connect the equipment into an outlet on a circuit different from that to which the receiver is connected.
- Consult the dealer or an experienced radio/TV technician for help.

**Caution:** Changes or modifications not expressly approved by HARMAN could void the user's authority to operate the equipment.

#### For Products That Transmit RF Energy:

##### (i) FCC AND IC INFORMATION FOR USERS

This device complies with Part 15 of the FCC rules and Industry Canada license-exempt RSS standard(s). Operation is subject to the following two conditions: (1) This device may not cause harmful interference; and (2) this device must accept any interference received, including interference that may cause undesired operation.

##### (ii) FCC/IC Radiation Exposure Statement

This equipment complies with FCC and ICSE radiation exposure limits set forth for an uncontrolled environment.

In case this equipment has to be subject to FCC/IC SAR (Specific Absorption Rate) exposure test, this equipment is designed to meet the requirements for exposure to radio waves established by the FCC and ICSE. These requirements set a SAR limit of 1.6 W/kg averaged over one gram of tissue. The highest SAR value reported under this standard during product certification for use when properly worn on the body or on the head, with no separation. To meet RF exposure guidelines and reduce exposure to RF energy during the operation, this equipment should be positioned at least this distance away from the body or the head.

#### For radio equipment operates in 5150-5850MHz

##### FCC and IC Caution:

High power radars are allocated as primary users of the 5.25 to 5.35 GHz and 5.65 to 5.85 GHz bands. These radar stations can cause interference with and/or damage to LE LAN (Licence-Exempt Local Area Network) devices. No configuration controls are provided for this wireless equipment allowing any change in the frequency of operations outside the FCC grant of authorization for US operation according to Part 15.407 of the FCC rules.

#### IC Caution:

User should also be advised that:

- (i) The device for operation in the band 5150 - 5250 MHz is only for indoor use to reduce the potential for harmful interference to co-channel mobile satellite systems; (ii) the maximum antenna gain permitted for devices in the bands 5250 - 5350 MHz and 5470 - 5725 MHz shall comply with the e.i.r.p. limit; and
- (ii) The maximum antenna gain permitted for devices in the band 5725 - 5825 MHz shall comply with the e.i.r.p. limits specified for point-to-point and non point-to-point operation as appropriate.

Use Restriction Attention in European Union, operation is limited to indoor use within the band 5150-5350 MHz.

#### Correct disposal of this product (Waste Electrical & Electronic Equipment)

This symbol means the product must not be discarded as household waste, and should be delivered to an appropriate collection facility for recycling. Proper disposal and recycling helps protect natural resources, human health and the environment. For more information on disposal and recycling of this product, contact your local municipality, disposal service, or the shop where you bought this product.



#### This product is RoHS compliant.

This product is in compliance with Directive 2011/65/EU, and its amendments, on the restriction of the use of certain hazardous substances in electrical and electronic equipment.

#### REACH

REACH (Regulation No 1907/2006) addresses the production and use of chemical substances and their potential impacts on human health and the environment. Article 33(1) of REACH Regulation requires suppliers to inform the recipients if an article contains more than 0.1 % (per weight per article) of any substance(s) on the Substances of Very High Concern (SVHC) Candidate List ("REACH candidate list"). This product contains the substance "lead" (CAS-No. 7439-92-1) in a concentration of more than 0.1% per weight.

At the time of release of this product, except for the lead substance, no other substances of REACH candidate list are contained in a concentration of more than 0.1% per weight in this product.

Note: On June 27, 2018, lead was added to the REACH candidate list. The inclusion of lead in the REACH candidate list does not mean that lead-containing materials pose an immediate risk or results in a restriction of permissibility of its use.

## For devices with headphone jacks

### WARNINGS/CAUTIONS



Do NOT use the headphones at a high volume for any extended period.

- To avoid hearing damage, use your headphones at a comfortable, moderate volume level.

- Turn the volume down on your device before placing the headphones on your ears, then turn the volume up gradually until you reach a comfortable listening level.

## For Products That Include Batteries

### Instructions for Users on Removal, Recycling and Disposal of Used Batteries

To remove the batteries from your equipment or remote control, reverse the procedure described in the owner's manual for inserting batteries. For products with a built-in battery that lasts for the lifetime of the product, removal may not be possible for the user. In this case, recycling or recovery centers handle the dismantling of the product and the removal of the battery. If, for any reason, it becomes necessary to replace such a battery, this procedure must be performed by authorized service centers. In the European Union and other locations, it is illegal to dispose of any battery with household trash. All batteries must be disposed of in an environmentally sound manner. Contact your local waste-management officials for information regarding the environmentally sound collection, recycling and disposal of used batteries.

**WARNING:** Danger of explosion if battery is incorrectly replaced. To reduce risk of fire, explosion or leakage of flammable liquid/gas, don't disassemble, crush, puncture, short external contacts, expose to temperature above 60°C (140°F), sunshine or like, expose to extremely low air pressure or dispose of in fire or water. Replace only with specified batteries. The symbol indicating 'separate collection' for all batteries and accumulators shall be the crossed-out wheeled bin shown below:



## WARNING - For Products Contain Coin/Button Cell Batteries

DO NOT INGEST BATTERY, CHEMICAL BURN HAZARD. This product contains a coin/button cell battery. If the coin/button cell battery is swallowed, it can cause severe internal burns in just 2 hours and can lead to death. Keep new and used batteries away from children. If the battery compartment does not close securely, stop using the product and keep it away from children. If you think batteries might have been swallowed or placed inside any part of the body, seek immediate medical attention.

### For All Products with Wireless Operation:

HARMAN International hereby declares that this equipment is in compliance with the essential requirements and other relevant provisions of Directive 2014/53/EU. The declaration of conformity may be consulted in the support section of our Web site, accessible from [www.jbl.com](http://www.jbl.com).

HARMAN International Industries, Incorporated. All rights reserved. JBL is a trademark of HARMAN International Industries, Incorporated, registered in the United States and/or other countries. Features, specifications and appearance are subject to change without notice.



[www.jbl.com](http://www.jbl.com)

## ČEŠTINA

### DŮLEŽITÉ BEZPEČNOSTNÍ POKYNY

#### U všech výrobků:

1. Přečtěte si tyto pokyny.
2. Tyto pokyny si uschovejte.
3. Respektujte všechna varování.
4. Postupujte podle všech pokynů.
5. Čistěte pouze suchým hadříkem.
6. Neblokujte žádné větrací otvory. Instalaci spotřebiče provádějte podle pokynů výrobce.
7. Spotřebič neinstalujte v blízkosti zdrojů tepla, jako jsou radiátory, tepelné registry, kamna nebo jiná zařízení (včetně zesilovačů), které produkují teplo.
8. Nemaňte bezpečnostní účel polarizované nebo uzemněné zástrčky. Polarizovaná zástrčka je opatřena dvěma plochými kontakty, kdy jeden je širší než druhý. Uzemňovací zástrčka má dva ploché kontakty a třetí uzemňovací kolík. Pro vaši bezpečnost je k dispozici široký kontakt nebo třetí kolík. Pokud dodaná zástrčka nezapadá do vaší zásuvky, požádejte elektrikáře o výměnu zastaralé zásuvky.
9. Napájecí kabel chraňte před pošlapáním nebo skřípnutím, zejména v okolí zástrček, zásuvek a na místech, kde vystupují ze zařízení.
10. Používejte pouze příslušenství/doplňky určené výrobcem.
11. Používejte pouze vozíky, podstavce, stativy, držáky či stoly doporučené výrobcem nebo prodávané se zařízením. Při používání vozíku buďte opatrní při přemísťování kombinace vozíku/přístroje, abyste zabránili poranění převrácením.
12. Odpojte přístroj během bouřek nebo po dlouhé době nečinnosti.
13. Veškeré opravy může provádět pouze kvalifikovaný servis. Pokud byl přístroj jakýmkoli způsobem poškozen, například když je poškozen napájecí kabel nebo zástrčka, došlo k rozlítí kapaliny nebo do přístroje spadly předměty, přístroj byl vystaven dešti nebo vlhkosti, nefunguje normálně nebo byl upuštěn, je vyžadována údržba.
14. Chcete-li spotřebič zcela odpojit od sítě, odpojte zástrčku napájecího kabelu ze zásuvky.
15. Síťová zástrčka napájecího kabelu musí zůstat snadno funkční.
16. Spotřebič je určen k použití pouze s napájecím a/nebo nabíjecím kabelem poskytnutým výrobcem.



Následující pokyny se nemusí vztahovat na vodotěsná zařízení. Další případné pokyny ohledně vodotěsnosti najdete v návodu k použití zařízení nebo ve stručné příručce.

- Přístroj nepoužívejte v blízkosti vody.
- Přístroj nevystavujte kapající nebo stříkající vodě a zajistěte, abyste na něj nepokládali žádné předměty naplněné kapalinami, například vázy.

**VÝSTRAHA:** CHCETE-LI SNÍŽIT RIZIKO POŽÁRU NEBO ÚRAZU ELEKTRICKÝM PROUDEM, NEVYSTAVUJTE SPOTŘEBIČ DEŠTI NEBO VLHKU.

## VÝSTRAHA

### NEBEZPEČÍ ÚRAZU ELEKTRICKÝM PROUDEM. NEOTEVÍRAT.



TENTO SYMBOL NA VÝROBKU ZNAMENÁ, ŽE UVNITŘ KRYTU VÝROBKU JE NEIZOLOVANÉ NEBEZPEČNÉ NAPĚTÍ, KTERÉ MŮŽE PŘEDSTAVOVAT RIZIKO ÚRAZU ELEKTRICKÝM PROUDEM.



TENTO SYMBOL NA VÝROBKU ZNAMENÁ, ŽE JSOU V TOMTO NÁVODU DŮLEŽITÉ POKYNY O PROVOZU A ÚDRŽBĚ.

### UPOZORNĚNÍ A PROHLÁŠENÍ FCC A IC PRO UŽIVATELE (POUZE USA A KANADA)

Toto zařízení vyhovuje části 15 předpisů FCC. Provoz zařízení podléhá následujícím dvěma podmínkám: (1) Toto zařízení nesmí způsobovat škodlivé rušení a (2) toto zařízení musí snést jakékoli vnější rušení, včetně rušené způsobujícího nesprávnou funkci.

CAN ICES-3(B)/NMB-3(B)

### PROHLÁŠENÍ O SHODĚ DODAVATELE FCC SDOC

Společnost HARMAN International tímto prohlašuje, že je toto zařízení ve shodě s částí 15, hlavou B předpisů FCC.

Prohlášení o shodě je k dispozici v sekci podpory na našem webu, která je přístupná na adrese [www.jbl.com](http://www.jbl.com)

### Prohlášení o rušení federální komise pro spoje

Toto zařízení bylo testováno a shledáno vyhovujícím v souladu s omezeními pro digitální zařízení třídy B podle části 15 předpisů komise FCC. Tato omezení jsou navržena s úmyslem poskytovat rozumnou ochranu před škodlivými vlivy rušení při instalaci v domácnostech. Toto zařízení generuje, používá a může vyzařovat vysokofrekvenční energii a, pokud není instalováno a používáno v souladu s pokyny, může způsobovat škodlivé rušení rádiových komunikací. V žádném případě však není možné zaručit, že v určité konkrétní situaci k rušení



HARMAN

HARMAN International Industries, Incorporated  
8500 Balboa Boulevard, Northridge, CA 91329 USA  
516.255.4545 (USA only)



70-JBLNHP-SAFB3  
SSA2020-002



English (en)

## EU DECLARATION OF CONFORMITY

1. Model No., trademark:

BAR 500, BAR 500 SUB

JBL

2. Name and address of the manufacturer's authorised representative:

Harman International Industries, Incorporated

EMEA Liaison Office, Danzigerkade 16G,1013 AP Amsterdam,The Netherlands

3. This declaration of conformity is issued under the sole responsibility of the manufacturer:

Harman International Industries, Incorporated

8500 Balboa Blvd, Northridge, CA 91329, UNITED STATES

4. Object of the declaration:

Multi-Channel Soundbar with wireless subwoofer

5. The object of the declaration described above is in conformity with the relevant Union harmonisation legislation directive and Other Union harmonisation legislation where applicable:

RED - 2014/53/EU, ERP - 2009/125/EC,

RoHS - (EU) 2015/863 amending Annex II to 2011/65/EU,

6. References to the relevant harmonised standards used or references to the other technical specifications in relation to which conformity is declared. References must be listed with their identification number and version and, where applicable, date of issue:

EN 55032:2015, EN 55032:2015/A11:2020, EN 55035:2017, EN 55035:2017/A11:2020

EN IEC 62311:2020, EN 62368-1:2014+A11:2017, EN 300 440V2.2.1, ETSI EN 301 489-1 V2.2.3, ETSI EN 301 489-17 V3.2.4

EN 61000-3-3:2013/A2:2021, EN IEC 61000-3-2:2019/A1:2021, EN 300 328 V2.2.2, EN 301 893 V2.1.1

(EC) No 1275/2008 & (EU) No 801/2013, EN 50564:2011, EN IEC 63000:2018

7. Where applicable, the notified body ... (name, number) ... performed ... (description of intervention)

..... And issued the EU-type examination certificate: ...

-

8. Where applicable, description of accessories and components, including software, which allow the radio equipment to operate as intended and covered by the EU declaration of conformity:

EPS: Model:

9. Additional information:

(Signature):

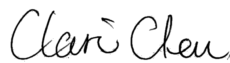

(Name, Function):

Clarice Chen Sr. Manager, Product Compliance & Sustainability

Signed for and on behalf of:

Harman International Industries, Incorporated

(Place and date of issue):

Shenzhen, China. 2022-09-05