

soundcore

Soundcore Icon

User Manual

Model No.: A3122
51005001394 V01

Benutzerhandbuch | Manuel de l'utilisateur | Manuale utente | Manual de usuario
Uživatelská příručka | Brugervejledning | Käyttöopas | Gebruikershandleiding
Brukerhåndbok | Användarhandbok | Руководство пользователя | Manual do Usuário
取扱説明書 | 사용 설명서 | 用户手册 | 使用者手冊
مدריך למשתמש | دليل المستخدم | Kullanım Kilavuzu

01	English	89	Русский
09	Deutsch	97	Portuguese
17	Français	105	日本語
25	Italiano	113	한국어
33	Español	121	简体中文
41	Čeština	129	繁體中文
49	Dansk	137	لَعَرَبِيَّة
57	Suomi	145	בְרִית
65	Nederlands	153	Türkçe
73	Norsk		
81	Svenska		

EN Safety Instructions

- Avoid dropping.
- Do not disassemble.
- Soundcore Icon can be immersed in water up to 1m for up to 30 minutes.
- Avoid extreme temperatures.
- Do not use the device outdoors during thunderstorms.
- Do not use any corrosive cleaner / oil to clean.

What's Included

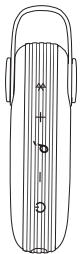

01

At a Glance

EN

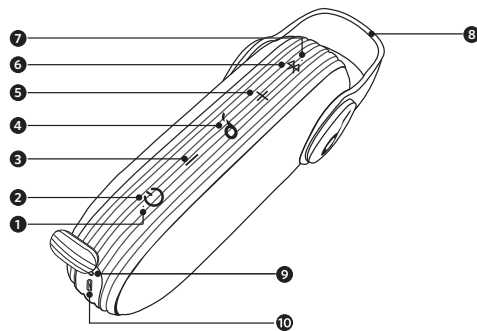

- | | | | |
|---|-----------------------|----|------------------------|
| 1 | Power Indicator | 6 | Bluetooth Button |
| 2 | Power Button | 7 | Bluetooth Indicator |
| 3 | Volume - Button | 8 | Carry-handle |
| 4 | Multi-function Button | 9 | 3.5mm Audio Input Port |
| 5 | Volume + Button | 10 | micro USB Port |

02

EN Using Your Soundcore Icon

1. Turn On / Off

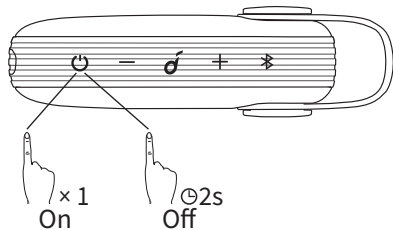

ON	Press
OFF	Press and hold for more than 2 seconds

a. Bluetooth mode

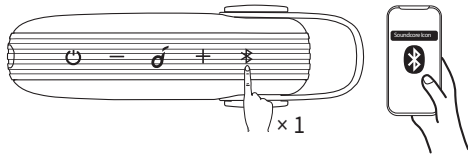

03



Flashing Blue

Bluetooth Pairing Mode



Solid Blue

Connected to a device

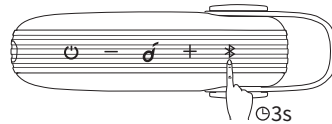
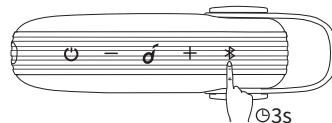

⊖3s Enter True Wireless Stereo Group Mode / Disconnect True Wireless Stereo



Flashing White

True Wireless Stereo Group Mode



Solid White

Connected to True Wireless Stereo
Note: When True Wireless Stereo group is successful, the LED indicator on the first speaker will flash in blue, the LED indicator on the second speaker will be solid blue.

04

EN



With True Wireless Stereo technology, you can pair your Soundcore Icon with another Soundcore Icon to explore the best sound effects with left and right sound channels separated on both speakers.



*1 Play / Pause



*2 Play Next Song



*3 Play Previous Song



*1 Answer Call / End Call



*2s Reject Call / Switch between a call on hold and an active call



*1s End current call and answer incoming call / End current call and switch to call on hold



*2s Switch audio source between Speaker and Phone



*1 Put current call on hold and answer incoming call



*2s Activate Siri / Other Voice Control Software



Volume Up / Down



Solid White

On a Call



Flashing Blue

Incoming Call

05

EN



When turned on, Soundcore Icon will automatically connect to the last connected device if available. If not, press the Bluetooth pairing button to activate pairing mode.

To pair a different device, press the Bluetooth button to re-enter pairing mode. Then repeat the pairing steps.

Having connection problems? Remove Soundcore Icon from your device's Bluetooth history and ensure it's less than 3 feet away. Then try pairing again. To get the best sound quality, make sure there is a clear line of sight between the connected device and your speaker.

b. AUX-In mode

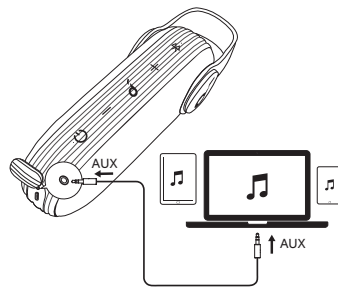

* SoundLine AUX cable sold separately.

06

EN

Plugging in an audio cable will automatically switch to AUX mode. When using AUX mode, control audio playback via the connected device.

Charging your Soundcore Icon

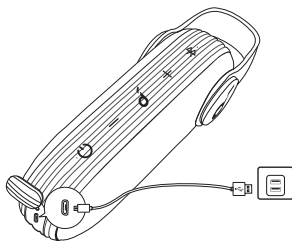

 Slow Flashing Red Low Battery

 Solid Red Charging

Off Fully Charged

07

EN

Use the included USB cable to charge your Soundcore Icon and make sure it is fully charged before its first use. Disconnect your speaker from the charger when fully charged. Do not charge your speaker for extended periods. When not in use, store your speaker in a cool place.

Specifications



Specifications are subject to change without notice.

Input: 5 V $\overline{=}$ 1 A

Audio output: 10 W

Battery capacity: max. 2600 mAh

Charging time: 4.0 hours

Playtime (varies by volume level and music content): 12hrs

Size: 182 x 61 x 62 mm / 7.2 x 2.4 x 2.4 inch

Weight (without packaging): 349 g / 12.3 oz

Bluetooth version: V5.0

Bluetooth range: 20 m / 66 ft

08

DE Sicherheitsinformationen

- Nicht fallen lassen.
- Nicht zerlegen.
- Soundcore Icon kann bis zu 30 Minuten lang in Wasser von bis zu einem Meter Tiefe eingetaucht sein.
- Extreme Temperaturen meiden.
- Das Produkt nicht bei Gewitter im Freien verwenden.
- Weder scharfe Reinigungsmittel noch Öl verwenden.

Im Lieferumfang

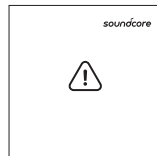
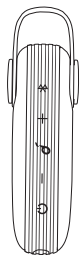

09

Auf einen Blick

DE

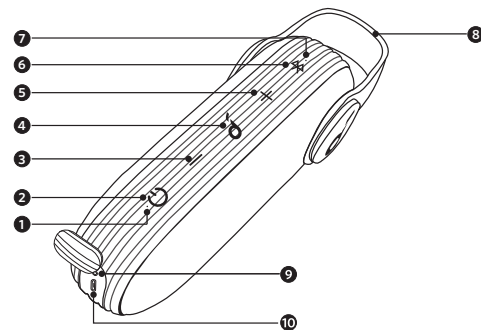

- | | | | |
|---|---------------------|----|---------------------|
| 1 | Betriebsanzeige | 6 | Bluetooth-Taste |
| 2 | Ein-/Aus-Taste | 7 | Bluetooth-Anzeige |
| 3 | Lautstärketaste - | 8 | Tragegriff |
| 4 | Multifunktionstaste | 9 | 3,5-mm-Audioeingang |
| 5 | Lautstärketaste + | 10 | Mikro-USB-Anschluss |

10

DE Verwendung Ihres Soundcore Icon

1. Ein- / Ausschalten

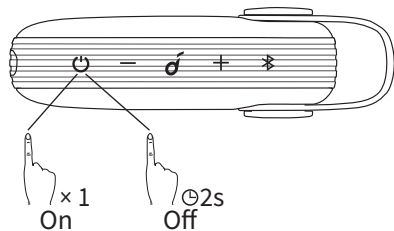

EIN	Drücken
AUS	Mindestens 2 Sekunden lang gedrückt halten

a. Bluetooth-Modus

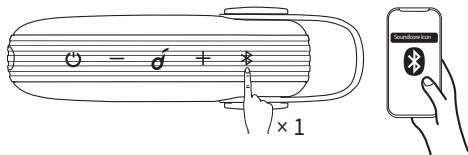

11



Blinkt blau

Bluetooth-Kopplungsmodus



Leuchtet blau

Mit einem Gerät verbunden

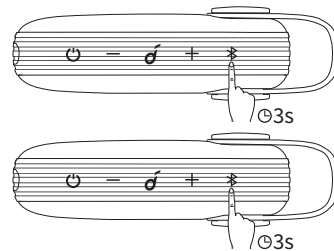

True Wireless Stereo-Gruppenmodus starten / True Wireless Stereo trennen



Blinkt weiß

True Wireless Stereo-Gruppenmodus



Leuchtet weiß

Mit True Wireless Stereo verbunden
Hinweis: Wenn die True Wireless Stereo-Gruppen erfolgreich gestartet wurde, blinkt die LED-Anzeige auf dem ersten Lautsprecher blau und die LED-Anzeige auf dem zweiten Lautsprecher leuchtet dauerhaft blau.

12

DE



Über True Wireless Stereo-Technologie können Sie Ihren Soundcore Icon mit einem anderen Soundcore Icon koppeln und durch Experimente mit dem linken und rechten Tonkanal den optimalen Sound für beide Lautsprecher erzielen.

- *1 Wiedergabe / Pause
 - *2 Nächsten Track abspielen
 - *3 Vorigen Track abspielen
 - *1 Anruf annehmen / beenden
 - 25s Anruf ablehnen / Zwischen gehaltenem und aktivem Anruf wechseln
 - 15s Aktuellen Anruf beenden und eingehenden Anruf annehmen / Aktuellen Anruf beenden und zu gehaltenem Anruf wechseln
 - 25s Audio-Quelle zwischen Lautsprecher und Telefon umschalten
 - *1 Aktuellen Anruf auf Halten setzen und eingehenden Anruf annehmen
 - 25s Siri / andere Sprachsteuerungssoftware aktivieren
 - Lauter / leiser
- | | | |
|--|---------------|-------------------|
| | Leuchtet weiß | Anruf läuft |
| | Blinkt blau | Eingehender Anruf |

13

DE



Ist diese Option aktiviert, stellt Soundcore Icon automatisch eine Verbindung zum zuletzt angeschlossenen Gerät her, sofern dieses verfügbar ist. Wenn nicht, drücken Sie die Bluetooth-Taste, um den Kopplungsmodus zu aktivieren.

Zum Koppeln mit einem anderen Gerät drücken Sie die Bluetooth-Taste, um den Kopplungsmodus erneut zu starten. Wiederholen Sie dann die Schritte zum Koppeln.

Probleme bei der Verbindungsherstellung? Löschen Sie Soundcore Icon aus dem Bluetooth-Verlauf Ihres Geräts und stellen Sie sicher, dass der Abstand weniger als 3 Meter beträgt. Wiederholen Sie dann den Kopplungsvorgang. Die beste Klangqualität erzielen Sie, wenn sich keine Hindernisse zwischen dem angeschlossenen Gerät und Ihrem Lautsprecher befinden.

b. AUX-Eingangsmodus

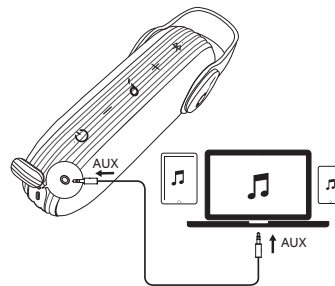

* Das SoundLine AUX-Kabel ist separat erhältlich.

14

DE



Der AUX-Modus wird automatisch aktiviert, wenn Sie ein Audiokabel anschließen.
Im AUX-Modus steuern Sie die Wiedergabe über das angeschlossene Gerät.

Aufladen Ihres Soundcore Icon

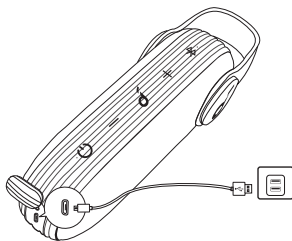

Blinkt langsam rot

Niedriger Akkustand



Leuchtet rot

Ladevorgang

Aus

Vollständig aufgeladen

15

DE



Verwenden Sie das USB-Kabel aus dem Lieferumfang zum Laden Ihres Soundcore Icon. Das Gerät muss vor dem ersten Gebrauch vollständig geladen werden.
Trennen Sie den Lautsprecher vom Ladegerät, wenn er vollständig aufgeladen ist. Laden Sie den Lautsprecher nicht über längere Zeiträume.
Wenn Ihr Lautsprecher nicht verwendet wird, bewahren Sie ihn an einem kühlen Ort auf.

Technische Daten



Änderungen der technischen Daten ohne Vorankündigung vorbehalten.

Eingang: 5 V $\overline{\text{---}}$ 1 A

Audioausgang: 10 W

Akkukapazität: Max. 2600 mAh

Ladedauer: 4,0 Stunden

Wiedergabedauer (je nach Lautstärke und Musikinhalt): 12 Std

Maße: 182 x 61 x 62 mm

Gewicht (ohne Verpackung): 349 g

Bluetooth-Version: V5.0

Bluetooth-Reichweite: 20 m

16

FR Consignes de sécurité

- Ne pas le faire tomber.
- Ne pas le démonter.
- Soundcore Icon peut être immergé dans l'eau à une profondeur maximale d'un mètre pendant 30 minutes au maximum.
- Éviter une utilisation à des températures extrêmes.
- En cas d'orage, ne pas utiliser le produit à l'extérieur.
- Ne pas utiliser de nettoyant corrosif ni d'huile pour le nettoyer.

Contenu

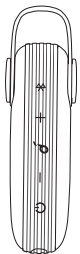

17

Récapitulatif

FR

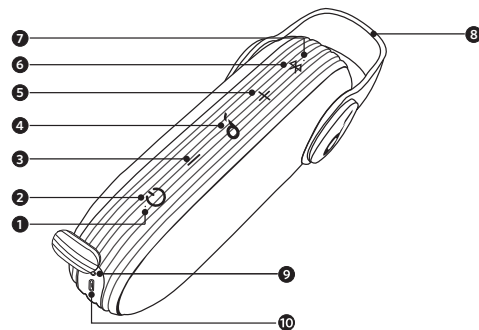

- | | | | |
|---|-----------------------|----|----------------------------|
| 1 | Voyant d'alimentation | 6 | Bouton Bluetooth |
| 2 | Bouton d'alimentation | 7 | Voyant Bluetooth |
| 3 | Bouton volume - | 8 | Poignée de transport |
| 4 | Bouton multifonction | 9 | Port d'entrée audio 3,5 mm |
| 5 | Bouton volume + | 10 | Port Micro USB |

18

FR Utilisation de votre Soundcore Icon

1. Allumer/éteindre

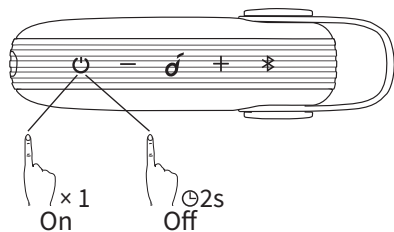

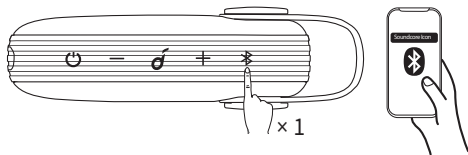

MARCHE	Appuyer une fois
ARRÊT	Maintenir appuyé pendant plus de 2 secondes

a. Mode Bluetooth



19

 Bleu clignotant	Mode de couplage Bluetooth
 Bleu fixe	Connecté à un périphérique

FR

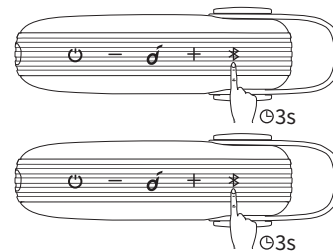

 ⊖ 3s Passer en mode Groupe True Wireless Stereo/déconnecter True Wireless Stereo

 Blanc clignotant Mode Groupe True Wireless Stereo

 Blanc fixe

Connecté à True Wireless Stereo
Remarque : lorsque le groupe True Wireless Stereo est connecté, le voyant LED sur le premier haut-parleur clignotera en bleu, le voyant LED sur le second haut-parleur sera bleu fixe.

20

FR



Avec la technologie True Wireless Stereo, vous pouvez coupler votre Soundcore Icon avec tout autre Soundcore Icon et profiter des meilleurs effets sonores avec des canaux audio gauche et droit distincts sur les deux haut-parleurs.

- *1 Lecture/pause
- *2 Morceau suivant
- *3 Morceau précédent
- *1 Répondre/mettre fin à l'appel
- *25 Rejeter l'appel/passer d'un appel en attente à un appel actif
- *015 Terminer l'appel en cours et répondre à un appel entrant/terminer l'appel en cours et passer à l'appel en attente
- *25 Basculer la source audio entre le haut-parleur et le téléphone
- *1 Mettre en attente l'appel en cours et répondre à un appel entrant
- *25 Activer Siri/un autre logiciel de contrôle vocal
- Augmenter/diminuer le volume

- Blanc fixe Appel en cours
- Bleu clignotant Appel entrant

FR



Une fois allumé, Soundcore Icon se connecte automatiquement au dernier appareil connecté s'il est disponible. Sinon, appuyez sur le bouton de couplage Bluetooth pour activer le mode de couplage.

Pour coupler un appareil différent, appuyez sur le bouton Bluetooth pour réactiver le mode de couplage. Répétez ensuite les étapes de couplage.

Des problèmes de connexion ? Retirez SoundCore Icon de l'historique Bluetooth de votre appareil, et assurez-vous qu'il soit à moins de 90 cm. Puis essayez à nouveau le couplage. Pour obtenir la meilleure qualité sonore possible, assurez-vous que l'espace soit dégagé entre l'appareil connecté et votre haut-parleur.

b. Mode AUX-In

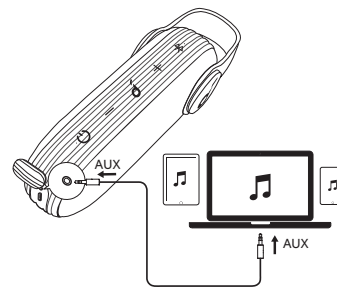

* Câble SoundLine AUX vendu séparément.

FR



Le branchement d'un câble audio fait passer l'appareil automatiquement en mode AUX.
Lorsque vous utilisez le mode AUX, contrôlez la lecture audio via l'appareil connecté.

Chargement de votre Soundcore Icon

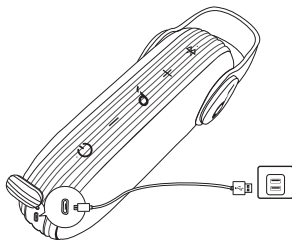

Rouge clignotant lentement

Batterie faible



Rouge fixe

En charge

Arrêt

Complètement chargé

23

FR



Utilisez le câble USB fourni pour charger votre Soundcore Icon et assurez-vous qu'il est complètement chargé avant la première utilisation.
Déconnectez votre haut-parleur du chargeur lorsqu'il est entièrement chargé. Ne chargez pas votre haut-parleur pendant une période prolongée.
Lorsqu'il n'est pas utilisé, stockez votre haut-parleur dans un endroit frais.

Spécifications



Les spécifications sont susceptibles d'être modifiées sans préavis.

Entrée : 5 V $\overline{=}$ 1 A

Sortie audio : 10 W

Capacité de la batterie : 2 600 mAh au maxi.

Temps de charge : 4 h

Durée de lecture (varie en fonction du niveau sonore et du contenu musical) : 12 h

Dimensions : 182 x 61 x 61 mm

Poids (sans emballage) : 349 g

Version Bluetooth : 5.0

Portée Bluetooth : 20 m

24

IT Informazioni sulla sicurezza

- Non far cadere il prodotto.
- Non smontare il prodotto.
- Soundcore Icon è impermeabile in acqua fino a 1 m per un massimo di 30 minuti.
- Evitare l'esposizione a temperature elevate.
- Non usare il dispositivo all'aperto durante un temporale.
- Non utilizzare detergenti o oli corrosivi per la pulizia.

Contenuto della confezione

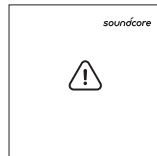
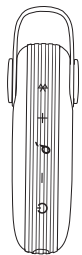

25

Descrizione del prodotto

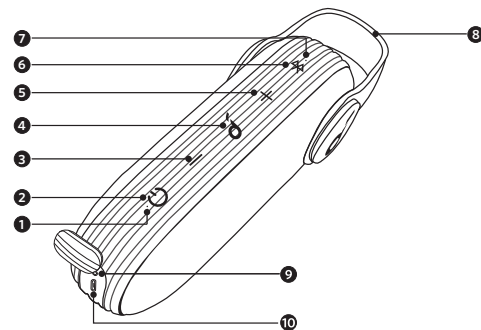

- | | | | |
|---|-----------------------------------|----|--------------------------------|
| 1 | Indicatore di alimentazione | 6 | Tasto Bluetooth |
| 2 | Tasto di accensione | 7 | Indicatore Bluetooth |
| 3 | Tasto di riduzione del volume (-) | 8 | Maniglia per trasporto |
| 4 | Tasto multifunzione | 9 | Porta ingresso audio da 3,5 mm |
| 5 | Tasto di aumento del volume (+) | 10 | Porta micro USB |

26

IT Utilizzo di Soundcore Icon

1. Accensione/Spegnimento

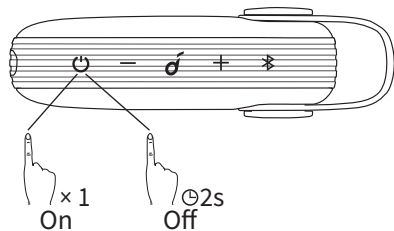

ON	Premere
OFF	Tenere premuto per almeno 2 secondi

a. Modalità Bluetooth

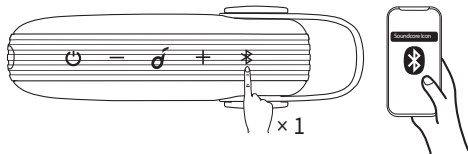

Blu lampeggiante

Modalità di associazione Bluetooth



Blu fisso

Connesso a un dispositivo

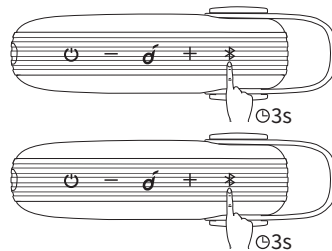

Attivazione/Disattivazione della modalità TWS (True Wireless Stereo)



Bianco lampeggiante

Modalità gruppo True Wireless Stereo



Bianco fisso











Connesso a True Wireless Stereo

Nota: quando la connessione al gruppo True Wireless Stereo viene stabilita correttamente, l'indicatore LED sul primo altoparlante lampeggerà in blu e quello sul secondo altoparlante sarà blu fisso.

IT



Con la tecnologia True Wireless Stereo, è possibile abbinare due Soundcore Icon per scoprire i migliori effetti sonori con i canali audio sinistro e destro separati su entrambi gli altoparlanti.

-  *1 Riproduzione/Pausa
-  *2 Riproduzione brano successivo
-  *3 Riproduzione brano precedente
-  *1 Risposta/Fine chiamata
-  2s Rifiuto di una chiamata/Passaggio da una chiamata in attesa a una chiamata attiva
-  15s Chiusura della chiamata in corso e risposta a una chiamata in arrivo/
Chiusura della chiamata in corso e passaggio a una chiamata in attesa
-  2s Passaggio della fonte audio dall'altoparlante al telefono
-  *1 Messa in attesa della chiamata in corso e risposta alla chiamata in arrivo
-  2s Attivazione di Siri/altro software di controllo vocale
-  Aumento/Diminuzione volume

-  Bianco fisso Chiamata in corso
-  Blu lampeggiante Chiamata in arrivo

IT



Quando attivato, Soundcore Icon si connette automaticamente all'ultimo dispositivo connesso, se disponibile. In caso contrario, premere il tasto Bluetooth per attivare la modalità di associazione.

Per associare un dispositivo diverso, premere il tasto Bluetooth per attivare nuovamente la modalità di associazione. Ripetere quindi la procedura di associazione.

In caso di problemi di connessione, rimuovere Soundcore Icon dalla cronologia del dispositivo Bluetooth e assicurarsi che si trovi a una distanza inferiore a 1 metro. Quindi provare nuovamente a eseguire l'associazione. Per migliorare la qualità dell'audio, verificare che la visuale tra il dispositivo connesso e l'altoparlante sia priva di ostacoli.

b. Modalità AUX-IN

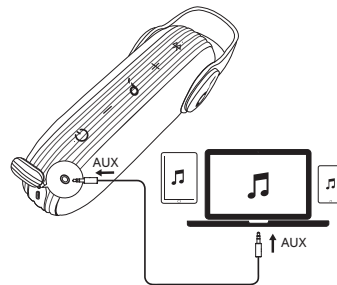

* Cavo SoundLine AUX venduto separatamente.

IT



Quando si collega un cavo audio, il dispositivo passa automaticamente alla modalità AUX.
Quando si utilizza la modalità AUX, controllare la riproduzione audio tramite il dispositivo collegato.

Carica di Soundcore Icon

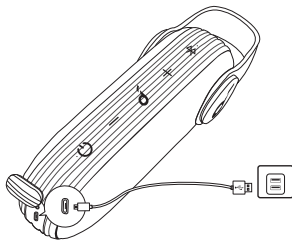

Rosso lampeggiante lento

Batteria in esaurimento



Rosso fisso

Carica

Disattivata

Carica completata

31



IT



Utilizzare il cavo USB incluso per caricare il dispositivo Soundcore Icon e accertarsi che sia completamente carico prima del primo utilizzo.
Quando l'altoparlante è completamente carico, scollegarlo dal caricabatteria. Non caricare l'altoparlante per periodi prolungati.
Quando non è in uso, conservare l'altoparlante in un luogo fresco.

Specifiche



Le specifiche sono soggette a modifica senza preavviso.

Ingresso: 5V $\overline{=}$ 1 A

Uscita audio: 10 w

Capacità della batteria: Max. 2600 mAh

Tempo di ricarica: 4 ore

Tempo di riproduzione (varia a seconda del livello del volume e del contenuto musicale): 12 ore

Dimensioni: 182 x 61 x 62 mm

Peso (senza confezione): 349 g

Versione Bluetooth: V 5.0

Portata Bluetooth: 20 m

32



ES Instrucciones de seguridad

- Evite que el dispositivo se caiga.
- No desmonte el dispositivo.
- El Soundcore Icon se puede sumergir en agua hasta 1 m durante un máximo de 30 minutos.
- Evite temperaturas extremas.
- No utilice el dispositivo en el exterior si hay tormenta.
- No utilice ningún aceite o limpiador corrosivo para limpiar el dispositivo.

Contenido

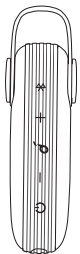

33

Vista general

ES

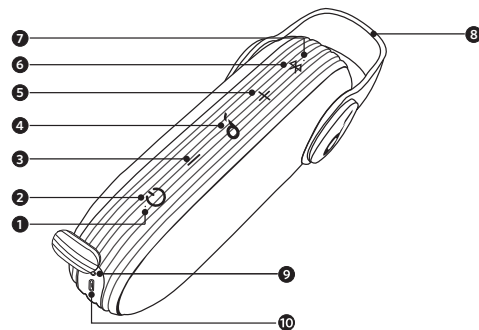

- | | | | |
|---|-----------------------------|----|--------------------------------------|
| 1 | Indicador de encendido | 6 | Botón Bluetooth |
| 2 | Botón de encendido | 7 | Indicador de Bluetooth |
| 3 | Botón para bajar el volumen | 8 | Manija de transporte |
| 4 | Botón multifunción | 9 | Puerto de entrada de audio de 3,5 mm |
| 5 | Botón para subir el volumen | 10 | Puerto micro-USB |

34

ES Uso del Soundcore Icon

1. Encendido/Apagado

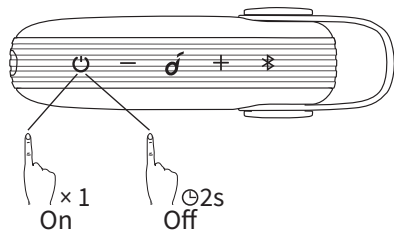

ENCENDER Pulsar una vez

APAGAR Mantener pulsado durante más de 2 segundos

a. Modo Bluetooth

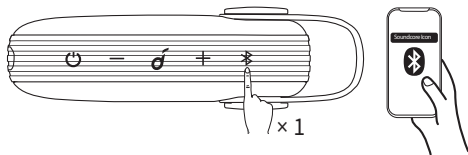

Parpadeo azul



Azul fijo

Modo de emparejamiento Bluetooth

Conectado a un dispositivo

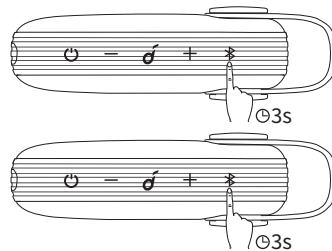

Acceder al modo de grupo True Wireless Stereo/Desconectar True Wireless Stereo



Parpadeo blanco

Modo de grupo True Wireless Stereo



Blanco fijo

Conectado a True Wireless Stereo

Nota: Cuando se ha accedido al modo de grupo True Wireless Stereo correctamente, el indicador led del primer altavoz parpadeará en azul y el indicador led del segundo altavoz se iluminará en azul fijo.

ES



Con la tecnología True Wireless Stereo, puede emparejar el Soundcore Icon a otro Soundcore Icon para explorar los mejores efectos de sonido mediante la separación de los canales de sonido izquierdo y derecho y su reproducción en cada altavoz de forma independiente.

- *x1 Reproducir/Pausar
 - *x2 Reproducir la canción siguiente
 - *x3 Reproducir la canción anterior
 - *x1 Responder/Finalizar llamada
 - *x2s Rechazar llamada/Cambiar entre una llamada en espera y una llamada activa
 - *x1s Finalizar la llamada actual y responder a la llamada entrante/Finalizar la llamada actual y cambiar a la llamada en espera
 - *x2s Cambiar la fuente de audio entre el altavoz y el teléfono
 - *x1 Poner la llamada actual en espera y responder a la llamada entrante
 - *x2s Activar Siri/otro software de control por voz
 - Subir/Bajar volumen
- | | | |
|--|---------------|------------------|
| | Blanco fijo | Llamada en curso |
| | Parpadeo azul | Llamada entrante |

37

ES



Al encenderlo, el Soundcore Icon se conectará automáticamente al último dispositivo conectado, si está disponible. Si no, pulse el botón Bluetooth para activar el modo de emparejamiento.

Para emparejar un dispositivo diferente, pulse el botón Bluetooth para volver a acceder al modo de emparejamiento. A continuación, repita el proceso de emparejamiento.

¿Está experimentando problemas de conexión? Elimine el Soundcore Icon del historial de Bluetooth del dispositivo y asegúrese de que esté a menos de 1 metro de distancia. A continuación, vuelva a intentar realizar el emparejamiento. Para obtener la mejor calidad de sonido, asegúrese de que exista una línea de visión clara entre el dispositivo conectado y el altavoz.

b. Modo AUX-In

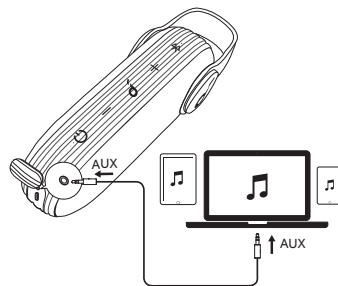

* El cable SoundLine AUX se vende por separado.

38

ES



Al conectar un cable de audio, se cambiará automáticamente al modo AUX.
Al utilizar el modo AUX, puede controlar la reproducción de audio a través del dispositivo conectado.

Carga del Soundcore Icon

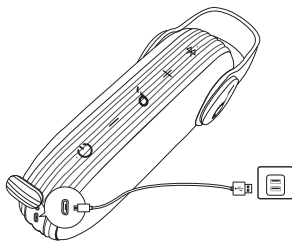

Parpadeo rojo lento

Batería baja



Rojo fijo

Carga en curso

Apagado

Carga completa

39

ES



Utilice el cable USB incluido para cargar el Soundcore Icon y asegúrese de que esté completamente cargado antes de utilizarlo por primera vez. Desconecte el altavoz del cargador cuando esté completamente cargado. No cargue el altavoz durante periodos de tiempo prolongados. Cuando no esté en uso, almacene el altavoz en un lugar fresco.

Especificaciones



Las especificaciones están sujetas a cambios sin previo aviso.

Entrada: 5 V $\overline{\text{---}}$ 1 A

Salida de audio: 10 W

Capacidad de la batería: 2600 mAh máx.

Tiempo de carga: 4 horas

Tiempo de reproducción (varía en función del nivel de volumen y el contenido de la música): 12 horas

Tamaño: 182 × 61 × 62 mm

Peso (sin embalaje): 349 g

Versión de Bluetooth: V5.0

Alcance de Bluetooth: 20 m

40

CS Bezpečnostní pokyny

- Dávejte pozor, abyste zařízení neupustili na zem.
- Zařízení nerozebírejte.
- Zařízení Soundcore Icon může být až na 30 minut ponořeno do vody do hloubky až 1 m.
- Vyhýbejte se extrémním teplotám.
- Nepoužívejte zařízení venku během bouřek.
- K čištění nepoužívejte korozivní čisticí prostředky ani benzín.

Co je součástí balení

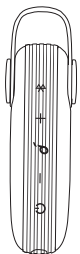

41

Přehled

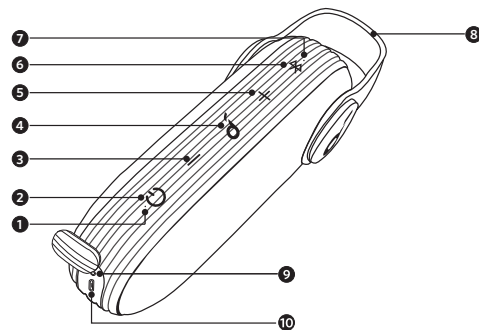

- | | | | |
|---|-----------------------------|----|-------------------------|
| 1 | Kontrolka napájení | 6 | Tlačítko Bluetooth |
| 2 | Tlačítko napájení | 7 | Kontrolka Bluetooth |
| 3 | Tlačítko snížení hlasitosti | 8 | Madlo |
| 4 | Multifunkční tlačítko | 9 | 3,5mm port audio vstupu |
| 5 | Tlačítko zvýšení hlasitosti | 10 | Port Micro USB |

42

CS Návod k použití reproduktoru Soundcore Icon

1. Zapnutí/vypnutí

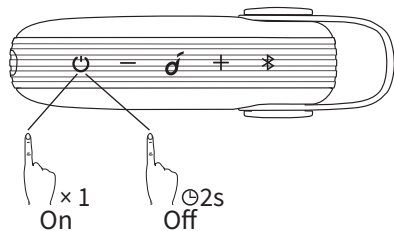

ZAPNUTÍ	Stiskněte
VYPNUTÍ	Stiskněte a podržte alespoň na 2 sekundy

a. Režim Bluetooth

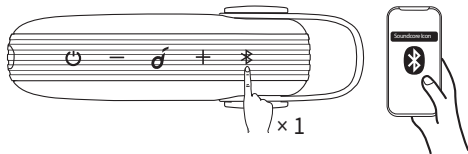

43

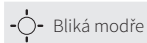

Bliká modře

Režim párování Bluetooth



Svítlí modře

Připojeno k zařízení

CS

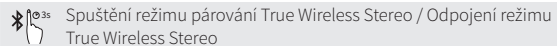
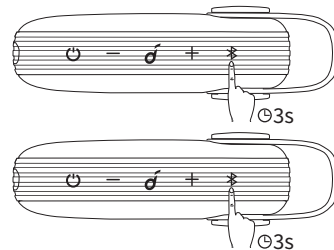

Spuštění režimu párování True Wireless Stereo / Odpojení režimu True Wireless Stereo



Bliká bíle

Režim párování True Wireless Stereo

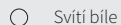

Svítlí bíle

Připojeno v režimu True Wireless Stereo











Poznámka: Pokud úspěšně proběhne seskupení True Wireless Stereo, kontrolka na prvním reproduktoru bude modře blikat, kontrolka na druhém reproduktoru bude trvale modře svítit.



44

CS



Díky technologii True Wireless Stereo můžete prostřednictvím Bluetooth spárovat dva reproduktory Soundcore Icon a objevovat ty nejlepší zvukové efekty s levým a pravým zvukovým kanálem na dvou samostatných reproduktorech.

-  *1 Přehrát / pozastavit
-  *2 Přehrát další skladbu
-  *3 Přehrát předchozí skladbu
-  *1 Přijmout / ukončit hovor
-  *25 Odmítnout hovor / Přepínat mezi pozastaveným a aktivním hovorem
-  *15 Ukončit probíhající hovor a přijmout příchozí hovor / Ukončit probíhající hovor a přepnout na pozastavený hovor
-  *25 Přepnout zdroj audia mezi reproduktorem a telefonem
-  *1 Odložit probíhající hovor a přijmout příchozí hovor
-  *25 Aktivovat Siri / jiný software pro ovládání hlasem
-  Zvýšit / snížit hlasitost

	Svítil bíle	Probíhá hovor
	Bliká modře	Příchozí hovor

45

CS



Po zapnutí se reproduktor Soundcore Icon automaticky připojí k poslednímu připojenému zařízení, jestliže je dostupné. V opačném případě stisknutím tlačítka párování Bluetooth aktivujete režim párování. Chcete-li párovat jiné zařízení, stisknutím tlačítka Bluetooth znovu přejdete do režimu párování.

Poté zopakujte kroky párování. Máte problémy s připojením? Odeberte reproduktor Soundcore Icon z historie Bluetooth svého zařízení a ujistěte se, že je ve vzdálenosti kratší než 1 metr. Poté zařízení zkuste znovu spárovat. Nejlepší kvality zvuku dosáhnete tak, že zajistíte, aby mezi připojeným zařízením a reproduktorem nebyly překážky blokující spojení.

b. Režim AUX-In

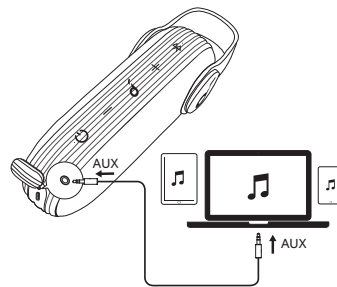

* Kabel SoundLine AUX se prodává samostatně.

46

CS



Připojením audiokabelu se automaticky zapne režim AUX.
Při použití režimu AUX ovládejte přehrávání zvuku z připojeného zařízení.

Nabíjení reproduktoru Soundcore Icon

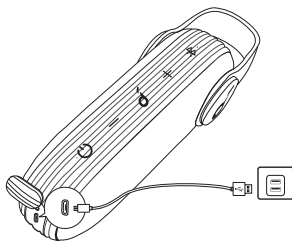

	Pomalou bliká červeně	Téměř vybitá baterie
	Svíí červeně	Nabíjení
Nesvíí		Plně nabito

47

CS



K nabíjení reproduktoru Soundcore Icon používejte dodaný kabel USB. Ujistěte se, že je reproduktor před prvním použitím plně nabitý. Po dokončení nabíjení reproduktor od nabíječky odpojte. Nenechávejte reproduktor nabíjet příliš dlouho. Pokud reproduktor nepoužíváte, uchovávejte ho na chladném místě.

Specifikace



Specifikace se mohou bez předchozího upozornění změnit.

Vstup: 5 V $\overline{=}$ 1 A

Výstup zvuku: 10 W

Kapacita baterie: max. 2600 mAh

Doba nabíjení: 4,0 hodiny

Doba přehrávání (liší se podle hlasitosti a hudebního obsahu): 12 hodin

Rozměry: 182 x 61 x 62 mm

Hmotnost (bez obalu): 349 g

Verze Bluetooth: V5.0

Dosah připojení Bluetooth: 20 m

48

DA Sikkerhedsinstruktioner

- Undgå at tabe produktet.
- Produktet må ikke skilles ad.
- Soundcore Icon kan nedsænkes i vand ned til 1 m i op til 30 minutter.
- Undgå ekstreme temperaturer.
- Brug ikke enheden udendørs i tordenvej.
- Brug aldrig ætsende rengøringsmiddel / olie ved rengøring.

Hvad er inkluderet

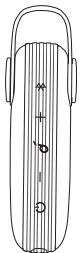

49

Et overblik

DA

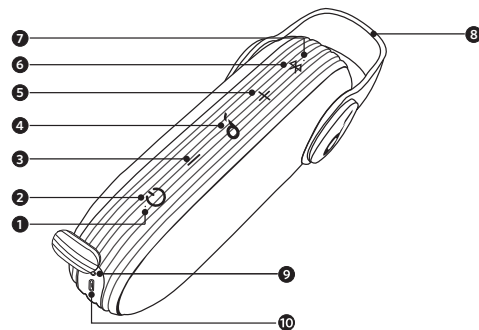

- | | | | |
|---|--------------------|----|------------------------|
| 1 | Strømindikator | 6 | Bluetooth-knap |
| 2 | Tænd/sluk-knap | 7 | Bluetooth-indikator |
| 3 | Lydstyrke - knap | 8 | Bærehåndtag |
| 4 | Multifunktionsknap | 9 | 3,5 mm lydindgangsport |
| 5 | Lydstyrke + knap | 10 | micro USB-port |

50

DA Sådan bruger du Soundcore Icon

1. Tænd/sluk

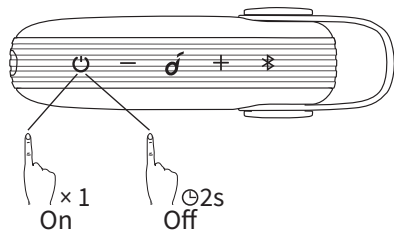

TÆND	Tryk én gang
SLUKKE	Tryk og hold nede i mere end 2 sekunder

a. Bluetooth-tilstand

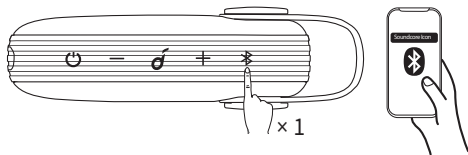

Blinker blåt

Bluetooth-parring



Lyser blåt

Tilsluttet til en enhed

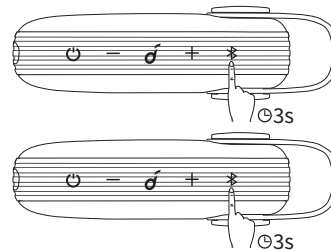

Start gruppetilstand for True Wireless Stereo / Frakobl True Wireless Stereo



Blinker hvidt

Gruppetilstand for True Wireless Stereo



Lyser hvidt

Tilsluttet til True Wireless Stereo
Bemærk: Når True Wireless Stereo-gruppe er etableret, vil LED-indikatoren på den første højttaler blinke blåt, mens LED-indikatoren på den anden højttaler vil lyse blåt.

DA



Med True Wireless Stereo-teknologi kan du parre din Soundcore Icon med en anden Soundcore Icon for at udforske de bedste lydeffekter med de venstre og højre lydkanaler separeret på hver sin højttaler.

- *1 Afspil / pause
 - *2 Afspil næste sang
 - *3 Afspil forrige sang
 - *1 Besvar opkald / afslut opkald
 - *2s Afvis opkald / Skift mellem et opkald på hold og et aktivt opkald
 - *1s Afslut nuværende opkald og besvar indgående opkald / Afslut nuværende opkald og skift til opkald på hold
 - *2s Skift lydkilde mellem højttaler og telefon
 - *1 Sæt nuværende opkald på hold, og besvar indgående opkald
 - *2s Aktivér Siri / anden stemmestyringssoftware
 - Lydstyrke op / ned
- | | | |
|--|--------------|------------------|
| | Lyser hvidt | Taler i telefon |
| | Blinker blåt | Indgående opkald |

53

DA



Når Soundcore Icon er tændt, vil den automatisk oprette forbindelse til den senest tilsluttede enhed, hvis den er tilgængelig. Hvis ikke, skal du trykke på Bluetooth-knappen for at aktivere parringstilstand.

Hvis du vil parre en anden enhed, skal du trykke på Bluetooth-knappen for at starte parringstilstand igen. Gentag derefter trinnene for parring.

Har du forbindelsesproblemer? Fjern Soundcore Icon fra din enheds Bluetooth-historik og sørg for, at enheden er mindre end 1 meter væk. Prøv derefter at udføre parringen igen. Du får den bedste lyd kvalitet ved at sørge for, at der er frit sigt mellem den tilsluttede enhed og din højttaler.

b. AUX-In-tilstand

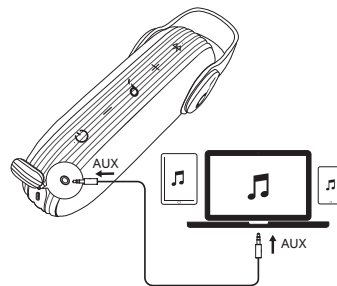

* SoundLine AUX-kabel sælges separat.

54



DA

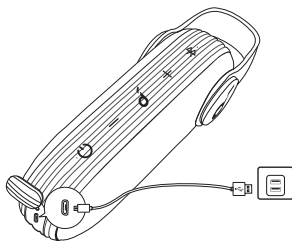

Når du indsætter et lyd-kabel, skiftes der automatisk til AUX-tilstand. Når du bruger AUX-tilstand, kan du styre lyd-afspilning via den tilsluttede enhed.

Sådan oplader du Soundcore Icon



-  Blinker langsomt rødt Lavt batteriniveau
-  Lyser rødt Oplader

Slukket Fuldt opladet

55

DA



Brug det medfølgende USB-kabel til at oplade din Soundcore Icon og sørg for, at den er fuldt opladet, første gang du bruger den. Frakobl din højttaler fra opladeren, når den er fuldt opladet. Oplad ikke din højttaler i længere perioder. Opbevar din højttaler på et køligt sted, når du ikke bruger den.

Specifikationer



Specifikationerne kan ændres uden varsel.

Input: 5 V $\overline{\overline{=}}$ 1 A

Lydoutput: 10 W

Batterikapacitet: maks. 2.600 mAh

Opladningstid: 4,0 timer

Afspilningstid (varierer afhængigt af lydstyrke og musikindhold): 12 timer

Størrelse: 182 x 61 x 62 mm

Vægt (uden emballage): 349 g

Bluetooth-version: V5.0

Bluetooth-dækning: 20 m / 66 ft

56

FI Turvallisuusohjeet

- Älä pudota.
- Älä pura.
- Soundcore Icon voidaan upottaa enintään 1 metrin syvyiseen veteen enintään 30 minuutiksi.
- Vältä ääriämpötiloja.
- Älä käytä tuotetta ulkona ukkosella.
- Älä käytä puhdistukseen syövyttävää puhdistusainetta tai öljyä.

Pakkauksen sisältö

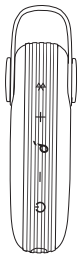

57

Pikakatsaus

FI

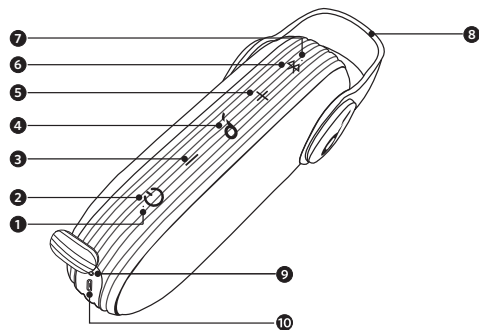

- | | | | |
|---|--------------------------|----|---------------------------|
| 1 | Virran merkkivalo | 6 | Bluetooth-painike |
| 2 | Virtapainike | 7 | Bluetoothin merkkivalo |
| 3 | Äänvoimakkuus - -painike | 8 | Kantokahva |
| 4 | Monitoimipainike | 9 | 3,5 mm:n äänituloliitäntä |
| 5 | Äänvoimakkuus + -painike | 10 | Mikro-USB-portti |

58

FI Soundcore Iconin käyttö

1. Käynnistäminen/sammuttaminen

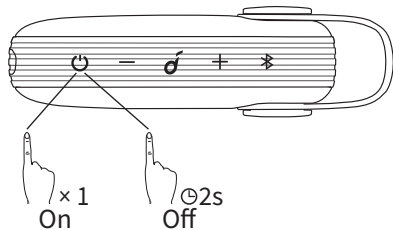

PÄÄLLE	Paina
POIS	Paina yli kahden sekunnin ajan.

a. Bluetooth-tila

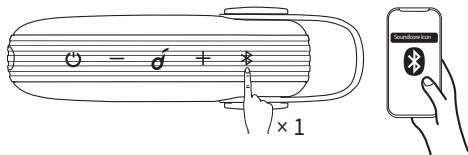

59



Vilkkuva sininen

Bluetooth-pariilitostila



Tasaisen sininen

Liitetty laitteeseen

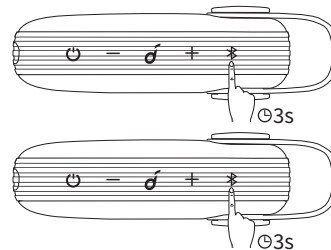

Siirry True Wireless Stereo -ryhmätilaan / Katkaise True Wireless Stereo



Vilkkuva valkoinen

True Wireless Stereo -ryhmätila



Tasaisen valkoinen

Yhteydessä True Wireless Stereo

Huomautus: Kun True Wireless Stereo -ryhmän muodostaminen onnistuu, ensimmäisen kaiuttimen merkivalo vilkkuu sinisenä ja toisen kaiuttimen merkivalo palaa tasaisen sinisenä.

60

FI



True Wireless Stereo -teknologialla voit muodostaa laiteparin Soundcore Iconisi ja toisen Soundcore Iconin välille ja hyödyntää parhaita äänitehosteita, koska vasen ja oikea äänikanava erotetaan erotetaan kaiuttimien välillä.



*1 Toista/keskeytä



*2 Toista seuraava kappale



*3 Toista edellinen kappale



*1 Vastaa / lopeta puhelu



02s Hylkää puhelu / Vaihda pidossa olevan puhelun ja aktiivisen puhelun välillä



01s Lopeta nykyinen puhelu ja vastaa saapuvaan puheluun / Lopeta nykyinen puhelu ja siirry pidossa olevaan puheluun



02s Vaihda äänilähdettä kaiuttimen ja puhelimen välillä



*1 Aseta nykyinen puhelu pitoon ja vastaa saapuvaan puheluun



02s Aktivoi Siri / muu puheohjausohjelmisto



Lisää / vähennä äänenvoimakkuutta



Tasaisen valkoinen

Puhelu kesken



Vilkkuva sininen

Saapuva puhelu

61

FI



Kun Soundcore Icon kytketään päälle, se muodostaa automaattisesti yhteyden viimeksi yhteydessä olleeseen laitteeseen, jos se on käytettävissä. Jos ei ole, aktivoi pariliitostila painamalla Bluetooth-painiketta.

Voit muodostaa pariliitoksen toiseen laitteeseen siirtymällä uudelleen pariliitostilaan Bluetooth-painiketta painamalla. Toista sitten pariliitoksen vaiheet.

Tuottaako yhteys ongelmia? Poista Soundcore Icon laitteesi Bluetooth-historiasta ja varmista, että se on enintään 90 cm:n päässä. Yritä pariliittää laitteet uudelleen. Varmista paras äänenlaatu poistamalla esteet yhdistetyn laitteen ja kaiuttimen väliltä.

b. AUX-In-tila

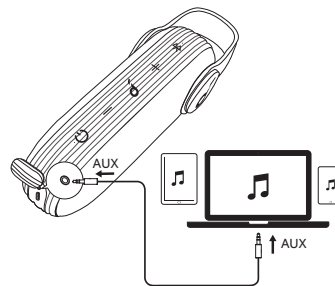

* SoundLine AUX -kaapeli myydään erikseen.

62

FI



Äänikaapelin kytkeminen käynnistää AUX-tilan automaattisesti. AUX-tilassa voit ohjata äänentoistoa yhdistetyn laitteen kautta.

Soundcore Iconin lataaminen

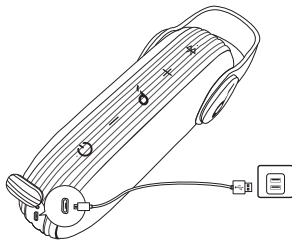

Hitaasti vilkkuva punainen Akku vähissä



Tasaisen punainen Lataus käynnissä

Sammuksissa

Ladattu täyteen

63

FI



Lataa Soundcore Icon sen mukana toimitetulla USB-kaapelilla ja varmista, että se on ladattu täyteen ennen ensimmäistä käyttökertaa. Irrota kaiutin laturista, kun se on ladattu täyteen. Älä lataa kaiutinta pitkään. Kun kaiutin ei ole käytössä, säilytä sitä viileässä paikassa.

Tekniset tiedot



Tekniset tiedot voivat muuttua ilman erillistä ilmoitusta.

Tulo: 5 V $\overline{\text{---}}$ 1 A

Äänilähtö: 10 W

Akun kapasiteetti: enint. 2600 mAh

Latausaika: 4,0 tuntia

Toisto aika (riippuu äänenvoimakkuudesta ja musiikkisisällöstä): 12 h

Koko: 182 x 61 x 62 mm

Paino (ilman pakkausta): 349 g / 12,3 oz

Bluetooth-versio: V5.0

Bluetoothin kantomatka: 20 m / 66 ft

64

NL Veiligheidsinstructies

- Laat het apparaat niet vallen.
- Demonteer het apparaat niet.
- Soundcore Icon kan tot 30 minuten worden ondergedompeld in water tot 1 m diepte.
- Vermijd extreme temperaturen.
- Gebruik het apparaat niet in de buitenlucht tijdens onweer.
- Gebruik geen bijtende schoonmaakmiddelen of olie om te reinigen.

Inbegrepen componenten

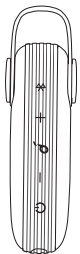

65

In één oogopslag

NL

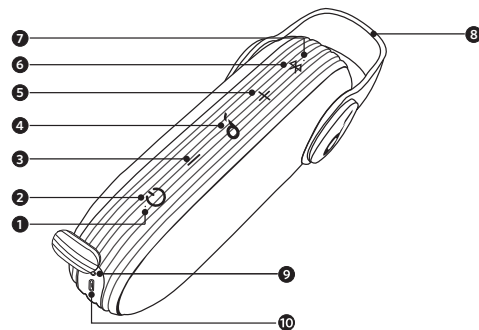

- | | | | |
|---|-------------------------|----|---------------------------|
| 1 | Voedingsindicatielampje | 6 | Bluetooth-knop |
| 2 | Aan/uit-knop | 7 | Bluetooth-indicatielampje |
| 3 | Knop volume - | 8 | Draaggreep |
| 4 | Multifunctionele knop | 9 | 3,5 mm audio-ingang |
| 5 | Knop volume + | 10 | micro-USB-poort |

66

NL Uw Soundcore Icon gebruiken

1. In-/uitschakelen

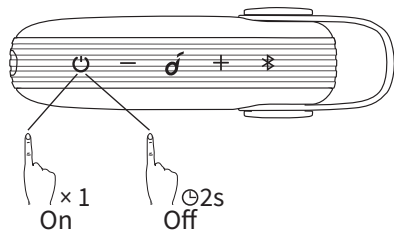

AAN	Druk één keer
UIT	Houd de knop langer dan 2 seconden ingedrukt

a. Bluetooth-modus

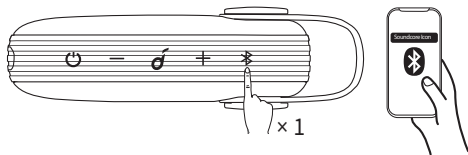

67



Knippert blauw

Bluetooth-koppelingsmodus

NL



Brandt blauw

Verbonden met een apparaat

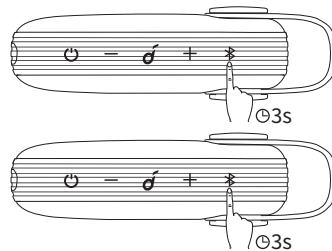

Groepsmodus True Wireless Stereo inschakelen / Verbinding True Wireless Stereo verbreken



Knippert wit

Groepsmodus True Wireless Stereo



Brandt wit

Verbonden met True Wireless Stereo

Opmerking: wanneer de True Wireless Stereo-groep is verbonden, knippert het led-indicatielampje op de eerste luidspreker blauw, terwijl het led-indicatielampje op de tweede luidspreker blauw brandt.

68

NL



Met True Wireless Stereo-technologie kunt u uw Soundcore Icon met een andere Soundcore Icon koppelen om de beste geluidseffecten te verkennen met een gescheiden linker- en rechtergeluidskanaal op de luidsprekers.



*1 Afspelen / pauzeren



*2 Volgend nummer afspelen



*3 Vorig nummer afspelen



*1 Oproep beantwoorden / beëindigen



o2s Oproep weigeren / Schakelen tussen een oproep in de wacht en een actieve oproep



o1s Huidige oproep beëindigen en binnenkomende oproep beantwoorden / Huidige oproep beëindigen en overschakelen naar oproep in de wacht



o2s Schakelen tussen luidspreker en telefoon als audiobron



*1 Huidige oproep in de wacht zetten en binnenkomende oproep beantwoorden



o2s Siri / andere spraakbesturingssoftware activeren



Volume omhoog / omlaag



Brandt wit

In gesprek



Knippert blauw

Binnenkomende oproep

69

NL



Wanneer de Soundcore Icon is ingeschakeld, maakt deze automatisch verbinding met het laatst verbonden apparaat (indien beschikbaar). Als dit niet het geval is, drukt u op de Bluetooth-knop om de koppelingsmodus te activeren.

Als u een ander draadloos apparaat wilt koppelen, drukt u op de Bluetooth-knop om de koppelingsmodus opnieuw te activeren. Herhaal vervolgens de koppelingsstappen.

Hebt u verbingsproblemen? Verwijder de Soundcore Icon uit de Bluetooth-geschiedenis van uw apparaat en zorg ervoor dat de Soundcore Icon zich op minder dan 1 m afstand bevindt. Probeer vervolgens opnieuw te koppelen. Zorg er om de beste geluidskwaliteit te verkrijgen voor dat er geen obstakels tussen het verbonden apparaat en uw luidspreker staan.

b. AUX-In-modus

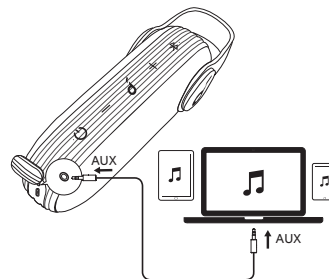

* De SoundLine AUX-kabel wordt afzonderlijk verkocht.

70

NL



Wanneer u een audiokabel aansluit, schakelt het apparaat automatisch over naar de AUX-modus. Als de AUX-modus is ingeschakeld, bedient u het afspelen van audio via het gekoppelde apparaat.

Uw Soundcore Icon opladen

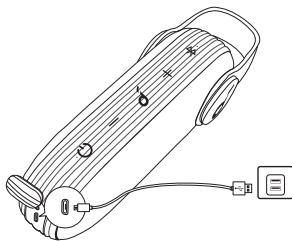

Knippert langzaam rood Batterij bijna leeg



Brandt rood Batterij wordt opgeladen

Uit

Batterij volledig opgeladen

71

NL



Gebruik de meegeleverde USB-kabel om uw Soundcore Icon op te laden en zorg ervoor dat de batterij van het apparaat volledig is opgeladen vóór het eerste gebruik.

Koppel uw luidspreker los van de oplader wanneer de batterij volledig is opgeladen. Laad uw luidspreker niet op gedurende langere perioden. Bewaar de luidspreker op een koele plek als deze niet wordt gebruikt.

Specificaties



Specificaties zijn onderhevig aan verandering zonder kennisgeving.

Ingang: 5 V \equiv 1 A

Audio-uitgang: 10 W

Batterijcapaciteit: max. 2600 mAh

Oplaadtijd: 4,0 uur

Afspeltime (afhankelijk van volume en muziekinhoud): 12 uur

Afmetingen: 182 x 61 x 62 mm

Gewicht (zonder verpakking): 349 g

Bluetooth-versie: V5.0

Bluetooth-bereik: 20 m

72

NO Sikkerhetsinstruksjoner

- Unngå å miste produktet.
- Ikke demonter produktet.
- Soundcore Icon kan legges i opptil 1 m dypt vann i opptil 30 minutter.
- Unngå ekstreme temperaturer.
- Ikke bruk enheten utendørs under tordenvær.
- Ikke bruk etsende rengjøringsmiddel eller olje til å vaske.

Hva er inkludert

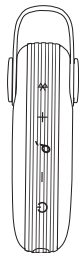

73

Kort oppsummert

NO

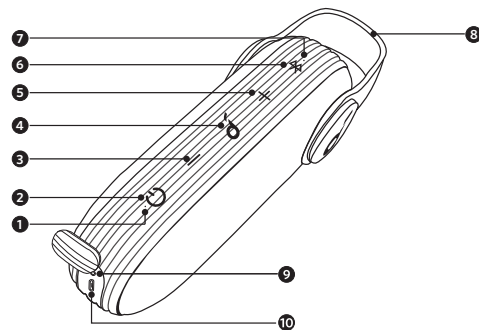

- | | | | |
|---|--------------------|----|-----------------------|
| 1 | Av/på-indikator | 6 | Bluetooth-knapp |
| 2 | Av/på-knapp | 7 | Bluetooth-indikator |
| 3 | Volum ned-knapp | 8 | Bærehåndtak |
| 4 | Flerfunksjonsknapp | 9 | 3,5 mm lydinningsport |
| 5 | Volum opp-knapp | 10 | micro-USB-port |

74

NO Bruke Soundcore Icon

1. Slå av/på

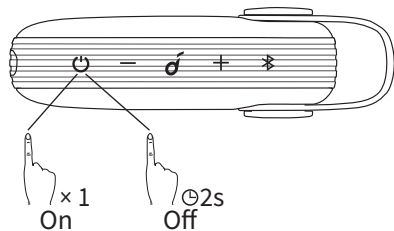

PÅ	Trykk
AV	Trykk og hold nede i mer enn 2 sekunder

a. Bluetooth-modus

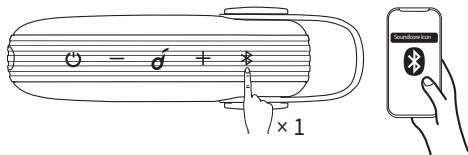

75



Blinker blått

Bluetooth-paringsmodus

NO



Lyser kontinuerlig blått

Koblet til en enhet

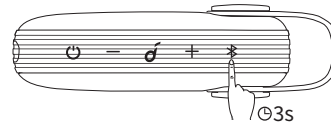
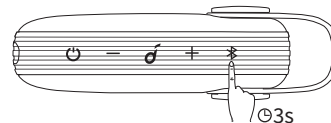

Koble til True Wireless Stereo-paringsmodus / koble fra True Wireless Stereo



Blinker hvitt

True Wireless Stereo-paringsmodus



Lyser kontinuerlig hvitt

Koblet til True Wireless Stereo

Merk: Når True Wireless Stereo-gruppen er tilkoblet, blinker lampen på den første høyttaleren blått og lampen på den andre høyttaleren lyser kontinuerlig blått

76

NO



Med True Wireless Stereo-teknologi kan du pare Soundcore Icon med en annen Soundcore Icon for å få de beste lydeffektene med venstre og høyre lydkanaler separert på begge høyttalere.

- *1 Spill av / pause
- *2 Spill neste sang
- *3 Spill forrige sang
- *1 Svar på / avslutt samtale
- *2s Avslå samtale / bytt mellom en samtale på vent og en aktiv samtale
- *1s Avslutt gjeldende samtale og svar på innkommende anrop / avslutt gjeldende samtale og bytt til samtale som er satt på vent
- *2s Bytt lydkilde mellom høyttaler og telefon
- *1 Sett gjeldende samtale på vent, og svar på innkommende anrop
- *2s Aktiver Siri / annen talekontrollprogramvare
- Volum opp/ned
- Lyser kontinuerlig hvitt I en samtale
- Blinker blått Innkommende anrop

77

NO



Når Soundcore Icon er slått på, kobles den automatisk til den sist tilkoblede enheten hvis den er tilgjengelig. Hvis ikke trykker du på Bluetooth-knappen for å aktivere paringsmodus. Hvis du vil pare en annen enhet, trykker du på Bluetooth-knappen for å gå tilbake til paringsmodus. Deretter gjentar du paringstrinnene. Har du tilkoblingsproblemer? Fjern Soundcore Icon fra enhetens Bluetooth-historikk, og sørg for at den er under 1 meter unna. Deretter prøver du å pare igjen. For å få best mulig lyd kvalitet må du kontrollere at det er en klar siktlinje mellom den tilkoblede enheten og høyttaleren.

b. AUX-In-modus

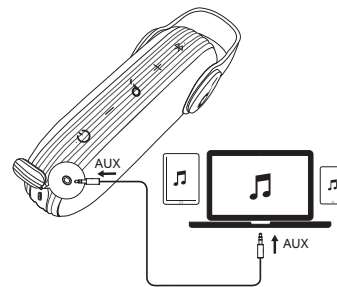

* SoundLine AUX-kabel selges separat.

78

NO

Hvis du kobler til en lyd-kabel, bytter enheten automatisk til AUX-modus. Når du bruker AUX-modus, kontrollerer du lydavspillingen via den tilkoblede enheten.

Lade Soundcore Icon

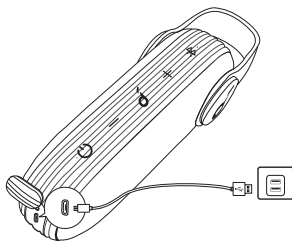

Blinker sakte rødt

Lavt batterinivå



Lyser kontinuerlig rødt

Lading

Av

Fulladet

79

NO

Bruk den medfølgende USB-kabelen for å lade Soundcore Icon, og sørg for at den er helt oppladet før du bruker den første gang. Koble høyttaleren fra laderen når enheten er fulladet. Ikke lade høyttaleren for lenge om gangen. Når enheten ikke er i bruk, bør den oppbevares på et kjølig sted.

Spesifikasjoner



Spesifikasjonene kan endres uten varsel.

Strømtilførsel: 5 V $\overline{\text{---}}$ 1 A

Lydutgang: 10 w

Batterikapasitet: maks. 2600 mAh

Ladetid: 4,0 timer

Avspillingstid (varierer etter volumnivå og musikkinnhold): 12 timer

Størrelse: 182 x 61 x 62 mm

Vekt (uten emballasje): 349 g

Bluetooth-versjon: V5.0

Bluetooth-dekningsområde: 20 m

80

SV Säkerhetsföreskrifter

- Undvik att tappa produkten.
- Plocka inte isär produkten.
- Soundcore Icon kan sänkas ned under vatten till högst 1 m djup i upp till 30 minuter.
- Undvik extrema temperaturer.
- Använd inte produkten utomhus när det åskar.
- Använd inte frätande rengöringsmedel/-oljor för rengöring.

Innehåll

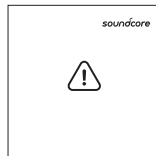
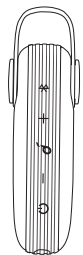

81

Överblick

SV

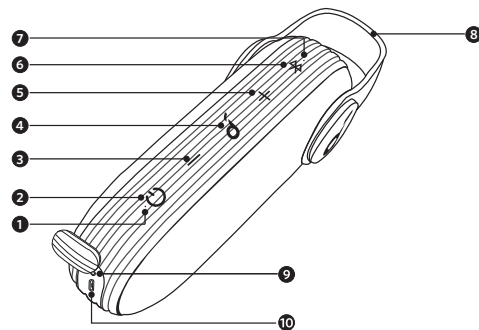

- | | | | |
|---|--------------------|----|---------------------|
| 1 | Strömindikator | 6 | Bluetooth-knapp |
| 2 | Strömbrytare | 7 | Bluetooth-indikator |
| 3 | Volym - knapp | 8 | Handtag |
| 4 | Flerfunktionsknapp | 9 | 3,5 mm ljudingång |
| 5 | Volym + knapp | 10 | micro USB-port |

82

SV Använda Soundcore Icon

1. Slå på/av

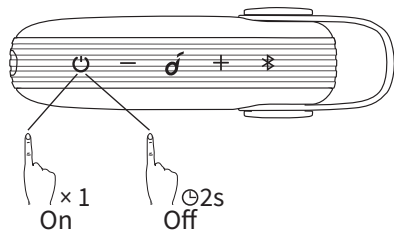

PÅ	Tryck en gång
AV	Håll intryckt i mer än 2 sekunder

a. Bluetooth-läge

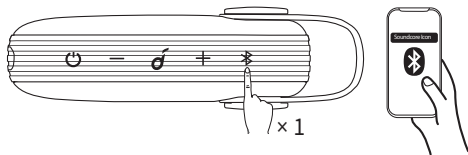

Blinkar blått

Bluetooth-parkopplingsläge



Lyser blått

Ansluten till en enhet

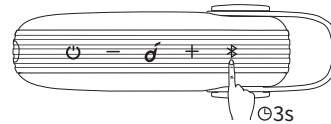
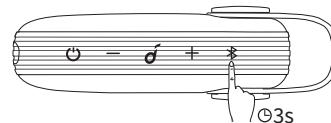

Aktivera/inaktivera gruppläge för True Wireless Stereo



Blinkar vitt

True Wireless Stereo-gruppläge



Lyser vitt

Ansluten till True Wireless Stereo

Obs! När True Wireless Stereo-gruppen är aktiverad blinkar lysdioden på den första högtalaren blått, lysdioden på den andra högtalaren lyser blått.

SV



Med True Wireless Stereo-teknik kan du parkoppla Soundcore Icon med en annan Soundcore Icon för att få bästa möjliga ljudeffekter med vänster och höger ljudkanal separerade på de båda högtalarna.

- *1 Spela upp/pausa
- *2 Spela upp nästa låt
- *3 Spela upp föregående låt
- *1 Svvara/avsluta samtal
- *2s Avvisa samtal/växla mellan ett parkerat och ett aktivt samtal
- *1s Avsluta pågående samtal och besvara inkommande samtal/avsluta pågående samtal och växla till parkerat samtal
- *2s Växla ljudkälla mellan högtalare och telefon
- *1 Parkera det pågående samtalet och besvara inkommande samtal
- *2s Aktivera Siri/annan röststyrningsprogramvara
- Volym upp/ned
- Lyser vitt I ett samtal
- Blinkar blått Inkommande samtal

85

SV



När Soundcore Icon är påslagen ansluter den automatiskt till den senast anslutna enheten om den är tillgänglig. Om inte trycker du på Bluetooth-knappen för att aktivera parkopplingsläget.

Om du vill parkoppla med en annan enhet trycker du på Bluetooth-knappen för att återaktivera parkopplingsläget. Sedan uppberar du parkopplingsstegen.

Har du anslutningsproblem? Ta bort Soundcore Icon från din enhets Bluetooth-historik och se till att den är mindre än en meter bort. Prova sedan att parkoppla igen. För bästa möjliga ljudkvalitet ska du se till att det inte finns några synliga hinder mellan den anslutna enheten och högtalaren.

b. AUX-ingångsläge

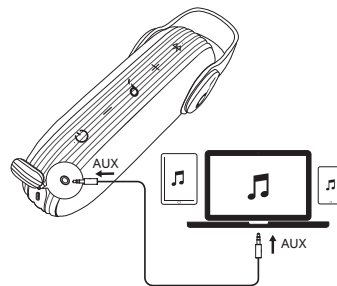

* SoundLine AUX-kabel säljs separat.

86

SV

Om du ansluter en ljudkabel växlar enheten automatiskt till AUX-läge. När du använder AUX-läget styr du ljuduppspelningen via den anslutna enheten.

Ladda Soundcore Icon

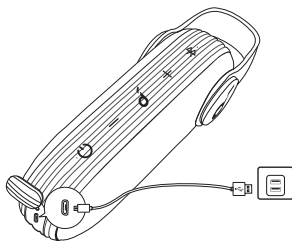

Blinkar långsamt rött Låg batterinivå



Lyser rött Laddar

Av

Fulladdad

87

SV

Använd den medföljande USB-kabeln för att ladda Soundcore Icon och se till att den är fulladdad före första användningen. Koppla bort högtalaren från laddaren när den är fulladdad. Ladda inte högtalaren för länge. Förvara högtalaren på en sval plats när du inte använder den.

Specifikationer



Specifikationerna kan ändras utan föregående meddelande.

Ingång: 5 V $\overline{\text{---}}$ 1 A

Ljudutgång: 10 W

Batterikapacitet: Max. 2600 mAh

Laddningstid: 4,0 timmar

Speltid (varierar beroende på volymnivå och innehåll): 12 timmar

Storlek: 182 x 61 x 62 mm

Vikt (utan förpackning): 349 g

Bluetooth-version: V5.0

Bluetooth-räckvidd: 20 m

88

RU Инструкции по технике безопасности

- Оберегайте устройство от падений.
- Не разбирайте устройство.
- Soundcore Icon можно погружать в воду на глубину до 1 м и не более чем на 30 минут.
- Оберегайте устройство от воздействия экстремальных температур.
- Не используйте устройство вне помещений во время грозы.
- Не используйте для очистки устройства масла / чистящие средства, вызывающие коррозию.

Комплект поставки

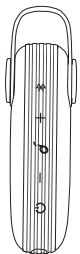

89

Краткий обзор

RU

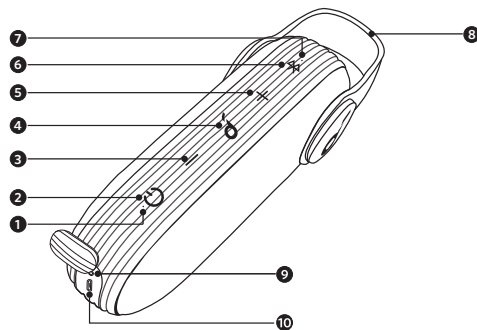

- | | | | |
|---|-----------------------------|----|----------------------------|
| 1 | Индикатор питания | 6 | Кнопка Bluetooth |
| 2 | Кнопка питания | 7 | Индикатор Bluetooth |
| 3 | Кнопка уменьшения громкости | 8 | Ручка для переноски |
| 4 | Многофункциональная кнопка | 9 | Входной аудиоразъем 3,5 мм |
| 5 | Кнопка увеличения громкости | 10 | Порт Micro-USB |

90

RU Использование Soundcore Icon

1. Включение / выключение

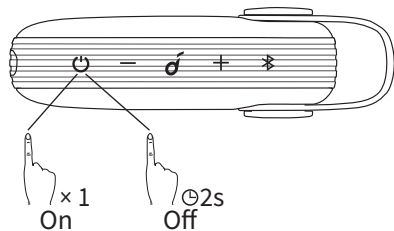

ВКЛ. Одно нажатие

ВЫКЛ. Нажмите и удерживайте более 2 секунд

а. Режим Bluetooth

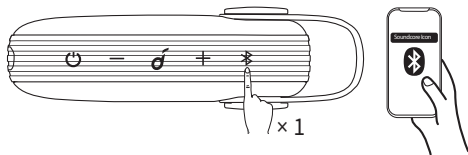

Мигает синим

Режим сопряжения через Bluetooth

RU



Постоянно горит синим

Установлено подключение к устройству

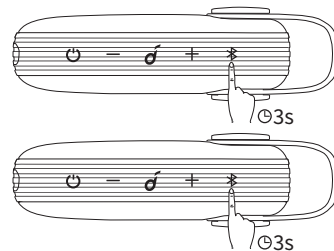

Переход в групповой режим True Wireless Stereo / выход из True Wireless Stereo



Мигает белым

Групповой режим True Wireless Stereo



Постоянно горит белым

Подключено к True Wireless Stereo

Примечание. При включении группового режима True Wireless Stereo светодиодный индикатор на первой колонке будет мигать синим светом, а светодиодный индикатор на второй колонке будет непрерывно гореть синим светом.

RU



С технологией True Wireless Stereo вы можете выполнить сопряжение Soundcore Icon с другой колонкой Soundcore Icon, чтобы наслаждаться стереозвучанием с обеих колонок.

- *1 Воспроизведение / пауза
- *2 Воспроизведение следующей композиции
- *3 Воспроизведение предыдущей композиции
- *1 Ответить / завершить вызов
- 2s Отклонить вызов / переключение между удерживаемым и активным вызовами
- 1s Завершение текущего вызова и ответ на поступающий вызов / завершение текущего вызова и переключение на удерживаемый вызов
- 2s Переключение источника аудио между колонкой и телефоном
- *1 Поставить текущий вызов на удержание и ответить на входящий вызов
- 2s Активация Siri / другого ПО голосового управления
- Увеличение / уменьшение громкости

- Постоянно горит белым Выполняется вызов
- Мигает синим Входящий вызов

93

RU



При включении Soundcore Icon подключается к последнему подключенному устройству, если оно доступно. Если этого не происходит, нажмите кнопку Bluetooth, чтобы включить режим сопряжения. Для сопряжения с другим устройством нажмите кнопку Bluetooth, чтобы повторно войти в режим сопряжения. Затем повторите указанные действия для сопряжения с устройством.

Возникли проблемы с подключением? Удалите Soundcore Icon из истории подключений Bluetooth на устройстве, убедитесь, что устройство и Soundcore Icon находятся на расстоянии менее 90 см (3 футов) друг от друга. Затем повторите попытку сопряжения. Для наилучшего качества звучания убедитесь, что колонка и сопряженное устройство находятся в прямой видимости друг от друга.

в. Режим AUX-In

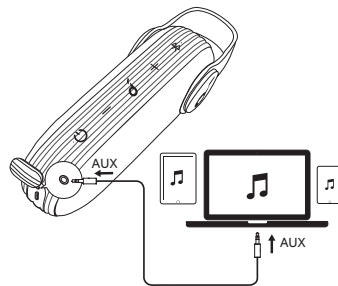

* Кабель SoundLine AUX приобретается отдельно.

94

RU



При подключении аудиокабеля устройство автоматически переходит в режим AUX.
В режиме AUX управление воспроизведением выполняется с помощью подключенного устройства.

Зарядка Soundcore Icon

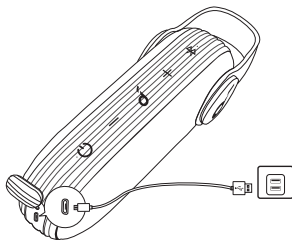

Медленно мигает красным Низкий заряд аккумулятора



Постоянно горит красным Выполняется зарядка

Не горит

Аккумулятор заряжен полностью

95

RU



Перед первым использованием воспользуйтесь входящим в комплект кабелем USB для зарядки Soundcore Icon и убедитесь, что устройство полностью заряжено.

Отключите колонку от зарядного устройства по достижении полного заряда. Не заряжайте колонку в течение длительного периода времени. Если вы не используете колонку, храните ее в прохладном месте.

Технические характеристики



Технические характеристики могут быть изменены без предварительного уведомления.

Входной ток: 5 В \equiv 1 А

Мощность звука: 10 Вт

Емкость аккумулятора: 2600 мА ч макс.

Время зарядки: 4,0 часа

Время воспроизведения (зависит от уровня громкости и воспроизводимого аудиоконтента): 12 часов

Размер: 182 x 61 x 62 мм

Вес (без упаковки): 349 г

Версия Bluetooth: V5.0

Радиус действия Bluetooth: 20 м

96

PT Instruções de Segurança

- Evite derrubar.
- Não desmonte.
- O Soundcore Icon pode ser mergulhado na água até 1 m de profundidade por até 30 minutos.
- Evite temperaturas extremas.
- Não use o dispositivo em áreas externas durante tempestades.
- Não limpe com limpadores/óleos corrosivos.

O que está Incluído

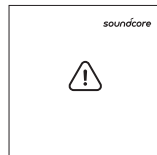
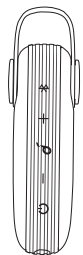

97

Visão Rápida

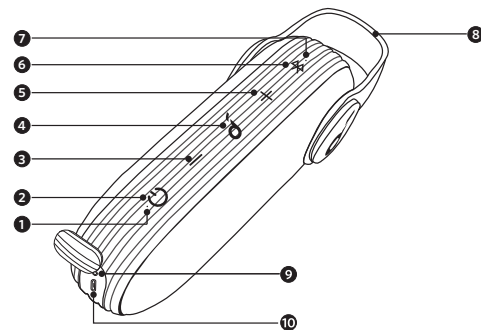

- | | | | |
|---|------------------------------|----|-------------------------------------|
| 1 | Indicador de energia | 6 | Botão Bluetooth |
| 2 | Botão Liga/Desliga | 7 | Indicador Bluetooth |
| 3 | Botão para aumentar o volume | 8 | Alça de transporte |
| 4 | Botão Multifunção | 9 | Porta de Entrada de Áudio de 3,5 mm |
| 5 | Botão para diminuir o volume | 10 | Porta micro USB |

98

PT Como usar o Soundcore Icon

1. Ligar/Desligar

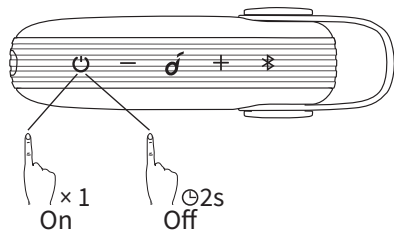

LIGAR	Pressione
DESLIGAR	Mantenha pressionado por mais de 2 segundos

a. Modo Bluetooth

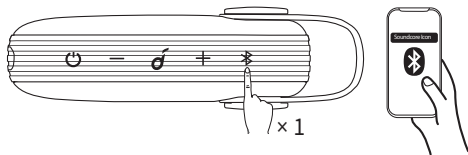

Azul piscando

Modo de Emparelhamento Bluetooth



Azul constante

Conectado a um dispositivo

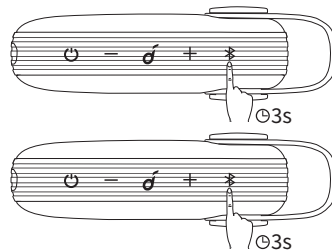

Ativar o Modo de Grupo True Wireless Stereo/Desconectar o True Wireless Stereo



Branca piscando

Modo de Grupo True Wireless Stereo



Branco Constante

Conectado ao True Wireless Stereo
Observação: quando o grupo True Wireless Stereo estiver conectado com sucesso, o indicador LED no primeiro altofalante ficará azul piscando, o indicador LED no segundo altofalante ficará azul constante.

PT



Com a tecnologia True Wireless Stereo, é possível emparelhar o Soundcore Icon a outro Soundcore Icon e explorar os melhores efeitos de som com os canais de som esquerdo e direito separados, cada um em um alto-falante diferente.

- *1 Reproduzir/Pausar
- *2 Reproduzir Próxima Música
- *3 Reproduzir Música Anterior
- *1 Atender/Encerrar Chamada
- *2s Rejeitar Chamada/Alternar entre uma chamada em espera e uma chamada ativa
- *1s Encerrar a chamada atual e atender a chamada recebida/Encerrar a chamada atual e alternar para a chamada em espera
- *2s Alternar fonte de áudio entre alto-falante e telefone
- *1 Colocar a chamada atual em espera e atender a chamada recebida
- *2s Ativar Siri/Outro Software de Controle por Voz
- Aumentar/Diminuir Volume

	Branco Constante	Em Chamada
	Azul piscando	Chamada Recebida

PT



Quando ligado, o Soundcore Icon conecta-se automaticamente ao último dispositivo conectado, se disponível. Se não estiver disponível, pressione o botão Bluetooth para ativar o modo de emparelhamento. Para emparelhar um dispositivo diferente, pressione o botão Bluetooth para acessar o modo de emparelhamento novamente. Em seguida, repita as etapas de emparelhamento.

Problemas de conexão? Remova o Soundcore Icon do histórico do Bluetooth de seu dispositivo e verifique se ele está a menos de 3 metros de distância. Em seguida, tente emparelhar novamente. Para obter a melhor qualidade de som, certifique-se de que a linha de visão entre o dispositivo conectado e o alto-falante esteja livre.

b. Modo AUX-In

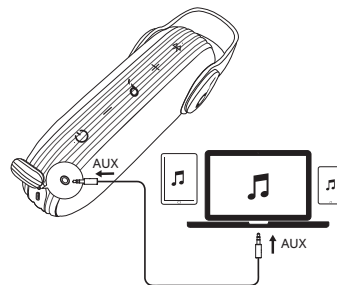

* Cabo AUX SoundLine vendido separadamente.

PT

Ao conectar um cabo de áudio, o modo AUX é automaticamente ativado. Ao usar o modo AUX, controle a reprodução de áudio por meio do dispositivo conectado.

Como recarregar o Soundcore Icon

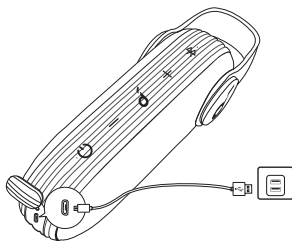

Vermelho Piscando Lentamente Bateria Fraca



Vermelho constante Carregando

Desligar

Totalmente Carregado

103

PT

Use o cabo USB incluso para carregar o Soundcore Icon e carregue totalmente antes de usar pela primeira vez. Desconecte o alto-falante do carregador quando estiver totalmente carregado. Não carregue o alto-falante por longos períodos. Quando não estiver em uso, guarde o alto-falante em um local fresco.

Especificações



As especificações estão sujeitas a alterações sem aviso prévio.

Entrada: 5 V $\overline{\text{---}}$ 1 A

Saída de áudio: 10 w

Capacidade da bateria: máx. 2600 mAh

Tempo de carregamento: 4,0 horas

Tempo de reprodução (varia de acordo com o volume e o conteúdo da música): 12hrs

Tamanho: 182 x 61 x 62 mm

Peso (sem embalagem): 349 g/12,3 oz

Versão do Bluetooth: V5.0

Alcance do Bluetooth: 20 m/66 pés

104

JP 安全にご使用いただくために

- 過度な衝撃を与えないでください。
- 危険ですので分解しないでください。
- Soundcore Icon は、30 分以内であれば水深 1 m まで沈めることができます。ただし安全のため、水中での長時間のご使用はお控えください。
- 極端な温度下では使用しないでください。
- 雷雨の激しい時は屋外での使用をお控えください。
- お手入れの際、化学薬品は使用しないでください。

パッケージ内容

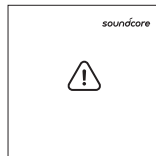
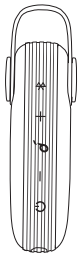

105

外観

JP

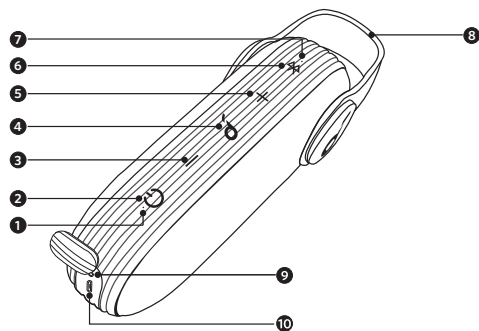

- | | |
|------------|---------------------|
| ① 電源表示 | ⑥ Bluetooth ボタン |
| ② 電源ボタン | ⑦ Bluetooth 表示 |
| ③ 音量ダウンボタン | ⑧ 持ち運び用バンド |
| ④ 多機能ボタン | ⑨ 3.5 mm オーディオ入力ポート |
| ⑤ 音量アップボタン | ⑩ Micro USB ポート |

106

JP Soundcore Icon の使用方法

電源のオン/オフ

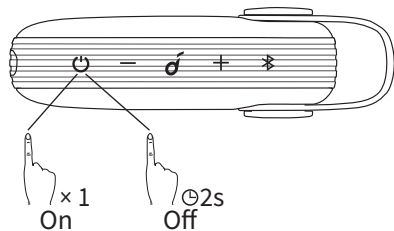

オン	押す
オフ	2 秒以上長押し

a. Bluetooth モード

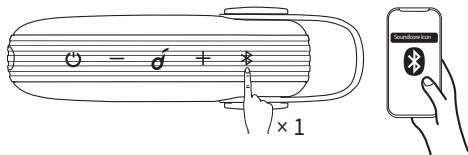

青色の点滅

Bluetooth ペ어링モード

JP



青色の点灯

機器と接続完了

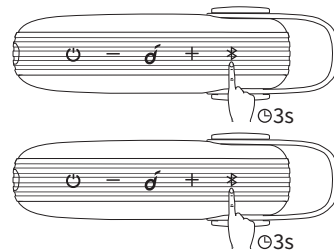

3 秒以上長押し

完全ワイヤレスステレオペアリングモード ON / OFF



白色の点滅

完全ワイヤレスステレオペアリングモード

完全ワイヤレスステレオペアリングモード
で機器に接続完了



白色の点灯

注意：ペアリングに成功すると、1 台目の
スピーカーの LED 表示が青色に点滅し、2
台目のスピーカーの LED 表示は青色に点灯
します。

JP



完全ワイヤレスステレオペアリングモードでは、2台の Soundcore Icon を接続し、より立体的なサウンドをお楽しみいただけます。

*1 再生 / 一時停止

*2 次の曲へ

*3 前の曲へ

*1 (着信時) 通話開始 / 通話終了

*2s (着信時 2 秒長押し) 通話拒否 / 通話切り替え

*1s (着信時 1 秒以上長押し) 通話を終了し、新規着信または保留中の通話に応答

*2s 通話中に音源をスピーカーとスマートフォン間で切り替え

*1 通話を保留し、新規着信に応答

*2s Siri やその他音声認識ソフトの起動

音量のアップ / ダウン

白色の点灯 通話中

青色の点滅 着信

109

JP



電源が入ると、Soundcore Icon は前回接続していた機器と自動的に接続します。接続されない場合は、Bluetooth ボタンを押して、ペアリングモードを起動します。

他の機器と接続したい場合は、Bluetooth ボタンを押して再度ペアリングの設定をしてください。

ペアリングができない場合は、接続する機器の Bluetooth の履歴から Soundcore Icon を削除し、接続機器と約 90 cm 以内の距離で、再度ペアリングを行ってください。高音質でお楽しみいただくために、接続機器と Soundcore Icon との間に干渉物を置かないようにしてください。

b. AUX モード

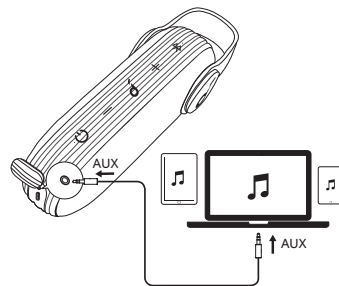

* SoundLine AUX ケーブルは別売です。

110

JP



オーディオケーブルを挿し込むと、自動的に AUX モードに切り替わります。

AUX モードを使用する際には、接続機器側の再生機能进行操作してください。

Soundcore Icon の充電方法

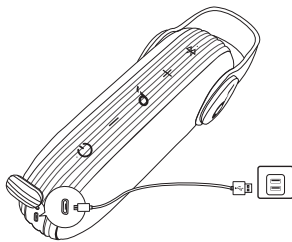

● 赤色の点滅

バッテリー残量が少なくなっています

● 赤色の点灯

充電中

オフ

満充電

JP



付属の USB ケーブルを使って Soundcore Icon の充電を行います。初回使用時は、使用前に満充電の状態まで充電してからお使いください。

充電が完了したら、Soundcore Icon を充電器から取り外してください。充電完了後は、充電し続けしないでください。

使用しないときは、涼しい場所に保管してください。

製品の仕様



仕様は予告なく変更されることがあります。

入力：5V=1A

オーディオ出力：10W

バッテリー容量：2600mAh

充電時間：約4時間

再生可能時間（音量や音楽コンテンツにより異なる）：最大12時間

サイズ：約182 x 61 x 62mm

重量（本体のみ）：約349g

Bluetooth：5.0

Bluetooth 動作範囲：20m

KO 안전 지침

- 떨어뜨리지 마십시오.
- 분해하지 마십시오.
- Soundcore Icon 은 최대 30 분 동안 최대 1m 까지 물에서 견딜 수 있습니다.
- 너무 높거나 낮은 기온에 노출하지 마십시오.
- 뇌우가 내릴 때는 야외에서 이 장치를 사용하지 마십시오.
- 세척을 위해 부식성 세척제나 오일을 사용하지 마십시오.

제품 구성

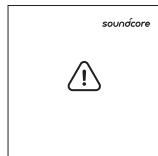
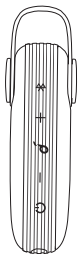

113

요약

KO

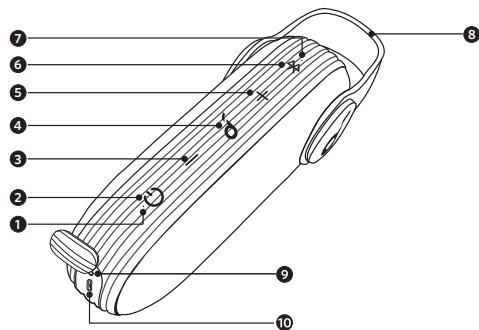

- 1 전원 표시등
- 2 전원 버튼
- 3 볼륨 - 버튼
- 4 다기능 버튼
- 5 볼륨 + 버튼

- 6 Bluetooth 버튼
- 7 Bluetooth 표시등
- 8 휴대용 손잡이
- 9 3.5mm 오디오 입력 포트
- 10 Micro USB 포트

114

KO Soundcore Icon 사용하기

1. 전원 켜기 / 끄기

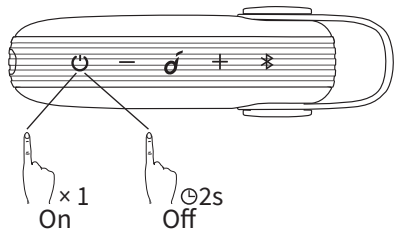

켜기 한 번 누릅니다
 끄기 2 초 이상 길게 누릅니다

a. Bluetooth 모드

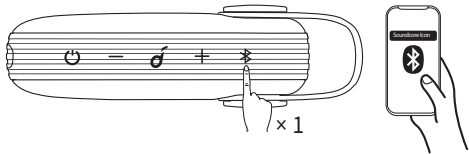

파란색으로 깜박임 Bluetooth 페어링 모드
 파란색 유지 장치에 연결되었습니다

KO

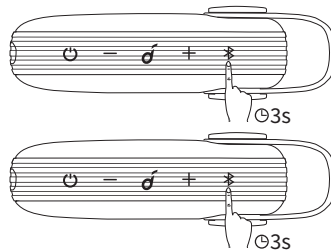

x 3s TWS(True Wireless Stereo) 그룹 모드 시작 /TWS(True Wireless Stereo) 분리

흰색으로 깜박임 TWS(True Wireless Stereo) 그룹 모드
 TWS(True Wireless Stereo) 에 연결됨

흰색 유지

참고 사항 : TWS(True Wireless Stereo) 그룹이 연결되면 첫 번째 스피커의 LED 표시등이 파란색으로 깜박이고 두 번째 스피커의 LED 표시등은 파란색으로 유지됩니다.

KO



TWS(True Wireless Stereo) 기술을 사용하면 Soundcore Icon 을 또 다른 Soundcore Icon 과 페어링하여 두 스피커에서 분리된 왼쪽과 오른쪽 사운드 채널을 통해 최상의 사운드 효과를 누릴 수 있습니다.

- *1 재생 / 일시중지
- *2 다음 곡 재생
- *3 이전 곡 재생
- *1 전화 받기 / 통화 종료
- *2s 통화 거절 / 대기 중인 통화와 연결된 통화 간 전환
- *1s 현재 통화를 종료하고 걸려오는 전화를 받음 / 현재 통화를 종료하고 대기 중인 통화로 전환
- *2s 스피커와 전화기 간 오디오 소스 전환
- *1 현재 연결된 통화를 대기 상태로 전환하고 걸려오는 전화 받기
- *2s Siri/ 기타 음성 제어 소프트웨어 활성화
- 볼륨 높이기 / 줄이기
- 흰색 유지 통화 중
- 파란색으로 깜박임 통화 수신 중

KO



Soundcore Icon 은 전원을 켤 때 가장 최근에 연결한 장치가 감지되면 해당 장치를 자동으로 연결합니다 . 감지되지 않으면 Bluetooth 페어링 버튼을 눌러 페어링 모드를 활성화합니다 .

다른 장치를 페어링하려면 Bluetooth 버튼을 눌러 페어링 모드를 다시 시작합니다 . 그런 다음 페어링 단계를 반복합니다 .

연결에 문제가 있습니까 ? 장치의 Bluetooth 기록에서 Soundcore Icon 을 제거하고 90cm 이내로 간격을 유지합니다 . 그런 다음 다시 페어링을 시도하십시오 . 최고의 음질을 원한다면 연결 장치와 스피커 사이를 가로막는 방해물이 없어야 합니다 .

b. AUX-In 모드

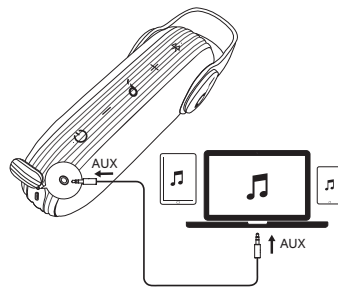

* SoundLine AUX 케이블은 별도로 판매합니다 .

KO

오디오 케이블을 플러그인하면 자동으로 AUX 모드로 전환됩니다.
AUX 모드를 사용할 때는 연결된 장치를 통해 오디오 재생을 제어하십시오.

Soundcore Icon 충전하기

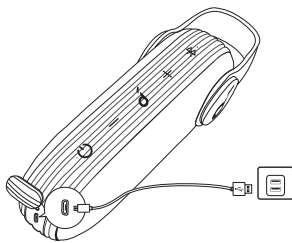

빨간색으로 천천히 깜박임

배터리 부족



빨간색 유지

충전

끄기

완전히 충전됨

KO

함께 제공되는 USB 케이블로 Soundcore Icon 을 충전하십시오. 처음 사용할 때는 반드시 완전히 충전한 후에 사용하십시오.
완전히 충전되면 충전기에서 스피커를 분리합니다. 완전히 충전된 후에는 스피커를 충전하지 마십시오.
사용하지 않을 경우 서늘한 곳에 스피커를 보관하십시오.

사양



사양은 사전 통지 없이 변경될 수 있습니다.

입력 : 5V $\overline{\text{---}}$ 1 A

오디오 출력 : 10w

배터리 용량 : 최대 2600mAh

충전 시간 : 4.0 시간

재생 시간 (볼륨 수준과 음악 콘텐츠에 따라 달라짐) : 12 시간

크기 : 182 x 61 x 62 mm / 7.2 x 2.4 x 2.4 인치

무게 (포장 제외) : 349 g / 12.3 oz

Bluetooth 버전 : V5.0

Bluetooth 범위 : 20 m / 66 ft

CN 安全须知

- 避免掉落。
- 请勿拆卸设备。
- Soundcore Icon 可浸没 1 米水深长达 30 分钟。
- 避免在极端温度下使用。
- 雷暴天气期间，请勿在户外使用本设备。
- 请勿使用任何具有腐蚀性的清洁剂 / 油来清洁设备。

内含物品

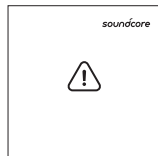
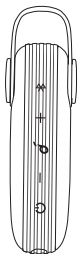

121

概览

CN

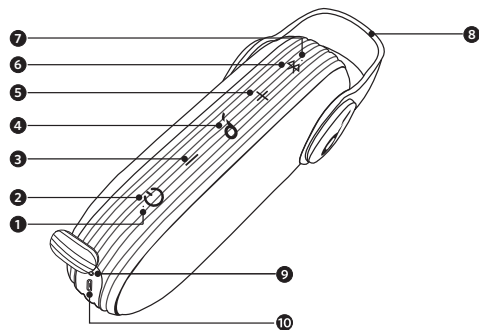

- 1 电源指示灯
- 2 电源按钮
- 3 音量降低按钮
- 4 多功能按钮
- 5 音量升高按钮

- 6 蓝牙按钮
- 7 蓝牙指示灯
- 8 提手
- 9 3.5mm 音频输入端口
- 10 micro USB 端口

122

CN 使用 Soundcore Icon

1. 打开 / 关闭

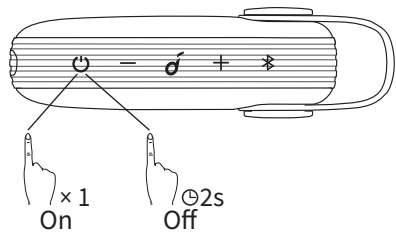

开	按下
关	长按 2 秒以上

a. 蓝牙模式

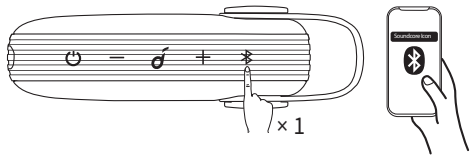

123



蓝灯闪烁

蓝牙配对模式



蓝灯常亮

已连接到设备

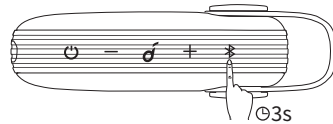
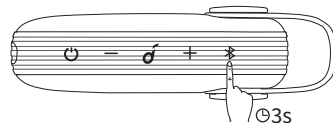

进入 True Wireless Stereo 群组模式 / 断开配对的 True Wireless Stereo



白灯闪烁

True Wireless Stereo 群组模式



白灯常亮

已连接到 True Wireless Stereo

注意：当 True Wireless Stereo 组成成功连接时，第一个扬声器上的 LED 指示灯将闪烁蓝色，第二个扬声器上的 LED 指示灯将白色常亮。

124

CN



使用 True Wireless Stereo 技术将您的 Soundcore Icon 与另外一台 Soundcore Icon 配对，可使左右声道分别连接至两个扬声器，从而实现最佳音响效果。



*1 播放 / 暂停



*2 播放下一曲目



*3 播放上一曲目



*1 接听通话 / 结束通话



*25 拒绝通话 / 在保持的通话和当前通话之间切换



*015 结束当前通话后接听来电 / 结束当前通话后切换至保持的通话



*25 在扬声器与手机之间切换音频来源



*1 保持当前通话并接听来电



*25 激活 Siri/ 其他语音控制软件



音量升高 / 降低

○ 白灯常亮

通话中



蓝灯闪烁

收到来电

125

CN



Soundcore Icon 在打开后会自动连接至上次连接的设备（如有）。如果未曾连接设备，按“蓝牙配对”按钮激活配对模式。要配对不同设备，请按“蓝牙”按钮重新进入配对模式。然后，重复配对步骤即可。

遇到连接问题该怎么办？从设备的蓝牙历史记录中移除 Soundcore Icon，确保它在 3 英尺之内。然后，再次尝试配对。为了获得最佳音质，请确保相连设备与扬声器之间没有任何遮挡。

b. AUX-In 模式

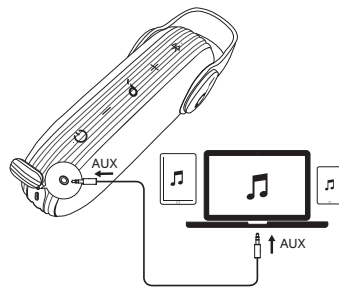

* SoundLine AUX 线单独出售。

126

CN



插入音频连接线将自动切换到 AUX 模式。

使用 AUX 模式时，将通过连接的设备控制音频播放。

Soundcore Icon 充电

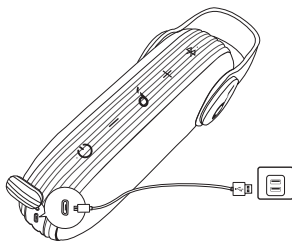

红灯慢速闪烁

电量低



红灯常亮

充电

熄灭

已充满

127

CN



首次使用之前，请先使用随附的 USB 线为 Soundcore Icon 充电，并确保其已充满电。

充满电后，将扬声器与充电器断开。请勿对扬声器长时间充电。不使用时，请将扬声器存放在阴凉处。

产品规格



规格如有变更，恕不另行通知。

输入电源：5V $\overline{\text{---}}$ 1A

音频输出：10w

电池容量：最大 2600 mAh

充电时间：4.0 小时

播放时间（因音量和音乐内容而异）：12hrs

尺寸：182 x 61 x 62 毫米 / 7.2 x 2.4 x 2.4 英寸

重量（不含包装）：349 克 / 12.3 盎司

蓝牙版本：V5.0

蓝牙范围：20 米 / 66 英尺

128

TW 安全指示

- 避免掉落。
- 請勿拆卸產品。
- Soundcore Icon 可浸入最深達 1 公尺的水中，時間最長可 30 分鐘。
- 避免極端溫度。
- 請勿在雷雨天候中於戶外使用本裝置。
- 請勿使用具腐蝕性的清潔劑 / 油料進行清潔。

內容物

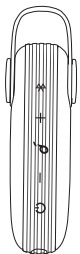

129

概觀

TW

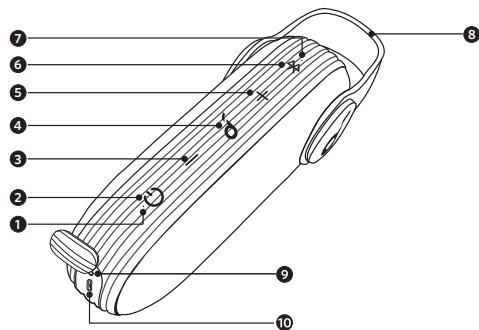

- | | |
|----------|------------------|
| 1 電源指示燈 | 6 藍牙按鈕 |
| 2 電源按鈕 | 7 藍牙指示燈 |
| 3 音量降低按鈕 | 8 手提握把 |
| 4 多功能按鈕 | 9 3.5mm 音訊輸入連接埠 |
| 5 音量增加按鈕 | 10 micro USB 連接埠 |

130

TW 使用 Soundcore Icon

1. 開啟 / 關閉

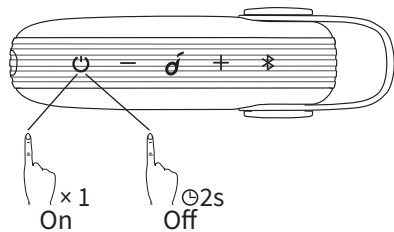

開啟	按下
關閉	按住超過 2 秒

a. 藍牙模式

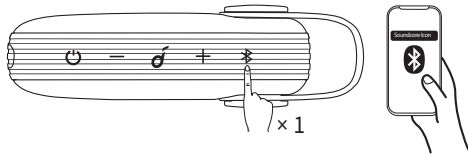

閃爍藍燈

藍牙配對模式

TW



持續亮起藍燈

已連線至裝置

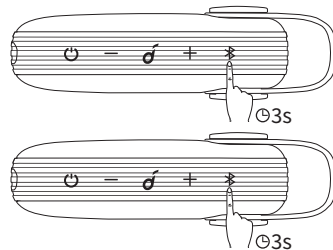

進入真無線立體聲群組模式 / 中斷真無線立體聲



閃爍白燈

真無線立體聲群組模式



持續亮起白燈

已連線至真無線立體聲

附註：當真無線立體聲群組成功時，第一個揚聲器上的 LED 指示燈會閃爍藍燈，而第二個揚聲器上的 LED 指示燈會持續亮起藍燈。

TW



運用真無線立體聲技術，可以將 Soundcore Icon 與另一個 Soundcore Icon 進行配對，並透過兩個揚聲器分別輸出左聲道與右聲音源，實現最佳音效體驗。

- *1 播放 / 暫停
 - *2 播放下一首
 - *3 播放前一首
 - *1 接聽通話 / 結束通話
 - *25 拒絕通話 / 在保留通話和進行中通話間切換
 - *15 結束目前通話並接聽來電 / 結束目前通話並切換至保留通話
 - *25 在揚聲器或手機間切換音訊來源
 - *1 保留目前通話並接聽來電
 - *25 啟動 Siri / 其它語音控制軟體
 - 音量增加 / 降低
- | | | |
|--|--------|-----|
| | 持續亮起白燈 | 通話中 |
| | 閃爍藍燈 | 來電 |

133



啟動時，Soundcore Icon 會自動連線至最近一次連線的裝置 (若有)。如果沒有，請按下藍牙配對按鈕來啟動配對模式。

若要配對不同的裝置，請按下藍牙按鈕重新進入配對模式。然後重複配對步驟。

有連線問題嗎？將 Soundcore Icon 由您裝置的藍牙記錄中移除，並確認裝置之間的距離小於 3 英尺。然後再次嘗試配對。為實現最佳音效，請確認連線裝置與揚聲器之間沒有遮蔽物或障礙物。

TW

b. AUX-In 模式

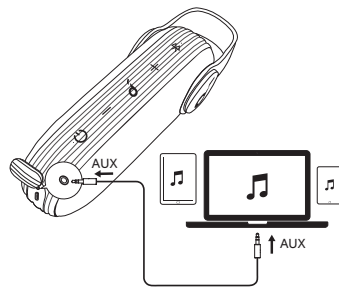

* SoundLine AUX 連接線為另售。

134

TW



插入音訊連接線將自動切換為 AUX 模式。
使用 AUX 模式時，請透過連線的裝置來控制音訊播放。

為 Soundcore Icon 充電

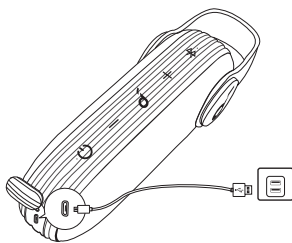

緩慢閃爍紅燈

電池電力不足



持續亮起紅燈

充電中

關閉

已完全充飽

135



請使用隨附的 USB 連接線為您的 Soundcore Icon 充電，並在第一次使用前確認已充飽電。

電力完全充飽時請中斷揚聲器與充電器的連接。請勿讓您的揚聲器進行長時間的充電。

未使用時，請將您的揚聲器放置在涼爽處。

TW

規格



規格可能隨時變更，恕不另行通知。

輸入：5V = 1A

音訊輸出：10w

電池容量：最高 2600 mAh

充電時間：4.0 小時

播放時間 (視音量大小與音樂內容而有所不同)：12 小時

尺寸：182 x 61 x 62 mm / 7.2 x 2.4 x 2.4 in

重量 (不含包裝)：349 g / 12.3 oz

藍牙版本：V5.0

藍牙範圍：20 m/66 ft

136

AR

إرشادات السلامة

- تجنب إسقاط الجهاز.
- لا تفكك الجهاز.
- يمكن غمس جهاز Soundcore Icon في الماء حتى عمق متر واحد ولغاية 30 دقيقة.
- تجنب درجات الحرارة الشديدة.
- لا تستخدم الجهاز في الخارج أثناء وجود عاصفة رعدية.
- لا تستخدم أي منظف زيت مسيب للتآكل لتنظيف الجهاز.

اللوازم المضمّنة

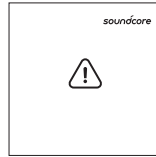
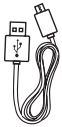
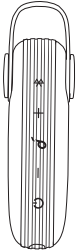

137

AR نظرة سريعة

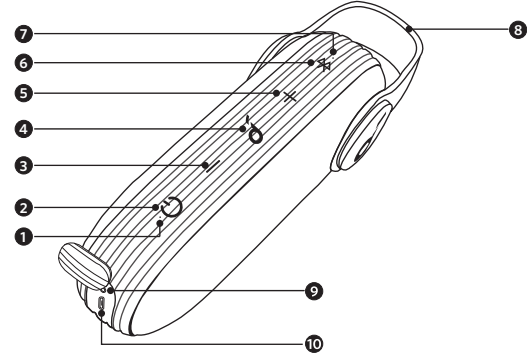

- 6 زر Bluetooth
- 7 مؤشر Bluetooth
- 8 مقبض حمل
- 9 منفذ إدخال الصوت بقياس 3,5 مم
- 10 منفذ USB من نوع ميكرو

- 1 مؤشر الطاقة
- 2 زر الطاقة
- 3 مستوى الصوت - الزر
- 4 زر متعدد الوظائف
- 5 مستوى الصوت + الزر

138

AR

استخدام جهاز Soundcore Icon

1. التشغيل / إيقاف التشغيل

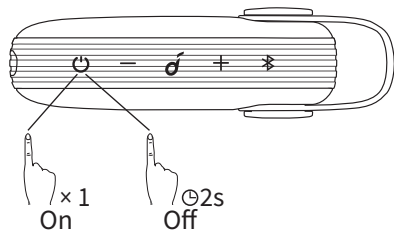

لتشغيل
الضغط
إيقاف التشغيل
الضغط باستمرار لأكثر من ثانيتين

أ. وضع Bluetooth

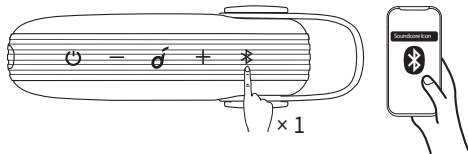

وضع الاقتران عبر Bluetooth

أزرق وامض



متصل بجهاز

أزرق ثابت

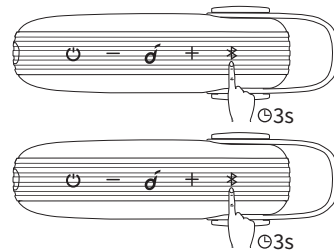

الدخول في وضع المجموعة / True Wireless Stereo
فصل True Wireless Stereo

وضع المجموعة True Wireless Stereo

أبيض وامض



متصل بتقنية True Wireless Stereo
ملاحظة: عند توصيل مجموعة True Wireless Stereo،
سيومض مؤشر LED بمكبر الصوت الأول باللون الأزرق،
وسيكون مؤشر LED بمكبر الصوت الثاني بأزرق ثابت.

أبيض ثابت



AR

بفضل تقنية True Wireless Stereo، يمكنك إقران جهاز Soundcore Icon بجهاز Soundcore Icon آخر لاستكشاف أفضل المؤثرات الصوتية مع قنوات للصوت على اليسار واليمين مفصولة على مكبري الصوت.



تشغيل / إيقاف مؤقت x1

تشغيل الأغنية التالية x2

تشغيل الأغنية السابقة x3

الرد على مكالمة / إنهاء مكالمة x1

رفض مكالمة / التبديل بين مكالمة قيد الانتظار ومكالمة نشطة x2s

إنهاء المكالمة الحالية والرد على المكالمة الواردة / إنهاء المكالمة الحالية والتبديل إلى مكالمة قيد الانتظار x1s

تبديل مصدر الصوت بين مكبر الصوت والهاتف x2s

وضع المكالمة الحالية قيد الانتظار والرد على المكالمة الواردة x1

تنشيط Siri / برامج التحكم الأخرى بالصوت x2s

رفع مستوى الصوت / خفضه

أبيض ثابت ○ في مكالمة

أزرق وامض ○- في مكالمة واردة

AR

عند تشغيل جهاز Soundcore Icon، سيتصل تلقائيًا بأخر جهاز اتصل به إذا كان متوفرًا. في حال عدم الاتصال، اضغط على زر Bluetooth لتنشيط وضع الاقتران.



للاقتران بجهاز آخر، اضغط على زر Bluetooth للدخول مجددًا في وضع الاقتران. بعد ذلك، كرر خطوات الاقتران.

هل تواجه مشاكل في الاتصال؟ أزل جهاز Soundcore Icon من محفظات Bluetooth في جهازك وتأكد من أنه على بُعد أقل من 3 أقدام. ثم حاول الاقتران من جديد. للحصول على أفضل جودة صوت، تأكد من توفر خط رؤية واضح بين الجهاز المتصل ومكبر الصوت.

ب. وضع AUX-In

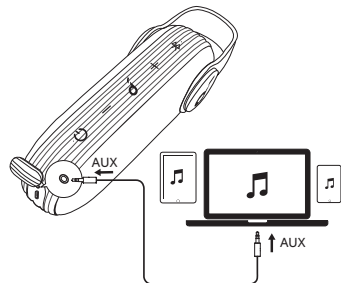

* يتم بيع كبل SoundLine AUX بشكل منفصل.

AR

سيؤدي توصيل كبل صوت إلى التبدل إلى وضع AUX تلقائيًا. عند استخدام وضع AUX، يمكنك التحكم بإعادة تشغيل الصوت عبر الجهاز المتصل.



شحن جهاز Soundcore Icon

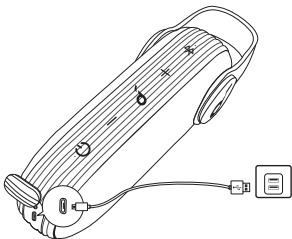

مستوى شحن البطارية منخفض

أحمر وامض ببطء

قيد الشحن

أحمر ثابت

مشحون بالكامل

إيقاف التشغيل

AR

استخدم كبل USB المضمن لشحن جهاز Soundcore Icon وتأكد من شحنه بالكامل قبل استخدامه للمرة الأولى. أفضل مكبر الصوت عن الشاحن عند اكتمال شحنه. لا تشحن مكبر الصوت لفترات طويلة. عند عدم استخدام مكبر الصوت، ضعه في مكان بارد.



المواصفات

إن المواصفات عرضة للتغيير من دون إشعار.



الإدخال: 5 فولت = 1 أمبير

إخراج الصوت: 10 واط

طاقة البطارية: 2600 ميلي أمبير في الساعة كحد أقصى

وقت الشحن: 4.0 ساعات

وقت التشغيل (يختلف بحسب مستوى الصوت ومحتوى الموسيقى): 12 ساعة

الحجم: 182 x 61 x 62 مم / 7.2 x 2.4 x 2.4 بوصة

الوزن (من دون الغلاف): 349 جرام / 12.3 أونصة

إصدار Bluetooth: V5.0

نطاق Bluetooth: 20 م / 66 قدمًا

HE

הוראות בטיחות

- מנע נפילה של ההתקן.
- אל תפרק את ההתקן.
- ה-Soundcore Icon ניתן לטבילה במים לעומק של עד מטר אחד ולמשך עד 30 דקות.
- הימנע מטמפרטורות קיצוניות.
- אל תשתמש בהתקן מחוץ למבנה במהלך סופת רעמים.
- אל תשתמש בחומר ניקוי משתך או בשמן לצורך ניקוי.

תכולת האריזה

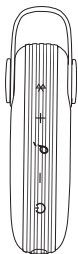

145

סקירה מהירה HE

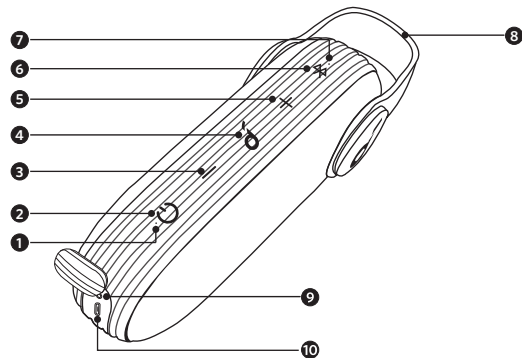

- 6 לחצן Bluetooth
- 7 נורית חייוי Bluetooth
- 8 ידית נשיאה
- 9 כניסת שמע 3.5 מ"מ
- 10 יציאת micro USB

- 1 נורית חייוי הפעלה
- 2 לחצן הפעלה
- 3 לחצן הפחתת עוצמת הקול
- 4 לחצן רב-תפקודי
- 5 לחצן הגברת עוצמת הקול

146

HE

השימוש ב-Soundcore Icon שלך

1. הפעלה/כיבוי

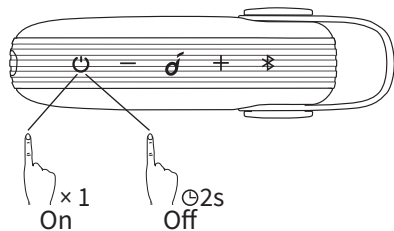

מופעל לחץ
כבוי לחץ והחזק למשך יותר מ-2 שניות

א. מצב Bluetooth

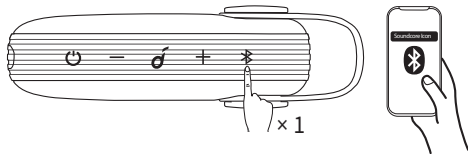

147

HE

מצב שיוך Bluetooth

כחול מהבהב



מחובר להתקן

כחול המאיר ברציפות

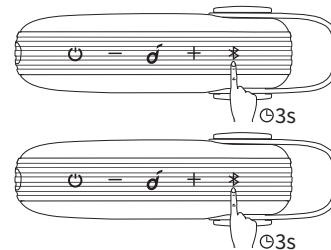

היכנס למצב 'סטריאו אלחוטי אמיתי' (TWS) קבוצתי / התנתק ממצב 'סטריאו אלחוטי אמיתי' (TWS)



מצב 'סטריאו אלחוטי אמיתי' (TWS) קבוצתי

לבן מהבהב



מחובר למצב 'סטריאו אלחוטי אמיתי' (TWS) הערה: כאשר מצב 'סטריאו אלחוטי אמיתי' (TWS) קבוצתי פועל בהצלחה, נורת LED החיווי ברמקול הראשון תהבהב בכחול, נורת LED החיווי ברמקול השני תאיר ברציפות בכחול.

לבן המאיר ברציפות





148

HE

באמצעות טכנולוגיית 'סטריאו אלחוטי אמיתי' (TWS) באפשרותך לשייך את מכשיר ה-Soundcore Icon- עם מכשירי Soundcore Icon- אחר במטרה לחקור את אפקטי הצליל הטובים ביותר עם ערוצי צליל ימניים ושמאליים נפרדים בשני הרמקולים.





הפעלה/השהיה  x1

השמע את השיר הבא  x2

השמע את השיר הקודם  x3

ענה לשיחה / סיים שיחה  x1

דחה שיחה / עבור בין שיחה מוחזקת לשיחה פעילה  x2s

סיים את השיחה הנוכחית וענה לשיחה נכנסת / סיים את השיחה הנוכחית ועבור לשיחה מוחזקת  x1s

העבר את מקור השמע בין הרמקול לטלפון  x2s

העבר את השיחה הנוכחית למצב החזקה וענה לשיחה נכנסת  x1

הפעל את Siri / תוכנה אחרת לבקרת עוצמת הקול  x2s

הגברה/החלשה של עוצמת הקול  x2s

לכן המאיר ברציפות מתנהלת שיחה

כחול מהבהב שיחה נכנסת



HE

כאשר ה-Soundcore Icon- מופעל, הוא יתחבר אוטומטית למכשיר המחובר האחרון, אם זמין. אם לא, לחץ על לחצן שייך ה-Bluetooth כדי להפעיל את מצב השייך.

כדי לשייך מכשיר אחר, לחץ על לחצן ה-Bluetooth כדי להיכנס מחדש למצב שייך. לאחר מכן חזור על שלבי השייך.

האם נתקלת בבעיות התחברות? הסר את ה-Soundcore Icon- מהיסטוריית ה-Bluetooth של המכשיר האחר וודא כי הוא נמצא במרחק של פחות מ-1 מטר ממנו. לאחר מכן נסה לשייך פעם נוספת. כדי לקבל את איכות הצליל הטובה ביותר, ודא כי קיים קו ראייה פנוי בין המכשיר המחובר לרמקול שלך.



ב. מצב AUX-In

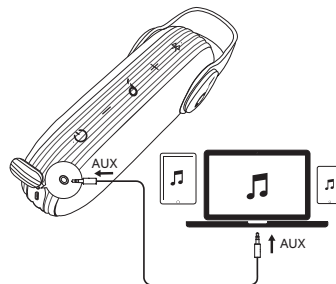

* כבל SoundLine AUX נמכר בנפרד.

HE

חיבור של כבל שמע יביא למעבר אוטומטי אל מצב AUX. בעת שימוש במצב AUX, השליטה בהשמעה נעשית דרך ההתקן המחובר.



טעינת ה-Soundcore Icon שלך

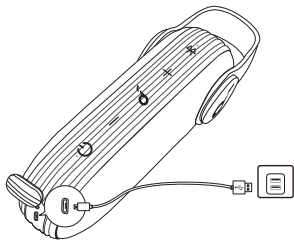

סוללה חלשה

אדום המהבהב לאט



בטעינה

אדום המאיר ברציפות



טעינה מלאה

כבוי

151

HE

השתמש בכבל ה-USB המצורף כדי לטעון את ה-Soundcore Icon וודא כי המכשיר טעון במלואו לפני השימוש הראשון בו. לאחר שהרמקול הגיע לטעינה מלאה, נתק אותו מהמטען. אל תטען את הרמקול לפרקי זמן ממושכים. כאשר הרמקול אינו בשימוש, אחסן אותו במקום קריר.



מפרט טכני

המפרט כפוף לשינויים ללא הודעה מראש.



הזנת מתח: 5 וולט = 1 אמפר

יציאת שמע: 10w

קיבולת סוללה: 2600 מילי-אמפר/שע' מקסימום

זמן טעינה: 4.0 שעות

זמן השמעה (משתנה לפי עוצמת הקול וסוג המוזיקה): 12 שעות

גודל: 61 x 182 x 62 מ"מ / 2.4 x 2.4 x 7.2 אינץ'

משקל (ללא אריזה): 349 גרם / 12.3 אונקיות

גרסת Bluetooth: גרסה 5.0

טווח Bluetooth: 20 מ' / 66 רגל

152

TR Güvenlik Talimatları

- Düşürmemeye özen gösterin.
- Parçalarına ayırmayın.
- Soundcore Icon yaklaşık 30 dakika boyunca 1 metreye kadar suya daldırılabilir.
- Ürünü aşırı ısıya maruz bırakmayın.
- Fırtına esnasında cihazı açık havada kullanmayın.
- Temizlemek için aşındırıcı temizlik malzemesi/yağ kullanmayın.

İçindekiler

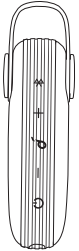

153

Genel Bakış

TR

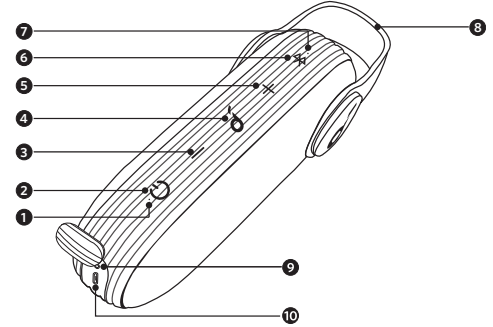

- | | | | |
|---|-------------------|----|------------------------------------|
| 1 | Güç Göstergesi | 6 | Bluetooth Düğmesi |
| 2 | Güç Düğmesi | 7 | Bluetooth Göstergesi |
| 3 | Ses Azaltma Düğme | 8 | Taşıma Kulpu |
| 4 | Çok Amaçlı Düğme | 9 | 3,5 mm Ses Girişi Bağlantı Noktası |
| 5 | Ses Artırma Düğme | 10 | Mikro USB Bağlantı Noktası |

154

TR Soundcore Icon'ın Kullanımı

1. Açma/Kapama

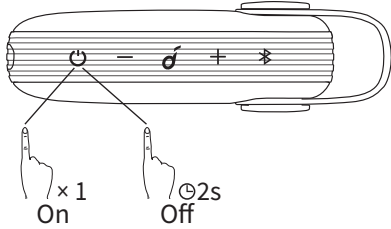

AÇ	Düğmeye basın
KAPAT	2 saniyeden uzun süre basılı tutun

a. Bluetooth modu

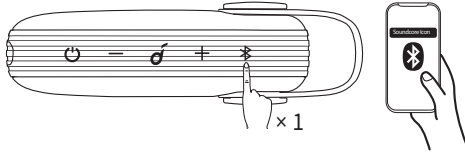

Yanıp Sönen Mavi

Bluetooth Eşleştirme Modu



Sabit Mavi

Bir cihaza bağlandı

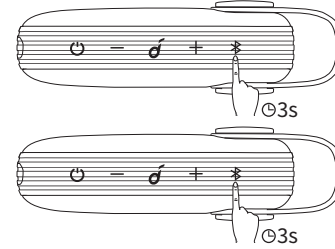

True Wireless Stereo Grup Moduna Giriş Yap/True Wireless Stereo Grup Modu Bağlantısını Kes



Yanıp Sönen Beyaz True Wireless Stereo Grup Modu















Sabit Beyaz

True Wireless Stereo'ya Bağlandı

Not: True Wireless Stereo grubu başarılı şekilde bağlandığında ilk hoparlör üzerinde yer alan LED göstergesi mavi renkte yanıp sönmeye başlayacak, ikinci hoparlör üzerinde yer alan LED göstergesi ise sabit şekilde beyaz renkte yanacaktır.

TR

True Wireless Stereo teknolojisi ile iki hoparlöre dağıtılan sol ve sağ ses kanallarıyla en iyi ses efektlerini keşfetmek için Soundcore Icon cihazınızı bir başka Soundcore Icon cihaz ile eşleştirebilirsiniz.

-  *1 Oynat/Duraklat
 -  *2 Sonraki Şarkıyı Çal
 -  *3 Önceki Şarkıyı Çal
 -  *1 Aramayı Yanıtla/Aramayı Sonlandır
 -  *25 Aramayı Reddet/Beklemeye alınan aramadan aktif aramaya geç
 -  *15 Mevcut aramayı sonlandır ve gelen aramayı yanıtla/Mevcut aramayı sonlandır ve bekleyen aramaya geç
 -  *25 Ses kaynağını Hoparlör ve Telefon arasında değiştir
 -  *1 Mevcut aramayı beklemeye al ve gelen çağrıyı yanıtla
 -  *25 Siri'yi/Başka Bir Sesli Kontrol Yazılımını etkinleştir
 -  Ses Seviyesini Artır/Azalt
- | | | |
|---|------------------|-------------|
|  | Sabit Beyaz | Aramada |
|  | Yanıp Sönen Mavi | Gelen Arama |

TR

Soundcore Icon açıldığında en son bağlanan cihaz kullanılabiliyorsa otomatik olarak bağlantı kurulur. En son bağlanan cihaz kullanılabiliyorsa eşleşme modunu etkinleştirmek için Bluetooth düğmesine basın. Farklı bir cihaz ile eşleştirmek için eşleştirme moduna tekrar girmek üzere Bluetooth düğmesine basın. Ardından eşleştirme adımlarını tekrarlayın. Bağlantıda sorun mu yaşıyorsunuz? Soundcore Icon'ı cihazınızın Bluetooth geçmişinden kaldırın ve Soundcore Icon ile cihazınız arasındaki mesafenin yaklaşık 1 metreyi aşmadığından emin olun. Ardından tekrar eşleştirmeyi deneyin. En kaliteli sesi almak için bağlanan cihaz ile hoparlörünüz arasında açık bir görüş hattı bulunduğundan emin olun.

b. AUX-Girişi modu

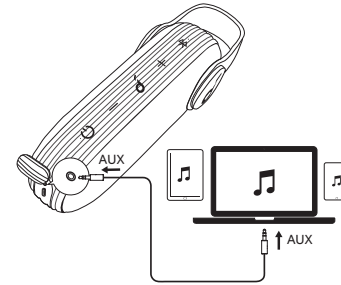

* SoundLine AUX kablosu ayrı satılmaktadır.



TR

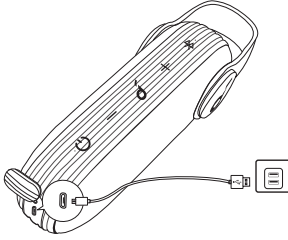

Ses kablosu takılması otomatik olarak AUX moduna geçilmesini sağlayacaktır. AUX modunu kullanırken bağlı cihaz aracılığıyla ses çalma durumunu kontrol edin.

Soundcore Icon'ın Şarj Edilmesi



	Yavaşça Yanıp Sönen Kırmızı	Düşük Pil
	Sabit Kırmızı	Şarj oluyor
Kapalı		Tam Dolu

159

TR



Soundcore Icon'ı şarj etmek için kutusundan çıkan USB kablosunu kullanın ve ilk kullanımdan önce hoparlörünüzün tamamen şarj edildiğinden emin olun.

Tamamen şarj olduğunda şarj cihazını hoparlörünüzden çıkarın. Hoparlörünüzü gerektiğinden uzun süre şarj etmeyin. Hoparlörü kullanmadığınız zamanlarda serin bir yerde saklayın.

Teknik özellikler



Teknik özellikler önceden bildirilmeksizin değiştirilebilir.

Giriş: 5 V  1 A

Ses çıkışı: 10 w

Pil kapasitesi: maks. 2.600 mAh

Şarj süresi: 4,0 saat

Çalma süresi (ses seviyesine ve müzik içeriğe göre değişiklik gösterir): 12 saat

Boyut: 182 x 61 x 62 mm (7,2 x 2,4 x 2,4 inç)

Ağırlık (paket hariç): 349 g (12,3 oz)

Bluetooth sürümü: V5.0

Bluetooth aralığı: 20 m (66 ft)

160

Declaration of Conformity

Hereby, Anker Innovations Limited declares that the radio equipment type A3122 is in compliance with Directive 2014/53/EU. The full text of the EU declaration of conformity is available at the following internet address: www.soundcore.com

Maximum output power: 2.0dBm

Frequency band: 2.4G band (2.4000GHz-2.4835GHz)

Anker Innovations Limited

Room 1318-19, Hollywood Plaza, 610 Nathan Road, Mongkok, Kowloon, Hong Kong

FCC Statement

This device complies with Part 15 of the FCC Rules. Operation is subject to the following two conditions: (1) This device may not cause harmful interference, and (2) this device must accept any interference received, including interference that may cause undesired operation.

Warning: Changes or modifications not expressly approved by the party responsible for compliance could void the user's authority to operate the equipment.

Customer Service

Kundenservice | カスタマーサポート | Service Client | Servizio ai Clienti
Atención al Cliente | Serviço de Apoio ao Cliente | 客服支持 | Обслуживание клиентов
Zákaznická podpora | Kundeservice | Asiakaspalvelu | 고객 서비스 | Klantenservice
Kundeservice | Kundtjänst | 客戶服務 | خدمة العملاء | שירות לקוחות | Müşteri Hizmetleri



18-month limited warranty

18 Monate beschränkte Herstellergarantie | 18ヶ月保証 | Garantie limitée de 18 mois
Garanzia limitata 18 mesi | Garantía limitada de 18 meses | 18 meses de garantia limitada
18个月质保期 | Ограниченная гарантия на 18 месяцев | 18 měsíční omezená záruka
18 måneders begrænset garanti | 18 kuukauden rajoitettu takuu | 18개월 제한 보증
18 maanden beperkte garantie | 18-månaders begrænset garanti
18 månaders begränsad garanti | 18個月有限保固 | ضمانة 18 شهراً محدودة
טווח אחריות מוגבל ל-18 חודשים | 18 aylık sınırlı Garanti



Lifetime technical support

Lebenslanger technischer Support | テクニカルサポート | Support technique à vie
Supporto tecnico a vita | Asistencia técnica de por vida
Suporte técnico ao longo da vida útil do produto | 终身客服支持
Техническая поддержка на весь срок эксплуатации | Doživotní technická podpora
Teknisk support i hele produktets levetid | Elinikäinen tekninen tuki | 평생 기술 지원
Levenslange technische ondersteuning | Teknisk støtte hele levetiden
Livstids teknisk support | 永久技術支援
الدعم الفني مدى الحياة | תמיכה טכנית לכל החיים | Ömür Boyu Teknik Destek Hizmeti



service@soundcore.com



+1 (800) 988 7973 (US) Mon-Fri 9:00 - 17:00 (PT)
+44 (0) 1604 936200 (UK) Mon-Fri 6:00 - 11:00 (GMT)
+49 (0) 69 9579 7960 (DE) Mon-Fri 6:00 - 11:00
+81 (0)3 4455 7823 (日本) 月 - 金 9:00 - 17:00
+86 400 0550 036 (中国) 周一至周五 9:00 - 17:30
+82-2-6464-7088 (韩国) 월 - 금 9:00-17:30

For FAQs and more information, please visit:

soundcore.com/support

