

## Foreword

Thank you for purchasing this car.

This instruction manual is applicable to the X55 series. Before using the vehicle for the first time, please read this instruction manual carefully and familiarize yourself with the vehicle structure, various functions, usage methods and relevant regulations of the company as soon as possible. Any loss caused by failure to follow the instructions in the instruction manual or modified by the company, you will lose the right to file a claim. The contents of the instruction manual will help you master the correct way to drive and maintain your vehicle so that you can fully enjoy driving.

This instruction manual is intended to provide you with instructions on the use and maintenance of the vehicle. Please check the car purchase contract for the specific configuration of the vehicle you purchased. If you have any questions about this car and this instruction manual, please contact BAIC Authorized dealer. The pictures, data and instructions contained in this User's Guide are in accordance with the product definition at the time of preparation. In view of the continuous modification and improvement of the vehicle by the company, the pictures, data and instructions contained in the instruction manual are only used as an introduction to the method of use, and are not used as the basis for acceptance of the order.

We will continue to improve all models, so we reserve the right to make changes to any part of the vehicle, equipment or technical specifications at any time. Data relating to delivery scope, appearance, performance, size, weight, fuel consumption, specifications, and vehicle function are all correct at the time of printing. Some of the equipment/features described in this article may not be available on your vehicle (please contact BAIC Authorized dealer for details). All information, illustrations or descriptions in this User's Guide are not considered legal commitments.

The Company reaffirms that it is solely responsible for the revision of this User's Guide and reserves all rights and rights of modification as stipulated in the Copyright Law.

No part of this User's Guide may be reproduced, copied, or translated without our prior written consent, and may not be reproduced, stored in a public retrieval system, or transmitted electronically, mechanically, or in any other form.

## Foreword (continued)

The "short press" in the text description of this manual indicates less than 2 seconds and greater than or equal to 0.1 seconds, and "long press" indicates 2 seconds or more and less than 1 minute.

This series of models is equipped with two air intake grilles, which are subject to the actual car you purchased.

Equipment/features marked with "\*" are only available for some models or as an option or optional feature for certain models, please refer to the actual vehicle configuration.

'Warning,' 'Attention', 'Tips' and certain special symbols will appear frequently in this User's Guide. Special attention should be paid to these contents. Ignoring these warnings may result in personal injury or damage to your vehicle.



**Warning**, which means "Do not do this" or "Do not let this happen."



**Attention**, which means "Please follow this action" or "This operation is possible."



**Tips** offering useful information.



"" Means "Do not do this" or "Do not make this happen".



"" Means "Please follow this action" or "This operation is possible".



"" A similar identifier, which is meant to indicate an item in the diagram.



"" A similar sign, which indicates the direction of operation or action.

## Advice the user

1. Before using the vehicle, please read this instruction manual carefully. When using the vehicle, please follow the instructions in the instruction manual to ensure that you are familiar with the operation and maintenance of the vehicle and drive the vehicle safely. Our company is not responsible for any loss caused by improper use of the vehicle.

2. Be sure to carry out regular vehicle maintenance and maintenance in accordance with the Maintenance Information Sheet.

3. In order to adapt to driver different sizes, the driving position should be adjusted as follows:

- Seat front and rear adjustment, height adjustment, backrest tilt adjustment, headrest adjustment;
- Steering wheel position adjustment;
- Rear view mirror position adjustment.

4. Wearing a seat belt is a necessary guarantee for the safe driving of the driver inside the car. Adults should wear seat belts correctly.

Children should correctly select and use child restraints and seat belts in accordance with the relevant requirements in this instruction manual.

5. Pre-vehicle inspection:

- Whether the vehicle lighting works normally;
  - Cleanliness of windshield and mirrors, wiper working condition;
  - The viewing angle of the rear view mirror;
  - Tire pressure and tire wear. The condition of the tire directly affects the power, economy and smoothness of the vehicle. It is also related to the safety of the vehicle. Please properly use and maintain the wheels (including spare wheels) as required. Check that the tire pressure should be in the cold state of the tire;
  - Liquid level such as oil, coolant, brake fluid, etc.;
- Battery condition.

6. Check the individual alarm lights by placing the keyless start/stop button in the "RUN" mode.

7. Engine operation:

- Do not run the engine for a long time in a closed warehouse to prevent exhaust gas poisoning;
- When the battery is depleted, the engine's electronic control unit and starter will not work properly and the engine will not start.

8. brake:

- When the engine is turned off, the vacuum booster does not work, the brake pedal pedaling force will increase significantly, and the braking efficiency will be greatly reduced. Therefore, it is strictly prohibited that the vehicle will slide down when the engine is turned off;
- Vehicles equipped with CVT transmissions should stop the vehicle before applying the vehicle and apply the electronic parking brake to confirm that the electronic parking function is reliable.

## Advise the user (continued)

Then place the shift lever in the "P" position. Vehicles equipped with manual transmissions should stop the vehicle before applying the vehicle, apply electronic parking brake to ensure reliable electronic parking, and then place the shift lever in the appropriate gear according to the safety requirements of the parking position;

- When braking on an emergency or on a slippery road, ABS prevents the wheels from locking and is conducive to stability in the direction of travel. However, careful driving is still a must.

9. About the combination meter alarm light:

- If there is a red alarm light (such as brake, oil, coolant temperature, etc.) on the instrument when driving, it should be safely parked as soon as possible. Check the vehicle according to the instructions in this instruction manual. If necessary, please contact the Beijing Auto Special Dealer.

- If there is a yellow warning light on the instrument cluster while driving, check the vehicle according to the instructions in this manual. If necessary, please contact the Beijing Auto Special Dealer for inspection.

10. Electrical accessories:

- Any electrical accessories must be installed in accordance with the specified power supply location and wiring method. Please operate at the BAIC Authorized dealer.

11. The vehicle is equipped with a catalytic converter. It is strictly forbidden to use leaded gasoline, otherwise the catalytic converter will be damaged quickly.

12. Tips on security:

Following the following important driving rules will help ensure the safety of the driver and occupants throughout the journey!

- Strictly observe traffic rules and drive safely;

- Do not drive the vehicle after drinking or after taking the medicine;

- Observe the speed limit sign and do not speed.

13. When filming the front windshield inside, pay special attention not to let water enter the instrument panel; do not put wet umbrellas, water cups, etc. on the instrument panel when using the vehicle daily, otherwise water entering the instrument panel may cause electrical appliances installed on the instrument panel. The component is damaged.

14. For the repair and modification of the vehicle, please go to the BAIC Authorized dealer. The BAIC Authorized dealer has the necessary tools, diagnostic equipment, maintenance information and qualified staff.

**Contents****Safe operation instruction****1****Operating system and equipment****2****Driving guide****3****Maintenance****4****Emergency handling****5****Technical data****6****Maintenance information****7**



## Safety operation instruction

|  |     |                         |     |
|--|-----|-------------------------|-----|
| Safe driving .....   | 002 | Child safety ride ..... | 028 |
| General description .....  | 002 | Child safety .....      | 028 |
| The driver and passenger correct sitting position .....                        | 003 | Child seat .....        | 029 |
| Pedal area .....   | 005 | Safety label .....      | 034 |
| Seat belts .....   | 007 |                         |     |
| General description .....  | 007 |                         |     |
| Wearing the seat belt correctly .....  | 010 |                         |     |
| Seat belt inspection and maintenance .....                                     | 014 |                         |     |
| Maintenance and scrapping of seat belt preloading force limiting device* ..... | 015 |                         |     |
| Airbag system .....  | 016 |                         |     |
| General instructions .....   | 016 |                         |     |
| The airbag may unfold .....  | 023 |                         |     |
| The airbag may not be deployed .....   | 024 |                         |     |
| The bottom of the vehicle is subject to collision .....                        | 027 |                         |     |

## General description

This chapter mainly introduces important information, operating methods, recommendations, and safety precautions for safe driving. For the safety of drivers and passengers, please read and follow the relevant regulations carefully

### Caution

● **Be sure to carry this instruction manual with you. If you lend or resell la vehicle, be sure to give the user manual to the user or new owner.**

Keep the vehicle in safe driving Vehicle failure is very dangerous for safe driving. In order to keep the vehicle in safe driving state, please refer to the “Maintenance Information Form” to go to the BAIC Authorized dealer for regular maintenance of the vehicle and carry out the vehicle before each driving.

Daily maintenance (see “Daily maintenance” on page 203).

## Correctly adjust the seat

Before the vehicle is driven, all occupants should make the seat back as vertical as possible and adjust the seat position.

### Always wear seat belts

The airbag only has an auxiliary protection function and cannot replace the protective effect of the seat belt in an accident. Therefore, all drivers and passengers must wear the seat belt correctly.

### Properly house all child occupants

Children should be properly placed on the seats on both sides of the rear row. When the child is too small to wear the seat belt, it must be properly placed in the child restraint and the child lock is locked.

(LOCK) status, do not leave the child alone in the car.

### Be alert to the dangers of airbags

Although the airbag can protect, but if the driver is too close to the airbag or is not properly protected, the airbag deployment may be for the driver.

The injury is caused by the member, especially for the baby. Be sure to follow all instructions in this owner's Manual.

Do not drink and drive. You cannot drive after drinking alcohol. After drinking, people's ability to respond to changes in the environment will be reduced, so do not drink and drive, and do not let your friends drink and drive

### Never speeding

Over speed is one of the main a causes of vehicle collision and t casualty accidents. Do not drive more than the speed limit specified by the road, and do not exceed the safe speed allowed by actual road conditions while driving.

Carrying pets safely when carrying a pet in the car, make sure that the pet is properly placed. Do not play with c the pet while driving. Do not leave the pet alone in the car.



 Warning

- Do not distract yourself from outside factors while driving, such as smoking, eating, talk with occupant or make a call.
- Do not drive a vehicle when the responsiveness declined. Such as after taking drugs, alcohol, and drugs that are prone to lethargy can impair people's ability to respond.
- Strictly observe the traffic regulations and speed limits.
- When driving the vehicle, avoid crushing crop straw, weeds, etc. , to prevent hooking to the vicinity of the vehicle exhaust pipe, which may cause the vehicle to catch fire.

### The driver and passenger are sitting correctly

#### The driver is sitting correctly

The correct sitting posture of the driver can reduce the driving fatigue and ensure the safety of the vehicle.



To ensure the safety of drivers and passengers, the driver should do the following before driving the vehicle:

- Move the seat to the proper position so that the knee joint can be fully depressed and the accelerator pedal, brake pedal and clutch pedal\* can be fully depressed.
- Adjust the backrest to a suitable angle so that the back fits perfectly against the backrest.

- Adjust the headrest so that the middle of the headrest is flush with the center of the driver's ear and the back of the head is as close as possible to the headrest.
- Adjust the steering wheel so that the chest and the steering wheel are at least 25 cm away. Make sure that the elbow joint is slightly bent to hold the highest point of the steering wheel.
- Adjust the mirror to the proper position.
- Wear the seat belt correctly.

### Front occupant correct sitting position

To ensure safe ride, the front occupants should do the following:

- Adjust the seat so that the front occupant and the dashboard are at the right distance as far as possible to provide the most effective safety protection when the airbag is triggered.
- Adjust the seat back so that can fits back.
- Adjust the headrest so that the middle of the headrest is aligned with the middle of the front passenger's ears and the back of the head is as close as possible to the headrest.
- Wear the seat belt correctly.
- Both feet should be placed in the foot space in front of the front seats.

#### Warning

**In order to reduce the risk of accidents and injuries, the following must be strictly observed:**

- The distance between the driver's chest and the steering wheel should not be too close, otherwise the airbag will not provide effective protection and may cause injury to the driver.
- The driver's hands should always be on the outer ring of the steering wheel (9 o'clock and 3 o'clock position) to ensure that all the meters and indicators on the instrument cluster are visible.
- The driver must not adjust the seat and headrest while the vehicle is running. If necessary, adjust the seat and headrest to the correct position after the vehicle has stopped, and then start off.

#### Warning

- The front passenger and the instrument panel should not be too close, otherwise the airbag will not provide effective protection and may even cause damage to the front passengers.
- Do not rest your feet on the instrument panel or on the window during driving, and do not sit on the seat. Always place your feet in the foot space, otherwise it will be in case of emergency braking or accident. Easy to get hurt.
- The seat back should not be tilted excessively during driving. The seat belt must be properly worn to maintain the correct sitting position to avoid injury during emergency braking.

**Rear occupant sitting correctly**

To ensure safe ride, the rear occupants should do the following:

- Adjust the headrest so that the middle and back of the headrest are multiplied

- Align the middle of the ear and make the back of the head

It may be close to the headrest.

- Keep your posture in a correct position and try to keep your back close Seat back.

- Place your feet in the foot space in front of the rear seats and close to the floor.

Wear the seat belt correctly.

- When carrying children, appropriate protective measures must be taken in accordance with relevant regulations.

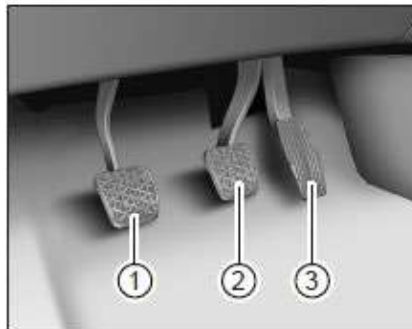
**Pedal area****Manual transmission model**

1 Clutch pedal

2 Brake pedal

3 Accelerator

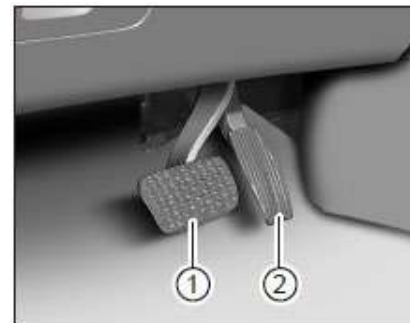
**CVT transmission model**

1 Brake pedal

2 Accelerator

**Caution**

- Before the vehicle is driven, it must be ensured that all the pedals can be easily stepped on at any time and can be automatically returned.

 Warning

● It is strictly forbidden to wear high-heeled shoes and slippers to drive the vehicle. The high- heeled heel may hinder the brake pedal and the clutch pedal from being pushed to the end; wearing slippers may cause slipping when the brake pad applied, and the maximum braking force cannot be applied in time, which may easily cause an accident.

**Driver's side pad**

The foot pads should be fixed in the foot space. After installation, please make sure that the foot pad is close to the carpet, and make sure that there is a certain distance between the foot pad and the clutch pedal, brake pedal and throttle pedal so that there is no interference between the foot pad and the pedal.

 Warning

- When the brake pedal is depressed by the floor mat and other items, it will affect the vehicle's braking and may cause serious traffic accidents.
- Do not store anything in the driver's foot well, otherwise the item may slip into the pedal area and prevent the driver from operating the pedal. In the event of an emergency brake or an emergency, the driver can easily cause a serious accident if he cannot operate the brake pedal.
- It must be ensured that the foot pads are securely fastened to the floor.
- No other foot pads or coverings should be placed on the floor mat top to prevent the pad from shrinking and obstructing the pedal movement.
- Do not use more than the thickness of the mat 10mm.

### General description

All seats in the car are equipped with a three-point safety belt.

The height of the fulcrum on the front seat belt is adjustable, and the pretension is installed in the lower retractor.

In some models, the left rear seat belt has a preload force limiting function. In the middle of the rear seat of the vehicle, the safety belt has a double-lock tongue structure, which is used differently than other seat belts. (See “Wearing the Seat Belt in the Rear Seat” on page 012)

For driving safety, all drivers and passengers must wear seat belts correctly.

Proper wearing of the seat belt can limit the occupants to the appropriate position, effectively preventing the occupants from colliding with the interior parts and absorbing a lot of kinetic energy, reducing the degree of damage to the occupants.

At the same time, proper wearing of the seat important prerequisite for the protection of the airbag. At the moment of deployment of the airbag, the body position, sitting posture and movement of the occupant have a greater influence on the protection effect of the airbag. Failure to properly wear the seat belt and abnormal seating posture may result in the vulnerable parts of the driver's head and neck being injured by the instantaneous impact force when the airbag is deployed. Especially for children, this damage can be fatal. In the moment of collision, the seat belt can restrain the upper body of the driver and passenger in time , ensuring that the inside of the vehicle is within the protection range after the airbag is deployed, so that the airbag can function most effectively.



### Warning

**In order to reduce the risk of casualties in an accident, it is important to strictly observe the following:**

● **As long as the vehicle is driving, the driver must always wear a seat belt. This will reduce the damage to the vehicle during emergency braking and traffic accidents.**

● **It is strictly forbidden to wear the same seat belt (even if it is a child).**

● **Pregnant women or those who need care from others must also wear seat belts. If you do not wear the safety belt, you may be seriously injured.**

● **Loose clothing (such as a coat) before wearing the seat belt to avoid affecting the fit of the seat belt to the body and its protective function.**

### Warning

- When wearing a seat belt, the seat belt must not be crushed with fragile or sharp objects (such as glasses, ballpoint pens, etc.) as this may result in injury to the occupants.
- Make sure that the buckle socket is not caught by foreign objects, otherwise the lock tongue cannot be inserted into the buckle.
- The locking tongue of the seat belt must be correctly inserted into the buckle. Wrong wearing of the seat belt will affect the protection of the seat belt.
- The seat belt must be kept clean at all times, and a heavily soiled seat belt may cause the retractor to become unsmooth.
- If the belt webbing is broken or cracked, the fixing bolts are loose, and the retractor malfunctions, the seat belt will not provide protection in the event of an accident. All parts of the seat belt should be inspected regularly for properness.

### Warning

- In the event of a serious collision, the used seat belt or the stretched safety belt should be replaced at the Beijing Auto Special Dealer, and even if no obvious deformation on the appearance, it needs to be replaced. Also check the seat belt fixing device.
- It is strictly forbidden to repair, disassemble and install the parts on the retractor or the seat belt. It is strictly forbidden to modify the seat belt in any way. The maintenance of the seat belt parts should be carried out by the Beijing Auto Special Dealer.

### Seat belt height adjustment



Using the seat belt height adjustment device, the height of the fulcrum on the seat belt can be adjusted to accommodate the shoulder height of different occupants.

Hold the lower end of the regulator guide block 1. Press the upper end lock button of the guide block and hold it.

Move the guide block up and down to adjust the seat belt to the proper position.

Loosen the regulator guide block.

5. After the height adjustment is completed, pull the safety belt firmly to check if the adjuster is securely locked.



Warning

● **The driver must not adjust the seat belt height while the vehicle is running.**

#### **Seat belt preload force limiting function \***

Some models of seat belts are equipped with a pre-tensioning force limit device that is equipped to ensure that the seat belt secures the occupant's body during a crash. When the severity of the collision accident reaches a certain level, the pre-tensioning force limiting device may be activated, and the retractor tightens the seat belt in the rewinding direction to slow the occupant's forward movement. If the tightening force exceeds a certain limit, the force-limiting device will relax the seat belt and reduce the force acting on the body.

 Caution

● **Seat belts with pretension function can only be used once. A new seat belt must be replaced after the pretension has been detonated. Pretension This is normal and does not indicate a fire in the vehicle.**

● **The seat belt pretension will become very hot after the detonation, so do not touch the relevant parts within a few minutes after the pretension is detonated.**

### The consequences of the driver and passenger not wearing a seat belt

Many people think that in the event of a mild collision, it is a misunderstanding to use your own hands to support your body from injury.

The driver and passenger who are not wearing the seat belt will move forward at the speed before the collision due to inertia. At this time, the vehicle does not move at the same speed as the driver and the passenger may be injured.



Drivers and passengers who are not wearing seat belts will throw forward after the vehicle collided, which will not only hurt the yourself, but also endanger to other people in the car.

#### Warning

● **It is useless to protected by hands if a strong collision happened, so that it is impossible to withstand the serious damage or hurts.**

### Wear seat belts correctly

#### Wear front seat belts



Before using the seat belt, first adjust the front and rear seats, height\* and backrest angle to the appropriate position. (Driver seat adjustment See page 130, front passenger seat adjustment parameters See page 132)

The upper part of the seat belt is placed close to the front chest and over the shoulder. The lower part of the seat belt is placed close to the hip and should not be applied to the abdomen. Seat belts are not used correctly, not only



It can provide protection, but it is likely to cause other serious injuries.

 **Warning**

- **Do not wrap the seat belt when using the seat belt. When the seat belt is wrapped around the body, it will increase the pressure on the body of the seat belt and reduce the protection of the seat belt.**
- **Seat belts should be tightened as much as possible without compromising comfort, which will provide better protection. The lack of a seat belt will greatly reduce the protection of the user.**

### Seat belt lock



Slowly pull the seat belt out of the retractor, then insert the locking clasp into the buckle you hear the “click” clasp, then pull back on the seat belt to confirm reliable locking.

### Seat belt adjustment



Gently pull the seat belt to adjust the length of the belt, and adjust it to a comfortable position as required.

First, lower the lower part of the seat belt as far as possible, and cross the hip as much as possible, then lift the upper part of the seat belt upwards so that the lower part of the seat belt is in close contact with the body. In this way, the body's strong pelvic area can withstand greater impact, reducing the chance of internal injuries to the abdomen.

**Seat belt unlock**

The seat belt lock can be released by pressing the red button on the buckle. After unlocking the seat belt, push the safety belt in the direction of the upward fixed point and the seat belt will be automatically retracted into the retractor.

**Wear seat belts on both sides of the rear seat**

The seat belts on both sides of the rear seat are worn in the same way as the front seats.

**Wear the rear seat belt intermediate belt**

When sitting in the middle of the rear seat, first pull the seat belt from the retractor at the rear of the roof so that the arrowed side of the lock tongue aligns with the arrowed side of the buckle to lock the seat belt. Tongue 1 inserted buckle 2 in.



Sit straight on the seat and fit the back as far as possible to the seat back.

Thread the seat belt lock 3 across the hip Insert the buckle into the buckle 4 and lock the seat belt. Hold the upper and lower sections of the seat belt and adjust them slightly to make the ride more comfortable and safe.

To unlock the seat belt, press the buckle 4 the red button on the button can be removed from the lock o clasp 3.

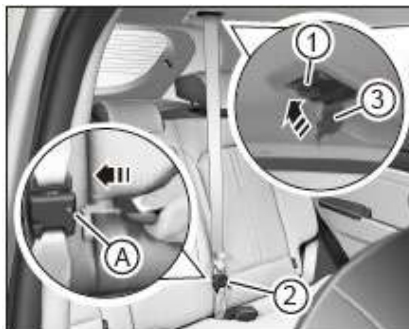

After the seat belt is used, it should be taken back into the retractor as follows:

Hold the lock tongue 1 upper end webbing, use the rear row

Side belt buckle compression buckle 2 Side notch A pull out the latch 1 , retract the seat belt into the retractor, and insert the locking tongue 1 and the locking tongue 3 into the securing slots on the roof.

### Pregnant women wearing seat belts



If the driver is a pregnant woman, to ensure the safety of the pregnant woman and the fetus, the seat belt should be pass through the chest evenly and worn as low as possible in front of the hip, and then flattened so that the lower abdomen can be free from pressed.

### Children wearing seat belts

The seat belts of this model are mainly designed for adults. It is recommended that children under the age of 12 and under 12 and children not exceeding 1.5 m use suitable child restraints.

#### Warning

- **When wearing a seat belt, do not bypass it from behind or from under the arm. Seat belts Avoid the face and neck when crossing the shoulder, but do not slide off the shoulders. If the seat belt is not used correctly, it may cause serious injury.**
- **When wearing a seat belt, if the seat belt passes under the arm, in the event of a crash, the occupant's body may move forward more, increasing the chance of injury to the head and neck of the occupant, and the seat belt force. Most of it acts on the ribs on one side, causing injuries.**

### Seat belt inspection and maintenance

#### Seat belt reliability check

The seat belt retractor locks the seat belt's slip when hollowing three conditions are encountered: When the seat belt is quickly pulled out of the retractor;

When the vehicle is decelerating rapidly;

When the seat belt retractor is tilted at a large angle. In order to check the reliability of the seat belt, grab;

The upper belt is fastened and pulled quickly. At this time, the retractor should lock the seat s belt. If the retractor cannot lock t the seat belt, please go to the BAIC Authorized dealer for inspection or repair.

**Seat belt maintenance**

Check the seat belt and all its components regularly (e.g. buckles, bolts, retractors, webbing and security belt height adjustments) are working properly.

If the seat belt part is found to be damaged, the web is cracked, or otherwise damaged, replace the entire seat belt assembly.

**Maintenance and scrapping of seat belt preloading force limiting device**

\*

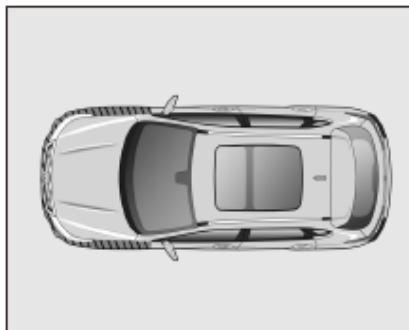

Please go to the BAIC Authorized dealer as soon as possible when the following conditions occur:

- An accident occurred in the front of the vehicle (shaded in the picture), but the seat belt pretension did not work.
- Seat belt pretensions and surrounding components are scratched, cracked, or otherwise damaged.

When performing any work on the retractor with preload function, please do so at the BAIC Authorized dealer, otherwise the seat belt pretension may not work properly in the event of an accident.

When the pretension need strobe scrapped, it must comply with the relevant safety regulations. The BAIC Authorized dealer Store is familiar with the relevant safety regulations and can provide you with inquiries.

 **Warning**

- **If a safety belt retractor is repaired by a repair shop or non-professional authorized by Beijing Auto, or if the safety belt retractor is not used properly, the potential risk of accidents will increase.**
- **It is not permissible to repair, disassemble or install the seat belt or seat belt retractor parts yourself.**

## General descriptions

The airbag system plays an auxiliary protective role. In order to fully play the protective role of the triggered airbag system, the driver and passenger must maintain the correct sitting posture, and children need to use appropriate child seats for protection.

### Caution

● **The dust produced during airbag explosion process may irritate the skin and eyes, even cause asthma worse. After airbag explosion occurs, thoroughly wash all exposed skin with water and warm soap.**

**After the airbag is exploded, parts of the airbag system will become hot. Do not touch them to avoid scalding.**

### Warning

● **The air bag only has the auxiliary protection function, cannot replace the protect function of seat belt in the accident.**

## Airbag function



In the event of a serious collision with a vehicle, the air bag will expand rapidly in a very short time and then deflate and contract to relieve the inertial impact of the human body. Therefore, the driver and passenger must maintain the correct posture and wear the safety belt, in order to effectively obtain the air bag protection.

In the event of a serious collision, the driver or passenger who is not wearing a seat belt cannot control themselves and will be randomly moved or thrown out of the car. Airbag even rapid expansion, also cannot produce effective protection to the human body.

The position of normal sitting position of drivers and passengers must maintain an appropriate distance from the front positive air bag, so that the air bag can fully expand when triggered, effectively protecting the driver.

### Caution

● **When a vehicle collision occurs, the decisive factor for airbag triggering is related to the collision energy, the type of collision, collision angle, obstacles, vehicle speed, and other factors in the event of a collision. Thus it is possible that the airbag is not triggered even when serious damage occurs to the vehicle.**

**Airbag working conditions**

Ignition switch is in the "ON" position or keyless start/stop button is in the "RUN" mode.

On the dashboard, the alarm light of airbag system must be in normal state (normal state: after starting the vehicle, the warning light goes on for several seconds and then goes out during system self-test.).

Vehicle passenger cabin never been inundated (Once been inundated, the airbag controller may have short circuit, which may lead to the failure of airbag system).

**Airbag system fault alarm lamp**

The airbag system fault alarm lamp located on the integrated dashboard will alert the driver of the airbag system fault. When keyless start/stop button is located in "RUN" mode, the system self-check times alarm light is on for a few seconds and then off.

If the following phenomenon appears, It means that airbag system has fault, the airbag and seatbelt tensioner may not work properly when collision, please go to nearest BAIC authorized dealer for inspection:

- The airbag system fails when the keyless start/stop press position is in "RUN" mode. The alarm light is not on.
- When the keyless start/stop pressed position is in "RUN" mode, the air bag system fails. The alarm light is always on.
- During driving the vehicle, airbag system failure. The alarm light will light on.

**Maintenance and scrapping of airbag**

The components of the airbag system are installed in different parts of the vehicle, any operation of the airbag system or dismantling of airbag system components for maintenance of other vehicle components must be implemented by professional technical staff. Otherwise, it may damage the airbag system and may result in that the airbag system is triggered abnormally or not triggered in an accident.

If the vehicle is scrapped, the unexpanded airbag is potentially dangerous, and therefore they must be detonated by professionals..

 Warning

- When clean the steering wheel or dashboard, shall not use detergent containing solvents, otherwise may cause these parts surface material embrittlement and degeneration, once the airbag is triggered, the broken plastic could cause serious injuries to occupants.
- Do not attempt to repair, remove or install components of the airbag system by yourself. If the maintained by non-professional personnel, it will increase the potential risk of accident casualties. The airbag system is not maintained properly. In the event of an accident, the airbag may not expand or should not expand.
- Do not attempt to modify the front bumper or body structure.
- The airbag can only be triggered once, after which the whole airbag system parts must be replaced.



Driver side front airbag 1 In the middle of the steering wheel  
 Passenger side front airbag 2 in the dashboard above the glove box  
 Front airbags expanded when a vehicle is hit hard in the front, but can also be deployed by a similar impact (such as hitting a ditch in the road). It may also not expanded when the front part of a vehicle hits a thin cylindrical object such as a tree or telephone pole.

The damage of the vehicle is not the sufficient condition for front airbag whether expanded or not.

 Caution

- **The front airbag expansion and contraction of air is completed in a very short period of time, can only work once, and cannot provide protective effects for a possible second collision.**

Please contact the BAIC authorized dealer as soon as possible in case of any of the following situations:

- The front airbag has been expanded.
- The front of the vehicle was involved in a collision, but the airbag was not deployed.
- The upper part of the driver's airbag or the front occupant is rupturing or otherwise damaging the upper part of the airbag (arrow position in the picture).



The airbag is equipped with a deflating hole. When an accident occurs, the airbag inflates rapidly instantly, and then begins to deflate immediately after the air bag is fully deployed, so as to reduce the impact on the head, chest and other parts of the body of the occupant. It also enables the driver to maintain forward vision and perform steering or other operations. It makes a loud noise when it is deployed, followed by a small amount of smoke, which is normal.

#### Seating position

In order to provide the best protection against serious impact, front airbags must be deployed in a very short period of time. If the driver or passenger is too close to the front airbag, the expanding front airbag can cause facial abrasions or other damage. So sit properly. (See page 003, "drivers and passengers sitting properly")

#### Front side airbag \*



Front side airbag 3 is located outside the back of the front seat.

To ensure the normal function of side airbag, it is NOT allowed to place obstructions between the side airbags and driving personnel.



#### Warning

- Drivers and front-seat passengers are prohibited from leaning their heads or bodies against the door, or putting their arms on the door or out of the window, otherwise they may cause injury when the airbag is deployed sideways.
- Do not place anything between the driver, the front passenger and the door. Otherwise it will interfere with side airbags, influence its protection.
- Do not allow the seat cover to cover the outside of the seat back airbag, otherwise it will hinder the side airbag deployment.

Vehicle in side collision, side air bags according to the strength of the side collision, impact Angle, speed and impact point to determine whether the airbag. In some of the side collisions, the side airbags may not deploy. Vehicle damage is not a sufficient condition for side air bag inflation.

In some collisions, side airbags do not deploy, which can cause injury if you do not wear a seat belt. Airbag systems work best when used in conjunction with properly worn seatbelts, so all drivers and passengers must always wear their seatbelts correctly.

 Caution

● **Side airbags are not intended for front and rear impacts or minor side impacts. They are not intended for vehicle overturning, nor are they effective for emergency braking or driving on bumpy roads or passing depressions.**

 Caution

● **Vehicle engine compartment and the trunk was strongly side impact, side air bags may not deploy.**

Please contact BAIC authorized dealer as soon as possible in case of:

- Either side airbags have been deployed
- A collision occurred at the door, but the side airbag did not deploy.
- Backrest with side airbags have other surface scratches, broken or damaged.

### Seating position

In order to provide the best protection against severe side impact, Side airbags are deployed in a very short time.

If the driver is too close to the side airbag, the expanded side airbag may bruise the driver, so sit properly. (See page 003, "drivers and passengers sitting properly")

**Side-curtain airbags\***

Side curtain airbags 4 Located nearby the roof on both sides of the girder. The words "AIRBAG" are marked on pillars B and C.

In the event of a side impact, the system may trigger the side-curtain airbags on the side of the collision.

Once triggered, the gas produced by the gas generator will be quickly charged into the side-curtain air bag. The side curtain type airbag expands rapidly, covers the side window and the door, and provides the protection to the human body and head.

To provide ideal additional protection in an accident, side-curtain airbags expand rapidly in an instant. A small amount of smoke may be released during the expansion of the airbag, which is a normal phenomenon.



In the case of serious side impact, the side-curtain airbag filled with gas can effectively reduce the risk of head and upper body injuries. When the vehicle has a certain degree of side impact, whether the side-curtain airbag is deployed depends on the impact intensity, impact Angle, speed and impact point. Side-curtain airbags do not deploy in all side crashes, in front crashes, rear crashes, or most rollover crashes.

Vehicle collision happened to these systems may develop positive air bags, side-curtain airbag and the front seat side airbag \*.

#### Caution

- In order to ensure that the side-curtain airbag can expand normally, there must be no barrier between the air bag and the driver.
- The expansion and contraction of the side-curtain airbag is completed in a very short time. It can only work once and cannot protect the second side impact that may occur.

#### Warning

- The side-curtain airbag provides additional protection only in the event of severe side impact and does not replace the safety belt.
- Do not lean your head or body on the door, or put your arms on the door or out of the window, or you will cause injury when the side curtain airbag is deployed.

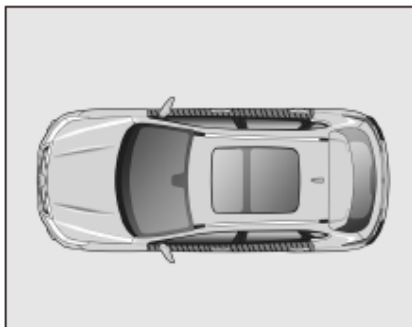

Please contact the BAIC authorized dealer as soon as possible in case of any of the following situations:

- Either side-curtain airbag has been deployed.
- A collision occurred on the side of the vehicle, but the side-curtain airbag was not deployed.
- Side-curtain type air bag external decorative plate broken or other damage.

### Sitting posture

In order to provide the best protection function under the serious impact, side-curtain type airbags must be in a very short period of time.

If the driver or passenger is too close to the side-curtain airbag, the expanded side-curtain airbag can cause head injury or other damage, so please keep the correct posture. (See the page 003“driver and passenger correct posture”

### Airbag may deploy

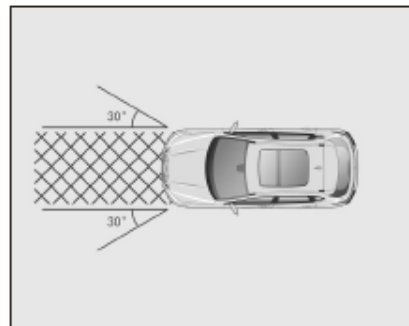

If the impact to the left or right direction of the vehicle is within 30 °degree and exceeds the set critical level, the front airbag may be deployed. Install other protective devices in front of the vehicle, and the sensor will not be able to sense the impact properly, which will hinder the normal operation of the front airbag. The side-curtain airbag \* may deploy if the vehicle is hit sideways and exceeds the critical level set.



Warning

● Be sure to wear your seat belt properly. Otherwise, in the event of an accident, the airbag may cause shock to the occupant, resulting in serious injury or even death to the occupant

### Airbag may NOT expand

Airbags provide protection for drivers and passengers in the event of a collision. In a collision accident, the airbag will determine whether to deploy or not according to the impact intensity, impact Angle, speed and impact point. In many types of collision accident such as rear-end collision, side collision, the oblique collision, rollover accidents, with a finer pillars front collision accident, such as airbags may not be deployed.

### Rear-end collision

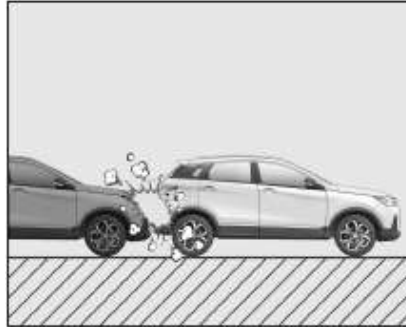

When the rear car involved rear-end collision, under the action of inertial force, the driver and passenger personnel to the back of the back to move, from the front of the airbag to the driver and passenger personnel also play no protective role, at this time front airbag may not be deployed, Side-curtain airbag \* does not work.

### Side collision



When side collision occurs, the driver and passenger have side displacement, so the air bag deployed from the front cannot protect the driver and passenger, the front air bag \* may not be deployed, and the side air bag \* and the side curtain air bag\* may be deployed.

**Oblique collision (into collision Angle)**

When oblique collision occurs, the impact energy received by the air bag system may not be enough to trigger the front air bag to deploy, and at this time, the front air bag may not deploy, and the side air bag and the side-curtain air bag may not work.



When the side outside the passenger compartment is hit, the body is slightly hit, and the front air bag, the side air bag \*, and the side-curtain air bag \* do not work.

**Rear-end collision**

In a rear-end collision with a large truck, the driver instinctively applies emergency braking and the front of the vehicle declines. Due to the high clearance between large trucks and the ground, the front part of the vehicle will get to the bottom of the truck, and the collapse deformation of the front part of the vehicle will absorb the impact energy, so that the impact deceleration detected by the air bag sensor is not large. At this time, the forward air bag may not be deployed, and the side air bag and the side curtain air bag may not work.

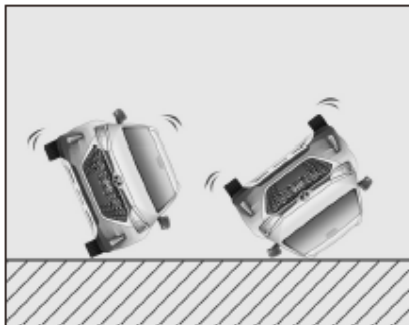
**Rollover**

In rollover accidents, the airbag may not deploy, and if the airbag deploys unexpectedly, it will not provide the driver with protection.

**Special collision**

If the vehicle collides with some thinner object, such as a pole or a tree, in such a collision, the impact point is concentrated in one place and the impact energy is absorbed rapidly through the vehicle's severe deformation, and the airbag sensor may not deploy without the full impact force being transmitted.



The front of the vehicle hit a wall, the body suffered a weak collision, but the collision intensity did not reach the airbag deployment condition, the front airbag will not deploy, the side airbag \* and the side-curtain air bag \* do not work.



### Bottom of the vehicle collision situations

If the vehicle is subjected to severe impact, such as flying over steps, hitting shoulder or hard objects, and crossing deep pits, even if the deformation of the vehicle is slight, due to the influence of rigid vehicle parts, the airbag may be deployed when the detected deceleration reaches the airbag deployment condition.

#### Hitting shoulder or hard objects



#### Vehicles across a deep pit



#### Vehicles fall or fly over steps

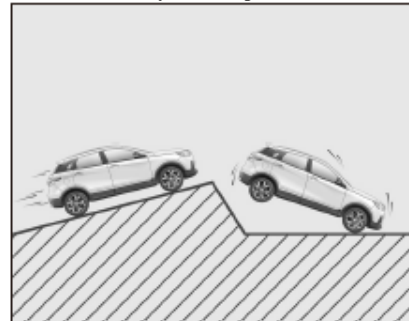

## Child Safety



Warning

- Do not allow children to stand or kneel on the seat.
- Do not allow children into the luggage compartment while the vehicle is in moving. Children can be seriously injured in accidents or emergency braking.
- As a driver, you must be responsible for the safety of the children on board. Don't let children distract you from driving.
- Children not be left alone in the vehicle, or they may suffer fatal injuries from suffocation.
- Children in cars need adult supervision. Please choose the appropriate child restraint device according to the child's figure.
- When there are children in the rear row seat, be sure to put the child protective locks on.

### Carrying multiple children

ISOFIX child safety seat fixing device is set on the seats on both sides of the rear row of the car, which can be used to fix up to 2 sets of ISOFIX child safety seats.

If the children have grown up and are suitable for fastening seat belt, just arrange the oldest child to sit on front passenger seat:

- Move the front passenger seat as far back as possible.
- Have the child sit upright in the chair.
- Reduce the height of the seat belt, wear and fasten your seat belt



Do NOT hold infants in your arms while driving, otherwise they may be injured or killed in accidents.

According to the accident statistics, confirmed that children sitting in the rear seat is safer than the front seat.

It is recommended that children aged 12 or younger, and height less than 1.5m should sit in the back seat. And according to the age, height and weight of the choice of appropriate child seats or use the existing seat belt, to ensure the safety of children in the rear seat.

## Child seat

It is suggested to put the instruction manual of child seat together with this instruction manual and carry it with the car.

### Warning

- If there is no child protection device, children aged 12 and under and not taller than 1.5m shall not only use the safety belt in the car, otherwise the child may suffer abdominal and neck injuries in emergency braking or accidents.
- One seat belt can only be used by one person. Two children are not allowed to share one seat belt.
- Children are not allowed to sit on the lap of adults. It is very dangerous for children to wear the same seat belt.

### Caution

- The installation and use of child seats shall comply with the requirements of traffic laws and the instructions of the manufacturer of child seats.



It is forbidden to place the child seat facing backward on the front seat of the vehicle, otherwise when the airbag deploy, it will hit the back of the child seat with great force, resulting in serious injury or even death of children.



There is a warning sign on the sun visor on the front passenger side of the vehicle to remind the correct installation of child seats.

Be sure to read and follow the instructions on these signs.

Do not use rear child restraint system in seat with front airbag protection (activated)!

**Child seat classification (for reference only)**

0/0+ Child safety seat:

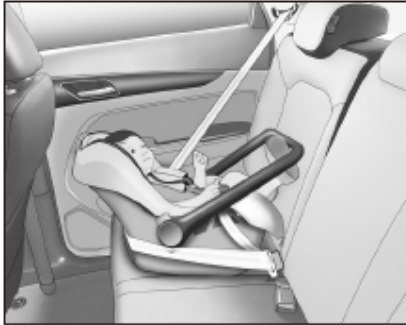

For infants under 18 months of age with body weight less than 13kg, it is best to adjust to lying down

Lying position 0/0+ Child safety seat

I Child safety seat:



For baby and child under 4 years old, body weight in 9 kg ~ 18 kg babies and child, it is best to use the child seat equipped with seat belts I group.

II Child safety seat:



For child under 7 years old, body weight 15 kg ~ 25 kg, it is best to use the group II child seat together with the three-point seat belt.

## III. Child safety seat:



For children over 7 years old, weighing 22kg to 36kg, height below 1.50m, it is best to use the group III child seat together with the three-point seat belt..

 Warning

- Height more than 1.50 m children can use the existing vehicle seat belt, without the use of child seats.

 Warning

- The upper portion of seat belt shall pass the center of shoulder rather than neck, and shall closely press against the body.
- The lower portion of seat belt shall pass the hip rather than abdomen, and closely press against the body. If necessary, just adjust the seat belt.

**Properly installed child seats**

The front seat must be adjusted to appropriate position according to the side of the child seat and the child before installing the child seat onto the rear seat. In the event of a collision or emergency braking, a child sitting on the rear seat is less likely injured by a hard object, and the child sitting on the rear seat will not be injured due to expansion of the airbag..

### ISOFIX child safety seat fixing device

Vehicles on both sides of the rear seat is equipped with 1 set of ISOFIX child safety seat fixing device, each set of equipment including 2 anchor support and 1 on the anchor support.

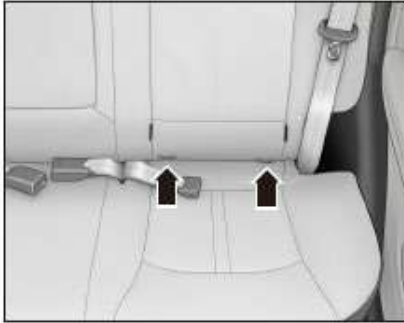

Anchor support is located in the "ISOFIX" under the logo inside the gap between seat backrest and seat cushion below. Please install according to the instruction manual provided by the child seat manufacturer.

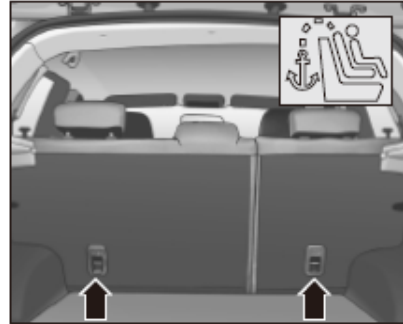

The upper anchor support is located under the back seat back (the position is indicated by the icon).

#### Caution

- The "ISOFIX" anchor support on the back of the rear seat backrest can only be used for fixing "ISOFIX" child safety seats.
- Child safety seat anchor support from top to bottom, only can withstand the load of child safety seats. Under no circumstances shall it be used to secure other articles or equipment.

**ISOFIX Child seat corresponding ISOFIX fixed position**

| Quality group      | Size category | Fixed module | Fixed position       |                          |                  |
|--------------------|---------------|--------------|----------------------|--------------------------|------------------|
|                    |               |              | Front passenger seat | Rear seats of both sides | Rear middle seat |
| Portable bed       | F             | ISO/L1       | X                    | IL**                     | X                |
|                    | G             | ISO/L2       | X                    | IL**                     | X                |
| 0 group: < 10kg    | E             | ISO/R1       | X                    | IL*                      | X                |
| 0+ group: < 13kg   | E             | ISO/R1       | X                    | IL*                      | X                |
|                    | D             | ISO/R2       | X                    | IL*                      | X                |
|                    | C             | ISO/R3       | X                    | IL*                      | X                |
| I group: 9-18kg    | D             | ISO/R2       | X                    | IL*                      | X                |
|                    | C             | ISO/R3       | X                    | IL*                      | X                |
|                    | B             | ISO/F2       | X                    | IUF                      | X                |
|                    | B1            | ISO/F2X      | X                    | IL*                      | X                |
|                    | A             | ISO/F3       | X                    | IUF                      | X                |
| II group: 15-25kg  |               |              | X                    |                          | X                |
| III group: 22-36kg |               |              | X                    |                          | X                |

Note: fill in the form of letters means:

IUF—ISOFIX universal ISOFIX for "facing forward" child seats in this quality group.

IL—Apply to install one of the following ways of general ISOFIX child seats.

- Use pull-up straps or support legs to "face back";
- Use the support leg to "face forward";
- Using the baby seat belt or fixed support leg.

X—Not suitable for the installation instructions of the children weight or baby seat.

: Should be installed with a supporting leg car seats, please refer to the child seat manufacturer's installation instructions.

\*: The child seat is fixed through two low fixing rings of ISOFIX, occupying two rear seats.

**Safety label**

The location of the safety label is shown in the figure below:

- The airbag warning label is located on the front passenger visor;
- The warning and attention labels of cooling fan and air conditioning system are located at the front and left side of the cover parts of the engine room.

These labels are used to alert potential hazards likely to cause serious injury. Please carefully read these signs.

If the labels are removed or blurred, please go to the authorized dealer of BAIC Motor for replacement.



## 2. Operating system and equipment

|   |     |   |     |
|---|-----|---|-----|
| Instrument and control mechanism .....                                      | 037 | The central door lock system .....                        | 087 |
| Instrument and control mechanism arrangement (CVT Transmission model) ..... | 037 | Child safety locks .....                                  | 092 |
| Instrument and control mechanism arrangement (MT Transmission model) .....  | 039 | Engine hatch .....  | 092 |
| Instrument cluster (5 inch) * .....   | 041 | Trunk .....   | 094 |
| Driving computer display screen (5 inch) * .....                            | 044 | Fueling port .....  | 097 |
| Instrument and alarm lights (5 inch) .....                                  | 048 | Electric Windows .....                                    | 098 |
| Instrument cluster (7 inch) * .....   | 056 | Power sunroof* .....                                      | 101 |
| Driving computer display screen (7 inch) * .....                            | 058 | Panoramic sunroof* .....                                  | 105 |
| Instrument and alarm lights (7 inch) * .....                                | 066 | Panoramic sunroof shade curtain .....                     | 107 |
| steering wheel .....  | 075 | Headlights and view .....                                 | 110 |
| Multi-function steering wheel .....   | 076 | Lamp position (front) .....                               | 110 |
| Smart key .....   | 078 | Lamp position (back) .....                                | 111 |
| Turn on and off .....   | 078 | The light switch (Auto headlights are not equipped) ..... | 112 |
| Keyless entry and keyless start system .....                                | 083 | The light switch (Auto headlights are equipped) .....     | 112 |
| Keyless start/stop button .....   | 085 | Light control .....                                       | 112 |
| Security alarm system .....   | 085 | Interior lights .....                                     | 119 |

|  |            |  |            |
|--|------------|--|------------|
| Wiper and washer combination switch..... | 120        | Air outlet on both sides.....                                    | 150        |
| Interior rearview mirror.....            | 124        | <b>Audio system &amp; Diagnostic interface .....</b>             | <b>151</b> |
| External rearview mirror.....            | 126        | GPS & Media system * .....                                       | 151        |
| Sun visor .....                          | 128        | Intelligent vehicle system .....                                 | 151        |
| <b>Seats and storage devices .....</b>   | <b>130</b> | Diagnostic interface.....  | 151        |
| Seats.....                               | 130        | <b>Accessories /retrofitting &amp; microwave interface .....</b> | <b>152</b> |
| Storage device.....                      | 136        | Accessories /retrofitting & microwave interface.....             | 152        |
| <b>Electrical device interface .....</b> | <b>142</b> |  |            |
| <b>A/C &amp; heating system .....</b>    | <b>143</b> |  |            |
| General descriptions .....               | 143        |  |            |
| Automatic air conditioner.....           | 144        |  |            |
| Electric air conditioner.....            | 147        |  |            |
| A/C air filter.....                      | 150        |  |            |
| Central air outlet .....                 | 150        |  |            |

### Instrument and control mechanism arrangement (model with CVT)

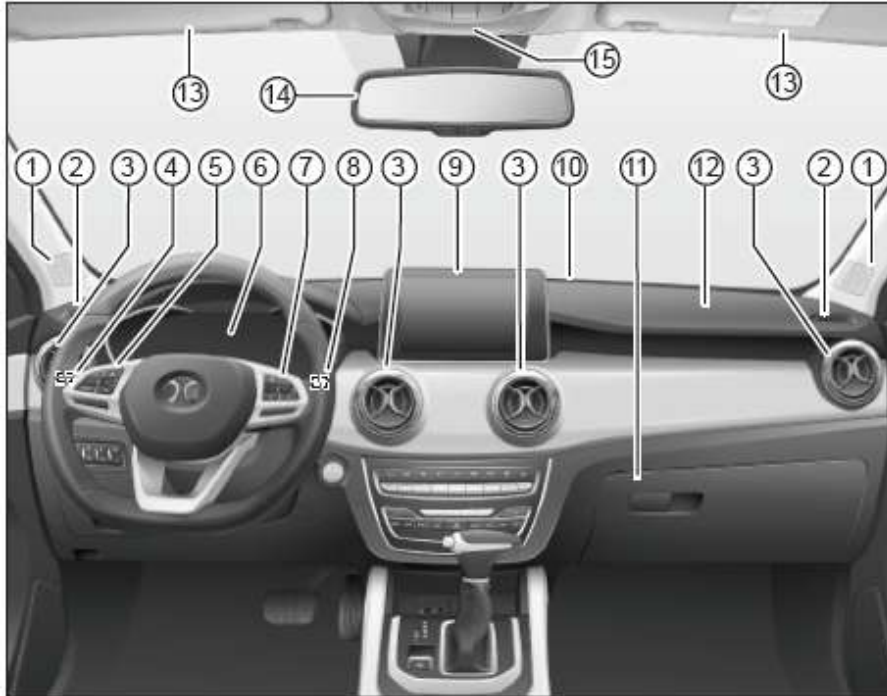

1. Tweeter
2. Side windshield defrosting/defogging air outlet
3. A/C vent
4. Light combination switch
5. Cruise control & setting button
6. Instrument cluster
7. Audio system control button
8. Wiper and washer combination switch
9. Multi-media display screen
10. Windshield defrosting/defogging air outlet
11. Glove box
12. Front passenger frontal airbag
13. Sun visor
14. Interior rearview mirror
15. Sunroof and front dome light switch

### Instrument and control mechanism arrangement (model with CVT)

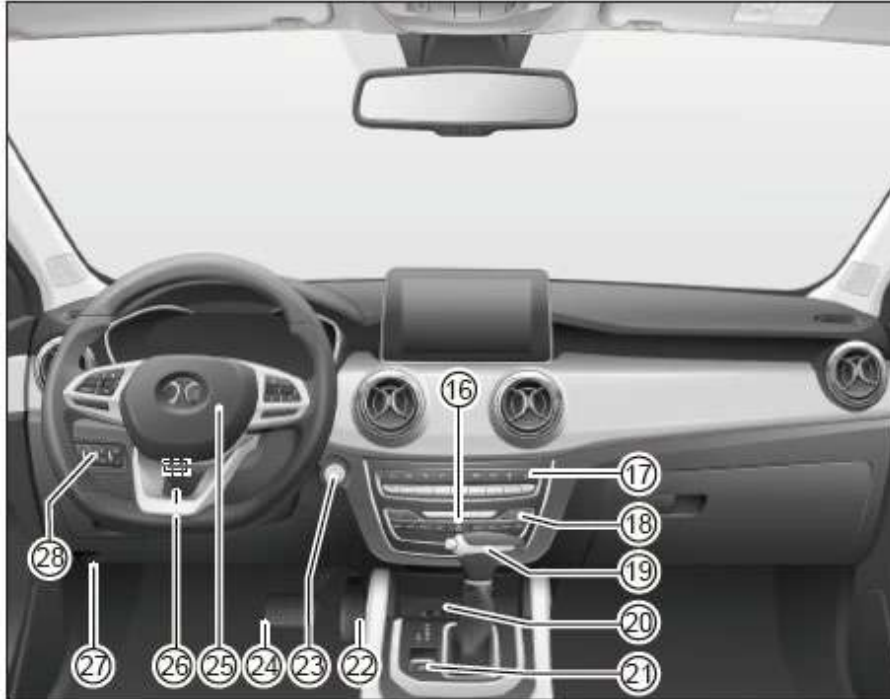

16. Hazard warning light switch
17. Air conditioning control panel
18. Multimedia Control Panel
19. Gearshift lever \*
20. USB interface/mobile internet\*
21. EPB switch
22. Accelerator pedal
23. Keyless start/stop button\*
24. Brake pedal
25. Driver's frontal airbag
26. Steering wheel adjustment lock handle
27. Hood opening handle
28. Multifunction switch panel (headlight height adjustment knob\*, and backlight brightness adjustment switch, etc.)

### Instrument and control mechanism arrangement (model with MT)

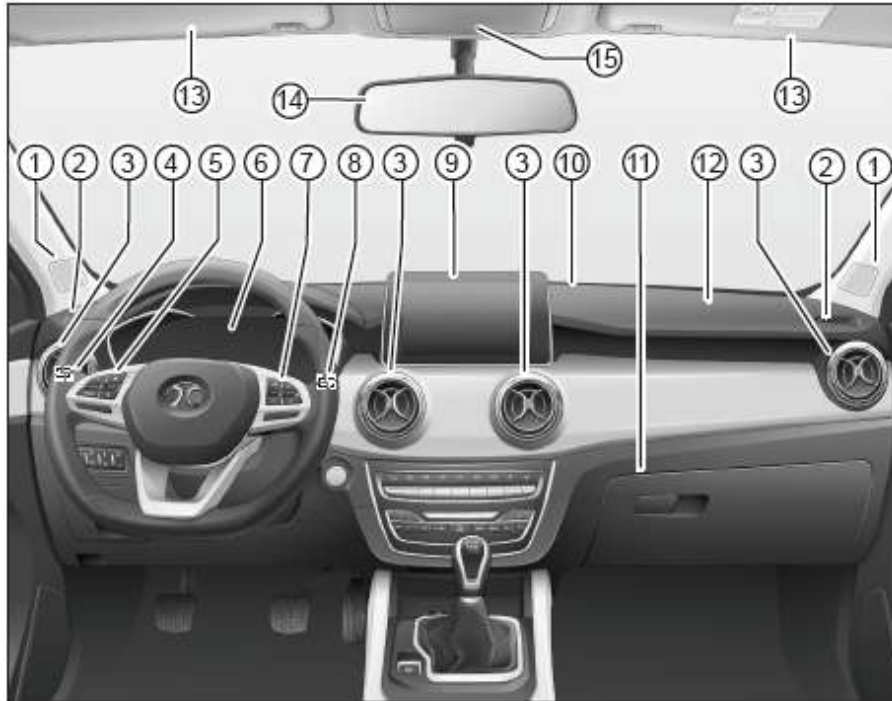

1. Tweeter
2. Side windshield defrosting/defogging air outlet
3. A/C vent
4. Light combination switch
5. Cruise control & setting button
6. Instrument cluster
7. Audio system control button
8. Wiper and washer combination switch
9. Multi-media display screen
10. Windshield defrosting/defogging air outlet
11. Glove box
12. Front passenger frontal airbag
13. Sun visor
14. Interior rearview mirror
15. Sunroof and front dome light switch

### Instrument and control mechanism arrangement (model with MT)

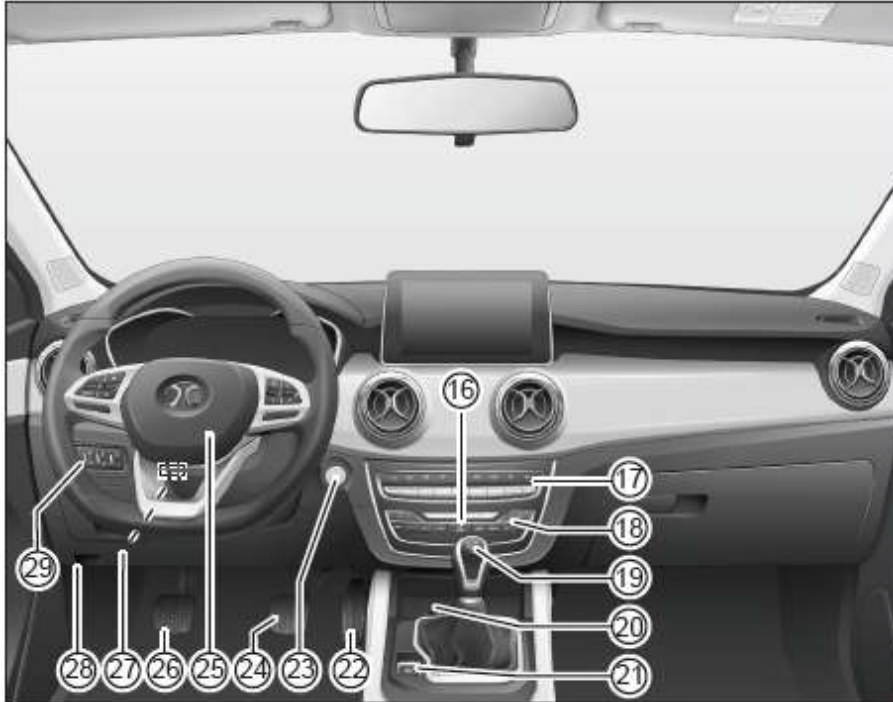

16. Hazard warning light switch
17. Air conditioning control panel
18. Multimedia Control Panel
19. Gearshift lever \*
20. USB interface/mobile internet\*
21. EPB switch
22. Accelerator pedal
23. Keyless start/stop button\*
24. Brake pedal
25. Driver's frontal airbag
26. Clutch pedal
27. Steering wheel adjustment lock handle
28. Hood opening handle
29. Multifunction switch panel (headlight height adjustment knob\*, and backlight brightness adjustment switch, etc.)

## Instrument cluster (5 inches)

1. Tweeter
2. Speedometer
3. Adjustment button (INFO)
4. Fuel gauge
5. Trip computer screen
6. Engine coolant temperature gauge
7. Adjustment button (RESET)
8. Engine tachometer

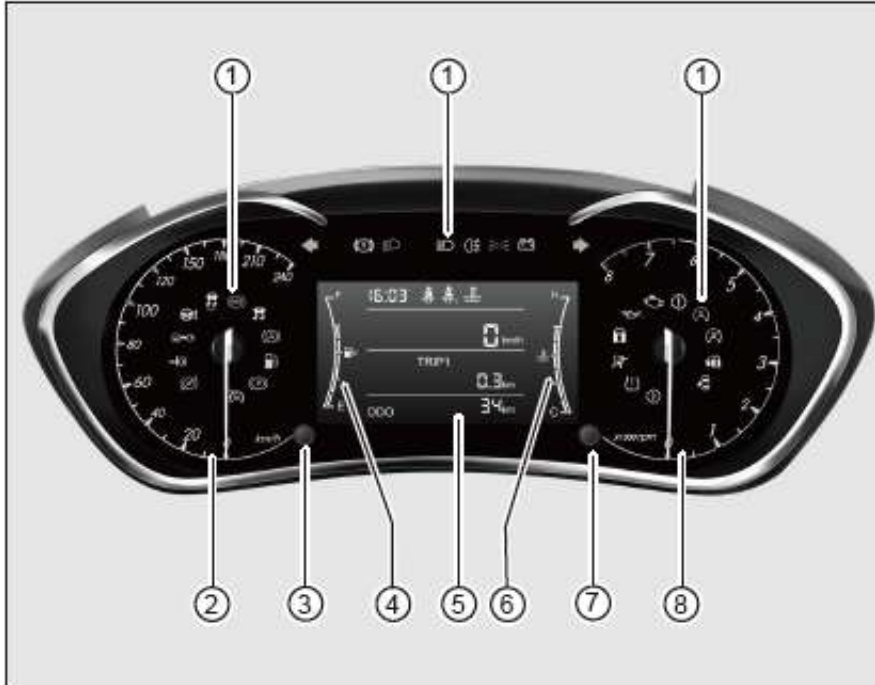

### Engine tachometer

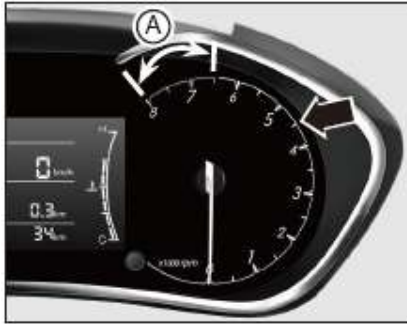

Tachometer indicates engine speed per minute, and the pointer value  $\times 1000\text{r/min}$  is the engine speed.

 Warning

● Do not let the engine speed approaches the area A indicated by the arrow, or it is easy to damage the engine

### Speedometer



The speedometer indicates the instantaneous speed of vehicle (unit: km/h)

 Caution

● When the vehicle is traveling, you should observe the speedometer from time to time, not speeding

 Warning

● Getting higher gear engaged in time will help to save fuel and reduce the operating noise of engine.

### Engine coolant temperature gauge

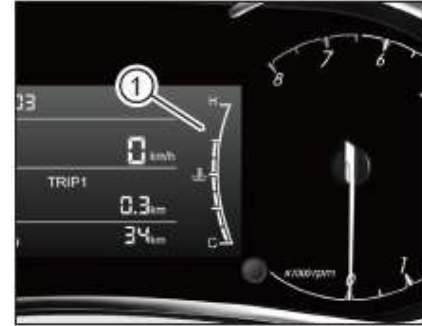

Engine coolant temperature gauge is used to indicate the temperature of engine coolant. After normal driving for a period of time, the indication bar should be light to the middle location or nearby.

If the indication bar 1 is displayed at the top position or nearby, it indicates coolant temperature is too high, you should stop the vehicle under safe conditions and shut down the engine as soon as possible, and check the coolant level. When coolant is sufficient or after adding coolant to a suitable range, if the indication bar is still displayed at the top or nearby for many times when the vehicle is traveling,



you should stop your vehicle under safe conditions as soon as possible, and contact the authorized dealers of BAIC for repair.

 Warning

- When the engine is running, it is strictly prohibited to open the coolant reservoir filler cap and radiator cap. Otherwise, the high pressure hot coolant or vapor will jet out and cause scalding.

### Fuel gauge



Fuel gauge 1 can display the amount of fuel remaining in the fuel tank.

In case of braking, acceleration, turning or running on slope, the fuel in fuel tank may shake, and then the accuracy of indication of fuel gauge will be affected. Therefore,

 Warning

- The arrow mark 2 at the lower part of the fuel gauge indicates the fuel filler is on the right side of the vehicle.

When the fuel shortage occurs the last segment of the fuel gauge flashes and the yellow fuel warning light  goes on. Trip computer screen displays the message "Add Fuel", and the vehicle can travel about 50 km at this time.

 Caution

- Do not drive until the fuel tank is completely exhausted. Irregular fuel supply may result in engine misfire, and unburned fuel enters into the exhaust device. Exhaust three-way catalytic converter will therefore be damaged!

### Trip computer screen (5 inches)

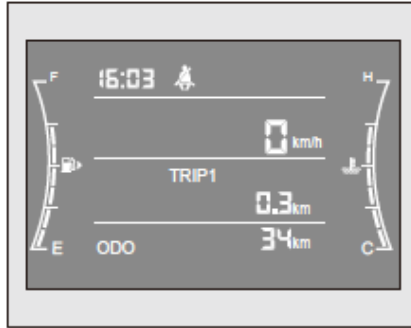

When keyless start/stop button is in "RUN" mode, in the driving parameter interface, driving parameters can be checked in cycle by short press of the button **INFO**. Information can be viewed includes: subtotal mileage A, subtotal mileage B, average fuel consumption A, average fuel consumption B, instantaneous fuel consumption, maintenance mileage, recharge mileage.

### Subtotal mileage A

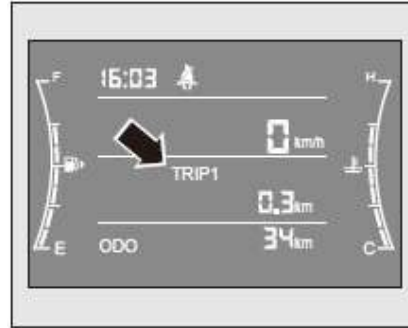

Subtotal mileage A can accumulate the mileage within a range, and its mileage range is 0.0km ~ 9999.9km. When the maximum mileage is reached, subtotal mileage A is automatically cleared and restarted.

In the interface of subtotal mileage A, the value of subtotal mileage A can be cleared by pressing the button **RESET**. If average fuel consumption A is cleared, subtotal mileage A will be cleared also. Meanwhile, when keyless start/stop button is in "OFF" mode for 2h, subtotal mileage A is automatically cleared.

### Subtotal mileage B



Subtotal mileage B can accumulate the mileage within a range, and its mileage range is 0.0km ~ 9999.9km. When the maximum mileage is reached, subtotal mileage B is automatically cleared and restarted.

In the interface of subtotal mileage B, the value of subtotal mileage B can be cleared by pressing the button **RESET**. If average fuel consumption B is cleared, subtotal mileage B will be cleared also.

## Average consumption A

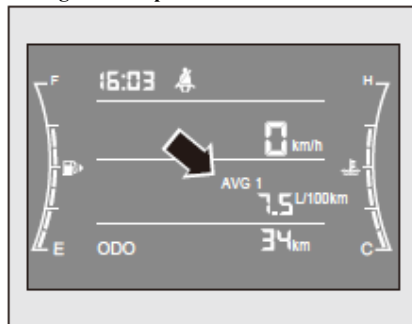

The average fuel consumption display value is calculated according to the total fuel and mileage since clearing the average fuel consumption last time, in unit of L/100km.

In the interface of average fuel consumption A, clear the average fuel consumption a value by long pressing the button **RESET**. When reconnecting the power after power off 2h, the average fuel consumption A will also be cleared. When battery is powered off, average fuel consumption A will be cleared also.

## Average consumption B

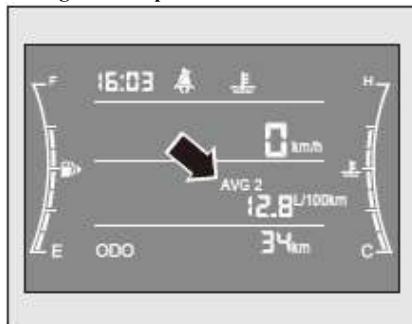

In the interface of average fuel consumption B, clear the average fuel consumption B value by long pressing the button **RESET**. When battery is powered off, average fuel consumption B will be cleared also.

## Instantaneous fuel consumption

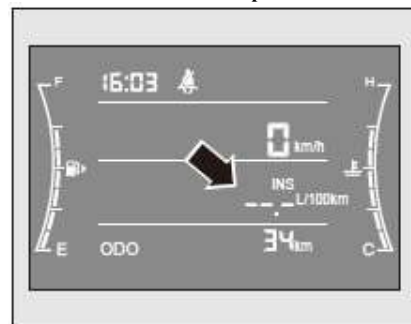

Instantaneous fuel consumption is the fuel consumption at a moment, in unit of L/100km. When the vehicle is idling, instantaneous fuel consumption show as “—.—”

 Warning

- This instantaneous fuel consumption does not reflect the actual situation. This information can help the driver to adjust the driving habits, in order to achieve the desired fuel consumption value and achieve fuel-efficient driving

### Maintenance mileage

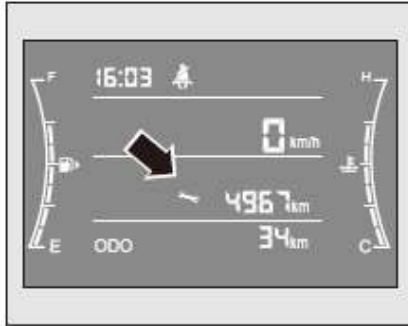

The maintenance information shows the mileage from the next vehicle maintenance. The first maintenance mileage is 5000km, interval maintenance mileage is 5000km. It is advised to check the vehicle regularly and maintain in time.

Long press **RESET** over 10s, switch keyless start/stop button “OFF” mode, then turn to “RUN” mode immediately.

Press **RESET** and **INFO** at the same time over 10s, maintenance mileage will be reset.

### Range

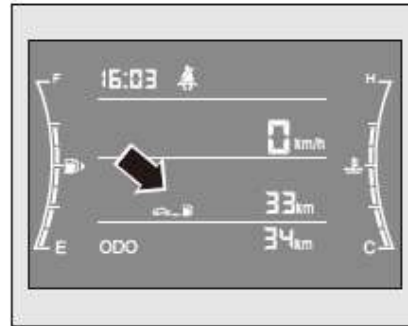

It can estimate and display the distance the vehicle can continue to travel based on current driving mode and fuel in the tank. If you drive in a more economical mode, this distance may increase

### Total mileage

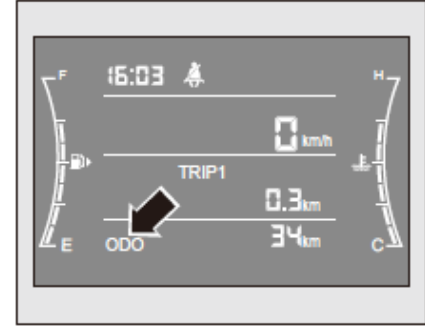

ODO: It shows the total mileage the vehicle has driven, its range is 0km~9999999km.

**Tire information**

The tire pressure information shows the tire pressure state of the vehicle. In normal case, combination meter doesn't have tire pressure information and warning light information. When the tire pressure is abnormal, warning lights light up, accompanied by a prompt tone, and the driving computer display shows the trolley icon and the corresponding faulty tire flashes.

When the TPMS is abnormal, the tire pressure monitoring alarm light flashes first 60s, then the light is on consistently with a beep. When the signal of TPMS is lost, the driving computer display has no tire pressure information, and the tire pressure monitoring alarm light flashes.

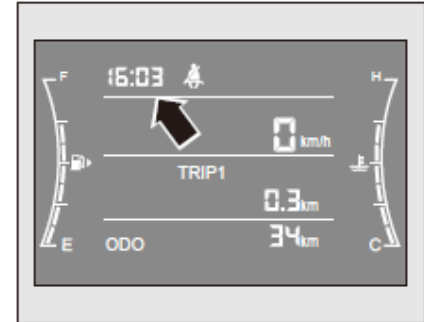
**Clock display**

Show the time currently in 24h mode, adjust the time by central control audio host.

### Combination instrument indicator light and warning light (5 inches)

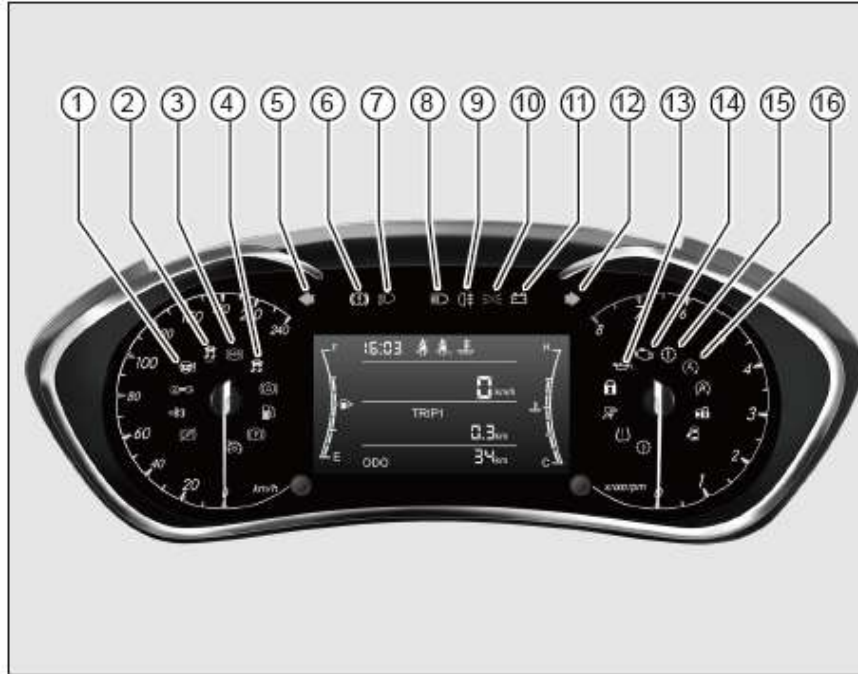

1. Electric power steering fault warning light
2. ESP OFF indicator light
3. ABS fault warning light
4. ESP run/fault warning light
5. Left turn signal lamp
6. Brake system fault/brake liquid low level warning light
7. Low beam ON indicator light
8. High beam ON indicator light
9. Back fog lamp ON indicator light
10. Position lamp ON indicator light
11. Battery charging fault warning light
12. Right turn signal lamp
13. Oil pressure warning light
14. Engine system fault warning light
15. Transmission fault warning light
16. Idle start/stop run indicator light

### Combination instrument indicator light and warning light (5 inches)

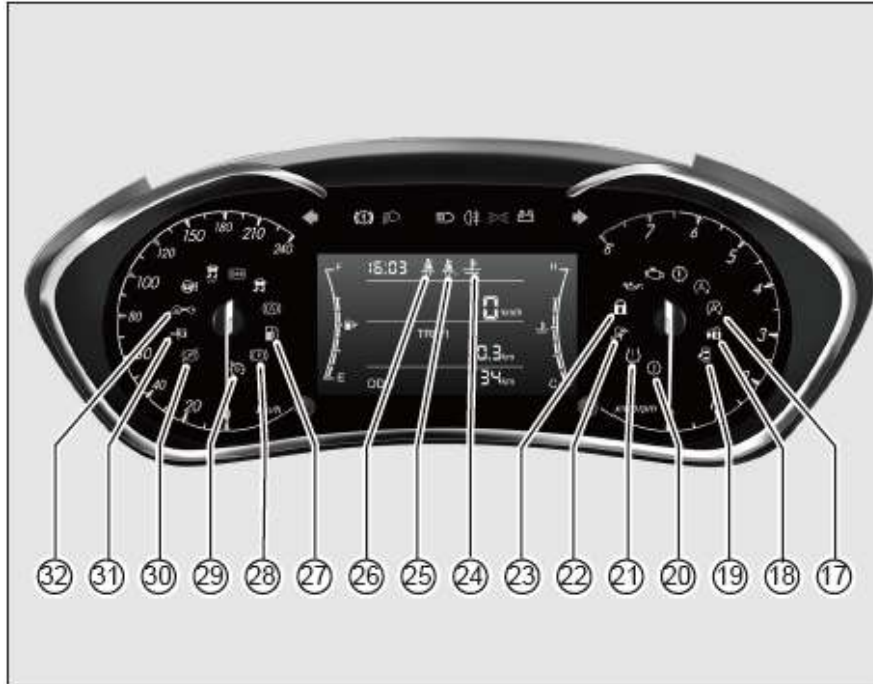

17. Idle start/stop OFF/fault indicator light
18. Engine immobilizer fault warning light
19. Door open indicator light
20. Transmission oil temperature warning light
21. Tire pressure monitoring warning light
22. Airbag system fault warning light
23. Anti-theft indicator light
24. Engine coolant temperature warning light
25. Passenger seat belt not fastening warning light
26. Driver seat belt not fastening warning light
27. Fuel warning light
28. Parking brake indicator light
29. Cruise control switch indicator light
30. Parking brake warning light
31. Keyless start fault warning light
32. Electric steering column clock indicator light

Description indicator light & warning light (5 inches)

1. Electric power steering fault warning light  (yellow)

When keyless start/stop button is in the "RUN" mode, the warning light remains ON to check by itself, and goes out after self-test.

If the electric power steering fault warning light goes on after self-test, or the light is on when the engine is running, it indicates that electric power steering has a fault, there is no power steering, but you can still control steering. In this case large force is needed to operate the steering wheel, especially in sharp turns and at low speed, so you should drive with caution, and contact the authorized dealer of BAIC for repair as soon as possible. (See page 167 for "electric power steering system")

2. ESP OFF indicator light  (yellow)

When keyless start/stop button is in the "RUN" mode, the warning light remains ON to check by itself, and goes out after self-test. In the normal state, the system default ESP function is on. To turn off this function, press the ESP off switch. At this time, the ESP function is turned off

and the ESP off indicator light is off. Press this switch again, the ESP function is turned on, and the ESP off indicator light is off.

3. ABS fault warning light  (yellow)

When keyless start/stop button is in the "RUN" mode, the warning light remains ON to check by itself, and goes out after self-test. If the warning light goes on in the process of traveling, it indicates that the ABS system has a fault.

#### Warning

● **If the warning light goes on during traveling, you can drive at low speed to the destination in the premise of ensuring safety, but you still should contact the authorized dealer of BAIC Motor for repair as soon as possible.**

● **If the brake system fault/low brake fluid level warning lights go on at the same time, you should stop immediately in the premise of ensuring safety, and contact the authorized dealer of BAIC for repair.**

4. ESP run/ fault warning light  (yellow)

When keyless start/stop button is in the "RUN" mode, the warning light remains ON to check by itself, and goes out after self-test.

If ESP run/fault warning light flashes on the process of driving, it indicates that ESP system is working.

If ESP run/fault warning light remains on when on the process of normal driving, it indicates the ESP system has a fault, so you should contact the authorized dealer of BAIC for repair as soon as possible.

5. Left turn signal indicator  (green)

It indicates that the left turn signal lamp is turned on. When the left turn signal lamp or hazard warning light is turned on, this indicator will flash.

If the light flashes faster than normal, it indicates that the left turn signal lamp has fault or the bulb is damaged. Please contact the authorized dealer of BAIC for repairs as soon as possible.



6. Brake system fault/ brake fluid low level warning light  (red)

When keyless start/stop button is in the "RUN" mode, the warning light remains ON to check by itself, and goes out after self-test.

If the warning light does not go out or goes on the process of driving, it indicates that the brake system may have a fault or lack brake fluid.

 Warning

**The warning light goes on in the process of driving:**

- Do not depress the brake pedal repeatedly.
- You should stop immediately in the premise of ensuring safety, and immediately contact the

7. Low beam ON indicator light  (green)

It indicates that the low beam is turned on. When the low beam is turned on, this indicator will go on.

8. High beam ON indicator light  (blue)

It indicates that the high beam is turned on. When the high beam is turned on, this indicator will go on.

9. Front fog lamp ON indicator light  (green)

It indicates the front fog lamp is enabled, and it goes on when the front fog lamp is turned on.

10. Position lamp ON indicator light  (green)

It indicates the position lamp is enabled, and it goes on when the position lamp (small lamp) is turned on.

11. Battery charging fault warning light  (red)

When keyless start/stop button is in the "RUN" mode, the battery charging fault warning light goes on. The light goes out after the engine starts. If the warning light does not go out, it indicates there is a battery charging system fault, you should contact the authorized dealer of BAIC for repair as soon as possible.

 Warning

- If the warning light goes on in the process of traveling, you should stop immediately in the premise of safety, and contact the authorized dealer of BAIC for repair as soon as possible. If no measures are taken, it could lead to serious loss of battery power, and the engine will not work.

12. Right turn signal indicator  (green)

It indicates that the right turn signal lamp is turned on. When the right turn signal lamp or hazard warning light is turned on, this indicator will flash.

If the light flashes faster than normal, it indicates that the right turn signal lamp has fault or the bulb is damaged. Please contact the authorized dealer of BAIC for repairs as soon as possible.

13. Oil pressure warning light  (red)

When the ignition switch is in the "ON" position or keyless start/stop button is in the "RUN" mode, the oil pressure warning light goes on, and goes out after the engine starts.

 Warning

● If the warning light goes on in the process of traveling, you should stop immediately in the premise of safety, and contact the authorized dealer of BAIC for repair as soon as possible. If no measures are taken, it could cause serious damages to the engine.

14. Engine system fault warning light  (yellow)

When keyless start/stop button is in the "RUN" mode, the engine system fault warning light goes on, and then goes out after the engine starts.

If this warning light remains on after you start the engine, or goes on or flashes on traveling, it indicates engine control system has a fault. At this point, the vehicle can still travel, but you should go to the authorized dealer of BAIC for repair.

 Caution

● If the warning light goes on in the process of traveling, you should contact the authorized dealer of BAIC for repair as soon as possible. If no measures are taken, the performance of the engine may be seriously affected.

15. Transmission fault warning light  (yellow, CVT models only)

When keyless start/stop button is in the "RUN" mode, the warning light goes ON to check by itself, and goes out after self-test. When the transmission fault occurs, the warning light goes on. You should slow down or stop in the premise of ensuring safety, and contact the authorized dealer of BAIC for repair as soon as possible.

16. Idle start/stop run indicator light  (green)

When keyless start/stop button is in the "RUN" mode, the warning light remains ON to check by itself, and goes out after self-test.

The light indicates start/stop system status. When the vehicle enters into idle stop mode, the light goes on.

17. Idle start/stop OFF/fault indicator light  (yellow)

When keyless start/stop button is in the "RUN" mode, the warning light remains ON to check by itself, and goes out after self-test.

If the indicator does not go out after the self-test, or flashes and then lights up during driving, it indicates the system has a fault.

When the idle start/stop function turns off, the idle start/stop off/fault indicator lights up.

18. Engine immobilizer fault warning light  (red)

When keyless start/stop button is in the "RUN" mode, the warning light remains ON to check by itself, and goes out after self-test.

If the engine immobilizer adaption fails, the warning light goes on.

19. Door open indicator light  (red)

It indicates the switch status of door/ engine hood and trunk door. The light goes on if any of them is open.

 Warning

● **When speed is over 5km/h, if the door is not closed, there is a sound alert. After 60s, the light will go on continuously until all doors are closed.**

20. Transmission oil temperature warning light 

(yellow, CVT only)

When keyless start/stop button is in the "RUN" mode, the light remains ON to check by itself, and goes out after self-test. When the transmission oil temperature is too high, the warning light goes on. You should slow down or stop in the premise of ensuring safety, and contact the authorized dealer of BAIC for repair as soon as possible.

21. Tire pressure monitoring warning light  (yellow)

When keyless start/stop button is in the "RUN" mode, the warning light remains ON to check by itself, and goes out after self-test.

If tire pressure is abnormal, the warning light goes on, and the trip computer screen displays the corresponding tire fault information, and there is a graph to show specific location of the tire fault.

 Caution

● **If the warning light goes on in the process of traveling, you should immediately stop in the premise of ensuring safety, check the tire pressure, and contact with the authorized dealer of BAIC.**

22. Airbag system fault warning light  (red)

When keyless start/stop button is in the "RUN" mode, the warning light remains ON to check by itself, and goes out after self-test. If the airbag system fault warning light does not go out after self-test or goes on during driving, it indicates the airbag system has a fault.

 Warning

● **If the airbag system fault warning light goes on, it cannot guarantee the airbag system is in normal state, and you should stop immediately in the premise of safety, and contact the authorized dealer of BAIC for repair as soon as possible.**

23. Anti-theft indicator light  (red)

When keyless start/stop button is in the "RUN" mode, the light remains ON to check by itself, and goes out after self-test.

After lock the vehicle successfully, if the indicator light low frequent flashes, it indicates that the alarm system is in anti-theft state. When an anti-theft intrusion is detected, the alarm indicator lights up.

24. Engine coolant temperature warning light  (red)

When keyless start/stop button is in the "RUN" mode, the light remains ON to check by itself, and goes out after self-test. If the warning light goes on in the process of traveling, it indicates the engine coolant temperature is too high.

 Warning

● **If engine coolant temperature is too high, please slow down engine rotating speed, and stop in the premise of ensuring safety. After the temperature drops to normal temperature, check the coolant level.**

● **If engine coolant temperature is too high constantly, stop and check, or contact the authorized dealer of BAIC for repair as soon as possible.**

25. Front passenger seat belt not fastening warning light  (red)

After the vehicle is powered, if front passenger does not fasten the seat belt, the warning light goes on. When the seat belt is not fastened, if the speed is more than 25km/h or traveling time is more than 60s or traveled distance is over 300m, the seat belt not fastening warning light will flash accompanied by 120s of sound alert. After 120s, the seat belt not fastening warning light still remains ON, but the sound alert will stop.

 Warning

● **If some heavy things are lay on front passenger seat, when keyless start/stop button is in the "RUN" mode, it will lead front seat belt not fastening warning light to light up.**

26. Driver seat belt not fastening warning light  (red)

After the vehicle is powered, if driver does not fasten the seat belt, the warning light goes on. When the seat belt is not fastened, if the speed is more than 25km/h or traveling time is more than 60s or traveled distance is over 300m, the seat belt not fastening warning light will flash accompanied by 120s of sound alert. After 120s, the seat belt not fastening warning light still remains ON, but the sound alert will stop.

27. Fuel warning light  (yellow)

When keyless start/stop button is in the "RUN" mode, the light remains ON to check by itself, and goes out after self-test.

If the warning light goes on, it indicates that the remaining amount of fuel is less, and you should add fuel. If the warning light flashes, it indicates that the fuel sensor has a fault, while the fuel gauge does not indicate properly. Please contact the authorized dealer of BAIC for repair.

28. Parking brake indicator light  (red)

When keyless start/stop button is in the "RUN" mode, the light remains ON to check by itself. After self-test. If pull up the EPB, the indicator light goes on, if not pull up the EPB, the indicator light goes out.

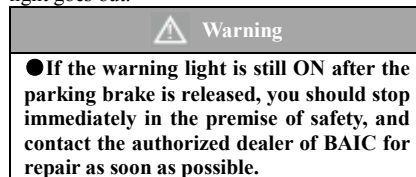

29. Cruise control switch indicator light  (green)

When the light flashes at frequency of 2Hz, it indicates that Cruise control function is turned on. When the indicator light remains on, it indicates that it has entered into Cruise control state.

30. Parking brake warning light  (yellow)

When keyless start/stop button is in the "RUN" mode, the light remains ON to check by itself, and goes out after self-test. When EPB system has a fault, warning light goes on, please contact the authorized dealer of BAIC for repair as soon as possible.

31. Keyless start fault warning light  (red)

It indicates the PEPS system warning information. When the light goes on, it may occur some conditions as below:

①No smart key found. ②Smart key is forgotten inside the car. ③Smart key is not inside the car.④ Smart key does not have enough power. ⑤please put the smart key close to emergence start zone.

32. Electric steering column lock indicator light  (red)

It indicates the ESCL system warning information. When the light goes on, it may occur some conditions as below:

①Steering column lock has a fault, it need to stop to check. ②Prompt the driver to turn the steering wheel. ③Steering column lock unlock failed.

## Instrument cluster (7')

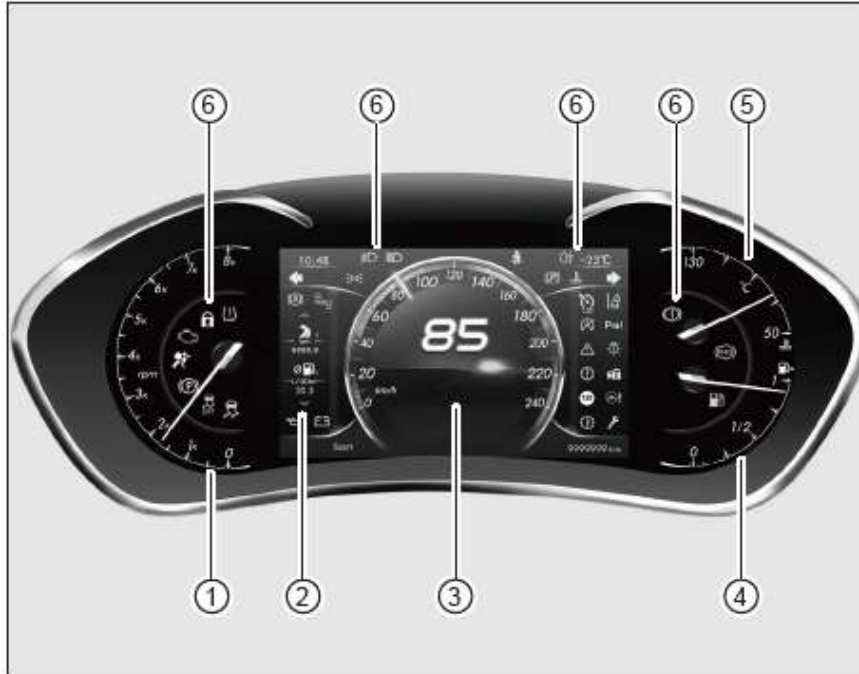

1. Engine tachometer
2. Trip computer screen
3. Speedometer
4. Fuel gauge
5. Engine coolant temperature gauge
6. Indicator light and alarm light

### Engine tachometer



Tachometer indicates engine speed per minute, and the pointer value  $\times 1000\text{r/min}$  is the engine speed.

#### Warning

- Do not let the engine speed approaches the  area indicated by the arrow, or it is easy to damage the engine.

### Speed meter



The speedometer indicates the instantaneous speed of vehicle (unit: km/h).

#### Caution

- When the vehicle is traveling, you should observe the speedometer from time to time, not speeding.

#### Warning

- Getting higher gear engaged in time will help to save fuel and reduce the operating noise of engine.

### Engine coolant temperature gauge



Engine coolant temperature gauge is used to indicate the temperature of engine coolant.

After normal driving for a period of time, the engine has reached to normal operating temperature, and the indication bar should be light to the middle location or nearby.

If the indication bar  is displayed at the top position or nearby, it indicates coolant temperature is too high, you should stop the vehicle under safe conditions and shut down the engine as soon as possible, and check the coolant level. When coolant is sufficient or after adding coolant to a suitable range, if the indication bar is still displayed at the top

or nearby for many times when the vehicle is traveling, you should pull out under safe conditions as soon as possible, and contact the authorized dealer of BAIC Motor for repair.

 Warning

- When the engine is running, it is strictly prohibited to open the coolant reservoir filler cap and radiator cap. Otherwise, the high-pressure hot coolant or vapor will jet out and cause scalding.

Fuel meter



Fuel gauge 1 can display the amount of fuel remaining in the fuel tank

In case of braking, acceleration, turning or running on slope, the fuel in fuel tank may shake, and then the accuracy of indication of fuel gauge will be affected. Therefore, please park the vehicle on flat road and then inspect the level of fuel.

 Warning

- Getting higher gear engaged in time will help to save fuel and reduce the operating noise of engine.

Arrow mark turned to red area indicates that fuel is low, and the yellow fuel warning light  will be lightened.

 Caution

- Do not drive until the fuel tank is completely exhausted. Irregular fuel supply may result in engine misfire, and unburned fuel enters into the exhaust device. Exhaust three-way catalytic converter will therefore be damaged!

### The driving computer screen\*







Do not drive until the fuel tank is completely exhausted. Irregular fuel supply may result in engine misfire, and unburned fuel enters into the exhaust device. Exhaust three-way catalytic converter will therefore be damaged!

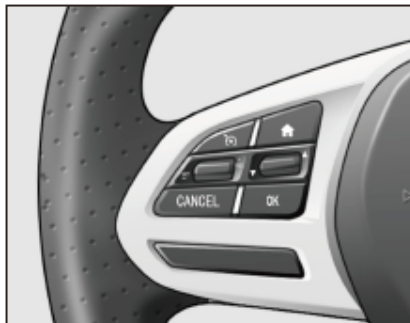

## Instrument operation button



-  Enter/Reset key
-  Return/Menu key
-  Page Up
-  Page Down

## Driving Information



When keyless start/stop button is in "RUN" mode, the driving parameters would display when press the button, included: Subtotal mileage1 /Average fuel consumption1; subtotal mileage2 /Average fuel consumption 2; driving duration/Average speed; Endurance / Fuel Usage, long press the Button to hide the driving information. And to show the information again, a shortly press is required.

## Subtotal mileage1/ Average fuel consumption1



Subtotal mileage 1 is the cumulated mileage during a period driving mileage, with the range of 0.0-9999.9 km.

The average fuel consumption display value is calculated according to the total fuel and mileage since clearing the average fuel consumption last time, in unit of L/100km.

### Clearance of Subtotal mileage1/ Average fuel consumption1

Subtotal mileage 1 / average fuel consumption 1 could be cleared through below circumstances:

1. Under subtotal mileage1/ Average fuel page, press the **OK** button for a long time and the reset window will pop out, switch the **▲** / **▼** button, choose **OK** then  $\checkmark$  to confirm the clearance.
2. When the keyless start/stop button is on 'off' for two hours, subtotal mileage 1 is automatically cleared and restarted.
3. When the maximum mileage is reached, subtotal mileage 1 is automatically cleared and restarted.
4. If the battery power is off, the average fuel consumption will also be cleared.

### Subtotal mileage2/ Average fuel consumption2



Subtotal mileage 2 is the cumulated mileage during a period driving mileage, with the range of 0.0-9999.9 km.

The average fuel consumption display value is calculated according to the total fuel and mileage since clearing the average fuel consumption last time, in unit of L/100km.

### Clearance of Subtotal mileage2/ Average fuel consumption2

Through the following methods, or the following conditions to clearance of Subtotal mileage 2 / average fuel consumption 2

- 1 Under subtotal mileage1/ Average fuel page, press the reset button for a long time, then use the **▲** / **▼** button to switch to the reset then  $\checkmark$  to confirm the clearance.
2. When the maximum mileage is reached, subtotal mileage 1 is automatically cleared and restarted.
3. If the battery power is off, the average fuel consumption will also be cleared.

**Traveling time / Average speed**

Traveling time is the cumulative driving time after the reset, it starts timing when the keyless start/stop button is in "RUN" mode, and Maximum time displayed is 99:59.

Average speed is calculated as the distance/travel time.

**Clearance driving time / average speed**

Driving time / average speed could be cleared through below circumstances:

1. Under driving time / average speed page, press the **OK** button for a long time and the reset window will pop out, switch the **▲**/**▼** button, choose 'reset' then **√** and **OK** to confirm the clearance.
2. When the keyless start/stop button is on 'off' for two hours, driving time / average speed is automatically cleared and restarted.
3. When the maximum traveling time is reached, driving time / average speed is automatically cleared and restarted.
4. If the battery power is off, the driving time / average speed will also be cleared.

**Range / Instantaneous fuel consumption**

Range could be estimated and display the distance the vehicle can continue to travel based on current driving mode and fuel in the tank. If you drive in a more economical mode, this distance may change.

When estimated driving distance is lower than 30km, range will display as 'low range', and you should refill timely.

Instantaneous fuel consumption is the fuel consumption at a moment, in unit of L/100km, and '--.' when idling.

### Instrument Settings

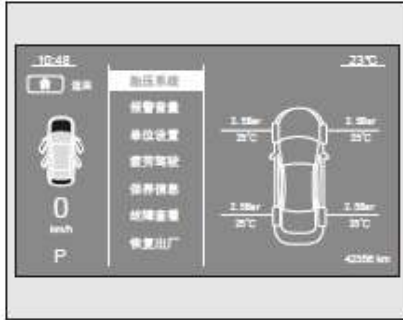

When the keyless start/stop button is in "RUN" mode, short press **▲** button to enter into the instrument settings. After entering, switch **▲** / **▼** button to view the 'Tire pressure', 'Alarm volume', 'Unit setting', 'Fatigue driving', 'Maintenance', 'Malfunction', and 'Default setting'. Check the setting information in cycle by short pressing the key **OK** and press **▲** to select.

### Tire pressure system

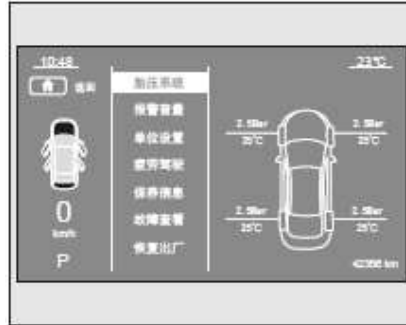

Tire information shows tire pressure and temperature of the four wheels. When tires are malfunctioned other than tire pressure system issues, the fault tire will show as red, when tire pressure is malfunctioned, all tires will turn yellow. A text reminder would show above the car image.

### Warning

- After the car is turned off and restart, when the instrument self-detection is over, the instrument could show the pressure and temperature of the tires, this is the historical data of last driving, not the current status, it will be updated after car traveling for some time.
- The tire pressure sensor is activated only after traveling for some time at speed of more than 30km/h, the instrument will update to show the current tire pressure and temperature. And the tire pressure system will work normally.

## Alarm volume



Choose 'Alarm volume' at instrument setting page, shortly press **OK** button to set the alarm volume. Switch **▲/▼** button to choose among 'high' 'medium' and 'low', shortly press **OK** button to complete setting. Then shortly press **🏠** to return to upper menu, long press **🏠** to return to main menu.

## Unit setting



Choose 'Unit setting' at instrument setting page, shortly press **OK** button to set the unit system. Switch **▲/▼** button to choose between 'Metric' and 'British', shortly press **OK** button to complete setting. Then shortly press **🏠** to return to upper menu, long press **🏠** to return to main menu.

## Metric/British system comparison

| Unit        | Metric  | British   |
|-------------|---------|-----------|
| Distance    | km      | miles     |
| Speed       | km/h    | mph       |
| Temperature | °C      | °F        |
| Fuel usage  | L/100km | miles/gal |

### Fatigue driving



Choose 'Fatigue driving' at instrument setting page, shortly press **OK** button to enter. Switch **▲** / **▼** button to choose among 'on/off' 'high speed' and 'normal', shortly press **OK** button to complete setting. Then shortly press **⬆** to return to upper menu, long press **⬆** to return to main menu.

### High speed mode



After entering the high-speed mode setting interface, short press **OK** button to set the high speed mode. Switch **▲** / **▼** button to choose time duration, shortly press **OK** button to complete setting. Available choice under high-speed mode is 2 hours, 3 hours, and 4 hours. When the accumulated continuous driving time reaches fatigue remind setting time, remind message "Please take a rest" will appear on the trip computer screen, please pull and rest for your own safety.

### Normal Mode



After entering the normal mode setting interface, short press **OK** button to set the normal mode. Switch **▲** / **▼** button to choose time duration, shortly press **OK** button to complete setting. Available choice under normal mode is 3 hours, 4 hours, and 5 hours. When the accumulated continuous driving time reaches fatigue remind setting time, remind message "Please take a rest" will appear on the trip computer screen, please pull and rest for your own safety.

### Maintenance Information



Maintenance information displays the mileage before the next maintenance.

The first maintenance mileage of the vehicle is 5000km, reserve maintenance is 5000km, and occasionally check is suggested to keep maintenance timely.

Long press **OK** button for 30 seconds will reset the maintenance mileage.

### Malfunction review



When alarm warning information displayed on instrument interface, these information will automatically be stored into malfunction page. Select 'Malfunction', shortly press **OK** to enter malfunction interface, switch **▲/▼** button to check the information of malfunction, if there is a fault, please go to BAIC distributors to check and maintain; if no fault, 'no fault' will display.

### Default Setting



After enter into the default setting interface, short press **OK** to browse in cycle using **▲/▼**, and press **OK** to select, and return to the menu interface.

After selecting default setting, all function will reset to default state.

### Combination instrument indicator light and warning light 7' \*

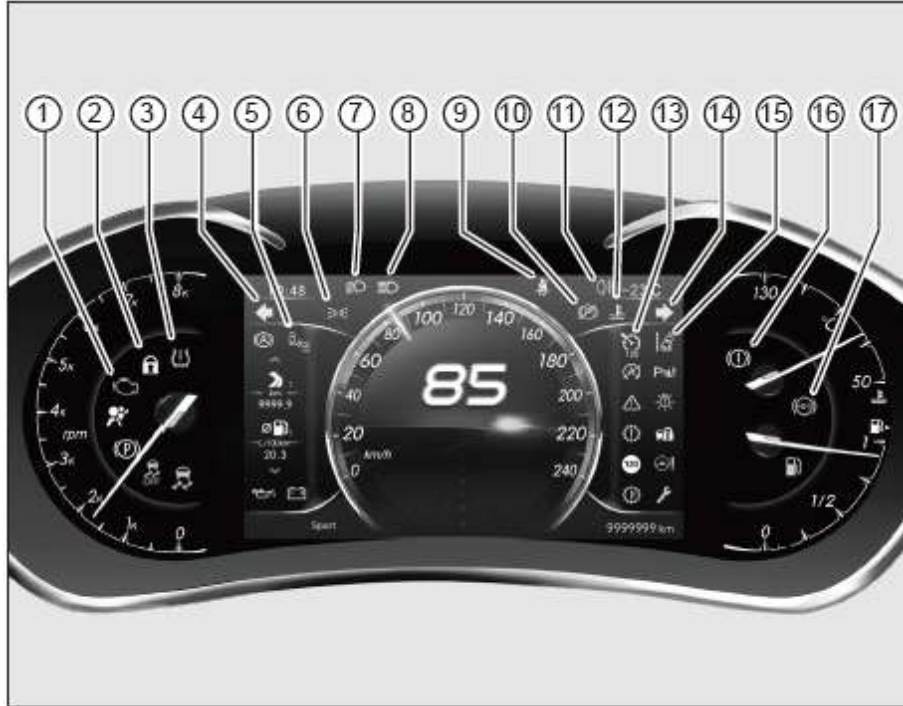

1. Engine system fault warning light
2. Anti-theft indicator light
3. Tire pressure monitoring warning light\*
4. Left turn signal lamp
5. Dead zone monitoring indicator/fault warning light\*
6. Position light ON indicator light
7. Low beam ON indicator light
8. High beam ON indicator light
9. Seat belt not fastening warning light
10. EPB fault warning light
11. Rear fog lamp ON indicator light
12. Engine coolant temperature warning light
13. Cruise control ON indicator light\*
14. Right turn signal lamp
15. Lane departure indicator/fault warning light\*
16. Brake system fault/low brake fluid level warning light
17. ABS fault warning light



## Combination instrument indicator light and warning light 7)\*



18. Fuel warning light
19. Radar system fault warning light \*
20. Light system fault warning light \*
21. Engine immobilizer fault warning light
22. Electric power steering fault warning light
23. Maintenance Reminder light
24. Transmission oil temperature fault warning light\*
25. Over-speed warning light \*
26. Transmission fault warning light\*
27. Fault reminder indicator light
28. Idling start-stop indicator light \*, Idling start-stop OFF/ fault warning light\*
29. Battery charging fault warning light
30. Oil pressure gauge warning light
31. ESP operation fault warning light\*
32. ESP OFF indicator light\*
33. Parking brake indicator light
34. Airbag system fault warning light

### Combination instrument indicator light and warning light 7\*\*

#### 1. Engine system fault warning light (yellow)

When the keyless start/stop button is in "RUN" mode, the engine system fault warning light is on; after start up, it will turn off.

If the light is still on after the engine is working, or the light turn on during traveling, the engine system is faulted. The car could still be driving, but it is highly recommended to drive to a BAIC distributor to check the engine.

#### Caution

● **If the warning light turn on during travel, you should contact BAIC distributor to check and maintain ASAP. If no action is taken, it might cause serious damage to engine.**

#### 2. Anti-theft indicator light (red)

When the keyless start/stop button is in "RUN" mode, this light is on for self-detection, after self-detection it will turn off. After successfully locked the car, a low frequency flick of the light indicates that the alarm system is on. When an instruction is detected, the warning light will be on constantly.

#### 3. Tire pressure monitoring warning light (yellow)

When the keyless start/stop button is in "RUN" mode, this light is on for self-detection, after self-detection it will turn off.

If the light is still on after the self-detection, or the flick for 60s turn on constantly during traveling, the pressure is abnormal. Combination instrument warning window will show the abnormal tire with the warning light and prompt tone.

#### Caution

● **If the warning light turn on during travel, you should pull off under safe circumstances, check the tire pressure and contact BAIC distributor.**

#### 4. Left turn signal lamp (green)

It indicates that the left turn signal lamp is turned on. When the left turn signal lamp or hazard warning light is turned on, this indicator will flash.

If the light flashes faster than normal, it indicates that the left turn signal lamp has fault or the bulb is damaged. At this time the trip computer screen displays the message "Left turn signal lamp fault". Check the turn signal lamp for fault, and contact the authorized dealer of BAIC Motor for repairs as soon as possible.

5. Dead zone monitoring indicator / fault warning light\*  (green/red)

When dead zone monitoring system is on, the light is on as green. If the system is dysfunctional, the light is red. Meanwhile the combination instrument warning window will show the abnormal tire with the warning light and prompt tone.

6. Position light ON indicator light  (green)

This light indicates that the position light is ON.

7. Low beam ON indicator light  (green)

It indicates that the low beam is turned on. When the low beam is turned on, this indicator will go on.

8. High beam ON indicator light  (blue)

It indicates that the high beam is turned on. When the high beam is turned on, this indicator will go on.

9. Seat belt not fastening warning light  (red)

After the vehicle is powered, if the driver or front passenger does not fasten a seat belt, the seat belt not fastening warning light goes on. When the seat belt is not fastened, if the vehicle speed is greater than 25km/h or traveling time is more than 60s or distance traveled is over 300m, the seat belt not fastening warning light will flash accompanied by 120 seconds of sound alert. After 120s, the seat belt not fastening warning light still remains ON, the sound alert will stop.

#### Warning

● **If heavy objects are placed on the front passenger seat, after the vehicle is powered on, they may result in the seat belt not fastening warning light on the instrument remains ON even if the driver has fastened the seat belt.**

10. EPB fault warning light  (yellow)

When the keyless start/stop button is in "RUN" mode, this light is on for self-detection, after self-detection it will turn off.

When EPB system is dysfunctional, the warning light will turn on, please go to the authorized dealer of BAIC Motor for repairs as soon as possible.

11. Rear fog lamp ON indicator light  (yellow)

It indicates that the rear fog lamp is enabled, and it goes on when the rear fog lamp is turned on.

### 12. Engine coolant temperature warning light (red)

When the keyless start/stop button is in "RUN" mode, this light is on for self-detection, after self-detection it will turn off. If the warning light goes on in the process of traveling, it indicates the engine coolant temperature is too high. Trip computer screen displays the message "high engine water temperature".

#### Warning

- If the engine cooling water temperature is too high, please reduce the engine speed, immediately stop the vehicle under the precondition that the safety is ensured, wait until the temperature lowers to normal level, and then inspect the level of coolant.
- If the engine coolant temperature meter displays sustained highest temperature or near. Please park and inspect the vehicle, or get the vehicle inspected and repaired by the authorized dealer of BAIC Motor.

### 13. Cruise control ON indicator light\* (green)

The light sparkles with 2HZ indicates that the cruise control system is in processing. After the light turn on constantly, the function is ready and work normally.

### 14. Right turn signal lamp (green)

It indicates that the right turn signal lamp is turned on. When the right turn signal lamp or hazard warning light is turned on, this indicator will flash.

If the indicator flashes quicker than normal state, it means that the circuit of right turn signal lamp is in fault or the bulb is broken. At this time the trip computer screen displays the message "right turn signal lamp fault". Check the turn signal lamp for fault, and contact the authorized dealer of BAIC Motor for repairs as soon as possible.

### 15. Lane departure indicator/fault warning light\* (green/red)

When lane departure pre-warning system is on, the light is on as green. If the system is dysfunctional, the light is red. Meanwhile the combination instrument warning window will display 'Lane departure pre-warning system error' with the warning light and prompt tone.

### 16. Brake system fault/low brake fluid level warning light (red)

When the keyless start/stop button is in "RUN" mode, this light is on for self-detection, after self-detection it will turn off. If the warning light does not go out or goes on during driving, it indicates that the brake system may have a fault or lack brake fluid.

The trip computer screen displays "brake system fault" when it goes on, and it indicates there is a brake system fault. If the message "Add brake fluid" is displayed, it indicates low brake fluid level.

#### Warning

- The warning light goes on in the process of traveling:**
- Do not depress the brake pedal repeatedly.
  - You should stop immediately in the premise of ensuring safety, and immediately contact the authorized dealer of BAIC Motor.

17. ABS fault warning light  (Yellow)

When the ignition switch is in the "ON" position or keyless start/stop button is in the "RUN" mode, the warning light remains ON for about 3s to perform self-test, and goes out after self-test.

If the warning light goes on in the process of traveling, it indicates that the ABS system has a fault. Meanwhile, the trip computer screen displays the message "Please check ABS".



Warning

● If the warning light goes on during traveling, you can drive at low speed to the destination in the premise of ensuring safety, but you still should contact the authorized dealer of BAIC Motor for repair as soon as possible.

● If the brake system fault/low brake fluid level warning lights go on at the same time, you should stop immediately in the premise of ensuring safety, and contact the authorized dealer of BAIC Motor for repair.

18. Fuel warning light  (red)

When the ignition switch is in the "ON" position or keyless start/stop button is in the "RUN" mode, the warning light remains ON for about 3s to perform self-test, and goes out after self-test. If the warning light goes on, it indicates that the remaining amount of fuel is less, and you should add fuel. At this time, the trip computer screen displays the message "Please add fuel".

If the warning light flashes, it indicates that the fuel sensor has a fault, while all the indicator lights on the fuel gauge go out. At this time, the trip computer screen displays the message "Fuel sensor fault", please contact the authorized dealer of BAIC Motor for repair.

19. Radar system fault warning light \*  (yellow)

Start reversing radar, the warning light will turn yellow is the system is dysfunctional. The trip computer screen display the message "Reversing radar error" with a prompt tone.

20. Light system fault warning light \*  (yellow)

This indicator light presents the condition of the outside light, when the light outside the vehicle is in error, it will turn on. The warning window will pop out "Light system error" with a prompt tone.

If the warning light turn on during a trip, please pull out to check the outside light under a safe situation.

## 21. Engine immobilizer fault warning light



(red)

When the ignition switch is in the "ON" position or keyless start/stop button is in the "RUN" mode, the warning light remains ON for about 3s to perform self-test, and goes out after self-test.

If the immobilizer adapter fails, the warning light flashes. The warning window will pop out "Engine immobilizer failure" with a prompt tone.

22. Electric power steering fault warning light  (yellow)

When the ignition switch is in the "ON" position or keyless start/stop button is in the "RUN" mode, the warning light  remains ON for about 3s to perform self-test, and goes out after self-test. When the engine is running, if the electric power steering fault warning light goes on, it indicates that the system has a fault, there is no power steering, but you can still control steering. In this case large force is needed to operate the steering wheel, especially in sharp turns and at low speed, so you should drive with caution, and contact the authorized dealer of BAIC Motor for repair as soon as possible.

Maintenance Reminder light

This indicator light presents the situation of the maintenance status. It means that currently the trip mileage exceeds the maintenance mileage when turned on, and please go to certificated BAIC distributors to maintain.

24. Transmission oil temperature fault warning light\*  (yellow, only for CVT models)

When the keyless start/stop button is in "RUN" mode, this light is on for self-detection, after self-detection it will turn off. The warning light turned-on indicates the oil temperature of the transmission is over the limit, the warning window will pop out "Transmission oil temperature warning" with a prompt tone. Please slow down and contact a certificated BAIC distributor to detect the problem under safe condition.

25. Over-speed warning light \*  (oversea models)



This indicator light presents whether the vehicle is over-speed, when speed exceeds 120km/h, it will turn on. Warning window shows "Caution, you are over-speed", with a prompt tone. When speed is reduced under 115km/h, the indicator light turn off.

26. Transmission fault warning light\*  (yellow, CVT models only)



When the keyless start/stop button is in "RUN" mode, this light is on for self-detection, after self-detection it will turn off. When the transmission fault occurs the trip computer screen displays the message "Transmission fault", the warning light goes on. You should slow down or stop in the premise of ensuring safety, and contact the authorized dealer of BAIC Motor for repair as soon as possible.

27. Fault reminder indicator light  |

When malfunction occurs and store into "Malfunction" page, the indicator light turn on.

28. Idling start-stop indicator light \*  (green), Idling start-stop OFF/ fault warning light\*  (yellow)

When the keyless start/stop button is in "RUN" mode, this light is on for self-detection, after self-detection it will turn off.

When idling start-stop function is activated, the indicator light \*  turned on; when idling start-stop function is off, the warning light\*  (yellow) turned on. If the idling start-stop OFF/ fault warning light\*  didn't turn off after self-detection or turn on during traveling, it indicates that idling start-stop system is dysfunctional.

29. Battery charging fault warning light  (red)

When the ignition switch is in the "ON" position or keyless start/stop button is in the "RUN" mode, the battery charging fault warning light goes on. The light goes out after the engine starts.

If the warning light does not go out, it indicates there is a battery charging system fault, you should contact the authorized dealer of BAIC Motor for repair as soon as possible.

● **If the warning light goes on in the process of traveling, you should stop immediately in the premise of safety, and contact the authorized dealer of BAIC Motor for repair as soon as possible. If no measures are taken, it could lead to serious loss of battery power, and the engine will not work.**

30. Oil pressure gauge warning light  (red)  
When the keyless start/stop button is in "RUN" mode, this light is on for self-detection, after self-detection it will turn off.

 Warning

● **If the warning light turn on during travel, you should contact BAIC distributor to check and maintain ASAP. If no action is taken, it might cause serious damage to engine.**

31. ESP operation fault warning light\*  (yellow)

When the ignition switch is in the "ON" position or keyless start/stop button is in the "RUN" mode, the warning light remains ON for about 3s to perform self-test, and goes out after self-test.

In the process of traveling, if ESP operation fault warning light flashes at frequency of 2Hz, it indicates that the ESP system is working properly. During normal driving, if ESP indicator light remains ON, it indicates that the ESP system has a fault, you should contact the authorized dealer of BAIC Motor for repair as soon as possible.

32. ESP OFF indicator light\*  (yellow)

When the ignition switch is in the "ON" position or keyless start/stop button is in the "RUN" mode, the indicator light goes on for about 3 seconds to perform self-test, and goes out after self-test.

In general state, the system default is turning on ESP. If you need to turn off this function, press the ESP off switch once, then the ESP is turned off and ESP indicator light goes out. Then press this switch again, ESP is turned on, and ESP off indicator light goes out.

33. Parking brake indicator light  (red)

When the ignition switch is in the "ON" position or keyless start/stop button is in the "RUN" mode, the warning light remains ON for about 3s to perform self-test, and goes out after self-test.

When pulling up the parking brake, the warning light goes on. If the parking brake is not released during traveling (speed is over 5km/h), the warning light flashes accompanied by a buzzer sound alert, and the trip computer screen displays the message "Please release the parking brake."

 Warning

● If the warning light is still ON after the parking brake is released, you should stop immediately in the premise of safety, and contact the authorized dealer of BAIC Motor for repair as soon as possible.

34. Airbag system fault warning light  (red)

When the keyless start/stop button is in "RUN" mode, this light is on for self-detection, after self-detection it will turn off. If the airbag system fault warning light does not go out after self-test or goes on during driving, it indicates the airbag system has a fault. Trip computer screen displays the message "Please check the airbag".

 Warning

● If the airbag system fault warning light goes on, it cannot guarantee the airbag system is in normal state, and you should stop immediately in the premise of safety, and contact the authorized dealer of BAIC Motor for repair as soon as possible.



## Steering wheel

### Adjust the position of steering wheel



The driver may, in light of his figure and driving habit, adjust the height of steering wheel.



Loose the steering wheel adjustment lock lever ① to the lower to adjust the steering wheel up and down, facilitating driving comfort, and safety of different persons.

After appropriate adjustment, hold the steering wheel, push back the lock lever ① up, and shake the steering wheel to confirm the steering wheel position is locked reliably.

#### Caution

- Do not adjust the steering wheel violently up and down when the locking handle is not released, because this will cause damage to components.

#### Warning

- Using the steering wheel position adjustment device not according to operational requirements and incorrect posture can cause serious damage.
- In order to avoid dangerous driving situations and accidents, you can only adjust the steering wheel when the vehicle is stopped.
- When adjusting the driver's seat or steering wheel, you should note that: The distance between the steering wheel and the chest must not be less than 25cm. If it is less than 25cm, the airbag system cannot play an effective protection role.
- Please forcibly press down the locking lever, so as to prevent the position of steering column changes when the vehicle is running.
- The steering wheel should face the driver's chest. Do not face the steering wheel directly. Otherwise, the driver's frontal airbag will not be able to provide effective protection in the event of an

## Multifunction steering wheel











The multifunction steering wheel is equipped with the following function button switches;

1. Constant speed cruise and instrument setting buttons
2. Sound system control button
3. horn

### \*Constant speed cruise and instrument setting buttons \*













-  Turn on or off constant speed cruise function.
-  Release current cruise control
-  Reset cruise speed or increase cruise speed
-  Set cruise speed or reduce cruise speed
-  O Confirmation key, reset key:
-  Return key, menu key
-  Turn up
-  Turn down

### Sound system control button \*



### Sound system control button (intelligent vehicle system):



-  Radio / Bluetooth function switch;
-  Mute;  : Mute, hang up;
-  Previous chapter
-  Next chapter;
-  Volume turn up;
-  Volume turn down
-  : hang up the phone ;  : Voice broadcast;
-  : Answer the phone.

### Horn



Press the region near the horn logo  on the steering wheel, the horn will sound and stop when your hand releases.

### Caution

- The horn should be checked regularly to ensure that the horn works properly.
- Do not hit or bang the horn with your fist to avoid damaging the horn.
- Please observe the ban on traffic control regulations and use the horns in civilization

## Smart key

### General description

The vehicle equipped with two smart keys.<sup>2</sup>

The effective range of the smart key may be reduced due to the influence of the external environment, which is normal. Smart key short-term failures may come from other keys, pacemakers or other radio transmitters. If the smart key fails, try the following:

- Go to a place closer to the vehicle and try again. In rainy and snowy weather, the effective range of smart keys may be reduced.
- Take a few steps to the left or right, take the smart key a little higher, and then try again. If there are other vehicles or objects between the smart key and the vehicle, the transmission of signals may be blocked.
- Check the battery inside the key. To replace the battery, see “Smart Key Battery Replacement Method” on page 082.

The smart key contains a mechanical key that can be used in an emergency. General description  
If the smart key does not work, a mechanical key can be used to open the door.  
If the smart key is lost, please contact the BAIC authorized dealer as soon as possible.  
Re-adapt the key to avoid theft of the vehicle.

### Caution

- **Do not attach any objects that interfere with electromagnetic waves on the smart key.**
- **Do not expose the smart key to high temperatures for extended periods of time, such as on an instrument panel or bonnet under direct sunlight.**
- **Do not soak the smart key or clean it in an ultrasonic washer.**

### Caution

- **Do not put the smart key with a device that emits electromagnetic waves, such as a mobile phone.**
- **Don't take apart the smart key.**
- **When flying with a smart key, be sure not to press any buttons on the smart key in the cabin. Pressing the button may cause the smart key to emit radio waves, which may interfere with the flight of the aircraft.**
- **If the smart key is lost, for the safety of your property, you should contact the BAIC authorized dealer Store as soon as possible to re-adapt the key.**

**Key function**

Press the icon button on the smart key, realize the corresponding function.

**🔒 Locking the door**

After the lock is successful, all the turn signals flash once. When the multimedia display "arming tone" is turned on, the arming is successful and the horn is beep once.

**🔓 Unlock the door**

After the unlocking is successful, all the turn signals flash 2 times and the position lights light for 25 seconds. Unlock

**🔓 Open the trunk lid**

Press and hold for more than 1 second, unlock the trunk lid, and press the request switch on the trunk lid again to open the trunk lid.2

**🔍 Car search**

All turn signals flash 2 times and the horn sounds 2 times.2



**👁 Caution**

● **When the unlock/lock button is pressed continuously several times, the door lock protection function is triggered and the unlock/lock function is temporarily disabled.**

**Locking the door**

With all doors, bonnet and trunk lid closed, press the lock button **🔒** and all the turn signals flash once, and external rear-view mirror automatically fold (if this function equipped). Check that all doors are securely locked.

Here are some examples of how to unlock the door stop button by pressing the lock when the door is not closed:

- With all doors closed, but the engine compartment cover or trunk lid is not closed, press the lock button . All the turn signals flash 3 times, the horn sounds 3 times, and all the doors remain locked. However, after about 10 seconds, the horn will sound again, and all the turn signals will flash once with each horn, until the unlock button  is pressed. Or stop after 30 seconds of alarm timeout, reminding the user that the engine compartment cover or trunk lid is not closed.

- In the case where any of the doors is not closed, the lock key  lock is pressed and the lock is not performed. When the multimedia display “arming tone” is turned on, the arming fails, the horn sounds 3 times, and the turn signal flashes 3 times to remind you

### Operating system and equipment



With all the doors locked, press the unlock button once,  all the turn signals flash 2 times, the position lights for 25 seconds, the doors are unlocked, and the folded exterior mirrors are automatically deployed (if equipped). After using the smart key unlock function, if none of the four doors and two covers are opened within 30 seconds, all doors will be automatically re-locked.

### Warning

● Smart Key Unlock can be set to unlock the left front door a single time or unlock all doors individually. This feature can be set via the multimedia display. (For detailed operation, please refer to the separate instruction manual)

**Open the trunk**

Press and hold the trunk lid unlock button  on the smart key for more than 1 second to unlock the trunk lid.

Press the request switch on the trunk lid again and lift it up to open the trunk lid.

Carry a valid smart key within 1m of the request switch from the lid of the lid The trunk lid can be opened by pressing the request switch on the trunk lid and lifting it up. (Equipped with keyless entry models)



**Car search function2**

When the vehicle is in the defense state, press the search button  on the smart key within < 20m (open space) to activate the search function. At this time, all the turn signals flash twice. The horn sounded 2 times.



The smart key contains a mechanical key. If the smart key does not work, a mechanical key can be used to unlock the door.

Mechanical key removal step:

1. Press and hold the lock button  ;
2. Remove the smart key cover  ;
3. Pull out the mechanical key  .

### Change battery



When the smart key power is low, the driving computer display will show “The smart key power low. (7-inch cluster), remind you to replace the battery. The smart key may be damaged when replacing the battery, so it is recommended to go to the BAIC authorized Dealer for replacement. If you replace it by yourself, should prepare the lithium battery CR2032.

### Caution

- Be careful not to touch the internal circuit board of the smart key, otherwise static electricity may be generated and the smart key may be damaged.
- Need to use CR2032 model lithium battery
- Make sure the positive and negative terminals of the key battery are installed correctly.
- Do not allow the battery to come into contact with water as it may cause damage to the battery.
- Be careful not to bend the electrode when loading the key battery, and there must be no dust or oil inside the battery case.
- When replacing the battery of the key, be careful not to lose any parts and be sure to close the key battery cover.
- Dispose of used batteries in accordance with local regulations.

### Smart key battery replacement method



1. Use a sharp tool such as tweezers to insert the battery cover holder from the hole at the bottom of the key.
2. Use your hand to remove the battery cover from the end of the battery cover.





3. Remove the battery from the battery cover.
4. Replace the batteries and replace them in the reverse order.

After the battery is replaced, you need to test whether the function of the smart key is normal. If the smart key still does not work, please contact the BAIC authorized dealer.

### Keyless entry and keyless start system

#### Keyless unlock\*

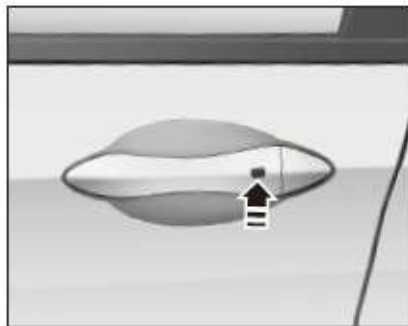

A vehicle equipped with a keyless entry system is equipped with a request switch on the driver's side door handle. When all the doors of the vehicle are in the locked state, carrying the effective smart key, the driver's side door handle request switch can be pressed within 1 m from the driver's side door handle to unlock the door.

#### Keyless lock

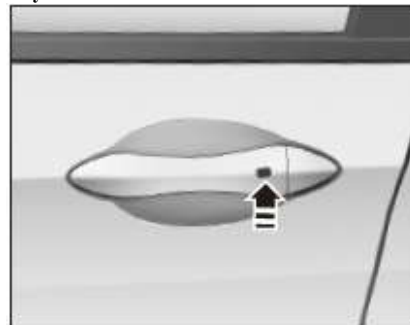

When the keyless start/stop button is in the "OFF" mode and all doors are closed, carry a valid smart key and press the driver's side door handle request switch within 1m from the driver's side door handle to lock all Car door.

**i** Warning

- Pressing the request switch on the door handle several times in succession will trigger the door lock motor protection function, and the unlocking and locking functions will be temporarily disabled.
- Do not use fingernails or other sharp objects to press the request switch on the door handle to avoid damage to the switch.

**Key reminder function**  
Smart key forgotten in the car

If a smart key is left in the car, when any of the doors from open to four doors are closed, and lock the vehicle with the smart key outside the vehicle, or press the request switch on the door handle taking another smart key, the trip computer screen will display: "smart key is left in the car" accompanied by 3 beeps, and locking fails.

## Smart key is not in the car



When the keyless start/stop button is in the "RUN" mode, if no smart key is detected in the vehicle during the time from any door opens to all doors are closed, the driving computer display will display the "smart key not in the car" reminder message. And icons (7-inch meters), At the same time, the turn signal flashes 3 times and the horn sounds 3 times.

**No smart key found**

When the keyless start/stop button is in the OFF mode or any other mode, if there is no smart key in the car, press the keyless start/stop button, the driving computer display will first display "Please close the key to the emergency starting area", if the smart key is found, the display will show "No smart key is found" with a beep (7-inch meter).

**Keyless start / stop button**

P You can switch the power mode and start/stop function by pressing the keyless start/stop button. (See "Keyless Start/Stop Buttons" on page 156)

**Anti-theft alarm system**

Your vehicle is equipped with a body anti-theft system and an engine electronic anti-theft system. For maximum safety and ease of operation, we strongly recommend that you read this instruction carefully to fully understand its features and usage.

 **Caution**

● **When the door is unlocked, the vehicle exits the anti-theft alarm status, but if no door, trunk lid or engine bonnet is opened within about 30 seconds, all doors are automatically re-locked, and the vehicle anti-theft alarm will automatically return to anti-theft alarm status.**



After the lock is carried out by the smart key, the whole vehicle enters the armed state, and all the doors and the engine compartment cover and the trunk lid are in a monitored state. If a door, trunk lid or bonnet is found to be opened illegally, for example if someone forcibly opens the door, the alarm will be activated.

If the smart key or remote control key is used to lock the vehicle, the vehicle horn sounds, and turn lights flash, reminding the vehicle does not enter into the alarm state,

you should check whether the engine hood and trunk lid are closed reliably. If so, but you still cannot activate the alarm, please go to the authorized dealer of BAIC Motor for repair, in order to avoid property loss due to alarm fault.

**Trigger conditions for alarm status:**

- The door, engine compartment cover or trunk lid is illegally opened(not opened by smart key) in the fortified state.
- In the fortified state, the driver's door is unlocked with the mechanical key and the engine is not started within 15 seconds.

**The phenomenon triggered by the alarm state:**

- All the turn signals flash and the horn sounds.

**The method of releasing the anti-theft alarm state after triggering:**

- Press the unlock button on the smart key to release the anti-theft alarm status, and the light and sound signals stop. The vehicle is unlocked.
- The anti-theft alarm state can also be released after the vehicle engine is started.

## Central locking system

### Central locking system description

The central locking system locks and unlocks all doors:

1. Use the smart key to operate the central locking system.
2. The central door lock system can be operated in the car with a central door lock button.

### Central door lock button

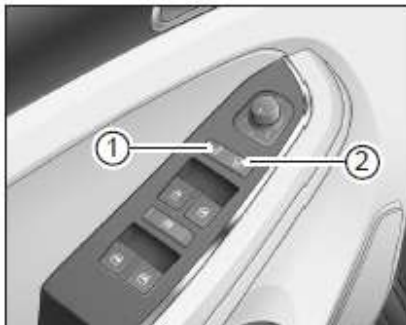

The central door lock control button 1 and button 2 unlock and lock all doors in the car.

The central door lock control button remains active even if the keyless start/stop button is in the "OFF" mode.

Unlock the door: Press button 1 to unlock all doors.

Lock the door: Press button 2 and all doors are locked and the door cannot be opened from outside the car.

After locking by button 2, each door can still be opened separately in the car. Pull the handle inside the door twice, unlock it for the first time, and open the door for the second time. When the four doors of any of the four doors are open, the door lock operation cannot be performed by button 2.

#### Caution

- **Never leave children or people with reduced mobility in the car alone! They may inadvertently cause a serious accident by touching the switch or controller inadvertently.**
- **After the door is locked, prevent others from pulling the door open to enter the vehicle while waiting for the red light, but it will also make it more difficult for others to rescue in case of accident.**

### Open the door from the car



Each door has an inside door handle.

When the central locking system is in the locked state, if you need to open the door from the inside of the car by pulling the handle, you need to pull the inner handle twice. Pull the inner handle for the first time, unlock the door, and pull it inside for the second time.

Pull the hand to open the door.

When the door is unlocked, pull the inner handle to open the door.

#### Caution

- **In the case of locking the door, after pulling the inner handle once, do not pull the door hard to avoid damage to the handle and the door lock.**

#### Automatic lock function

When all the doors are locked, after unlocking the door with the smart key, No one of the four doors and two covers was opened within 30 seconds. The central door lock will automatically lock. While the vehicle is in motion, when the vehicle speed is higher than the set value, the central door lock will automatically lock and lock all the doors.

#### Warning

- **The speed of the automatic lock-off function can be set in the multimedia display when it is turned on, off, and activated. (For detailed operation, please refer to the separate instruction manual)**

#### Automatic unlock function

After the vehicle has stopped, put the keyless start/stop button in the “OFF” mode and the central locking will be automatically unlocked. During the running of the vehicle, if a collision occurs, the airbag is inflated and the four door locks are automatically unlocked.

#### Warning

- **Automatic unlocking can be set to unlock the left front door a single time or unlock all doors individually. This feature can be set via the multimedia display. (For detailed operation, please refer to the separate instruction manual)**

**Overheat protection of the door lock motor**

If the body computer drives the door lock motor 6 times (each time less than 1.2 seconds), if the 7th time is an unlocking action, it can be executed. After that, no matter what kind of door lock action signal is input (except for automatic unlocking after collision), the body computer will not drive any door lock motor for any action in about 20 seconds, and protect the door lock motor from overheating. After about 20 seconds, the door lock motor drive control function returned to normal.

**Warning**

- **Do not use the remote control and the central control door lock to repeatedly lock and unlock the door to prevent the door lock motor from entering the thermal protection mode.**

**Lock and unlock the door with a mechanical key**

1. Pull the driver's side door handle outward.

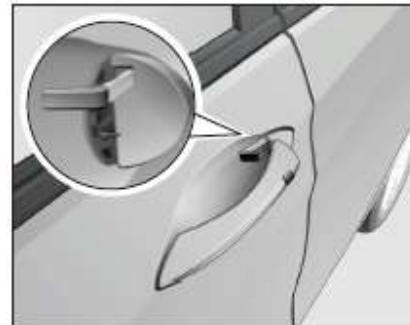

2. Insert the mechanical key from the notch on the left side of the lock cylinder cover, against the lock cover, and gently push the key about 1mm and rotate the key to open the lock cover.

**Caution**

- **The keyhole cover is made of plastic. Pay attention to the strength when opening. Do not use excessive force to avoid damage to the lock cover.**



3. Remove the lock cylinder cover.



4. Insert the mechanical key into the lock cylinder and turn it clockwise to lock all the doors. Turn counterclockwise to unlock all doors.

 Caution

● In the absence of electricity in the battery, the driver's side door can only be unlocked and locked with a mechanical key.

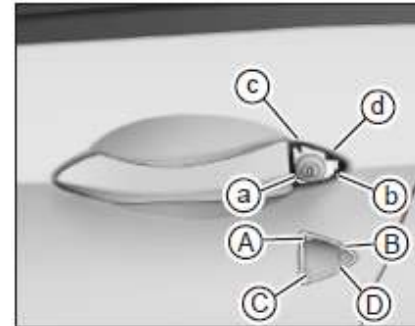

5. Cylinder cover A 、 B Lock cylinder corresponding a 、 b



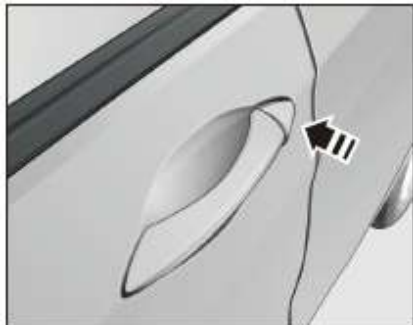

6. C and D points of the lock cylinder cover are attached to the c and d points corresponding to the door lock cylinder (as shown in step 5), press the upper part of the lock cylinder cover, When you hear the "click" sound, the installation is complete.

#### Four doors and two cover unclosed reminder

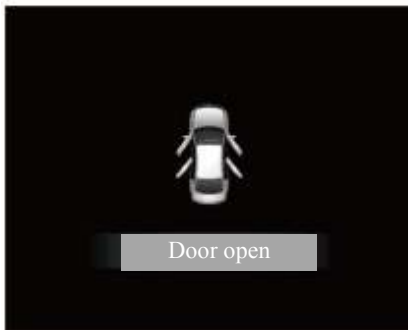

The indicator light will illuminate or the corresponding (5-inch), or un-closed door icon will be displayed in the middle of the combination meter (7-inch).

#### Warning

● Before the vehicle is driven, it must be ensured that all the doors, engine compartment cover and trunk lid are closed. If there is a reminder that the door, engine compartment cover and trunk lid are not closed on the driving computer display, driving is strictly prohibited

## Child safety lock      Engine compartment cover



When there is a child in the back row, be sure to lock the child to the locked state. The child safety lock lever is tilted upwards, and the child safety lock is locked; the child safety lock lever is tilted downward, and the child safety lock is unlocked.

### Warning

- In order to prevent children in the car from inadvertently opening the rear door and causing accidents, it is recommended to lock the child safety lock when riding the child.
- The door locked by the child's safety lock can only be opened from outside the car even if the door has been unlocked.
- Both rear doors have child safety locks

### Caution

- After the child safety lock is locked, the door cannot be opened from the inside of the car. When the rear door cannot open the door with the inner handle, it may be that the child safety lock is working. Do not pull the inner handle hard to avoid damage.

## Engine cover

### Open the engine compartment cover



1. Pull the engine compartment cover opening handle at the front end of the driver's side sill in the direction of the arrow. The bonnet is unlocked and the bonnet will pop up slightly.



2. Raise the bonnet slightly and lift the bonnet up from the gap in the middle of the bonnet by pushing the safety hook handle with your hand pointing to the left



3. Open the bonnet to the proper position, pinch the rubber sleeve of the support rod, pull the support rod from the buckle, and snap the head into the oval hole on the engine compartment cover to confirm the reliable support.

### Close the engine compartment cover 2



1. Check that there are no foreign objects in the engine compartment to prevent damage to the vehicle parts.

2. Support the engine compartment cover and push it up slightly so that the poles can come out of the support hole.

Retract and tighten the support rod.3

3. Slowly lower the engine compartment cover to approximately 20 cm from the top of the front grille and loosen your hands.

Use the cockpit cover to lock itself. After locking, push the engine compartment cover up and down to confirm that the safety lock is in place.

 Warning

- If you put the engine compartment cover down and the distance from the upper part of the front grille is too large, let go or close the engine compartment cover downwards, which may damage the headlights and the front grille.
- If steam or fumes are emitted from the engine compartment, do not open the engine compartment cover to prevent injury.
- If the engine compartment cover is unlocked while the vehicle is running, the engine compartment cover may be opened by high-speed airflow causing a serious accident. Therefore, after closing the engine compartment cover, it is necessary to check whether the locking device has been reliably locked.

### Trunk Suitcase considerations

 Warning

- Keep the trunk lid closed during driving. If the trunk lid is opened, the baggage in the trunk may be accidentally thrown during driving, resulting in an accident or loss. Therefore, you must confirm that the trunk lid is closed before driving.
- It is strictly forbidden to carry passengers in the trunk, otherwise it will easily cause serious injury or even death in case of emergency braking or collision.
- Do not allow children to enter the trunk. If the child is accidentally locked in the trunk, it may cause it to overheat or suffocate

### Open the trunk Using a smart key



Press and hold the trunk lid unlock button 1 on the smart key to unlock the trunk lid. Press the trunk lid request switch again and pull up the trunk lid to open the trunk lid.

**Use the trunk lid request switch to unlock**

In the case where the entire vehicle is unlocked, the trunk lid can be unlocked by pressing the request switch on the trunk lid, and the trunk lid can be opened by pulling up the trunk lid. In the case that the whole vehicle is locked, there is a valid smart key within 1m from the trunk lid request switch. Pressing the request switch on the trunk lid can unlock the trunk lid and pull up the trunk lid. Open the trunk lid.

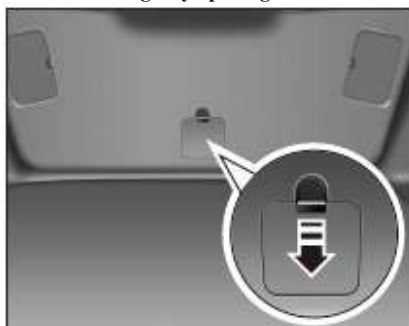
**Trunk lid emergency opening**

1. Fold the rear seat forward into the interior of the trunk, and in the lower middle of the trunk lid, pull it down and remove the trunk lock cover.

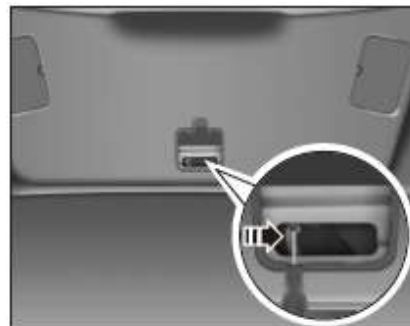

2. Insert a screwdriver or similar item into the small hole of the white lock lever and push the trunk lock to the right. The lever can unlock the trunk and push the trunk lid outward to open.2

 Warning

When using the trunk, the following precautions should be observed, otherwise the body parts may be caught and cause serious injury:

- After the trunk lid is opened at a certain angle, it will bounce to the fully open position. Be cautious of the safe of top.
- Before opening the trunk lid, remove foreign objects (such as snow or ice) from the trunk lid to prevent from pinching.

 Caution

● If there are too many items in the trunk and you can't confirm whether the item will touch the trunk lid, you can first hold the trunk lid and slowly try to close it, and then confirm that there is no problem, then close the trunk lid.

## Close the Trunk



1. Grasp the handle on the trunk lid and pull the trunk lid close to the rear bumper position.



2. Press both hands slightly against the front and bottom to close the trunk lid. After the trunk lid is closed, the reminder icon of trunk not closed on the driving computer display will disappear.



**Warning**

● **When closing the trunk lid, you should take care to check against the fingers and other parts of the suitcase and the contents of the trunk.**

### Fuel port



The fuel filler door opening handle is located on the inside floor of the driver's side sill. Pull up the fuel filler door to open the handle to unlock the fuel filler door.

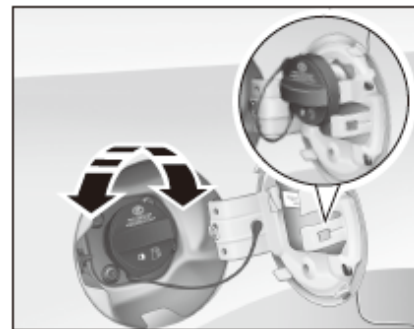

When filling the fuel, slowly loosen the filler cap in the counterclockwise direction. Before completely unscrewing, the filler cap is slightly stopped at the filler port to relieve internal pressure, then the filler cap is removed and placed in the clip.

After the filling is completed, turn the filler cap clockwise until you hear a click, indicating that the filler cap is fully tightened.

After tightening the filler cap, close the filler door by hand.

## Power Windows



Warning

● When closing the power window, be careful not to injure people. If the occupant's head, neck or hand are caught by the window, it can cause serious injury or even death.

### Driver side power window control switch

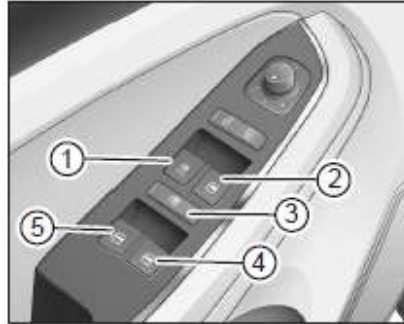

The electric window control switch (main switch) is located on the driver's side door armrest and controls the lifting of all windows.

- 1 left front window glass lift switch
- 2 right front window glass lift switch
- 3 passenger side window glass lift prohibition switch
- 4 right rear window glass lift switch
- 5 left rear window lift switch

### Driver side window lift control



Pull up and hold the switch, and the left front window glass rises and release the switch and it will stop.

Press the switch down and hold it, and the left front window glass will drop and release the switch and it will stop.

If the short pull switch (quick release after light pull switch), the left front window glass will automatically rise to the top. If the switch is touched during the automatic rise of the window glass, the window glass will remain at the current position (with anti-pinch function) Model).



If the switch is pressed shortly (quick release after light pressure switch), the left front window glass will automatically drop to the bottom. If the switch is touched during the automatic lowering of the window glass, the window glass will remain in the current position.

 Warning

● The vehicle with the AUTO logo on the left front window lifter has a one-button lift function.

### Window glass anti-pinch function\*

Electric window regulators equipped with anti-pinch function, when the window glass is difficult or hindered during the closing process, the window glass will stop rising and fall again.

 Caution

● When the window is about to be completely closed, the automatic lowering (anti-clamp function) will stop the induction. Therefore, before the window is closed, check whether the occupant's hand and objects have been removed from the window.

### Manual initialization and self-learning of the left front window

After the vehicle is unexpectedly powered off, the one-key lifting and anti-pinch function of the left front window glass will be invalid (only some models have it), and the function recovery should be resumed as follows:

1. The keyless start/stop button is in the "RUN" mode;
2. Pull up the window switch and the glass rises. After the glass stops at the fully closed position, hold it for more than 1 second.
3. Press the switch down and hold until the window is lowered to the end;
4. Cycle through steps 2 and 3 again, and the glass will automatically rise (some models have), auto-drop function and anti-pinch function will resume.

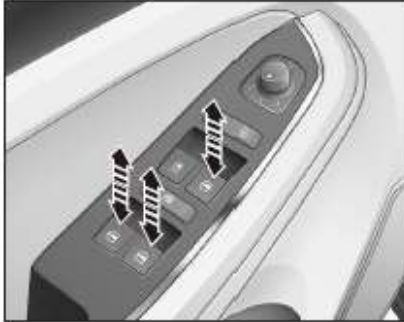
**Driver to passenger side window lift control**

Pull up and hold the switch, and the corresponding window glass rises and release the switch and it will stop

Press the switch down and hold it, and the corresponding window glass will drop and release the switch and it will stop.

If the switch is pressed shortly (quick release after light pressure switch), the corresponding window glass will automatically fall to the bottom. If the switch is touched during the automatic lowering of the window glass, the window glass will remain at the current position.

**Passenger side window glass lift prohibition switch**

In the state where the passenger side window lift prohibition switch is pressed, the front passenger side and rear passenger side window glass lift switches cannot control the window glass lift. The driver's side window lift switch can still control the window lift of each door.

Press the switch again to release the prohibition, and the switch will pop up.

 **Warning**

- Do not leave children or people with limited mobility in the car alone! They may inadvertently touch the switch or controller and cause a serious accident.
- Pay attention when closing the window glass to prevent the window glass from injuring others.
- When there are children in the car, and driving, you should press the window lift prohibition switch to prevent the children from driving the car to open the window and cause an accident.

**Passenger side window lift control**

The passenger side window glass lift switch is located on the armrest of each door, and pulling up or pressing down the switch can control the lifting of the corresponding window glass.

**Power sunroof \***  
**Power sunroof switch**

- ① **SLIDE OPEN**: Power sunroof open switch
- ② **TILT UP**: Power Sunroof off switch

When the keyless start/stop button is in the "RUN" mode, the sunroof can be opened, closed and lifted by operating the sunroof switch.

⚠ Warning

● In order to ensure driving safety, the driver is prohibited from performing the sunroof switch operation while the vehicle is running.

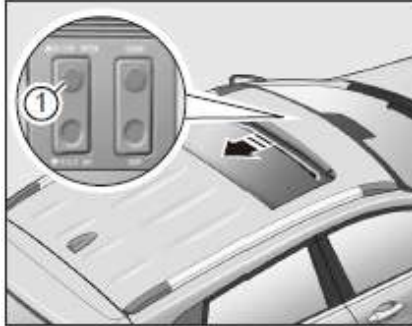
**Power sunroof slide open**

When the keyless start/stop button is in "RUN" mode:

- Long press the sunroof switch 1 , the sunroof glass starts to slide back from the closed position, and release the switch and it will stop.
- Short press the sunroof switch 1. The sunroof glass starts to slide back automatically from the closed position. During the operation, any switch of the sunroof glass is pressed and the sunroof glass stops sliding.

**Power sunroof sliding off**

When the keyless start/stop button is in "RUN" mode:

- Long press the sunroof switch 2, the sunroof glass starts to slide forward from the open position, and then release the switch and it will stop.
- Short press the sunroof switch 2, the sunroof glass starts to slide forward automatically from the open position. During the operation, any switch of the sunroof glass is pressed and the sunroof glass stops sliding.

**Caution**

- Long press the sunroof switch, the sunroof glass does not have anti-trap function during the closing process.
- Short press the sunroof switch, the sunroof glass has anti-trap function during the closing process.

**Lifting ventilation open**

The keyless start/stop button is in "RUN" mode, when the sunroof is closed:

- Press the sunroof switch 2, and the sunroof glass will automatically start to lift upward from the closed position.

**Lifting ventilation closed**

The keyless start/stop button is in "RUN" mode, when the sunroof is closed:

- Press the sunroof switch 1, the sunroof glass starts to close automatically from the lifting position

**Sunroof anti-pinch function**

Short press the switch to close the sunroof, and the sunroof has anti-trap function. If the sunroof is blocked when the sunroof is closed, the sunroof will move a certain distance in the direction of opening and stop moving.

 **Warning**

- Be careful when closing the sunroof. It is important to ensure that no one is in the operating range of the sunroof to avoid serious injury or injury to others.
- Do not operate the sunroof when the temperature is very low (less than  $-20^{\circ}\text{C}$ ). In such an environment, the sunroof anti-clamp function may not be activated, causing accidents, and the low temperature may also damage the motor.

 Warning

- Do not try to test the anti-pinch function by hand or a part of the body. Otherwise, it is very likely to cause serious damage to the body.
- The sunroof may stop monitoring obstacles at the point where it will be completely closed. There is no anti-pinch function at this time.
- The sunroof anti-pinch function cannot prevent your fingers from being caught.

**Sunroof manual initialization and self-learning**

In some cases (such as the battery electrode is disconnected or the vehicle is used after long-term parking), it may be necessary to manually perform the sunroof initialization, as follows:

1. Within 5 seconds, switch the keyless start/stop button to “RUN” mode, then turn it off, then switch to “RUN” mode;
2. Within 5 seconds after the first step, press and hold the sunroof lift switch and keep it. The sunroof glass is completely upright. After hearing the “click” sound, the sunroof glass will perform the following operations in sequence: full off-full On-off; after this process is completed, the sunroof stops running, the switch is released, and the sunroof glass initialization process is completed.

If the sunroof initialization fails, you need to re-initialize according to the above steps.



**Sunroof Sunshade**

The sunshade can be opened with the sunroof, but the sunshade needs to be manually pulled back off when closed.

 Caution

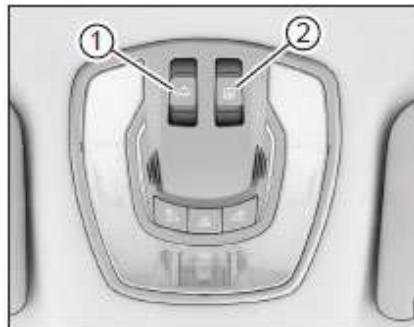
- Do not forcibly close the sunroof sunshade when the sunroof is open.

**Panoramic power sunroof\*****Panoramic sunroof switch**

- ①  Sunroof switch
- ②  Sunshade switch



When the keyless start/stop button is in the “RUN” mode, the sunroof switch can be operated to open, close and lift the sunroof. The sunroof switch can be operated to open and close the sunroof sunshade

 **Warning**

- **In order to ensure driving safety, the driver is prohibited from performing the sunroof switch operation while the vehicle is running.**

**Panoramic sunroof slides open**

When the keyless start/stop button is in the “RUN” mode,

- Gently press the sunroof switch  to the first gear backwards, and the sunroof glass starts to slide back from the closed position. And release the switch and it will stop.
- Slightly press the sunroof switch  to the second gear slightly later, the sunroof glass will automatically slide back from the closed position. During operation, once any switch of the panoramic sunroof switch is pressed, the sunroof glass will stop sliding.



**Panoramic sunroof sliding off**

When the keyless start/stop button is in the “RUN” mode,

- Gently press and hold the sunroof switch  to the first gear, and the sunroof glass will slide forward from the sliding open position, and then stop.

- Press the sunroof switch  to the second gear slightly, and the sunroof glass will automatically slide forward from the sliding open position. During operation, once any switch of the panoramic sunroof switch is pressed, the sunroof glass will stop sliding.

**1 Warning**

- **When the sunroof and sunroof sunshade are closed, press the sunroof switch  backwards, the switch will open the sunroof sunshade first.**
- **When both the sunroof window and the sunroof sunshade are open, press the sunroof sunshade switch  forward. The switch will close the skylight first**

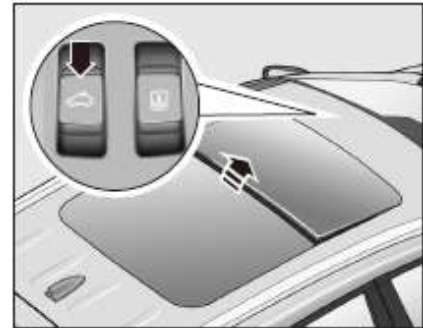
**Panoramic sunroof lift up**

When the keyless start/stop button is in the “RUN” mode,

- With the sunroof fully closed, press the sunroof switch  forward to open the sunroof glass upwards.



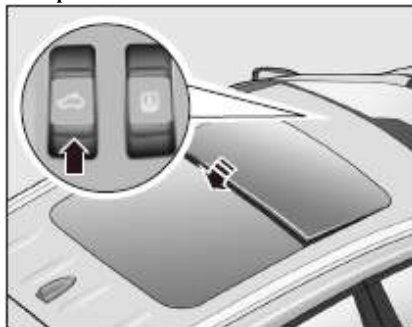

**Lift up close**



When the keyless start/stop button is in RUN mode:

With the sunroof lifted open, press the sunroof switch  backwards and the sunroof glass closes downwards.

**i Warning**



- When both the window glass and the sunroof are closed, pressing the sunroof switch  forward will give priority to opening the sunroof.
- When the window glass is opened and the sunroof is also open, press the sunroof switch  to close the sunroof glass.

**⚠ Caution**

- Gently press and hold the sunroof switch  to the first gear, and the sunroof glass does not have the anti-pinch function during the closing process.
- Press the sunroof switch  to the second gear slightly later, and the sunroof glass will have the anti-pinch function during the automatic closing process.

**Panoramic sunroof sunshade  
Sunshade open**

When the keyless start/stop button is in RUN mode:

- Gently press the sunroof switch  to the first gear backwards. The sunroof starts to slide back from the closed position. And release the switch and it will stop.
- Slightly press the sunroof switch  to the second gear slightly backwards, and the sunroof starts to slide back automatically from the closed position. During operation,

Once any switch of the panoramic sunroof switch is pressed, the sunshade will stop running.

● When the sunshade is opened to the full opening position of the sunroof, the sunshade will stop running. At this time, if you need to fully open the sunshade, you need to press the sunshade switch  to the second gear slightly backwards, and the sunshade will be fully opened. During operation, once any switch of the panoramic sunroof switch is pressed, the sunshade will stop running.

### Sunroof close



When the keyless start/stop button is in RUN mode:

● Gently press the sunroof switch  to the first gear, and the sunroof starts to run from the open position to the closed position. And release the switch and it will stop.

● Press the sunroof switch  to the second gear slightly forward, and the sunroof will start to automatically move from the open position to the closed position. During operation, once any switch of the panoramic sunroof switch is pressed, the sunroof will stop running.

● When the sunshade is closed to the sunroof open position, the sunshade will stop running. In this case, if you need to completely close the sunshade, you need to press the sunshade switch  to the second gear again, and the sunshade will be completely closed. During operation, once any switch of the panoramic sunroof switch is pressed, the sunshade will stop running.

**Panoramic sunroof manual initialization and self-learning**

In some cases (such as a sudden power outage of the battery or after the vehicle has been parked for a long time), it may be necessary to manually initialize the sunroof glass and sunshade.

**The sunroof glass initialization operation is as follows:**

1. Within 5 seconds, switch the keyless start/stop button to "RUN" mode, then turn it off, then switch to "RUN" mode;
2. Within 3 seconds after the first step, press and hold the sunroof switch forward and keep it. The sunroof glass is completely upright. After hearing the "click" sound, the sunroof glass will perform the following operations in sequence: Full Off - Fully Open - Full off; after this process is completed, the sunroof stops running, the switch is released, and the sunroof glass initialization process is completed. If the sunroof initialization fails, you need to re-initialize according to the above steps.

**The sunshade initialization operation is as follows:**

1. Within 5 seconds, switch the keyless start/stop button to "RUN" mode, then turn it off, then switch to "RUN" mode;
2. Within 3 seconds after the first step, press and hold the sunshade switch forward and hold it. After hearing the "beep" sound, the sunshade will perform the following operations in sequence: full open - full off; completed in this process after that, the sunshade stops running, the switch is released, and the sunshade initialization process is completed. If the sunshade initialization fails, you need to re-initialize according to the above steps.

### Headlight position (front)

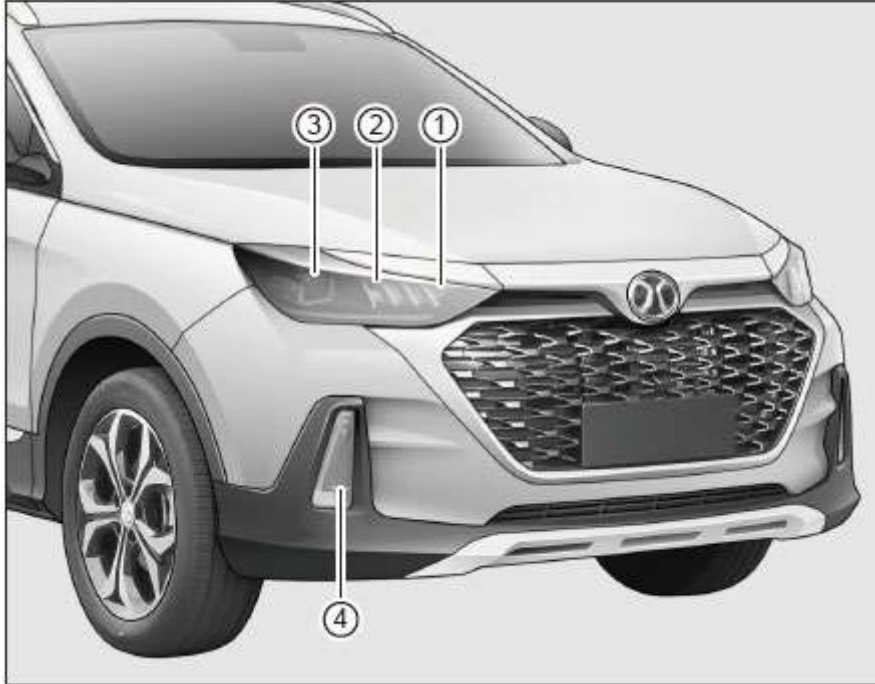

1. Turn signal light
  2. Front position light\* (halogen headlight model)
  3. Near / high beam
  4. Daytime running lights\* (halogen headlight models);  
Daytime running lights / front position lights\* (LED headlight models)
- Note: The headlights of this series have two configurations, namely halogen headlights and LED headlights, which are subject to the actual car you purchased.

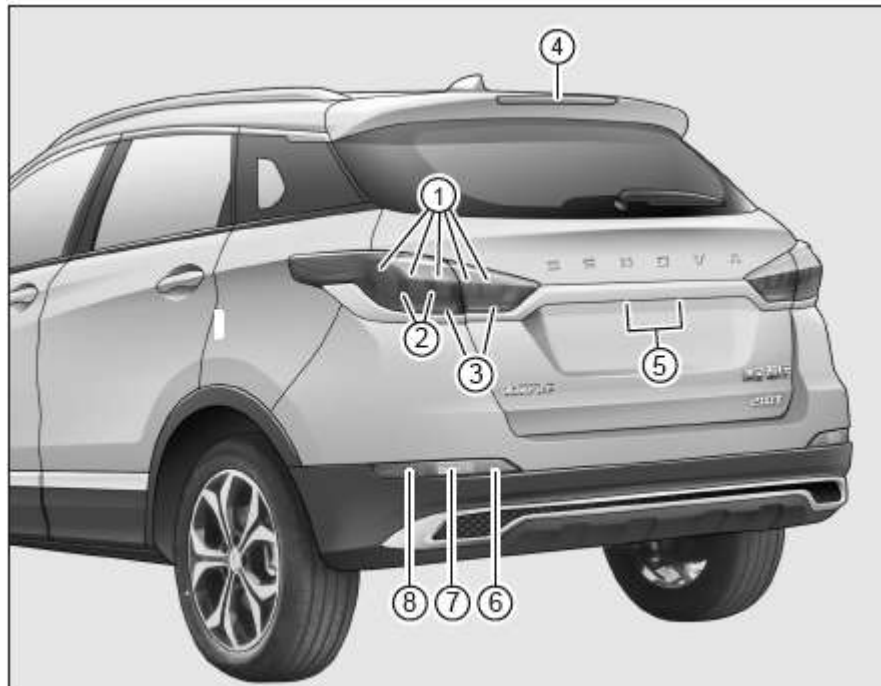
**Lamp position (rear)**

1. Rear position light
2. Brake light
3. Turn signal
4. High brake light
5. License plate light
6. Retro-reflector
7. Reversing light
8. Rear fog light

### Light combination switch (not equipped with automatic lighting headlight models)

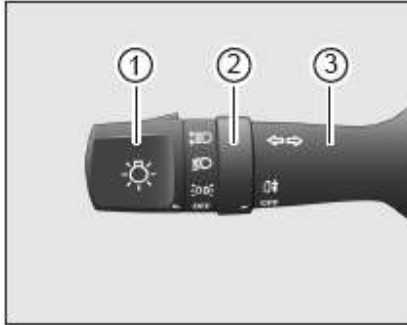

- 1 light control knob
- 2 fog light control knob
- 3 light control joystick



### Light combination switch (equipped to automatically light the headlights)

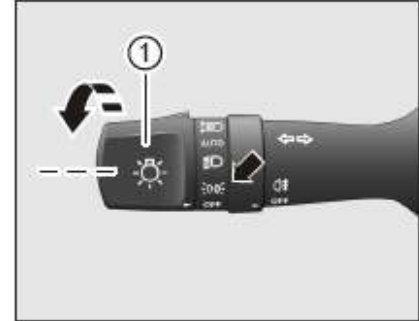

- 1 light control knob
- 2 fog light control knob
- 3 light control joystick

### Lighting control Position light (small light)



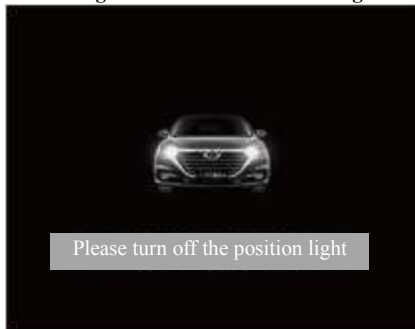

Turn the light control knob 1 so that the mark  on the light control knob is aligned with the  position. The position light on the front and rear position lights, the rear license plate light, the key backlight and the combination meter light up, and turn back to the OFF position to turn off. .

**Position light does not turn off warning**

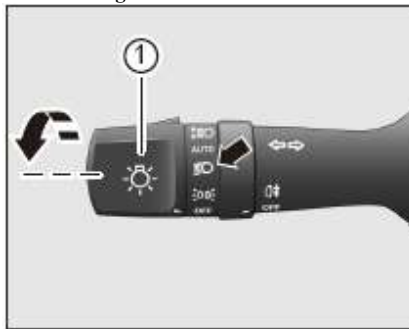
When the keyless start/stop button is in the "OFF" mode, open the driver's door. If the position light or low beam is on, the instrument cluster will indicate "Please turn off the position light" on the driving computer display, together with a beep. Reminder (7-inch meter).

**Front headlight**

When the keyless start/stop button is in the "RUN" mode, turn the light control knob 1 to align the mark  on the light control knob to the position , the headlights light up, and turn back to the OFF position to turn off.

**i Warning**

- **When the low beam is lit, the vertical control panel pushes the light control lever to illuminate the high beam. Pull the light control lever toward the steering wheel to turn off the high beam.**

 Caution

● Because the headlights are lit, heat is generated and needs to be dissipated through the vent holes on the headlights, so the headlights are not sealed. Moist gas can also enter the headlight through the vent hole, and condensation on the surface of the icy lampshade is a normal natural phenomenon, which does not affect the lighting function and service life of the headlight. When condensation occurs in the headlights, park the vehicle in a dry, ventilated area and the water vapor will gradually dissipate. If there is water in the lampshade, please go to the Beijing Auto Special Dealer for maintenance.

### Headlights automatically light up \*

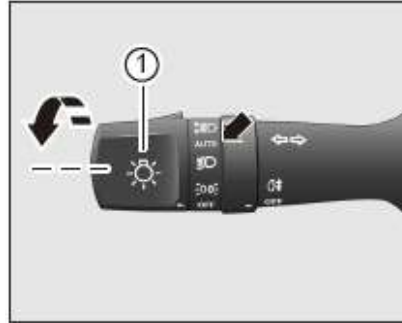

When the keyless start/stop button is in the “RUN” mode, turn the light control knob 1 so that the mark  on the light control knob is aligned with the AUTO position, and the light outside the vehicle is dark (such as at night or through a tunnel). In this case, the headlights will automatically light up and turn off when they turn back to the OFF position.

### High beam warning



Pull the light control joystick toward the steering wheel plane. The high beam lights up. When released, the light control joystick automatically bounces back and the high beam lights go out to alert the vehicles and pedestrians ahead.

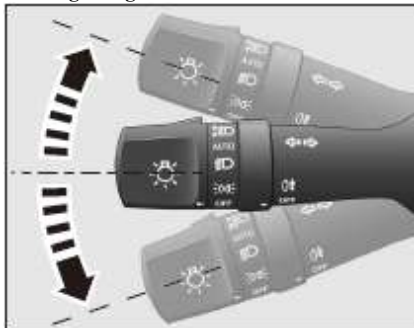

**Turn signal light**

Move the light control lever down to the end, and the external left turn signal and the left turn indicator in the instrument cluster flash with a tick.

Move the light control joystick up to the end, and the external right turn signal and the right turn indicator in the instrument cluster flash with a tick.

When the steering is completed, the joystick will automatically return with the steering wheel's return, while the external turn signal and the turn indicator in the instrument cluster are extinguished.

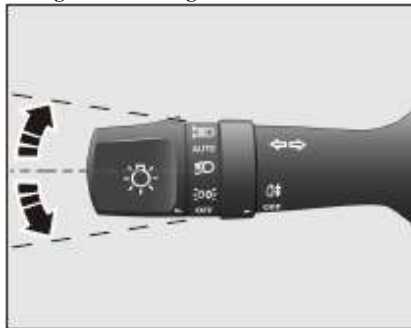
**Change lane flash signal**

Gently push the light control joystick down or up, but not over the limit point. When the handle is released, the joystick automatically returns to the position. The corresponding external turn signal and the indicator light on the instrument cluster flash 3 times at the same time, accompanied by a tick.

**Caution**

- **When the steering or lane change is completed, please confirm that the light joystick has been returned, otherwise you should manually return to the position.**

**Fog light control**

**Keyless Start/Stop** Press the key in the "RUN" mode and the headlights are turned on, turn the fog light control knob 1 upwards, the fog light will be turned on, and the rear fog light on indicator will light in the combination meter. Turn the fog lamp control knob 1 down to turn off the rear fog lamp, and the rear fog lamp turn on indicator.

**Caution**

- **It is only necessary to turn on the fog light when it is rainy, foggy or snowy or has poor visibility.**

### Manual adjustment of height of headlamp



The illumination height of headlights is affected by the weight distribution of passengers and luggage in the vehicle. Ensure the visual angle to the road to provide adequate lighting for the front of the vehicle by adjusting headlight height. The illumination height of headlights is adjusted with the knob . The greater the value, the lower the illumination height.

Select the knob position according to the following sample.

| Knob Position | Number of occupants        | Loads in the trunk             |
|---------------|----------------------------|--------------------------------|
| 0             | Only the driver            | none                           |
|               | Driver and front passenger | none                           |
| 1             | Seats are all used.        | none                           |
| 2             | Seats are all used         | Full load(Evenly distributed)  |
| 3             | Only the driver            | Full load (Evenly distributed) |

### Lighting delay off

Lighting delay off function is also called follow me home function, which provides users with delayed lighting service keyless start/stop button from the "RUN" mode or "ACC" mode to "OFF" mode, lift the lighting control lever toward the steering wheel plane, then the follow me home function is enabled. The low beam will remain on for some time and then goes out. Press lock button on the smart/remote control key within 5 minutes, the follow me home function will be activated again.

#### Warning

● You can set the enabling, disabling and light time of the follow me home function on the trip computer screen. (See separate instructions for detailed operation)

### Backlight brightness adjustment



When the ignition switch is in the "ON" position or keyless start/stop button is in the "RUN" mode, and the position lamps or low beam go on, the backlight of all lights will go on. Toggle up the adjustment knob to enhance the backlight brightness of the instruments and buttons, and down to weaken the backlight brightness of the instruments

### Hazard warning light



Hazard warning light switch is located above the air conditioning control panel.

In the event of an emergency, warn other drivers with the hazard warning light to avoid traffic accidents.

Turn on the hazard warning light in the following conditions:

1. The vehicle breaks down owing to any technical fault.
2. When the vehicle is at the end of the team in a traffic jam.

3. Any emergency is encountered.

4. When towing another vehicle or being Night mode towed.

When you press down the hazard warning light switch, all turn signal lamps will flash simultaneously, the two turn signal lamp indicator lights in the instrument cluster also flash simultaneously.

Even if the keyless start/stop button is in "OFF" mode, the hazard alarm lamp can still work

If you need to turn off the hazard warning light, press the hazard warning lamp switch again

#### Caution

● **When the engine is not started, if there is no special needs, do not turn on the hazard warning light for a long time, so as not to result in battery power loss.**

### Night mode



Press the button **NIGHT PANEL** located below the multifunction switch panel at the lower left side of the instrument panel, the lights of the entire vehicle instruments and buttons enter into the night mode.

Press the button again to exit the night mode. Night mode (NIGHT PANEL) provides the driver with a safe and comfortable night driving environment, And eliminates light on the influence of unnecessary light on the driver. Only the most important information is displayed, allowing the driver to concentrate.

### Enter into night mode

Only when the following conditions are met, night mode (NIGHT PANEL) can be enabled:

- The keyless start/stop button is located in "RUN" mode.
- Position lamps or low beam in the light combination switch go on
- Press the button **NIGHT PANEL**
- State shown after entering the night vision mode:
  - Speed, fuel, water temperature dial backlight extinguished, pointer to zero
  - Other backlight brightness of the instrument cluster and button backlight is reduced to 10%

### Withdrawal from Night Mode

When any of the following conditions occur, the nighttime mode (NIGHT PANEL) will exit.

- Turn off keyless start/stop buttons;
- Turn off combination switch;
- Press the button **NIGHT PANEL** again.

When the following conditions occur, corresponding function in the instrument will exit the night mode (NIGHT PANEL):

- Speed, fuel, water temperature dial back light, pointer return to normal instructions

## Interior lighting lamps

The front of the reading lamp (with panoramic sunroof)



Press the switch  the driver's reading lamp goes on, and goes out by pressing the switch again.

Press the switch  front passenger reading lamp goes on and goes out by pressing the switch again.

Press the switch  the front lighting lamp in the vehicle automatically go on when the door is opened, remain on for about 30s after the door is closed continuously, and then go out gradually

## Front reading lamp (without panoramic sunroof)

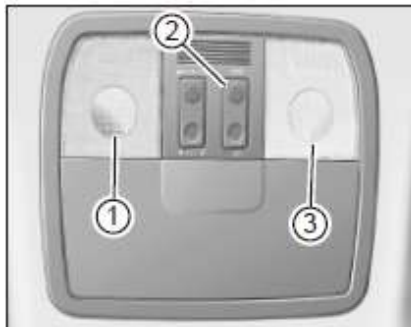

Press the switch ①, the driver's reading lamp goes on, and goes out by pressing the switch again.

Press the switch ③, front passenger reading lamp goes on and goes out by pressing the switch again. Press the switch ② to the "DOOR" position, the front reading lamp goes on automatically when the door is opened, and remains ON for about 30s and then gradually goes out.

## Function that lights go on when the door is opened

Press the switch  or press the switch ② to "DOOR" position, the function that lights go on when the door is opened will be enabled.

When the keyless start/stop button is in "RUN" mode, open any door and the front reading lamp will be lit.

After doors are closed, the front reading lamp will go on gradually and go out after about 30s. If any of the doors is not closed, the front reading lamp will remain ON for 10 minutes.

When the ignition switch is not in the "ON" position or keyless start/stop button is not in "RUN" mode, after any of the doors is unlocked, the front reading lamp will go on.

After all doors are locked, the front reading lamp will go on and gradually go out after about 30s. If any of the doors is not locked, the front reading lamp will remain ON for 10 minutes

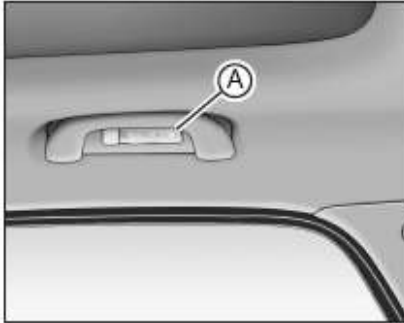
**Rear lighting lamp**

Press the lampshade panel (A) to turn on the rear lighting lamp. Press the lampshade (A) again to turn it off.

Rear lighting lamp also has the function that lights go on when the door is opened, its activation and disable condition is the same with that of front reading lamp.

**Trunk light**

When you open the trunk lid, the trunk lighting lamp automatically goes on, and it goes out after closing the trunk lid.

 **Caution**

● When the engine is not started, do not turn on the interior lighting lamps for a long time, so as not to result in battery power loss.

**Wiper and washer combination switch**

**Wiper and washer combination switch**  
(Models without rain-sensing)

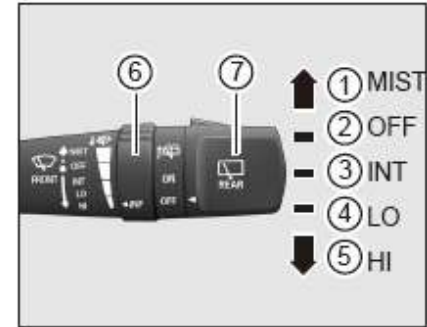

- ① MIST: Single wiping
- ② OFF: Stop
- ③ INT: Intermittent wiping
- ④ LO: Low-speed wiping
- ⑤ HI: High-speed wiping
- ⑥ Intermittent time adjustment knob
- ⑦ Rear wiper and washing control knob

Only when the keyless start/stop button is in RUN mode, the wiper/washer works.

① If you want to select the gear, just push up or press down the control rod:

MIST: When the wiper lever is toggled to the "MIST" position and released, the wiper lever will automatically bounce back to the "OFF" position, then the front wiper wipes once at low speed. Toggle the wiper lever to "MIST" position but not release, the front wiper continuously wipes until you release.

② OFF: Wipers do not work.

③ INT: Toggle the wiper lever to "INT" position, front wiper will enter into intermittent wiping status (this function is only limited to specific vehicle configuration, and it is automatic mode for some models).

④ LO: Toggle the wiper lever to the "LO" position, the front wiper wipes at low speed.

⑤ HI: Toggle the wiper lever to the "HI" position, the front wiper wipes at high speed.

⑥ Intermittent time adjustment knob: When it is in INT intermittent wiping position, rotate this knob to adjust the intermittent time of the front wiper



Rotate intermittent time adjustment knob to adjust the intermittent wiping time of the system.

Intermittent time is divided into 4 levels. It is level 4 (Intermittent time is shortest) when rotating the knob up to the highest, level 1 (Intermittent time is longest) to the lowest, and it is levels 2, 3 in the middle position. Adjust intermittent wiping speed to suit your driving habit.

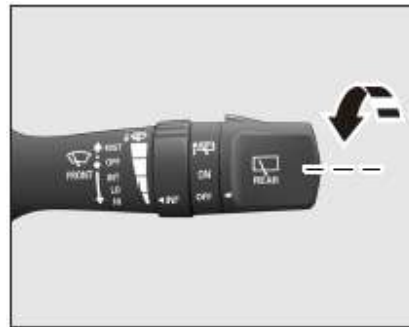

⑦ Rear wiper switch knob: Rotate the rear wiper knob switch up to the "ON" position, the rear wiper is turned on and wipes at a certain frequency, and stops when rotating to "OFF" position

**Warning**

- If the trunk lid is open, the rear wiper will not work.

**Caution**

- When the windshield is dry, you should spray water first before wiping, and wiping without water is prohibited.
- At low temperatures, when the wiping operation is performed, you should ensure the wiper blade is not frozen on the windshield.
- In winter, you should promptly remove snow and ice on the wiper arm and the wiper blade, including

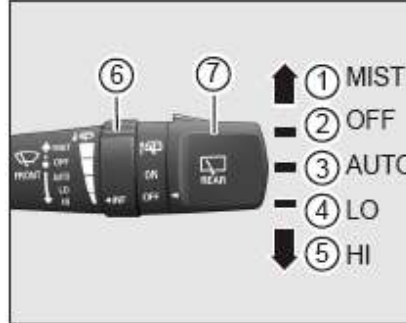
**Wiper and washer combination switch (models with rain-sensing)**

- ① MIST: Single wiping
- ② OFF: Stop
- ③ AUTO: Automatic wiping
- ④ LO: Low-speed wiping
- ⑤ HI: High-speed wiping
- ⑥ Automatic wiping sensitivity adjustment knob
- ⑦ Rear wiper and washing control knob

When the system senses rain, keyless start/stop button is in the "RUN" and the wiper switch is turned to "AUTO" position, it will automatically turn on windshield wiper, and changes wiper speed according to the size of rainfall.

When the wiper control rod is at the position "LO" (low-speed wiping) or "HI" (high-speed wiping), the wiper will wipe the windshield at the set speed, and the automatic sensing function will not work.

**Caution**

- When washing the vehicle with an automatic washing machine, do not place the wiper control lever in "AUTO" position, as this may damage the wiper. When the wipers are not needed, you should turn off the system





You can adjust system automatic wiping speed by rotating automatic wiping sensitivity adjustment knob.

Sensitivity is divided into 4 levels. It is level 4 (fastest) when rotating the knob up to the highest, level 1 (slowest) to the lowest, and it is levels 2 and 3 in the middle position. Adjust the automatic wiping speed to suit your driving habit.

#### Rain/light sensor

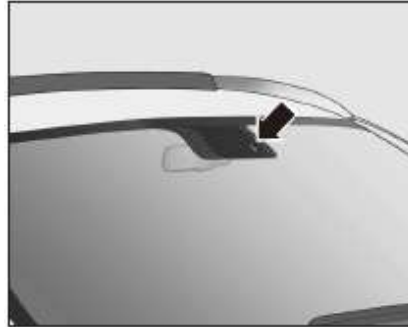

Rainfall/light sensor is located on the front windshield near the interior rearview mirror. If the sensor is covered with mud, oil and dust, the wiper "AUTO" and headlights automatic turning on may not work properly

#### Front windshield washer

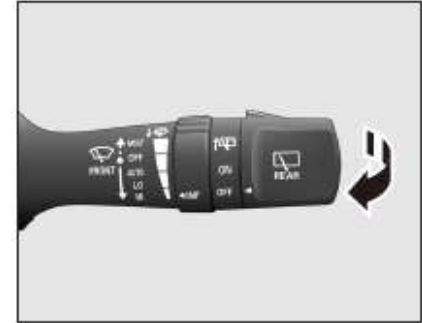

When keyless start/stop button is in "RUN" mode, toggle the wiper lever to the steering wheel plane, the washing motor starts to work, the front windshield washing nozzle sprays water, and stops after released, and the front wiper will automatically continue wiping for several times and stop.



Toggle the wiper lever to the steering wheel plane and hold, the washer sprays water continuously, and then stops automatically

### Tips

● If the front wiper switch is changed into a low-speed or high-speed mode during continuous wiping, the continuous wiping function is terminated, and the new mode wiping request is immediately implemented.

### Rear windshield washer



When the rear wiper works, rotate the rear wiper control knob forward, so that the marks  on the knob  are aligned to, the rear windshield washer nozzle sprays water. After releasing, the wiper control knob automatically rotates to the rear wiper starting position and the washer stops spraying water

### Interior rearview mirror

#### Manual dimming interior rearview mirror

Before driving, you should adjust the interior rearview mirror to get the best vision angle. And you should keep the interior rearview mirror clean.



At night, toggle the lever back on the mirror seat to the anti-glare position. Adjust the internal

rearview mirrors to reduce glare to eyes by lights of the vehicles in the rear.

Toggle the lever forward to the initial position to return to normal vision.

 Caution

- To ensure traveling safety, you should minimize vision "dead zone" when adjusting the rearview mirror.
- You should adjust the positions of all rearview mirrors before driving, and shall not adjust the rearview mirror while driving

### Automatic dimming interior rearview mirror



At night, automatic dimming interior rearview mirror can adjust the color of the mirror according to the intensity of light in the rear, to reduce glare on the eyes of the driver by lights of vehicles in the rear.



 Caution

- To ensure proper function of front and rear dimming sensors of the interior mirror, it is prohibited to touch or cover the sensors.

### External rearview mirror

Exterior rearview mirrors have electrical adjustment, electric heating\*, and electric folding\* function

#### Warning

● Image of object reflected by exterior rearview mirrors is smaller than the real situation. The actual distance between object and vehicle may seem shorter. Do not wrongly evaluate the distance from vehicle in the rear to avoid accidents.

### Exterior rearview mirror angle adjustment



Exterior rearview mirror adjustment knob is on the armrest of driver's door.

1. Select the rearview mirror needing adjustment, rotate the adjustment knob to the position of **L** (left exterior rearview mirror) or **R** (right exterior rearview mirror);
2. Operate the adjustment knob forward or backward to adjust the up or down angles of the exterior rearview mirrors. Operate the adjustment knob to the left or right to adjust the left or right angle of the exterior rearview mirrors



3. After adjustment, rotate the adjustment knob  to its position.

#### Caution

- If the electrical adjustment function of exterior rearview mirror fails, just push the edge of mirror gently, so as to carry out adjustment. And go to the authorized dealer of BAIC Motor for repair as soon as possible.
- Do not adjust the rearview mirror angle continuously for a long time, so as not to damage the motor

## Exterior rearview mirror electric folding



Rotate the adjustment knob  to the position , and then the exterior rearview mirrors on both sides automatically deploy at the same time as long as you turn the adjustment knob from the position .

After all doors, the engine hood and the trunk lid are closed, the exterior rearview mirrors automatically fold by pressing the lock button on the smart key, and automatically deploy by pressing the unlock button on the smart key.

 Tips

- For safety, when the speed is greater than 15km/h, the rearview mirror will not respond when the operation adjustment knob is folded.
- After unlocking the door with a mechanical key, the engine needs to be activated so that the rearview mirror can automatically unfold.
- If the exterior rearview mirror frame moves due to external force, then you must completely fold the rearview mirrors electrically, never manually adjust the rearview mirror frame. Otherwise, it will affect the mirror adjustment function

## Exterior rearview mirror manual folding

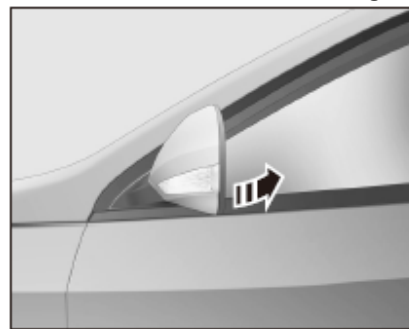



For models exterior rearview mirrors are manually folded, pull back the exterior rearview mirrors with hand to fold the exterior rearview mirrors to the side of the vehicle

 Caution

- It is prohibited to drive the vehicle when any exterior rearview mirror is folded, which will reduce the judgment to the vehicle and the obstacle in the rear, and may cause an accident!

**Heating of exterior rearview mirror\***

Start the engine, press down the rear windshield defrosting/defogging button  on the air conditioning panel, and the indicator light on the button goes on, the rearview mirrors and rear windshield heating is started for defrosting and defogging, and the system automatically turns off after about 15 minutes. Press the button again if heating is still needed.

If you need to turn off the heating function during heating in advance, you can just press the windshield defrosting/defogging button  again

**Tips**

- Exterior rearview mirrors and the rear windshield heating only works when the engine is running.

**Caution**

- Unless particularly necessary, do not turn on the rearview mirror heating function, to avoid overheat of the rearview mirrors and rear windshield and waste of battery power

**Sun visor**

Flip down the sun visor.



Both the driver's side sun visor and front passenger sun visor can be turned down from their brackets to shield sunlight from the windshield.

A ticket holder is set on the inner side of the sun visor to temporarily store bills

**Flip the sun visor to the side**

First flip down the sun visor, disengage the hinge on the right side of the sun visor from the snap, and then turn the sun visor to the window glass to shield sunlight from the side door

 **Warning**

● **Do not flip the sun visor to the inner side when the vehicle is traveling, in order to avoid danger**

**Vanity mirror**

Open the vanity mirror cover on sun visor, so as to use the vanity mirror

 **Warning**

● **The driver should never use vanity mirror while driving. The front passenger should also not use vanity mirror when the vehicle is traveling, to avoid injury during emergency braking or collision**

## Seats

Correct adjustment of seats can ensure the seat belt and airbag systems to fully play protection role

### Warning

● It is strictly prohibited to adjust the driver's seat during traveling, so as not to result in serious accidents caused by losing control of the vehicle due to the movement of the seat.

● It is strictly prohibited to place objects below the manually adjusted seat. Otherwise, these items may accidentally push the seat adjustment lever upward, and the seat may move suddenly, resulting in loss of control of the vehicle in motion.

The objects placed below the driver's seat also will hinder the operation of the brake pedal, and lead to serious accidents.

● When adjusting the seat, observe persons or objects behind the seat, so as to avoid personal injury or damage to object

### Caution

● After seat position adjustment, you should try to move forward and backward the seat and backrest, to ensure the seat is reliably locked. When the engine is not started, do not frequently adjust the power seat, in order to avoid battery power loss.

### Tips

● When measuring the depth of the seat cushion, the seat position is designed: The back angle is 25 degrees, the front and back position is to adjust the seat to the last position, and then slide forward 40 mm position.

● Front row: The maximum adjusting angle of the seat back is (76 +4) degree, which can be reversed forward (24 +3) degree and backward (52 +3) degree at the designed position.

● Back row: Back-to-back angle of locking state (24 +3) degree, can be turned forward 98.5 degree.

## Driver's seat six-way power adjustment

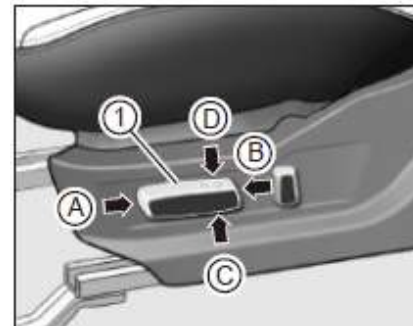

Front and rear, up and down adjustment of seats: Flip the switch ① in the direction indicated by the arrow to adjust the seats back and forth, up and down:

A - Adjust backward;

B - Adjust forward;

C - Adjust upward

D - Adjust downward;



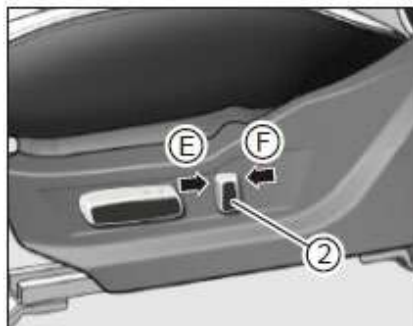

Inclination adjustment of backrest: Flip the switch 2 in the direction indicated by the arrow to adjust inclination of the backrest  
 E - Backrest tilting backward  
 F - Backrest tilting forward;

#### Six-way manual adjustment of driver's seat



Seat front and back adjustment:  
 Pull up the adjustment lever ① below the front part of the seat, move back and forth the seat to the proper position. Loosen the adjustment lever, and slightly move the seat back and forth until it is reliably locked



Seat cushion up or down adjustment:  
 Rotate the adjustment hand wheel ② to adjust the seat cushion up or down



**Inclination adjustment of backrest:**  
Flip up the adjustment handle ③ while shake the backrest forward and backward to the right inclination angle. Loosen the adjustment handle, and slightly shake the backrest forward and backward until it is reliably locked.

#### Four-way manual adjustment of front passenger seat



**Seat front and back adjustment:**  
Pull up the adjustment lever ① below the front part of the seat, move back and forth the seat to the proper position. Loosen the adjustment lever, and slightly move the seat back and forth until it is reliably locked.



**Inclination adjustment of backrest:**  
Flip up the adjustment handle ②, while shake the backrest forward and backward to the right inclination angle. Loosen the adjustment handle, and slightly shake the backrest forward and backward until it is reliably locked.

### Front Seat Heating

Some models have front seat heating function. Seat heating is divided into three stages. The first stage heating temperature range is 30 ~34 C, the second stage heating temperature range is 35 ~39 C, and the third stage heating temperature range is 40 ~44 C. The temperature fluctuation range of each stage is less than 1 C. Seat heating and adjustment can be set up in the multimedia screen. Detailed operation can be found in separate instructions.

### Rear seat

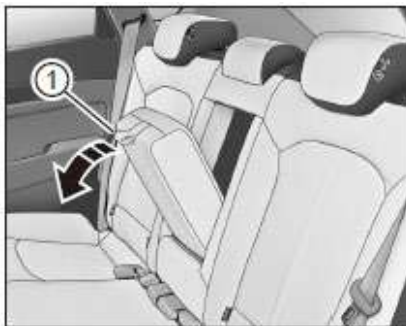

#### Rear seat center armrest\*

Open: Pull down the ring belt ① to open the rear seat center armrest.

Withdraw: when you need to withdraw the armrest, lift up the center armrest, and push it into the rear seat backrest\*

### Fold rear seat backrest

If the big items need to be placed in the vehicle, the rear seat backrest can be folded to increase storage space of the trunk.

Preparation before folding: adjust the front seat forward to the appropriate position, lower the rear seat headrest to lowest position, and move the seat belts of the rear seats on both sides to the outer side



**Folding method:**

Pull up the lock button ② in the outer side of the seat backrest on the right side and flip backrest forward, and then you can fold the backrest of the seat for one person.

The backrest of the seat for two persons can be folded in the same way

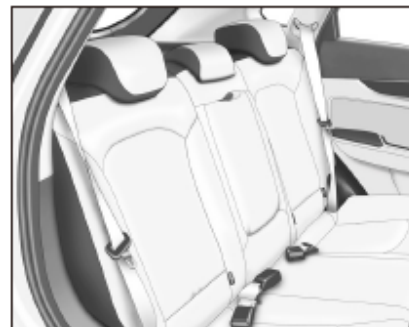

When the rear seat backrests are all folded, the interior storage space can be maximized.

**Folding recovery:**

First move the seat belt to the outer side, and then push the seat backrest back into place. Shake the seat backrest back and forth to ensure the backrest is reliably locked.

**Headrest**

Front seat headrest

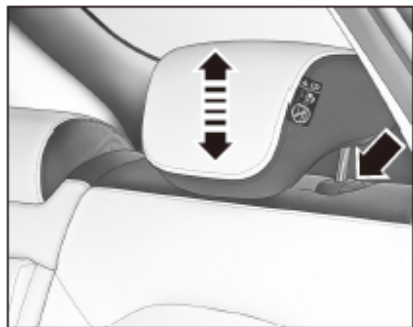

Rear seat headrest

**Seat headrest adjustment**

To ensure safety and comfort, please adjust the headrest to the proper position before driving. Move up: Grasp both sides of the headrest, and lift it up vertically to the desired position.

Move down: Press the lock button, and then move the headrest vertically downward to the desired position, and then release the lock button

**i Tips**

● If it is necessary to remove the headrest, just press down and hold the locking button, and then fully pull out the headrest.

**⚠ Warning**

Never remove the headrest. Otherwise, it will cause serious injury in the event of an accident:

● Headrest position must be properly adjusted according to the height of person, in order to realize effective protection.

● To ensure a good vision of the interior rearview mirror, the rear seat headrest usually can be adjusted to the lowest position. When rear seats are seated with persons, the headrest shall be adjusted upward to the appropriate position

Storage device

 Warning

● It is prohibited to place any inflammable substance in the vehicle. Such as gas lighters, spare gasoline, alcohol, beer, and so on Especially in the hot summer, the temperature in the vehicle is very high, it will cause a fire or an explosion in sealed container.

● Relative movement between metal parts exists in many positions in the vehicle. Never leave carelessly dangerous items such as gas lighters in the seat rails, engine compartment and other locations. Once the dangerous items are squeezed rupture, it could cause an explosion or fire, causing serious damage to life or property.

● It is prohibited to use lighter in the storage area to provide illumination

Storage box on driver's door trim panel



The storage box on driver's side door trim panel can be used to store drink bottle and the like.

The positions of storage boxes on other door trim panels are substantially the same.

 Caution

● Do not place chocolate or medicines and other heat-labile goods, as well as tea cup not sealed in the storage box

Glove box



Pull the handle to open the glove box, and push up the glove box cover to close the glove box

 Caution

● When liquid container is placed in the glove box, the cover should be tightened, to avoid damages to vehicle electrical devices due to liquid effluent.

● Close the glove box cover when the vehicle is traveling, in order to avoid personal injury due to emergency braking or an accident

**Glasses box**

In the closed state, press the rear part of the glasses case, it can automatically pop up. Push up glasses case until you hear a "click" sound to close it.

 **Caution**

● Glasses case only allows you to place glasses and other lightweight items, but not place other heavy items such as a mobile phone.

**Storage tank**

In front of the shift rod, there is a storage tank, which can hold bills, cards and other small items.

 **Warning**

● It is prohibited to use this tank as ash tray, otherwise fire may occur



There is a storage tank behind the shift lever, which can be used for placing items such as mobile phones.

Before using the storage tank, the lid of the storage box should be opened backwards. 1

### Front Tea Cup Positioning Groove



Two cup positioning grooves are set behind the shift lever, which can be used to place beverage bottles or sealed cups.

Before using the storage tank, the lid of the storage box should be opened backwards



Warning

● It is prohibited to use this cup positioning groove as ashtray, because there is fire hazards.

### Front center armrest inner storage box/case



Press the lock switch 1 of the front (outside) of the central armrest, and turn the lid of the storage box upward, so that the upper storage box of the front row central armrest can be used. It can be used to place business cards, refueling cards, bills and other items.

Press down to close and lock the lid of the storage box



The front of the central armrest can be lifted up directly, and the front row central armrest storage box can be used. It can be used to place some sealed snacks, drinks and other items. The storage tank can be closed by pressing down the central armrest.



**Front Seat Back Storage Bag**

A storage bag located behind the back of the front seat can be used to store some light and soft items, such as newspapers

 **Caution**

● **If placed too thick articles, it is easy to affect the comfort of the back row passengers, and may lead to irreversible deformation of the storage bags.**

**Boot**

To make it possible to carry larger items in the suitcase. Please observe the following safety matters:

- The center of gravity of the object should be close to the floor and the rear seat back;
- Hard objects should be close to the rear seat back;
- Do not let objects affect the reliable closure of the rear door, nor let the rear door press the object when it closes.
- Do not store liquid, fragile and dangerous goods in the suitcase.
- It is suggested that the storage items should be properly bundled.

 **Caution**

● **The storage space of the suitcase can be expanded by folding seats. When the volume of the suitcase is enlarged and heavy goods are loaded, the fixing belt is used to fix the articles well, so as to prevent the sliding of the articles in case of emergency braking or acceleration from causing injury.**

## Rear item plate



There is a sling ① linked with the trunk lid on both sides of the rear item plate, the rear item plate will also be opened together when the trunk lid is opened, so that trunk opening is larger. When closing the trunk lid, the rear item plate also falls down to cover items in the trunk. When the linkage is not required, disengage the slings from the fixed pile on the trunk lid.

 **Warning**

● **You should only place some lightweight and soft items on the rear item plate, such as clothes, scarves and the like. Otherwise, heavy or easily scrolling items will be thrown forward causing hurt in emergency braking or a collision.**



You can increase trunk storage space by removing the rear item plate.

Removal: disengage the slings from the fixed pile on the trunk lid, appropriately lift it up and pull back to remove it. The removed rear item plate can be temporarily placed against the front seat backrest

Installation: lift the rear item plate appropriately and push forward, so that the slots ② at both ends clamp the stuck boss ③ on the trim panel, and then release.

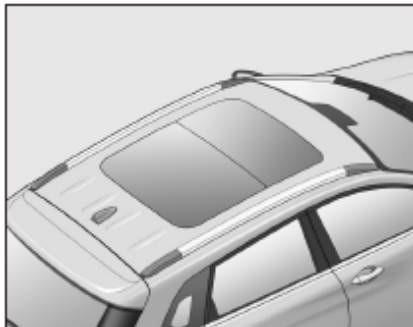
**Roof luggage rack\***

The roof rack of this car is an ornament and does not have the ability to load articles.

**i Tips**

- **The roof rack of this car is an ornament and does not have the ability to load articles.**

### Cigarette lighter seat, USB interface, HDMI interface

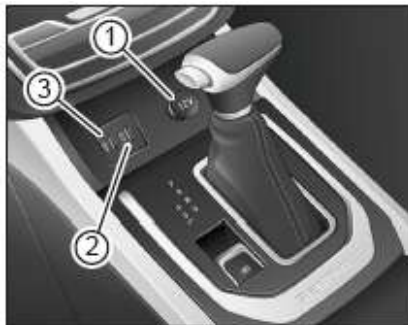

- ① 12V power socket: Take off the plug of power socket, and then use the power plug for automobile to get power through power socket.
- ② HDMI: Used for locomotive interconnection
- ③ USB interface: Used to connect USB
- ④ devices.
- ⑤ These interfaces are powered only when keyless start/stop keys are in ACC or RUN mode.



When the left side of the luggage box is equipped with a 12V output voltage and 120W maximum power intake socket, the key-less start/stop button is located in ACC or RUN mode, the intake socket will be powered.

#### Caution

- When the engine is not started, it is necessary to avoid long-term power supply in order to avoid battery power shortage.

#### Warning

- It is strictly forbidden to use electrical equipment that exceeds the maximum allowable power to avoid vehicle breakdown or serious accidents.
- If the connected electrical equipment is overheated, it must be shut down immediately and the plug should be pulled from the outlet to avoid causing fire.
- Children should not be allowed to play with electrical devices connected to the access socket in order to avoid accidents.
- After use, the protective cover of the power socket should be covered in time to prevent foreign bodies from falling into it and causing danger.

### General descriptions

Vehicle air conditioning system is a device to achieve cooling, dehumidification, heating, ventilation, and cleaning of air inside the vehicle. The air conditioning only works when the engine is running. To obtain better effect of the air conditioning, doors and sunroof should be closed when using the air conditioning.

Air conditioning system will increase the additional loads and fuel consumption of the engine, so it should be turned off when not needed.

If the ambient humidity is high, slight fog may appear on the windshield when the air conditioning system is turned on,

### Tips

- **In order to make air conditioning system in good condition ,ensure the air conditioning system works for some time at least once a week (even in cold winter).**
- **The external air intake port of the air conditioning in the lower front position of the windshield should be kept clean and smooth to ensure the air conditioning system external air intake is normal.**
- **In summer, the vehicle is exposed under the sun, the temperature in the vehicle will be very high, open the windows and sunroof for ventilation to rapidly reduce the temperature inside the vehicle.**
- **When the air conditioning system refrigerates, water stains may be left on the ground under the vehicle, which is a normal phenomenon**

### Caution

- **Air conditioning can only operate when the engine and blower are turned on. When the blower is closed or the temperature is close to zero, the air conditioning will not be able to refrigerate**

## Automatic air conditioning



1. Temperature regulating button
2. Ventilation mode selection button
3. Air volume regulating button
4. Air conditioning Off button
5. Refrigeration On/Off button
6. Fully automatic operation button
7. Air internal and external circulation keys
8. Front windshield defrosting/defogging button
9. Rear windshield defrosting/defogging Button

### 1. Temperature regulating button

The button can adjust the outlet temperature, raise the temperature by pushing the button up, and lower the temperature by pushing the button down

### 2. Ventilation mode selection button

Short press the ventilation mode selection Button, the air valve can be switched among the following modes:



The air blows towards the upper portion of body



The air blows towards the upper and lower portions of body.



The air blows towards the lower portion of body



The air flows towards front windshield and lower body

### 3. Air volume regulating button

The button can adjust the air volume of the air outlet, push the button upward to increase the air volume, and push the button downward to reduce the air volume.

### 4. Air conditioning off button

When the air conditioning system is open, press the air conditioning shutdown button, the air conditioning system enters standby state, and the multimedia display screen will not display the air conditioning information interface. Press the other air-conditioning system keys accept the air-conditioning shutdown button, which will wake up the function of the air-conditioning system, and the multi-media display screen will display the air-conditioning information interface for a period of time.

### 5. Refrigeration On/Off button

Press the refrigeration on/off button, the indicator light on the button goes on, the compressor starts running. When the button is pressed again, the compressor stops running, and the indicator light on the button goes out.

### 6. Fully automatic operation button

Press the fully automatic operation button, the air conditioning system into the automatic operation mode, the indicator light on the button goes on.

### i Tips

● If you press other buttons (other than rear windshield defrosting/defogging button, the temperature control knob and air conditioning inner circulation button) in the fully automatic operation mode, then the system will execute the command of the button. The indicator light on the fully automatic operation button goes out, and the system exits the automatic operation mode

### 7. Air outer circulation button

After pressing the button, the indicator light on the button lights up, and the air circulation mode is inner circulation; when pressing the button again, the indicator light on the button goes out, and the air circulation mode returns to the outer circulation

When power is off or air conditioning is turned off, air recirculation mode maintains the set state. The default is the state before turning off when the air conditioning is turned on next time.

### 8. Front windshield defrosting/defogging button

The defroster/defogger is used to reduce RES/+SET/- SRC the moisture, mist, and frost on the windshield, in order to improve forward vision

Press the front windshield defrosting/ defrosting button, and the indicator light on the button lights up and enters the front windshield defrosting/defrosting mode. At this time, the air conditioning refrigeration automatically opens, the air flows to the "front window", and the air becomes external circulation.

At this time, the air volume adjustment button can be pushed upward to adjust the air volume to the maximum position and speed up the defrosting/defrosting of the front windowpane. To turn off this function, press the front windshield defrosting/defrosting button again, the indicator lights on the button turn off, and the air conditioning system returns to the previous set state.

#### 9. Rear windshield defrosting/defogging button

Only when the engine is running, the rear windshield defrosting/defogging function works. The defroster/defogger is used to reduce moisture, fog, frost on the rear windshield, in order to improve rear vision

Press the rear windshield defrosting/defogging button, the indicator light on the button goes on. The defroster/defogger works for about 15 minutes, and then turns off automatically.

To turn the function off in advance, press the rear windshield defrosting/defogging button, again, the indicator light on the button goes out

#### Caution

● **If shut down the engine before the rear windshield defroster/defogger automatically turns off, when the engine is started again, the rear windshield defroster/defogger no longer continues working.**

● **Using the rear windshield defrosting/defogging function increases the power consumption, which leads to increased fuel consumption, so you should turn off the defrosting/defogging function after frost/fog is cleared.**

#### Solar sensor

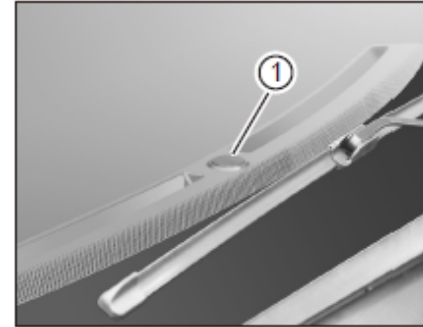

The solar sensor 1 is on the middle part of the instrument panel.

Solar sensor detects the intensity of solar radiation to help automatic air conditioning system to regulate the temperature inside the vehicle.

Do not cover the solar sensor in order to avoid the impact on solar radiation detection



## Automatic air conditioning



1. Temperature regulating button
2. Ventilation mode selection button
3. Air volume regulating button
4. Air conditioning shutdown button
5. Refrigeration Open/Close button
6. Air Outer Circulation button
7. Air inner circulation button
8. Front windshield defrosting/defogging button
9. Rear windshield defrosting/defogging button

### 1. Temperature regulating button

The button can adjust the outlet temperature, push the button upward to raise the temperature, and push the button downward to lower the temperature.

### 2. Ventilation mode selection button

Press the ventilation mode selection button, and the air valve can be switched between the following modes in a circular way:



The airflow blows to the upper of the body.



The airflow blows to the upper and lower parts of the body.



The airflow blows to the lower of the body



The airflow blows to the front windshield and the lower part of the body.

When different valve modes are switched, the corresponding mode states are displayed on the air-conditioning display screen.

### 3. Air volume regulating button

The button can adjust the air volume of the air outlet, push the button upward to increase the air volume, and push the button downward to reduce the air volume.

### 4. Air conditioning shutdown button

When the air conditioning system is open, press the air conditioning shutdown button, the air conditioning system enters standby state, and the multimedia display screen will not display the air conditioning information interface. Press the other air-conditioning system keys accept the air-conditioning shutdown button, which will wake up the function of the air-conditioning system, and the multi-media display screen will display the air-conditioning information interface for a period of time.

### 5. Refrigeration Open/Close button

Press the refrigeration open/close button, the indicator light on the button lights up, and the compressor starts to run; when the key is pressed again, the compressor stops running and the indicator light on the button goes out.

### 6. Air Outer Circulation button

Press the automatic operation button, the air conditioning system enters the automatic operation mode, and the indicator light on the button lights up.

### 7. Air inner circulation button

After pressing the button, the indicator light on the button lights up, and the air circulation mode is inner circulation; when pressing the button again, the indicator light on the button goes out, and the air circulation mode returns to the outer circulation.

When the power is cut off or the air conditioning is turned off, the air circulation mode will remain in the set state at that time. The next time the air conditioner is turned on, it will default to the state set before it is turned off.

### 8...Front windshield defrosting/defogging button

The defroster/defogger is used to reduce the moisture, mist, and frost on the windshield, in order to improve forward vision

Press the front windshield defrosting/defrosting button, and the indicator light on the button lights up and enters the front windshield defrosting/defrosting mode. At this time, the air conditioning refrigeration automatically opens, the air flows to the "front window", and the air becomes external circulation.

At this time, the air volume adjustment button can be pushed upward to adjust the air volume to the maximum position and speed up the defrosting/defrosting of the front windowpane. To turn off this function, press the front windshield defrosting/defrosting button again, the indicator lights on the button turn off, and the air conditioning system returns to the previous set state.

#### **9. Rear windshield defrosting/defogging button**

Only when the engine is running, the rear windshield defrosting/defogging function works. The defroster/defogger is used to reduce moisture, fog, frost on the rear windshield, in order to improve rear Vision

Press the rear windshield defrosting/defogging button, the indicator light on the button goes on. The defroster/defogger works for about 15 minutes, and then turns off automatically. To turn the function off in advance, press the rear windshield defrosting/defogging button again, the indicator light on the button goes out

#### **Vehicle rapid cooling**

1. Start the engine:
2. Press the refrigeration on/off button the compressor starts running
3. Pull the temperature adjustment button to the desired set temperature
4. Press the ventilation mode selection button and blow the air from the air outlet to the upper part of the body
5. Pull up the air volume adjustment button to the maximum air volume
6. The air circulation mode is set to internal circulation.

When temperature inside the vehicle is very high, you can open windows and sunroof for ventilation for a short time, which helps to reduce the rapid temperature in the vehicle.

When the air temperature in the vehicle drops appropriately, you may need to re-set air circulation mode and appropriate air volume

#### **Vehicle fast heating**

1. Start the engine
2. Pull the temperature adjustment button to the maximum setting temperature
3. Press the ventilation mode selection button and blow the air from the air outlet to the lower part of the body.

The heating system uses the heat of the engine to heat the air, so the heating system only works when the engine is running. If the engine coolant temperature does not reach normal operating temperature, the heating system cannot achieve the desired heating effect

### A/C air filter

Air conditioning filter is installed in the filter housing below the ventilation trim panel on the right side of the instrument panel, and which can be seen by removing the glove box. Its role is to keep air in the vehicle fresh and prevent pollen and dust from entering into the vehicle.

In order for a good air environment in the vehicle, air conditioning filter should be replaced regularly according to requirements of "Maintenance Information Sheet". If the vehicle often travels in dusty areas, air filter replacement interval should be shortened.

When the air volume control knob  TEMP is set at the position of larger air volume, but the air volume at the air outlet is small, the air conditioner air filter should be replaced as soon as possible

### Central air outlet



Adjust the wind direction by adjusting the center air outlet on the top, bottom, left and right.  
Turn the button on the edge of the air outlet counterclockwise to open the air outlet.  
Turn the button on the edge of the air outlet clockwise to close the air outlet

### Air outlet on both sides

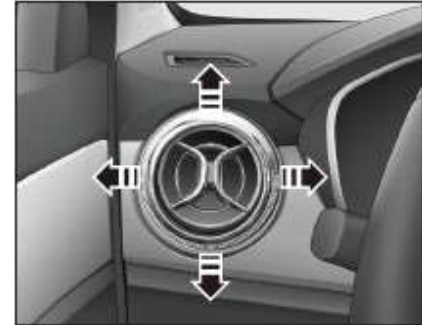

Adjust the wind direction on both sides of the instrument panel by adjusting the upper, lower, left and right sides.  
Turn the button on the edge of the air outlet counterclockwise to open the air outlet  
Turn the button on the edge of the air outlet clockwise to close the air outlet.

## Navigation and multimedia audio system



Some models are equipped with navigation functions and multimedia audio systems. Please refer to separate instructions for specific use.

## Intelligent Vehicle System

Some models are equipped with intelligent vehicle-borne systems that integrate satellite navigation, wireless Internet access, voice interaction, Bluetooth calls, network music, radio and network radio. For specific usage, please refer to separate instructions.

## Diagnostic Interface



The diagnostic interface is located at the bottom left of the dashboard.

The diagnostic interface is used for the digital communication between the vehicle electronic control unit and the diagnostic equipment, and the vehicle identification code information can be read through the diagnostic interface.

VIN can be read out on the diagnostic interface using external diagnostic devices.

Purchasing Channel and Contact Form of Diagnostic Equipment: Beijing Automobile Sales Co., Ltd. 010-56173175

At present, there are two sets of diagnostic instruments.

-Parts Code: T11200001; Parts Name: Beijing Automobile Diagnostic System

-Parts code: T19900010; Parts name: PAD diagnostic kit.

## Accessories, retrofitting and microwave window

Before installing accessories or replacement of parts, be sure to consult with the authorized dealer of BAIC Motor. We recommend that you always use the accessories and spare parts approved by the company.

Improper modification would seriously impair the performance of the vehicle, and even cause serious accidents. For example:

- Installation of larger or smaller wheels will affect anti-lock brake system (ABS) and the normal operation of other systems of the vehicle.
- Modification of steering wheel and other safety-related facilities may cause system fault.
- For vehicle equipped with side curtain airbag, installation of accessories on the side panel center pillar and across the rear windshield will hinder the normal work of the side curtain

● Improper installation or modification of accessories may weaken the protective effect of the airbag system, and even lead to fatal injuries.

● Installation of beverage cup holder, telephone holder, etc. On the housing or within the scope of the airbag system, they can cause serious injury during airbag deployment.

● Modification of the front portion of the vehicle may damage the vehicle protection performance for pedestrians.

● Do not coat exhaust pipes, three way catalytic converter, and insulation panel with protective bottom layer or anti-corrosion materials, so as not to affect heat dissipation

It is prohibited to install other high-power electrical equipment other than the original vehicle configuration



After the installation of electrical equipment with power higher than the rated power, fire may be caused due to heat and short circuit of the harness caused by too large load



Warning

Do not arbitrarily change the harness when modifying the automobile data recorder, navigation, DVD player



When the harness is modified, the wire with high internal resistance generates a lot of heat, which may cause a fire

Banning the use of high-power light bulb

When bulb with power higher than the rated power is used for brighter lighting, too large harness load may cause a fire

### Microwave window

Vehicle without inner rearview mirror shield

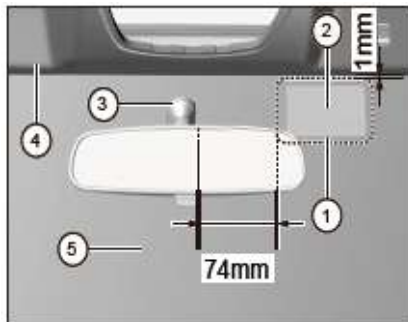

- 1 microwave window
- 2 electronic identification
- 3 endoscope base
- 4 ceiling
- 5 front windshield

The microwave window is located on the front windshield and is used to install the automobile electronic logo. Installation location does not allow film sticking, heating wire, etc., to ensure the effective reading of data.

Vehicle model with inner rearview mirror shield

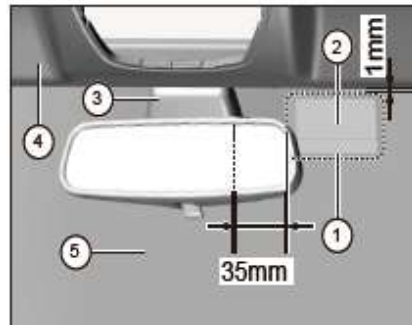

1. Microwave window
2. Electronic identification
3. Inside rearview mirror base shield
4. Ceiling
5. Front windshield

The microwave window is located on the front windshield and is used to install the automobile electronic logo. Installation location does not allow film sticking, heating wire, etc., to

### 3. Driving guide

|   |     |  |     |
|---|-----|--|-----|
| Starting and Driving.....                   | 156 | ABS anti-lock brake system .....                       | 173 |
| General descriptions .....                  | 156 | EBD electronic brake force distribution .....          | 173 |
| Keyless start/stop button .....             | 156 | BA Brake Assist System .....                           | 173 |
| ignition switch .....                       | 157 | ESP electronic stability system.....                   | 174 |
| Shut down the engine .....                  | 160 | Uphill Auxiliary System .....                          | 175 |
| transmission .....                          | 161 | Traction control system (TCS) .....                    | 175 |
| Park .....                                  | 165 | Cruise control* .....                                  | 176 |
| Parking method .....                        | 165 | Setting up constant speed cruise * .....               | 176 |
| Precautions for parking safety .....        | 166 | Tire Pressure Monitoring System* .....                 | 179 |
| Electric power steering system.....         | 67  | Parking Radar and Reversing Image System * .....       | 181 |
| General descriptions .....                  | 167 | Panoramic Image System * .....                         | 186 |
| EPS self-leaning.....                       | 167 | Introduction of Panoramic Image System .....           | 186 |
| Brake system.....                           | 168 | Lane Deviation and Blind Zone Monitoring System* ..... | 189 |
| General descriptions.....                   | 168 | BSD Blind area monitoring system .....                 | 190 |
| Electronic Parking Brake System (EPB) ..... | 171 | Idle start-stop system * .....                         | 192 |
|   |     | General descriptions .....                             | 192 |



---

|  |            |
|--|------------|
| Usage method .....                               | 192        |
| Battery Sensor .....                             | 194        |
| <b>Driving Skills .....</b>                      | <b>195</b> |
| Traffic Safety Inspection .....                  | 195        |
| Running-in driving.....                          | 196        |
| Driving essentials in different situations ..... | 197        |
| Efficient Use of Vehicles .....                  | 200        |

## General descriptions

Vehicle is equipped with electronic anti-theft function, which is used to prevent the illegal starting the vehicle. Transceiver chip inside the key is equipped with an electronic code, which is sent to the vehicle when the engine is started. Only when the electronic code sent by the transceiver chip matches with the electronic code stored in the vehicle, the engine can be started. If you use a key (or other tools) with wrong electronic code, the engine cannot be started.

## Keyless start/stop button



Keyless start/stop button is on the instrument panel in the lower right of the steering wheel.

### Power mode switch

Models with CVT transmission: place the shift lever to gear "P" or gear "N", without depressing the brake pedal; models with manual transmission: When the clutch pedal is not depressed. Press the keyless start/stop button, the power modes will be switched in the following order:

- When the button is not pressed: Keyless start/stop button is off, then it is "OFF" mode (the indicator light on the button light does not go on);

- When the button is pressed for the first time: Go to "RUN" mode (indicator light on the button is green), the instrument cluster goes on, all electrical devices are in the ON state;

- When the button is pressed for the second time: Switch to the "ACC" mode (red INDICATOR LIGHT on the button), circuits of CD and other accessories are connected. In this mode, if you open the driver's door, the power mode returns to the "OFF" mode (the indicator light on the button goes on);

- When the button is pressed for the third time: Return to "OFF" mode (the indicator light on the button goes off).

Successively press the keyless start/stop button, and then you can switch among the "OFF" → "RUN" → "ACC" modes.

 Tips

● **Models with CVT transmission:** The brake pedal must be depressed when the shift lever is in gear "P" or gear "N" to start the engine. When the shift lever is in any other position. The engine cannot be started.

● **Models with manual transmission:** The clutch pedal must be depressed to start the engine. There is no direct relationship with the shift lever position, but for safety reason, it is strongly recommend that the shift lever is turned to the neutral position before starting the engine.

● **Press the keyless start/stop button to start the engine or switch power mode, but you must ensure the smart key is in the effective area of the vehicle.**

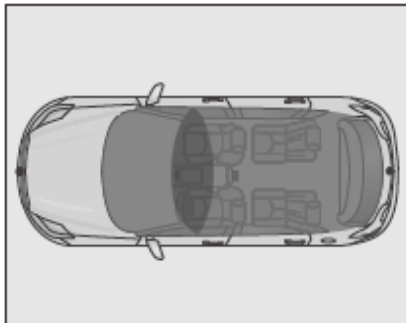

Effective area for detection of the smart key: except some special trunk positions (such as position covered with metal materials), other internal space can be covered.

## Start the engine

### Start the engine with keyless start/stop button\*

When the smart key is in the effective detection range, models equipped with keyless start/stop function start as follows:

#### 1. Vehicle model equipped with manual

- Depress the clutch pedal to the end and hold;
- Place the shift lever in neutral position
- Press the keyless start/stop button to start the engine transmission

#### 2. Models with CVT transmission

- Depress the brake pedal to the end and hold;
- The shift lever is placed to gear "P" or gear "N";
- Press the keyless start/stop button to start the engine.



Start the engine when the keyless start/stop button is in the "OFF" mode:

Models with CVT transmission: When the brake pedal is not depressed at this time, the trip computer screen will show "Please start by depressing the brake"(7 inch meter)

Models with manual transmission: When the clutch pedal is not depressed at this time, the trip computer screen will show "Please start by depressing the clutch". (7 inch meter)



Start the engine when the keyless start/stop button is in the "OFF" mode, depress the brake pedal, and press the keyless start/stop button. If it is not at gear "P" or "N" at this time, the trip computer screen shows "Please start by shifting to gear P/N". (7 inch meter)

The vehicle will not start, and the keyless start/stop button switches to "RUN" mode.



For models with CVT transmission, depress the brake pedal when parking, press the keyless start/stop button, the engine is shut down. If it is not at gear "P" at this time, the trip computer screen will show "Please confirm parking at gear P", (7 inch meter) and keyless start/stop button switches from "RUN" mode to "ACC" mode.

## Smart key emergency start



If the vehicle is in a strong signal interference region, or the smart key battery power is low, press the keyless start/stop button to start the vehicle, the trip computer screen will show "No Smart Key". (7 inch meter) At this point, you should start with emergency start methods



Place the smart key in the emergency start sign of the central armrest box, press the keyless start/stop button to start the vehicle.

 Tips

- When the battery power is low and the engine cannot be started, try to start the engine with jumper cables to rescue battery. (See "jumper start" on page 261)

 Warning

- Don't run the engine in any poorly ventilated place or enclosed place, The engine exhaust contains toxic gases, which can cause coma and even suffocation death.
- When the engine is running, never leave the vehicle in unattended state, so as to avoid accidents.
- Do not start the engine by pushing or pulling the vehicle. Otherwise, it may result in a collision accident. And it may also cause unburned fuel to enter into the three-way catalytic converter to damage the three-way catalytic converter.

 Caution

● If it is difficult start to the engine, do not let the starter continuously works for more than 10s when you start the engine. If the engine cannot be started, start operation must be stopped, and try to start again after about 30s, so as to avoid overheating damage to the starter and battery power loss.

● When the ambient temperature is no higher than  $-10\text{ }^{\circ}\text{C}$ , the time used to start up the engine may increase. Because the starter needs to operate longer to overcome the greater running resistance and poor combustion environment, so you should turn off all unnecessary electrical equipment's when starting.

### Shut down the engine

1. Depress the brake pedal and the clutch pedal (models with manual transmission), park the vehicle stably, pull up the parking brake, and place the shift lever to gear "P" or the neutral position.

2. Turn off the ignition switch or press the keyless start/stop button once to shut down the engine, and then release the brake pedal and the clutch pedal (models with manual transmission)

 Caution

● After engine flameout, the cooling fan may continue running for some time. When working in the engine compartment at this point, you should be careful not to be wounded by the fan.

● After operation under large load, it is recommended let the engine idle for a few minutes before Flame out, so that the cooling system continues to operate to quickly reduce the temperature of the engine.

### Emergency flameout method

Depress the brake pedal, press the keyless start/stop button twice consecutively within 2s or long press keyless start/stop button for more than 2s, the engine can be shut down.

 Warning

● Never shut down the engine when the vehicle is traveling! Otherwise, it may result in loss of control, thus an accident.

● After shutting down the engine, the brake booster does not work, and a larger force is required to depress the brake pedal to decelerate the vehicle.

● When an accident occurs, the vehicle fuel leakage may occur, so you should immediately shut down the engine to prevent fire.

## Transmission

### Models equipped with CVT transmission\*

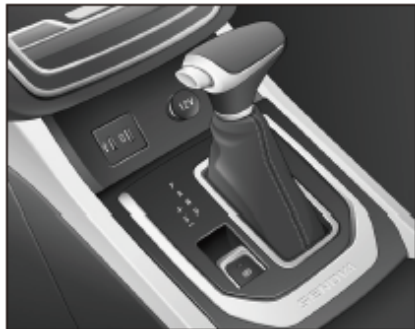

#### Vehicle starting and parking

1. Depress the brake pedal to the end, and place the shift lever to gear "P" or gear "N" to start the engine.
2. Depress and hold the brake pedal, hold down the lock button in front of the shift lever, place the shift lever in gear "D", release the parking brake first and then the brake pedal, and slowly depress the accelerator pedal, the vehicle will start traveling

3. Depress the brake pedal when parking, park the vehicle stable, pull up the parking brake tightly, and place the shift lever to gear "P"

#### Caution

● **Do not place the shift lever in forward gear when the engine is running, but depress the brake pedal, so that the vehicle remains stationary for a long time. If you need a long time idling operation, place the shift lever in gear "P" or gear "N"**

#### Gear description of models with CVT transmission

After the shift lever is placed into the appropriate gear, the trip computer screen displays the current gear

#### Gear "P" (parking gear):

Used when parking or starting the engine. Before placing the shift lever to gear "P", ensure the vehicle is parked stable completely.

#### Gear "R" (reverse gear):

Used when reversing before placing the shift lever to gear "R", ensure the vehicle is completely stopped and the engine is in idling state.

When shifting from gear "P" to gear "R", you must depress the brake pedal and press the lock button in front of the shift lever, the reversing light goes on automatically when shifting to gear "R".

#### Gear "N" (neutral gear):

When the vehicle should be stopped for a short time and the engine is idling (such as waiting for traffic lights), it may be placed in neutral gear. When it is in the neutral position and the transmission is not locked, you should depress the brake pedal or pull up the parking brake at this time.

If you need to shift the shift lever from gear "N" to gear "R", you must depress the brake pedal first to stop the vehicle completely, press the lock button in front of the shift lever to shift gears.

**Gear D (driving gear):**

Used when the vehicle is traveling forward, the transmission will automatically upshift or downshift according to the engine speed and vehicle speed

**Gear 'S' (sport model):**

After entering sport mode, the "Sport" icon is displayed on the instrument cluster, and the speedometer ring becomes Yellow (7 inch meter); The icon S lights up on the instrument cluster (5 inch meter). After entering into sports mode, the transmission automatically shifts at high engine speed, giving priority to ensuring power and acceleration of the vehicle

Gear "D" and gear "S" can be switched at any time. When selecting gear "S", the gear can be raised and lowered manually, push to the "+" direction for upshift, and the "-" direction for downshift. After upshift or downshift, the shift lever automatically returns to gear "S"

 **Warning**

● **For models with CVT transmission, it is strictly prohibited to shift into gear "N" to slide in the process of traveling, which can severely damage the transmission, and even cause accidents**



 **Caution**

● **For models with CVT transmission, before starting the engine, ensure the shift lever is located in gear "P" or gear "N", and do not start the engine in other gears.**

● **When the shift lever is shift from gear "P" or gear "N" into other gears, do not depress the accelerator pedal.**

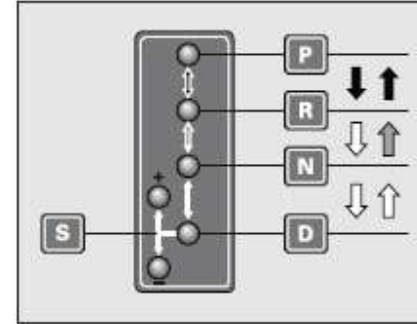
● **In the process of traveling, do not suddenly shift the shift lever to gear "R" or gear "P", in order to avoid damage to the transmission.**

**Instructions of gears**

-  Depress the brake pedal and press the lock button;
-  Press the lock button;
-  Just push the shift lever



**Reverse gear**

1. Stop the vehicle.
2. Depress the brake pedal, place the shift lever to gear “R”, and then release the parking brake.
3. After shifting into gear “R”, slowly release the brake pedal and slowly depress the accelerator pedal, the vehicle can travel in reverse gear, then:

- The backup signal lamp will come on.
- Rear view system automatically starts, and the reverse image (if equipped) is displayed in the multimedia screen.
- Parking radar starts, when the vehicle gets near obstacle, it can send out audible alarm prompt at different frequencies (see “parking radar system “on page181” )

**Gear “P” lock emergency lifting**

when the battery has no power, you can lift gear “P” lock as described below

1. Hold the lower end of the shift lever dust cover and lift it up slightly, and disengage the shift panel from the auxiliary instrument panel.
2. Toggle the gear “p” lock lever① on the shift operating mechanism up and hold.
3. Hold down the lock button in front of the shift lever, and operate the shift lever down to release gear “P” lock. .

**Models equipped with manual transmission**

Manual transmission has six forward gears and one reverse gear. Gear position is shown at the top of the lever.

The trip computer screen will show upshift and downshift information

**i Tips**

- You need to pull up the ring ① below the shift lever when shifting into reverse gear.

### Vehicle starting and parking

1. Check and ensure the shift lever is in neutral position.
2. Press down the clutch pedal to the end, and start up the engine.
3. Place the shift lever to gear "1" or reverse gear.
4. Slowly lift the clutch pedal, appropriately depress the accelerator, release the parking brake, the vehicle will start to move forward.
5. When parking, depress the brake pedal to decelerate the vehicle. Timely downshift according to vehicle speed, after the vehicle stops stably, pull up the parking brake, and place the shift

#### Tips

- **During deceleration, the engine auxiliary braking can be used by downshift, which helps to maintain a safe speed, and prevents brake overheating when traveling down a long slope**

#### Caution

- **During downshift at high speed, never shift by several gears. Otherwise, it will lead to a sharp increase in engine speed, causing damage to the engine, clutch and transmission.**
- **At low temperatures, when the engine has just started, the engine will be preheated to higher speed, and operate the vehicle carefully.**
- **When the shift lever is switched to other gear from neutral position, do not depress the accelerator pedal.**
- **When shifting, the clutch pedal should be depressed to the end**

### Reverse

1. Stop the vehicle and press on the brake pedal
2. Push the clutch pedal, press the front button of the shift lever handle, place the shift lever in the "R" gear position, and release the electronic parking brake.
3. After the "R" gear is hung in, the clutch pedal and the brake pedal are slowly loosened, and the vehicle is backed up to block the driving. At this time:
  - Reversing lights on
  - Back-up image system \* automatically starts and displays back-up image (if equipped) on the multimedia display screen.
  - When parking radar starts and approaches obstacles, sound alarms at different frequencies are given (see "Parking Radar System" on page 181).

### Parking method

1. Park the vehicle stable, pull up the parking brake, and ensure the vehicle is reliably parked.
2. For models with CVT transmission, place the gear shift lever to gear "P".
3. Turn off all lights and all electrical Equipment.
4. Make sure that the sunroof (if any) and all windows are closed.
5. Shut down the engine
6. Carry valuables, the key and lock all doors.
7. The alarm indicator light flashes at low frequency, indicating that anti-theft system has been activated.
8. When parking on a slope, to prevent the vehicle moves into the traveling road accidentally, turn the steering wheel according to the following requirements. When parking on the steep slope, you should also block the wheels with blocks.

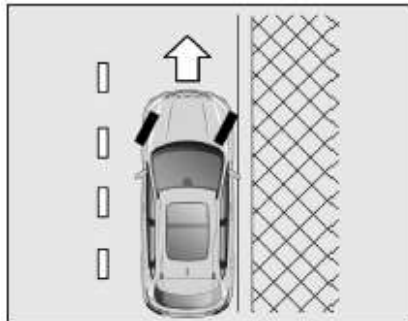

When parking on downhill road with curb, turn the steering wheel toward the curb

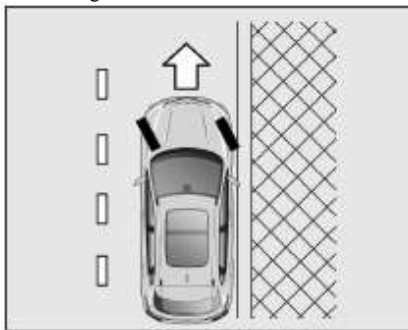

When parking on uphill road with curb, turn the steering wheel toward the direction away from the curb

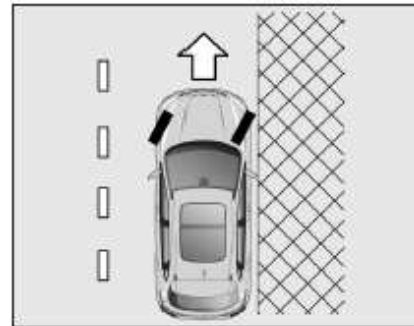

When the vehicle head towards the uphill or downhill without curb, turn the steering wheel so that the wheels rotate toward the curb.

## Precautions for parking safety

### Warning

- Do not park the vehicle near flammable items, to avoid the fire.
- For models with CVT transmission, you must place the shift lever to gear "P". Otherwise, the vehicle could move unexpectedly, causing an accident.
- Confirm the parking brake is reliable.
- The driver should always carry the key to the vehicle when leaving the vehicle. Otherwise, the person staying in the vehicle may start the engine or turn on the electrical equipment mistakenly, causing serious injury or death.
- Never leave a child or others needing care alone in the vehicle! Otherwise, it may cause suffocation or move the vehicle accidentally, resulting in serious accidents.

### Warning

- It is strictly prohibited to stay in the vehicle for a long time when turning on the air conditioning or heating and the vehicle is started. Otherwise, you may be poisoned by vehicle exhaust gas, or resulting in death





Do not park the vehicle on dry leaves or straw and other flammable items. Otherwise, hot engine or exhaust pipe may ignite flammable items and cause a fire.

Do not depress the accelerator pedal for a long time when parking or stopping under engine running state. Otherwise, the engine or exhaust system may get overheated, and then fire may occur.

## General descriptions

Electric power steering system (EPS) can provide assistance while driving, so that the steering wheel can be operated more easily.

When parking or traveling at very low speed, if the steering wheel is operated consecutively for several times, EPS will reduce steering assistance to prevent the system from overheating, and the steering wheel becomes more heavier. If you continue to operate like this, the electric power steering system will enter into thermal protection mode, the electric power steering fault warning light  will

goes on, power assistance disappears, and the steering wheel becomes very heavy, especially when parking or traveling at low speed. When the electric power steering system temperature reduces, power assistance will return to normal, and then the electric power steering fault alarm light  goes off.

When the engine is running, the electric power steering fault warning light remains on, indicating that the electric power steering system is not working properly. Please contact the authorized dealer of BAIC Motor for inspection of the electric power steering system.

## PS self-learning

After connecting the power again after the battery is disconnected for a long time, EPS will lose the positive return function (This function can improve the steering wheel positive return performance) and soft stop point function (this function can reduce the impact sense when the steering wheel is quickly rotated to the end), follow these steps to perform EPS self-learning to restore these functions:

1. Start the engine;
2. In the parking state, turn the steering wheel from the middle position to the left to the end for 1s, then to the right to the end for 1s, then finally back to the middle position;
3. Travel over 300m in straight at speed greater than 30km/h;
4. Park and flame out, restart the engine, EPS self-learning is completed.

## i Tips

● The required straight driving distance by EPS self-learning depends on road conditions: only a short distance is required to complete the self-learning on a dry and flat road, a longer distance is required on a slippery road and road with potholes

## General descriptions

The brake system mainly consists of:

1. Four-wheel disc brakes have good thermal stability.
2. Dual-circuit hydraulic system, if one circuit fails, the other can still provide brake to the two wheels.
3. Vacuum booster reduces the brake pedal force with the engine vacuum.
4. Anti-lock brake system (ABS) can still maintain good direction stability during emergency braking.
5. Electronic brake force distribution system (EBD) automatically adjusts the force distribution ratio between the front and rear axles, to improve braking efficiency.
6. Brake Assist system (BA) can improve vehicle safety during emergency brake.
7. Electronic Stability Program (ESP)\* can improve the stability of the vehicle during traveling

### Caution

- **During normal driving, do not habitually place foot on the brake pedal, because this will reduce the effectiveness of the brake, shorten the life of brake pad, and increase vehicle fuel consumption. The always-lit brake lamp may also lead to wrong judgment of road condition by followed drivers.**
- **When driving the vehicle down a long slope, the prolonged use of brake will accumulate heat, so that the braking effect will be reduced. In this case, you should shift to a lower gear to realize auxiliary braking with the engine. In order to increase the braking force, don't apply the brake continuously, but apply it intermittently**

### Caution

- **After wading in water, you must check the braking performance. Appropriately press down the brake, so as to inspect whether the brake works normally. If it is abnormal, you should frequently depress the brake pedal slightly, the brake is dried until it returns to normal.**
- **When driving, ensure to keep sufficient distance with other vehicles, in order to ensure sufficient reaction time and braking distance during emergency braking.**
- **Do not always depress abruptly the brake pedal frequently, which will accelerate the wear of the brake pad.**
- **During vehicle traveling, if the engine flames out, do not use inching braking, which will reduce the vacuum booster vacuum, and you will need a larger force to depress the brake pedal to decelerate the vehicle to stop.**

### Factors which affect the braking effect

#### 1. Wear

The wear of brake pad to a great extent depends on using condition and driving mode, especially for those vehicles which are often used for short distance trip in urban area or in sport mode. So it is necessary to check the thickness of the brake pad within the predetermined maintenance time interval.

#### 2. Wet road or road with salt on the surface

**Wet road:** When driving in heavy rain or water, or after washing, the brake discs and friction blocks will become moist, or when it freezes in the winter, the braking efficiency will be reduced, slightly depress the brake pedal for several times to dry the brake and recover its performance.

**Road with salt:** when traveling on the road with salt, if you do not brake for a long time, a layer of salt will form on the brake discs and brake pads, the brake performance will be reduced. You should slightly depress the brake pedal for several times to clear the salt layer on the brake disc and friction block

#### 3. Mountain environment

Due to the high mountain and long slope in mountain environment, brake is used more frequently and for longer time, and often works continuously in high-intensity braking conditions, these factors will cause deteriorated braking performance. Therefore, when traveling downhill, never slide in neutral position and avoid frequent braking. If possible, use the low speed gear and the engine brake to control the vehicle speed, so as to reduce the working load of wheel brake and reduce the temperature of brake. When the engine brake is being used, if the transmission is set at a lower gear, the engine speed will be higher, the dragging force generated will be higher, and thus the braking effect will be more obvious.

#### 4. Plateau environment

Due to the thin air and low pressure at high altitude, the brake booster vacuum becomes small. Therefore greater braking force is needed to depress the brake pedal in the plateau region. When braking is needed, do not depress the brake pedal with the inching method, but rather keep the foot on the brake pedal to ensure braking performance by controlling the brake pedal force

#### 5. Ice and snow weather

Since the frictional coefficient of snowy/icy road is low, in the course of braking operation, the braking distance will greatly increase, and the braking distance will also increase as the vehicle speed increase. Therefore, when driving he vehicle on snowy or icy road, please properly control the vehicle speed, and keep the safe distance away from vehicle in front of you or the vehicle on side of you.



#### Warning

**● When driving the vehicle on snowy or icy road, it is prohibited to slide the vehicle with the transmission set at neutral position.**

#### 6. Brake disc surface rust

If the vehicle is parked for a long time, then the brake disc corrosion can occur, and the friction block dirt may occur at the same time. We recommend that you drive at low speed and brake for several time to clean the brake discs before full driving.

#### 7. Brake system fault

If you find that the braking distance increases suddenly or the stroke of brake pedal increases, it is likely that the brake system is in fault.

You should adjust the driving style in the premise of ensuring safety, exert greater force to the brake pedal, and drive at low speed to the nearest the authorized dealer of BAIC Motor.

 Warning

**●If the vehicle completely loses brake, do not drive forcibly, you should stop safely, contact the authorized dealer of BAIC Motor and wait for rescue.**

#### 8. Overheating of brake

When braking is not needed, do not put your foot on the brake pedal. Otherwise, it would lead to overheating of the brake, reduce brake performance, extend the braking distance, and increase the wear of the friction block and brake disc.

#### Brake wear indicator

Friction block is equipped with wear sound prompter. If you hear a piercing scream or scratching sound (which is different from the brake squeezing, which is usually caused by the dust on the brake when braking slightly), it indicates that you need to replace the friction blocks

#### Hydraulic brake system

Hydraulic brake system transfers the brake hydraulic pressure through the dual-circuit. If one circuit is in fault, the other circuit will continue to work. In this case, you should drive at low speed to the nearest BAIC authorized dealer for repair in the premise of ensuring safety. In such case, more force shall be applied to the pedal.

#### Brake system fault warning light



If the brake system fault warning Light  goes on during driving, it indicates that the brake system has a fault, and then you need to check the brake fluid level. If the level of brake fluid is normal, it means that other fault exists in the brake system. You should immediately stop in the premise of ensuring safety, and contact the authorized dealer of BAIC Motor for inspection and repair



## Electronic Parking Brake System (EPB)



### Applying electronic parking brake

Manual application of electronic parking brake : When the vehicle stops and the keyless start/stop button is in the "RUN" mode, Pull up the electronic parking brake switch to apply the electronic parking brake, At this point, the parking brake Indicator light  on the instrument cluster goes on

Automatic application of electronic parking brake:

When the keyless start/stop button is switched to "OFF" mode after the vehicle stops, the vehicle can automatically apply the parking brake.

Secondary application of electronic parking brake:

In some special cases (such as steep slopes), when the Keyless start / stop button is located at "RUN" Mode and the parking brake has been applied, at this time , Pull up the electronic parking brake switch again and hold it in 3 seconds, the secondary clamping of the brake caliper can be realized which can ensure parking safety

### Caution

- **When parking on a larger ramp, electronic parking brake should be applied twice to ensure parking Safety.**

### Release electronic parking brake

Manual release of electronic parking brake:

When the vehicle stops and the keyless start/stop button is in the "RUN" mode, keep the brake pressed constantly. Electricity parking brake can be released by pressing down the electronic parking brake switch. At this point, the parking brake Indicator light  on the instrument cluster goes out

Automatic release of the electronic parking brake: When the vehicle starts, all the doors are closed and the driver's seat belt is fastened. The electronic parking brake can be released automatically when the accelerator pedal is pressed after the gear is in "D" or "R" gear.

 Tips

- If the brake pedal is not pressed and the electronic parking brake switch is pressed downward, the electronic parking brake will not be released, and there will be a text reminder "Please step on the brake to release the electronic parking" on the multi-functional display screen of the combined instrument. (7 inch meter)
- Make sure the driver's seat belt is fastened, otherwise the electronic parking brake will not be released automatically.

 Caution

- When the vehicle is in the parking state, do not step on the accelerator pedal to avoid accelerating the loss of the electronic parking brake and reducing the service life of the electronic parking brake.
- When the electronic parking brake needs to be released in non-special circumstances (such as ramp start), it is suggested that the automatic release method should not be used, and the long-term automatic release method should be adopted to reduce the service life of the electronic parking brake.

**Remove automatic parking**

In some special cases, when the engine needs to be extinguished without parking, the automatic parking can be relieved by the following operations:

1. The keyless start/stop button is in "RUN" mode, press the brake pedal and hold it.
2. Pressing the electronic parking brake switch and holding it for more than 3 seconds.
3. After 3 seconds, keep the electronic parking brake switch pressed and switch the keyless start/stop button to "OFF" mode, the vehicle will not park automatically.

### ABS: anti-lock brake system

ABS anti - lock brake system prevents the wheels from being locked during braking, to help the driver to better control the direction of the vehicle, and reduce vehicle sliding on a slippery road when braking.

#### Operating mode of anti-lock brake system (ABS)

When the ABS system is working, you can feel the brake pedal shake and hear the clicking sound, and this is a normal phenomenon.

During emergency braking, before the vehicle stops or gets out of danger, do not release the brake pedal (this is vital!) You should not repeatedly depress the brake pedal. Otherwise, it will abort the ABS working and may increase braking distance.

If the road is slippery, even if the brake pedal is pressed slightly, the ABS will be activated, which will enable the driver to obtain the information about road conditions by applying brake then adjust his driving mode.



Caution

● **ABS anti-lock system function has some limitations. Develop good driving habits is essential to ensure safe driving, and you shall not drive lightly because the system is equipped with ABS.**

● **In order to obtain the shortest possible braking distance and braking stability, you should depress the brake pedal as firmly as possible.**

● **After ABS system fault, the conventional vehicle brake system can still work, but there is no wheel anti-lock function, and the braking distance may be longer accordingly**

#### ABS fault warning light

If the ABS fault warning light goes on during traveling, it indicates the brake system has a fault, and you should drive at low speed to the nearest the authorized dealer of BAIC Motor for repair. During ABS self-detection, you will hear "Ge long" sound or feel a slight vibration of the brake pedal, which is normal and does not indicate a fault

### EBD electronic brake force distribution

EBD electronic brake force distribution system automatically adjusts the braking force distribution ratio between the front and rear axles, to improve braking performance, which to certain extent can reduce the braking distance, and improve braking stability together with ABS.

#### BA Brake Assist System

BA Brake Assist system can provide auxiliary braking during emergency braking. When the driver depresses the brake pedal quickly in case of emergency, but the depressing force is inadequate, the system will automatically increase the braking force, thus shortening the braking distance.

### ESP electronic stability system\*

ESP electronic stability system can improve the stability of the vehicle, for example, it can reduce the risk of vehicle sliding when accelerating and traveling on a curve.

ESP and ABS work together. If the ABS system has a fault, the ESP will not work.

ESP will work only when the engine is running. In special circumstances, you should lift the ESP function, such as:

- When the vehicle equipped with tire chains is traveling.
- When the vehicle is traveling in deep snow or on loose road.
- When vehicle is caught in muddy road and needs to move back and forth.

When BCM receives ESP emergency brake signal, the brake light will flash quickly; when the vehicle stops at a higher speed, the danger alarm light will automatically flash to remind the rear car to prevent rear-end collision. at this time, Pressing the switch of the danger alarm lamp to turn off the danger alarm lamp.

### ESP operation fault warning light

If the ESP fault warning light  flashes during driving, it indicates the ESP system is currently implementing stability adjustment.

If the ESP fault warning light  remains on in the process of traveling, it indicates the ESP system has a fault. You should drive the vehicle at low speed to the nearest the authorized dealer of BAIC Motor for repair.

#### ESP self-learning

Power the battery on after disconnecting for a long time, the ESP fault warning light  goes on. Conduct ESP self-learning in these steps to restore its function.

1. Start the engine:
2. In the parking state, turn the steering wheel from the middle position to the left to the end and hold for 1s, then to the right to the end and hold for 1s, and finally back to the middle position;

3. Travel over 300m in straight at speed greater than 30km/h;
4. Park and flame out, restart the engine, ESP self-learning is completed.



#### Tips



● **The desired straight traveling distance for self-learning depends on road conditions: Only a short distance is required to complete the self-learning on a dry and flat road, a longer distance is required on a slippery road and road with potholes.**

### ESP function is turned off



ESP function is automatically turned on when you start the engine each time.

Press the ESP off button  OFF to turn off the ESP function, then the ESP off indicator light  OFF on the instrument cluster will go on.

Press again the ESP off button  OFF to turn on ESP function, then the ESP off indicator light  OFF on the instrument cluster will go out



Warning

● **Electronic Stability Program (ESP) has some limitations for stability control of the vehicle, even if the vehicle is equipped with an electronic stability system (ESP), you should be ready to adjust driving style according to the road and traffic conditions. This is particularly important for driving on slippery and wet roads. Do not drive dangerously because this system improves vehicle stability, otherwise there will be danger of accidents!**

### Uphill Auxiliary System

Uphill auxiliary system can increase the convenience of the driver to start parking on the ramp. On the ramp, when the vehicle starts, the driver loosens the brake pedal and the system automatically maintains the brake for a period of time, so that the vehicle will not slide. At this time, the driver should quickly step on the acceleration pedal to make the vehicle start smoothly.

### Traction Control System (TCS)

The traction control system can limit the idling of wheels. When the vehicle starts to step on the accelerating pedal or accelerates rapidly on the road with low adhesion coefficient, the driving wheel may cause unacceptable slip (idling). TCS system can control the dynamic performance of the vehicle through the intervention of braking force and engine system.

## Set cruise control

Cruise control system is an electronic throttle control program, which makes the vehicle automatically maintain a constant speed. After using cruise control when driving on long highway, the driver does not need to depress the accelerator pedal, and the vehicle can maintain the set speed, thereby reducing driver fatigue and improving driving comfort.

Cruise control condition:





1. Cruise control takes effect only at speed of 40km/h and above;
2. The brake system, vehicle speed signal, the accelerator pedal, intake and fuel system have no fault.

### Warning

- **When driving in heavy traffic, in area with heavy wind, on rough roads, on rain, snow, ice and other slippery road surface, do not use cruise control to avoid accident due to loss of control.**
- **The set speed and distance from preceding vehicle shall be suitable for the traffic conditions, and the cruising control system is only a driving aid system, and shall be used prudently.**
- **Cruise control system should be promptly turned off after use**

## Start cruise control



1. Press the cruise control main switch button , the cruise control function is turned on, the cruise control green indicator light  on the instrument cluster flashes, and the vehicle enters into the cruise control ready state.
2. Control the vehicle speed to the desired cruise speed (40km/h and above).
3. Toggle the cruise control speed setting button  down to position and SRC hold for 1-2s, to set the current speed as the cruise speed, then the cruise control indicator light  goes on.
4. Release the accelerator pedal, the vehicle enters into cruise control state

**Reduce cruise speed**

In the cruise control state, toggle the cruise speed setting **SET** button down to position and reduce the cruise SRC speed, the cruise speed drops 2km/h when it is toggled once. Press and hold down, the cruise control speed will continue to decrease.

**Increase cruise control speed**

In the cruise control state, toggle the cruise speed setting button up **RES** to position and increase the cruise speed, the cruise speed increases 2km/h when it is toggled once. Press and hold up, the cruise control speed will continue to increase

**Overtaking**

When you need to overtake, depress the accelerator pedal to accelerate, exceeding the cruise speed (overtaking as usual). After releasing the accelerator pedal, the vehicle will gradually restore the previous set cruise control speed

**Pause cruise control**



In the cruise control state, when any of the following circumstances occurs, the cruise control automatically pauses, but the memorized cruise speed will be saved:

- When depressing the brake pedal;
- When pressing the cruise control pause button **CANCEL** ;
- When the shift lever is in neutral position;

**Recover cruise control**

When cruise control pauses, toggle the cruise speed setting button up **RES** to position and hold for 1-2s, you can SET/- SRC re-enter into the cruise control state, the cruise speed will return to the previously saved cruise control speed before stopping

**Turn off cruise control**

In cruise control state, press the cruise control main switch button  to turn off the cruise control function of the vehicle, while the green cruise control indicator light on the instrument cluster  goes out, the memorized speed is cleared, and so you need to re-set cruise speed next time



### Direct tire pressure monitoring system

Direct tire pressure monitoring system uses tire pressure sensor installed on rim to monitor tire pressure and temperature, then transmits the information to receiving device through wireless transmitter, and displays the corresponding information on combined instrument.

#### Tire information (5 inch meter)



The tire pressure information shows the tire pressure status. Normally, tire pressure information and alarm lamp in combination instrument show that when tire pressure is abnormal, tire pressure monitoring alarm lamp in combination instrument lights up, accompanied by prompt sound. The driving computer display screen shows the car icon and the corresponding fault tire flashes.

When the tire pressure monitoring system is abnormal, the tire pressure monitoring alarm lamp in the combined instrument will flicker for 60 seconds and then be long-lighted, accompanied by prompt sound. When the signal of tire pressure monitoring system is lost, the tire pressure of the computer display screen of the driving car is displayed without tire pressure, and the tire pressure monitoring alarm lamp flashes.

#### Tire information (7 inch meter)



Enter the instrument settings to view tire information, tire information shows the pressure and temperature of the tire.

### i Tips

● This figure is for reference only, and specific values displayed on the real vehicle shall prevail.

● After the vehicle goes out, restart the vehicle. After the instrument self-checks, the instrument can display the tire temperature and pressure value, which is the historical value before the last stop and extinguish, and the tire temperature and pressure value of the non-current vehicle state. When the vehicle starts running, the system can update the current tire status in real time.

● After the vehicle starts, the running speed exceeds 30 km/h and after a period of time, the instrument shows the current tire pressure and temperature, and the tire pressure monitoring system automatically enters the normal working mode.

### Tire Temperature/Pressure Alarm (7-inch meter)



When abnormal tire pressure, rapid air leakage, high pressure, low pressure and high temperature occur, the alarm of abnormal tire failure will be displayed in the alarm window of the combined instrument. At the same time, the tire pressure monitoring alarm lamp  on the combined instrument will be lighted accordingly. Drivers should stop in a safe condition and immediately contact the authorized dealer of BAIC Motor

### Fault Alarm of Type Pressure System (7-inch meter)



When the tire pressure system fails, or the tire pressure sensor fails, or the tire pressure sensor loses, or the tire pressure sensor power is low, the alarm of the tire pressure system failures will be displayed in the alarm window of the combined instrument, and the tire pressure monitoring alarm lamp  on the combined instrument will be lighted accordingly. At this time, please come to the authorized dealer of BAIC Motor in time to repair tire pressure system, in order to avoid affecting traffic safety.

### Caution

- Tire pressure monitoring system is not a tire pressure gauge, and it cannot prevent a flat tire and tire burst. Its main function is to monitor tire temperature and pressure.
- If you use the radio transmitting device (such as wireless headphones, walkie-talkies) in or near the vehicle, the tire pressure monitoring systems interfered.
- After transposition of wheels, you should go to the authorized dealer of BAIC Motor for tire pressure sensors re-adaptation. Otherwise, the actual position of the tire displayed on the trip computer screen will be inconsistent with actual situation.
- After replacing the wheels, you should go to the authorized dealer of BAIC Motor to install and adapt the tire pressure sensors. (The spare tire equipped with the vehicle has no such tire pressure sensor.)

### Parking radar system Display of instrument cluster

The parking radar system has two configurations: one is that only 3 rear parking radar sensors are installed on the rear bumper; the other is that not only 3 rear parking radar sensors are installed on the rear bumper, but also 2 front parking radar sensors are mounted on the front bumper.

Parking radar system is a safety assist device when parking or reversing the vehicle. It uses ultrasonic to detect the approximate distance between the vehicle and the obstacle, displays with the trip computer screen, and alerts the driver by intermittent sound signal

When the parking radar works, the trip computer screen will enter into parking radar display interface, the front two and rear four sections of lines on the screen represent an the orientation and distance to the vehicle of the obstacle, while sending out beep warning.

Where is the obstacle in the radar detection area, the line of the corresponding area is lighted, and when there is no obstacle behind the vehicle,

the wireless line is lighted. As the obstacles get closer to the bumper, the buzzer will buzz more and more rapidly until it continues to buzz, reminding the driver to pay attention to the obstacles behind

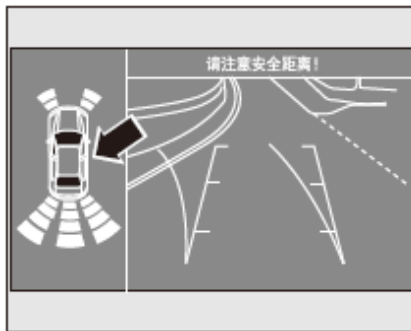



### Rear parking radar on condition (only equipped with rear parking radar models)

When the keyless start/stop button is in "RUN" mode, place the shift lever to gear "R", the rear parking radar is turned on, and place the shift lever to gear "R" to exit the rear parking radar

### Front and rear parking radar on condition (equipped front and rear parking radar models)



When the keyless start/stop button  is in "RUN" mode, press the button on the Multi-function switch panel or place the shift lever in gear "R", the front and rear parking radar is turned on, and then the indicator light on the button goes on.

When the vehicle traveling speed is larger than 15km/h or press the button  again, the front and rear parking radar is turned off, and then the indicator light on the button goes out

### Detection Range of Front Radar and Response Mode of Buzzer

| The distance from the bumper (cm) | Responding method          | Color |
|-----------------------------------|----------------------------|-------|
| 30-60                             | Quick sound intermittently | green |
| <30                               | Continuous sounding        | red   |

### Rear radar buzzer responding method

| The distance from the bumper (cm) | Responding method           | color  |
|-----------------------------------|-----------------------------|--------|
| 90 ~ 150                          | Slow sound intermittently   | green  |
| 30 ~ 60                           | Medium sound intermittently | green  |
| 30 ~ 60                           | Quick sound intermittently  | yellow |
| < 30                              | Continuous sounding         | red    |

The sensor may not identify the following objects:

1. Sharp or slim objects such as ropes, chains, thinner column and pile.
2. Objects can absorb sensor frequency, such as clothes, sponge material, or snow.
3. Relatively low step

### 4. Lower half opened rolling gate

### Fault Alarm Instructions for Parking Radar System

#### Radar fault warning



When the parking radar system is on, if the system detects the fault information, the combined instrument will send out sound prompt (5 inch meter) or text prompt (7 inch meter). At the same time, the display screen will display the fault prompt interface.

### Warning

● Parking radar system is only a kind of backing auxiliary system, drivers still need to pay attention to the surrounding environment in the process of backing up.

● The ultrasonic sensor of parking radar system has blind area when detecting obstacles. When reversing, the driver must pay attention to observation to avoid reversing accident.

● Parking radar system sensor is a precise part. Do not disassemble and repair it without permission. The company will not undertake quality assurance for damage caused by user's private disassembly and repair.

● The surface of certain items does not reflect the signals from the alarm system sensors, which prevents the alarm system from detecting such items or persons wearing such clothes.

 Caution

- If water droplets are attached to the surface of the ultrasonic sensor, the sensitivity of the ultrasonic sensor will be reduced, and the sensitivity can be restored by erasing the water droplets attached to the ultrasonic sensor.
- Extravehicular noise sources may interfere with the alarm system, causing the system to fail to detect items or personnel normally.
- When backing up in narrow places or on slopes, the system may detect railings, trees or slopes, which is a normal phenomenon.
- In order to ensure the function of the ultrasonic sensor, it is necessary to keep it clean and avoid icing. Cleaning parking radar system with high pressure cleaner should be short-term and gentle, and the distance between nozzle and ultrasonic sensor should be at least 10 centimeters.

### Reversing Image System

The reversing camera is mounted on the vehicle trunk lid. Rearview system picks up the image in rear of the vehicle with this camera, and sends it to the multimedia screen in the cab to assist the driver for reversing.

When reversing, the driver can clearly see the scene behind the vehicle through the multimedia screen, to avoid damages to the vehicle. However, the system also has the vision dead zone. For example, it cannot detect small objects below the bumper, as well as objects getting close to the rear part of the bumper and corners on both sides.

### Turning on and off the reversing view system

When the vehicle is in the "R" gear, the rear-view camera starts to work, and the multimedia display screen will display the reverse image in real time. At the same time, the backing image is accompanied by dynamic and static trajectory indication. The driver can judge the distance between the ground obstacle and the vehicle according to the static trajectory indication. The static trajectory indicates the distance as shown in the following figure. When the vehicle exits the "R" block, the rear-view camera stops working and the multimedia display screen returns to the previous display interface.

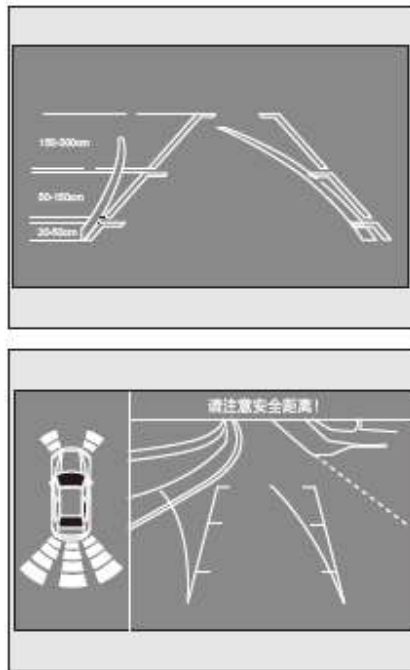

### Fault Description of Reversing Image System

When the reversing image is turned on, if the system detects the fault information, the multimedia display screen displays the fault prompt interface, which is as follows.



### The Situation Affecting the Effect of Reversing Image



In storms or foggy days



The surface of the camera is frozen or covered with mud, dust and snow.



Reversing at night.



Reversing in the dark without backing lights.

## Introduction of Panoramic Image System

The panoramic image system consists of four wide-angle cameras and a panoramic system controller installed around the body. Panoramic image system can assist drivers to observe the environment around the vehicle, expand the scope of vision of the driver, and facilitate the driver to drive the vehicle

Panoramic Imaging System (AVM) includes the following main functions

- 360-degree panoramic image

-The controller seamlessly stitches the images of four cameras around the car body to form a 360-degree panorama. The display effect is similar to that of the aerial overhead image, which can display the images around the car body 360 degrees.

- Mobile Object Recognition
- lane departure warning
- Blind zone detection

## Panoramic Image System Switch



The panoramic image system switch is located on the multifunctional switch panel.



### Opening Conditions of Panoramic Image System

When the keyless start/stop button is in "RUN" mode, it can be opened by satisfying any of the following conditions:

1. Place the shift lever to gear "R"
2. When the speed is less than 15 km/h, press the switch on the left dashboard.

### Exit Conditions of Panoramic Image System

When the AVM is opened, it can exit if it meets any of the following conditions:

- A: place the shift lever to gear "P"(MT models are in neutral) after 5 seconds;
- B: Press the lower right corner button  of the display screen in the non-gear "R" "C: In the non-gear "R", the vehicle speed is greater than 15km/h;
- D: Under the gear "R", press the switch on the left dashboard

E. Press the keyless start/stop button to "OFF" or "ACC" mode.

Note: When the opening condition is 2, it cannot be closed by means of A.

### Interface switching operation of AVM system

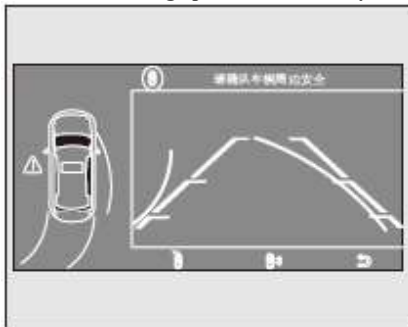

When the system starts, the default screen of the system is rear view plus panorama, which can be switched to other views through gear, turning lights, or touch screen operation.

The vehicle is in the "R" block, and the screen default screen is the rear view, which integrates dynamic and static auxiliary lines

When the steering wheel does not rotate, the dynamic trajectory coincides with the static trajectory. When the steering wheel is rotated, the dynamic auxiliary line will calculate the vehicle trajectory line according to the steering wheel angle to assist the driver in parking.

Note: When the opening condition is 2, it cannot be closed by means of A.

### MOD Mobile Object Recognition

When the vehicle is still, the panoramic image system can recognize moving objects in the camera image. When the system detects moving objects in the image, the system will give corresponding prompts to remind the driver that there are moving objects around the vehicle and drive cautiously.

#### Start and close

When the vehicle is still, the moving object recognition function opens and closes simultaneously with the panoramic system. When the vehicle is moving, the moving object recognition function automatically stops working. When the system detects a moving object, a red warning icon is displayed in the corresponding area of the panoramic image to prompt. Mobile object recognition can be turned off by soft keys  under panoramic interface

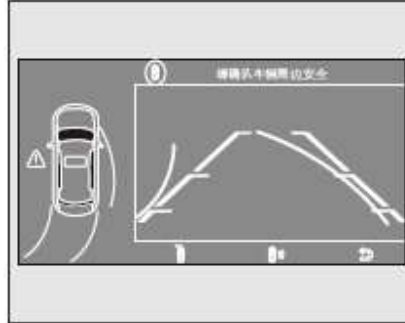

- The smallest object that the system can detect is an object about 50 cm in length and 50 cm in width.
- The system can only detect objects within 2 meters of the front and rear of the body, excluding the blind area of the camera.
- This function is prohibited when the speed of the vehicle is not zero.

#### i Tips

- This function is only used to help drivers drive safely. It is not a vehicle driving safety system. It only plays an auxiliary role and cannot replace the driver's control.
- When the camera is covered by rain and snow, mud, ice and snow, there will be false alarms and omissions. Drivers are advised to drive carefully.
- When in the night, rain, snow, fog, shadow and other environments, the function will appear false alarm and missed alarm, please drive cautiously

### LDW Lane Deviation Warning System

The panoramic image system uses the camera to detect the lane line. When the vehicle is detected to deviate from the lane and there is no turning light command in the corresponding direction (the system confirms that the driver has no intention of changing lanes), the system alarms the driver that the vehicle is deviating from the lane and drives cautiously.

#### Start and close



#### Start Conditions:

When the keyless start/stop button is in the "RUN" mode or the vehicle is started and the speed is over 60 km/h, it can be opened by satisfying any of the following conditions:

- Press the LDW switch key
- Host Security Setup Interface Setup

#### Closing conditions:

When LDW is opened, it can exit if any of the following conditions are satisfied

- Vehicle speed is less than 60 km/h.
- Press the LDW switch key.
- The host security settings interface is set up.

#### Alarm mode

The system can provide icon visual alarm and continuous sound alarm.

When the system detects the change of vehicle status, the corresponding lane will change color. The Lane color and the corresponding vehicle status are as follows: the lane is not identified, the lane is dark blue; the lane is identified, not deviated, the lane is bright blue;

The lane has been identified and the departure lane is red. When the driver's intention to deviate from the lane is detected, the alarm is forbidden.  
**Start and close**



LDW can be switched on and off, alarm sound and alarm sensitivity can be set on the multimedia display screen

### Tips

- This function is only used to help drivers drive safely. It is not a vehicle driving safety system. It only plays an auxiliary role and cannot replace the driver's control.
- When the camera is covered by rain and snow, mud, ice and snow, there will be false alarms and omissions. Drivers are advised to drive carefully.
- When in the night, rain, snow, fog, shadow and other environments, the function will appear false alarm and missed alarm, please drive cautiously.

### BSD Blind Zone Monitoring System

Blind area monitoring system uses side camera to detect the blind area of rearview mirror and alert the driver so as to avoid accidents due to the blind area of rearview mirror in the course of lane changing

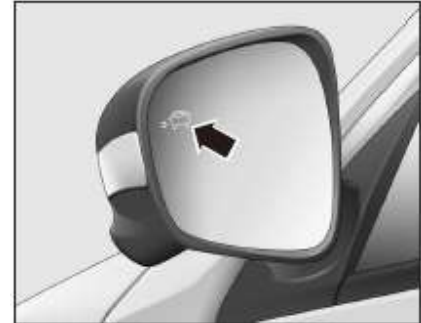

When the driving vehicle is detected in the blind area set by the system, the blind area monitoring indicator in the corresponding side rearview mirror will be long on. When the driver turns on the corresponding side turning light, the indicator will flicker, and the system will alert the driver that there is a driving vehicle in the blind area of the rearview mirror.

**Start and close**

Start conditions:

When the keyless start/stop button is in "RUN" mode or the vehicle is started, it can start if any of the following conditions are satisfied

- When the vehicle speed is greater than 30km/h;
- Host security settings interface to set

Close conditions:

- When the vehicle speed is less than 30km/h;
- Host security settings interface to set

**Alarm mode:**

When the system detects mobile vehicles, it can provide LED light visual alarm and sound alarm.

**Detection range**

- The system can recognize only four-wheeled vehicles.
- The system does not alarm vehicles driving in the opposite direction.
- The system can only recognize the area of about 6 \*3 m behind the vehicle.

**Function Configuration**

The starting and closing of the blind area monitoring system can be set on the multimedia display screen.

**i Tips**

● **Careful diversion. This function is only used to help drivers drive safely. It is not a vehicle driving safety system. It is only used to supplement the shortcomings of rearview mirror, and cannot replace the driver's control.**

● **When the camera is covered by rain and snow, mud, ice and snow, there will be false alarms and omissions. Drivers are advised to drive carefully.**



● **When in the night, rain, snow, fog, shadow and other environments, the function will appear false alarm and missed alarm, please drive cautiously.**



## General description



The use of automatic idle start-stop function can save fuel. When the vehicle stops and the engine idles (such as red light, short stop, etc.), under certain conditions, the idle start-stop system will automatically extinguish the engine. When starting again, the starter automatically runs and drags the engine to start quickly

## Usage method



When the keyless start/stop button is switched to RUN mode, the idle start/stop system is turned on by default. After the vehicle stops automatically, the idle start-stop operation indicator lights  up, and after the automatic start-up, the idle start-stop operation indicator lights  out.

If the idle start-stop system needs to be shut down, press the idle start-stop switch  located on the multi-function switch panel, then the idle start-stop/stop/failure indicator light  on the combined instrument will light up.

If the idle start-stop switch  is pressed again, the idle start-stop system will be turned on again, and the idle start-stop/stop/failure indicator  will be turned off.

When the idle start-stop function is on, if the system fails, the idle start-stop/shut-down/failure indicator  lights on the combined instrument will always be on after flashing for a period of time, and the idle start-stop function cannot be realized by the system.

## Idle start-stop conditions:

1. Idle start-stop system is in the open state;
2. Battery sensor detection has enough energy for the next start;
3. Coolant temperature is above 60 C;
4. Vacuum of brake vacuum booster is sufficient;
5. Engine cover is in closed state; driver side door is closed;
6. Accelerator pedal is completely released;
7. Vehicle is relatively static (speed is less than 3 km/h);
8. There was once a start of more than 10 km/h.

**Idle start-stop operation method.**

After the vehicle meets the conditions of idle start-stop:

For CVT transmission models: press the brake pedal, block position in the "D" block, the engine will automatically extinguish; once again ready to start, as long as the release of the brake pedal, you can start the engine.

For manual transmission models, if the gear is in neutral position and the clutch pedal is loosened, the engine will automatically extinguish; when preparing to start again, the engine can be started as long as the clutch pedal is pressed down.

 Caution

- When the engine starts automatically, if the driver does not gear or step on the throttle within 15 seconds, the engine will again enter the intelligent shutdown state.

 Caution

- If the vehicle goes out unexpectedly during operation, when the driver steps on the brake pedal, the shift rod is placed in "P" gear, "N" gear (CVT transmission type) or the clutch pedal is pressed down, and the shift rod is placed in neutral gear (manual transmission type), the engine will start automatically.
- When the internal temperature of the battery is very high or very low, the idle start-stop function will not be realized.
- After the battery is cut off and the power supply is re-connected, the system will learn by itself. The idle start-stop function cannot be realized at this stage. Only after the vehicle runs for a period of time can the idle start-stop function be used

 Caution

If the system fails to achieve idle start-stop function, the engine will not stop automatically:

- idle start-stop function is used too frequently;
- current altitude is higher than about 3200m;
- battery power is very low, there is not enough energy for the next start, or battery signal failure;
- engine hatch is open or not closed;
- the maximum speed of vehicle just starting is less than 10km/ H;
- engine coolant temperature is lower than 60 or higher than 105 C; driver side door is open;
- When the engine idles and stops, the brake vacuum is insufficient due to the continuous tread on the brake pedal.

 Caution

- When the engine is in the state of automatic shutdown, once the following situation occurs, the engine will start automatically and quickly.
- Battery power is below the limit, or battery signal failure;
- The vacuum degree of brake vacuum booster is insufficient.
- The vehicle appears to "slide" forward or backward, and the speed is greater than 5 km/h.
- Turn off idle start-stop switch.

**Battery Sensor**

Battery sensor is a precise electronic component. It monitors the working state of the battery by detecting the voltage, current, temperature and other information inside the battery.

There is a contact resistance requirement between the battery negative cable and the battery sensor. It is not allowed to disassemble the battery negative cable privately. Otherwise, the battery sensor will not be able to output the correct power signal and the idle start-stop system may fail.

 Caution

- If the battery needs to be replaced, only the same type of battery is allowed to be replaced. After the battery is replaced, the battery sensor needs to be adapted to authorize dealer of BAIC. Otherwise, the accuracy of sensor parameters will be affected, which will affect the normal operation of idle start-stop system.
- I When the engine can't start due to the long time parking of the vehicle and the insufficient battery power, it can start over. If the battery or battery sensor of the vehicle can't be disassembled, otherwise the idle start-stop system may fail.



## Traveling safety inspection

You'd better to conduct a safety inspection before driving for a few minutes, which will help safe driving. You should be familiar with all parts of the vehicle, and carefully observe to perform these checks

### Before the engine is started

#### Outside the vehicle:

Tire:

Check the tire pressure, as well as for the existence of the cutting, damage, or excessive wear, bumps.

Wheel bolts:

Ensure that no bolt is lost or loosen.

Vehicle lights:

Make sure that the headlamp, brake lamp, reversing lamps, turn signal lamps and other lamps work normally. Inspect the lighting direction of headlamp

### In the engine compartment:

Oil and fluid level:

Ensure levels of all fluids are normal, such as engine oil, coolant, brake fluid and the like.

Conditions of battery and cable:

Check the battery housing for cracks, the terminals for corrosion or loosening, the cable for connections in good condition.

#### Inside the vehicle:

Seat belt:

Check and confirm that the lock tongue and the buckle can be fastened firmly. Make sure that the seat belt is not worn or damaged.

Instrument and control devices:

Particularly ensure instrument panel indicator light and defrosting/defogging functions are normal.

Brake Pedal:

Check the pedal has enough free travel

### After the engine is started

#### Before traveling:

Oil and fluid leak

After the vehicle has been parked for a while, inspect whether fuel, engine oil, water or other fluid is leaking from the bottom of vehicle. The water drop after use of air conditioner is normal phenomenon.

#### During driving:

Instrument:

Ensure the red and yellow warning lights on the instrument cluster do not go on.

Brake:

Drive at low speed in the premise of ensuring safety, depress the brake pedal to check whether the brake is reliable, the vehicle will not deviate, and the brake has no abnormal sound.

Noise:

Pay attention to check whether the vehicle has abnormal noise

### Driving in Running-in period

To improve the life of the vehicle, the vehicle running-in should be carried out in early use before normal use. The regulations in the running-in period are as follows:

- The running-in mileage is 1500km.
- Choose a better road and drive under light load.
- Do not let the speed exceeds 80% of the maximum speed.
- Do not depress the accelerator pedal to the end for sudden acceleration.
- Avoid sudden braking in the first 300km.
- Strictly implement the operating procedures, and maintain the engine at the normal operating temperature. Seriously carry out routine maintenance of the vehicle, always check, and pay attention to the sound and temperature variation of all assemblies.

### Running-in of engine

The running - in of engine in accordance with the above requirements will not only prolong the service life, but also reduce the fuel consumption. The new engine must undergo running-in of 1500km, and you must comply with the following provisions in the running-in period:

- The engine should avoid running at high speed, never exceeding 80% of the maximum speed.
- Never towing as a tractor.

After the vehicle has run for 1000-1500km, gradually increase the engine speed and vehicle speed to the maximum permissible range.

In the early stage of running-in, the internal friction resistance of the engine will be much greater than that after running-in, and oil consumption may be higher than normal. So the engine oil should be checked regularly. All the moving parts of the engine can achieve the best fit state after running-in

### Running-in of tire and brake pad

In the first 500km, please drive the vehicle at medium speed, so as to run in the new tire.

During the first 300km, new brake pad and brake disc do not reach the optimal friction condition. You should avoid emergency braking, maintain adequate safe braking distance, and slowly depress the brake, so as to achieve the best running-in state.

 Warning

- **The new tire and brake pad which have not been run in can't achieve the optimal adhesive force and frictional force. Therefore, in the first 500km, please carefully drive the vehicle and run in the tires, so as to prevent the occurrence of accident.**
- **The new brake pad shall also go through running-in in accordance with the above requirements.**
- **When driving the vehicle, please keep an appropriate distance away from other vehicles, so as to avoid the occurrence of any situation which requires emergency braking. Because the new tires and the friction block have not undergone running-in, the adhesion and friction is less, easily leading to accidents**

### Driving essentials in different situations

In manual mode of CVT vehicle, when the vehicle is driving on rough road or braking urgently, the vehicle may temporarily withdraw from manual mode to protect the transmission. At this time, the gear display will change to "D" gear, and when the vehicle returns to normal driving, the manual mode "S" will be automatically restored

When the CVT vehicle is in the extreme climbing condition (23% of the slope is up to 28% of the slope), it will increase the speed because the clutch is in the sliding state for a long time (or repeated for a short time). This condition will cause the clutch to be in the non-closed heating state for a long time, which will cause the temperature of the clutch to rise rapidly to the alarm of the limit transmission, and even the transmission will protect itself from the power until the oil temperature drops.

### Drive in the rain

When it rains, visibility is reduced, window fogging and the road is very slippery, so please drive carefully.

- Downpour causes reduced vision, so you should turn on the headlamps, fog lamps and hazard warning lights.
- After brake is wet, it will affect braking performance. Therefore, you need to increase the distance between vehicles and reduce the speed when driving in the rain.
- When it rains, do not drive at high speed, because the higher the speed, the easier the water film forms between the tire and the road surface, which will reduce the adhesion of the tire, thus reducing the performance of the steering and brake systems

 Warning

- **When driving the vehicle on a slippery road, the emergency braking, acceleration and turn may cause the skidding of tire, so that the maneuverability may reduce and thus accident may occur**

### Wading driving

#### Caution

- Please note the water waves aroused by the vehicles in front and the oncoming vehicles, which may lead to water exceeding the maximum permitted depth. Once the depth of water reaches the bottom of the body, do not forcibly wade.
- You should speed up before entering into water under no circumstances. The formation of water vortices caused by acceleration will make water enter into the vehicle and damage to the engine and other assemblies.
- Do not open any door in the process of wading. Otherwise, water may enter into the vehicle, damaging electronic systems and equipment in the vehicle.
- When wading, after engine flameout, never forcibly start the engine again, the engine may be inhaled some water, starting the engine again will cause irreversible damage to the engine

If the vehicle needs to pass through road with water, please note the following precautions:

- Before wading, please correctly estimate or detect the wading depth and characteristics of water area, do not forcibly wade when the water situation is unknown
- The idle start-stop function of the engine must always be turned off.
- Shift to a lower gear, but avoid high engine speed.
- Choose a flat place, and drive the vehicle steadily and slowly at the speed as walking.
- During wading driving, do not stop half-way, and do not let the engine stall.
- After wading, slightly depress the brake pedal for several times to dry the brake, in order to restore the braking force.
- After wading, the mud on the tread should be promptly removed

### Key points for driving in winter

#### Warning

- If you try to increase the braking effect of the engine on a slippery road surface through downshifting, the drive wheels may lose grip, which increases the risk of slipping and accidents.
- If the exhaust duct is blocked or ventilation is poor, carbon monoxide (CO) and other toxic gases may enter into the vehicle. Especially when the vehicle is trapped in snow, there is a risk of fatal injury

 Caution

- If the engine or auxiliary heating system works, ensure there is no snow in the area on the exhaust pipe and around the vehicle. You should ensure adequate supply of fresh air into the vehicle.
- When de-icing the rear windshield, be careful not to damage the seals and plastic parts on the rear windshield.
- Drive carefully on slippery roads. Avoid emergency acceleration, braking and steering. Do not use cruise control.
- When winter comes, go to the authorized dealer of BAIC Motor for winter protection and maintenance of the vehicle.

**Preparation before winter:**

1. Change fluids suitable for low temperature environment in advance:
  - Select oil with viscosity suitable for low-temperature environment;
  - Select coolant suitable for low temperature environment;
  - Select antifreeze washing fluid suitable for low-temperature environment.
2. Check the tires, and ensure the tires have adequate tread depth.
3. If necessary, you can buy a set of tire chains matching front wheels.
4. Ensure good battery performance.
5. Depending on the driving destination, it is recommended to carry the necessary emergency supplies: deicing scraper, flashing signal device, small shovel, jumper cables, air pump and so on.

**Before driving:**

1. If the door lock hole is frozen, please spray some deicing agent into the door lock hole. When the door lock is not frozen, spray some glycerol in it, so as to prevent the door lock from getting frozen.
2. Do not forcibly open the frozen window or move the wipers on frozen windshield, but you should use warm water to melt frozen parts. Immediately wipe the water clean to prevent freezing.
3. Clear the ice and snow below the fender.

**When driving:**

For CVT models, if the vehicle is in low-temperature environment for a long time (such as all night long), after starting the engine and placing the gear shift lever in traveling gears, the vehicle starting lag may occur. This feature will be obvious only after the engine is started up in cold state, and will disappear after the vehicle runs. During the initial lag stage, you should not depress the accelerator pedal. If the pedal is depressed forcibly, it may damage the transmission.

Start and drive smoothly, and drive at appropriate speed according to road conditions.

#### **When parking:**

When parking on a flat ground, place the shift lever to gear "P" (Models CVT transmission) or gear "R" (models with manual transmission), and block the wheels with stones. In the premise of ensuring safety, do not use the parking brake, which may freeze, resulting in that it is difficult to release the parking brake.



Warning

- **When parking on steep slope, you must pull up tightly the parking brake to apply parking brake.**

#### **Brake essentials**

Never use the brake pedal as a footrest. If the foot is placed on the brake pedal when traveling, the brake system may overheat. This will increase the braking distance and may even lead to fault of the brake system, so there is a risk of accidents. Do not depress the brake pedal and the accelerator pedal at the same time while driving. Continuously depress the brake pedal will cause excessive and premature wear of the brake pad. After heavy braking, you should not stop immediately, but you should continue to drive for a short distance, in order to cool the brake faster with the air.

If the brake system only undergoes a moderate braking, the braking effect should be checked from time to time. the method is that forcefully depress the brake pedal at high speed, in order to improve the gripping force of the brake.

#### **Highly-efficient use of vehicle**

- Keep the correct tire pressure: Insufficient pressure can lead to tire wear and waste of fuel.
- Wheel alignment should be accurate. Otherwise, it will lead to excessive tire wear, increase the engine load, and waste fuel.
- Do not place unnecessary items in the vehicle. Heavy load will increase the engine load, resulting in increased fuel consumption.
- Accelerate slowly and steadily, and avoid rapid start. Please get a high speed gear engaged as soon as possible.
- Avoid congestion area as far as possible, and avoid continuous acceleration and braking. Stop-go driving style wastes fuel.

● Avoid unnecessary stopping and braking: Keep a stable speed. Drive with traffic lights, and reduce the times of vehicle stopping. Try to choose the road with no traffic lights to drive. Keep appropriate distance from the vehicle in the front to avoid emergency brake, which reduces wear of the brake.

● Don't put your foot on brake pedal. This will lead to early wearing and overheating of brake disc as well as wasting of fuel.

● When driving the vehicle, don't get it collided with road shoulder. When driving the vehicle on a bumpy road, please reduce the vehicle speed.

● Keep the chassis free from soil, so as to not only reduce the deadweight of vehicle, but also prevent corrosion

● Carry out vehicle maintenance and keep in good working condition. Dirty air filter, improper valve clearance, dirty spark plugs, dirty oil and grease, etc., will reduce engine performance and waste fuel. To extend the service life and reduce operating costs of all components, it must be regularly maintained. If you frequently drive in bad conditions, the mileage and maintenance interval should be shortened

#### **Fuel-saving driving**

The fuel - saving driving will not only save the fuel, but also be environmentally. Some fuel-saving measures are introduced for you as follows:

● Remove unnecessary loads before driving.

● Maintain the appropriate tire pressure.

● Start smoothly, and try to avoid emergency acceleration and deceleration.

● After the cold start, drive slowly for

a few minutes, and then accelerate after engine warm-up. It generally does not need to run the engine warm-up in place.

● Plan the traveling route, and choose a good road.

● Drive at economic speed as far as possible.

● In light of the running speed, please select the appropriate gear, and don't make the vehicle run at high speed with a low speed gear engaged.

● When driving the vehicle at high speed, don't open the windows.

● Rationally use the air conditioning, and reduce the use of high-power audio and other high-power electrical devices.

● When driving in urban areas, idle start-stop system should be turned on.

● If the vehicle is to be stopped for long time, please turn off the engine, and don't make the engine run at idle speed for long time.

● Regularly conduct maintenance of the vehicle in accordance with the requirements, and keep good vehicle condition

### Safety operation instruction

|  |     |  |     |
|--|-----|--|-----|
| Maintenance .....  | 203 | Battery.....                                 | 222 |
| Precautions for routine maintenance .....                  | 204 | Battery .....                                | 222 |
| Routine maintenance items outside the vehicle.....         | 205 | Windshield washer and wiper .....            | 225 |
| Routine maintenance items inside the vehicle.....          | 206 | Tires and wheels .....                       | 232 |
| Routine maintenance item of other parts.....               | 207 | Clean the outside of the vehicle .....       | 239 |
| Engine compartment .....                                   | 208 | Clean the inside of the vehicle .....        | 242 |
| Engine compartment (full coverage)* .....                  | 208 | Anti-corrosion measures .....                | 243 |
| Engine compartment * .....                                 | 209 | Recycling and Environmental Protection ..... | 244 |
| Safety instructions for working in engine compartment..... | 210 | Recycling and Environmental Protection.....  | 244 |
| The engine fuel system.....                                | 211 |  |     |
| The engine cooling system.....                             | 212 |  |     |
| The engine lubrication system.....                         | 215 |  |     |
| The braking system .....                                   | 219 |  |     |
| Brake.....   | 219 |  |     |
| Braking vacuum booster.....                                | 219 |  |     |
| The brake fluid.....                                       | 219 |  |     |



### Overview of Maintenance

As the increase in traveling mileage, its components will gradually wear out, and the technical condition will continuously to deteriorate. To guarantee good performance of the vehicle and the vehicle has a high hedge when it is resold, you need to conduct vehicle maintenance during use.

Maintenance is divided into regular maintenance and routine maintenance. Please go to the authorized dealer of BAIC Motor for regular maintenance. Routine maintenance is mainly performed by the driver.

You must abide by safety operation specification when performing any maintenance or inspection. Improper operation may cause fault or damage to vehicle functions and even accidents.

### Regular maintenance

Timely conduct regular maintenance of vehicle is an essential link in the use of vehicle. Refer to requirement in "Maintenance information sheet" for regular maintenance mileage interval or time interval and maintenance items. You can also go to the authorized dealer of BAIC Motor regular maintenance in a timely manner according to the mileage reminder on the trip computer screen maintenance (see "Maintenance Information" on page 050).

#### Caution

- **Not timely regular maintenance will degrade the performance of the vehicle and cause damage to the vehicle, and you will lose the right to warranty claims.**

### Routine maintenance

Routine maintenance items should be checked every day before normal driving. If you want the vehicle to continuously run, this is necessary. Routine maintenance is the responsibility of the driver.

Routine maintenance and inspection can be done by the driver himself, and may also be conducted by the authorized dealer of BAIC Motor if necessary.

The driver must pay attention to safety during routine maintenance, comply with safety operation specification, in order to avoid injury to yourself or damage to the vehicle.

If you need to dismantle, install, or replace parts, maintenance should be carried out by qualified personnel. If you have any questions about vehicle maintenance and repair, please consult the authorized dealer of BAIC Motor

 Warning

- Before performing routine maintenance work, you should park the vehicle on flat ground in a safe area, and pull up the parking brake tightly. Do not carry out routine maintenance work in unsafe area with heavy traffic, more persons and explosive hazardous areas or on the ramp.
- If you must run the engine in a similar closed environment such as a garage, you should ensure there is proper ventilation in order to discharge exhaust

 Warning

- Before routine maintenance, you should take off loose clothes and ties, pile up long hair, take off bracelets, watches and other jewelry, and wear gloves.
- Engine and exhaust system will generate heat during working, and it can easily cause burns. Therefore, you should wait at least about 30 minutes after the engine is shut down, and then conduct routine maintenance until the engine and exhaust system cool.
- Never enter below the vehicle when the vehicle is only supported by the jack. If you must enter below the vehicle, please support the vehicle with safe support bracket.

 Warning

- When the ignition switch is in the "ON" position or keyless start/stop button is in the "RUN" mode, do not disconnect or connect battery cable connector or other electrical components.
- With the engine is shut down, the fuel pipeline pressure is still high, do not disassemble the fuel pipeline, and go to the authorized dealer of BAIC Motor to repair the fuel system.
- It is prohibited to get objects with spark, flame or sparks near parts of the fuel system and the battery.
- Do not let skin directly contact with used engine oil or coolant.

Before normal driving each day, conduct routine inspection of the vehicle.

If there is any abnormal sound, vibration, or smell, be sure to immediately identify the cause or go to the authorized dealer of BAIC Motor for inspection or repair.

When conducting any inspection or maintenance, you must comply with "Precautions for routine maintenance".

(See "precautions for routine maintenance for routine maintenance" on page 204)

#### **Doors and the engine hood**

Check whether all doors, engine hood and trunk lid are working properly.

Check all locks are normal, lubricate the hinges and locks if necessary.

Ensure the hook can still keep the engine hood closed when the engine hood latch hook is opened.

#### **Vehicle lights**

Regularly clean the headlights.

Check to ensure the headlights, brake lights, position lamps, turn signal lamp lamps and other lighting equipment can be used normally and fixed reliably

#### **Tire**

Before long-distance traveling, you should carefully check the tires for damage, cracks or excessive wear, measure the tire pressure with tire gauge, and adjust the pressure of all the tires (including the spare wheel) to the predetermined value. (See "Tires and wheels" on page 232 for details)

#### **Wheel transposition**

It is recommended to conduct a transposition of front and rear wheels after traveling every about 10000km. The interval mileage of wheel transposition may vary depending on driving habits and road conditions. (See "Wheels inspection and transposition" on page 236)

#### **Windshield**

Promptly clean the windshield. Check the windshield for cracks or other damage at least once every six months.

#### **Air conditioning air inlet**

Air conditioning air inlet is located in the lower right of the front windshield, which is equipped with porous ventilation trim panel. External air is sucked into the vehicle through the air conditioning.

Leaves and other debris on the air conditioning ventilation trim panel should be cleaned regularly. Especially in rain and snow, the snow on the windshield and front windshield ventilation trim panel should be promptly removed, ensure the air inlet and water flowing passage of the air conditioning are smooth. Otherwise, the drain outlet may be clogged, affecting the effect of air conditioning, or even cause fault of the air conditioning system.

**Accelerator pedal**

Check whether the operation of the accelerator pedal is proper, ensure there is no catching or uneven force of the accelerator pedal, and ensure the foot pad does not interfere with the operation of the accelerator pedal.

**Clutch pedal**

Check whether the clutch pedal operation is normal, ensure the clutch engagement and disengagement are reliable, there is no noise of the transmission when shifting, and the pedal height is appropriate.

**Service brake pedal**

Check whether the operation of the brake pedal is normal, ensure there is proper clearance when the brake pedal is fully depressed, and ensure the foot pad does not interfere with operation of the brake pedal.

**Electronic Parking Brake**

Operation of electronic parking brake switch to ensure reliable parking function

**Steering wheel**

Check whether the steering wheel free travel is too large, whether steering is hard steering or there is other unusual noise

**Seat belt**

Check whether all parts of the seat belt (for example buckle, lock-tongue, and retractor) are working properly and smoothly, as well as firmly installed. Check the seat belt webbing for cracks, scratches, wear, or damage.

**Cleaning and maintenance of instrument panel and plastic parts**

Regularly clean the instrument panel and plastic surface with a clean soft cloth. And you can spray the right amount instrument panel wax for Protection

Special stains can be cleaned with dedicated solvent-free plastic cleaning agents.

**Warning**

● **It is prohibited to use solvent containing cleaning agent to clean the instrument panel and airbag module surface. Otherwise, it may damage the surface of the material airbag module, and may result in serious injury when the airbag deploys**

**Cleaning and maintenance of leather**

Suck the dust on the surface of the leather with vacuum cleaner, and wipe it with a wet and soft cloth, and then with another soft and dry cloth. After it is completely dry, you can spray the right amount of leather care agent for protection. If the dirt can't be cleared away by the above-mentioned means, please use the professional leather detergent to carry out cleaning.

**Caution**

- **After wiping the leather with leather detergent, please use the soft dry cloth to wipe the leather dry.**
- **Do not place a soft cloth impregnated with cleaning agent on any part of the trim for a long time, in order to avoid local fading.**

**Warning lights, indicator lights and buzzer**

Ensure that all warning lights, indicator lights, and buzzer are working properly

**Windshield defogger and defroster**

When operating the heater or air conditioning, check whether air can be appropriately and sufficiently blown out from the outlets of the defogger and defroster.

**Wiper and washer**

Check whether the wiper and washer are working properly. If scratches are left after the wiper works, you should immediately go to the authorized dealer of BAIC Motor for replacement of wiper blade

**Windshield washer**

Check whether there is sufficient washing fluid in the windshield washing fluid reservoir.

**Braking Fluid Level:**

Ensure that the brake fluid level in brake fluid reservoir is between the MIN and MAX lines

**Engine coolant**

After engine cooling, check the coolant level in the reservoir.

**Engine oil**

Park the vehicle on the flat ground, shut down the engine, and check the engine oil level with a dipstick 10 minutes later. (See "Engine oil level inspection method" on page 216)

**Fluid leakages**

After the vehicle is stopped for some time, check whether there is fuel, oil, coolant, or other fluid leaks below the vehicle. Water dripping after use of air conditioning is normal. If there is any leakage or obvious gasoline odor, find the reason and immediately contact the authorized dealer of BAIC Motor for repairs

**Engine accessory belt**

Ensure that the accessory belt is not worn, loose, cracked or has no grease.

## Engine compartment (full coverage)

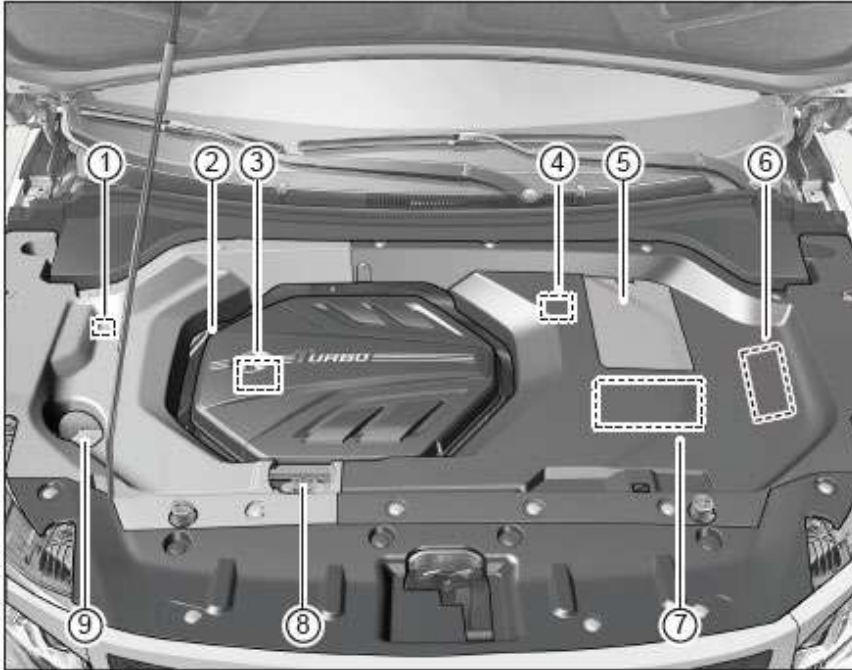

1. Engine coolant reservoir filler cap
2. Engine oil dipstick
3. Engine oil filler cap
4. Brake fluid reservoir filler cap
5. Battery Repair Gate Cover
6. Fuse box in engine compartment
7. Air filter
8. Engine coolant reservoir filler cap
9. Windshield washing fluid reservoir filler cap

 Caution

● Users are advised not to disassemble and assemble the engine compartment panels on their own to avoid unnecessary damage. For disassembly and assembly, please go to authorized dealer of BAIC Motor

## Engine compartment



1. Engine coolant reservoir filler cap
2. Engine oil dipstick
3. Brake fluid reservoir filler cap
4. Battery
5. Fuse box in engine compartment
6. Air filter
7. Engine coolant reservoir filler cap
8. Engine oil filler cap
9. Windshield washing fluid reservoir filler cap

## Safety instructions for operation in engine Compartment

When working in the engine or in the engine compartment, such as checking or filling fluids, burns and other injuries may occur, and there is potential risk of a fire or other accidents. Therefore, you should pay attention to related warning instructions and safety regulations.

### Warning

- If the steam or coolant overflowing is observed, do not immediately open the engine hood, because this will lead to burns. You can only open the engine hood until there is no steam or coolant overflows, and the engine has cooled down.
- Do not touch the cooling fan, which is controlled by the temperature. It may also automatically turn on in the engine stall state.
- Timely remove foreign body in the engine compartment during routine inspection or regular maintenance, and do not leave gloves, rags and other flammable materials or tools in the engine compartment. Items left could cause engine fault or damage, or even a fire

### Warning

- Check the vehicle for oil leakage positions. Avoid oil dripping onto hot engine or the exhaust system, or there will be fire hazards.
- When adding fluids, do not confuse them. Otherwise, it will cause serious malfunction of the vehicle.
- Before working below the vehicle, ensure that the vehicle cannot move and support it reliably with the appropriate bracket. You cannot ensure it is safe below the vehicle when it is supported only with the jack.
- If the engine hood is not locked when the vehicle is traveling, the engine hood can be opened by high-speed air, thus causing serious accidents. Therefore, you should check whether the locking device is reliably locked after closing the engine hood.



## Fuel

In order to ensure performance of the vehicle, the unleaded gasoline (#92 and above) in line with the provisions of the vehicle must be used.

### Caution

- You should go to regular gasoline stations to fill. Use of gasoline not meeting the standard will reduce engine life or even damage the engine.
- Never fill diesel to the vehicle. If diesel is added mistakenly, do not start the engine, and you should contact the authorized dealer of BAIC Motor for thorough cleaning of the fuel system.
- In special cases, a small amount of gasoline lower grade can be filled. At this time, you should control the engine to run at a moderate-speed and low-load operating condition. If the engine runs under heavy load or at high speed operation running with full throttle, it can damage the engine. You shall fill gasoline with the predetermined grade as soon as possible

### Caution

- The vehicle is equipped with three-way catalytic converter. Only unleaded gasoline is allowed, otherwise the three-way catalytic converter will be damaged as long as the leaded petrol is filled once.
- When refueling, it indicates that the tank is "full" when the refueling gun automatically stops. Do not forcibly refuel. Otherwise, the expansion space in the fuel tank will be filled with fuel, and fuel may overflow during thermal expansion. Please immediately wipe away the fuel sprayed on painted surface of vehicle body.
- The vehicle is equipped with three-way catalytic converters. You should fill fuel before the warning light goes on, and do not run out of the fuel. When the fuel level is too low, irregular fuel supply can cause the engine misfire, causing unburned fuel to enter into the exhaust system, and damaging the three-way catalytic converter due to overheating. Too low oil level is also not conducive to the fuel pump lubrication

### Warning

- Fuel vapor is highly flammable and causes a fire. When filling, shut down the engine, and smoking, using a cell phone, and other sparks or open flames are strictly prohibited.
- Before fully opening the filler cap, you should first loosen the fuel filler cap, so that the internal fuel pressure is released completely. Otherwise, personal injury can be caused by the fuel vapor discharged from the fuel filler.
- After refueling is completed, ensure the fuel filler cap has been tightened to prevent accidents when fuel spills.

### Engine coolant

The coolant circulates in the engine cooling system to take away the excessive heat generated in the engine, to ensure normal operating temperature of the engine. The specified coolant can also play anti-boil, anti-corrosion, scale prevention and anti-freeze effects

### Warning light (red) for too high engine coolant temperature

If the warning light  for too high engine coolant temperature goes on during running, it indicates that the engine coolant temperature is too high. Trip computer screen displays

#### Warning

● When the warning light  for too high engine coolant temperature goes on, you should not continue to drive. Otherwise, it will cause engine overheating, and damage the engine severely

### Check the engine coolant level

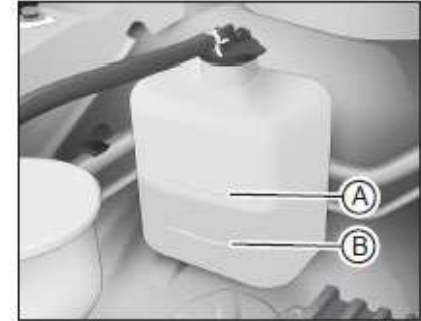

Check the coolant level after engine cooling down

A Coolant upper limit mark

B : Coolant lower limit mark.

The level of coolant shall be between the upper limit mark and lower limit mark.

If the level is below the lower limit mark, you should timely add the coolant with specified model

### Engine coolant adding



Check the coolant level after engine cooling. If you find a lack of coolant, you can open the coolant reservoir filler cap ①, and add coolant to the position between the upper and lower limit marks.

If the amount of coolant is insufficient greatly or frequently, please go to the authorized dealer of BAIC Motor for inspection of the vehicle cooling system

#### Warning

- Before the engine is cooled, do not open the coolant reservoir filler cap or radiator cap, because the coolant temperature is high. There may be hot coolant or steam ejected when opening, causing burns.
- Do not mix coolants of different types or brands, and do not add additives or other fluid in the coolant. Otherwise, it may damage the engine.
- If the coolant within the coolant reservoir has fading or discoloration phenomenon, you should timely change the coolant.

### Replacement of engine coolant

Please regularly go to the authorized dealer of BAIC Motor for change of engine coolant in accordance with provisions of "Maintenance Information Sheet"

#### Caution

- The coolant with stronger ability of anti-freeze should be used in winter or cold regions to adapt to the ambient temperature, in order to prevent the engine being damaged by freezing.
- The coolant shall be placed in enclosed container, and be kept away from children



Under normal traveling conditions, the engine coolant temperature gauge A scale on the instrument cluster should be located near the middle position.

When the engine is running under heavy load and the ambient temperature is very high, the coolant temperature may rise, and the corresponding indication may also rise. When the coolant temperature is too high, the indication bar points to the highest region, the warning light  for too high engine coolant temperature goes on to alert the driver that there is a fault. You should immediately stop in the premise of ensuring safety, let the engine idle for a few minutes, shut down the engine, and then check the cooling system after the temperature drops to room temperature,. If the level of coolant is normal, it is likely that the system is overheated owing to the fault of radiator fan. Please inspect whether

the radiator fan fuse has blown out, and if necessary replace the fuse.

If the coolant temperature becomes too high again after traveling a short distance, you must immediately stop in the premise of ensuring safety, shut down the engine, and contact the authorized dealer of BAIC Motor for maintenance of cooling system

### Engine oil

Selection of engine oil

Refer to "Maintenance Information Sheet" provides periodic replacement of engine oil, go to the authorized dealer of BAIC Motor for replacement. Only change engine oil as required, you can only ensure the life of the engine. Please check whether the model and specification on the packaging of oil is applied to the engine and the appropriate use environment when buying engine oil

### Recommended SAE viscosity of engine oil

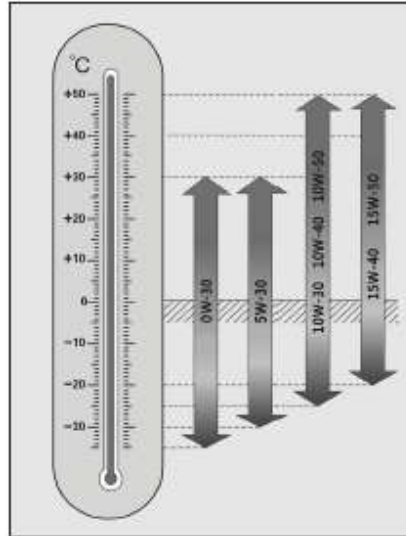

Select the appropriate engine oil depending on the ambient temperature.

### Engine oil pressure warning light (red)

If the engine oil pressure warning light  goes on continuously after the engine starts, it indicates that there a fault of the engine lubrication system, then you should immediately shut down the engine, and check the engine oil level.

If the oil level is normal, but the warning light goes on, you should not continue to drive, but you should shut down the engine, and contact the authorized dealer of BAIC Motor for repair of the engine lubrication system

#### Caution

● If you continue to drive after the engine oil pressure warning light  goes on , it would seriously damage the engine

### Inspection Method of Engine Oil Level

- Check engine oil level by oil gauge: 1. Park the vehicle on the horizontal ground.
2. Start the engine and warm it up until the engine temperature reaches its normal working temperature (about 5 minutes).
3. Turn off the engine and wait for at least 5 minutes for the engine oil to flow back to the oil pan.
- 4 Pull out the oil gauge, wipe off the oil mark on the gauge with a clean cloth, and insert the oil gauge again to the end.
- 5 Pull out the oil gauge again and check whether the liquid level is between the upper and lower limit marks.

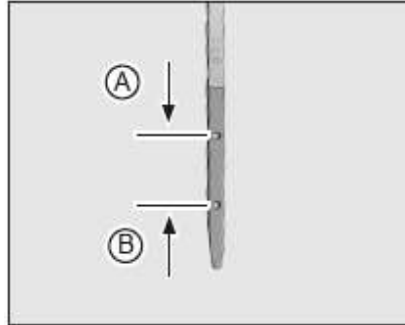

A : Oil cap marking.

B : Oil lower limit marking

Engine operation will consume a certain amount of oil, oil consumption depends on driving mode and vehicle operating conditions. Therefore, it is necessary to check the oil level regularly, and it is better to check the oil level after each injection and before long-distance driving.

In summer, when vehicles travel long distances on expressways, tractor trailers, or in mountainous areas, the oil level should not exceed the upper limit mark A when the engine is running under such harsh conditions.

### Engine oil supplement

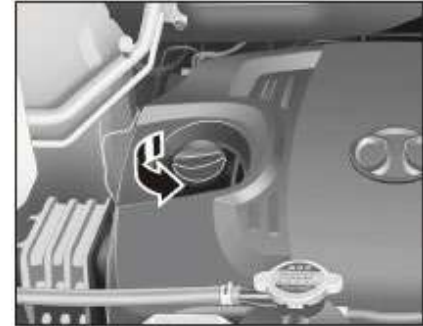

1. Parking the vehicle on the horizontal ground.
2. Open the engine hatch.
3. Pad a cloth around the filling port to prevent oil dropping onto the engine
4. Turn the oil filling cover on counterclockwise
5. In order to avoid excessive oil filling, add a small amount of oil several times, each time should be injected with a small amount of oil and check the oil level.

(It takes several minutes for the oil to flow from the filling port to the oil pan.)

6. When the oil level reaches between the upper mark and the lower mark, stop filling the oil and tighten the oil filling cap.

7. Put away the cloth and clean around the filling mouth

 Caution

● If the level of engine oil exceeds the maximum mark A, be sure not to start up the engine. Otherwise, it may damage the three-way catalytic converter and the engine. If too much is filled, please contact the authorized dealer of BAIC Motor to remove excessive oil.

 Warning

● The engine oil is a kind of inflammable substance. When adding the engine oil, be sure to be careful, and be sure not to splash the engine oil onto hot components of engine or exhaust system.

### Replacement of engine oil Notes

 Caution

● Be sure to replace the engine oil at the time interval as specified in the **Maintenance Information Sheet.**

Go to the authorized dealer of BAIC Motor for engine oil change. If the vehicle is traveling in adverse conditions, such as:

- Frequent short trips
- Prolonged idling (such as taxis)
- Dusty area
- Often towing a trailer
- Traveling in alpine region

It is necessary to increase the number of related maintenance items between regular maintenance, or shorten the maintenance interval.

 Tips

- The new engine oil will soon change color after the engine runs for some time. This is a normal phenomenon, and you not need to change oil in advance.
- Disposal of used engine oil is a highly professional work, and requires the corresponding professional knowledge and necessary special tools. It is recommended to be recovered by the authorized dealer of BAIC Motor.
- Waste oil is extremely harmful to the environment and water, so do not pour waste oil into the sewer pipe or on the soil or lawn.

 Caution

- The engine oil with a stronger ability of antifreeze should be used in winter or cold regions to adapt to the ambient temperature, in order to facilitate cold start and good lubrication of the engine.
- Do not mix engine oil of different types or brands, and do not add other additives in engine oil. Otherwise, it may damage the engine.
- If you continue to drive after the engine oil pressure warning light goes on, it would seriously damage the engine.
- If too little engine oil is filled, it may damage the engine. If too much engine oil is filled, it may damage the engine and the three-way catalytic converter.

 Warning

- Without the relevant professional knowledge, be sure not to replace the engine oil by yourself.
- If the skin is stained with engine oil , please wash the skin thoroughly.
- Any other additives should not be added in the engine oil, as this may damage the engine.
- The engine oil filler cap shall always be tightened up, otherwise engine oil may splash out when the engine is running and then cause fire.



## Brake

Four-wheel disc brakes are equipped with automatic gap adjustment devices. When the brake pad is worn, the brake will automatically adjust the gap after the brake pedal is depressed. Under some driving or weather conditions, you may hear brake noise during mild to moderate braking, which is normal and will not affect the performance of the brake system.

### Caution

● You should regularly check the brake.  
For detailed information, see "Maintenance Information Sheet".

## Brake vacuum booster

Check the brake vacuum booster function:

1. With the engine is shut down, depress the brake pedal for several times repeatedly until the travel of the pedal is same each time, and then carry out the following checks.
2. Depress and hold the brake pedal, the pedal height should be lowered when the engine is started.
3. When the brake pedal is depressed and the engine is shut down, hold the pedal for about 30s, and the pedal height should remain unchanged.
4. Release the brake pedal and let the engine run for 1 minute, and then shut down the engine. Repeatedly depress the brake pedal for several times, the pedal travel should be gradually reduced when depressed each time. Otherwise, it means the vacuum booster is not working properly.

When braking during traveling, if large force is needed to depress the brake pedal, it indicates there is no vacuum in the vacuum booster. You should immediately stop in the premise of ensuring safety and contact the authorized dealer of BAIC Motor.

## Brake fluid

Brake fluid is used to deliver pressure in the vehicle hydraulic brake system.

In the course of use, the level of brake fluid in brake fluid reservoir may lower slightly owing to the wear of friction plate. If this situation is found, please decide whether it is necessary to add the brake fluid in light of the level of brake fluid. If the brake pedal travel becomes longer unexpectedly or brake fluid level drops significantly, please contact the authorized dealer of BAIC Motor for repair of the brake system.

### Warning

● Brake fluid should be stored in position not easily reached by children. Please go to a doctor immediately if swallowing brake fluid by mistake.

 Warning

- You avoid the brake fluid to contact with eyes or skin. If inadvertently contact, wash immediately with plenty of water, and timely seek medical treatment.
- Don't splash the brake fluid on to hot engine, otherwise fire may occur.

 Caution

- Brake fluid is highly absorbent, so the container should be kept sealed to prevent deterioration of the brake fluid due to water absorption.
- Clean the brake fluid on paint surface of the vehicle since it is corrosive to the paint surface.

**Brake system fault/low brake fluid level warning light  (red)**

If the brake system fault/low brake fluid level warning light  goes on in the process of traveling, it indicates there is a brake system fault or brake fluid level is low.

 Warning

- If the warning light goes on during traveling, do not repeatedly depress the brake pedal, and you should immediately stop in the premise of ensuring safety, and contact the authorized dealer of BAIC Motor for maintenance of the brake system.

**Check the brake fluid level**

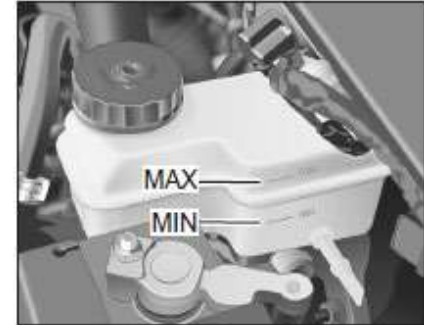

Observe the mark line on the brake fluid reservoir.

- “MAX” : The upper limit mark for level of brake fluid.
- “MIN” : The lower limit mark for level of brake fluid.

The level of brake fluid shall be between the upper limit mark and lower limit mark.

If fluid level decreases significantly in a short time, it indicates that the brake system has leakage. You should stop immediately in the premise of ensuring safety, and contact the authorized dealer of BAIC Motor for maintenance of the brake system.

**Add brake fluid**

If fluid level is below the lower limit mark, the trip computer screen displays "Please fill brake fluid", and you must timely add brake fluid.

 **Warning**

- Do not mix brake fluids of different brands or types, and waste brake fluid may not be used, so as not to reduce braking performance and cause brake system fault.
- Brake fluid level must not exceed the "MAX" upper limit mark, so as not to result in paint corrosion, component pollution, and even cause a fire due to overflow.

**Replacement of brake fluid**







To ensure normal operation of the brake system, you shall change brake fluid in accordance with provisions of "Maintenance Information Sheet". Go to the authorized dealer of BAIC for brake fluid change.

 **Warning**

- Failure to replace the brake fluid in time as required may lead to malfunction of brake system and thus cause serious accident.
- If the brake fluid level is below the lower limit mark of the reservoir, do not drive the vehicle, in order to avoid accidents.
- If the brake fluid is left in the hydraulic system for many years without change, it will deteriorate, and air resistance will be produced in the brake pipe when braking, thus affecting braking performance and driving safety, and even causing complete failure of the brake system, causing an accident

## Battery

### Warning signs and instructions for handling of battery

|   |   |  |
|---|---|--|
| 1 |  | Open flames, sparks, high light and smoking are prohibited in workplace!   |
| 2 |  | When handling the battery, please wear the goggles!  |
| 3 |  | Children shall be kept away from electrolyte and battery!  |
| 4 |  | The battery electrolyte is a kind of highly corrosive substance. When handling the electrolyte, please wear the protective gloves and goggles! |
| 5 |  | Be sure to read the battery instruction before you start working!  |
| 6 |  | When the battery is being charged, the explosive gas mixture may be generated!   |

### Warning

- It is prohibited to let objects with sparks, flames or sparks get close to the battery.
- Never let the battery terminals shorted. Otherwise, high-energy electric spark generated by a short circuit may hurt the operator.
- Before operation of the battery, you should touch the body to eliminate any static electricity buildup, in order to avoid sparks to ignite highly explosive battery gas.
- The acid in battery strongly corrosive, so you should wear protective gloves and glasses. Don't upset the battery, otherwise the electrolyte may flow out from vent hole.

### Warning

- If the acid fluid is splashed into eyes, please immediately flush the eyes with fresh water for several minutes, and then immediately get medical treatment. If the acid fluid is splashed onto skin or clothes, please immediately use the wiping cloth to absorb it, and then immediately flush the skin or cloth with soapy water and fresh water. If the electrolyte is orally taken by mistake, please take medical treatment immediately.
- Please keep children away from acid liquor and battery.

### Environmental instructions



Battery contains pollutants. It is illegal to dispose the battery with household waste together. The battery must be collected separately and recycled in an environmentally friendly manner. Please dispose the battery in an environmentally friendly manner. Bring the exhausted battery power to the authorized dealer of BAIC authorized special waste battery recycling point.



**Inspect the battery.**

1. Check whether the battery is fixed well.
2. Check whether the battery positive and negative cable connectors are loose or corroded.
3. Check the battery positive and negative cable insulation for damage.
4. Keep the battery surface clean and dry, to prevent blocking the vent of the battery. Before long-distance traveling or after use of the battery for more than one year, you should go to the authorized dealer of BAIC to check battery power.

**Jumper start**

If you need to start the engine in jumper mode, see page 256 for jumper starting. If the engine still cannot be started in jumper mode or the battery cannot be charged, the battery should be replaced. Please contact the authorized dealer of BAIC for replacement of the battery.

**Battery charging**

If the vehicle is parked for a long time without use, or frequent starts, or often short travel short distances in cold environments, it can cause battery power loss, and you will be unable to start the vehicle. The battery needs to be charged additionally. Go to the authorized dealer of BAIC for charging



● **Do not charge the battery when it is not removed. Otherwise, it could seriously damage the electrical components of the vehicle.**

● **Do not attempt to charge the battery if the battery is frozen in cold environments, because there is the risk of explosion.**

**Protection in winter**

Since the starting power provided by the battery at low temperature is lower than that at normal temperature.

Therefore, before winter, you'd better go to the authorized dealer of BAIC Motor for inspection of the vehicle battery, and charge the battery or replace it if necessary.

In extremely cold weather conditions, battery charging will take longer. If the battery is insufficiently charged, the battery fluid will freeze and damage the battery. To ensure the effectiveness of the battery, you should check it regularly.

If the vehicle is parked for several weeks or longer in extremely cold environments, the vehicle battery should be removed and stored at room temperature to protect the battery from freeze damage.

**Vehicle is not used for a long time.**

When the vehicle is not used for more than a month, you should disconnect the negative battery cable, and charge the battery once a month.

If the vehicle is not used and the battery is not used for a long time, the battery will fail due to self-discharge.

**Replace Battery**

Before the operation, be sure to carefully read and comply with the safety instructions relating to handling of battery.



When replacing the battery, ensure the battery is installed correctly, and the terminal toward the middle of the vehicle and positive terminal facing forward. Ensure the battery tray and plate is properly fixed to prevent movement of the battery in an accident or emergency braking.

**Caution**

● When dismantling the battery, please disconnect the negative cable firstly, and then disconnect the positive cable. Before connecting the battery again, please turn off all electrical equipment on the vehicle. Firstly connect the positive cable, and then the negative cable.

**Warning**

● Replace only with battery of the same specification. When using battery of other specifications, they may be cannot installed in place or it is difficult to connect the battery cable due to terminal position, and may even lead to electrical component fault or damage.

● Removing and installing the battery requires a certain expertise and tools, because in some cases, it may damage the battery and fuse box. It is recommended to go to the authorized dealer of BAIC for replacement of battery.

### Add windshield washing fluid

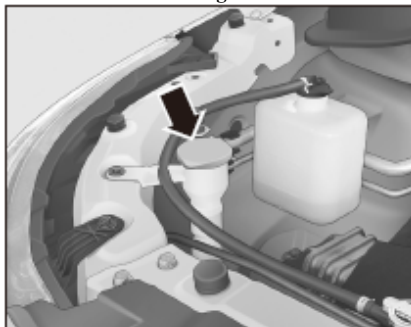

The washing fluid of the windshield washer is supplied by the washing fluid reservoir located in the engine compartment. When using windshield washer, the washer nozzle can only spray washing fluid intermittently, or does not spray the washing fluid, it indicates that the washing fluid may be lack. If it is found that the washing fluid level is too

low, you should add the washing fluid to the fluid reservoir. If windshield washing system still does not work when you add enough washing fluid, please contact the authorized dealer of BAIC for inspection. In order to obtain good washing effects, please use special washing fluid. You should fill the washing fluid slowly.

#### Caution

- You should promptly add special windshield washing fluid, avoid scraping in dry state. Otherwise, it will damage the wiper blade and easily scratch the windshield.
- When ambient temperature is below 0 °C , the washing fluid with the corresponding freezing ability should be used.

#### Warning

- Be sure to observe safety rules when working in the engine compartment.
- You shall not add coolant or any other additive to the windshield washing fluid. Otherwise, it will leave oil stain when cleaning the glass, which will seriously affect vision and cause an accident.
- Do not let dirt enter into the washing fluid, or it may clog or damage the washer nozzles.

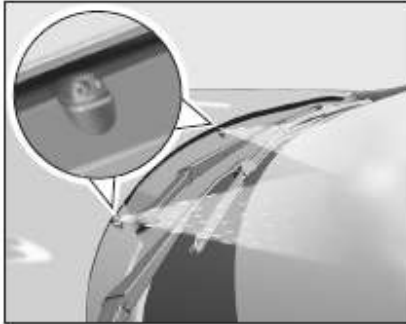
**Washer nozzle inspection**

Front windshield washer nozzle

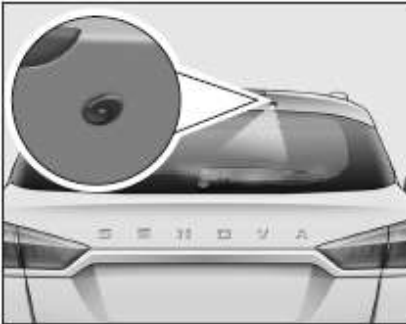

Rear windshield washer nozzle

If there is debris near the washer nozzle, please clean timely. Otherwise, it may affect the normal working of the windshield washer.

Turn the ignition switch to the "ON" position or keyless start/stop button is in the "RUN" mode, toggle the front wiper and washer combination switch to perform front and rear water spraying, and observe water pressure and ejection position. If the water pressure is too small or the injection position is not correct, please go to the authorized dealer of BAIC for repair.

**Windshield wiper blade inspection and cleaning**

Front windshield wiper



Rear windshield wiper



If any of windshield and wiper blades is contaminated, it will reduce the wiping effect. The main contamination sources are dust, sand, insects, tree soap and water wax used by washing machine. If the wiper blade is not wiping correctly, you should clean the windshield and wiper blades with high-quality cleaner or mild detergent, and then rinse with fresh water.

Steps for cleaning the wiper blade are as follows:

1. Lift up the wiper arm from windshield.
2. Hold the wiper arm.
3. Carefully wipe the dust and dirt on the wiper blade and the surface of the windshield with a soft cloth.
4. After cleaning, place the wiper arm gently back into place.

 Caution

● **In order to prevent horizontal stripes forming on the glass surface when wiping, the wiper blades should be cleaned regularly. To avoid damage to the wiper blade, do not clean it with gasoline, kerosene, paint thinner, or other similar solvents.**

● **If the windshield after wiping is still dirty, scrub the wiper blades with a sponge or cloth. If the situation is not improved, please replace the wiper blade.**

● **If the weather is cold, you should check whether the wiper blades are frozen every time you turn on the front windshield washer. You can only turn on the windshield washer in the case of no interference and obstacles.**

● **In hot summer or snow weather and the vehicle is not used for a long time, you can lift the wiper arm to slow down the aging of the wiper blade.**

**Replace windshield wiper blades. Wiper wiping noise may be caused by the following reasons:**

● Hard wax residues are consolidated on a windshield when washing the vehicle in an automatic vehicle washing equipment. This hard waxy residue can only be removed with a special cleaner.

● If the wiper blade is damage, it also may cause friction sound, and then you replace the wiper blade.

● There is dust or foreign material on external surface of windshield.

● The positioning angle of the wiper arm is not correct. In such case, please get the angle inspected and adjusted by the authorized dealer of BAIC Wiper blade must be checked regularly, and damaged wiper blade should be timely replaced. Otherwise, it may scratch the windshield.

 Caution

- Regularly clean the wiper blades and all window glass.
- Do not wipe without water in dry state, in order to avoid wear and damage of the adhesive tape and scratch of the windshield, thus affecting driving safety.
- Wiper blades should be replaced 1-2 times per year.

Front windshield wiper blade replacement method (with frame)

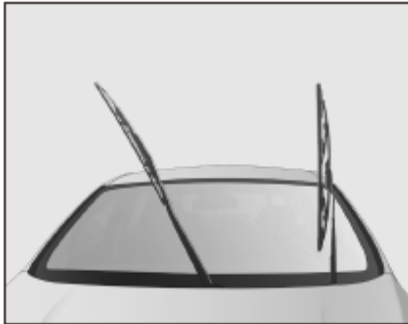

1. Lift up the wiper arm from windshield.

Place a thick towel in the lower part of the wiper arm to prevent damage to windshield because the wiper arm accidentally bounce back.

 Caution

- Before replacement of wiper blade is completed, do not turn on the power, to avoid damages to windshield and engine hood due to sudden movement of wipers.



2. Rotate the wiper blade, so that the angle between it and the wiper arm is about 90°.

3. Hold the wiper blade and remove it by moving slightly in the direction of the arrow.

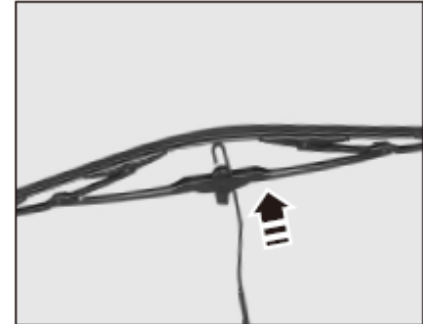

4. Replace with new wiper blade

5. Block the wiper blade wiper arm upward into the groove.

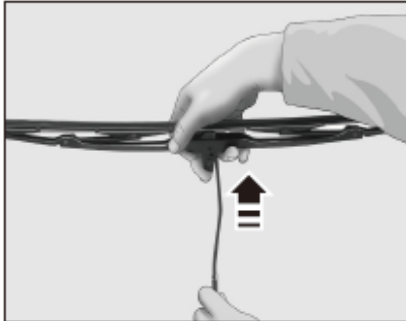

6. Pull up the wiper blade slightly in the direction of the arrow, and it indicates it is installed in place when you hear the "click" sound.
7. Check the wiper blade installation is reliable, remove the towel, place the wiper arm gently back into place.

#### Front windshield wiper blade replacement method (frameless)



1. Lift up the wiper arm from windshield. Place a thick towel in the lower part of the wiper arm to prevent damage to windshield because the wiper arm accidentally bounce back.

#### Caution

- Before replacement of wiper blade is completed, do not turn on the power, to avoid damages to windshield and engine hood due to sudden movement of wipers.

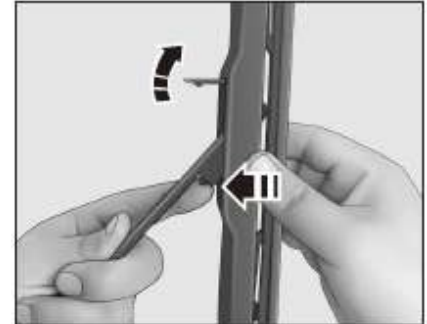

2. Rotate the wiper blade, so that the angle between it and the wiper arm is about 15°.
3. Gently toggle wiper blade locking snap and hold with the index finger.

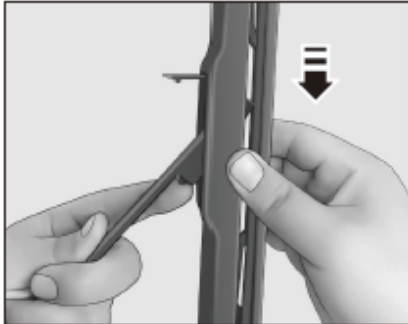

4. Hold the wiper blade and remove it by moving slightly in the direction of the arrow.

**Caution**

● After removing the wiper blade, you should be very careful, and place a thick towel in the lower part of the wiper arm to prevent damage to windshield because the wiper arm accidentally bounce back.

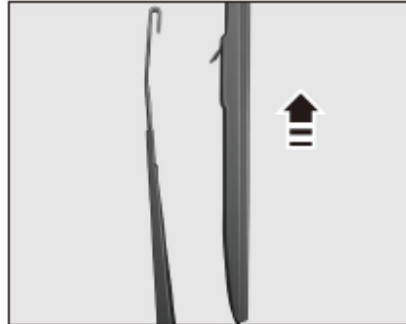

5. Replace with new wiper blade
6. Block the wiper blade wiper arm up ward into the groove and it indicates it is installed in place when you hear the "click" sound.
7. Check the wiper blade installation is reliable, remove the towel, place the wiper arm gently back into place.

### Rear windshield wiper blade replacement method



Wiper blades and wiper brush holder are replaced at the same time:

1. Lift the wiper arm away from the windshield, put a thick towel in the lower part of the wiper arm, to prevent accidental damage to the windshield due to wiper arm bouncing back.
2. Hold the wiper brush holder, rotate counterclockwise to the limit position, and then continue to rotate until you hear a "click" sound, then the wiper brush holder disengage from c the wiper arm.

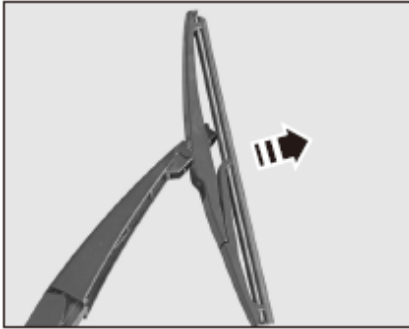

3. Pull the wiper brush holder out diagonally.

 **Caution**

● After removing the wiper holder, you should be very careful to prevent damage to windshield due to the wiper arm bounce back.

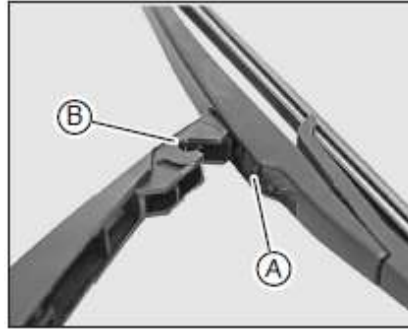

4. Replace the wiper brush holder.

5. Make the wiper brush holder boss A snap into the groove B of the wiper arm.

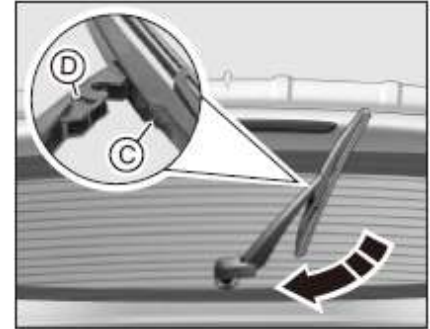

6. Rotate clockwise the wiper brush holder, so that the boss C snaps into the groove D of the wiper arm.

7. After installation, check whether the wiper holder is installed reliably. Remove the towel, and fold back the wiper arm on the windshield.

**Check on wheel**

Check the four tires before driving, and regularly check for bulge, scratches, abnormal wear, cracks and iron nail on the tread and sidewall. You should not drive if above phenomena exist, and contact the authorized dealer of BAIC for inspection and replacement.

Common causes for damage of tire:

- The tire collides or rubs with road shoulder;
- Drive quickly passing through pit on the road;
- Tire pressure is too low or too high.

**Potential fault of tires**

Some tire damage is difficult to detect. If abnormal vibration or deviation is found when the vehicle is traveling, one tire may have fault. You should go to the authorized dealer of BAIC Motor for tire inspection as soon as possible at this time.

 **Warning**

- **Road adhesion of new tires may not reach optimal state during the first 500km, so you should drive carefully at appropriate speed, and implement running-in of new tires to prevent accidents.**
- **Road adhesion of tires with worn tread wear mark may be insufficient, which will directly affect the braking efficiency, so these tires should be replaced.**

 **Warning**

- **You should not continue driving when tire bulge, cracks, and other phenomena exist. Because the tire may burst during driving, causing a traffic accident and injury.**
- **If the vehicle travels at high speed when the tire pressure is obviously insufficient, the tire will deform continuously, which can easily lead to overheating and tire burst.**
- **Avoid using tire of age more than six years; if you have to use it, then you must be very cautious when driving, and driving should be at low speed.**
- **Don't use any used wheel or used tire of which the source is unknown, because though there is no visible damage on such wheel or tire, may be it has been damaged, and when the vehicle is running, they may get the vehicle out of control and cause traffic accident.**

**Tire pressure.**

Suitable tire pressure can extend the life of the tire, while improving driving comfort, fuel economy, and handling stability.

When the tire pressure is too low, it will increase tire wear and will greatly affect the steering stability and fuel economy of the vehicle, and increases the risk of tire fault. Too high tire pressure may cause unsmooth running of vehicle and uneven wear of tire, so that the service life of tire will be shortened.

You should only check the tire pressure when the tire is cold. Cold tire means the vehicle is not driven at least for three hours or after the vehicle travels no more than 1.6km.

About cold tire pressure standard, see "Tire Information".

**Tire information**

Data label about tire information is pasted on the lower side of the C pillar of left wall panel, and you should inflate the tire in accordance with the specified the tire pressure on the data label.

When to check the tire pressure

When to check the tire pressure you should check the tire pressure (including the spare tire) at least once a week or before long-distance traveling, and spare tire pressure should be 4.2bar.

**Tire pressure inspection method**

You can check tire pressure with a tire gauge when the tire is cold.



1. Remove the valve cap from the tire valve, and check the tire valve with soap method for leakage.

**i Tips**

● You may add domestic detergent into fresh water, apply the solution to the valve inside, and observe whether there is any bubble generated. If there is bubble generated, it means that the air leaks.



2. Place the tire pressure gauge against the valve with force, and the gauge will show the tire pressure.

3. Check and adjust the tire pressure until it meets the standard value. See "Tire Information" on page 224 for standard tire pressure.

After the inspection is completed, be sure to mount the valve cap onto the valve inside. Valve cap can prevent dust and moisture from entering into the tire valve.

#### Tips

**After traveling for some time, the pressure in the tire should rise by 0.2 ~ 0.5bar. You check the tire pressure at this time. Never deflate tires in order to make measured tire pressure meet the standards. Otherwise, the tire pressure in cold state will be lower than the standard value.**

#### **Tire Pressure Monitoring System\***

The system consists of 4 tire pressure sensors and 1 tire pressure receiver. Sensors are installed in the 4 wheel hubs. Sensor exquisites tire pressure, temperature and other signals in real time, and sent information to the receiving device via a wireless transmitter. After decoding analysis, the current tire pressure, temperature values are displayed on the instrument cluster. (See "Tire Pressure Monitoring System\*" on page180).

#### **When shall the new tire be replaced?**



If any of the following circumstances occurs, please replace the tire with a new one

- The wear mark on tire has been worn.
- The cord yarn or cord fabric in tire is exposed.
- The thread or side of tire is cracked, and the crack is so deep that the cord yarn or cord fabric is visible.



- The tire is bulged or delaminated.
- The tire is punctured, scratched or otherwise damaged, and the damaged portion can't be repaired.

- Tire age reaches 6 years since the date of manufacture. (Including the spare tire)

There are wear marks on every genuine tire, which are located at the bottom of thread pattern and distributed along the circumference of tire. If the tread wears to wear mark, it means that the remaining tread thickness is less than 1.6mm, and you should replace the tire.

When hard belt appears on the full tire tread, continuous rubber trace will be left on the ground during emergency braking, when it passes throughout its tire width, it will be very dangerous.

#### Warning

● **Even if the tire is not used, it will age with the time. No matter how much the tire tread remains, the tire should be replaced after 6 years.**

● **Often traveling in hot environments or with overload will lead to accelerated aging of the tire due to overheating, tire life will be reduced, so you should more frequently inspect tires to prevent tire suddenly bursting, causing the accident.**

● **Mix using tires of different brands, with different structures (radial and bias belted tires), different sizes, and different treads will result in adverse effects on braking and handling performance, and may cause an accident.**

#### Purchase of new tire



Check the vehicle tire information label to know the tire type and size.

You must use tires of the same brand, specification, model, size, tread and conditions on the same axle.

#### Tips

**There are two kinds of tire specifications for this series of vehicles, which are based on real vehicles.**

### Single-guide tread tire

When installing single-guide tread tire, if the direction is reversed, the braking efficiency and driving safety of the vehicle will be seriously affected.



The installation direction of the single-guide tread tire can be identified by the direction indicated by the side arrow of the tire, and it contains the word "ROTATION". It must be ensured that wheels rotate in the direction indicated by the arrow as the vehicle moves forward.

The installation direction of single-guide tread tire cannot be reversed, and the replaced tire must have the correct specifications and be installed with full consideration of the axle/wheel rotation direction.

### Accidental burst handling

The vehicle uses a tubeless tire, so burst is not common during normal driving, and it will be rarer if tires are properly maintained. But in case of a burst, it is recommended to take the following countermeasures:

If one front tire bursts, the vehicle will deviate to the side under the dragging effect of the flat tire. You should immediately release the accelerator pedal, hold the steering wheel to control the steering, keep the vehicle in the original lane, and slightly depress the brake pedal to stop the vehicle in the emergency lane or safe location, and then replace with the spare wheel.

If one rear tire bursts during driving, the vehicle may have abnormal vibration and noise, but you can still control the steering. Release the accelerator pedal at this time, turn the steering wheel to the desired direction to drive the vehicle, in order to maintain control of the vehicle, and slightly depress the brake pedal to stop the vehicle in the emergency lane or safe location, and then replace with the spare wheel.

### Wheels inspection and transposition

The purpose of regular wheel transposition is to make all the tires are worn evenly, thus extending the overall life of tires. Implement wheel transposition after driving every about 10,000km. Before wheel transposition, you should check the tire and wheel for damages, and continue wheel transposition and wheel alignment if there is no damage.

#### Caution

- During wheel transposition, the front wheel should maintain a better state.
- If one tire is worn unevenly or excessively, you should go to the authorized dealer of BAIC Motor for wheel alignment.

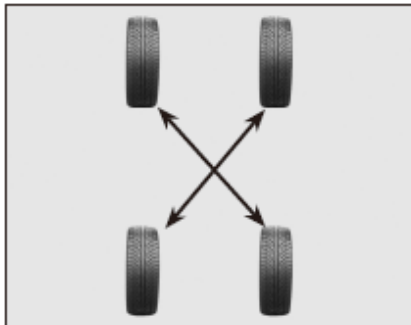

During wheel transposition, wheel transposition shall be carried out in diagonal manner. Spare wheel does not participate in transposition.

After transposition of rear wheels, ensure all the wheel bolts are tightened to the specified torque. And adjust pressure of all tires to the specified value.

After traveling 1000km, check the wheel bolts tightening situation again.

#### Caution

● **For models equipped with tire pressure monitoring system\*, after wheel transposition, you should go to the authorized dealer of BAIC Motor for tire pressure sensors re-adaptation. Otherwise, the position of the tire displayed on the trip computer screen will not correspond with reality.**

#### Warning

● **Dirt on the joint surface between wheel and brake disc may cause wheel bolts loosening, causing the wheel to fall off and traffic accidents . Therefore, when replacing the wheels, the corrosion or dirt on the joint surface between the wheel and the brake disc should be removed.**

#### Wheel balance

Wheel dynamic balancing has been carried out for the vehicle in the factory, but tire wear or loss of balance weight and other factors will affect the wheel balancing in the use course of the vehicle. Dynamic wheel imbalance can lead to wheel wobble and abnormal tire wear during operation, thus affecting vehicle stability. Therefore, Beijing should regularly check the vehicle dealership

#### Misalignment of wheels

Inaccurate wheel alignment can cause uneven tire wear, thereby reducing the vehicle's stability. If excessive or uneven tire wear is found, you should go to the authorized dealer of BAIC Motor for wheel alignment as soon as possible.

### Tire chain

Do not install tire chains without the approval by BAIC. Improper snow chains can damage vehicle tires, rims, brakes, and body. During use, pay attention to the following issues:

- Tire chains only can be installed on front wheels;
- Please observe the installation instruction of tire chains and speed limits for different road conditions;
- After installing tire chains, you should not exceed speed of 50km/h.
- To prevent wheels being damaged and tire chains being abraded severely, be sure to remove tire chains when traveling on road without snow.

### Replacement of rim

You should always check the condition of the rim. If the rim distorts, deforms, cracks, severe corrode or scratches, it should be replaced. If the wheel mounting bolts often become loose, you should replace the rim and wheel mounting bolts. If a flat tire is caused by rim damage, the rim should be replaced (except some repairable aluminum rims).



#### Warning

- **Use of an improper rim will affect the vehicle's braking and handling, and may cause the tire to disengage from the rim, resulting in loss of control of the vehicle and causing the accident.**
- **Use of rims not meeting specification will result in problems in bearing life, brake cooling, speedometer and odometer calibration, vehicle ground clearance, clearance between tires or tire chains and the body and chassis and other aspects.**
- **It will also be dangerous if the vehicle is installed with old rims.**  
Because you cannot know how the old rim had been used and how much mileage has it been used. Invisible cracks could lead to accidents when driving.

**Clean the exterior of the vehicle**

In order to maintain the appearance of the vehicle clean, correct and appropriate external cleanliness is very important.

Whenever possible, place the vehicle in the garage or in a covered place, in order to reduce the chances of damage to the paint surface of the vehicle.

If you must leave the vehicle in the outdoors, please park it in the shade or cover the vehicle with vehicle cover. You should not scratch the vehicle body paint when removing the vehicle cover.

**Wash the vehicle**

In the following cases, you should clean the vehicle to protect the body paint:

- After traveling in rain, acidic rain may cause damage to the paint surface.
- After traveling along the coast, sea erosion may cause the body to rust.
- When soot, bird droppings, tree oil, metal particles, or bodies of insects and other pollutants remain on the body surface, it may cause damage to the paint surface.
- When dust or mud blocks are left on the body surface, it may cause damage to the paint surface.

**Washing method:**

1. Wash the dirt on the vehicle with a wet sponge and plenty of water.
2. Clean thoroughly the vehicle with mixture of a special vehicle washing soap or general dishwashing detergent and warm water.
3. Wash the vehicle with enough water.

4. After washing the vehicle, wipe it again with a special cloth (suede), so as not to leave dry spots on the vehicle.

When cleaning the vehicle, pay attention to the following points:

- After passing the road with deicing salt, the seams, doors, windows, the engine hood and other parts of the vehicle are susceptible to corrosion by deicing salt. Therefore, these positions must be cleaned.
- Ensure the drainage holes underneath the door are smooth.
- When cleaning the vehicle, rinse the bottom of the vehicle and wheel fenders, in order to ensure that mud, salts, and other contaminants are washed.



**Caution**

- Do not wash the engine compartment with water, because it may cause fault of electrical lines, engines, and related components in the engine compartment.
- It is prohibited to contact electrical components and vents with water or other fluids, as this may damage the electrical components.
- Do not clean surfaces of the vehicle with harsh household soap, harsh chemical detergents, and other dissolving agents.

**Caution**

- Do not wash the vehicle when the vehicle body surface is very hot. Otherwise, water spots will form on the paint surface.
- Do not wipe the body with a hard towel or a piece of coarse cloth.

**Warning**

- Do not implement maintenance of vehicle with fuel, turpentine, engine oil, nail polish remover, or other volatile fluids, which are all toxic and flammable, and can easily lead to fires and explosions!

**Remove the stains**

You should remove oil stains, chemical pollutant, insect body, oil and fruit juice dripping from trees, etc., at the bottom of the vehicle or elsewhere, so as not to damage the body paint.

**Vehicles waxing**

Often vehicle waxing can protect the paint and helps to maintain the appearance of the vehicle. Polishing is required after using wax, in order to remove the wax remaining on body surface.

**Caution**

- Thoroughly clean the vehicle before waxing.
- You should not use wax containing abrasives, detergents, or mixture, which can damage the body paint.

**Wipe the glass outside the vehicle**

Clean the windshield, window glass, and rearview mirror with alcohol-based glass cleaner, and wipe glass surface dry with non-woven fabric or suede.

 **Caution**

- **When cleaning the dust on windshield surface, do not wipe the windshield directly with a dry cloth or duster, because the dust contains a large number of fine sand, which will leave scratches on the glass in the above described manner.**

**Vehicle bottom maintenance**

In winter, in regions with deicing salts used, you should clean the bottom of the vehicle timely, to prevent corrosion of the bottom of the vehicle and suspension system components due to accumulation of dirt or salt. In the winter or spring, you must check the vehicle bottom for corrosion and sealing conditions. If necessary, please contact the authorized dealer of BAIC Motor for repairs.

**Clean the aluminum alloy rim**

Aluminum alloy wheels should be cleaned regularly, particularly when used on road with deicing salt in freezing winter. If wheels are stained with salt, it will corrode aluminum rim and make it fade.

 **Caution**

- **Do not clean the wheel with cleaners containing acid or alkali component, in order to avoid corrosion of the aluminum alloy rims.**
- **After using detergents, rinse the wheel within 15 minutes to wash the detergent completely, so as not to leave marks on the aluminum rims.**

**Wheels**

- When washing the vehicle, you should clean the inside of the wheel.
- When cleaning the wheels, do not use abrasive cleaners.
- Regularly check whether the rim flange for deformation or erosion. Deformation or corrosion may cause leakage or damage to the tire edge.
- Timely remove the stone tablets embedded in the tire tread, so as not to affect tire performance.
- It is recommended to wax the wheels, to reduce erosion to the wheel by soil.

**Clean the chrome plated parts.**

It is recommended to wash the plated parts with chrome polishing agent not containing abrasive, in order to keep bright.

**Wipe the glass inside the vehicle**

When wiping the glass in vehicle, do not use tools with a blade or wipe with chlorinated disinfectant, which will damage the rear windshield defogger wire.

During vehicle glass fogging in winter, right amount of dedicated glass anti-fog agent can be sprayed to prevent fogging.

**Seat belt**

Seat belt webbing can be washed with sponge moistened with neutral detergent.

After cleaning, the seat belt webbing should be completely dry before use. You should not withdraw the wet webbing directly within the retractor, to avoid damage to the retractor.

Do not wash the seat belt webbing with bleach, dye, and chemical solvents.

Otherwise, it will seriously damage the webbing.

**Foot mat**

Whatever foot pad is used, you should confirm it is suitable to the vehicle, and it is reliably and properly fixed, so as not to interfere with the pedal.

**Warning**

● **If you use non-fixed foot pad, after sliding it may hinder the operation of the brake pedal and the accelerator pedal, causing serious accidents.**



**Ensure vehicle be free of corrosion.**

- Regularly clean and wax the vehicle to keep it clean.
- Always check whether there is minor paint damage and make repairs as soon as possible.
- Check the vehicle bottom for accumulation of sand, dirt, or salt, and wash with water as soon as possible if so.

 **Caution**

- **It is prohibited to remove dirt, sand or other debris by washing the passenger compartment with water, but rather with a vacuum cleaner or broom.**
- **Do not allow water or other liquids to contact with the electrical components inside the vehicle. Otherwise, it will damage the electrical components.**

Anti-freezing agent and snow-melting agent used on road are corrosive, and they will accelerate corrosion and aging of underbody parts such as the exhaust system, parking brake cable, brake pipelines, bottom plate and the fenders.

Therefore, after traveling on such roads, you should clean the bottom of the vehicle timely.

Other rust-proof and anticorrosion measures may have special requirements in some regions, please consult with the authorized dealer of BAIC Motor.

**Most common factors for vehicle Corrosion**

- Moist dirt or debris accumulates in the body sheet metal cavity or other parts.
- Sand and small stones or small accidents cause damages to paint surface or other protective layer.

## Recycling and Environmental Protection

### Material recovery

#### Plastic

Plastic and rubber parts are marked in accordance with current regulations. In order to facilitate recycling, the range of materials used has been limited: most plastics are recyclable thermoplastic materials by melting, granulating and crushing.

#### Metal

100% recyclable.

#### Glass

It can be disassembled and centralized by the glass manufacturer for processing.

#### Rubber

Tires and seals can be used as waterproof rolls, rubber runways etc after being crushed.

### Environmental Protection

The car can be entrusted to BAIC Motor for maintenance, which can control various pollution hazards and make you contribute to environmental protection.

#### Scrapped or damaged parts

It can't be discarded casually. BAIC Motor has measures to recycle and protect the environment.

#### Waste oil

BAIC Motor is responsible for collecting and processing, commissioning them to replace and control various pollution hazards.

#### Waste storage batteries and batteries

Do not throw away batteries and remote control batteries at will. They are harmful to the environment. Please send them to recognized collection points.

## 5. Emergency treatment

|   |     |
|---|-----|
| Warning triangle .....                                      | 246 |
| Spare tire and tool kit .....                               | 247 |
| Spare tire .....  | 247 |
| Tool kit .....  | 248 |
| Replacement of fuse .....                                   | 254 |
| Fuse box in engine compartment .....                        | 256 |
| Specification and function of engine compartment fuse ..... | 256 |
| Instrument panel fuse box .....                             | 258 |
| Specification and function of instrument panel fuse .....   | 258 |
| Replacement of bulb .....                                   | 260 |
| Jumper start .....  | 261 |
| Emergency towing .....                                      | 264 |
| Emergency towing .....                                      | 264 |

Storage location of warning triangular



Warning triangular is placed on the lower left ① of the trunk carpet. Lift the trunk carpet drawstring, and lift the carpet open, then you can see it.

Deployment and placing of warning triangular

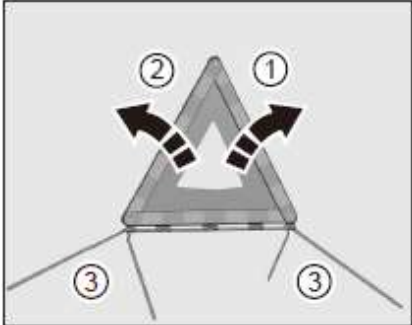

Pull open the two folded edges ① and ② of the warning triangle and lock the locking opening at the top. Pull open the four brackets ③ at the bottom, place it in rear of the vehicle, and make the reflective surface of the warning triangle facing the rear. Fold it in reverse order and put it away after use. When folding, place the force applying point in the upper region of the two reflectors on both sides. Break off with right hand slightly to the outside, so you can easily separate the two reflectors to avoid damage.

Placing distance of warning triangular

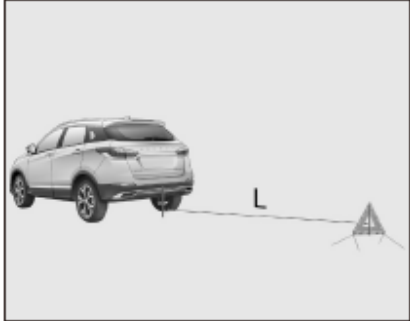

|                    |                 |            |
|--------------------|-----------------|------------|
|                    | General highway | Expressway |
| Placing distance L | 50-100m         | ≥150m      |

1 Tips

● Here is just a reference number, please place the warning triangle according to traffic regulations.

## Spare tire



Spare wheel is under the trunk carpet, please take it out in the following steps:

1. Open the trunk lid.
2. Lift up the trunk carpet drawstring.

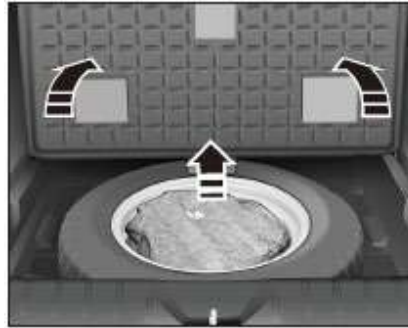

3. Fully lift up the trunk carpet and remove the vehicle tool kit.



4. Unscrew the special fixing screw in the center of the spare wheel with hand counterclockwise, and remove the spare wheel.

## Tool kit

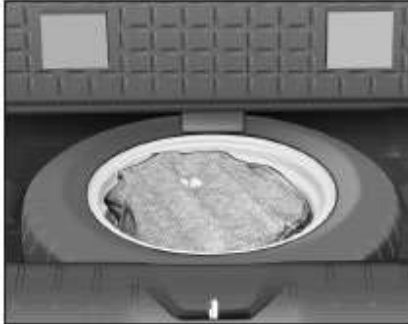

The vehicle is equipped with vehicle kit placed in the spare wheel rim, and you can see the carpet lifting luggage.

### Tips

- After using vehicle tools, put them away, so as to avoid abnormal sound and easy to use next time.

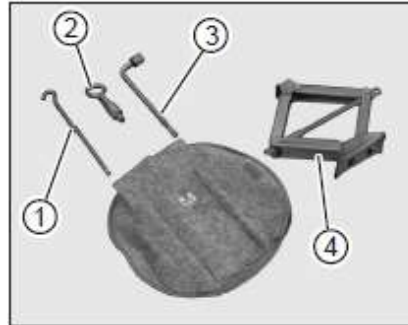

Open the vehicle tool kit, tools that can be used are as follows:

- 1 Jack operating handle;
- 2 Removable traction ring;
- 3 Wheel dismantling wrench;
- 4 Jack

### Reflective Vest

The glove box is equipped with a reflective vest, which can be used by drivers when dealing with vehicle failures at night or under low visibility conditions, in order to improve the driver's recognition under the vehicle.

### Warning

- The improper use of jack may cause serious injury.
- Please only use the jack on hard and flat ground.
- The jack may only be used for replacement of wheel. The jack may not be used to lift up any other heavy article or vehicle.
- When using the jack, don't start up the engine, otherwise accident may occur.
- When using the jack to lift up the vehicle, be sure not to place any portion of your body under the vehicle, otherwise accident may occur.
- If it is necessary to carry out operation under the vehicle, be sure to place the appropriate support under the vehicle.

 Caution

- Spare wheel rim sizes and tire sizes may be different from those of the damaged wheels. After installing the spare wheel, the vehicle controllability will change. Please reasonably control the vehicle speed, avoid sharp acceleration and emergency braking.
- Spare wheel can only be used in short term. Don't let the vehicle speed exceed 80km/h.
- Do not use 2 or more spare wheels when traveling.

## Preparatory work

If the tire burst, puncture, bulge, leakage, and other phenomena exist, you should drive slowly to a flat place where safe operation can be carried out to replace the spare wheel, to avoid further damage to tires and rims. Turn on the hazard warning light at the same time and place the warning triangle in a predetermined distance behind the vehicle.

 Warning

It is dangerous to replace the wheel. The vehicle may slide down from the jack, overturn, and hold the operator or others down, causing serious injury or death. Replace the wheel in a safe flat place. Please strictly comply with the relevant regulations. All occupants shall leave the vehicle and wait in a safe place.

In order to prevent the vehicle from moving, please take the following measures:

- Pull up the parking brake to apply parking brake.
- Place the shift lever to gear "P". (Models with CVT transmission)
- Shut down the engine, and do not start the engine during vehicle lifting process.
- Do not allow any person to leave in the vehicle.

## Remove the wheel with fault



1. Place appropriate stoppers in front and rear of the wheel which is in diagonal to the wheel with fault, to prevent vehicle movement when jacked up.



2. Place the jack at correct support point. Make sure that the jack is positioned on flat and solid ground.



3. Rotate the jack screw so that jack head notch blocks the body supporting point, but do not jack up the vehicle.  
4. Place the spare wheel below the wheel on side of the wheel with fault, in order to play a role in safety precautions.



5. Loosen the fixing bolts of the wheel with fault by 1-2 turns counter clock wise with the wheel dismantling wrench.<sup>5</sup>

#### Tips

- You must fully loosen the bolts of the wheel with fault before jacking up the vehicle.
- Do not remove the wheel mounting bolts before the wheel leaves the ground.





6. Rotate clockwise the jack and lift up the vehicle with the jack handle and wheel dismantling wrench until the wheel with fault leaves the ground.

7. Remove the wheel mounting bolts, remove the wheel with fault, and place the wheel with fault in the appropriate position below the vehicle with the outer surface upward, and replace the spare wheel.

#### Caution

● When the vehicle is traveling, the heat generated by the brake system can cause wheel mounting bolts hot, so you should be careful not to be burned when dismantling the wheels.

#### Warning

- Strictly comply with the notices for operation of jack.
- Do not jack up the vehicle at the position other than a predetermined support point.
- Do not place a pad above or below the jack.
- Do not use any jack not equipped with the vehicle.
- Never jack up the vehicle too high.
- In the course of lifting, please continuously observe the conditions of vehicle. If you find that the vehicle is obviously tilted or acts abnormally, please stop the lifting operation, identify and eliminate the problem, and then carry out the operation again.

#### Install the spare wheel.

#### Warning

- It is prohibited to use the spare wheel with damage or reaching wear limit. Try to avoid using tires more than 6 years.
- After installing the spare wheel, tire pressure should be checked and adjusted to within a predetermined range.
- Spare wheel is only used in emergency situations, so you should drive carefully at speed less 80km/h when spare wheel is used, and avoid sharp acceleration and emergency braking.

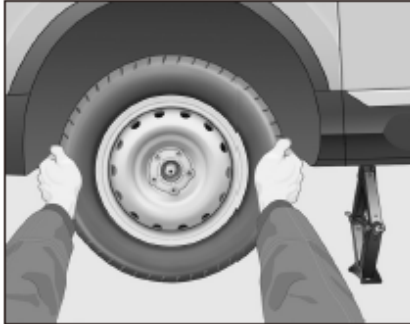

1. Align the installation holes on spare wheel with the installation holes on brake disc.

 **Caution**

● **Before installing the spare wheel, the mud and dirt between the wheel and the brake disc fit surfaces shall be cleaned.**

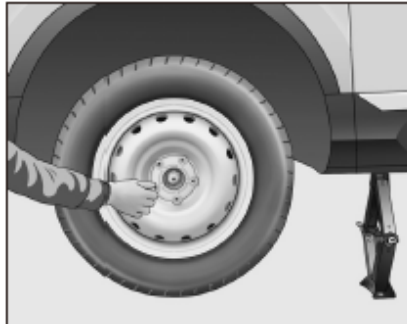

2. Mount all wheel fixing bolts, first tighten them with hand as far as possible, and then push the wheel inward, and then see if you can tighten them further, to confirm wheels are fully fixed.

3. Rotate jack handle counter-clockwise, and lower the vehicle.



4. Tighten the wheel fixing bolts clockwise with the wheel bolt wrench, do not use any other tool, such as a hammer and a pipe barrel, and ensure that the wrench completely entangle the bolt.

5. Tighten the wheel fixing bolts in the diagonal sequence as shown in ① to ⑤. The predetermined torque is  $110 \pm 5 \text{ N} \cdot \text{m}$

 Warning

- Please keep the wheel bolts and the thread on rim clean, and make sure that they are free of oil stain.
- Please correctly tighten up the wheel bolts in accordance with the specified tightening torque, otherwise when the vehicle is running, the bolts may get loosened and thus traffic accident may occur.
- Tighten the wheel bolts with the wheel bolt dismantling wrench provided with the vehicle, but you cannot confirm the torque. Reasonably control the traveling speed, avoid sharp acceleration and emergency braking, and go to the authorized dealer of BAIC Motor as soon as possible to check and ensure the predetermined torque is reached.

 Caution

- When changing wheels, if bolts have corrosion or hard to be unscrewed, then you must replace the bolts and clean the threaded holes when checking the tightening torque.
- After installing the spare wheel, you should go to the authorized dealer of BAIC Motor for repair as soon as possible, after the wheel with fault is repaired, the spare wheel should be immediately replaced.

 Tips

- After replacing the spare wheel for a period of time, the tire pressure monitoring alarm lamp in the combined instrument will light up, accompanied by a period of sound reminder and fault information prompt (7 inch meter), which is a normal phenomenon. After repairing and replacing the faulty wheels, the tire pressure monitoring alarm lights will be automatically extinguished after a period of driving.

**Tools and parts are put away.**

- The dismantled wheel with fault should be promptly and correctly placed at the position for spare wheel.
- After being used, the tool kit shall be cleaned in time and then placed in their original position.
- After replacing the wheel, do not forget to take the warning triangular.

### Instrument panel fuse box



The instrument panel fuse box is located in the lower left side of the instrument panel, and you can see it by removing the instrument panel fuse box cover ① .

### Fuse box in engine compartment

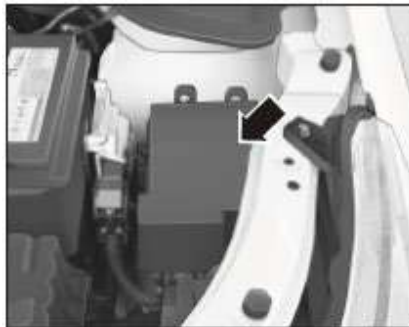

Engine compartment fuse box is in the left side of the engine compartment.

### Check or replace fuse

If any electrical equipment does not work, firstly inspect whether it is caused by damage of fuse. You can determine which one or several fuses control the component in accordance with the chart. (Please refer to the “Engine compartment fuse box” on Page 256) and (Please refer to the “Instrument panel fuse box” on Page 258).

Before determining whether the damaged fuse is the fault reason, replace all the fuses with fault and check whether electrical equipment can work properly.

If the fault persists, please contact the authorized dealer of BAIC Motor for repair.

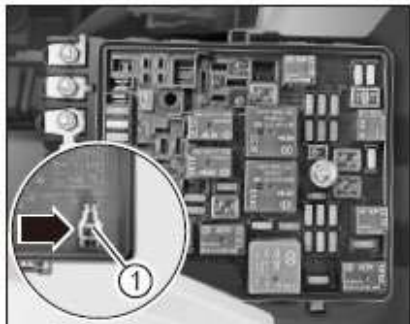

Open the engine compartment fuse box cover, you can see the fuse, and pull the fuse out with the fuse puller ①

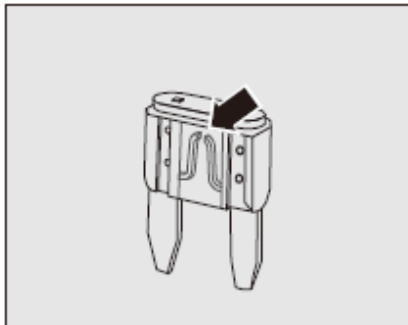

Unplug the fuse corresponding to the electrical equipment not working and check it. Check whether the fuse wire is blown. If it has blown (the fuse indicated by the arrow has disconnection phenomenon), and replace it with spare fuse of the same or lower amperage. If the fuse with the same rating blows in a short time again, it indicates that the vehicle may have a serious electrical fault. It is prohibited to use the faulty electrical equipment, leave the blown fuse in the fuse box, and contact the authorized dealer of BAIC Motor for repair.

#### Tips

● If there is no spare fuse can be replaced with and the vehicle cannot move, you can remove a fuse with equal or lower amperage from other circuit. But you ensure the electrical equipment is not temporarily used, and it will not affect driving, such as the cigarette lighter or the radio.

#### Caution

● If you replace the blown fuse with a spare fuse with lower amperage and the fault is eliminated, you should also replace it with fuse of the correct rating as soon as possible.

Fuse box in engine compartment

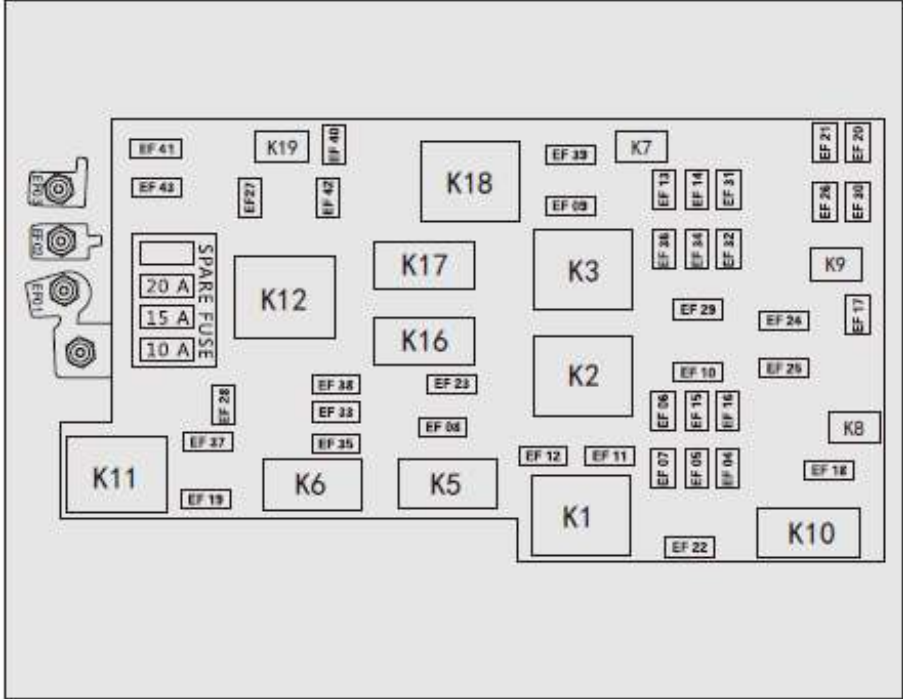

Specification and function of engine compartment fuse

| Number | Specifications | Control object           |
|--------|----------------|--------------------------|
| EF01   | 150A           | Generator                |
| EF02   | 60A            | Electric power steering  |
| EF03   | 80A            | IEC Power 1              |
| EF04   | 10A            | Engine management system |
| EF05   | 15A            | Ignition coil            |
| EF06   | 15A            | Fuel injector            |
| EF07   | 10A            | Engine sensor            |
| EF08   | 30A            | Low-speed fan            |
| EF09   | 40A            | High-speed fan           |
| EF10   | 7.5A           | A/C compressor           |
| EF11   | 15A            | Fuel pump                |
| EF12   | 20A            | Electronic vacuum pump   |
| EF13   | 10A            | Left high beam lamp      |
| EF14   | 10A            | Left high beam lamp      |
| EF15   | 10A            | Left low beam lamp       |
| EF16   | 10A            | Right low beam lamp      |
| EF17   | 30A            | EPB Calipers left motor  |
| EF18   | 30A            | EPB Calipers right motor |
| EF19   | 30A            | Start                    |
| EF20   | 15A            | Horn                     |
| EF21   | 15A            | Front washer             |
| EF22   | 15A            | Rear washer              |

| Number | Specifications | Control object            |
|--------|----------------|---------------------------|
| EF23   | 20A            | Wiper                     |
| EF24   | 30A            | IEC Power supply 2        |
| EF25   | 40A            | ESP/ABS motor             |
| EF26   | 25A            | Anti-lock valve           |
| EF27   | 30A            | Left window               |
| EF28   | 30A            | Right window              |
| EF29   | 20A            | BCM lamp 1                |
| EF30   | 20A            | BCM lamp 2                |
| EF31   | 10A            | Engine management system  |
| EF32   | 10A            | Transmission control unit |
| EF33   | 10A            | Battery sensor            |
| EF34   | 20A            | BCM Lock                  |
| EF35   | 10A            | BCM logic power supply    |
| EF36   | 10A            | Brake lamp                |
| EF37   | 5A             | EMS start feedback        |
| EF38   | 5A             | EMS feedback              |
| EF39   | 40A            | Standby                   |
| EF40   | 60A            | Standby                   |
| EF41   | 30A            | Standby                   |
| EF42   | 15A            | Standby                   |
| EF43   | 10A            | Standby                   |
| K1     | 40A            | Main relay                |

| Number | Specifications | Control object                      |
|--------|----------------|-------------------------------------|
| K2     | 70A            | Low speed fan                       |
| K3     | 70A            | High speed fan                      |
| K4     | 15A            | A/C compressor solenoid valve relay |
| K5     | 30A            | Fuel pump                           |
| K6     | 30A            | Electronic vacuum pump              |
| K7     | 20A            | High beam lamp                      |
| K8     | 20A            | Low beam lamp                       |
| K9     | -              | Standby                             |
| K10    | 30A            | Standby                             |
| K11    | 40A            | Star                                |
| K12    | 40A            | Start control, start and stop       |
| K13    | 25A            | Horn                                |
| K14    | 25A            | Front washer                        |
| K15    | 25A            | Rear washer                         |
| K16    | 30A            | Front wiper 1                       |
| K17    | 30A            | Front wiper 2                       |
| K18    | 70A            | Standby                             |
| K19    | 20A            | Standby                             |



## Warning

● Use of an improper fuse may cause a fire or casualties.



## Caution

● Turn off the ignition switch and all electrical switches before replacing the fuse.

● Do not remove the fuse with a screwdriver or other metal object, because this can cause a short circuit and electrical system fault.

## Instrument panel fuse box

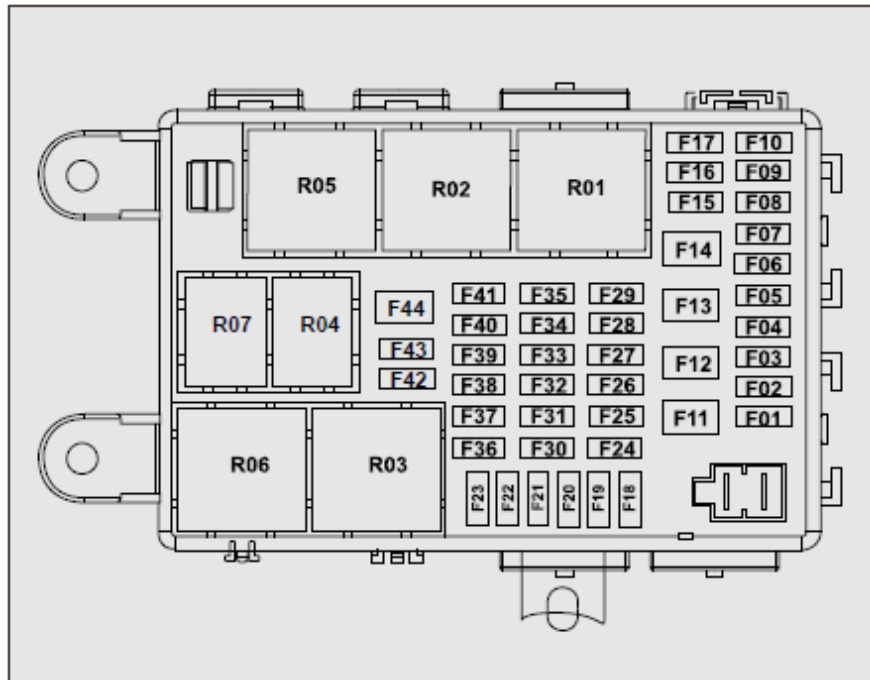

## Specification and function of instrument panel fuse

| Number | Specifications | Control object                               |
|--------|----------------|--|
| F01    | 7.5A           | OBD Power supply                             |
| F02    | 10A            | Instrument                                   |
| F03    | 15A            | Audio Power supply                           |
| F04    | 10A            | HVAC Power supply                            |
| F05    | 30A            | Ignition key power supply2                   |
| F06    | 15A            | T-BOX Power supply                           |
| F07    | 10A            | PEPS Power supply 1                          |
| F08    | 7.5A           | Panoramic Camera System                      |
| F09    | -              | Standby                                      |
| F10    | 7.5A           | Blower feedback                              |
| F11    | 30A            | Ignition key power supply 1                  |
| F12    | 30A            | Blower motor                                 |
| F13    | 30A            | Power seat power supply                      |
| F14    | 30A            | EPB Left power supply                        |
| F15    | 20A            | Sunroof module power supply                  |
| F16    | 10A            | PEPS working power supply 2                  |
| F17    | -              | Standby                                      |
| F18    | 15A            | Electronic steering column lock power supply |
| F19    | 30A            | EPB right power supply                       |



| Number | Specifications | Control object   |
|--------|----------------|--|
| F20    | -              | Standby  |
| F21    | -              | Standby  |
| F22    | -              | Standby  |
| F23    | -              | Standby  |
| F24    | 7.5A           | Vehicle internal temperature sensor/defrost relay/QCM power supply |
| F25    | 7.5A           | Reversing light/sunroof  |
| F26    | 5A             | BCM/PEPS energy-saving power supply                                |
| F27    | 7.5A           | A/C control/ A/C panel   |
| F28    | -              | Standby  |
| F29    | -              | Standby  |
| F30    | 7.5A           | EMS wake-up power supply   |
| F31    | 7.5A           | TCU/ESP/ABS power supply   |
| F32    | 10A            | BCM/EPS wake-up power supply                                       |
| F33    | 7.5A           | Airbag power supply  |
| F34    | 7.5A           | Tire pressure module/reversing radar power supply                  |
| F35    | 7.5A           | Rain sensor/A/C /PEPS Power supply                                 |
| F36    | 10A            | Exterior electric rearview mirrors switching power supply          |
| F37    | 15A            | 12V power supply   |

| Number | Specifications | Control object                               |
|--------|----------------|--|
| F38    | 15A            | Power supply of cigarette lighter            |
| F39    | 10A            | T BOX/Audio/BCM energy-saving power supply   |
| F40    | 5A             | PEPS feedback power supply                   |
| F41    | -              | Standby                                      |
| F42    | 30A            | Rear defrost                                 |
| F43    | 7.5A           | Heating of electric exterior rearview mirror |
| F44    | 30A            | Standby                                      |
| R01    | 40A            | IG1 relay                                    |
| R02    | 40A            | ACC relay                                    |
| R03    | 40A            | Defrost relay                                |
| R04    | 30A            | IG2 relay                                    |
| R05    | 40A            | Blower high-speed relay                      |
| R06    | 40A            | Air conditioning blower relay                |
| R07    | -              | Standby                                      |



## Warning

● Use of an improper fuse may cause a fire or casualties.



## Tips

● For different models, the fuse may be slightly different, please check the real vehicle.

● It is likely that an electrical device is equipped with several fuses, and it is also likely that some electrical devices share a fuse.

### Replacement of light bulb

Turn signal lamps, brake lights, headlights are related to traffic safety. Check the vehicle lighting before driving each time.

Usually you need to remove other related parts when replacing the bulbs, and some bulbs need to be replaced in the engine compartment. Such situation is complex and requires specialized skills and tools, and we recommend you go to the authorized dealer of BAIC Motor for replacement of the bulbs.

#### Caution

- The bulb may be hot when it just goes out, you should replace it after waiting for the lamp cooling.
- Do not touch the bulb with bare hands, and wrap it with lint-free cloth, so as not to affect the lighting effects.

### Specification of bulbs

| Headlight name            | Model     | Specifications     | Quantity                       | Light color |
|---------------------------|-----------|--------------------|--------------------------------|-------------|
| Front turn signal lamp    | PY21W LED | 21W/12V<br>12W/12V | Each one on the left and right | Amber       |
| Front position lamp       | LED       | 18W/12V            | Each one on the left and right | White       |
| Daytime running lamp      | LED       | 4.5W/12V           | Each one on the left and right | White       |
| Low beam lamp             | LED       | 27W/12V<br>23W/12V | Each one on the left and right | White       |
| High beam lamp            | LED       | 30W/12V<br>34W/12V | Each one on the left and right | White       |
| Brake lamp                | LED       | 3W/12V             | Each one on the left and right | Red         |
| Rear position lamp        | LED       | 4.5W/12V           | Each one on the left and right | Red         |
| Rear turn signal lamp     | LED       | 7W/12V             | Each one on the left and right | Amber       |
| Reversing lamp            | W16W      | 16W/12V            | Each one on the left and right | White       |
| High mounted brake lamp   | LED       | 2W/12V             | 1                              | Red         |
| License plate lamp        | W5W       | 5W/12V             | Each one on the left and right | White       |
| Rear fog lamp             | P21W      | 42W/12V            | Each one on the left and right | Red         |
| Front interior dome light | C5W C10W  | 5W/12V 10W/12V     | 2<br>3                         | White       |
| Trunk lamp                | C5W       | 5W/12V             | 1                              | White       |

**Jumper start**

If the engine can't be started up owing to the fact that the battery has discharged electricity excessively, please start up the engine by connecting the battery on another vehicle with the jumper cable. In such case, please pay attention to the following notices:

- Rated voltage of the battery must be 12V or more, and the capacity (Ah) should not be less than the battery with fault.
- Use only jumper cables with sufficiently large cross-section.
- Only use the jumper cable equipped with insulated electrode holder.

**Warning**

- **Don't charge the battery which has been frozen - Danger of explosion! Even for the unfrozen battery, in the course of charging, battery electrolyte may also overflow and cause corrosion. The frozen battery must be replaced.**
- **There may be explosive hydrogen in the vicinity of the battery. The battery must stay away from sparks and open flames.**
- **In jump state, the two vehicles may not touch with each other. Otherwise, once the positive poles of two batteries are connected, the circuit will be closed immediately, and thus danger may occur.**

**Caution**

- **Before carrying out any operation relating to battery, be sure to carefully read and comply with the safety instructions relating to handling of battery.**

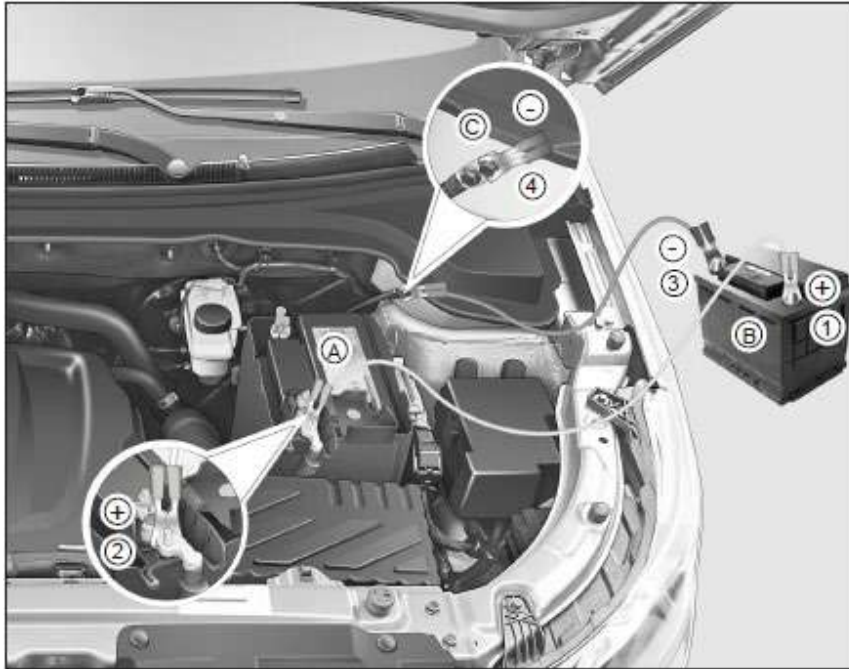

When connecting the jumper cable, firstly connect the positive terminal, and then connect the negative terminal.

A: Battery of fault vehicle

B: Battery of rescue vehicle

C: Ground of vehicle with fault

1. If the battery of the rescue vehicle is far away from the battery of fault vehicle, park the two vehicles so that the two batteries are closer to each other.

2. Pull up the parking brake to apply parking brake.

3. For Models with CVT transmission, place the shift lever to the gear "P" (parking gear).

4. Turn off all electrical devices (such as lights, heaters, refrigeration, etc.).

5. Turn the ignition switch to the

→ 2 . Connect carefully not to cause a short circuit.

8. Connect the black negative jumper cable, as shown in the figure 3 → 4 . Connect carefully not to cause a short circuit.

9. Start the engine of the rescue vehicle, and let it run for a few minutes.

10. Depress the accelerator pedal of the rescue vehicle, so that the rescue vehicle engine speed is maintained at about 2000r/min.

11. Start the engine of the fault vehicle in the normal way.

12. After the fault vehicle engine starts, carefully disengage jumper cables in the reverse order of connection.

13. Appropriately dispose the dry towel, because it may be contaminated by corrosive acid solution.

#### Caution

- When connecting or removing jumper cables, first fully connect or disconnect a jumper cable, then the other jumper cable, never cause a short circuit.
- When removing the jumper cables, first let the fault vehicle engine idle, to prevent stalling.
- When dismantling the jumper cable, please turn on the blower or rear windshield heater on electricity-shortage vehicle, so as to reduce the peak value of voltage generated in the course of dismantlement of cable.

#### Warning

- The improper use of jumper cable may cause explosion of battery and serious injury.
- The engine compartment is a highly dangerous area, and improper operation may cause injury/death accident.
- Be sure not to directly connect the negative jumper cable to the negative pole of faulty battery, otherwise the spark generated at the moment when the cable is connected may ignite the flammable gas generated by battery and thus cause explosion.
- Be sure not to connect the negative jumper cable to any component of fuel system or brake pipeline, otherwise fire may occur.
- In the course of operation, be sure not to bend over to face the battery, otherwise you may be burnt by electrolyte.
- Do not allow open flame get close to the battery. Otherwise, it will lead to an explosion.

## Emergency towing

When you need to tow the vehicle, you must comply with traffic regulations. Improper towing equipment can damage the vehicle. To ensure correct towing method and protect vehicle against accidental damage, it is recommended to find a professional roadside assistance personnel to tow the vehicle. In preparation for towing, the driver and rescue personnel should observe the following precautions:

- Before towing, ensure that transmission, steering and transmission systems are in working status. If the systems are damaged, it is necessary to load the vehicle with a plate rescue vehicle or lift the front wheels for traction.
- The driving (front) wheels of models with CVT transmission must get off the ground while being towed.

### Front towing of the vehicle



#### Installation of front towing ring

1. Take the wheel dismantling wrench and removable towing ring from the tool kit in the trunk.
2. Press the bottom right corner of towing ring mounting hole cover on the front bumper (shown by the arrow part) to open.



3. Screw the traction ring clockwise completely into the mounting hole of the towing ring.



4. Tighten the towing ring securely with wheel dismantling wrench.

#### Rear towing of the vehicle



#### Installation of rear traction ring

1. Take the wheel dismantling wrench and removable towing ring from the tool kit in the trunk.
2. Press the bottom right corner of towing ring mounting hole cover on the rear bumper (as shown by the arrow) to open it.



3. Screw the traction ring clockwise completely into the mounting hole of the towing ring.



4. Tighten the towing ring securely with wheel dismantling wrench.

 Warning

- The inexperienced driver may not tow any other vehicle, otherwise accident may occur.
- When towing the vehicle, be sure to carry out operation under the instruction of professional personnel, otherwise unnecessary injury may occur.

 Caution

- The hazard warning lamps of the towed vehicle must be turned on, and you should obey traffic laws.
- When towing the vehicle with wire rope, metal chain, or metal bar, it may cause damage to the body, and it is recommended to use a dedicated towing rope.
- Maintain the towing rope on the same straight traveling line with the front and rear vehicles. If the vehicle is towed not in straight, it may damage the body.
- Please ensure that towing rope is always in the tense state.



**Vehicle towing**

If the vehicle needs rescue, it is recommended to find the authorized dealer of BAIC Motor or professional rescue vehicle roadside assistance company. When contacting them, you shall tell them the transmission form, and whether steering, braking, drive systems can work, in order to use the appropriate towing way.

When towing vehicle, using proper towing equipment will prevent vehicle from damage. Professional vehicle roadside assistance company personnel are familiar with the traffic laws, so you can seek help from them!

**Use a plate rescue vehicle to rescue.**

The best towing way is to load and fix the fault vehicle to the rescue vehicle. When the vehicle in accident needs towing, this way should be adopted in priority.

**Caution**

- After loading the fault vehicle to the rescue vehicle, pull up the parking brake of the fault vehicle and fix the four wheels to prevent the fault vehicle moving during emergency braking of the rescue vehicle.

**Tow the vehicle from the front.**

Release the parking brake of the fault vehicle, lift and fix the front wheels.

**Caution**

- When lifting the front wheels of the fault vehicle, you shall ensure that the rear part has appropriate clearance. Otherwise, during the towing process, the rear bumper of the fault vehicle will bump with the ground, causing damage

**Tow the vehicle from the front**

Release the parking brake of the fault vehicle, lift and fix the rear wheels.

## 6. Technical Data

|   |     |
|---|-----|
| Identification code .....                     | 270 |
| Product nameplate .....                       | 270 |
| Model of engine and transmission .....        | 271 |
| Parameters of complete vehicle .....          | 272 |
| Size parameter .....                          | 272 |
| General technical characteristics .....       | 273 |
| Main specifications and capacity of oil ..... | 276 |
| Main specifications and capacity of oil ..... | 276 |

### Identification code & Product nameplate

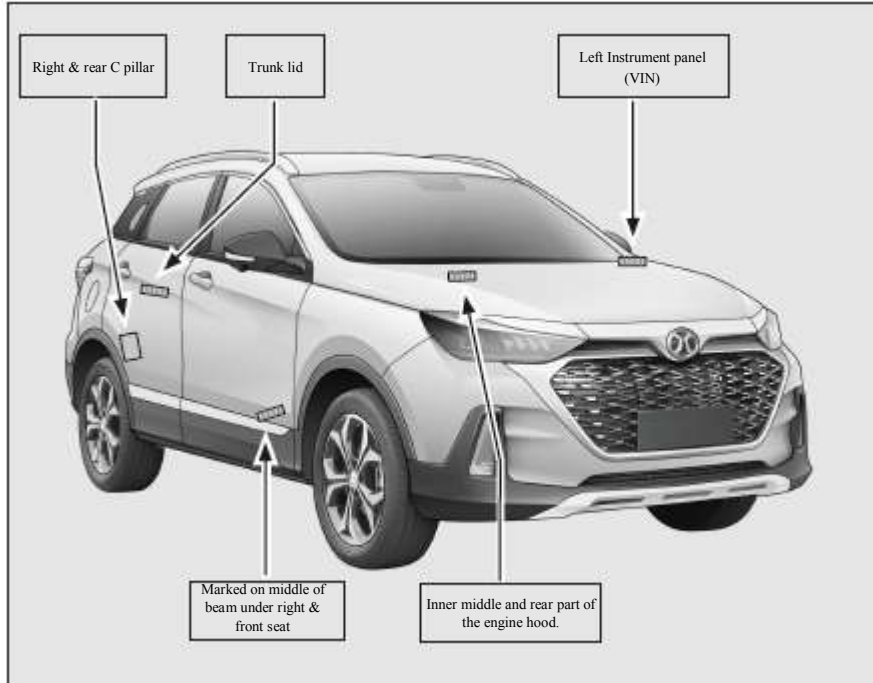

VIN is a unique identification number of the vehicle, which is showed on the front and rear vehicle. The position show as left marked and paste

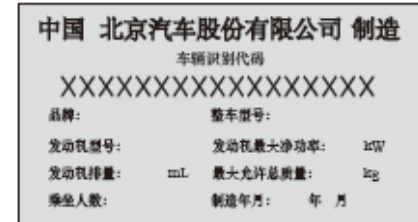

Vehicle product nameplate is located at the top right of the front wall panel in the engine compartment, which includes the following main information:

- Vehicle identification number (VIN)
- Brand and model;
- Model of engine, and maximum net power of engine;
- Displacement of engine and maximum permissible total mass;
- Number of seat, and manufacture date.

## Model of Engine and Transmission

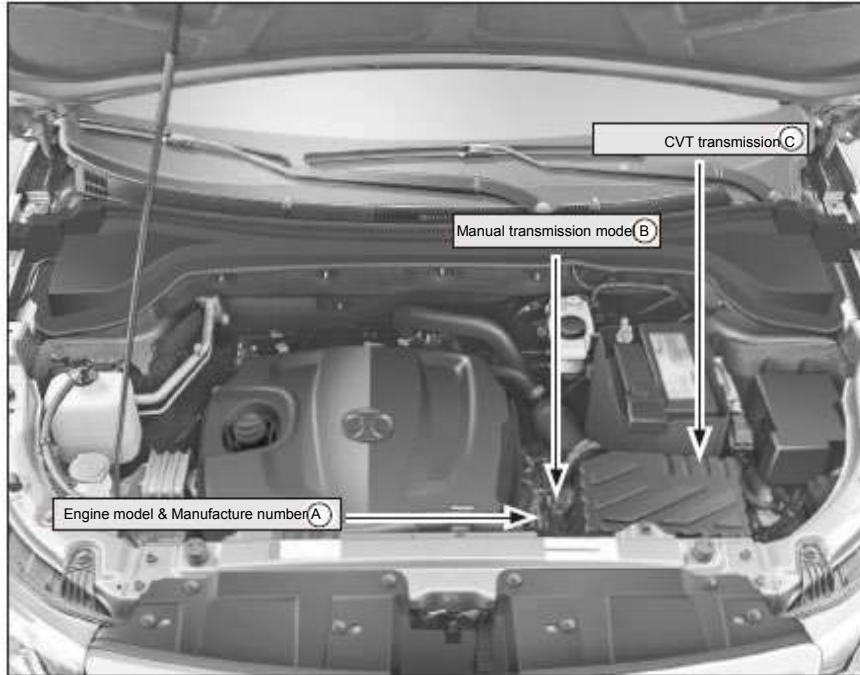

Engine model & Manufacture number A is located on the engine housing where the starter motor is installed.

Model B of manual transmission is on the transmission housing where the starter installed.

Model C of CVT transmission is located on the rear cover of transmission.

## Size parameter

Unit of dimension: mm

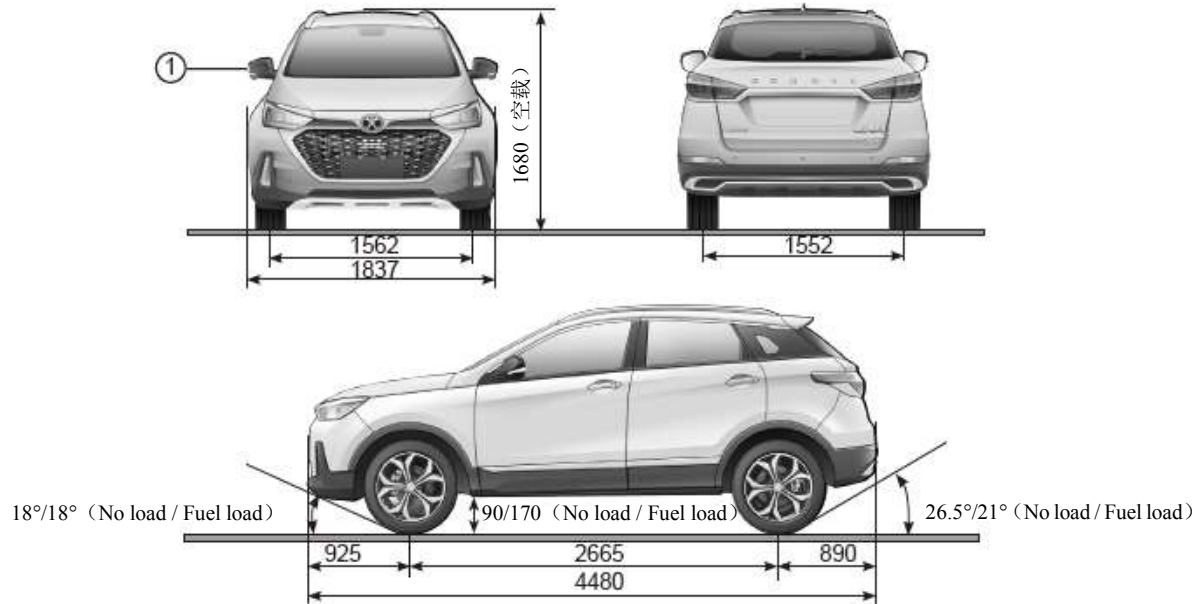

Note: External rearview mirror 1 of the vehicle is not include in the overall size.

## General technical characteristics

| Vehicle code   | SENOVA X55   |                     |                 |                     |                 |                     |                 |                     |
|--|--|---------------------|-----------------|---------------------|-----------------|---------------------|-----------------|---------------------|
| Vehicle model  | BJ7153U5<br>EMB  | BJ7153U5<br>EMB-BSG | BJ7153U5<br>ECB | BJ7153U5<br>ECB-BSG | BJ7154U5<br>EMB | BJ7154U5<br>EMB-BSG | BJ7154U5<br>ECB | BJ7154U5<br>ECB-BSG |
| Curb weight (kg)   | 1410   |                     | 1431            |                     | 1410            |                     | 1431            |                     |
| The front/rear axle load curb weight (kg)                    | 810/600  |                     | 826/605         |                     | 810/600         |                     | 826/605         |                     |
| Maximum permissible total mass (kg)                          | 1850   |                     | 1871            |                     | 1850            |                     | 1871            |                     |
| The front/rear axle load Maximum permissible total mass (kg) | 920/930  |                     | 930/941         |                     | 920/930         |                     | 930/941         |                     |
| Engine model:  | A151E-1  |                     |                 |                     | 4A91T           |                     |                 |                     |
| Engine type  | Inline four-cylinder, multi-point fuel injection, turbocharged |                     |                 |                     |                 |                     |                 |                     |
| Transmission type  | MT   |                     | CVT             |                     | MT              |                     | CVT             |                     |
| Drive type   | Front drive two wheel drive                                    |                     |                 |                     |                 |                     |                 |                     |
| Emission level   | Chinese National V   |                     |                 |                     |                 |                     |                 |                     |
| Fuel   | Unleaded petrol of 92# and above                               |                     |                 |                     |                 |                     |                 |                     |
| Engine displacement (ml)                                     | 1499   |                     |                 |                     |                 |                     |                 |                     |
| Engine displacement (ml)                                     | 75   |                     |                 |                     |                 |                     |                 |                     |
| Engine displacement (ml)                                     | 84.8   |                     |                 |                     |                 |                     |                 |                     |
| Compression ratio  | 9.5:1  |                     |                 |                     |                 |                     |                 |                     |
| Maximum power/speed (kW/rpm)                                 | 110/6000   |                     |                 |                     |                 |                     |                 |                     |
| Maximum torque/speed(N· m/rpm)                               | 210/2000 ~ 4500  |                     |                 |                     |                 |                     |                 |                     |
| Maximum net power (kW/rpm)                                   | 100/6000   |                     |                 |                     |                 |                     |                 |                     |
| Idle speed (r/min)   | 750±30   |                     |                 |                     |                 |                     |                 |                     |
| Ignition order   | 1-3-4-2  |                     |                 |                     |                 |                     |                 |                     |

## General technical characteristics

| Vehicle code  |                       |                                       | SENOVA X55      |                     |                 |                     |                 |                     |                 |                     |
|---|-----------------------|---------------------------------------|-----------------|---------------------|-----------------|---------------------|-----------------|---------------------|-----------------|---------------------|
| Vehicle model   |                       |                                       | BJ7153U5<br>EMB | BJ7153U5<br>EMB-BSG | BJ7153U5<br>ECB | BJ7153U5<br>ECB-BSG | BJ7154U5<br>EMB | BJ7154U5<br>EMB-BSG | BJ7154U5<br>ECB | BJ7154U5<br>ECB-BSG |
| Maximum vehicle speed(km/h)   |                       |                                       | 185             |                     | 175             |                     | 185             |                     | 175             |                     |
| Max. gradability %  |                       |                                       | 40              |                     |                 |                     |                 |                     |                 |                     |
| Fuel depletion limit for composite working conditions (L/100km)                   |                       |                                       | 7.2             | 7                   | 7.4             | 7.2                 | 7.3             | 7.1                 | 7.6             | 7.2                 |
| Fuel tank capacity (L)  |                       |                                       | 55              |                     |                 |                     |                 |                     |                 |                     |
| Wheel alignment Parameters (no-load)  | camber angle          | Front wheels (left and right wheels)  | -0.8° ±0.5°     |                     |                 |                     |                 |                     |                 |                     |
|   |                       | Rear wheels (left and right wheels)   | -0.8° ±0.25°    |                     |                 |                     |                 |                     |                 |                     |
|   | Kingpin inclination   | Front wheels (left and right wheels)  | 13° ±1.0°       |                     |                 |                     |                 |                     |                 |                     |
|   | Kingpin caster angle  | Front wheels (left and right wheels)) | 2.9° ±0.5°      |                     |                 |                     |                 |                     |                 |                     |
|   | Top beam (unilateral) | Front wheel                           | 0.14° ±0.04°    |                     |                 |                     |                 |                     |                 |                     |
| Rear wheel  |                       | 0.21° ±0.1°                           |                 |                     |                 |                     |                 |                     |                 |                     |
| Number of seats (including the driver's seat)                                     |                       |                                       | 5               |                     |                 |                     |                 |                     |                 |                     |
| Brake pedal free travel (mm)  |                       |                                       | 5 ~ 10          |                     |                 |                     |                 |                     |                 |                     |
| Braking Force of Pedal (N)  |                       |                                       | < 500           |                     |                 |                     |                 |                     |                 |                     |
| The distance of brake pedal initial position to the carpet (mm) (vertical height) |                       |                                       | 175             |                     |                 |                     |                 |                     |                 |                     |



## General technical characteristics

| Vehicle code                                       |                  | SENOVA X55         |                        |                 |                     |                 |                     |                 |                     |  |
|--|------------------|--------------------|------------------------|-----------------|---------------------|-----------------|---------------------|-----------------|---------------------|--|
| Vehicle model                                      |                  | BJ7153U5<br>EMB    | BJ7153U5<br>EMB-BSG    | BJ7153U5<br>ECB | BJ7153U5<br>ECB-BSG | BJ7154U5<br>EMB | BJ7154U5<br>EMB-BSG | BJ7154U5<br>ECB | BJ7154U5<br>ECB-BSG |  |
| Front brake<br>plate thickness<br>(mm)             | standard size    | 26                 |                        |                 |                     |                 |                     |                 |                     |  |
|  | Wear limit       | 24                 |                        |                 |                     |                 |                     |                 |                     |  |
| Front brake<br>block<br>thickness(mm)              | standard size    | 11                 |                        |                 |                     |                 |                     |                 |                     |  |
|  | Wear limit       | 2                  |                        |                 |                     |                 |                     |                 |                     |  |
| Rear brake plate<br>thickness (mm)                 | standard size    | 10                 |                        |                 |                     |                 |                     |                 |                     |  |
|  | Wear limit       | 8                  |                        |                 |                     |                 |                     |                 |                     |  |
| Rear brake<br>block<br>thickness(mm)               | standard size    | 10.2               |                        |                 |                     |                 |                     |                 |                     |  |
|  | Wear limit       | 2                  |                        |                 |                     |                 |                     |                 |                     |  |
| wheel  | Driving<br>Wheel | Tire pressure(kPa) | 220                    |                 |                     |                 |                     |                 |                     |  |
|  |                  | Tire specification | 225/55 R17、 225/50 R18 |                 |                     |                 |                     |                 |                     |  |
|  |                  | Rim specification  | 17X7J、 18X7J           |                 |                     |                 |                     |                 |                     |  |
|  | Spare<br>wheel   | Tire pressure(kPa) | 420                    |                 |                     |                 |                     |                 |                     |  |
|  |                  | Tire specification | T155/80 R17            |                 |                     |                 |                     |                 |                     |  |
|  |                  | Rim specification  | 17x4T                  |                 |                     |                 |                     |                 |                     |  |
| The residual amount of unbalance<br>wheel assembly |                  | ≤ 6g, recheck≤ 8g  |                        |                 |                     |                 |                     |                 |                     |  |

## Main specifications and capacity of oil

| Parts                              |         | Description of oil and fluid | Specifications         | Filling quantities |
|------------------------------------|---------|------------------------------|------------------------|--------------------|
| Engine oil                         | 4A91T   | Oil                          | 5W-30 SJ 及以上, 全合成      | 3.5L               |
|                                    | A151E-1 |                              | SN 5W-30               | 3.5L               |
| Transmission                       | 6MT     | Transmission oil             | GL-4 75W-90            | 2.0±0.1L           |
|                                    | CVT     |                              | CVTF-EX1               | 4.38±0.05L         |
| Engine cooling system              |         | Coolant                      | all organic -40℃       | 5.7L               |
| Brake system                       |         | Braking fluid                | DOT4 +                 | 1.0L               |
| Windshield washing fluid reservoir |         | Washing fluid                | Freezing point of -35℃ | 4.5L               |
| Air conditioning system            |         | Refrigerant                  | HFC-134A               | 550g               |

## Remark:

1. Above capacity is approximate, and the actual amount will be slightly different.
2. The capacity in this table is the design value, and the manufacturer is entitled to adjust the actual amount according to products, equipment, and climate change.

## 7. Maintenance Information

|                                    |     |
|------------------------------------|-----|
| Maintenance specification .....    | 278 |
| Maintenance Information Sheet..... | 279 |

**Maintenance specification**

Maintenance of the vehicle is generally divided into "General Conditions" and "Harsh Conditions", please make the appropriate maintenance in accordance with conditions of use.

If it is not "harsh conditions ", it will be the "General Conditions ".The following are the "harsh conditions":

- Often traveling in dusty regions or frequently exposed to air with high salt-content.
- Driving on uneven road, road with water or mountain road.
- Often driving in cold regions. In the cold season, the vehicle often travels in short distances.
- Frequent use of the brake and emergency braking.
- Used as a towing vehicle.
- Used as taxi or rental vehicle

- With traffic jam at the temperature higher than 32 °C exceeds 50 % of total driving time.
- Time of vehicle driving at above 120km/h at the temperature higher than 30 °C exceeds 50% of the total driving time.
- Travel with overloaded

 Caution

**● If there is component fault or any other abnormality, you should timely go to the authorized dealer of BAIC for vehicle inspection and maintenance and retain the maintenance records at any time.**

## Maintenance Information Sheet

| Regular Maintenance Items                                   |     | Initial maintenance time is 5,000km/6 months (subject to vehicle purchase invoice), whichever comes first. | Regular maintenance time is 5,000km/6 months (from the last service), whichever comes first. | Additional information   |
|---|-----|--|--|--|
| Engine oil/engine oil filter                                |     | ●  | ●  | Replace every 2500km under severe using conditions   |
| Engine oil/engine oil filter                                | 6MT | —  | —  | Replace 1st : 15000km/1 year (whichever comes first);<br>Then replace every 30000km/2 year (whichever comes first)   |
|   | CVT | —  | —  | Replace every 60000km/3 year (whichever comes first)   |
| Spark Plug  |     | —  | —  | Replace every 40000km  |
| Fuel filter   |     | —  | —  | Replace every 20000km/1 year (whichever comes first)   |
| 10000km/6 months (whichever comes first) Air filter element |     | —  | —  | Under general conditions, clean at interval of 10,000 km/6 months cleaning (whichever comes first), and replace in interval of 20000km/1 year (whichever comes first);<br>Under harsh conditions, clean at interval of 5000km/3 months (whichever comes first), and replace at interval of 10000km/6 months (whichever comes first). |
| The air filter element of the air conditioning              |     | —  | —  | Clean at interval of 10000km/6 months;<br>Replace every 20000km/1 year (whichever comes first)   |
| Engine accessory belt                                       |     | ○  | ○  | Check the belt for crack, chip or abrasion and adjust the tension  |

NOTE : ● representing replacement ○ representing inspection “—” representing no operation or see additional instructions

| Regular Maintenance Items  |         | Initial maintenance time is 5000km/6 months (subject to vehicle purchase invoice), whichever comes first. | Regular maintenance time is 5000km/6 months (from the last service), whichever comes first. | Additional information  |
|--|---------|---|---|---|
| Idling speed of the engine   |         | ○   | ○   |   |
| Check whether the crankcase ventilation control system is normal.                        | A151E-1 | —   | —   | Inspect every 10000km/6 month (whichever comes first)   |
|  | 4A91T   | —   | —   | Inspect every 40000km/2 years (whichever comes first)   |
| Engine coolant   |         | ○   | ○   | Inspect every 40000km/2 years (whichever comes first)   |
| Braking fluid  |         | ○   | ○   | Replace every 40000km/2 years (whichever comes first)   |
| Front and rear brake pads: Check the thickness and wear of the pads.                     |         | —   | ○   |   |
| Tire/rim (including the spare wheel)   |         | ○   | ○   | Check the tire wear, adjust the tire pressure, and implement wheel transposition or tire change if necessary.   |
| Suspension and steering tie rod ball, steering gear housing, and drive shaft dust shield |         | ○   | ○   |   |
| Radiator, brake, fuel pipelines and connections thereof                                  |         | ○   | ○   | Replace part, if the rubber hose is crack, bulge, cuts, burns, and oil leakage. In spring, inspect whether the front of radiator is shaded (The key is middle in condenser and radiator). |
| Whether exhaust system leaks due to damage   |         | ○   | ○   |   |
| Door hinge and door stopper, door lock, engine hood, trunk lid hinge and buckle          |         | —   | —   | Inspect every 20000km/1 year (whichever comes first)  |

| Regular Maintenance Items  | Initial maintenance time is 5,000km/6 months (subject to vehicle purchase invoice), whichever comes first. | Regular maintenance time is 5,000km/6 months (from the last service), whichever comes first. | Additional information |
|--|--|--|------------------------|
| Electrical equipment functions (including power window lifter, electric rearview mirrors, air conditioning, sunroof, etc.)   | ○  | ○  |                        |
| Computer-based check: Read out the fault storage information in various system controllers with specialized diagnostic equipment   | ○  | ○  |                        |
| Wiper and washing devices  | ○  | ○  |                        |
| Battery  | ○  | ○  |                        |
| Check the dampers of the four wheels and the appearance of its damping pring, check if chassis fasteners are loose, and in case of any looseness, it is necessary to fasten according to required torque | ○  | ○  |                        |
| Check the function of seat belt  | ○  | ○  |                        |
| Test drive:Power, braking, smoothness,noise, gears, etc.   | ○  | ○  |                        |

NOTE: ● representing replacement ○ representing inspection "-"representing no operation or see additional instructions