



AUDIX Technology (Shenzhen) Co., Ltd.
52 Block, Shenzhen Science & Industry Park,
Nantou, Shenzhen, Guangdong, China

Tel : 0755-26639495-6-7
Fax : 86 0755-26632877

Technical Compliance Statement

No. ACS-E14463

The following products have been tested by us with the listed standards and found in compliance with the council EMC directive 2004/108/EC. It is demonstrative for the compliance with this EMC Directive.

Submitter : TPV Display Technology (Wuhan) Co., Ltd.

Unique No.11 Zhuankou Development District of Economic
Technological Development Zone Wuhan City, P.R.China

Product : LCD Monitor

Brand Name	Model No.
AOC	M2060***; 195LM00001

Test Standards :

EN 55022: 2010+AC: 2011 (Class B) AS/NZS CISPR 22: 2009+A1: 2010	Limits and methods of measurement of radio disturbance characteristics of information technology equipment	
EN 61000-3-2: 2006+A1: 2009+A2: 2009	Electromagnetic compatibility(EMC) Part 3 :Limits Section 2 : Limits for harmonic current emissions (equipment input current ≤ 16A per phase)	
EN 61000-3-3: 2013	Electromagnetic compatibility(EMC) Part 3 :Limits Section 3 : Limits of voltage fluctuations and flicker in low-voltage supply systems for equipment with rated current ≤ 16A	
EN 55024: 2010	Information technology equipment-Immunity characteristics limits and methods of measurement	
	IEC 61000-4-2: 2008	Electrostatic discharge
	IEC 61000-4-3: 2010	RF Field Strength susceptibility
	IEC 61000-4-4: 2012	Electrical Fast transients
	IEC 61000-4-5: 2005	Surge
	IEC 61000-4-6: 2013	Conducted Susceptibility
	IEC 61000-4-8: 2009	Magnetic field immunity
	IEC 61000-4-11: 2004	Dips / Voltage Interruption Variation

Stamp only for EMC Dept. Report

Signature: David Jin

David Jin
Manager

Date : Oct.16, 2014



The statement is based on a single evaluation of one sample of above mentioned products. It does not imply an assessment of the whole production and does not permit the use of the test lab. logo.

EMC TEST REPORT

for

TPV Display Technology (Wuhan) Co., Ltd.

LCD Monitor

Brand Name	Model No.
AOC	M2060***; 195LM00001

Prepared for : TPV Display Technology (Wuhan) Co., Ltd.
Unique No.11 Zhuankou Development District of Economic
Technological Development Zone Wuhan City, P.R.China

Prepared By : Audix Technology (Shenzhen) Co., Ltd.
No. 6, Ke Feng Rd., 52 Block,
Shenzhen Science & Industrial Park,
Nantou, Shenzhen, Guangdong, China

Tel: (0755) 26639496
Fax: (0755) 26632877

Report Number : ACS-E14463
Date of Test : Oct.05~10, 2014
Date of Report : Oct.16, 2014

TABLE OF CONTENTS

Description	Page
Test Report Verification.....	6
1. SUMMARY OF STANDARDS AND RESULTS.....	7
1.1. Description of Standards and Results	7
2. GENERAL INFORMATION.....	8
2.1. Description of Device (EUT).....	8
2.2. Tested Supporting System Details	9
2.3. Block Diagram of connection between EUT and simulators.....	10
2.4. Test Facility	11
2.5. Measurement Uncertainty	11
3. CONDUCTED DISTURBANCE AT MAINS TERMINALS TEST	12
3.1. Test Equipment	12
3.2. Block Diagram of Test Setup.....	12
3.3. Test Standard	12
3.4. Power Line Conducted Emission at Mains Terminals Limit	12
3.5. EUT Configuration on Test	12
3.6. Operating Condition of EUT	13
3.7. Test Procedure	13
3.8. Conducted Disturbance at Mains Terminals Test Results	13
4. RADIATED DISTURBANCE MEASUREMENT.....	28
4.1. Test Equipments.....	28
4.2. Block Diagram of Test Setup.....	29
4.3. Test Standard	30
4.4. Radiated Emission Limit.....	30
4.5. EUT Configuration on Test	30
4.6. Operating Condition of EUT	30
4.7. Test Procedure	30
4.8. Radiated Emission Test Results.....	31
5. HARMONIC CURRENT TEST	60
5.1. Test Equipments.....	60
5.2. Block Diagram of Test Setup.....	60
5.3. Test Standard	60
5.4. Limits of Harmonic Current.....	60
5.5. EUT Configuration on Test	60
5.6. Operating Condition of EUT	60
5.7. Test Procedure	60
5.8. Test Results.....	61
6. VOLTAGE FLUCTUATIONS & FLICKER TEST	65
6.1. Test Equipment	65
6.2. Block Diagram of Test Setup.....	65
6.3. Test Standard	65
6.4. Limits of Voltage Fluctuation and Flick	65
6.5. EUT Configuration on Test	65
6.6. Operating Condition of EUT	65
6.7. Test Procedure	65
6.8. Test Results.....	65
7. IMMUNITY PERFORMANCE CRITERIA.....	67
8. ELECTROSTATIC DISCHARGE IMMUNITY TEST	68
8.1. Test Equipments.....	68

8.2.	Block Diagram of Test Setup	68
8.3.	Test Standard	68
8.4.	Severity Levels and Performance Criterion	68
8.5.	EUT Configuration	68
8.6.	Operating Condition of EUT	68
8.7.	Test Procedure	69
8.8.	Test Results	69
9.	RF FIELD STRENGTH SUSCEPTIBILITY TEST	71
9.1.	Test Equipments	71
9.2.	Block Diagram of Test Setup	71
9.3.	Test Standard	71
9.4.	Test Severity Level and Performance Criterion	71
9.5.	EUT Configuration	71
9.6.	Operating Condition of EUT	71
9.7.	Test Procedure	72
9.8.	Test Results	72
10.	ELECTRICAL FAST TRANSIENT/BURST IMMUNITY TEST	74
10.1.	Test Equipments	74
10.2.	Block Diagram of Test Setup	74
10.3.	Test Standard	74
10.4.	Severity Levels and Performance Criterion	74
10.5.	EUT Configuration	74
10.6.	Operating Condition of EUT	74
10.7.	Test Procedure	75
10.8.	Test Results	75
11.	SURGE TEST	77
11.1.	Test Equipments	77
11.2.	Block Diagram of Test Setup	77
11.3.	Test Standard	77
11.4.	Severity Levels and Performance Criterion	77
11.5.	EUT Configuration	77
11.6.	Operating Condition of EUT	77
11.7.	Test Procedure	78
11.8.	Test Results	78
12.	INJECTED CURRENTS SUSCEPTIBILITY TEST	80
12.1.	Test Equipments	80
12.2.	Block Diagram of Test Setup	80
12.3.	Test Standard	80
12.4.	Severity Levels and Performance Criterion	80
12.5.	EUT Configuration	80
12.6.	Operating Condition of EUT	80
12.7.	Test Procedure	81
12.8.	Test Results	81
13.	MAGNETIC FIELD IMMUNITY TEST	83
13.1.	Test Equipments	83
13.2.	Block Diagram of Test Setup	83
13.3.	Test Standard	83
13.4.	Severity Levels and Performance Criterion	83
13.5.	EUT Configuration on Test	83
13.6.	Operating Condition of EUT	83
13.7.	Test Procedure	83
13.8.	Test Results	83
14.	VOLTAGE DIPS AND INTERRUPTIONS TEST	85
14.1.	Test Equipment	85
14.2.	Block Diagram of Test Setup	85
14.3.	Test Standard	85

14.4.	Severity Levels and Performance Criterion	85
14.5.	EUT Configuration	85
14.6.	Operating Condition of EUT	85
14.7.	Test Procedure	85
14.8.	Test Results.....	85
15.	PHOTOGRAPHS	87
15.1.	Photos of Power Line Conducted Emission Test.....	87
15.2.	Photos of Radiated Emission Test (In Anechoic Chamber).....	88
15.3.	Photo of Harmonic / Flicker Test.....	89
15.4.	Photos of Electrostatic Discharge Immunity Test.....	90
15.5.	Photo of RF Strength Susceptibility Test.....	91
15.6.	Photo of Electrical Fast Transient/Burst Immunity Test.....	91
15.7.	Photo of Surge Test.....	92
15.8.	Photo of Injected Currents Susceptibility Test	92
15.9.	Photo of Magnetic Field Test.....	93
15.10.	Photo of Voltage Dips and interruptions test.....	93

TEST REPORT VERIFICATION

Applicant : TPV Display Technology (Wuhan) Co., Ltd.

EUT Description : LCD Monitor

(A) Model No. & Brand Name	Brand Name	Model No.
	AOC	M2060***; 195LM00001

(B) Power Supply : AC 100V-240V, 50/60Hz

(C) Test Voltage : AC 230V/50Hz

Measurement Standard Used:

AS/NZS CISPR 22: 2009+A1: 2010, EN 55022: 2010+AC: 2011 (Class B)
 EN 61000-3-2: 2006+A1: 2009+A2: 2009, EN 61000-3-3: 2013
 EN 55024: 2010
 (IEC 61000-4-2: 2008, IEC 61000-4-3: 2010, IEC 61000-4-4: 2012,
 IEC 61000-4-5: 2005, IEC 61000-4-6: 2013, IEC 61000-4-8: 2009, IEC 61000-4-11: 2004)

The device described above is tested by Audix Technology (Shenzhen) Co., Ltd. to determine the maximum emission levels emanating from the device and the severe levels of the device can endure and its performance criterion. The test results are contained in this test report and Audix Technology (Shenzhen) Co., Ltd. is assumed full responsibility for the accuracy and completeness of test. Also, this report shows that the EUT is technically compliant with the EN 55022, EN 61000-3-2, EN 61000-3-3 and EN 55024 requirements.

This report applies to above tested sample only. This report shall not be reproduced in part without written approval of Audix Technology (Shenzhen) Co., Ltd.

Date of Test : Oct.05~10, 2014 Report of date: Oct.16, 2014

Prepared by : Lisa Liang
 Lisa Liang / Assistant

Reviewed by : Jack Zhong
 Jack Zhong / Assistant Manager

信華科技 (深圳) 有限公司
 Audix Technology (Shenzhen) Co., Ltd.
 EMC 部門報告專用章

Stamp only for EMC Dept. Report

Signature: David Jin

Approved & Authorized Signer :

David Jin / Manager

1. SUMMARY OF STANDARDS AND RESULTS

1.1. Description of Standards and Results

The EUT have been tested according to the applicable standards as referenced below.

EMISSION				
Description of Test Item	Standard	Results	Remark	
Conducted disturbance at mains terminals	EN 55022: 2010+AC: 2011	PASS	Meets Class B Minimum passing margin is 10.26dB at 0.158MHz	
Conducted disturbance at telecommunication port	EN 55022: 2010+AC: 2011	N/A	N/A	
Radiated disturbance (30-1000MHz)	EN 55022: 2010+AC: 2011	PASS	Meets Class B Minimum passing margin is 4.32dB at 66.900MHz	
Radiated disturbance (1-6GHz)	EN 55022: 2010+AC: 2011	PASS	Meets Class B Minimum passing margin is 7.91dB at 2909.741MHz	
Harmonic current emissions	EN 61000-3-2: 2006+A1: 2009+A2: 2009	PASS	Meets the Class D requirement	
Voltage fluctuations & flicker	EN 61000-3-3: 2013	PASS	Meets the requirement	
IMMUNITY (EN 55024: 2010)				
Description of Test Item	Basic Standard	Results	Performance Criteria	Observation Criteria
Electrostatic discharge (ESD)	IEC 61000-4-2: 2008	PASS	B	A & B
Radio-frequency, Continuous radiated disturbance	IEC 61000-4-3: 2010	PASS	A	A
Electrical fast transient (EFT)	IEC 61000-4-4: 2012	PASS	B	A & B
Surge (Input a.c. power port)	IEC 61000-4-5: 2005	PASS	B	A & B
Surge (Telecommunication port)		N/A	N/A	N/A
Radio-frequency, Continuous conducted disturbance	IEC 61000-4-6: 2013	PASS	A	A
Power frequency magnetic field	IEC 61000-4-8: 2009	PASS	A	A
Voltage dips, >95% reduction	IEC 61000-4-11: 2004	PASS	B	A
Voltage dips, 30% reduction		PASS	C	A
Voltage interruptions		PASS	C	B

N/A is an abbreviation for Not Applicable.

2. GENERAL INFORMATION

2.1. Description of Device (EUT)

Description : LCD Monitor

Model Number & Brand Name	Brand Name	Model No.
	AOC	M2060***; 195LM00001

The “*” could be any alphanumeric character including blank for marketing differentiation.

Test Model : M2060***

Applicant : TPV Display Technology (Wuhan) Co., Ltd.
Unique No.11 Zhuankou Development District of Economic Technological Development Zone Wuhan City, P.R.China

Max Resolution : 1920*1080@60Hz

Max Work Frequency : 170MHz

Power Cord : Unshielded, Detachable, 1.5m / 1.2m (3 pins)

DVI Cable : Shielded, Detachable, 1.5m (Bonded two ferrite cores)

VGA Cable : Shielded, Detachable, 1.5m / 1.2m (Bonded two ferrite cores)

VGA Cable : Shielded, Detachable, 1.5m / 1.2m (Without core)

Date of Test : Oct.05~10, 2014

Date of Receipt : Oct.04, 2014

Sample Type : Prototype production

2.2. Tested Supporting System Details

No.	Description	ACS No.	Manufacturer	Model	Serial Number	Approved type
1.	Personal Computer	Test PC S	DELL	Vostro 470	2SP05W1	<input checked="" type="checkbox"/> FCC DoC <input checked="" type="checkbox"/> BSMI ID:R33002
		Power Cord: Unshielded, Detachable, 1.8m Display Card: HD3450 (DVI+VGA+HDMI)				
2.	USB Keyboard	ACS-EMC- K03R	DELL	SK-8115	CN-ODJ313-7161 6-711-04WJ	<input checked="" type="checkbox"/> FCC DoC <input checked="" type="checkbox"/> BSMI ID: T3A002
		Power Cord: shielded, Undetachable, 2.0m				
3.	USB Mouse	ACS-EMC-M03R	DELL	M056UO	512023253	<input checked="" type="checkbox"/> FCC DoC <input checked="" type="checkbox"/> BSMI ID: R41108
		Power Cord: shielded, Undetachable, 1.8m				
4.	Printer	ACS-EMC-PT04	HP	C9079A	N/A	<input checked="" type="checkbox"/> FCC DoC <input checked="" type="checkbox"/> BSMI ID: R33001
		USB Cable: Shielded, Detachable, 1.8m Power Cord: Unshielded, Detachable, 1.8m Power Adapter: HP, M/N: 0957-2119, BSMI ID: R33030 DC Cable: Unshielded, Detachable, 1.5m				
5.	HDD	ACS-EMC-HDD01	Terasys	F12-UF	A0100215-53900 31	<input checked="" type="checkbox"/> FCC DoC <input checked="" type="checkbox"/> BSMI ID: 4912A022
		USB Cable: Shielded, Detachable, 1.8m				

2.3. Block Diagram of connection between EUT and simulators

For EMI Tests

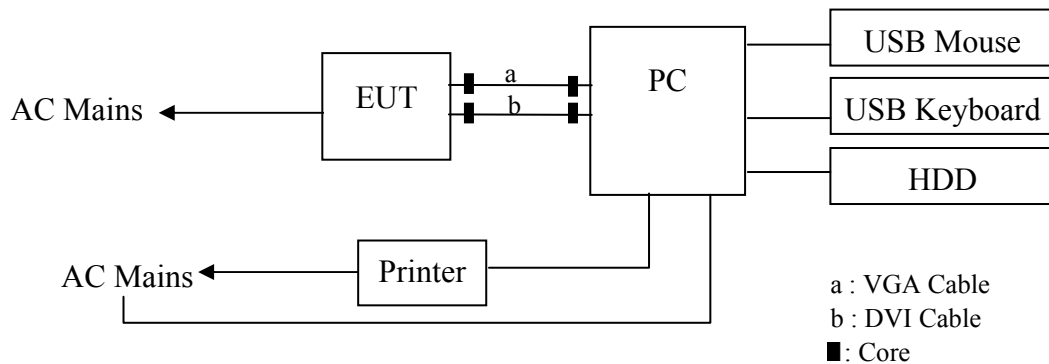

For EMS Tests

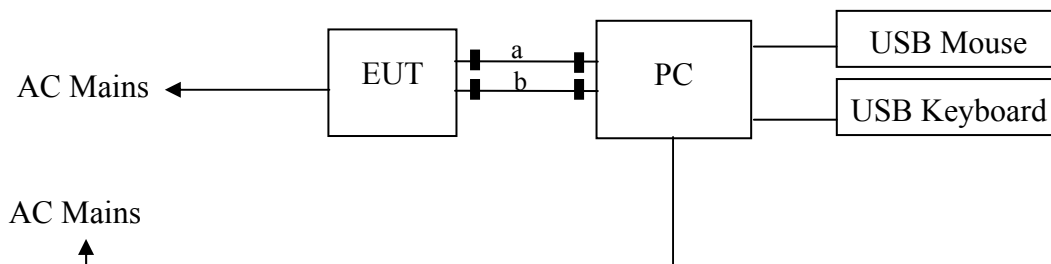

(EUT: LCD Monitor)

2.4. Test Facility

Site Description

- Name of Firm : Audix Technology (Shenzhen) Co., Ltd.
No. 6, Ke Feng Rd., 52 Block, Shenzhen Science & Industrial Park, Nantou, Shenzhen, Guangdong, China
- 3m Anechoic Chamber : Certificated by FCC, USA
Registration Number: 90454
Valid Date: Feb.22, 2015
- 3m & 10m Anechoic Chamber : Certificated by FCC, USA
Registration Number: 794232
Valid Date: Oct.31, 2015
- EMC Lab. : Certificated by DAkkS, Germany
Registration No: D-PL-12151-01-00
Valid Date: Dec.15, 2016
- Accredited by NVLAP, USA
NVLAP Code: 200372-0
Valid Date: Mar.31, 2015

2.5. Measurement Uncertainty

(95% confidence levels, k=2)

Test Item	Uncertainty
Uncertainty for Conduction emission test in No. 2 Conduction	3.08dB
Uncertainty for Radiation Emission test in 10m chamber (Distance: 10m)	3.45dB (30~200MHz, Polarize: H)
	3.47dB (30~200MHz, Polarize: V)
	3.62dB (200M~1GHz, Polarize: H)
	3.52dB (200M~1GHz, Polarize: V)
Uncertainty for Radiation Emission test in 10m chamber (1GHz-18GHz)	5.10dB (Distance: 3m Polarize: V)
	5.26dB (Distance: 3m Polarize: H)
Uncertainty for Flicker test	5.18%
Uncertainty for Harmonic test	9.4%
Uncertainty for C/S Test	1.36dB (Using CDN test)
	3.20dB (Using EM clamp test)
Uncertainty for R/S Test	1.73dB (80MHz~200MHz)
	1.76dB(200MHz~1000MHz)
	1.75dB(1GHz~6GHz)
Uncertainty for test site temperature and humidity	0.6°C
	3%
Pressure	1kPa

3. CONDUCTED DISTURBANCE AT MAINS TERMINALS TEST

3.1. Test Equipment

Item	Equipment	Manufacturer	Model No.	Serial No.	Last Cal.	Cal. Interval
1.	Test Receiver	Rohde & Schwarz	ESCI	100843	Nov.08, 13	1 Year
2.	L.I.S.N.#1	Rohde & Schwarz	ENV4200	100041	Apr. 28,14	1 Year
3.	L.I.S.N.#2	Kyoritsu	KNW-407	8-1628-5	Apr. 28,14	1 Year
4.	Terminator	Hubersuhner	50Ω	No. 1	Apr. 28,14	1 Year
5.	Terminator	Hubersuhner	50Ω	No. 2	Apr. 28,14	1 Year
6.	RF Cable	Fujikura	3D-2W	No.2	Apr. 28,14	1 Year
7.	Coaxial Switch	Anritsu	MP59B	6201397223	May. 16,14	1 Year
8.	Pulse Limiter	Rohde & Schwarz	ESH3-Z2	100340	Apr. 28,14	1 Year

3.2. Block Diagram of Test Setup

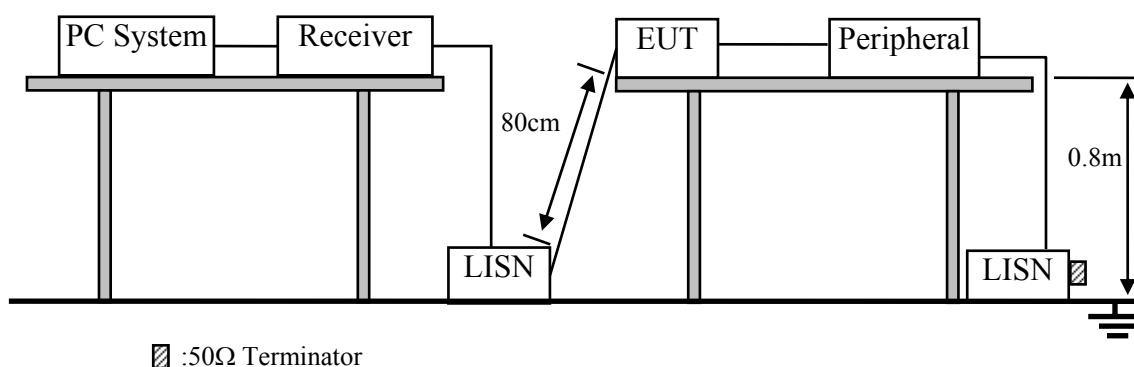

3.3. Test Standard

EN 55022: 2010+AC: 2011, Class B

3.4. Power Line Conducted Emission at Mains Terminals Limit

Frequency	Maximum RF Line Voltage	
	Quasi-Peak Level dB(μV)	Average Level dB(μV)
150kHz ~ 500kHz	66 ~ 56*	56 ~ 46*
500kHz ~ 5MHz	56	46
5MHz ~ 30MHz	60	50

Notes: 1. * Decreasing linearly with logarithm of frequency.

2. The lower limit shall apply at the transition frequencies.

3.5. EUT Configuration on Test

The following equipments are installed on Conducted Emission Test to meet EN 55022 requirement and operating in a manner which tends to maximize its emission characteristics in a normal application.

3.5.1. LCD Monitor (EUT)

Model Number : M2060***

Serial Number : N/A

3.5.2. Support Equipment : As Tested Supporting System Detail, in Section 2.2.

3.6. Operating Condition of EUT

- 3.6.1. Setup the EUT and simulator as shown as Section 3.2.
- 3.6.2. Turned on the power of all equipment.
- 3.6.3. PC system ran the Self-test program “H-win” by windows XP and sent “H” Character to LCD Monitor (EUT) through DVI / VGA card, the Screen of EUT displayed and filled with “H” pattern.
- 3.6.4. The other peripheral devices were driven and operated in turn during all testing.

3.7. Test Procedure

The EUT was placed on a non-metallic table, 80cm above the ground plane. The EUT Power connected to the power mains through a line impedance stabilization network (L.I.S.N. #1). This provided a 50-ohm coupling impedance for the EUT (Please refer to the block diagram of the test setup and photographs). The other peripheral devices power cord connected to the power mains through a line impedance stabilization network (L.I.S.N.#2). Both sides of power line were checked for maximum conducted interference. In order to find the maximum emission, the relative positions of equipments and all of the interface cables were changed according to EN 55022 Class B on conducted Disturbance test.

The bandwidth of test receiver (R & S ESCI) is set at 9kHz.

The frequency range from 150kHz to 30MHz is checked. The test results are reported and test results for Conducted Disturbance Test on Section 3.8.

3.8. Conducted Disturbance at Mains Terminals Test Results

PASS. (All emissions not reported below are too low against the prescribed limits.)

The EUT with the following test modes were tested and selected (No.3~8) to read Q.P values and Average values, all the test results are listed in next pages.

EUT: LCD Monitor

Model No. : M2060***

Test Date: Oct.10, 2014

Temperature: 23.8°C

Humidity: 45%

Pressure: 101.4kPa

No.	Test Mode	Port	Resolution & Frequency	Reference Test Data No.	
				Line	Neutral
1.	1.5m Power Cable+1.5m DVI Cable	DVI	640*480/60Hz	# 1	# 2
2.			1280*1024/75Hz	# 3	# 4
3. ※			1920*1080/60Hz	# 5	# 6
4.			1920*1080/60Hz	# 7	# 8
5.	1.5m Power Cable+1.5m VGA Cable (VGA Cable Without Core)	VGA	1920*1080/60Hz	# 9	# 10
6.			1920*1080/60Hz	# 11	# 12
7.			1920*1080/60Hz	# 13	# 14
8.			1920*1080/60Hz	# 15	# 16

(※ Worst test mode)

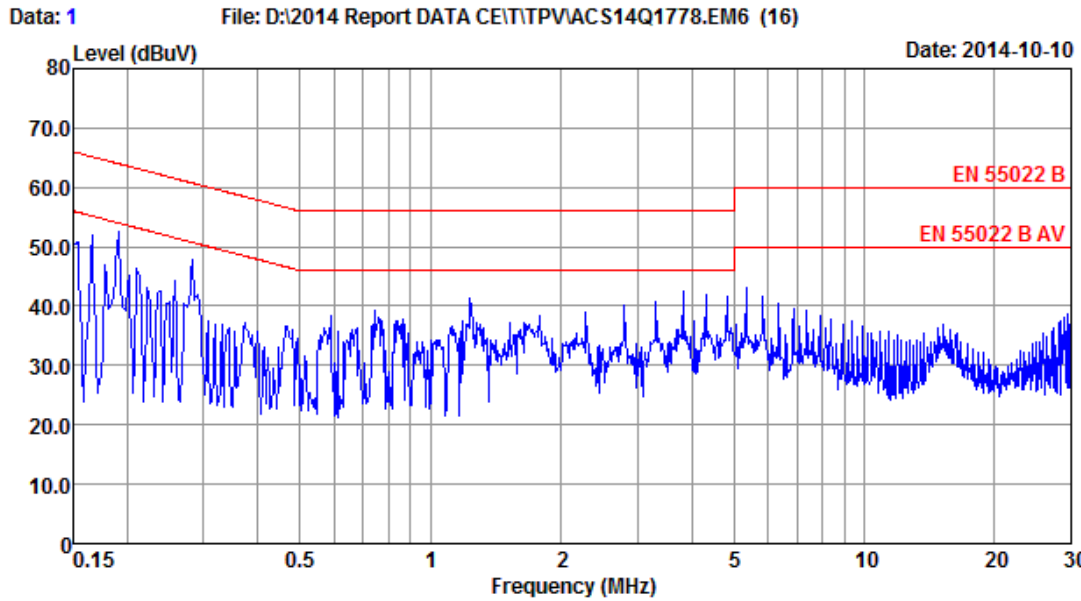

Site no	:2# Conduction	Data No	:1
Dis./Lisn	:14 ENV4200 L1	LISN phase:	LINE
Limit	:EN 55022 B	Pre	:101.4kPa
Env./Ins.	:23.8*C/45%	Engineer	:Nick_Huang
EUT	:M2060***		
Power Rating	:AC 230V/50Hz		
Test Mode	:Running "H" Pattern		
	DVI:640*480@60Hz		
	1.5m Power Cable+1.5m DVI Cable		

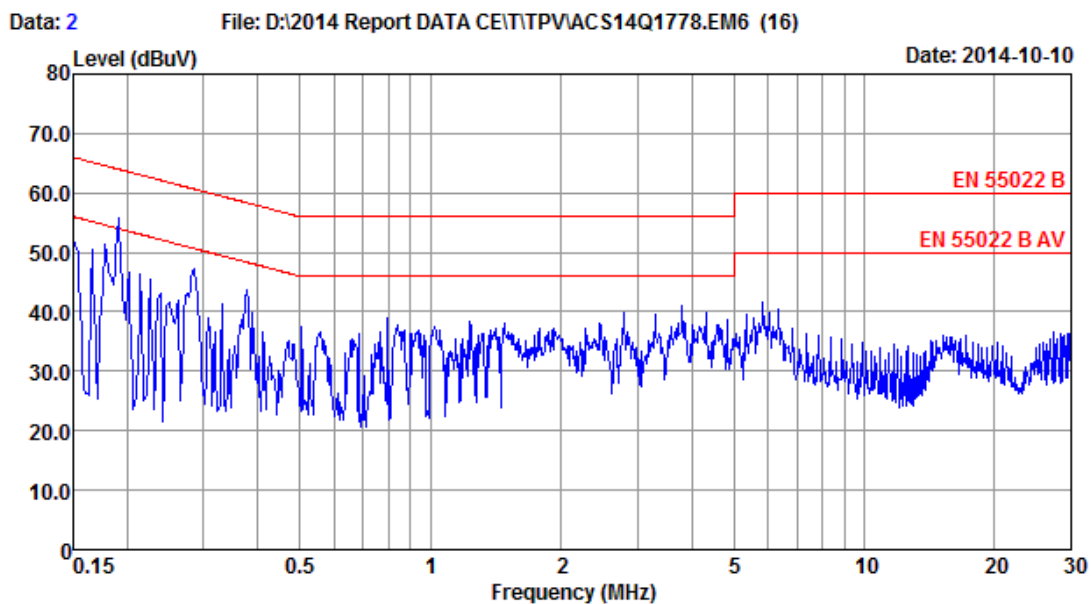

Site no	:2# Conduction	Data No	:2
Dis./Lisn	:14 ENV4200 N	LISN phase:	NEUTRAL
Limit	:EN 55022 B	Pre	:101.4kPa
Env./Ins.	:23.8*C/45%	Engineer	:Nick_Huang
EUT	:M2060***		
Power Rating	:AC 230V/50Hz		
Test Mode	:Running "H" Pattern		
	DVI:640*480@60Hz		
	1.5m Power Cable+1.5m DVI Cable		

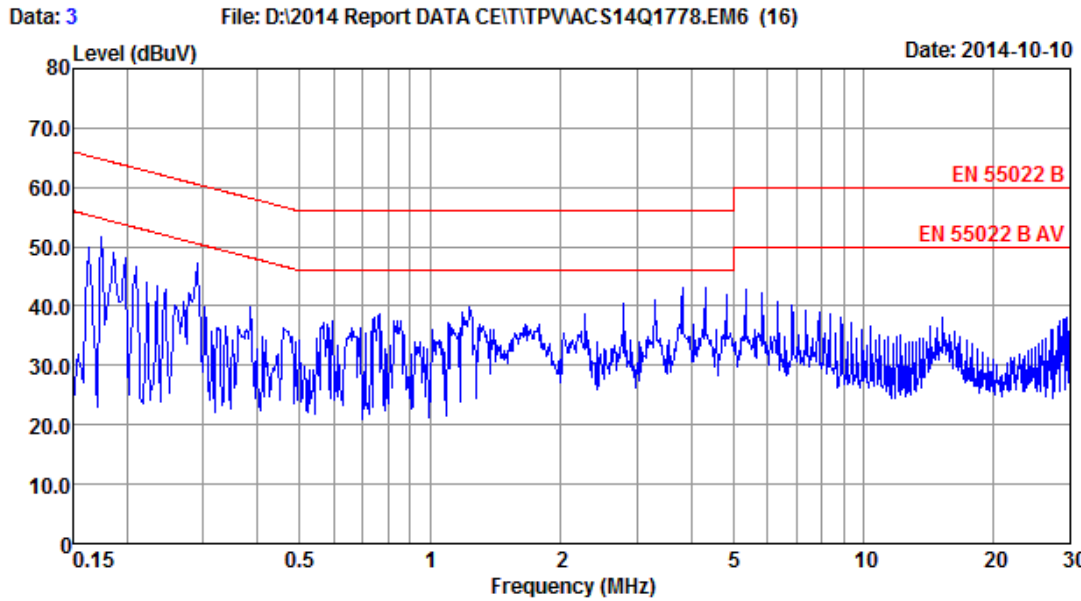

Site no	:2# Conduction	Data No	:3
Dis./Lisn	:14 ENV4200 L1	LISN phase:	LINE
Limit	:EN 55022 B	Pre	:101.4kPa
Env./Ins.	:23.8*C/45%	Engineer	:Nick_Huang
EUT	:M2060***		
Power Rating	:AC 230V/50Hz		
Test Mode	:Running "H" Pattern		
	DVI:1280*1024@75Hz		
	1.5m Power Cable+1.5m DVI Cable		

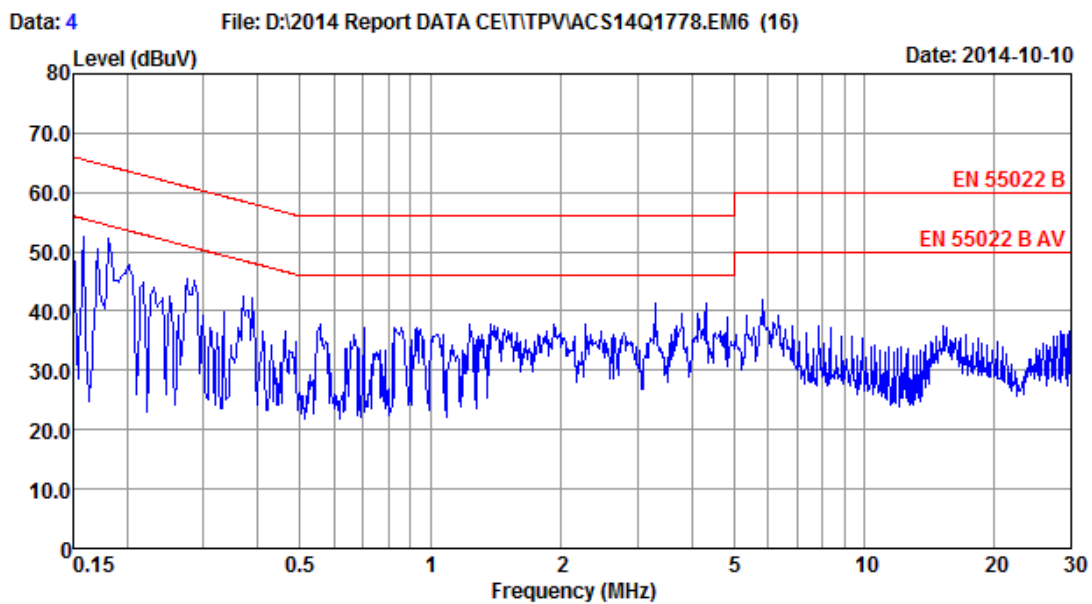

Site no	:2# Conduction	Data No	:4
Dis./Lisn	:14 ENV4200 N	LISN phase:	NEUTRAL
Limit	:EN 55022 B	Pre	:101.4kPa
Env./Ins.	:23.8*C/45%	Engineer	:Nick_Huang
EUT	:M2060***		
Power Rating	:AC 230V/50Hz		
Test Mode	:Running "H" Pattern		
	DVI:1280*1024@75Hz		
	1.5m Power Cable+1.5m DVI Cable		

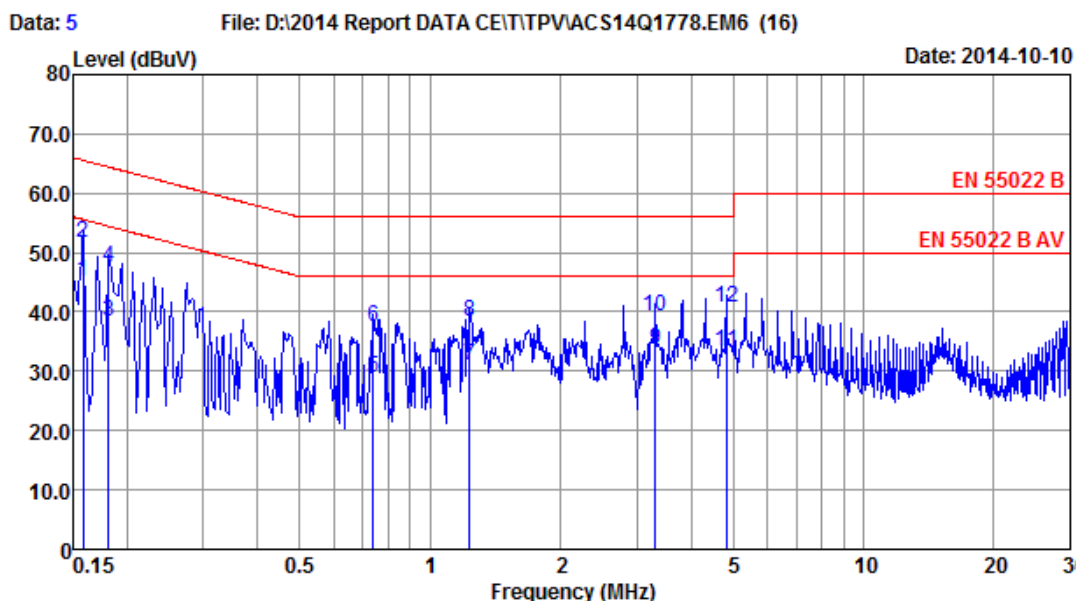

```

Site no       :2# Conduction
Dis./Lisn    :14 ENV4200 L1
Limit        :EN 55022 B
Env./Ins.    :23.8*C/45%
EUT          :M2060***
Power Rating :AC 230V/50Hz
Test Mode    :Running "H" Pattern
              DVI:1920*1080@60Hz
              1.5m Power Cable+1.5m DVI Cable
Data No      :5
LISN phase   :LINE
Pre          :101.4kPa
Engineer     :Nick_Huang
    
```

No	Freq (MHz)	LISN Factor (dB)	Cable Loss (dB)	Reading (dBuV)	Emission Level (dBuV)	Limits (dBuV)	Margin (dB)	Remark
1	0.158	9.89	9.90	25.51	45.30	55.56	10.26	Average
2	0.158	9.89	9.90	31.90	51.69	65.56	13.87	QP
3	0.182	9.93	9.90	18.63	38.46	54.42	15.96	Average
4	0.182	9.93	9.90	27.72	47.55	64.42	16.87	QP
5	0.739	9.79	9.89	9.28	28.96	46.00	17.04	Average
6	0.739	9.79	9.89	17.85	37.53	56.00	18.47	QP
7	1.236	9.75	9.90	11.47	31.12	46.00	14.88	Average
8	1.236	9.75	9.90	18.74	38.39	56.00	17.61	QP
9	3.310	9.76	9.92	13.96	33.64	46.00	12.36	Average
10	3.310	9.76	9.92	19.58	39.26	56.00	16.74	QP
11	4.822	9.74	9.93	13.63	33.30	46.00	12.70	Average
12	4.822	9.74	9.93	21.08	40.75	56.00	15.25	QP

Remarks: 1.Emission Level=LISN Factor+Cable Loss(Include 10dB pulse limit)+Reading.
 2.If the average limit is met when using a quasi-peak detector, the EUT shall be deemed to meet both limits and measurement with average detector is unnecessary.

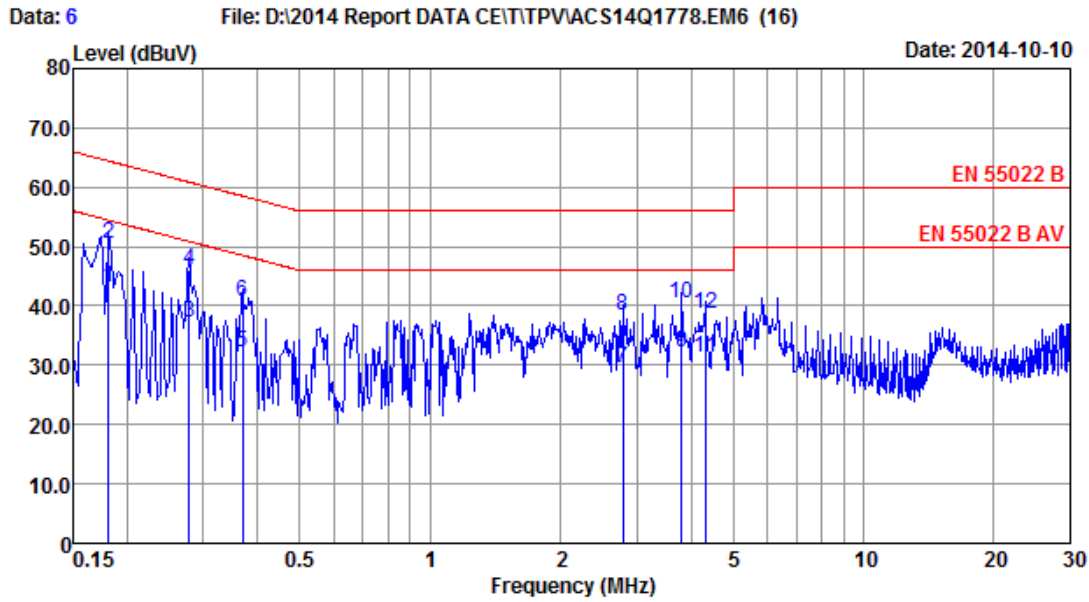

Site no	:2# Conduction	Data No	:6
Dis./Lisn	:14 ENV4200 N	LISN phase	:NEUTRAL
Limit	:EN 55022 B	Pre	:101.4kPa
Env./Ins.	:23.8*C/45%	Engineer	:Nick_Huang
EUT	:M2060***		
Power Rating	:AC 230V/50Hz		
Test Mode	:Running "H" Pattern		
	DVI:1920*1080@60Hz		
	1.5m Power Cable+1.5m DVI Cable		

No	Freq (MHz)	LISN Factor (dB)	Cable Loss (dB)	Reading (dBuV)	Emission Level (dBuV)	Limits (dBuV)	Margin (dB)	Remark
1	0.182	9.91	9.90	23.40	43.21	54.42	11.21	Average
2	0.182	9.91	9.90	30.62	50.43	64.42	13.99	QP
3	0.277	9.89	9.89	17.43	37.21	50.90	13.69	Average
4	0.277	9.89	9.89	26.35	46.13	60.90	14.77	QP
5	0.369	9.89	9.89	12.41	32.19	48.52	16.33	Average
6	0.369	9.89	9.89	20.97	40.75	58.52	17.77	QP
7	2.779	9.75	9.92	9.85	29.52	46.00	16.48	Average
8	2.779	9.75	9.92	18.59	38.26	56.00	17.74	QP
9	3.799	9.75	9.92	12.63	32.30	46.00	13.70	Average
10	3.799	9.75	9.92	20.67	40.34	56.00	15.66	QP
11	4.315	9.76	9.93	11.47	31.16	46.00	14.84	Average
12	4.315	9.76	9.93	18.99	38.68	56.00	17.32	QP

Remarks: 1.Emission Level=LISN Factor+Cable Loss(Include 10dB pulse limit)+Reading.
 2.If the average limit is met when using a quasi-peak detector, the EUT shall be deemed to meet both limits and measurement with average detector is unnecessary.

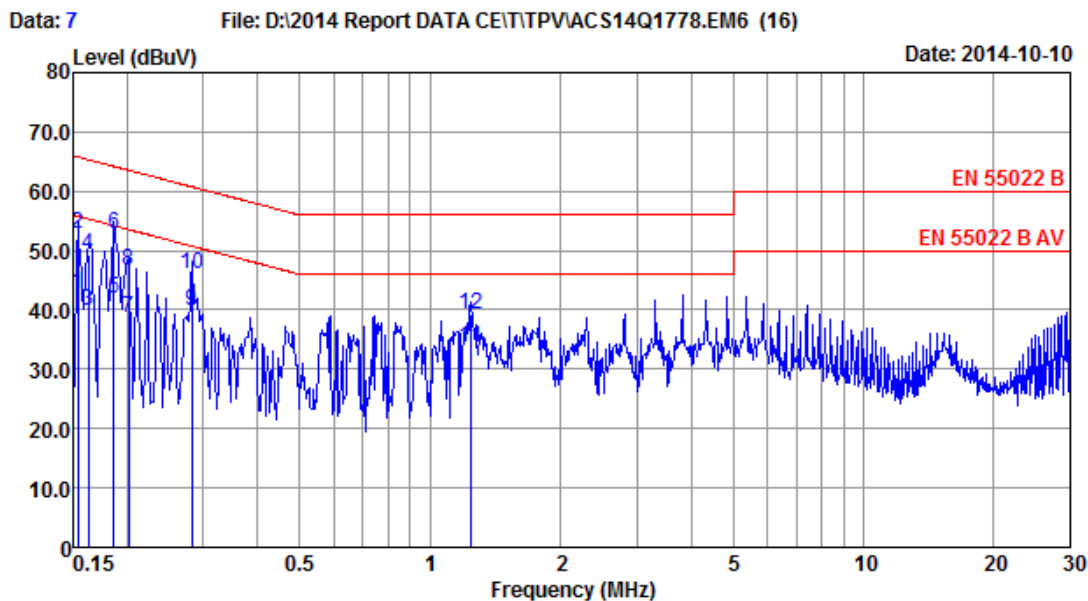

```

Site no       :2# Conduction
Dis./Lisn    :14 ENV4200 L1
Limit        :EN 55022 B
Env./Ins.    :23.8*C/45%
EUT          :M2060***
Power Rating :AC 230V/50Hz
Test Mode    :Running "H" Pattern
              DVI:1920*1080@60Hz
              1.2m Power Cable+1.5m DVI Cable
Data No      :7
LISN phase   :LINE
Pre          :101.4kPa
Engineer     :Nick_Huang
    
```

No	Freq (MHz)	LISN Factor (dB)	Cable Loss (dB)	Reading (dBuV)	Emission Level (dBuV)	Limits (dBuV)	Margin (dB)	Remark
1	0.154	9.89	9.90	23.02	42.81	55.78	12.97	Average
2	0.154	9.89	9.90	33.07	52.86	65.78	12.92	QP
3	0.162	9.90	9.90	20.05	39.85	55.34	15.49	Average
4	0.162	9.90	9.90	29.52	49.32	65.34	16.02	QP
5	0.186	9.94	9.90	21.98	41.82	54.20	12.38	Average
6	0.186	9.94	9.90	33.09	52.93	64.20	11.27	QP
7	0.202	9.96	9.90	18.77	38.63	53.54	14.91	Average
8	0.202	9.96	9.90	26.89	46.75	63.54	16.79	QP
9	0.282	9.89	9.89	20.16	39.94	50.76	10.82	Average
10	0.282	9.89	9.89	26.25	46.03	60.76	14.73	QP
11	1.242	9.75	9.90	13.96	33.61	46.00	12.39	Average
12	1.242	9.75	9.90	19.56	39.21	56.00	16.79	QP

Remarks: 1.Emission Level=LISN Factor+Cable Loss(Include 10dB pulse limit)+Reading.
 2.If the average limit is met when using a quasi-peak detector, the EUT shall be deemed to meet both limits and measurement with average detector is unnecessary.

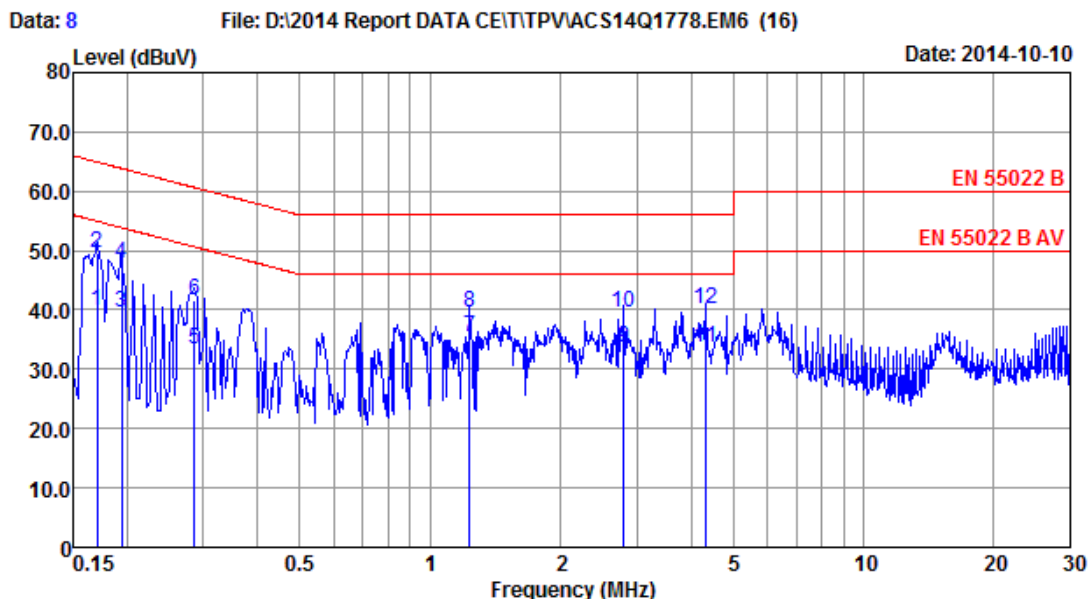

```

Site no       :2# Conduction
Dis./Lisn    :14 ENV4200 N
Limit        :EN 55022 B
Env./Ins.    :23.8*C/45%
EUT          :M2060***
Power Rating :AC 230V/50Hz
Test Mode    :Running "H" Pattern
              DVI:1920*1080@60Hz
              1.2m Power Cable+1.5m DVI Cable
Data No      :8
LISN phase   :NEUTRAL
Pre          :101.4kPa
Engineer     :Nick_Huang
    
```

No	Freq (MHz)	LISN Factor (dB)	Cable Loss (dB)	Reading (dBuV)	Emission Level (dBuV)	Limits (dBuV)	Margin (dB)	Remark
1	0.170	9.91	9.90	20.14	39.95	54.94	14.99	Average
2	0.170	9.91	9.90	29.65	49.46	64.94	15.48	QP
3	0.194	9.90	9.90	19.78	39.58	53.84	14.26	Average
4	0.194	9.90	9.90	28.07	47.87	63.84	15.97	QP
5	0.286	9.89	9.89	13.64	33.42	50.63	17.21	Average
6	0.286	9.89	9.89	21.90	41.68	60.63	18.95	QP
7	1.236	9.73	9.90	15.78	35.41	46.00	10.59	Average
8	1.236	9.73	9.90	20.04	39.67	56.00	16.33	QP
9	2.794	9.75	9.92	14.00	33.67	46.00	12.33	Average
10	2.794	9.75	9.92	19.94	39.61	56.00	16.39	QP
11	4.315	9.76	9.93	13.97	33.66	46.00	12.34	Average
12	4.315	9.76	9.93	20.49	40.18	56.00	15.82	QP

Remarks: 1.Emission Level=LISN Factor+Cable Loss(Include 10dB pulse limit)+Reading.
 2.If the average limit is met when using a quasi-peak detector, the EUT shall be deemed to meet both limits and measurement with average detector is unnecessary.

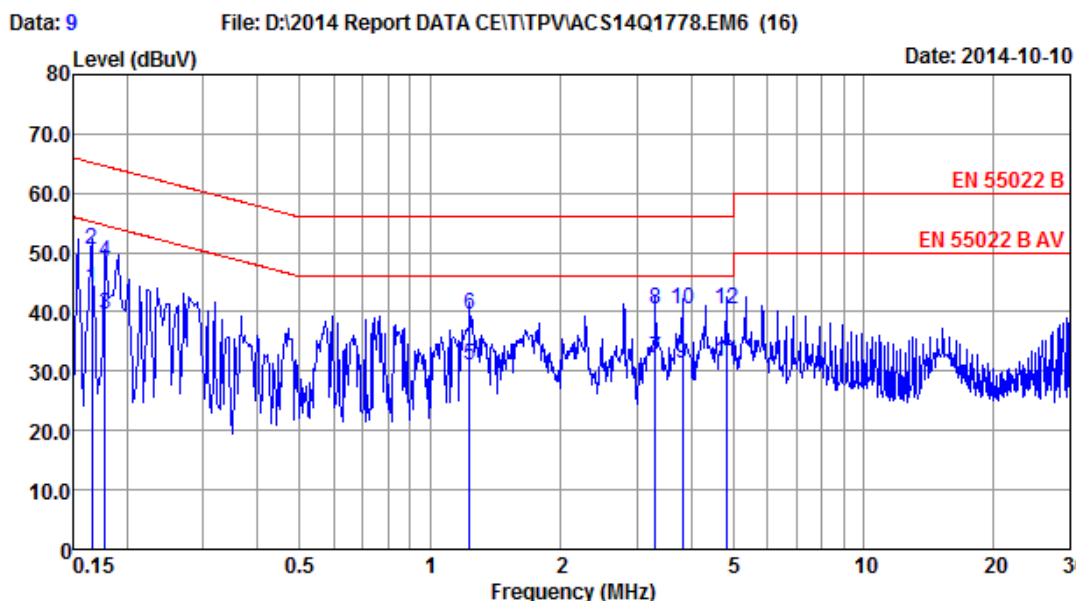

```

Site no       :2# Conduction
Dis./Lisn    :14 ENV4200 L1
Limit        :EN 55022 B
Env./Ins.    :23.8*C/45%
EUT          :M2060***
Power Rating :AC 230V/50Hz
Test Mode    :Running "H" Pattern
              VGA:1920*1080@60Hz
              1.5m Power Cable+1.5m VGA Cable
              VGA Cable Without Core
Data No      :9
LISN phase  :LINE
Pre         :101.4kPa
Engineer    :Nick_Huang
    
```

No	Freq (MHz)	LISN Factor (dB)	Cable Loss (dB)	Reading (dBuV)	Emission Level (dBuV)	Limits (dBuV)	Margin (dB)	Remark
1	0.166	9.91	9.90	24.17	43.98	55.16	11.18	Average
2	0.166	9.91	9.90	30.52	50.33	65.16	14.83	QP
3	0.178	9.93	9.90	19.72	39.55	54.59	15.04	Average
4	0.178	9.93	9.90	28.61	48.44	64.59	16.15	QP
5	1.236	9.75	9.90	11.47	31.12	46.00	14.88	Average
6	1.236	9.75	9.90	19.95	39.60	56.00	16.40	QP
7	3.310	9.76	9.92	12.62	32.30	46.00	13.70	Average
8	3.310	9.76	9.92	20.69	40.37	56.00	15.63	QP
9	3.820	9.75	9.92	11.53	31.20	46.00	14.80	Average
10	3.820	9.75	9.92	20.65	40.32	56.00	15.68	QP
11	4.822	9.74	9.93	11.83	31.50	46.00	14.50	Average
12	4.822	9.74	9.93	20.88	40.55	56.00	15.45	QP

Remarks: 1.Emission Level=LISN Factor+Cable Loss(Include 10dB pulse limit)+Reading.
 2.If the average limit is met when using a quasi-peak detector, the EUT shall be deemed to meet both limits and measurement with average detector is unnecessary.

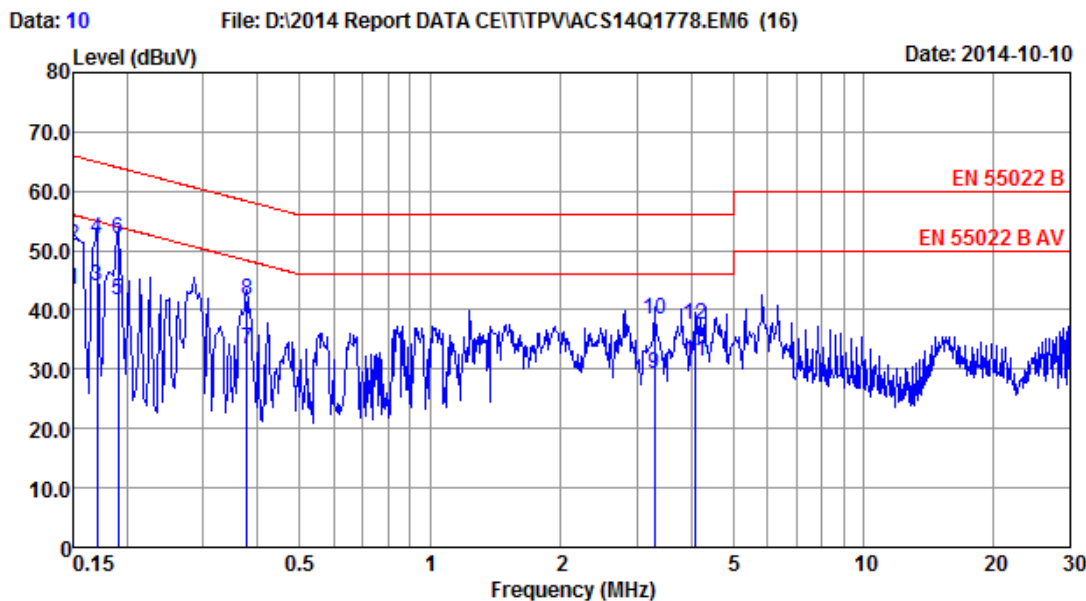

Site no	:2# Conduction	Data No	:10
Dis./Lisn	:14 ENV4200 N	LISN phase	:NEUTRAL
Limit	:EN 55022 B	Pre	:101.4kPa
Env./Ins.	:23.8°C/45%	Engineer	:Nick_Huang
EUT	:M2060***		
Power Rating	:AC 230V/50Hz		
Test Mode	:Running "H" Pattern		
	VGA:1920*1080@60Hz		
	1.5m Power Cable+1.5m VGA Cable		
	VGA Cable Without Core		

No	Freq (MHz)	LISN Factor (dB)	Cable Loss (dB)	Reading (dBuV)	Emission Level (dBuV)	Limits (dBuV)	Margin (dB)	Remark
1	0.150	9.92	9.90	23.58	43.40	56.00	12.60	Average
2	0.150	9.92	9.90	31.01	50.83	66.00	15.17	QP
3	0.170	9.91	9.90	24.31	44.12	54.94	10.82	Average
4	0.170	9.91	9.90	32.18	51.99	64.94	12.95	QP
5	0.190	9.90	9.90	21.79	41.59	54.02	12.43	Average
6	0.190	9.90	9.90	32.12	51.92	64.02	12.10	QP
7	0.377	9.89	9.89	13.69	33.47	48.34	14.87	Average
8	0.377	9.89	9.89	21.74	41.52	58.34	16.82	QP
9	3.293	9.75	9.92	9.54	29.21	46.00	16.79	Average
10	3.293	9.75	9.92	18.81	38.48	56.00	17.52	QP
11	4.092	9.76	9.93	11.51	31.20	46.00	14.80	Average
12	4.092	9.76	9.93	17.86	37.55	56.00	18.45	QP

Remarks: 1.Emission Level=LISN Factor+Cable Loss(Include 10dB pulse limit)+Reading.
 2.If the average limit is met when using a quasi-peak detector, the EUT shall be deemed to meet both limits and measurement with average detector is unnecessary.

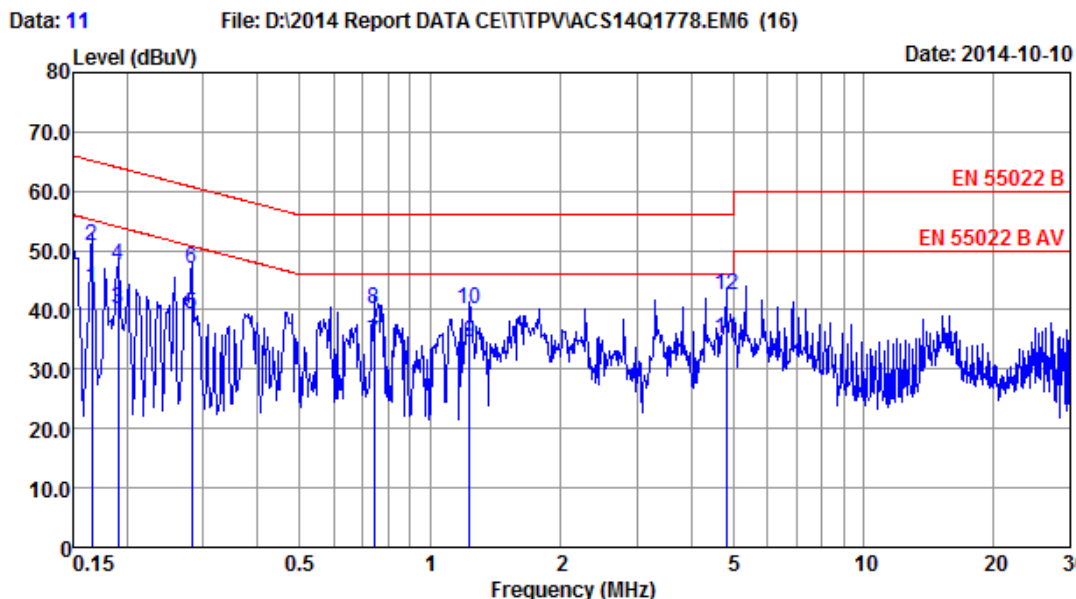

Site no	:2# Conduction	Data No	:11
Dis./Lisn	:14 ENV4200 L1	LISN phase:	LINE
Limit	:EN 55022 B	Pre	:101.4kPa
Env./Ins.	:23.8°C/45%	Engineer	:Nick_Huang
EUT	:M2060***		
Power Rating	:AC 230V/50Hz		
Test Mode	:Running "H" Pattern		
	VGA:1920*1080@60Hz		
	1.5m Power Cable+1.2m VGA Cable		
	VGA Cable Without Core		

No	Freq (MHz)	LISN Factor (dB)	Cable Loss (dB)	Reading (dBuV)	Emission Level (dBuV)	Limits (dBuV)	Margin (dB)	Remark
1	0.166	9.91	9.90	23.98	43.79	55.16	11.37	Average
2	0.166	9.91	9.90	31.08	50.89	65.16	14.27	QP
3	0.190	9.95	9.90	20.17	40.02	54.02	14.00	Average
4	0.190	9.95	9.90	27.77	47.62	64.02	16.40	QP
5	0.282	9.89	9.89	19.36	39.14	50.76	11.62	Average
6	0.282	9.89	9.89	27.16	46.94	60.76	13.82	QP
7	0.743	9.79	9.89	14.78	34.46	46.00	11.54	Average
8	0.743	9.79	9.89	20.57	40.25	56.00	15.75	QP
9	1.236	9.75	9.90	14.85	34.50	46.00	11.50	Average
10	1.236	9.75	9.90	20.57	40.22	56.00	15.78	QP
11	4.822	9.74	9.93	15.36	35.03	46.00	10.97	Average
12	4.822	9.74	9.93	22.98	42.65	56.00	13.35	QP

Remarks: 1.Emission Level=LISN Factor+Cable Loss(Include 10dB pulse limit)+Reading.
 2.If the average limit is met when using a quasi-peak detector, the EUT shall be deemed to meet both limits and measurement with average detector is unnecessary.

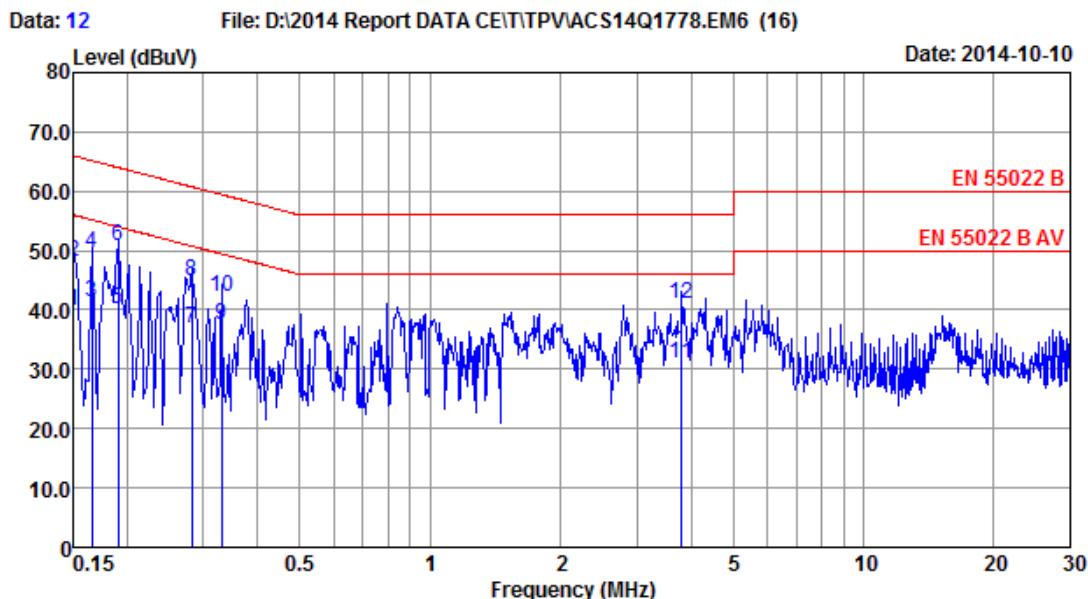

Site no	:2# Conduction	Data No	:12
Dis./Lisn	:14 ENV4200 N	LISN phase	:NEUTRAL
Limit	:EN 55022 B	Pre	:101.4kPa
Env./Ins.	:23.8°C/45%	Engineer	:Nick_Huang
EUT	:M2060***		
Power Rating	:AC 230V/50Hz		
Test Mode	:Running "H" Pattern		
	VGA:1920*1080@60Hz		
	1.5m Power Cable+1.2m VGA Cable		
	VGA Cable Without Core		

No	Freq (MHz)	LISN Factor (dB)	Cable Loss (dB)	Reading (dBuV)	Emission Level (dBuV)	Limits (dBuV)	Margin (dB)	Remark
1	0.150	9.92	9.90	20.01	39.83	56.00	16.17	Average
2	0.150	9.92	9.90	28.32	48.14	66.00	17.86	QP
3	0.166	9.91	9.90	21.52	41.33	55.16	13.83	Average
4	0.166	9.91	9.90	29.70	49.51	65.16	15.65	QP
5	0.190	9.90	9.90	20.38	40.18	54.02	13.84	Average
6	0.190	9.90	9.90	30.88	50.68	64.02	13.34	QP
7	0.282	9.89	9.89	16.99	36.77	50.76	13.99	Average
8	0.282	9.89	9.89	25.03	44.81	60.76	15.95	QP
9	0.330	9.89	9.89	17.84	37.62	49.44	11.82	Average
10	0.330	9.89	9.89	22.58	42.36	59.44	17.08	QP
11	3.799	9.75	9.92	11.21	30.88	46.00	15.12	Average
12	3.799	9.75	9.92	21.40	41.07	56.00	14.93	QP

Remarks: 1.Emission Level=LISN Factor+Cable Loss(Include 10dB pulse limit)+Reading.
 2.If the average limit is met when using a quasi-peak detector, the EUT shall be deemed to meet both limits and measurement with average detector is unnecessary.

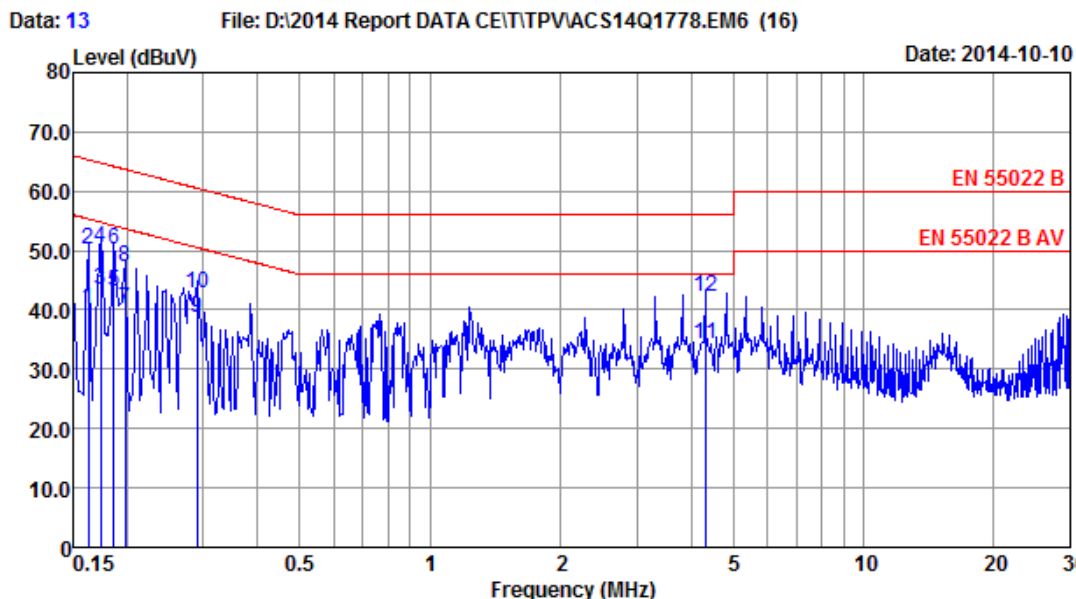

Site no	:2# Conduction	Data No	:13
Dis./Lisn	:14 ENV4200 L1	LISN phase:	LINE
Limit	:EN 55022 B	Pre	:101.4kPa
Env./Ins.	:23.8°C/45%	Engineer	:Nick_Huang
EUT	:M2060***		
Power Rating	:AC 230V/50Hz		
Test Mode	:Running "H" Pattern		
	VGA:1920*1080@60Hz		
	1.5m Power Cable+1.5m VGA Cable		

No	Freq (MHz)	LISN Factor (dB)	Cable Loss (dB)	Reading (dBuV)	Emission Level (dBuV)	Limits (dBuV)	Margin (dB)	Remark
1	0.162	9.90	9.90	20.31	40.11	55.34	15.23	Average
2	0.162	9.90	9.90	30.29	50.09	65.34	15.25	QP
3	0.174	9.92	9.90	23.62	43.44	54.77	11.33	Average
4	0.174	9.92	9.90	30.51	50.33	64.77	14.44	QP
5	0.186	9.94	9.90	23.19	43.03	54.20	11.17	Average
6	0.186	9.94	9.90	30.46	50.30	64.20	13.90	QP
7	0.198	9.96	9.90	20.29	40.15	53.71	13.56	Average
8	0.198	9.96	9.90	27.26	47.12	63.71	16.59	QP
9	0.289	9.88	9.89	18.88	38.65	50.54	11.89	Average
10	0.289	9.88	9.89	23.10	42.87	60.54	17.67	QP
11	4.315	9.75	9.93	14.63	34.31	46.00	11.69	Average
12	4.315	9.75	9.93	22.60	42.28	56.00	13.72	QP

Remarks: 1.Emission Level=LISN Factor+Cable Loss(Include 10dB pulse limit)+Reading.
 2.If the average limit is met when using a quasi-peak detector, the EUT shall be deemed to meet both limits and measurement with average detector is unnecessary.

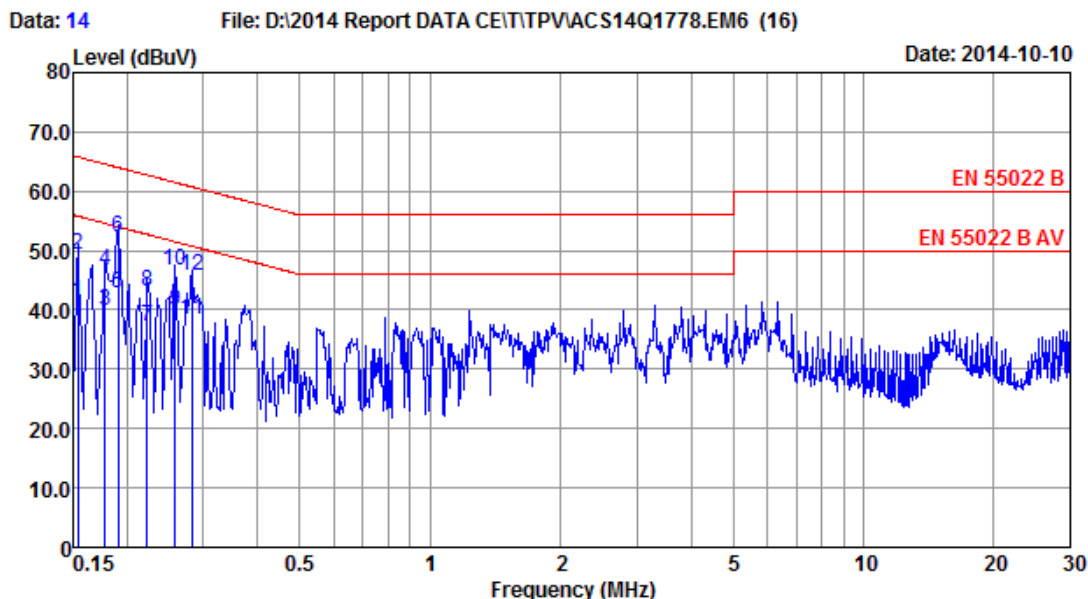

Site no	:2# Conduction	Data No	:14
Dis./Lisn	:14 ENV4200 N	LISN phase	:NEUTRAL
Limit	:EN 55022 B	Pre	:101.4kPa
Env./Ins.	:23.8*C/45%	Engineer	:Nick_Huang
EUT	:M2060***		
Power Rating	:AC 230V/50Hz		
Test Mode	:Running "H" Pattern		
	VGA:1920*1080@60Hz		
	1.5m Power Cable+1.5m VGA Cable		

No	Freq (MHz)	LISN Factor (dB)	Cable Loss (dB)	Reading (dBuV)	Emission Level (dBuV)	Limits (dBuV)	Margin (dB)	Remark
1	0.154	9.92	9.90	21.56	41.38	55.78	14.40	Average
2	0.154	9.92	9.90	29.37	49.19	65.78	16.59	QP
3	0.178	9.91	9.90	20.00	39.81	54.59	14.78	Average
4	0.178	9.91	9.90	26.69	46.50	64.59	18.09	QP
5	0.190	9.90	9.90	22.94	42.74	54.02	11.28	Average
6	0.190	9.90	9.90	32.47	52.27	64.02	11.75	QP
7	0.222	9.90	9.90	17.44	37.24	52.74	15.50	Average
8	0.222	9.90	9.90	23.30	43.10	62.74	19.64	QP
9	0.258	9.89	9.89	20.14	39.92	51.51	11.59	Average
10	0.258	9.89	9.89	26.77	46.55	61.51	14.96	QP
11	0.282	9.89	9.89	18.70	38.48	50.76	12.28	Average
12	0.282	9.89	9.89	25.94	45.72	60.76	15.04	QP

Remarks: 1.Emission Level=LISN Factor+Cable Loss(Include 10dB pulse limit)+Reading.
 2.If the average limit is met when using a quasi-peak detector, the EUT shall be deemed to meet both limits and measurement with average detector is unnecessary.

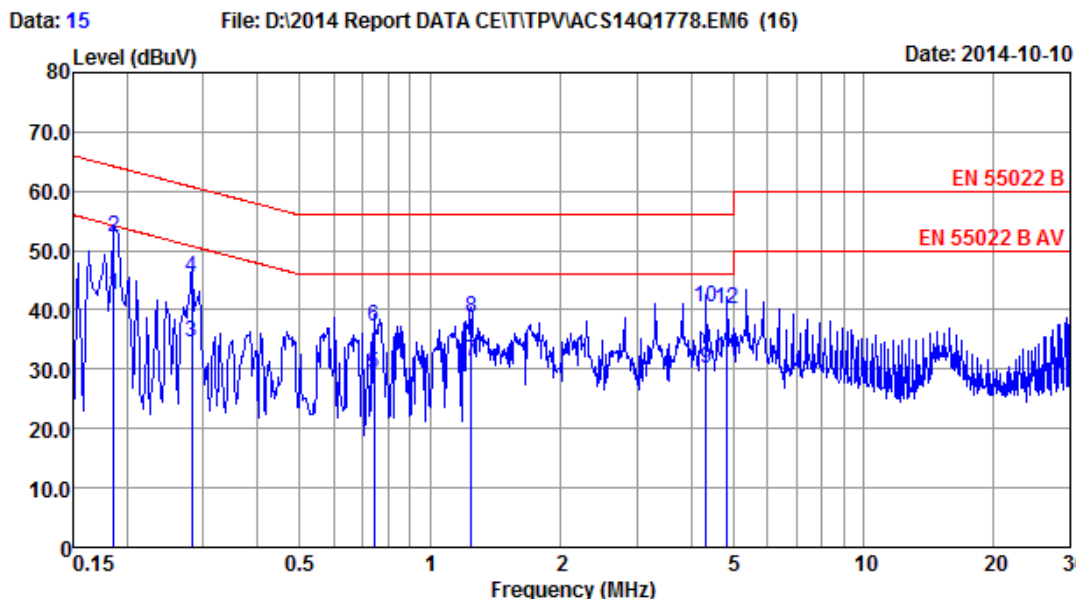

Site no	:2# Conduction	Data No	:15
Dis./Lisn	:14 ENV4200 L1	LISN phase:	LINE
Limit	:EN 55022 B	Pre	:101.4kPa
Env./Ins.	:23.8°C/45%	Engineer	:Nick_Huang
EUT	:M2060***		
Power Rating	:AC 230V/50Hz		
Test Mode	:Running "H" Pattern		
	VGA:1920*1080@60Hz		
	1.5m Power Cable+1.2m VGA Cable		

No	Freq (MHz)	LISN Factor (dB)	Cable Loss (dB)	Reading (dBuV)	Emission Level (dBuV)	Limits (dBuV)	Margin (dB)	Remark
1	0.186	9.94	9.90	22.68	42.52	54.20	11.68	Average
2	0.186	9.94	9.90	32.34	52.18	64.20	12.02	QP
3	0.282	9.89	9.89	14.90	34.68	50.76	16.08	Average
4	0.282	9.89	9.89	25.59	45.37	60.76	15.39	QP
5	0.743	9.79	9.89	9.52	29.20	46.00	16.80	Average
6	0.743	9.79	9.89	17.54	37.22	56.00	18.78	QP
7	1.242	9.75	9.90	11.68	31.33	46.00	14.67	Average
8	1.242	9.75	9.90	18.88	38.53	56.00	17.47	QP
9	4.338	9.75	9.93	10.44	30.12	46.00	15.88	Average
10	4.338	9.75	9.93	20.76	40.44	56.00	15.56	QP
11	4.848	9.74	9.93	12.17	31.84	46.00	14.16	Average
12	4.848	9.74	9.93	20.55	40.22	56.00	15.78	QP

Remarks: 1.Emission Level=LISN Factor+Cable Loss(Include 10dB pulse limit)+Reading.
 2.If the average limit is met when using a quasi-peak detector, the EUT shall be deemed to meet both limits and measurement with average detector is unnecessary.

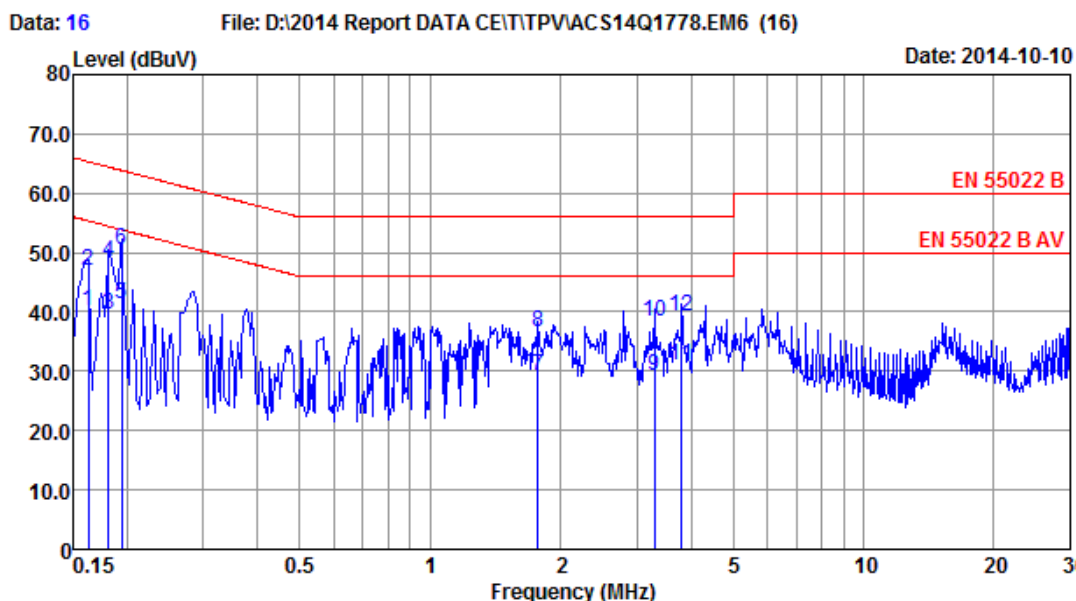

Site no	:2# Conduction	Data No	:16
Dis./Lisn	:14 ENV4200 N	LISN phase	:NEUTRAL
Limit	:EN 55022 B	Pre	:101.4kPa
Env./Ins.	:23.8°C/45%	Engineer	:Nick_Huang
EUT	:M2060***		
Power Rating	:AC 230V/50Hz		
Test Mode	:Running "H" Pattern		
	VGA:1920*1080@60Hz		
	1.5m Power Cable+1.2m VGA Cable		

No	Freq (MHz)	LISN Factor (dB)	Cable Loss (dB)	Reading (dBuV)	Emission Level (dBuV)	Limits (dBuV)	Margin (dB)	Remark
1	0.162	9.91	9.90	20.41	40.22	55.34	15.12	Average
2	0.162	9.91	9.90	27.04	46.85	65.34	18.49	QP
3	0.182	9.91	9.90	19.62	39.43	54.42	14.99	Average
4	0.182	9.91	9.90	28.56	48.37	64.42	16.05	QP
5	0.194	9.90	9.90	21.45	41.25	53.84	12.59	Average
6	0.194	9.90	9.90	30.54	50.34	63.84	13.50	QP
7	1.772	9.74	9.90	9.51	29.15	46.00	16.85	Average
8	1.772	9.74	9.90	16.83	36.47	56.00	19.53	QP
9	3.293	9.75	9.92	9.63	29.30	46.00	16.70	Average
10	3.293	9.75	9.92	18.69	38.36	56.00	17.64	QP
11	3.799	9.75	9.92	11.47	31.14	46.00	14.86	Average
12	3.799	9.75	9.92	19.51	39.18	56.00	16.82	QP

Remarks: 1.Emission Level=LISN Factor+Cable Loss(Include 10dB pulse limit)+Reading.
 2.If the average limit is met when using a quasi-peak detector, the EUT shall be deemed to meet both limits and measurement with average detector is unnecessary.

4. RADIATED DISTURBANCE MEASUREMENT

4.1. Test Equipments

4.1.1. For frequency range 30MHz~1000MHz (At 10m Anechoic Chamber)

Item	Equipment	Manufacturer	Model No.	Serial No.	Last Cal.	Cal. Interval
1.	10m Chamber	AUDIX	N/A	N/A	Nov.25,13	1 Year
2.	EMC Analyzer	Agilent	E7405A	MY42000131	Oct.31, 13	1 Year
3.	EMC Analyzer	Agilent	E7405A	MY45116588	Oct.31, 13	1 Year
4.	Test Receiver	Rohde & Schwarz	ESCI	100842	Apr. 28,14	1 Year
5.	Amplifier	Agilent	8447D	2944A10684	Apr. 28,14	1Year
6.	Amplifier	Agilent	8447D	2944A11140	Apr. 28,14	1 Year
7.	Trilog-Broadband Antenna	SCHWARZBECK	VULB 9168	9168-493	Apr. 08,14	1 Year
8.	Trilog-Broadband Antenna	SCHWARZBECK	VULB 9168	9168-429	Dec.03, 13	1 Year
9.	RF Cable	MIYAZAKI	CFD400-NL	10m Chamber No.1	Apr. 28,14	1 Year
10.	RF Cable	MIYAZAKI	CFD400-NL	10m Chamber No.2	Apr. 28,14	1 Year
11.	Coaxial Switch	Anritsu	MP59B	6201397220	May. 16,14	1 Year
12.	Coaxial Switch	Anritsu	MP59B	6201397221	May. 16,14	1 Year
13.	Coaxial Switch	Anritsu	MP59B	6201397222	May. 16,14	1 Year

4.1.2. For frequency range 1GHz~6GHz (At 10m Anechoic Chamber)

Item	Equipment	Manufacturer	Model No.	Serial No.	Last Cal.	Cal. Interval
1.	EMC Analyzer	Agilent	N9030A	MY51380221	Oct.31, 13	1 Year
2.	Horn Antenna	ETS	3115	9510-4580	Jun.06, 14	1 Year
3.	Amplifier	Agilent	8449B	3008A00863	Apr. 28,14	1 Year
4.	RF Cable	Hubersuhner	SUCOFLEX106	77977/6	Apr. 28,14	1 Year
5.	RF Cable	Hubersuhner	SUCOFLEX106	28616/2	Apr. 28,14	1 Year
6.	10m Chamber	AUDIX	N/A	N/A	Mar.31, 14	1 Year

4.2. Block Diagram of Test Setup

4.2.1. In Anechoic Chamber Test Setup Diagram for 30MHz~1000MHz

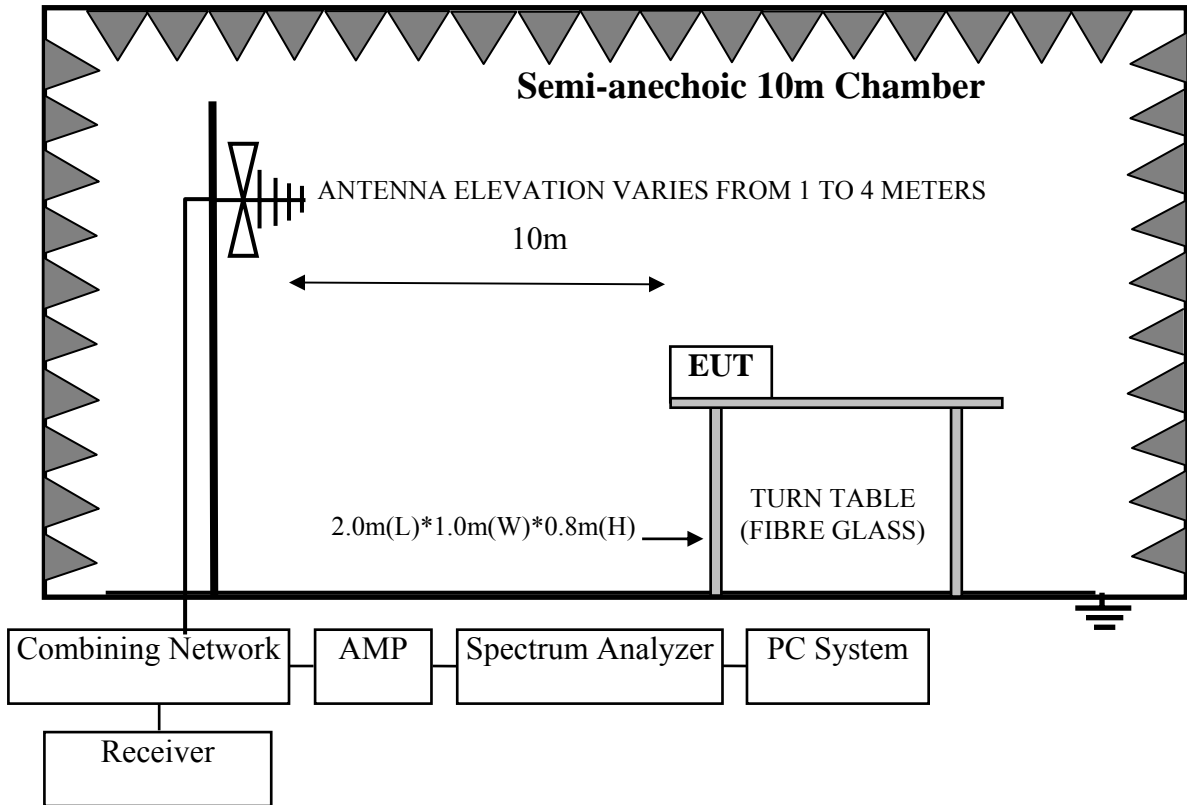

4.2.2. In Anechoic (10m) Chamber Test Setup Diagram for 1-6GHz

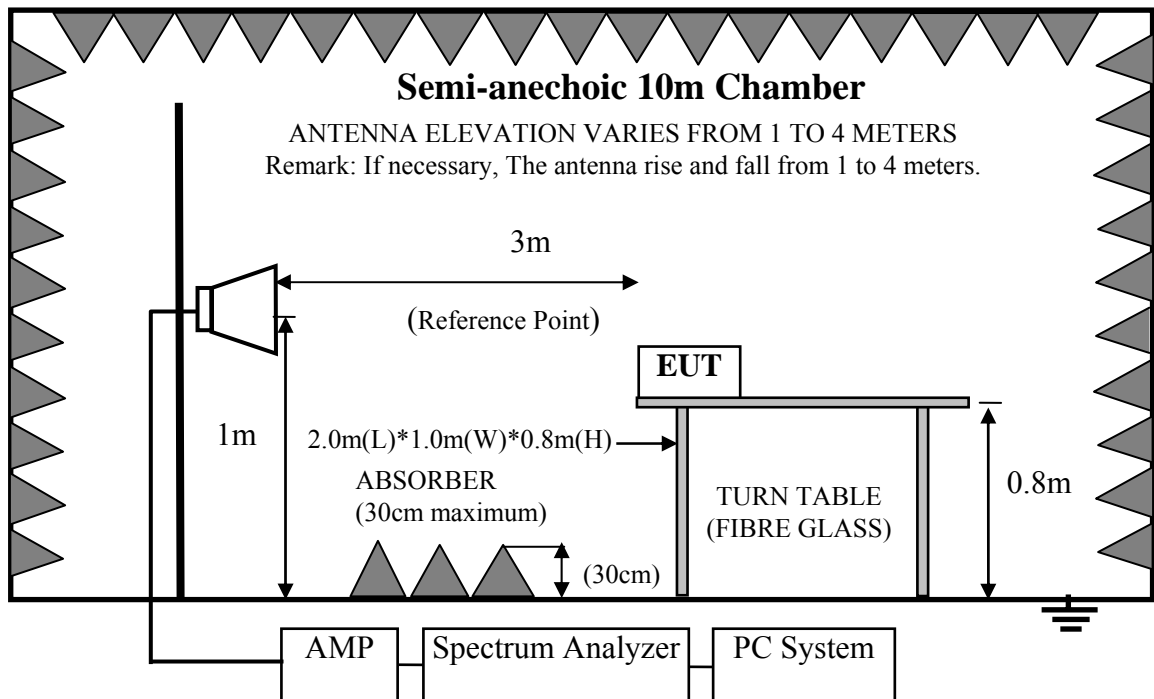

4.3. Test Standard

EN 55022: 2010+AC: 2011, Class B

4.4. Radiated Emission Limit

All emanations from a Class B computing devices or system, including any network of conductors and apparatus connected thereto, shall not exceed the level of field strengths specified below:

FREQUENCY (MHz)	DISTANCE (Meters)	FIELD STRENGTHS LIMITS (dBμV/m)
30 ~ 230	10	30
230 ~ 1000	10	37
1000~3000	3	70(Peak) 50(Average)
3000~6000	3	74(Peak) 54(Average)

- Note:
- (1) Emission level = Antenna Factor + Cable Loss + Reading
Emission level = Antenna Factor - Amp Factor + Cable Loss + Reading (above 1000MHz)
 - (2) The lower limit shall apply at the transition frequencies.
 - (3) Distance refers to the distance in meters between the test instrument antenna and the closed point of any part of the E.U.T..

4.5. EUT Configuration on Test

The configurations of EUT are listed in Section 3.5.

4.6. Operating Condition of EUT

Same as Conducted Emission test that is listed in Section 3.6. except the test set up replaced by Section 4.2.

4.7. Test Procedure

The EUT was placed on a non-metallic table, 80 cm above the ground plane inside a semi-anechoic chamber. An antenna was located 3m & 10m from the EUT on an adjustable mast. A pre-scan was first performed in order to find prominent radiated emissions. For final emissions measurements at each frequency of interest, the EUT were rotated and the antenna height was varied between 1m and 4m in order to maximize the emission. Measurements in both horizontal and vertical polarities were made and the data was recorded. In order to find the maximum emission, the relative positions of equipments and all the interface cables were changed according to EN 55022 Class B on Radiated Disturbance test.

The bandwidth setting on the test receiver (R&S TEST RECEIVER ESCI) is 120 kHz.

The resolution bandwidth of the EMC Analyzer N9030A was set at 1MHz. (For above 1GHz)

The frequency range from 30MHz to 1000MHz was pre-scanned with a peak detector and all final readings of measurement from Test Receiver are Quasi-Peak values.

The frequency range from 1GHz to 6GHz was checked and all final readings of measurement were with Peak and Average detector, measurement distance was 3m at semi-anechoic chamber. The portion of the test volume that was obstructed by absorber placed on the floor (30cm maximum).

Finally, selected operating situations at Anechoic Chamber measurement, all the test results are listed in section 4.8.

4.8. Radiated Emission Test Results

PASS. (All emissions not reported below are too low against the prescribed limits.)

EUT: LCD Monitor Model No. : M2060***

For frequency range 30MHz~1GHz

The EUT with the following test modes were tested and selected (No.3 ~8) to read Q.P values, all the test results are listed in next pages.

Test Date: Oct.09, 2014 Temperature: 23.5°C Humidity: 48% Pressure: 101.5kPa

No.	Test Mode	Port	Resolution & Frequency	Reference Test Data No.	
				Horizontal	Vertical
1.	1.5m Power Cable+1.5m VGA Cable (VGA Cable Without Core)	VGA	640*480/60Hz	# 2	# 1
2.			1280*1024/75Hz	# 4	# 3
3. ※			1920*1080/60Hz	# 6	# 5
4.			1920*1080/60Hz	# 8	# 7
5.			1920*1080/60Hz	# 10	# 9
6.			1920*1080/60Hz	# 12	# 11
7.			1920*1080/60Hz	# 14	# 13
8.		1.5m Power Cable+1.5m DVI Cable	DVI	1920*1080/60Hz	# 16

(※ Worst test mode)

For frequency range 1GHz~6GHz

The EUT with below test mode were measured within Anechoic Chamber and the test results listed in next pages

Test Date: Oct.10, 2014 Temperature: 21.2°C Humidity: 48.4% Pressure: 101.7kPa.

No.	Test Mode	Port	Resolution & Frequency	Reference Test Data No.	
				Horizontal	Vertical
1	1.5m Power Cable+1.5m VGA Cable (VGA Cable Without Core)	VGA	1280*1024/75Hz	# 1	# 2
2※			1920*1080/60Hz	# 3	# 4
3	1920*1080/60Hz		# 5	# 6	
4	1920*1080/60Hz		# 7	# 8	
5	1920*1080/60Hz		# 9	# 10	
6	1920*1080/60Hz		# 11	# 12	
7	1.5m Power Cable+1.5m DVI Cable	DVI	1920*1080/60Hz	# 13	# 14

(※ Worst test mode)

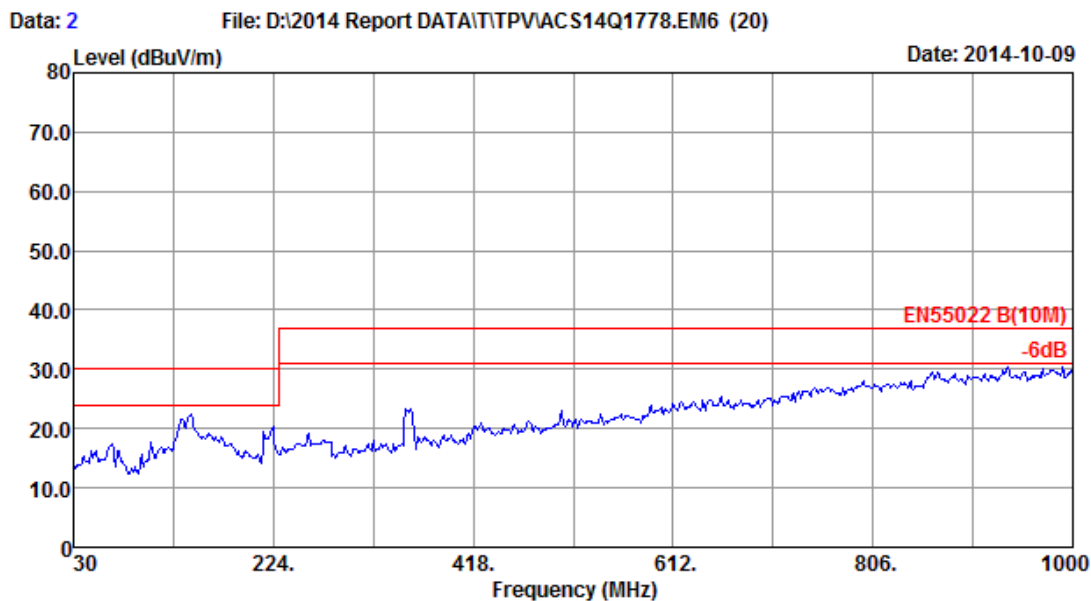

Site no.	: 10m Chamber	Data No.	: 2
Dis. / Ant.	: 10m 2013 9168-429	Ant. pol.	: HORIZONTAL
Limit	: EN55022 B(10M)	Pre	: 101.5kPa
Env. / Ins.	: 23.5°C/48%	Engineer	: ELLIS
EUT	: M2060***		
Power Rating	: AC 230V/50Hz		
Test Mode	: Running "H" Pattern		
	VGA:640*480@60Hz		
	1.5m Power Cable+1.5m VGA Cable		
	VGA Without Core		

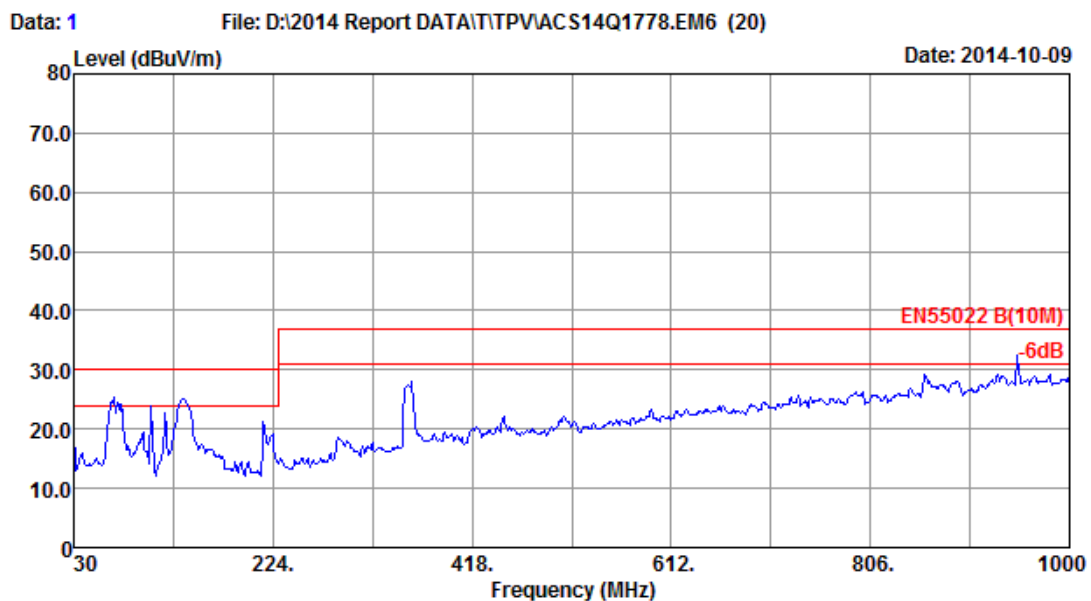

Site no.	: 10m Chamber	Data No.	: 1
Dis. / Ant.	: 10m 2014 9168-493	Ant. pol.	: VERTICAL
Limit	: EN55022 B(10M)	Pre	: 101.5kPa
Env. / Ins.	: 23.5°C/48%	Engineer	: ELLIS
EUT	: M2060***		
Power Rating	: AC 230V/50Hz		
Test Mode	: Running "H" Pattern		
	VGA:640*480@60Hz		
	1.5m Power Cable+1.5m VGA Cable		
	VGA Without Core		

Data: 4 File: D:\2014 Report DATA\TTPV\ACS14Q1778.EM6 (20) Date: 2014-10-09

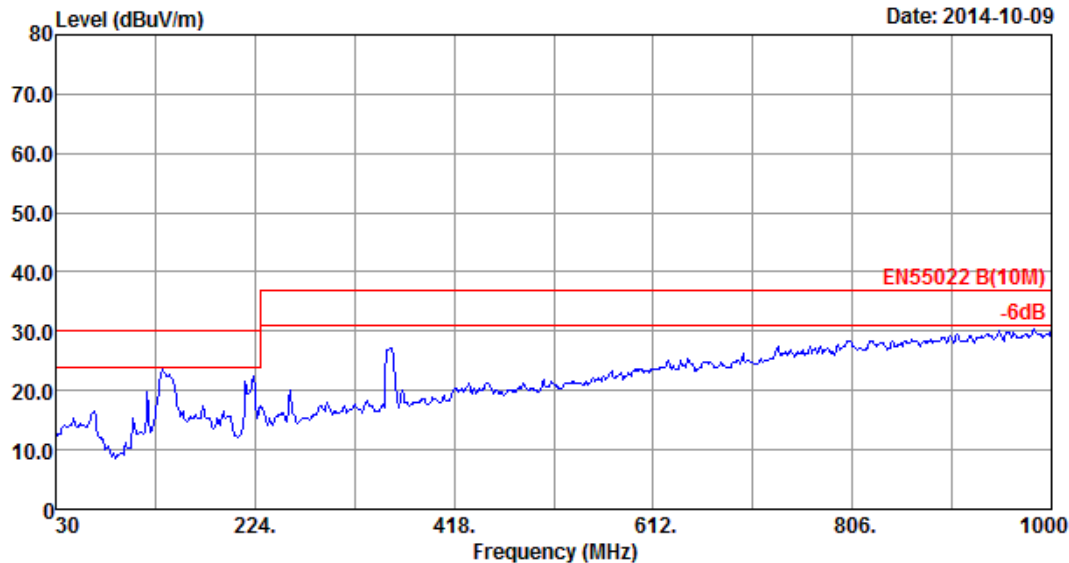

Site no. : 10m Chamber	Data No. : 4
Dis. / Ant. : 10m 2013 9168-429	Ant. pol. : HORIZONTAL
Limit : EN55022 B(10M)	Pre : 101.5kPa
Env. / Ins. : 23.5°C/48%	Engineer : ELLIS
EUT : M2060***	
Power Rating : AC 230V/50Hz	
Test Mode : Running "H" Pattern	
VGA:1280*1024@60Hz	
1.5m Power Cable+1.5m VGA Cable	
VGA Without Core	

Data: 3 File: D:\2014 Report DATA\TTPV\ACS14Q1778.EM6 (20)

Date: 2014-10-09

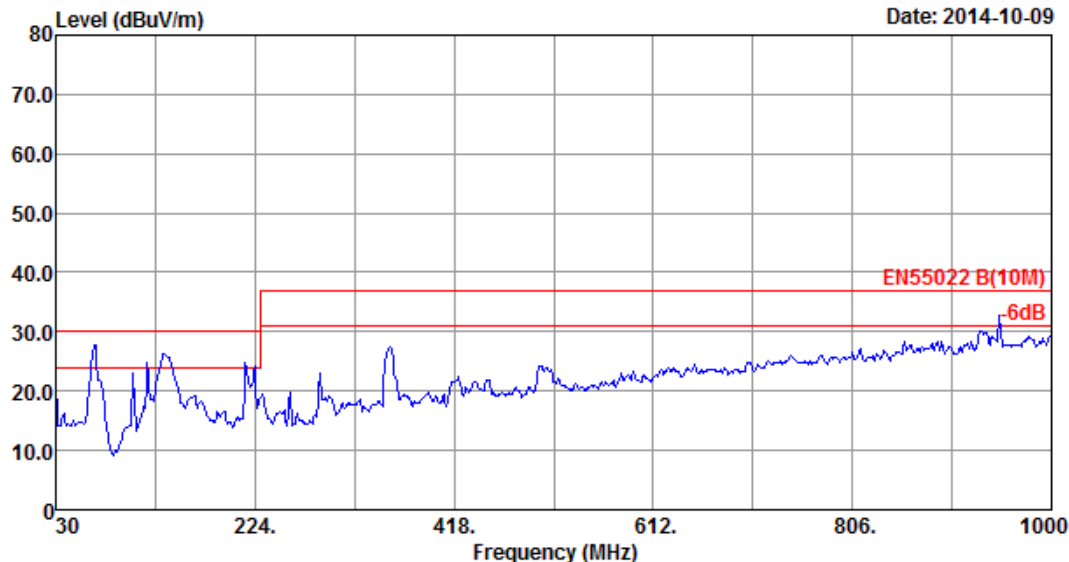

Site no. : 10m Chamber	Data No. : 3
Dis. / Ant. : 10m 2014 9168-493	Ant. pol. : VERTICAL
Limit : EN55022 B(10M)	Pre : 101.5kPa
Env. / Ins. : 23.5°C/48%	Engineer : ELLIS
EUT : M2060***	
Power Rating : AC 230V/50Hz	
Test Mode : Running "H" Pattern	
VGA:1280*1024@60Hz	
1.5m Power Cable+1.5m VGA Cable	
VGA Without Core	

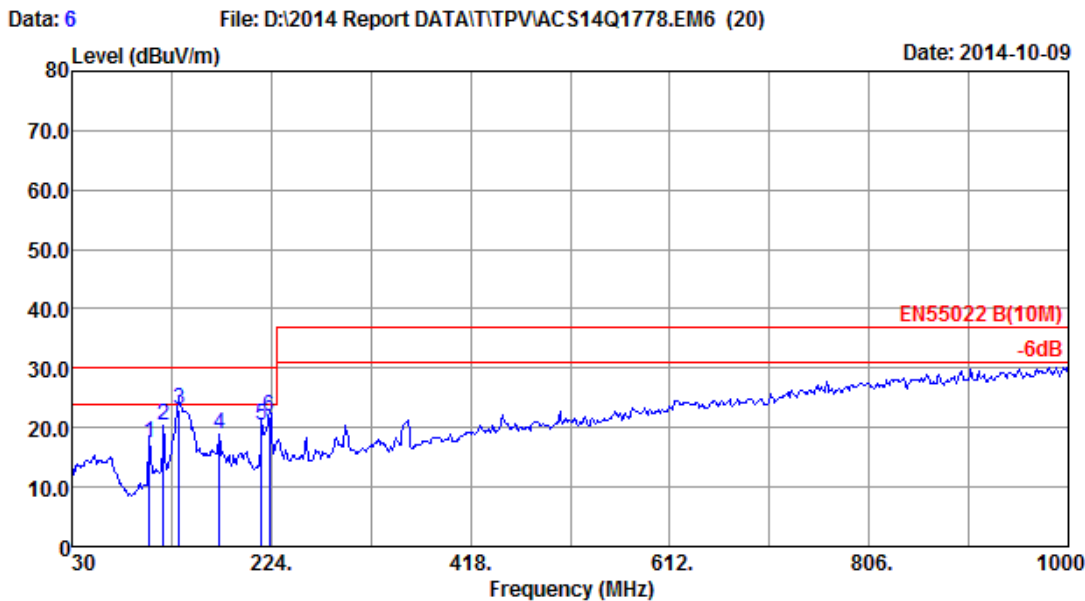

```

Site no.      : 10m Chamber           Data No.   : 6
Dis. / Ant.   : 10m 2013 9168-429    Ant. pol.  : HORIZONTAL
Limit        : EN55022 B(10M)        Pre       : 101.5kPa
Env. / Ins.   : 23.5*C/48%          Engineer  : ELLIS
EUT          : M2060***
Power Rating  : AC 230V/50Hz
Test Mode    : Running "H" Pattern
              VGA:1920*1080@60Hz
              1.5m Power Cable+1.5m VGA Cable
              VGA Without Core
    
```

	Freq. (MHz)	Ant. Factor (dB/m)	Cable Loss (dB)	Reading (dBuV)	Emission Level dBuV/m)	Limits (dBuV/m)	Margin (dB)	Remark
1	105.660	10.13	1.11	6.23	17.47	30.00	12.53	QP
2	119.240	11.02	1.19	8.16	20.37	30.00	9.63	QP
3	134.760	12.41	1.27	9.43	23.11	30.00	6.89	QP
4	173.560	12.37	1.43	5.02	18.82	30.00	11.18	QP
5	214.300	9.79	1.56	8.94	20.29	30.00	9.71	QP
6	222.060	9.94	1.58	10.35	21.87	30.00	8.13	QP

- Remarks:
1. Emission Level= Antenna Factor + Cable Loss + Reading.
 2. The emission levels that are 20dB below the official limit are not reported.
 3. The worst emission was detected at 134.760 MHz with corrected signal level of 23.11 dBuV/m (Limit is 30.00dBuV/m) when the antenna was at horizontal polarization and at 4.0m high and the turn table was at 144°.
 4. 0° was the table front facing the antenna. Degree is calculated from 0° clockwise facing the antenna.

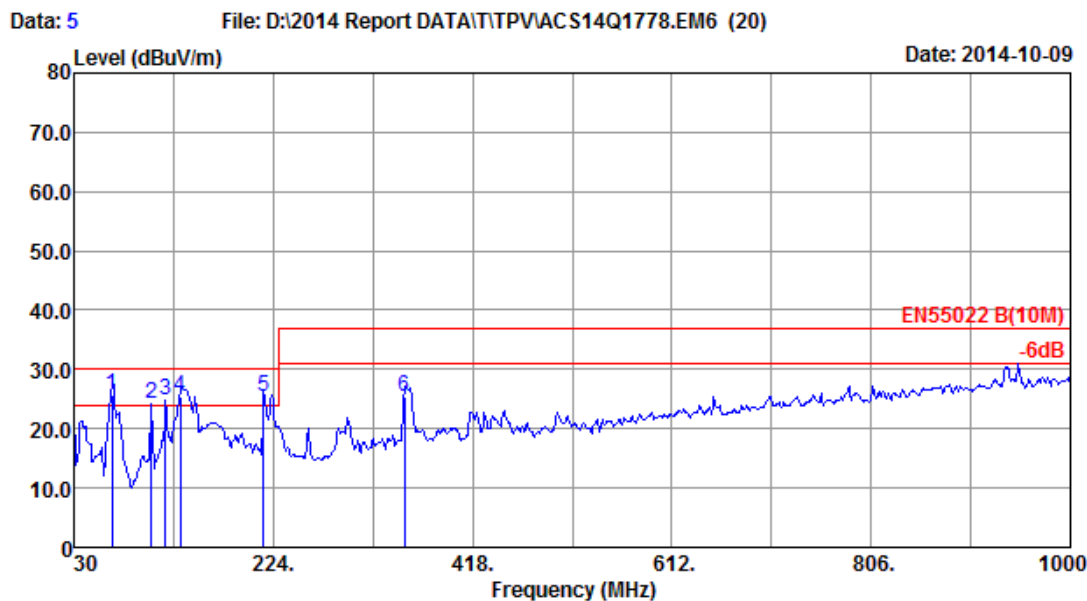

Site no. : 10m Chamber Data No. : 5
 Dis. / Ant. : 10m 2014 9168-493 Ant. pol. : VERTICAL
 Limit : EN55022 B(10M) Pre : 101.5kPa
 Env. / Ins. : 23.5°C/48% Engineer : ELLIS
 EUT : M2060***
 Power Rating : AC 230V/50Hz
 Test Mode : Running "H" Pattern
 VGA:1920*1080@60Hz
 1.5m Power Cable+1.5m VGA Cable
 VGA Without Core

	Freq. (MHz)	Ant. Factor (dB/m)	Cable Loss (dB)	Reading (dBuV)	Emission Level dBuV/m)	Limits (dBuV/m)	Margin (dB)	Remark
1	66.900	12.47	1.11	12.10	25.68	30.00	4.32	QP
2	105.660	9.73	1.37	13.04	24.14	30.00	5.86	QP
3	119.240	10.76	1.43	12.64	24.83	30.00	5.17	QP
4	133.450	12.27	1.49	11.70	25.46	30.00	4.54	QP
5	214.800	9.90	1.74	13.60	25.24	30.00	4.76	QP
6	352.040	14.40	2.07	8.79	25.26	37.00	11.74	QP

- Remarks:
1. Emission Level= Antenna Factor + Cable Loss + Reading.
 2. The emission levels that are 20dB below the official limit are not reported.
 3. The worst emission was detected at 66.900 MHz with corrected signal level of 25.68 dBμV/m (Limit is 30.00dBμV/m) when the antenna was at vertical polarization and at 1.0m high and the turn table was at 348°.
 4. 0° was the table front facing the antenna. Degree is calculated from 0° clockwise facing the antenna.

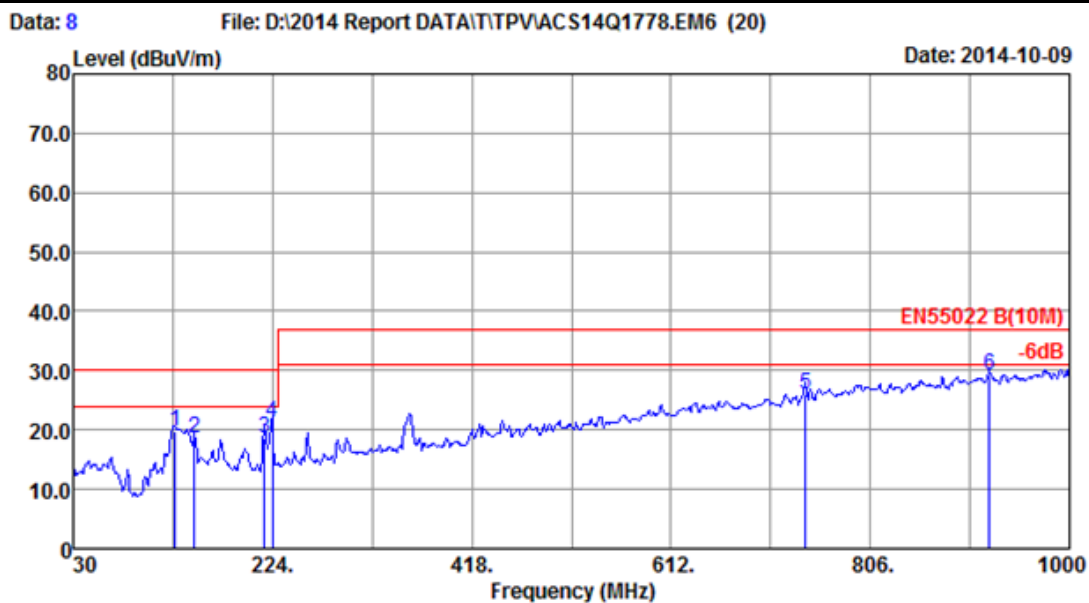

Site no.	: 10m Chamber	Data No.	: 8
Dis. / Ant.	: 10m 2013 9168-429	Ant. pol.	: HORIZONTAL
Limit	: EN55022 B(10M)	Pre	: 101.5kPa
Env. / Ins.	: 23.5°C/48%	Engineer	: ELLIS
EUT	: M2060***		
Power Rating	: AC 230V/50Hz		
Test Mode	: Running "H" Pattern		
	VGA:1920*1080@60Hz		
	1.2m Power Cable+1.5m VGA Cable		
	VGA Without Core		

	Freq. (MHz)	Ant. Factor (dB/m)	Cable Loss (dB)	Reading (dBuV)	Emission Level dBuV/m)	Limits (dBuV/m)	Margin (dB)	Remark
1	128.940	11.80	1.24	6.75	19.79	30.00	10.21	QP
2	148.340	13.43	1.33	3.96	18.72	30.00	11.28	QP
3	216.240	9.82	1.56	7.21	18.59	30.00	11.41	QP
4	224.000	9.98	1.59	9.83	21.40	30.00	8.60	QP
5	742.950	21.86	3.42	0.77	26.05	37.00	10.95	QP
6	922.400	23.85	4.00	1.32	29.17	37.00	7.83	QP

Remarks: 1. Emission Level= Antenna Factor + Cable Loss + Reading.
 2. The emission levels that are 20dB below the official limit are not reported.

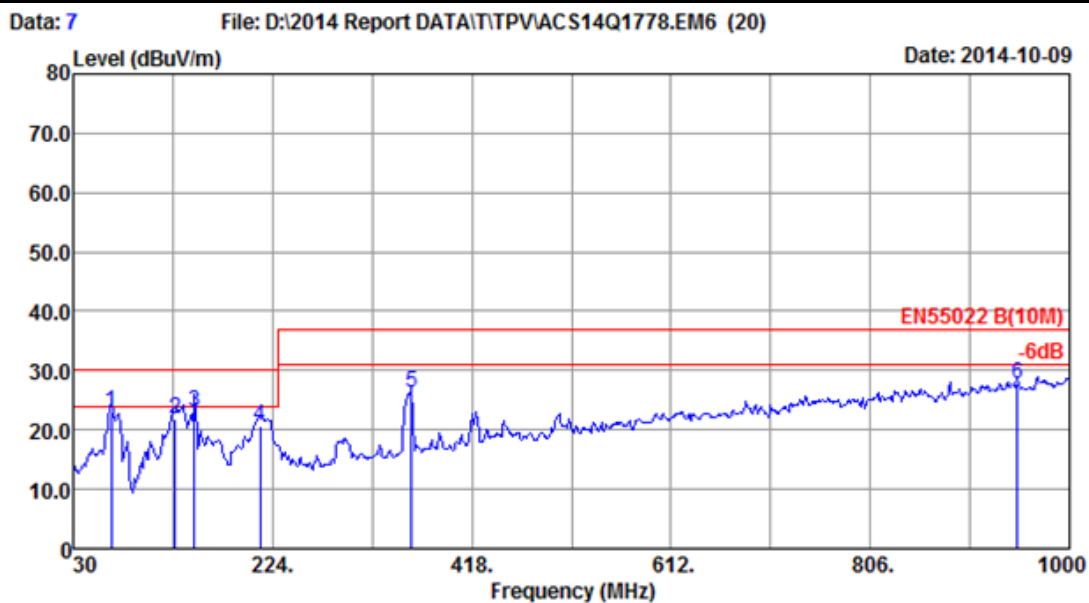

Site no. : 10m Chamber Data No. : 7
 Dis. / Ant. : 10m 2014 9168-493 Ant. pol. : VERTICAL
 Limit : EN55022 B(10M) Pre : 101.5kPa
 Env. / Ins. : 23.5°C/48% Engineer : ELLIS
 EUT : M2060***
 Power Rating : AC 230V/50Hz
 Test Mode : Running "H" Pattern
 VGA:1920*1080@60Hz
 1.2m Power Cable+1.5m VGA Cable
 VGA Without Core

	Freq. (MHz)	Ant. Factor (dB/m)	Cable Loss (dB)	Reading (dBuV)	Emission Level dBuV/m)	Limits (dBuV/m)	Margin (dB)	Remark
1	66.860	12.48	1.11	9.53	23.12	30.00	6.88	QP
2	128.940	11.75	1.47	8.64	21.86	30.00	8.14	QP
3	148.340	13.53	1.55	7.99	23.07	30.00	6.93	QP
4	212.360	9.98	1.74	8.85	20.57	30.00	9.43	QP
5	359.800	14.69	2.09	9.63	26.41	37.00	10.59	QP
6	949.560	24.20	3.47	0.21	27.88	37.00	9.12	QP

Remarks: 1. Emission Level= Antenna Factor + Cable Loss + Reading.
 2. The emission levels that are 20dB below the official limit are not reported.

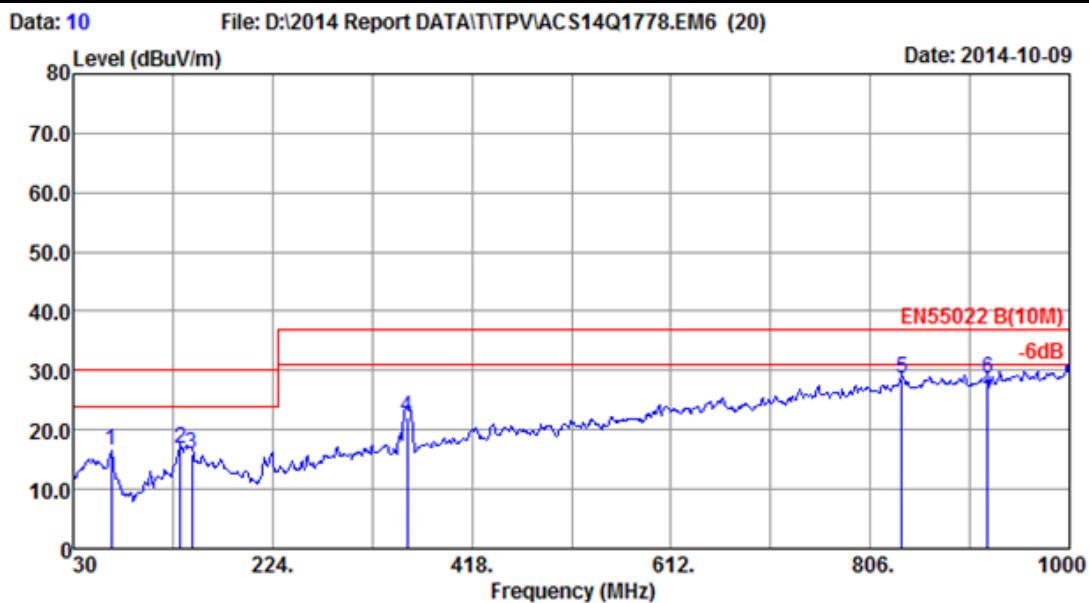

Site no.	: 10m Chamber	Data No.	: 10
Dis. / Ant.	: 10m 2013 9168-429	Ant. pol.	: HORIZONTAL
Limit	: EN55022 B(10M)	Pre	: 101.5kPa
Env. / Ins.	: 23.5°C/48%	Engineer	: ELLIS
EUT	: M2060***		
Power Rating	: AC 230V/50Hz		
Test Mode	: Running "H" Pattern		
	VGA:1920*1080@60Hz		
	1.5m Power Cable+1.2m VGA Cable		
	VGA Without Core		

	Freq. (MHz)	Ant. Factor (dB/m)	Cable Loss (dB)	Reading (dBuV)	Emission Level dBuV/m)	Limits (dBuV/m)	Margin (dB)	Remark
1	66.860	12.28	0.94	3.19	16.41	30.00	13.59	QP
2	134.760	12.41	1.27	3.05	16.73	30.00	13.27	QP
3	145.430	13.44	1.32	1.31	16.07	30.00	13.93	QP
4	354.950	15.10	1.99	5.19	22.28	37.00	14.72	QP
5	837.040	22.70	3.73	2.11	28.54	37.00	8.46	QP
6	920.460	23.81	3.99	0.96	28.76	37.00	8.24	QP

Remarks: 1. Emission Level= Antenna Factor + Cable Loss + Reading.
 2. The emission levels that are 20dB below the official limit are not reported.

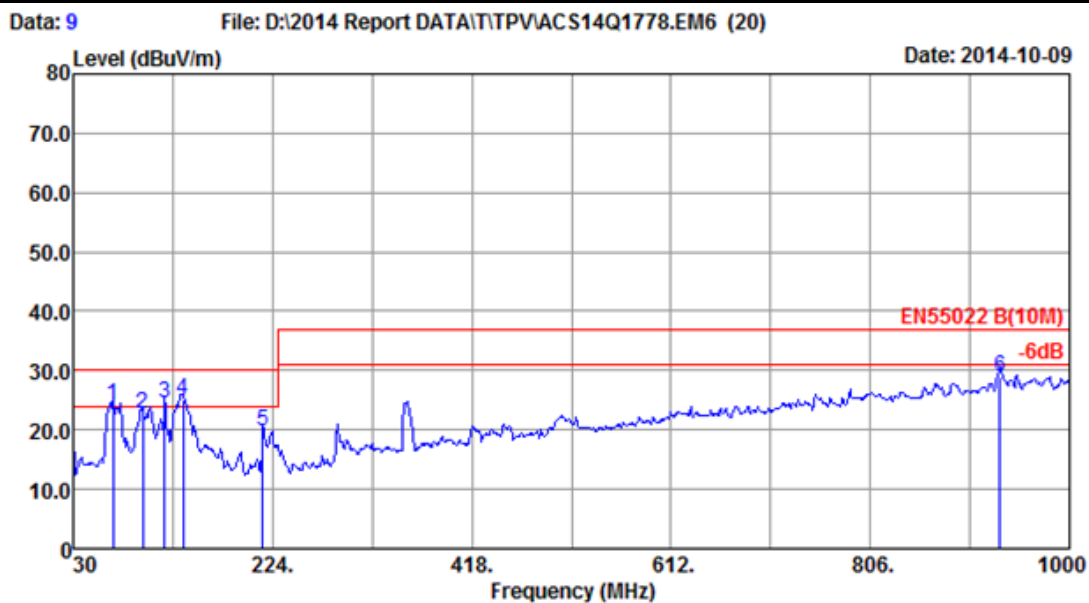

Site no. : 10m Chamber	Data No. : 9
Dis. / Ant. : 10m 2014 9168-493	Ant. pol. : VERTICAL
Limit : EN55022 B(10M)	Pre : 101.5kPa
Env. / Ins. : 23.5°C/48%	Engineer : ELLIS
EUT : M2060***	
Power Rating : AC 230V/50Hz	
Test Mode : Running "H" Pattern	
VGA:1920*1080@60Hz	
1.5m Power Cable+1.2m VGA Cable	
VGA Without Core	

	Freq. (MHz)	Ant. Factor (dB/m)	Cable Loss (dB)	Reading (dBUV)	Emission Level (dBUV/m)	Limits (dBUV/m)	Margin (dB)	Remark
1	68.800	12.08	1.12	11.08	24.28	30.00	5.72	QP
2	97.900	8.59	1.33	12.95	22.87	30.00	7.13	QP
3	119.240	10.76	1.43	12.40	24.59	30.00	5.41	QP
4	136.700	12.67	1.51	10.84	25.02	30.00	4.98	QP
5	214.300	9.90	1.74	8.27	19.91	30.00	10.09	QP
6	932.100	24.04	3.43	1.52	28.99	37.00	8.01	QP

Remarks: 1. Emission Level= Antenna Factor + Cable Loss + Reading.
 2. The emission levels that are 20dB below the official limit are not reported.

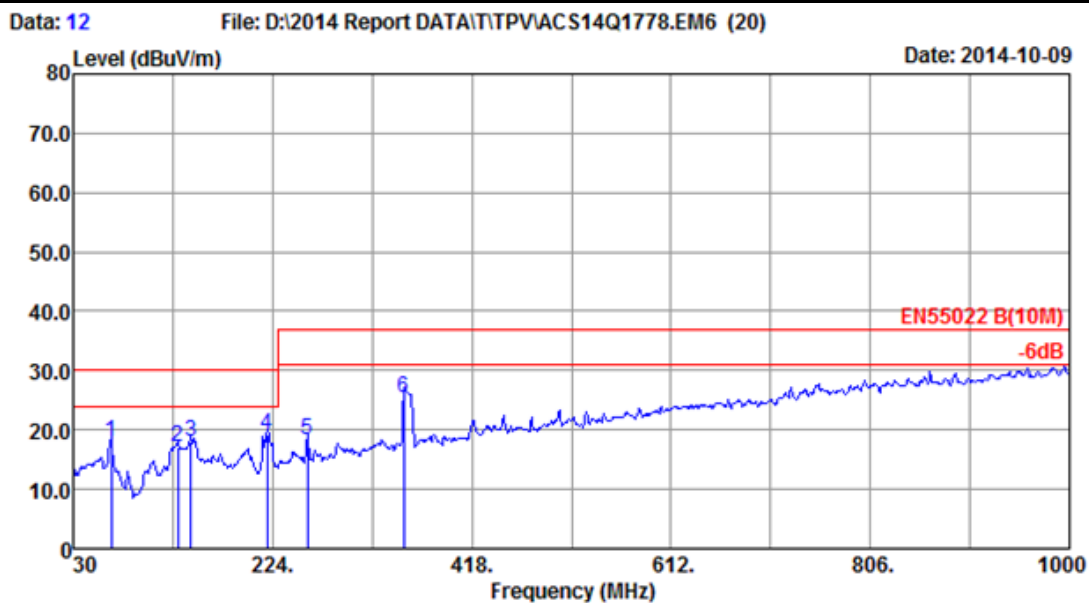

Site no.	: 10m Chamber	Data No.	: 12
Dis. / Ant.	: 10m 2013 9168-429	Ant. pol.	: HORIZONTAL
Limit	: EN55022 B(10M)	Pre	: 101.5kPa
Env. / Ins.	: 23.5°C/48%	Engineer	: ELLIS
EUT	: M2060***		
Power Rating	: AC 230V/50Hz		
Test Mode	: Running "H" Pattern		
	VGA:1920*1080@60Hz		
	1.5m Power Cable+1.5m VGA Cable		

	Freq. (MHz)	Ant. Factor (dB/m)	Cable Loss (dB)	Reading (dBuV)	Emission Level dBuV/m)	Limits (dBuV/m)	Margin (dB)	Remark
1	66.860	12.28	0.94	4.75	17.97	30.00	12.03	QP
2	131.850	12.17	1.25	3.71	17.13	30.00	12.87	QP
3	144.460	13.35	1.31	3.26	17.92	30.00	12.08	QP
4	219.150	9.88	1.57	7.74	19.19	30.00	10.81	QP
5	257.950	12.16	1.68	4.38	18.22	37.00	18.78	QP
6	352.040	14.98	1.98	8.33	25.29	37.00	11.71	QP

Remarks: 1. Emission Level= Antenna Factor + Cable Loss + Reading.
 2. The emission levels that are 20dB below the official limit are not reported.

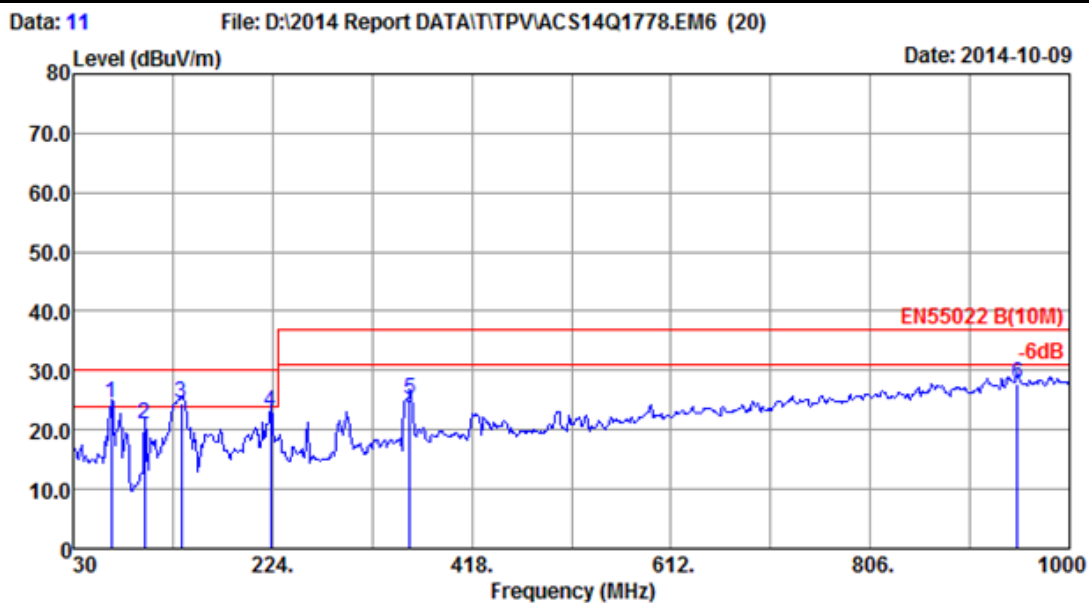

Site no.	: 10m Chamber	Data No.	: 11
Dis. / Ant.	: 10m 2014 9168-493	Ant. pol.	: VERTICAL
Limit	: EN55022 B(10M)	Pre	: 101.5kPa
Env. / Ins.	: 23.5°C/48%	Engineer	: ELLIS
EUT	: M2060***		
Power Rating	: AC 230V/50Hz		
Test Mode	: Running "H" Pattern		
	VGA:1920*1080@60Hz		
	1.5m Power Cable+1.5m VGA Cable		

	Freq. (MHz)	Ant. Factor (dB/m)	Cable Loss (dB)	Reading (dBuV)	Emission Level dBuV/m)	Limits (dBuV/m)	Margin (dB)	Remark
1	66.800	12.50	1.11	10.90	24.51	30.00	5.49	QP
2	99.840	8.69	1.34	10.80	20.83	30.00	9.17	QP
3	134.960	12.44	1.50	10.50	24.44	30.00	5.56	QP
4	222.060	9.70	1.76	11.62	23.08	30.00	6.92	QP
5	357.860	14.57	2.09	8.29	24.95	37.00	12.05	QP
6	949.560	24.20	3.47	0.21	27.88	37.00	9.12	QP

Remarks: 1. Emission Level= Antenna Factor + Cable Loss + Reading.
 2. The emission levels that are 20dB below the official limit are not reported.

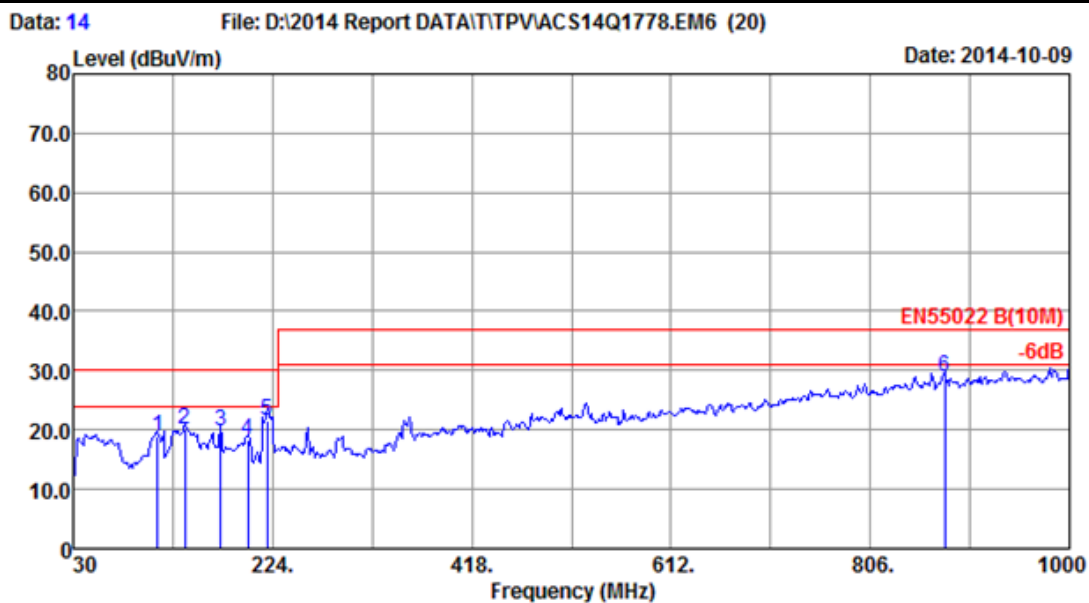

Site no.	: 10m Chamber	Data No.	: 14
Dis. / Ant.	: 10m 2013 9168-429	Ant. pol.	: HORIZONTAL
Limit	: EN55022 B(10M)	Pre	: 101.5kPa
Env. / Ins.	: 23.5°C/48%	Engineer	: ELLIS
EUT	: M2060***		
Power Rating	: AC 230V/50Hz		
Test Mode	: Running "H" Pattern		
	VGA:1920*1080@60Hz		
	1.5m Power Cable+1.2m VGA Cable		

	Freq. (MHz)	Ant. Factor (dB/m)	Cable Loss (dB)	Reading (dBuV)	Emission Level dBuV/m)	Limits (dBuV/m)	Margin (dB)	Remark
1	112.450	10.70	1.15	6.90	18.75	30.00	11.25	QP
2	138.640	12.86	1.29	5.97	20.12	30.00	9.88	QP
3	173.560	12.37	1.43	6.05	19.85	30.00	10.15	QP
4	199.750	10.02	1.51	6.74	18.27	30.00	11.73	QP
5	219.150	9.88	1.57	10.07	21.52	30.00	8.48	QP
6	878.750	22.92	3.87	2.16	28.95	37.00	8.05	QP

Remarks: 1. Emission Level= Antenna Factor + Cable Loss + Reading.
 2. The emission levels that are 20dB below the official limit are not reported.

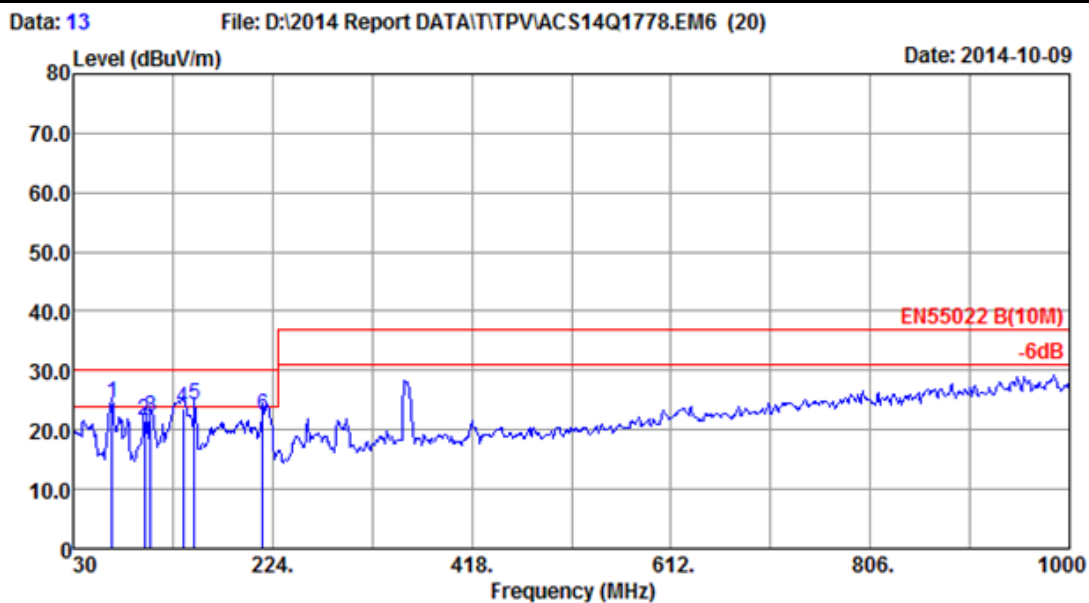

Site no.	: 10m Chamber	Data No.	: 13
Dis. / Ant.	: 10m 2014 9168-493	Ant. pol.	: VERTICAL
Limit	: EN55022 B(10M)	Pre	: 101.5kPa
Env. / Ins.	: 23.5°C/48%	Engineer	: ELLIS
EUT	: M2060***		
Power Rating	: AC 230V/50Hz		
Test Mode	: Running "H" Pattern		
	VGA:1920*1080@60Hz		
	1.5m Power Cable+1.2m VGA Cable		

	Freq. (MHz)	Ant. Factor (dB/m)	Cable Loss (dB)	Reading (dBuV)	Emission Level (dBuV/m)	Limits (dBuV/m)	Margin (dB)	Remark
1	67.830	12.24	1.12	11.16	24.52	30.00	5.48	QP
2	99.840	8.69	1.34	11.65	21.68	30.00	8.32	QP
3	105.660	9.73	1.37	10.91	22.01	30.00	7.99	QP
4	136.700	12.67	1.51	9.43	23.61	30.00	6.39	QP
5	148.340	13.53	1.55	9.19	24.27	30.00	5.73	QP
6	214.300	9.90	1.74	10.93	22.57	30.00	7.43	QP

Remarks: 1. Emission Level= Antenna Factor + Cable Loss + Reading.
 2. The emission levels that are 20dB below the official limit are not reported.

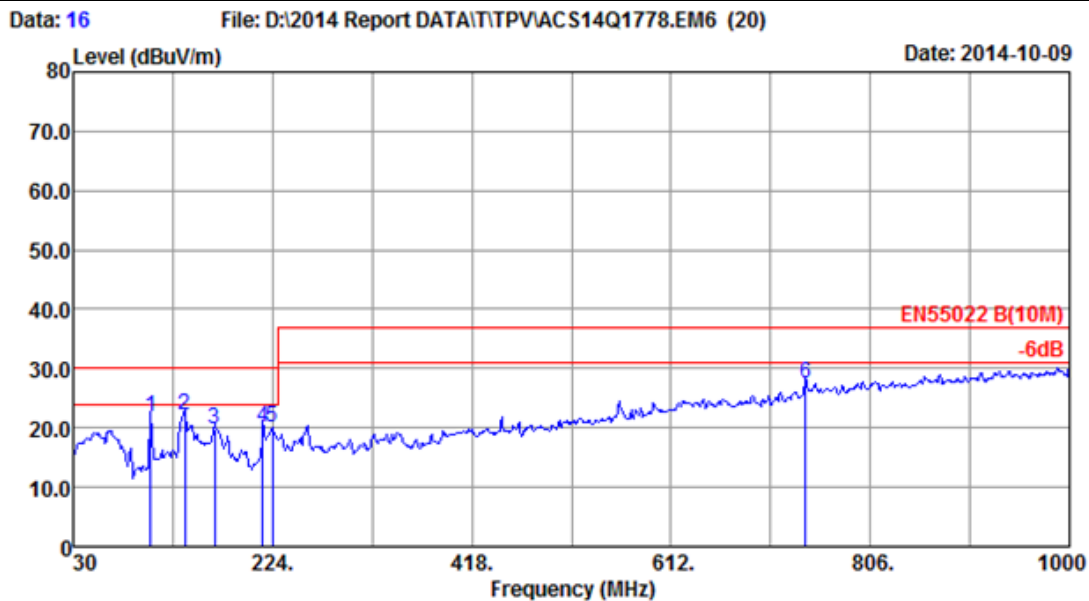

Site no.	: 10m Chamber	Data No.	: 16
Dis. / Ant.	: 10m 2013 9168-429	Ant. pol.	: HORIZONTAL
Limit	: EN55022 B(10M)	Pre	: 101.5kPa
Env. / Ins.	: 23.5°C/48%	Engineer	: ELLIS
EUT	: M2060***		
Power Rating	: AC 230V/50Hz		
Test Mode	: Running "H" Pattern		
	DVI:1920*1080@60Hz		
	1.5m Power Cable+1.5m DVI Cable		

	Freq. (MHz)	Ant. Factor (dB/m)	Cable Loss (dB)	Reading (dBuV)	Emission Level dBuV/m)	Limits (dBuV/m)	Margin (dB)	Remark
1	105.660	10.13	1.11	10.60	21.84	30.00	8.16	QP
2	138.640	12.86	1.29	7.94	22.09	30.00	7.91	QP
3	167.740	12.91	1.40	5.42	19.73	30.00	10.27	QP
4	214.300	9.79	1.56	8.84	20.19	30.00	9.81	QP
5	224.000	9.98	1.59	8.56	20.13	30.00	9.87	QP
6	742.950	21.86	3.42	2.25	27.53	37.00	9.47	QP

Remarks: 1. Emission Level= Antenna Factor + Cable Loss + Reading.
 2. The emission levels that are 20dB below the official limit are not reported.

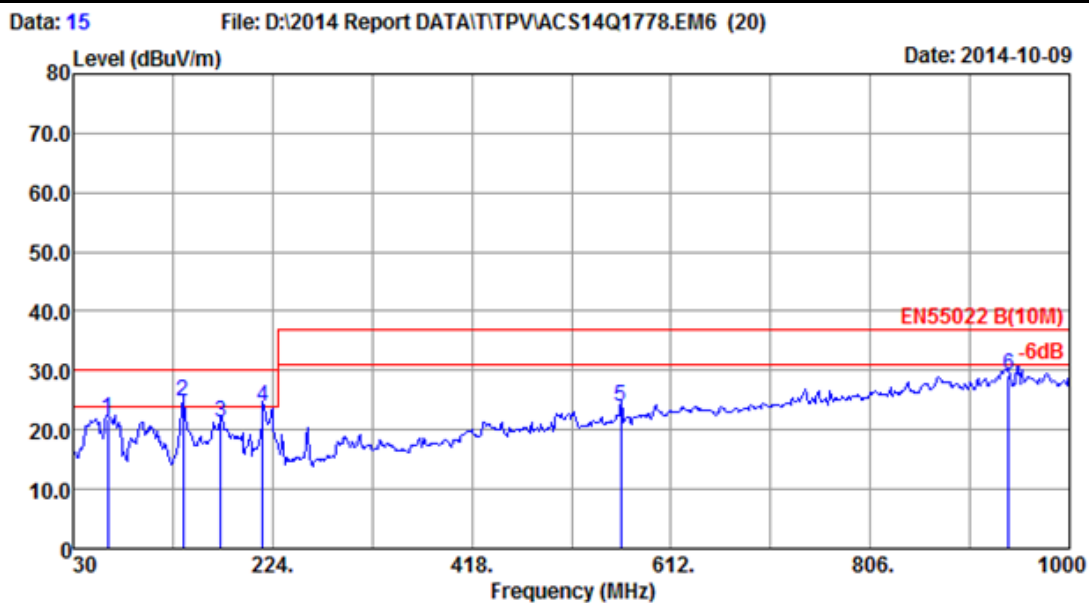

Site no.	: 10m Chamber	Data No.	: 15
Dis. / Ant.	: 10m 2014 9168-493	Ant. pol.	: VERTICAL
Limit	: EN55022 B(10M)	Pre	: 101.5kPa
Env. / Ins.	: 23.5°C/48%	Engineer	: ELLIS
EUT	: M2060***		
Power Rating	: AC 230V/50Hz		
Test Mode	: Running "H" Pattern		
	DVI:1920*1080@60Hz		
	1.5m Power Cable+1.5m DVI Cable		

	Freq. (MHz)	Ant. Factor (dB/m)	Cable Loss (dB)	Reading (dBUV)	Emission Level dBUV/m)	Limits (dBUV/m)	Margin (dB)	Remark
1	63.950	12.91	1.08	7.81	21.80	30.00	8.20	QP
2	136.700	12.67	1.51	10.50	24.68	30.00	5.32	QP
3	173.560	12.44	1.63	7.18	21.25	30.00	8.75	QP
4	214.300	9.90	1.74	12.23	23.87	30.00	6.13	QP
5	563.500	18.97	2.59	2.27	23.83	37.00	13.17	QP
6	940.830	24.12	3.45	1.66	29.23	37.00	7.77	QP

Remarks: 1. Emission Level= Antenna Factor + Cable Loss + Reading.
 2. The emission levels that are 20dB below the official limit are not reported.

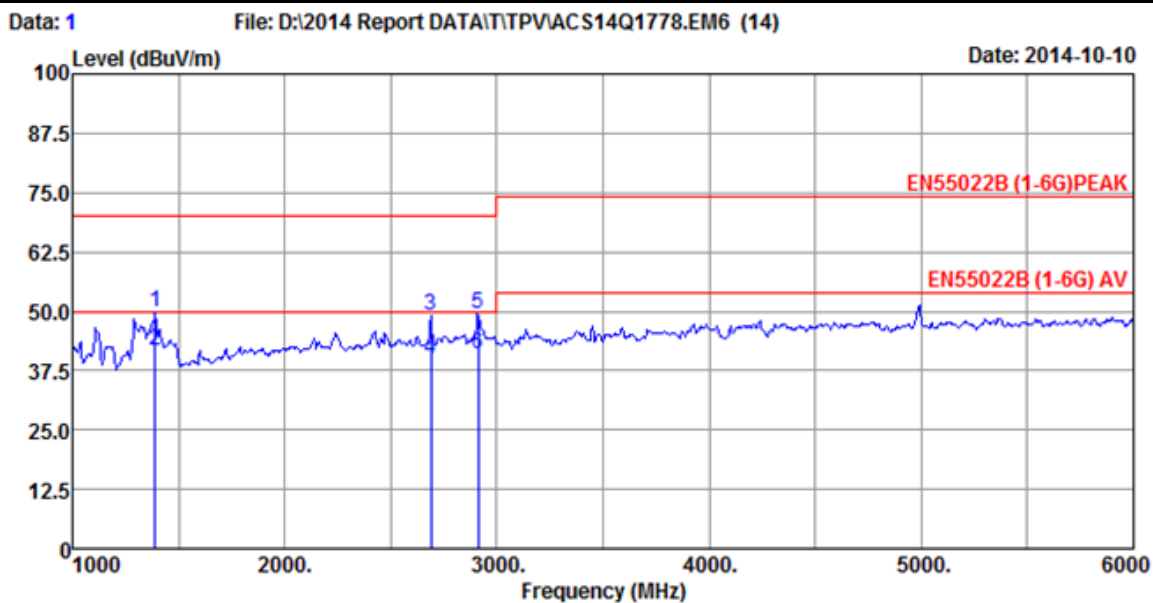

Site no.	: 10m Chamber	Data No.	: 1
Dis. / Ant.	: 3m 2014 3115 4580	Ant. pol.	: HORIZONTAL
Limit	: EN55022B (1-6G) PEAK	Pre	: 101.7kPa
Env. / Ins.	: 21.2°C/48.4%	Engineer	: Bery_Guo
EUT	: M2060***		
Power Rating	: AC 230V/50Hz		
Test Mode	: Running 'H' Pattern		
	VGA:1280*10240@75Hz		
	1.5m Power Cable+1.5m VGA Cable		
	VGA Without Core		

Freq. (MHz)	Ant. Factor (dB/m)	Cable Loss (dB)	Amp Factor (dB)	Reading (dBUV)	Emission			Remark
					Level (dBUV/m)	Limits (dBUV/m)	Magin (dB)	
1 1390.659	25.47	2.12	35.40	57.54	49.73	70.00	20.27	Peak
2 1391.547	25.47	2.12	35.40	49.41	41.60	50.00	8.40	Average
3 2690.974	29.13	3.55	34.85	51.37	49.20	70.00	20.80	Peak
4 2691.415	29.14	3.55	34.85	42.15	39.99	50.00	10.01	Average
5 2910.635	29.75	3.65	34.89	51.03	49.54	70.00	20.46	Peak
6 2911.244	29.75	3.65	34.89	42.50	41.01	50.00	8.99	Average

Remarks: 1. Emission Level= Antenna Factor + Cable Loss + Reading-Amp Factor (Peak/Average).
 2. The emission levels that are 20dB below the official limit are not reported.

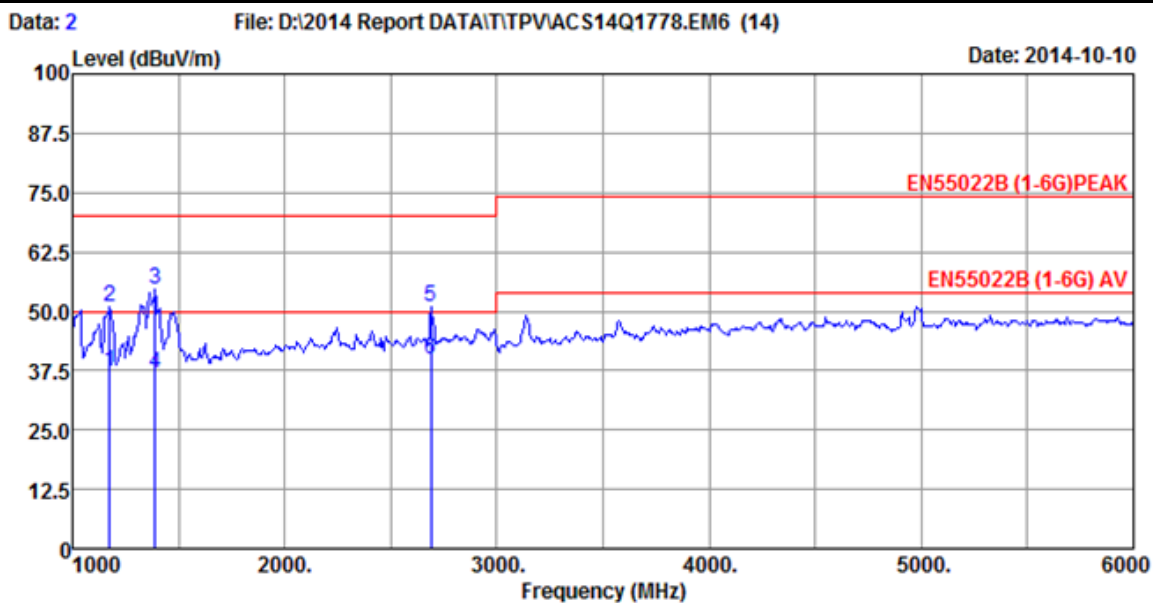

Site no.	: 10m Chamber	Data No.	: 2
Dis. / Ant.	: 3m 2014 3115 4580	Ant. pol.	: VERTICAL
Limit	: EN55022B (1-6G) PEAK	Pre	: 101.7kPa
Env. / Ins.	: 21.2°C/48.4%	Engineer	: Bery_Guo
EUT	: M2060***		
Power Rating	: AC 230V/50Hz		
Test Mode	: Running 'H' Pattern		
	VGA:1280*1024@75Hz		
	1.5m Power Cable+1.5m VGA Cable		
	VGA Without Core		

Freq. (MHz)	Ant. Factor (dB/m)	Cable Loss (dB)	Amp Factor (dB)	Reading (dBuV)	Emission		Magin (dB)	Remark
					Level (dBuV/m)	Limits (dBuV/m)		
1 1174.714	25.60	1.89	35.71	45.56	37.34	50.00	12.66	Average
2 1175.968	25.59	1.89	35.71	59.01	50.78	70.00	19.22	Peak
3 1390.735	25.47	2.12	35.40	62.37	54.56	70.00	15.44	Peak
4 1391.124	25.47	2.12	35.40	44.57	36.76	50.00	13.24	Average
5 2690.652	29.13	3.55	34.85	53.24	51.07	70.00	18.93	Peak
6 2691.254	29.14	3.55	34.85	42.17	40.01	50.00	9.99	Average

Remarks: 1. Emission Level= Antenna Factor + Cable Loss + Reading-Amp Factor (Peak/Average).
 2. The emission levels that are 20dB below the official limit are not reported.

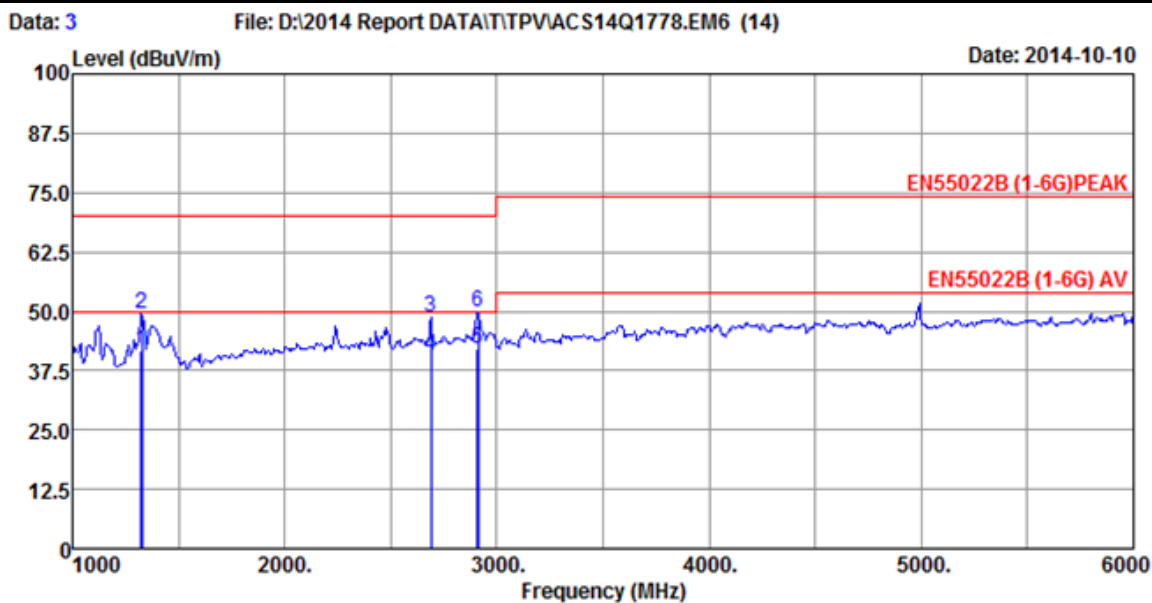

Site no.	: 10m Chamber	Data No.	: 3
Dis. / Ant.	: 3m 2014 3115 4580	Ant. pol.	: HORIZONTAL
Limit	: EN55022B (1-6G) PEAK	Pre	: 101.7kPa
Env. / Ins.	: 21.2°C/48.4%	Engineer	: Bery_Guo
EUT	: M2060***		
Power Rating	: AC 230V/50Hz		
Test Mode	: Running 'H' Pattern		
	VGA:1920*1080@60Hz		
	1.5m Power Cable+1.5m VGA Cable		
	VGA Without Core		

Freq. (MHz)	Ant. Factor (dB/m)	Cable Loss (dB)	Amp Factor (dB)	Reading (dBuV)	Emission		Magin (dB)	Remark
					Level (dBuV/m)	Limits (dBuV/m)		
1 1324.254	25.51	2.05	35.49	49.68	41.75	50.00	8.25	Average
2 1325.975	25.50	2.06	35.49	57.34	49.41	70.00	20.59	Peak
3 2690.854	29.13	3.55	34.85	51.05	48.88	70.00	21.12	Peak
4 2691.124	29.14	3.55	34.85	42.57	40.41	50.00	9.59	Average
5 2909.741	29.75	3.64	34.89	43.59	42.09	50.00	7.91	Average
6 2910.659	29.75	3.65	34.89	51.46	49.97	70.00	20.03	Peak

Remarks: 1. Emission Level= Antenna Factor + Cable Loss + Reading-Amp Factor (Peak/Average).
 2. The emission levels that are 20dB below the official limit are not reported.

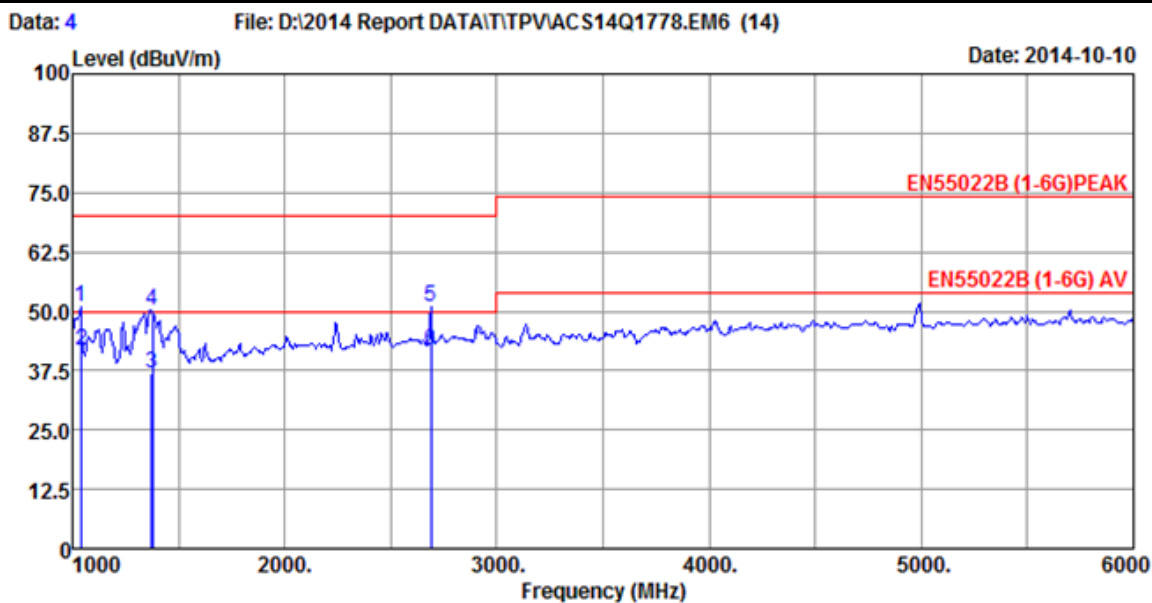

Site no.	: 10m Chamber	Data No.	: 4
Dis. / Ant.	: 3m 2014 3115 4580	Ant. pol.	: VERTICAL
Limit	: EN55022B (1-6G) PEAK	Pre	: 101.7kPa
Env. / Ins.	: 21.2°C/48.4%	Engineer	: Bery_Guo
EUT	: M2060***		
Power Rating	: AC 230V/50Hz		
Test Mode	: Running 'H' Pattern		
	VGA:1920*1080@60Hz		
	1.5m Power Cable+1.5m VGA Cable		
	VGA Without Core		

Freq. (MHz)	Ant. Factor (dB/m)	Cable Loss (dB)	Amp Factor (dB)	Reading (dBuV)	Emission		Magin (dB)	Remark
					Level (dBuV/m)	Limits (dBuV/m)		
1 1040.795	25.68	1.72	35.94	59.29	50.75	70.00	19.25	Peak
2 1041.326	25.68	1.72	35.94	50.27	41.73	50.00	8.27	Average
3 1374.968	25.48	2.11	35.42	44.56	36.73	50.00	13.27	Average
4 1375.857	25.47	2.11	35.42	58.16	50.32	70.00	19.68	Peak
5 2690.635	29.13	3.55	34.85	53.10	50.93	70.00	19.07	Peak
6 2691.415	29.14	3.55	34.85	43.71	41.55	50.00	8.45	Average

Remarks: 1. Emission Level= Antenna Factor + Cable Loss + Reading-Amp Factor (Peak/Average).
 2. The emission levels that are 20dB below the official limit are not reported.

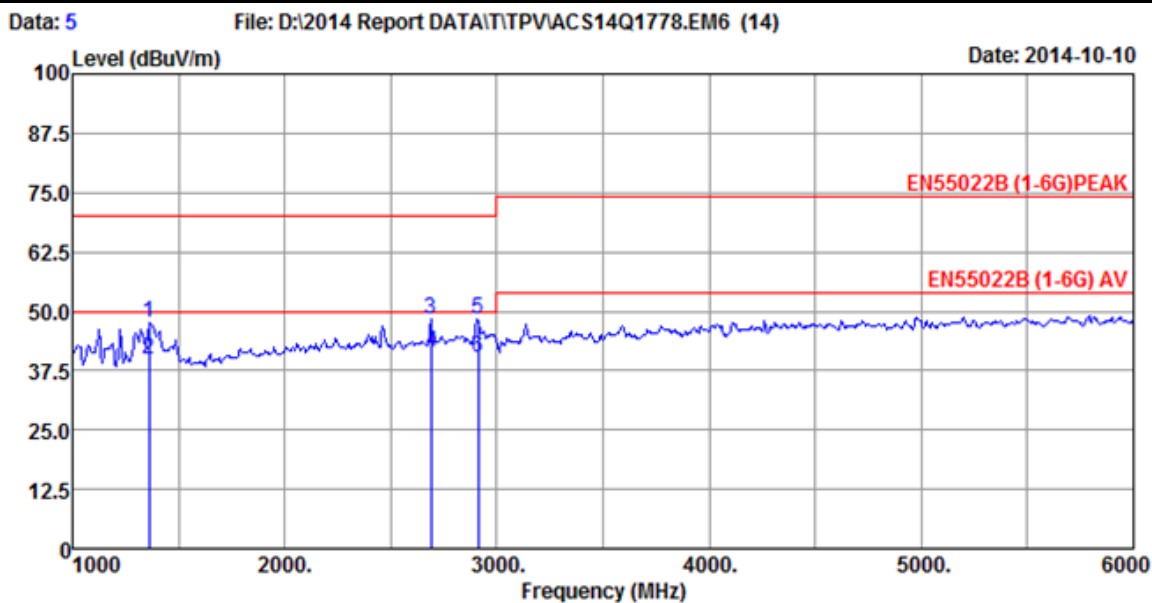

Site no.	: 10m Chamber	Data No.	: 5
Dis. / Ant.	: 3m 2014 3115 4580	Ant. pol.	: HORIZONTAL
Limit	: EN55022B (1-6G) PEAK	Pre	: 101.7kPa
Env. / Ins.	: 21.2°C/48.4%	Engineer	: Bery_Guo
EUT	: M2060***		
Power Rating	: AC 230V/50Hz		
Test Mode	: Running 'H' Pattern		
	VGA:1920*1080@60Hz		
	1.2m Power Cable+1.5m VGA Cable		
	VGA Without Core		

Freq. (MHz)	Ant. Factor (dB/m)	Cable Loss (dB)	Amp Factor (dB)	Reading (dBuV)	Emission			Remark
					Level (dBuV/m)	Limits (dBuV/m)	Magin (dB)	
1 1360.124	25.48	2.09	35.44	55.38	47.51	70.00	22.49	Peak
2 1361.285	25.48	2.09	35.44	47.59	39.72	50.00	10.28	Average
3 2690.784	29.13	3.55	34.85	50.52	48.35	70.00	21.65	Peak
4 2691.698	29.14	3.56	34.85	43.57	41.42	50.00	8.58	Average
5 2910.635	29.75	3.65	34.89	49.66	48.17	70.00	21.83	Peak
6 2911.748	29.75	3.65	34.89	41.57	40.08	50.00	9.92	Average

Remarks: 1. Emission Level= Antenna Factor + Cable Loss + Reading-Amp Factor (Peak/Average).
 2. The emission levels that are 20dB below the official limit are not reported.

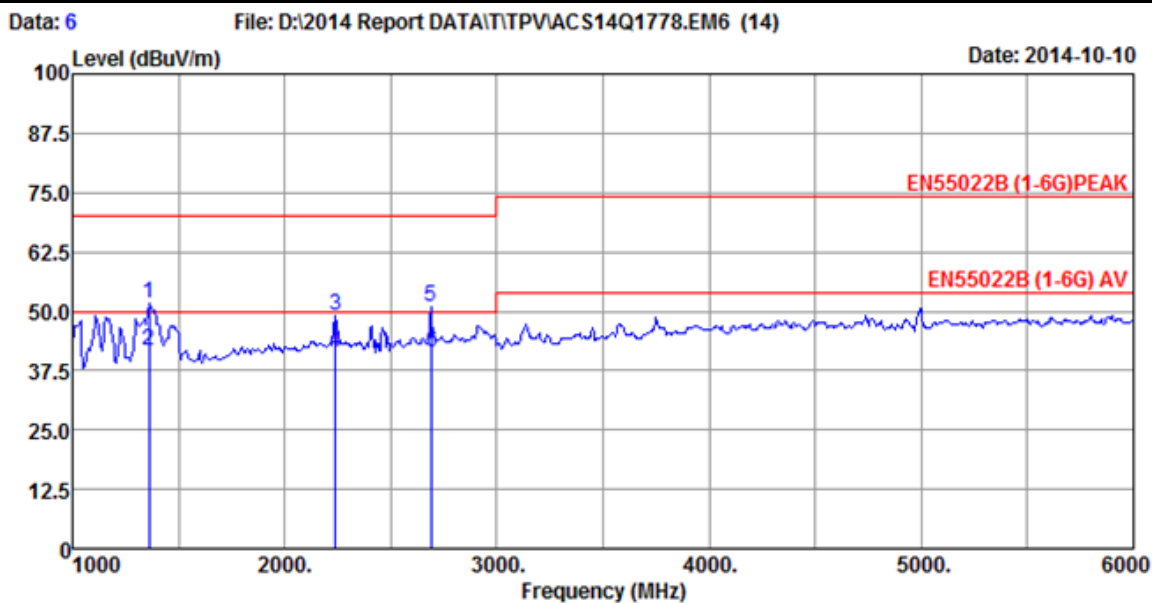

Site no.	: 10m Chamber	Data No.	: 6
Dis. / Ant.	: 3m 2014 3115 4580	Ant. pol.	: VERTICAL
Limit	: EN55022B (1-6G) PEAK	Pre	: 101.7kPa
Env. / Ins.	: 21.2°C/48.4%	Engineer	: Bery_Guo
EUT	: M2060***		
Power Rating	: AC 230V/50Hz		
Test Mode	: Running 'H' Pattern		
	VGA:1920*1080@60Hz		
	1.2m Power Cable+1.5m VGA Cable		
	VGA Without Core		

Freq. (MHz)	Ant. Factor (dB/m)	Cable Loss (dB)	Amp Factor (dB)	Reading (dBuV)	Emission		Magin (dB)	Remark
					Level (dBuV/m)	Limits (dBuV/m)		
1 1360.989	25.48	2.09	35.44	59.64	51.77	70.00	18.23	Peak
2 1361.451	25.48	2.09	35.44	49.58	41.71	50.00	8.29	Average
3 2240.854	28.19	3.44	34.89	52.39	49.13	70.00	20.87	Peak
4 2241.312	28.19	3.44	34.89	44.70	41.44	50.00	8.56	Average
5 2690.635	29.13	3.55	34.85	52.95	50.78	70.00	19.22	Peak
6 2691.547	29.14	3.56	34.85	43.56	41.41	50.00	8.59	Average

Remarks: 1. Emission Level= Antenna Factor + Cable Loss + Reading-Amp Factor (Peak/Average).
 2. The emission levels that are 20dB below the official limit are not reported.

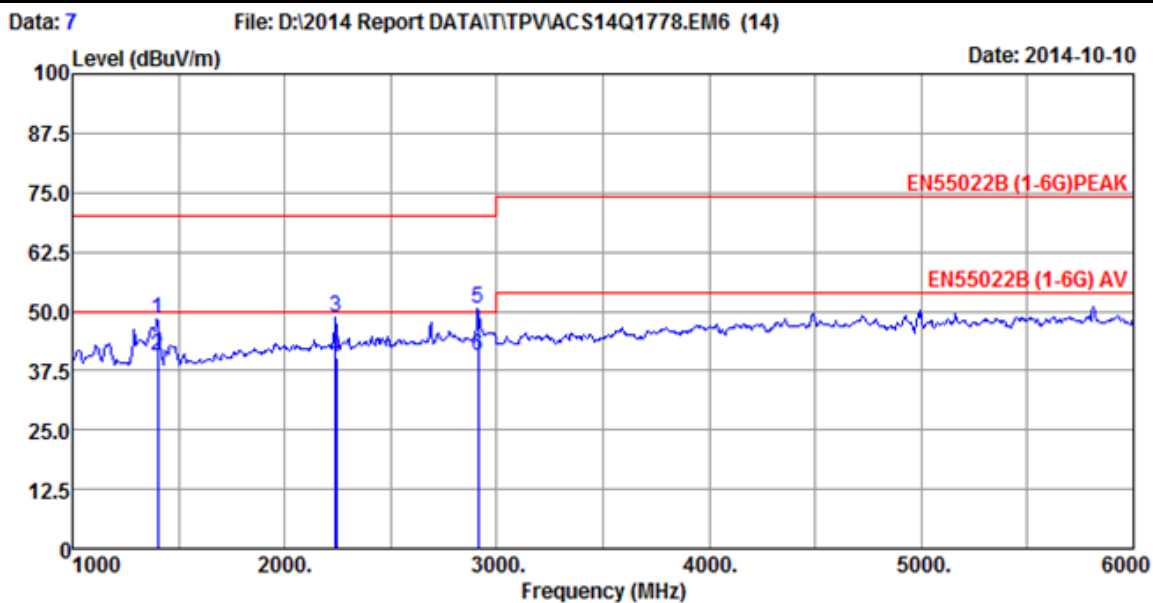

Site no.	: 10m Chamber	Data No.	: 7
Dis. / Ant.	: 3m 2014 3115 4580	Ant. pol.	: HORIZONTAL
Limit	: EN55022B (1-6G) PEAK	Pre	: 101.7kPa
Env. / Ins.	: 21.2°C/48.4%	Engineer	: Bery_Guo
EUT	: M2060***		
Power Rating	: AC 230V/50Hz		
Test Mode	: Running 'H' Pattern		
	VGA:1920*1080@60Hz		
	1.5m Power Cable+1.2m VGA Cable		
	VGA Without Core		

Freq. (MHz)	Ant. Factor (dB/m)	Cable Loss (dB)	Amp Factor (dB)	Reading (dBuV)	Emission		Magin (dB)	Remark
					Level (dBuV/m)	Limits (dBuV/m)		
1 1400.451	25.46	2.13	35.39	56.23	48.43	70.00	21.57	Peak
2 1401.124	25.46	2.13	35.39	48.53	40.73	50.00	9.27	Average
3 2240.874	28.19	3.44	34.89	51.85	48.59	70.00	21.41	Peak
4 2241.968	28.19	3.44	34.89	43.55	40.29	50.00	9.71	Average
5 2910.524	29.75	3.65	34.89	51.86	50.37	70.00	19.63	Peak
6 2911.245	29.75	3.65	34.89	42.18	40.69	50.00	9.31	Average

Remarks: 1. Emission Level= Antenna Factor + Cable Loss + Reading-Amp Factor (Peak/Average).
 2. The emission levels that are 20dB below the official limit are not reported.

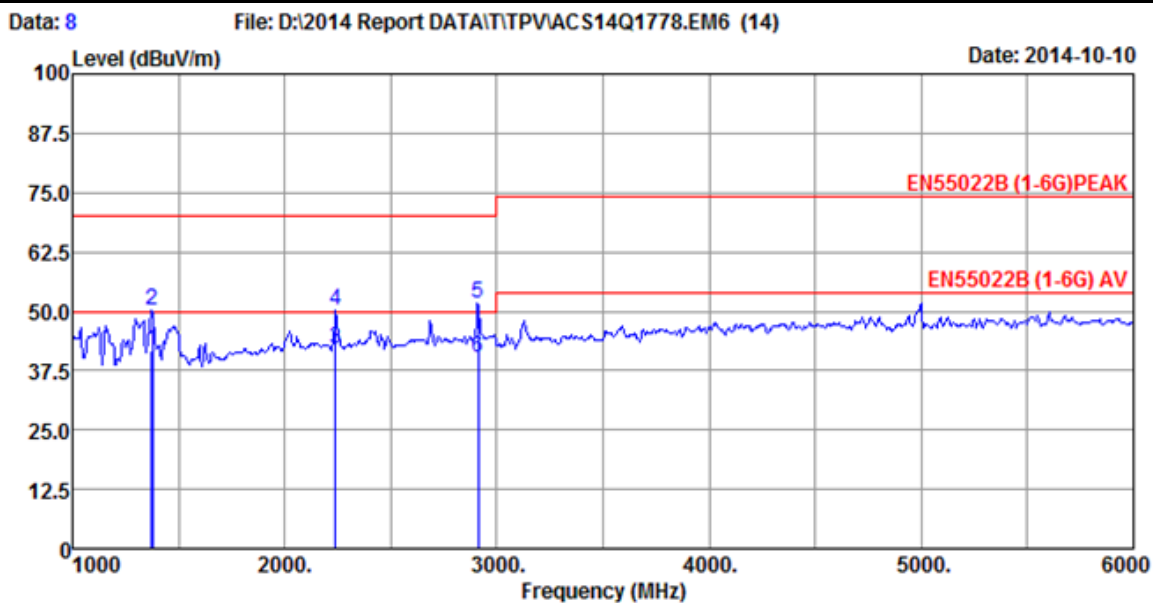

Site no.	: 10m Chamber	Data No.	: 8
Dis. / Ant.	: 3m 2014 3115 4580	Ant. pol.	: VERTICAL
Limit	: EN55022B (1-6G) PEAK	Pre	: 101.7kPa
Env. / Ins.	: 21.2°C/48.4%	Engineer	: Bery_Guo
EUT	: M2060***		
Power Rating	: AC 230V/50Hz		
Test Mode	: Running 'H' Pattern		
	VGA:1920*1080@60Hz		
	1.5m Power Cable+1.2m VGA Cable		
	VGA Without Core		

Freq. (MHz)	Ant. Factor (dB/m)	Cable Loss (dB)	Amp Factor (dB)	Reading (dBUV)	Emission		Magin (dB)	Remark
					Level (dBUV/m)	Limits (dBUV/m)		
1 1374.154	25.48	2.11	35.42	49.56	41.73	50.00	8.27	Average
2 1375.748	25.47	2.11	35.42	58.11	50.27	70.00	19.73	Peak
3 2240.316	28.18	3.44	34.89	45.17	41.90	50.00	8.10	Average
4 2241.649	28.19	3.44	34.89	53.30	50.04	70.00	19.96	Peak
5 2910.635	29.75	3.65	34.89	52.98	51.49	70.00	18.51	Peak
6 2911.254	29.75	3.65	34.89	41.57	40.08	50.00	9.92	Average

Remarks: 1. Emission Level= Antenna Factor + Cable Loss + Reading-Amp Factor (Peak/Average).
 2. The emission levels that are 20dB below the official limit are not reported.

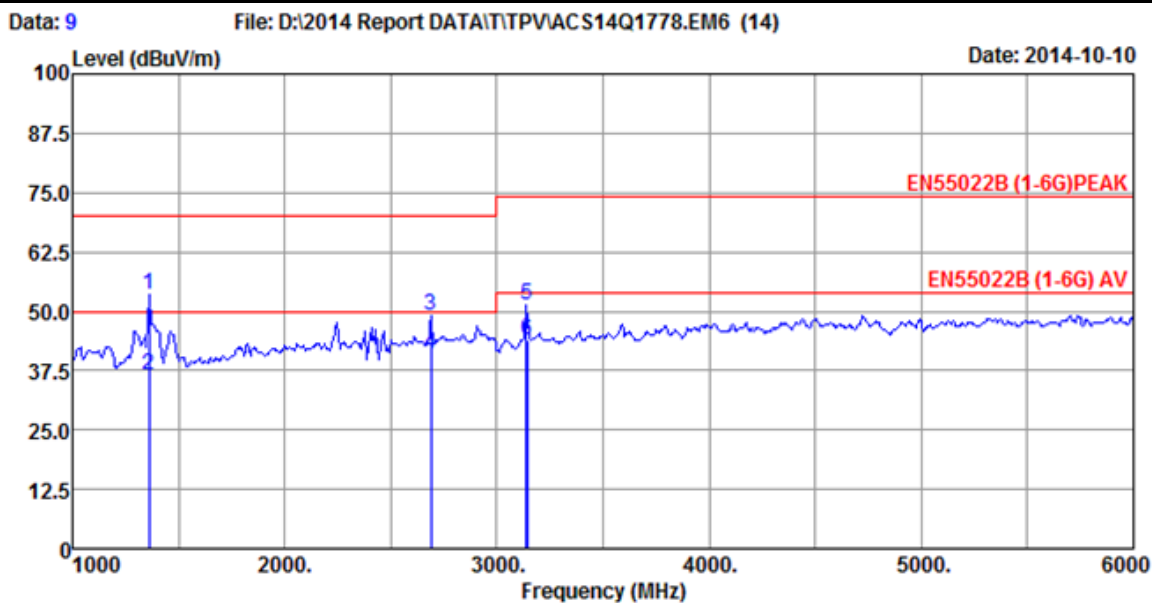

Site no.	: 10m Chamber	Data No.	: 9
Dis. / Ant.	: 3m 2014 3115 4580	Ant. pol.	: HORIZONTAL
Limit	: EN55022B (1-6G) PEAK	Pre	: 101.7kPa
Env. / Ins.	: 21.2°C/48.4%	Engineer	: Bery_Guo
EUT	: M2060***		
Power Rating	: AC 230V/50Hz		
Test Mode	: Running 'H' Pattern		
	VGA:1920*1080@60Hz		
	1.5m Power Cable+1.5m VGA Cable		

Freq. (MHz)	Ant. Factor (dB/m)	Cable Loss (dB)	Amp Factor (dB)	Reading (dBuV)	Emission			Remark
					Level (dBuV/m)	Limits (dBuV/m)	Magin (dB)	
1 1360.748	25.48	2.09	35.44	61.38	53.51	70.00	16.49	Peak
2 1361.956	25.48	2.09	35.44	44.53	36.66	50.00	13.34	Average
3 2690.365	29.13	3.55	34.85	51.22	49.05	70.00	20.95	Peak
4 2691.415	29.14	3.55	34.85	42.96	40.80	50.00	9.20	Average
5 3140.635	30.31	3.80	34.90	52.04	51.25	74.00	22.75	Peak
6 3141.254	30.31	3.80	34.90	44.57	43.78	54.00	10.22	Average

Remarks: 1. Emission Level= Antenna Factor + Cable Loss + Reading-Amp Factor (Peak/Average).
 2. The emission levels that are 20dB below the official limit are not reported.

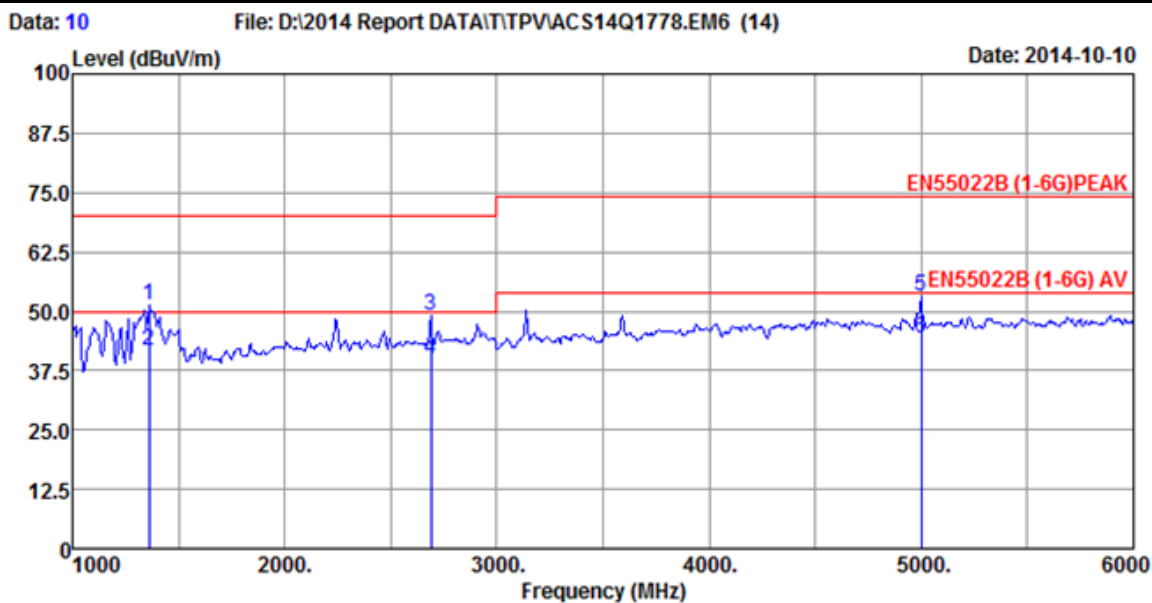

Site no. : 10m Chamber Data No. : 10
 Dis. / Ant. : 3m 2014 3115 4580 Ant. pol. : VERTICAL
 Limit : EN55022B (1-6G) PEAK Pre : 101.7kPa
 Env. / Ins. : 21.2°C/48.4% Engineer : Bery_Guo
 EUT : M2060***
 Power Rating : AC 230V/50Hz
 Test Mode : Running 'H' Pattern
 VGA:1920*1080@60Hz
 1.5m Power Cable+1.5m VGA Cable

No.	Freq. (MHz)	Ant. Factor (dB/m)	Cable Loss (dB)	Amp Factor (dB)	Reading (dBuV)	Emission		Margin (dB)	Remark
						Level (dBuV/m)	Limits (dBuV/m)		
1	1360.653	25.48	2.09	35.44	59.06	51.19	70.00	18.81	Peak
2	1361.451	25.48	2.09	35.44	49.55	41.68	50.00	8.32	Average
3	2690.857	29.13	3.55	34.85	51.09	48.92	70.00	21.08	Peak
4	2691.231	29.14	3.55	34.85	42.16	40.00	50.00	10.00	Average
5	5000.635	33.20	4.79	34.45	49.42	52.96	74.00	21.04	Peak
6	5001.254	33.20	4.79	34.45	40.57	44.11	54.00	9.89	Average

Remarks: 1. Emission Level= Antenna Factor + Cable Loss + Reading-Amp Factor (Peak/Average).
 2. The emission levels that are 20dB below the official limit are not reported.

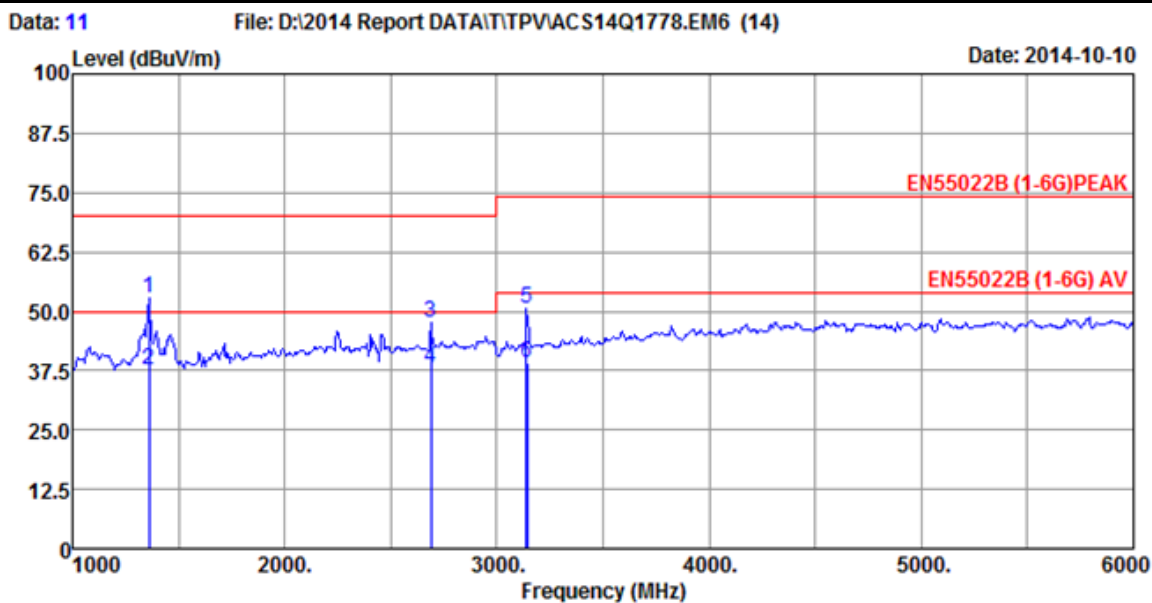

Site no.	: 10m Chamber	Data No.	: 11
Dis. / Ant.	: 3m 2014 3115 4580	Ant. pol.	: HORIZONTAL
Limit	: EN55022B (1-6G) PEAK	Pre	: 101.7kPa
Env. / Ins.	: 21.2°C/48.4%	Engineer	: Bery_Guo
EUT	: M2060***		
Power Rating	: AC 230V/50Hz		
Test Mode	: Running 'H' Pattern		
	VGA:1920*1080@60Hz		
	1.5m Power Cable+1.2m VGA Cable		

Freq. (MHz)	Ant. Factor (dB/m)	Cable Loss (dB)	Amp Factor (dB)	Reading (dBuV)	Emission		Magin (dB)	Remark
					Level (dBuV/m)	Limits (dBuV/m)		
1 1360.212	25.48	2.09	35.44	60.80	52.93	70.00	17.07	Peak
2 1361.540	25.48	2.09	35.44	45.46	37.59	50.00	12.41	Average
3 2690.656	29.13	3.55	34.85	49.82	47.65	70.00	22.35	Peak
4 2691.355	29.14	3.55	34.85	40.20	38.04	50.00	11.96	Average
5 3140.542	30.31	3.80	34.90	51.28	50.49	74.00	23.51	Peak
6 3141.956	30.31	3.80	34.90	40.01	39.22	54.00	14.78	Average

Remarks: 1. Emission Level= Antenna Factor + Cable Loss + Reading-Amp Factor (Peak/Average).
 2. The emission levels that are 20dB below the official limit are not reported.

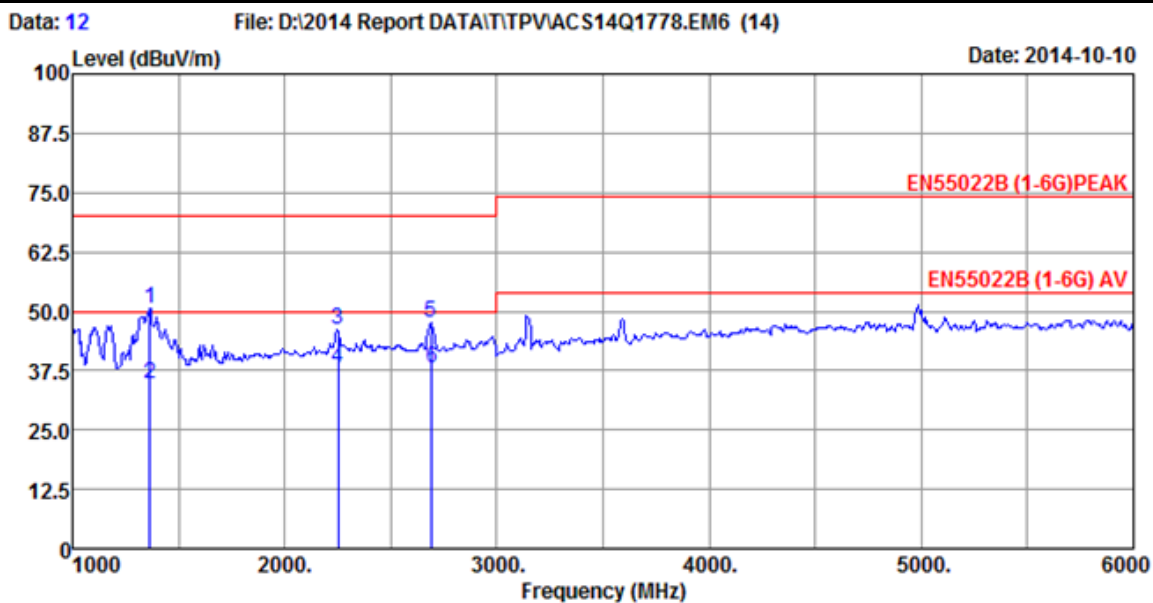

Site no.	: 10m Chamber	Data No.	: 12
Dis. / Ant.	: 3m 2014 3115 4580	Ant. pol.	: VERTICAL
Limit	: EN55022B (1-6G) PEAK	Pre	: 101.7kPa
Env. / Ins.	: 21.2°C/48.4%	Engineer	: Bery_Guo
EUT	: M2060***		
Power Rating	: AC 230V/50Hz		
Test Mode	: Running 'H' Pattern		
	VGA:1920*1080@60Hz		
	1.5m Power Cable+1.2m VGA Cable		

Freq. (MHz)	Ant. Factor (dB/m)	Cable Loss (dB)	Amp Factor (dB)	Reading (dBuV)	Emission			Remark
					Level (dBuV/m)	Limits (dBuV/m)	Magin (dB)	
1 1365.212	25.48	2.10	35.43	58.58	50.73	70.00	19.27	Peak
2 1366.667	25.48	2.10	35.43	42.45	34.60	50.00	15.40	Average
3 2250.054	28.20	3.44	34.89	49.33	46.08	70.00	23.92	Peak
4 2251.741	28.20	3.44	34.89	41.10	37.85	50.00	12.15	Average
5 2690.652	29.13	3.55	34.85	49.94	47.77	70.00	22.23	Peak
6 2691.741	29.14	3.56	34.85	40.19	38.04	50.00	11.96	Average

Remarks: 1. Emission Level= Antenna Factor + Cable Loss + Reading-Amp Factor (Peak/Average).
 2. The emission levels that are 20dB below the official limit are not reported.

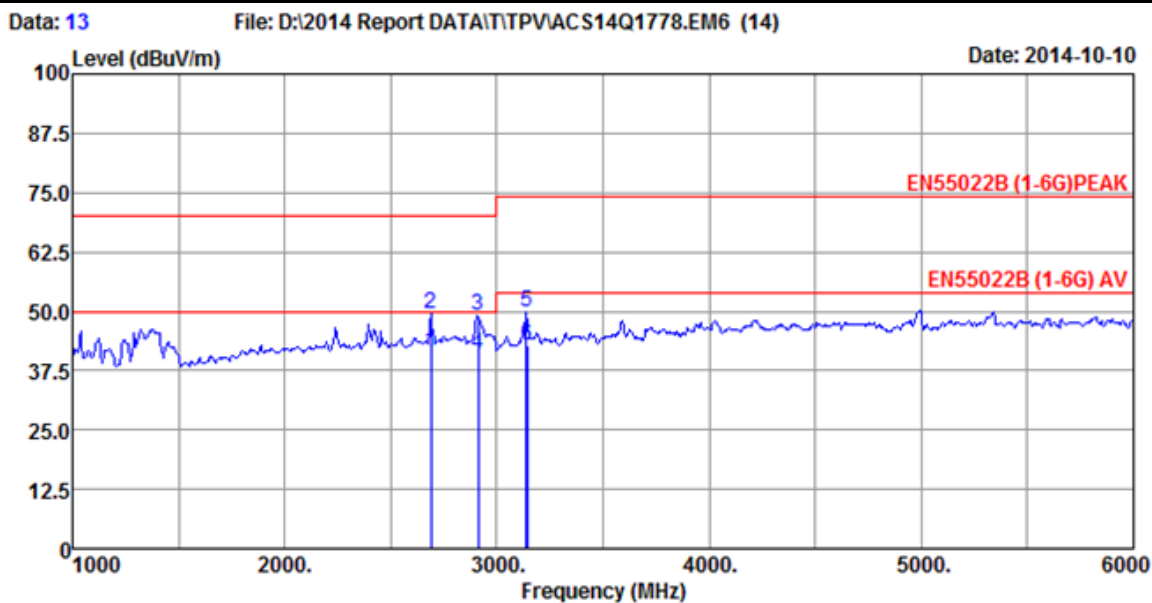

Site no. : 10m Chamber Data No. : 13
 Dis. / Ant. : 3m 2014 3115 4580 Ant. pol. : HORIZONTAL
 Limit : EN55022B (1-6G) PEAK Pre : 101.7kPa
 Env. / Ins. : 21.2°C/48.4% Engineer : Bery_Guo
 EUT : M2060***
 Power Rating : AC 230V/50Hz
 Test Mode : Running 'H' Pattern
 DVI:1920*1080@60Hz
 1.5m Power Cable+1.5m DVI Cable

Freq. (MHz)	Ant. Factor (dB/m)	Cable Loss (dB)	Amp Factor (dB)	Reading (dBUV)	Emission		Magin (dB)	Remark
					Level (dBUV/m)	Limits (dBUV/m)		
1 2689.154	29.13	3.55	34.85	43.56	41.39	50.00	8.61	Average
2 2690.480	29.13	3.55	34.85	51.49	49.32	70.00	20.68	Peak
3 2910.784	29.75	3.65	34.89	50.48	48.99	70.00	21.01	Peak
4 2911.964	29.75	3.65	34.89	42.56	41.07	50.00	8.93	Average
5 3140.635	30.31	3.80	34.90	50.73	49.94	74.00	24.06	Peak
6 3141.857	30.31	3.80	34.90	43.57	42.78	54.00	11.22	Average

Remarks: 1. Emission Level= Antenna Factor + Cable Loss + Reading-Amp Factor (Peak/Average).
 2. The emission levels that are 20dB below the official limit are not reported.

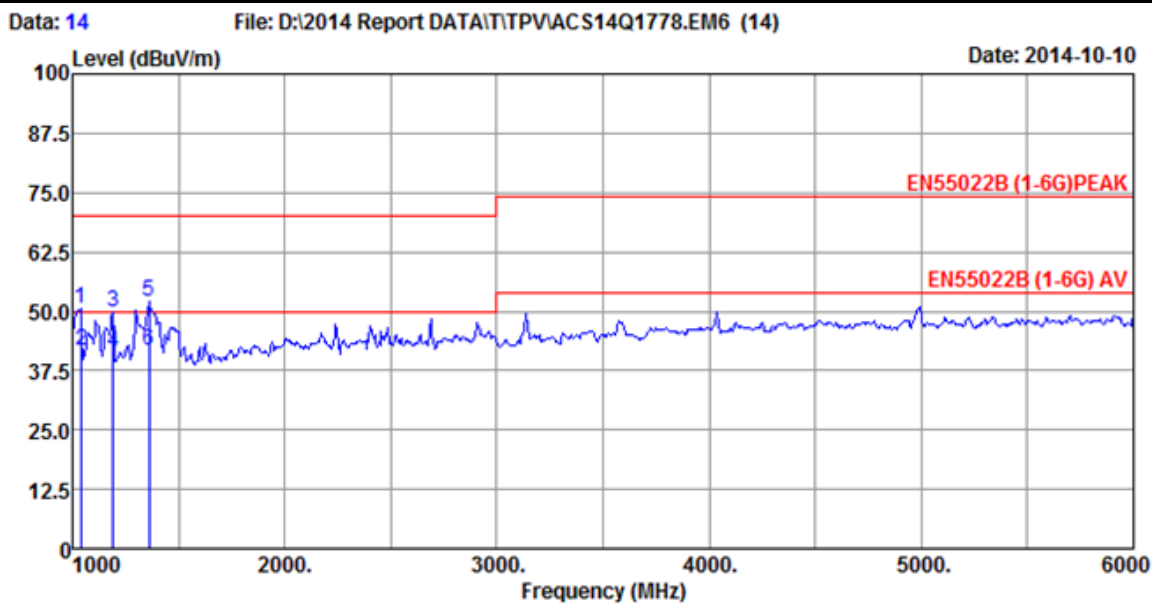

```

Site no.      : 10m Chamber           Data No.   : 14
Dis. / Ant.   : 3m 2014 3115 4580     Ant. pol.  : VERTICAL
Limit         : EN55022B (1-6G) PEAK  Pre        : 101.7kPa
Env. / Ins.   : 21.2*C/48.4%          Engineer   : Bery_Guo
EUT           : M2060***
Power Rating  : AC 230V/50Hz
Test Mode     : Running 'H' Pattern
               DVI:1920*1080@60Hz
               1.5m Power Cable+1.5m DVI Cable
    
```

Freq. (MHz)	Ant. Factor (dB/m)	Cable Loss (dB)	Amp Factor (dB)	Reading (dBuV)	Emission			Remark
					Level (dBuV/m)	Limits (dBuV/m)	Magin (dB)	
1 1040.326	25.68	1.72	35.94	58.93	50.39	70.00	19.61	Peak
2 1041.524	25.68	1.72	35.93	50.24	41.71	50.00	8.29	Average
3 1190.857	25.59	1.91	35.69	57.91	49.72	70.00	20.28	Peak
4 1191.245	25.59	1.91	35.69	49.67	41.48	50.00	8.52	Average
5 1360.668	25.48	2.09	35.44	59.78	51.91	70.00	18.09	Peak
6 1361.263	25.48	2.09	35.44	49.69	41.82	50.00	8.18	Average

Remarks: 1. Emission Level= Antenna Factor + Cable Loss + Reading-Amp Factor (Peak/Average).
 2. The emission levels that are 20dB below the official limit are not reported.

5. HARMONIC CURRENT TEST

5.1. Test Equipments

Item	Equipment	Manufacturer	Model No.	Serial No.	Last Cal.	Cal. Interval
1.	AC Source	California Instruments	5001ix	58481	Oct.31, 13	1 Year
2.	Power Analyzer	California Instruments	PACS-1	72627	Oct.31, 13	1 Year

5.2. Block Diagram of Test Setup

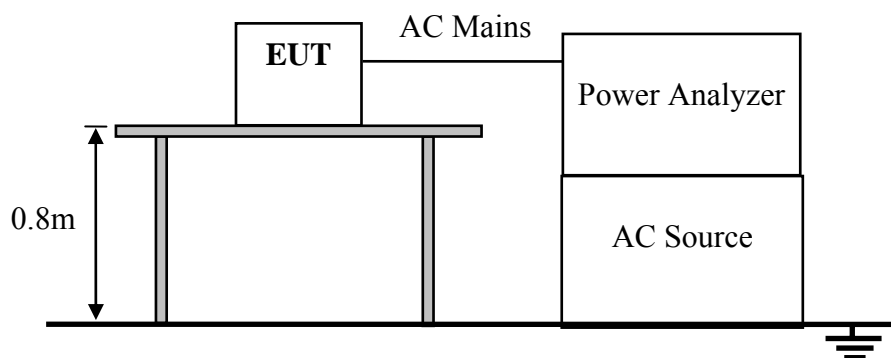

5.3. Test Standard

EN 61000-3-2: 2006+A1: 2009+A2: 2009; Class D

5.4. Limits of Harmonic Current

Limits for Class D Equipment		
Harmonic order (n)	Maximum permissible harmonic current per watt (mA/W)	Maximum permissible harmonic current (A)
3	3.4	0.23
5	1.9	1.14
7	1.0	0.77
9	0.5	0.40
11	0.35	0.33
13	0.30	0.21
15 ≤ n ≤ 39 (odd harmonic only)	3.85/n	0.15 × 15/n

Remark: if the EUT Power level is below 75 Watts and therefore has no defined limits.

5.5. EUT Configuration on Test

The configurations of EUT are listed in Section 3.5.

5.6. Operating Condition of EUT

Same as Conducted Emission test that is listed in Section 3.6. except the test set up replaced by Section 5.2.

5.7. Test Procedure

The EUT was placed on the top of a wooden table 0.8 meters above the ground and operated to produce the maximum harmonic components under normal operating conditions for each successive harmonic component in turn. The correspondent test program of test instrument to measure the current harmonics emanated from EUT is chosen. The measure time shall be not less than the necessary for the EUT to be exercised.

5.8. Test Results

PASS.

The EUT was tested and all the test results are listed in next pages.

Harmonics – Class-D per Ed. 4.0 (2014)(Run time) incl. inter-harmonics

EUT: M2060***
 Test category: Class-D per Ed. 4.0 (2014) (European limits)
 Test date: 2014-10-5
 Test duration (min): 2.5
 Comment: Running "H" Pattern
 Customer: TPV

Tested by: SUN
 Test Margin: 100
 Start time: 16:36:09
 End time: 16:39:01
 Data file name: H-000325.cts_data

Test Result: N/L Source qualification: Normal

Current & voltage waveforms



Harmonics and Class D limit line European Limits

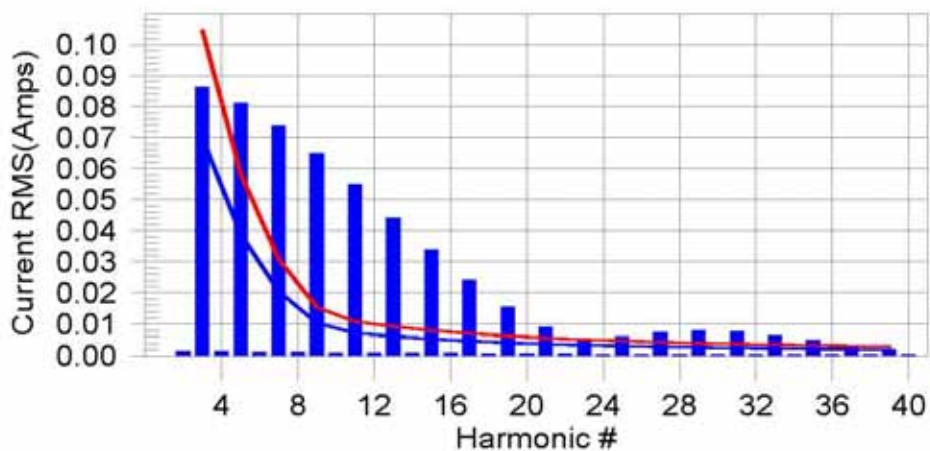

Test result: N/L Worst harmonic was #11 with 763.1% of the limit.

Current Test Result Summary (Run time)

EUT: M2060***
 Test category: Class-D per Ed. 4.0 (2014) (European limits)
 Test date: 2014-10-5
 Test duration (min): 2.5
 Comment: Running "H" Pattern
 Customer: TPV

Tested by: SUN
 Test Margin: 100
 Start time: 16:36:09
 End time: 16:39:01
 Data file name: H-000325.cts_data

Test Result: N/L Source qualification: Normal
 THC(A): 0.000 I-THD(%): 0.0 POHC(A): 0.000 POHC Limit(A): 0.000
 Highest parameter values during test:
 V_RMS (Volts): 230.07 Frequency(Hz): 50.00
 I_Peak (Amps): 0.814 I_RMS (Amps): 0.199
 I_Fund (Amps): 0.092 Crest Factor: 4.109
 Power (Watts): 20.5 Power Factor: 0.452

Harm#	Harms(avg)	100%Limit	%of Limit	Harms(max)	150%Limit	%of Limit	Status
2	0.002	0.000	N/A	0.002	0.000	N/A	N/L
3	0.086	0.070	N/A	0.087	0.105	N/A	N/L
4	0.001	0.000	N/A	0.002	0.000	N/A	N/L
5	0.081	0.039	N/A	0.081	0.058	N/A	N/L
6	0.001	0.000	N/A	0.001	0.000	N/A	N/L
7	0.074	0.021	N/A	0.074	0.031	N/A	N/L
8	0.001	0.000	N/A	0.001	0.000	N/A	N/L
9	0.065	0.010	N/A	0.065	0.015	N/A	N/L
10	0.001	0.000	N/A	0.001	0.000	N/A	N/L
11	0.055	0.007	N/A	0.055	0.011	N/A	N/L
12	0.001	0.000	N/A	0.001	0.000	N/A	N/L
13	0.044	0.006	N/A	0.045	0.009	N/A	N/L
14	0.001	0.000	N/A	0.001	0.000	N/A	N/L
15	0.034	0.005	N/A	0.034	0.008	N/A	N/L
16	0.001	0.000	N/A	0.001	0.000	N/A	N/L
17	0.024	0.005	N/A	0.024	0.007	N/A	N/L
18	0.001	0.000	N/A	0.001	0.000	N/A	N/L
19	0.016	0.004	N/A	0.016	0.006	N/A	N/L
20	0.001	0.000	N/A	0.001	0.000	N/A	N/L
21	0.009	0.004	N/A	0.009	0.006	N/A	N/L
22	0.001	0.000	N/A	0.001	0.000	N/A	N/L
23	0.006	0.003	N/A	0.006	0.005	N/A	N/L
24	0.001	0.000	N/A	0.001	0.000	N/A	N/L
25	0.006	0.003	N/A	0.006	0.005	N/A	N/L
26	0.000	0.000	N/A	0.001	0.000	N/A	N/L
27	0.007	0.003	N/A	0.007	0.004	N/A	N/L
28	0.000	0.000	N/A	0.001	0.000	N/A	N/L
29	0.008	0.003	N/A	0.008	0.004	N/A	N/L
30	0.000	0.000	N/A	0.000	0.000	N/A	N/L
31	0.008	0.003	N/A	0.008	0.004	N/A	N/L
32	0.000	0.000	N/A	0.001	0.000	N/A	N/L
33	0.006	0.002	N/A	0.007	0.004	N/A	N/L
34	0.000	0.000	N/A	0.000	0.000	N/A	N/L
35	0.005	0.002	N/A	0.005	0.003	N/A	N/L
36	0.000	0.000	N/A	0.000	0.000	N/A	N/L
37	0.003	0.002	N/A	0.003	0.003	N/A	N/L
38	0.000	0.000	N/A	0.000	0.000	N/A	N/L
39	0.002	0.002	N/A	0.002	0.003	N/A	N/L
40	0.000	0.000	N/A	0.000	0.000	N/A	N/L

Note: The EUT power level is below 75.0 Watts and therefore has no defined limits

Voltage Source Verification Data (Run time)

EUT: M2060***
 Test category: Class-D per Ed. 4.0 (2014) (European limits)
 Test date: 2014-10-5
 Test duration (min): 2.5
 Comment: Running "H" Pattern
 Customer: TPV

Tested by: SUN
 Test Margin: 100
 Start time: 16:36:09
 End time: 16:39:01
 Data file name: H-000325.cts_data

Test Result: N/L Source qualification: Normal

Highest parameter values during test:

Voltage (Vrms): 230.07
 I_Peak (Amps): 0.814
 I_Fund (Amps): 0.092
 Power (Watts): 20.5
 Frequency(Hz): 50.00
 I_RMS (Amps): 0.199
 Crest Factor: 4.109
 Power Factor: 0.452

Harm#	Harmonics	V-rms	Limit V-rms	% of Limit	Status
2		0.087	0.460	19.00	OK
3		0.456	2.070	22.01	OK
4		0.053	0.460	11.63	OK
5		0.039	0.920	4.28	OK
6		0.029	0.460	6.25	OK
7		0.036	0.690	5.28	OK
8		0.009	0.460	1.93	OK
9		0.040	0.460	8.79	OK
10		0.013	0.460	2.74	OK
11		0.033	0.230	14.31	OK
12		0.010	0.230	4.51	OK
13		0.033	0.230	14.18	OK
14		0.004	0.230	1.62	OK
15		0.022	0.230	9.68	OK
16		0.008	0.230	3.57	OK
17		0.022	0.230	9.43	OK
18		0.009	0.230	3.79	OK
19		0.018	0.230	7.99	OK
20		0.006	0.230	2.79	OK
21		0.015	0.230	6.53	OK
22		0.003	0.230	1.39	OK
23		0.009	0.230	3.73	OK
24		0.003	0.230	1.44	OK
25		0.009	0.230	3.88	OK
26		0.002	0.230	0.97	OK
27		0.013	0.230	5.72	OK
28		0.002	0.230	0.82	OK
29		0.008	0.230	3.50	OK
30		0.002	0.230	0.87	OK
31		0.011	0.230	4.84	OK
32		0.002	0.230	0.84	OK
33		0.010	0.230	4.50	OK
34		0.003	0.230	1.11	OK
35		0.008	0.230	3.58	OK
36		0.002	0.230	0.72	OK
37		0.006	0.230	2.52	OK
38		0.002	0.230	0.84	OK
39		0.006	0.230	2.39	OK
40		0.003	0.230	1.24	OK

6. VOLTAGE FLUCTUATIONS & FLICKER TEST

6.1. Test Equipment

Same as Section 5.1.

6.2. Block Diagram of Test Setup

Same as Section 5.2.

6.3. Test Standard

EN 61000-3-3: 2013

6.4. Limits of Voltage Fluctuation and Flick

Test Item	Limit	Note
P_{st}	1.0	P_{st} means Short-term flicker indicator
P_{lt}	0.65	P_{lt} means long-term flicker indicator
T_{max}	500ms	T_{max} means maximum time that dt exceeds 3.3%
$d_{max}(\%)$	4%	d_{max} means maximum relative voltage change.
$d_c(\%)$	3.3%	d_c means relative steady-state voltage change.

6.5. EUT Configuration on Test

The configurations of EUT are listed in Section 3.5.

6.6. Operating Condition of EUT

Same as Section 5.6.

6.7. Test Procedure

The EUT was placed on the top of a wooden table 0.8 meters above the ground and operated to produce the most unfavorable sequence of voltage changes under normal conditions. During the flick measurement, the measure time shall include that part of whole operation changes. The observation period for short-term flicker indicator is 10 minutes and the observation period for long-term flicker indicator is 2 hours.

6.8. Test Results

PASS.

Please refer to the following page.

Flicker Test Summary per EN/IEC61000-3-3 (Run time)

EUT: M2060***
 Test category: All parameters (European limits)
 Test date: 2014-10-5
 Test duration (min): 10
 Comment: Running "H" Pattern
 Customer: TPV

Tested by: SUN
 Test Margin: 100
 Start time: 16:40:28
 End time: 16:51:00
 Data file name: F-000326.cts_data

Test Result: Pass

Status: Test Completed

Pst and limit line

European Limits

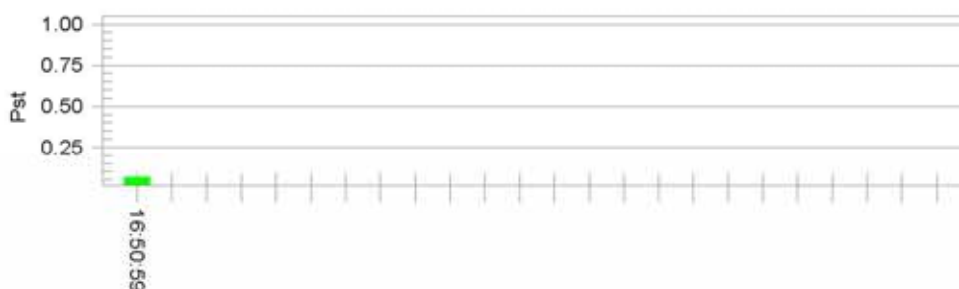

Plt and limit line



Parameter values recorded during the test:

Vrms at the end of test (Volt):	230.05		
Highest dt (%):	0.00	Test limit (%):	N/A
T-max (mS):	0	Test limit (mS):	500.0
Highest dc (%):	0.00	Test limit (%):	3.30
Highest dmax (%):	0.00	Test limit (%):	4.00
Highest Pst (10 min. period):	0.064	Test limit:	1.000
Highest Plt (2 hr. period):	0.028	Test limit:	0.650

7. IMMUNITY PERFORMANCE CRITERIA

Performance Level

The test results shall be classified in terms of the loss of function or degradation of performance of the equipment under test, relative to a performance level by its manufacturer or the requestor of the test, or the agreed between the manufacturer and the purchaser of the product.

Definition related to the performance level:

1. Based on the used product standard
2. Based on the declaration of the manufacturer, requestor or purchaser

Performance criterion A

When seen from the normal viewing distance, the EUT shall operate with no change beyond the manufacturer's specification, in flicker, colour, focus and jitter (except for the power frequency magnetic field test).

Power frequency magnetic field test

For CRT monitors, the following also applies:

The jitter shall be measured using a measuring microscope as specified in 6.6.14 of ISO 9241-3.

The jitter (in mm) shall not exceed the value $\frac{(\text{character height in mm} + 0,3) \times 2,5}{33,3}$ when the monitor is immersed in a continuous magnetic field of 1A/m (r.m.s.) at one of the power frequencies of 50Hz.

Alternatively, a field of 50A/m may be applied, and a transparent graduated mask used to assess the jitter. In that case, the jitter shall not exceed 50 times the value in the above formula.

NOTE-This test level is used to simplify the measurement of jitter. Lesser values of the test level may be used if non-linearity is experienced, due to, for example, saturation of screening material.

The EUT shall be tested in two positions, both perpendicular to the magnetic field.

Performance criterion B

Screen disturbances during the application of the test are permissible.

Performance criterion C

Failures which are not self-recovered after removal of the external disturbance, but which can be recovered to normal operation by reset or reboot are permissible.

8. ELECTROSTATIC DISCHARGE IMMUNITY TEST

8.1. Test Equipments

Item	Equipment	Manufacturer	Model No.	Serial No.	Last Cal.	Cal. Interval
1	ESD Tester	EM Test	Dito	P1349126669	Jun. 05,14	1 Year

8.2. Block Diagram of Test Setup

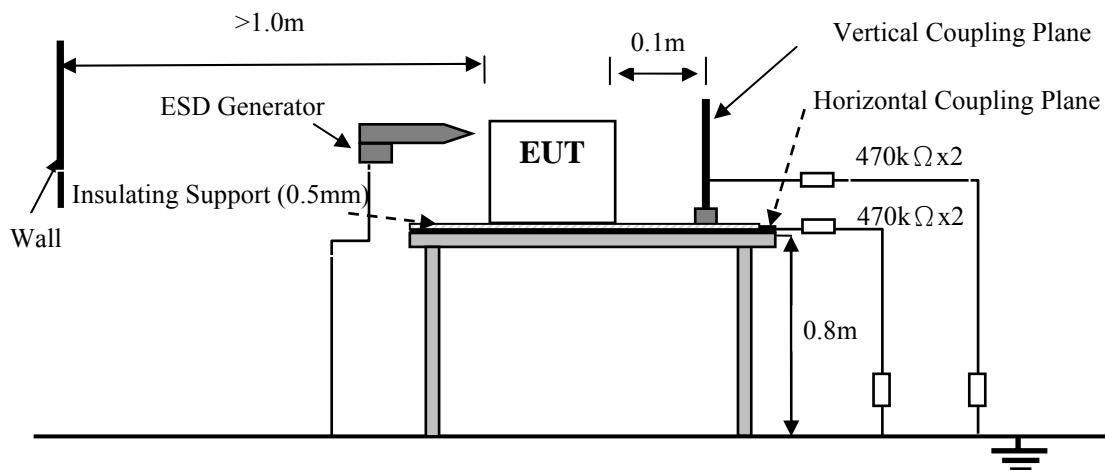

8.3. Test Standard

EN 55024: 2010 (IEC 61000-4-2: 2008)

(Severity Level 1 & 2 & 3 for Air Discharge at 2 kV & 4 kV & 8kV,
Severity Level 1 & 2 for Contact Discharge at 2 kV & 4kV)

8.4. Severity Levels and Performance Criterion

Severity Level	Test Voltage Contact Discharge (kV)	Test Voltage Air Discharge (kV)	Performance criterion
1.	2	2	B
2.	4	4	
3.	6	8	
4.	8	15	
X	Special	Special	

8.5. EUT Configuration

The configurations of EUT are listed in Section 3.5.

8.6. Operating Condition of EUT

Same as Conducted Emission test that is listed in Section 3.6. except the test set up replaced by Section 8.2.

8.7. Test Procedure

8.7.1. Air Discharge:

The test was applied on non-conductive surfaces of EUT. The round discharge tip of the discharge electrode was approached as fast as possible to touch the EUT. After each discharge, the discharge electrode was removed from the EUT. The generator was re-triggered for a new single discharge and repeated 20 times for each pre-selected test point. This procedure was repeated until all the air discharge completed

8.7.2. Contact Discharge:

All the procedure was same as Section 8.7.1. except that the generator was re-triggered for a new single discharge and repeated 50 times for each pre-selected test point. The tip of the discharge electrode was touching the EUT before the discharge switch was operated.

8.7.3. Indirect discharge for horizontal coupling plane:

At least 20 single discharges were applied to the horizontal coupling plane, at points on each side of the EUT. The discharge electrode positions vertically at a distance of 0.1m from the EUT and with the discharge electrode touching the coupling plane.

8.7.4. Indirect discharge for vertical coupling plane:

At least 20 single discharges were applied to the center of one vertical edge of the coupling plane. The coupling plane, of dimensions 0.5m X 0.5m, was placed parallel to, and positioned at a distance of 0.1m from the EUT. Discharges were applied to the coupling plane, with this plane in sufficient different positions that the four faces of the EUT are completely illuminated.

8.8. Test Results

PASS.

The EUT was tested and all the test results are listed in next page.

Electrostatic Discharge Test Results

Audix Technology (Shenzhen) Co., Ltd.

Applicant : TPV Display Technology (Wuhan) Co., Ltd.	Test Date : Oct.07, 2014
EUT : LCD Monitor	Temperature : 22.4±0.6°C
M/N : M2060***	Humidity : 46±3%
Test Voltage : AC 230V/50Hz	Test Mode : Same as section 3.6
Test Engineer : Sun	Pressure : 99.7±1kPa
Required Performance : B	Actual Performance : A & B

Air Discharge: ±2kV ±4kV ±8kV # For Air Discharge each Point Positive 10 times and negative 10 times discharge.

Contact Discharge: ±2kV ±4kV # For Contact Discharge each point positive 25 times and negative 25 times discharge

For the time interval between successive single discharges an initial value of one second.

Discharge Voltage (kV)	Type of discharge	Dischargeable Points	Performance		Result (Pass/Fail)
			Required	Observation	
±2	Contact	5,6,8	B	A	Pass
±4	Contact	5,6,8	B	B	Pass
±2	Air	1,2,3,4,6,7,9	B	A	Pass
±4	Air	1,2,3,4,6,7,9	B	A	Pass
±8	Air	1,2,3,4,6,7,9	B	B	Pass
±2	HCP-Bottom	Edge of the HCP	B	A	Pass
±2	VCP-Front	Center of the VCP	B	A	Pass
±2	VCP-Left	Center of the VCP	B	A	Pass
±2	VCP-Back	Center of the VCP	B	A	Pass
±2	VCP-Right	Center of the VCP	B	A	Pass
±4	HCP-Bottom	Edge of the HCP	B	A	Pass
±4	VCP-Front	Center of the VCP	B	A	Pass
±4	VCP-Left	Center of the VCP	B	A	Pass
±4	VCP-Back	Center of the VCP	B	A	Pass
±4	VCP-Right	Center of the VCP	B	A	Pass

Discharge Points Description

<u>1</u>	Buttons	<u>8</u>	Metal
<u>2</u>	LED	<u>9</u>	Key Lock
<u>3</u>	Screen	<u>10</u>	
<u>4</u>	Slots	<u>11</u>	
<u>5</u>	Screws	<u>12</u>	
<u>6</u>	VGA/ DVI Port	<u>13</u>	
<u>7</u>	AC In Port	<u>14</u>	

Remark: After discharge to the ungrounded part of EUT, it needs the bleeder resistor to remove the charge prior to next ESD pulse.

The class "B" means the EUT will blank screen during test, but it can recover by itself after test.

Discharge was considered on Contact and Air and Horizontal Coupling Plane (HCP) and Vertical Coupling Plane (VCP).

9. RF FIELD STRENGTH SUSCEPTIBILITY TEST

9.1. Test Equipments

Item	Equipment	Manufacturer	Model No.	Serial No.	Last Cal.	Cal. Interval
1.	2#Chamber	AUDIX	N/A	N/A	Apr. 28,14	1Year
2.	Signal Generator	Agilent	N5181A	MY49061013	Oct.31, 13	1Year
3.	Amplifier	A&R	100W/1000M1	17028	NCR	NCR
4.	Power Meter	Anritsu	ML2487A	6K00002472	Aug. 20,14	1Year
5.	Power Sensor	Anritsu	MA2491A	032516	Aug. 20,14	1Year
6.	Log-periodic Antenna	A&R	AT1080	16512	NCR	NCR

Note: NCR: No calibration required(calibrated with system)

9.2. Block Diagram of Test Setup

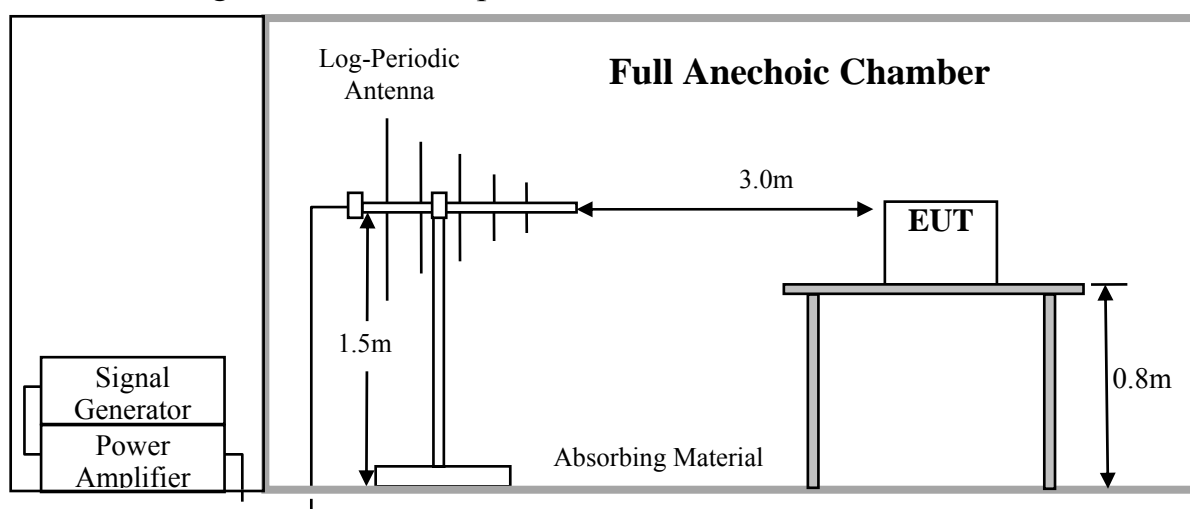

9.3. Test Standard

EN 55024: 2010 (IEC 61000-4-3: 2010)
(Severity Level: 2 at 3V / m)

9.4. Test Severity Level and Performance Criterion

Severity Level	Test Field Strength V/m	Performance Criteria
1.	1	A
2.	3	
3.	10	
X.	Special	

9.5. EUT Configuration

The configurations of EUT are listed in Section 3.5.

9.6. Operating Condition of EUT

Same as Conducted Emission test that is listed in Section 3.6. except the test set up replaced by Section 9.2.

9.7. Test Procedure

Testing was performed in a Fully anechoic chamber as recommended by IEC 61000-4-3. The EUT was placed on an 80 cm high non-conductive table located in the area of field uniformity. The radiating antenna was placed 3m in front of the EUT and Support system, and dwell time of the radiated interference was controlled by an automated, computer-controlled system. The signal source was stepped through the applicable frequency range at a rate no faster than 1% of the fundamental. The signal was amplitude modulated 80% over the frequency range 80 MHz to 1GHz at a level of 3 V/m. The dwell time was set at 3 s. Field presence was monitored during testing via a field probe placed in close proximity to the EUT. Throughout testing, the EUT was closely monitored for signs of susceptibility. The test was performed with the antennae oriented in both a horizontal and vertical polarization.

All the scanning conditions are as follows:

Test conditions	
Frequency	80MHz-1GHz
Frequency increments step	1% of momentary used
Test level	3V/m (unmodulated)
Dwell time	3s
Test signal	80% amplitude modulated by 1kHz sinusoidal audio signal

9.8. Test Results

PASS.

The EUT was tested and all the test results are listed in next page.

RF Field Strength Susceptibility Test Results

Audix Technology (Shenzhen) Co., Ltd.

Applicant : TPV Display Technology (Wuhan) Co., Ltd.	Test Date : Oct.10, 2014																																		
EUT : LCD Monitor	Temperature : 25±0.6°C																																		
M/N : M2060***	Humidity : 47±3%																																		
Test Voltage : AC 230V/50Hz	Pressure : 101.2±1kPa																																		
Test Engineer : Mark	Test Mode : Same as section 3.6																																		
Required Performance : A	Actual Performance : A																																		
Modulation: <input checked="" type="checkbox"/> AM <input type="checkbox"/> Pulse <input type="checkbox"/> none 1 kHz 80%																																			
Frequency Rang :80 MHz -1000MHz																																			
	<table border="1" style="width: 100%; border-collapse: collapse;"> <thead> <tr> <th rowspan="2"></th> <th colspan="2">Horizontal</th> <th colspan="2">Vertical</th> <th rowspan="2">Result (Pass / Fail)</th> </tr> <tr> <th>Required</th> <th>Observation</th> <th>Required</th> <th>Observation</th> </tr> </thead> <tbody> <tr> <td style="text-align: center;">Front</td> <td style="text-align: center;">A</td> <td style="text-align: center;">A</td> <td style="text-align: center;">A</td> <td style="text-align: center;">A</td> <td style="text-align: center;">Pass</td> </tr> <tr> <td style="text-align: center;">Right</td> <td style="text-align: center;">A</td> <td style="text-align: center;">A</td> <td style="text-align: center;">A</td> <td style="text-align: center;">A</td> <td style="text-align: center;">Pass</td> </tr> <tr> <td style="text-align: center;">Rear</td> <td style="text-align: center;">A</td> <td style="text-align: center;">A</td> <td style="text-align: center;">A</td> <td style="text-align: center;">A</td> <td style="text-align: center;">Pass</td> </tr> <tr> <td style="text-align: center;">Left</td> <td style="text-align: center;">A</td> <td style="text-align: center;">A</td> <td style="text-align: center;">A</td> <td style="text-align: center;">A</td> <td style="text-align: center;">Pass</td> </tr> </tbody> </table>		Horizontal		Vertical		Result (Pass / Fail)	Required	Observation	Required	Observation	Front	A	A	A	A	Pass	Right	A	A	A	A	Pass	Rear	A	A	A	A	Pass	Left	A	A	A	A	Pass
	Horizontal		Vertical		Result (Pass / Fail)																														
	Required	Observation	Required	Observation																															
Front	A	A	A	A	Pass																														
Right	A	A	A	A	Pass																														
Rear	A	A	A	A	Pass																														
Left	A	A	A	A	Pass																														
Remark:																																			

10. ELECTRICAL FAST TRANSIENT/BURST IMMUNITY TEST

10.1. Test Equipments

Item	Equipment	Manufacturer	Model No.	Serial No.	Last Cal.	Cal. Interval
1.	Burst Tester	TESEQ	NSG3025	28017	Apr. 28,14	1 Year
2.	CDN	TESEQ	CDN8014	29638	Apr. 28,14	1 Year

10.2. Block Diagram of Test Setup

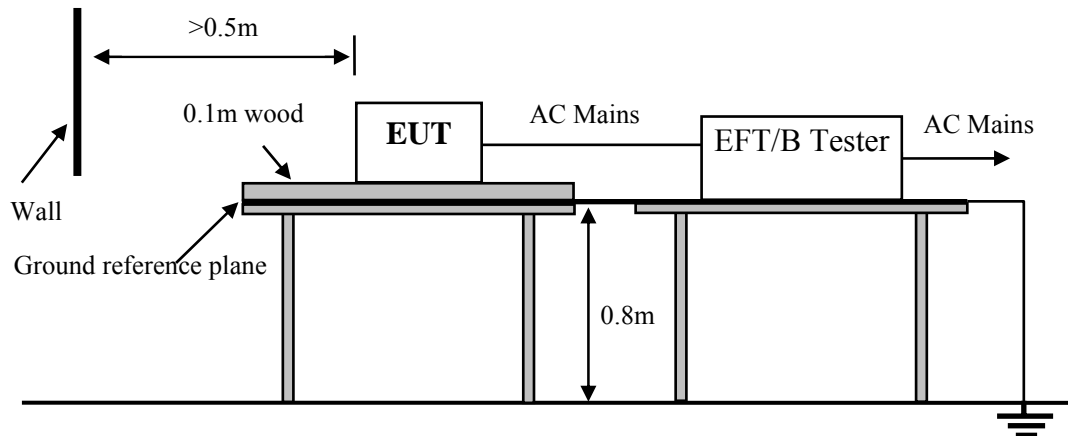

10.3. Test Standard

EN 55024: 2010 (IEC 61000-4-4: 2012)
(Severity Level: Level 1 at 0.5kV, Level 2 at 1kV)

10.4. Severity Levels and Performance Criterion

Open Circuit Output Test Voltage $\pm 10\%$			
Severity Level	On Power Supply Lines	On I/O (Input/Output) Signal data and control lines	Performance criterion
1.	0.5 kV	0.25 kV	B
2.	1 kV	0.5 kV	
3.	2 kV	1 kV	
4.	4 kV	2 kV	
X	Special	Special	

10.5. EUT Configuration

The configurations of EUT are listed in Section 3.5.

10.6. Operating Condition of EUT

Same as Conducted Emission test that is listed in Section 3.6. except the test set up replaced by Section 10.2.

10.7. Test Procedure

The EUT and its simulators were placed on the ground reference plane and were insulated from it by a wood support $0.1\text{m} \pm 0.01\text{m}$ thick. The ground reference plane was $1\text{m} \times 1\text{m}$ metallic sheet with 0.65mm minimum thickness. This reference ground plane was project beyond the EUT by at least 0.1m on all sides and the minimum distance between EUT and all other conductive structure, except the ground plane was more than 0.5m . All cables to the EUT was placed on the wood support, cables not subject to EFT/B was routed as far as possible from the cable under test to minimize the coupling between the cables.

10.7.1. For input and AC power ports:

The EUT was connected to the power mains by using a coupling device that couples the EFT interference signal to AC power lines. Both positive transients and negative transients of test voltage were applied during compliance test and the duration of the test can't less than 1min.

10.7.2. For signal lines and control lines ports:

Ports which are intended to be connected to telecommunication networks (e.g. public switched telecommunication networks, integrated services digital networks, local area networks and similar networks.)

10.7.3. For DC input and DC output power ports:

It's unnecessary to test.

10.8. Test Results

PASS.

The EUT was tested and all the test results are listed in next page.

Electrical Fast Transient/Burst Test Results

Audix Technology (Shenzhen) Co., Ltd.

Applicant : TPV Display Technology (Wuhan) Co., Ltd. EUT : LCD Monitor M/N : M2060*** Test Voltage : AC 230V/50Hz Test Engineer : Sun Required Performance : B	Test Date : Oct.07, 2014 Temperature : 22.4±0.6°C Humidity : 46±3% Test Mode : Same as section 3.6 Pressure : 99.7±1kPa Actual Performance : A & B
-------------------------------------------------------------------------------------------------------------------------------------------------------------------------------	-------------------------------------------------------------------------------------------------------------------------------------------------------------------

Repetition Frequency : 5 kHz Burst Duration : 15ms Burst Period: 300ms

Inject Time(s): 120s Inject Method: Direct
 Inject Line: AC Mains DC Supply Signal

Line	Test Voltage	Performance			Result (Pass/Fail)
		Required	Observation(+)	Observation(-)	
L	0.5kV	B	A	A	Pass
	1kV	B	B	B	Pass
N	0.5kV	B	A	A	Pass
	1kV	B	B	B	Pass
PE	0.5kV	B	A	A	Pass
	1kV	B	B	B	Pass
L N	0.5kV	B	A	A	Pass
	1kV	B	B	B	Pass
L PE	0.5kV	B	A	A	Pass
	1kV	B	B	B	Pass
N PE	0.5kV	B	A	A	Pass
	1kV	B	B	B	Pass
L N PE	0.5kV	B	A	A	Pass
	1kV	B	B	B	Pass
Signal Line					

Remark: The class "B" means the EUT will blank screen during test, but it can recover by itself after test.

11. SURGE TEST

11.1. Test Equipments

Item	Equipment	Manufacturer	Model No.	Serial No.	Last Cal.	Cal. Interval
1	Transient Test System	EMC PARTNER	TRANSIENT 2000	TRA2006 F-S-T-D-R -1500	Oct.31, 13	1 Year
2	CDN	EMC PARTNER	CDN-UTP8	CDN-UTP8-1 508	Oct.31, 13	1 Year
3	CDN	EMC PARTNER	CDN2000-06-25	CDN2000-06 -25 0111	Oct.31, 13	1 Year

11.2. Block Diagram of Test Setup

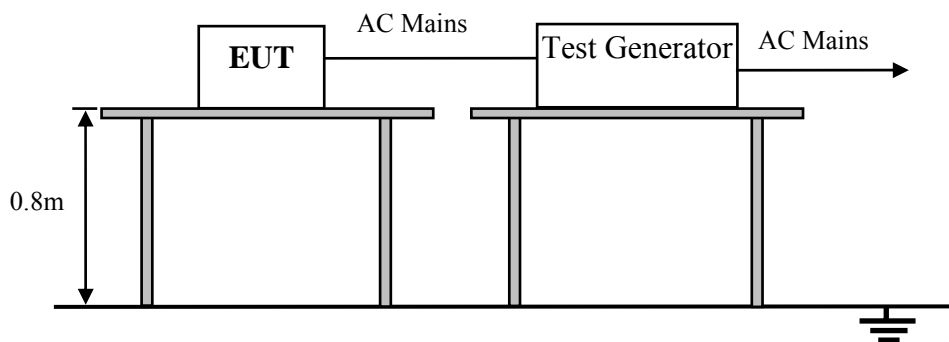

11.3. Test Standard

EN 55024: 2010 (IEC 61000-4-5: 2005)

(Severity Level: Line to Line was Level 1 at 0.5kV& Level 2 at 1kV,

Line to Ground Level 1 at 0.5kV& Level 2 at 1kV& Level 3 at 2kV)

11.4. Severity Levels and Performance Criterion

Severity Level	Open-Circuit Test Voltage kV	Performance criterion
1	0.5	B
2	1.0	
3	2.0	
4	4.0	
*	Special	

11.5. EUT Configuration

The configurations of EUT are listed in Section 3.5.

11.6. Operating Condition of EUT

Same as Conducted Emission test that is listed in Section 3.6. except the test set up replaced by Section 11.2

11.7. Test Procedure

- 1) Set up the EUT and test generator as shown on Section 11.2.
- 2) For line-to-line coupling mode, provide a 1kV 1.2/50us voltage surge (at open-circuit condition) and 8/20us current surge to EUT selected points, and for active line / neutral lines to ground are same except test level is 2kV.
- 3) At least 5 positive and 5 negative (polarity) tests with a maximum 1/min repetition rate are applied during test.
- 4) Different phase angles are done individually.
- 5) Record the EUT operating situation during compliance test and decide the EUT immunity criterion for above each test.

11.8. Test Results

PASS.

The EUT was tested and all the test results are listed in next page.

Surge Immunity Test Results

Audix Technology (Shenzhen) Co., Ltd.

Applicant : TPV Display Technology (Wuhan) Co., Ltd. <hr/> EUT : LCD Monitor <hr/> M/N : M2060*** <hr/> Power Supply : AC 230V/50Hz <hr/> Test Engineer : Sun <hr/> Required Performance : B	Test Date : Oct.07, 2014 <hr/> Temperature : 22.4±0.6°C <hr/> Humidity : 46±3% <hr/> Test Mode : Same as section 3.6 <hr/> Pressure : 99.7 ±1kPa <hr/> Actual Performance : A & B
-----------------------------------------------------------------------------------------------------------------------------------------------------------------------------------------------------------------------	-------------------------------------------------------------------------------------------------------------------------------------------------------------------------------------------------------------

No.of pluse: ±5 Interval:60 Seconds

Line : AC Mains DC Supply Signal

Location	Phase	500V			1kV			2kV			Result (Pass/Fail)
		Performance			Performance			Performance			
		Required	+	-	Required	+	-	Required	+	-	
L-N	0°	B	A	A	B	A	A				Pass
	90°	B	A	A	B	A	A				Pass
	180°	B	A	A	B	A	A				Pass
	270°	B	A	A	B	A	A				Pass
L-PE	0°	B	A	A	B	A	A	B	B	B	Pass
	90°	B	A	A	B	A	A	B	B	B	Pass
	180°	B	A	A	B	A	A	B	B	B	Pass
	270°	B	A	A	B	A	A	B	B	B	Pass
N-PE	0°	B	A	A	B	A	A	B	B	B	Pass
	90°	B	A	A	B	A	A	B	B	B	Pass
	180°	B	A	A	B	A	A	B	B	B	Pass
	270°	B	A	A	B	A	A	B	B	B	Pass
Signal Line											

Remark: The class “B” means the EUT will blank screen during test, but it can recover by itself after test.

12. INJECTED CURRENTS SUSCEPTIBILITY TEST

12.1. Test Equipments

Item	Equipment	Manufacturer	Model No.	Serial No.	Last Cal.	Cal. Interval
1.	Signal Generator	Agilent	N5181A	MY49061013	Oct.31, 13	1 Year
2.	Amplifier	AR	25A250A	19152	NCR	NCR
3.	Amplifier	AR	100A250	19368	NCR	NCR
4.	Power meter	HP	436A	2016A07891	Apr. 28,14	1Year
5.	Power sensor	Agilent	8482B	MY41090514	Nov.23, 13	1Year
6.	CDN	FCC	FCC-801-M2-25	47	Apr. 28,14	1 Year
7.	CDN	FCC	FCC-801-M3-25	107	Apr. 28,14	1 Year
8.	CDN	FCC	FCC-801-M2-25	07035	Apr. 28,14	1 Year
9.	CDN	FCC	FCC-801-M3-25	07045	Apr. 28,14	1 Year
10.	PC	N/A	N/A	N/A	N/A	N/A
11.	Attenuator	Weinschel	40-6-34	LJ092	Apr. 28,14	1 Year
12.	EM Injection Clamp	FCC	F-203I-23mm	403	Apr. 28,14	1 Year
13.	RF Cable	MICABLE	A04-07-07-2M	09111340	NCR	NCR
14.	RF Cable	STORM	MFR-57500	90-195-2MTR	NCR	NCR

Note: NCR: No calibration required(calibrated with system)

12.2. Block Diagram of Test Setup

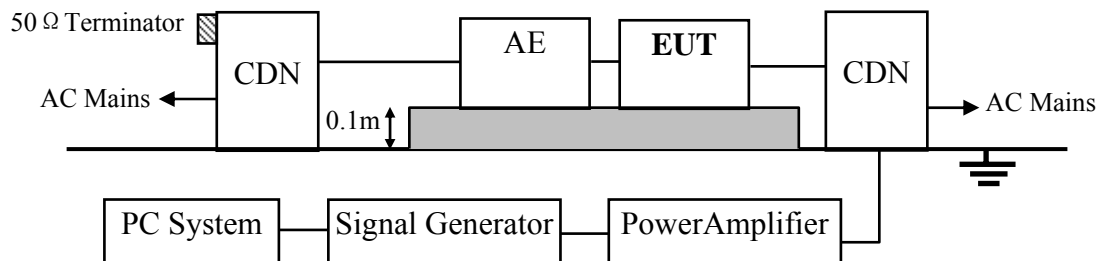

12.3. Test Standard

EN 55024: 2010 (IEC 61000-4-6: 2013)

(Severity Level 2 at 3V (r.m.s.) and frequency is from 0.15MHz to 80MHz)

12.4. Severity Levels and Performance Criterion

Severity Level	Voltage Level (e.m.f.) V	Performance criterion
1	1	A
2	3	
3	10	
X	Special	

12.5. EUT Configuration

The configurations of EUT are listed in Section 3.5.

12.6. Operating Condition of EUT

Same as Conducted Emission test that is listed in Section 3.6. except the test set up replaced by Section 12.2.

12.7. Test Procedure

- 1) Set up the EUT, CDN and test generators as shown on Section 12.2.
- 2) Let the EUT work in test mode and test it.
- 3) The EUT are placed on an insulating support 0.1m high above a ground reference plane. CDN (coupling and decoupling device) is placed on the ground plane about 0.3m from EUT. Cables between CDN and EUT are as short as possible, and their height above the ground reference plane shall be between 10 and 30 mm (where possible).
- 4) The disturbance signal described below is injected to EUT through CDN.
- 5) The EUT operates within its operational mode(s) under intended climatic conditions after power on.
- 6) The frequency range is swept from 0.150MHz to 80MHz using 3V signal level, and with the disturbance signal 80% amplitude modulated with a 1kHz sine wave.
- 7) The rate of sweep shall not exceed 1.5×10^{-3} decades/s. Where the frequency is swept incrementally, the step size shall not exceed 1% of the start and thereafter 1% of the preceding frequency value.
- 8) Recording the EUT operating situation during compliance testing and decide the EUT immunity criterion.

12.8. Test Results

PASS.

The EUT was tested and all the test results are listed in next page.

Injected Currents Susceptibility Test Results

Audix Technology (Shenzhen)Co.,Ltd.

Applicant : TPV Display Technology (Wuhan) Co., Ltd.	Test Date : Oct.10, 2014
EUT : LCD Monitor	Temperature : 25±0.6°C
M/N : M2060***	Humidity : 47±3%
Power Supply : AC 230V/50Hz	Test Mode : Same as section 3.6
Test Engineer : Mark	Pressure : 101.2±1kPa
Required Performance : A	Actual Performance : A

Frequency Range (MHz)	Injected Position	Voltage Level (e.m.f.)	Required	Observation	Result
					(Pass / Fail)
0.15 ~ 20	AC Mains	3V	A	A	PASS
20 ~ 80	AC Mains	3V	A	A	PASS

Modulation Signal:1kHz 80% AM

Remark:

13. MAGNETIC FIELD IMMUNITY TEST

13.1. Test Equipments

Item	Equipment	Manufacturer	Model No.	Serial No.	Last Cal.	Cal. Interval
1.	Magnetic Field Tester	HEAFELY	MAG100.1	083858-10	Apr. 28,14	1 Year

13.2. Block Diagram of Test Setup

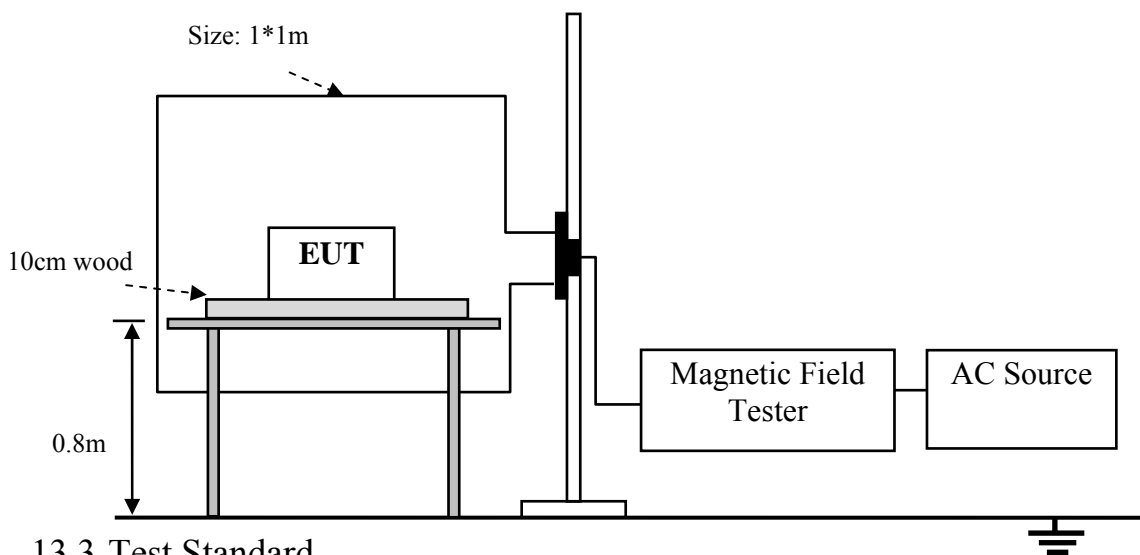

13.3. Test Standard

EN 55024: 2010 (IEC 61000-4-8: 2009)
(Severity Level 1 at 1A/m)

13.4. Severity Levels and Performance Criterion

Severity Level	Magnetic Field Strength A/m	Performance criterion
1.	1	A
2.	3	
3.	10	
4.	30	
5.	100	
X.	Special	

13.5. EUT Configuration on Test

The configurations of EUT are listed in Section 3.5.

13.6. Operating Condition of EUT

Same as Conducted Emission test that is listed in Section 3.6. except the test set up replaced by Section 13.2.

13.7. Test Procedure

The EUT was subjected to the test magnetic field by using the induction coil of standard dimensions (1m*1m) and shown in Section 13.2. The induction coil was then rotated by 90° in order to expose the EUT to the test field with different orientations.

13.8. Test Results

PASS.

The EUT was tested and all the test results are listed in next page.

Magnetic Field Immunity Test Results

Audix Technology (Shenzhen) Co., Ltd.

Applicant : TPV Display Technology (Wuhan) Co., Ltd. <hr/> EUT : LCD Monitor <hr/> M/N : M2060*** <hr/> Test Voltage : AC 230V/50Hz <hr/> Test Engineer : Mark <hr/> Required Performance : A	Test Date : Oct.10, 2014 <hr/> Temperature : 25±0.6°C <hr/> Humidity : 48±3% <hr/> Test Mode : Same as section 3.6 <hr/> Pressure : 101.2±1kPa <hr/> Actual Performance : A				
Test Level	Testing Duration	Coil Orientation	Required	Observation	Result (Pass/Fail)
1A/m	5 min / coil	X	A	A	PASS
1A/m	5 min / coil	Y	A	A	PASS
1A/m	5 min / coil	Z	A	A	PASS
Remark:					

14. VOLTAGE DIPS AND INTERRUPTIONS TEST

14.1. Test Equipment

Item	Equipment	Manufacturer	Model No.	Serial No.	Last Cal.	Cal. Interval
1.	Main Interference Simulator	HAEFELY	PLINE 1610	083690-05	Apr. 28,14	1 Year

14.2. Block Diagram of Test Setup

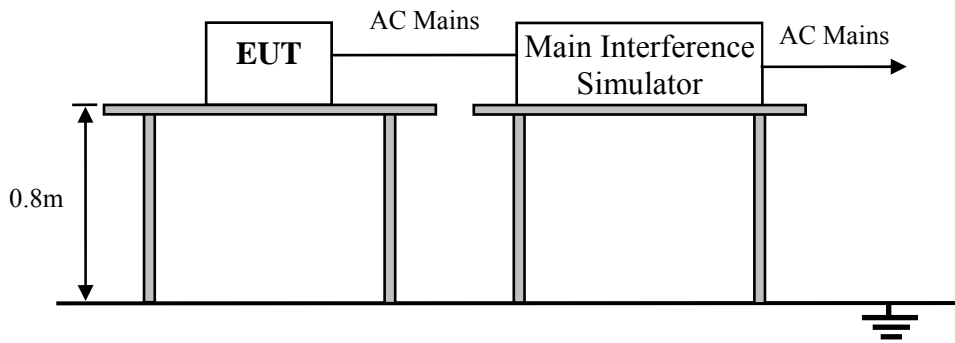

14.3. Test Standard

EN 55024: 2010 (IEC 61000-4-11: 2004)

14.4. Severity Levels and Performance Criterion

Test Level %U _T	Voltage dip and short interruptions %U _T	Duration (in period)	Performance Criterion
0	100	250	C
0	100	0.5	B
70	30	25	C

14.5. EUT Configuration

The configurations of EUT are listed in Section 3.5.

14.6. Operating Condition of EUT

Same as Conducted Emission test that is listed in Section 3.6. except the test set up replaced by Section 14.2.

14.7. Test Procedure

- 1) The EUT and test generator were setup as shown on Section 14.2.
- 2) The interruption is introduced at selected phase angles with specified duration.
- 3) Record any degradation of performance.

14.8. Test Results

PASS.

The EUT was tested and all the test results are listed in next page.

Voltage Dips And Interruptions Test Results

Audix Technology (Shenzhen) Co., Ltd.

Applicant : TPV Display Technology (Wuhan) Co., Ltd. <hr/> EUT : LCD Monitor <hr/> M/N : M2060*** <hr/> Power Supply : AC 100V/50Hz ; AC 230V/50Hz <hr/> Test Engineer : Mark <hr/> Required Performance : B & C	Test Date : Oct.10, 2014 <hr/> Temperature : 25±0.6°C <hr/> Humidity : 47±3% <hr/> Test Mode : Same as section 3.6 <hr/> Pressure : 101.2±1kPa <hr/> Actual Performance : A & B
---------------------------------------------------------------------------------------------------------------------------------------------------------------------------------------------------------------------------------	------------------------------------------------------------------------------------------------------------------------------------------------------------------------------------------------

Test Level % U _T	Voltage Dips & Short Interruptions % U _T	Duration (in period)	Phase Angle	Required	Observation	Result
						(Pass / Fail)
0	100	0.5P	0° -360°	B	A	PASS
70	30	25P	0° -360°	C	A	PASS
0	100	250P	0° -360°	C	B	PASS

Note 1: U_T is the rated voltage for the equipment.

Note 2: The frequency of the test voltage shall be within ±2% of the rated frequency, the output voltage shall be within ±5% of the rated voltage.

Remark: The class “B” means the EUT will suspended work for power lost during test, but when the power supply, it can recover to normal by itself.

15. PHOTOGRAPHS

15.1. Photos of Power Line Conducted Emission Test



15.2. Photos of Radiated Emission Test (In Anechoic Chamber)

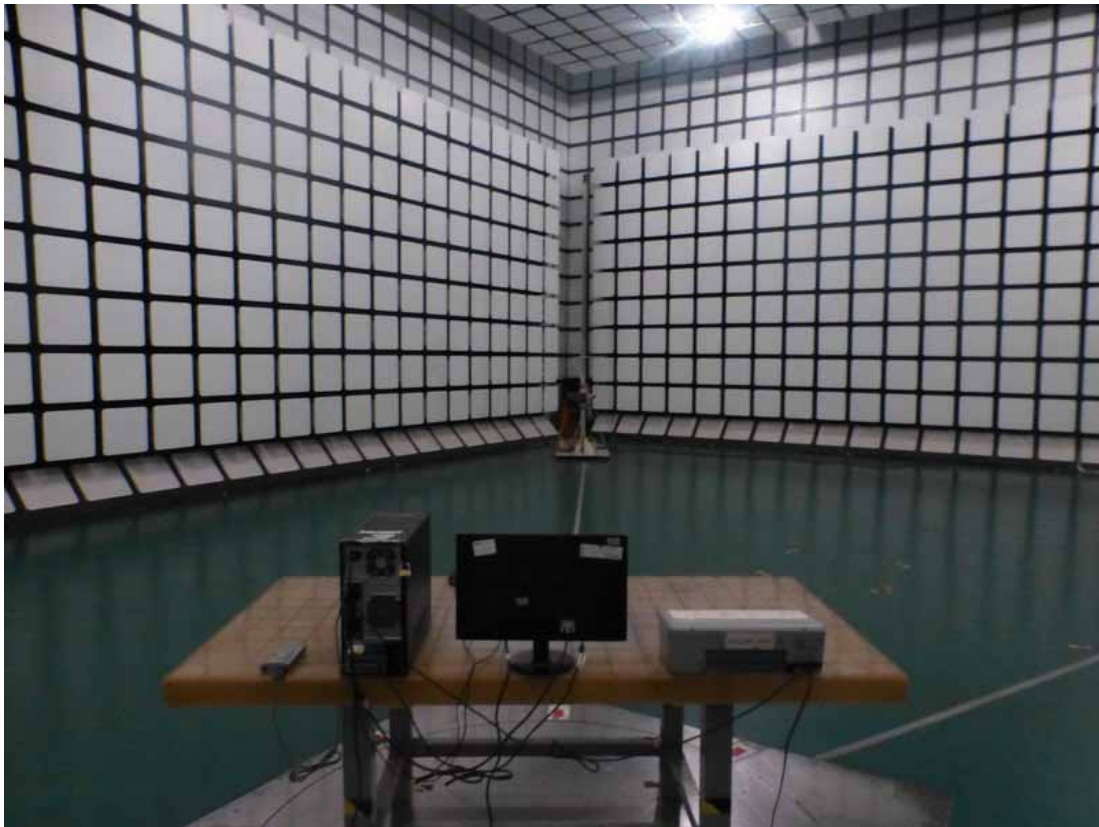

(At Anechoic 10m Chamber Test 1GHz –6GHz)

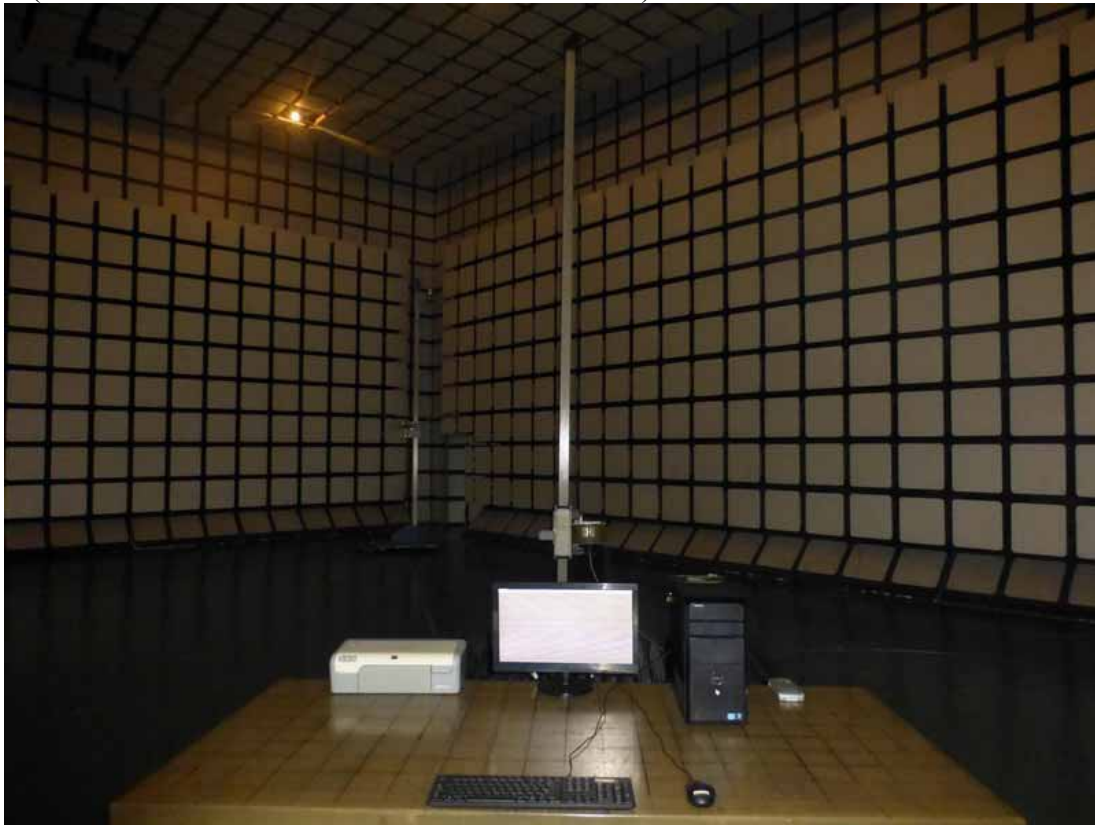

15.3. Photo of Harmonic / Flicker Test



15.4. Photos of Electrostatic Discharge Immunity Test

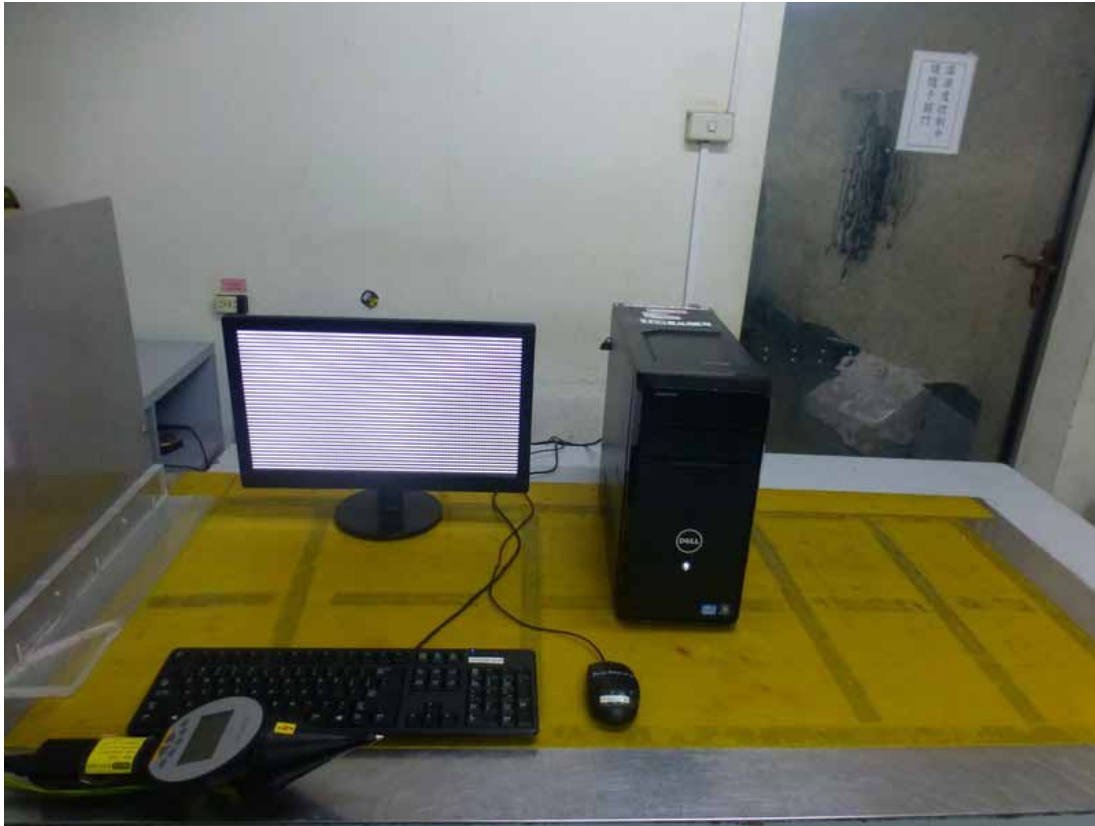

15.5. Photo of RF Strength Susceptibility Test

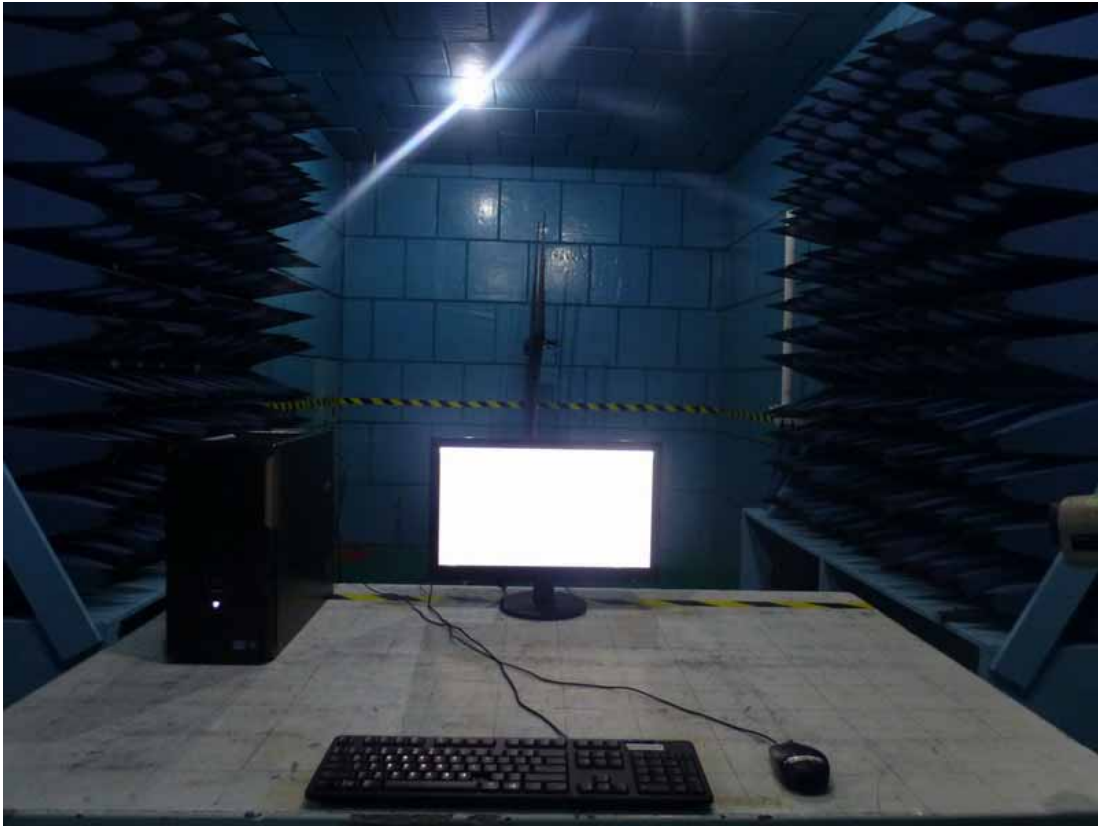

15.6. Photo of Electrical Fast Transient/Burst Immunity Test



15.7. Photo of Surge Test

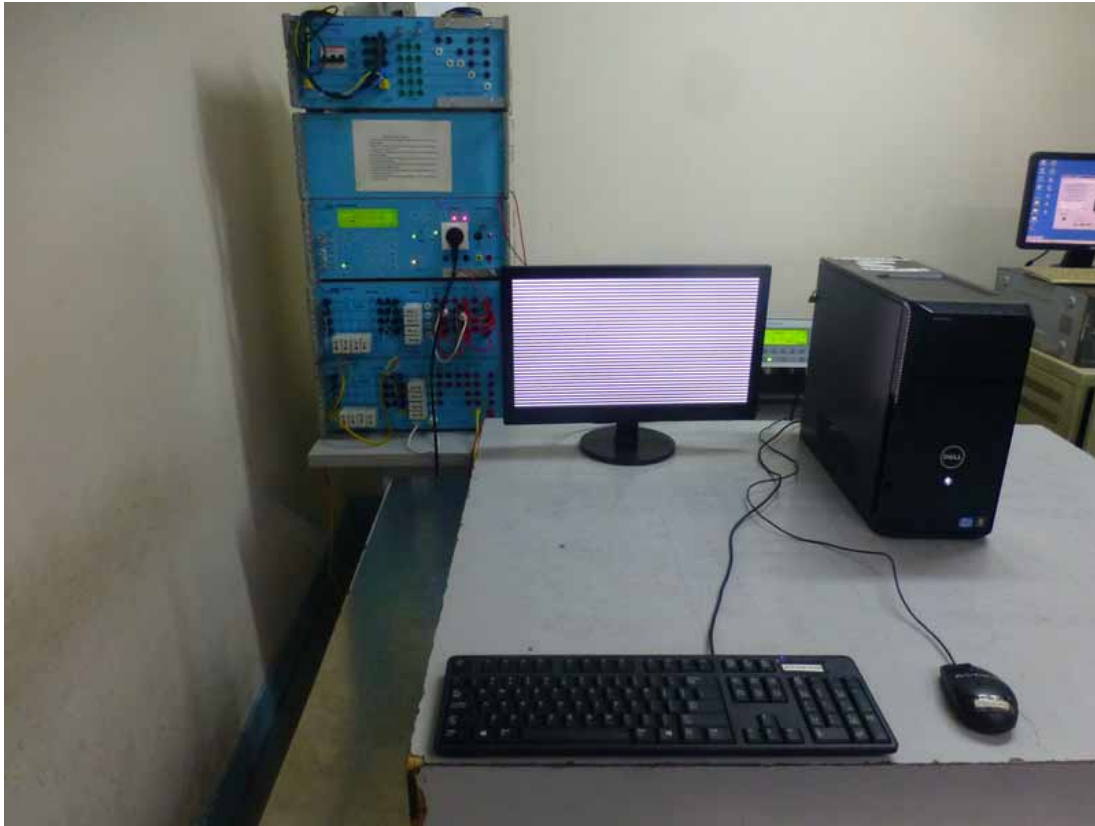

15.8. Photo of Injected Currents Susceptibility Test



15.9. Photo of Magnetic Field Test

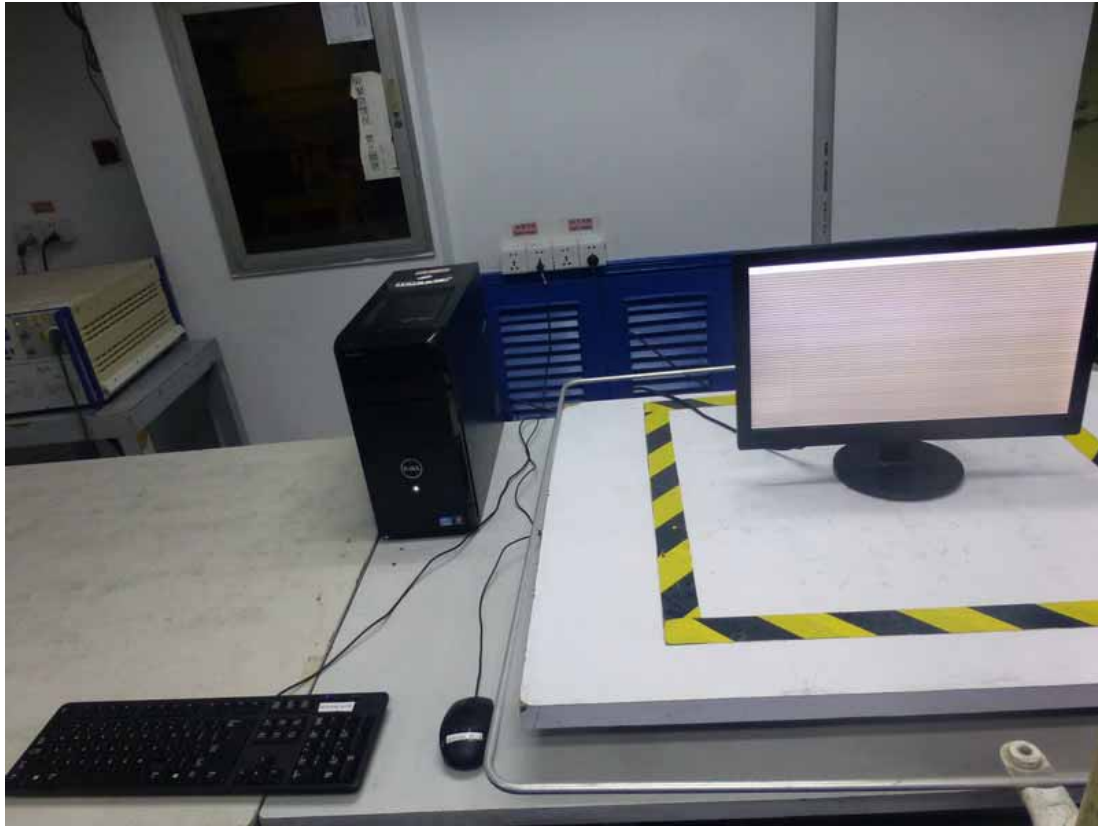

15.10. Photo of Voltage Dips and interruptions test

