



By Lenoxx

www.lenoxx.com.au



1300 666 848



LenoxxElectronics



LenoxxElectronics



@LenoxxAustralia

ASSEMBLY INSTRUCTIONS

Model Number: BS524B

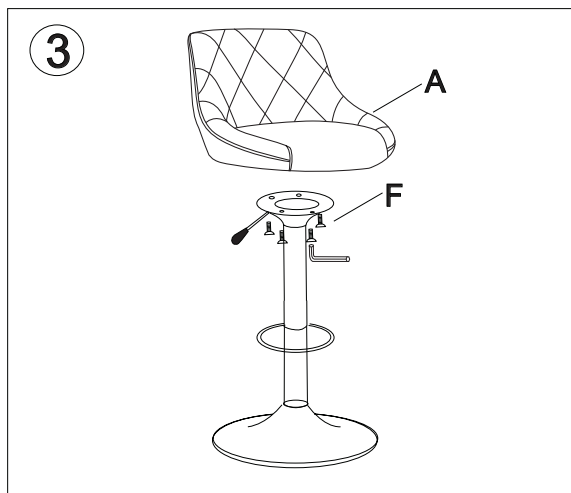
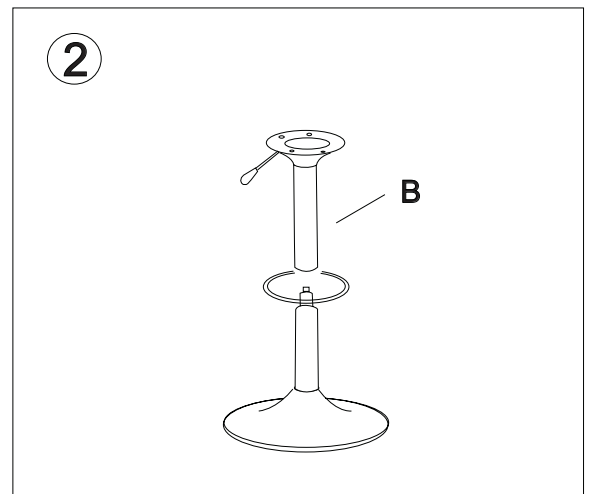
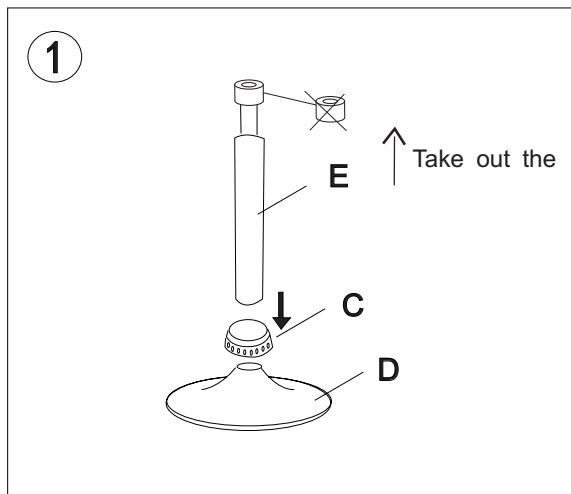
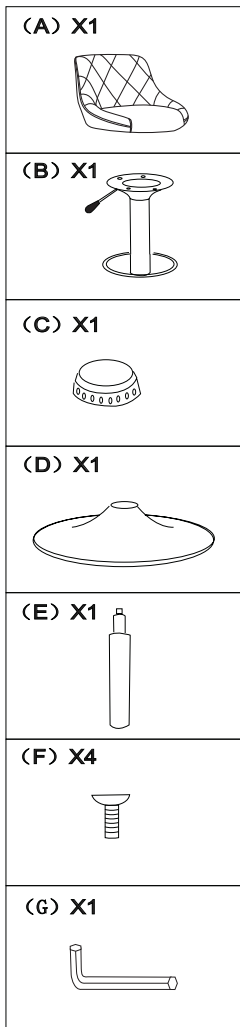

LENOXX

LEADERS IN SOUND ENTERTAINMENT

Lenoxx Electronics (Aust) Pty Ltd

6 Oban Court Laverton North Vic 3026

Phone (03) 9267 2100 Fax (03) 9267 2199

ABN 97 844 321 851

Email Address: lenoxx@lenoxx.com.au

Web Site: www.lenoxx.com.au

WARRANTY CARD

WE WARRANT THIS PRODUCT TO BE FREE FROM DEFECTS IN MATERIAL AND WORKMANSHIP UNDER NORMAL USE FOR A PERIOD OF 12 MONTHS AFTER DELIVERY TO THE ULTIMATE USER AND WE WILL REPAIR AT NO CHARGE OR REPLACE IT AT OUR OPTION SHOULD IT BECOME DEFECTIVE UNDER THIS WARRANTY PROVIDING YOU SUBMIT PROOF OF PURCHASE (ORIGINAL SALES RECEIPT) WHEN MAKING A REQUEST UNDER THIS WARRANTY. THIS WARRANTY DOES NOT APPLY TO ANY PRODUCT, WHICH HAS BEEN SUBJECT TO MISUSE NEGLECT OR ACCIDENT. THE WARRANTY DOES NOT COVER: HANDLES, BATTERIES, ELECTRICAL CORDS, ANTENNAS, MICROPHONES, BROKEN CABINETS OR ANY OTHER ACCESSORIES USED IN CONNECTION WITH THE PRODUCT. UNDER NO CIRCUMSTANCES WILL LENOXX ELECTRONICS (AUSTRALIA) PTY LTD BE LIABLE FOR ANY INCIDENTAL OR CONSEQUENTIAL DAMAGE.

CAUTION:

CHOKING HAZARD – UNIT MAY CONTAIN SMALL PARTS NOT SUITABLE FOR CHILDREN UNDER THE AGE OF 3.

IMPORTANT MESSAGE:

BEFORE SENDING YOUR UNIT TO LENOXX FOR REPAIR, YOU MUST SUPPLY PROOF OF PURCHASE (ORIGINAL RECEIPT) TO VALIDATE YOUR WARRANTY

THIS WARRANTY IS IN ADDITION TO OTHER RIGHTS AND REMEDIES OF THE CONSUMER UNDER A LAW IN RELATION TO THE GOODS OR SERVICES TO WHICH THE WARRANTY RELATES.

“Our goods come with guarantees that cannot be excluded under the Australian Consumer Law. You are entitled to a replacement or refund for major failure and for compensation for any other reasonably foreseeable loss or damage. You are also entitled to have the goods repaired or replaced if the goods fail to be of acceptable quality and the failure does not amount to a major failure”.

For warranty registration please visit our website

www.lenoxx.com.au

Service Direct Line (Australia only): 1300 666 848

MODEL NO:

BS524B

BATCH NO:

PR4611