



Installation, Operation, and Maintenance

# Water Source Heat Pump Axiom™ Horizontal/Vertical — EXH/EXV, DXH/DXV

0.75 to 6 Tons – 60 Hz, High Efficiency and Two-Stage High Efficiency



**Model Numbers:**

DXHG 024-070 - 60 Hz

DXVG 024-070 - 60 Hz

EXHG 009-070 - 60 Hz

EXVG 009-070 - 60 Hz

## ⚠ SAFETY WARNING

Only qualified personnel should install and service the equipment. The installation, starting up, and servicing of heating, ventilating, and air-conditioning equipment can be hazardous and requires specific knowledge and training. Improperly installed, adjusted or altered equipment by an unqualified person could result in death or serious injury. When working on the equipment, observe all precautions in the literature and on the tags, stickers, and labels that are attached to the equipment.

May 2023

WSHP-SVX014J-EN

TRANE  
TECHNOLOGIES™



# Introduction

Read this manual thoroughly before operating or servicing this unit.

## Warnings, Cautions, and Notices

Safety advisories appear throughout this manual as required. Your personal safety and the proper operation of this machine depend upon the strict observance of these precautions.

The three types of advisories are defined as follows:



Indicates a potentially hazardous situation which, if not avoided, could result in death or serious injury.



Indicates a potentially hazardous situation which, if not avoided, could result in minor or moderate injury. It could also be used to alert against unsafe practices.



Indicates a situation that could result in equipment or property-damage only accidents.

## Important Environmental Concerns

Scientific research has shown that certain man-made chemicals can affect the earth's naturally occurring stratospheric ozone layer when released to the atmosphere. In particular, several of the identified chemicals that may affect the ozone layer are refrigerants that contain Chlorine, Fluorine and Carbon (CFCs) and those containing Hydrogen, Chlorine, Fluorine and Carbon (HCFCs). Not all refrigerants containing these compounds have the same potential impact to the environment. Trane advocates the responsible handling of all refrigerants.

## Important Responsible Refrigerant Practices

Trane believes that responsible refrigerant practices are important to the environment, our customers, and the air conditioning industry. All technicians who handle refrigerants must be certified according to local rules. For the USA, the Federal Clean Air Act (Section 608) sets forth the requirements for handling, reclaiming, recovering and recycling of certain refrigerants and the equipment that is used in these service procedures. In addition, some states or municipalities may have additional requirements that must also be adhered to for responsible management of refrigerants. Know the applicable laws and follow them.

### **⚠ WARNING**

#### **Proper Field Wiring and Grounding Required!**

Failure to follow code could result in death or serious injury.

All field wiring **MUST** be performed by qualified personnel. Improperly installed and grounded field wiring poses **FIRE** and **ELECTROCUTION** hazards. To avoid these hazards, you **MUST** follow requirements for field wiring installation and grounding as described in **NEC** and your local/state/national electrical codes.

### **⚠ WARNING**

#### **Personal Protective Equipment (PPE) Required!**

Failure to wear proper PPE for the job being undertaken could result in death or serious injury.

Technicians, in order to protect themselves from potential electrical, mechanical, and chemical hazards, **MUST** follow precautions in this manual and on the tags, stickers, and labels, as well as the instructions below:

- **Before installing/servicing this unit, technicians MUST put on all PPE required for the work being undertaken (Examples; cut resistant gloves/sleeves, butyl gloves, safety glasses, hard hat/bump cap, fall protection, electrical PPE and arc flash clothing). ALWAYS refer to appropriate Safety Data Sheets (SDS) and OSHA guidelines for proper PPE.**
- **When working with or around hazardous chemicals, ALWAYS refer to the appropriate SDS and OSHA/GHS (Global Harmonized System of Classification and Labelling of Chemicals) guidelines for information on allowable personal exposure levels, proper respiratory protection and handling instructions.**
- **If there is a risk of energized electrical contact, arc, or flash, technicians MUST put on all PPE in accordance with OSHA, NFPA 70E, or other country-specific requirements for arc flash protection, PRIOR to servicing the unit. NEVER PERFORM ANY SWITCHING, DISCONNECTING, OR VOLTAGE TESTING WITHOUT PROPER ELECTRICAL PPE AND ARC FLASH CLOTHING. ENSURE ELECTRICAL METERS AND EQUIPMENT ARE PROPERLY RATED FOR INTENDED VOLTAGE.**

**⚠ WARNING****Follow EHS Policies!**

Failure to follow instructions below could result in death or serious injury.

- All Trane personnel must follow the company's Environmental, Health and Safety (EHS) policies when performing work such as hot work, electrical, fall protection, lockout/tagout, refrigerant handling, etc. Where local regulations are more stringent than these policies, those regulations supersede these policies.
- Non-Trane personnel should always follow local regulations.

**Copyright**

This document and the information in it are the property of Trane, and may not be used or reproduced in whole or in

part without written permission. Trane reserves the right to revise this publication at any time, and to make changes to its content without obligation to notify any person of such revision or change.

**Trademarks**

All trademarks referenced in this document are the trademarks of their respective owners.

**Revision History**

- Removed EXHF/DXHF data and ZN524 data throughout the document.
- Added Symbio™ 400-B information throughout the document.
- Updated the dimensional data diagrams and tables for EXH/DXH in the Unit Dimensions chapter.
- Updated the Electrical data tables and Wiring Diagram chapter.



# Table of Contents

Model Number Description . . . . .	6	Low Voltage Wiring (AC)	
EXVH/DXVH Models . . . . .	6	Requirements . . . . .	27
Overview of Manual . . . . .	7	Filter Installation . . . . .	27
Unit Nameplate . . . . .	7	Supply-Air Ductwork . . . . .	28
Compressor Nameplate . . . . .	7	Return-Air Ductwork . . . . .	28
Model Number Description . . . . .	7	Ducted Panel . . . . .	28
General Information . . . . .	8	Ducted Filter Rack . . . . .	30
Unit Description . . . . .	8	Sound Attenuation Pad . . . . .	30
Air-to-Refrigerant Coil . . . . .	8	Hanging the Horizontal Unit . . . . .	30
Water-to-Refrigerant Coil . . . . .	8	Condensate Drain Connection . . . . .	31
Controls . . . . .	8	Supply Pipe Connections . . . . .	31
System Input Devices and Functions . . . . .	8	Cleaning and Flushing the Water Loop . . . . .	31
Deluxe 24V Controls (option) . . . . .	8	Field Installed Power Wiring . . . . .	32
Symbio™ 400-B/Tracer® UC400-B		Main Unit Power Wiring . . . . .	32
(option) . . . . .	8	Control Power Transformer . . . . .	32
Pump Module (Field Installed		Thermostat Location . . . . .	33
Accessory) . . . . .	8	Thermostats and Zone Sensors . . . . .	33
Waterside Economizer (Option) . . . . .	8	Controls Using 24 Vac . . . . .	36
Boilerless Control/Electric Heat		External Smoke Detection Wiring to	
(Option) . . . . .	8	Unit . . . . .	39
Pre-Installation . . . . .	10	Deluxe Controller . . . . .	39
Unit Inspection Checklist . . . . .	10	Symbio™ 400-B/UC400-B	
Jobsite Inspection Checklist . . . . .	10	Controller . . . . .	39
Jobsite Storage . . . . .	10	Airflow Adjustment . . . . .	39
Unit Dimensions . . . . .	12	Units with Deluxe 24V controls . . . . .	39
Service Clearances . . . . .	12	Waterside Economizer Installation . . . . .	40
Unit Dimensions . . . . .	14	Waterside Economizer Installation for	
Weights . . . . .	26	Horizontal 0.75 to 6 Ton Units . . . . .	40
Weight Distribution for Hanging the DXH		Waterside Economizer Installation for	
and EXH Model . . . . .	26	Vertical Units . . . . .	41
Installation . . . . .	27	Waterside Economizer Start-Up	
General Installation Checks . . . . .	27	Sequence . . . . .	44
Main Electrical . . . . .	27	Electrical Data . . . . .	46
Electric Heat Requirements . . . . .	27	Pre-Start Checklist . . . . .	51
		Start-Up . . . . .	52
		Initial Unit Start-Up . . . . .	52
		Start-Up Checklist and Log . . . . .	52
		Operating Pressures . . . . .	52

Water Pressure Drop .....	59	Deluxe Controls .....	63
Water Volume .....	60	Wiring Diagrams .....	66
Maintenance .....	61	Warranty Information .....	67
Preventative Maintenance .....	61	Standard Warranty .....	67
Condensate Trap .....	62	Extended Warranty .....	67
Troubleshooting .....	63		



# Model Number Description

## EXVH/DXVH Models

### Digits 1–3 — Unit Configuration

**EXV** = High Efficiency Vertical  
**DXV** = Two-stage High Efficiency Vertical  
**EXH** = High Efficiency Horizontal  
**DXH** = Two-stage High Efficiency Horizontal

### Digit 4 — Development Sequence

**G**

### Digits 5–7 — Nominal Size (MBH)

**009** = 9.0 MBH (EX only)  
**012** = 12.0 MBH (EX only)  
**015** = 15.0 MBH (EX only)  
**018** = 18.0 MBH (EX only)  
**024** = 24.0 MBH  
**030** = 30.0 MBH (EX only)  
**036** = 36.0 MBH  
**042** = 42.0 MBH (EX only)  
**048** = 48.0 MBH  
**060** = 60.0 MBH  
**070** = 70.0 MBH

### Digit 8 — Voltage (Volts/Hz/Phase)

**4** = 460/60/3  
**7** = 265/60/1  
**A** = 208-230/60/1  
**B** = 208-230/60/3

### Digit 9 — Heat Exchanger

**1** = Copper-Water Coil  
**2** = Cupro-Nickel Water Coil  
**7** = Insulated Copper-Water Coil/Suction Line  
**8** = Insulated Cupro-Nickel Water Coil/Suction Line

### Digit 10 — Design Sequence

**A** = First Design Sequence

### Digit 11 — Refrigeration Circuit

**0** = Heating and Cooling Circuit  
**2** = Heating and Cooling Circuit with Hot Gas Reheat  
**3** = Heating and Cooling Circuit with Waterside Economizer  
**4** = Heating and Cooling Circuit with Waterside Economizer, Hot Gas Reheat

### Digit 12 — Blower Configuration

**K** = Variable ECM Motor, Constant Torque

### Digit 13 — Freeze Protection<sup>2</sup>

**A** = 20°F Freezestat (For Glycol Loop)  
**B** = 35°F Freezestat (For Water Loop)

### Digit 14 — Open Digit = 0

### Digit 15 — Supply-Air Arrangement

**T** = Top Supply-Air Arrangement  
**B** = Back Supply-Air Arrangement  
**L** = Left Supply-Air Arrangement  
**R** = Right Supply-Air Arrangement

### Digit 16 — Return-Air Arrangement

**L** = Left Return-Air Arrangement  
**R** = Right Return-Air Arrangement

### Digit 17 — Control Types

**D** = Deluxe 24V Controls  
**H** = Symbio™ 400-B/UC400-B  
**J** = Symbio 400-B/UC400-B w/Air-Fi® Wireless Communications

### Digit 18 — Tstat/Sensor Location

**0** = Wall Mounted Location

### Digit 19 — Fault Sensors

**1** = Condensate Overflow Sensor  
**3** = Condensate Overflow and Filter Maintenance Timer  
**6** = Condensate Overflow and Fan Status  
**J** = Fan Status, Filter Maintenance Timer and Condensate Overflow Sensor

### Digit 20 — Temperature Sensor

**0** = No Additional Temperature Sensor  
**1** = Entering Water Sensor

### Digit 21 — Insulation

**1** = Matte Faced Insulation  
**2** = Foil Faced Insulation

### Digit 22 — Electric Heat

**0** = No Electric Heat  
**6** = Field Mounted External Boilerless LOW Electric Heat  
**7** = Field Mounted External Boilerless MED Electric Heat  
**8** = Field Mounted External Boilerless HIGH Electric Heat  
**9** = Boilerless Electric Heat Ready

### Digit 23 — Unit Mounted Disconnect

**0** = No Unit Mounted Disconnect  
**2** = Unit Mounted Disconnect

### Digit 24 — Filter Type

**1** = 1-inch Throwaway Filter  
**2** = 2-inch Throwaway Filter  
**4** = 2-inch MERV 8  
**5** = 2-inch MERV 13

### Digit 25 — Acoustic Arrangement

**1** = Standard Sound Attenuation  
**2** = Deluxe Sound Attenuation

### Digits 26–36 — Does Not Apply

**0000000000** = Digits 26-36 are not applicable to the EXV or DXV products

### Digit 37 — Ducted Filter Rack

**0** = Non-ducted filter rack  
**A** = Ducted Filter Rack Side Access/LH-RH  
**C** = Ducted Filter Rack (Bottom Access)

### Digit 38 — Isolation Valve

**0** = No Isolation Valve  
**1** = Factory Mounted Isolation Valve

### Digit 39 — Power Connection

**1** = Single Point  
**2** = Electric Heat Power Separate from Unit

### Digit 40 — Drain Pan

**A** = Polymer Drain Pan  
**B** = Stainless Steel Drain Pan

### Model Number Note:

#### Notes:

1. Deluxe Sound option to be made available in later product release.
2. 20°F Freezestat is typically used in a geothermal application. 35°F Freezestat is typically used in a boiler/tower application



## Overview of Manual

**Note:** *One copy of this document ships inside the control panel of each unit and is customer property. It must be retained by the unit's maintenance personnel.*

This booklet describes proper installation, operation, and maintenance procedures for air cooled systems.

By carefully reviewing the information within this manual and following the instructions, the risk of improper operation and/or component damage will be minimized.

It is important that periodic maintenance be performed to help assure trouble free operation. A maintenance schedule is provided at the end of this manual.

Should equipment failure occur, contact a qualified service organization with qualified, experienced HVAC technicians to properly diagnose and repair this equipment.

### Unit Nameplate

The unit nameplate is located on the outside of the control box access panel at the front of the unit. It includes the unit

model number, serial number, electrical characteristics, refrigerant charge, and other pertinent unit data.

### Compressor Nameplate

The nameplate for the compressors are located on the compressor shell.

### Model Number Description

All products are identified by a multiple-character model number that precisely identifies a particular type of unit. Its use will enable the owner/operator, installing contractors, and service engineers to define the operation, specific components, and other options for any specific unit.

When ordering replacement parts or requesting service, be sure to refer to the specific model number and serial number printed on the unit nameplate.



# General Information

## Unit Description

Before shipment, each unit is leak tested, dehydrated, charged with refrigerant and run tested for proper control operation.

## Air-to-Refrigerant Coil

The air-to-refrigerant coil is aluminum fin, mechanically bonded to the copper tubing.

## Water-to-Refrigerant Coil

The water-to-refrigerant coil is a copper or cupro-nickel (option) and steel tube (tube-within-a-tube) design, leak tested to assure there is no cross leakage between the water tube (copper/cupro-nickel) and refrigerant gas (steel tube).

Table 1. High/low pressure switch

	Trip	Recover	Unit
LP	40 +/-4	56 +/-4	psig
HP	650 +/-10	550 +/-10	psig

## Controls

The available control type is a Deluxe 24V control option, a Symbio™ 400-B/Tracer® UC400-B BACnet® control option for all unit sizes.

All power wiring to the equipment is made at the unit's compressor contactor or optional disconnect switch for the EXH/V 0.75 to 6 ton units and the DXH/V 2 to 6 ton units. For units without the disconnect switch, the power wiring needs to be connected to the screw terminals of the compressor contactor. All low-voltage wiring is made at the unit's low voltage terminal plug.

## System Input Devices and Functions

A thermostat, zone sensor, or building automation system is required to operate the water-source heat pump. The flexibility of having several mode capabilities depends upon the type of sensor and/or remote panel selected.

Troubleshooting and connection diagrams for the 24V control systems may be located in the back of this manual. All digital control troubleshooting tips and connection diagrams are located in BAS-SVX065\*-EN (UC400-B).

## Deluxe 24V Controls (option)

Units containing the Deluxe 24V control design will incorporate a microprocessor-based control board. The Trane microprocessor board is factory wired to a terminal plug to provide all necessary terminals for field connection.

The deluxe board is equipped with a random start relay, anti-short cycle timer, brown out protection, compressor disable, condensate overflow, unit safety control, diagnostics, and a generic relay (which may be available for field use).

## Symbio™ 400-B/Tracer® UC400-B (option)

The Symbio 400-B/UC400-B is a BTL Listed BACnet® controller that can operate stand- alone or within a Building Automation System (BAS) such as Tracer® SC+. For installation, operation, and maintenance, see BAS-SVX065\*-EN (UC400-B).

## Pump Module (Field Installed Accessory)

The pump module shall consist of either a single or dual 1/6 HP cast iron pump and a brass three-way shut-off valve. The pump module kits shall contain the necessary components for the installation, operation and maintenance of the water circuit of a closed-loop distributed pumping application.

## Waterside Economizer (Option)

Instructions for mechanical connection of the waterside economizer to the water-source heat pump may be found in the dimensional section of this manual.

The waterside economizer is designed to begin economizing mode when water temperatures fall below the field adjustable temperature of 25, 35, 45, 55 or 60°F (for the Deluxe control option), or below the programmed set-point (for the Symbio™ 400-B/UC400-B control option).

When the temperature is less than the setpoint, fluid will flow into the economizing coil, while simultaneously halting mechanical operation of the compressor. Mechanical cooling will continue on a call for a second stage from the thermostat or system control. Entering water temperature sensor is factory provided for field installation on the entering water side of the coil.

## Boilerless Control/Electric Heat (Option)

This option targets building designs that do not incorporate a boiler to heat the loop system. During a heavy heating load, the loop temperature may begin to fall. As the loop temperature decreases, the heating capacity of the heat pump will also decrease. In the heating mode, when the loop temperature falls below 55°F (factory setting), the electric heater is energized, and the compressor is locked out. The system's electric heat source will continue to be utilized for primary heating until the loop temperature rises



above 60°F. Once the loop temperature rises above 60°F, the boilerless controller returns the unit to normal compressor heating operation and locks out the electric heater.

For the EXV/H and DXV/H models, the electric heat will be field installed by the contractor.

**Note:** *The boilerless controller has a field adjustable entering water temperature setting of 25, 35, 45, 55, and 60 degrees. The compressor operation will return to normal operation when the loop temperature rises 5 degrees above the setpoint. This electric heat option is designed for primary heat only, not to run as supplemental heat to the heating function of the heat pump.*

**Table 2. Refrigerant charge (EXH/EXV)**

Model (60 Hz)	Heat Pump (oz)/Kg)	Heat Pump w/ HGR (oz)/Kg)
EXH/V009	35 / 0.992	37 / 1.049
EXH/V012	35 / 0.992	37 / 1.049
EXH/V015	39.5 / 1.12	42.5 / 1.205
EXH/V018	56 / 1.588	59.5 / 1.687
EXH/V024	60 / 1.701	64 / 1.814

**Table 2. Refrigerant charge (EXH/EXV) (continued)**

Model (60 Hz)	Heat Pump (oz)/Kg)	Heat Pump w/ HGR (oz)/Kg)
EXH/V030	67 / 1.899	72.5 / 2.055
EXH/V036	68 / 1.928	74 / 2.098
EXH/V042	83 / 2.353	90.5 / 2.566
EXH/V048	87 / 2.466	95 / 2.693
EXH/V060	101 / 2.863	111 / 3.147
EXH/V070	122 / 3.459	132 / 3.742

**Table 3. Refrigerant charge (DXH/DXV)**

Model (60 Hz)	Heat Pump (oz)/Kg)	Heat Pump w/ HGR (oz)/Kg)
DXH/V024	59 / 1.673	63 / 1.786
DXH/V036	64 / 1.814	70 / 1.984
DXH/V048	86 / 2.438	94 / 2.665
DXH/V060	101 / 2.863	111 / 3.147
DXH/V070	123 / 3.487	133 / 3.77



# Pre-Installation

## ⚠ WARNING

### Fiberglass Wool!

Exposure to glass wool fibers without all necessary PPE equipment could result in cancer, respiratory, skin or eye irritation, which could result in death or serious injury. Disturbing the insulation in this product during installation, maintenance or repair will expose you to airborne particles of glass wool fibers and ceramic fibers known to the state of California to cause cancer through inhalation.

You **MUST** wear all necessary Personal Protective Equipment (PPE) including gloves, eye protection, a NIOSH approved dust/mist respirator, long sleeves and pants when working with products containing fiberglass wool.

#### Precautionary Measures:

- Avoid breathing fiberglass dust.
- Use a NIOSH approved dust/mist respirator.
- Avoid contact with the skin or eyes. Wear long-sleeved, loose-fitting clothing, gloves, and eye protection.
- Wash clothes separately from other clothing; rinse washer thoroughly.
- Operations such as sawing, blowing, tear-out, and spraying may generate fiber concentrations requiring additional respiratory protection. Use the appropriate NIOSH approved respirator.

#### First Aid Measures:

- Eye Contact - Flush eyes with water to remove dust. If symptoms persist, seek medical attention.
- Skin Contact - Wash affected areas gently with soap and warm water after handling.

## Unit Inspection Checklist

- Unpack all components of the kit.
- Check carefully for any shipping damage. If any damage is found it must be reported immediately and a claim made against the transportation company.

**Important:** *Equipment is shipped FOB (Free on Board) at the manufacturer. Therefore, freight claims for damages against the carrier must be initiated by the receiver.*

- Visually inspect the components for shipping damage as soon as possible after delivery, before it is stored. Concealed damage must be reported within 15 days.
- If concealed damage is discovered, stop unpacking the shipment.

- Do not remove damaged material from the receiving location. Take photos of the damage, if possible. The owner must provide reasonable evidence that the damage did not occur after delivery.
- Notify the carrier's terminal of damage immediately by phone and by mail. Request an immediate joint inspection of the damage by the carrier and the consignee.
- Do not attempt to repair any damaged parts until the parts are inspected by the carrier's representative.

## Jobsite Inspection Checklist

Always perform the following checks before accepting a unit:

- Verify that the nameplate data matches the data on the sales order and bill of lading (including electrical data).
- Verify that the power supply complies with the unit nameplate specifications.
- Visually inspect the exterior of the unit, for signs of shipping damage. Do not sign the bill of lading accepting the unit(s) until inspection has been completed. Check for damage promptly after the unit(s) are unloaded. Once the bill of lading is signed at the jobsite, the unit(s) are now the property of the SOLD TO party and future freight claims MAY NOT be accepted by the freight company.

## Jobsite Storage

### NOTICE

#### Microbial Growth!

Failure to follow instructions below could result in odors and damage to the equipment and building materials.

**The floor or foundation must be level and the condensate drain at the proper height for proper drainage and condensate flow. Standing water and wet surfaces inside the equipment can become an amplification site for microbial growth (mold). If there is evidence of microbial growth on the interior insulation, it should be removed and replaced prior to operating the system.**

This unit is intended for indoor use only. To protect the unit from damage due to the elements, and to prevent possible IAQ contaminant sources from growing, the unit should be stored indoors. If indoor storage is not possible, the following provisions for outdoor storage must be met:

- Place the unit(s) on a dry surface or raise above the ground to assure adequate air circulation beneath the unit.
- Cover the unit(s) with a water proof tarp to protect them from the elements.

- Make provisions for continuous venting of the covered units to prevent moisture from standing on the unit(s) surfaces. Wet interior unit insulation can become an amplification site for microbial growth (mold) which has been determined to be a cause of odors and serious health related indoor air quality problems.
- Store units in the normal UP orientation to maintain oil in the compressor.
- Horizontal units may be stacked no more than three units high. Do not stack the vertical unit configurations.



# Unit Dimensions

## Service Clearances

Per NEC requirements, 36 inches of access and working space shall be provided and maintained around all control boxes and electrical equipment to permit ready and safe

operation and maintenance of such equipment. Local codes may require more clearance to electrical equipment. Check all code requirements prior to unit installation.

Figure 1. Clearances - EXH/DXH 0.75 to 6 tons

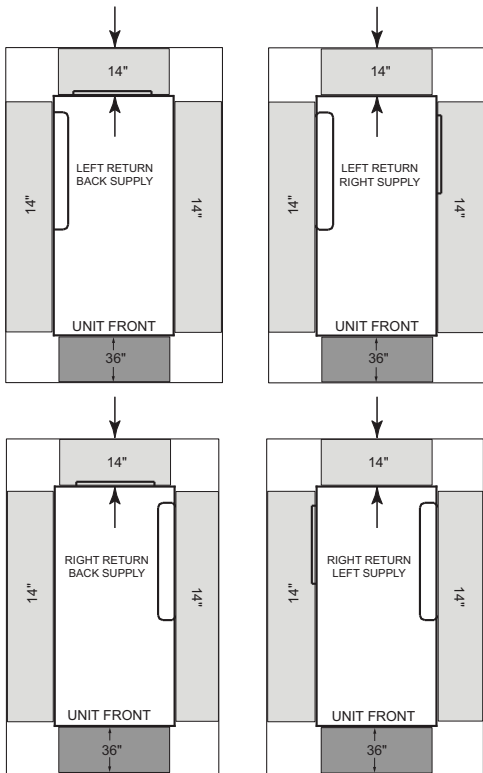

A minimum 14-inch clearance for servicing the unit is required for all EXH 0.75 to 6 tons configurations from other mechanical and electrical equipment (where shown) to enable panel removal from the unit for service/maintenance ability. The optimum clearance required is 20 inches.

**Notes:**

- Return air direction (left-hand or right hand) is NOT field convertible. Units must be ordered with correct return air side.
- For horizontal models, be sure to allow enough clearance between the condensate drain and the ceiling to allow for pitching of the condensate line. See Figure 20, p. 31 for pitching requirements.

**Figure 2. Clearance – EXVG/DXVG 0.75 to 6 tons**

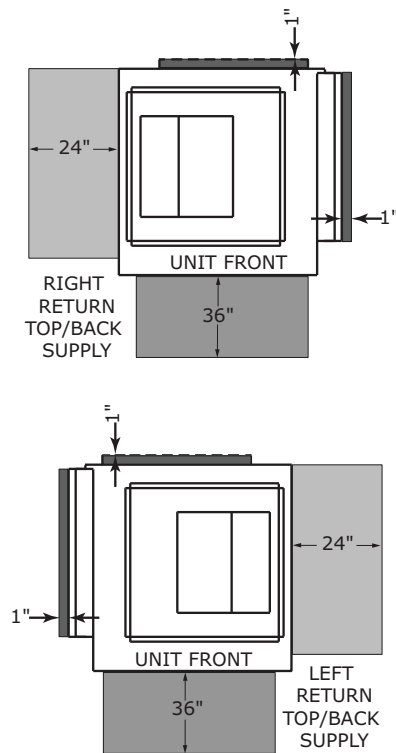

A 24-inch clearance from other mechanical and electrical equipment (where shown) is recommended for most unit configurations. This will enable panel removal from the unit for service/maintenance.

The 24-inch side clearance on EXVG/DXVG 0.75 to 6T models is for optimal access only. Side clearance is not a requirement as most components can be accessed from the front of the unit.

A 1-inch minimum clearance between the filter rack and any obstacle is required for units in a free return application to provide proper air flow to the air-to-refrigerant coil. A 12-inch minimum clearance between the filter rack and any obstacle should be provided to properly attached ductwork.

The 1-inch dimension shown in the back of the unit represents the supply duct collar for the back supply option. This clearance is needed to clear these flanges.



## Unit Dimensions

# Unit Dimensions

Figure 3. Left return/back supply (EXHG/DXHG)

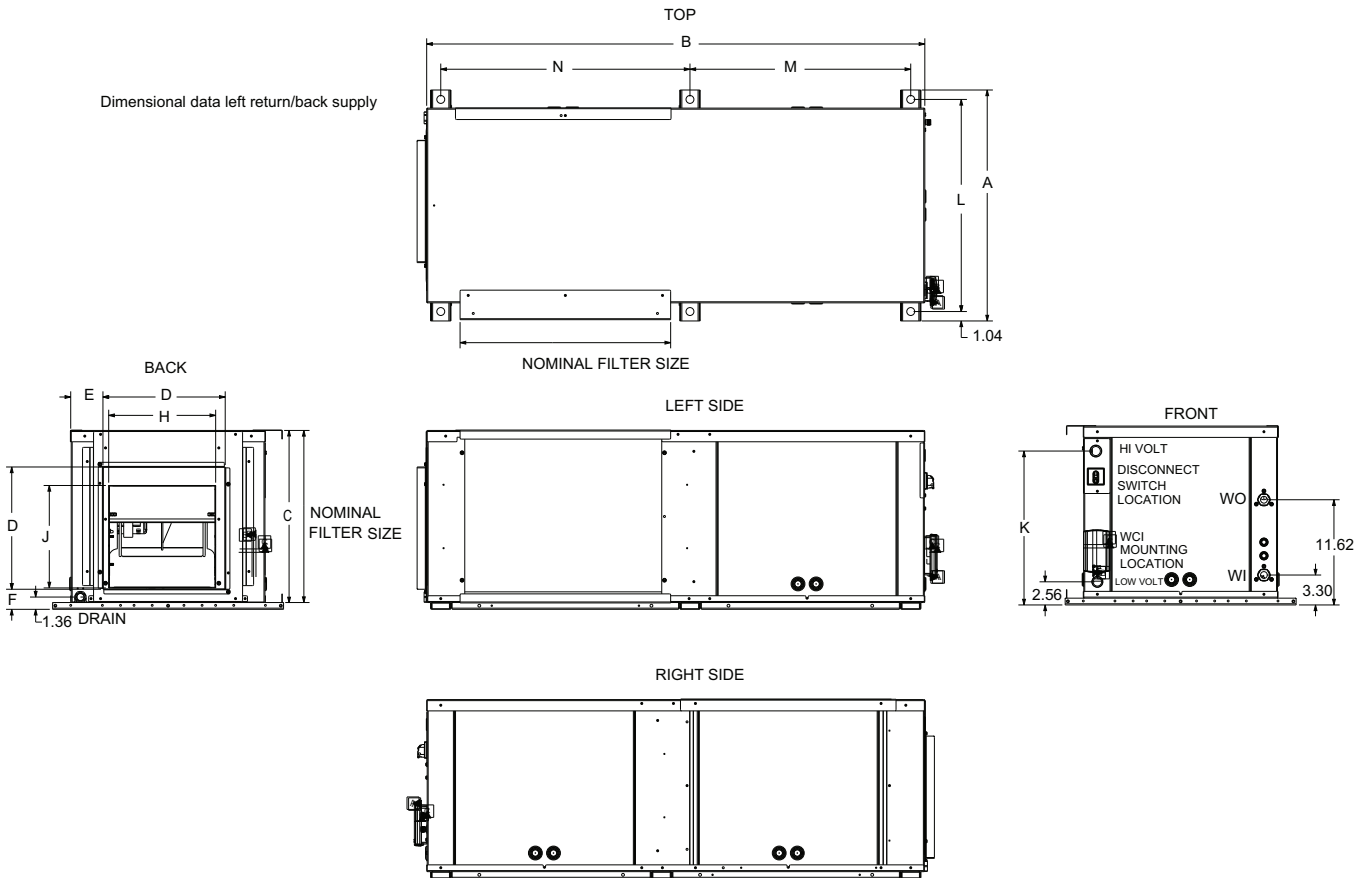
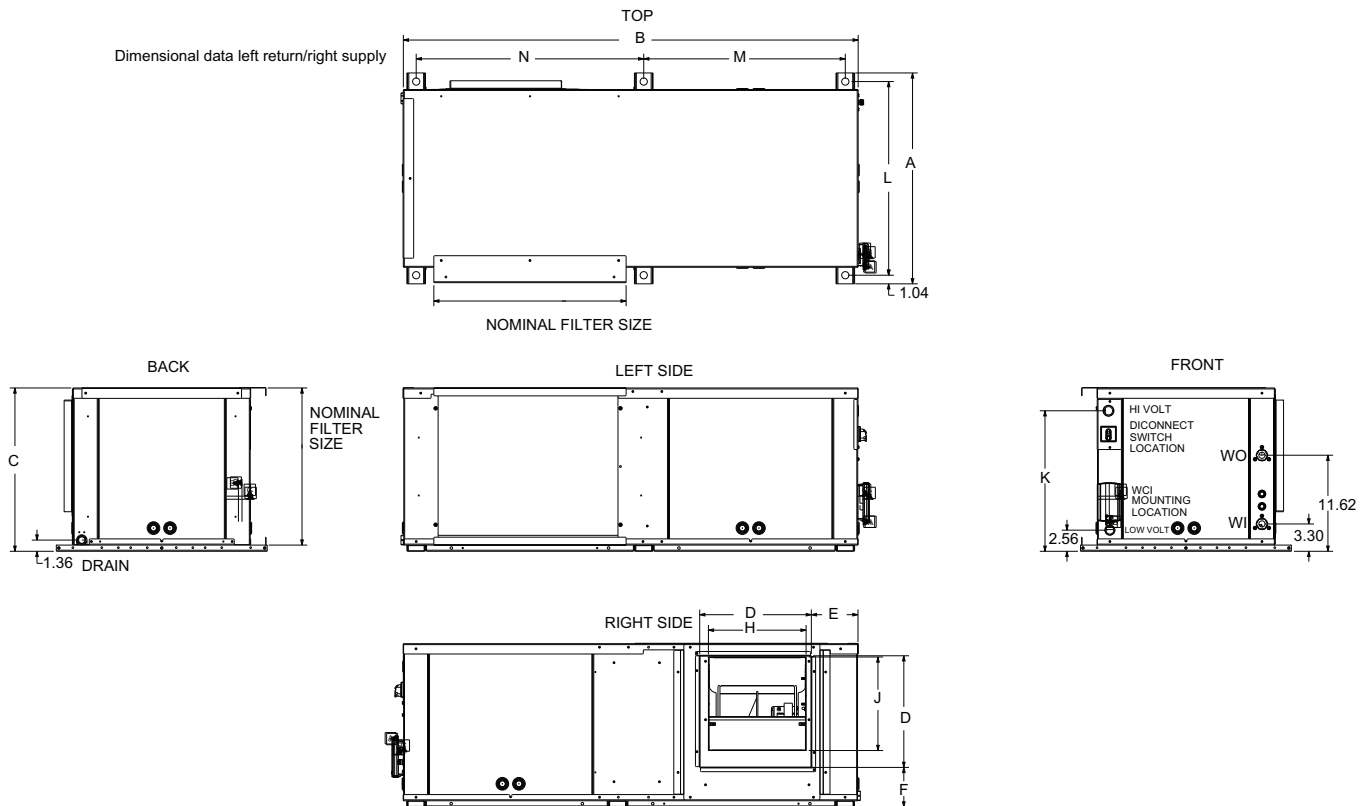

Table 4. Dimensional data left return/back supply (EXHG/DXHG)

Unit	Width		Height	Duct Collar	Duct Collar Location		Blower Opening		Hi Volt	Unit hanging location			Nominal Filter Size	W.I. NPTI	W.O. NPTI	DRAIN NPTI
	A	B			E	F	H	J		K	L	M				
EXHG009, EXHG012	25.50	46.00	17.75	13.50	3.50	2.00	10.13	9.38	15.00	23.50	19.88	23.00	17 x 20	0.50	0.50	0.75
EXHG015	25.50	49.00	18.75	13.50	3.88	2.25	10.50	11.25	16.00	23.50	21.38	24.50	17 x 20	0.75	0.75	0.75
EXHG018, EXHG/DXHG024	25.50	55.00	19.75	13.50	3.50	2.25	11.75	11.25	17.00	23.50	24.38	27.50	18 x 23	0.75	0.75	0.75
EXHG030, EXHG/DXHG036	28.00	68.00	21.75	16.50	3.63	2.13	13.88	13.50	19.00	26.00	30.88	34.00	20 x 30	1.00	1.00	0.75
EXHG042, EXHG/DXHG048	29.38	77.75	22.13	16.50	3.50	2.50	13.88	13.50	19.25	27.25	30.88	43.75	20 x 20 (x2)	1.00	1.00	0.75
EXHG/DXHG060, 070	29.38	86.75	22.13	16.50	3.50	2.50	13.88	13.50	19.25	27.25	30.88	52.75	20 x 20, 20 x 30	1.00	1.00	0.75

Note: Dimensions represent unit hanging dimensions including base rails for hanging.

**Figure 4. Left return/right supply (EXHG/DXHG)**

**Table 5. Dimensional data left return/right supply (EXHG/DXHG)**

Units	Width		Height	Duct Collar Location			Blower Opening		Hi Volt	Unit hanging location			Nominal Filter Size	W.I. NPTI	W.O. NPTI	DRAIN NPTI
	A	B		D	E	F	H	J		K	L	M				
EXHG009, EXHG012	25.50	46.00	17.75	13.50	3.38	3.00	10.13	9.38	15.00	23.50	19.88	23.00	17 x 20	0.50	0.50	0.75
EXHG015	25.50	49.00	18.75	13.50	5.88	4.00	10.50	11.25	16.00	23.50	21.38	24.50	17 x 20	0.75	0.75	0.75
EXHG018, EXHG/DXHG024	25.50	55.00	19.75	13.50	5.63	4.75	11.75	11.25	17.00	23.50	24.38	27.50	18 x 23	0.75	0.75	0.75
EXHG030, EXHG/DXHG036	28.00	68.00	21.75	16.50	5.63	3.88	13.88	13.50	19.00	26.00	30.88	34.00	20 x 30	1.00	1.00	0.75
EXHG042, EXHG/DXHG048	29.38	77.75	22.13	16.50	5.63	3.75	13.88	13.50	19.25	27.25	30.88	43.75	20 x 20 (x2)	1.00	1.00	0.75
EXHG/DXHG060, 070	29.38	86.75	22.13	16.50	5.63	3.75	13.88	13.50	19.25	27.25	30.88	52.75	20 x 20, 20 x 30	1.00	1.00	0.75

**Note:** Dimensions represent unit hanging dimensions including base rails for hanging.



## Unit Dimensions

Figure 5. Right return/left supply (EXHG/DXHG)

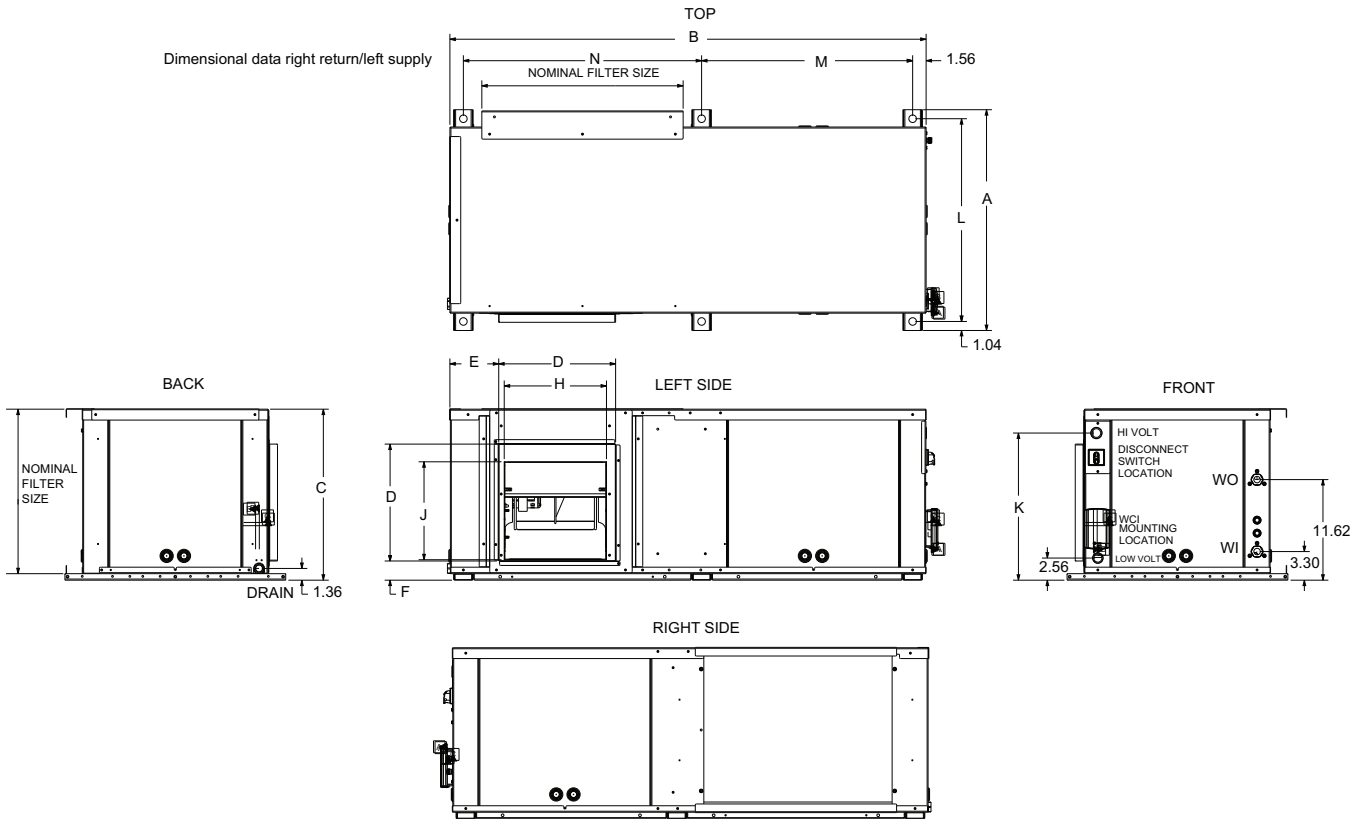
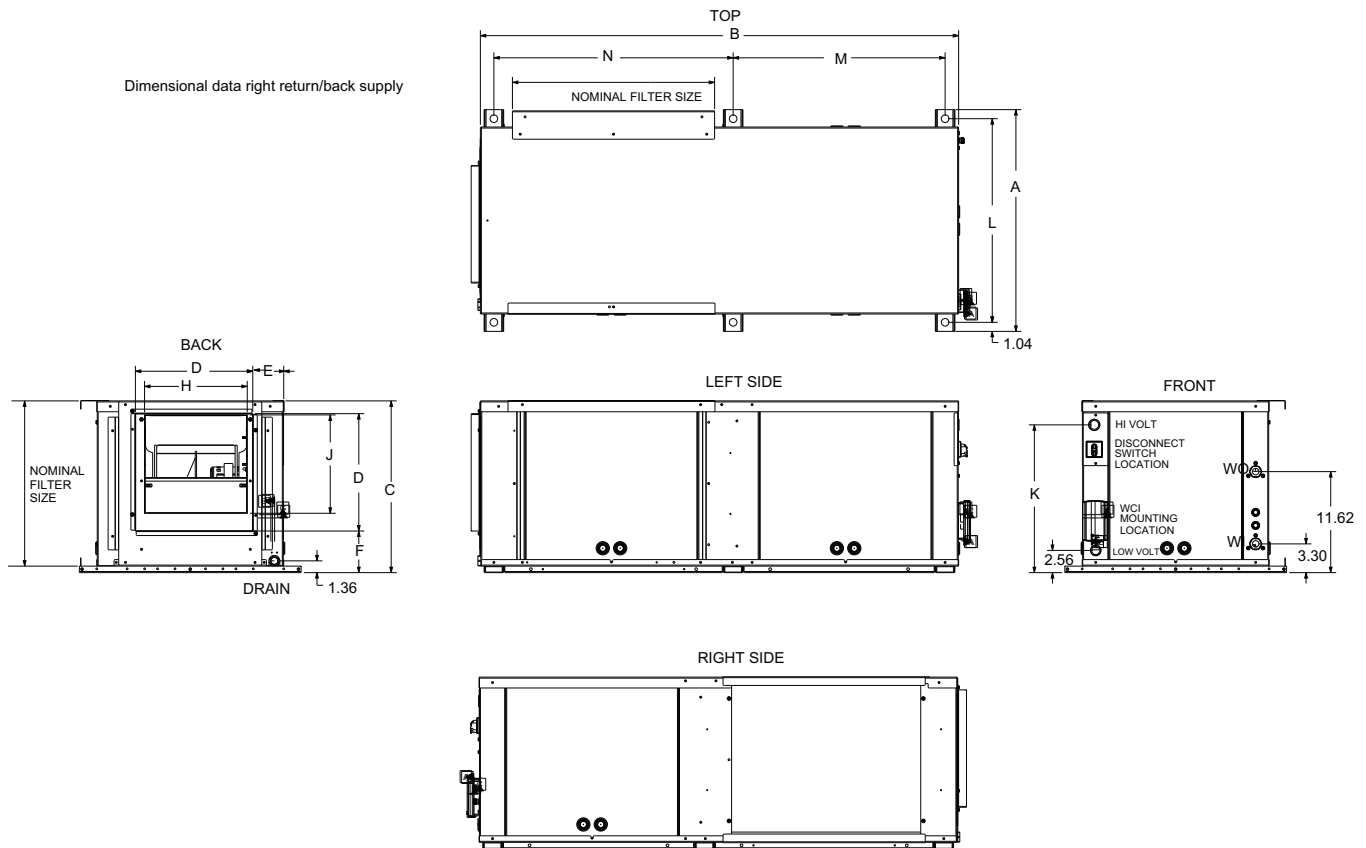

Table 6. Dimensional data right return/left supply (EXHG/DXHG)

Unit	Width	Depth	Height	Duct Collar	Duct Collar Location		Blower Opening		Hi Volt	Unit hanging location			Nominal Filter Size	W.I. NPTI	W.O. NPTI	DRAIN NPTI
	A	B	C	D	E	F	H	J	K	L	M	N				
EXHG009, EXHG012	25.50	46.00	17.75	13.50	5.50	2.00	10.13	9.38	15.00	23.50	19.88	23.00	17 x 20	0.50	0.50	0.75
EXHG015	25.50	49.00	18.75	13.50	5.88	2.25	10.50	11.25	16.00	23.50	21.38	24.50	17 x 20	0.75	0.75	0.75
EXHG018, EXHG/DXHG024	25.50	55.00	19.75	13.50	5.63	2.25	11.75	11.25	17.00	23.50	24.38	27.50	18 x 23	0.75	0.75	0.75
EXHG030, EXHG/DXHG036	28.00	68.00	21.75	16.50	5.63	2.13	13.88	13.50	19.00	26.00	30.88	34.00	20 x 30	1.00	1.00	0.75
EXHG042, EXHG/DXHG048	29.38	77.75	22.13	16.50	5.63	2.50	13.88	13.50	19.25	27.25	30.88	43.75	20 x 20 (x2)	1.00	1.00	0.75
EXHG/DXHG060, 070	29.38	86.75	22.13	16.50	5.63	2.50	13.88	13.50	19.25	27.25	30.88	52.75	20 x 20, 20 x 30	1.00	1.00	0.75

Note: Dimensions represent unit hanging dimensions including base rails for hanging.



**Figure 6. Right return/back supply (EXHG/DXHG)**

**Table 7. Dimensional data right return/back supply (EXHG/DXHG)**

Unit	Width	Depth	Height	Duct Collar	Duct Collar Location		Blower Opening		Hi Volt	Unit hanging location			Nominal Filter Size	W.I. NPTI	W.O. NPTI	DRAIN NPTI
	A	B	C	D	E	F	H	J	K	L	M	N				
EXHG009, EXHG012	25.50	46.00	17.75	13.50	3.25	3.00	10.13	9.38	15.00	23.50	19.88	23.00	17 x 20	0.50	0.50	0.75
EXHG015	25.50	49.00	18.75	13.50	3.88	4.00	10.50	11.25	16.00	23.50	21.38	24.50	17 x 20	0.75	0.75	0.75
EXHG018, EXHG/DXHG024	25.50	55.00	19.75	13.50	3.50	4.75	11.75	11.25	17.00	23.50	24.38	27.50	18 x 23	0.75	0.75	0.75
EXHG030, EXHG/DXHG036	28.00	68.00	21.75	16.50	3.63	3.88	13.88	13.50	19.00	26.00	30.88	34.00	20 x 30	1.00	1.00	0.75
EXHG042, EXHG/DXHG048	29.38	77.75	22.13	16.50	3.50	2.50	13.88	13.50	19.25	27.25	30.88	43.75	20 x 20 (x2)	1.00	1.00	0.75
EXHG/DXHG060, 070	29.38	86.75	22.13	16.50	3.50	3.75	13.88	13.50	19.25	27.25	30.88	52.75	20 x 20, 20 x 30	1.00	1.00	0.75

**Note:** Dimensions represent unit hanging dimensions including base rails for hanging.



## Unit Dimensions

Figure 7. Left return/top supply (EXVG/DXVG)

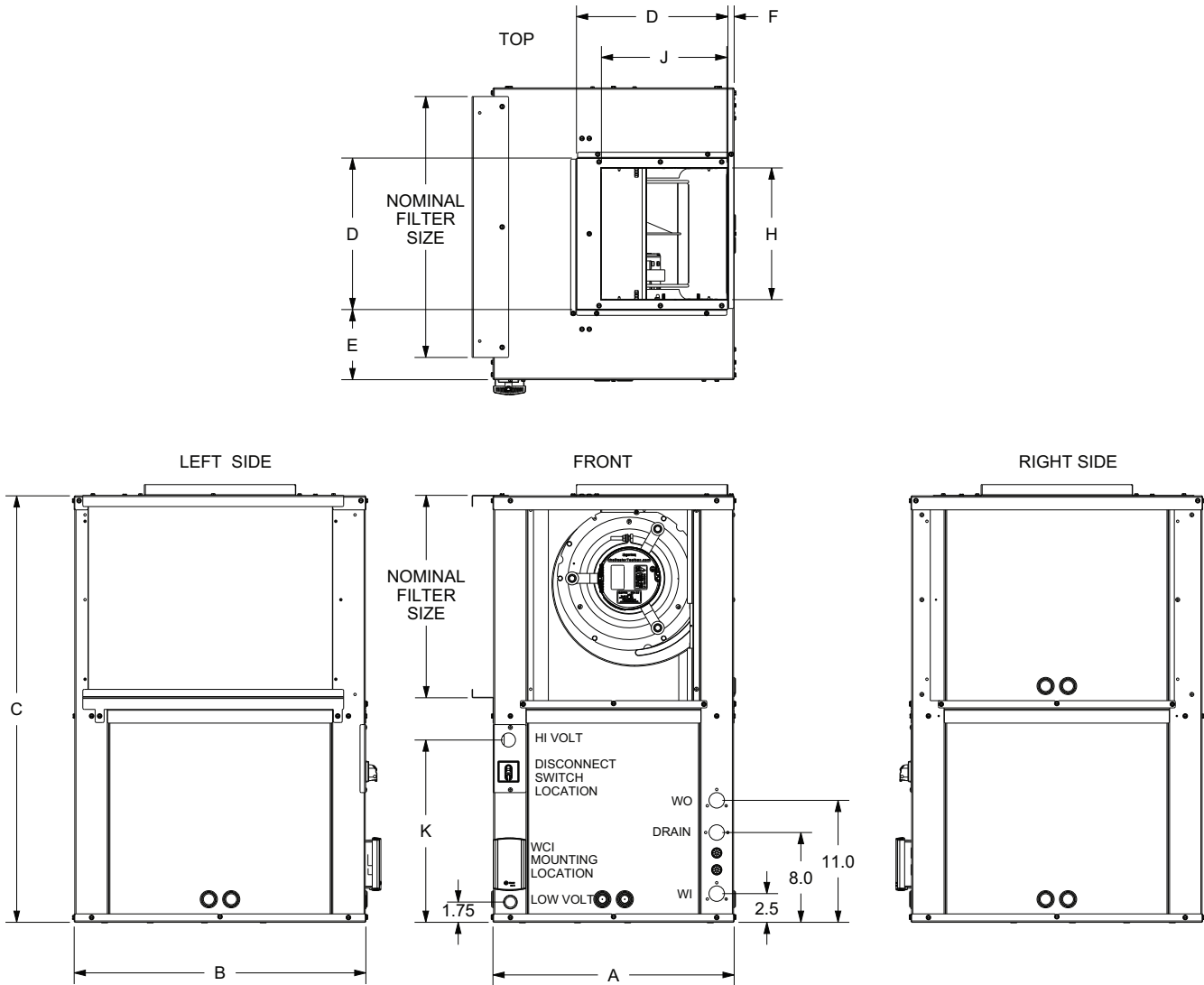
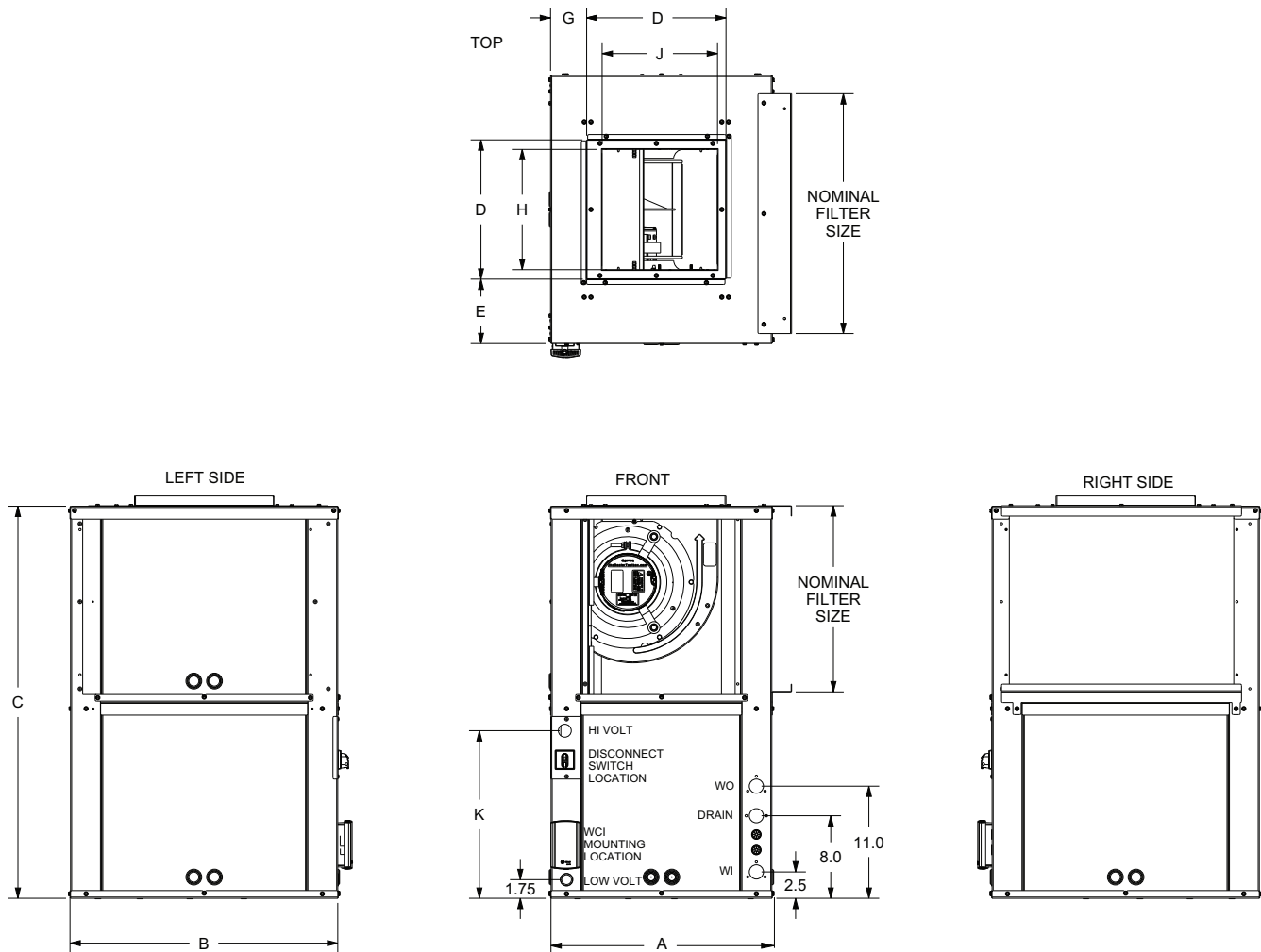

Table 8. Dimensional data left return/top supply (EXVG/DXVG)

Unit	Cabinet			Duct Collar	Duct Collar Location			Blower Opening		Hi Volt	Nominal Filter Size	W.I. NPTI	W.O. NPTI	Drain NPTI
	Width A	Depth B	Height C		E	F	G	H	J					
EXVG009-012	21.50	21.50	34.00	13.25	4.00	1.00	3.50	10.50	9.60	14.25	16 x 19	1/2	1/2	3/4
EXVG015	21.50	23.00	36.00	13.25	4.75	0.63	3.50	10.50	11.30	15.25	17 x 20	3/4	3/4	3/4
EXVG018, EXVG/DXVG024	21.50	26.00	38.00	13.25	6.25	0.63	3.50	11.80	11.30	16.25	18 x 23	3/4	3/4	3/4
EXVG030, EXVG/DXVG036	24.00	32.50	42.00	16.50	7.25	0.75	3.50	13.70	13.50	18.25	20 x 30	1	1	3/4
EXVG042, EXVG/DXVG048	25.40	32.50	49.00	16.50	7.25	0.75	3.50	13.70	13.50	18.25	27 x 30	1	1	3/4
EXVG/DXVG060-070	25.40	32.50	55.00	16.50	7.25	0.75	3.50	13.70	13.50	18.25	30 x 33	1	1	3/4

Note: Units in a free return application will require more than a 1 in. clearance to provide proper air flow to the unit's air-to-refrigerant coil.

**Figure 8. Right return/top supply (EXVG/DXVG)**

**Table 9. Dimensional data right return/top supply (EXVG/DXVG)**

Unit	Cabinet			Duct Collar	Duct Collar Location			Blower Opening		Hi Volt	Nominal Filter Size	W.I. NPTI	W.O. NPTI	Drain NPTI
	Width A	Depth B	Height C		E	F	G	H	J					
EXVG009-012	21.50	21.50	34.00	13.25	4.00	1.00	3.50	10.50	9.60	14.25	16 x 19	1/2	1/2	3/4
EXVG015	21.50	23.00	36.00	13.25	4.75	0.63	3.50	10.50	11.30	15.25	17 x 20	3/4	3/4	3/4
EXVG018, EXVG/DXVG024	21.50	26.00	38.00	13.25	6.25	0.63	3.50	11.80	11.30	16.25	18 x 23	3/4	3/4	3/4
EXVG030, EXVG/DXVG036	24.00	32.50	42.00	16.50	7.25	0.75	3.50	13.70	13.50	18.25	20 x 30	1	1	3/4
EXVG042, EXVG/DXVG048	25.40	32.50	49.00	16.50	7.25	0.75	3.50	13.70	13.50	18.25	27 x 30	1	1	3/4
EXVG/DXVG060-070	25.40	32.50	55.00	16.50	7.25	0.75	3.50	13.70	13.50	18.25	30 x 33	1	1	3/4

**Note:** Units in a free return application will require more than a 1 in. clearance to provide proper air flow to the unit's air-to-refrigerant coil.

# Unit Dimensions

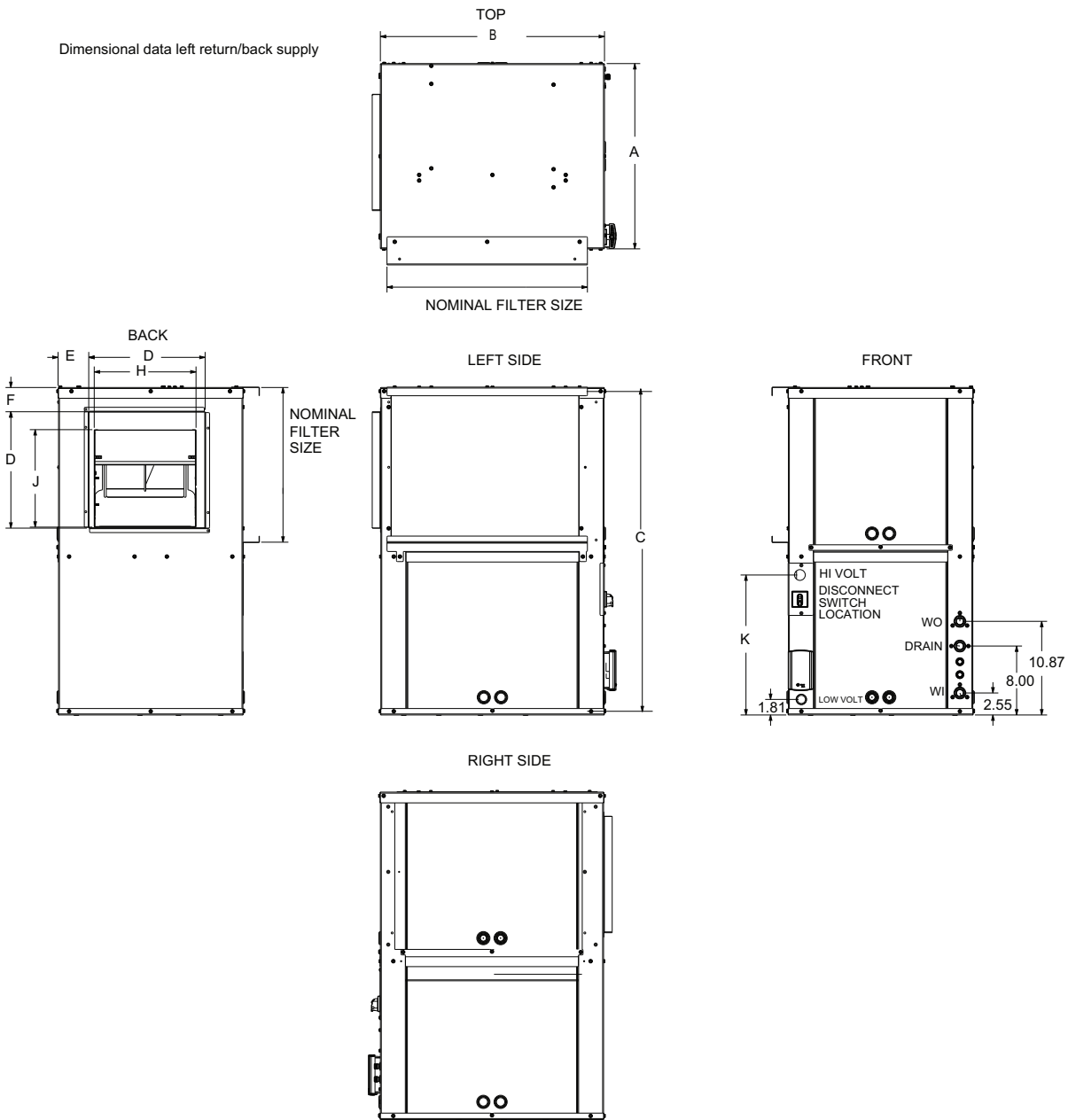
**Figure 9. Left return/back supply (EXVG/DXVG)**



**Table 10. Dimensional data left return/back supply (EXVG/DXVG)**

Cab	Unit		Width A	Depth B	Height C	Duct Collar Location		Blower Opening		Hi Volt K	Nominal Filter Size	W.I. NPTI	W.O. NPTI	Drain NPTI	
	EXVG	DXVG				D	E	H	J						
B	009, 012	–	21.50	21.50	34.00	13.50	3.50	2.00	10.13	9.38	14.25	16 x 19	1/2	1/2	3/4
C	015	–	21.50	23.00	36.00	13.50	3.88	2.25	10.50	11.25	15.25	17 x 20	3/4	3/4	3/4
D	018, 024	024	21.50	26.00	38.00	13.50	3.50	2.75	11.75	11.25	16.25	18 x 23	3/4	3/4	3/4
E	030, 036	036	24.00	32.50	42.00	16.50	3.63	2.13	13.88	13.50	18.25	20 x 30	1	1	3/4
F	042, 048	048	25.40	32.50	49.00	16.50	3.50	2.50	13.88	13.50	18.25	27 x 30	1	1	3/4
G	060, 070	060, 070	25.40	32.50	55.00	16.50	3.50	2.50	13.88	13.50	18.25	30 x 33	1	1	3/4

**Note:** Units in a free return application will require more than a 1 in. clearance to provide proper air flow to the unit's air-to-refrigerant coil.

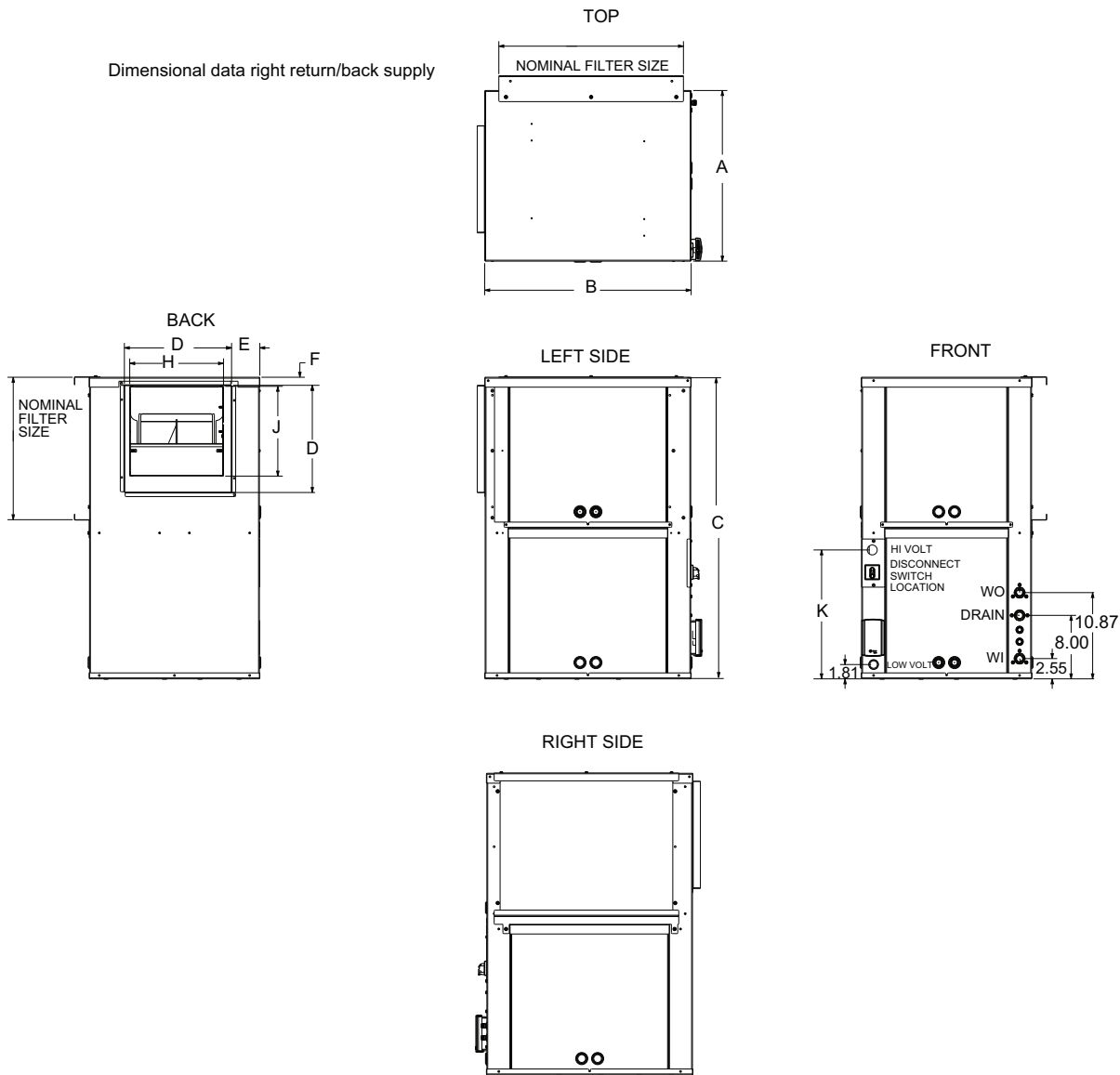
**Figure 10. Right return/back supply (EXVG/DXVG)**

**Table 11. Dimensional data right return/back supply (EXVG/DXVG)**

Cab	Unit		Width A	Depth B	Height C	Duct Collar Location			Blower Opening		Hi Volt K	Nominal Filter Size	W.I. NPTI	W.O. NPTI	Drain NPTI
	EXVG	DXVG				D	E	F	H	J					
B	009, 012	–	21.50	21.50	34.00	13.50	3.25	1.00	10.13	9.38	14.25	16 x 19	1/2	1/2	3/4
C	015	–	21.50	23.00	36.00	13.50	3.88	1.00	10.50	11.25	15.25	17 x 20	3/4	3/4	3/4
D	018, 024	024	21.50	26.00	38.00	13.50	3.50	1.00	11.75	11.25	16.25	18 x 23	3/4	3/4	3/4
E	030, 036	036	24.00	32.50	42.00	16.50	3.63	1.00	13.88	13.50	18.25	20 x 30	1	1	3/4
F	042, 048	048	25.40	32.50	49.00	16.50	3.50	1.00	13.88	13.50	18.25	27 x 30	1	1	3/4
G	060, 070	060, 070	25.40	32.50	55.00	16.50	3.50	1.00	13.88	13.50	18.25	30 x 33	1	1	3/4

**Note:** Units in a free return application will require more than a 1 in. clearance to provide proper air flow to the unit's air-to-refrigerant coil.



## Unit Dimensions

Figure 11. Waterside economizer<sup>1</sup> (EXHG/DXHG)

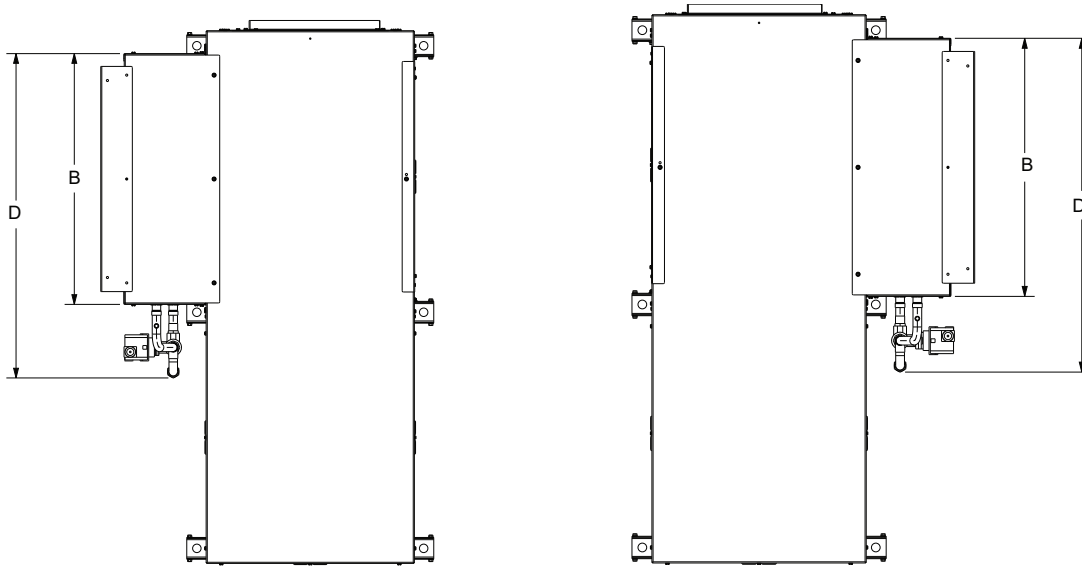

2" AIR FILTER (1.38 FOR 1")

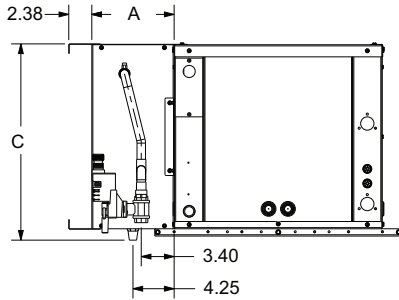

2" AIR FILTER (1.38 FOR 1")

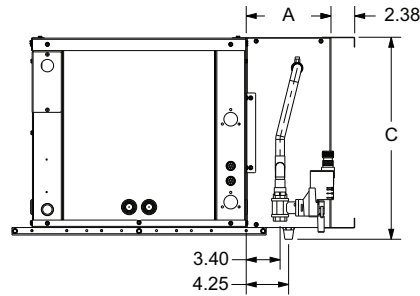

Table 12. Dimensional data waterside economizer (EXHG/DXHG)

Cab	Unit				WSE Dimensions				Pipe Size	
					Width	Depth	Height	Depth W/Piping	A	B
	EXHG		DXHG		A	B	C	D	NPTI	NPTI
B	009	012	-	-	8.5	21.5	18.25	29.00	0.75	0.75
C	015	-	-	-		23.0	19.25	30.50	0.75	0.75
D	018	024	024	-		26.0	22.25	33.50	0.75	0.75
E	030	036	036	-		32.5		38.25	1	1
F	042	048	048	-			29.25	50.50	1	1
G	060	070	060	070			35.25	59.50	1	1

Table 13. Waterside economizer weights and part numbers - horizontal

Unit Model	Waterside Economizer	Weight w/out H <sub>2</sub> O	Weight w/H <sub>2</sub> O
EXHG009-012 LR	WSHPECN00016	27	30
EXHG015 LR	WSHPECN00017	29	33
EX/DXHG018-024 LR	WSHPECN00018	35	40
EX/DXHG030-036 LR	WSHPECN00019	41	48
EX/DXHG042-048 LR	WSHPECN00020	50	59

<sup>1</sup> Waterside economizer installation requires field piping.

**Table 13. Waterside economizer weights and part numbers - horizontal (continued)**

Unit Model	Waterside Economizer	Weight w/out H <sub>2</sub> O	Weight w/H <sub>2</sub> O
EX/DXHG060-070 LR	WSHPECN00021	59	70
EXHG009-012 RR	WSHPECN00023	27	30
EXHG015 RR	WSHPECN00024	29	33
EX/DXHG018-024 RR	WSHPECN00025	35	40
EX/DXHG030-036 RR	WSHPECN00026	41	48
EX/DXHG042-048 RR	WSHPECN00027	50	59
EX/DXHG060-070 RR	WSHPECN00028	59	70

**Figure 12. Waterside economizer (EXVG/DXVG)**

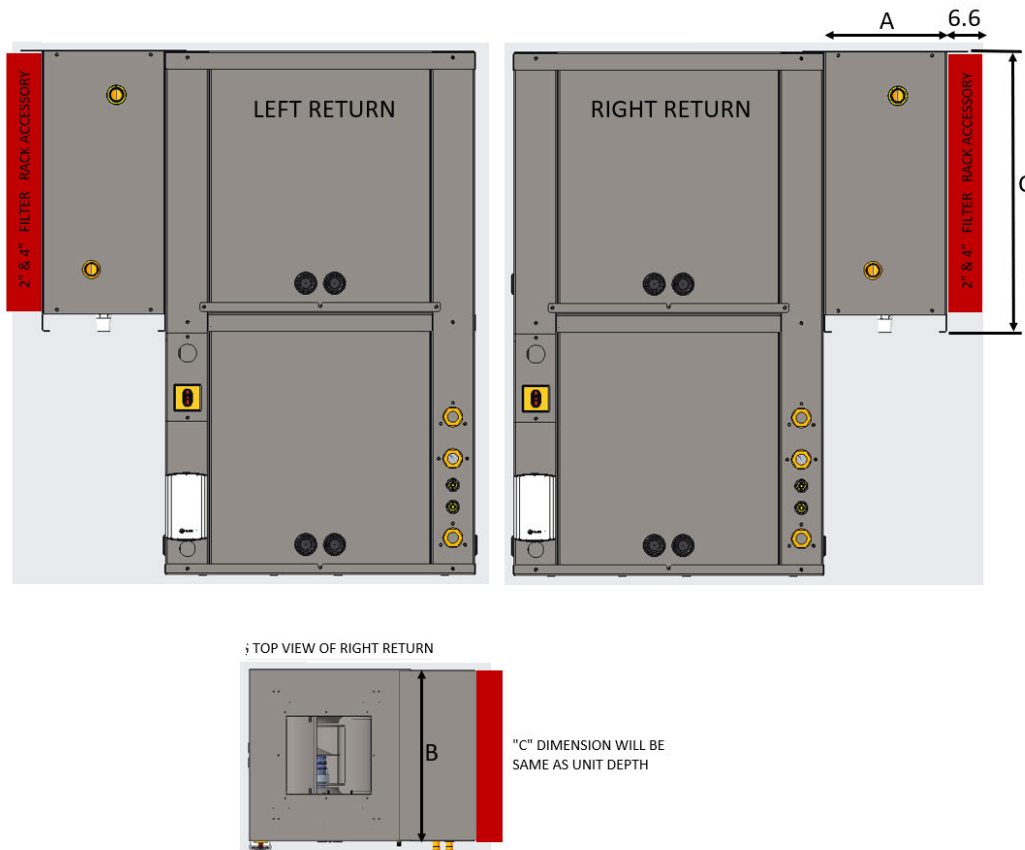

**Table 14. Dimensional data waterside economizer (EXVG/DXVG)**

Unit	Cabinet	WSE Dimensions		
		A (Width)	B (Depth)	C (Height)
EXVG009-012	B	8.5	21.5	18.25
EXVG015	C	8.5	23.0	19.25
EXVG018-024, DXVG024	D	8.5	26.0	22.25
EXVG030-036, DXVG036	E	8.5	32.5	22.25
EXVG042-048, DXVG048	F	8.5	32.5	29.25
EXVG/DXVG060-070	G	8.5	32.5	35.25



## Unit Dimensions

Figure 13. Waterside economizer (EXVG/DXVG)

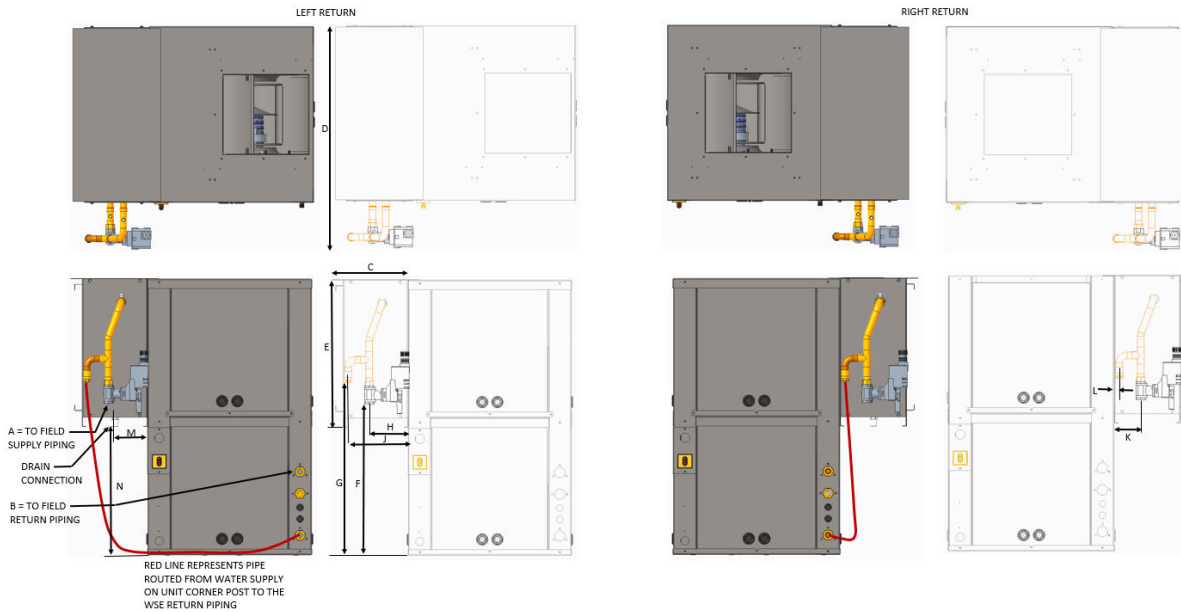

Table 15. Dimensional data waterside economizer (EXVG/DXVG)

Unit	Cabinet	Pipe Size		WSE Size			Piping Location						Drain	
		A NPTI	B NPTI	C Width	D Depth	E Height	F Height	G Height	H Width	J Width	K Width	L Width	M Width	N Height
EXVG009-012	B	1/2	1/2	8.5	27.5	18.25	17.75	20.75	5.0	7.88	3.5	0.63	4.25	15.75
EXVG015	C	3/4	3/4	8.5	29.0	19.25	19.75	22.75	5.0	7.88	3.5	0.63	4.25	16.75
EXVG018-024, DXVG024	D	3/4	3/4	8.5	32.0	21.75	21.75	24.75	5.0	7.88	3.5	0.63	4.25	15.75
EXVG030-036, DXVG036	E	1	1	8.5	38.5	22.75	22.75	25.75	5.0	8	3.5	0.5	4.25	19.75
EXVG042-048, DXVG048	F	1	1	8.5	38.5	22.75	22.75	25.75	5.0	8	3.5	0.5	4.25	19.75
EXVG/ DXVG060-070	G	1	1	8.5	38.5	22.75	22.75	25.75	5.0	8	3.5	0.5	4.25	19.75

Table 16. Waterside economizer weights and part numbers - vertical

Unit Model	Waterside Economizer	Weight w/out H <sub>2</sub> O (lbs)	Weight w/H <sub>2</sub> O (lbs)
EXVG009-012 LR	WSHPECN00002	27	30
EXVG015 LR	WSHPECN00003	29	33
EX/DXVG018-024 LR	WSHPECN00004	35	40
EX/DXVG030-036 LR	WSHPECN00005	41	48
EX/DXVG042-048 LR	WSHPECN00006	51	60
EX/DXVG060-070 LR	WSHPECN00007	60	71
EXVG009-012 RR	WSHPECN00009	27	30
EXVG015 RR	WSHPECN00010	29	33
EX/DXVG018-024 RR	WSHPECN00011	35	40
EX/DXVG030-036 RR	WSHPECN00012	41	48
EX/DXVG042-048 RR	WSHPECN00013	51	60
EX/DXVG060-070 RR	WSHPECN00014	60	71



Figure 14. Waterside economizer coil piping diagram

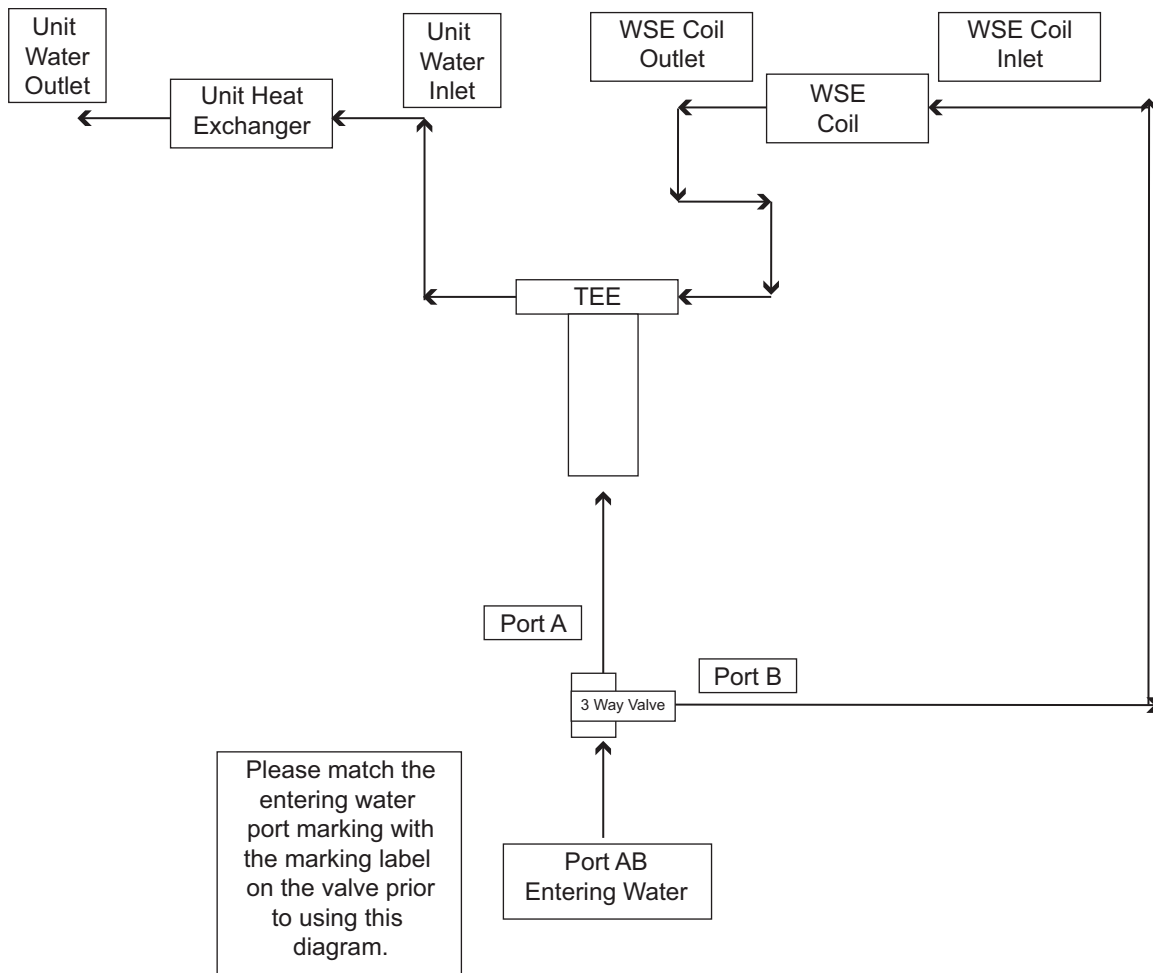



# Weights

**Table 17. Unit weights DXH 2 to 6 tons (Approximate)**

DXH	Shipping Weight with pallet (lbs)	Unit Weight without pallet (lbs)
024	393	269
036	458	313
048	560	381
060	613	434
070	613	434

**Table 18. Unit weights DXVG 2 to 6 tons (Approximate)**

DXV	Shipping Weight with pallet (lbs)	Unit Weight without pallet (lbs)
024	296	236
036	342	279
048	419	354
060	440	371
070	506	437

**Table 19. Unit weights EXVG 0.75 to 6 tons (Approximate)**

EXV (60 Hz)	Shipping Weight with pallet (lbs)	Unit Weight without pallet (lbs)
009	207	152
012	207	152
015	246	188
018	282	222
024	296	236
030	343	280
036	344	281
042	394	329
048	410	374
060	436	394
070	501	432

**Table 20. Unit weights EXH 0.75 to 6 tons (Approximate)**

EXH (60 Hz)	Shipping Weight with pallet (lbs)	Unit Weight without pallet (lbs)
009	297	173
012	297	173

**Table 20. Unit weights EXH 0.75 to 6 tons (Approximate) (continued)**

EXH (60 Hz)	Shipping Weight with pallet (lbs)	Unit Weight without pallet (lbs)
015	297	173
018	393	269
024	393	269
030	458	313
036	458	313
042	560	381
048	560	381
060	613	434
070	613	434

## Weight Distribution for Hanging the DXH and EXH Model

**⚠ WARNING**

**Improper Unit Lift!**

Failure to properly lift unit in a LEVEL position could result in unit dropping and possibly crushing operator/technician which could result in death or serious injury, and equipment or property-only damage.

Test lift unit approximately 24 inches (61 cm) to verify proper center of gravity lift point. To avoid dropping of unit, reposition lifting point if unit is not level.

Approximate weight distribution for proper hanging of the unit is indicated by weight distribution in the figure below. Tolerance on the weights determined are ±15%.

**Figure 15. Weight distribution DXH 2 to 6 tons; EXH 0.75 to 6 tons**

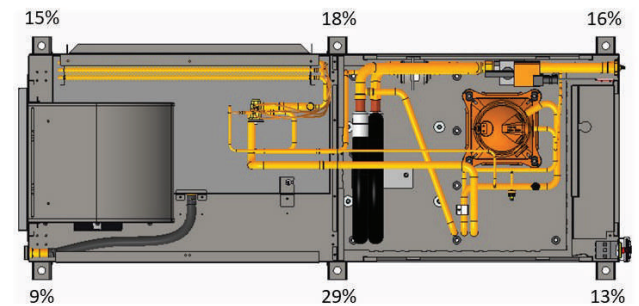



# Installation

## ⚠ WARNING

### Proper Field Wiring and Grounding Required!

Failure to follow code could result in death or serious injury.

All field wiring **MUST** be performed by qualified personnel. Improperly installed and grounded field wiring poses **FIRE** and **ELECTROCUTION** hazards. To avoid these hazards, you **MUST** follow requirements for field wiring installation and grounding as described in NEC and your local/state/national electrical codes.

## General Installation Checks

The checklist below is a summary of the steps required to successfully install a commercial unit. This checklist is intended to acquaint the installing personnel with what is required in the installation process. It does not replace the detailed instructions that are in the applicable sections of this manual.

1. Remove packaging and inspect the unit. Check the unit for shipping damage and material shortage; file a freight claim and notify appropriate sales representation.  
The EXH/V 0.75 to 6 tons and DXH/V 2 to 6 tons have been anchored to the skid with (4) angle brackets. Remove these brackets before lifting unit into place.
2. Verify the correct model, options and voltage from the unit nameplate.
3. Pull out all field attached parts (i.e. filter rack, duct collar, filter and mounting screws) from the unit packaging for field mounting.
4. Verify the installation location of the unit will provide the required clearance for proper operation.
5. Remove refrigeration access panel and inspect the unit. Be certain the refrigerant tubing has clearance from adjacent parts.
6. Fabricate and install duct work
7. Install and connect a condensate drain line and trap to the drain connection.

## Main Electrical

### ⚠ WARNING

#### Hazardous Voltage!

Failure to disconnect power before servicing could result in death or serious injury.

Disconnect all electric power, including remote disconnects before servicing. Follow proper lockout/tagout procedures to ensure the power can not be inadvertently energized. Verify that no power is present with a voltmeter.

1. Verify the power supply complies with the unit nameplate specifications.
2. Inspect all control panel components; tighten any loose connections.
3. Connect properly sized and protected power supply wiring to a field-supplied/installed disconnect switch and to the main compressor contactor/power block 1K1 for DXH/V 2 to 6 tons and EXH/V 0.75 to 6 ton units.
4. Install proper grounding wires to an earth ground.

**Note:** All field-installed wiring must comply with NEC and applicable local codes.

## Electric Heat Requirements

1. Verify that the power supply complies with the electric heater specifications on the unit and heater nameplate.
2. Inspect the heater junction box and control panel; tighten any loose connections.
3. Check electric heat circuits for continuity.

## Low Voltage Wiring (AC) Requirements

1. Install the zone sensor or thermostat.
2. Connect properly sized control wiring to the proper termination points between the zone thermostat or sensor and the unit control panel.

## Filter Installation

Each unit ships with 1 in. (25.4 mm) standard, 2 in. (50.8 mm) standard, 2 in. MERV 8 or 2 in. MERV 13 filter. The quantity of filters is determined by unit size. The EXH and DXH units require field installation of the 1 in. or 2 in. filters rack. All sheet metal bracket, filter and hardware are in a box located on the side of the unit within the unit packaging. All vertical units ship with the filter rack and filters factory installed.

**Note:** Do not operate the unit without filters.

## Supply-Air Ductwork

Horizontal DXH and EXH units require duct flanges to be field installed. The duct flange ships in a box on the side of the unit. Install the flange with (8) 3/8 in. (213 mm) factory supplied screws.

Install the 1 in. (25.4 mm) supply-air duct flange to the vertical and horizontal equipment with the (8) 5/16 in. (7.94 mm) factory-supplied head screws. The duct collar assembly for each unit is shipped with the unit in the same box where the IOM manual is located.

When attaching the field ductwork to the unit, provide a watertight flexible connector at the unit to prevent operating sounds from transmitting through the ductwork (See the figure below).

Elbows with turning vanes or splitters are recommended to minimize air noise due to turbulence and to reduce static pressure.

**Figure 16. Flexible supply-air connector (field provided)**

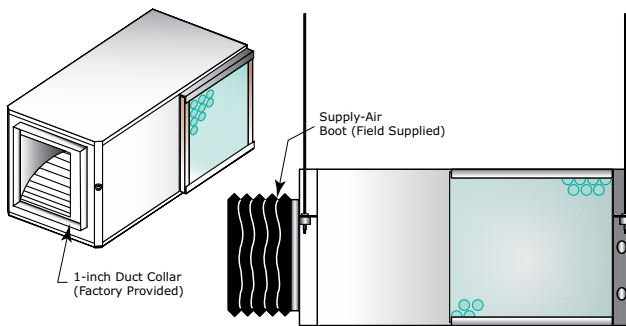

## Return-Air Ductwork

Install the 1/2 in. (25.4 mm/50.8 mm) adjustable filter rack to the horizontal equipment only with the use of (4) 5/16 in. (7.94 mm) factory supplied head screws. The vertical equipment factory ships with the filter rack and filter(s) installed.

When attaching the field ductwork to the unit, provide a water-tight flexible connector at the unit to prevent operating sounds from transmitting through the ductwork.

Elbows with turning vanes or splitters are recommended to minimize air noise due to turbulence and to reduce static pressure.

**Figure 17. Flexible return-air connector (field provided)**

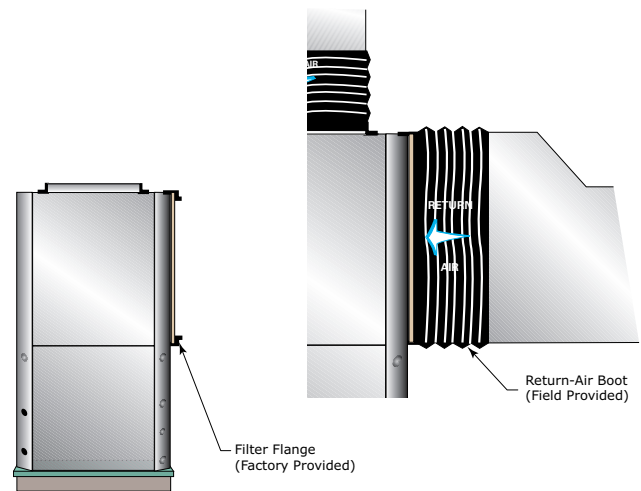

## Ducted Panel

The return-air arrangement may be easily converted from a free return-air system, to a ducted return-air system with the addition of a return-air side panel. By replacing the filter racks with the return-air panel, a complete seal from the duct to the unit is possible. The 1.5 duct flange facilitates ease of field connection to the duct system. This accessory is typically used when the return-air filter is placed in a built-in ceiling grille, or placed within a field provided filter rack assembly.

Install the return-air duct panel to the return-air opening with the six screws provided for the filter rack assembly.

**Figure 18. Return-air duct panel**

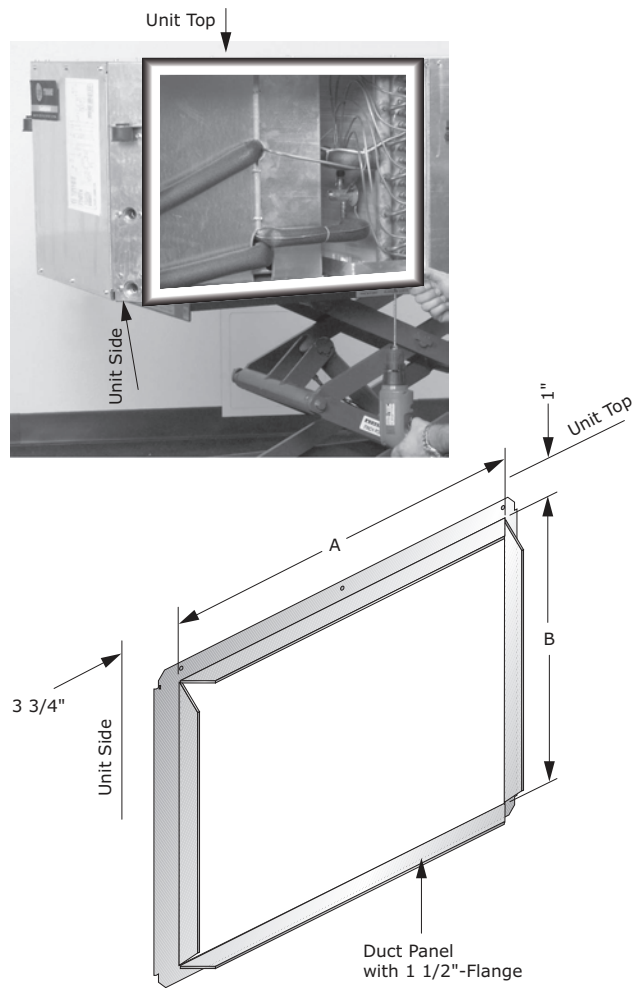
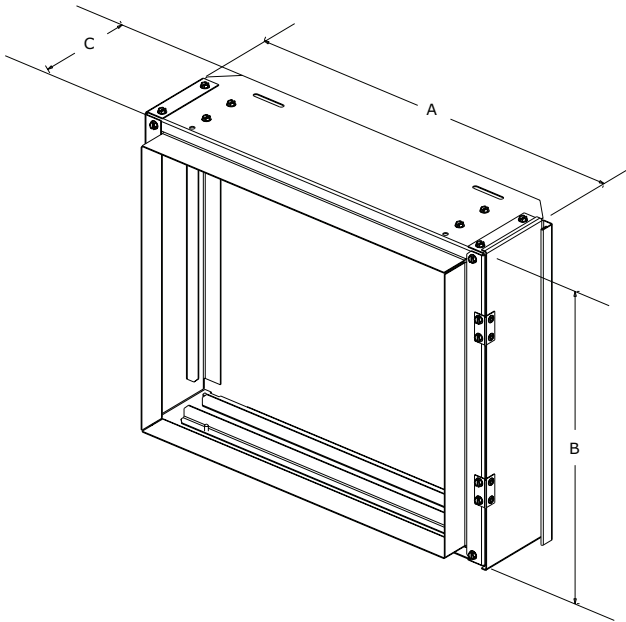

**Table 21. Ducted panel - return air**

Unit Size	A (in.)	B (in.)	Duct Collar Part Number
EXVG009-012	18.50	16.50	WSHPPND00002
EXVG015	20.00	17.50	WSHPPND00003
EXVG018-024, DXVG024	23.00	18.50	WSHPPND00004
EXVG030-036, DXVG036	29.50	20.50	WSHPPND00005
EXVG042-048, DXVG048	29.50	27.25	WSHPPND00006
EXVG060-070, DXVG060-070	29.50	33.25	WSHPPND00007
EXHG009-012	18.50	16.50	WSHPPND00011
EXHG015	20.00	17.50	WSHPPND00012
EXHG018-024, DXHG024	23.00	18.50	WSHPPND00013
EXHG030-036, DXHG036	29.50	20.50	WSHPPND00014
EXHG042-048, DXHG048	38.88	19.75	WSHPPND00015
EXHG060-070, DXHG060-070	47.88	19.75	WSHPPND00016



## Ducted Filter Rack



When it is necessary to have filter access at the unit in a ducted return, a ducted filter rack is available. This option allows access to the filter at the unit. Vertical unit filter racks are available in right or left access configurations. Horizontal units are available in bottom access configuration.

**Table 22. Ducted filter opening size - 0.75 to 6 tons**

Unit Size	A (in.)	B (in.)	C (in.)
EXHG 009-012	19.00	16.25	6.6
EXHG 015	20.50	17.25	6.6
EXHG 018-024, DXHG 024	23.50	18.25	6.6
EXHG 030-036, DXHG 036	30.00	20.25	6.6
EXHG 042-048, DXHG 048	40.50	21.00	6.6
EXHG 060-070, DXHG 060-070	50.50	21.00	6.6
EXVG 009-012	19.00	16.25	6.6
EXVG 015	20.50	17.25	6.6
EXVG 018-024, DXVG 024	23.50	18.25	6.6
EXVG 030-036, DXVG 036	30.00	20.25	6.6
EXVG 042-048, DXVG 048	30.00	27.00	6.6
EXVG 060-070, DXVG 060-070	30.00	32.75	6.6

**Note:** All dimensions in inches. All dimensions are for accessory 2 or 4-inch filter rack.

## Sound Attenuation Pad

For sound-sensitive installations, a vibration pad (field provided) should be placed beneath the horizontal or vertical equipment. For the horizontal unit, the pad should be approximately twice the size of the unit foot print. For the vertical unit, the pad should be 0.5 in. (12.7 mm) thick, and equal to the overall unit foot print.

## Hanging the Horizontal Unit

### ⚠ WARNING

#### Proper Structural Support Required!

Failure to ensure proper structural ceiling support could result in unit falling from its location which could result in death or serious injury.

Ceiling structure must be strong enough to support the weight of the unit and any accessories. If unsure, check with a structural engineer.

To hang the horizontal configuration (see the figure below):

1. Install the hanging isolators (located in the return-air section of the unit) into the six hanging brackets.
2. The base of the unit (hanging rails) must be fully supported while unit is being lifted for install. This can be achieved by using a lift with a large enough supporting surface, or a wooden structure can fully support the base if desired.
3. Secure the equipment to a joist, concrete, etc. with the use of 3/8 in. (9.7 mm) field provided (all-thread) rod. Each rod should contain field provided nuts and washers to complete the hanging installation.
4. All plumbing to the unit should conform per national and local codes and is the responsibility of the contractor. The 0.5 to 6 ton horizontals and EX/DXHG models do not need to be sloped. EXHG and DXHG 0.75 to 6 ton models must be installed level.

**Notes:**

- *Rods must be perpendicular to the mounting holes in the base rail of the horizontal unit.*
- *For 0.75 to 6 ton EXHF and DXHF models, follow pitching instructions from previous generation IOM.*

**Figure 19. Hanging the unit**

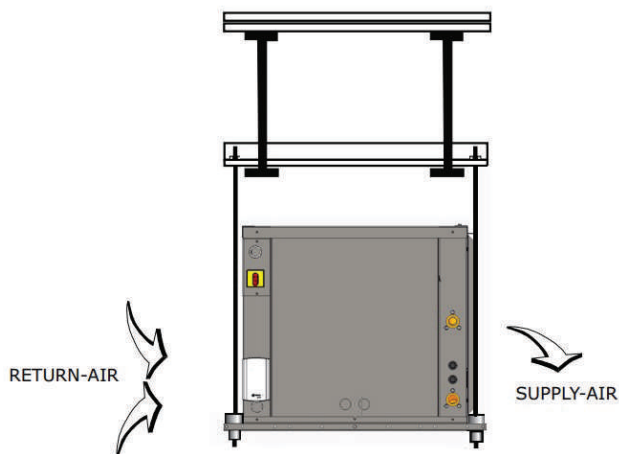

## Condensate Drain Connection

**Figure 20. Negative pressure system**

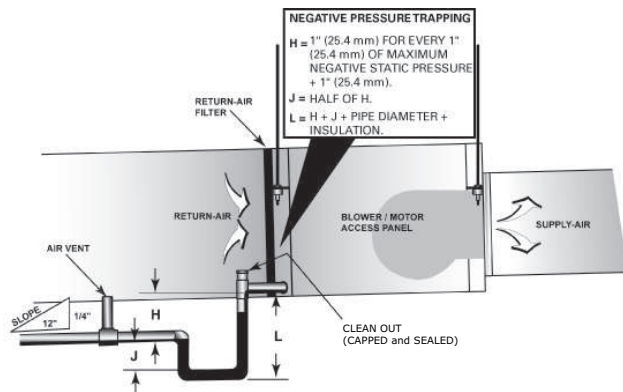

Install proper trapping to the equipment. The unit drain connection is 0.75 in. NPT for all DXH, DXV, and EXH/V 0.75 to 6 ton models.

When designing the condensate trap for the water-source system, it is important to consider the unit draw-thru design requiring negative pressure trapping.

In a properly trapped system, when condensate forms during normal operation, the water level in the trap rises until there is a constant flow. It is imperative to maintain water in the trap and not allow the trap to dry out during heating season. Keeping trap primed at all times will enable the water to flow properly. See the figure above for appropriate dimensions required in a negative pressure system.

## Supply Pipe Connections

**Figure 21. Supply/return pipe connections**

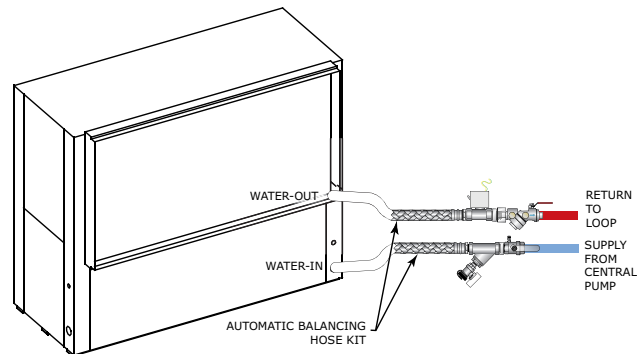

Connect the supply and return hoses to the water-inlet (from supply) and water-outlet (to return) of the unit. For vibration isolation, it is recommended that flexible steel braided hoses be installed instead of hard piping the equipment to the main loop system. Figure above shows connection of a Hays Mesurflo® balancing hose kit to the water-in and water-out of a vertical unit.

**Note:** Above figure example incorporates the Hays Mesurflo® balancing hose kit and a 2-position isolation valve into the system design. An isolation valve is often used in variable speed pumping applications. The isolation valve is designed to stop water flow to the unit during non operation times. This allows the loop water pumps to run only when a requirement for pumping is needed for greater energy efficiency of the overall system design.

## Cleaning and Flushing the Water Loop

After the piping system is complete, the flexible hose connectors should be doubled back to complete the water circuit external to the unit (avoiding trash settle-out in the condenser). An extra pipe may be necessary to connect the hose kits.

1. Water circulation system should be filled with clean water using the water make up connections.

**Note:** Air vents should be open during filling.

2. With the air vents closed, start the circulating pump and then crack the air vents to bleed off the trapped air, assuring circulation through all components of the system.

**Note:** Make up water must be available to the system to replace the volume formerly occupied by the air that is bled off.

3. With the air vented and the water circulating, the entire system should be checked for leaks with repairs made as required.
4. Operate the supplementary heat system (boiler) making checks per manufacturer's instructions. During this operation, visual checks should be made for leaks

that may have occurred due to increased heat. Repair as required.

5. Open the system at the lowest point for the initial blow down (making sure the make up water is equal to the water being dumped). Continue blow down until the water leaving the drain runs clear, but not less than 2 hours.
6. Shut down pumps and supplementary heat system. Reconnect the hoses placing the water-to-refrigerant heat exchanger in the water circulating system.

**Note:** Vents should be open when the pumps and supplementary heat system are shut down.

## Field Installed Power Wiring

### ⚠ WARNING

#### Proper Field Wiring and Grounding Required!

Failure to follow code could result in death or serious injury.

All field wiring **MUST** be performed by qualified personnel. Improperly installed and grounded field wiring poses **FIRE** and **ELECTROCUTION** hazards. To avoid these hazards, you **MUST** follow requirements for field wiring installation and grounding as described in NEC and your local/state/national electrical codes.

### NOTICE

#### Use Copper Conductors Only!

Failure to use copper conductors could result in equipment damage as the equipment was not designed or qualified to accept other types of conductors.

Verify that the power supply available is compatible with the unit's nameplate. Use only copper conductors to connect the power supply to the unit.

## Main Unit Power Wiring

### ⚠ WARNING

#### Proper Field Wiring and Grounding Required!

Failure to follow code could result in death or serious injury.

All field wiring **MUST** be performed by qualified personnel. Improperly installed and grounded field wiring poses **FIRE** and **ELECTROCUTION** hazards. To avoid these hazards, you **MUST** follow requirements for field wiring installation and grounding as described in NEC and your local/state/national electrical codes.

A field supplied disconnect switch must be installed at or near the unit in accordance with the National Electric Code (NEC latest edition).

Location of the applicable electric service entrance for HIGH (line voltage) may be found in the Dimensions section of this manual.

The high-voltage connection is made at the 1K1 contactor or 1TB power block inside the unit control box (See the figure below). Refer to the customer connection diagram that is shipped with the unit for specific termination points.

Provide proper grounding for the unit in accordance with the local and national codes.

**Figure 22. Power wiring example**

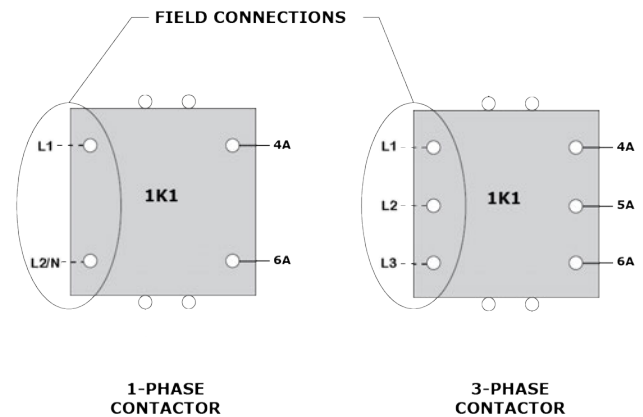

## Control Power Transformer

The 24 V control power transformers are to be used only with the accessories called out in this manual. A 50 VA transformer is externally fused. Transformers rated greater than 50 VA are equipped with circuit breakers. If a circuit breaker trips, turn OFF all power to the unit before attempting to reset it.

### ⚠ WARNING

#### Hazardous Voltage!

Failure to disconnect power before servicing could result in death or serious injury.

Disconnect all electric power, including remote disconnects before servicing. Follow proper lockout/tagout procedures to ensure the power can not be inadvertently energized. Verify that no power is present with a voltmeter.

The transformer is located in the control panel.



## Thermostat Location

Figure 23. Thermostat/sensor location

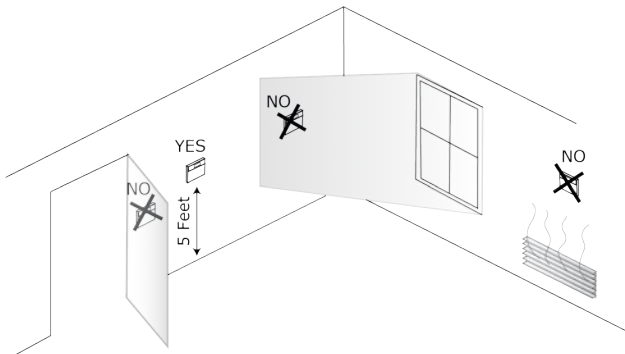





Location of the thermostat or zone sensor is an important element of effective room control.

Areas where the thermostat or zone sensor should not be located include:



- Behind doors or corners
- Near hot or cold air ducts
- Near radiant heat (heat emitted from appliances or the sun)
- Near concealed pipes or chimneys
- On outside walls or other non conditioned surfaces
- In airflows from adjacent zones or other units.

## Thermostats and Zone Sensors





Table 23. Thermostat selection for use with the Deluxe controller

Thermostat	Part Number	Description
	X13511535010	1 Heat/1 Cool, non-programmable commercial thermostat for conventional air conditioners and heat pumps that are configured without auxiliary heat <ul style="list-style-type: none"> <li>• 1 H/1 C</li> </ul>
	X13511536010	3 Heat/2 Cool, non-programmable commercial thermostat for conventional air conditioners and heat pumps that are configured with or without auxiliary heat. <ul style="list-style-type: none"> <li>• 3 H/2 C</li> </ul>
	X13511537010	3 Heat/2 Cool, programmable commercial thermostat for conventional (rooftop) air conditioners and heat pumps that are configured with or without auxiliary heat. <ul style="list-style-type: none"> <li>• 3 H/2 C</li> </ul>
	X13511538010	3Heat/2 Cool, programmable touch screen thermostat for conventional air conditioners and heat pump systems. The thermostat will provide the human interface, zone temperature sensing both local and optional remote temperature sensing, and set point scheduling on a daily/weekly basis. This thermostat can also display humidity with a control signal for dehumidification with a local humidity sensor or optional remote humidity sensor. <ul style="list-style-type: none"> <li>• 3 H/2 C</li> </ul>





**Table 23. Thermostat selection for use with the Deluxe controller (continued)**

Thermostat	Part Number	Description
	Pivot — BAYSTAT814A-W.	Pivot Smart Thermostat is a Wi-Fi/ethernet thermostat for commercial applications. It has a very simple interface for occupants to adjust the thermostat. Cooling and heating control of multiple systems is made even easier and faster when connected to the Pivot App. Supports 2 stage heat pump with auxiliary heat.
	XL824 - TCONT824AS52DB.	The XL824 Smart thermostat is a Wi-Fi/ethernet thermostat for Residential applications such as single family homes, condominiums and apartments. Supports 2 stage heat pump with auxiliary heat. The XL824 can be connected to the Nexia Home App and other home automation systems.



**Table 24. Zone sensor selection for use with Symbio™ 400-B/Tracer® UC400-B controller**

Sensor	Part Number	Description
	X13790886010	Wired temperature sensor with an LCD display <ul style="list-style-type: none"> <li>• Allows an occupant to control the temperature setpoint, request timed override of system operation, and provides a COMM module to service technicians. Symbio 400-B/UC400-B Compatible</li> </ul>
	X13651467020	Communication Module <ul style="list-style-type: none"> <li>• Sold in packs of 12</li> <li>• Provides local RJ22 connection to Trane® service tools for easy, low cost maintenance.</li> </ul>
	X13511529010	Zone Sensor <ul style="list-style-type: none"> <li>• Symbio 400-B/UC400-B compatible</li> <li>• External setpoint adjustment wheel</li> </ul>
	X13511527010	Zone Sensor <ul style="list-style-type: none"> <li>• Symbio 400-B/UC400-B compatible</li> <li>• External setpoint adjustment wheel</li> <li>• ON and CANCEL buttons</li> </ul>

**Table 24. Zone sensor selection for use with Symbio™ 400-B/Tracer® UC400-B controller (continued)**

Sensor	Part Number	Description
	X1379084501	Zone Sensor <ul style="list-style-type: none"> <li>• Symbio 400-B/UC400-B compatible</li> <li>• External setpoint adjustment wheel</li> <li>• ON and CANCEL buttons</li> <li>• Fan switch AUTO-OFF</li> </ul>
	X1379044401	Temperature and relative humidity sensor <ul style="list-style-type: none"> <li>• Symbio 400-B/UC400-B compatible</li> </ul>
	X13790993001	Commercial Touch Screen Programmable Zone Sensor <ul style="list-style-type: none"> <li>• Supports Standby, Occupied, and Unoccupied</li> <li>• 7 day, 5+2 day, and 5+1+1 day</li> <li>• Cannot be used with BAS as sensor ties up BACnet link. For use with factory-programmed Symbio 400-B/UC400-B.</li> </ul> <p><b>Notes:</b></p> <ul style="list-style-type: none"> <li>• <i>Adjusting the rotary switch on Symbio 400-B/UC400-B may be required to correspond address configuration in the sensor. See the installation manual for more information.</i></li> <li>• <i>Additional configuration is needed in the field to use the Programmable zone sensors (to put BAS points in service on Symbio 400-B/UC400-B).</i></li> </ul>
	X13790992001	Residential Touch Screen Programmable Zone Sensor <ul style="list-style-type: none"> <li>• Supports Awake, Away, Home, and Sleep</li> <li>• 7 day, 5+2 day, and 5+1+1 day</li> <li>• Cannot be used with BAS as sensor ties up BACnet link. For use with factory-programmed Symbio 400-B/UC400-B.</li> </ul> <p><b>Notes:</b></p> <ul style="list-style-type: none"> <li>• <i>Adjusting the rotary switch on Symbio 400-B/UC400-B may be required to correspond address configuration in the sensor. See the installation manual for more information.</i></li> <li>• <i>Additional configuration is needed in the field to use the Programmable zone sensors (to put BAS points in service on Symbio 400-B/UC400-B).</i></li> </ul>

**Table 25. Wireless zone sensor selection for use with Symbio 400-B/UC400-B controller**

Sensor	Part Number	Description
	X13790955010	Trane Air-Fi® WCS-SD (display) <ul style="list-style-type: none"> <li>Symbio 400-B/UC400-B Compatible</li> <li>Easy-to-use interface for clear and simple monitoring and control</li> </ul>
	X13790956010	Trane Air-Fi WCS-SB (base) <ul style="list-style-type: none"> <li>Symbio 400-B/UC400-B Compatible</li> <li>Simplicity</li> <li>Eliminates local temperature control when higher control level is required.</li> </ul>
	X13790973030	Wireless communications sensor accessory—2% relative humidity (RH) sensor module (WCS-SH) The optional RH sensor module plugs in to any WCS model, further simplifying installation by eliminating the needed for additional wiring.

## Controls Using 24 Vac

Before installing any wire, refer to the electrical access locations in the Unit Dimensions and Weights sections of this manual.

Ensure that the AC control wiring between the controls and the unit termination point does not exceed 3 Ohms/ conductor for the length of the run.

### NOTICE

#### Component Failure!

Resistance in excess of 3 ohms per conductor could result in component failure due to insufficient AC voltage supply.

Do not exceed three (3) ohms per conductor for the length of the run.

Check all loads and conductors for grounds, shorts, and mis-wiring. Use copper conductors unless otherwise specified. Do not run the AC low-voltage wiring in the same conduit with the high voltage power wiring.

**Table 26. 24V AC conductors**

Distance from unit to control	Recommended wire size
000-460 ft	18 gauge
461-732 ft	16 gauge
733-1000 ft	14 gauge

Low-voltage connection diagrams for deluxe 24 V control packages for these thermostats mounted on 0.75 to 6 ton equipment sizes are shown in the figures below.

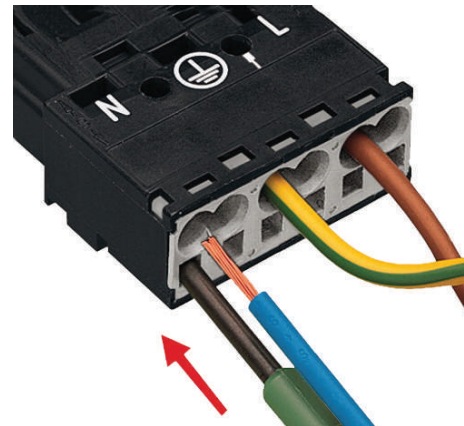
**Figure 24. Low voltage wire connection**

**Figure 25. Low voltage single wire connection**

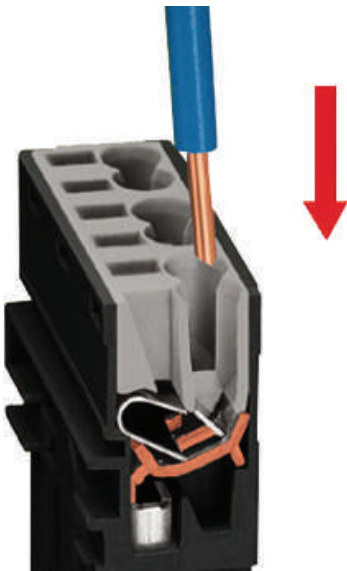

Make connection for a single-wire by inserting a single wire after stripping off the coating.

**Figure 26. Low voltage stranded wire connection**

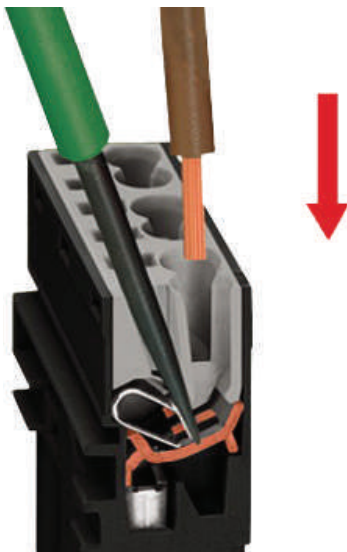

Follow the steps to connect the stranded wire:

1. Release the spring with a dedicated screwdriver (blade width 2.5 mm)
2. Insert the stripped cable as far as it gets inserted.
3. Complete the connection by removing the screwdriver.

**Figure 27. Deluxe controls**

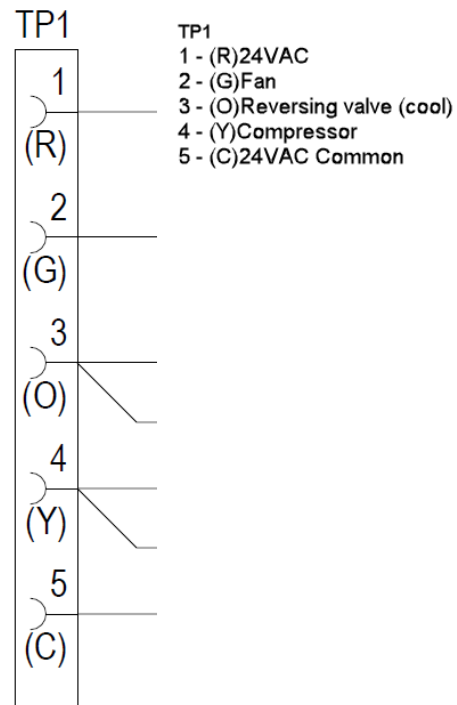

**Figure 28. TP1 connection type**

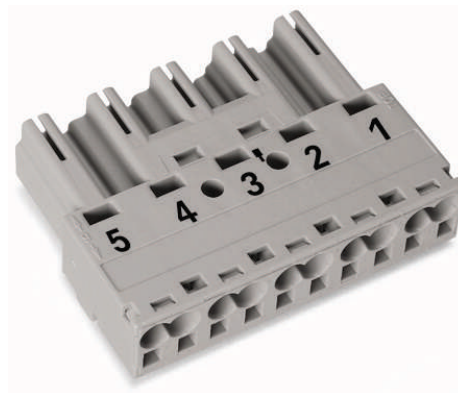

Present on all 0.5 to 5 ton H/V units.

Figure 29. Deluxe controls with WSE or DX two-stage

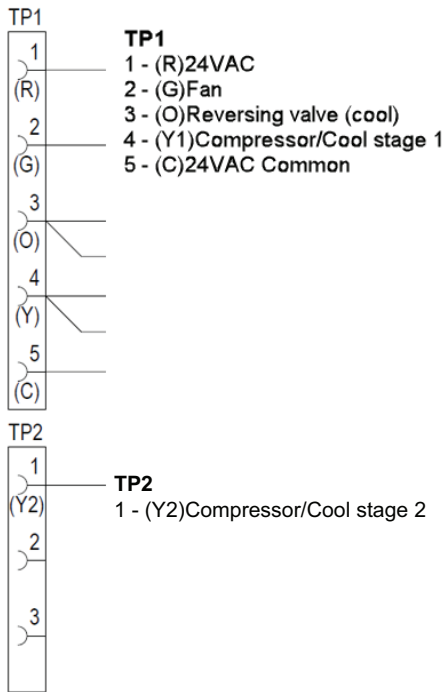

Figure 30. TP2 connection type



Only present on units with Deluxe 24V controls and either 2-speed compressor (DXV/H) or water side economizer (WSE) coil DX and WSE on DLX.

Figure 31. Deluxe controls humidistat connections between wires H1 and H2 in control box



Figure 32. Deluxe controls general alarm and compressor disable

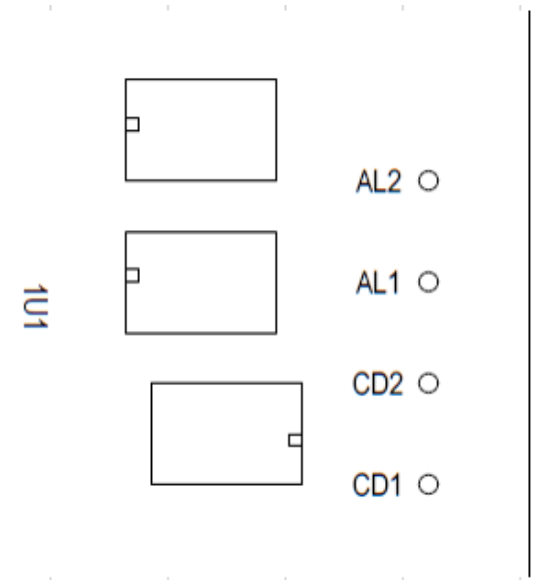

Deluxe board (1U1) connections

AL1, AL2 - Alarm Contact output

CD1, CD2 - Compressor Disable input (24Vac)

For installation, operation and programming see BAS-SVX065\*-EN (UC400-B) and BAS-SVX092\*-EN (Symbio™ 400-B).

**⚠ WARNING**

**Hazardous Voltage!**

Failure to disconnect power before servicing could result in death or serious injury.

Disconnect all electric power, including remote disconnects before servicing. Follow proper lockout/tagout procedures to ensure the power can not be inadvertently energized. Verify that no power is present with a voltmeter.

**⚠ WARNING**

**Proper Field Wiring and Grounding Required!**

Failure to follow code could result in death or serious injury.

All field wiring **MUST** be performed by qualified personnel. Improperly installed and grounded field wiring poses **FIRE** and **ELECTROCUTION** hazards. To avoid these hazards, you **MUST** follow requirements for field wiring installation and grounding as described in NEC and your local/state/national electrical codes.

## External Smoke Detection Wiring to Unit

### Deluxe Controller

To inhibit operation of the compressor and fan for a safety shutdown, it is necessary to break the wire (21X) from the 24 Volt transformer to the 1TB1 terminal block. This can be done with the dry contacts of a relay. When that connection is opened, it terminates voltage to both the deluxe controller and the thermostat, which stops/prevents all control function to the fan and compressor.

### Symbio™ 400-B/UC400-B Controller

To inhibit operation of the compressor and fan for a safety shutdown, it is necessary to break the wire (21A) from the 24 Volt transformer to the Symbio 400-B/UC400-B (1U1). This can be done with the dry contacts of a relay. When that connection is opened, it terminates the power voltage to the controller, which stops/prevents all control function including the fan and compressor.

## Airflow Adjustment

### ⚠ WARNING

#### Rotating Components!

Failure to disconnect power before servicing could result in rotating components cutting and slashing technician which could result in death or serious injury.

During installation, testing, servicing and troubleshooting of this product it may be necessary to work with live and exposed rotating components. Have a qualified or licensed service individual who has been properly trained in handling exposed rotating components, perform these tasks.

### Units with Deluxe 24V controls

The ECM is programmed for constant torque and delivers airflow similar to a PSC motor while operating at a higher efficiency.

Figure 33. ECM control box



Figure 34. ECM control board

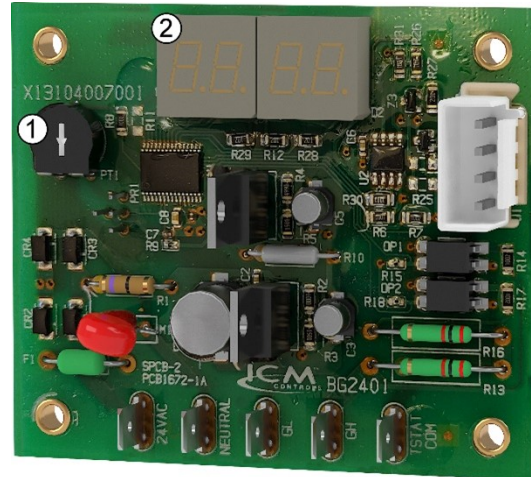

1. Potentiometer will be used to adjust the PWM output
2. Seven segment display

Using a screwdriver, the potentiometer will be used to adjust the PWM output from 20% to 100% PWM. Increasing the PWM will increase the motor speed. When setting the airflow for air balancing, the high-speed terminal (GH) must have 24 Vac signal. This will ensure that the PWM output will be adjusted for the full load airflow.

The display will show the commanded motor speed percentage. If running on low speed (GL), the low-speed value will be displayed. If running in GH the high-speed value will be displayed. If both GH and GL input signals are present, the PWM output value will be the GH value.

**Note:** ECM control board is only on units with Deluxe 24V controls. Tracer® TU is used to adjust fan speed on units with Symbio™ 400-B/UC400-B controls.

## Waterside Economizer Installation

### ⚠ WARNING

#### Hazardous Voltage!

Failure to disconnect power before servicing could result in death or serious injury.

Disconnect all electric power, including remote disconnects before servicing. Follow proper lockout/tagout procedures to ensure the power can not be inadvertently energized. Verify that no power is present with a voltmeter.

### ⚠ WARNING

#### Proper Field Wiring and Grounding Required!

Failure to follow code could result in death or serious injury.

All field wiring **MUST** be performed by qualified personnel. Improperly installed and grounded field wiring poses **FIRE** and **ELECTROCUTION** hazards. To avoid these hazards, you **MUST** follow requirements for field wiring installation and grounding as described in NEC and your local/state/national electrical codes.

### Waterside Economizer Installation for Horizontal 0.75 to 6 Ton Units

The following steps were sequenced to aid in the installation and pairing of a water side economizer to a 0.75 to 6 ton horizontal water source heat pump.

1. Remove the filter bracket from the unit. It is secured by four screws: three on top (circled) and two on the bottom (not shown). Do not discard the filter brackets.

**Figure 35. Step 1**



2. Mount the waterside economizer to the unit. It is secured to the unit using the three engagement holes used for the filter bracket on the top. Secure the sides of the economizer using the two L-Brackets on each side by lining up the engagement holes for the

fasteners (total of four for each bracket). The engagement hole locations and L-Bracket can be seen in the [Figure 36, p. 40](#).

**Figure 36. Step 2**

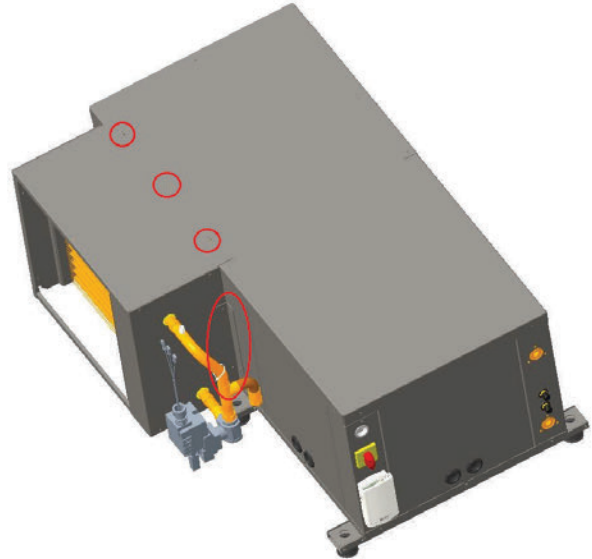

3. Attach the filter bracket to the waterside economizer using the five screws removed earlier. Install the air filter.
4. Install the braided hose connecting point A (leaving the WSE) to point B (entering the WSHP). Connect the supply water to point D and the return water to point C.

**Figure 37. Step 4**

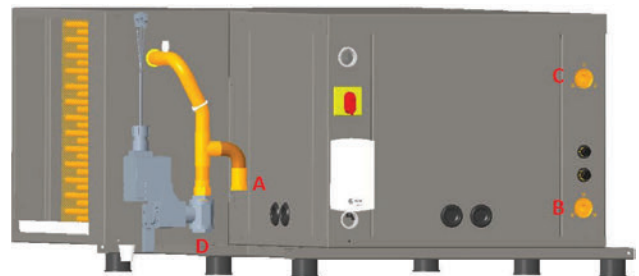

5. Locate the entering water sensor that is located behind the unit's control box, and wire tie it to the water SUPPLY side of the piping. The sensor must be mounted before the two-position valve. Attaching the sensor anywhere else will cause the WSE to not operate correctly. Bundle up any excess sensor wire and wire tie the bundle neatly.
6. Locate the WSE valve wires (35B (COM), 36B (OPEN), 37B (CLOSE)) behind control box, and connect to the valve actuator. Bundle up any excess wire and wire tie the bundle neatly. Direction of rotation is reversible with switch.
7. Insulate the economizing piping package and the associated hoses via field pipe insulation. Insulating the



pipng will prevent condensation from forming on the pipe and dripping on the floor.

**Notes:**

- *Trane does not provide insulation on the economizing piping package. The insulation must be field provided and field installed.*
- *Trane does not provide condensate overflow protection of the waterside economizer. This must be field provided and installed.*

8. Field pipe the drain lines of the waterside economizer and water-source heat pump. Both the WSE and unit condensate drains must be separately trapped for proper handling of condensation (see Figure 38, p. 41 ). Both Vertical and Horizontal units will be piped similar to each other. The drain connection is located on the bottom side of the economizing coil.

**Figure 38. Step 8**

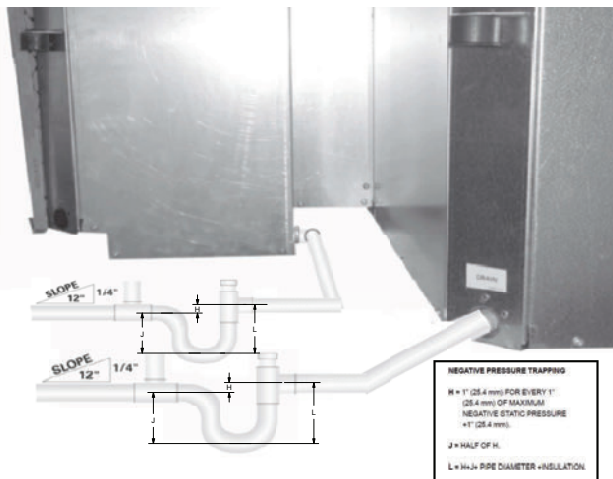

**Table 27. Economizer part numbers**

Supply-Air Arrangement	Unit	Part Number
Left Supply	EXVG009-012	WSHPECN00016
	EXVG015	WSHPECN00017
	EXVG018-024, DXVG024	WSHPECN00018
	EXVG030-036, DXVG036	WSHPECN00019
	EXVG042-048, DXVG048	WSHPECN00020
	EXVG060-070, DXVG060-070	WSHPECN00021
Right Supply	EXVG009-012	WSHPECN00023
	EXVG015	WSHPECN00024
	EXVG018-024, DXVG024	WSHPECN00025
	EXVG030-036, DXVG036	WSHPECN00026
	EXVG042-048, DXVG048	WSHPECN00027
	EXVG060-070, DXVG060-070	WSHPECN00028

**Waterside Economizer Installation for Vertical Units**

The following steps were sequenced to aid in the installation and pairing of a water side economizer to a EXV and DXV water source heat pump.

1. Remove the filter bracket from the unit. It is secured by five screws: three on top (circled) and two on the bottom (not shown). Do not discard the filter brackets.

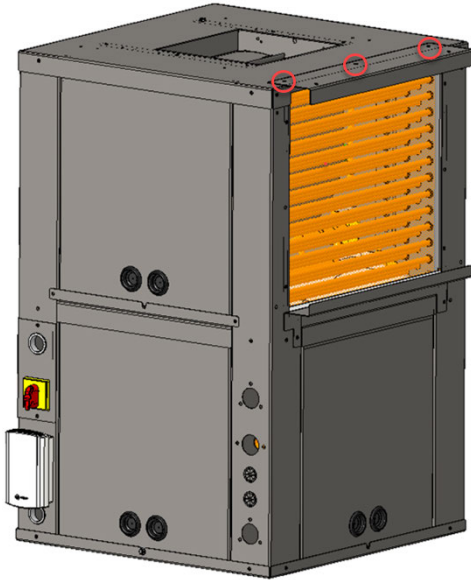
**Figure 39. Step 1**

2. Mount the waterside economizer to the unit. It is secured to the unit using the five engagement holes that were used for the filter brackets: three on top and two on the bottom.

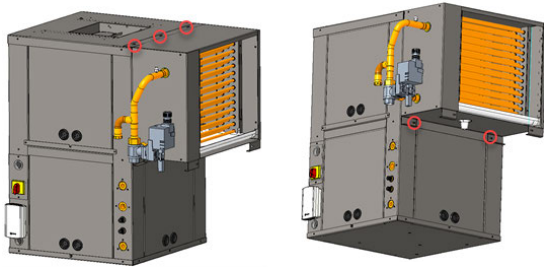
**Figure 40. Step 2**

3. Attach the filter brackets to the waterside economizer using five screws. Install the air filter.

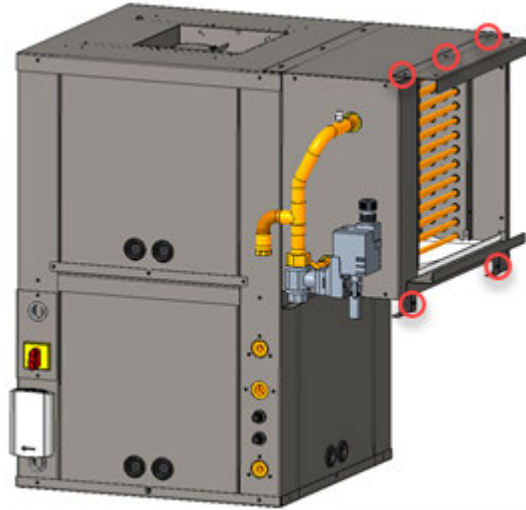
**Figure 41. Step 3**

4. Install the braided hose connecting point A (leaving the WSE) to point B (entering the WSHP). Connect the supply water to point D and the return water to point C.

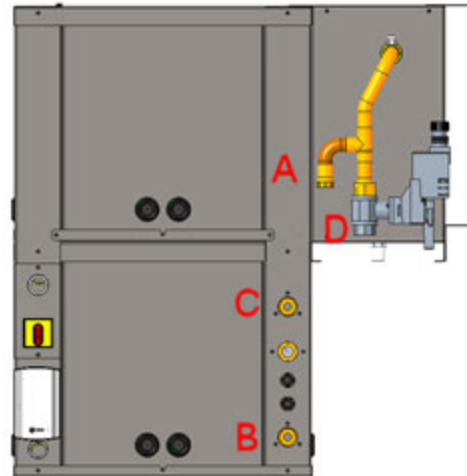
**Figure 42. Step 4**

5. Locate the entering water sensor that is located behind the unit's control box, and wire tie it to the water SUPPLY side of the piping. The sensor must be mounted before the two-position valve. Attaching the sensor anywhere else will cause the WSE to not operate correctly. Bundle up any excess sensor wire and wire tie the bundle neatly.
6. Locate the WSE valve wires (35B (COM), 36B (OPEN), 37B (CLOSE)) behind control box, and connect to the valve actuator. Bundle up any excess wire and wire tie the bundle neatly. Direction of rotation is reversible with switch.
7. Insulate the economizing piping package and the associated hoses via field pipe insulation. Insulating the

pipng will prevent condensation from forming on the pipe and dripping on the floor.

**Notes:**

- *Trane does not provide insulation on the economizing piping package. This insulation must be field provided and field installed.*
- *Trane does not provide condensate overflow protection of the waterside economizer. This must be field provided and installed.*

8. Field pipe the drain lines of the waterside economizer and water-source heat pump together prior to installing a condensate trap for proper trapping of condensation (see ). The vertical units will be piped similar to the horizontal units.

**Figure 43. Step 8**

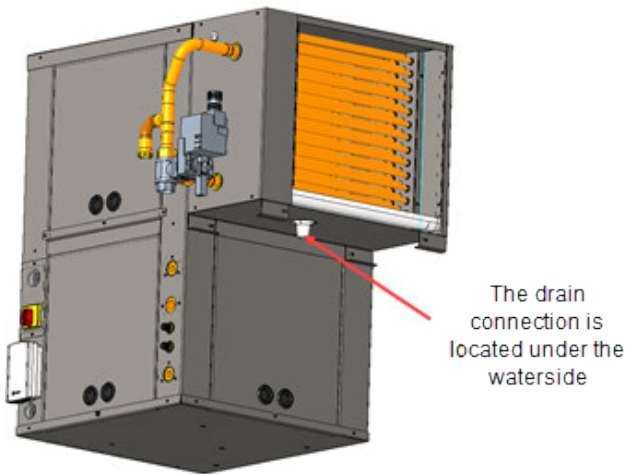

**Table 28. Economizer part numbers**

Supply-Air Arrangement	Unit	Part Number
Left Supply	EXVG009-012	WSHPECN00002
	EXVG015	WSHPECN00003
	EXVG018-024, DXVG024	WSHPECN00004
	EXVG030-036, DXVG036	WSHPECN00005
	EXVG042-048, DXVG048	WSHPECN00006
	EXVG060-070, DXVG060-070	WSHPECN00007
Right Supply	EXVG009-012	WSHPECN00009
	EXVG015	WSHPECN00010
	EXVG018-024, DXVG024	WSHPECN00011
	EXVG030-036, DXVG036	WSHPECN00012
	EXVG042-048, DXVG048	WSHPECN00013
	EXVG060-070, DXVG060-070	WSHPECN00014



# Waterside Economizer Start-Up Sequence

1. Set the thermostat to the highest position.
  2. Set the thermostat system switch to COOL with the fan control to AUTO. The compressor should NOT run.
  3. Reduce the thermostat setting until the compressor, reversing valve, solenoid valve, and loop pump are energized. Adjust water flow utilizing pressure/temperature plugs and comparing to tables contained in specification sheet data. Water leaving the heat exchanger should be warmer than the entering water temperature (approximately 9 to 12°F); blower operation should be smooth; compressor and blower amps should be within data plate ratings; the suction line should be cool with no frost observed in the refrigerant circuit.
  4. Check the cooling refrigerant pressures against values in "Operating Pressures," p. 52.
- Note:** *If cooling mode is activated, and the entering water temperature of the heat pump falls below 55°F, the 2-position, water side economizing valve will become energized (open) and compressor operation will halt allowing for free cooling in the space.*
5. Turn the thermostat system switch to the OFF position. Unit should stop running and the reversing valve should de-energize.
  6. Leave unit off for approximately FIVE minutes to allow for pressure equalization.
  7. Turn the thermostat to the lowest setting.
  8. Set the thermostat system switch to the HEAT position.
  9. Adjust the temperature setting upward until the unit is energized. Warm air should blow from the register. A water temperature decrease of approximately 5 to 9°F leaving the heat exchanger should be noted. The blower and compressor operation should be smooth with no frost observed in the refrigeration circuit.
  10. Check the heating refrigerant pressures against values in "Operating Pressures," p. 52.
- Note:** *For units with boilerless electric heat option: In heating mode, if the entering water temperature of the heat pump falls below 45°F, the electric heater will be energized, and compressor operation will halt. Once the entering water temperature rises above 50°F, the boilerless controls returns the unit.*
11. Set the thermostat to maintain the desired space temperature.
  12. Instruct the owner on system operation.

**Table 29. Waterside economizing three-way valve specifications (DXHG/DXVG units)**

Unit Size	Valve Conn. Size	Valve Pres. Rating	Valve Close-off pressure	Valve Temp. Range	Actuator
DXHG/DXVG 024	3/4 FPT	600 psi	200 psi	0°F to 212°F -18°C to 121°C	Non-spring return type 24 Vac +/- 20% 135 second stroke time 24 Cv at full port
DXHG/DXVG 036-070	1 FPT	600 psi	200 psi	0°F to 212°F -18°C to 121°C	Non-spring return type 24 Vac +/- 20% 135 second stroke time 30 Cv at full port

**Note:** *The valve body is constructed from forged brass with nickel plating, with the ball and stem constructed of stainless steel. For other information pertaining to the economizing water valve, see the valve's data plate.*

**Table 30. Waterside economizing three-way valve specifications (EXHG/EXVG units)**

Unit Size	Valve Conn. Size	Valve Pres. Rating	Valve Close-off pressure	Valve Temp. Range	Actuator
EXHG 009-015	1/2 FPT	600 psi	200 psi	0°F to 250°F -18°C to 121°C	Non-spring return type 24 Vac +/- 20% 135 second stroke time 10 Cv at full port
EXHG 018-036 EXVG 009-024	3/4 FPT	600 psi	200 psi	0°F to 250°F -18°C to 121°C	Non-spring return type 24 Vac +/- 20% 135 second stroke time 24 Cv at full port

## Waterside Economizer Start-Up Sequence

**Table 30. Waterside economizing three-way valve specifications (EXHG/EXVG units) (continued)**

Unit Size	Valve Conn. Size	Valve Pres. Rating	Valve Close-off pressure	Valve Temp. Range	Actuator
EXHG 042-070 EXVG 030-070	1 FPT	600 psi	200 psi	0°F to 250°F -18°C to 121°C	Non-spring return type 24 Vac +/- 20% 135 second stroke time 30 Cv at full port

*Note: The valve body is constructed from forged brass with nickel plating, with the ball and stem constructed of stainless steel. For other information pertaining to the economizing water valve, see the valve's data plate.*



# Electrical Data

**Table 31. Electrical data - 0.75 to 6 tons, EX\*009-070**

Model No.	Unit Volts	Total Unit FLA	Comp RLA	Comp LRA	Blower Motor FLA	Blower Motor HP	Minimum Circuit Ampacity	Maximum Overcurrent Protective Device
EXV/H009	208-230/60/1	4.2	3.6	27.0	0.6	1/3	6/6	15/15
EXV/H009	265/60/1	3.5	3.0	22.0	0.5	1/3	5	15
EXV/H012	208-230/60/1	6.6	5.7	27.0	0.9	1/3	8/8	15/15
EXV/H012	265/60/1	5.3	4.5	32.0	0.8	1/3	7	15
EXV/H015	208-230/60/1	8.1	7.3	36.0	0.8	1/3	10/10	15/15
EXV/H015	265/60/1	5.5	4.8	30.0	0.7	1/3	7	15
EXV/H018	208-230/60/1	9.8	8.5	38.0	1.3	1/2	12/12	20/20
EXV/H018	265/60/1	7.9	6.8	35.0	1.1	1/2	10	15
EXV/H024	208-230/60/1	15.2	13.5	58.3	1.7	1/2	19/19	30/30
EXV/H024	265/60/1	10.5	9.0	54.0	1.5	1/2	13	20
EXV/H024	208-230/60/3	8.8	7.1	55.4	1.7	1/2	11/11	15/15
EXV/H024	460/60/3	4.4	3.5	28.0	0.9	1/2	6	15
EXV/H030	208-230/60/1	15.6	14.1	73.0	1.5	3/4	20/20	30/30
EXV/H030	265/60/1	12.5	11.2	60.0	1.3	3/4	16	25
EXV/H030	208-230/60/3	10.4	8.9	58.0	1.5	3/4	13/13	20/20
EXV/H030	460/60/3	5.0	4.2	28.0	0.8	3/4	7	15
EXV/H036	208-230/60/1	18.0	16.0	77.0	2.0	3/4	23/23	35/35
EXV/H036	265/60/1	13.9	12.2	72.0	1.7	3/4	17	25
EXV/H036	208-230/60/3	12.0	10.0	71.0	2.0	3/4	15/15	20/20
EXV/H036	460/60/3	5.7	4.7	38.0	1.0	1	7	15
EXV/H042	208-230/60/1	19.9	16.7	79.0	3.2	3/4	25/25	40/40
EXV/H042	208-230/60/3	13.6	10.4	73.0	3.2	3/4	17/17	25/25
EXV/H042	460/60/3	7.4	5.8	38.0	1.6	1	9	15
EXV/H048	208-230/60/1	20.5	17.9	112.0	2.6	1	25/25	40/40
EXV/H048	208-230/60/3	16.1	13.5	88.0	2.6	1	20/20	30/30
EXV/H048	460/60/3	7.3	6.0	44.0	1.3	1	9	15
EXV/H060	208-230/60/1	25.2	21.4	135.0	3.8	1	31/31	50/50
EXV/H060	208-230/60/3	18.3	14.5	98.0	3.8	1	22/22	35/35
EXV/H060	460/60/3	8.2	6.3	55.0	1.9	1	10	15
EXV/H070	208-230/60/1	31.4	26.4	134.0	5.0	1	39/39	60/60
EXV/H070	208-230/60/3	21.0	16.0	110.0	5.0	1	26/26	40/40
EXV/H070	460/60/3	10.3	7.8	52.0	2.5	1	13	20

**Table 32. Electrical data - 2 to 6 tons, DX\*024-070**

Model No.	Unit Volts	Total Unit FLA	Comp RLA	Comp LRA	Blower Motor FLA	Blower Motor HP	Minimum Circuit Ampacity	Maximum Overcurrent Protective Device
DXV/H024	208-230/60/1	13.3	11.7	58.3	1.6	1/2	17/17	25/25
DXV/H024	265/60/1	10.5	9.1	54.0	1.4	1/2	13	20
DXV/H024	208-230/60/3	8.1	6.5	55.4	1.6	1/2	10/10	15/15
DXV/H024	460/60/3	4.3	3.5	28.0	0.8	1/2	6	15
DXV/H036	208-230/60/1	15.1	13.1	73.0	2.0	3/4	19/19	30/30
DXV/H036	265/60/1	11.9	10.2	60.0	1.7	3/4	15	20
DXV/H036	208-230/60/3	10.7	8.7	58.0	2.0	3/4	13/13	20/20
DXV/H036	460/60/3	5.3	4.3	28.0	1.0	1	7	15
DXV/H048	208-230/60/1	20.4	17.9	96.0	2.5	1	25/25	40/40
DXV/H048	208-230/60/3	16.7	14.2	88.0	2.5	1	21/21	30/30
DXV/H048	460/60/3	7.5	6.2	44.0	1.3	1	10	15
DXV/H060	208-230/60/1	25.0	21.2	104.0	3.8	1	31/31	50/50
DXV/H060	208-230/60/3	17.8	14.0	83.1	3.8	1	22/22	35/35
DXV/H060	460/60/3	8.3	6.4	41.0	1.9	1	10	15
DXV/H070	208-230/60/1	31.9	26.9	139.9	5.0	1	39/39	60/60
DXV/H070	208-230/60/3	21.5	16.5	110.0	5.0	1	26/26	40/40
DXV/H070	460/60/3	9.7	7.2	52.0	2.5	1	12	15

**Table 33. EXV/H and DXV/H electric duct heater data (0.75 to 6 tons)**

MODEL	EH Size	Volts	kW	Amps
EXV/H009	Medium	208-230/60/1	2.0/2.5	9.8/10.9
EXV/H009	Medium	265/60/1	2.3	8.6
EXV/H012	Medium	208-230/60/1	2.0/2.5	9.8/10.9
EXV/H012	Medium	265/60/1	2.3	8.6
EXV/H015	Medium	208-230/60/1	2.0/2.5	9.8/10.9
EXV/H015	Medium	265/60/1	2.3	8.6
EXV/H018	Medium	208-230/60/1	3.3/4.0	15.7/17.4
EXV/H018	Medium	265/60/1	3.7	13.8
EXV/H024	Medium	208-230/60/1	3.3/4.0	15.7/17.4
EXV/H024	Medium	265/60/1	3.7	13.8
EXV/H024	Medium	208-230/60/3	3.3/4.0	9.1/10.1
EXV/H024	Medium	460/60/3	3.7	4.6
EXV/H030	Medium	208-230/60/1	4.1/5.0	19.7/21.7
EXV/H030	Medium	265/60/1	4.6	17.3
EXV/H030	Medium	208-230/60/3	4.1/5.0	11.4/12.6
EXV/H030	Medium	460/60/3	4.6	5.8
EXV/H036	Low	208-230/60/1	4.9/6.0	23.6/26.1
EXV/H036	Medium	208-230/60/1	8.2/10.0	39.3/43.5
EXV/H036	High	208-230/60/1	12.3/15.0	59.0/65.2
EXV/H036	Low	265/60/1	5.5	20.7



## Electrical Data

**Table 33. EXV/H and DXV/H electric duct heater data (0.75 to 6 tons) (continued)**

MODEL	EH Size	Volts	kW	Amps
EXV/H036	Medium	265/60/1	9.2	34.5
EXV/H036	High	265/60/1	13.7	51.8
EXV/H036	Low	208-230/60/3	4.9/6.0	13.6/15.1
EXV/H036	Medium	208-230/60/3	8.2/10.0	22.7/25.1
EXV/H036	High	208-230/60/3	12.3/15.0	34.1/37.7
EXV/H036	Low	460/60/3	5.5	6.9
EXV/H036	Medium	460/60/3	9.2	11.5
EXV/H036	High	460/60/3	13.8	17.3
EXV/H042	Low	208-230/60/1	4.9/6.0	23.6/26.1
EXV/H042	Medium	208-230/60/1	8.2/10.0	39.3/43.5
EXV/H042	High	208-230/60/1	12.3/15.0	59.0/65.2
EXV/H042	Low	208-230/60/3	4.9/6.0	13.6/15.1
EXV/H042	Medium	208-230/60/3	8.2/10.0	22.7/25.1
EXV/H042	High	208-230/60/3	12.3/15.0	34.1/37.7
EXV/H042	Low	460/60/3	5.5	6.9
EXV/H042	Medium	460/60/3	9.2	11.5
EXV/H042	High	460/60/3	13.8	17.3
EXV/H048	Low	208-230/60/1	4.9/6.0	23.6/26.1
EXV/H048	Medium	208-230/60/1	8.2/10.0	39.3/43.5
EXV/H048	High	208-230/60/1	12.3/15.0	59.0/65.2
EXV/H048	Low	208-230/60/3	4.9/6.0	13.6/15.1
EXV/H048	Medium	208-230/60/3	8.2/10.0	22.7/25.1
EXV/H048	High	208-230/60/3	12.3/15.0	34.1/37.7
EXV/H048	Low	460/60/3	5.5	6.9
EXV/H048	Medium	460/60/3	9.2	11.5
EXV/H048	High	460/60/3	13.8	17.3
EXV/H060	Low	208-230/60/1	4.9/6.0	23.6/26.1
EXV/H060	Medium	208-230/60/1	8.2/10.0	39.3/43.5
EXV/H060	High	208-230/60/1	12.3/15.0	59.0/65.2
EXV/H060	Low	208-230/60/3	4.9/6.0	13.6/15.1
EXV/H060	Medium	208-230/60/3	8.2/10.0	22.7/25.1
EXV/H060	High	208-230/60/3	12.3/15.0	34.1/37.7
EXV/H060	Low	460/60/3	5.5	6.9
EXV/H060	Medium	460/60/3	9.2	11.5
EXV/H060	High	460/60/3	13.8	17.3
EXV/H070	Low	208-230/60/1	4.9/6.0	23.6/26.1
EXV/H070	Medium	208-230/60/1	8.2/10.0	39.3/43.5
EXV/H070	High	208-230/60/1	12.3/15.0	59.0/65.2
EXV/H070	Low	208-230/60/3	4.9/6.0	13.6/15.1
EXV/H070	Medium	208-230/60/3	8.2/10.0	22.7/25.1
EXV/H070	High	208-230/60/3	12.3/15.0	34.1/37.7



**Table 33. EXV/H and DXV/H electric duct heater data (0.75 to 6 tons) (continued)**

MODEL	EH Size	Volts	kW	Amps
EXV/H070	Low	460/60/3	5.5	6.9
EXV/H070	Medium	460/60/3	9.2	11.5
EXV/H070	High	460/60/3	13.8	17.3
DXV/H024	Medium	208-230/60/1	3.3/4.0	15.7/17.4
DXV/H024	Medium	265/60/1	3.7	13.8
DXV/H024	Medium	208-230/60/3	3.3/4.0	9.1/10.1
DXV/H024	Medium	460/60/3	3.7	4.6
DXV/H036	Low	208-230/60/1	4.9/6.0	23.6/26.1
DXV/H036	Medium	208-230/60/1	8.2/10.0	39.3/43.5
DXV/H036	High	208-230/60/1	12.3/15.0	59.0/65.2
DXV/H036	Low	265/60/1	5.5	20.7
DXV/H036	Medium	265/60/1	9.2	34.5
DXV/H036	High	265/60/1	13.7	51.8
DXV/H036	Low	208-230/60/3	4.9/6.0	13.6/15.1
DXV/H036	Medium	208-230/60/3	8.2/10.0	22.7/25.1
DXV/H036	High	208-230/60/3	12.3/15.0	34.1/37.7
DXV/H036	Low	460/60/3	5.5	6.9
DXV/H036	Medium	460/60/3	9.2	11.5
DXV/H036	High	460/60/3	13.8	17.3
DXV/H048	Low	208-230/60/1	4.9/6.0	23.6/26.1
DXV/H048	Medium	208-230/60/1	8.2/10.0	39.3/43.5
DXV/H048	High	208-230/60/1	12.3/15.0	59.0/65.2
DXV/H048	Low	208-230/60/3	4.9/6.0	13.6/15.1
DXV/H048	Medium	208-230/60/3	8.2/10.0	22.7/25.1
DXV/H048	High	208-230/60/3	12.3/15.0	34.1/37.7
DXV/H048	Low	460/60/3	5.5	6.9
DXV/H048	Medium	460/60/3	9.2	11.5
DXV/H048	High	460/60/3	13.8	17.3
DXV/H060	Low	208-230/60/1	4.9/6.0	23.6/26.1
DXV/H060	Medium	208-230/60/1	8.2/10.0	39.3/43.5
DXV/H060	High	208-230/60/1	12.3/15.0	59.0/65.2
DXV/H060	Low	208-230/60/3	4.9/6.0	13.6/15.1
DXV/H060	Medium	208-230/60/3	8.2/10.0	22.7/25.1
DXV/H060	High	208-230/60/3	12.3/15.0	34.1/37.7
DXV/H060	Low	460/60/3	5.5	6.9
DXV/H060	Medium	460/60/3	9.2	11.5
DXV/H060	High	460/60/3	13.8	17.3
DXV/H070	Low	208-230/60/1	4.9/6.0	23.6/26.1
DXV/H070	Medium	208-230/60/1	8.2/10.0	39.3/43.5
DXV/H070	High	208-230/60/1	12.3/15.0	59.0/65.2
DXV/H070	Low	208-230/60/3	4.9/6.0	13.6/15.1



## Electrical Data

**Table 33. EXV/H and DXV/H electric duct heater data (0.75 to 6 tons) (continued)**

MODEL	EH Size	Volts	kW	Amps
DXV/H070	Medium	208-230/60/3	8.2/10.0	22.7/25.1
DXV/H070	High	208-230/60/3	12.3/15.0	34.1/37.7
DXV/H070	Low	460/60/3	5.5	6.9
DXV/H070	Medium	460/60/3	9.2	11.5
DXV/H070	High	460/60/3	13.8	17.3

**Note:** Electric heat performance table with heat rise data can be found in Installation Instructions (WSHP-SVN011\*-EN).

**Table 34. Electrical data - minimum and maximum**

Digit 8	Rated Voltage	Hz	Ph	Minimum Utilization Voltage	Maximum Utilization Voltage
4	460	60	3	414	506
7	265	60	1	239	292
A	208-230	60	1	197	253
B	208-230	60	3	187	253



## Pre-Start Checklist

Before energizing the unit, the following system devices must be checked:

- Is the high voltage power supply correct and in accordance with the nameplate ratings?
- Is phasing of the unit correct per compressor rotation (scroll compressor only)?
- Is the field wiring and circuit protection the correct size?
- Is the low voltage control circuit wiring correct per the unit wiring diagram?
- Is the piping system clean/complete and correct? (A recommendation of all system flushing of debris from the water-to-refrigerant heat exchanger, along with air purging from the water-to-refrigerant heat exchanger be done in accordance with the Closed-Loop/Ground Source Heat Pump Systems Installation Guide).
- Is vibration isolation provided? (i.e. unit isolation pad, hose kits)
- Is unit serviceable? (See clearance specifications in Unit Dimensions and Weights).
- Are the low/high-side pressure temperature caps secure and in place?
- Are all the unit access panels secure and in place?
- Is the thermostat in the OFF position?
- Is the water flow established and circulating through all the units?
- Is the duct work correctly sized, run, taped, insulated and weather proofed with proper unit arrangement?
- Is the condensate line properly sized, run, trapped, pitched and primed?
- Is the zone sensor correctly wired and in a good location?
- Does the indoor blower turn freely without rubbing?
- Has all work been done in accordance with applicable local and national codes?
- Has heat transfer fluid been added in the proper mix to prevent freezing in closed system application?



# Start-Up

## Initial Unit Start-Up

**Note:** Start-up with the heat pump thermostat is included below:

1. Set the thermostat to the highest position.
2. Set the thermostat system switch to COOL with the fan control to AUTO. The compressor should NOT run.
3. Reduce the thermostat setting until the compressor, reversing valve, solenoid valve, and loop pump are energized. Adjust water flow utilizing pressure/temperature plugs and comparing to tables contained in specification sheet data.
4. Water leaving the heat exchanger should be warmer than the entering water temperature (approximately 9-12°F); blower operation should be smooth; compressor and blower amps should be within data plate ratings; the suction line should be cool with no frost observed in the refrigerant circuit.
5. Check the cooling refrigerant pressures against values in "Operating Pressures," p. 52.
6. Turn the thermostat system switch to the OFF position. Unit should stop running and the reversing valve should de-energize.
7. Leave unit off for approximately FIVE minutes to allow for pressure equalization.
8. Turn the thermostat to the lowest setting.
9. Set the thermostat system switch to the HEAT position.
10. Adjust the temperature setting upward until the unit is energized. Warm air should blow from the register. A water temperature decrease of approximately 5-9°F leaving the heat exchanger should be noted. The blower and compressor operation should be smooth with no frost observed in the refrigeration circuit.
11. Check the heating refrigerant pressures against values in "Operating Pressures," p. 52.
12. Set the thermostat to maintain the desired space temperature.
13. Instruct the owner on system operation.

**Table 35. Checklist**

MODE	Heat	Cool
Entering fluid temperature	_____F	_____F
Leaving fluid temperature	_____F	_____F
Temperature differential	_____F	_____F
Return-air temperature DB/WB	_____F	_____F

**Table 35. Checklist (continued)**

MODE	Heat	Cool
Supply-air temperature DB/WB	_____F	_____F
Temperature differential	_____F	_____F
Water coil heat exchanger (Water Pressure IN)	_____PSIG	_____PSIG
Water coil heat exchanger (Water Pressure OUT)	_____PSIG	_____PSIG
Pressure Differential	_____PSIG	_____PSIG
COMPRESSOR		
Amps		
Volts		
Discharge line temperature (after 10 minutes)	_____F	_____F

## Start-Up Checklist and Log

Installing Contractor: Use this checklist to thoroughly check-out the system and units before and during start-up. (This form need not be returned to the factory unless requested during technical service support).

Job Name:	
Model Number:	
Date:	
Serial Number:	

To minimize troubleshooting and costly system failures, complete the following checks and data entries before the system is put into full operation.

## Operating Pressures

There are many variables (airflow, air temperatures) in an air conditioning system that will affect operating refrigerant pressures and temperatures. The charts below shows approximate conditions and is based on air flow at the rated SCFM, entering air at 80.6°F (DB), 66.2°F (WB) in cooling, 68°F (DB) in heating. (+)Heating data with 35°F EWT is based on the use of an anti-freeze solution having a freezing point 20°F lower than the minimum expected entering temperature.

**Table 36. Operating pressures in cooling/heating for DX\* units**

Model	Entering Water Temp Entering Water Temp (°F)	Water Flow (GPM)	Operating Data							
			Cooling				Heating			
			Suction Pressure (psig)	Discharge Pressure (pgig)	Water Temp Rise (°F)	Air Temp Drop (°F DB)	Suction Pressure (psig)	Discharge Pressure (psig)	Water Temp Drop (°F)	Air Temp Rise (°F DB)
DXV/H024	32	4.80	—	—	—	—	89-103	285-362	5-7	18-28
DXV/H024	32	6.00	—	—	—	—	91-105	288-366	4-5	19-28
DXV/H024	45	4.80	132-152	173-220	11-14	24-30	109-126	301-383	7-8	23-33
DXV/H024	45	6.00	132-151	166-212	9-12	24-30	112-129	304-387	5-7	24-33
DXV/H024	55	4.80	132-152	200-254	11-14	24-29	125-144	318-404	8-10	27-37
DXV/H024	55	6.00	132-152	193-246	9-11	24-29	129-148	321-408	6-8	28-38
DXV/H024	68	4.80	136-156	239-305	11-14	23-29	149-172	342-436	9-12	32-42
DXV/H024	68	6.00	136-156	232-296	9-11	23-29	154-177	345-439	7-10	33-43
DXV/H024	75	4.80	139-159	263-335	11-14	23-28	164-188	354-451	10-13	34-45
DXV/H024	75	6.00	138-159	256-326	9-11	23-29	169-195	357-455	8-10	35-46
DXV/H024	86	4.80	143-164	303-386	11-14	22-28	190-218	373-475	11-14	38-49
DXV/H024	86	6.00	143-164	296-376	9-11	23-28	197-226	376-478	9-11	39-50
DXV/H024	95	4.80	145-167	339-432	11-14	22-28	—	—	—	—
DXV/H024	95	6.00	145-167	331-422	9-11	22-28	—	—	—	—
DXV/H036	32	7.20	—	—	—	—	90-104	262-333	5-6	16-24
DXV/H036	32	9.00	—	—	—	—	92-105	263-335	4-5	16-25
DXV/H036	45	7.20	138-159	177-225	11-14	24-29	109-125	278-354	6-7	19-28
DXV/H036	45	9.00	138-159	170-217	9-11	24-29	111-128	280-357	5-6	20-29
DXV/H036	55	7.20	140-161	204-260	11-14	23-29	125-143	293-373	7-9	22-32
DXV/H036	55	9.00	140-161	198-251	9-11	23-29	128-147	295-376	5-7	23-32
DXV/H036	68	7.20	143-164	243-310	10-13	22-28	148-170	314-399	8-10	27-37
DXV/H036	68	9.00	143-164	237-301	8-11	23-28	152-175	317-403	7-8	27-37
DXV/H036	75	7.20	145-166	265-338	10-13	22-28	163-187	326-415	9-11	29-39
DXV/H036	75	9.00	145-166	259-330	8-10	22-28	168-193	329-419	7-9	30-40
DXV/H036	86	7.20	147-170	304-387	10-13	22-27	190-218	346-440	10-12	33-44
DXV/H036	86	9.00	147-169	298-379	8-10	22-27	196-225	350-446	8-10	34-45
DXV/H036	95	7.20	149-172	341-433	10-13	21-27	—	—	—	—
DXV/H036	95	9.00	149-172	334-425	8-10	21-27	—	—	—	—
DXV/H048	32	9.60	—	—	—	—	87-100	260-331	5-6	16-25
DXV/H048	32	12.00	—	—	—	—	89-102	262-333	4-5	16-25
DXV/H048	45	9.60	135-155	179-227	11-14	24-29	105-121	278-353	6-8	20-29
DXV/H048	45	12.00	135-155	172-219	9-11	24-29	108-124	280-356	5-6	20-30
DXV/H048	55	9.60	137-157	206-262	11-14	23-28	121-139	292-372	7-9	23-33
DXV/H048	55	12.00	137-157	200-254	9-11	23-29	124-142	294-375	6-7	24-34
DXV/H048	68	9.60	141-162	246-313	10-13	22-28	143-165	312-398	8-11	28-38
DXV/H048	68	12.00	140-162	239-305	8-11	22-28	147-169	316-402	7-9	29-39
DXV/H048	75	9.60	142-164	268-341	10-13	22-27	157-181	324-412	9-12	30-41
DXV/H048	75	12.00	142-164	261-333	8-10	22-28	162-186	328-417	7-9	31-42



**Start-Up**

**Table 36. Operating pressures in cooling/heating for DX\* units (continued)**

Model	Operating Data									
	Entering Water Temp Entering Water Temp (°F)	Water Flow (GPM)	Cooling				Heating			
			Suction Pressure (psig)	Discharge Pressure (pgig)	Water Temp Rise (°F)	Air Temp Drop (°F DB)	Suction Pressure (psig)	Discharge Pressure (psig)	Water Temp Drop (°F)	Air Temp Rise (°F DB)
DXV/H048	86	9.60	145-167	307-391	10-13	21-27	183-211	343-437	10-13	34-45
DXV/H048	86	12.00	145-166	301-383	8-10	21-27	189-218	348-443	8-11	35-46
DXV/H048	95	9.60	146-168	343-437	10-13	21-27	—	—	—	—
DXV/H048	95	12.00	146-168	337-428	8-10	21-27	—	—	—	—
DXV/H060	32	12.00	—	—	—	—	87-101	285-363	5-6	15-24
DXV/H060	32	15.00	—	—	—	—	89-103	288-366	4-5	16-24
DXV/H060	45	12.00	136-156	180-230	10-12	22-28	106-122	299-381	6-7	19-28
DXV/H060	45	15.00	136-157	174-222	8-10	22-28	108-124	302-384	5-6	20-29
DXV/H060	55	12.00	138-159	210-267	10-12	22-27	121-139	313-398	7-9	22-32
DXV/H060	55	15.00	138-159	203-259	8-10	22-27	124-142	315-401	6-7	23-33
DXV/H060	68	12.00	141-162	251-320	9-12	21-27	143-165	333-424	8-10	27-37
DXV/H060	68	15.00	141-162	245-312	8-10	21-27	147-170	335-427	7-8	28-38
DXV/H060	75	12.00	143-164	275-350	9-12	21-27	158-181	343-436	9-11	29-40
DXV/H060	75	15.00	143-164	269-342	7-10	21-27	162-187	345-439	7-9	30-40
DXV/H060	86	12.00	146-167	316-402	9-12	20-26	184-211	361-460	10-13	33-44
DXV/H060	86	15.00	145-167	310-394	7-9	20-26	189-218	364-463	8-10	34-45
DXV/H060	95	12.00	148-170	353-450	9-12	20-26	—	—	—	—
DXV/H060	95	15.00	148-170	347-442	7-9	20-26	—	—	—	—
DXV/H070	32	14.00	—	—	—	—	89-102	277-353	4-6	16-25
DXV/H070	32	17.50	—	—	—	—	91-104	278-354	4-5	17-25
DXV/H070	45	14.00	130-150	171-218	11-14	23-28	107-123	296-376	6-7	20-30
DXV/H070	45	17.50	130-150	167-213	8-11	23-28	110-126	298-379	5-6	21-30
DXV/H070	55	14.00	132-151	199-254	10-13	22-28	122-140	312-397	6-8	23-33
DXV/H070	55	17.50	131-151	194-247	8-11	22-28	125-144	314-400	5-7	24-34
DXV/H070	68	14.00	136-156	237-302	10-13	22-28	144-165	333-424	8-10	28-38
DXV/H070	68	17.50	136-156	232-295	8-11	22-28	148-170	336-428	6-8	28-39
DXV/H070	75	14.00	139-160	260-331	10-13	22-27	157-181	345-439	8-11	30-40
DXV/H070	75	17.50	139-159	254-324	8-11	22-27	162-187	348-443	7-9	31-41
DXV/H070	86	14.00	143-164	300-382	10-13	21-27	183-211	363-462	10-12	34-45
DXV/H070	86	17.50	142-164	294-374	8-10	21-27	189-218	367-467	8-10	35-45
DXV/H070	95	14.00	145-166	336-427	10-13	21-26	—	—	—	—
DXV/H070	95	17.50	144-166	330-420	8-10	21-26	—	—	—	—

**Table 37. Operating pressures in cooling/heating for EX\* units**

Model	Entering Water Temp Entering Water Temp (°F)	Water Flow (GPM)	Operating Data							
			Cooling				Heating			
			Suction Pressure (psig)	Discharge Pressure (pgig)	Water Temp Rise (°F)	Air Temp Drop (°F DB)	Suction Pressure (psig)	Discharge Pressure (psig)	Water Temp Drop (°F)	Air Temp Rise (°F DB)
EXV/H009	32	1.80	—	—	—	—	94-108	256-326	4-5	13-21
EXV/H009	32	2.25	—	—	—	—	96-110	257-327	3-4	13-22
EXV/H009	45	1.80	137-157	170-217	10-13	23-28	115-132	274-348	5-7	19-28
EXV/H009	45	2.25	137-157	163-208	8-11	23-28	118-135	276-351	4-6	19-28
EXV/H009	55	1.80	138-158	198-252	10-13	23-28	133-152	288-366	6-8	22-31
EXV/H009	55	2.25	137-158	191-243	8-11	23-28	136-156	290-369	5-7	23-32
EXV/H009	68	1.80	143-164	238-302	10-13	22-27	158-182	308-391	7-9	25-35
EXV/H009	68	2.25	142-164	231-294	8-10	22-28	162-187	311-396	6-8	26-36
EXV/H009	75	1.80	146-168	258-328	10-13	22-27	173-199	319-406	8-10	28-38
EXV/H009	75	2.25	145-167	251-320	8-10	22-27	178-205	323-411	7-9	28-39
EXV/H009	86	1.80	150-173	296-376	10-13	21-27	200-230	338-430	9-12	31-42
EXV/H009	86	2.25	150-173	289-368	8-10	21-27	207-238	343-436	7-10	31-42
EXV/H009	95	1.80	153-176	333-424	10-12	20-26	—	—	—	—
EXV/H009	95	2.25	153-176	326-415	8-10	20-26	—	—	—	—
EXV/H012	32	2.40	—	—	—	—	91-104	265-338	5-6	17-26
EXV/H012	32	3.00	—	—	—	—	92-106	267-340	4-5	17-26
EXV/H012	45	2.40	136-156	173-220	12-15	25-30	111-128	286-364	6-8	22-31
EXV/H012	45	3.00	135-156	165-210	9-12	25-30	114-131	288-367	5-6	22-32
EXV/H012	55	2.40	137-158	201-255	11-15	24-29	128-148	302-385	7-9	26-36
EXV/H012	55	3.00	137-157	193-246	9-12	24-30	132-152	305-389	6-8	26-36
EXV/H012	68	2.40	140-161	241-306	11-14	23-29	153-176	325-414	9-11	31-41
EXV/H012	68	3.00	140-161	233-297	9-11	23-29	158-182	329-419	7-9	32-42
EXV/H012	75	2.40	142-163	263-334	11-14	23-28	168-193	338-430	10-13	34-44
EXV/H012	75	3.00	141-163	255-325	9-11	23-28	174-200	343-436	8-10	35-45
EXV/H012	86	2.40	144-166	302-384	11-13	22-27	194-223	359-457	11-14	37-48
EXV/H012	86	3.00	144-166	294-375	8-11	22-27	201-232	365-465	9-12	38-50
EXV/H012	95	2.40	146-169	340-432	10-13	21-27	—	—	—	—
EXV/H012	95	3.00	146-168	332-423	8-11	21-27	—	—	—	—
EXV/H015	32	3.00	—	—	—	—	89-103	268-341	5-6	18-27
EXV/H015	32	3.75	—	—	—	—	91-105	270-343	4-5	18-27
EXV/H015	45	3.00	131-151	176-224	12-16	24-29	109-126	287-365	6-8	22-32
EXV/H015	45	3.75	131-151	169-215	10-12	24-29	112-128	289-367	5-6	23-32
EXV/H015	55	3.00	134-154	207-263	12-15	23-29	125-144	301-383	7-9	26-36
EXV/H015	55	3.75	134-154	199-253	10-12	23-29	129-148	304-387	6-8	26-36
EXV/H015	68	3.00	138-159	247-315	12-15	23-28	149-172	321-409	9-11	31-41
EXV/H015	68	3.75	138-159	240-305	10-12	23-28	154-177	325-413	7-9	32-42
EXV/H015	75	3.00	140-161	268-341	12-15	23-28	164-189	333-424	10-12	33-44
EXV/H015	75	3.75	140-161	260-331	9-12	23-28	169-194	337-429	8-10	34-45



**Start-Up**

**Table 37. Operating pressures in cooling/heating for EX\* units (continued)**

Model	Entering Water Temp Entering Water Temp (°F)	Water Flow (GPM)	Operating Data							
			Cooling				Heating			
			Suction Pressure (psig)	Discharge Pressure (pgig)	Water Temp Rise (°F)	Air Temp Drop (°F DB)	Suction Pressure (psig)	Discharge Pressure (psig)	Water Temp Drop (°F)	Air Temp Rise (°F DB)
EXV/H015	86	3.00	143-164	306-389	12-15	22-28	190-218	354-451	11-14	38-49
EXV/H015	86	3.75	143-164	298-380	9-12	22-28	196-226	359-457	9-12	39-50
EXV/H015	95	3.00	145-166	345-439	11-14	22-27	—	—	—	—
EXV/H015	95	3.75	145-166	337-429	9-12	22-27	—	—	—	—
EXV/H018	32	3.60	—	—	—	—	92-105	274-349	5-6	17-26
EXV/H018	32	4.50	—	—	—	—	93-107	276-351	4-5	17-26
EXV/H018	45	3.60	133-153	175-223	12-15	25-31	111-128	294-374	6-8	22-32
EXV/H018	45	4.50	133-153	168-213	10-12	26-31	114-131	296-376	5-6	23-32
EXV/H018	55	3.60	134-155	203-259	12-15	25-30	127-146	311-396	7-9	26-36
EXV/H018	55	4.50	134-154	196-249	10-12	25-31	130-150	314-400	6-8	27-36
EXV/H018	68	3.60	138-159	243-310	12-15	24-30	150-173	336-428	9-11	31-41
EXV/H018	68	4.50	138-159	236-300	9-12	24-30	155-178	340-433	7-9	32-42
EXV/H018	75	3.60	141-162	266-338	12-15	24-29	165-190	350-445	10-12	34-45
EXV/H018	75	4.50	141-162	258-328	9-12	24-29	170-196	354-451	8-10	35-45
EXV/H018	86	3.60	144-166	304-388	12-15	23-29	191-220	371-472	11-14	38-49
EXV/H018	86	4.50	144-166	297-378	9-12	23-29	198-228	376-479	9-12	39-50
EXV/H018	95	3.60	146-168	340-433	11-14	22-28	—	—	—	—
EXV/H018	95	4.50	146-168	333-424	9-12	23-28	—	—	—	—
EXV/H024	32	4.80	—	—	—	—	89-102	280-356	5-6	17-26
EXV/H024	32	6.00	—	—	—	—	90-104	282-359	4-5	18-27
EXV/H024	45	4.80	133-153	176-224	12-15	23-28	109-125	302-384	7-8	23-33
EXV/H024	45	6.00	133-153	171-217	9-12	23-28	111-128	305-388	5-7	24-33
EXV/H024	55	4.80	133-153	203-258	12-15	22-28	125-144	321-408	8-10	27-37
EXV/H024	55	6.00	133-153	197-250	9-12	22-28	128-148	324-412	6-8	28-38
EXV/H024	68	4.80	136-157	243-310	11-14	22-28	149-171	346-440	9-12	32-42
EXV/H024	68	6.00	136-157	236-300	9-12	22-28	153-176	350-445	7-10	33-43
EXV/H024	75	4.80	139-159	267-340	11-14	22-27	163-188	359-457	10-13	35-46
EXV/H024	75	6.00	138-159	260-331	9-12	22-28	169-194	363-463	8-10	35-46
EXV/H024	86	4.80	142-163	308-392	11-14	21-27	189-217	379-482	11-14	39-50
EXV/H024	86	6.00	141-163	300-382	9-11	21-27	196-226	384-488	9-12	39-51
EXV/H024	95	4.80	144-165	344-438	11-14	21-27	—	—	—	—
EXV/H024	95	6.00	143-165	337-428	9-11	21-27	—	—	—	—
EXV/H030	32	6.00	—	—	—	—	90-103	260-330	5-6	18-27
EXV/H030	32	7.50	—	—	—	—	92-105	263-334	4-5	18-27
EXV/H030	45	6.00	136-157	176-224	12-15	25-30	109-125	288-367	6-8	22-32
EXV/H030	45	7.50	136-156	170-216	9-12	25-30	111-128	292-371	5-7	23-32
EXV/H030	55	6.00	136-157	204-259	12-15	25-30	124-143	310-395	8-10	26-36
EXV/H030	55	7.50	136-156	197-251	9-12	25-30	128-147	313-399	6-8	27-37



**Table 37. Operating pressures in cooling/heating for EX\* units (continued)**

Model	Entering Water Temp Entering Water Temp (°F)	Water Flow (GPM)	Operating Data							
			Cooling				Heating			
			Suction Pressure (psig)	Discharge Pressure (pgig)	Water Temp Rise (°F)	Air Temp Drop (°F DB)	Suction Pressure (psig)	Discharge Pressure (psig)	Water Temp Drop (°F)	Air Temp Rise (°F DB)
EXV/H030	68	6.00	138-159	245-312	12-15	24-29	148-170	333-423	9-12	31-41
EXV/H030	68	7.50	138-159	237-302	9-12	24-29	152-175	336-427	7-9	32-42
EXV/H030	75	6.00	140-162	269-342	12-15	24-29	162-187	343-437	10-12	34-44
EXV/H030	75	7.50	140-161	261-333	9-12	24-29	168-193	346-441	8-10	34-45
EXV/H030	86	6.00	143-165	310-395	11-14	23-29	189-217	367-467	11-14	38-49
EXV/H030	86	7.50	143-165	302-385	9-11	23-29	195-225	370-471	9-11	38-50
EXV/H030	95	6.00	145-167	347-441	11-14	23-28	—	—	—	—
EXV/H030	95	7.50	145-167	339-431	9-11	23-28	—	—	—	—
EXV/H036	32	7.20	—	—	—	—	90-104	270-344	5-6	17-26
EXV/H036	32	9.00	—	—	—	—	92-106	272-346	4-5	17-26
EXV/H036	45	7.20	137-157	177-226	11-14	24-29	109-125	290-369	6-8	21-31
EXV/H036	45	9.00	137-157	170-216	9-11	24-29	111-128	293-372	5-6	22-31
EXV/H036	55	7.20	137-158	205-261	11-14	24-29	124-142	306-390	7-9	25-34
EXV/H036	55	9.00	137-158	198-252	9-11	24-29	127-146	309-393	6-8	25-35
EXV/H036	68	7.20	140-161	246-313	11-14	23-29	146-168	328-418	9-11	29-39
EXV/H036	68	9.00	140-161	239-304	9-11	23-29	150-173	332-422	7-9	30-40
EXV/H036	75	7.20	142-163	268-342	11-14	23-28	160-184	340-433	9-12	32-42
EXV/H036	75	9.00	142-163	261-333	9-11	23-28	165-190	344-438	8-10	33-43
EXV/H036	86	7.20	145-167	308-392	11-14	22-28	186-214	360-458	10-13	36-46
EXV/H036	86	9.00	145-166	301-383	8-11	22-28	192-221	365-464	9-11	36-47
EXV/H036	95	7.20	147-169	345-439	10-13	22-27	—	—	—	—
EXV/H036	95	9.00	147-169	338-430	8-11	22-27	—	—	—	—
EXV/H042	32	8.40	—	—	—	—	89-102	256-326	4-6	15-24
EXV/H042	32	10.50	—	—	—	—	91-104	257-327	4-5	15-24
EXV/H042	45	8.40	138-158	173-220	11-13	23-29	108-124	274-348	6-7	19-29
EXV/H042	45	10.50	138-158	168-213	8-11	23-29	110-127	276-351	5-6	20-29
EXV/H042	55	8.40	138-159	201-256	10-13	23-28	123-142	289-368	7-9	23-33
EXV/H042	55	10.50	138-159	195-249	8-11	23-28	126-145	292-371	6-7	24-33
EXV/H042	68	8.40	140-161	240-306	10-13	22-28	146-169	310-395	8-11	28-38
EXV/H042	68	10.50	140-161	234-297	8-10	22-28	151-173	314-399	7-9	28-39
EXV/H042	75	8.40	142-163	263-335	10-13	22-27	161-185	322-410	9-12	30-41
EXV/H042	75	10.50	142-163	257-327	8-10	22-27	166-191	326-414	7-9	31-41
EXV/H042	86	8.40	145-166	304-386	10-13	21-27	188-216	340-433	10-13	34-45
EXV/H042	86	10.50	145-166	297-378	8-10	21-27	194-223	345-439	8-11	35-46
EXV/H042	95	8.40	146-168	340-433	10-12	21-26	—	—	—	—
EXV/H042	95	10.50	146-168	333-424	8-10	21-26	—	—	—	—
EXV/H048	32	9.60	—	—	—	—	87-100	261-332	5-6	16-25
EXV/H048	32	12.00	—	—	—	—	89-102	262-334	4-5	16-25



**Start-Up**

**Table 37. Operating pressures in cooling/heating for EX\* units (continued)**

Model	Entering Water Temp Entering Water Temp (°F)	Water Flow (GPM)	Operating Data							
			Cooling				Heating			
			Suction Pressure (psig)	Discharge Pressure (pgig)	Water Temp Rise (°F)	Air Temp Drop (°F DB)	Suction Pressure (psig)	Discharge Pressure (psig)	Water Temp Drop (°F)	Air Temp Rise (°F DB)
EXV/H048	45	9.60	137-157	181-230	11-14	23-29	105-121	279-354	6-8	20-29
EXV/H048	45	12.00	137-157	174-222	9-11	23-29	108-124	281-357	5-6	20-30
EXV/H048	55	9.60	137-158	210-267	11-14	23-28	121-139	293-373	7-9	23-33
EXV/H048	55	12.00	137-157	203-258	9-11	23-29	124-142	296-376	6-7	24-34
EXV/H048	68	9.60	140-161	250-318	10-13	22-28	144-166	313-398	8-11	28-38
EXV/H048	68	12.00	140-161	243-310	8-11	22-28	148-170	316-403	7-9	29-39
EXV/H048	75	9.60	142-163	273-347	10-13	22-28	158-182	324-413	9-12	31-41
EXV/H048	75	12.00	142-163	266-339	8-11	22-28	163-188	328-418	7-9	31-42
EXV/H048	86	9.60	145-167	313-398	10-13	21-27	185-212	343-437	10-13	35-45
EXV/H048	86	12.00	145-166	306-390	8-10	21-27	191-219	347-442	8-11	36-46
EXV/H048	95	9.60	147-169	350-446	10-13	21-26	—	—	—	—
EXV/H048	95	12.00	147-169	344-438	8-10	21-26	—	—	—	—
EXV/H060	32	12.00	—	—	—	—	87-101	260-331	5-6	16-24
EXV/H060	32	15.00	—	—	—	—	89-103	262-333	4-5	16-25
EXV/H060	45	12.00	133-153	176-224	10-13	23-28	105-121	278-354	6-8	20-29
EXV/H060	45	15.00	133-152	171-218	8-11	23-28	108-124	280-356	5-6	20-29
EXV/H060	55	12.00	134-154	205-261	10-13	23-28	120-138	292-372	7-9	23-33
EXV/H060	55	15.00	134-154	199-254	8-10	23-28	123-142	294-375	6-7	24-33
EXV/H060	68	12.00	138-159	244-311	10-13	22-28	143-164	312-397	8-11	28-38
EXV/H060	68	15.00	138-159	238-303	8-10	22-28	147-169	315-401	7-9	28-38
EXV/H060	75	12.00	140-161	268-340	10-13	22-27	157-181	323-411	9-11	30-40
EXV/H060	75	15.00	140-161	261-332	8-10	22-27	162-186	326-415	7-9	31-41
EXV/H060	86	12.00	143-165	308-392	10-13	21-27	183-211	342-435	10-13	34-45
EXV/H060	86	15.00	143-164	301-383	8-10	21-27	189-217	346-440	8-11	35-45
EXV/H060	95	12.00	145-167	344-438	10-12	21-26	—	—	—	—
EXV/H060	95	15.00	145-167	337-429	8-10	21-26	—	—	—	—
EXV/H070	32	14.00	—	—	—	—	90-104	275-350	5-6	16-25
EXV/H070	32	17.50	—	—	—	—	92-106	276-352	4-5	16-25
EXV/H070	45	14.00	132-152	172-219	10-13	22-28	108-124	296-376	6-8	20-29
EXV/H070	45	17.50	132-151	168-214	8-10	22-28	111-127	298-379	5-6	20-30
EXV/H070	55	14.00	134-154	200-255	10-13	22-28	123-141	313-398	7-9	23-32
EXV/H070	55	17.50	134-154	195-249	8-10	22-28	126-145	315-401	6-7	23-33
EXV/H070	68	14.00	138-158	239-304	10-13	22-27	144-166	335-427	8-10	27-37
EXV/H070	68	17.50	138-158	233-296	8-10	22-27	148-171	338-431	7-8	28-38
EXV/H070	75	14.00	140-161	261-333	10-12	22-27	158-182	347-442	9-11	30-40
EXV/H070	75	17.50	140-161	256-325	8-10	22-27	163-187	350-446	7-9	30-41
EXV/H070	86	14.00	143-164	301-383	10-12	21-27	184-212	365-465	10-13	33-44
EXV/H070	86	17.50	143-164	295-376	8-10	21-27	190-219	369-470	8-10	34-45

**Table 37. Operating pressures in cooling/heating for EX\* units (continued)**

Model	Entering Water Temp Entering Water Temp (°F)	Water Flow (GPM)	Operating Data							
			Cooling				Heating			
			Suction Pressure (psig)	Discharge Pressure (pgig)	Water Temp Rise (°F)	Air Temp Drop (°F DB)	Suction Pressure (psig)	Discharge Pressure (psig)	Water Temp Drop (°F)	Air Temp Rise (°F DB)
EXV/H070	95	14.00	145-167	337-429	10-12	21-26	—	—	—	—
EXV/H070	95	17.50	145-167	331-421	8-10	21-26	—	—	—	—

## Water Pressure Drop

Use the following tables to define feet of head/pressure drop. Please note the feet of pressure (ft/head) provided is at AHRI/ISO standard.

To calculate feet of head, when using gauges that read in PSIG, multiply PSI by 2.31.

**Table 38. Cooling water pressure drop (WPD) in feet of head for DX\* units**

Unit Size	EWT °F	GPM	Ft. Pressure
DXV/H024	86	6.0	3.0
DXV/H036	86	9.0	6.0
DXV/H048	86	12.0	6.4
DXV/H060	86	15.0	11.2
DXV/H070	86	17.5	9.4

**Table 39. Cooling water pressure drop (WPD) in feet of head for EX\* units**

Unit Size (60 Hz)	EWT °F	GPM	Ft. Pressure
EXV/H009	86	2.3	3.4
EXV/H012	86	3.0	5.9
EXV/H015	86	3.8	8.2
EXV/H018	86	4.5	1.9
EXV/H024	86	6.0	3.0
EXV/H030	86	7.5	4.1
EXV/H036	86	9.0	5.8
EXV/H042	86	10.5	4.9
EXV/H048	86	12.0	5.9
EXV/H060	86	15.0	10.6
EXV/H070	86	17.5	9.3

**Table 40. Heating water pressure drop (WPD) in feet of head for DX\* units**

Unit Size	EWT °F	GPM	Ft. Pressure
DXV/H024	68	6.0	3.3
DXV/H036	68	9.0	6.3
DXV/H048	68	12.0	6.6
DXV/H060	68	15.0	12.0
DXV/H070	68	17.5	10.0

**Table 41. Heating water pressure drop (WPD) in feet of head for EX\* units**

Unit Size (60 Hz)	EWT °F	GPM	Ft. Pressure
EXV/H009	68	2.3	3.7
EXV/H012	68	3.0	6.4
EXV/H015	68	3.8	8.8
EXV/H018	68	4.5	2.0
EXV/H024	68	6.0	3.2
EXV/H030	68	7.5	4.5
EXV/H036	68	9.0	6.1
EXV/H042	68	10.5	5.1
EXV/H048	68	12.0	6.2
EXV/H060	68	15.0	11.4
EXV/H070	68	17.5	9.9



## Start-Up

# Water Volume

The information below is provided for use in calculating glycol requirements for the unit.

**Table 42. Water volume for DX\* units**

Unit Size	Water Side Volume (in <sup>3</sup> )	Water Side Volume (ft <sup>3</sup> )	Water Side Volume (gallons)
DXV/H024	118.6	0.069	0.513
DXV/H036	118.6	0.069	0.513
DXV/H048	196.5	0.114	0.851
DXV/H060	222.6	0.129	0.964
DXV/H070	284.0	0.164	1.229

**Table 43. Water volume for EX\* units**

Unit Size (60 Hz)	Water Side Volume (in <sup>3</sup> )	Water Side Volume (ft <sup>3</sup> )	Water Side Volume (gallons)
EXV/H009	34.6	0.02	0.15
EXV/H012	34.6	0.02	0.15
EXV/H015	41.0	0.024	0.177
EXV/H018	118.6	0.069	0.513
EXV/H024	118.6	0.069	0.513
EXV/H030	118.6	0.069	0.513

**Table 43. Water volume for EX\* units (continued)**

Unit Size (60 Hz)	Water Side Volume (in <sup>3</sup> )	Water Side Volume (ft <sup>3</sup> )	Water Side Volume (gallons)
EXV/H036	118.6	0.069	0.513
EXV/H042	196.5	0.114	0.851
EXV/H048	196.5	0.114	0.851
EXV/H060	222.6	0.129	0.964
EXV/H070	284.0	0.164	1.229



# Maintenance

## ⚠ WARNING

### Hazardous Service Procedures!

Failure to follow all precautions in this manual and on the tags, stickers, and labels could result in death or serious injury.

Technicians, in order to protect themselves from potential electrical, mechanical, and chemical hazards, **MUST** follow precautions in this manual and on the tags, stickers, and labels, as well as the following instructions: Unless specified otherwise, disconnect all electrical power including remote disconnect and discharge all energy storing devices such as capacitors before servicing. Follow proper lockout/tagout procedures to ensure the power can not be inadvertently energized. When necessary to work with live electrical components, have a qualified licensed electrician or other individual who has been trained in handling live electrical components perform these tasks.

## Preventative Maintenance

Maintenance on the unit is simplified with the following preventive suggestions:

Filter maintenance must be performed to assure proper operation of the equipment. Filters should be inspected at least every three months, and replaced when it is evident they are dirty. Filter sizing is shown below.

**Table 44. Filter sizing DX\* models**

Size	Filter Size (Nominal) inches
DXHG	
024	18 x 23
036	20 x 30
048	20 x 20 (Qty = 2)
060	20 x 20 and 30 x 20
070	20 x 20 and 30 x 20
DXVG	
024	18 x 23
036	20 x 30
048	27 x 30
060	30 x 33
070	30 x 33

**Table 45. Filter sizing EX\* models**

Size	Filter Size (Nominal) inches
EXHG	
009	16 x 19
012	16 x 19
015	17 x 20
018	18 x 23
024	18 x 23
030	20 x 30
036	20 x 30
042	20 x 20 (Qty = 2)
048	20 x 20 (Qty = 2)
060	20 x 20 and 30 x 20
070	20 x 20 and 30 x 20
EXVG	
009	16x19
012	16x19
015	17x20
018	18x23
024	18x23
030	20x30
036	20x30
042	27x30
048	27x30
060	33x30
070	30x33

Check the contactors and relays within the control panel at least once a year. It is good practice to check the tightness of the various wiring connections within the control panel.

A strainer (60 mesh or greater) must be used on an open loop system to keep debris from entering the unit heat exchanger and to ensure a clean system.

For units on well water, it is important to check the cleanliness of the water-to-refrigerant heat exchanger. Should it become contaminated with dirt and scaling as a result of bad water, the heat exchanger will have to be back flushed and cleaned with a chemical that will remove the scale. This service should be performed by an experienced service person.

### ⚠ WARNING

#### Hazardous Chemicals!

Failure to follow this safety precaution could result in death or serious injury. Coil cleaning agents can be either acidic or highly alkaline and can burn severely if contact with skin or eyes occurs.

Handle chemical carefully and avoid contact with skin. **ALWAYS** wear Personal Protective Equipment (PPE) including goggles or face shield, chemical resistant gloves, boots, apron or suit as required. For personal safety refer to the cleaning agent manufacturer's Materials Safety Data Sheet and follow all recommended safe handling practices.

It should be noted that the water quality should be checked periodically (See below).

**Table 46. Water quality**

Scaling	Amount
Calcium and magnesium (total hardness)	Less than 350 ppm
Corrosion	
pH	7-9.5
Hydrogen Sulfide	Less than 1 ppm

**Table 46. Water quality (continued)**

Scaling	Amount
Sulfates	Less than 25 ppm
Chlorides	Less than 125 ppm
Carbon Dioxide	Less than 75 ppm
Total dissolved solids (TDS)	Less than 1000 ppm
Biological Growth	
Iron Bacteria	Low
Erosion	
Suspended Solids	Low

## Condensate Trap

For units incorporating a negative trap design, ensure that the condensate system is primed with water at all times. Allowing a negative, pressure condensate system to run dry could cause a break in the condensate seal allowing the fan to draw water from the condensate line to spray moisture into the mechanical system. By maintaining a primed condensate trap, a seal will be created and will help prevent these complications.



# Troubleshooting

## ⚠ WARNING

### Hazardous Service Procedures!

Failure to follow all precautions in this manual and on the tags, stickers, and labels could result in death or serious injury.

Technicians, in order to protect themselves from potential electrical, mechanical, and chemical hazards, **MUST** follow precautions in this manual and on the tags, stickers, and labels, as well as the following instructions: Unless specified otherwise, disconnect all electrical power including remote disconnect and discharge all energy storing devices such as capacitors before servicing. Follow proper lockout/tagout procedures to ensure the power can not be inadvertently energized. When necessary to work with live electrical components, have a qualified licensed electrician or other individual who has been trained in handling live electrical components perform these tasks.

## Deluxe Controls

Troubleshooting units which contain the deluxe control option may be made easy by using the three LEDs (light emitting diodes). These LEDs are provided for indicating the operating mode of the controller. The LEDs are intended to aid in troubleshooting. The LEDs are labeled on the circuit board with numbers as referenced in the table below.

Table 47. Diagnostic LEDs

Color: Green	Color: Red		Controller Mode
LED1	LED2	LED3	
OFF	OFF	OFF	Control OFF
ON	OFF	OFF	Normal/Compressor OFF
ON	OFF	FLASH	Anti-short cycle
ON	OFF	ON	Normal/Compressor ON
FLASH	ON	OFF	Brownout Condition
ON	FLASH	ON	Soft Lockout (low pressure)
ON	FLASH	FLASH	Soft Lockout (high pressure)
ON	ON	ON	Manual Lockout (low pressure)
ON	ON	FLASH	Manual Lockout (high pressure)
ON	FLASH	OFF	Manual Lockout (condensate overflow)
ON	ON	OFF	Compressor Disable

Table 48. Troubleshooting table

Problem	Heat- ing	Cool- ing	Cause	Correction
No response to any thermostat setting				
	X	X	Main power off	Check fuses
	X	X	Defective control transformer	Replace
	X	X	Broken or loose connection	Repair
	X	X	Defective thermostat	Replace
	X	X	Transformer	Reset Transformer
Unit short cycles	X	X	Thermostat or sensor improperly located	Relocate



## Troubleshooting

**Table 48. Troubleshooting table (continued)**

Problem	Heat- ing	Cool- ing	Cause	Correction
Blower runs, but compressor does not	X	X	Defective compressor overload	Replace (if external)
	X	X	Defective compressor contactor	Replace
	X	X	Supply Voltage too low	Correct
	X	X	Defective compressor capacitor	Replace
	X	X	Defective windings	Replace
	X	X	Limit switches open	Check cause/Replace or repair
Insufficient capacity	X	X	Dirty filter	Replace/clean
	X	X	Blower RPM too low	Correct
	X	X	Loss of conditioned air due to leaks in ductwork	Repair leaks
		X	Introduction of excessively hot return-air	Correct
	X		Introduction of excessively cold return-air	Correct
	X	X	Low on refrigerant charge	Locate leak, repair and recharge by weight (not by superheat)
	X	X	Restricted thermal expansion valve	Replace
	X	X	Defective reversing valve	See WSHP-IOM-# for touch test chart
	X	X	Thermostat improperly located	Relocate
	X	X	Unit undersized	Recalculate heat gains/losses
	X	X	Inadequate water flow	Increase GPM
	X	X	Scaling in heat exchanger	Clean or replace
		X	Water too hot	Decrease temperature
	X		Water too cold	Increase temperature
X	X	Filter drier blocked	Replace	
X	X	Defective reversing valve	Check or replace	
High pressure switch open		X	Inadequate GPM	Increase water flow to unit
		X	Water too hot	Decrease temperature
	X		Inadequate air flow	Check, clean blower and coil
	X		Dirty filter	Clean/replace
	X	X	Overcharged with refrigerant	Decrease charge
	X	X	Defective pressure switch	Check or replace
High head pressure		X	Trash in heat exchanger	Backflush
		X	Low water flow	Increase GPM
	X	X	Overcharge of refrigerant	Decrease charge
	X	X	Non-condensable in system	Evacuate and recharge by weight
	X	X	Water too hot	Decrease temperature
	X		Dirty filter	Clean / replace
	X		Inadequate air flow	Check, clean blower and coil



**Table 48. Troubleshooting table (continued)**

Problem	Heat- ing	Cool- ing	Cause	Correction
Low suction pressure	X	X	Undercharged	Locate leak, repair and recharge
	X	X	Restricted thermal expansion valve	Repair / replace
		X	Inadequate air flow	Check, clean blower and coil
		X	Dirty filter	Clean/replace
	X		Inadequate GPM	Increase GPM
Low pressure switch open	X		Inadequate GPM	Increase GPM
	X		Water too cold	Increase temperature
		X	Inadequate air flow	Increase CFM
		X	Dirty filter	Clean/replace
	X	X	Undercharged with refrigerant	Increase charge
	X	X	Defective pressure switch	Replace
	X	X	Heat transfer fluid too cold	Raise water temperature



# Wiring Diagrams

This section contains wiring diagrams and isolation valve wiring connections.

**Table 49. Isolation valve wiring connections**

Control Type	3-Wire Isolation Valve Connections		
	Common	Close	Open
Deluxe 24V	93B	92B	91B

**Note:** For field installed valves, wires 91B, 92B and 93B are coiled behind control box. For field-provided two wire valves connect to wires 91B and 93B.

**Note:** Wiring diagrams can be accessed via e-Library by entering the diagram number in the literature order number search field or by calling technical support.

**Table 50. Wiring diagram matrix for GEV/H, EXV/H, and DXV/H models**

Number	Unit Description	Model
23115845	DELUXE CONTROLS 2 STAGE HEAT PUMP w/ECM MOTOR, SINGLE PHASE	DX only
23115846	DELUXE CONTROLS HEAT PUMP w/HOT GAS REHEAT AND ECM MOTOR, SINGLE PHASE	EX/GE
23115847	DELUXE CONTROLS HEAT PUMP w/WATER SIDE ECONOMIZER AND ECM MOTOR, SINGLE PHASE	EX/GE
23115848	DELUXE CONTROLS HEAT PUMP w/ECM MOTOR, SINGLE PHASE	EX/GE
23115849	DELUXE CONTROLS 2 STAGE HEAT PUMP w/ECM MOTOR, THREE PHASE	DX only
23115850	DELUXE CONTROLS HEAT PUMP w/HOT GAS REHEAT AND ECM MOTOR, THREE PHASE	EX/GE
23115851	DELUXE CONTROLS HEAT PUMP w/WATER SIDE ECONOMIZER AND ECM MOTOR, THREE PHASE	EX/GE
23115852	DELUXE CONTROLS HEAT PUMP w/ECM MOTOR, THREE PHASE	EX/GE
23115861	SYMBIO™ 400-B/UC400-B CONTROLS w/ECM MOTOR, SINGLE PHASE	EX/DX/GE
23115862	SYMBIO 400-B/UC400-B CONTROLS w/ECM MOTOR, THREE PHASE	EX/DX/GE
23116088	DELUXE CONTROLS 2 STAGE HEAT PUMP w/HOT GAS REHEAT, SINGLE PHASE	DXV/H
23116089	DELUXE CONTROLS 2 STAGE HEAT PUMP w/HOT GAS REHEAT, THREE PHASE	DXV/H
23116151	DELUXE CONTROLS HEAT PUMP w/BOILERLESS ELECTRIC HEAT, SINGLE PHASE	EX/GE
23116152	DELUXE CONTROLS HEAT PUMP w/BOILERLESS ELECTRIC HEAT, THREE PHASE	EX/GE
23116153	400-B CONTROLS HEAT PUMP w/BOILERLESS ELECTRIC HEAT CONTROL, SINGLE PHASE	EX/DX/GE
23116154	400-B CONTROLS HEAT PUMP w/BOILERLESS ELECTRIC HEAT CONTROL, THREE PHASE	EX/DX/GE
23116156	400-B CONTROLS HEAT PUMP AND HOT GAS REHEAT w/BOILERLESS ELEC HEAT CONTROL, SINGLE PHASE	EX/DX/GE
23116157	400-B CONTROLS HEAT PUMP AND HOT GAS REHEAT w/BOILERLESS ELEC HEAT CONTROL, THREE PHASE	EX/DX/GE



## Warranty Information

### Standard Warranty

The standard water-source heat pump warranty is Trane's parts-only warranty, running 12 months from startup, not to exceed 18-months from shipment.

There is a standard 5-year compressor warranty.

### Extended Warranty

The optional extended warranty is a second through fifth year warranty. The time starts at the end of the standard 1 year coverage through the fifth year.

These extended warranties apply only to new equipment installed in domestic Trane Commercial Systems Group sales territories and must be ordered prior to start-up.

Trane - by Trane Technologies (NYSE: TT), a global innovator - creates comfortable, energy efficient indoor environments for commercial and residential applications. For more information, please visit [trane.com](http://trane.com) or [tranetechnologies.com](http://tranetechnologies.com).

Trane has a policy of continuous product and product data improvements and reserves the right to change design and specifications without notice. We are committed to using environmentally conscious print practices.

WSHP-SVX014J-EN 13 May 2023  
Supersedes WSHP-SVX014H-EN (June 2022)

©2023 Trane