

FCC Radio Test Report

FCC ID: OL3AT10DONGLE

Report No. : BTL-FCCP-1-2301G001
Equipment : Dongle
Model Name : AT10DONGLE
Brand Name : Alcatel-Lucent Enterprise
Applicant : ALE International
Address : 32, Avenue Kléber – 92700 Colombes – FRANCE
Manufacturer : ALE International
Address : 32, Avenue Kléber – 92700 Colombes – FRANCE

Radio Function : Bluetooth EDR

FCC Rule Part(s) : FCC CFR Title 47, Part 15, Subpart C (15.247)
Measurement : ANSI C63.10-2013
Procedure(s)

Date of Receipt : 2023/1/6
Date of Test : 2023/6/9 ~ 2023/6/12
Issued Date : 2023/8/9

The above equipment has been tested and found in compliance with the requirement of the above standards by BTL Inc.

Prepared by : 
Eddie Lee, Engineer

Approved by : 
Jerry Chuang, Supervisor

**BTL Inc.**

No.18, Ln. 171, Sec. 2, Jiuzong Rd., Neihu Dist., Taipei City 114, Taiwan

Tel: +886-2-2657-3299 Fax: +886-2-2657-3331 Web: www.newbtl.com Service mail: btl_qa@newbtl.com

Declaration

BTL represents to the client that testing is done in accordance with standard procedures as applicable and that test instruments used has been calibrated with standards traceable to international standard(s) and/or national standard(s).

BTL's reports apply only to the specific samples tested under conditions. It is manufacture's responsibility to ensure that additional production units of this model are manufactured with the identical electrical and mechanical components. **BTL** shall have no liability for any declarations, inferences or generalizations drawn by the client or others from **BTL** issued reports.

This report is the confidential property of the client. As a mutual protection to the clients, the public and ourselves, the test report shall not be reproduced, except in full, without our written approval.

BTL's laboratory quality assurance procedures are in compliance with the **ISO/IEC 17025** requirements, and accredited by the conformity assessment authorities listed in this test report.

BTL is not responsible for the sampling stage, so the results only apply to the sample as received.

The information, data and test plan are provided by manufacturer which may affect the validity of results, so it is manufacturer's responsibility to ensure that the apparatus meets the essential requirements of applied standards and in all the possible configurations as representative of its intended use.

Limitation

For the use of the authority's logo is limited unless the Test Standard(s)/Scope(s)/Item(s) mentioned in this test report is (are) included in the conformity assessment authorities acceptance respective.

Please note that the measurement uncertainty is provided for informational purpose only and are not use in determining the Pass/Fail results.

CONTENTS

REVISION HISTORY	5
1 SUMMARY OF TEST RESULTS	6
1.1 REFERENCE TEST GUIDANCE	6
1.2 TEST FACILITY	7
1.3 MEASUREMENT UNCERTAINTY	7
1.4 TEST ENVIRONMENT CONDITIONS	8
1.5 DUTY CYCLE	9
2 GENERAL INFORMATION	10
2.1 DESCRIPTION OF EUT	10
2.2 TEST MODES	12
2.3 BLOCK DIAGRAM SHOWING THE CONFIGURATION OF SYSTEM TESTED	13
2.4 SUPPORT UNITS	14
3 AC POWER LINE CONDUCTED EMISSIONS TEST	15
3.1 LIMIT	15
3.2 TEST PROCEDURE	15
3.3 DEVIATION FROM TEST STANDARD	15
3.4 TEST SETUP	16
3.5 TEST RESULT	16
4 RADIATED EMISSIONS TEST	17
4.1 LIMIT	17
4.2 TEST PROCEDURE	18
4.3 DEVIATION FROM TEST STANDARD	18
4.4 TEST SETUP	18
4.5 EUT OPERATING CONDITIONS	19
4.6 TEST RESULT – BELOW 30 MHZ	20
4.7 TEST RESULT – 30 MHZ TO 1 GHZ	20
4.8 TEST RESULT – ABOVE 1 GHZ	20
5 NUMBER OF HOPPING CHANNEL	21
5.1 APPLIED PROCEDURES	21
5.2 TEST PROCEDURE	21
5.3 DEVIATION FROM STANDARD	21
5.4 TEST SETUP	21
5.5 EUT OPERATION CONDITIONS	21
5.6 TEST RESULTS	21
6 AVERAGE TIME OF OCCUPANCY	22
6.1 APPLIED PROCEDURES / LIMIT	22
6.2 TEST PROCEDURE	22
6.3 DEVIATION FROM STANDARD	22
6.4 TEST SETUP	22
6.5 EUT OPERATION CONDITIONS	22
6.6 TEST RESULTS	22
7 HOPPING CHANNEL SEPARATION MEASUREMENT	23
7.1 APPLIED PROCEDURES / LIMIT	23
7.2 TEST PROCEDURE	23
7.3 DEVIATION FROM STANDARD	23
7.4 TEST SETUP	23
7.5 TEST RESULTS	23

8	BANDWIDTH TEST	24
8.1	APPLIED PROCEDURES	24
8.2	TEST PROCEDURE	24
8.3	DEVIATION FROM STANDARD	24
8.4	TEST SETUP	24
8.5	EUT OPERATION CONDITIONS	24
8.6	TEST RESULTS	24
9	OUTPUT POWER TEST	25
9.1	APPLIED PROCEDURES / LIMIT	25
9.2	TEST PROCEDURE	25
9.3	DEVIATION FROM STANDARD	25
9.4	TEST SETUP	25
9.5	EUT OPERATION CONDITIONS	25
9.6	TEST RESULTS	25
10	ANTENNA CONDUCTED SPURIOUS EMISSION	26
10.1	APPLIED PROCEDURES / LIMIT	26
10.2	TEST PROCEDURE	26
10.3	DEVIATION FROM STANDARD	26
10.4	TEST SETUP	26
10.5	EUT OPERATION CONDITIONS	26
10.6	TEST RESULTS	26
11	LIST OF MEASURING EQUIPMENTS	27
12	EUT TEST PHOTO	29
13	EUT PHOTOS	29
APPENDIX A	AC POWER LINE CONDUCTED EMISSIONS	30
APPENDIX B	RADIATED EMISSIONS - 30 MHZ TO 1 GHZ	35
APPENDIX C	RADIATED EMISSIONS - ABOVE 1 GHZ	38
APPENDIX D	NUMBER OF HOPPING CHANNEL	55
APPENDIX E	AVERAGE TIME OF OCCUPANCY	57
APPENDIX F	HOPPING CHANNEL SEPARATION MEASUREMENT	60
APPENDIX G	BANDWIDTH	63
APPENDIX H	OUTPUT POWER	66
APPENDIX I	ANTENNA CONDUCTED SPURIOUS EMISSION	68

REVISION HISTORY

Report No.	Version	Description	Issued Date	Note
BTL-FCCP-1-2301G001	R00	Original Report.	2023/6/19	Invalid
BTL-FCCP-1-2301G001	R01	Revised report to address TCB's comments.	2023/8/1	Invalid
BTL-FCCP-1-2301G001	R02	Revised report to address TCB's comments.	2023/8/4	Invalid
BTL-FCCP-1-2301G001	R03	Revised report to address TCB's comments.	2023/8/9	Valid

1 SUMMARY OF TEST RESULTS

Test procedures according to the technical standards.

Standard(s) Section	Description	Test Result	Judgement	Remark
15.207	AC Power Line Conducted Emissions	APPENDIX A	Pass	-----
15.205 15.209 15.247(d)	Radiated Emissions	APPENDIX B APPENDIX C	Pass	-----
15.247 (a)(1)(iii)	Number of Hopping Frequency	APPENDIX D	Pass	-----
15.247 (a)(1)(iii)	Average Time of Occupancy	APPENDIX E	Pass	-----
15.247 (a)(1)	Hopping Channel Separation	APPENDIX F	Pass	-----
15.247 (a)(1)	Bandwidth	APPENDIX G	Pass	-----
15.247 (b)(1)	Output Power	APPENDIX H	Pass	-----
15.247(d)	Antenna conducted Spurious Emission	APPENDIX I	Pass	-----
15.203	Antenna Requirement	-----	Pass	NOTE (3)

NOTE:

- (1) "N/A" denotes test is not applicable in this Test Report.
- (2) The report format version is TP.1.1.1.
- (3) The EUT has internal antenna, which was permanently attached, fulfill the requirement of this section. Please refer to the EUT photos.

1.1 REFERENCE TEST GUIDANCE

KDB 558074 D01 15.247 Meas Guidance v05r02

1.2 TEST FACILITY

The test locations stated below are under the TAF Accreditation Number 0659.

The test location(s) used to collect the test data in this report are:

No. 68-1, Ln. 169, Sec. 2, Datong Rd., Xizhi Dist., New Taipei City 221, Taiwan
(FCC DN: TW0659)

C05 CB08 CB11 SR10 SR11

No. 72, Ln. 169, Sec. 2, Datong Rd., Xizhi Dist., New Taipei City 221, Taiwan
(FCC DN: TW0659)

C06 CB21 CB22

1.3 MEASUREMENT UNCERTAINTY

The reported uncertainty of measurement $y \pm U$, where expanded uncertainty U is based on a standard uncertainty multiplied by a coverage factor of $k = 2$, providing a level of confidence of approximately **95 %**. The measurement instrumentation uncertainty considerations contained in CISPR 16-4-2. The BTL measurement uncertainty is less than the CISPR 16-4-2 U_{cispr} requirement.

A. AC power line conducted emissions test:

Test Site	Method	Measurement Frequency Range	U (dB)
C05	CISPR	150 kHz ~ 30 MHz	3.44

B. Radiated emissions test :

Test Site	Measurement Frequency Range	U (dB)
CB21	0.03 GHz ~ 0.2 GHz	4.17
	0.2 GHz ~ 1 GHz	4.72
	1 GHz ~ 6 GHz	5.21
	6 GHz ~ 18 GHz	5.51
	18 GHz ~ 26 GHz	3.69
	26 GHz ~ 40 GHz	4.23

C. Conducted test :

Test Item	U (dB)
Occupied Bandwidth	0.5338
Output power	0.3659
Conducted Spurious emissions	0.5416
Conducted Band edges	0.5348
Dwell time	0.6606
Channel separation	0.6606
Channel numbers	0.6606

NOTE:

Unless specifically mentioned, the uncertainty of measurement has not been taken into account to declare the compliance or non-compliance to the specification.

1.4 TEST ENVIRONMENT CONDITIONS

Test Item	Environment Condition	Test Voltage	Tested by
AC Power Line Conducted Emissions	20 °C, 53 %	DC 5V	Jay Tien
Radiated emissions below 1 GHz	Refer to data	DC 5V	Mark Wang
Radiated emissions above 1 GHz	Refer to data	DC 5V	Mark Wang
Number of Hopping Frequency	24.5 °C, 44 %	DC 5V	Jay Tien
Average Time of Occupancy	24.5 °C, 44 %	DC 5V	Jay Tien
Hopping Channel Separation	24.5 °C, 44 %	DC 5V	Jay Tien
Bandwidth	24.5 °C, 44 %	DC 5V	Jay Tien
Output Power	24.5 °C, 44 %	DC 5V	Jay Tien
Antenna conducted Spurious Emission	24.5 °C, 44 %	DC 5V	Jay Tien

1.5 DUTY CYCLE

If duty cycle is $\geq 98\%$, duty factor is not required.
 If duty cycle is $< 98\%$, duty factor shall be considered.

Remark	Delta 1			Delta 2	On Time/Period	10 log(1/Duty Cycle)
Mode	ON (ms)	Numbers (ON)	On Time (B) (ms)	Period (ON+OFF) (ms)	Duty Cycle (%)	Duty Factor (dB)
BT (1 Mbps)	2.900	1	2.900	3.740	77.54%	1.10
BT (2 Mbps)	2.900	1	2.900	3.740	77.54%	1.10
BT (3 Mbps)	2.900	1	2.900	3.740	77.54%	1.10

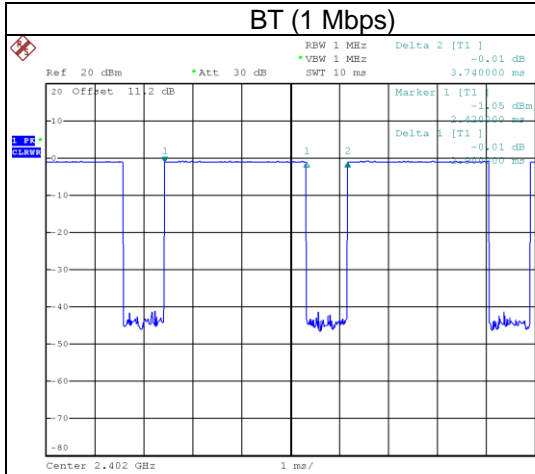

Date: 12.JUN.2023 19:49:05

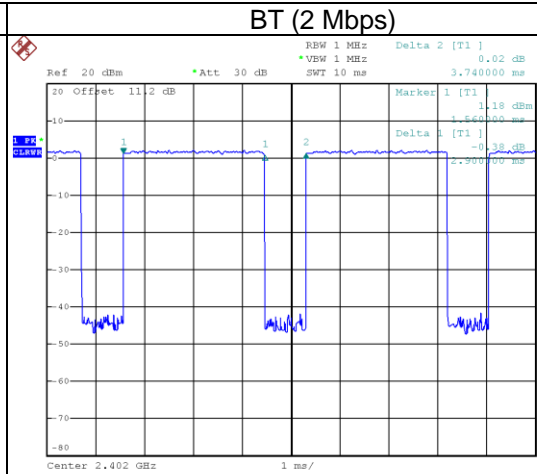

Date: 12.JUN.2023 19:51:59

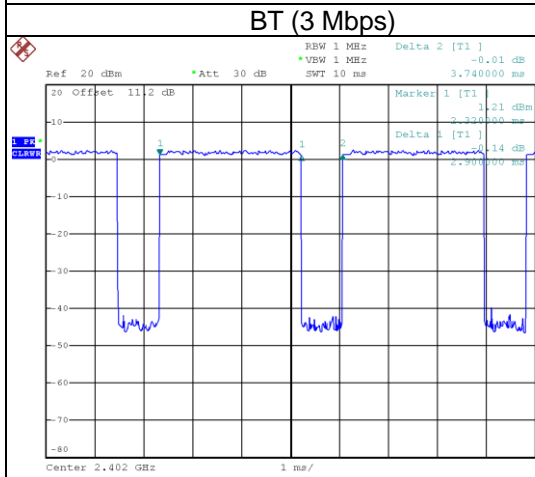

Date: 12.JUN.2023 19:54:15

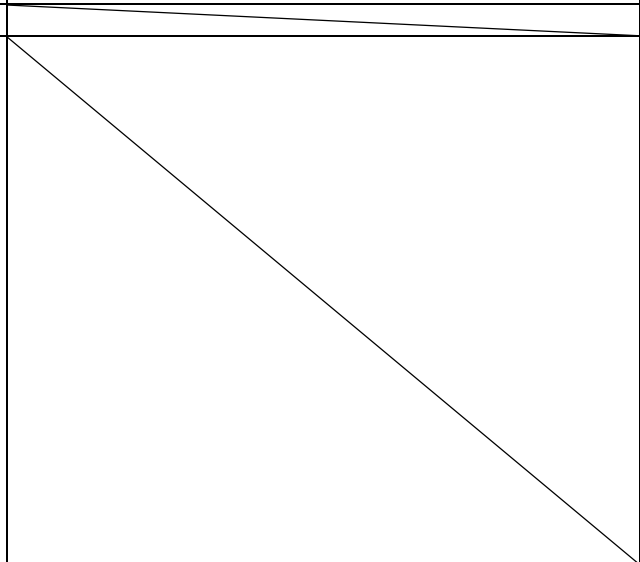

2 GENERAL INFORMATION

2.1 DESCRIPTION OF EUT

Equipment	Dongle
Model Name	AT10DONGLE
Brand Name	Alcatel-Lucent Enterprise
Model Difference	N/A
Power Source	DC voltage supplied from USB port.
Power Rating	DC 5V
Products Covered	N/A
HVIN	AT10DONGLE
FVIN	N/A
Operation Band	2400 MHz ~ 2483.5 MHz
Operation Frequency	2402 MHz ~ 2480 MHz
Modulation Type	GFSK, $\pi/4$ -DQPSK, 8DPSK
Modulation Technology	FHSS
Transfer Rate	1 Mbps, 2 Mbps, 3Mbps
Output Power Max.	1 Mbps: 2.18 dBm (0.0017 W) 2 Mbps: 4.87 dBm (0.0031 W) 3 Mbps: 5.37 dBm (0.0034 W)
Operating Software	RTLBTAPP v5.2.2.50
Test Model	AT10DONGLE
Sample Status	Engineering Sample
EUT Modification(s)	N/A

NOTE:

(1) The above EUT information is declared by manufacturer and for more detailed features description, please refers to the manufacturer's specifications or user's manual.

(2) Channel List:

Channel	Frequency (MHz)	Channel	Frequency (MHz)	Channel	Frequency (MHz)
00	2402	27	2429	54	2456
01	2403	28	2430	55	2457
02	2404	29	2431	56	2458
03	2405	30	2432	57	2459
04	2406	31	2433	58	2460
05	2407	32	2434	59	2461
06	2408	33	2435	60	2462
07	2409	34	2436	61	2463
08	2410	35	2437	62	2464
09	2411	36	2438	63	2465
10	2412	37	2439	64	2466
11	2413	38	2440	65	2467
12	2414	39	2441	66	2468
13	2415	40	2442	67	2469
14	2416	41	2443	68	2470
15	2417	42	2444	69	2471
16	2418	43	2445	70	2472
17	2419	44	2446	71	2473
18	2420	45	2447	72	2474
19	2421	46	2448	73	2475
20	2422	47	2449	74	2476
21	2423	48	2450	75	2477
22	2424	49	2451	76	2478
23	2425	50	2452	77	2479
24	2426	51	2453	78	2480

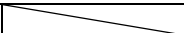
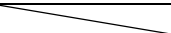
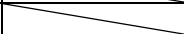
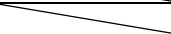
25	2427	52	2454		
26	2428	53	2455		

(3) Table for Filed Antenna:

Antenna	Brand	Part number	Type	Connector	Gain (dBi)
-	Shenzhen HamyWe Technology Co., Ltd.	HM3216ANT2450-HM02	Ceramic Antenna	N/A	4.34

(4) The above Antenna information are derived from the antenna data sheet provided by manufacturer and for more detailed features description, please refer to the manufacturer's specifications, the laboratory shall not be held responsible.

2.2 TEST MODES

Test Items	Test mode	Channel	Note
AC power line conducted emissions	Normal/Idle	-	-
Transmitter Radiated Emissions (below 1GHz)	1 Mbps	00	-
Transmitter Radiated Emissions (above 1GHz)	1/3 Mbps	00/78	Bandedge
	1/3 Mbps	00/39/78	Harmonic
Number of Hopping Frequency	1/3 Mbps	00~78	-
Average Time of Occupancy	1/3 Mbps	00/39/78	-
Hopping Channel Separation	1/3 Mbps	00/39/78	-
Bandwidth	1/3 Mbps	00/39/78	-
Peak Output Power	1/2/3 Mbps	00/39/78	-
Antenna conducted Spurious Emission	1/3 Mbps	00/39/78	-

NOTE:

- (1) For radiated emission band edge test, both Vertical and Horizontal are evaluated, but only the worst case (Horizontal) is recorded.
- (2) All X, Y and Z axes are evaluated, but only the worst case (X axis) is recorded.

2.3 BLOCK DIAGRAM SHOWING THE CONFIGURATION OF SYSTEM TESTED

Equipment letters and Cable numbers refer to item numbers described in the tables of clause 2.4.

AC power line conducted emissions

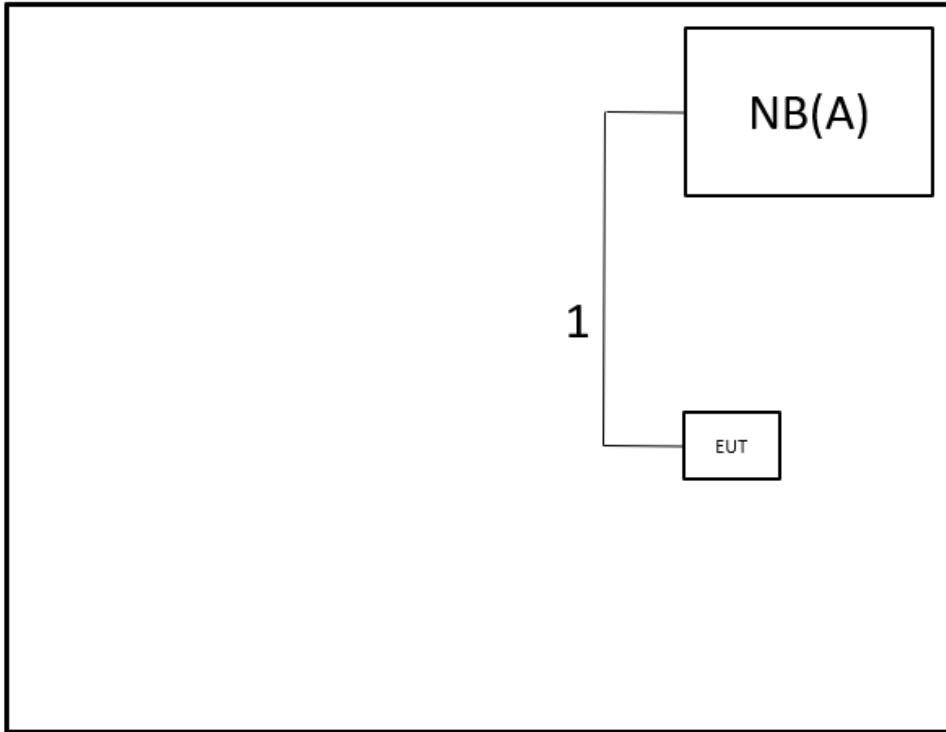

Radiated Emissions

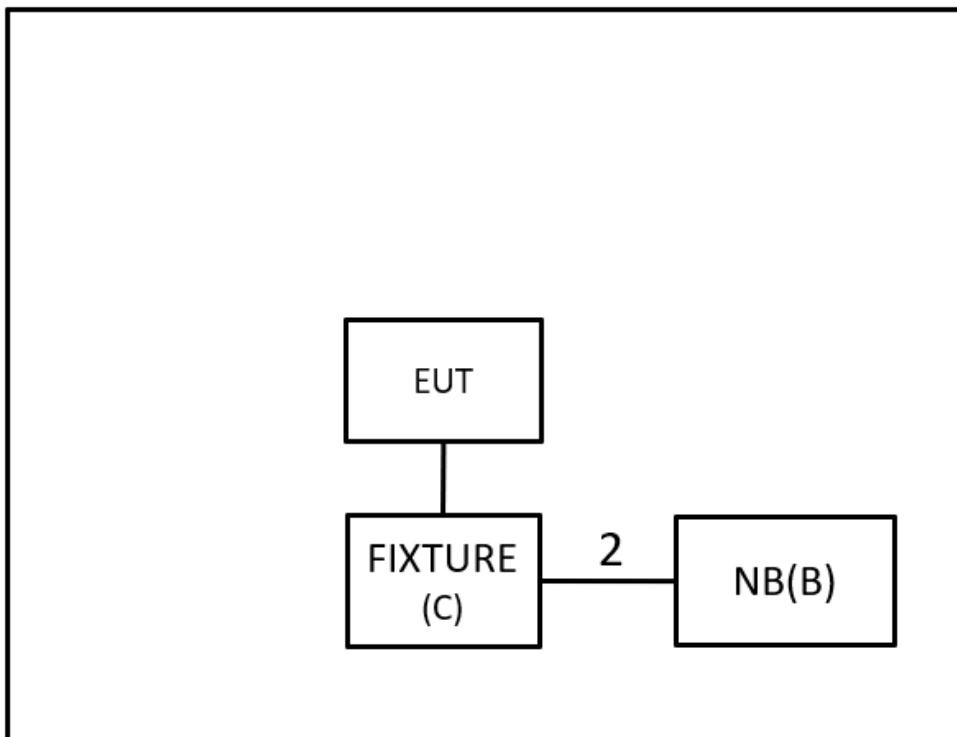

2.4 SUPPORT UNITS

Item	Equipment	Brand	Model No.	Series No.	Remarks
A	NB	ASUS	X555L	X555LN-0021B421 0U	Furnished by test lab.
B	NB	HP	TPN-C125	N/A	Furnished by test lab.
C	FIXTURE	N/A	N/A	N/A	Furnished by test lab.

Item	Shielded	Ferrite Core	Length	Cable Type	Remarks
1	No	No	1.5m	USB Cable	Furnished by test lab.
2	No	No	1m	USB extension Cable	Furnished by test lab.

3 AC POWER LINE CONDUCTED EMISSIONS TEST

3.1 LIMIT

Frequency (MHz)	Limit (dB μ V)	
	Quasi-peak	Average
0.15 - 0.5	66 - 56 *	56 - 46 *
0.50 - 5.0	56	46
5.0 - 30.0	60	50

NOTE:

- (1) The tighter limit applies at the band edges.
- (2) The limit of " * " marked band means the limitation decreases linearly with the logarithm of the frequency in the range.
- (3) The test result calculated as following:
 Measurement Value = Reading Level + Correct Factor
 Correct Factor = Insertion Loss + Cable Loss + Attenuator Factor (if use)
 Margin Level = Measurement Value – Limit Value
 Calculation example:

Reading Level		Correct Factor		Measurement Value
38.22	+	3.45	=	41.67

Measurement Value		Limit Value		Margin Level
41.67	-	60	=	-18.33

The following table is the setting of the receiver.

Receiver Parameter	Setting
Attenuation	10 dB
Start Frequency	0.15 MHz
Stop Frequency	30 MHz
IF Bandwidth	9 KHz

3.2 TEST PROCEDURE

- a. The EUT was placed 0.8 m above the horizontal ground plane with the EUT being connected to the power mains through a line impedance stabilization network (LISN).
 All other support equipment were powered from an additional LISN(s).
 The LISN provides 50 Ohm/50uH of impedance for the measuring instrument.
- b. Interconnecting cables that hang closer than 40 cm to the ground plane shall be folded back and forth in the center forming a bundle to keep the cable above 40 cm.
- c. Excess I/O cables that are not connected to a peripheral shall be bundled in the center.
 The end of the cable will be terminated, using the correct terminating impedance.
 The overall length shall not exceed 1 m.
- d. The LISN is spaced at least 80 cm from the nearest part of the EUT chassis.
- e. For the actual test configuration, please refer to the related Item - EUT TEST PHOTO.

NOTE:

- (1) In the results, each reading is marked as Peak, QP or AVG per the detector used.
 BW=9 kHz (6 dB Bandwidth)
- (2) All readings are Peak unless otherwise stated QP or AVG in column of Note. Both the QP and the AVG readings must be less than the limit for compliance.

3.3 DEVIATION FROM TEST STANDARD

No deviation.

3.4 TEST SETUP

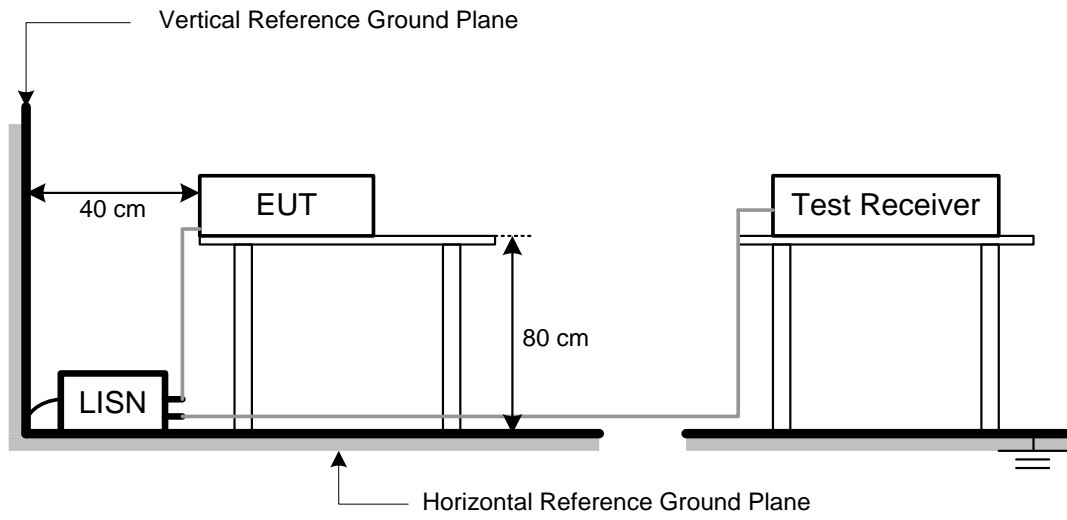

3.5 TEST RESULT

Please refer to the APPENDIX A.

4 RADIATED EMISSIONS TEST

4.1 LIMIT

In case the emission fall within the restricted band specified on 15.205, then the 15.209 limit in the table below has to be followed.

LIMITS OF RADIATED EMISSIONS MEASUREMENT (9 kHz to 1000 MHz)

Frequency (MHz)	Field Strength (microvolts/meter)	Measurement Distance (meters)
0.009~0.490	2400/F(KHz)	300
0.490~1.705	24000/F(KHz)	30
1.705~30.0	30	30
30~88	100	3
88~216	150	3
216~960	200	3
960~1000	500	3

LIMITS OF RADIATED EMISSIONS MEASUREMENT (Above 1000 MHz)

Frequency (MHz)	Radiated Emissions (dBuV/m)		Measurement Distance (meters)
	Peak	Average	
Above 1000	74	54	3

NOTE:

- (1) The limit for radiated test was performed according to FCC CFR Title 47, Part 15, Subpart C.
- (2) The tighter limit applies at the band edges.
- (3) Emission level (dBuV/m)=20log Emission level (uV/m).
- (4) The test result calculated as following:

Measurement Value = Reading Level + Correct Factor

Correct Factor = Antenna Factor + Cable Loss - Amplifier Gain(if use)

Margin Level = Measurement Value - Limit Value

Calculation example:

Reading Level		Correct Factor		Measurement Value
35.45	+	-11.37	=	24.08

Measurement Value		Limit Value		Margin Level
24.08	-	40	=	-15.92

Spectrum Parameter	Setting
Attenuation	Auto
Start Frequency	1000 MHz
Stop Frequency	10th carrier harmonic
RBW / VBW (Emission in restricted band)	1MHz / 3MHz for Peak, 1MHz / 1/T for Average

Mode	VBW(Hz)
BT (1M)	360
BT (2M)	360
BT (3M)	360

Spectrum Parameter	Setting
Attenuation	Auto
Start ~ Stop Frequency	9KHz~90KHz for PK/AVG detector
Start ~ Stop Frequency	90KHz~110KHz for QP detector
Start ~ Stop Frequency	110KHz~490KHz for PK/AVG detector
Start ~ Stop Frequency	490KHz~30MHz for QP detector
Start ~ Stop Frequency	30MHz~1000MHz for QP detector

4.2 TEST PROCEDURE

- a. The measuring distance of 3 m shall be used for measurements. The EUT was placed on the top of a rotating table 0.8 meter above the ground at a 3 meter semi-anechoic chamber. The table was rotated 360 degrees to determine the position of the highest radiation.(below 1GHz)
- b. The measuring distance of 3 m shall be used for measurements. The EUT was placed on the top of a rotating table 1.5 meter above the ground at a 3 meter semi-anechoic chamber. The table was rotated 360 degrees to determine the position of the highest radiation.(above 1GHz)
- c. The height of the equipment or of the substitution antenna shall be 0.8 m or 1.5 m, the height of the test antenna shall vary between 1 m to 4 m. Both horizontal and vertical polarizations of the antenna are set to make the measurement.
- d. For each suspected emission, the EUT was arranged to its worst case and then the antenna was tuned to heights find the maximum reading (used Bore sight function).
- e. The receiver system was set to peak and average detect function and specified bandwidth with maximum hold mode when the test frequency is above 1GHz.
- f. The initial step in collecting radiated emission data is a receiver peak detector mode pre-scanning the measurement frequency range. Significant peaks are then marked and then Quasi Peak detector mode re-measured.
- g. All readings are Peak unless otherwise stated QP in column of Note. Peak denotes that the Peak reading compliance with the QP Limits and then QP Mode measurement didn't perform. (below 1GHz)
- h. All readings are Peak Mode value unless otherwise stated AVG in column of Note. If the Peak Mode Measured value compliance with the Peak Limits and lower than AVG Limits, the EUT shall be deemed to meet both Peak & AVG Limits and then only Peak Mode was measured, but AVG Mode didn't perform. (above 1GHz)
- i. For the actual test configuration, please refer to the related Item – EUT TEST PHOTO.
- j. In the Radiation bandedge test, the software was automatically obtained the maximum emission point in 2310-2390 MHz and 2483.5-2500 MHz.

4.3 DEVIATION FROM TEST STANDARD

No deviation.

4.4 TEST SETUP

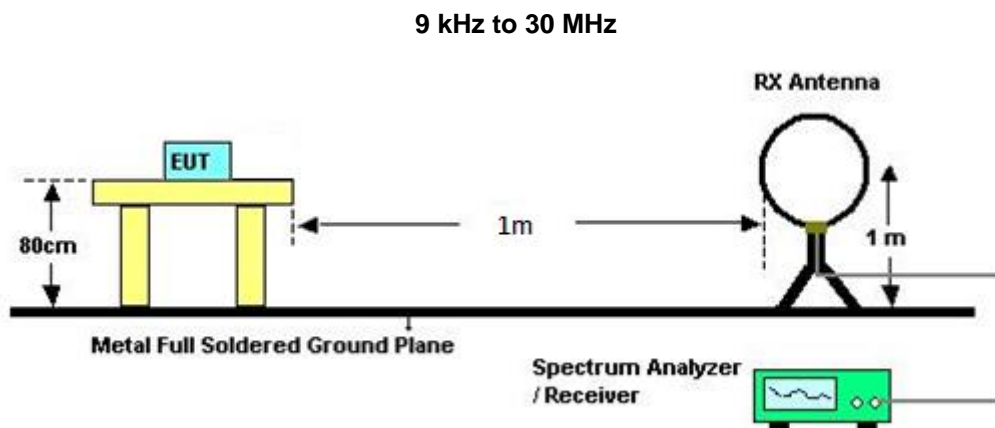

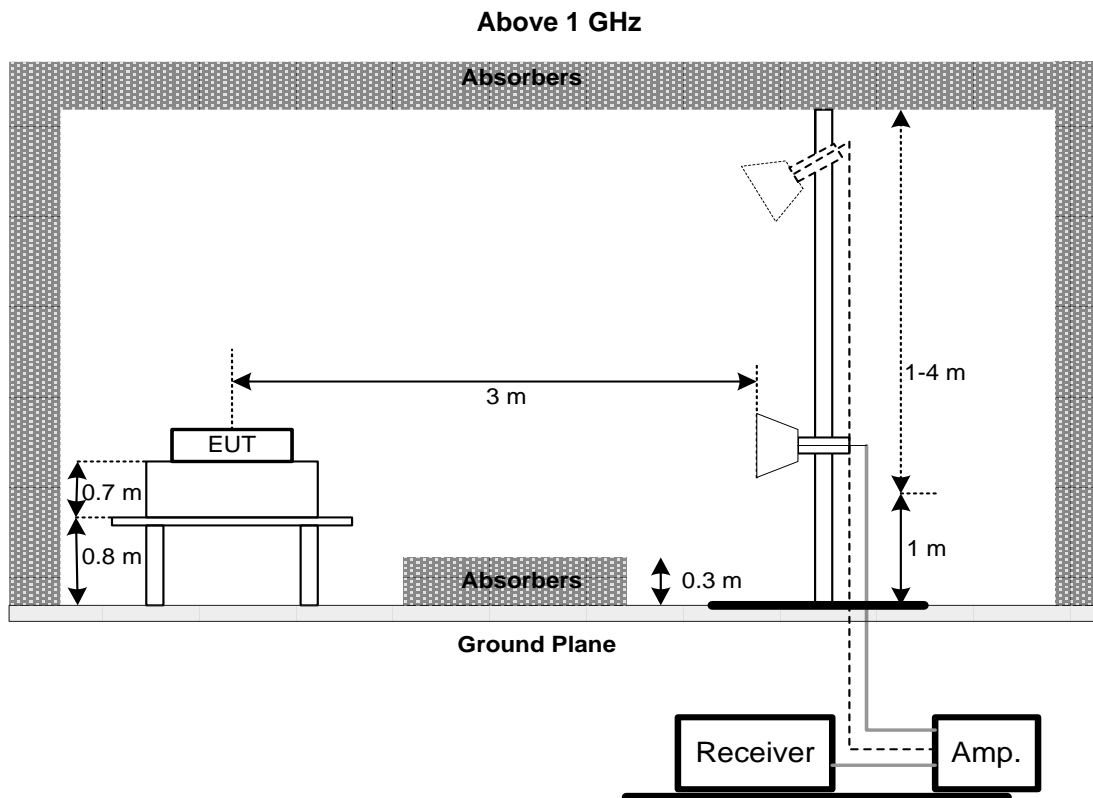
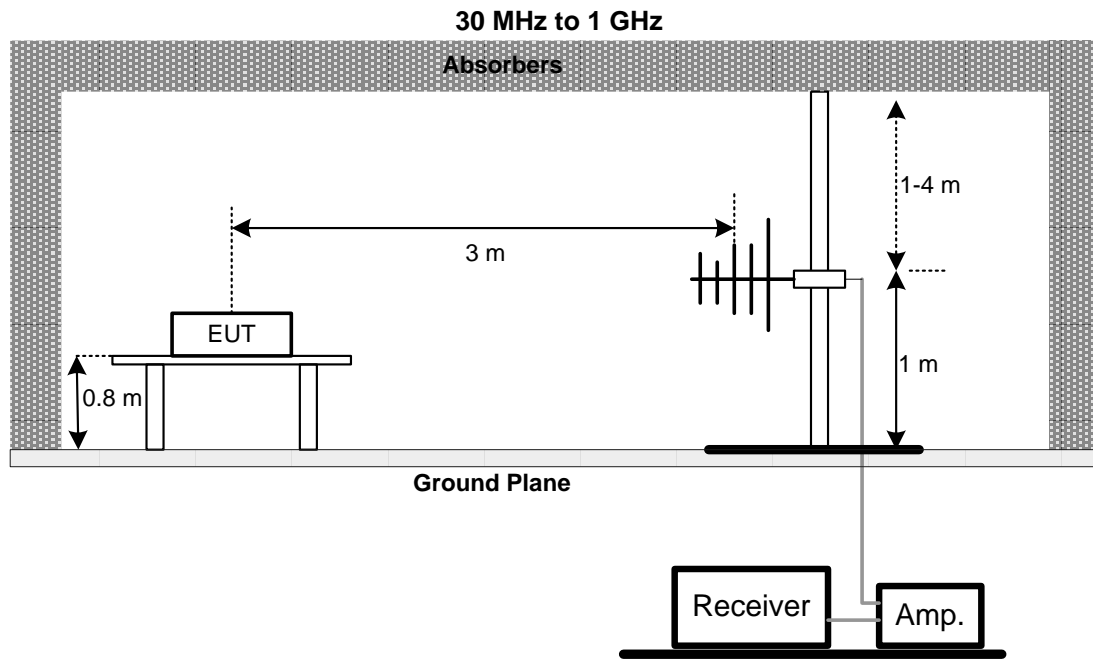

4.5 EUT OPERATING CONDITIONS

The EUT was programmed to be in continuously transmitting mode.

4.6 TEST RESULT – BELOW 30 MHZ

There were no emissions found below 30 MHz within 20 dB of the limit.

4.7 TEST RESULT – 30 MHZ TO 1 GHZ

Please refer to the APPENDIX B.

4.8 TEST RESULT – ABOVE 1 GHZ

Please refer to the APPENDIX C.

NOTE:

- (1) No limit: This is fundamental signal, the judgment is not applicable.
For fundamental signal judgment was referred to Peak output test.

5 NUMBER OF HOPPING CHANNEL

5.1 APPLIED PROCEDURES

Section	Test Item	Frequency Range (MHz)	Result
15.247(a)(1)(iii)	Number of Hopping Channel	2400-2483.5	PASS

Spectrum Parameters	Setting
Attenuation	Auto
Span Frequency	> Operating Frequency Range
RBW	100 KHz
VBW	100 KHz
Detector	Peak
Trace	Max Hold
Sweep Time	Auto

5.2 TEST PROCEDURE

- a. The EUT was directly connected to the spectrum analyzer and antenna output port as show in the block diagram below,
- b. Spectrum Setting: RBW=100KHz, VBW=100KHz, Sweep time = Auto.

5.3 DEVIATION FROM STANDARD

No deviation.

5.4 TEST SETUP



5.5 EUT OPERATION CONDITIONS

The EUT tested system was configured as the statements of 3.5 unless otherwise a special operating condition is specified in the follows during the testing.

5.6 TEST RESULTS

Please refer to the APPENDIX D.

6 AVERAGE TIME OF OCCUPANCY

6.1 APPLIED PROCEDURES / LIMIT

Section	Test Item	Limit	Frequency Range (MHz)	Result
15.247(a)(1)(iii)	Average Time of Occupancy	0.4sec	2400-2483.5	PASS

6.2 TEST PROCEDURE

- a. The transmitter output (antenna port) was connected to the spectrum analyzer
- b. Set RBW of spectrum analyzer to 1MHz and VBW to 1MHz.
- c. Use a video trigger with the trigger level set to enable triggering only on full pulses.
- d. Sweep Time is more than once pulse time.
- e. Set the center frequency on any frequency would be measure and set the frequency span to zero span.
- f. Measure the maximum time duration of one single pulse.
- g. Set the EUT for DH5, DH3 and DH1 packet transmitting.
- h. Measure the maximum time duration of one single pulse.
- i. Measure the maximum time duration of one single pulse.
A Period Time = (channel number)*0.4

For Normal Mode (79 Channel):

DH1 Time Solt: Reading * (1600/2)*31.6/(channel number)

DH3 Time Solt: Reading * (1600/2)*31.6/(channel number)

DH5 Time Solt: Reading * (1600/2)*31.6/(channel number)

For AFH Mode (20 Channel):

DH1 Time Solt: Reading * (1600/2)*8/(channel number)

DH3 Time Solt: Reading * (1600/4)*8/(channel number)

DH5 Time Solt: Reading * (1600/6)*8/(channel number)

6.3 DEVIATION FROM STANDARD

No deviation.

6.4 TEST SETUP



6.5 EUT OPERATION CONDITIONS

The EUT tested system was configured as the statements of 3.5 unless otherwise a special operating condition is specified in the follows during the testing.

6.6 TEST RESULTS

Please refer to the APPENDIX E.

7 Hopping Channel Separation Measurement

7.1 APPLIED PROCEDURES / LIMIT

Frequency hopping systems operating in the 2400-2483.5 MHz band may have hopping channel carrier frequencies that are separated by 25 KHz or two-thirds of the 20 dB bandwidth of the hopping channel, whichever is greater.

Spectrum Parameter	Setting
Attenuation	Auto
Span Frequency	> Measurement Bandwidth or Channel Separation
RBW	30 KHz
VBW	100 KHz
Detector	Peak
Trace	Max Hold
Sweep Time	Auto

7.2 TEST PROCEDURE

- a. The EUT must have its hopping function enabled
- b. Span = wide enough to capture the peaks of two adjacent channels
 Resolution (or IF) Bandwidth (RBW) \geq 1% of the span
 Video (or Average) Bandwidth (VBW) \geq RBW
 Sweep = Auto
 Detector function = Peak
 Trace = Max Hold

7.3 DEVIATION FROM STANDARD

No deviation.

7.4 TEST SETUP

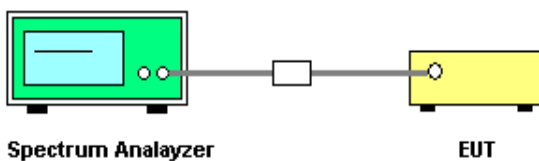

7.5 TEST RESULTS

Please refer to the APPENDIX F.

8 BANDWIDTH TEST

8.1 APPLIED PROCEDURES

Section	Test Item	Frequency Range (MHz)
15.247(a)(2)	Bandwidth	2400-2483.5

Spectrum Parameter	Setting
Attenuation	Auto
Span Frequency	> Measurement Bandwidth or Channel Separation
RBW	30 KHz (20dB Bandwidth) / 30 KHz (Channel Separation)
VBW	100 KHz (20dB Bandwidth) / 100 KHz (Channel Separation)
Detector	Peak
Trace	Max Hold
Sweep Time	Auto

8.2 TEST PROCEDURE

- a. The EUT was directly connected to the spectrum analyzer and antenna output port as show in the block diagram below,
- b. Spectrum Setting: RBW= 30KHz, VBW=100KHz, Sweep Time = Auto.

8.3 DEVIATION FROM STANDARD

No deviation.

8.4 TEST SETUP



8.5 EUT OPERATION CONDITIONS

The EUT tested system was configured as the statements of 3.5 unless otherwise a special operating condition is specified in the follows during the testing.

8.6 TEST RESULTS

Please refer to the APPENDIX G.

9 OUTPUT POWER TEST

9.1 APPLIED PROCEDURES / LIMIT

Section	Test Item	Limit	Frequency Range (MHz)	Result
15.247(b)(1)	Peak Output Power	0.125Watt or 21dBm	2400-2483.5	PASS

9.2 TEST PROCEDURE

- a. The EUT was directly connected to the power meter and antenna output port as show in the block diagram below,
- b. The maximum peak conducted output power was performed in accordance with FCC KDB 558074 D01 15.247 Meas Guidance.

9.3 DEVIATION FROM STANDARD

No deviation.

9.4 TEST SETUP

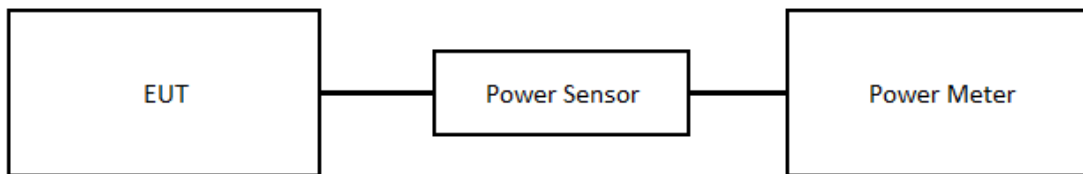

9.5 EUT OPERATION CONDITIONS

The EUT tested system was configured as the statements of 3.5 unless otherwise a special operating condition is specified in the follows during the testing.

9.6 TEST RESULTS

Please refer to the APPENDIX H.

10 ANTENNA CONDUCTED SPURIOUS EMISSION

10.1 APPLIED PROCEDURES / LIMIT

In any 100 kHz bandwidth outside the frequency band in which the spread spectrum or digitally modulated device is operating, the RF power that is produced shall be at least 20 dB below that in the 100 kHz bandwidth within the band that contains the highest level of the desired power, based on either an RF conducted or a radiated measurement, provided that the transmitter demonstrates compliance with the peak conducted power limits.

10.2 TEST PROCEDURE

- a. The EUT was directly connected to the spectrum analyzer and antenna output port as show in the block diagram below,
- b. Spectrum Setting: RBW= 100KHz, VBW=100KHz, Sweep time = Auto.
- c. Offset=antenna gain+cable loss

10.3 DEVIATION FROM STANDARD

No deviation.

10.4 TEST SETUP



10.5 EUT OPERATION CONDITIONS

The EUT tested system was configured as the statements of 3.5 unless otherwise a special operating condition is specified in the follows during the testing.

10.6 TEST RESULTS

Please refer to the APPENDIX I.

11 LIST OF MEASURING EQUIPMENTS

AC Power Line Conducted Emissions						
Item	Kind of Equipment	Manufacturer	Type No.	Serial No.	Calibrated Date	Calibrated Until
1	TWO-LINE V-NETWORK	R&S	ENV216	101521	2022/9/28	2023/9/27
2	Test Cable	EMCI	EMCRG58-BM-B M-9000	220331	2023/3/30	2024/3/29
3	EMI Test Receiver	R&S	ESR 7	101433	2022/11/16	2023/11/15
4	Measurement Software	EZ	EZ EMC (Version NB-03A1-01)	N/A	N/A	N/A

Radiated Emissions						
Item	Kind of Equipment	Manufacturer	Type No.	Serial No.	Calibrated Date	Calibrated Until
1	Preamplifier	EMCI	EMC330N	980850	2022/9/19	2023/9/18
2	Preamplifier	EMCI	EMC118A45SE	980819	2023/3/7	2024/3/6
3	Pre-Amplifier	EMCI	EMC184045SE	980907	2022/9/28	2023/9/27
4	Preamplifier	EMCI	EMC001340	980579	2022/9/30	2023/9/29
5	Test Cable	EMCI	EMC104-SM-SM-1000	220319	2023/3/14	2024/3/13
6	Test Cable	EMCI	EMC104-SM-SM-3000	220322	2023/3/14	2024/3/13
7	Test Cable	EMCI	EMC104-SM-SM-7000	220324	2023/3/14	2024/3/13
8	EXA Signal Analyzer	keysight	N9020B	MY57120120	2023/2/24	2024/2/23
9	Loop Ant	Electro-Metrics	EMCI-LPA600	291	2022/9/19	2023/9/18
10	Horn Antenna	RFSPIN	DRH18-E	211202A18EN	2023/5/12	2024/5/11
11	Horn Ant	Schwarzbeck	BBHA 9170D	1136	2023/5/12	2024/5/11
12	Log-bicon Antenna	Schwarzbeck	VULB9168	1369	2023/5/9	2024/5/8
13	6dB Attenuator	EMCI	EMCI-N-6-06	AT-06001	2023/5/9	2024/5/8
14	Test Cable	EMCI	EMC101G-KM-K M-3000	220329	2023/3/14	2024/3/13
15	Test Cable	EMCI	EMC102-KM-KM-1000	220327	2023/3/14	2024/3/13
16	Measurement Software	EZ	EZ EMC (Version NB-03A1-01)	N/A	N/A	N/A

Number of Hopping Frequency						
Item	Kind of Equipment	Manufacturer	Type No.	Serial No.	Calibrated Date	Calibrated Until
1	Spectrum Analyzer	R&S	FSP38	101139	2023/3/9	2024/3/8

Average Time of Occupancy						
Item	Kind of Equipment	Manufacturer	Type No.	Serial No.	Calibrated Date	Calibrated Until
1	Spectrum Analyzer	R&S	FSP38	101139	2023/3/9	2024/3/8

Hopping Channel Separation						
Item	Kind of Equipment	Manufacturer	Type No.	Serial No.	Calibrated Date	Calibrated Until
1	Spectrum Analyzer	R&S	FSP38	101139	2023/3/9	2024/3/8

Bandwidth						
Item	Kind of Equipment	Manufacturer	Type No.	Serial No.	Calibrated Date	Calibrated Until
1	Spectrum Analyzer	R&S	FSP38	101139	2023/3/9	2024/3/8

Output Power						
Item	Kind of Equipment	Manufacturer	Type No.	Serial No.	Calibrated Date	Calibrated Until
1	Power Meter	Keysight	8990B	MY51000517	2023/3/15	2024/3/14
2	Power Sensor	Keysight	N1923A	MY58310005	2023/3/15	2024/3/14

Antenna conducted Spurious Emission						
Item	Kind of Equipment	Manufacturer	Type No.	Serial No.	Calibrated Date	Calibrated Until
1	Spectrum Analyzer	R&S	FSP38	101139	2023/3/9	2024/3/8

Remark: "N/A" denotes no model name, no serial no. or no calibration specified.
All calibration period of equipment list is one year.

12 EUT TEST PHOTO

Please refer to document Appendix No.: TP-2301G001-FCCP-1 (APPENDIX-TEST PHOTOS).

13 EUT PHOTOS

Please refer to document Appendix No.: EP-2301G001-1 (APPENDIX-EUT PHOTOS).

APPENDIX A AC POWER LINE CONDUCTED EMISSIONS

Test Mode	Normal	Tested Date	2023/6/9
Test Frequency	-	Phase	Line

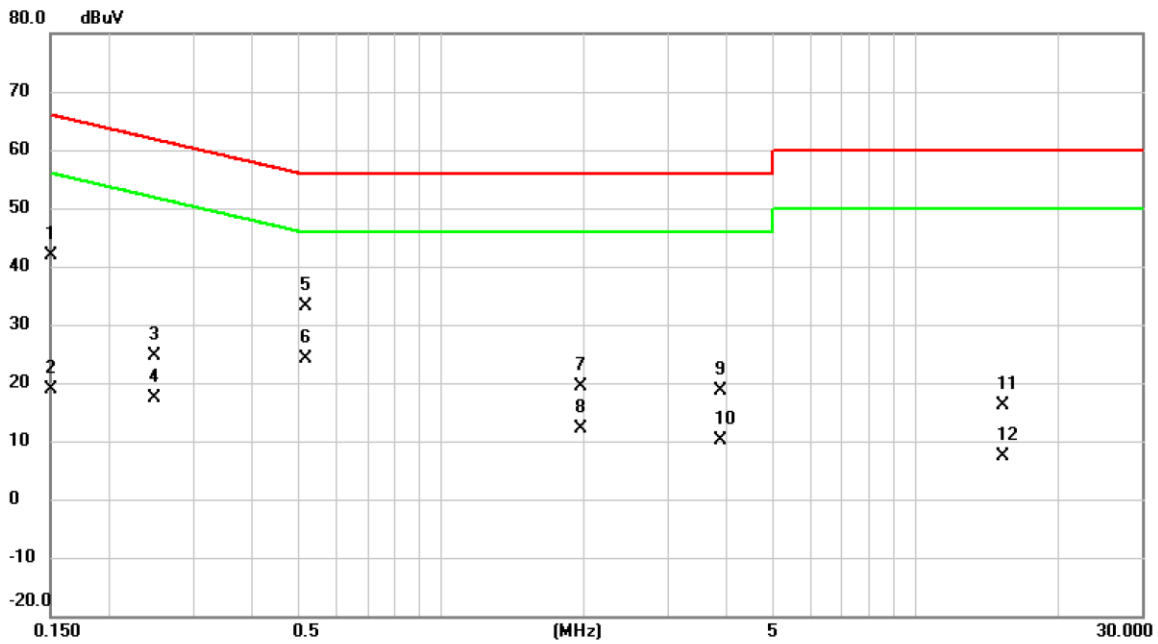

No.	Mk.	Freq.	Reading Level	Correct Factor	Measurement	Limit	Margin	Detector	Comment
		MHz	dBuV	dB	dBuV	dBuV	dB		
1		0.1500	41.86	0.04	41.90	66.00	-24.10	QP	
2		0.1500	18.82	0.04	18.86	56.00	-37.14	AVG	
3		0.2490	24.66	0.03	24.69	61.79	-37.10	QP	
4		0.2490	17.46	0.03	17.49	51.79	-34.30	AVG	
5		0.5190	32.99	0.02	33.01	56.00	-22.99	QP	
6	*	0.5190	24.20	0.02	24.22	46.00	-21.78	AVG	
7		1.9748	19.36	0.07	19.43	56.00	-36.57	QP	
8		1.9748	11.99	0.07	12.06	46.00	-33.94	AVG	
9		3.8873	18.68	0.05	18.73	56.00	-37.27	QP	
10		3.8873	10.08	0.05	10.13	46.00	-35.87	AVG	
11		15.2835	16.10	0.15	16.25	60.00	-43.75	QP	
12		15.2835	7.15	0.15	7.30	50.00	-42.70	AVG	

REMARKS:

- (1) Measurement Value = Reading Level + Correct Factor.
- (2) Margin Level = Measurement Value - Limit Value.

Test Mode	Normal	Tested Date	2023/6/9
Test Frequency	-	Phase	Neutral

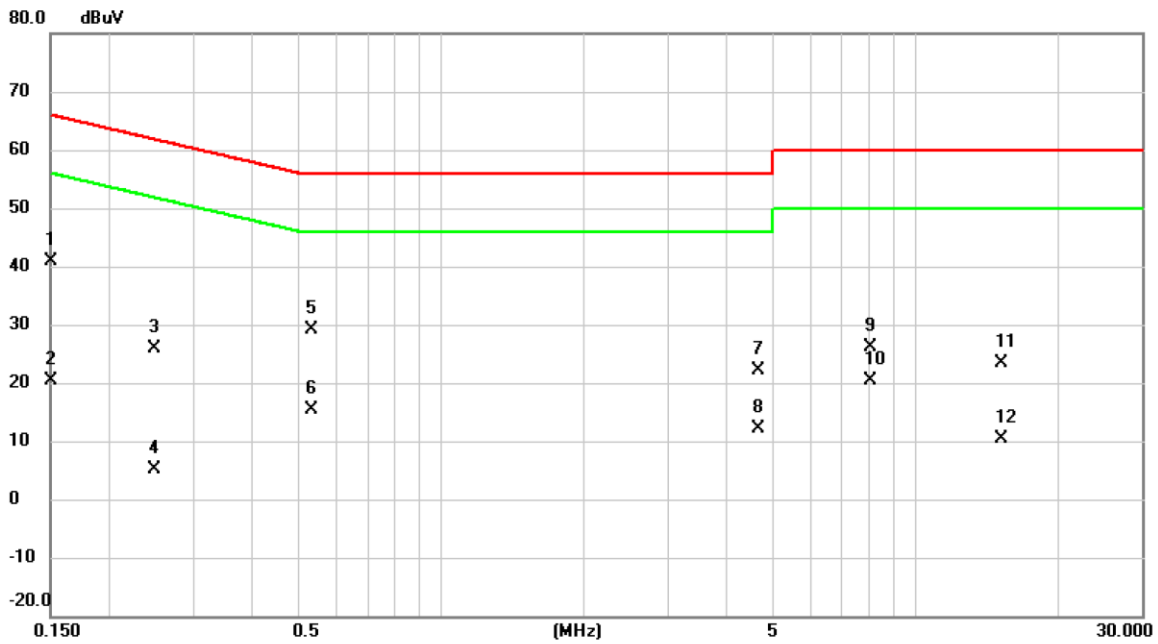

No. Mk.	Freq. MHz	Reading Level dBuV	Correct Factor dB	Measurement dBuV	Limit dBuV	Margin dB	Detector	Comment
1 *	0.1500	40.96	0.04	41.00	66.00	-25.00	QP	
2	0.1500	20.43	0.04	20.47	56.00	-35.53	AVG	
3	0.2490	25.78	0.03	25.81	61.79	-35.98	QP	
4	0.2490	5.05	0.03	5.08	51.79	-46.71	AVG	
5	0.5325	29.04	0.02	29.06	56.00	-26.94	QP	
6	0.5325	15.44	0.02	15.46	46.00	-30.54	AVG	
7	4.6658	22.20	0.05	22.25	56.00	-33.75	QP	
8	4.6658	12.15	0.05	12.20	46.00	-33.80	AVG	
9	8.0295	26.00	0.09	26.09	60.00	-33.91	QP	
10	8.0295	20.21	0.09	20.30	50.00	-29.70	AVG	
11	15.2025	23.30	0.15	23.45	60.00	-36.55	QP	
12	15.2025	10.32	0.15	10.47	50.00	-39.53	AVG	

REMARKS:

- (1) Measurement Value = Reading Level + Correct Factor.
- (2) Margin Level = Measurement Value - Limit Value.

Test Mode	Idle	Tested Date	2023/6/9
Test Frequency	-	Phase	Line

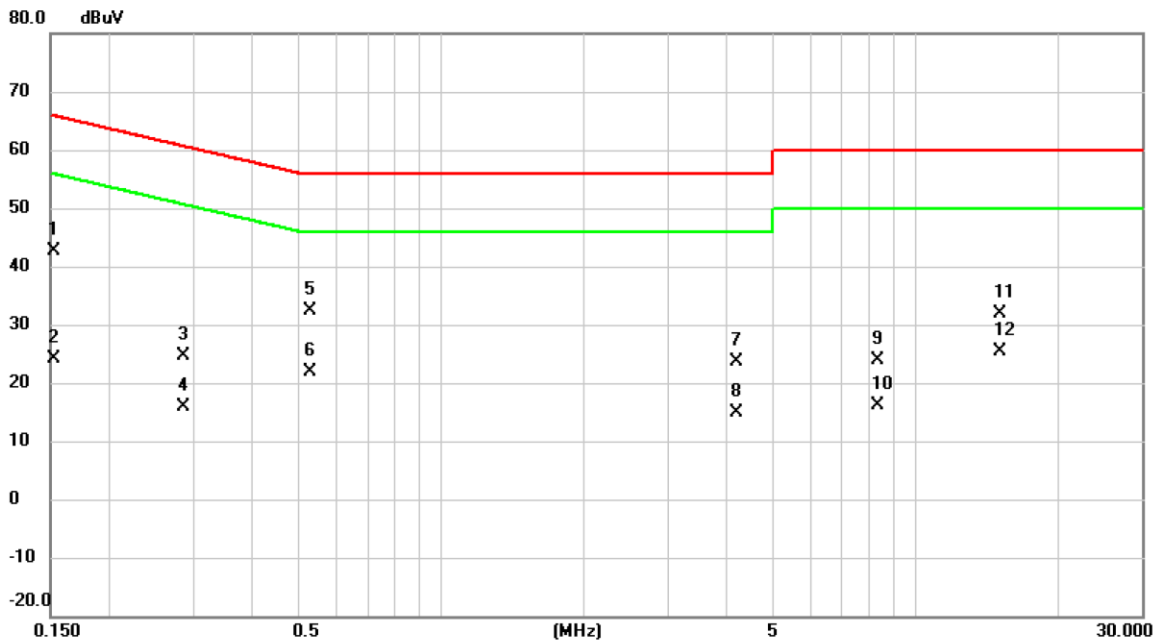

No.	Mk.	Freq.	Reading Level	Correct Factor	Measurement	Limit	Margin	Detector	Comment
		MHz	dBuV	dB	dBuV	dBuV	dB		
1	*	0.1522	42.47	0.04	42.51	65.88	-23.37	QP	
2		0.1522	23.99	0.04	24.03	55.88	-31.85	AVG	
3		0.2872	24.60	0.02	24.62	60.60	-35.98	QP	
4		0.2872	15.86	0.02	15.88	50.60	-34.72	AVG	
5		0.5302	32.46	0.02	32.48	56.00	-23.52	QP	
6		0.5302	21.90	0.02	21.92	46.00	-24.08	AVG	
7		4.1843	23.59	0.05	23.64	56.00	-32.36	QP	
8		4.1843	14.75	0.05	14.80	46.00	-31.20	AVG	
9		8.3265	23.87	0.10	23.97	60.00	-36.03	QP	
10		8.3265	15.96	0.10	16.06	50.00	-33.94	AVG	
11		15.0968	31.69	0.15	31.84	60.00	-28.16	QP	
12		15.0968	25.33	0.15	25.48	50.00	-24.52	AVG	

REMARKS:

- (1) Measurement Value = Reading Level + Correct Factor.
- (2) Margin Level = Measurement Value - Limit Value.

Test Mode	Idle	Tested Date	2023/6/9
Test Frequency	-	Phase	Neutral

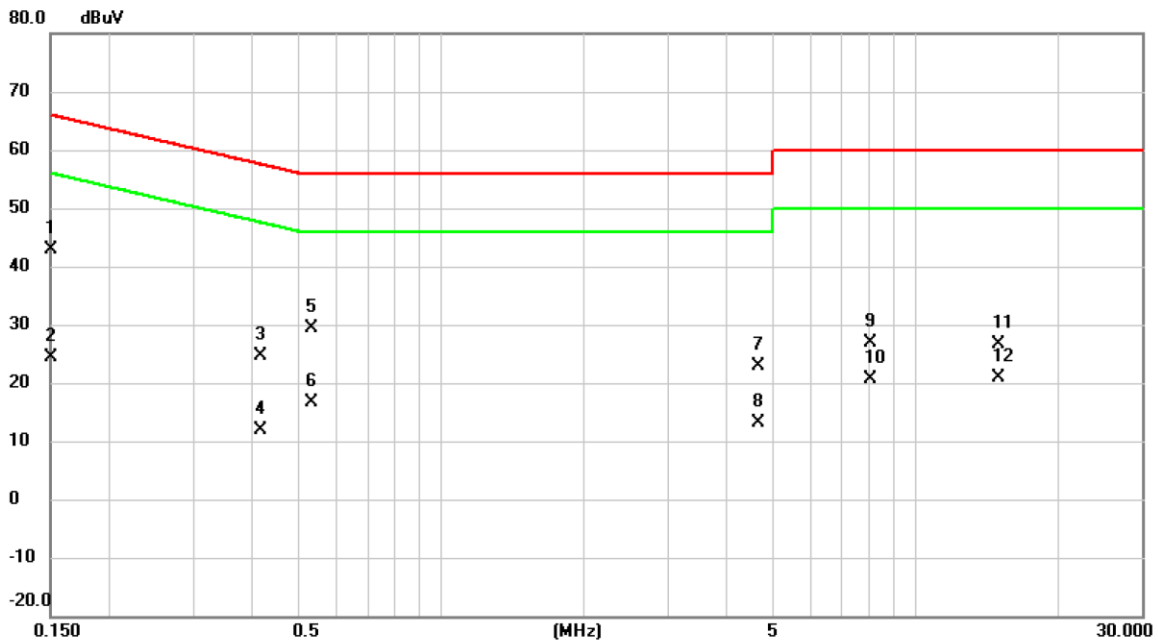

No.	Mk.	Freq.	Reading Level	Correct Factor	Measurement	Limit	Margin	Detector	Comment
		MHz	dBuV	dB	dBuV	dBuV	dB		
1	*	0.1500	42.83	0.04	42.87	66.00	-23.13	QP	
2		0.1500	24.37	0.04	24.41	56.00	-31.59	AVG	
3		0.4154	24.65	0.02	24.67	57.54	-32.87	QP	
4		0.4154	11.85	0.02	11.87	47.54	-35.67	AVG	
5		0.5324	29.30	0.02	29.32	56.00	-26.68	QP	
6		0.5324	16.58	0.02	16.60	46.00	-29.40	AVG	
7		4.6792	22.93	0.05	22.98	56.00	-33.02	QP	
8		4.6792	13.01	0.05	13.06	46.00	-32.94	AVG	
9		8.0586	26.74	0.09	26.83	60.00	-33.17	QP	
10		8.0586	20.52	0.09	20.61	50.00	-29.39	AVG	
11		14.9437	26.43	0.15	26.58	60.00	-33.42	QP	
12		14.9437	20.77	0.15	20.92	50.00	-29.08	AVG	

REMARKS:

- (1) Measurement Value = Reading Level + Correct Factor.
- (2) Margin Level = Measurement Value - Limit Value.

APPENDIX B RADIATED EMISSIONS - 30 MHZ TO 1 GHZ

Test Mode	BT (1 Mbps)	Test Date	2023/6/9
Test Frequency	2402MHz	Polarization	Vertical
Temp	22°C	Hum.	51%

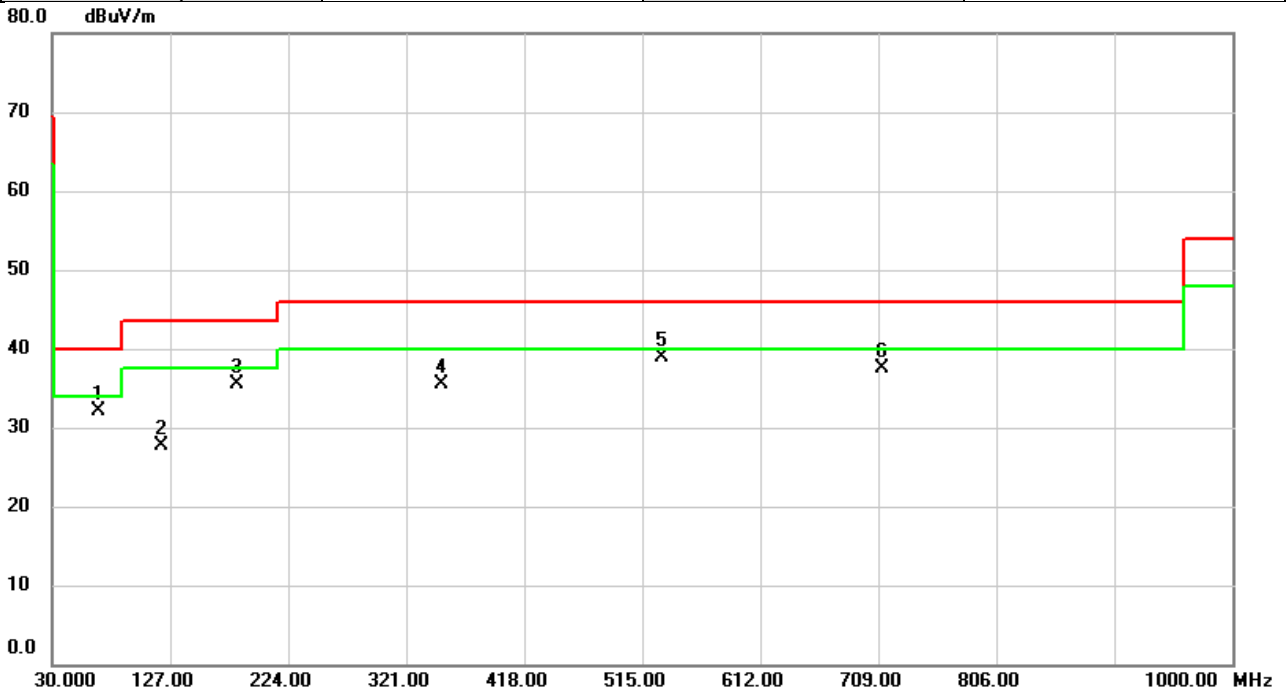

No.	Mk.	Freq. MHz	Reading Level dBuV	Correct Factor dB	Measure- ment dBuV/m	Limit dBuV/m	Over dB	Detector	Comment
1		68.5413	45.79	-13.77	32.02	40.00	-7.98	peak	
2		119.6603	42.17	-14.46	27.71	43.50	-15.79	peak	
3		181.3523	48.98	-13.53	35.45	43.50	-8.05	peak	
4		350.2940	45.68	-10.23	35.45	46.00	-10.55	peak	
5	*	531.0373	44.65	-5.75	38.90	46.00	-7.10	peak	
6		711.9100	39.86	-2.42	37.44	46.00	-8.56	peak	

REMARKS:

- (1) Measurement Value = Reading Level + Correct Factor.
- (2) Margin Level = Measurement Value - Limit Value.

Test Mode	BT (1 Mbps)	Test Date	2023/6/9
Test Frequency	2402MHz	Polarization	Horizontal
Temp	22°C	Hum.	51%

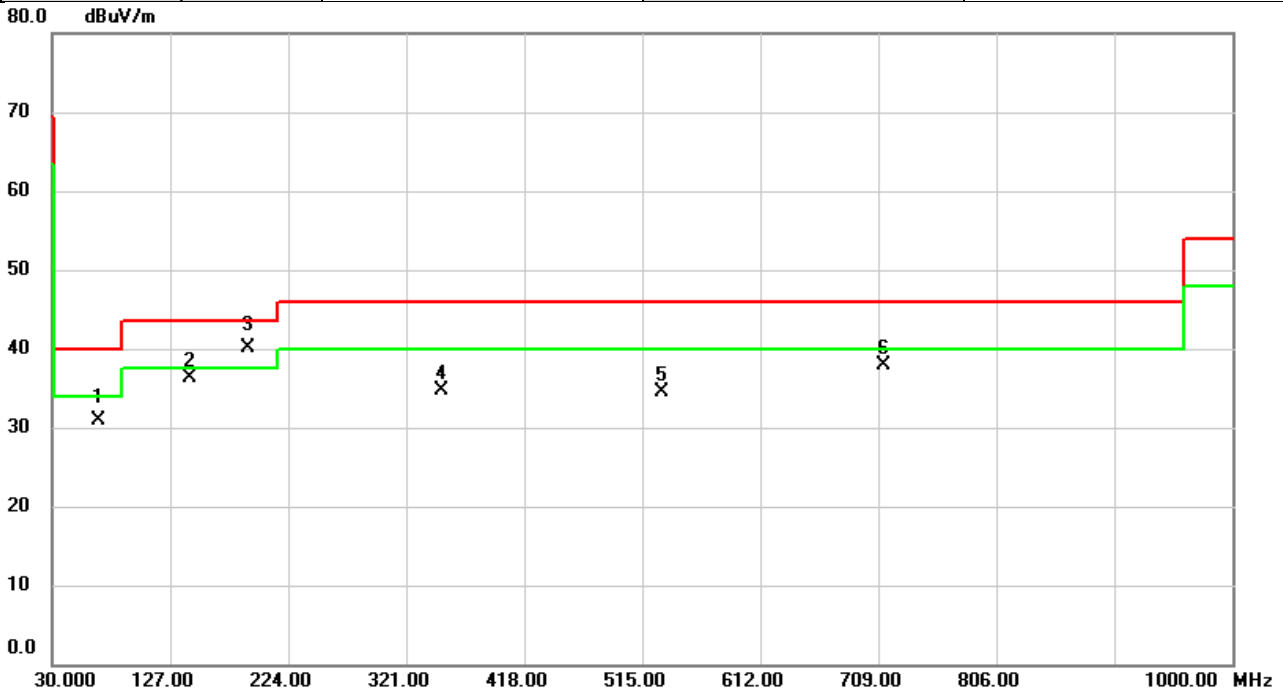

No.	Mk.	Freq.	Reading Level	Correct Factor	Measurement	Limit	Over	Detector	Comment
		MHz	dBuV	dB	dBuV/m	dBuV/m	dB		
1		68.5413	44.70	-13.77	30.93	40.00	-9.07	QP	
2		143.4900	48.81	-12.43	36.38	43.50	-7.12	peak	
3	*	191.3110	54.74	-14.69	40.05	43.50	-3.45	QP	
4		350.5203	44.92	-10.22	34.70	46.00	-11.30	peak	
5		531.0696	40.31	-5.75	34.56	46.00	-11.44	peak	
6		713.9146	40.25	-2.37	37.88	46.00	-8.12	peak	

REMARKS:

- (1) Measurement Value = Reading Level + Correct Factor.
- (2) Margin Level = Measurement Value - Limit Value.

APPENDIX C RADIATED EMISSIONS - ABOVE 1 GHZ

Test Mode	BT (1 Mbps)	Test Date	2023/6/9
Test Frequency	2402MHz	Polarization	Horizontal
Temp	22°C	Hum.	51%

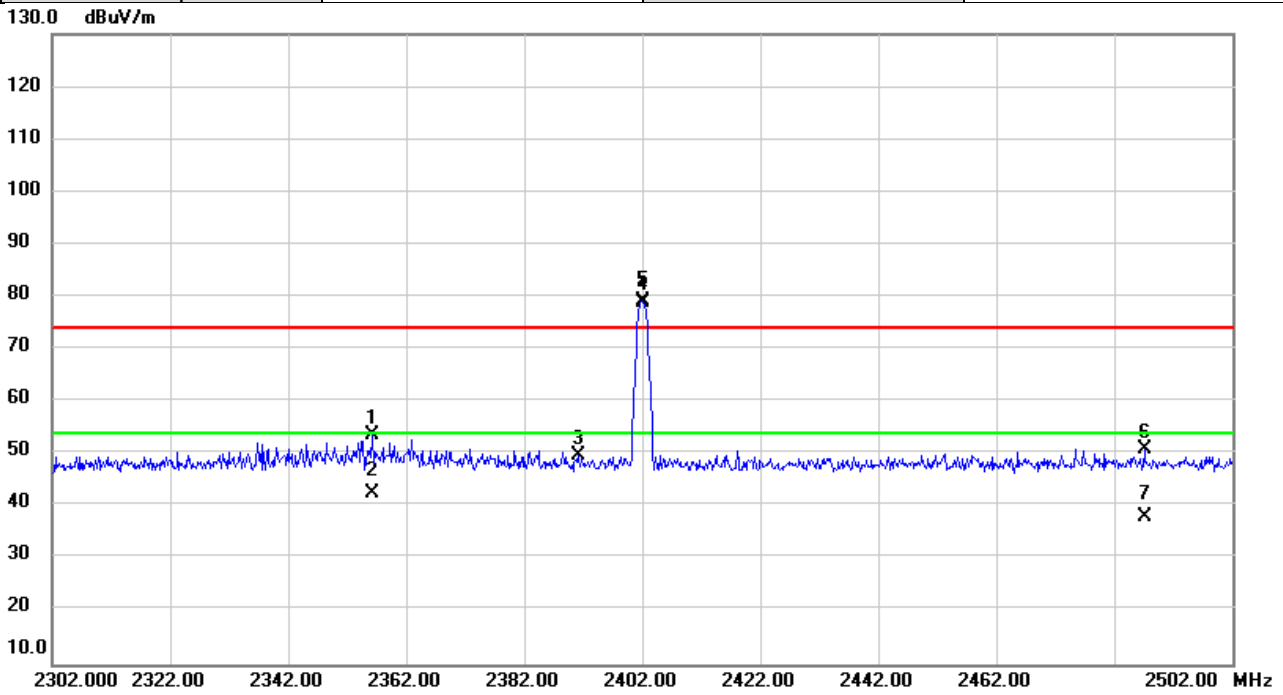

No.	Mk.	Freq.	Reading Level	Correct Factor	Measurement	Limit	Over	Detector	Comment
		MHz	dBuV	dB	dBuV/m	dBuV/m	dB		
1		2356.207	59.12	-5.44	53.68	74.00	-20.32	peak	
2		2356.207	48.05	-5.44	42.61	54.00	-11.39	AVG	
3		2391.120	55.02	-5.37	49.65	74.00	-24.35	peak	No Limit
4	X	2402.000	84.65	-5.36	79.29	74.00	5.29	peak	No Limit
5	*	2402.000	84.17	-5.36	78.81	54.00	24.81	AVG	No Limit
6		2487.100	56.20	-5.21	50.99	74.00	-23.01	peak	
7		2487.100	43.19	-5.21	37.98	54.00	-16.02	AVG	

REMARKS:

- (1) Measurement Value = Reading Level + Correct Factor.
- (2) Margin Level = Measurement Value - Limit Value.

Test Mode	BT (1 Mbps)	Test Date	2023/6/9
Test Frequency	2480MHz	Polarization	Horizontal
Temp	22°C	Hum.	51%

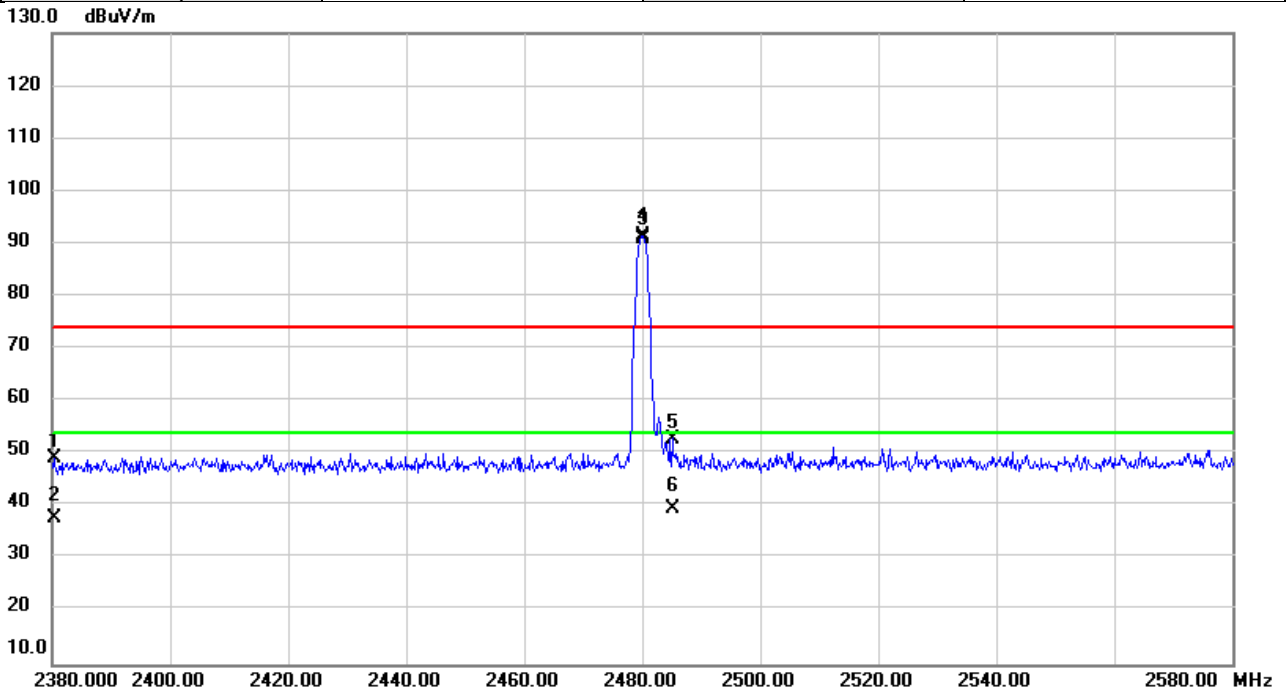

No.	Mk.	Freq.	Reading Level	Correct Factor	Measurement	Limit	Over	Detector	Comment
		MHz	dBuV	dB	dBuV/m	dBuV/m	dB		
1		2380.307	54.49	-5.39	49.10	74.00	-24.90	peak	
2		2380.307	43.07	-5.39	37.68	54.00	-16.32	AVG	
3	X	2480.000	96.59	-5.22	91.37	74.00	17.37	peak	No Limit
4	*	2480.000	96.21	-5.22	90.99	54.00	36.99	AVG	No Limit
5		2485.080	58.11	-5.21	52.90	74.00	-21.10	peak	
6		2485.080	44.83	-5.21	39.62	54.00	-14.38	AVG	

REMARKS:

- (1) Measurement Value = Reading Level + Correct Factor.
- (2) Margin Level = Measurement Value - Limit Value.

Test Mode	BT (3 Mbps)	Test Date	2023/6/9
Test Frequency	2402MHz	Polarization	Horizontal
Temp	22°C	Hum.	51%

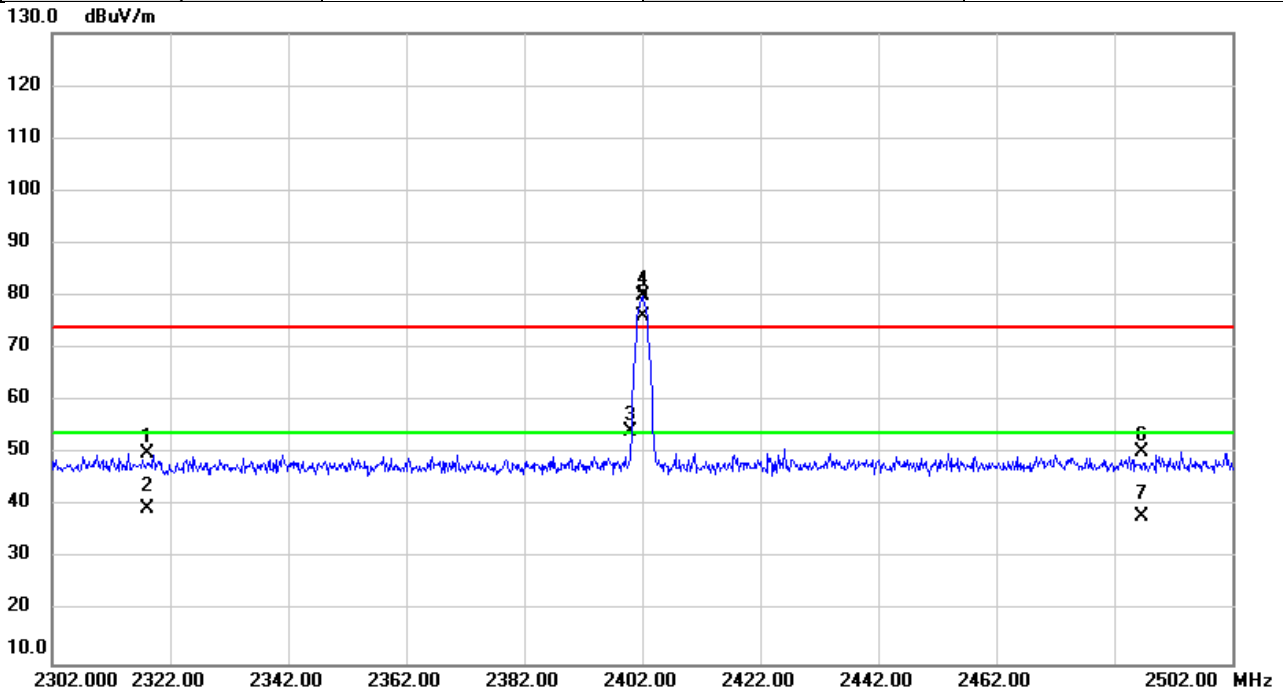

No.	Mk.	Freq.	Reading Level	Correct Factor	Measurement	Limit	Over	Detector	Comment
		MHz	dBuV	dB	dBuV/m	dBuV/m	dB		
1		2318.139	55.51	-5.50	50.01	74.00	-23.99	peak	
2		2318.139	44.96	-5.50	39.46	54.00	-14.54	AVG	
3		2400.000	59.77	-5.37	54.40	74.00	-19.60	peak	No Limit
4	X	2402.000	85.29	-5.36	79.93	74.00	5.93	peak	No Limit
5	*	2402.000	81.66	-5.36	76.30	54.00	22.30	AVG	No Limit
6		2486.646	55.57	-5.21	50.36	74.00	-23.64	peak	
7		2486.646	43.20	-5.21	37.99	54.00	-16.01	AVG	

REMARKS:

- (1) Measurement Value = Reading Level + Correct Factor.
- (2) Margin Level = Measurement Value - Limit Value.

Test Mode	BT (3 Mbps)	Test Date	2023/6/9
Test Frequency	2480MHz	Polarization	Horizontal
Temp	22°C	Hum.	51%

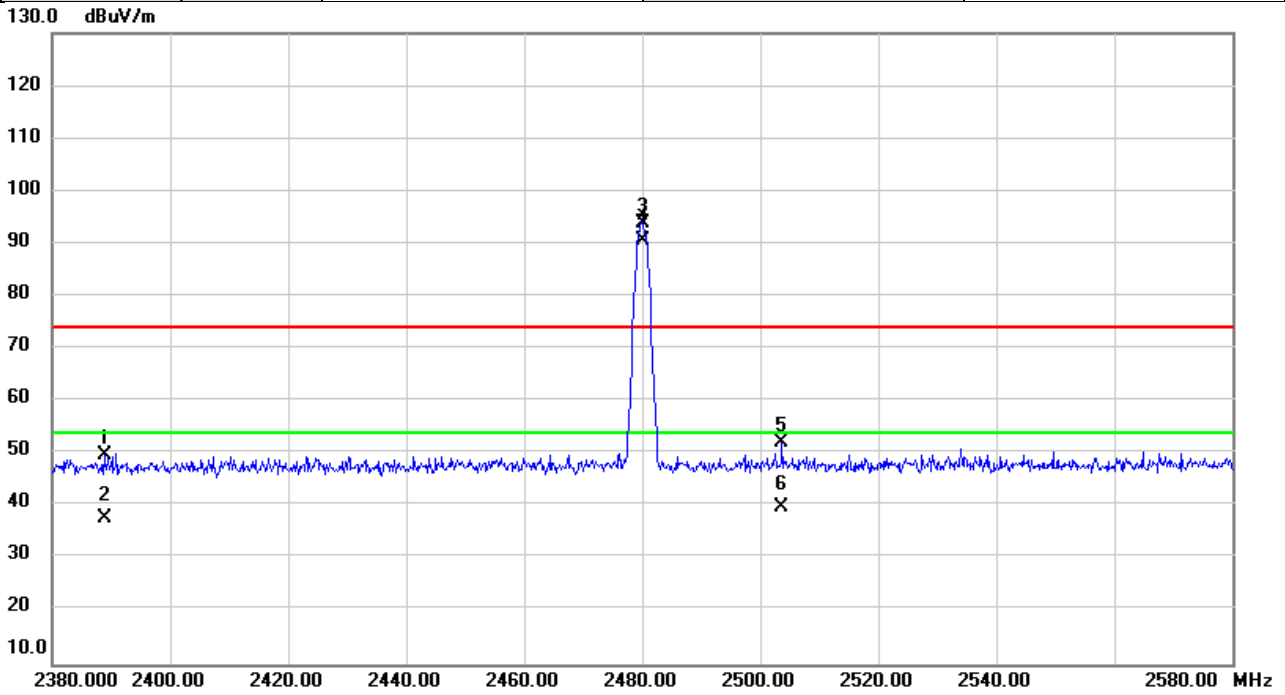

No.	Mk.	Freq.	Reading Level	Correct Factor	Measurement	Limit	Over	Detector	Comment
		MHz	dBuV	dB	dBuV/m	dBuV/m	dB		
1		2388.920	55.10	-5.39	49.71	74.00	-24.29	peak	
2		2388.922	43.02	-5.39	37.63	54.00	-16.37	AVG	
3	X	2480.000	99.22	-5.22	94.00	74.00	20.00	peak	No Limit
4	*	2480.000	95.63	-5.22	90.41	54.00	36.41	AVG	No Limit
5		2503.627	57.35	-5.18	52.17	74.00	-21.83	peak	
6		2503.627	44.90	-5.18	39.72	54.00	-14.28	AVG	

REMARKS:

- (1) Measurement Value = Reading Level + Correct Factor.
- (2) Margin Level = Measurement Value - Limit Value.

Test Mode	BT (1 Mbps)	Test Date	2023/6/9
Test Frequency	2402MHz	Polarization	Vertical
Temp	22°C	Hum.	51%

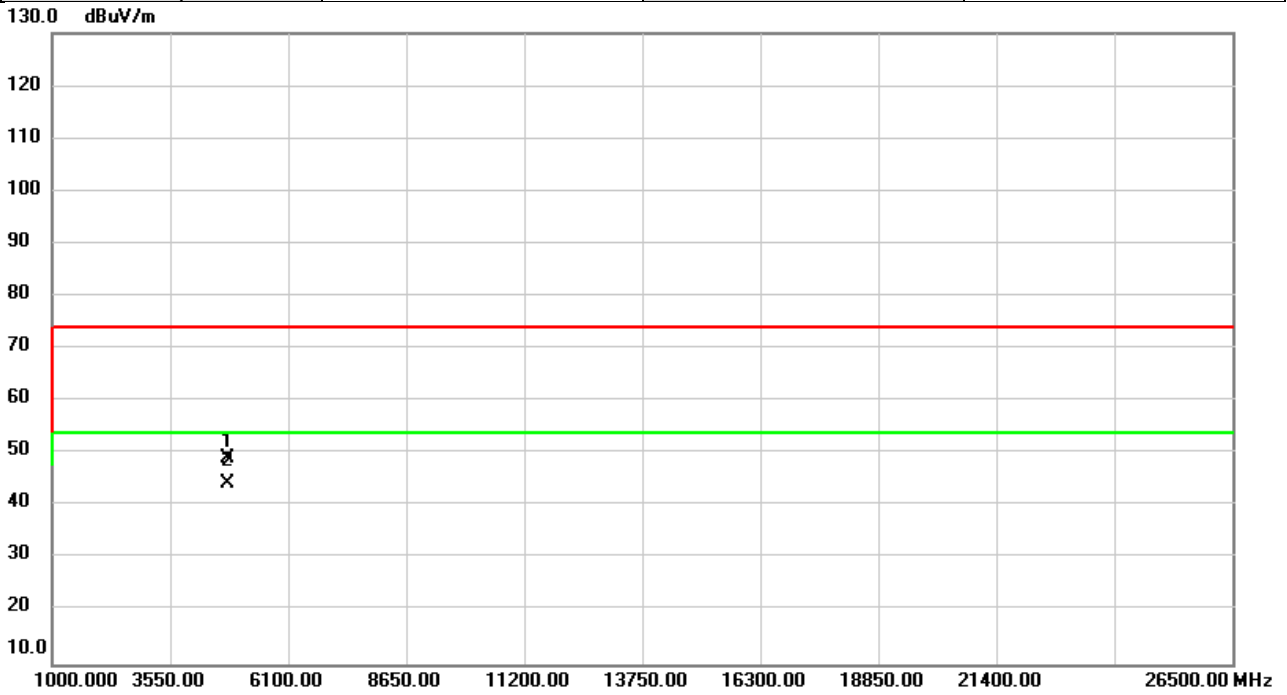

No.	Mk.	Freq. MHz	Reading Level dBuV	Correct Factor dB	Measure- ment dBuV/m	Limit dBuV/m	Over dB	Detector	Comment
1		4804.000	48.66	0.53	49.19	74.00	-24.81	peak	
2	*	4804.000	43.93	0.53	44.46	54.00	-9.54	AVG	

REMARKS:

- (1) Measurement Value = Reading Level + Correct Factor.
- (2) Margin Level = Measurement Value - Limit Value.

Test Mode	BT (1 Mbps)	Test Date	2023/6/9
Test Frequency	2402MHz	Polarization	Horizontal
Temp	22°C	Hum.	51%

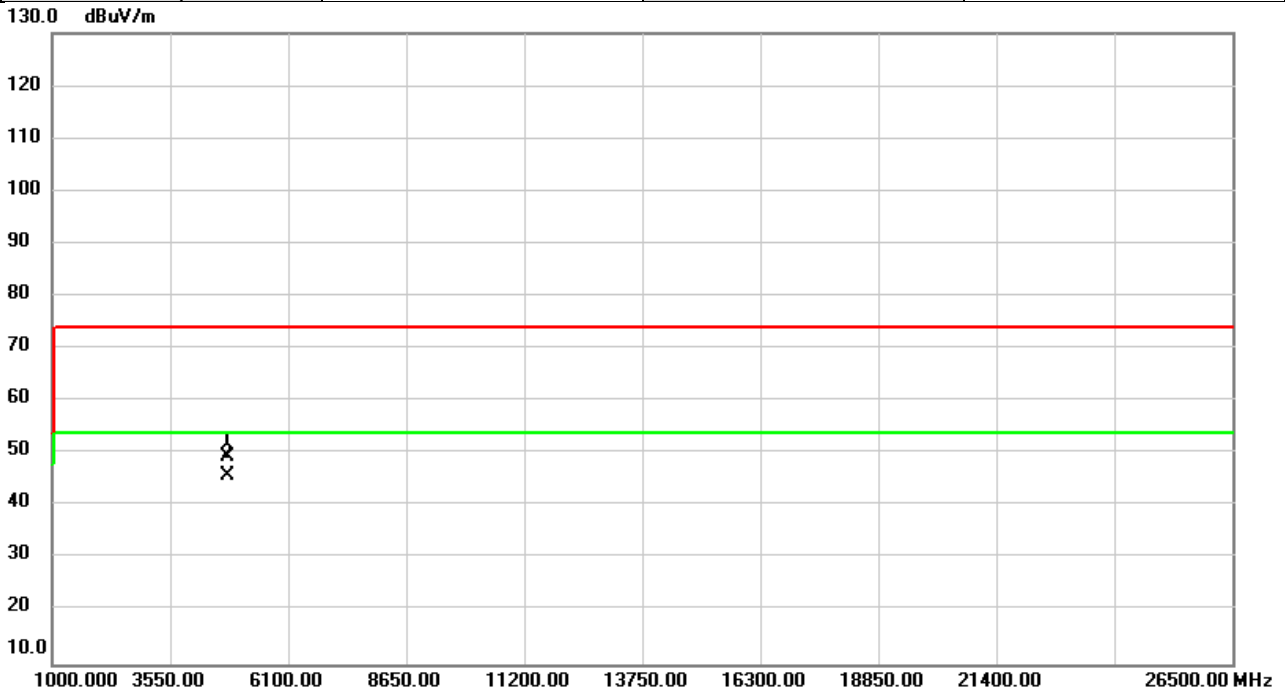

No.	Mk.	Freq. MHz	Reading Level dBuV	Correct Factor dB	Measure- ment dBuV/m	Limit dBuV/m	Over dB	Detector	Comment
1		4804.000	49.04	0.53	49.57	74.00	-24.43	peak	
2	*	4804.000	45.34	0.53	45.87	54.00	-8.13	AVG	

REMARKS:

- (1) Measurement Value = Reading Level + Correct Factor.
- (2) Margin Level = Measurement Value - Limit Value.

Test Mode	BT (1 Mbps)	Test Date	2023/6/9
Test Frequency	2441MHz	Polarization	Vertical
Temp	22°C	Hum.	51%

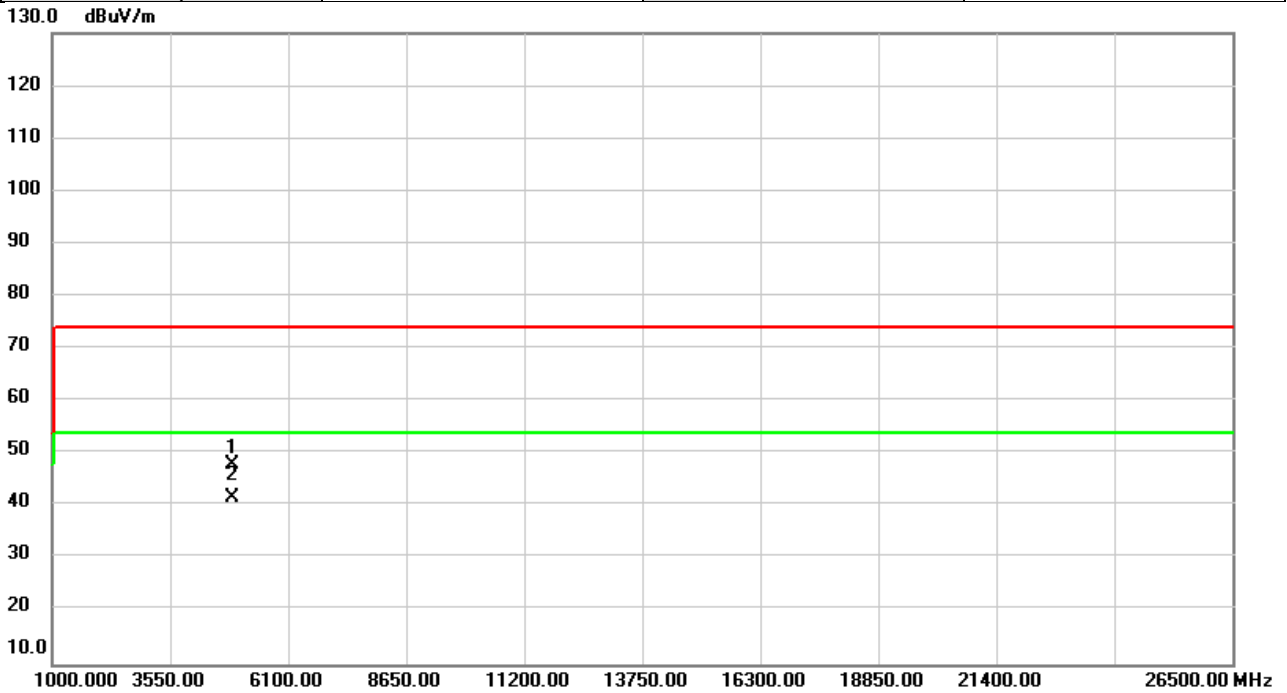

No.	Mk.	Freq. MHz	Reading Level dBuV	Correct Factor dB	Measure- ment dBuV/m	Limit dBuV/m	Over dB	Detector	Comment
1		4882.000	47.20	0.76	47.96	74.00	-26.04	peak	
2	*	4882.000	40.91	0.76	41.67	54.00	-12.33	AVG	

REMARKS:

- (1) Measurement Value = Reading Level + Correct Factor.
- (2) Margin Level = Measurement Value - Limit Value.

Test Mode	BT (1 Mbps)	Test Date	2023/6/9
Test Frequency	2441MHz	Polarization	Horizontal
Temp	22°C	Hum.	51%

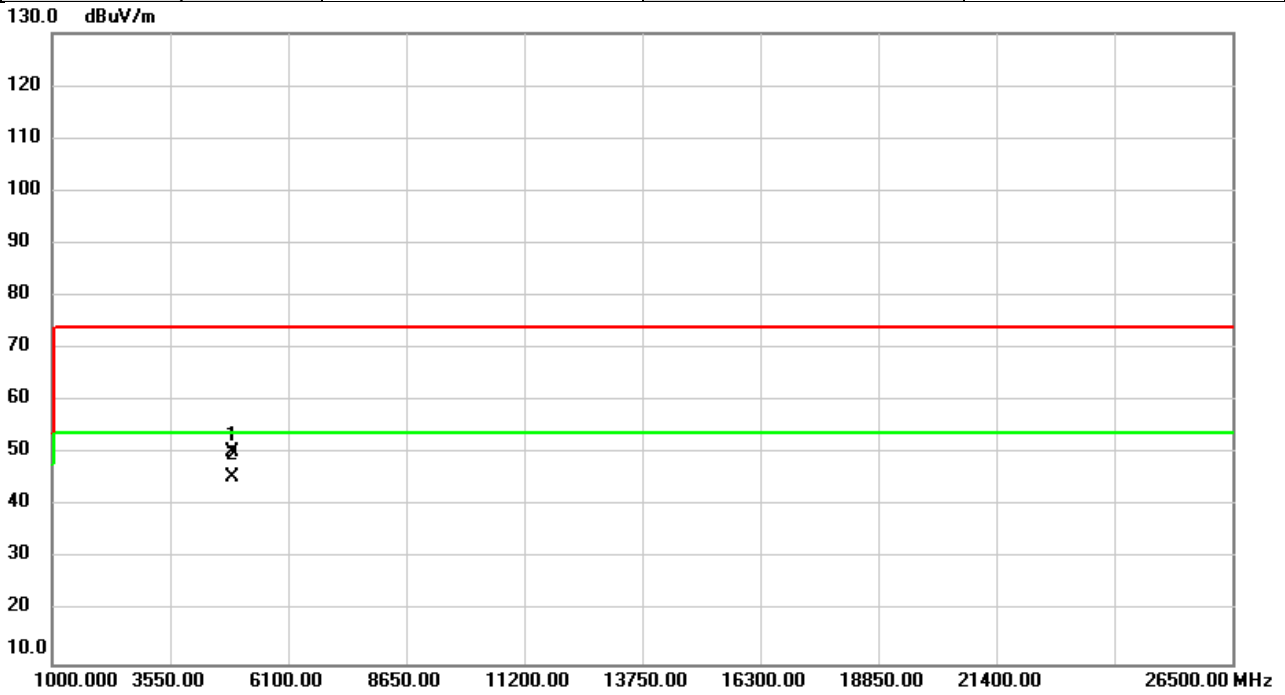

No.	Mk.	Freq. MHz	Reading Level dBuV	Correct Factor dB	Measure- ment dBuV/m	Limit dBuV/m	Over dB	Detector	Comment
1		4882.000	49.64	0.76	50.40	74.00	-23.60	peak	
2	*	4882.000	44.82	0.76	45.58	54.00	-8.42	AVG	

REMARKS:

- (1) Measurement Value = Reading Level + Correct Factor.
- (2) Margin Level = Measurement Value - Limit Value.

Test Mode	BT (1 Mbps)	Test Date	2023/6/9
Test Frequency	2480MHz	Polarization	Vertical
Temp	22°C	Hum.	51%

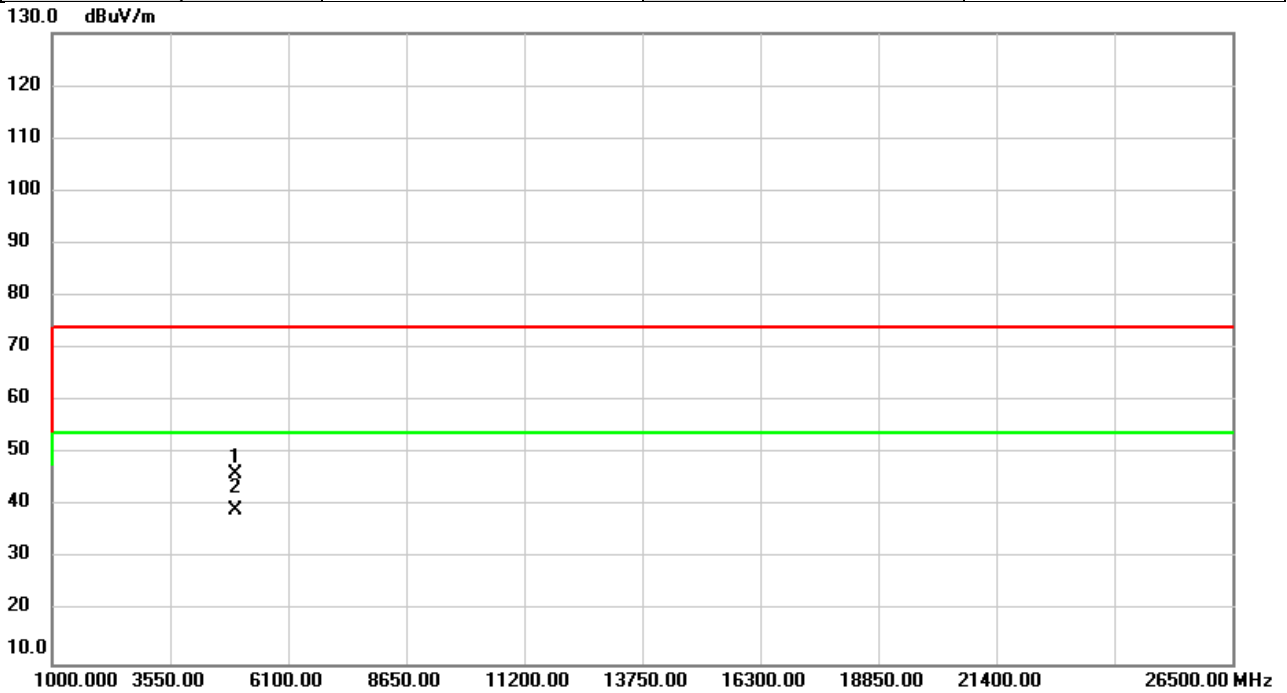

No.	Mk.	Freq. MHz	Reading Level dBuV	Correct Factor dB	Measure- ment dBuV/m	Limit dBuV/m	Over dB	Detector	Comment
1		4960.000	45.29	1.00	46.29	74.00	-27.71	peak	
2	*	4960.000	38.11	1.00	39.11	54.00	-14.89	AVG	

REMARKS:

- (1) Measurement Value = Reading Level + Correct Factor.
- (2) Margin Level = Measurement Value - Limit Value.

Test Mode	BT (1 Mbps)	Test Date	2023/6/9
Test Frequency	2480MHz	Polarization	Horizontal
Temp	22°C	Hum.	51%

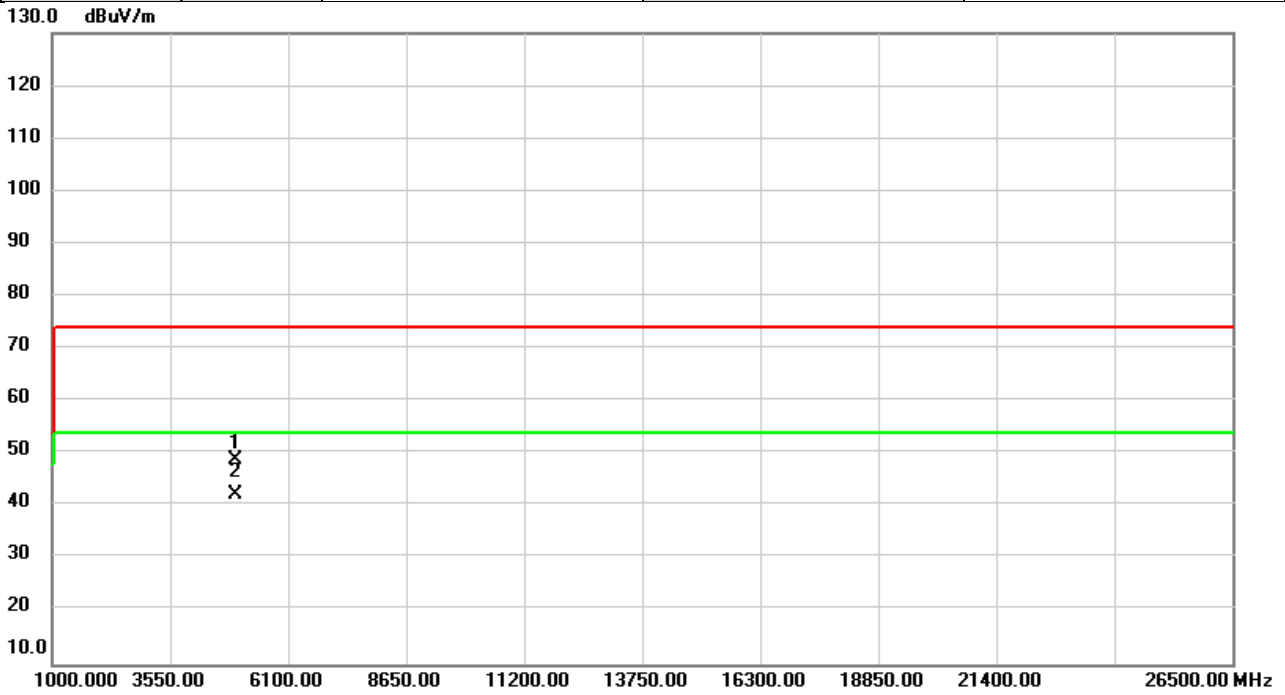

No.	Mk.	Freq. MHz	Reading Level dBuV	Correct Factor dB	Measure- ment dBuV/m	Limit dBuV/m	Over dB	Detector	Comment
1		4960.000	47.93	1.00	48.93	74.00	-25.07	peak	
2	*	4960.150	41.23	1.00	42.23	54.00	-11.77	AVG	

REMARKS:

- (1) Measurement Value = Reading Level + Correct Factor.
- (2) Margin Level = Measurement Value - Limit Value.

Test Mode	BT (3 Mbps)	Test Date	2023/6/9
Test Frequency	2402MHz	Polarization	Vertical
Temp	22°C	Hum.	51%

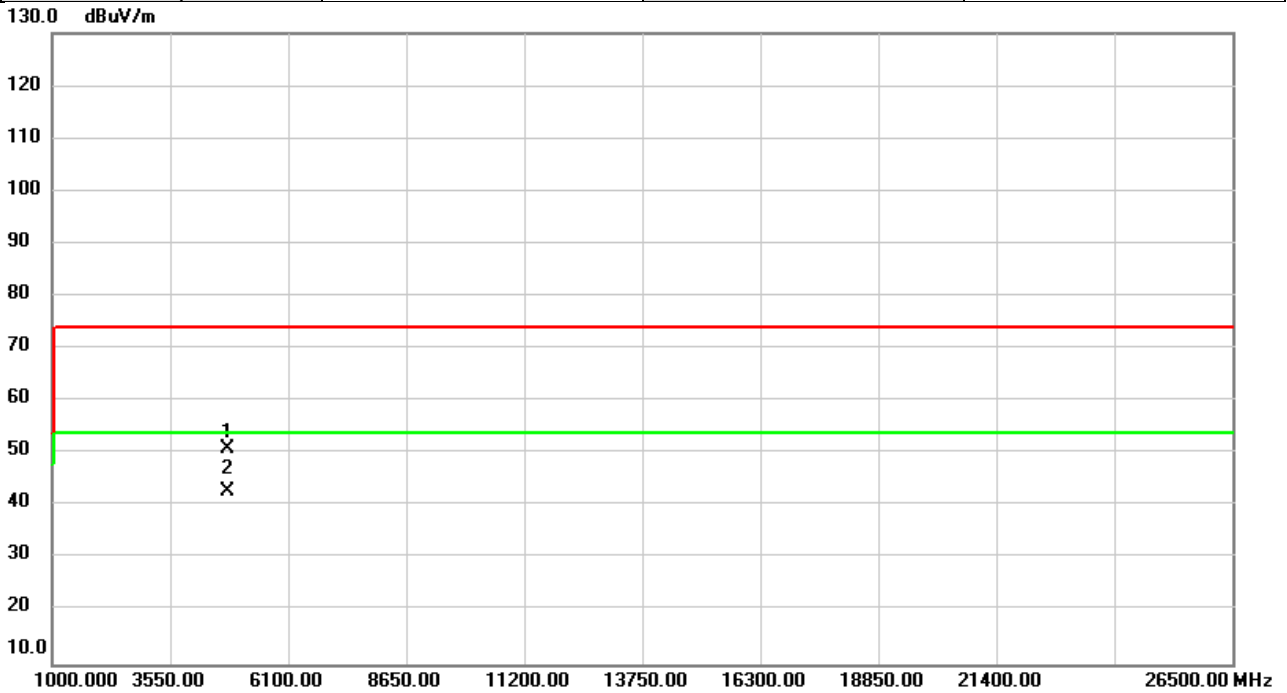

No.	Mk.	Freq. MHz	Reading Level dBuV	Correct Factor dB	Measure- ment dBuV/m	Limit dBuV/m	Over dB	Detector	Comment
1		4804.000	50.29	0.53	50.82	74.00	-23.18	peak	
2	*	4804.000	42.24	0.53	42.77	54.00	-11.23	AVG	

REMARKS:

- (1) Measurement Value = Reading Level + Correct Factor.
- (2) Margin Level = Measurement Value - Limit Value.

Test Mode	BT (3 Mbps)	Test Date	2023/6/9
Test Frequency	2402MHz	Polarization	Horizontal
Temp	22°C	Hum.	51%

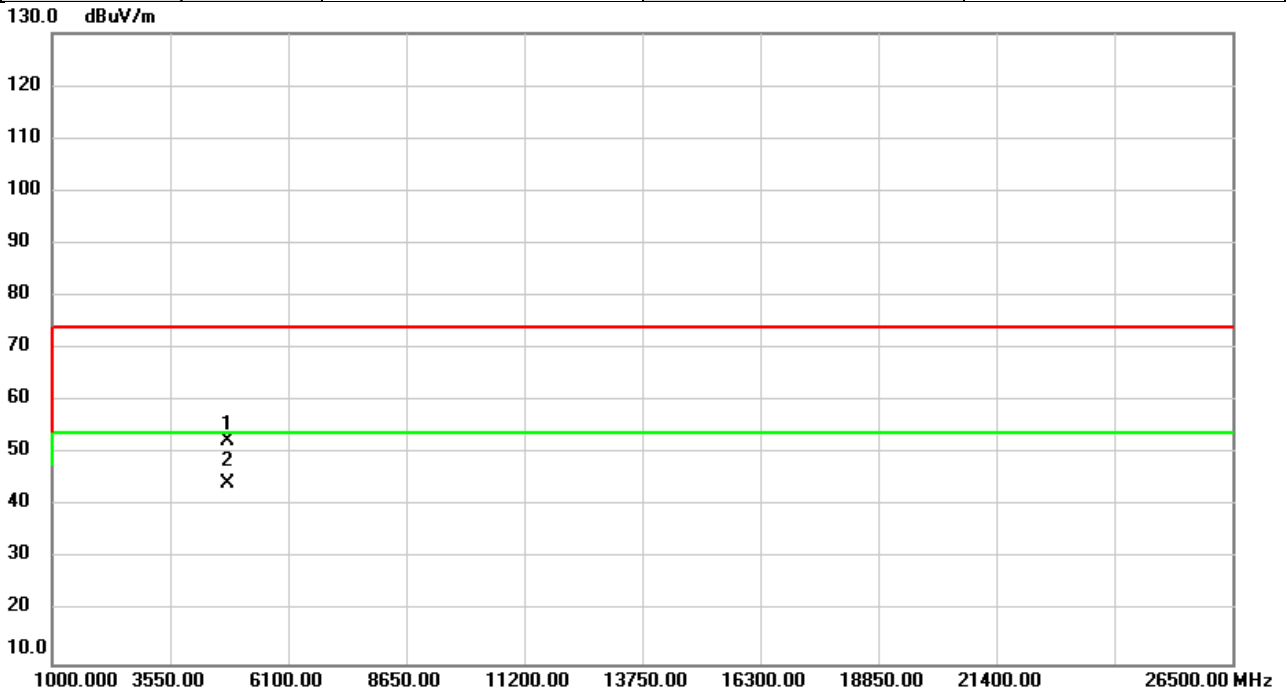

No.	Mk.	Freq. MHz	Reading Level dBuV	Correct Factor dB	Measure- ment dBuV/m	Limit dBuV/m	Over dB	Detector	Comment
1		4804.000	52.01	0.53	52.54	74.00	-21.46	peak	
2	*	4804.000	43.97	0.53	44.50	54.00	-9.50	AVG	

REMARKS:

- (1) Measurement Value = Reading Level + Correct Factor.
- (2) Margin Level = Measurement Value - Limit Value.

Test Mode	BT (3 Mbps)	Test Date	2023/6/9
Test Frequency	2441MHz	Polarization	Vertical
Temp	22°C	Hum.	51%

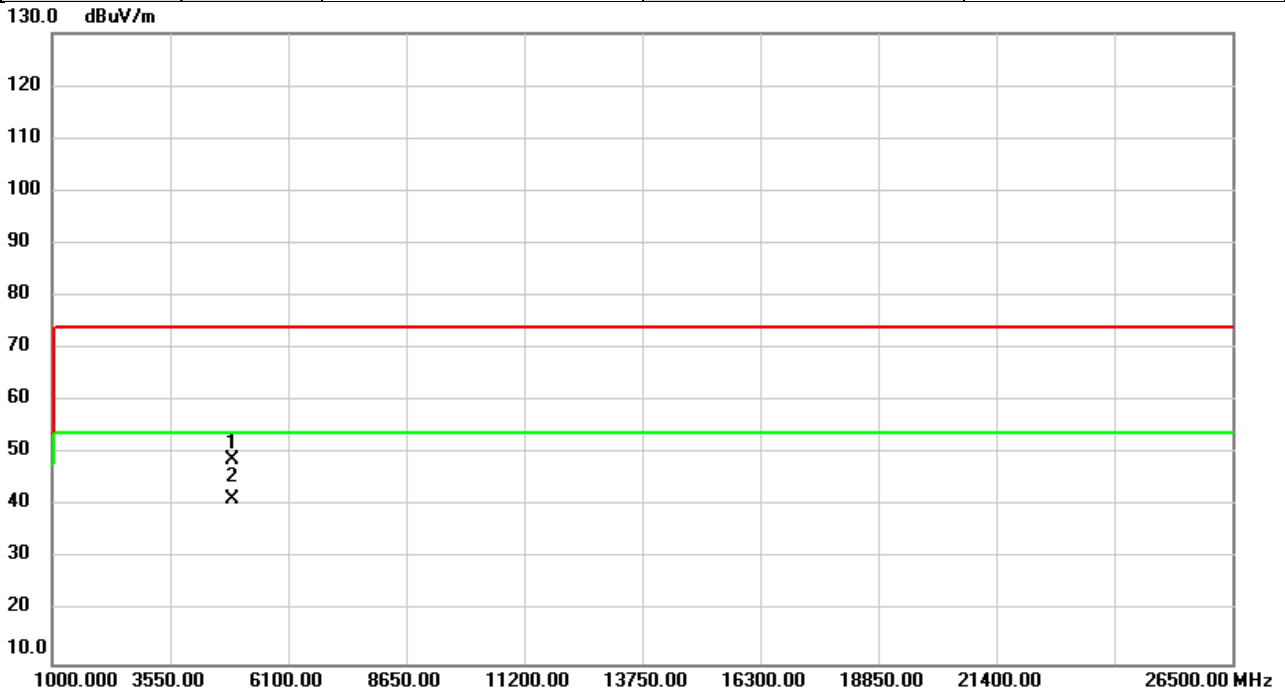

No.	Mk.	Freq. MHz	Reading Level dBuV	Correct Factor dB	Measure- ment dBuV/m	Limit dBuV/m	Over dB	Detector	Comment
1		4882.000	48.07	0.76	48.83	74.00	-25.17	peak	
2	*	4882.000	40.57	0.76	41.33	54.00	-12.67	AVG	

REMARKS:

- (1) Measurement Value = Reading Level + Correct Factor.
- (2) Margin Level = Measurement Value - Limit Value.

Test Mode	BT (3 Mbps)	Test Date	2023/6/9
Test Frequency	2441MHz	Polarization	Horizontal
Temp	22°C	Hum.	51%

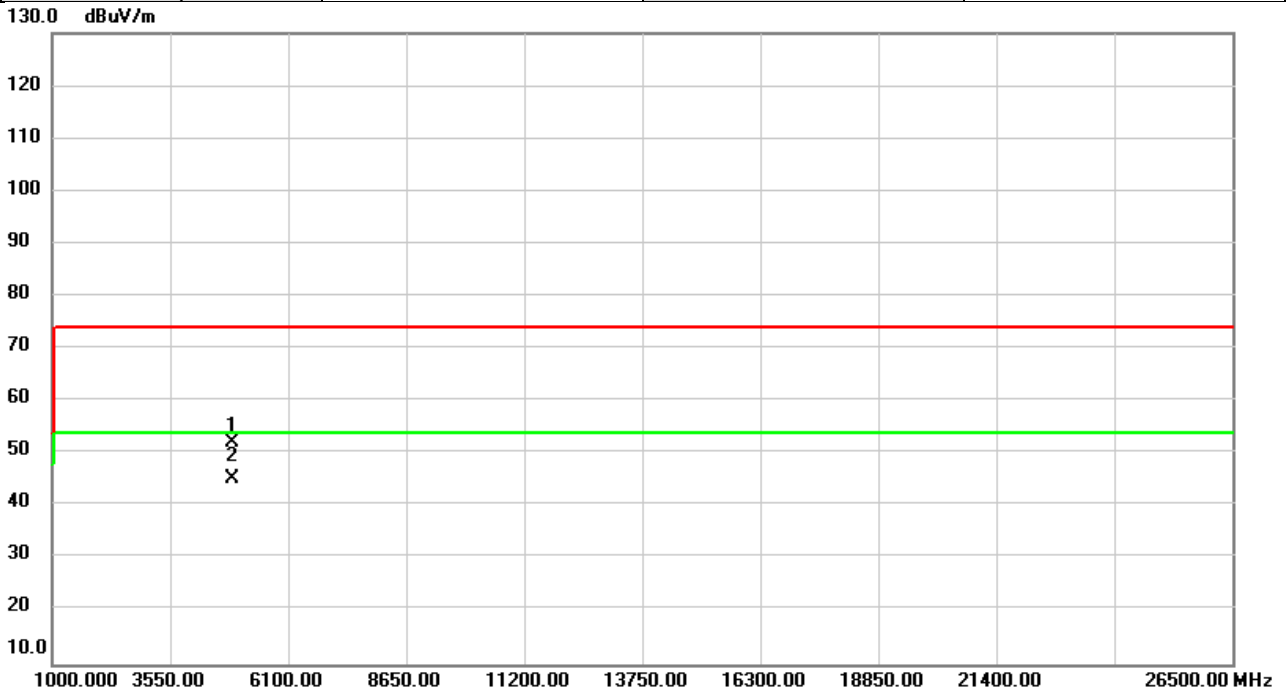

No.	Mk.	Freq. MHz	Reading Level dBuV	Correct Factor dB	Measure- ment dBuV/m	Limit dBuV/m	Over dB	Detector	Comment
1		4882.000	51.47	0.76	52.23	74.00	-21.77	peak	
2	*	4882.000	44.56	0.76	45.32	54.00	-8.68	AVG	

REMARKS:

- (1) Measurement Value = Reading Level + Correct Factor.
- (2) Margin Level = Measurement Value - Limit Value.

Test Mode	BT (3 Mbps)	Test Date	2023/6/9
Test Frequency	2480MHz	Polarization	Vertical
Temp	22°C	Hum.	51%

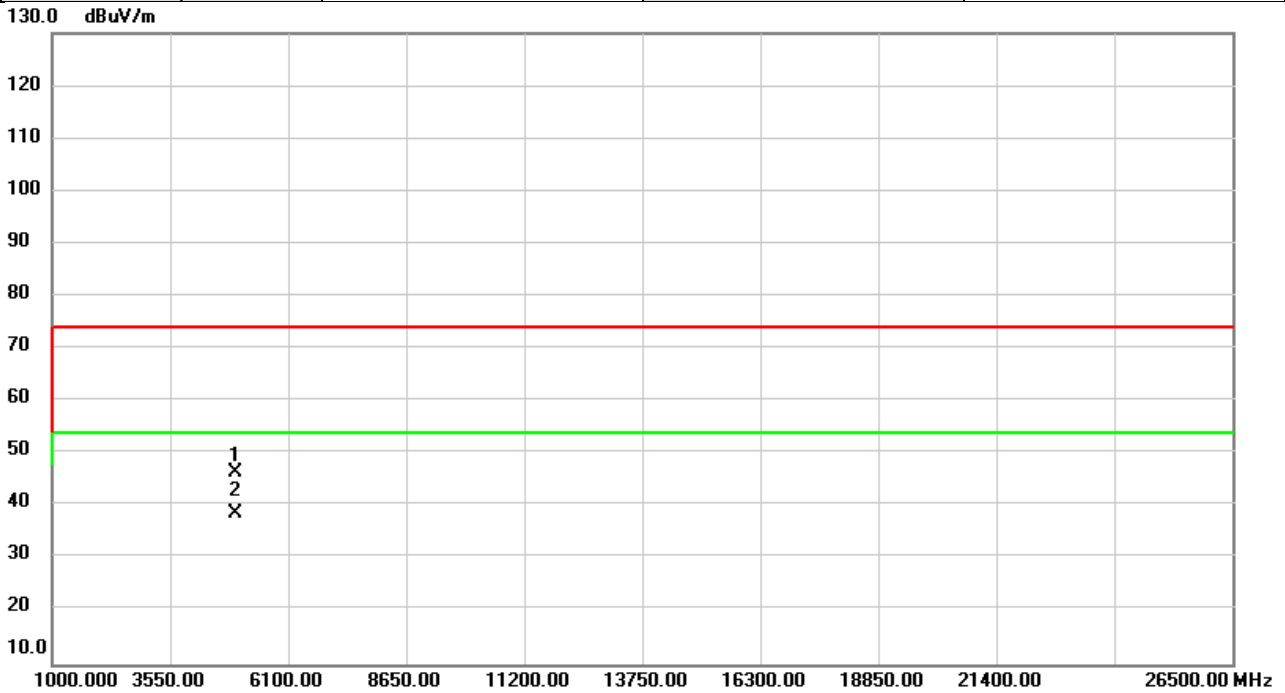

No.	Mk.	Freq. MHz	Reading Level dBuV	Correct Factor dB	Measure- ment dBuV/m	Limit dBuV/m	Over dB	Detector	Comment
1		4960.000	45.43	1.00	46.43	74.00	-27.57	peak	
2	*	4960.000	37.65	1.00	38.65	54.00	-15.35	AVG	

REMARKS:

- (1) Measurement Value = Reading Level + Correct Factor.
- (2) Margin Level = Measurement Value - Limit Value.

Test Mode	BT (3 Mbps)	Test Date	2023/6/9
Test Frequency	2480MHz	Polarization	Horizontal
Temp	22°C	Hum.	51%

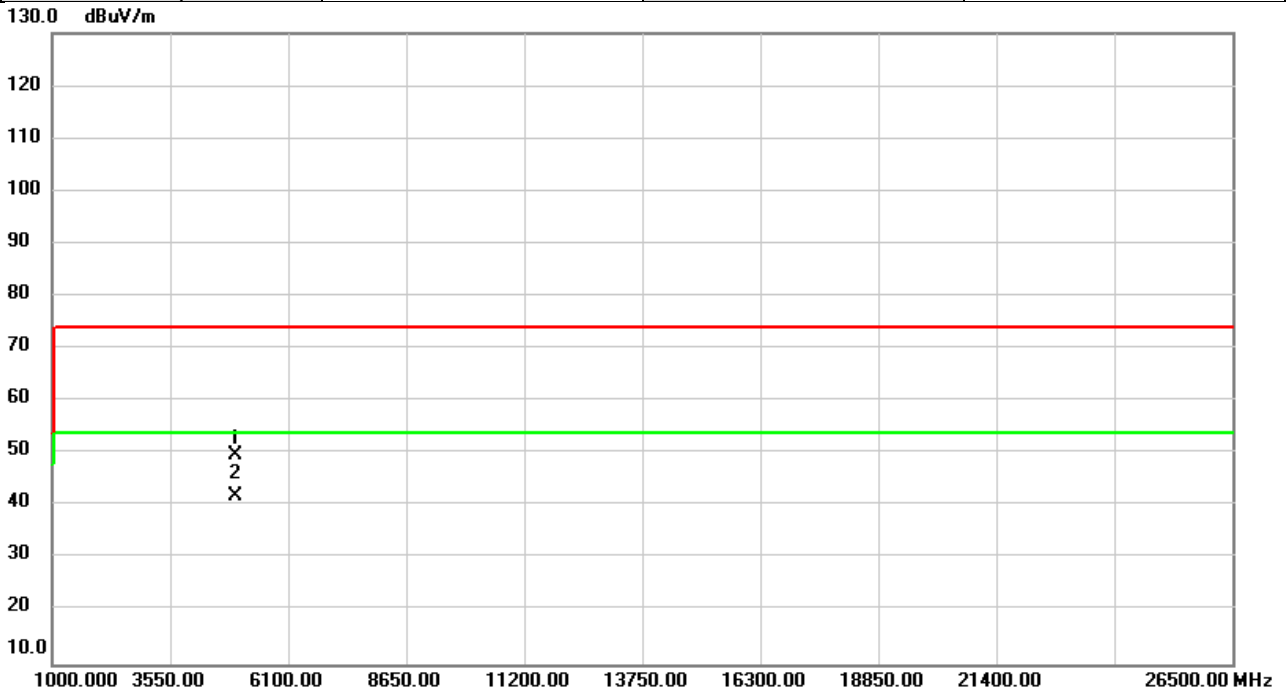

No.	Mk.	Freq. MHz	Reading Level dBuV	Correct Factor dB	Measure- ment dBuV/m	Limit dBuV/m	Over dB	Detector	Comment
1		4960.000	48.68	1.00	49.68	74.00	-24.32	peak	
2	*	4960.000	40.96	1.00	41.96	54.00	-12.04	AVG	

REMARKS:

- (1) Measurement Value = Reading Level + Correct Factor.
- (2) Margin Level = Measurement Value - Limit Value.

APPENDIX D NUMBER OF HOPPING CHANNEL

Test Mode	1/3Mbps
-----------	---------

Test Mode	Number of Hopping Channel	≥ Limit	Test Result
1 Mbps	79	15	Pass
3 Mbps	79	15	Pass

1 Mbps

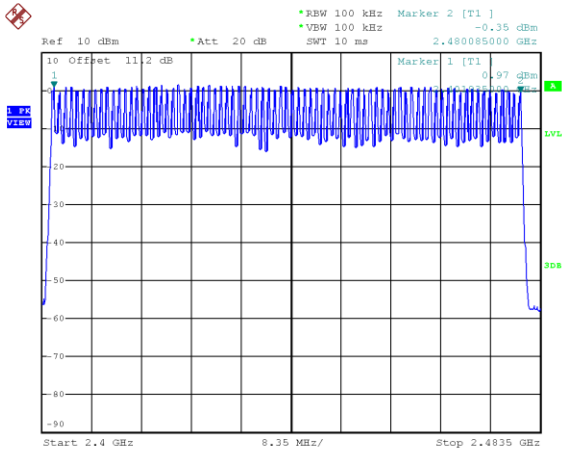

Date: 12.JUN.2023 14:51:34

3 Mbps

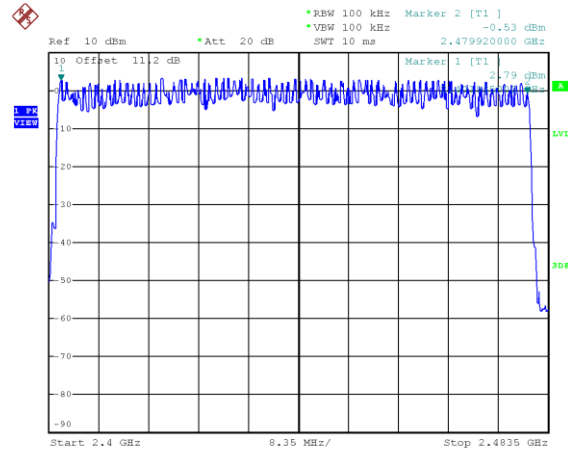

Date: 12.JUN.2023 15:26:52

APPENDIX E AVERAGE TIME OF OCCUPANCY

Test Mode : 1Mbps

Data Packet	Frequency (MHz)	Pulse Duration (ms)	Dwell Time (s)	Limits (s)	Test Result
DH5	2402	2.8800	0.3072	0.4000	Pass
DH3	2402	1.6400	0.2624	0.4000	Pass
DH1	2402	0.3850	0.1232	0.4000	Pass
DH5	2441	2.8800	0.3072	0.4000	Pass
DH3	2441	1.6400	0.2624	0.4000	Pass
DH1	2441	0.3850	0.1232	0.4000	Pass
DH5	2480	2.8800	0.3072	0.4000	Pass
DH3	2480	1.6400	0.2624	0.4000	Pass
DH1	2480	0.3850	0.1232	0.4000	Pass

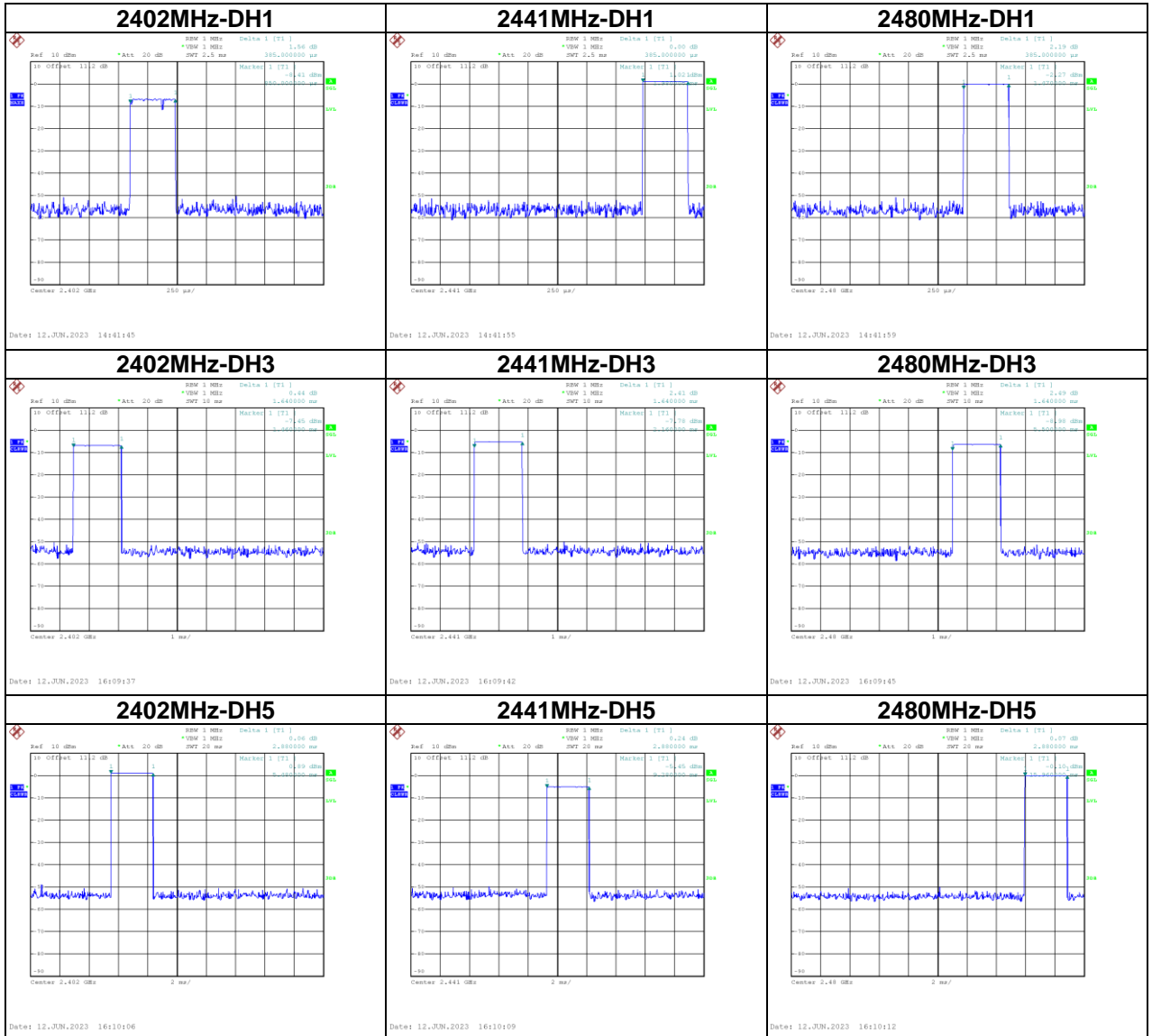

Test Mode : 3Mbps

Data Packet	Frequency	Pulse Duration(ms)	Dwell Time(s)	Limits(s)	Test Result
3DH5	2402	2.8800	0.3072	0.4000	Pass
3DH3	2402	1.6400	0.2624	0.4000	Pass
3DH1	2402	0.3950	0.1264	0.4000	Pass
3DH5	2441	2.9200	0.3115	0.4000	Pass
3DH3	2441	1.6400	0.2624	0.4000	Pass
3DH1	2441	0.3950	0.1264	0.4000	Pass
3DH5	2480	2.8800	0.3072	0.4000	Pass
3DH3	2480	1.6400	0.2624	0.4000	Pass
3DH1	2480	0.3950	0.1264	0.4000	Pass

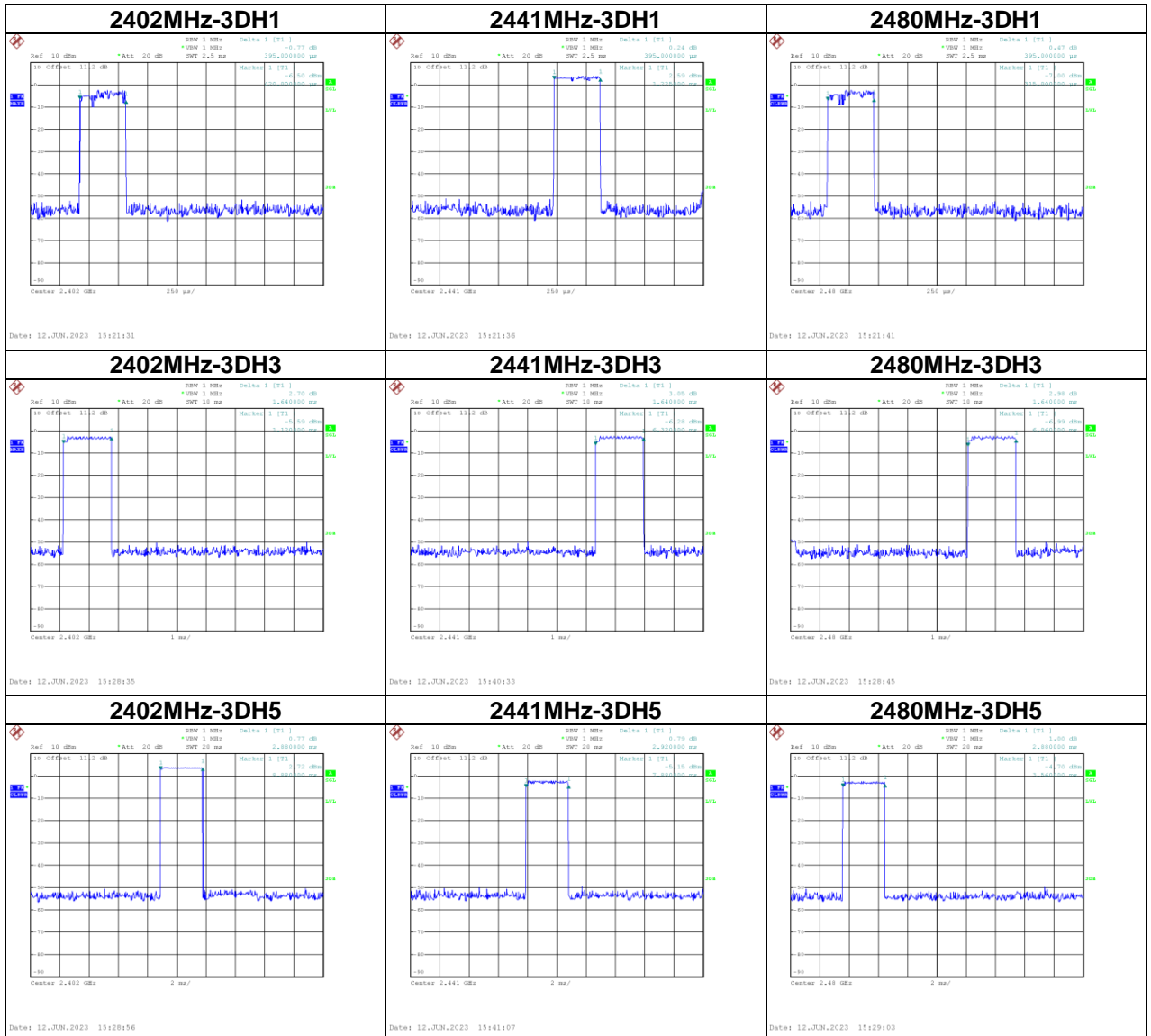

APPENDIX F HOPPING CHANNEL SEPARATION MEASUREMENT

Test Mode : Hopping on _1Mbps

Frequency (MHz)	Channel Separation (MHz)	2/3 of 20dB Bandwidth (MHz)	Test Result
2402	1.008	0.639	Pass
2441	1.002	0.639	Pass
2480	1.008	0.635	Pass

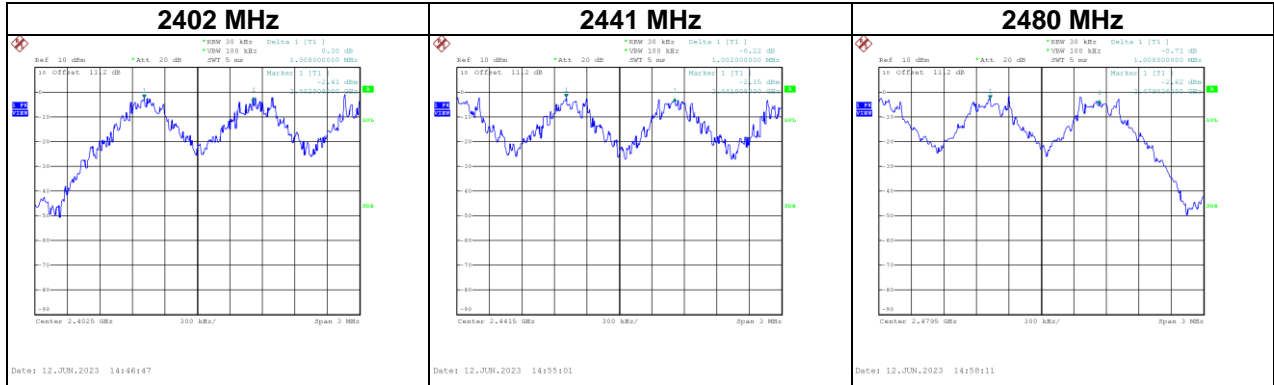

Test Mode : Hopping on _3Mbps

Frequency (MHz)	Channel Separation (MHz)	2/3 of 20dB Bandwidth (MHz)	Test Result
2402	1.002	0.855	Pass
2441	1.010	0.873	Pass
2480	0.993	0.868	Pass

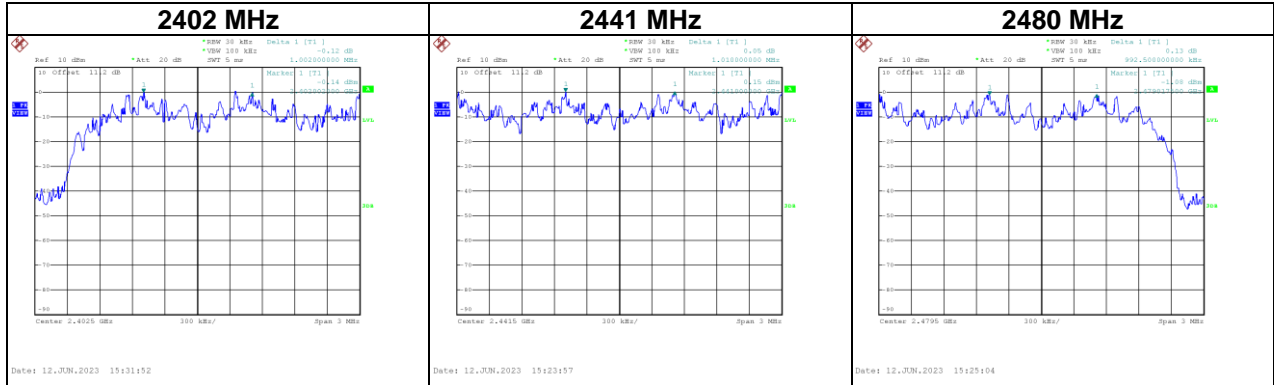

APPENDIX G BANDWIDTH

Test Mode : 1Mbps

Frequency (MHz)	20dB Bandwidth (MHz)	99% Occupied BW (MHz)	Test Result
2402	0.958	0.880	Pass
2441	0.958	0.880	Pass
2480	0.953	0.880	Pass

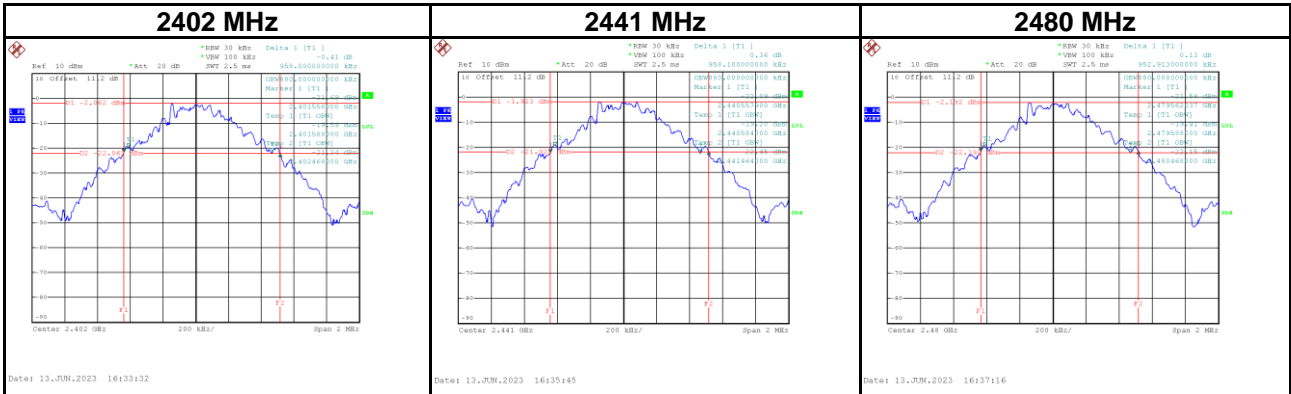

Test Mode : 3Mbps

Frequency (MHz)	20dB Bandwidth (MHz)	99% Occupied BW (MHz)	Test Result
2402	1.282	1.196	Pass
2441	1.310	1.192	Pass
2480	1.302	1.196	Pass

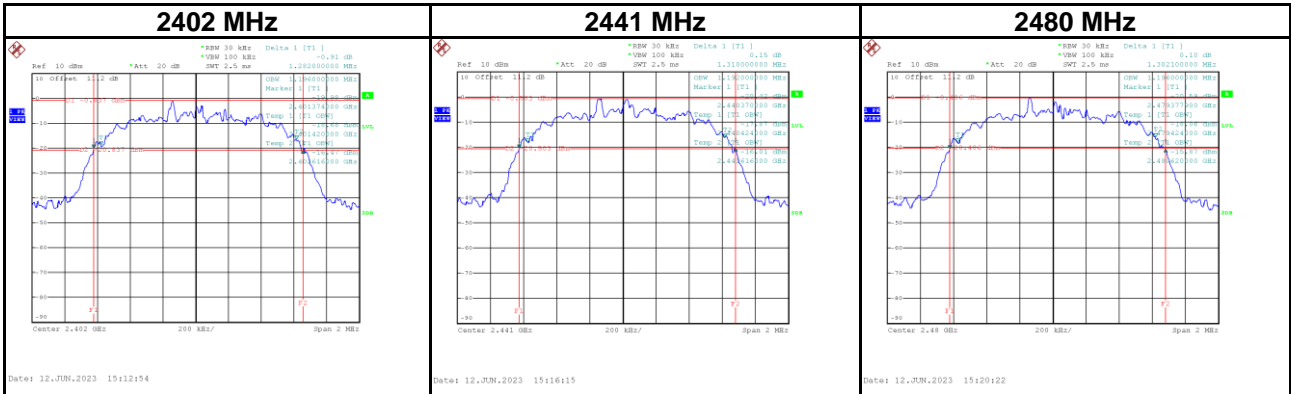

APPENDIX H OUTPUT POWER

Test Mode :	1Mbps	Tested Date	2023/6/13
-------------	-------	-------------	-----------

Frequency (MHz)	Conducted Power (dBm)	Conducted Power (W)	Max. Limit (dBm)	Max. Limit (W)	Test Result
2402	2.05	0.0016	21.00	0.1259	Pass
2441	2.18	0.0017	21.00	0.1259	Pass
2480	2.13	0.0016	21.00	0.1259	Pass

Test Mode :	2Mbps	Tested Date	2023/6/13
-------------	-------	-------------	-----------

Frequency (MHz)	Conducted Power (dBm)	Conducted Power (W)	Max. Limit (dBm)	Max. Limit (W)	Test Result
2402	4.84	0.0030	21.00	0.1259	Pass
2441	4.83	0.0030	21.00	0.1259	Pass
2480	4.87	0.0031	21.00	0.1259	Pass

Test Mode :	3Mbps	Tested Date	2023/6/13
-------------	-------	-------------	-----------

Frequency (MHz)	Conducted Power (dBm)	Conducted Power (W)	Max. Limit (dBm)	Max. Limit (W)	Test Result
2402	5.31	0.0034	21.00	0.1259	Pass
2441	5.37	0.0034	21.00	0.1259	Pass
2480	5.23	0.0033	21.00	0.1259	Pass

APPENDIX I ANTENNA CONDUCTED SPURIOUS EMISSION

Test Mode | 1Mbps

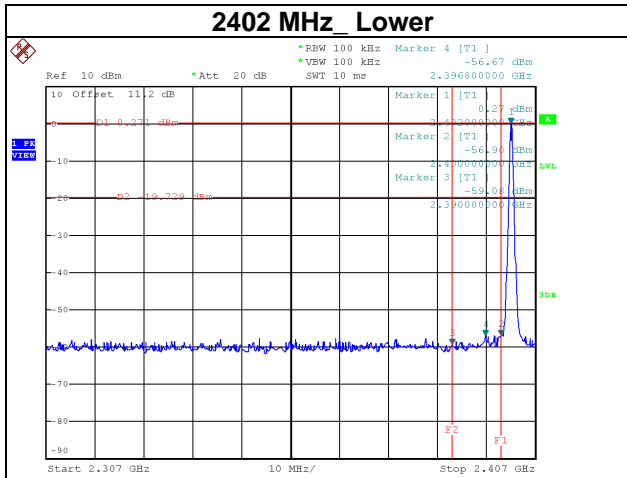

Date: 13.JUN.2023 16:33:01

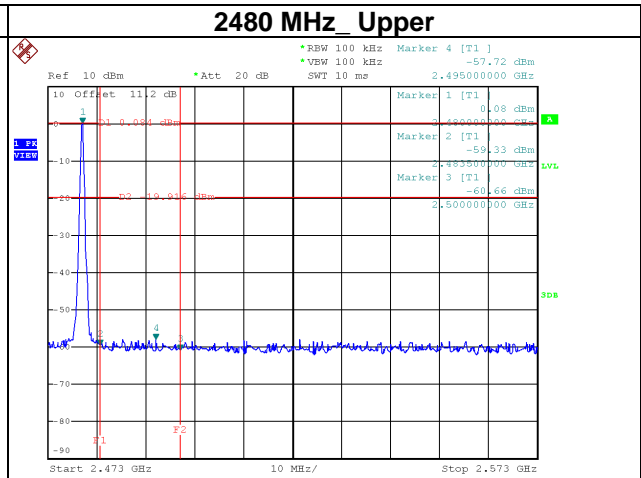

Date: 13.JUN.2023 16:36:37

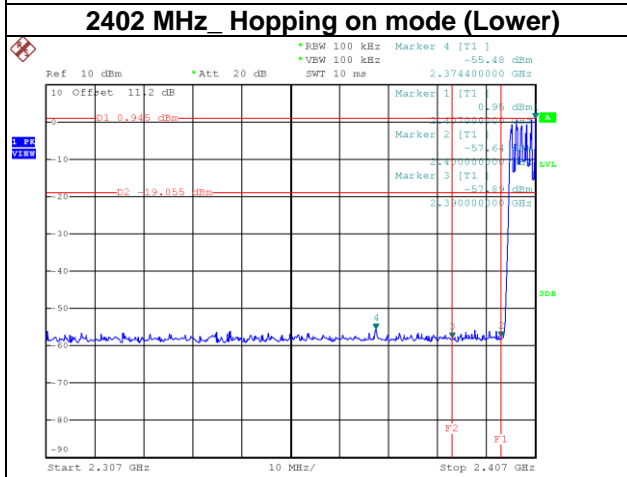

Date: 12.JUN.2023 14:52:08

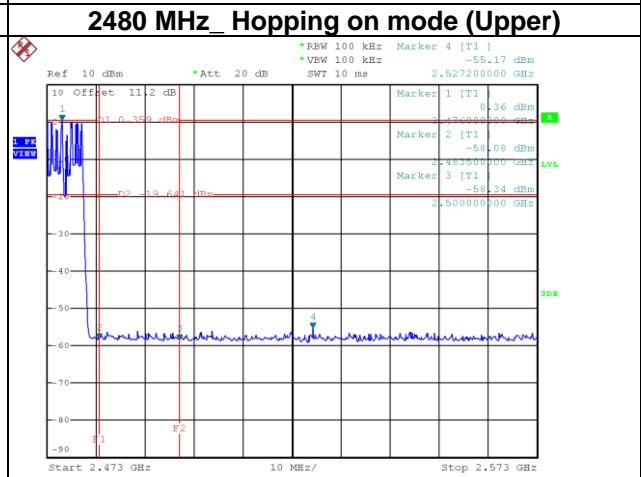

Date: 12.JUN.2023 14:59:57

2402 MHz – 10th Harmonics

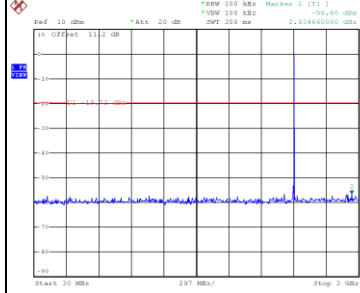

Date: 13 JUN 2023 16:33:45

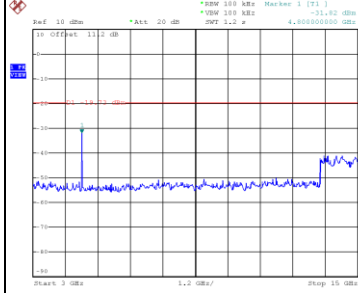

Date: 13 JUN 2023 16:33:51

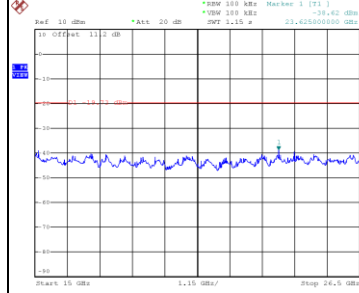

Date: 13 JUN 2023 16:33:58

2441 MHz – 10th Harmonics

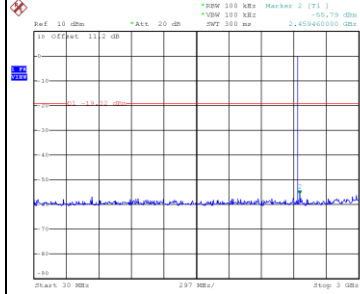

Date: 13 JUN 2023 16:35:01

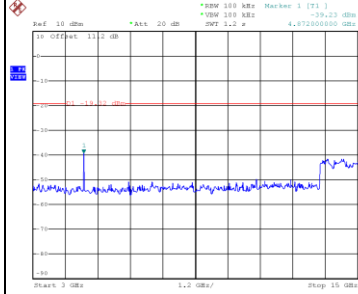

Date: 13 JUN 2023 16:35:08

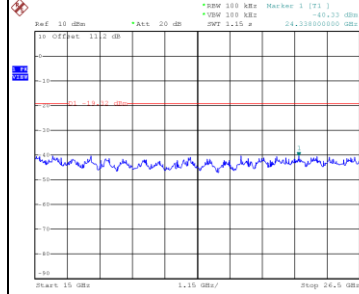

Date: 13 JUN 2023 16:35:15

2480 MHz – 10th Harmonics

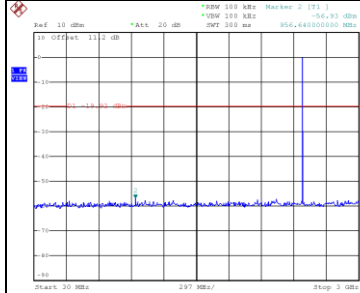

Date: 13 JUN 2023 16:37:29

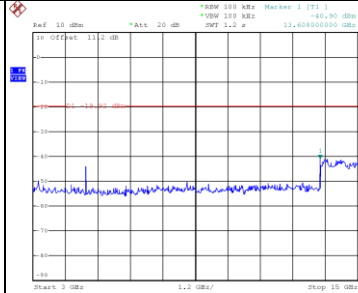

Date: 13 JUN 2023 16:37:36

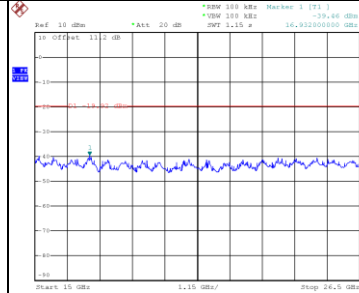

Date: 13 JUN 2023 16:37:43

Test Mode 3Mbps

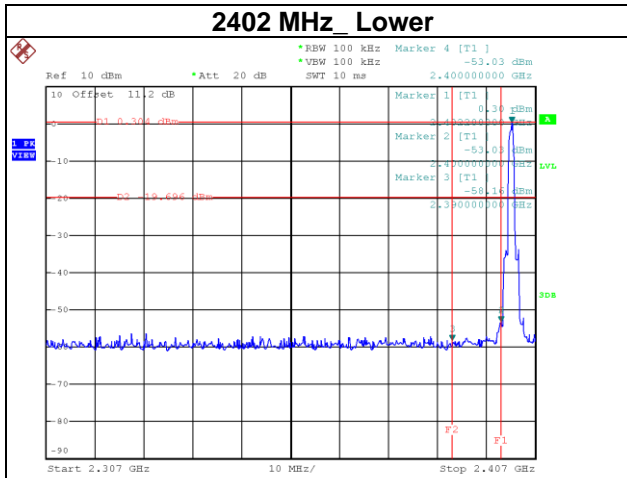

Date: 12.JUN.2023 15:12:29

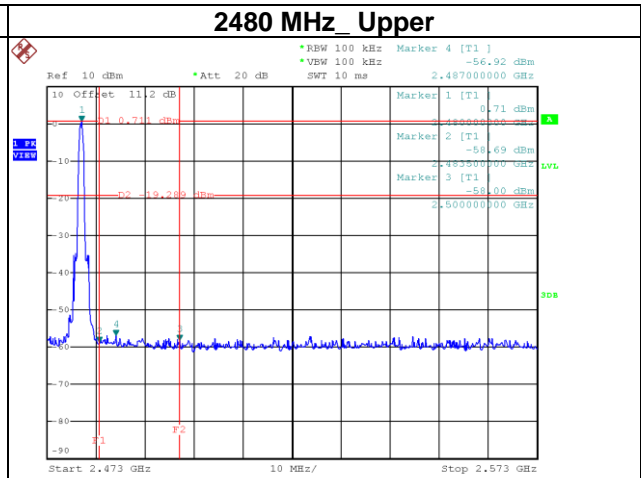

Date: 12.JUN.2023 15:19:59

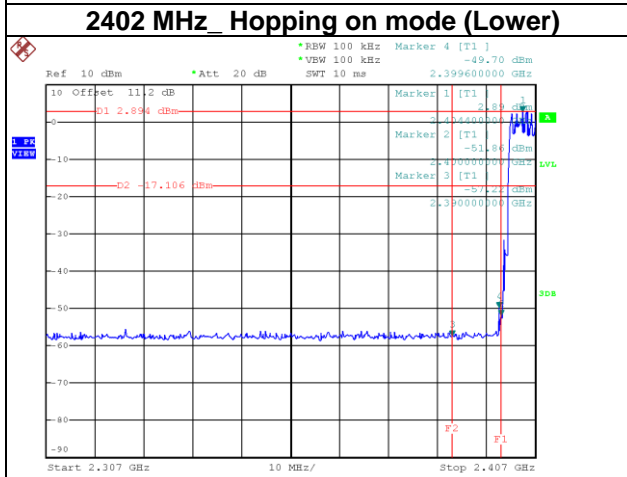

Date: 12.JUN.2023 15:37:03

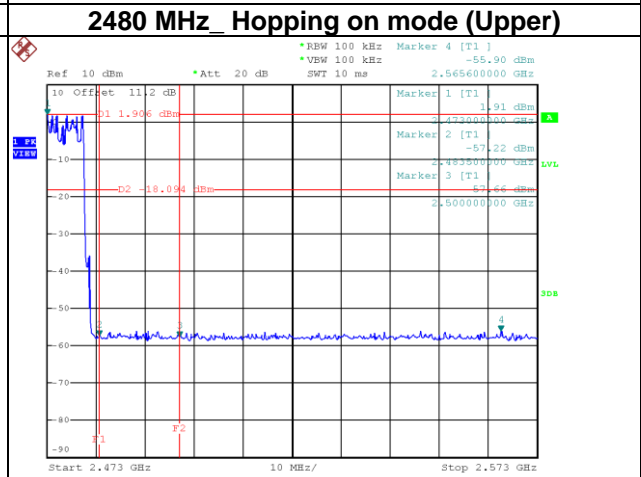

Date: 12.JUN.2023 15:38:37

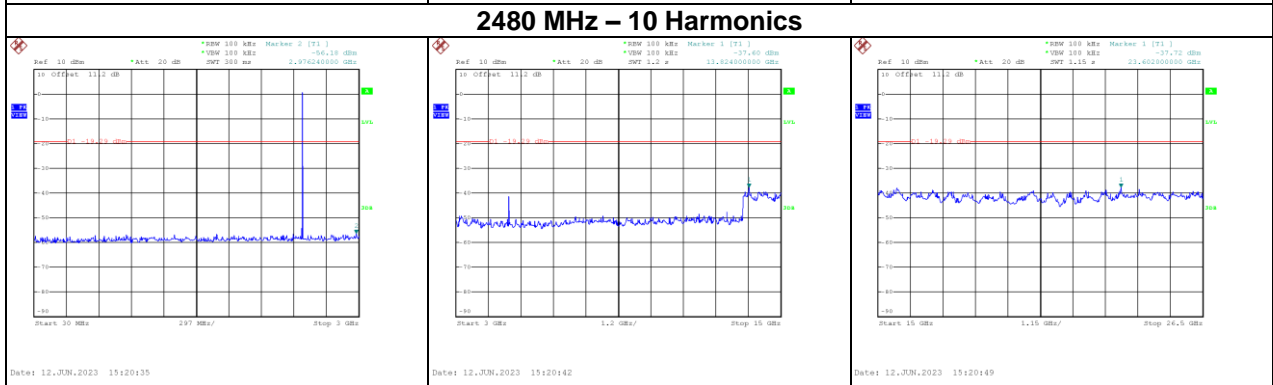
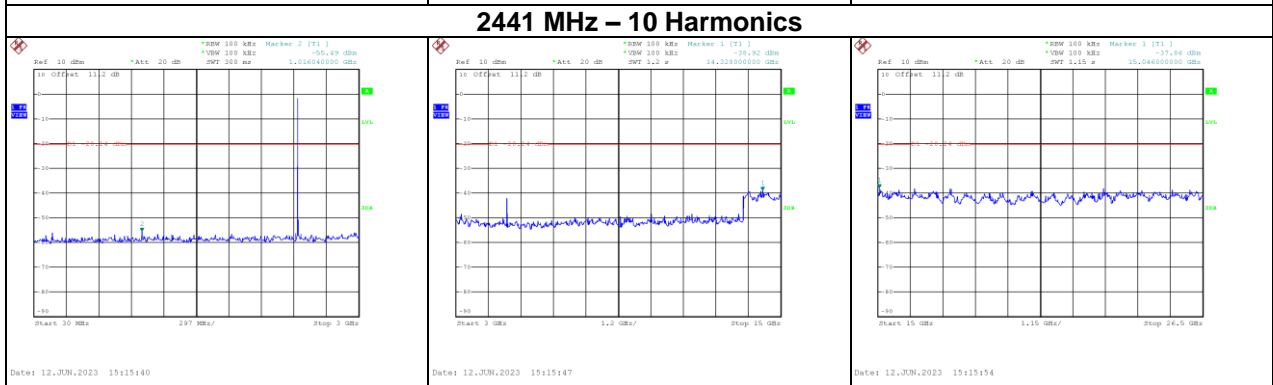
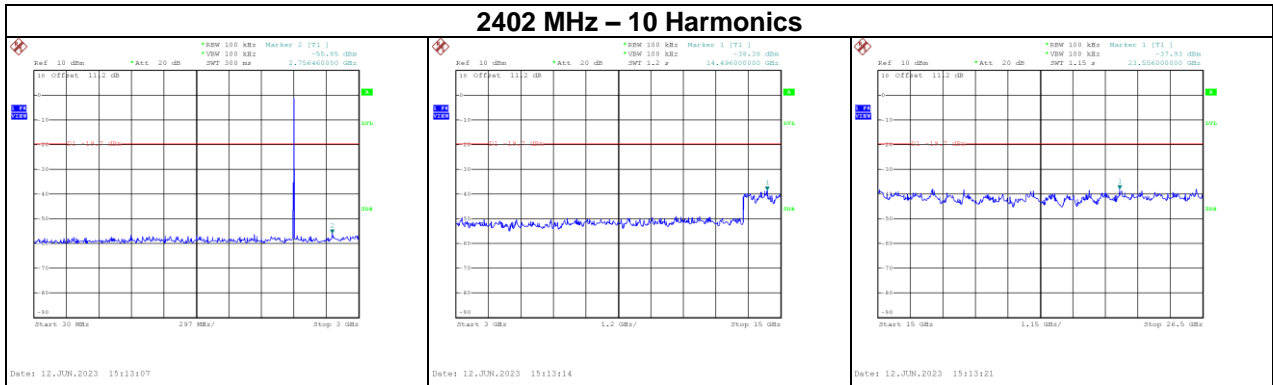

End of Test Report