FCC Test Report

Report No.: AGC01110200706FE02B

FCC ID : 2AOKB-A3119

APPLICATION PURPOSE : Class II permissove change

PRODUCT DESIGNATION : Soundcore Mini 3

BRAND NAME : *soundcore*

MODEL NAME : A3119

APPLICANT : Anker Innovations Limited

DATE OF ISSUE : Aug. 16, 2022

STANDARD(S) : FCC Part 15.247

REPORT VERSION : V1.0



Attestation of Global Compliance (Shenzhen) Co., Ltd

Any report having not been signed by authorized approver, or having been altered without authorization, or having not been stamped by the "Dedicated Testing/Inspection Stamp" is deemed to be invalid. Copying or excerpting portion of, or altering the content of the report is not permitted without the written authorization of AGC. The test results presented in the report apply only to the tested sample. Any objections to report issued by AGC should be submitted to AGC within 15days after the issuance of the test report. Further enquiry of validity or verification of the test report should be addressed to AGC by agc01@agccert.com.

Attestation of Global Compliance(Shenzhen)Co., Ltd
Attestation of Global Compliance(Shenzhen)Std & Tech Co., Ltd
Tel: +86-755 2523 4088 E-mail: agc@agccert.com Web: <http://www.agccert.com/>



REPORT REVISE RECORD

| Report Version | Revise Time | Issued Date | Valid Version | Notes |
|----------------|-------------|---------------|---------------|-----------------|
| V1.0 | / | Aug. 16, 2022 | Valid | Initial Release |

Note:

The original test report Ref. No. AGC01110200706FE02 dated Aug. 11, 2020 was modified on Aug. 16, 2022 to include the following changes:

- Change the EUT photos;
- Change the EMC test photos;
- Delete factory information;
- Change the AMP IC(FS2008E Change to ANT9121);
- Change the Charger IC(SY6927B Change to SY6913C);
- Change the BOOST IC(SY7069A Change to AP2004H);
- Change the Hardware Version number(Changes in Hardware Version have no effect on RF);
- The Radiated Emission and Line Conduction Emission tests have been updated.

Any report having not been signed by authorized approver, or having been altered without authorization, or having not been stamped by the "Dedicated Testing/Inspection Stamp" is deemed to be invalid. Copying or excerpting portion of, or altering the content of the report is not permitted without the written authorization of AGC. The test results presented in the report apply only to the tested sample. Any objections to report issued by AGC should be submitted to AGC within 15days after the issuance of the test report. Further enquiry of validity or verification of the test report should be addressed to AGC by agc01@agccert.com.

TABLE OF CONTENTS

1. VERIFICATION OF COMPLIANCE..... 4

2. GENERAL INFORMATION 5

 2.1. PRODUCT DESCRIPTION..... 5

 2.2. TABLE OF CARRIER FREQUENCIES 5

 2.3. RELATED SUBMITTAL(S)/GRANT(S)..... 6

 2.4. TEST METHODOLOGY..... 6

 2.5. SPECIAL ACCESSORIES 6

 2.6. EQUIPMENT MODIFICATIONS 6

 2.7. ANTENNA REQUIREMENT 6

3. MEASUREMENT UNCERTAINTY 7

4. DESCRIPTION OF TEST MODES 8

5. SYSTEM TEST CONFIGURATION 9

 5.1 CONFIGURATION OF TESTED SYSTEM..... 9

 5.2. EQUIPMENT USED IN TESTED SYSTEM 9

 5.3. SUMMARY OF TEST RESULTS 9

6. TEST FACILITY 10

7. RADIATED EMISSION11

 7.1. MEASUREMENT PROCEDURE 11

 7.2. TEST SETUP 12

 7.3. LIMITS AND MEASUREMENT RESULT 13

 7.4. TEST RESULT 13

8. FCC LINE CONDUCTED EMISSION TEST 19

 8.1. LIMITS OF LINE CONDUCTED EMISSION TEST 19

 8.2. BLOCK DIAGRAM OF LINE CONDUCTED EMISSION TEST 19

 8.3. PRELIMINARY PROCEDURE OF LINE CONDUCTED EMISSION TEST 20

 8.4. FINAL PROCEDURE OF LINE CONDUCTED EMISSION TEST 20

 8.5. TEST RESULT OF LINE CONDUCTED EMISSION TEST 21

APPENDIX A: PHOTOGRAPHS OF TEST SETUP 23

APPENDIX B: PHOTOGRAPHS OF EUT 23

Any report having not been signed by authorized approver, or having been altered without authorization, or having not been stamped by the “Dedicated Testing/Inspection Stamp” is deemed to be invalid. Copying or excerpting portion of, or altering the content of the report is not permitted without the written authorization of AGC. The test results presented in the report apply only to the tested sample. Any objections to report issued by AGC should be submitted to AGC within 15days after the issuance of the test report. Further enquiry of validity or verification of the test report should be addressed to AGC by agc01@agccert.com.

1. VERIFICATION OF COMPLIANCE

| | |
|---------------------------------|--|
| Applicant | Anker Innovations Limited |
| Address | Room 1318-19, Hollywood Plaza, 610 Nathan Road, Mongkok, Kowloon, Hongkong |
| Manufacturer | Anker Innovations Limited |
| Address | Room 1318-19, Hollywood Plaza, 610 Nathan Road, Mongkok, Kowloon, Hongkong |
| Product Designation | Soundcore Mini 3 |
| Brand Name | <i>soundcore</i> |
| Test Model | A3119 |
| Date of test | Jul. 14, 2022 to Aug. 12, 2022 |
| Deviation | No any deviation from the test method |
| Condition of Test Sample | Normal |
| Test Result | Pass |
| Report Template | AGCRT-US-BLE/RF |

We hereby certify that:

The above equipment was tested by Attestation of Global Compliance (Shenzhen) Co., Ltd. The test data, data evaluation, test procedures, and equipment configurations shown in this report were made in accordance with the procedures given in ANSI C63.10 (2013) and the energy emitted by the sample EUT tested as described in this report is in compliance with radiated emission limits of FCC part 15.247.

Prepared By



Alan Duan
(Project Engineer)

Aug. 16, 2022

Reviewed By



Calvin Liu
(Reviewer)

Aug. 16, 2022

Approved By



Max Zhang
(Authorized Officer)

Aug. 16, 2022

Any report having not been signed by authorized approver, or having been altered without authorization, or having not been stamped by the "Dedicated Testing/Inspection Stamp" is deemed to be invalid. Copying or excerpting portion of, or altering the content of the report is not permitted without the written authorization of AGC. The test results presented in the report apply only to the tested sample. Any objections to report issued by AGC should be submitted to AGC within 15days after the issuance of the test report. Further enquiry of validity or verification of the test report should be addressed to AGC by agc01@agccert.com.

2. GENERAL INFORMATION

2.1. PRODUCT DESCRIPTION

The EUT is designed as a “Soundcore Mini 3”. It is designed by way of utilizing the GFSK technology to achieve the system operation.

A major technical description of EUT is described as following

| | |
|----------------------------|---|
| Operation Frequency | 2.402GHz to 2.480GHz |
| RF Output Power | 7.096dBm(Max) |
| Bluetooth Version | V5.0 |
| Modulation | BR <input type="checkbox"/> GFSK, EDR <input type="checkbox"/> π /4-DQPSK, <input type="checkbox"/> 8DPSK BLE <input checked="" type="checkbox"/> GFSK 1Mbps <input type="checkbox"/> GFSK 2Mbps |
| Number of channels | 40 Channels |
| Antenna Designation | PCB Antenna(Comply with requirements of the FCC part 15.203) |
| Antenna Gain | 0.6dBi |
| Hardware Version | V4.0 |
| Software Version | V1.3 |
| Power Supply | DC 3.7V by battery or DC 5V by adapter |

2.2.TABLE OF CARRIER FREQUENCYS

| Frequency Band | Channel Number | Frequency |
|----------------|----------------|-----------|
| 2400~2483.5MHZ | 0 | 2402MHZ |
| | 1 | 2404MHZ |
| | : | : |
| | 38 | 2478 MHZ |
| | 39 | 2480 MHZ |

Any report having not been signed by authorized approver, or having been altered without authorization, or having not been stamped by the “Dedicated Testing/Inspection Stamp” is deemed to be invalid. Copying or excerpting portion of, or altering the content of the report is not permitted without the written authorization of AGC. The test results presented in the report apply only to the tested sample. Any objections to report issued by AGC should be submitted to AGC within 15days after the issuance of the test report. Further enquiry of validity or verification of the test report should be addressed to AGC by agc01@agccert.com.

2.3. RELATED SUBMITTAL(S)/GRANT(S)

This submittal(s) (test report) is intended for **FCC ID: 2AOKB-A3119** filing to comply with the FCC Part 15.247 requirements.

2.4. TEST METHODOLOGY

Both conducted and radiated testing was performed according to the procedures in ANSI C63.10 (2013). Radiated testing was performed at an antenna to EUT distance 3 meters.

2.5. SPECIAL ACCESSORIES

Refer to section 5.2.

2.6. EQUIPMENT MODIFICATIONS

Not available for this EUT intended for grant.

2.7. ANTENNA REQUIREMENT

This intentional radiator is designed with a permanently attached antenna of an antenna to ensure that no antenna other than that furnished by the responsible party shall be used with the device.

For more information of the antenna, please refer to the APPENDIX B: PHOTOGRAPHS OF EUT.

3. MEASUREMENT UNCERTAINTY

The reported uncertainty of measurement $y \pm U$, where expanded uncertainty U is based on a standard uncertainty multiplied by a coverage factor of $k=2$, providing a level of confidence of approximately 95%.

| Item | Measurement Uncertainty |
|---|-------------------------|
| Uncertainty of Conducted Emission for AC Port | $U_c = \pm 2.9$ dB |
| Uncertainty of Radiated Emission below 1GHz | $U_c = \pm 3.8$ dB |
| Uncertainty of Radiated Emission above 1GHz | $U_c = \pm 4.9$ dB |
| Uncertainty of total RF power, conducted | $U_c = \pm 0.8$ dB |
| Uncertainty of RF power density, conducted | $U_c = \pm 2.6$ dB |
| Uncertainty of spurious emissions, conducted | $U_c = \pm 2$ % |
| Uncertainty of Occupied Channel Bandwidth | $U_c = \pm 2$ % |

Any report having not been signed by authorized approver, or having been altered without authorization, or having not been stamped by the "Dedicated Testing/Inspection Stamp" is deemed to be invalid. Copying or excerpting portion of, or altering the content of the report is not permitted without the written authorization of AGC. The test results presented in the report apply only to the tested sample. Any objections to report issued by AGC should be submitted to AGC within 15days after the issuance of the test report. Further enquiry of validity or verification of the test report should be addressed to AGC by agc01@agccert.com.

4. DESCRIPTION OF TEST MODES

| NO. | TEST MODE DESCRIPTION |
|-----|--------------------------------------|
| 1 | Low channel TX_2402MHz_GFSK_1Mbps |
| 2 | Middle channel TX_2440MHz_GFSK_1Mbps |
| 3 | High channel TX_2480MHz_GFSK_1Mbps |

- Note: 1. Only the result of the worst case was recorded in the report, if no other cases.
 2. For Conducted Test method, a temporary antenna connector is provided by the manufacture.
 3. For Radiated Emission, 3axis were chosen for testing for each applicable mode.

Software Setting

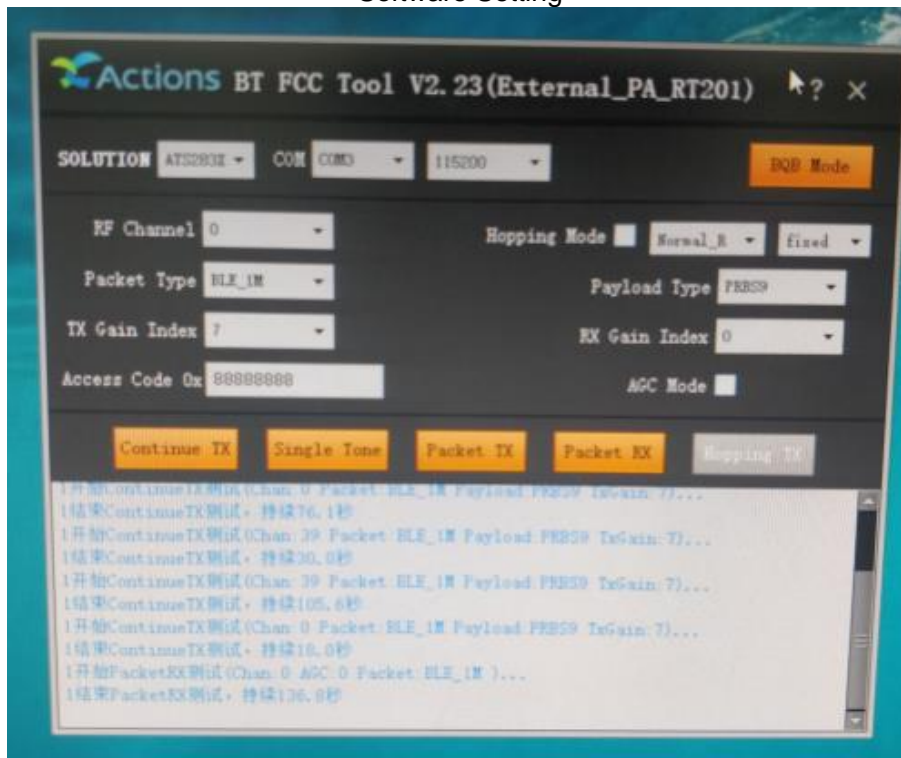

Any report having not been signed by authorized approver, or having been altered without authorization, or having not been stamped by the "Dedicated Testing/Inspection Stamp" is deemed to be invalid. Copying or excerpting portion of, or altering the content of the report is not permitted without the written authorization of AGC. The test results presented in the report apply only to the tested sample. Any objections to report issued by AGC should be submitted to AGC within 15days after the issuance of the test report. Further enquiry of validity or verification of the test report should be addressed to AGC by agc01@agccert.com.

5. SYSTEM TEST CONFIGURATION

5.1 CONFIGURATION OF TESTED SYSTEM

Radiated Emission Configure :

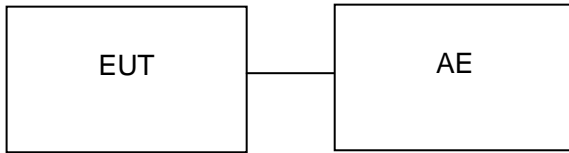

Conducted Emission Configure :

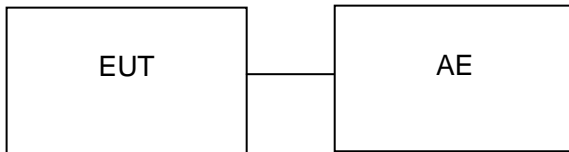

5.2. EQUIPMENT USED IN TESTED SYSTEM

| Item | Equipment | Model No. | ID or Specification | Remark |
|------|------------------|-------------|---------------------|-----------|
| 1 | Soundcore Mini 3 | A3119 | 2AOKB-A3119 | EUT |
| 2 | Control Box | USB-TTL | N/A | AE |
| 3 | Adapter | XCMS03-0510 | DC 5V | AE |
| 4 | Charger line | N/A | 0.6m unshielded | Accessory |

5.3. SUMMARY OF TEST RESULTS

| FCC RULES | DESCRIPTION OF TEST | RESULT |
|-----------|---------------------|-----------|
| 15.209 | Radiated Emission | Compliant |
| 15.207 | Conducted Emission | Compliant |

Any report having not been signed by authorized approver, or having been altered without authorization, or having not been stamped by the "Dedicated Testing/Inspection Stamp" is deemed to be invalid. Copying or excerpting portion of, or altering the content of the report is not permitted without the written authorization of AGC. The test results presented in the report apply only to the tested sample. Any objections to report issued by AGC should be submitted to AGC within 15days after the issuance of the test report. Further enquiry of validity or verification of the test report should be addressed to AGC by agc01@agccert.com.

6. TEST FACILITY

| | |
|--|--|
| Test Site | Attestation of Global Compliance (Shenzhen) Co., Ltd |
| Location | 1-2/F, Building 19, Junfeng Industrial Park, Chongqing Road, Heping Community, Fuhai Street, Bao'an District, Shenzhen, Guangdong, China |
| Designation Number | CN1259 |
| FCC Test Firm Registration Number | 975832 |
| A2LA Cert. No. | 5054.02 |
| Description | Attestation of Global Compliance(Shenzhen) Co., Ltd is accredited by A2LA |

TEST EQUIPMENT OF CONDUCTED EMISSION TEST

| Equipment | Manufacturer | Model | S/N | Cal. Date | Cal. Due |
|--------------------------|--------------|--------------------------|--------|---------------|---------------|
| Test Receiver | R&S | ESPI | 101206 | Mar. 28, 2022 | Mar. 27, 2023 |
| Artificial power network | R&S | ESH2-Z5 | 100086 | Jun. 08, 2022 | Jun. 07, 2023 |
| Test Software | FARA | EZ-EMC(Ver. AGC-CON03A1) | N/A | N/A | N/A |

TEST EQUIPMENT OF RADIATED EMISSION TEST

| Equipment | Manufacturer | Model | S/N | Cal. Date | Cal. Due |
|--------------------------------|----------------|---------------------|--------------|---------------|---------------|
| Test Receiver | R&S | ESCI | 10096 | Mar. 28, 2022 | Mar. 27, 2023 |
| EXA Signal Analyzer | Aglient | N9010A | MY53470504 | Nov. 17, 2021 | Nov. 16, 2022 |
| Signal Analyzer | Aglient | N9020A | MY52090123 | Sep. 06, 2021 | Sep. 05, 2022 |
| 2.4GHz Filter | EM Electronics | N/A | N/A | Mar. 18, 2022 | Mar. 19, 2024 |
| Attenuator | ZHINAN | E-002 | N/A | Sep. 03, 2020 | Sep. 02, 2022 |
| Horn Antenna | SCHWARZBEC | BBHA9170 | 768 | Oct. 31, 2021 | Oct. 30, 2023 |
| Active Loop Antenna (9K-30Mhz) | ZHINAN | ZN30900C | 18051 | Mar. 12, 2022 | Mar. 11, 2024 |
| Double-Ridged Waveguide Horn | ETS | 3117 | 00034609 | Apr. 23, 2021 | Apr. 22, 2023 |
| Preamplifier Assembly | ETS | 3117PA | 00225134 | Sep. 03, 2020 | Sep. 02, 2022 |
| Wideband Antenna | SCHWARZBECK | VULB9168 | VULB9168-494 | Jan. 08, 2021 | Jan. 07, 2023 |
| Test software | FARA | EZ-EMC (Ver RA-03A) | N/A | N/A | N/A |

Any report having not been signed by authorized approver, or having been altered without authorization, or having not been stamped by the "Dedicated Testing/Inspection Stamp" is deemed to be invalid. Copying or excerpting portion of, or altering the content of the report is not permitted without the written authorization of AGC. The test results presented in the report apply only to the tested sample. Any objections to report issued by AGC should be submitted to AGC within 15days after the issuance of the test report. Further enquiry of validity or verification of the test report should be addressed to AGC by agc01@agccert.com.

7. RADIATED EMISSION

7.1. MEASUREMENT PROCEDURE

1. The EUT was placed on the top of the turntable 0.8 or 1.5 meter above ground. The phase center of the receiving antenna mounted on the top of a height-variable antenna tower was placed 3 meters far away from the turntable.
2. Power on the EUT and all the supporting units. The turntable was rotated by 360 degrees to determine the position of the highest radiation.
3. The height of the broadband receiving antenna was varied between one meter and four meters above ground to find the maximum emissions field strength of both horizontal and vertical polarization.
4. For each suspected emissions, the antenna tower was scan (from 1 M to 4 M) and then the turntable was rotated (from 0 degree to 360 degrees) to find the maximum reading.
5. Set the test-receiver system to Peak or CISPR quasi-peak Detect Function with specified bandwidth under Maximum Hold Mode.
6. For emissions above 1GHz, use 1MHz RBW and 3MHz VBW for peak reading. Place the measurement antenna away from each area of the EUT determined to be a source of emissions at the specified measurement distance, while keeping the measurement antenna aimed at the source of emissions at each frequency of significant emissions, with polarization oriented for maximum response. The measurement antenna may have to be higher or lower than the EUT, depending on the radiation pattern of the emission and staying aimed at the emission source for receiving the maximum signal. The final measurement antenna elevation shall be that which maximizes the emissions. The measurement antenna elevation for maximum emissions shall be restricted to a range of heights of from 1 m to 4 m above the ground or reference ground plane.
7. When the radiated emissions limits are expressed in terms of the average value of the emissions, and pulsed operation is employed, the measurement field strength shall be determined by averaging over one complete pulse train, including blanking intervals, as long as the pulse train does not exceed 0.1 seconds. As an alternative (provided the transmitter operates for longer than 0.1 seconds) or in cases where the pulse train exceeds 0.1 seconds, the measured field strength shall be determined from the average absolute voltage during a 0.1 second interval during which the field strength is at its maximum values.
8. If the emissions level of the EUT in peak mode was 3 dB lower than the average limit specified, then testing will be stopped and peak values of EUT will be reported, otherwise, the emissions which do not have 3 dB margin will be repeated one by one using the quasi-peak method for below 1GHz.
9. For testing above 1GHz, the emissions level of the EUT in peak mode was lower than average limit (that means the emissions level in peak mode also complies with the limit in average mode), then testing will be stopped and peak values of EUT will be reported, otherwise, the emissions will be measured in average mode again and reported.
10. In case the emission is lower than 30MHz, loop antenna has to be used for measurement and the recorded data should be QP measured by receiver. High - Low scan is not required in this case.

7.2. TEST SETUP

Radiated Emission Test-Setup Frequency Below 30MHz

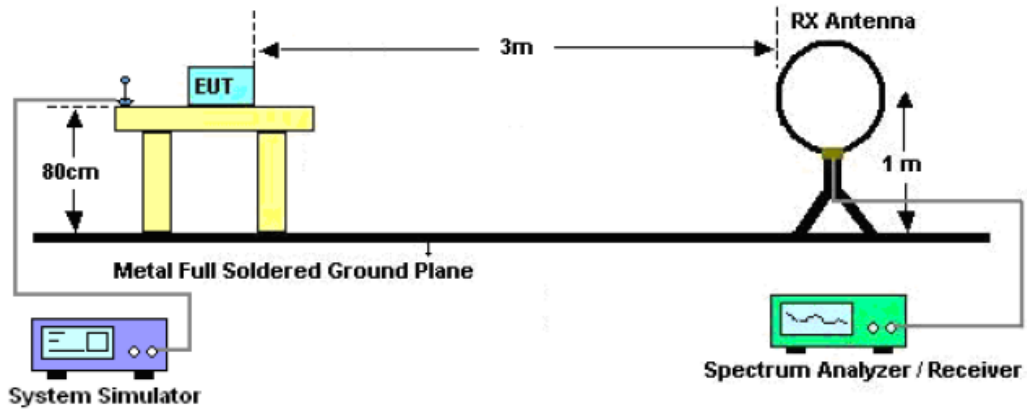

RADIATED EMISSION TEST SETUP 30MHz-1000MHz

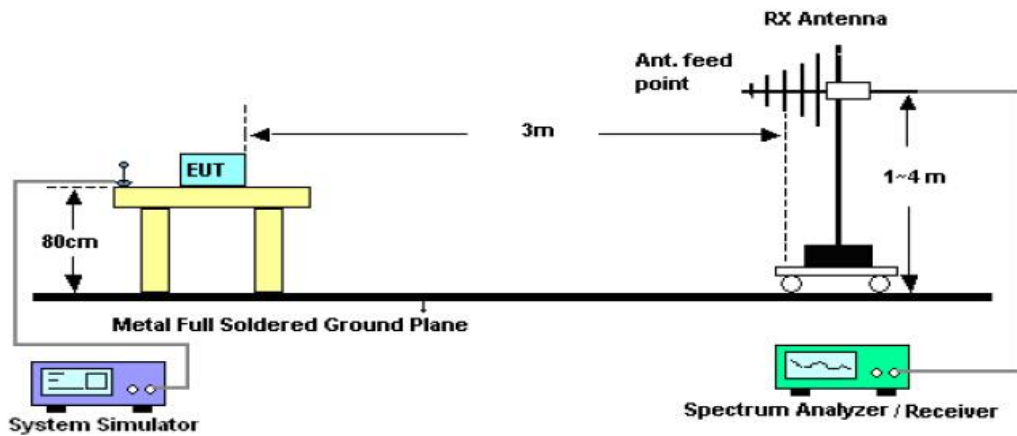

RADIATED EMISSION TEST SETUP ABOVE 1000MHz

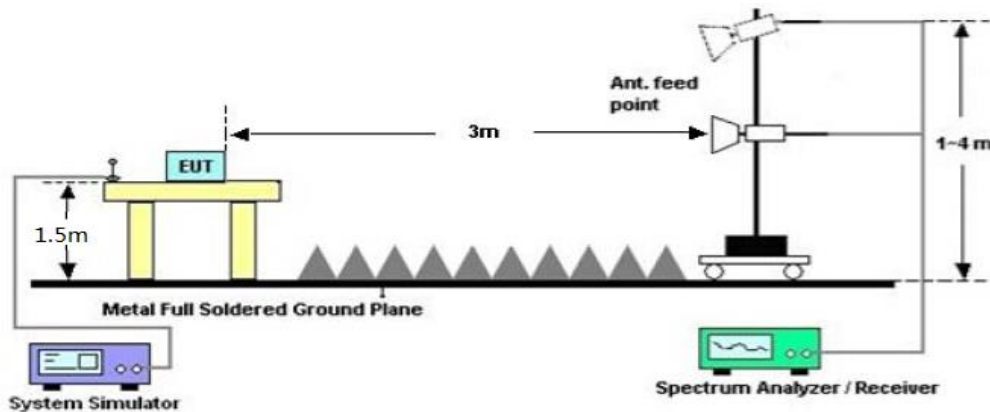

Any report having not been signed by authorized approver, or having been altered without authorization, or having not been stamped by the “Dedicated Testing/Inspection Stamp” is deemed to be invalid. Copying or excerpting portion of, or altering the content of the report is not permitted without the written authorization of AGC. The test results presented in the report apply only to the tested sample. Any objections to report issued by AGC should be submitted to AGC within 15 days after the issuance of the test report. Further enquiry of validity or verification of the test report should be addressed to AGC by agc01@agccert.com.

7.3. LIMITS AND MEASUREMENT RESULT

15.209 Limit in the below table has to be followed

| Frequencies (MHz) | Field Strength (micorvolts/meter) | Measurement Distance (meters) |
|-------------------|-----------------------------------|-------------------------------|
| 0.009~0.490 | 2400/F(KHz) | 300 |
| 0.490~1.705 | 24000/F(KHz) | 30 |
| 1.705~30.0 | 30 | 30 |
| 30~88 | 100 | 3 |
| 88~216 | 150 | 3 |
| 216~960 | 200 | 3 |
| Above 960 | 500 | 3 |

Note: All modes were tested For restricted band radiated emission, the test records reported below are the worst result compared to other modes.

7.4. TEST RESULT

RADIATED EMISSION BELOW 30MHZ

The amplitude of spurious emissions from 9kHz to 30MHz which are attenuated more than 20 dB below the permissible value need not be reported.

Any report having not been signed by authorized approver, or having been altered without authorization, or having not been stamped by the "Dedicated Testing/Inspection Stamp" is deemed to be invalid. Copying or excerpting portion of, or altering the content of the report is not permitted without the written authorization of AGC. The test results presented in the report apply only to the tested sample. Any objections to report issued by AGC should be submitted to AGC within 15days after the issuance of the test report. Further enquiry of validity or verification of the test report should be addressed to AGC by agc01@agccert.com.

RADIATED EMISSION BELOW 1GHZ

| | | | |
|--------------------|------------------|--------------------------|----------------|
| EUT | Soundcore Mini 3 | Model Name | A3119 |
| Temperature | 24°C | Relative Humidity | 59% |
| Pressure | 985hPa | Test Voltage | Normal Voltage |
| Test Mode | Mode 3 | Antenna | Horizontal |

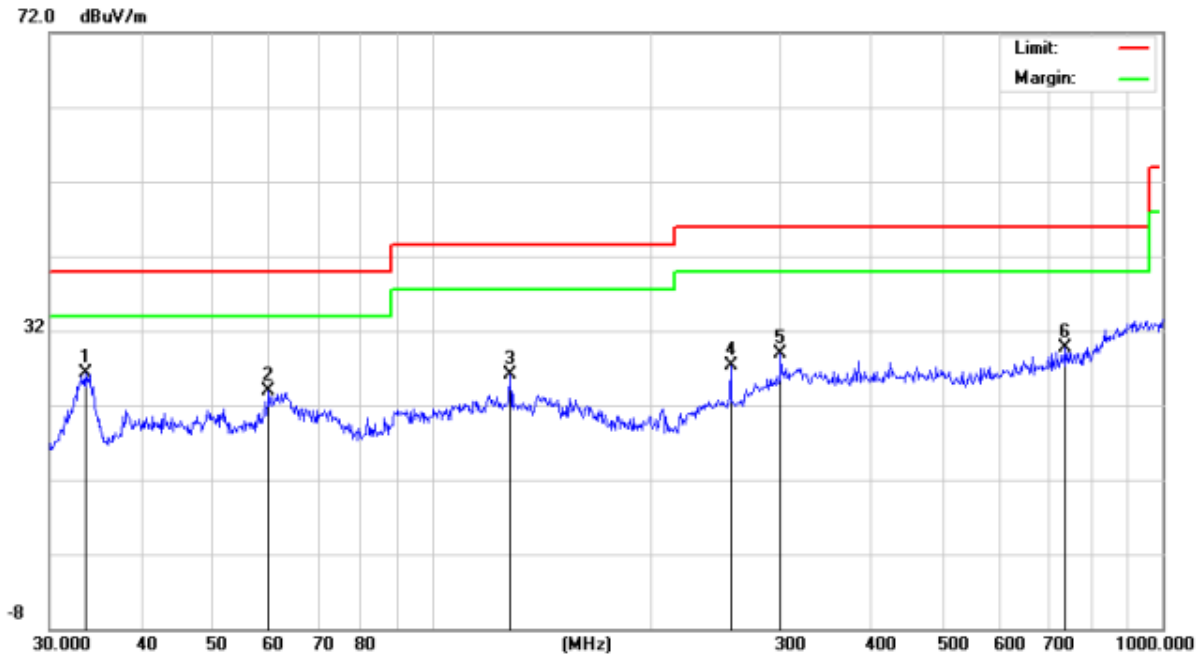

| No. | Mk. | Freq. MHz | Reading Level dBuV | Correct Factor dB | Measure- ment dBuV/m | Limit dBuV/m | Over dB | Detector |
|-----|-----|--------------|--------------------------|-------------------------|----------------------------|-----------------|------------|----------|
| 1 | * | 33.5623 | 14.03 | 12.28 | 26.31 | 40.00 | -13.69 | peak |
| 2 | | 59.8588 | 7.47 | 16.44 | 23.91 | 40.00 | -16.09 | peak |
| 3 | | 128.1127 | 8.28 | 17.84 | 26.12 | 43.50 | -17.38 | peak |
| 4 | | 256.5210 | 10.85 | 16.37 | 27.22 | 46.00 | -18.78 | peak |
| 5 | | 300.3672 | 8.46 | 20.44 | 28.90 | 46.00 | -17.10 | peak |
| 6 | | 737.0714 | 6.00 | 23.62 | 29.62 | 46.00 | -16.38 | peak |

RESULT: PASS

Any report having not been signed by authorized approver, or having been altered without authorization, or having not been stamped by the "Dedicated Testing/Inspection Stamp" is deemed to be invalid. Copying or excerpting portion of, or altering the content of the report is not permitted without the written authorization of AGC. The test results presented in the report apply only to the tested sample. Any objections to report issued by AGC should be submitted to AGC within 15days after the issuance of the test report. Further enquiry of validity or verification of the test report should be addressed to AGC by agc01@agccert.com.

| | | | |
|--------------------|------------------|--------------------------|----------------|
| EUT | Soundcore Mini 3 | Model Name | A3119 |
| Temperature | 24°C | Relative Humidity | 59% |
| Pressure | 985hPa | Test Voltage | Normal Voltage |
| Test Mode | Mode 3 | Antenna | Vertical |

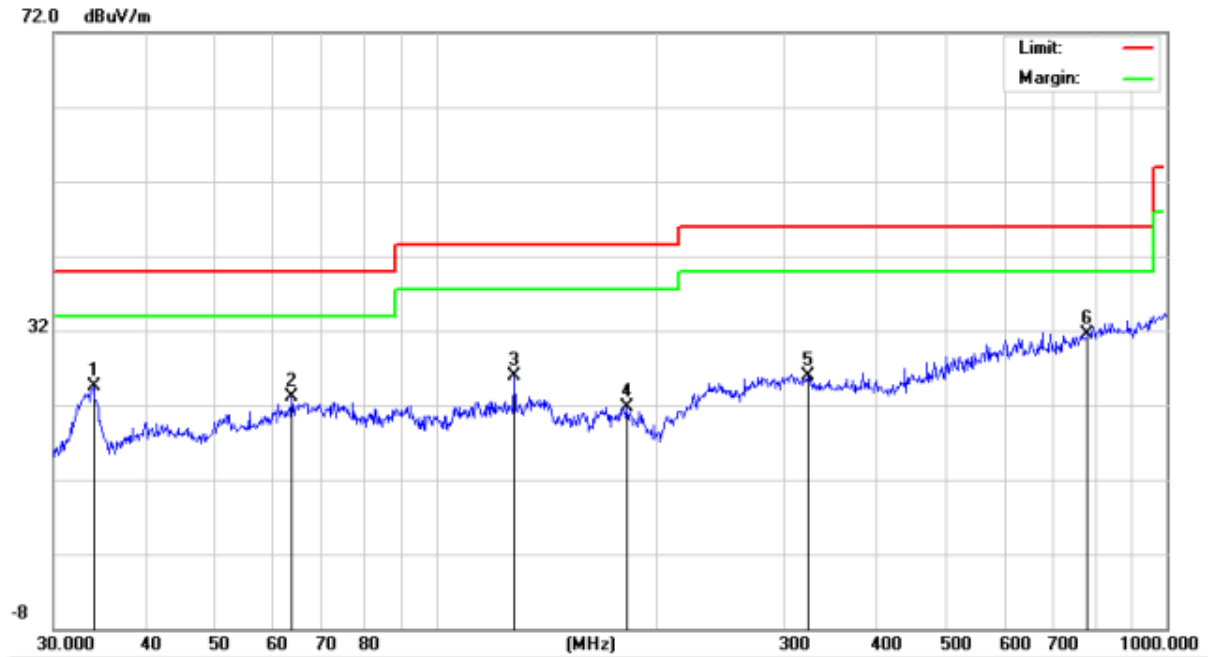

| No. | Mk. | Freq. MHz | Reading Level dBuV | Correct Factor dB | Measure- ment dBuV/m | Limit dBuV/m | Over dB | Detector |
|-----|-----|--------------|--------------------------|-------------------------|----------------------------|-----------------|------------|----------|
| 1 | | 34.0363 | 12.12 | 12.29 | 24.41 | 40.00 | -15.59 | peak |
| 2 | | 63.5356 | 6.08 | 16.95 | 23.03 | 40.00 | -16.97 | peak |
| 3 | | 128.1127 | 7.79 | 18.08 | 25.87 | 43.50 | -17.63 | peak |
| 4 | | 182.5592 | 5.10 | 16.61 | 21.71 | 43.50 | -21.79 | peak |
| 5 | | 323.3204 | 6.60 | 19.36 | 25.96 | 46.00 | -20.04 | peak |
| 6 | * | 779.6068 | 4.53 | 26.95 | 31.48 | 46.00 | -14.52 | peak |

RESULT: PASS

Note: 1. Factor=Antenna Factor + Cable loss, Over=Measurement-Limit.

2. All test modes had been tested. The BLE 1M mode 3 is the worst case and recorded in the report.

Any report having not been signed by authorized approver, or having been altered without authorization, or having not been stamped by the "Dedicated Testing/Inspection Stamp" is deemed to be invalid. Copying or excerpting portion of, or altering the content of the report is not permitted without the written authorization of AGC. The test results presented in the report apply only to the tested sample. Any objections to report issued by AGC should be submitted to AGC within 15days after the issuance of the test report. Further enquiry of validity or verification of the test report should be addressed to AGC by agc01@agccert.com.

RADIATED EMISSION ABOVE 1GHZ

| | | | |
|--------------------|------------------|--------------------------|----------------|
| EUT | Soundcore Mini 3 | Model Name | A3119 |
| Temperature | 24°C | Relative Humidity | 59% |
| Pressure | 985hPa | Test Voltage | Normal Voltage |
| Test Mode | Mode 1 | Antenna | Horizontal |

| Frequency (MHz) | Meter Reading (dBµV) | Factor (dB) | Emission Level (dBµV/m) | Limits (dBµV/m) | Margin (dB) | Value Type |
|-----------------|----------------------|-------------|-------------------------|-----------------|-------------|------------|
| 4804.000 | 47.36 | 0.08 | 47.44 | 74 | -26.56 | peak |
| 4804.000 | 36.54 | 0.08 | 36.62 | 54 | -17.38 | AVG |
| 7206.000 | 44.51 | 2.21 | 46.72 | 74 | -27.28 | peak |
| 7206.000 | 32.91 | 2.21 | 35.12 | 54 | -18.88 | AVG |
| | | | | | | |
| | | | | | | |

Remark:
Factor = Antenna Factor + Cable Loss – Pre-amplifier.

| | | | |
|--------------------|------------------|--------------------------|----------------|
| EUT | Soundcore Mini 3 | Model Name | A3119 |
| Temperature | 24°C | Relative Humidity | 59% |
| Pressure | 985hPa | Test Voltage | Normal Voltage |
| Test Mode | Mode 1 | Antenna | Vertical |

| Frequency (MHz) | Meter Reading (dBµV) | Factor (dB) | Emission Level (dBµV/m) | Limits (dBµV/m) | Margin (dB) | Value Type |
|-----------------|----------------------|-------------|-------------------------|-----------------|-------------|------------|
| 4804.000 | 46.84 | 0.08 | 46.92 | 74 | -27.08 | peak |
| 4804.000 | 37.57 | 0.08 | 37.65 | 54 | -16.35 | AVG |
| 7206.000 | 43.62 | 2.21 | 45.83 | 74 | -28.17 | peak |
| 7206.000 | 34.11 | 2.21 | 36.32 | 54 | -17.68 | AVG |
| | | | | | | |
| | | | | | | |

Remark:
Factor = Antenna Factor + Cable Loss – Pre-amplifier.

Any report having not been signed by authorized approver, or having been altered without authorization, or having not been stamped by the “Dedicated Testing/Inspection Stamp” is deemed to be invalid. Copying or excerpting portion of, or altering the content of the report is not permitted without the written authorization of AGC. The test results presented in the report apply only to the tested sample. Any objections to report issued by AGC should be submitted to AGC within 15days after the issuance of the test report. Further enquiry of validity or verification of the test report should be addressed to AGC by agc01@agccert.com.

| | | | |
|--------------------|------------------|--------------------------|----------------|
| EUT | Soundcore Mini 3 | Model Name | A3119 |
| Temperature | 24°C | Relative Humidity | 59% |
| Pressure | 985hPa | Test Voltage | Normal Voltage |
| Test Mode | Mode 2 | Antenna | Horizontal |

| Frequency (MHz) | Meter Reading (dBμV) | Factor (dB) | Emission Level (dBμV/m) | Limits (dBμV/m) | Margin (dB) | Value Type |
|--------------------|-------------------------|----------------|----------------------------|--------------------|----------------|------------|
| 4880.000 | 48.71 | 0.14 | 48.85 | 74 | -25.15 | peak |
| 4880.000 | 38.45 | 0.14 | 38.59 | 54 | -15.41 | AVG |
| 7320.000 | 45.16 | 2.36 | 47.52 | 74 | -26.48 | peak |
| 7320.000 | 34.82 | 2.36 | 37.18 | 54 | -16.82 | AVG |
| | | | | | | |
| | | | | | | |

Remark:
Factor = Antenna Factor + Cable Loss – Pre-amplifier.

| | | | |
|--------------------|------------------|--------------------------|----------------|
| EUT | Soundcore Mini 3 | Model Name | A3119 |
| Temperature | 24°C | Relative Humidity | 59% |
| Pressure | 985hPa | Test Voltage | Normal Voltage |
| Test Mode | Mode 2 | Antenna | Vertical |

| Frequency (MHz) | Meter Reading (dBμV) | Factor (dB) | Emission Level (dBμV/m) | Limits (dBμV/m) | Margin (dB) | Value Type |
|--------------------|-------------------------|----------------|----------------------------|--------------------|----------------|------------|
| 4880.000 | 47.33 | 0.14 | 47.47 | 74 | -26.53 | peak |
| 4880.000 | 37.54 | 0.14 | 37.68 | 54 | -16.32 | AVG |
| 7320.000 | 43.97 | 2.36 | 46.33 | 74 | -27.67 | peak |
| 7320.000 | 34.78 | 2.36 | 37.14 | 54 | -16.86 | AVG |
| | | | | | | |
| | | | | | | |

Remark:
Factor = Antenna Factor + Cable Loss – Pre-amplifier.

Any report having not been signed by authorized approver, or having been altered without authorization, or having not been stamped by the “Dedicated Testing/Inspection Stamp” is deemed to be invalid. Copying or excerpting portion of, or altering the content of the report is not permitted without the written authorization of AGC. The test results presented in the report apply only to the tested sample. Any objections to report issued by AGC should be submitted to AGC within 15days after the issuance of the test report. Further enquiry of validity or verification of the test report should be addressed to AGC by agc01@agccert.com.

| | | | |
|--------------------|------------------|--------------------------|----------------|
| EUT | Soundcore Mini 3 | Model Name | A3119 |
| Temperature | 24°C | Relative Humidity | 59% |
| Pressure | 985hPa | Test Voltage | Normal Voltage |
| Test Mode | Mode 3 | Antenna | Horizontal |

| Frequency (MHz) | Meter Reading (dBμV) | Factor (dB) | Emission Level (dBμV/m) | Limits (dBμV/m) | Margin (dB) | Value Type |
|--------------------|-------------------------|----------------|----------------------------|--------------------|----------------|------------|
| 4960.000 | 47.59 | 0.22 | 47.81 | 74 | -26.19 | peak |
| 4960.000 | 37.24 | 0.22 | 37.46 | 54 | -16.54 | AVG |
| 7440.000 | 43.18 | 2.64 | 45.82 | 74 | -28.18 | peak |
| 7440.000 | 33.82 | 2.64 | 36.46 | 54 | -17.54 | AVG |
| | | | | | | |
| | | | | | | |

Remark:
Factor = Antenna Factor + Cable Loss – Pre-amplifier.

| | | | |
|--------------------|------------------|--------------------------|----------------|
| EUT | Soundcore Mini 3 | Model Name | A3119 |
| Temperature | 24°C | Relative Humidity | 59% |
| Pressure | 985hPa | Test Voltage | Normal Voltage |
| Test Mode | Mode 3 | Antenna | Vertical |

| Frequency (MHz) | Meter Reading (dBμV) | Factor (dB) | Emission Level (dBμV/m) | Limits (dBμV/m) | Margin (dB) | Value Type |
|--------------------|-------------------------|----------------|----------------------------|--------------------|----------------|------------|
| 4960.000 | 47.16 | 0.22 | 47.38 | 74 | -26.62 | peak |
| 4960.000 | 38.71 | 0.22 | 38.93 | 54 | -15.07 | AVG |
| 7440.000 | 45.08 | 2.64 | 47.72 | 74 | -26.28 | peak |
| 7440.000 | 34.68 | 2.64 | 37.32 | 54 | -16.68 | AVG |
| | | | | | | |
| | | | | | | |

Remark:
Factor = Antenna Factor + Cable Loss – Pre-amplifier.

RESULT: PASS

Note: Other emissions are attenuated more than 20 dB below the permissible value.

Factor = Antenna Factor + Cable loss - Amplifier gain, Margin=Emission Level-Limit.

The “Factor” value can be calculated automatically by software of measurement system.

Any report having not been signed by authorized approver, or having been altered without authorization, or having not been stamped by the “Dedicated Testing/Inspection Stamp” is deemed to be invalid. Copying or excerpting portion of, or altering the content of the report is not permitted without the written authorization of AGC. The test results presented in the report apply only to the tested sample. Any objections to report issued by AGC should be submitted to AGC within 15days after the issuance of the test report. Further enquiry of validity or verification of the test report should be addressed to AGC by agc01@agccert.com.

8. FCC LINE CONDUCTED EMISSION TEST

8.1. LIMITS OF LINE CONDUCTED EMISSION TEST

| Frequency | Maximum RF Line Voltage | |
|---------------|-------------------------|---------------|
| | Q.P.(dBuV) | Average(dBuV) |
| 150kHz~500kHz | 66-56 | 56-46 |
| 500kHz~5MHz | 56 | 46 |
| 5MHz~30MHz | 60 | 50 |

Note: 1. The lower limit shall apply at the transition frequency.

2. The limit decreases linearly with the logarithm of the frequency in the range 0.15 MHz to 0.50 MHz.

8.2. BLOCK DIAGRAM OF LINE CONDUCTED EMISSION TEST

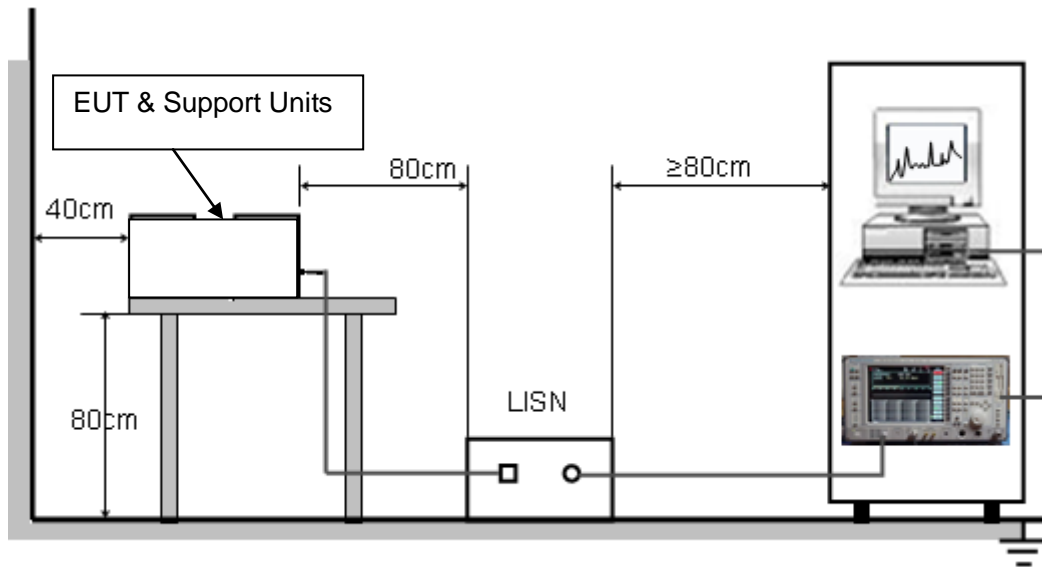

Any report having not been signed by authorized approver, or having been altered without authorization, or having not been stamped by the "Dedicated Testing/Inspection Stamp" is deemed to be invalid. Copying or excerpting portion of, or altering the content of the report is not permitted without the written authorization of AGC. The test results presented in the report apply only to the tested sample. Any objections to report issued by AGC should be submitted to AGC within 15days after the issuance of the test report. Further enquiry of validity or verification of the test report should be addressed to AGC by agc01@agccert.com.

8.3. PRELIMINARY PROCEDURE OF LINE CONDUCTED EMISSION TEST

1. The equipment was set up as per the test configuration to simulate typical actual usage per the user's manual. When the EUT is a tabletop system, a wooden table with a height of 0.8 meters is used and is placed on the ground plane as per ANSI C63.10 (see Test Facility for the dimensions of the ground plane used). When the EUT is a floor-standing equipment, it is placed on the ground plane which has a 3-12 mm non-conductive covering to insulate the EUT from the ground plane.
2. Support equipment, if needed, was placed as per ANSI C63.10.
3. All I/O cables were positioned to simulate typical actual usage as per ANSI C63.10.
4. All support equipments received AC120V/60Hz power from a LISN, if any.
5. The EUT received DC charging voltage by adapter which received AC120V/60Hz power by a LISN.
6. The test program was started. Emissions were measured on each current carrying line of the EUT using a spectrum Analyzer / Receiver connected to the LISN powering the EUT. The LISN has two monitoring points: Line 1 (Hot Side) and Line 2 (Neutral Side). Two scans were taken: one with Line 1 connected to Analyzer / Receiver and Line 2 connected to a 50 ohm load; the second scan had Line 1 connected to a 50 ohm load and Line 2 connected to the Analyzer / Receiver.
7. Analyzer / Receiver scanned from 150 kHz to 30MHz for emissions in each of the test modes.
8. During the above scans, the emissions were maximized by cable manipulation.
9. The test mode(s) were scanned during the preliminary test.

Then, the EUT configuration and cable configuration of the above highest emission level were recorded for reference of final testing.

8.4. FINAL PROCEDURE OF LINE CONDUCTED EMISSION TEST

1. EUT and support equipment was set up on the test bench as per step 2 of the preliminary test.
2. A scan was taken on both power lines, Line 1 and Line 2, recording at least the six highest emissions. Emission frequency and amplitude were recorded into a computer in which correction factors were used to calculate the emission level and compare reading to the applicable limit. If EUT emission level was less -2dB to the A.V. limit in Peak mode, then the emission signal was re-checked using Q.P and Average detector.
3. The test data of the worst case condition(s) was reported on the Summary Data page.

8.5. TEST RESULT OF LINE CONDUCTED EMISSION TEST

LINE CONDUCTED EMISSION TEST-L1

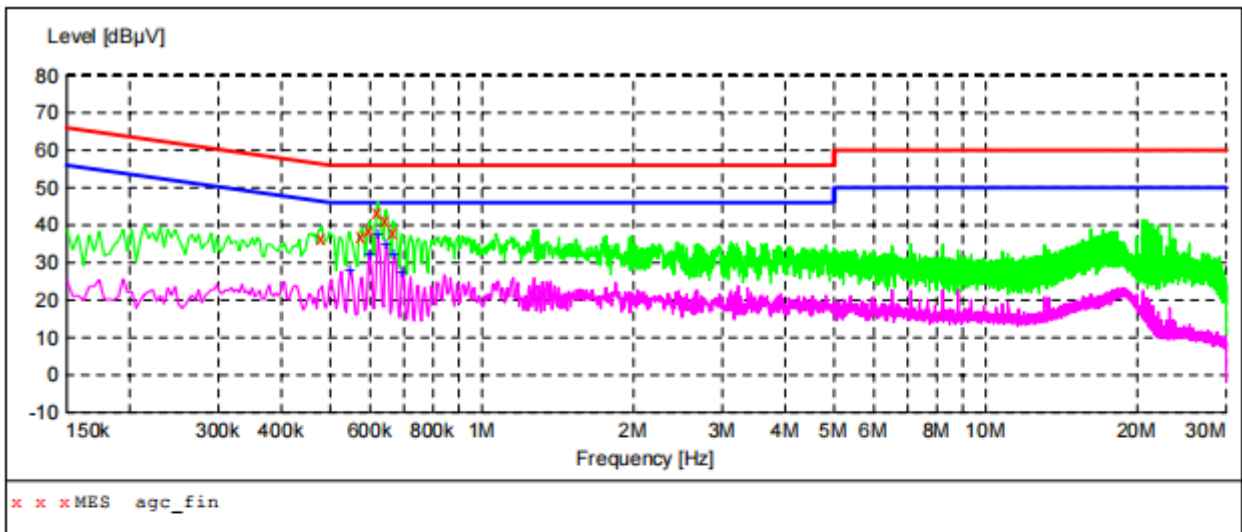

MEASUREMENT RESULT: "agc_fin"

| Frequency MHz | Level dBµV | Transd dB | Limit dBµV | Margin dB | Detector | Line | PE |
|------------------|---------------|--------------|---------------|--------------|----------|------|-----|
| 0.482000 | 36.60 | 5.4 | 56 | 19.7 | QP | L1 | GND |
| 0.578000 | 37.10 | 5.4 | 56 | 18.9 | QP | L1 | GND |
| 0.598000 | 38.70 | 5.4 | 56 | 17.3 | QP | L1 | GND |
| 0.622000 | 43.30 | 5.4 | 56 | 12.7 | QP | L1 | GND |
| 0.646000 | 41.50 | 5.4 | 56 | 14.5 | QP | L1 | GND |
| 0.666000 | 38.30 | 5.4 | 56 | 17.7 | QP | L1 | GND |

MEASUREMENT RESULT: "agc_fin2"

| Frequency MHz | Level dBµV | Transd dB | Limit dBµV | Margin dB | Detector | Line | PE |
|------------------|---------------|--------------|---------------|--------------|----------|------|-----|
| 0.550000 | 28.10 | 5.4 | 46 | 17.9 | AV | L1 | GND |
| 0.598000 | 32.40 | 5.4 | 46 | 13.6 | AV | L1 | GND |
| 0.622000 | 37.30 | 5.4 | 46 | 8.7 | AV | L1 | GND |
| 0.646000 | 35.00 | 5.4 | 46 | 11.0 | AV | L1 | GND |
| 0.670000 | 32.20 | 5.4 | 46 | 13.8 | AV | L1 | GND |
| 0.698000 | 27.50 | 5.4 | 46 | 18.5 | AV | L1 | GND |

RESULT: PASS

Any report having not been signed by authorized approver, or having been altered without authorization, or having not been stamped by the "Dedicated Testing/Inspection Stamp" is deemed to be invalid. Copying or excerpting portion of, or altering the content of the report is not permitted without the written authorization of AGC. The test results presented in the report apply only to the tested sample. Any objections to report issued by AGC should be submitted to AGC within 15days after the issuance of the test report. Further enquiry of validity or verification of the test report should be addressed to AGC by agc01@agccert.com.

LINE CONDUCTED EMISSION TEST-N

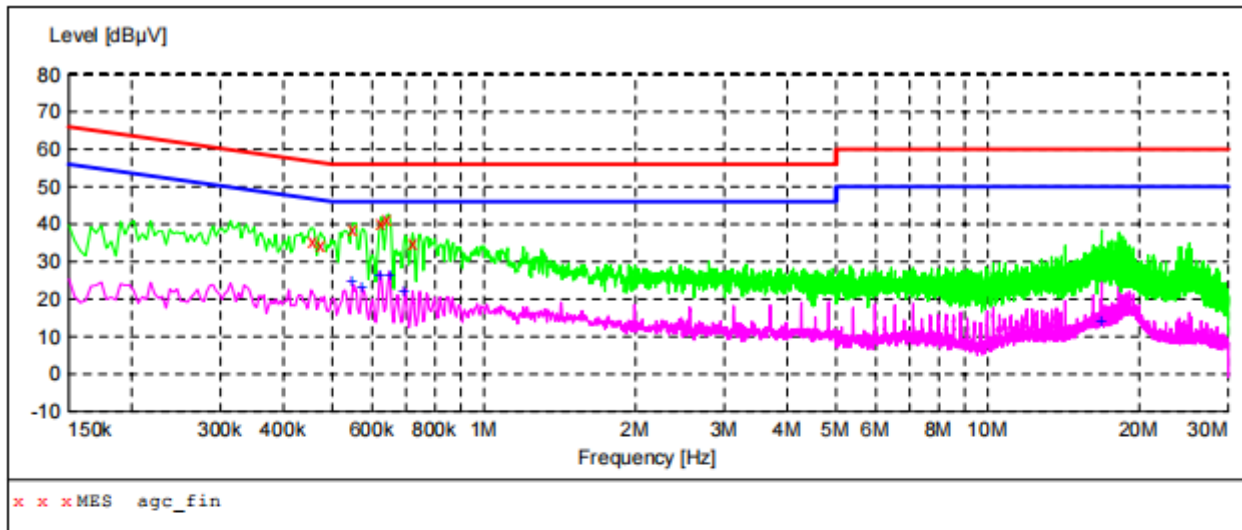

MEASUREMENT RESULT: "agc_fin"

| Frequency MHz | Level dBµV | Transd dB | Limit dBµV | Margin dB | Detector | Line | PE |
|------------------|---------------|--------------|---------------|--------------|----------|------|-----|
| 0.458000 | 35.60 | 5.5 | 57 | 21.1 | QP | N | GND |
| 0.474000 | 34.40 | 5.5 | 56 | 22.0 | QP | N | GND |
| 0.550000 | 38.60 | 5.4 | 56 | 17.4 | QP | N | GND |
| 0.626000 | 40.20 | 5.4 | 56 | 15.8 | QP | N | GND |
| 0.646000 | 41.20 | 5.4 | 56 | 14.8 | QP | N | GND |
| 0.722000 | 34.90 | 5.4 | 56 | 21.1 | QP | N | GND |

MEASUREMENT RESULT: "agc_fin2"

| Frequency MHz | Level dBµV | Transd dB | Limit dBµV | Margin dB | Detector | Line | PE |
|------------------|---------------|--------------|---------------|--------------|----------|------|-----|
| 0.550000 | 24.50 | 5.4 | 46 | 21.5 | AV | N | GND |
| 0.574000 | 23.10 | 5.4 | 46 | 22.9 | AV | N | GND |
| 0.622000 | 26.40 | 5.4 | 46 | 19.6 | AV | N | GND |
| 0.650000 | 26.40 | 5.4 | 46 | 19.6 | AV | N | GND |
| 0.698000 | 21.90 | 5.4 | 46 | 24.1 | AV | N | GND |
| 16.834000 | 14.20 | 8.5 | 50 | 35.8 | AV | N | GND |

RESULT: PASS

Note: All the test modes had been tested, the mode 3 was the worst case. Only the data of the worst case would be record in this test report.

Any report having not been signed by authorized approver, or having been altered without authorization, or having not been stamped by the "Dedicated Testing/Inspection Stamp" is deemed to be invalid. Copying or excerpting portion of, or altering the content of the report is not permitted without the written authorization of AGC. The test results presented in the report apply only to the tested sample. Any objections to report issued by AGC should be submitted to AGC within 15days after the issuance of the test report. Further enquiry of validity or verification of the test report should be addressed to AGC by agc01@agccert.com.

APPENDIX A: PHOTOGRAPHS OF TEST SETUP

Refer to the Report No.: AGC01110200706AP02A

APPENDIX B: PHOTOGRAPHS OF EUT

Refer to the Report No.: AGC01110200706AP03A

----END OF REPORT----

Any report having not been signed by authorized approver, or having been altered without authorization, or having not been stamped by the "Dedicated Testing/Inspection Stamp" is deemed to be invalid. Copying or excerpting portion of, or altering the content of the report is not permitted without the written authorization of AGC. The test results presented in the report apply only to the tested sample. Any objections to report issued by AGC should be submitted to AGC within 15days after the issuance of the test report. Further enquiry of validity or verification of the test report should be addressed to AGC by agc01@agccert.com.

Attestation of Global Compliance(Shenzhen)Co., Ltd

Attestation of Global Compliance(Shenzhen)Std & Tech Co., Ltd

Tel: +86-755 2523 4088 E-mail: agc@agccert.com Web: <http://www.agccert.com/>



Conditions of Issuance of Test Reports

1. All samples and goods are accepted by the Attestation of Global Compliance (Shenzhen) Co., Ltd. (the “Company”) solely for testing and reporting in accordance with the following terms and conditions. The company provides its services on the basis that such terms and conditions constitute express agreement between the company and any person, firm or company requesting its services (the “Clients”).
2. Any report issued by Company as a result of this application for testing services (the “Report”) shall be issued in confidence to the Clients and the Report will be strictly treated as such by the Company. It may not be reproduced either in its entirety or in part and it may not be used for advertising or other unauthorized purposes without the written consent of the Company. The Clients to whom the Report is issued may, however, show or send it, or a certified copy thereof prepared by the Company to its customer, supplier or other persons directly concerned. The Company will not, without the consent of the Clients, enter into any discussion or correspondence with any third party concerning the contents of the Report, unless required by the relevant governmental authorities, laws or court orders.
3. The Company shall not be called or be liable to be called to give evidence or testimony on the Report in a court of law without its prior written consent, unless required by the relevant governmental authorities, laws or court orders.
4. In the event of the improper use of the report as determined by the Company, the Company reserves the right to withdraw it, and to adopt any other additional remedies which may be appropriate.
5. Samples submitted for testing are accepted on the understanding that the Report issued cannot form the basis of, or be the instrument for, any legal action against the Company.
6. The Company will not be liable for or accept responsibility for any loss or damage however arising from the use of information contained in any of its Reports or in any communication whatsoever about its said tests or investigations.
7. Clients wishing to use the Report in court proceedings or arbitration shall inform the Company to that effect prior to submitting the sample for testing.
8. The Company is not responsible for recalling the electronic version of the original report when any revision is made to them. The Client assumes the responsibility to providing the revised version to any interested party who uses them.
9. Subject to the variable length of retention time for test data and report stored hereinto as otherwise specifically required by individual accreditation authorities, the Company will only keep the supporting test data and information of the test report for a period of six years. The data and information will be disposed of after the aforementioned retention period has elapsed. Under no circumstances shall we provide any data and information which has been disposed of after retention period. Under no circumstances shall we be liable for damage of any kind, including (but not limited to) compensatory damages, lost profits, lost data, or any form of special, incidental, indirect, consequential or punitive damages of any kind, whether based on breach of contract of warranty, tort (including negligence), product liability or otherwise, even if we are informed in advance of the possibility of such damages.

Any report having not been signed by authorized approver, or having been altered without authorization, or having not been stamped by the “Dedicated Testing/Inspection Stamp” is deemed to be invalid. Copying or excerpting portion of, or altering the content of the report is not permitted without the written authorization of AGC. The test results presented in the report apply only to the tested sample. Any objections to report issued by AGC should be submitted to AGC within 15days after the issuance of the test report. Further enquiry of validity or verification of the test report should be addressed to AGC by agc01@agccert.com.