

Service Manual

19" LCD MONITOR DELL 1907FPc



THESE DOCUMENTS ARE FOR REPAIR SERVICE INFORMATION ONLY. EVERY REASONABLE EFFORT HAS BEEN MADE TO ENSURE THE ACCURACY OF THIS MANUAL; WE CANNOT GUARANTEE THE ACCURACY OF THIS INFORMATION AFTER THE DATE OF PUBLICATION AND DISCLAIM RELIABILITY FOR CHANGES, ERRORS OR OMISSIONS.

Table of contents	
Table of contents -----	02
Revision List -----	03
ECN History -----	04
Important Safety Notice -----	05
1. Monitor Specifications -----	06
2. LCD Monitor Description -----	07
3. Operation instructions -----	08
3.1 General Instructions-----	08
3.2 Control buttons-----	08
3.3 Adjusting the Picture-----	12
3.4 Connect Your Monitor-----	19
4. Input/Output Specification -----	20
4.1 Input Signal Connector-----	20
4.2 Factory Preset Display Modes-----	21
4.3 Power Supply Requirements-----	21
4.4 Panel Specification-----	22
5. Block Diagram -----	25
5.1 Monitor Exploded View-----	25
5.2 Software Flow Chart-----	27
5.3 Electrical Block Diagram-----	29
6. Schematic Diagram -----	31
6.1 Main Board-----	31
6.2 Power Board-----	36
6.3 USB Board-----	38
7. Layout -----	40
7.1 Main Board-----	40
7.2 Power Board-----	41
7.3 USB Board-----	43
7.4 Key Board-----	43
8. Mechanical Instruction -----	44
9. Maintainability -----	53
9.1 Equipments and Tools Requirement-----	53
9.2 Trouble Shooting-----	54
10. White Balance Adjustment -----	60
11. EDID Content -----	62
12. ISP Instruction -----	63
13. Check List -----	69
14. BOM List -----	72
15. Definition Of Pixel Defects -----	105

Important Safety Notice

ANY PERSON ATTEMPTING TO SERVICE THIS CHASSIS MUST FAMILIARIZE HIMSELF WITH THE CHASSIS AND BE AWARE OF THE NECESSARY SAFETY PRECAUTIONS TO BE USED WHEN SERVICING ELECTRONIC EQUIPMENT CONTAINING HIGH VOLTAGES.

CAUTION: USE A SEPARATE ISOLATION TRANSFORMER FOR THIS UNIT WHEN SERVICING
REFER TO BACK COVER FOR IMPORTANT SAFETY GUIDELINGS

Proper service and repair is important to the safe, reliable operation of all Dell Company** Equipment. The service procedures recommended by Dell and described in this service manual are effective methods of performing service operations. Some of these service operations require the use of tools specially designed for the purpose. The special tools should be used when and as recommended.

It is important to note that this manual contains various CAUTIONS and NOTICES which should be carefully read in order to minimize the risk of personal injury to service personnel. The possibility exists that improper service methods may damage the equipment. It is also important to understand that these CAUTIONS and NOTICES ARE NOT EXHAUSTIVE. Dell could not possibly know, evaluate and advise the service trade of all conceivable ways in which service might be done or of the possible hazardous consequences of each way. Consequently, Dell has not undertaken any such broad evaluation. Accordingly, a servicer who uses a service procedure or tool which is not recommended by Dell must first satisfy himself thoroughly that neither his safety nor the safe operation of the equipment will be jeopardized by the service method selected.

** Hereafter throughout this manual, Dell Company will be referred to as Dell.

WARNING

Use of substitute replacement parts, which do not have the same, specified safety characteristics may create shock, fire, or other hazards.

Under no circumstances should the original design be modified or altered without written permission from Dell. Dell assumes no liability, express or implied, arising out of any unauthorized modification of design. Servicer assumes all liability.

FOR PRODUCTS CONTAINING LASER:

DANGER - Invisible laser radiation when open. AVOID DIRECT EXPOSURE TO BEAM.

CAUTION - Use of controls or adjustments or performance of procedures other than those specified herein may result in hazardous radiation exposure.

CAUTION - The use of optical instruments with this product will increase eye hazard.

TO ENSURE THE CONTINUED RELIABILITY OF THIS PRODUCT, USE ONLY ORIGINAL MANUFACTURER'S REPLACEMENT PARTS, WHICH ARE LISTED WITH THEIR PART NUMBERS IN THE PARTS LIST SECTION OF THIS SERVICE MANUAL.

Take care during handling the LCD module with backlight unit

- Must mount the module using mounting holes arranged in four corners.
- Do not press on the panel, edge of the frame strongly or electric shock as this will result in damage to the screen.
- Do not scratch or press on the panel with any sharp objects, such as pencil or pen as this may result in damage to the Panel.
- Protect the module from the ESD as it may damage the electronic circuit (C-MOS).
- Make certain that treatment person's body is grounded through wristband.
- Do not leave the module in high temperature and in areas of high humidity for a long time.
- Avoid contact with water as it may a short circuit within the module.

If the surface of panel becomes dirty, please wipe it off with a soft material. (Cleaning with a dirty or rough cloth may damage the panel.)

1. Monitor Specifications

LCD Panel	Screen type	Active matrix - TFT LCD
	Panel Type	LTM190EX-L01 (LPL)
		LM190E03-TLB4 (SEC)
	Size	480mm(19.0")
	Display Area	376.32(H) x 301.056(V)
	Pixel pitch	0.294mm(H) x 0.294mm(V)
	Viewable angle (CR>=10)	150(H) / 135(V) (type) (For LTM190EX-L01 panel)
140(H) / 140(V) (type) (For LM190E03-TLB4 panel)		
Response time	8ms(type)	
Input	Video	R, G, B Analog Interface
	Separate Sync	H/V TTL
	H-Frequency	30kHz – 81kHz
	V-Frequency	56 - 76Hz
Display Colors		16.7M Colors
Dot Clock		165MHz (Max)
Optimal preset resolution		1280 x 1024 at 60 Hz
Highest preset resolution		1280 x 1024 at 75 Hz
Plug & Play		VESA DDC
EPA ENERGY STAR®	ON Mode (with Dell Sound bar and USB active)	<65W
	OFF Mode	<3W
Connector Type		15-pin D-subminiature, blue connector; DVI-D, white connector
Input Video Signal		Analog RGB, 0.7 Volts +/-5%, positive polarity at 75 ohm input impedance
Power Source		100 V ~ 240 V± 10 %VAC, 50 ± 3Hz, 60 ± 3Hz
Environmental Considerations	Temperature:	Operating: 5° to 35°C (41° to 95°F) Non-operating: Storage: -20° to 60°C (-4° to 140°F); Shipping: -20° to 60°C (-4° to 140°F)
	Humidity:	Operating: 10% to 80% Non-operating: Storage: 5% to 90%; Shipping: 5% to 90%
	Altitude:	Operating: 3,657.6m (12,000 ft) max Non*operating: 12,192 m (40,000 ft) max
Weight	Weight with packaging: 8.6 kg (18.96 lbs)	
	Weight with stand assembly and cables: 7.1 kg (15.6 lbs)	
	Weight without stand assembly: 5.0 kg (11.02 lbs)	
	Weight of stand assembly: 1.6 kg (3.53 lbs)	

3. Operation instructions

3.1 General Instructions

Press the power button to turn the monitor on or off. The other control buttons are located at front panel of the monitor. By changing these settings, the picture can be adjusted to your personal preferences.

- The power cord should be connected.
- Connect the video cable from the monitor to the video card.
- Press the power button to turn on the monitor, the power indicator will light up.

3.2 Control Buttons

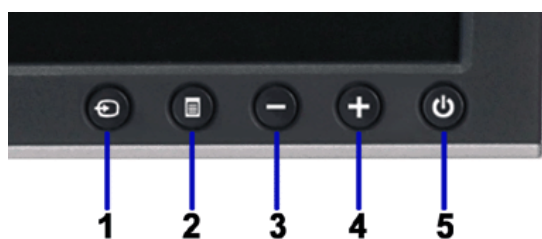



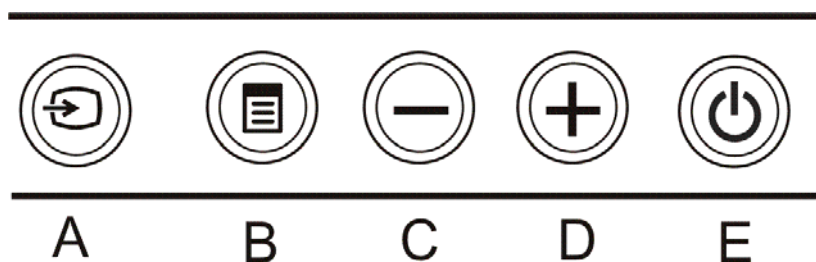

1.	Input select
2.	OSD menu / select button
3.	Down button
4.	Up button
5.	Power button (with power light indicator)

Using the front panel

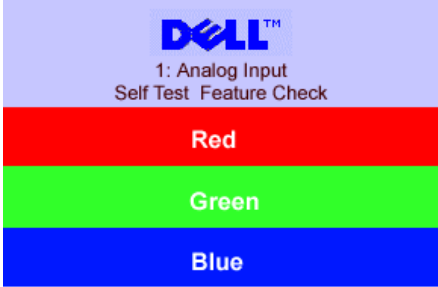
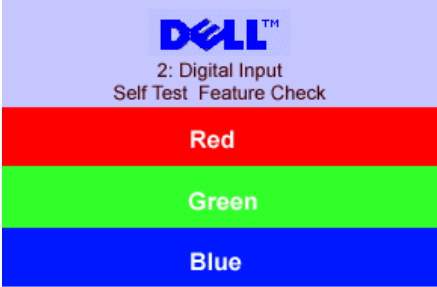
Use the buttons on the front of the monitor to adjust the image settings.



 <p>Input select</p>	<p>Use the Input Select button to select between two different video signals that may be connected to your monitor.</p> <p>NOTE: The floating 'Dell Self-test Feature Check' dialog appears on a black background If the monitor cannot sense a video signal. Depending upon the selected input, one of the dialogs shown below will scroll continually.</p> <div style="display: flex; justify-content: space-around; align-items: center;"> <div style="text-align: center;">  </div> <div style="text-align: center;">  </div> </div>
 <p>OSD menu / select</p>	<p>The Menu button is used to open and exit the on-screen display (OSD), and exit from menus and sub-menus.</p>
 <p>Down (-) and Up (+)</p>	<p>Use these buttons to adjust (decrease/increase ranges) items in the OSD menu.</p>
 <p>Power Button and Indicator</p>	<p>Use the power button to turn the monitor on and off.</p> <p>The green light indicates the monitor is on, and fully functional. An amber light indicates power save mode.</p>

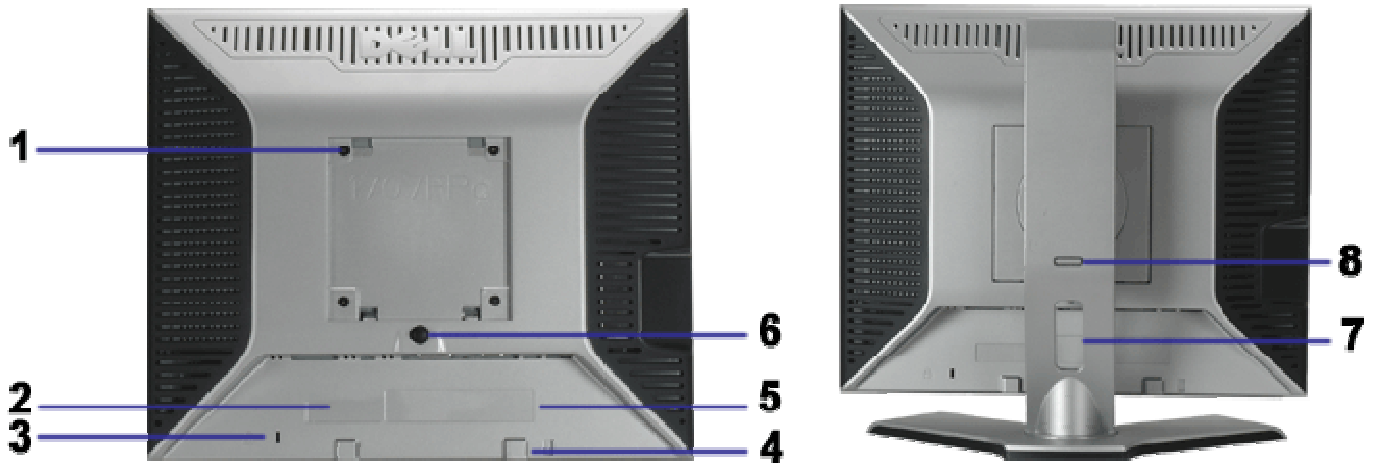

1	VESA mounting holes (100mm) (Behind attached base plate)	Use to mount the monitor.
2	Barcode serial number label	Refer to this label if you need to contact Dell for technical support.
3	Security lock slot	Use a security lock with the slot to help secure your monitor.
4	Dell Soundbar mounting brackets	Attach the optional Dell Soundbar.
5	Regulatory rating label	List the regulatory approvals.
6	Stand removal button	Press to release the stand
7	Cable holder	Help organize cables by placing them in the holder.
8	Lock down/release button	Push the monitor down, press the button to unlock the monitor, and then lift the monitor to the desired height.

Bottom View



1	Power connector	Insert the power cable.
2	Dell Soundbar power connector	Connect the power cord for the Soundbar (optional).
3	DVI connector	Connect your computer DVI cable.
4	VGA connector	Connect your computer VGA cable.
5	USB upstream connector	Connect the USB cable that came with your monitor to the monitor and the computer. Once this cable is connected you can use the USB connectors on the side and bottom of the monitor.
6	USB connector	Connect your USB devices.

Side View

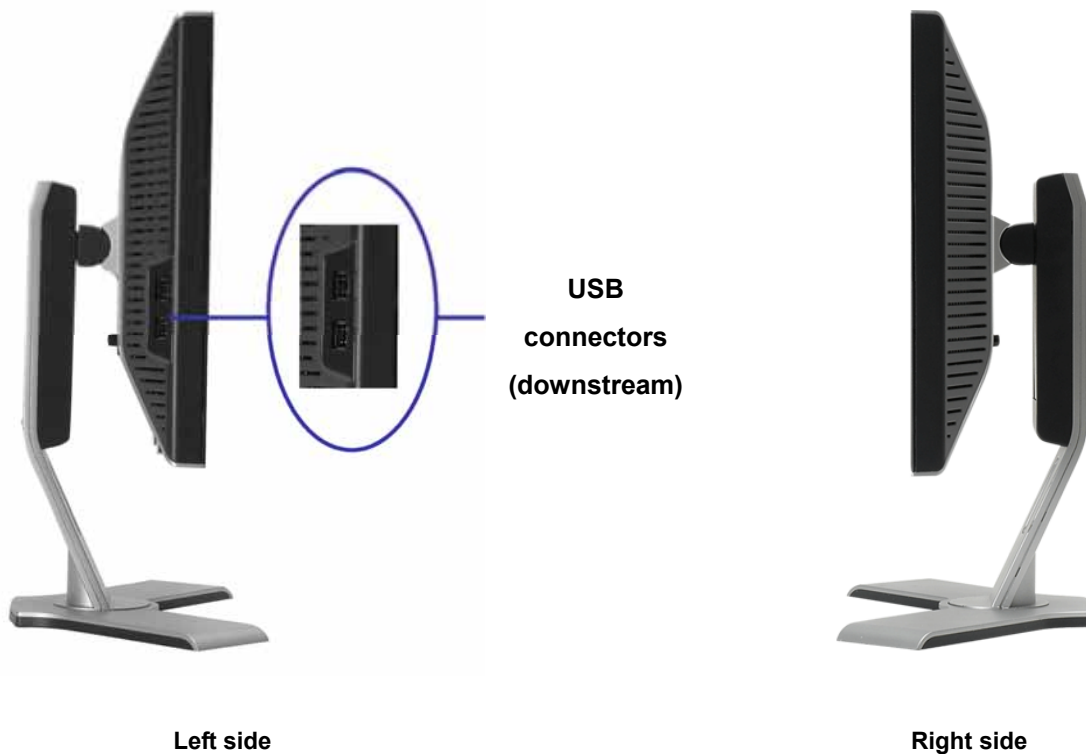



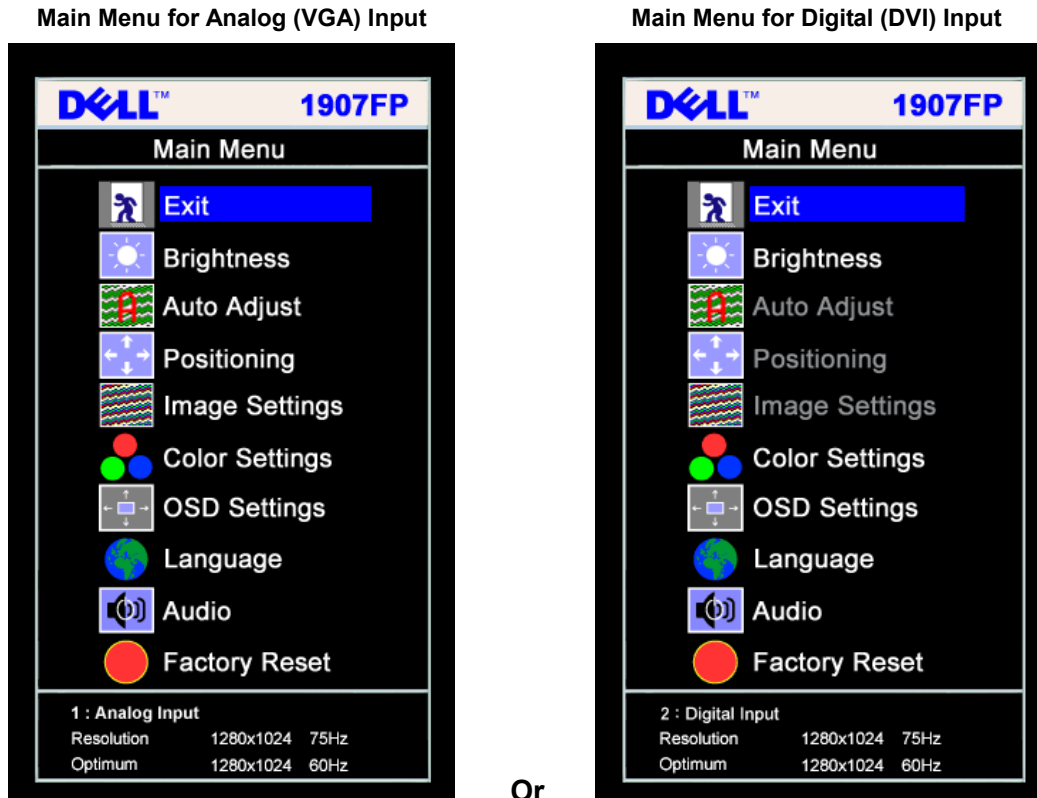

3.3 Adjusting the Picture







NOTE: If you change the settings and then either proceed to another menu, or exit the OSD menu, the monitor automatically saves those changes. The changes are also saved if you change the settings and then wait for the OSD menu to disappear.







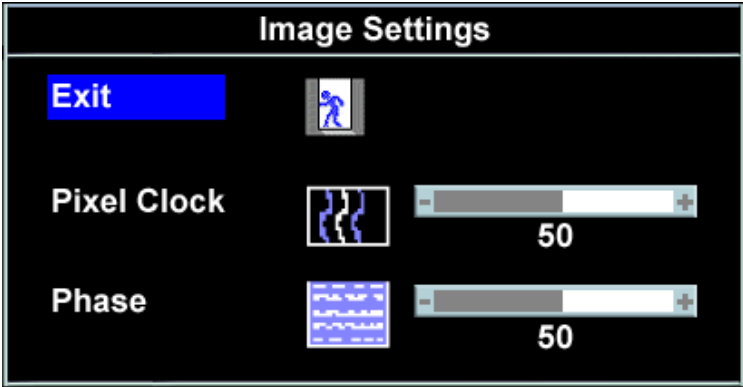









































NOTE: Positioning and Image Settings are only available when you are using the analog (VGA) connector.



1. Push the MENU button to open the OSD menu and display the main menu.
2. Push the - and + buttons to move between the setting options. As you move from one icon to another, the option name is highlighted. See the table below for a complete list of all the options available for the monitor.
3. Push the MENU button once to activate the highlighted option.
4. Push - and + button to select the desired parameter.
5. Push MENU to enter the slide bar and then use the - and + buttons, according to the indicators on the menu, to make your changes.
6. Push the MENU button once to return to the main menu to select another option or push the MENU button two or three times to exit from the OSD menu.

Icon	Menu and Submenus	Description
	Exit	Select to exit the Main menu
	Brightness/ Contrast	<p>Brightness adjusts the luminance of the backlight. Adjust Brightness first, then adjust Contrast only if further adjustment is necessary.</p> <p>Push the + button to increase luminance and push the - button to decrease luminance (min 0 ~ max 100).</p> <p>Contrast adjusts the degree of difference between darkness and lightness on the monitor screen.</p> <p>Push the + button to increase the contrast and push the - button to decrease the contrast (min 0 ~ max 100).</p> <div data-bbox="608 817 1289 1211" data-label="Image"> </div> <p> NOTE: When using DVI source, the contrast adjustment is not available.</p>
	Positioning: Horizontal Vertical	<p>Positioning moves the viewing area around on the monitor screen.</p> <p>When making changes to either the Horizontal or Vertical settings, no changes occur to the size of the viewing area. The image shifts in response to your selection.</p> <p>Minimum is 0 (-) and maximum is 100 (+).</p> <div data-bbox="608 1668 1289 2063" data-label="Image"> </div>

		<p> NOTE: When using DVI source, the Positioning option is not available.</p>
	<p>Auto Adjust</p>	<p>Even though your computer recognizes your monitor on startup, the Auto Adjustment function optimizes the display settings for use with your particular setup.</p> <p>Select to activate automatic setup and adjustment. The following dialog appears on a black screen as the monitor self-adjusts to the current input:</p> <div style="text-align: center; background-color: black; color: white; padding: 5px; width: fit-content; margin: 10px auto;">Auto Adjust In Progress</div> <p>Auto Adjustment allows the monitor to self-adjust to the incoming video signal. After using Auto Adjustment, you can further tune your monitor by using the Pixel Clock (Coarse) and Phase (Fine) controls under Image Settings.</p> <p> In most cases, Auto Adjust produces the best image for your configuration.</p>
	<p>Image settings:</p> <p>Pixel Clock (Coarse)</p> <p>Phase (Fine)</p>	<p>The Phase and Pixel Clock adjustments allow you to more closely adjust your monitor to your preference. These settings are accessed through the main OSD menu, by selecting Image Settings.</p> <p>Use the - and + buttons to make adjustments. (Minimum: 0 ~ Maximum: 100)</p> <p>If satisfactory results are not obtained using the Phase adjustment, use Pixel Clock (Coarse) and then use Phase (fine), again.</p> <p> NOTE: This function may change the width of the display image. Use the Horizontal function of the Position menu to center the display image on the screen.</p> <div style="text-align: center; margin: 10px 0;">  </div> <p> NOTE: When using DVI source, the Image Settings option is not available.</p>
	<p>Color Settings</p>	<p>Color Settings adjusts the color temperature, color hue, and saturation.</p>

	<p>Blue Preset</p> <p>Red Preset</p> <p>Normal Preset</p> <p>User Preset</p>	<div data-bbox="655 138 1241 593" style="border: 1px solid black; background-color: black; color: white; padding: 5px;"> <p style="text-align: center; margin: 0;">Color Settings</p> <p style="margin: 0;">Normal Preset (sRGB)</p> <p style="margin: 0;">Blue Preset</p> <p style="margin: 0;">Red Preset</p> <p style="margin: 0;">User Preset Exit </p> <p style="margin: 0;">Red  52</p> <p style="margin: 0;">Green  49</p> <p style="margin: 0;">Blue  48</p> </div> <p>The color hue is most noticeable in areas of white.</p> <ul style="list-style-type: none"> Blue Preset is selected to obtain a bluish tint. This color setting is typically used for text based applications (spreadsheets, programming, text editors, etc.). Red Preset is selected to obtain a redder tint. This color setting is typically used for color-intensive applications (photograph image editing, multimedia, movies, etc.). Normal Preset is selected to obtain the default (factory) color settings. This setting is also the “sRGB” standard default color space. User Preset: Use the plus and minus buttons to increase or decrease each of the three colors (R, G, B) independently, in single digit increments, from 0 to 100.
	<p>OSD</p> <p>Settings:</p> <p>Horizontal Position</p> <p>Vertical Position</p> <p>OSD Hold Time</p>	<p>Adjust the settings for the OSD, including the location, the amount of time the menu remains on-screen, and the rotation of the OSD.</p> <p>Position of the OSD:</p> <ul style="list-style-type: none"> To adjust the horizontal position of the OSD, use the - and + buttons, and move OSD to the left and right. To adjust the vertical position of the OSD, use the - and + buttons, and move OSD down and up. <p>OSD Hold Time: The OSD stays active for as long as it is in use. Adjusting the hold time, sets the length of time the OSD remains active after the last time you pressed a button. Use the - and + buttons to adjust the slider in 5 second increments, from 5 to 60 seconds.</p> <p>OSD Lock: Controls user access to adjustments. When Yes (+) is selected, no user adjustments are allowed. All buttons are locked except the menu button.</p>

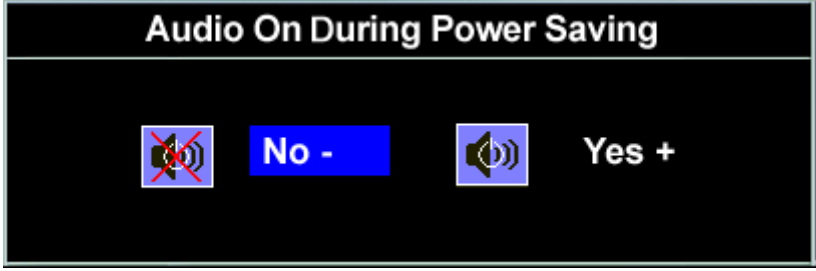
	OSD Lock	<p> NOTE: When the OSD is locked, pressing the menu button takes the user directly to the OSD settings menu, with OSD Lock selected. Select No (-) to unlock and allow user access to all applicable settings.</p> <div data-bbox="683 309 1212 757" style="border: 1px solid black; background-color: black; color: white; padding: 5px;"> <p style="text-align: center; margin: 0;">On Screen Display (OSD)</p> <table style="width: 100%; border-collapse: collapse;"> <tr> <td style="padding: 2px;">Exit </td> <td style="padding: 2px;">Exit</td> </tr> <tr> <td style="padding: 2px;">Horizontal Position </td> <td style="padding: 2px;"><div style="width: 100px; height: 15px; background: linear-gradient(to right, black 49%, white 49%, white 51%, black 51%); display: flex; justify-content: center; align-items: center;">50</div></td> </tr> <tr> <td style="padding: 2px;">Vertical Position </td> <td style="padding: 2px;"><div style="width: 100px; height: 15px; background: linear-gradient(to bottom, black 49%, white 49%, white 51%, black 51%); display: flex; justify-content: center; align-items: center;">50</div></td> </tr> <tr> <td style="padding: 2px;">OSD Hold Time </td> <td style="padding: 2px;"><div style="width: 100px; height: 15px; background: linear-gradient(to right, black 20%, white 20%, white 80%, black 80%); display: flex; justify-content: center; align-items: center;">20 Sec</div></td> </tr> <tr> <td style="padding: 2px;">OSD Rotation </td> <td style="padding: 2px;">- No Yes +</td> </tr> <tr> <td style="padding: 2px;">OSD Lock </td> <td style="padding: 2px;">- No Yes +</td> </tr> </table> </div> <p> NOTE: You can also lock or unlock the OSD by pushing and holding the Menu button for 15 seconds.</p>	Exit 	Exit	Horizontal Position 	<div style="width: 100px; height: 15px; background: linear-gradient(to right, black 49%, white 49%, white 51%, black 51%); display: flex; justify-content: center; align-items: center;">50</div>	Vertical Position 	<div style="width: 100px; height: 15px; background: linear-gradient(to bottom, black 49%, white 49%, white 51%, black 51%); display: flex; justify-content: center; align-items: center;">50</div>	OSD Hold Time 	<div style="width: 100px; height: 15px; background: linear-gradient(to right, black 20%, white 20%, white 80%, black 80%); display: flex; justify-content: center; align-items: center;">20 Sec</div>	OSD Rotation 	- No Yes +	OSD Lock 	- No Yes +
Exit 	Exit													
Horizontal Position 	<div style="width: 100px; height: 15px; background: linear-gradient(to right, black 49%, white 49%, white 51%, black 51%); display: flex; justify-content: center; align-items: center;">50</div>													
Vertical Position 	<div style="width: 100px; height: 15px; background: linear-gradient(to bottom, black 49%, white 49%, white 51%, black 51%); display: flex; justify-content: center; align-items: center;">50</div>													
OSD Hold Time 	<div style="width: 100px; height: 15px; background: linear-gradient(to right, black 20%, white 20%, white 80%, black 80%); display: flex; justify-content: center; align-items: center;">20 Sec</div>													
OSD Rotation 	- No Yes +													
OSD Lock 	- No Yes +													
	Language	<p>Select to have the OSD display in one of five languages (English, French, Spanish, German, or Japanese).</p> <div data-bbox="683 1034 1212 1563" style="border: 1px solid black; background-color: black; color: white; padding: 5px;"> <p style="text-align: center; margin: 0;">Language</p> <table style="width: 100%; border-collapse: collapse;"> <tr> <td style="padding: 2px;"></td> <td style="padding: 2px;">Exit</td> </tr> <tr> <td style="padding: 2px;"></td> <td style="padding: 2px;">English</td> </tr> <tr> <td style="padding: 2px;"></td> <td style="padding: 2px;">Español</td> </tr> <tr> <td style="padding: 2px;"></td> <td style="padding: 2px;">Français</td> </tr> <tr> <td style="padding: 2px;"></td> <td style="padding: 2px;">Deutsch</td> </tr> <tr> <td style="padding: 2px;"></td> <td style="padding: 2px;">日本語</td> </tr> </table> </div> <p> NOTE: The change only affects the OSD. It has no effect on any software running on the computer.</p>		Exit		English		Español		Français		Deutsch		日本語
	Exit													
	English													
	Español													
	Français													
	Deutsch													
	日本語													
	Audio (optional)	<p>You can select to have the audio on or off when the monitor is in power saving mode.</p> <p>Yes — enables audio</p> <p>No — disables audio (default)</p>												

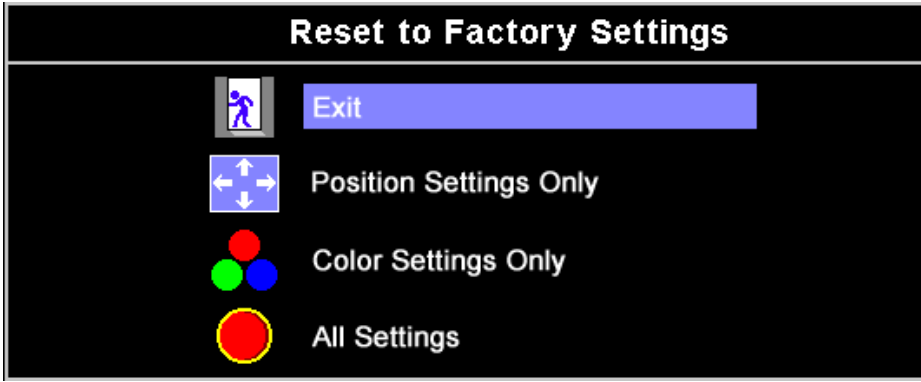
		 <p>NOTE: When the Dell Soundbar is not properly connected to the monitor, the audio menu is not available.</p>
 <p>Factory Reset:</p>		<p>Reset the OSD menu options to the factory-preset values.</p>  <p>Exit — Select to exit out of Reset to Factory Settings menu without resetting any OSD options.</p> <p>Position settings only — Change the settings for Image Position back to original factory settings.</p> <p>Color settings only — Change the Red, Green, and Blue settings back to their original factory settings and set the default setting for Normal Preset.</p> <p>All settings — Change all the user-adjustable settings including color, position, brightness, contrast and OSD hold time to the factory defaults. The language of the OSD does not change.</p>

OSD Warning Messages

One of the following warning messages may appear on the screen indicating that the monitor is out of synchronization.

1. Analog Input
Cannot Display This Video Mode
Optimum Resolution 1280 x1024 60Hz

2. Digital Input
Cannot Display This Video Mode
Optimum Resolution 1280 x1024 60Hz

This means that the monitor cannot synchronize with the signal that it is receiving from the computer. Either the signal is too high or too low for the monitor to use. See Specifications for the Horizontal and Vertical frequency ranges addressable by this monitor. Recommended mode is 1280 X 1024 @ 60Hz.

NOTE: The floating Dell Self-test Feature Check dialog appears on-screen if the monitor cannot sense a video signal.

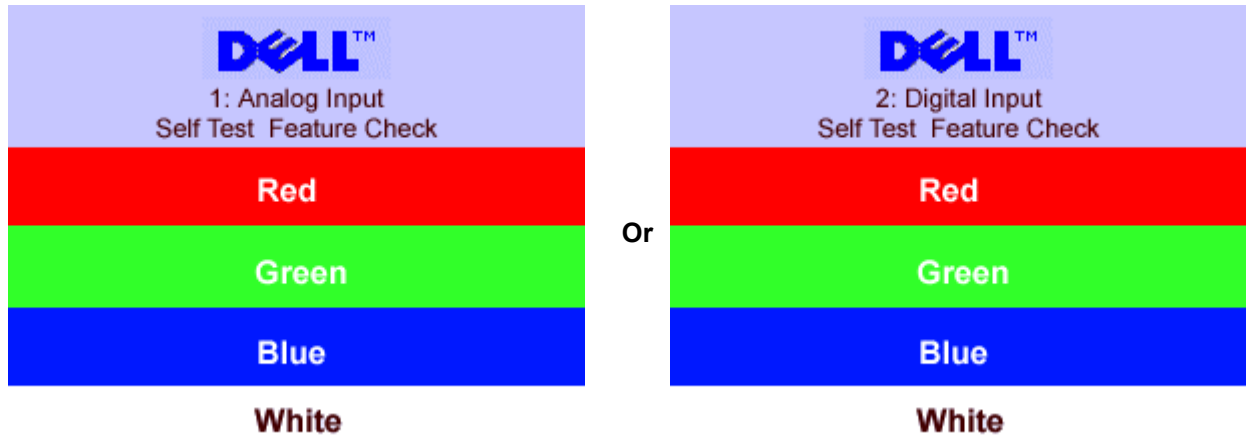

Occasionally, no warning message appears, but the screen is blank. This could also indicate that the monitor is not synchronizing with the computer.

3.4 Connect Your Monitor

CAUTION: Before you begin any of the procedures in this section, follow the safety instructions.

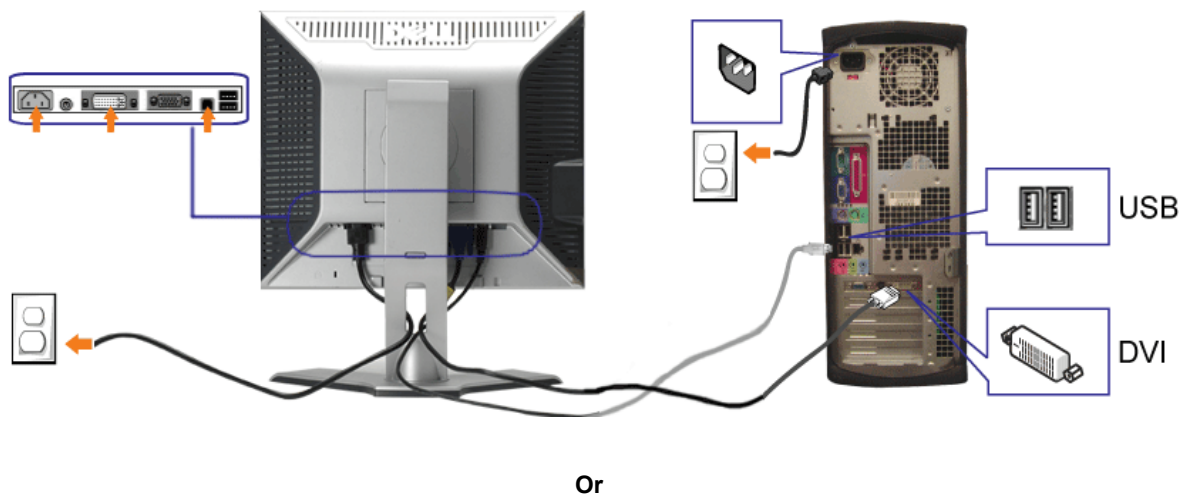

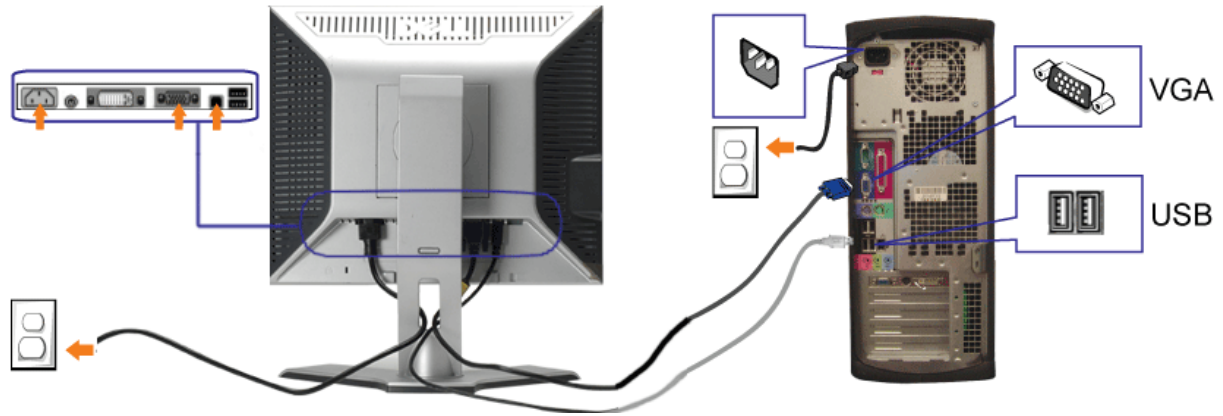

1. Turn off your computer and disconnect the power cable.
2. Connect either the white DVI or blue VGA cables to the connectors on the computer and the monitor.
Connect the USB cable that was included with your monitor to the computer and the upstream USB connector on the monitor. Once this cable is connected to the computer and the monitor, you can use the USB connectors on the monitor.
- 3.
4. Connect any USB devices.
5. Connect the power cables
6. Turn on your monitor and computer. If you do not see an image, push the input select button and ensure the correct input source is selected.

4. Input/Output Specification

4.1 Input Signal Connector

4.1.1 D-Sub Connector

Pin	Signal Assignment	Pin.	Signal Assignment
1.	Red Video	9.	DDC +5V
2.	Green Video	10.	GND-Sync
3.	Blue Video	11.	GND
4.	GND	12.	DDC Data
5.	Self Test	13.	H-Sync
6.	R-Ground	14.	V-Sync
7.	G-Ground	15.	DDC Clock
8.	B-Ground		

VGA Connector layout

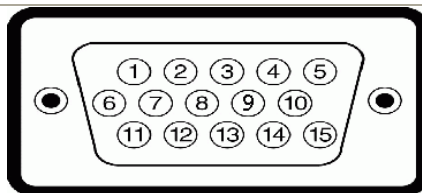

4.1.2 DVI Connector

Pin	Signal Assignment	Pin	Signal Assignment	Pin	Signal Assignment
1	T.M.D.S. Data 2-	9	T.M.D.S. Data 1-	17	T.M.D.S. Data 0-
2	T.M.D.S. Data 2+	10	T.M.D.S. Data 1+	18	T.M.D.S. Data 0+
3	T.M.D.S. Data 2 Shield	11	T.M.D.S. Data 1 Shield	19	T.M.D.S. Data 0 Shield
4	No Pin	12	No Pin	20	No Pin
5	No Pin	13	No Pin	21	No Pin
6	DDC Clock	14	+5V Power	22	T.M.D.S. Clock Shield
7	DDC Data	15	Ground (for +5V)	23	T.M.D.S. Clock +
8	No Connect	16	Hot Plug Detect	24	T.M.D.S. Clock -

DVI Connector Layout

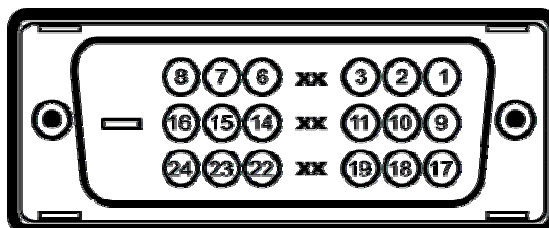

4.2 Factory Preset Display Modes

Display Mode	Horizontal Frequency (kHz)	Vertical Frequency (Hz)	Pixel Clock (MHz)	Sync Polarity (Horizontal/Vertical)
VESA, 720 x 400	31.5	70.0	28.3	-/+
VESA, 640 x 480	31.5	60.0	25.2	-/-
VESA, 640 x 480	37.5	75.0	31.5	-/-
VESA, 800 x 600	37.9	60.3	49.5	+/+
VESA, 800 x 600	46.9	75.0	49.5	+/+
VESA, 1024 x 768	48.4	60.0	65.0	-/-
VESA, 1024 x 768	60.0	75.0	78.8	+/+
VESA, 1152 x 864	67.5	75.0	108	+/+
VESA, 1280 x 1024	64.0	60.0	135.0	+/+
VESA, 1280 x 1024	80.0	75.0	135.0	+/+

4.3 Power Supply Requirements

A/C Line voltage range	: 100 V ~ 240 V
A/C Line frequency range	: 50 ± 3Hz, 60 ± 3Hz
Current	: 1.5A max at 100V; 0.8A max at 240 V
Peak surge current	: < 60A peak at 240 VAC and cold starting
Leakage current	: < 3.5mA
Power line surge	: No advance effects (no loss of information or defect) with a maximum of 1 half-wave missing per second
DC output Voltage	: 5VDC ± 5%; 12VDC ± 5%

4.4 Panel Specification

4.4.1 Display Characteristics

For LTM190EX- L01 panel

Items	Specification	Unit
Display area	376.32(H) x 301.056(V)	mm
Driver element	a-Si TFT active matrix	
Display colors	16.7M	colors
Number of pixels	1280 x 1024	pixel
Pixel arrangement	RGB vertical stripe	
Pixel pitch	0.294(H) x 0.294(W)	mm
Display mode	Normally White	
Surface treatment	Haze 25% , Hard-coating (3H)	

For LM190E03-TLB4 panel

Active screen size	19.0 inches (481.9mm) diagonal
Outline Dimension	396.0(H) x 324.0(V) x 16.5(D) mm(Typ.)
Pixel Pitch	0.098*RGB(H)mm x 0.294(V)mm
Pixel Format	1280 horizontal By 1024 vertical Pixels. RGB stripe arrangement
Interface	LVDS 2Port
Color depth	16.7M colors
Luminance, white	300 cd/m ² (Center 1Point, typ)
Viewing Angle (CR>10)	Viewing Angle Free [R/L 140(Typ.), U/D 140(Typ.)]
Power Consumption	Total TBD Watt(Typ.), (TBD W@V _{LCD} , 19.64 W@[Lamp=7.5mA])
Weight	2700g (Typ.)
Display operating mode	Transmissive mode, normally White
Surface treatments	Hard coating (3H), Anti-glare treatment of the front polarizer

4.4.2 Optical Characteristics

For LTM190EX- L01 panel

Item	Symbol	Condition	Min.	Typ.	Max.	Unit	Note	
Contrast Ratio (Center of screen)	C/R		450	700	-		(3) BM-5A	
Response Time	Rising	Tr	-	1.7	3	msec	(5) BM-7	
	Falling	Tf	-	6.3	9			
Luminance of White (Center of screen)	YL		250	300	-	cd/m ²	(6) BM-5A	
Color Chromaticity (CIE 1931)	Red	Rx	0.610	0.640	0.670		(7) PR650	
		Ry	0.299	0.329	0.359			
	Green	Gx	0.270	0.300	0.330			
		Gy	0.570	0.600	0.630			
	Blue	Bx	0.120	0.150	0.180			
		By	0.030	0.060	0.090			
	White	Wx	0.283	0.313	0.343			
		Wy	0.299	0.329	0.359			
	Color Chromaticity (CIE 1976)	Red	Ru'	-	0.452	-		
			Rv'	-	0.522	-		
Green		Gu'	-	0.125	-			
		Gv'	-	0.563	-			
Blue		Bu'	-	0.175	-			
		Bv'	-	0.158	-			
White		Wu'	-	0.198	-			
		Wv'	-	0.468	-			
Color Grayscale Linearity	White	$\Delta u'v'$	-	0.018	-		(9) PR650	
Viewing Angle	Hor.	θ L	65	75	-	Degrees	(8) BM-5A	
		θ R	65	75	-			
	Ver.	ϕ H	65	75	-			
		ϕ L	50	60	-			
Brightness Uniformity (9 Points)	Buni		-	-	25	%	(4) BM-5A	

For LM190E03-TLB4 panel

Parameter0	Symbol	Values			Units	Notes	
		Min	Typ	Max			
Contrast Ratio	CR	450	700	-		1	
Surface Luminance, white	L_{WH}	240	300	-	cd/m ²	2	
Luminance Variation	δ_{WHITE} 9P	75			%	3	
Response Time	Rise Time	Tr_R	-	2	4	ms	4
	Decay Time	Tr_D	-	6	12	ms	4
Color Coordinates [CIE1931]	RED	R_x	Typ -0.03	0.639	Typ +0.03		
		R_y		0.342			
	GREEN	G_x		0.297			
		G_y		0.615			
	BLUE	B_x		0.146			
		B_y		0.068			
	WHITE	W_x		0.313			
		W_y		0.329			
Viewing Angle (CR>5)							
	x axis, right($\phi=0^\circ$)	θ_r	70	80		Degree	5
	x axis, left ($\phi=180^\circ$)	θ_l	70	80			
	y axis, up ($\phi=90^\circ$)	θ_u	70	85			
	y axis, down ($\phi=270^\circ$)	θ_d	60	75			
Viewing Angle (CR>10)							
	x axis, right($\phi=0^\circ$)	θ_r	60	70		Degree	5
	x axis, left ($\phi=180^\circ$)	θ_l	60	70			
	y axis, up ($\phi=90^\circ$)	θ_u	60	75			
	y axis, down ($\phi=270^\circ$)	θ_d	50	65			
Gray Scale			-			6	

5. Block Diagram

5.1 Monitor Exploded View

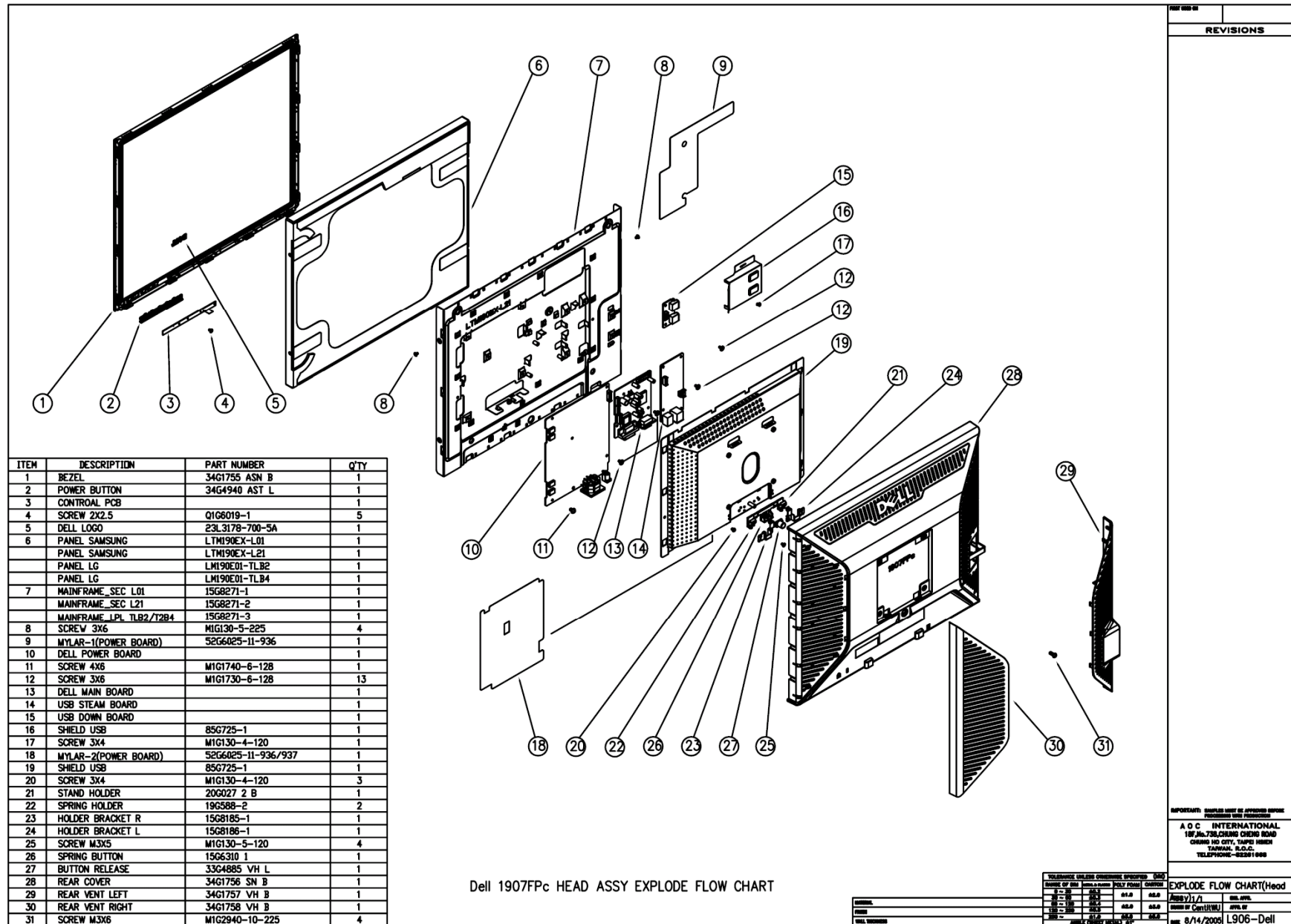

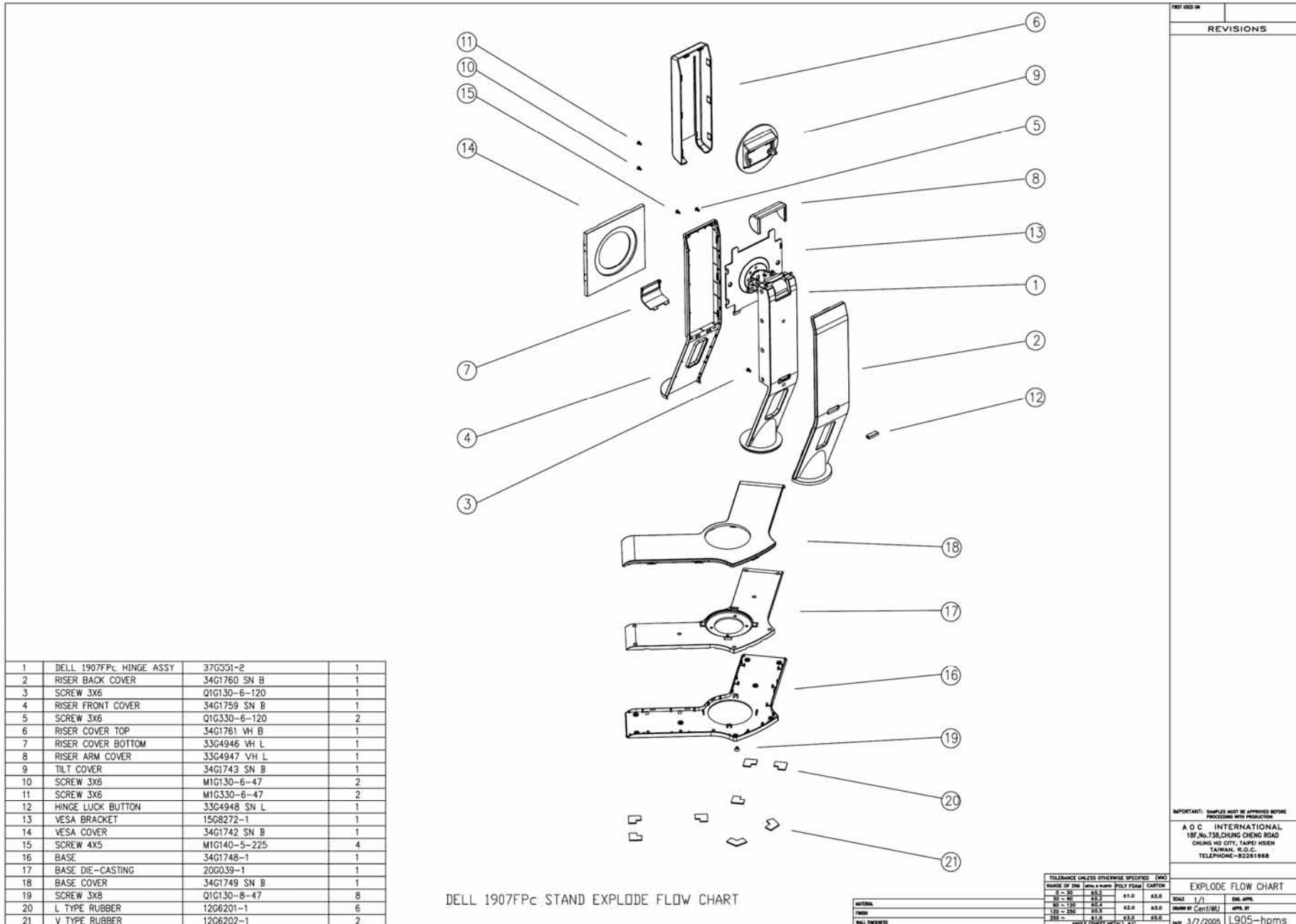

5.2 Software Flow Chart

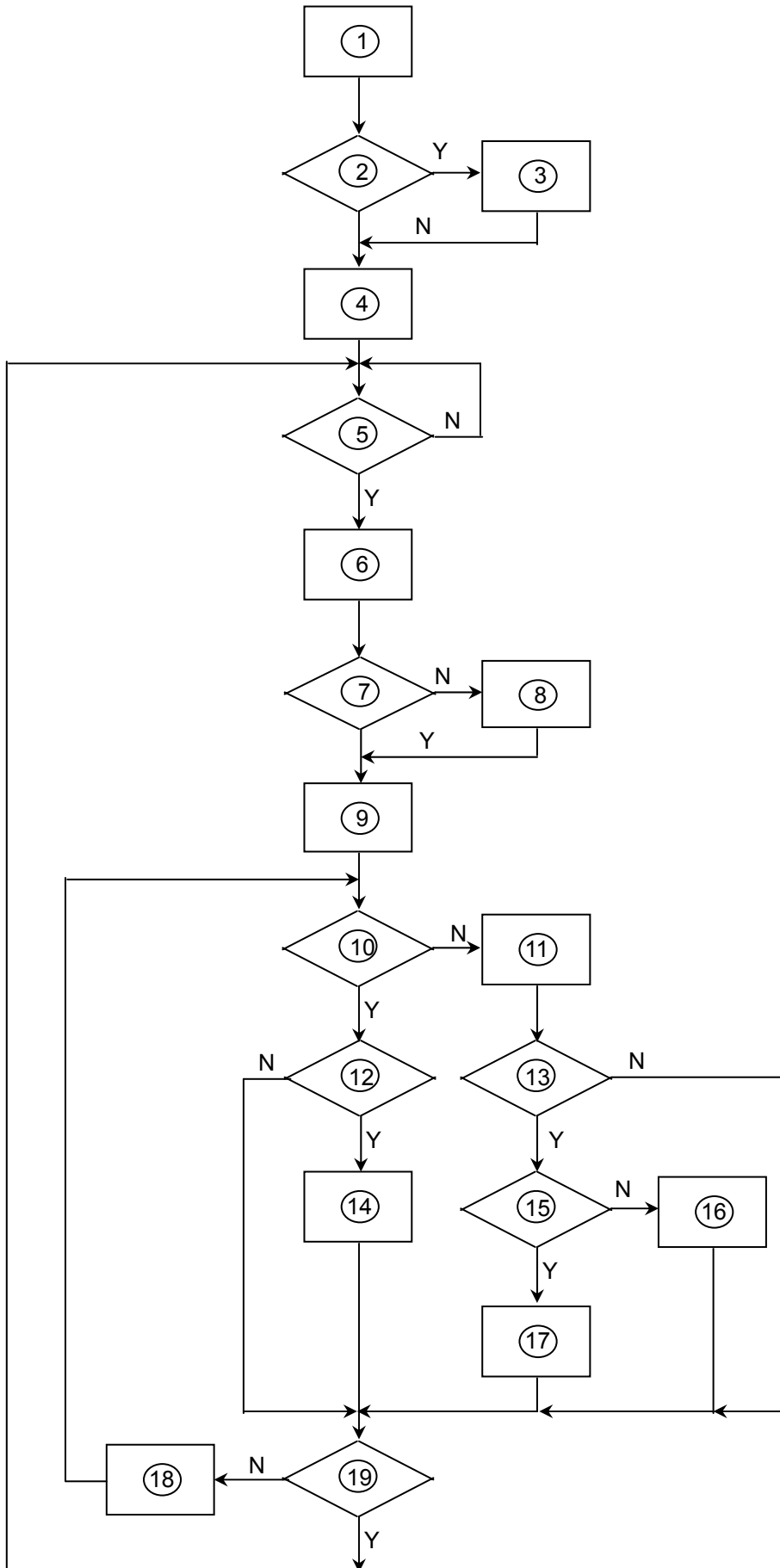

- 1) MCU Initializes.
- 2) Is the EEPROM blank?
- 3) Program the EEPROM by default values.
- 4) Get the PWM value of brightness from EEPROM.
- 5) Is the power key pressed?
- 6) Clear all global flags.
- 7) Are the AUTO and SELECT keys pressed?
- 8) Enter factory mode.
- 9) Save the power key status into EEPROM.
Turn on the LED and set it to green color. Scalar initializes.
- 10) In standby mode?
- 11) Update the lifetime of back light.
- 12) Check the analog port, are there any signals coming?
- 13) Does the scalar send out an interrupt request?
- 14) Wake up the scalar.
- 15) Are there any signals coming from analog port?
- 16) Display "No connection Check Signal Cable" message. And go into standby mode after the message disappears.
- 17) Program the scalar to be able to show the coming mode.
- 18) Process the OSD display.
- 19) Read the keyboard. Is the power key pressed?

5.3 Electrical Block Diagram

5.3.1 Main Board

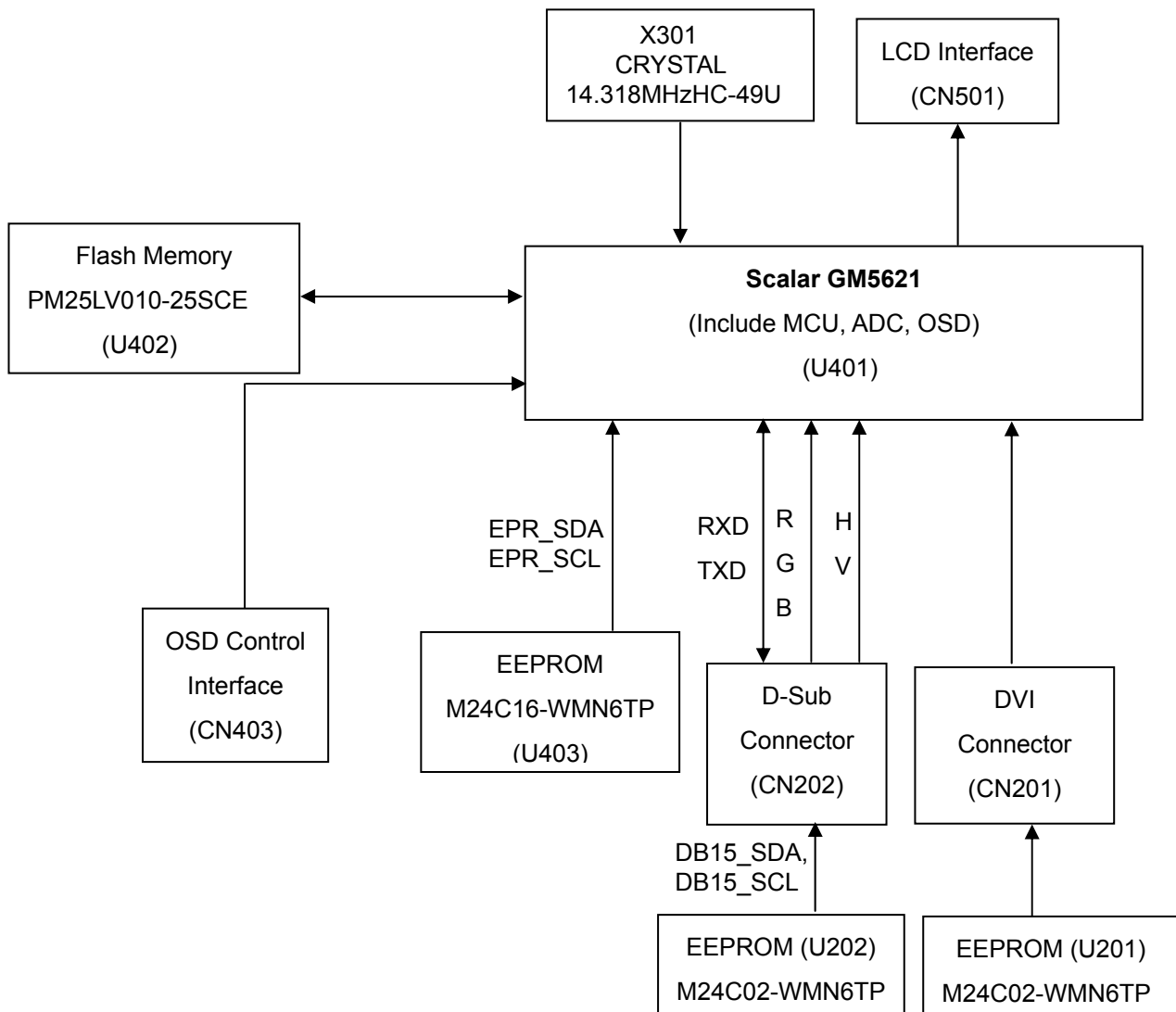

5.3.2 Inverter/Power Board

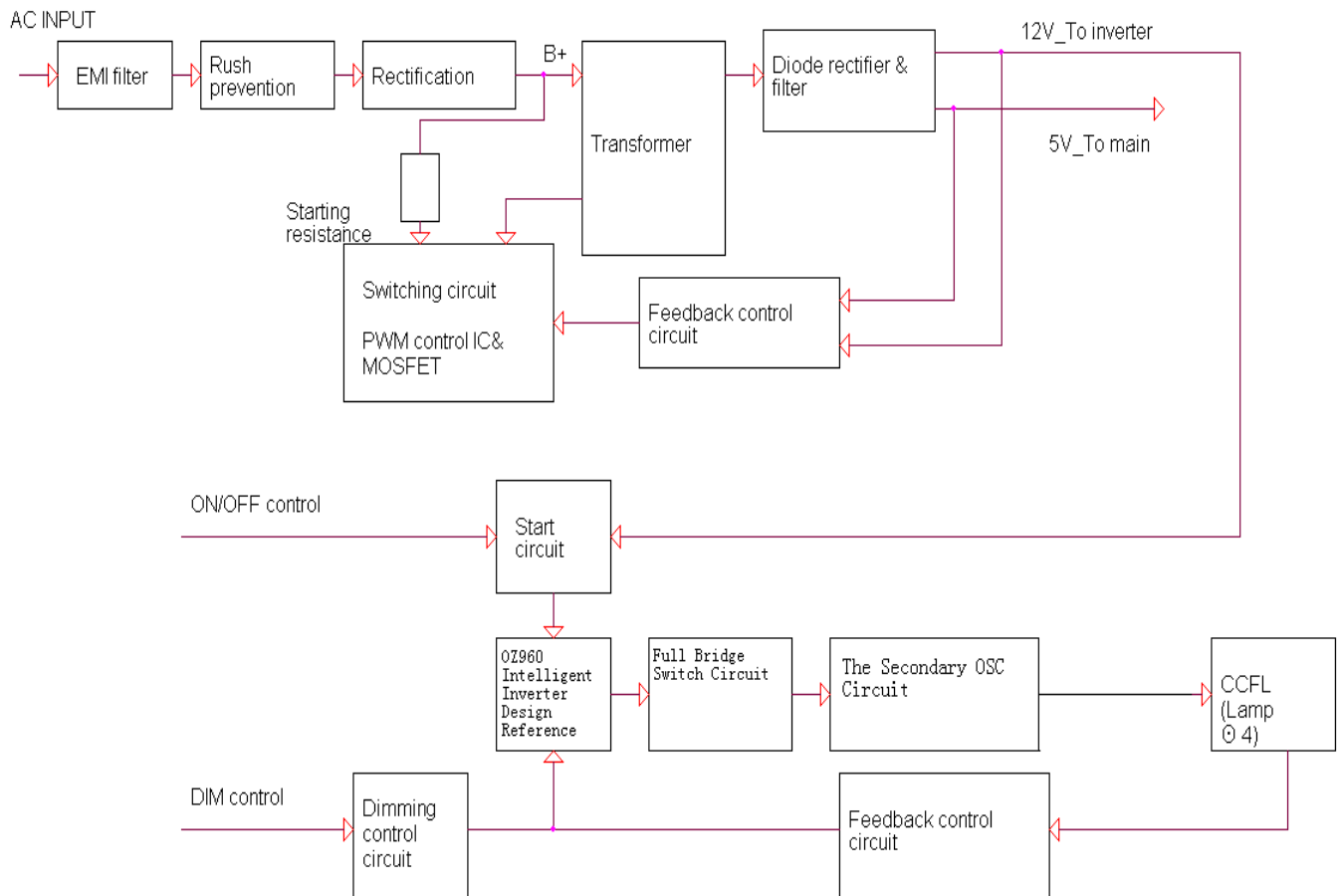

6. Schematic Diagram Main Board

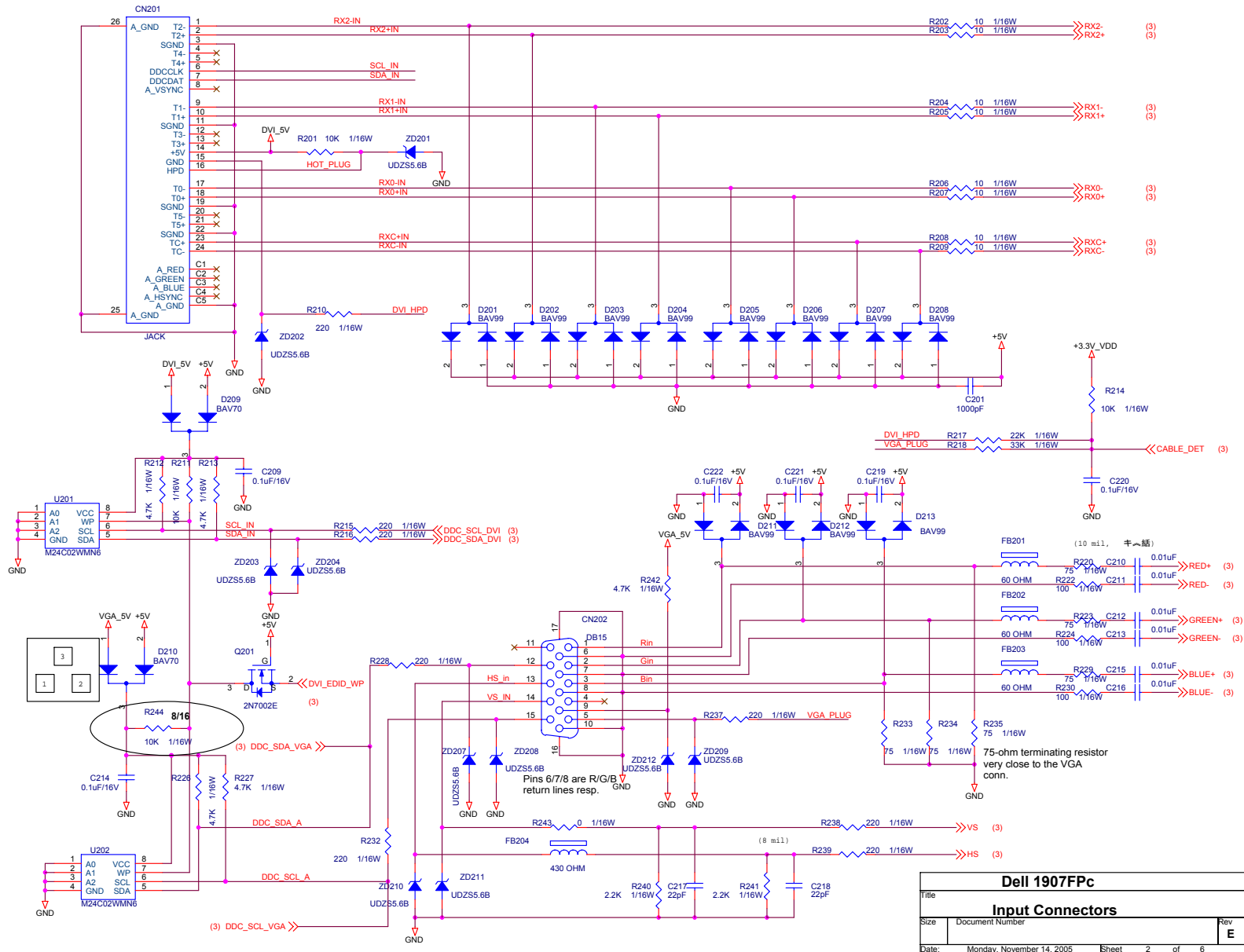

Dell 1907FPC		
Input Connectors		
File	Document Number	Rev
		E
Date:	Monday, November 14, 2005	Sheet 2 of 6

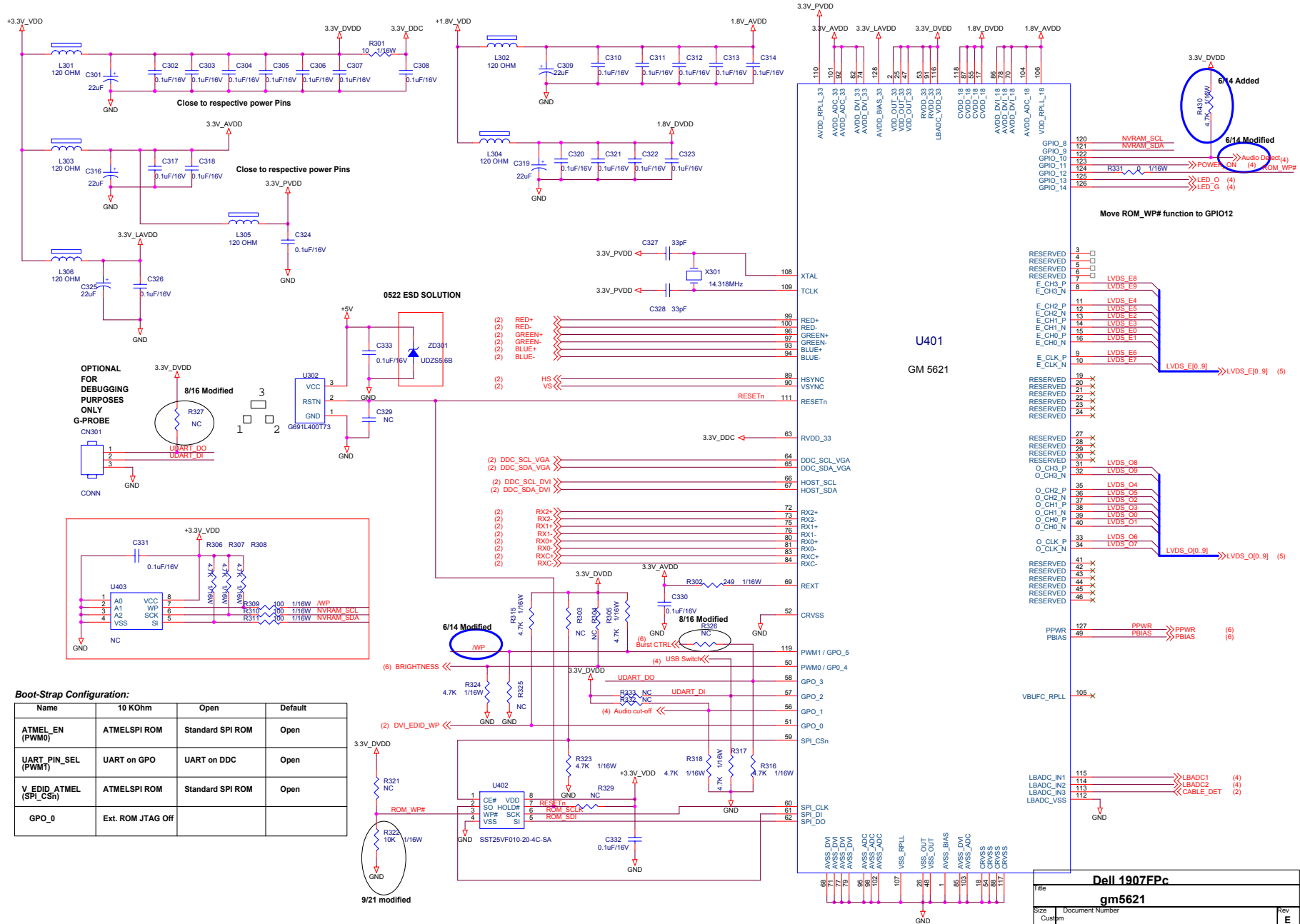

Boot-Strap Configuration:

Name	10 KOhm	Open	Default
ATMEL_EN (PWM0)	ATMELSPI ROM	Standard SPI ROM	Open
UART_PIN_SEL (PWM1)	UART on GPO	UART on DDC	Open
V_EDID_ATMEL (SPI_CSn)	ATMELSPI ROM	Standard SPI ROM	Open
GPO_0	Ext. ROM JTAG Off		

Dell 1907FPc

gm5621

Size:

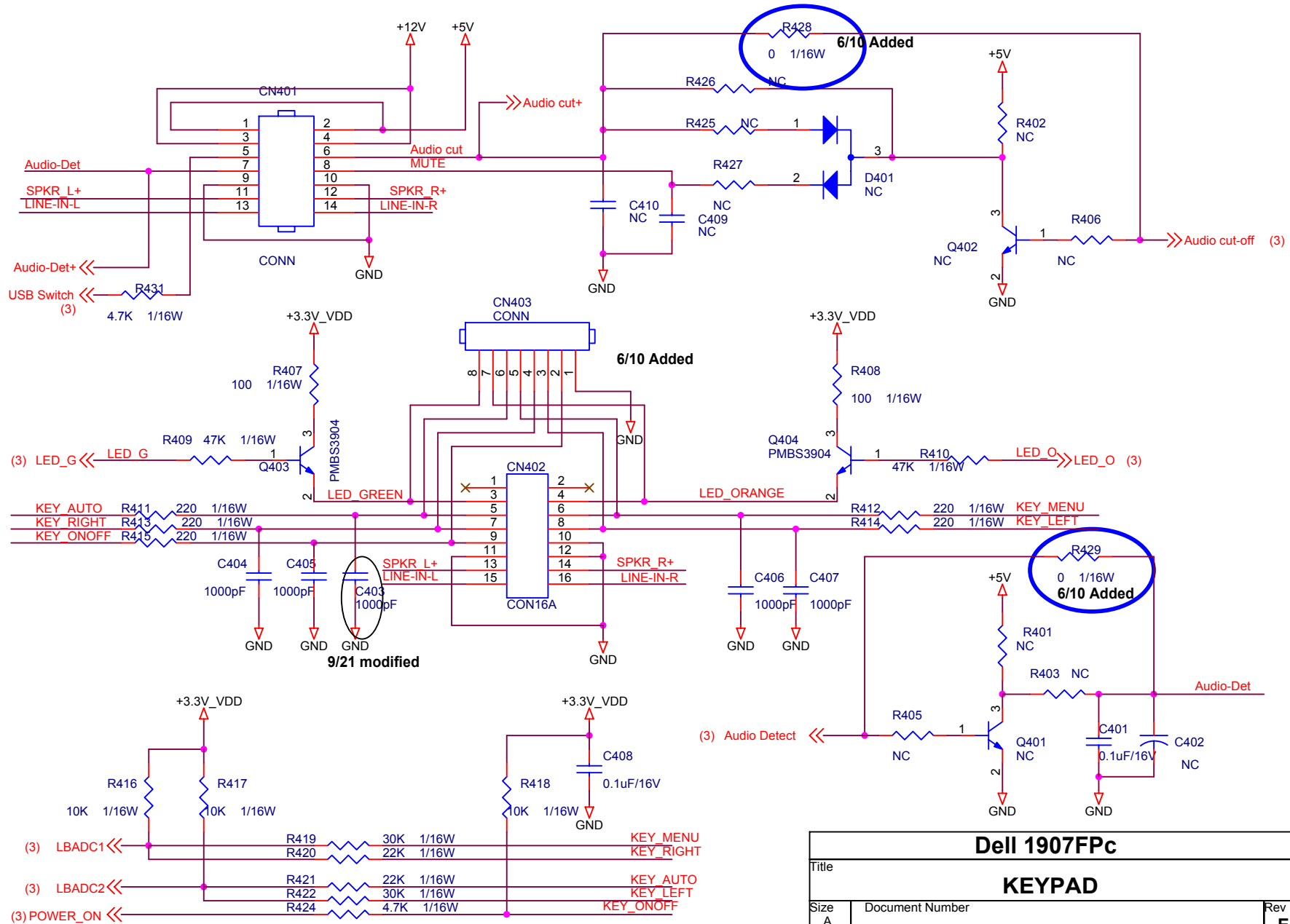

Dell 1907FPC		
Title		
KEYPAD		
Size A	Document Number	Rev E
Date:	Monday, November 14, 2005	Sheet 4 of 6

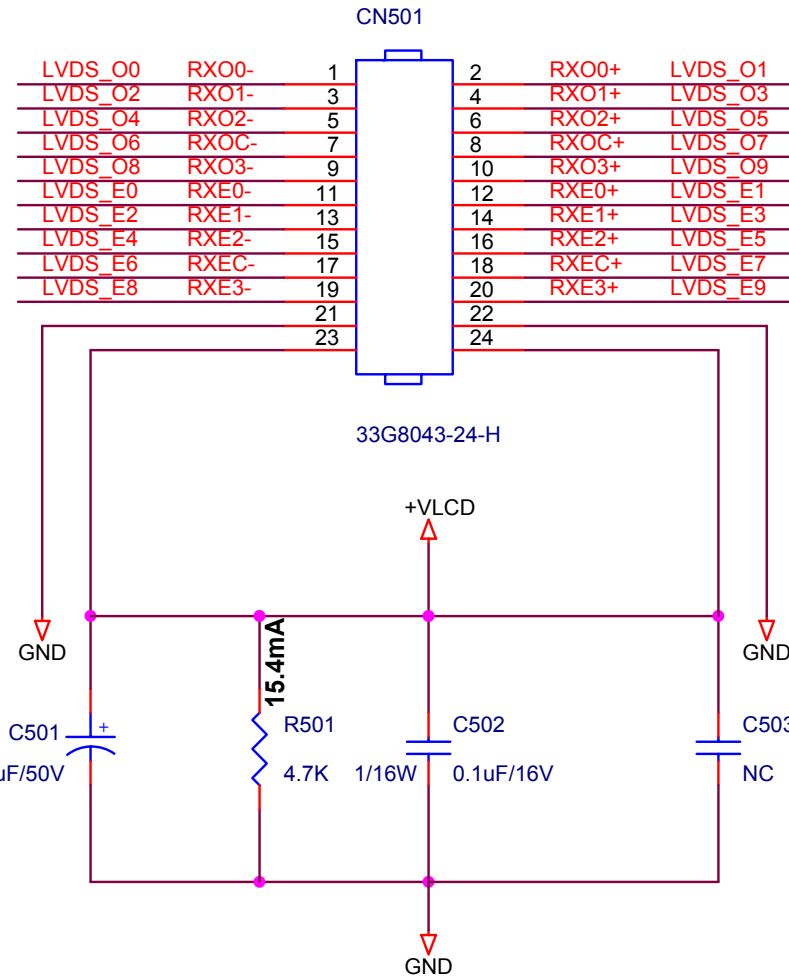
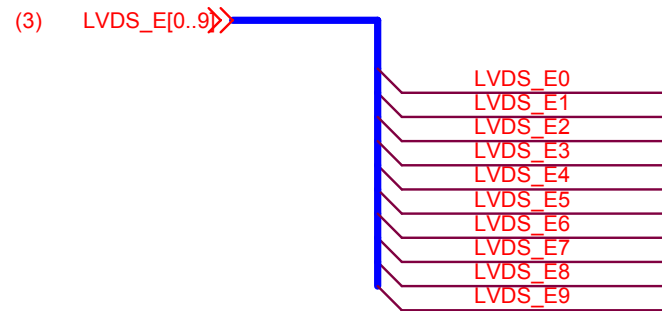
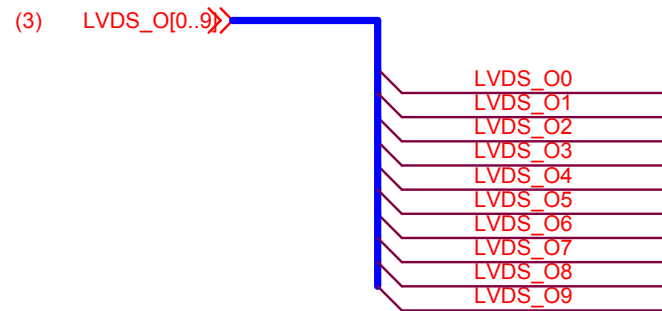

Dell 1907FPc		
Title		
PANEL INTERFACE		
Size A	Document Number	Rev E
Date:	Monday, November 14, 2005	Sheet 5 of 6

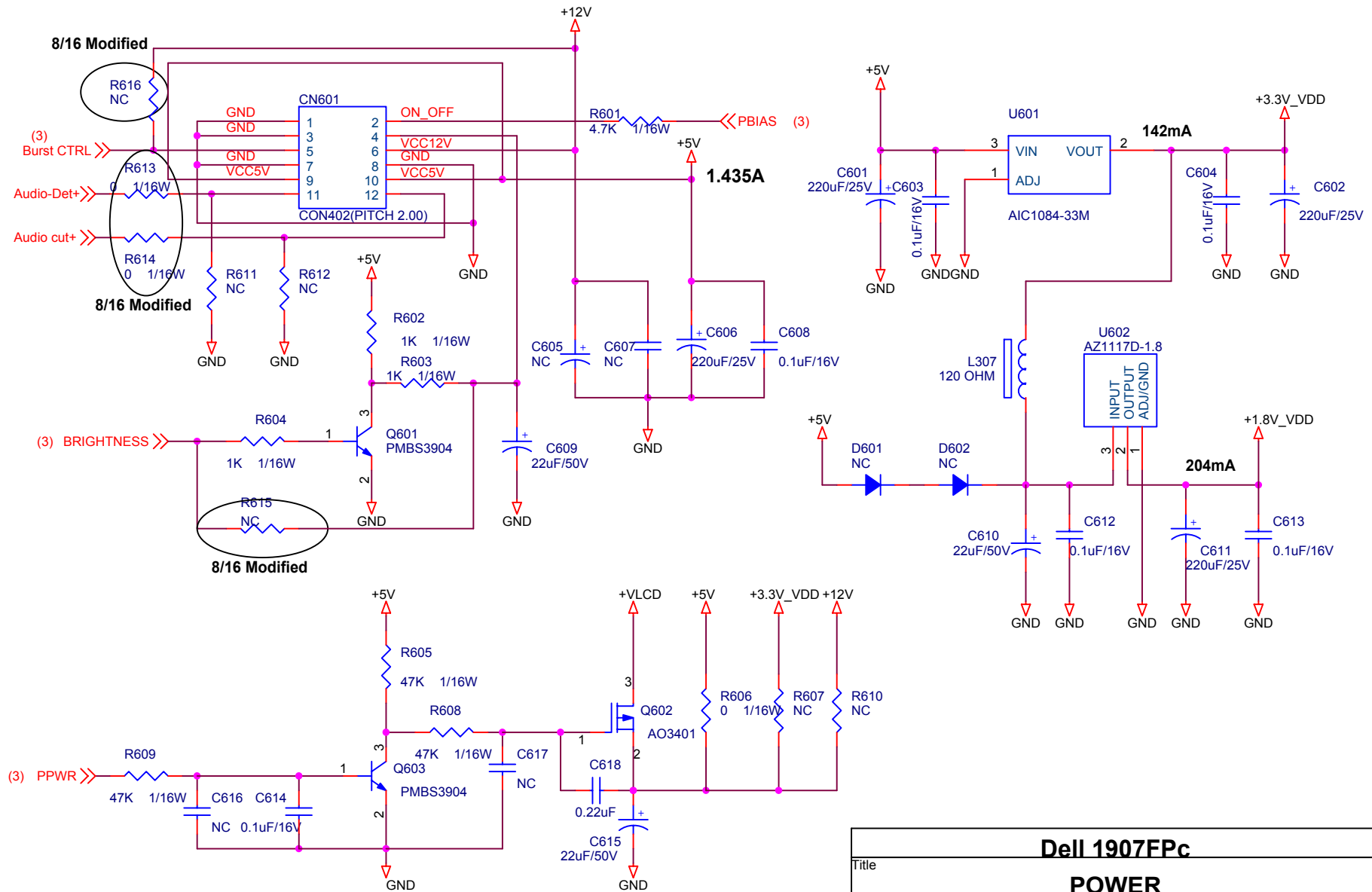

Dell 1907FPc		
POWER		
Size A	Document Number	Rev E
Date:	Monday, November 14, 2005	Sheet 6 of 6

6.2 Power Board

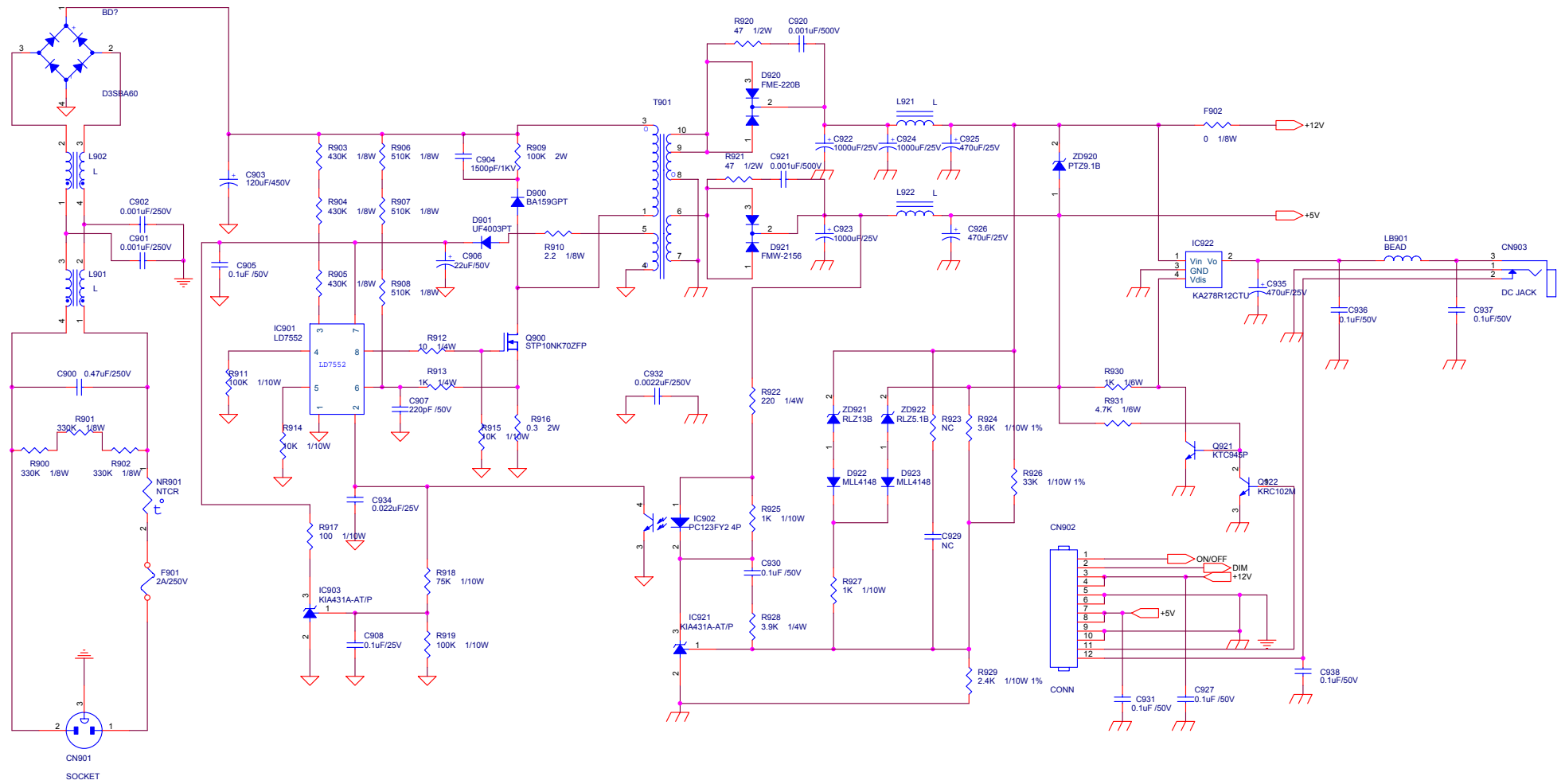

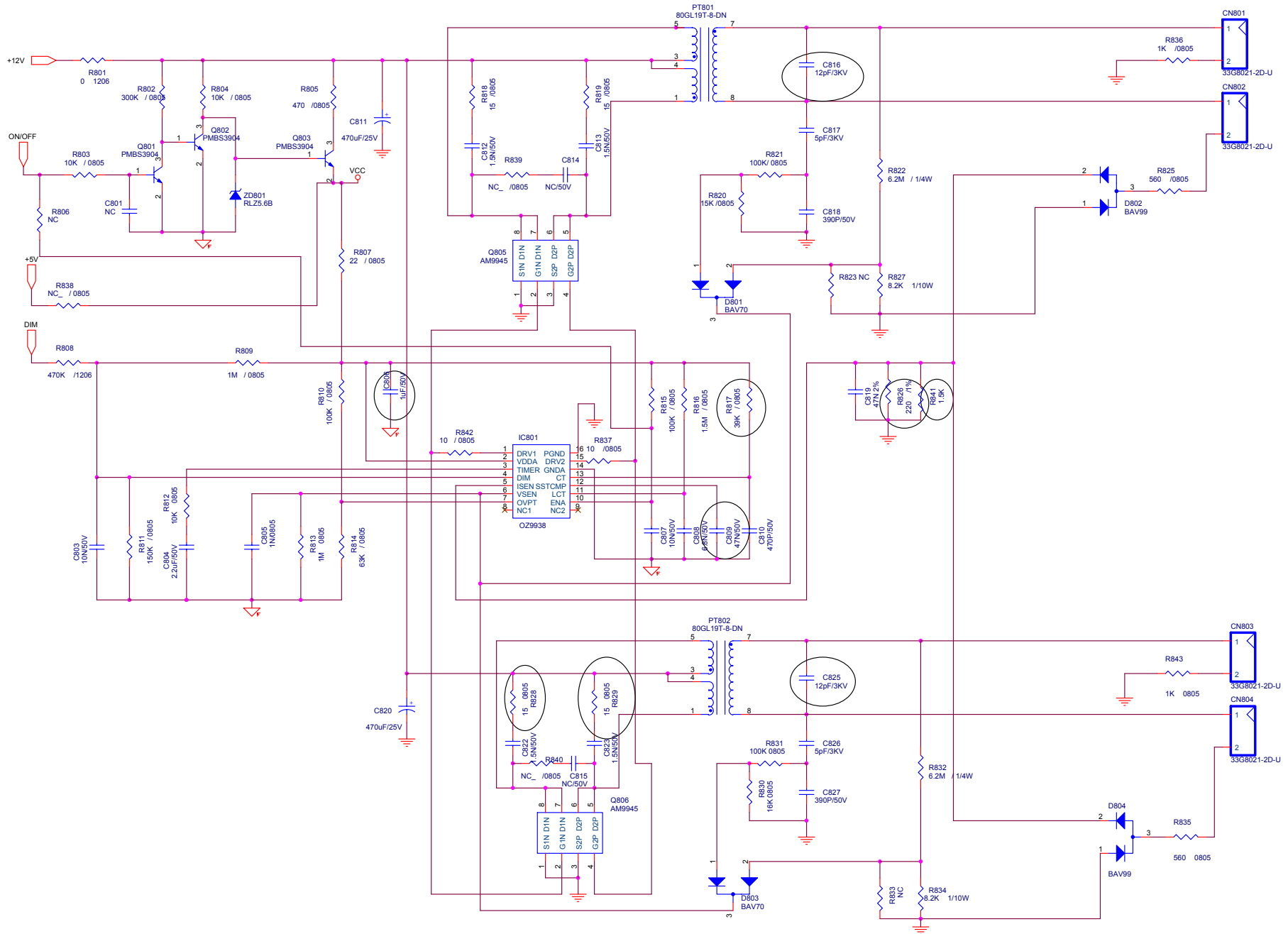

6.3 USB Board

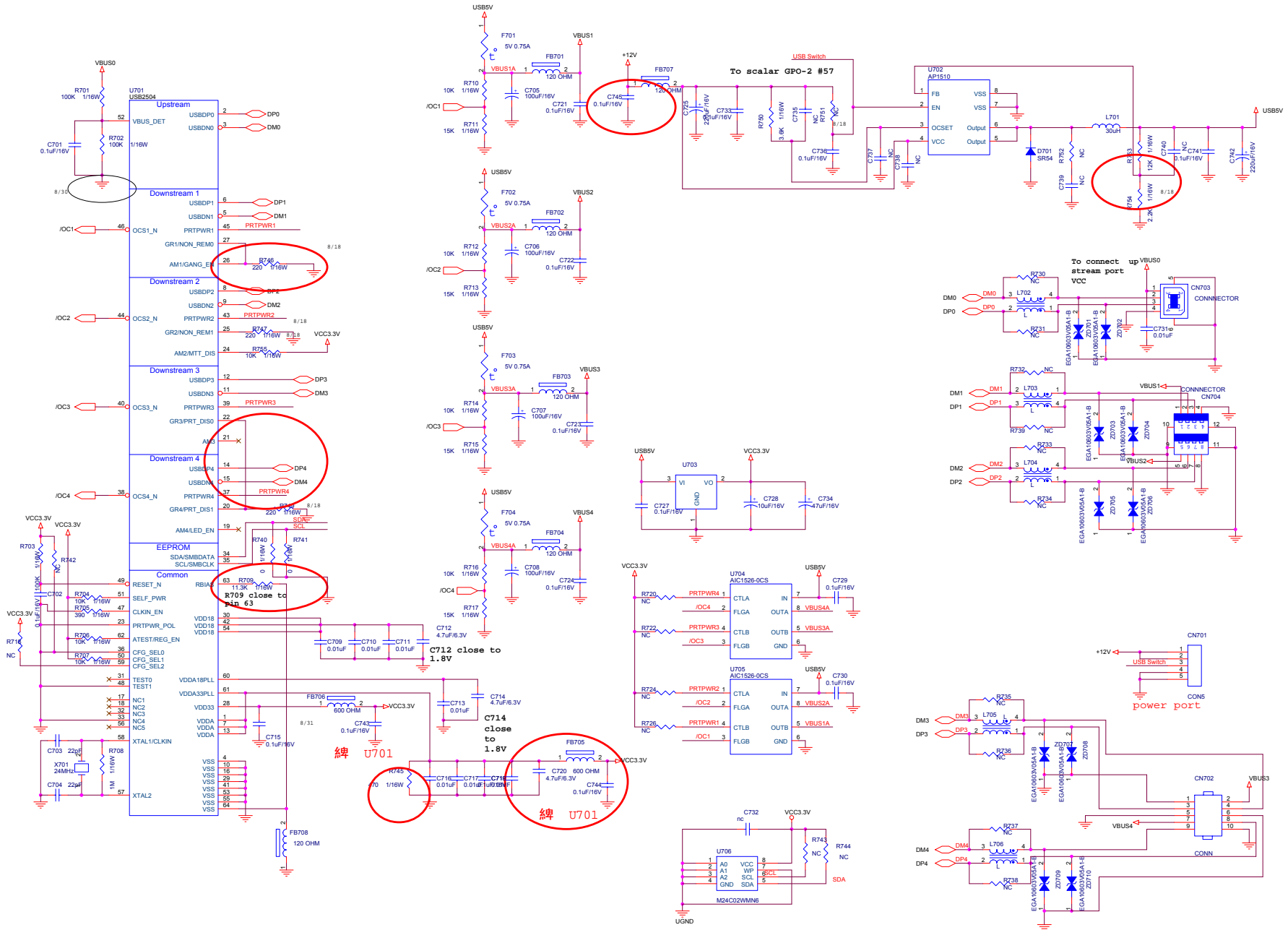

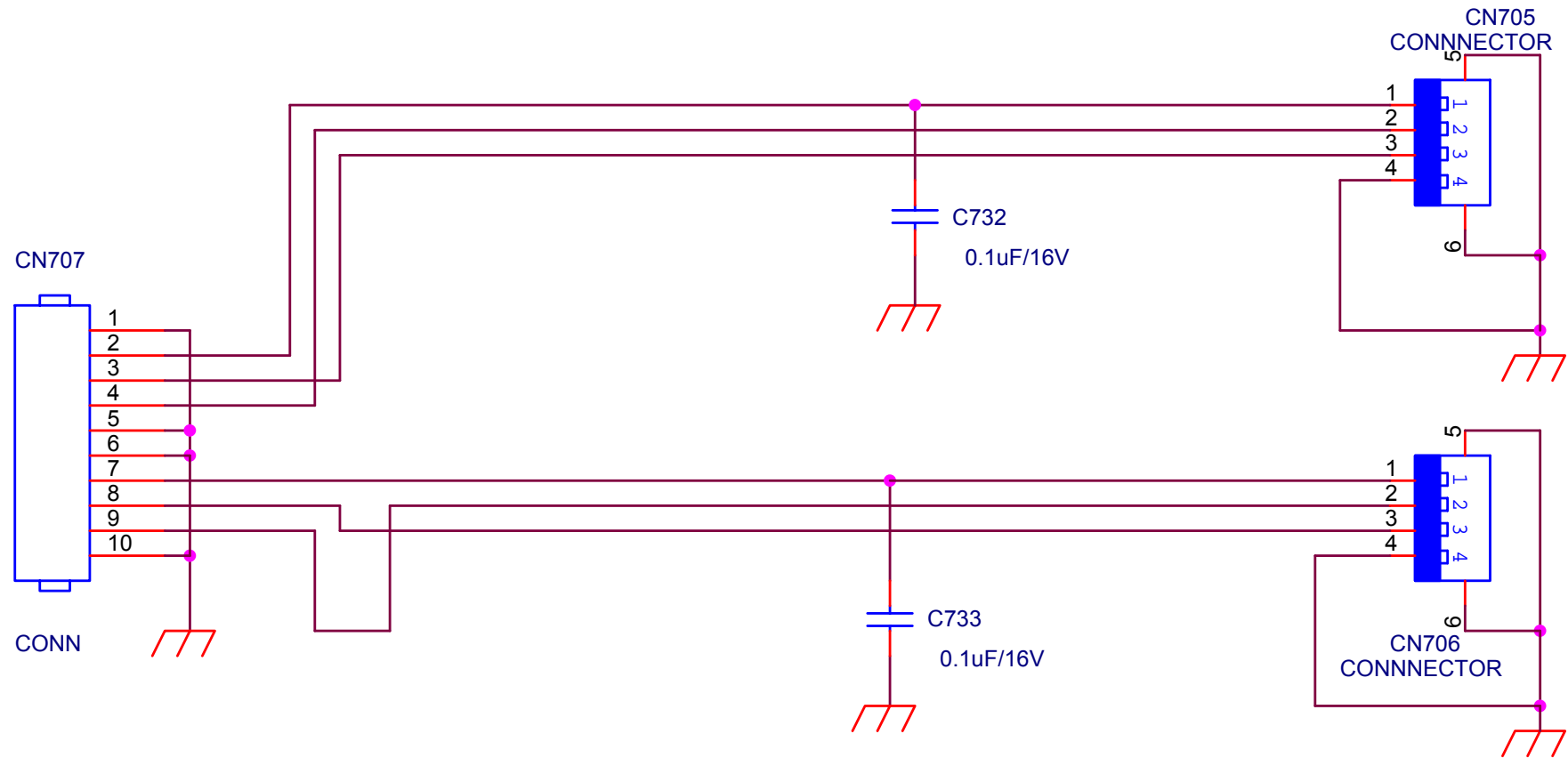

Title		
<Title>		
Size	Document Number	Rev
A	715G1665-A-2	<RevCode>
Date:	Wednesday, October 19, 2005	Sheet 1 of 1

7. PCB Layout

7.1 Main Board

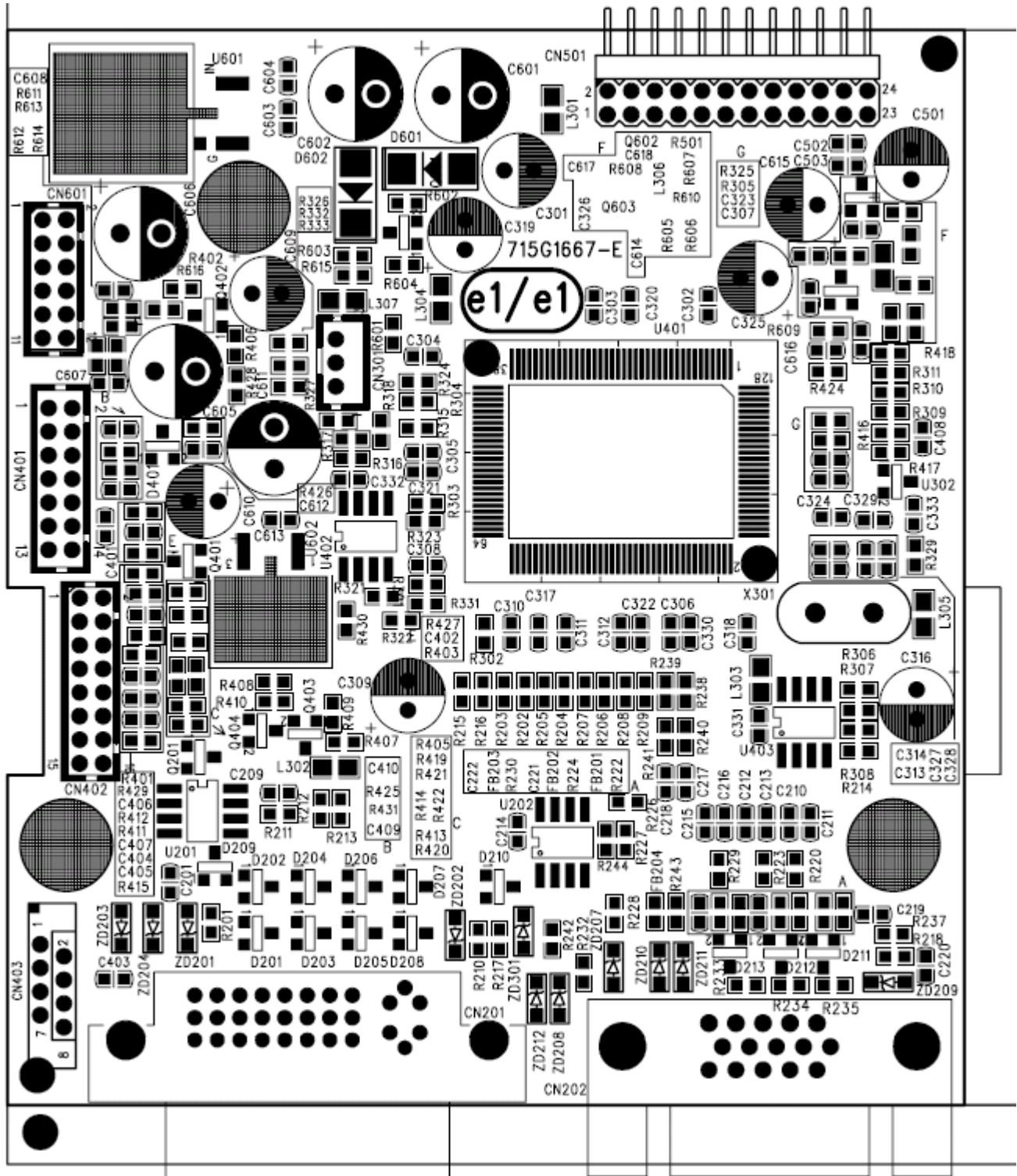

7.2 Inverter/Power Board

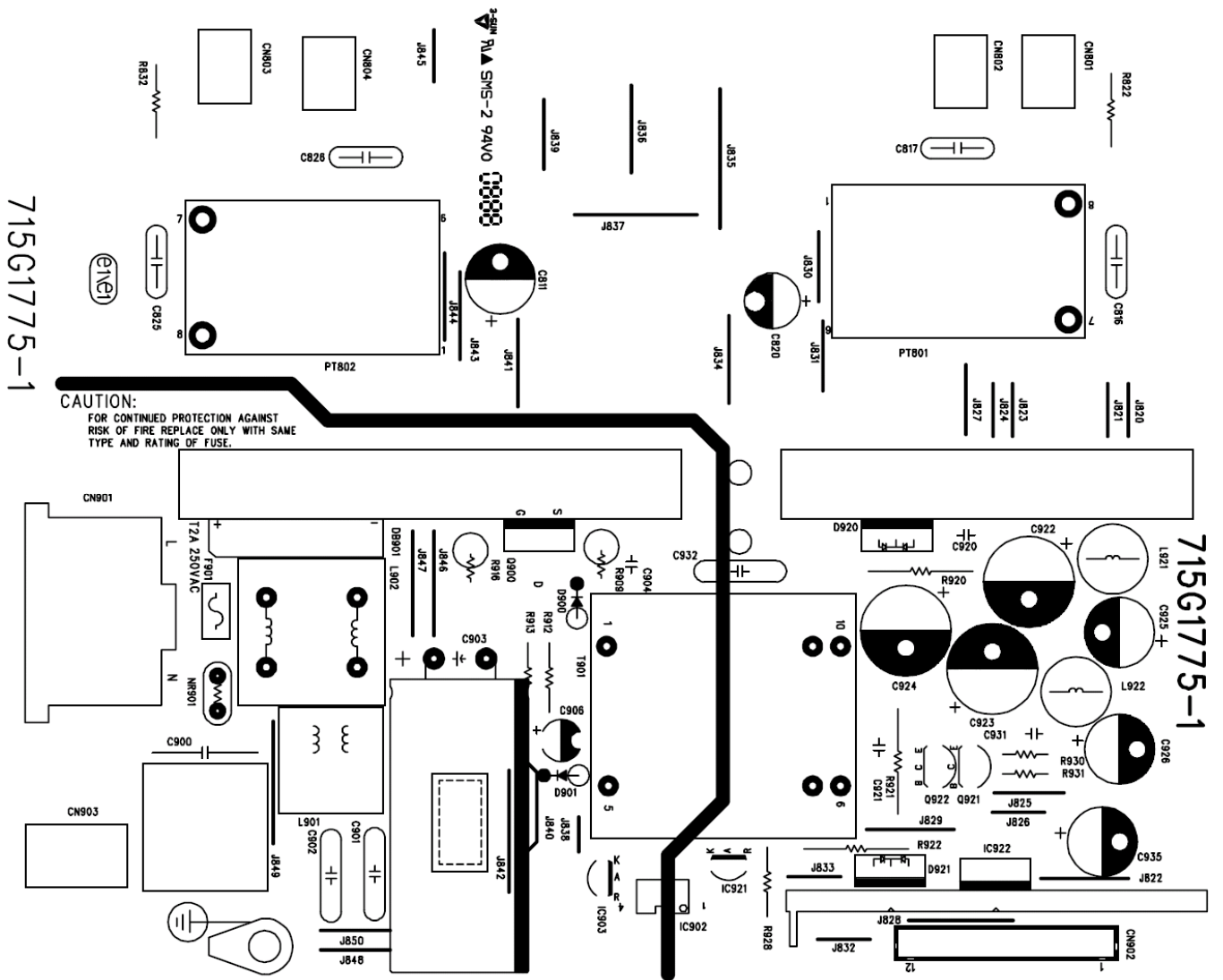

CAUTION:
FOR CONTINUED PROTECTION AGAINST
RISK OF FIRE REPLACE ONLY WITH SAME
TYPE AND RATING OF FUSE.

715G1775-1

715G1775-1

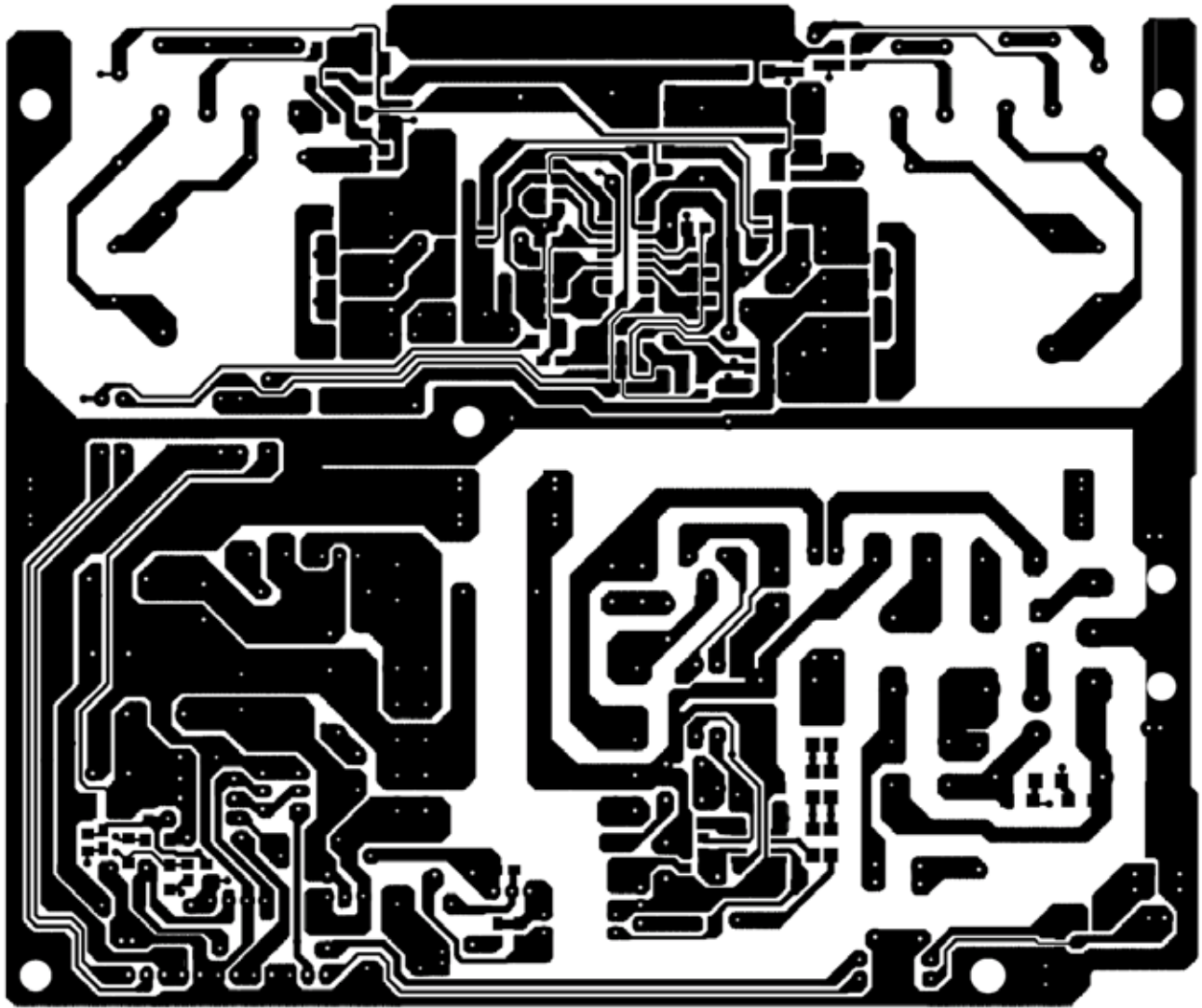

715G1775-1

7.3 USB Board

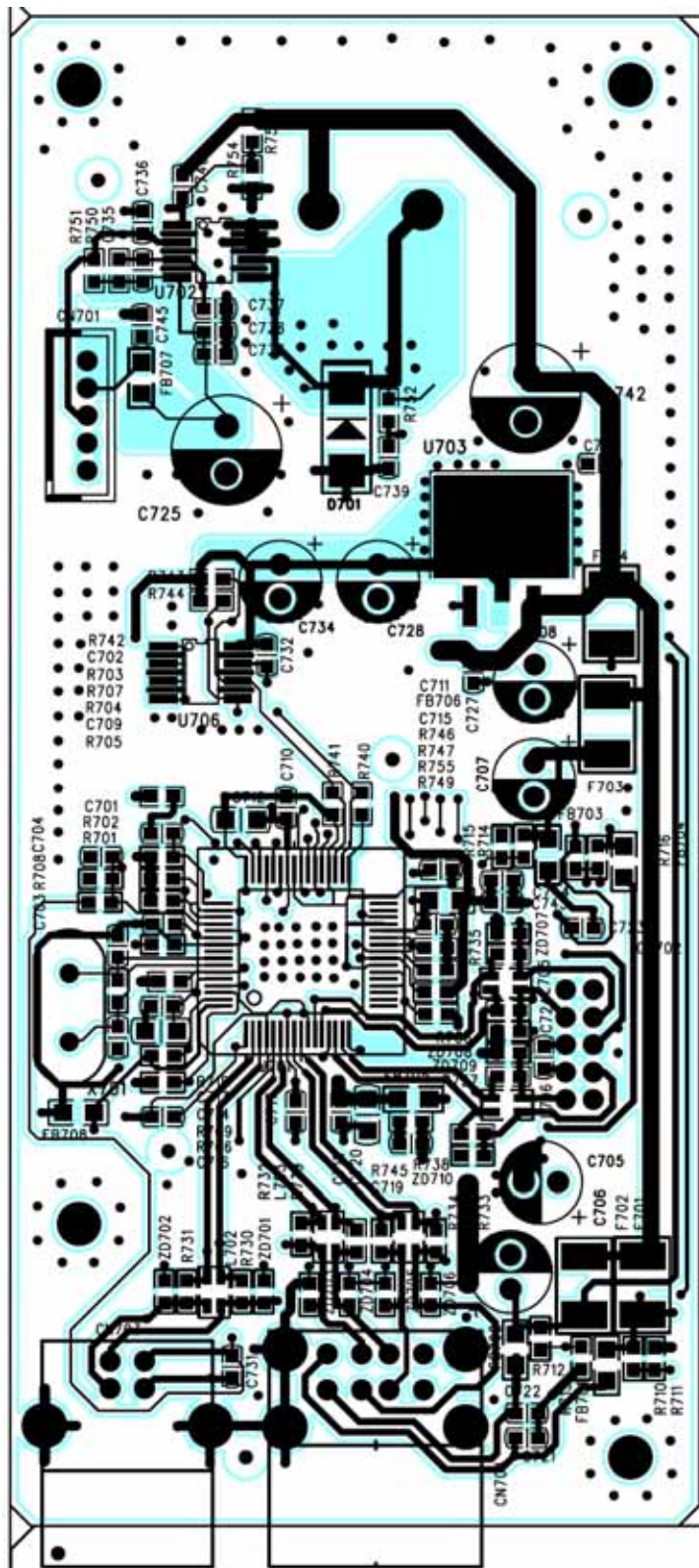

715G1666 E

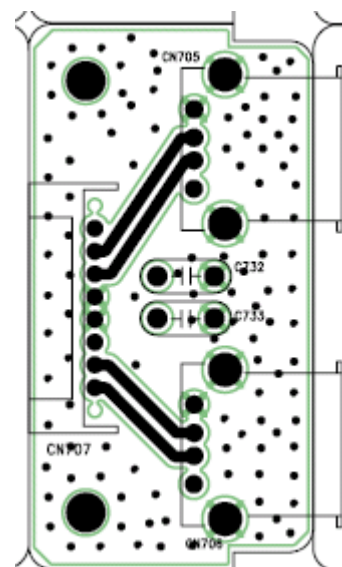

715G1665 A 2

7.4 Key Board

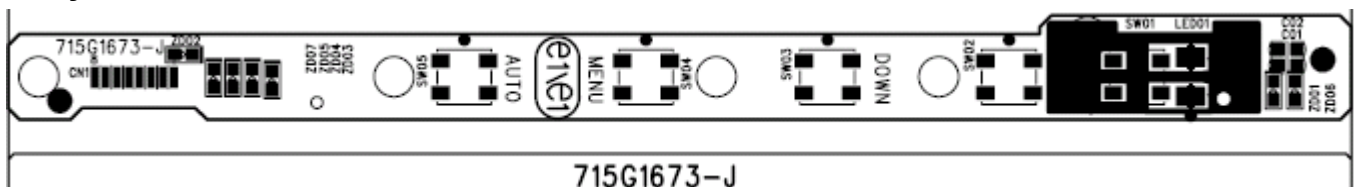



715G1673-J

8. Mechanical Instruction

Tools: 2 Power screwdrivers ($\phi=5\text{mm}$, $L=60\text{mm}$); 1 small cross screwdriver; turnbuckle driver;

Setting: Power screwdriver torque A=11 kgF. Cm; torque B=6 kgF. Cm

Note: Firstly, put the monitor on a soft, flat and clean surface, wear gloves.

Fig	Remark
	<p>Remove stand :</p> <ol style="list-style-type: none"> 1. Rotate the stand to allow access to the stand release button. 2. Press the Stand release button and lift up the Stand and away from the monitor.
	<ol style="list-style-type: none"> 1. Remove the 4 screws by torque A
	<ol style="list-style-type: none"> 2. Pry the monitor up then find out the hooks' position, use the tool (like the picture or other card) to insert into the gap of bezel and rear cover.



3. Take off the bezel



Remove rear cover :

Turn over the monitor as the Fig, hold the rear cover, and then slightly remove it.



Remove the shield :

1. Remove the 4 screws by
Torque B



2. Remove the USB2 board cover by Torque B or by manual



3. Remove the 5 screws by Torque B or by manual



4. Disconnect the wire harness between USB1 and USB2

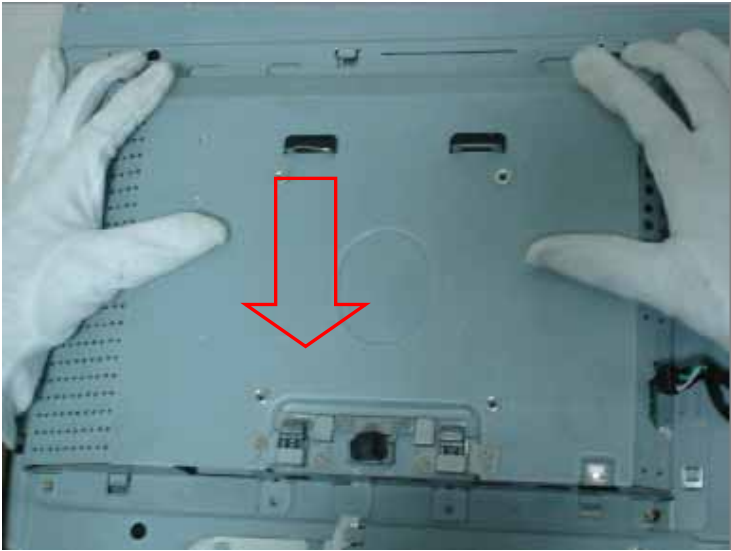

5. Push the main shield as the arrowhead direction



Disconnect the connector pin:
Disconnect the connector pin between key and main boards

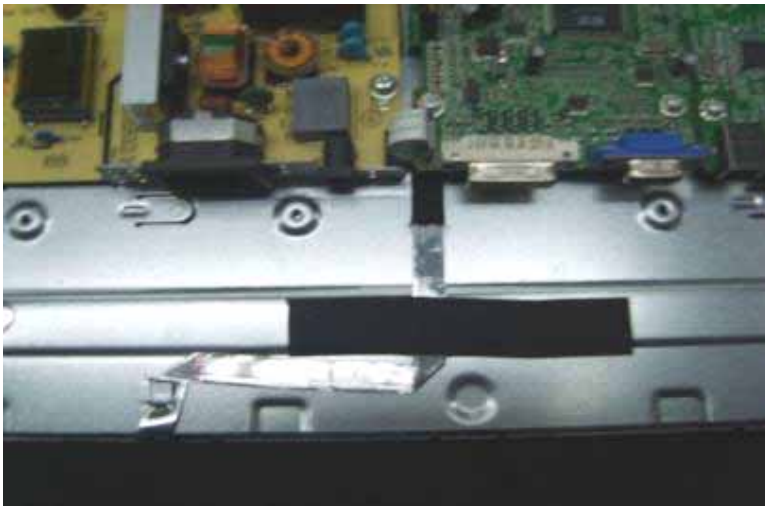

Install:
Lay the KEPC cable as the figure showed

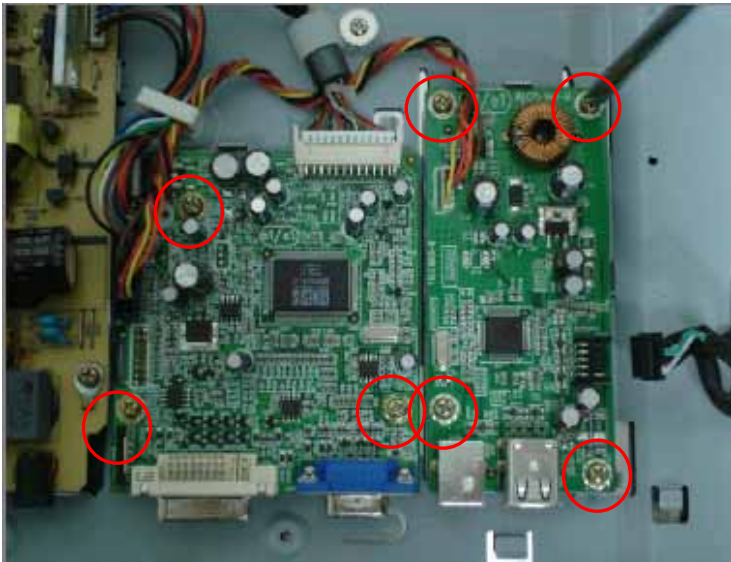

Remove USB and main board :

1. Remove the 7 screws by **Torque B**

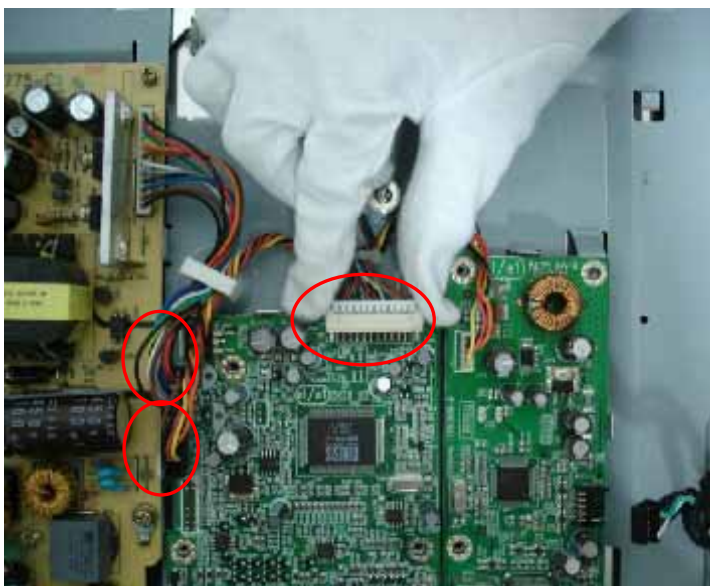

2. Disconnect the connector wire

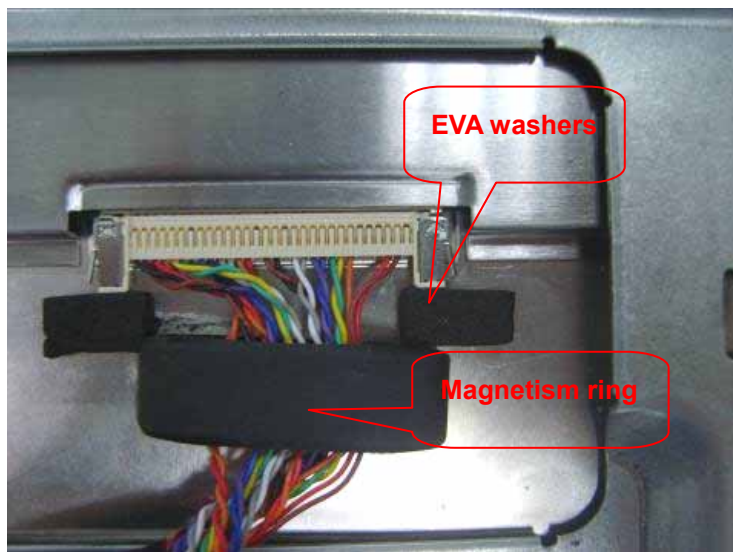

3. Disconnect the wire harness between main board and panel

Note: Make LVDS connector's metal side adown for SAMSUNG panel and upturned for other panel.

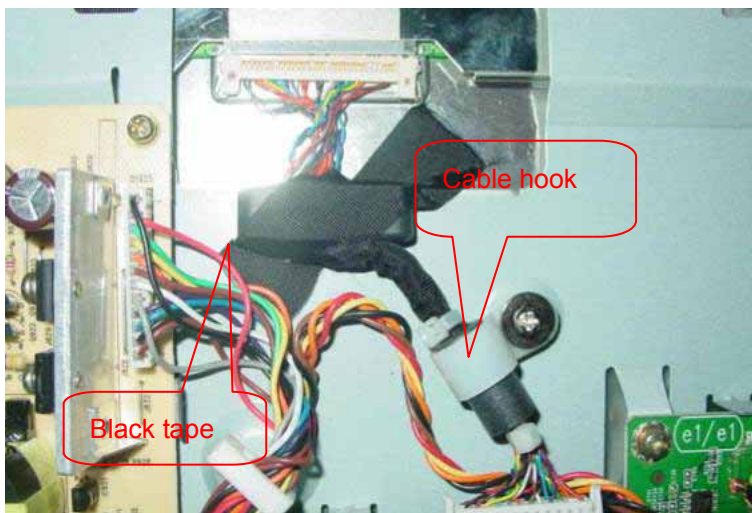

Install:

Fix the LVDS cable by black tape and cable hook



4. Disconnect the wire holder



Install:
Lay the cables as the line
direction

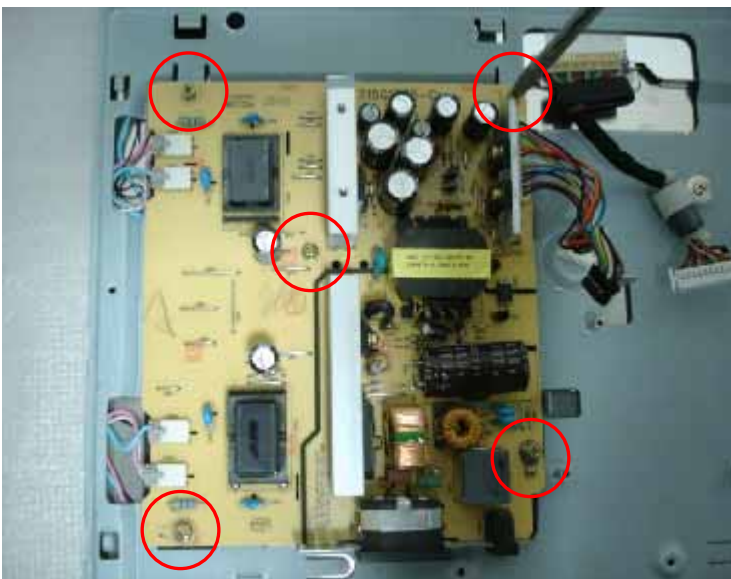

Remove the power board :
Remove the 5 screws by **Torque**
B



Disconnect wire harness :
Disconnect the wire harness
between power board and lamps

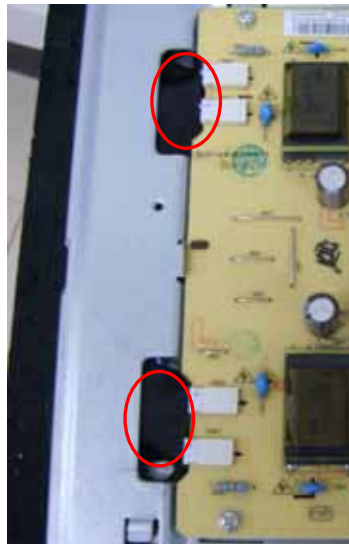

Fix the CCFL connector by black
tapes as the figure



Remove USB board :
Remove the 2 screws by **Torque**
B



Remove the main frame :
Remove the 4 screws (left and right) by **manual or torque = 3kgF.Cm**

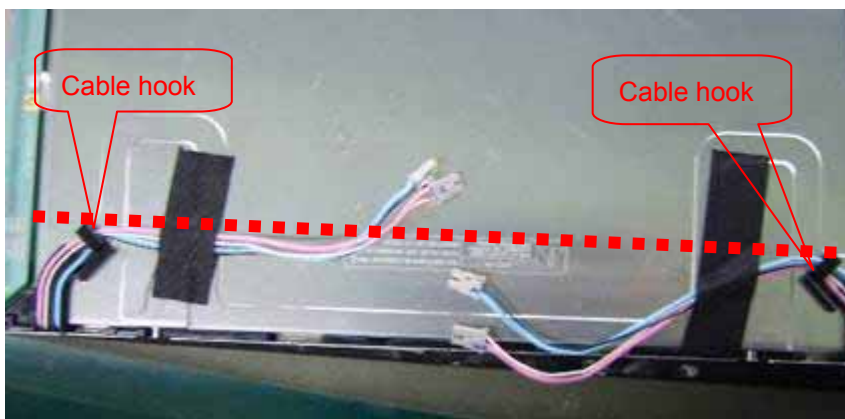

Samsung panel:
The CCFL line can't overtop dashed



LG panel:
The angle between CCFL line and vertical direction should be about 30 degree.

9. Maintainability

9.1 Equipments and Tools Requirement

1. Voltage meter
2. Oscilloscope
3. Pattern Generator
4. LCD Color Analyzer
5. Service Manual
6. User Manual

9.2 Trouble shooting

9.2.1 Main Board

- Note:** 1. If replace "Main-Board", Please re-do "DDC-content" programmed & "White-Balance".
2. If replace "Power Board" only, Please re-do "White-Balance".

No power

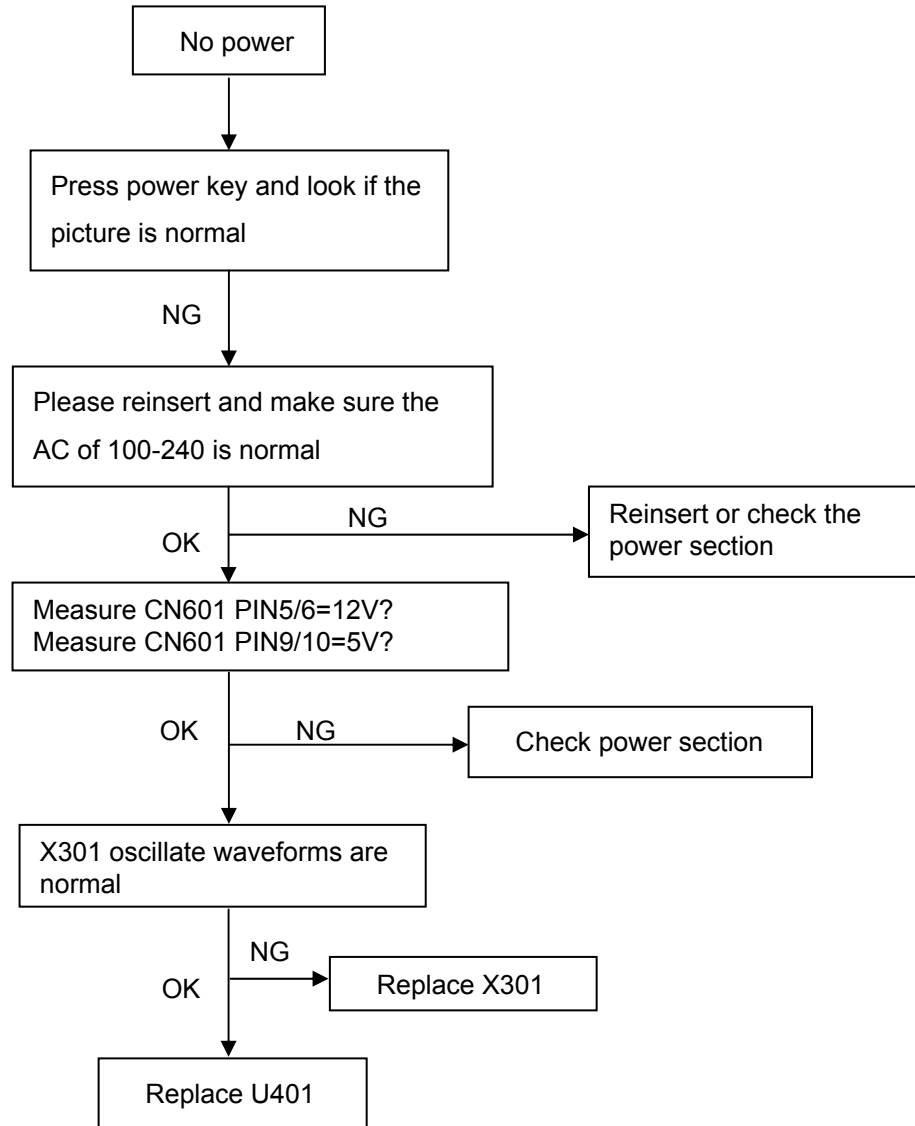

No picture (LED is orange)

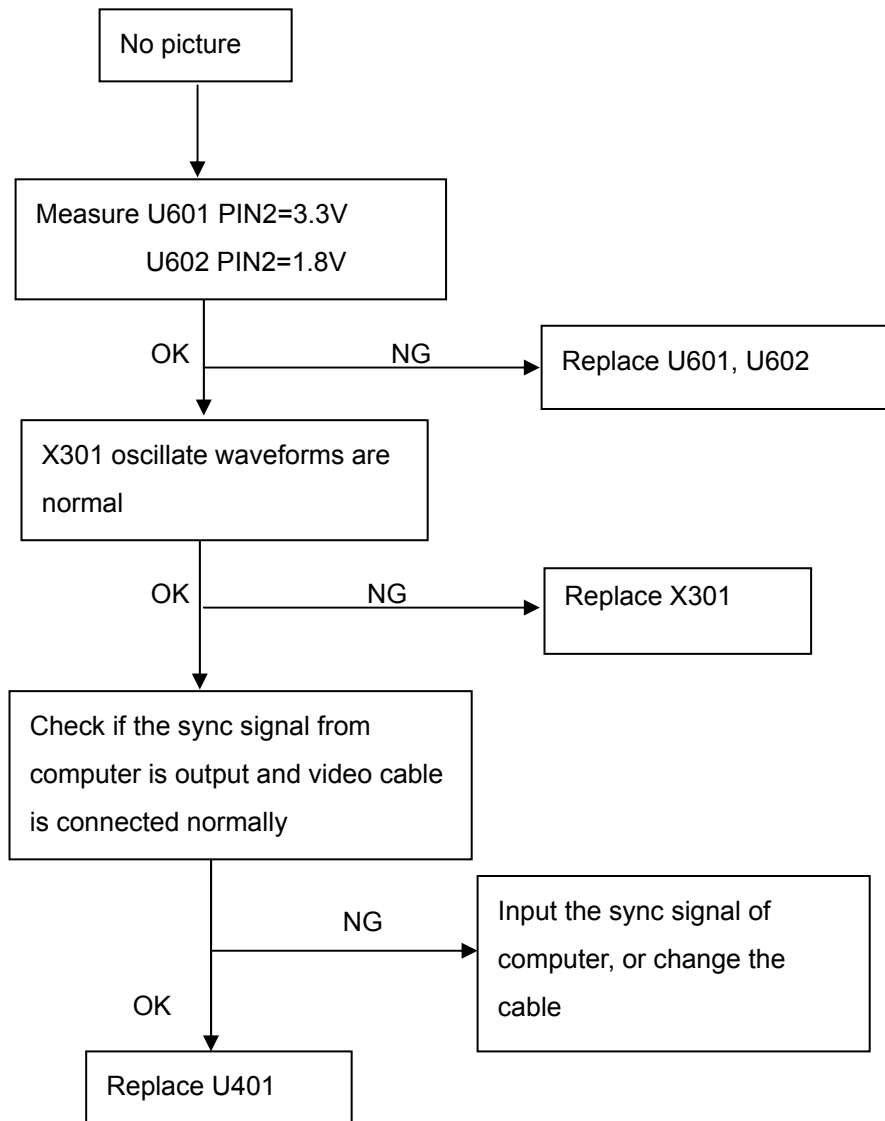

White screen

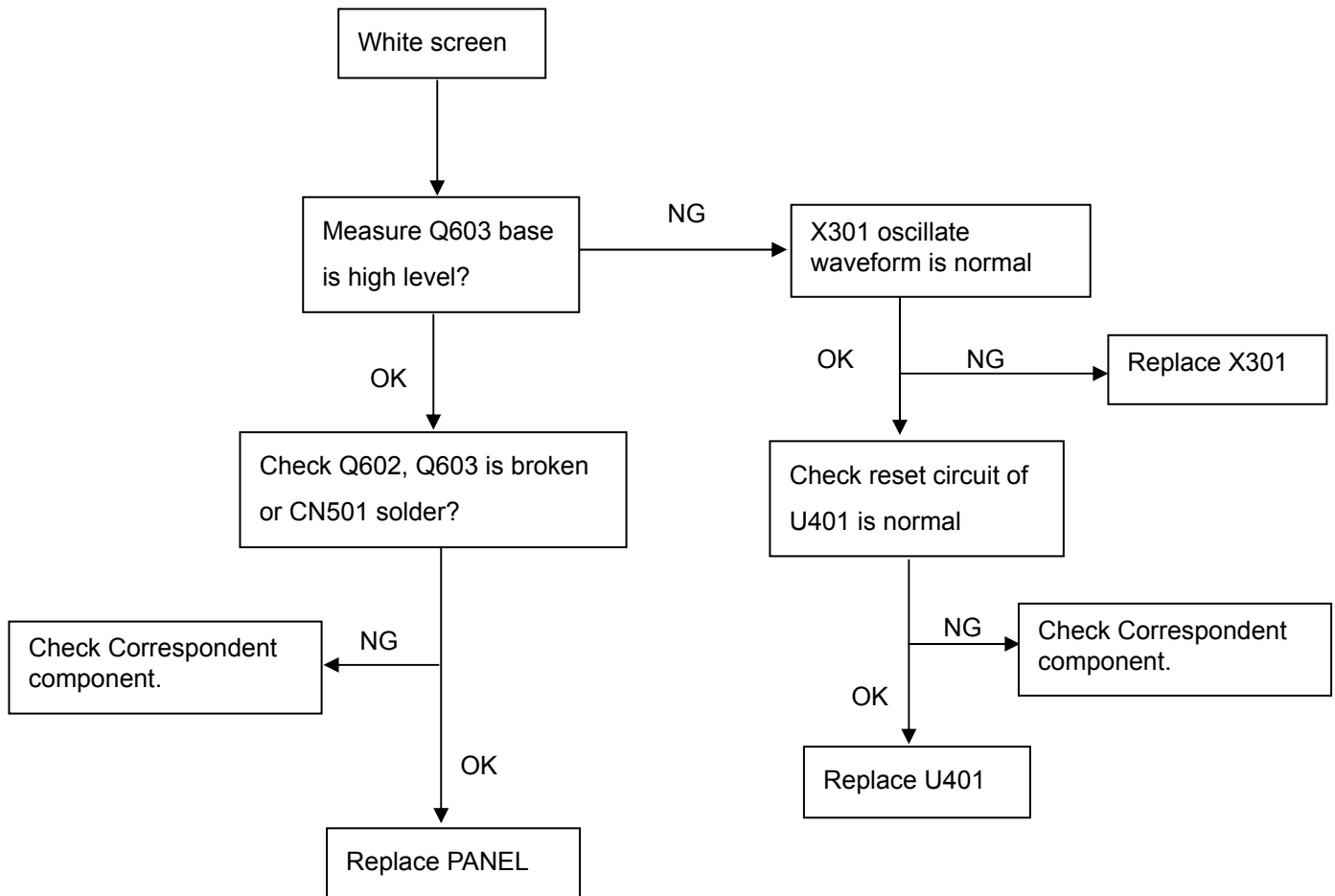

9.2.2 Inverter/Power Board

No Power

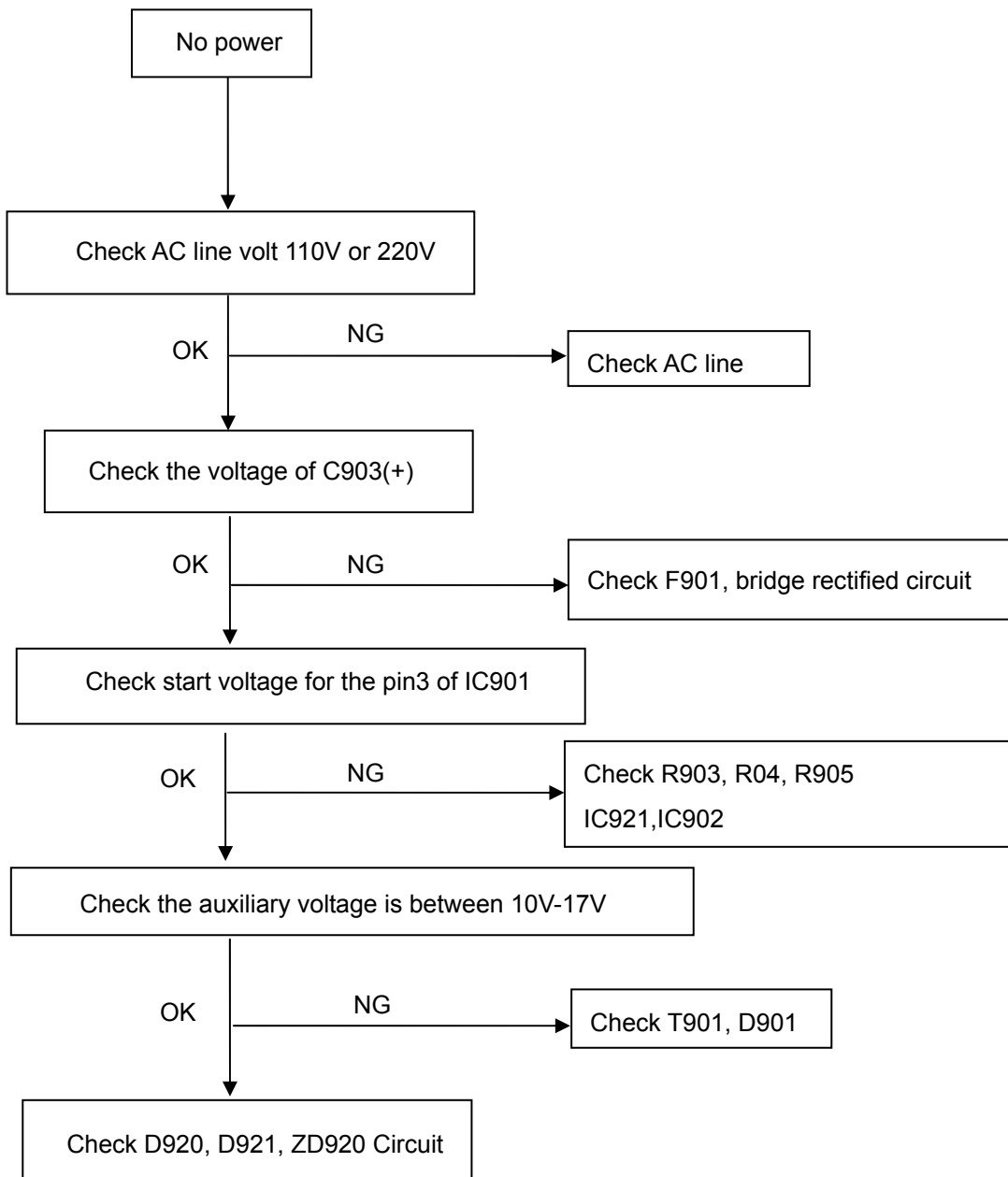

No Backlight

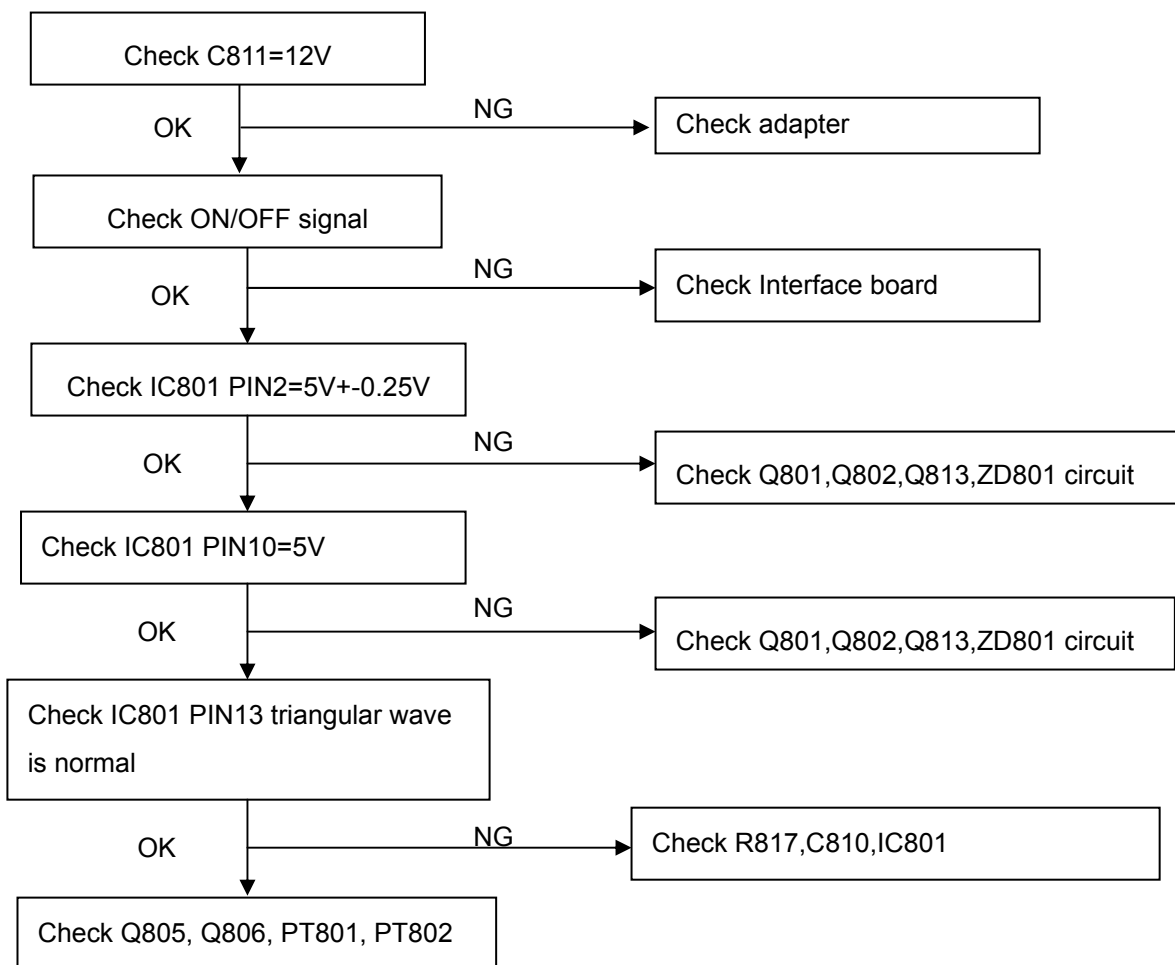

9.2.3 Key Board

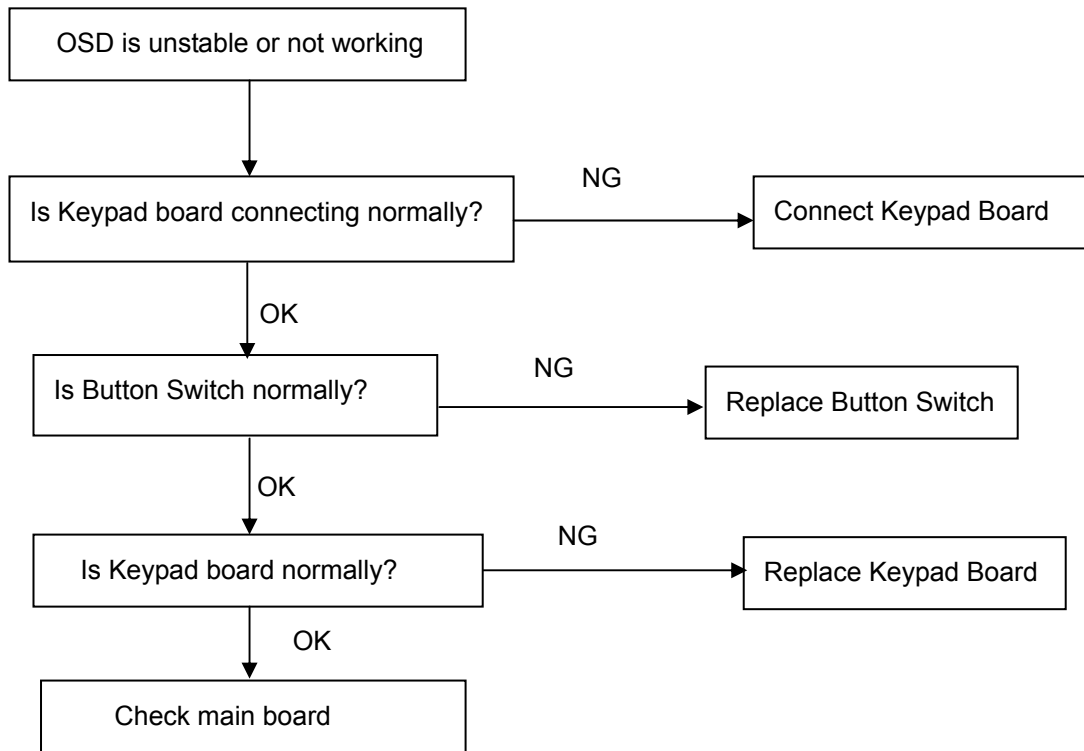



10. White balance, Luminance adjustment

Approximately 30 minutes should be allowed for warm up before proceeding White-Balance adjustment.

Before started adjust white balance, please setting the Chroma-7120 **MEM. Channel 3 to 6500⁰K** colors, **MEM. Channel 4 to 9300⁰K** colors, **MEM. Channel 9 to 5700⁰K** (our 9300 parameter is $x=283\pm 28$, $y=297\pm 28$, $Y = 200 \pm 20 \text{ cd/m}^2$, 6500 parameter is $x = 313\pm 28$, $y=329\pm 28$, $Y = 230 \pm 20 \text{ cd/m}^2$, and 5700 parameter is $x = 328 \pm 28$, $y = 344 \pm 28$, $Y = 230 \pm 20 \text{ cd/m}^2$)

How to setting MEM.channel you can reference to chroma 7120 user guide or simple use “**SC**” key and “**NEXT**” key to modify x, y, Y value and use “**ID**” key to modify the TEXT description Following is the procedure to do white-balance adjust.

Enter into factory mode:

Press MENU  and up button  at the same time, during press power button on will activate the factory mode, then press MENU again, main MENU will be in the middle of the screen.

Gain adjustment:

Move to “Factory Reset” and press MENU key to enter this sub-menu.

Move to “ Factory” and press MENU key.

Move to “ Auto Color” and press MENU key to adjust Gain and Offset automatically;

a. Adjust sRGB (6500⁰K) color-temperature

1. Switch the chroma-7120 to **RGB-mode** (with press “MODE” button)
2. Switch the MEM.channel to Channel 3 (with up or down arrow on chroma 7120)
3. The LCD-indicator on chroma 7120 will show $x = 313\pm 28$, $y=329\pm 28$, $Y = 230 \pm 20 \text{ cd/m}^2$
4. Adjust the RED on OSD window until chroma 7120 indicator reached the value $R=100$
5. Adjust the GREEN on OSD, until chroma 7120 indicator reached $G=100$
6. Adjust the BLUE on OSD, until chroma 7120 indicator reached $B=100$
7. Repeat above procedure (item 5,6,7) until chroma 7120 RGB value meet the tolerance $=100\pm 2$

b. Adjust Color1 (9300⁰K) color-temperature

8. Switch the chroma-7120 to **RGB-mode** (with press “MODE” button)
9. Switch the MEM.channel to Channel 4 (with up or down arrow on chroma 7120)
10. The LCD-indicator on chroma 7120 will show $x=283\pm 28$, $y=297\pm 28$, $Y = 200 \pm 20 \text{ cd/m}^2$
11. Adjust the RED on OSD window until chroma 7120 indicator reached the value $R=100$
12. Adjust the GREEN on OSD, until chroma 7120 indicator reached $G=100$
13. Adjust the BLUE on OSD, until chroma 7120 indicator reached $B=100$
14. Repeat above procedure (item 5,6,7) until chroma 7120 RGB value meet the tolerance $=100\pm 2$

c. Adjust Color2 (5700⁰K) color-temperature

15. Switch the chroma-7120 to **RGB-mode** (with press “MODE” button)
16. Switch the MEM.channel to Channel 9 (with up or down arrow on chroma 7120)
17. The LCD-indicator on chroma 7120 will show $x = 328 \pm 28$, $y = 344 \pm 28$, $Y = 230 \pm 20 \text{ cd/m}^2$

18. Adjust the RED on OSD window until chroma 7120 indicator reached the value R=100
19. Adjust the GREEN on OSD, until chroma 7120 indicator reached G=100
20. Adjust the BLUE on OSD, until chroma 7120 indicator reached B=100
21. Repeat above procedure (item 5,6,7) until chroma 7120 RGB value meet the tolerance =100±2
22. Move cursor to “ Exit/Save” sub-menu and press MENU key to save adjust value and exit.

Turn the POWER-button off to on to quit from factory mode.

Max Brightness measurement:

- a. Switch to the full white pattern, in user mode main menu:
 1. Set <Color Settings> Red, Green, and Blue to the max.
 2. Set <Brightness> Brightness, Contrast to the max.
- b. The Minimum brightness is $200\text{cd}/\text{m}^2 \pm 20$

11. EDID Content

Analog EDID

	00	01	02	03	04	05	06	07	08	09	10	11	12	13	14	15
0:	00	FF	FF	FF	FF	FF	FF	00	10	AC	14	40	30	39	38	37
16:	25	0F	01	03	68	26	1E	78	2E	EE	A5	A3	54	4C	99	26
32:	14	50	54	A5	4B	00	71	4F	81	80	01	01	01	01	01	01
48:	01	01	01	01	01	01	30	2A	00	98	51	00	2A	40	30	70
64:	13	00	78	2D	11	00	00	1E	00	00	00	FF	00	39	30	31
80:	32	33	36	35	34	37	38	39	30	0A	00	00	00	FC	00	44
96:	45	4C	4C	20	31	39	30	37	46	50	0A	20	00	00	00	FD
112:	00	38	4C	1F	53	0E	00	0A	20	20	20	20	20	20	00	3E

Digital EDID

	00	01	02	03	04	05	06	07	08	09	10	11	12	13	14	15
0:	00	FF	FF	FF	FF	FF	FF	00	10	AC	15	40	30	39	37	38
16:	25	0F	01	03	80	26	1E	78	2E	EE	A5	A3	54	4C	99	26
32:	14	50	54	A5	4B	00	71	4F	81	80	01	01	01	01	01	01
48:	01	01	01	01	01	01	30	2A	00	98	51	00	2A	40	30	70
64:	13	00	78	2D	11	00	00	1E	00	00	00	FF	00	37	30	31
80:	32	33	36	35	34	38	37	39	30	0A	00	00	00	FC	00	44
96:	45	4C	4C	20	31	39	30	37	46	50	0A	20	00	00	00	FD
112:	00	38	4C	1F	53	0E	00	0A	20	20	20	20	20	20	00	27

12. ISP Instruction

12.1 Software requirement and connection

Operating system requirement

(1) Microsoft windows OS. (2) 100M free hard-drive space. (3) 1 free parallel port for DDC2BI communication.

The hardware Connection

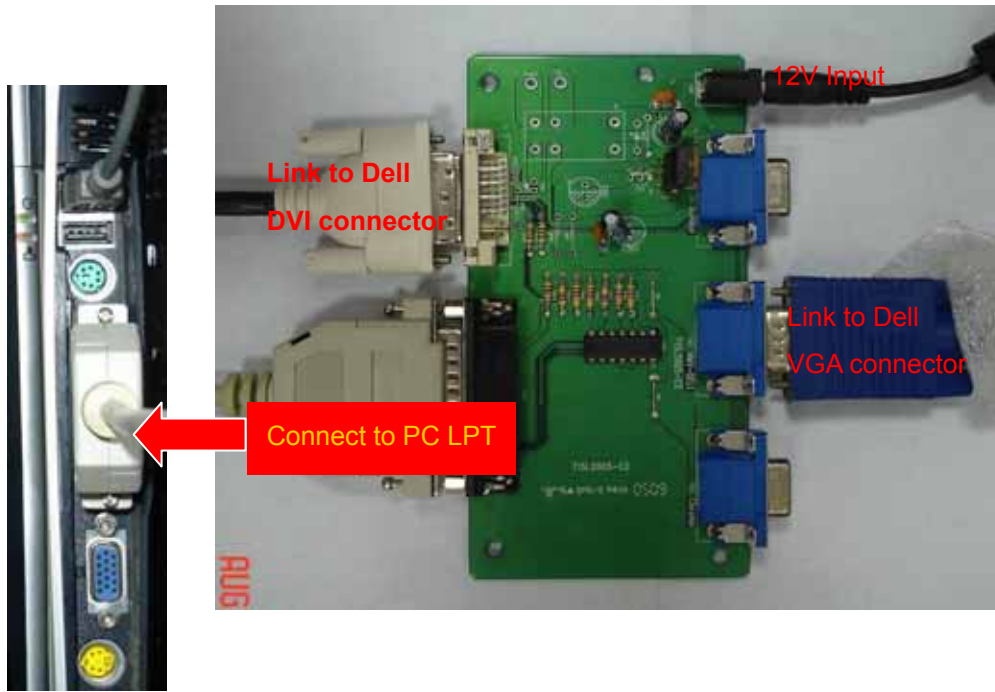

Note: VGA and DVI must not connect at the same time.

The relevant soft List

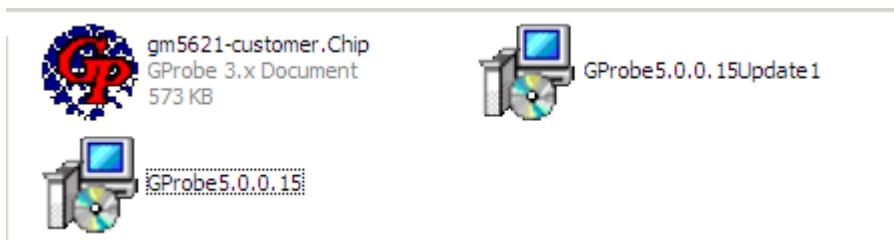

ISP_CODE

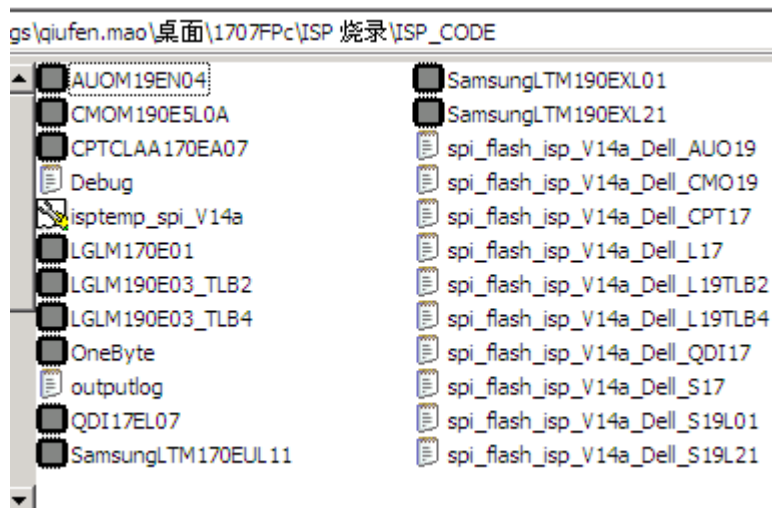

12.2 Install the software (Gprobe 5.0) for ISP Writer



A. Double-click the Install software

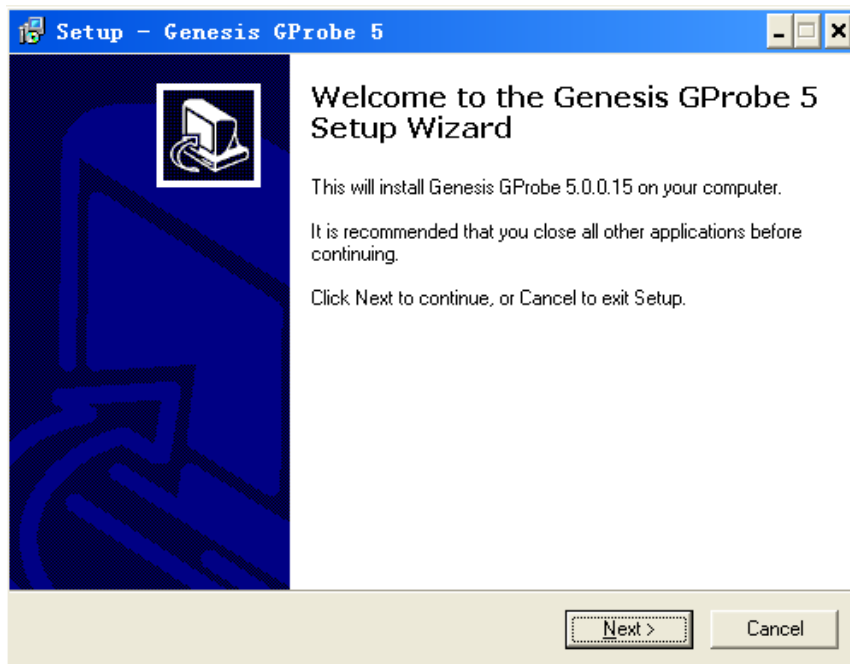

Select the folder where you would like Genesis Gprobe 5 to be installed

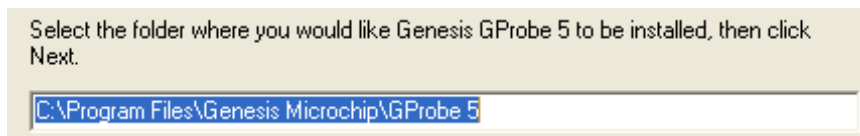

Completing the Genesis Gprobe 5 setup wizard

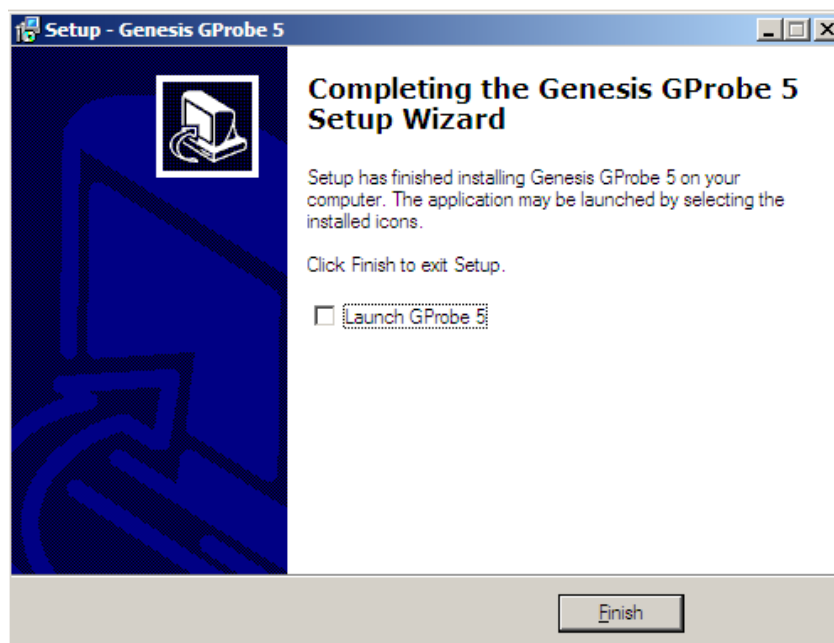

Note: After finishing the installation, you must restart the PC.

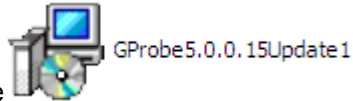

B. Next, install the Update software

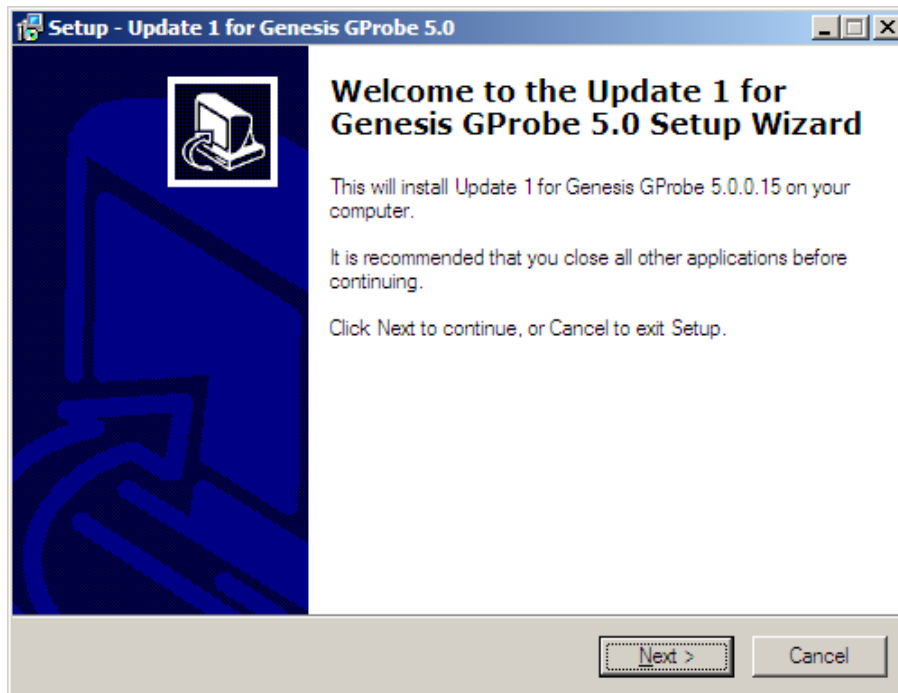

Completing the update 1 for Genesis Gprobe 5.0 setup wizard

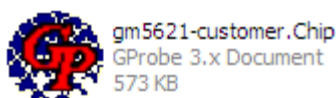
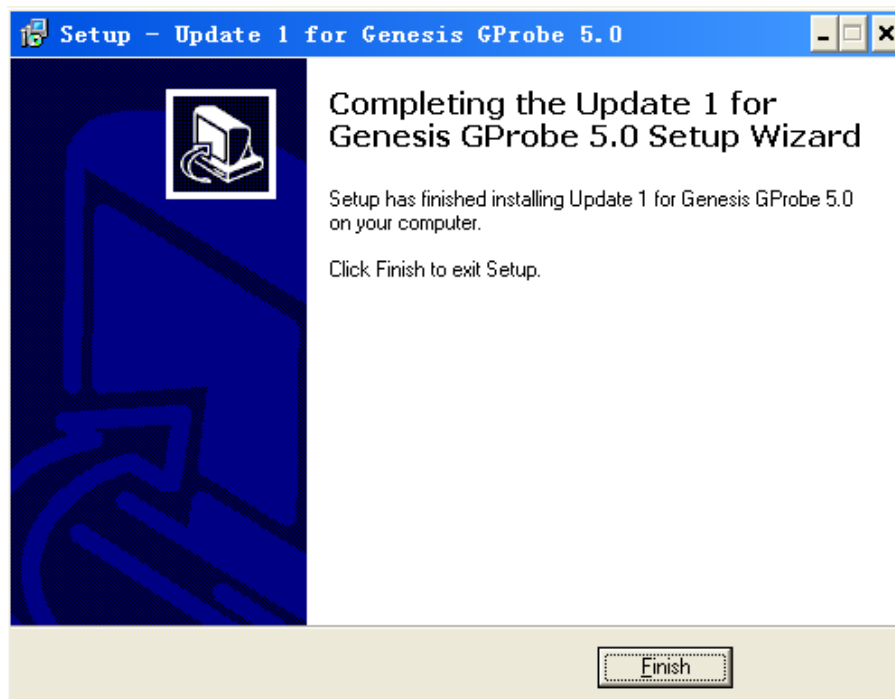

C. Copy the

to C: program files → GProbe5.0.0.15 → Genesis Microchip → GProbe 5

→ ChipDB folder, Installation Finished.

12.3 Run program



After the installation, a short-cut icon  will appear on your desktop, double click it will run the program.

(1). Select the IC type `gm5621-customer` (NOTE: If there is not this selection, please check the “ChipDB”):

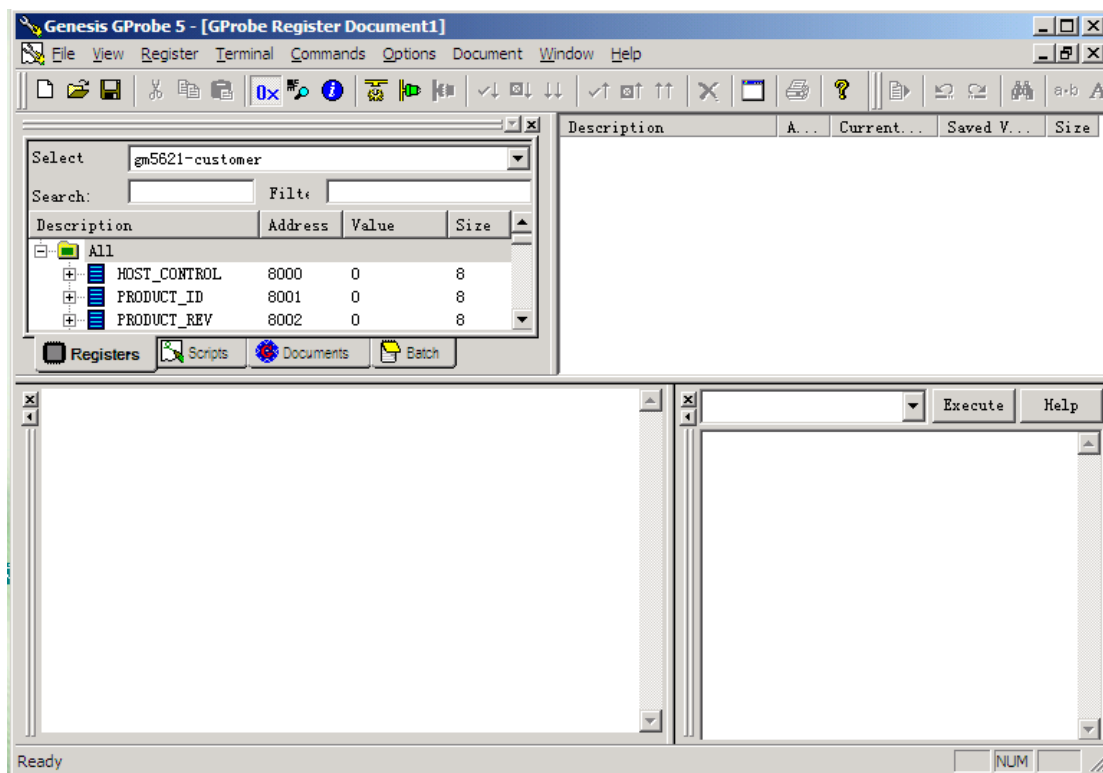

Note: Firstly, you can check the I²C normal or not by inputting the “test” in the position 

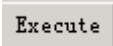
where to load MCU software. Click , if you can see “test pass” in the blank, the I²C is OK!

(2). Select **Options** → **Connection Setup F10**:

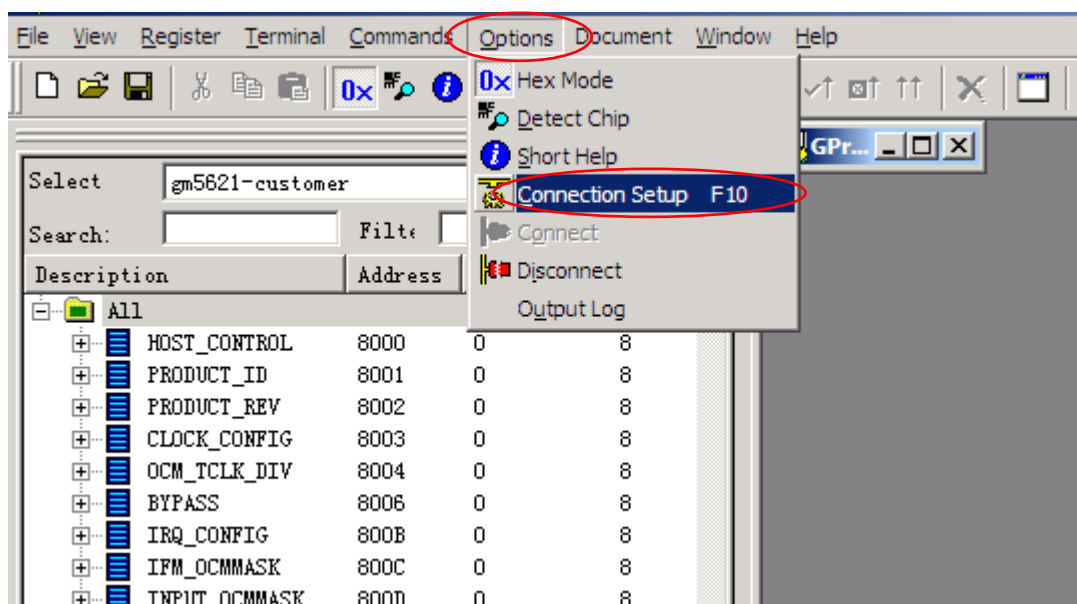

Set the **Connection Settings** → **Connection** → **Device to Parallel**, click **OK!**

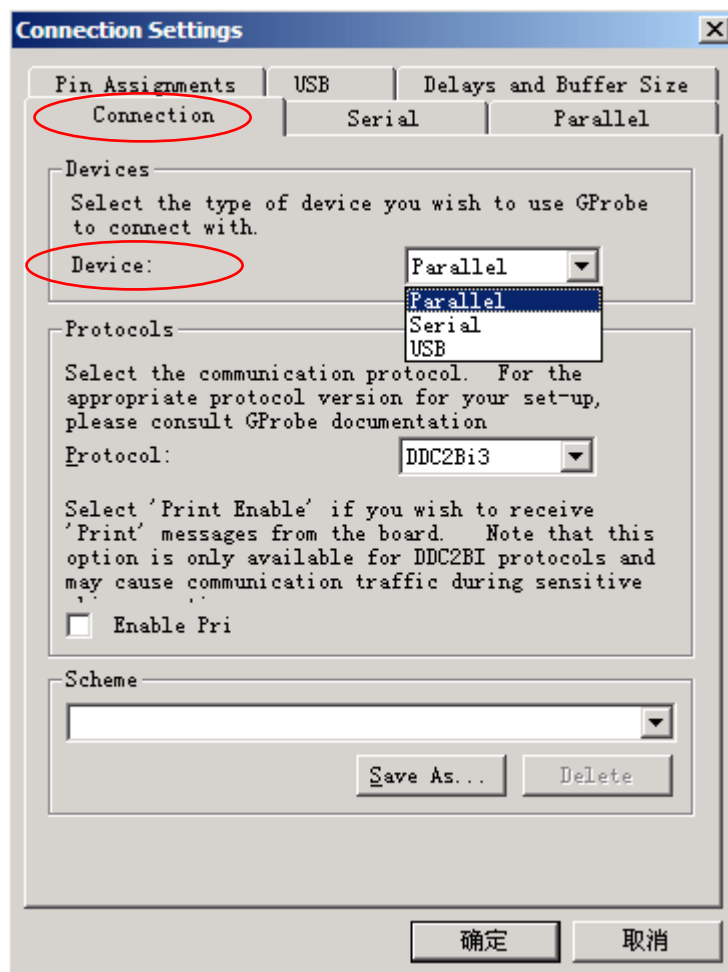

(3). Select **Commands** → **Batch**:

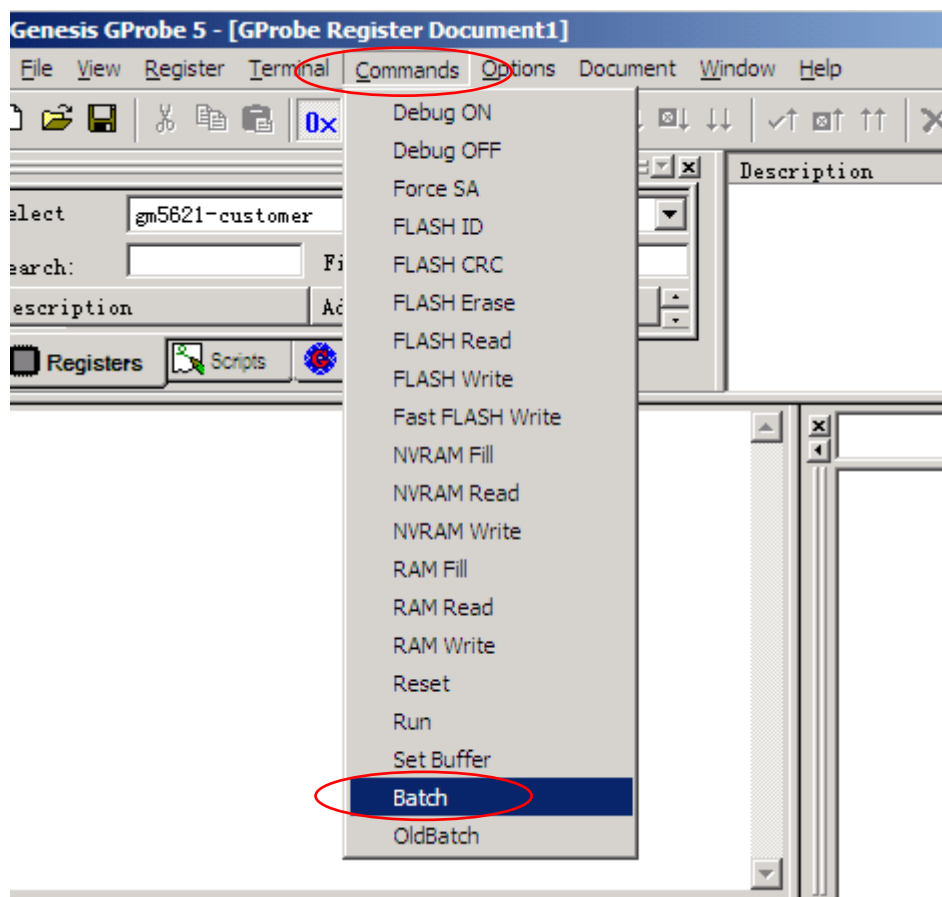

Click  to select MCU software in Dell ISP_CODE, please per as the follow fig

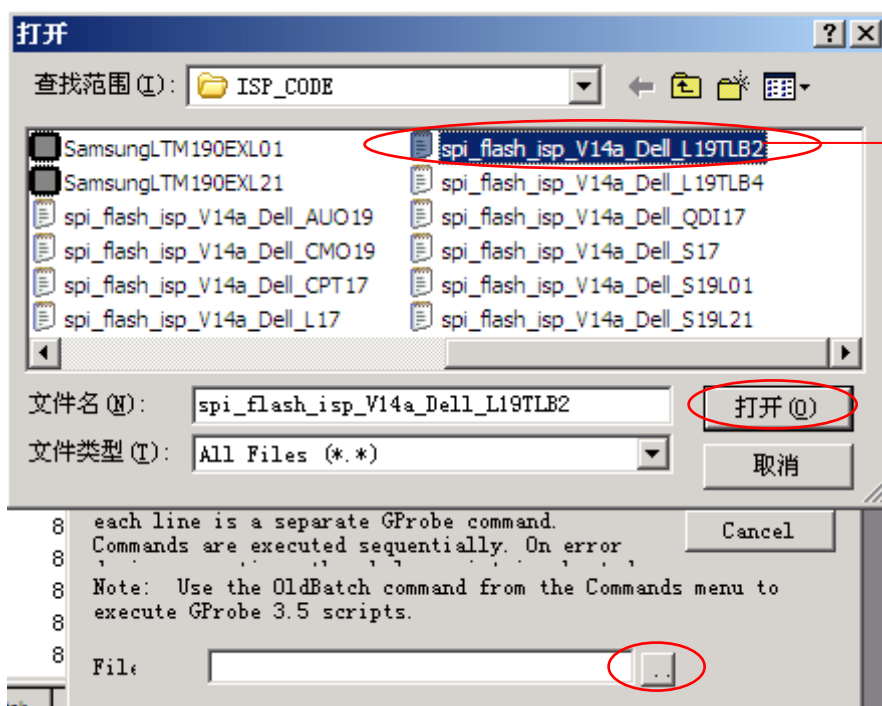

The text must be matching with the panel type of the monitor, such as if the panel you use is LPL 19" .you have choose the spi_flash_isp_V14a_Dell_L19TLB2 (.txt) or spi_flash_isp_V14a_Dell_L19TLB4 (.txt)

Click open.

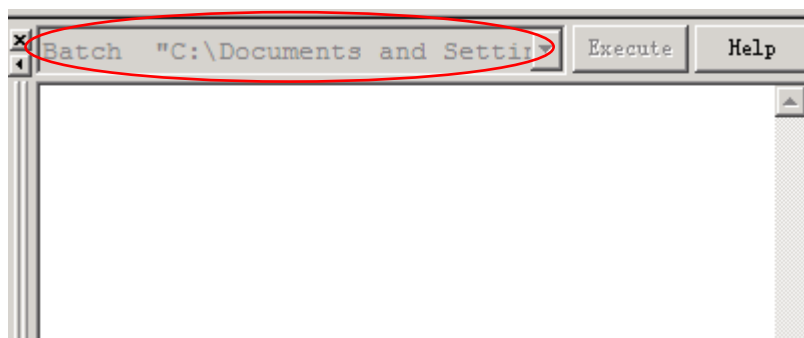

(4). Unplug the Dell AC power, until the LED indicator is off, press Enter or Execute button, when the .txt of MCU is in gray, for example `Batch "C:\Documents and Settings`, re-plug Dell AC power, Writer is in progress.

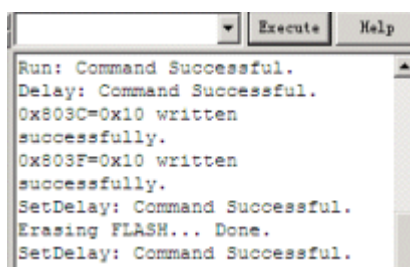

(5). When appear the "Execution time : 35.55ss , Batch Command Successful", Writer is complete!

13. Check List

- 1) After replacing LCD Main board and panel, Check if white-balance is within the specs, then re-writing DDC is necessary.

The white-balance value for each common color temperature:

9300 parameter is $x=283\pm 28$, $y=297\pm 28$, $Y = 180 \pm 10 \text{ cd/m}^2$,

6500 parameter is $x = 313\pm 28$, $y=329\pm 28$, $Y = 180 \pm 10 \text{ cd/m}^2$,

5700 parameter is $x = 328 \pm 28$, $y = 344 \pm 28$, $Y = 180 \pm 10 \text{ cd/m}^2$

The color temperature value above must be up to the situation of $x < y$. The value of Y should be confirmed according to different customers. 15" LCD is commonly $180\pm 20 \text{ cd/cm}^2$ (Center) and 17" LCD is required to be larger than 200 cd/cm^2 (Center). The exact brightness values are confirmed by the checking-regulations of different customers and different models.

2) Steps of white-balance adjustment for LCD:(Take 17" AOC LCD LM724 for example)

1. Required instruments: Chroma7120、 Chroma2325 (BGA265A)
2. First connect the instruments together and turn on the LCD power, then warm up for 30 minutes under full white screen mode. First press the "Reset" key in the menu to recover factory set as following.

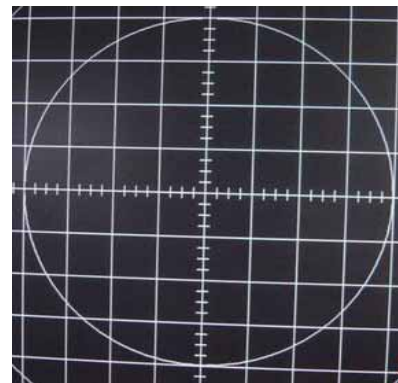

Set Chroma2325 at round-windows mode and make the detecting-head of Chroma7120 aim at the cross in the middle, the distance between the detecting-head and the cross is 20cm.

3. Set Chroma2325 (BGA265A) to be T144 (1280*1024/60HZ) and P105 of full white screen. Test if the white-balance value is within the specs. Please follow the steps below to adjust if it is beyond the specs.
4. Cut the power. Then press MENU key and re-plug power cable at the same time to enter into the factory mode. See the following pictures.



Select "F", then Select
AUTO LEVEL item.



5. Test white-balance again after Auto Level. Adjustment with hand is necessary if it is beyond the specs.
6. Select 7x00 item to adjust cool color-temperature and select 6x00 to adjust warm color- temperature. It can reach to the best effect through adjusting R/G/B value if it inclines to green or blue.

7. Select Exit to the upper menu after completing the adjustment. Then press POWER OFF to exit and save it.

3) Steps for writing DDC :

1. Employ PC, and connect the DDC-writing instrument and the instrument that is ready for writing into DDC to the power of 12V. Connect the signal cable of the latter to D-USB or DVI of DDC-writing instrument (The data-writing of monitor needs transfer-interface) and link the DDC-writing instrument with PC through printer interface. (See the schematic picture below)



(Connection for VGA)



(Connection for DVI)

2. Seek the document with the expanded name of **.BAT** in DDC file of this model. It appears the indication of " Input Serial No. : " after dual-click the document to be ready for DDC-writing.
3. Input the serial number of the product (For instance: AOC LM725 is 13 bits), and then press ENTER to start writing
4. Check the indication of DDC-writing program at the end. When you see the picture as the schematic picture above, the " Data compare OK!" Means being written well and that's the end. Please check if the Manufacturer Name, Vendor Assigned Code, Monitor Name, Serial Number, Week of Manufacture, Year of Manufacture are right. It will appear " Data compare error! " To indicate failure if the DDC-writing doesn't perform well. Please check the power resource and the connection of the signal cable, then return to step 3 by pressing ENTER and re-do it.
5. You can exit the program by pressing Ctrl plus C, and then cut the signal cable and the power.
6. The following picture is taking AOC LM725 EDID for example.

```

Manufacturer Name   : ADC
Product Code       : A725
Model Name         : LN725

Week of Manufacture : 22
Year of Manufacture : 2005
Video i/p definition : Analog
Checksum           : 6B
EEROM data table :
00 FF FF FF FF FF FF 00 05 E3 25 A7 01 00 00 00
16 0F 01 03 68 22 1B 78 2A 36 AD A2 59 4C 97 24
17 50 56 BF EF 00 01 00 01 01 01 01 01 01 01 01
01 01 01 01 01 01 BC 34 00 98 51 00 2A 40 10 90
13 00 54 0E 11 00 00 1E 00 00 00 FF 00 31 32 33
35 35 4A 41 30 30 30 30 31 00 00 00 FD 00 37
4B 1E 53 0E 00 0A 20 20 20 20 20 20 00 00 FC
00 4C 4D 37 32 35 0A 20 20 20 20 20 20 00 6B
data compare OK !

```

Notes:

1. Make sure the system time of PC is in accordance with the real time before writing.
2. The schematic picture is just as an example for description; the exact content of the DDC is dependent on the serial number of the BARCORD of this model.
3. Data DDC-writing needs a transfer interface.

Instruction : DDC-writing needs 4 files:

1. Barcode.txt (Supply Barcode length and flow number)
2. *.EXE (DDC-writing program)
3. WR.bat (Group order file for cycling utilization of *.EXE, and dual-click this file when perform DDC-writing)
4. W.dat (The content with 128 bits of DDC)

14. BOM List

Different key Parts List

Part NO	Description	Quantity	Unit	Remark
750GLG90E3T21Z D	19" TLB2 ZBD PANEL	1	PCS	T980KGCHKRDEUP
750GLG90E3T41Z D	LPL 19" TLB4 ZBD PANEL	1	PCS	T980KGCHKRDGUP
750GLS90EX1 Z	SEC 19" EX-L01-L00 PANEL	1	PCS	T980KSCDKRDFUP
750GLS90X2111Z	SEC 19" EX-L21-CL6 PANEL	1	PCS	T980KSCDKRDMUP
CBPC980KGC DRP	MAIN BOARD VER:A00,V4C09	1	PCS	T980KGCHKRDEUP/ T980KGCHKRDGUP
CBPC980KSC DRP	MAIN BOARD VER:A00,V4C09	1	PCS	T980KSCDKRDFUP/ T980KSCDKRDMUP
PWPC1942LGD3P	POWER BOARD VER:A00	1	PCS	T980KGCHKRDEUP/ T980KGCHKRDGUP
PWPC1942SED3P	POWER BOARD VER:A00	1	PCS	T980KSCDKRDFUP/ T980KSCDKRDMUP

Part list for T980KSCDKRDFUP model

Location	Part NO	Description	Quantity	Unit
	CBPC980KSC DRP	MAIN BOARD VER:A00,V4C09	1	PCS
	KEPC980KB9P	KEY BOARD	1	PCS
	PWPC1942SED3P	POWER BOARD VER:A00	1	PCS
	USB780A2P	USB BOARD	1	PCS
	USB980A1P	USB BOARD	1	PCS
	11G6070 1 GP	TIE MOUNTS	1	PCS
	11G6092 1	FIX BUTTON	1	PCS
	12G6212 2	RUBBER PAD	2	PCS
	15G6310 1	EMI GROUNDING SPRING	2	PCS
	15G6319 1	AC-BRACKET	1	PCS
	15G8146 1	KEYSINGTON BRACKET	1	PCS
	15G8271 1	MAIN FRAME-SAM L01	1	PCS
	23G3178700 5A	LOGO	1	PCS
	26G 800700 6A	S/N LABEL	1	PCS
	33G4885 VH L	BUTTON RELEASE	1	PCS
	33G4940AST L	BUTTON FUNC	1	PCS
	34G1755ASN B	BEZEL	1	PCS
	34G1756 SN B	REAR COVER	1	PCS
	34G1757 VH B	REAR VENT LEFT	1	PCS
	34G1758 VH B	REAR VENT RIGHT	1	PCS

	40G 19N700 4A	RATING LABEL	1	PCS
	40G 581700 3A6813	CARTON LABEL	1	PCS
	41G780070039A	PIG	1	PCS
	41G780070043A	QSG	1	PCS
	44G3231 12 A	EVA WASHER	2	PCS
	44G3947 1	EPS(L)	1	PCS
	44G3947 2	EPS(R)	1	PCS
	44G3947 3	EPS(M)	1	PCS
	44G3947700 2A	CARTON	1	PCS
	45G 88609 26	EPE BAG FOR BASE	1	PCS
	45G 88609 27	EPE BAG FOR MONITOR	1	PCS
	52G 1185 4	TYPE FOR DELL	104	CM
	52G 1186	SMALL TAPE	8	CM
	52G6020 2DEO	PROTECT FILM	1	PCS
	52G6022 1500	SMALL TAPE	12	CM
	52G6025 11936	MYLAR	1	PCS
	52G6025 11938	MYLAR	1	PCS
	70G1900700 3A	CD MANUAL	1	PCS
	85G 725 1	SHIELD USB	1	PCS
	89G 175 9	USB CABLE	1	PCS
E089B	89G 728GAA 2D	SIGNAL CABLE	1	PCS
E089D	89G174ELAA 1	DVI CABLE	1	PCS
E089A	89G402A18NISD	POWER CORD	1	PCS
E095	95G8018 30 99	PANEL HARNESS	1	PCS
	M1G 130 4120	SCREW M3X5	5	PCS
	M1G 130 4225	SCREW	4	PCS
	M1G 330 4128	SCREW M3X4	2	PCS
	M1G1730 6128	SCREW M3x6	13	PCS
	M1G1740 6128	SCREW	1	PCS
	M1G1830 5120	SCREW	1	PCS
	M1G2940 10225	SCREW	4	PCS
	Q1G6019 1	SCREW	5	PCS
	705G980KM34003	19" LCD COVER ASS'Y	1	PCS
E750L	750GLS90EX1 Z	SEC 19" EX-L01-L00 PANE	1	PCS
C301	67G215Y2207RV	RUBYCON 50V 22UF	1	PCS
C309	67G215Y2207RV	RUBYCON 50V 22UF	1	PCS
C316	67G215Y2207RV	RUBYCON 50V 22UF	1	PCS
C319	67G215Y2207RV	RUBYCON 50V 22UF	1	PCS
C325	67G215Y2207RV	RUBYCON 50V 22UF	1	PCS

C501	67G215Y2207RV	RUBYCON 50V 22UF	1	PCS
C609	67G215Y2207RV	RUBYCON 50V 22UF	1	PCS
C610	67G215Y2207RV	RUBYCON 50V 22UF	1	PCS
C615	67G215Y2207RV	RUBYCON 50V 22UF	1	PCS
	AIC980KSCDRP	MAIN BOARD	1	PCS
CN403	33G8019 8C	FPC/FFC CONN	1	PCS
CN601	33G8027 12	WAFER 2*6P 2.0MM R/A	1	PCS
CN401	33G8027 14	WAFER 14P 2.0MM DIP DUA	1	PCS
CN501	33G8043 24 H	CONNECTER	1	PCS
	40G 457624 1B	LABEL-CPU	1	PCS
	40G 45762412B	CBPC LABEL	1	PCS
C601	67G215L221 4N	KY25VB220-M-L8*11.5MM	1	PCS
C602	67G215L221 4N	KY25VB220-M-L8*11.5MM	1	PCS
C611	67G215L221 4N	KY25VB220-M-L8*11.5MM	1	PCS
CN202	88G 35315F H	D-SUB 15PIN	1	PCS
CN201	88G 35424F H	DV1 CONNECTOR 24PIN	1	PCS
X301	93G 22 53	CRYSTAL 14.318MHzHC-49U	1	PCS
U401	56G 562 97	GM 5621-LF-AA	1	PCS
U601	56G 563 21	AP1084K33LA	1	PCS
U602	56G 563 31	AI1117D-1.8-EI	1	PCS
U302	56G 643 13	G691L400T73UF SOT-23 GM	1	PCS
U201	56G1133 34	M24C02-WMN6TP	1	PCS
U202	56G1133 34	M24C02-WMN6TP	1	PCS
U403	56G1133 56	M24C16-WMN6TP	1	PCS
U402	56G1133 63SD4	PM25LV010-25SCE	1	PCS
Q403	57G 417 4	PMBS3904/PHILIPS-SMT(04	1	PCS
Q404	57G 417 4	PMBS3904/PHILIPS-SMT(04	1	PCS
Q601	57G 417 4	PMBS3904/PHILIPS-SMT(04	1	PCS
Q603	57G 417 4	PMBS3904/PHILIPS-SMT(04	1	PCS
Q201	57G 758 1	2N7002ESOT23 SILICONIX	1	PCS
Q602	57G 763 1	A03401 SOT23 BY AOS(A1)	1	PCS
R243	61L0603000	RST SM 0603 JUMP MAX 0R	1	PCS
R331	61L0603000	RST SM 0603 JUMP MAX 0R	1	PCS
R428	61L0603000	RST SM 0603 JUMP MAX 0R	1	PCS
R429	61L0603000	RST SM 0603 JUMP MAX 0R	1	PCS
R606	61L0603000	RST SM 0603 JUMP MAX 0R	1	PCS
R613	61L0603000	RST SM 0603 JUMP MAX 0R	1	PCS
R614	61L0603000	RST SM 0603 JUMP MAX 0R	1	PCS
R202	61L0603100	CHIP 10 OHM 1/10W	1	PCS

R203	61L0603100	CHIP 10 OHM 1/10W	1	PCS
R204	61L0603100	CHIP 10 OHM 1/10W	1	PCS
R205	61L0603100	CHIP 10 OHM 1/10W	1	PCS
R206	61L0603100	CHIP 10 OHM 1/10W	1	PCS
R207	61L0603100	CHIP 10 OHM 1/10W	1	PCS
R208	61L0603100	CHIP 10 OHM 1/10W	1	PCS
R209	61L0603100	CHIP 10 OHM 1/10W	1	PCS
R301	61L0603100	CHIP 10 OHM 1/10W	1	PCS
R215	61L0603101	RST SM 0603 RC0603 100R	1	PCS
R216	61L0603101	RST SM 0603 RC0603 100R	1	PCS
R222	61L0603101	RST SM 0603 RC0603 100R	1	PCS
R224	61L0603101	RST SM 0603 RC0603 100R	1	PCS
R228	61L0603101	RST SM 0603 RC0603 100R	1	PCS
R230	61L0603101	RST SM 0603 RC0603 100R	1	PCS
R232	61L0603101	RST SM 0603 RC0603 100R	1	PCS
R309	61L0603101	RST SM 0603 RC0603 100R	1	PCS
R310	61L0603101	RST SM 0603 RC0603 100R	1	PCS
R311	61L0603101	RST SM 0603 RC0603 100R	1	PCS
R407	61L0603101	RST SM 0603 RC0603 100R	1	PCS
R408	61L0603101	RST SM 0603 RC0603 100R	1	PCS
R602	61L0603102	RST SM 0603 RC0603 1K P	1	PCS
R603	61L0603102	RST SM 0603 RC0603 1K P	1	PCS
R604	61L0603102	RST SM 0603 RC0603 1K P	1	PCS
R201	61L0603103	RST SM 0603 RC0603 10K	1	PCS
R211	61L0603103	RST SM 0603 RC0603 10K	1	PCS
R214	61L0603103	RST SM 0603 RC0603 10K	1	PCS
R322	61L0603103	RST SM 0603 RC0603 10K	1	PCS
R416	61L0603103	RST SM 0603 RC0603 10K	1	PCS
R417	61L0603103	RST SM 0603 RC0603 10K	1	PCS
R418	61L0603103	RST SM 0603 RC0603 10K	1	PCS
R210	61L0603221	RST SM 0603 RC0603 220R	1	PCS
R237	61L0603221	RST SM 0603 RC0603 220R	1	PCS
R238	61L0603221	RST SM 0603 RC0603 220R	1	PCS
R239	61L0603221	RST SM 0603 RC0603 220R	1	PCS
R411	61L0603221	RST SM 0603 RC0603 220R	1	PCS
R412	61L0603221	RST SM 0603 RC0603 220R	1	PCS
R413	61L0603221	RST SM 0603 RC0603 220R	1	PCS
R414	61L0603221	RST SM 0603 RC0603 220R	1	PCS
R415	61L0603221	RST SM 0603 RC0603 220R	1	PCS

R240	61L0603222	RST SM 0603 RC0603 2K2	1	PCS
R241	61L0603222	RST SM 0603 RC0603 2K2	1	PCS
R217	61L0603223	CHIPR 22K OHM +-5% 1/10	1	PCS
R420	61L0603223	CHIPR 22K OHM +-5% 1/10	1	PCS
R421	61L0603223	CHIPR 22K OHM +-5% 1/10	1	PCS
R302	61L0603249 0F	CHIP 249OHM 1/16W 1%	1	PCS
R419	61L0603303	CHIP 30K OHM 5% 1/10W	1	PCS
R422	61L0603303	CHIP 30K OHM 5% 1/10W	1	PCS
R218	61L0603333	CHIP 33K OHM 1/10W	1	PCS
R212	61L0603472	RST SM 0603 RC0603 4K7	1	PCS
R213	61L0603472	RST SM 0603 RC0603 4K7	1	PCS
R226	61L0603472	RST SM 0603 RC0603 4K7	1	PCS
R227	61L0603472	RST SM 0603 RC0603 4K7	1	PCS
R242	61L0603472	RST SM 0603 RC0603 4K7	1	PCS
R305	61L0603472	RST SM 0603 RC0603 4K7	1	PCS
R306	61L0603472	RST SM 0603 RC0603 4K7	1	PCS
R307	61L0603472	RST SM 0603 RC0603 4K7	1	PCS
R308	61L0603472	RST SM 0603 RC0603 4K7	1	PCS
R315	61L0603472	RST SM 0603 RC0603 4K7	1	PCS
R316	61L0603472	RST SM 0603 RC0603 4K7	1	PCS
R317	61L0603472	RST SM 0603 RC0603 4K7	1	PCS
R318	61L0603472	RST SM 0603 RC0603 4K7	1	PCS
R323	61L0603472	RST SM 0603 RC0603 4K7	1	PCS
R324	61L0603472	RST SM 0603 RC0603 4K7	1	PCS
R409	61L0603472	RST SM 0603 RC0603 4K7	1	PCS
R410	61L0603472	RST SM 0603 RC0603 4K7	1	PCS
R424	61L0603472	RST SM 0603 RC0603 4K7	1	PCS
R430	61L0603472	RST SM 0603 RC0603 4K7	1	PCS
R431	61L0603472	RST SM 0603 RC0603 4K7	1	PCS
R501	61L0603472	RST SM 0603 RC0603 4K7	1	PCS
R601	61L0603472	RST SM 0603 RC0603 4K7	1	PCS
R605	61L0603473	RST SM 0603 RC0603 47K	1	PCS
R608	61L0603473	RST SM 0603 RC0603 47K	1	PCS
R609	61L0603473	RST SM 0603 RC0603 47K	1	PCS
R220	61L0603750 9F	75OHM 1% 1/10W	1	PCS
R223	61L0603750 9F	75OHM 1% 1/10W	1	PCS
R229	61L0603750 9F	75OHM 1% 1/10W	1	PCS
R233	61L0603750 9F	75OHM 1% 1/10W	1	PCS
R234	61L0603750 9F	75OHM 1% 1/10W	1	PCS

R235	61L0603750 9F	75OHM 1% 1/10W	1	PCS
C201	65G0603102 32	1000PF +-10% 50V X7R	1	PCS
C404	65G0603102 32	1000PF +-10% 50V X7R	1	PCS
C405	65G0603102 32	1000PF +-10% 50V X7R	1	PCS
C406	65G0603102 32	1000PF +-10% 50V X7R	1	PCS
C407	65G0603102 32	1000PF +-10% 50V X7R	1	PCS
C210	65G0603103 32	0.01UF +-10% 50V X7R	1	PCS
C211	65G0603103 32	0.01UF +-10% 50V X7R	1	PCS
C212	65G0603103 32	0.01UF +-10% 50V X7R	1	PCS
C213	65G0603103 32	0.01UF +-10% 50V X7R	1	PCS
C215	65G0603103 32	0.01UF +-10% 50V X7R	1	PCS
C216	65G0603103 32	0.01UF +-10% 50V X7R	1	PCS
C209	65G0603104 12	CER2 0603 X7R 16V 100N	1	PCS
C214	65G0603104 12	CER2 0603 X7R 16V 100N	1	PCS
C219	65G0603104 12	CER2 0603 X7R 16V 100N	1	PCS
C220	65G0603104 12	CER2 0603 X7R 16V 100N	1	PCS
C221	65G0603104 12	CER2 0603 X7R 16V 100N	1	PCS
C222	65G0603104 12	CER2 0603 X7R 16V 100N	1	PCS
C302	65G0603104 12	CER2 0603 X7R 16V 100N	1	PCS
C303	65G0603104 12	CER2 0603 X7R 16V 100N	1	PCS
C304	65G0603104 12	CER2 0603 X7R 16V 100N	1	PCS
C305	65G0603104 12	CER2 0603 X7R 16V 100N	1	PCS
C306	65G0603104 12	CER2 0603 X7R 16V 100N	1	PCS
C307	65G0603104 12	CER2 0603 X7R 16V 100N	1	PCS
C308	65G0603104 12	CER2 0603 X7R 16V 100N	1	PCS
C310	65G0603104 12	CER2 0603 X7R 16V 100N	1	PCS
C311	65G0603104 12	CER2 0603 X7R 16V 100N	1	PCS
C312	65G0603104 12	CER2 0603 X7R 16V 100N	1	PCS
C313	65G0603104 12	CER2 0603 X7R 16V 100N	1	PCS
C314	65G0603104 12	CER2 0603 X7R 16V 100N	1	PCS
C317	65G0603104 12	CER2 0603 X7R 16V 100N	1	PCS
C318	65G0603104 12	CER2 0603 X7R 16V 100N	1	PCS
C320	65G0603104 12	CER2 0603 X7R 16V 100N	1	PCS
C321	65G0603104 12	CER2 0603 X7R 16V 100N	1	PCS
C322	65G0603104 12	CER2 0603 X7R 16V 100N	1	PCS
C323	65G0603104 12	CER2 0603 X7R 16V 100N	1	PCS
C324	65G0603104 12	CER2 0603 X7R 16V 100N	1	PCS
C326	65G0603104 12	CER2 0603 X7R 16V 100N	1	PCS
C330	65G0603104 12	CER2 0603 X7R 16V 100N	1	PCS

C332	65G0603104 12	CER2 0603 X7R 16V 100N	1	PCS
C333	65G0603104 12	CER2 0603 X7R 16V 100N	1	PCS
C401	65G0603104 12	CER2 0603 X7R 16V 100N	1	PCS
C408	65G0603104 12	CER2 0603 X7R 16V 100N	1	PCS
C502	65G0603104 12	CER2 0603 X7R 16V 100N	1	PCS
C603	65G0603104 12	CER2 0603 X7R 16V 100N	1	PCS
C604	65G0603104 12	CER2 0603 X7R 16V 100N	1	PCS
C608	65G0603104 12	CER2 0603 X7R 16V 100N	1	PCS
C612	65G0603104 12	CER2 0603 X7R 16V 100N	1	PCS
C613	65G0603104 12	CER2 0603 X7R 16V 100N	1	PCS
C614	65G0603104 12	CER2 0603 X7R 16V 100N	1	PCS
C217	65G0603220 31	CER1 0603 NP0 50V 22P P	1	PCS
C218	65G0603220 31	CER1 0603 NP0 50V 22P P	1	PCS
C331	65G0603224 12	CHIP 0.22UF +-10% 16V X	1	PCS
C618	65G0603224 17	CAP:CER 0.22UF-20%-80%	1	PCS
C327	65G0603330 31	CER1 0603 NP0 50V 33P P	1	PCS
C328	65G0603330 31	CER1 0603 NP0 50V 33P P	1	PCS
L301	71G 56K121	CHIP BEAD	1	PCS
L302	71G 56K121	CHIP BEAD	1	PCS
L303	71G 56K121	CHIP BEAD	1	PCS
L304	71G 56K121	CHIP BEAD	1	PCS
L305	71G 56K121	CHIP BEAD	1	PCS
L306	71G 56K121	CHIP BEAD	1	PCS
L307	71G 56K121	CHIP BEAD	1	PCS
FB204	71G 59B431	BK1608 HW 431	1	PCS
FB201	71G 59C600	CHIP BEAD	1	PCS
FB202	71G 59C600	CHIP BEAD	1	PCS
FB203	71G 59C600	CHIP BEAD	1	PCS
D201	93G 64 33	DIO SIG SM BAV99 (PHSE)	1	PCS
D202	93G 64 33	DIO SIG SM BAV99 (PHSE)	1	PCS
D203	93G 64 33	DIO SIG SM BAV99 (PHSE)	1	PCS
D204	93G 64 33	DIO SIG SM BAV99 (PHSE)	1	PCS
D205	93G 64 33	DIO SIG SM BAV99 (PHSE)	1	PCS
D206	93G 64 33	DIO SIG SM BAV99 (PHSE)	1	PCS
D207	93G 64 33	DIO SIG SM BAV99 (PHSE)	1	PCS
D208	93G 64 33	DIO SIG SM BAV99 (PHSE)	1	PCS
D211	93G 64 33	DIO SIG SM BAV99 (PHSE)	1	PCS
D212	93G 64 33	DIO SIG SM BAV99 (PHSE)	1	PCS
D213	93G 64 33	DIO SIG SM BAV99 (PHSE)	1	PCS

D209	93G 64 42 P	BAV70 SOT-23	1	PCS
D210	93G 64 42 P	BAV70 SOT-23	1	PCS
ZD201	93G 39S 34 T	UDZS5.6B	1	PCS
ZD202	93G 39S 34 T	UDZS5.6B	1	PCS
ZD203	93G 39S 34 T	UDZS5.6B	1	PCS
ZD204	93G 39S 34 T	UDZS5.6B	1	PCS
ZD207	93G 39S 34 T	UDZS5.6B	1	PCS
ZD208	93G 39S 34 T	UDZS5.6B	1	PCS
ZD209	93G 39S 34 T	UDZS5.6B	1	PCS
ZD210	93G 39S 34 T	UDZS5.6B	1	PCS
ZD211	93G 39S 34 T	UDZS5.6B	1	PCS
ZD212	93G 39S 34 T	UDZS5.6B	1	PCS
ZD301	93G 39S 34 T	UDZS5.6B	1	PCS
	715G1667 E	MAIN BOARD	1	PCS
	AIK980KB9SMTP	KEY BOARD	1	PCS
C01	65G0603104 12	CER2 0603 X7R 16V 100N	1	PCS
C02	65G0603104 12	CER2 0603 X7R 16V 100N	1	PCS
SW01	77G 605 1 AL GP	SMD SWITCH	1	PCS
SW02	77G 605 1 AL GP	SMD SWITCH	1	PCS
SW03	77G 605 1 AL GP	SMD SWITCH	1	PCS
SW04	77G 605 1 AL GP	SMD SWITCH	1	PCS
SW05	77G 605 1 AL GP	SMD SWITCH	1	PCS
LED01	81G 14501 KT	CHIP LED	1	PCS
CN1	89G176S 8 7	FPC/FFC SMT R/A CONN. 1	1	PCS
ZD01	93G 39S 34 T	UDZS5.6B	1	PCS
ZD02	93G 39S 34 T	UDZS5.6B	1	PCS
ZD03	93G 39S 34 T	UDZS5.6B	1	PCS
ZD04	93G 39S 34 T	UDZS5.6B	1	PCS
ZD05	93G 39S 34 T	UDZS5.6B	1	PCS
ZD06	93G 39S 34 T	UDZS5.6B	1	PCS
ZD07	93G 39S 34 T	UDZS5.6B	1	PCS
	715G1673 J	KEY BOARD	1	PCS
	PW1942SED3SMTP	POWER BOARD FOR SMT	1	PCS
CN801	33G8021 2D AC	CONN.2P R/A 87210-0236	1	PCS
CN802	33G8021 2D AC	CONN.2P R/A 87210-0236	1	PCS
CN803	33G8021 2D AC	CONN.2P R/A 87210-0236	1	PCS
CN804	33G8021 2D AC	CONN.2P R/A 87210-0236	1	PCS
	40G 45762420A	ID LABEL	1	PCS
IC902	56G 139 3A	PC123Y22FZOF	1	PCS

NR901	61G 58080 WT	8 OHM NCT	1	PCS
C816	65G 3J1206ET	12PF 5% SL 3KV TDK	1	PCS
C825	65G 3J1206ET	12PF 5% SL 3KV TDK	1	PCS
C817	65G 3J5096ET	5PF 5% SL 3KV	1	PCS
C826	65G 3J5096ET	5PF 5% SL 3KV	1	PCS
C901	65G305M2222EM	2200PF+-20% 250VAC/400V	1	PCS
C902	65G305M2222EM	2200PF+-20% 250VAC/400V	1	PCS
C932	65G306M4722BM GP	4700PF +-20% 400VAC	1	PCS
C903	67G215L10115N	EC CAP 105 100UF 450V	1	PCS
C922	67G215L102 4N	KY25VB1000M-L 12.5*20	1	PCS
C923	67G215L102 4N	KY25VB1000M-L 12.5*20	1	PCS
C924	67G215L102 4N	KY25VB1000M-L 12.5*20	1	PCS
C811	67G215L471 4N	KY25VB470M-L10*16	1	PCS
C820	67G215L471 4N	KY25VB470M-L10*16	1	PCS
C925	67G215L471 4N	KY25VB470M-L10*16	1	PCS
C926	67G215L471 4N	KY25VB470M-L10*16	1	PCS
C935	67G215L471 4N	KY25VB470M-L10*16	1	PCS
L901	73G 174 76 L	CHOKE COIL LI TAI LF-00	1	PCS
L902	73G 174 77 L	LINE FILTER	1	PCS
L921	73G 253 91 LS	CHOKE BY LI SHIN	1	PCS
L922	73G 253 91 LS	CHOKE BY LI SHIN	1	PCS
T901	80GL17T 32 L	ADAPTOR BY LITAI	1	PCS
PT801	80GL19T 8 DN	OZ9RR_TRANS	1	PCS
PT802	80GL19T 8 DN	OZ9RR_TRANS	1	PCS
CN901	87G 501 32 S	AC SOCKET	1	PCS
CN903	88G 304 8K C	DC JACK	1	PCS
CN902	95G8013 12 13	WIRE HARNESS	1	PCS
	705G 780 61 26	R909 ASS'Y	1	PCS
	705G 780 61 27	R916 ASS'Y	1	PCS
	705G 780 93 26	D921/IC922 ASS'Y	1	PCS
	705G 780 93 27	D920 ASS'Y	1	PCS
	705G 780 93 28	DB901/Q900 ASS'Y	1	PCS
	705G 780 93 29	D901 ASS'Y	1	PCS
	PW1942LGD3AIP	POWER BOARD FOR AI	1	PCS
IC901	56G 379 52	LD7552BS	1	PCS
IC801	56G 608 10	OZ9938	1	PCS
Q801	57G 417 4	PMBS3904/PHILIPS-SMT(04	1	PCS
Q802	57G 417 4	PMBS3904/PHILIPS-SMT(04	1	PCS
Q803	57G 417 4	PMBS3904/PHILIPS-SMT(04	1	PCS

Q805	57G 763 14	AM9945N	1	PCS
Q806	57G 763 14	AM9945N	1	PCS
RJ807	61L0805000	CHIP O OHM 1/8W	1	PCS
R837	61L0805100	CHIPR 10 OHM+-5% 1/8W	1	PCS
R842	61L0805100	CHIPR 10 OHM+-5% 1/8W	1	PCS
R917	61L0805101	CHIPR 100 OHM +-5% 1/8W	1	PCS
R836	61L0805102	CHIPR 1K OHM +-5% 1/8W	1	PCS
R843	61L0805102	CHIPR 1K OHM +-5% 1/8W	1	PCS
R925	61L0805102	CHIPR 1K OHM +-5% 1/8W	1	PCS
R927	61L0805102	CHIPR 1K OHM +-5% 1/8W	1	PCS
R803	61L0805103	CHIPR 10K OHM +-5% 1/8W	1	PCS
R804	61L0805103	CHIPR 10K OHM +-5% 1/8W	1	PCS
R812	61L0805103	CHIPR 10K OHM +-5% 1/8W	1	PCS
R914	61L0805103	CHIPR 10K OHM +-5% 1/8W	1	PCS
R915	61L0805103	CHIPR 10K OHM +-5% 1/8W	1	PCS
R810	61L0805104	CHIPR 100K OHM+-5% 1/8W	1	PCS
R815	61L0805104	CHIPR 100K OHM+-5% 1/8W	1	PCS
R821	61L0805104	CHIPR 100K OHM+-5% 1/8W	1	PCS
R831	61L0805104	CHIPR 100K OHM+-5% 1/8W	1	PCS
R911	61L0805104	CHIPR 100K OHM+-5% 1/8W	1	PCS
R919	61L0805104	CHIPR 100K OHM+-5% 1/8W	1	PCS
R809	61L0805105	CHIP 1M OHM 5% 1/8W	1	PCS
R813	61L0805105	CHIP 1M OHM 5% 1/8W	1	PCS
R828	61L0805150	15 0805	1	PCS
R829	61L0805150	15 0805	1	PCS
R820	61L0805153	CHIPR 15K OHM+-5% 1/8W	1	PCS
R830	61L0805153	CHIPR 15K OHM+-5% 1/8W	1	PCS
R811	61L0805154	CHIP 150KOHM 5% 1/8W	1	PCS
R816	61L0805155	CHIP 1.5M OHM 5% 1/8W	1	PCS
R807	61L0805220	CHIP 22 OHM 5% 0805 1/8	1	PCS
R841	61L0805221	CHIPR 220 OHM +-5% 1/8W	1	PCS
R929	61L0805240 1F	CHIPR 2.4KOHM +-1% 1/8W	1	PCS
R802	61L0805304	300K OM 1/8W	1	PCS
R926	61L0805330 2F	CHIP 33KOHM 1/8W 1%	1	PCS
R924	61L0805360 1F	CHIP 3.6KOHM 1/8W 1%	1	PCS
R817	61L0805393	SMD 39KOHM/0805/+5% 1/	1	PCS
R825	61L0805561	CHIP 560 OHM 1/8W	1	PCS
R835	61L0805561	CHIP 560 OHM 1/8W	1	PCS
R827	61L0805562	CHIP 5.6K OHM 1/8W	1	PCS

R834	61L0805562	CHIP 5.6K OHM 1/8W	1	PCS
R814	61L0805563	CHIP 56K OHM 1/8W	1	PCS
R823	61L0805753	75K 1/8W	1	PCS
R833	61L0805753	75K 1/8W	1	PCS
R918	61L0805753	75K 1/8W	1	PCS
F902	61L1206000	RST SM 1206 JUMP MAX 0R	1	PCS
R801	61L1206000	RST SM 1206 JUMP MAX 0R	1	PCS
RJ801	61L1206000	RST SM 1206 JUMP MAX 0R	1	PCS
RJ802	61L1206000	RST SM 1206 JUMP MAX 0R	1	PCS
RJ803	61L1206000	RST SM 1206 JUMP MAX 0R	1	PCS
RJ804	61L1206000	RST SM 1206 JUMP MAX 0R	1	PCS
RJ805	61L1206000	RST SM 1206 JUMP MAX 0R	1	PCS
RJ808	61L1206000	RST SM 1206 JUMP MAX 0R	1	PCS
R818	61L1206150	CHIP 15 OHM 5% 1206 1/4	1	PCS
R819	61L1206150	CHIP 15 OHM 5% 1206 1/4	1	PCS
R910	61L1206229	CHIP 2.2OHM 5% 1/8W	1	PCS
R900	61L1206334	330K 1/4W	1	PCS
R901	61L1206334	330K 1/4W	1	PCS
R902	61L1206334	330K 1/4W	1	PCS
R903	61L1206434	430K 1206 1/4W 5%	1	PCS
R904	61L1206434	430K 1206 1/4W 5%	1	PCS
R905	61L1206434	430K 1206 1/4W 5%	1	PCS
R805	61L1206471	CHIPR 470 OHM+-5% 1/4W	1	PCS
R808	61L1206474	470K OHM 5% 1/4W	1	PCS
R906	61L1206514	CHIPR 510KOHM +-5% 1/4W	1	PCS
R907	61L1206514	CHIPR 510KOHM +-5% 1/4W	1	PCS
R908	61L1206514	CHIPR 510KOHM +-5% 1/4W	1	PCS
C805	65G0805102 32	CHIP 1000P 50VX7R 0805	1	PCS
C803	65G0805103 32	10NF/50V/0805/X7R	1	PCS
C807	65G0805103 32	10NF/50V/0805/X7R	1	PCS
C908	65G0805104 22	0.1UF +-10% 25V X7R 080	1	PCS
C905	65G0805104 32	CHIP 0.1U 50V X7R	1	PCS
C927	65G0805104 32	CHIP 0.1U 50V X7R	1	PCS
C930	65G0805104 32	CHIP 0.1U 50V X7R	1	PCS
C936	65G0805104 32	CHIP 0.1U 50V X7R	1	PCS
C937	65G0805104 32	CHIP 0.1U 50V X7R	1	PCS
C938	65G0805104 32	CHIP 0.1U 50V X7R	1	PCS
C806	65G0805105 22	CHIP 1UF 25V X7R 0805	1	PCS
C812	65G0805152 22	CHIP 0.005UF 25V X7R 08	1	PCS

C813	65G0805152 22	CHIP 0.005UF 25V X7R 08	1	PCS
C822	65G0805152 22	CHIP 0.005UF 25V X7R 08	1	PCS
C823	65G0805152 22	CHIP 0.005UF 25V X7R 08	1	PCS
C907	65G0805221 32	CHIP 220PF 50V X7R 0805	1	PCS
C934	65G0805223 22	CHIP 0.022UF 25V X7R 08	1	PCS
C804	65G0805225 12	CHIP 2.2UF 15V X7R 0805	1	PCS
C810	65G0805471 31	CHIP 470PF 50V NPO	1	PCS
C818	65G0805471 31	CHIP 470PF 50V NPO	1	PCS
C827	65G0805471 31	CHIP 470PF 50V NPO	1	PCS
C809	65G0805473 32	CHIP 0.047UF 50V X7R	1	PCS
C819	65G0805473 32	CHIP 0.047UF 50V X7R	1	PCS
C808	65G0805682 32	CHIP 6.8UF 50V X7R 0805	1	PCS
FB901	71G 57G301 EA	CHIP BEAD	1	PCS
D802	93G 64 33	DIO SIG SM BAV99 (PHSE)	1	PCS
D804	93G 64 33	DIO SIG SM BAV99 (PHSE)	1	PCS
D801	93G 64 42 PP	BAV70 SOT-23	1	PCS
D803	93G 64 42 PP	BAV70 SOT-23	1	PCS
D922	93G 6432S	IN4148W	1	PCS
D923	93G 6432S	IN4148W	1	PCS
ZD801	93G 39S 24 T	RLZ 5.6B LLDS	1	PCS
ZD922	93G 39S 25 T	RLZ5.1B LLDS	1	PCS
ZD920	93G 39S 38 T	PTZ 9.1B	1	PCS
ZD921	93G 39S 40 T	RLZ 13B LLDS	1	PCS
C903	6G 31502	1.5MM RIVET	2	PCS
L902	6G 31502	1.5MM RIVET	4	PCS
NR901	6G 31502	1.5MM RIVET	2	PCS
PT801	6G 31502	1.5MM RIVET	2	PCS
PT802	6G 31502	1.5MM RIVET	2	PCS
T901	6G 31502	1.5MM RIVET	6	PCS
IC903	56G 158 10 T	AZ431AZ-AE1	1	PCS
IC921	56G 158 10 T	AZ431AZ-AE1	1	PCS
Q921	57G 419501 T	KTC945P	1	PCS
Q922	57G 760 8 T	KRC102M-ATP	1	PCS
R912	61G 17210052T	100HM 5% 1/4W	1	PCS
R913	61G 17210252T	1K OHM 5% 1/4W	1	PCS
R922	61G 17222152T GP	220 OHM 5% 1/4W	1	PCS
R928	61G 17239252T	3.9KOHM 5% 1/4W	1	PCS
R930	61G 60210252T	CFR 1K OHM +-5% 1/6W	1	PCS
R931	61G 60247252T	4.7K OHM 5% 1/6W	1	PCS

R920	61G175L47052T	47OHM +-5% 1/2W	1	PCS
R921	61G175L47052T	47OHM +-5% 1/2W	1	PCS
R822	61G212Y625 KT	MGFR 6.2MOHM +-5% 1/2W	1	PCS
R832	61G212Y625 KT	MGFR 6.2MOHM +-5% 1/2W	1	PCS
C904	65G 1K152 1T	1.5NF/1KV Z5F+-10%	1	PCS
C931	65G 450104 4T	0.1UF Z5V 50V	1	PCS
C920	65G517K102 5T	1000PF 10% Y5P 500V	1	PCS
C921	65G517K102 5T	1000PF 10% Y5P 500V	1	PCS
C906	67G 2152207NT	KY50VB22M-TP5 5*11	1	PCS
F901	84G 56 1	FUSE 2A 250V WICKMANN	1	PCS
D900	93G1100 1052T	BA159G	1	PCS
	715G1775 1	PCB	1	PCS
	34FPE19P03	CASE EEL19	1	PCS
	34FPE19P03	CASE EEL19	1	PCS
R909	61G152M10458F	100K OHM 5% 2W	1	PCS
	96G 29 6	SHRINK TUBE UL/CSA	1	PCS
R916	61G152M30858F	0.3 OHM 5% 2W	1	PCS
	96G 29 6	SHRINK TUBE UL/CSA	1	PCS
IC922	56G 563 37	KA278R12CTU TO-220F-4L	1	PCS
	90G6263 1	HEAT SINK	1	PCS
D921	93G1506 2	FMW-2156	1	PCS
	M1L1730 8128	SCREW M3x8	1	PCS
	M1L1730 8128	SCREW M3x8	1	PCS
	71G 55 30	FERRITE BEAD 4.0*2*3	1	PCS
D920	93G 60258	FME-220B	1	PCS
	M1L1730 10128	SCREW M3x10	1	PCS
Q900	57G 667 21	STP10NK70ZFP	1	PCS
DB901	93G 50460506	D3SB60	1	PCS
	M1L1730 10128	SCREW M3x10	2	PCS
D901	93G1020 752T	UF4003	1	PCS
	96G 29 6	SHRINK TUBE UL/CSA	1	PCS
	33F206H24JWT0	A2006H00-2*12PHK	1	PCS
	33F206T2JWTOP	A2006TOP-2	23	PCS
	33F303SM24K30	PK2407P30/TD00-30LH	1	PCS
	33F303TTD1	TD00-T	23	PCS
	71F 100510 HS	FERRITE CORE	1	PCS
	USB780A2SMTP	USB BOARD FOR SMT	1	PCS
CN702	33G8027 10 H	WAFER 2*5P 2.0MM	1	PCS
C705	67G215L101 4N	KY25VB100M-L 6.3*11	1	PCS

C706	67G215L101 4N	KY25VB100M-L 6.3*11	1	PCS
C707	67G215L101 4N	KY25VB100M-L 6.3*11	1	PCS
C708	67G215L101 4N	KY25VB100M-L 6.3*11	1	PCS
C725	67G215L221 4N	KY25VB220-M-L8*11.5MM	1	PCS
C742	67G215L221 4N	KY25VB220-M-L8*11.5MM	1	PCS
C734	67G215L470 4N	KY25VB47M-L 5*11	1	PCS
C728	67G215Y100 7N	KY50VB10M-L 5*11	1	PCS
L701	73G 253127 L	CC-010730	1	PCS
CN704	88G 350 1 TN	USB CONN	1	PCS
CN703	88G 351 2B CL	USB CONN	1	PCS
X701	93G 22 45 J	24MHZ/30PF/49US	1	PCS
CN701	95G8014 14 33	USB HARNESS 5P	1	PCS
U702	56G 563 57	AP1510SA	1	PCS
U703	56G 585 4	AIC1117-33CY	1	PCS
U701	56G 659 2	IC USB CTRL USB2504 TQF	1	PCS
F701	61G 56075 WT	PTC KMC 5S075R001-0.75M	1	PCS
F702	61G 56075 WT	PTC KMC 5S075R001-0.75M	1	PCS
F703	61G 56075 WT	PTC KMC 5S075R001-0.75M	1	PCS
F704	61G 56075 WT	PTC KMC 5S075R001-0.75M	1	PCS
R740	61L0603000	RST SM 0603 JUMP MAX 0R	1	PCS
R741	61L0603000	RST SM 0603 JUMP MAX 0R	1	PCS
R704	61L0603103	RST SM 0603 RC0603 10K	1	PCS
R706	61L0603103	RST SM 0603 RC0603 10K	1	PCS
R707	61L0603103	RST SM 0603 RC0603 10K	1	PCS
R710	61L0603103	RST SM 0603 RC0603 10K	1	PCS
R712	61L0603103	RST SM 0603 RC0603 10K	1	PCS
R714	61L0603103	RST SM 0603 RC0603 10K	1	PCS
R716	61L0603103	RST SM 0603 RC0603 10K	1	PCS
R745	61L0603103	RST SM 0603 RC0603 10K	1	PCS
R747	61L0603103	RST SM 0603 RC0603 10K	1	PCS
R749	61L0603103	RST SM 0603 RC0603 10K	1	PCS
R755	61L0603103	RST SM 0603 RC0603 10K	1	PCS
R701	61L0603104	RST SM 0603 RC0603 100K	1	PCS
R702	61L0603104	RST SM 0603 RC0603 100K	1	PCS
R703	61L0603104	RST SM 0603 RC0603 100K	1	PCS
R708	61L0603105	RST SM 0603 RC0603 1M P	1	PCS
R709	61L0603113 2F	CHIPR 11.3 KOHM +-1% 1/	1	PCS
R753	61L0603123	CHIP 12K OHM 1/10W	1	PCS
R711	61L0603153	CHIPR 15KOHM+-5% 1/10W	1	PCS

R713	61L0603153	CHIPR 15KOHM+-5% 1/10W	1	PCS
R715	61L0603153	CHIPR 15KOHM+-5% 1/10W	1	PCS
R717	61L0603153	CHIPR 15KOHM+-5% 1/10W	1	PCS
R746	61L0603221	RST SM 0603 RC0603 220R	1	PCS
R754	61L0603222	RST SM 0603 RC0603 2K2	1	PCS
R750	61L0603362	CHIP 3.6K OHM 1/10W	1	PCS
R705	61L0603391	CHIP 390 OHM 1/10W	1	PCS
C709	65G0603103 32	0.01UF +-10% 50V X7R	1	PCS
C710	65G0603103 32	0.01UF +-10% 50V X7R	1	PCS
C711	65G0603103 32	0.01UF +-10% 50V X7R	1	PCS
C713	65G0603103 32	0.01UF +-10% 50V X7R	1	PCS
C715	65G0603103 32	0.01UF +-10% 50V X7R	1	PCS
C716	65G0603103 32	0.01UF +-10% 50V X7R	1	PCS
C717	65G0603103 32	0.01UF +-10% 50V X7R	1	PCS
C718	65G0603103 32	0.01UF +-10% 50V X7R	1	PCS
C719	65G0603103 32	0.01UF +-10% 50V X7R	1	PCS
C731	65G0603103 32	0.01UF +-10% 50V X7R	1	PCS
C701	65G0603104 12	CER2 0603 X7R 16V 100N	1	PCS
C702	65G0603104 12	CER2 0603 X7R 16V 100N	1	PCS
C721	65G0603104 12	CER2 0603 X7R 16V 100N	1	PCS
C722	65G0603104 12	CER2 0603 X7R 16V 100N	1	PCS
C723	65G0603104 12	CER2 0603 X7R 16V 100N	1	PCS
C724	65G0603104 12	CER2 0603 X7R 16V 100N	1	PCS
C727	65G0603104 12	CER2 0603 X7R 16V 100N	1	PCS
C733	65G0603104 12	CER2 0603 X7R 16V 100N	1	PCS
C736	65G0603104 12	CER2 0603 X7R 16V 100N	1	PCS
C741	65G0603104 12	CER2 0603 X7R 16V 100N	1	PCS
C703	65G0603220 31	CER1 0603 NP0 50V 22P P	1	PCS
C704	65G0603220 31	CER1 0603 NP0 50V 22P P	1	PCS
C712	65G0805475 A5	0805 4.7UF +-10% 10V X5	1	PCS
C714	65G0805475 A5	0805 4.7UF +-10% 10V X5	1	PCS
C720	65G0805475 A5	0805 4.7UF +-10% 10V X5	1	PCS
FB701	71G 56K121	CHIP BEAD	1	PCS
FB702	71G 56K121	CHIP BEAD	1	PCS
FB703	71G 56K121	CHIP BEAD	1	PCS
FB704	71G 56K121	CHIP BEAD	1	PCS
FB705	71G 56K121	CHIP BEAD	1	PCS
FB707	71G 56K121	CHIP BEAD	1	PCS
FB706	71G 56Z601	CHIP BEAD 600 OHM 0805	1	PCS

L702	73G253S 1 B	CHOKE COIL	1	PCS
L703	73G253S 1 B	CHOKE COIL	1	PCS
L704	73G253S 1 B	CHOKE COIL	1	PCS
L705	73G253S 1 B	CHOKE COIL	1	PCS
L706	73G253S 1 B	CHOKE COIL	1	PCS
ZD701	93G 64 49 SU	EGA10603 V05	1	PCS
ZD702	93G 64 49 SU	EGA10603 V05	1	PCS
ZD703	93G 64 49 SU	EGA10603 V05	1	PCS
ZD704	93G 64 49 SU	EGA10603 V05	1	PCS
ZD705	93G 64 49 SU	EGA10603 V05	1	PCS
ZD706	93G 64 49 SU	EGA10603 V05	1	PCS
ZD707	93G 64 49 SU	EGA10603 V05	1	PCS
ZD708	93G 64 49 SU	EGA10603 V05	1	PCS
ZD709	93G 64 49 SU	EGA10603 V05	1	PCS
ZD710	93G 64 49 SU	EGA10603 V05	1	PCS
D701	93G5004 1	SR54 T0-214AA	1	PCS
	715G1666 E	USB PCB	1	PCS
C732	65G601M104 7T	0.1UF +-20% 50V Y5V	1	PCS
C733	65G601M104 7T	0.1UF +-20% 50V Y5V	1	PCS
CN705	88G 352 2 CL	USB COW	1	PCS
CN706	88G 352 2 CL	USB COW	1	PCS
CN707	95G8014 10 30	WAFER 10P RIGHT ANGLE P	1	PCS
	715G1665 A 2	PCB	1	PCS
	33G4946 VH L	RISER COVER BTM	1	PCS
	33G4947 VH L	RISER ARM COVER	1	PCS
	34G1748 VH B	BASE	1	PCS
	34G1761 VH B	RISER COVER TOP	1	PCS
	12G6201 1	L TYPE RUBBER	6	PCS
	12G6202 1	V TYPE RUBBER	2	PCS
	15G8185 1	HOLDER BRACKET R	1	PCS
	15G8186 1	HOLDER BRACKET L	1	PCS
	15G8272 1	VESA BRACKT	1	PCS
	19G 588 2	SPRING-HOLDER	2	PCS
	20G 027 2 B	STAND HOLDER	1	PCS
	20G 039 1	BASE DIE CAST	1	PCS
	33G4948 SN L	HINGE LUCK BUUTON	1	PCS
	34G1742 SN B	VESA COVER	1	PCS
	34G1743 SN B	TILT COVER	1	PCS
	34G1749 SN B	BASE COVER	1	PCS

	34G1759 SN B	RISER-FRONT-COVER	1	PCS
	34G1760 SN B	RISER BACK COVER	1	PCS
	37G 551 2	HINGE ASSY(19")	1	PCS
	52G6025 11900	MYLAR FOR STAND HOLDER	2	PCS
	85G 724 1	SHIELD COVER	1	PCS
	M1G 130 5120	SCREW	4	PCS
	M1G 130 6 47	SCREW	2	PCS
	M1G 140 5225	SCREW 4X5MM	8	PCS
	M1G 330 5 47	SCREW	2	PCS
	Q1G 130 5120	SCREW 3*5mm	4	PCS
	Q1G 130 6120	SCREW (T3X6)	1	PCS
	Q1G 130 8 47	SCREW	8	PCS
	Q1G 330 6120	SCREW	2	PCS

T980KSCHBRDGGP

Location	Part No.	Description	Quantity	Unit
	CBPC980KSCDLP	CONVERSION BOARD VER:A00,V4C09	1	PCS
	KEPC980KB9P	KEY BOARD	1	PCS
	PWPC1942SED3P	POWER BOARD VER:A00	1	PCS
	USB780A2P	USB BOARD	1	PCS
	USB980A1P	USB BOARD	1	PCS
	11G6070 1 GP	TIE MOUNTS	1	PCS
	11G6092 1	FIX BUTTON	1	PCS
	12G6212 2	RUBBER PAD	2	PCS
	15G8146 1	KEYSINGTON BRACKET	1	PCS
	15G8271 2	MAIN FRAME-SAM L21	1	PCS
	23G3178700 3A	logo	1	PCS
	26G 800700 6A	S/N LABEL	1	PCS
	33G4885 VH L	BUTTON DELEASE	1	PCS
	33G4940AVI L	BUTTON FUNETION	1	PCS
	34G1755AVH B	BEZEL	1	PCS
	34G1756 SN B	REAR COVER	1	PCS
	34G1757 VH B	REAR VENT LEFT	1	PCS
	34G1758 VH B	REAR VENT RIGHT	1	PCS
	40G 19N700 3A	RATING LABEL	1	PCS
	40G 581700 3A6813	CARTON LABEL	1	PCS
	41G780070043B	QSG FOR WESTP	1	PCS
	41G780070044A	DVI SHEET	1	PCS
	44G3231 12 A	EVA WASHER	2	PCS
	44G3947 1	EPS(L)	1	PCS
	44G3947 2	EPS(R)	1	PCS
	44G3947 3	EPS(M)	1	PCS
	44G3947700 2A	CARTON	1	PCS
	45G 88609 26	EPE BAG FOR BASE	1	PCS
	45G 88609 27	EPE BAG FOR MONITOR	1	PCS
	52G 1185 4	type for dell	104	CM
	52G 1186	SMALL TAPE	8	CM
	52G6020 2DEO	PROTECT FILM	1	PCS
	52G6022 1500	SMALL TAPE	12	CM
	52G6025 11936	MYLAR	1	PCS
	52G6025 11938	MYLAR	1	PCS

	70G1900700 3C	CD MANUAL	1	PCS
	85G 725 1	SHIELD USB	1	PCS
	89G 175 9	USB CABLE	1	PCS
E089B	89G 728GAA 2D	SIGNAL CABLE	1	PCS
E089D	89G174ELAA 1	DVI CABLE	1	PCS
E095	95G8018 30 99	PANEL HARNESS	1	PCS
	M1G 130 4120	SCREW M3X5	5	PCS
	M1G 130 4225	SCREW	4	PCS
	M1G 330 4128	SCREW M3X4	1	PCS
	M1G1730 6128	SCREW M3x6	13	PCS
	M1G1740 6128	SCREW	1	PCS
	M1G1830 5120	SCREW	1	PCS
	M1G2940 10225	SCREW	4	PCS
	Q1G6019 1	SCREW	5	PCS
E750L	750GLS90X2111Z	SEC 19" EX-L21-CL6 PANE	1	PCS
C301	67G215Y2207RV	RUBYCON 50V 22UF	1	PCS
C309	67G215Y2207RV	RUBYCON 50V 22UF	1	PCS
C316	67G215Y2207RV	RUBYCON 50V 22UF	1	PCS
C319	67G215Y2207RV	RUBYCON 50V 22UF	1	PCS
C325	67G215Y2207RV	RUBYCON 50V 22UF	1	PCS
C501	67G215Y2207RV	RUBYCON 50V 22UF	1	PCS
C609	67G215Y2207RV	RUBYCON 50V 22UF	1	PCS
C610	67G215Y2207RV	RUBYCON 50V 22UF	1	PCS
C615	67G215Y2207RV	RUBYCON 50V 22UF	1	PCS
	AIC980KSCDLP	MAIN BOARD	1	PCS
CN403	33G8019 8C	FPC/FFC CONN	1	PCS
CN601	33G8027 12	WAFER 2*6P 2.0MM R/A	1	PCS
CN401	33G8027 14	WAFER 14P 2.0MM DIP DUA	1	PCS
CN501	33G8043 24 H	CONNECTER	1	PCS
	40G 457624 1B	LABEL-CPU	1	PCS
	40G 45762412B	CBPC LABEL	1	PCS
C601	67G215L221 4N	KY25VB220-M-L8*11.5MM	1	PCS
C602	67G215L221 4N	KY25VB220-M-L8*11.5MM	1	PCS
C611	67G215L221 4N	KY25VB220-M-L8*11.5MM	1	PCS
CN202	88G 35315F H	D-SUB 15PIN	1	PCS
CN201	88G 35424F H	DV1 CONNECTOR 24PIN	1	PCS
X301	93G 22 53	CRYSTAL 14.318MHzHC-49U	1	PCS
U402	56G1133 63SD5	PM25LV010-25SCE	1	PCS
	715G1667 1	MAIN BOARD	1	PCS

U401	56G 562 97	GM 5621-LF-AA	1	PCS
U601	56G 563 21	AP1084K33LA	1	PCS
U602	56G 563 31	AI1117D-1.8-EI	1	PCS
U302	56G 643 13	G691L400T73UF SOT-23 GM	1	PCS
U201	56G1133 34	M24C02-WMN6TP	1	PCS
U202	56G1133 34	M24C02-WMN6TP	1	PCS
U403	56G1133 56	M24C16-WMN6TP	1	PCS
Q403	57G 417 12 T	KEC 2N3904S-RTK/PS	1	PCS
Q404	57G 417 12 T	KEC 2N3904S-RTK/PS	1	PCS
Q601	57G 417 12 T	KEC 2N3904S-RTK/PS	1	PCS
Q603	57G 417 12 T	KEC 2N3904S-RTK/PS	1	PCS
Q201	57G 758 1	2N7002ESOT23 SILICONIX	1	PCS
Q602	57G 763 1	A03401 SOT23 BY AOS(A1)	1	PCS
R243	61L0603000	RST SM 0603 JUMP MAX 0R	1	PCS
R331	61L0603000	RST SM 0603 JUMP MAX 0R	1	PCS
R428	61L0603000	RST SM 0603 JUMP MAX 0R	1	PCS
R429	61L0603000	RST SM 0603 JUMP MAX 0R	1	PCS
R606	61L0603000	RST SM 0603 JUMP MAX 0R	1	PCS
R613	61L0603000	RST SM 0603 JUMP MAX 0R	1	PCS
R614	61L0603000	RST SM 0603 JUMP MAX 0R	1	PCS
R202	61L0603100	CHIP 10 OHM 1/10W	1	PCS
R203	61L0603100	CHIP 10 OHM 1/10W	1	PCS
R204	61L0603100	CHIP 10 OHM 1/10W	1	PCS
R205	61L0603100	CHIP 10 OHM 1/10W	1	PCS
R206	61L0603100	CHIP 10 OHM 1/10W	1	PCS
R207	61L0603100	CHIP 10 OHM 1/10W	1	PCS
R208	61L0603100	CHIP 10 OHM 1/10W	1	PCS
R209	61L0603100	CHIP 10 OHM 1/10W	1	PCS
R301	61L0603100	CHIP 10 OHM 1/10W	1	PCS
R215	61L0603101	RST SM 0603 RC0603 100R	1	PCS
R216	61L0603101	RST SM 0603 RC0603 100R	1	PCS
R222	61L0603101	RST SM 0603 RC0603 100R	1	PCS
R224	61L0603101	RST SM 0603 RC0603 100R	1	PCS
R228	61L0603101	RST SM 0603 RC0603 100R	1	PCS
R230	61L0603101	RST SM 0603 RC0603 100R	1	PCS
R232	61L0603101	RST SM 0603 RC0603 100R	1	PCS
R309	61L0603101	RST SM 0603 RC0603 100R	1	PCS
R310	61L0603101	RST SM 0603 RC0603 100R	1	PCS
R311	61L0603101	RST SM 0603 RC0603 100R	1	PCS

R407	61L0603101	RST SM 0603 RC0603 100R	1	PCS
R408	61L0603101	RST SM 0603 RC0603 100R	1	PCS
R602	61L0603102	RST SM 0603 RC0603 1K P	1	PCS
R603	61L0603102	RST SM 0603 RC0603 1K P	1	PCS
R604	61L0603102	RST SM 0603 RC0603 1K P	1	PCS
R201	61L0603103	RST SM 0603 RC0603 10K	1	PCS
R211	61L0603103	RST SM 0603 RC0603 10K	1	PCS
R214	61L0603103	RST SM 0603 RC0603 10K	1	PCS
R322	61L0603103	RST SM 0603 RC0603 10K	1	PCS
R416	61L0603103	RST SM 0603 RC0603 10K	1	PCS
R417	61L0603103	RST SM 0603 RC0603 10K	1	PCS
R418	61L0603103	RST SM 0603 RC0603 10K	1	PCS
R210	61L0603221	RST SM 0603 RC0603 220R	1	PCS
R237	61L0603221	RST SM 0603 RC0603 220R	1	PCS
R238	61L0603221	RST SM 0603 RC0603 220R	1	PCS
R239	61L0603221	RST SM 0603 RC0603 220R	1	PCS
R411	61L0603221	RST SM 0603 RC0603 220R	1	PCS
R412	61L0603221	RST SM 0603 RC0603 220R	1	PCS
R413	61L0603221	RST SM 0603 RC0603 220R	1	PCS
R414	61L0603221	RST SM 0603 RC0603 220R	1	PCS
R415	61L0603221	RST SM 0603 RC0603 220R	1	PCS
R240	61L0603222	RST SM 0603 RC0603 2K2	1	PCS
R241	61L0603222	RST SM 0603 RC0603 2K2	1	PCS
R217	61L0603223	CHIPR 22K OHM +-5% 1/10	1	PCS
R420	61L0603223	CHIPR 22K OHM +-5% 1/10	1	PCS
R421	61L0603223	CHIPR 22K OHM +-5% 1/10	1	PCS
R302	61L0603249 0F	CHIP 249OHM 1/16W 1%	1	PCS
R419	61L0603303	CHIP 30K OHM 5% 1/10W	1	PCS
R422	61L0603303	CHIP 30K OHM 5% 1/10W	1	PCS
R218	61L0603333	CHIP 33K OHM 1/10W	1	PCS
R212	61L0603472	RST SM 0603 RC0603 4K7	1	PCS
R213	61L0603472	RST SM 0603 RC0603 4K7	1	PCS
R226	61L0603472	RST SM 0603 RC0603 4K7	1	PCS
R227	61L0603472	RST SM 0603 RC0603 4K7	1	PCS
R242	61L0603472	RST SM 0603 RC0603 4K7	1	PCS
R305	61L0603472	RST SM 0603 RC0603 4K7	1	PCS
R306	61L0603472	RST SM 0603 RC0603 4K7	1	PCS
R307	61L0603472	RST SM 0603 RC0603 4K7	1	PCS
R308	61L0603472	RST SM 0603 RC0603 4K7	1	PCS

R315	61L0603472	RST SM 0603 RC0603 4K7	1	PCS
R316	61L0603472	RST SM 0603 RC0603 4K7	1	PCS
R317	61L0603472	RST SM 0603 RC0603 4K7	1	PCS
R318	61L0603472	RST SM 0603 RC0603 4K7	1	PCS
R323	61L0603472	RST SM 0603 RC0603 4K7	1	PCS
R324	61L0603472	RST SM 0603 RC0603 4K7	1	PCS
R409	61L0603472	RST SM 0603 RC0603 4K7	1	PCS
R410	61L0603472	RST SM 0603 RC0603 4K7	1	PCS
R424	61L0603472	RST SM 0603 RC0603 4K7	1	PCS
R430	61L0603472	RST SM 0603 RC0603 4K7	1	PCS
R431	61L0603472	RST SM 0603 RC0603 4K7	1	PCS
R501	61L0603472	RST SM 0603 RC0603 4K7	1	PCS
R601	61L0603472	RST SM 0603 RC0603 4K7	1	PCS
R605	61L0603473	RST SM 0603 RC0603 47K	1	PCS
R608	61L0603473	RST SM 0603 RC0603 47K	1	PCS
R609	61L0603473	RST SM 0603 RC0603 47K	1	PCS
R220	61L0603750 9F	75OHM 1% 1/10W	1	PCS
R223	61L0603750 9F	75OHM 1% 1/10W	1	PCS
R229	61L0603750 9F	75OHM 1% 1/10W	1	PCS
R233	61L0603750 9F	75OHM 1% 1/10W	1	PCS
R234	61L0603750 9F	75OHM 1% 1/10W	1	PCS
R235	61L0603750 9F	75OHM 1% 1/10W	1	PCS
C201	65G0603102 32	1000PF +-10% 50V X7R	1	PCS
C404	65G0603102 32	1000PF +-10% 50V X7R	1	PCS
C405	65G0603102 32	1000PF +-10% 50V X7R	1	PCS
C406	65G0603102 32	1000PF +-10% 50V X7R	1	PCS
C407	65G0603102 32	1000PF +-10% 50V X7R	1	PCS
C210	65G0603103 32	0.01UF +-10% 50V X7R	1	PCS
C211	65G0603103 32	0.01UF +-10% 50V X7R	1	PCS
C212	65G0603103 32	0.01UF +-10% 50V X7R	1	PCS
C213	65G0603103 32	0.01UF +-10% 50V X7R	1	PCS
C215	65G0603103 32	0.01UF +-10% 50V X7R	1	PCS
C216	65G0603103 32	0.01UF +-10% 50V X7R	1	PCS
C209	65G0603104 12	CER2 0603 X7R 16V 100N	1	PCS
C214	65G0603104 12	CER2 0603 X7R 16V 100N	1	PCS
C219	65G0603104 12	CER2 0603 X7R 16V 100N	1	PCS
C220	65G0603104 12	CER2 0603 X7R 16V 100N	1	PCS
C221	65G0603104 12	CER2 0603 X7R 16V 100N	1	PCS
C222	65G0603104 12	CER2 0603 X7R 16V 100N	1	PCS

C302	65G0603104 12	CER2 0603 X7R 16V 100N	1	PCS
C303	65G0603104 12	CER2 0603 X7R 16V 100N	1	PCS
C304	65G0603104 12	CER2 0603 X7R 16V 100N	1	PCS
C305	65G0603104 12	CER2 0603 X7R 16V 100N	1	PCS
C306	65G0603104 12	CER2 0603 X7R 16V 100N	1	PCS
C307	65G0603104 12	CER2 0603 X7R 16V 100N	1	PCS
C308	65G0603104 12	CER2 0603 X7R 16V 100N	1	PCS
C310	65G0603104 12	CER2 0603 X7R 16V 100N	1	PCS
C311	65G0603104 12	CER2 0603 X7R 16V 100N	1	PCS
C312	65G0603104 12	CER2 0603 X7R 16V 100N	1	PCS
C313	65G0603104 12	CER2 0603 X7R 16V 100N	1	PCS
C314	65G0603104 12	CER2 0603 X7R 16V 100N	1	PCS
C317	65G0603104 12	CER2 0603 X7R 16V 100N	1	PCS
C318	65G0603104 12	CER2 0603 X7R 16V 100N	1	PCS
C320	65G0603104 12	CER2 0603 X7R 16V 100N	1	PCS
C321	65G0603104 12	CER2 0603 X7R 16V 100N	1	PCS
C322	65G0603104 12	CER2 0603 X7R 16V 100N	1	PCS
C323	65G0603104 12	CER2 0603 X7R 16V 100N	1	PCS
C324	65G0603104 12	CER2 0603 X7R 16V 100N	1	PCS
C326	65G0603104 12	CER2 0603 X7R 16V 100N	1	PCS
C330	65G0603104 12	CER2 0603 X7R 16V 100N	1	PCS
C332	65G0603104 12	CER2 0603 X7R 16V 100N	1	PCS
C333	65G0603104 12	CER2 0603 X7R 16V 100N	1	PCS
C401	65G0603104 12	CER2 0603 X7R 16V 100N	1	PCS
C408	65G0603104 12	CER2 0603 X7R 16V 100N	1	PCS
C502	65G0603104 12	CER2 0603 X7R 16V 100N	1	PCS
C603	65G0603104 12	CER2 0603 X7R 16V 100N	1	PCS
C604	65G0603104 12	CER2 0603 X7R 16V 100N	1	PCS
C608	65G0603104 12	CER2 0603 X7R 16V 100N	1	PCS
C612	65G0603104 12	CER2 0603 X7R 16V 100N	1	PCS
C613	65G0603104 12	CER2 0603 X7R 16V 100N	1	PCS
C614	65G0603104 12	CER2 0603 X7R 16V 100N	1	PCS
C217	65G0603220 31	CER1 0603 NP0 50V 22P P	1	PCS
C218	65G0603220 31	CER1 0603 NP0 50V 22P P	1	PCS
C331	65G0603224 12	CHIP 0.22UF +-10% 16V X	1	PCS
C618	65G0603224 17	CAP:CER 0.22UF-20%-80%	1	PCS
C327	65G0603330 31	CER1 0603 NP0 50V 33P P	1	PCS
C328	65G0603330 31	CER1 0603 NP0 50V 33P P	1	PCS
L301	71G 56K121	CHIP BEAD	1	PCS

L302	71G 56K121	CHIP BEAD	1	PCS
L303	71G 56K121	CHIP BEAD	1	PCS
L304	71G 56K121	CHIP BEAD	1	PCS
L305	71G 56K121	CHIP BEAD	1	PCS
L306	71G 56K121	CHIP BEAD	1	PCS
L307	71G 56K121	CHIP BEAD	1	PCS
FB204	71G 59B431	BK1608 HW 431	1	PCS
FB201	71G 59C600	CHIP BEAD	1	PCS
FB202	71G 59C600	CHIP BEAD	1	PCS
FB203	71G 59C600	CHIP BEAD	1	PCS
D201	93G 64 33	DIO SIG SM BAV99 (PHSE)	1	PCS
D202	93G 64 33	DIO SIG SM BAV99 (PHSE)	1	PCS
D203	93G 64 33	DIO SIG SM BAV99 (PHSE)	1	PCS
D204	93G 64 33	DIO SIG SM BAV99 (PHSE)	1	PCS
D205	93G 64 33	DIO SIG SM BAV99 (PHSE)	1	PCS
D206	93G 64 33	DIO SIG SM BAV99 (PHSE)	1	PCS
D207	93G 64 33	DIO SIG SM BAV99 (PHSE)	1	PCS
D208	93G 64 33	DIO SIG SM BAV99 (PHSE)	1	PCS
D211	93G 64 33	DIO SIG SM BAV99 (PHSE)	1	PCS
D212	93G 64 33	DIO SIG SM BAV99 (PHSE)	1	PCS
D213	93G 64 33	DIO SIG SM BAV99 (PHSE)	1	PCS
D209	93G 64 42 P	BAV70 SOT-23	1	PCS
D210	93G 64 42 P	BAV70 SOT-23	1	PCS
ZD201	93G 39S 34 T	UDZS5.6B	1	PCS
ZD202	93G 39S 34 T	UDZS5.6B	1	PCS
ZD203	93G 39S 34 T	UDZS5.6B	1	PCS
ZD204	93G 39S 34 T	UDZS5.6B	1	PCS
ZD207	93G 39S 34 T	UDZS5.6B	1	PCS
ZD208	93G 39S 34 T	UDZS5.6B	1	PCS
ZD209	93G 39S 34 T	UDZS5.6B	1	PCS
ZD210	93G 39S 34 T	UDZS5.6B	1	PCS
ZD211	93G 39S 34 T	UDZS5.6B	1	PCS
ZD212	93G 39S 34 T	UDZS5.6B	1	PCS
ZD301	93G 39S 34 T	UDZS5.6B	1	PCS
	AIK980KB9SMTP	KEY BOARD	1	PCS
CN1	89G176S 8 10	FPC/FFC SMT R/A	1.02	PCS
C01	65G0603104 12	CER2 0603 X7R 16V 100N	1	PCS
C02	65G0603104 12	CER2 0603 X7R 16V 100N	1	PCS
SW01	77G 605 1 AL GP	SMD SWITCH	1	PCS

SW02	77G 605 1 AL GP	SMD SWITCH	1	PCS
SW03	77G 605 1 AL GP	SMD SWITCH	1	PCS
SW04	77G 605 1 AL GP	SMD SWITCH	1	PCS
SW05	77G 605 1 AL GP	SMD SWITCH	1	PCS
LED01	81G 14501 KT	CHIP LED	1	PCS
ZD01	93G 39S 34 T	UDZS5.6B	1	PCS
ZD02	93G 39S 34 T	UDZS5.6B	1	PCS
ZD03	93G 39S 34 T	UDZS5.6B	1	PCS
ZD04	93G 39S 34 T	UDZS5.6B	1	PCS
ZD05	93G 39S 34 T	UDZS5.6B	1	PCS
ZD06	93G 39S 34 T	UDZS5.6B	1	PCS
ZD07	93G 39S 34 T	UDZS5.6B	1	PCS
	715G1673 1	KEY BOARD	1	PCS
D901	93G1020 752T	UF4003	1	PCS
	PW1942SED3SMTP	POWER BOARD FOR SMT	1	PCS
CN801	33G8021 2D AC	CONN.2P R/A 87210-0236	1	PCS
CN802	33G8021 2D AC	CONN.2P R/A 87210-0236	1	PCS
CN803	33G8021 2D AC	CONN.2P R/A 87210-0236	1	PCS
CN804	33G8021 2D AC	CONN.2P R/A 87210-0236	1	PCS
	40G 45762420A	ID LABEL	1.003	PCS
IC902	56G 139 3A	PC123Y22FZOF	1	PCS
NR901	61G 58080 WT	8 OHM NCT	1	PCS
C816	65G 3J1206ET	12PF 5% SL 3KV TDK	1	PCS
C825	65G 3J1206ET	12PF 5% SL 3KV TDK	1	PCS
C817	65G 3J5096ET	5PF 5% SL 3KV	1	PCS
C826	65G 3J5096ET	5PF 5% SL 3KV	1	PCS
C901	65G305M2222EM	2200PF+-20% 250VAC/400V	1	PCS
C902	65G305M2222EM	2200PF+-20% 250VAC/400V	1	PCS
C932	65G306M4722BM GP	4700PF +-20% 400VAC	1	PCS
C903	67G215L10115N	EC CAP 105 100UF 450V	1	PCS
C922	67G215L102 4N	KY25VB1000M-L 12.5*20	1	PCS
C923	67G215L102 4N	KY25VB1000M-L 12.5*20	1	PCS
C924	67G215L102 4N	KY25VB1000M-L 12.5*20	1	PCS
C811	67G215L471 4N	KY25VB470M-L10*16	1	PCS
C820	67G215L471 4N	KY25VB470M-L10*16	1	PCS
C925	67G215L471 4N	KY25VB470M-L10*16	1	PCS
C926	67G215L471 4N	KY25VB470M-L10*16	1	PCS
C935	67G215L471 4N	KY25VB470M-L10*16	1	PCS
L901	73G 174 76 L	CHOKE COIL LI TAI LF-00	1	PCS

L902	73G 174 77 L	LINE FILTER	1	PCS
L921	73G 253 91 LS	CHOKE BY LI SHIN	1	PCS
L922	73G 253 91 LS	CHOKE BY LI SHIN	1	PCS
T901	80GL17T 32 L	ADAPTOR BY LITAI	1	PCS
PT801	80GL19T 8 DN	OZ9RR_TRANS	1	PCS
PT802	80GL19T 8 DN	OZ9RR_TRANS	1	PCS
CN901	87G 501 32 S	AC SOCKET	1	PCS
CN903	88G 304 8K C	DC JACK	1	PCS
CN902	95G8013 12 13	WIRE HARNESS	1	PCS
	705G 780 61 26	R909 ASS'Y	1	PCS
	705G 780 61 27	R916 ASS'Y	1	PCS
	705G 780 93 26	D921/IC922 ASS'Y	1	PCS
	705G 780 93 27	D920 ASS'Y	1	PCS
	705G 780 93 28	DB901/Q900 ASS'Y	1	PCS
R826	61L0805152	CHIPR 1.5K OHM +-5% 1/8	1	PCS
R839	61L1206220	CHIP 220OHM 5% 8W	1	PCS
R840	61L1206220	CHIP 220OHM 5% 8W	1	PCS
C814	65G0805152 31	1.5N/50V	1	PCS
C815	65G0805152 31	1.5N/50V	1	PCS
	PW1942LGD3AIP	POWER BOARD FOR AI	1	PCS
IC901	56G 379 52	LD7552BS	1	PCS
IC801	56G 608 10	0Z9938	1	PCS
Q801	57G 417 12 T	KEC 2N3904S-RTK/PS	1	PCS
Q802	57G 417 12 T	KEC 2N3904S-RTK/PS	1	PCS
Q803	57G 417 12 T	KEC 2N3904S-RTK/PS	1	PCS
Q805	57G 763 14	AM9945N	1	PCS
Q806	57G 763 14	AM9945N	1	PCS
RJ807	61L0805000	CHIP O OHM 1/8W	1	PCS
R837	61L0805100	CHIPR 10 OHM+-5% 1/8W	1	PCS
R842	61L0805100	CHIPR 10 OHM+-5% 1/8W	1	PCS
R917	61L0805101	CHIPR 100 OHM +-5% 1/8W	1	PCS
R836	61L0805102	CHIPR 1K OHM +-5% 1/8W	1	PCS
R843	61L0805102	CHIPR 1K OHM +-5% 1/8W	1	PCS
R925	61L0805102	CHIPR 1K OHM +-5% 1/8W	1	PCS
R927	61L0805102	CHIPR 1K OHM +-5% 1/8W	1	PCS
R803	61L0805103	CHIPR 10K OHM +-5% 1/8W	1	PCS
R804	61L0805103	CHIPR 10K OHM +-5% 1/8W	1	PCS
R812	61L0805103	CHIPR 10K OHM +-5% 1/8W	1	PCS
R914	61L0805103	CHIPR 10K OHM +-5% 1/8W	1	PCS

R915	61L0805103	CHIPR 10K OHM +-5% 1/8W	1	PCS
R810	61L0805104	CHIPR 100K OHM+-5% 1/8W	1	PCS
R815	61L0805104	CHIPR 100K OHM+-5% 1/8W	1	PCS
R821	61L0805104	CHIPR 100K OHM+-5% 1/8W	1	PCS
R831	61L0805104	CHIPR 100K OHM+-5% 1/8W	1	PCS
R911	61L0805104	CHIPR 100K OHM+-5% 1/8W	1	PCS
R919	61L0805104	CHIPR 100K OHM+-5% 1/8W	1	PCS
R809	61L0805105	CHIP 1M OHM 5% 1/8W	1	PCS
R813	61L0805105	CHIP 1M OHM 5% 1/8W	1	PCS
R828	61L0805150	15 0805	1	PCS
R829	61L0805150	15 0805	1	PCS
R820	61L0805153	CHIPR 15K OHM+-5% 1/8W	1	PCS
R830	61L0805153	CHIPR 15K OHM+-5% 1/8W	1	PCS
R811	61L0805154	CHIP 150KOHM 5% 1/8W	1	PCS
R816	61L0805155	CHIP 1.5M OHM 5% 1/8W	1	PCS
R807	61L0805220	CHIP 22 OHM 5% 0805 1/8	1	PCS
R841	61L0805221	CHIPR 220 OHM +-5% 1/8W	1	PCS
R929	61L0805240 1F	CHIPR 2.4KOHM +-1% 1/8W	1	PCS
R802	61L0805304	300K OM 1/8W	1	PCS
R926	61L0805330 2F	CHIP 33KOHM 1/8W 1%	1	PCS
R924	61L0805360 1F	CHIP 3.6KOHM 1/8W 1%	1	PCS
R817	61L0805393	SMD 39KOHM/0805/+5% 1/	1	PCS
R825	61L0805561	CHIP 560 OHM 1/8W	1	PCS
R835	61L0805561	CHIP 560 OHM 1/8W	1	PCS
R827	61L0805562	CHIP 5.6K OHM 1/8W	1	PCS
R834	61L0805562	CHIP 5.6K OHM 1/8W	1	PCS
R814	61L0805563	CHIP 56K OHM 1/8W	1	PCS
R823	61L0805753	75K 1/8W	1	PCS
R833	61L0805753	75K 1/8W	1	PCS
R918	61L0805753	75K 1/8W	1	PCS
F902	61L1206000	RST SM 1206 JUMP MAX 0R	1	PCS
R801	61L1206000	RST SM 1206 JUMP MAX 0R	1	PCS
RJ801	61L1206000	RST SM 1206 JUMP MAX 0R	1	PCS
RJ802	61L1206000	RST SM 1206 JUMP MAX 0R	1	PCS
RJ803	61L1206000	RST SM 1206 JUMP MAX 0R	1	PCS
RJ804	61L1206000	RST SM 1206 JUMP MAX 0R	1	PCS
RJ805	61L1206000	RST SM 1206 JUMP MAX 0R	1	PCS
RJ808	61L1206000	RST SM 1206 JUMP MAX 0R	1	PCS
R818	61L1206150	CHIP 15 OHM 5% 1206 1/4	1	PCS

R819	61L1206150	CHIP 15 OHM 5% 1206 1/4	1	PCS
R910	61L1206229	CHIP 2.2OHM 5% 1/8W	1	PCS
R900	61L1206334	330K 1/4W	1	PCS
R901	61L1206334	330K 1/4W	1	PCS
R902	61L1206334	330K 1/4W	1	PCS
R903	61L1206434	430K 1206 1/4W 5%	1	PCS
R904	61L1206434	430K 1206 1/4W 5%	1	PCS
R905	61L1206434	430K 1206 1/4W 5%	1	PCS
R805	61L1206471	CHIPR 470 OHM+-5% 1/4W	1	PCS
R808	61L1206474	470K OHM 5% 1/4W	1	PCS
R906	61L1206514	CHIPR 510KOHM +-5% 1/4W	1	PCS
R907	61L1206514	CHIPR 510KOHM +-5% 1/4W	1	PCS
R908	61L1206514	CHIPR 510KOHM +-5% 1/4W	1	PCS
C805	65G0805102 32	CHIP 1000P 50VX7R 0805	1	PCS
C803	65G0805103 32	10NF/50V/0805/X7R	1	PCS
C807	65G0805103 32	10NF/50V/0805/X7R	1	PCS
C908	65G0805104 22	0.1UF +-10% 25V X7R 080	1	PCS
C905	65G0805104 32	CHIP 0.1U 50V X7R	1	PCS
C927	65G0805104 32	CHIP 0.1U 50V X7R	1	PCS
C930	65G0805104 32	CHIP 0.1U 50V X7R	1	PCS
C936	65G0805104 32	CHIP 0.1U 50V X7R	1	PCS
C937	65G0805104 32	CHIP 0.1U 50V X7R	1	PCS
C938	65G0805104 32	CHIP 0.1U 50V X7R	1	PCS
C806	65G0805105 22	CHIP 1UF 25V X7R 0805	1	PCS
C812	65G0805152 22	CHIP 0.005UF 25V X7R 08	1	PCS
C813	65G0805152 22	CHIP 0.005UF 25V X7R 08	1	PCS
C822	65G0805152 22	CHIP 0.005UF 25V X7R 08	1	PCS
C823	65G0805152 22	CHIP 0.005UF 25V X7R 08	1	PCS
C907	65G0805221 32	CHIP 220PF 50V X7R 0805	1	PCS
C934	65G0805223 22	CHIP 0.022UF 25V X7R 08	1	PCS
C804	65G0805225 12	CHIP 2.2UF 15V X7R 0805	1	PCS
C810	65G0805471 31	CHIP 470PF 50V NPO	1	PCS
C818	65G0805471 31	CHIP 470PF 50V NPO	1	PCS
C827	65G0805471 31	CHIP 470PF 50V NPO	1	PCS
C809	65G0805473 32	CHIP 0.047UF 50V X7R	1	PCS
C819	65G0805473 32	CHIP 0.047UF 50V X7R	1	PCS
C808	65G0805682 32	CHIP 6.8UF 50V X7R 0805	1	PCS
FB901	71G 57G301 EA	CHIP BEAD	1	PCS
D802	93G 64 33	DIO SIG SM BAV99 (PHSE)	1	PCS

D804	93G 64 33	DIO SIG SM BAV99 (PHSE)	1	PCS
D801	93G 64 42 PP	BAV70 SOT-23	1	PCS
D803	93G 64 42 PP	BAV70 SOT-23	1	PCS
D922	93G 6432S	IN4148W	1	PCS
D923	93G 6432S	IN4148W	1	PCS
ZD801	93G 39S 24 T	RLZ 5.6B LLDS	1	PCS
ZD922	93G 39S 25 T	RLZ5.1B LLDS	1	PCS
ZD920	93G 39S 38 T	PTZ 9.1B	1	PCS
ZD921	93G 39S 40 T	RLZ 13B LLDS	1	PCS
C903	6G 31502	1.5MM RIVET	2	PCS
L902	6G 31502	1.5MM RIVET	4	PCS
NR901	6G 31502	1.5MM RIVET	2	PCS
PT801	6G 31502	1.5MM RIVET	2	PCS
PT802	6G 31502	1.5MM RIVET	2	PCS
T901	6G 31502	1.5MM RIVET	6	PCS
IC903	56G 158 10 T	AZ431AZ-AE1	1	PCS
IC921	56G 158 10 T	AZ431AZ-AE1	1	PCS
Q921	57G 419501 T	KTC945P	1	PCS
Q922	57G 760 8 T	KRC102M-ATP	1	PCS
R912	61G 17210052T	100HM 5% 1/4W	1	PCS
R913	61G 17210252T	1K OHM 5% 1/4W	1	PCS
R922	61G 17222152T GP	220 OHM 5% 1/4W	1	PCS
R928	61G 17239252T	3.9KOHM 5% 1/4W	1	PCS
R930	61G 60210252T	CFR 1K OHM +-5% 1/6W	1	PCS
R931	61G 60247252T	4.7K OHM 5% 1/6W	1	PCS
R920	61G175L47052T	47OHM +-5% 1/2W	1	PCS
R921	61G175L47052T	47OHM +-5% 1/2W	1	PCS
R822	61G212Y625 KT	MGFR 6.2MOHM +-5% 1/2W	1	PCS
R832	61G212Y625 KT	MGFR 6.2MOHM +-5% 1/2W	1	PCS
C904	65G 1K152 1T	1.5NF/1KV Z5F+-10%	1	PCS
C931	65G 450104 4T	0.1UF Z5V 50V	1	PCS
C920	65G517K102 5T	1000PF 10% Y5P 500V	1	PCS
C921	65G517K102 5T	1000PF 10% Y5P 500V	1	PCS
C906	67G 2152207NT	KY50VB22M-TP5 5*11	1	PCS
F901	84G 56 1	FUSE 2A 250V WICKMANN	1	PCS
D900	93G1100 1052T	BA159G	1	PCS
	715G1775 1	PCB	1	PCS
	34FPE19P03	CASE EEL19	1	PCS
R909	61G152M10458F	100K OHM 5% 2W	1	PCS

	96G 29 6	SHRINK TUBE UL/CSA	1	PCS
R916	61G152M30858F	0.3 OHM 5% 2W	1	PCS
	96G 29 6	SHRINK TUBE UL/CSA	1	PCS
IC922	56G 563 37	KA278R12CTU TO-220F-4L	1	PCS
	90G6263 1	HEAT SINK	1	PCS
D921	93G1506 2	FMW-2156	1	PCS
	M1G1730 8128	SCREW M3x8	2	PCS
D920	93G 60258	FME-220B	1	PCS
	M1G1730 10128	SCREW M3x10	1	PCS
Q900	57G 667 21	STP10NK70ZFP	1	PCS
DB901	93G 50460506	D3SB60	1	PCS
	M1G1730 10128	SCREW M3x10	2	PCS
	33F206H24JWT0	A2006H00-2*12PHK	1	PCS
	33F206T2JWTOP	A2006TOP-2	23	PCS
	33F303SM24K30	PK2407P30/TD00-30LH	1	PCS
	33F303TTD1	TD00-T	23	PCS
	71F 100510 HS	FERRITE CORE	1	PCS
	USB780A2SMTP	USB BOARD FOR SMT	1	PCS
CN702	33G8027 10 H	WAFER 2*5P 2.0MM	1	PCS
C705	67G215L101 4N	KY25VB100M-L 6.3*11	1	PCS
C706	67G215L101 4N	KY25VB100M-L 6.3*11	1	PCS
C707	67G215L101 4N	KY25VB100M-L 6.3*11	1	PCS
C708	67G215L101 4N	KY25VB100M-L 6.3*11	1	PCS
C725	67G215L221 4N	KY25VB220-M-L8*11.5MM	1	PCS
C742	67G215L221 4N	KY25VB220-M-L8*11.5MM	1	PCS
C734	67G215L470 4N	KY25VB47M-L 5*11	1	PCS
C728	67G215Y100 7N	KY50VB10M-L 5*11	1	PCS
L701	73G 253127 L	CC-010730	1	PCS
CN704	88G 350 1 TN	USB CONN	1	PCS
CN703	88G 351 2B CL	USB CONN	1	PCS
X701	93G 22 45 J	24MHZ/30PF/49US	1	PCS
CN701	95G8014 14 33	USB HARNESS 5P	1	PCS
	715G1666 1	USB BOARD	1	PCS
U702	56G 563 57	AP1510SA	1	PCS
U703	56G 585 4	AIC1117-33CY	1	PCS
U701	56G 659 2	IC USB CTRL USB2504 TQF	1	PCS
F701	61G 56075 WT	PTC KMC 5S075R001-0.75M	1	PCS
F702	61G 56075 WT	PTC KMC 5S075R001-0.75M	1	PCS
F703	61G 56075 WT	PTC KMC 5S075R001-0.75M	1	PCS

F704	61G 56075 WT	PTC KMC 5S075R001-0.75M	1	PCS
R740	61L0603000	RST SM 0603 JUMP MAX 0R	1	PCS
R741	61L0603000	RST SM 0603 JUMP MAX 0R	1	PCS
R704	61L0603103	RST SM 0603 RC0603 10K	1	PCS
R706	61L0603103	RST SM 0603 RC0603 10K	1	PCS
R707	61L0603103	RST SM 0603 RC0603 10K	1	PCS
R710	61L0603103	RST SM 0603 RC0603 10K	1	PCS
R712	61L0603103	RST SM 0603 RC0603 10K	1	PCS
R714	61L0603103	RST SM 0603 RC0603 10K	1	PCS
R716	61L0603103	RST SM 0603 RC0603 10K	1	PCS
R745	61L0603103	RST SM 0603 RC0603 10K	1	PCS
R747	61L0603103	RST SM 0603 RC0603 10K	1	PCS
R749	61L0603103	RST SM 0603 RC0603 10K	1	PCS
R755	61L0603103	RST SM 0603 RC0603 10K	1	PCS
R701	61L0603104	RST SM 0603 RC0603 100K	1	PCS
R702	61L0603104	RST SM 0603 RC0603 100K	1	PCS
R703	61L0603104	RST SM 0603 RC0603 100K	1	PCS
R708	61L0603105	RST SM 0603 RC0603 1M P	1	PCS
R709	61L0603113 2F	CHIPR 11.3 KOHM +-1% 1/	1	PCS
R753	61L0603123	CHIP 12K OHM 1/10W	1	PCS
R711	61L0603153	CHIPR 15KOHM+-5% 1/10W	1	PCS
R713	61L0603153	CHIPR 15KOHM+-5% 1/10W	1	PCS
R715	61L0603153	CHIPR 15KOHM+-5% 1/10W	1	PCS
R717	61L0603153	CHIPR 15KOHM+-5% 1/10W	1	PCS
R746	61L0603221	RST SM 0603 RC0603 220R	1	PCS
R754	61L0603222	RST SM 0603 RC0603 2K2	1	PCS
R750	61L0603362	CHIP 3.6K OHM 1/10W	1	PCS
R705	61L0603391	CHIP 390 OHM 1/10W	1	PCS
C709	65G0603103 32	0.01UF +-10% 50V X7R	1	PCS
C710	65G0603103 32	0.01UF +-10% 50V X7R	1	PCS
C711	65G0603103 32	0.01UF +-10% 50V X7R	1	PCS
C713	65G0603103 32	0.01UF +-10% 50V X7R	1	PCS
C715	65G0603103 32	0.01UF +-10% 50V X7R	1	PCS
C716	65G0603103 32	0.01UF +-10% 50V X7R	1	PCS
C717	65G0603103 32	0.01UF +-10% 50V X7R	1	PCS
C718	65G0603103 32	0.01UF +-10% 50V X7R	1	PCS
C719	65G0603103 32	0.01UF +-10% 50V X7R	1	PCS
C731	65G0603103 32	0.01UF +-10% 50V X7R	1	PCS
C701	65G0603104 12	CER2 0603 X7R 16V 100N	1	PCS

C702	65G0603104 12	CER2 0603 X7R 16V 100N	1	PCS
C721	65G0603104 12	CER2 0603 X7R 16V 100N	1	PCS
C722	65G0603104 12	CER2 0603 X7R 16V 100N	1	PCS
C723	65G0603104 12	CER2 0603 X7R 16V 100N	1	PCS
C724	65G0603104 12	CER2 0603 X7R 16V 100N	1	PCS
C727	65G0603104 12	CER2 0603 X7R 16V 100N	1	PCS
C733	65G0603104 12	CER2 0603 X7R 16V 100N	1	PCS
C736	65G0603104 12	CER2 0603 X7R 16V 100N	1	PCS
C741	65G0603104 12	CER2 0603 X7R 16V 100N	1	PCS
C703	65G0603220 31	CER1 0603 NP0 50V 22P P	1	PCS
C704	65G0603220 31	CER1 0603 NP0 50V 22P P	1	PCS
C712	65G0805475 A5	0805 4.7UF +-10% 10V X5	1	PCS
C714	65G0805475 A5	0805 4.7UF +-10% 10V X5	1	PCS
C720	65G0805475 A5	0805 4.7UF +-10% 10V X5	1	PCS
FB701	71G 56K121	CHIP BEAD	1	PCS
FB702	71G 56K121	CHIP BEAD	1	PCS
FB703	71G 56K121	CHIP BEAD	1	PCS
FB704	71G 56K121	CHIP BEAD	1	PCS
FB705	71G 56K121	CHIP BEAD	1	PCS
FB707	71G 56K121	CHIP BEAD	1	PCS
FB706	71G 56Z601	CHIP BEAD 600 OHM 0805	1	PCS
L702	73G253S 1 B	CHOKE COIL	1	PCS
L703	73G253S 1 B	CHOKE COIL	1	PCS
L704	73G253S 1 B	CHOKE COIL	1	PCS
L705	73G253S 1 B	CHOKE COIL	1	PCS
L706	73G253S 1 B	CHOKE COIL	1	PCS
ZD701	93G 64 49 SU	EGA10603 V05	1	PCS
ZD702	93G 64 49 SU	EGA10603 V05	1	PCS
ZD703	93G 64 49 SU	EGA10603 V05	1	PCS
ZD704	93G 64 49 SU	EGA10603 V05	1	PCS
ZD705	93G 64 49 SU	EGA10603 V05	1	PCS
ZD706	93G 64 49 SU	EGA10603 V05	1	PCS
ZD707	93G 64 49 SU	EGA10603 V05	1	PCS
ZD708	93G 64 49 SU	EGA10603 V05	1	PCS
ZD709	93G 64 49 SU	EGA10603 V05	1	PCS
ZD710	93G 64 49 SU	EGA10603 V05	1	PCS
D701	93G5004 1	SR54 T0-214AA	1	PCS
	715G1665 1 2	PCB	1	PCS
C732	65G601M104 7T	0.1UF +-20% 50V Y5V	1	PCS

C733	65G601M104 7T	0.1UF +-20% 50V Y5V	1	PCS
CN705	88G 352 2 CL	USB COW	1	PCS
CN706	88G 352 2 CL	USB COW	1	PCS
CN707	95G8014 10 30	WAFER 10P RIGHT ANGLE P	1	PCS
	19G 588 3	SPRING HOLDER	2	PCS
	85G 724 1 B	SHIELD COVER	1	PCS
	12G6201 1	L TYPE RUBBER	6	PCS
	12G6202 1	V TYPE RUBBER	2	PCS
	15G8185 1	HOLDER BRACKET R	1	PCS
	15G8186 1	HOLDER BRACKET L	1	PCS
	15G8272 1	VESA BRACKT	1	PCS
	20G 027 2 B	STAND HOLDER	1	PCS
	20G 039 1	BASE DIE CAST	1	PCS
	33G4946 VH L	RISER COVER BTM	1	PCS
	33G4947 VH L	RISER ARM COVER	1	PCS
	33G4948 SN L	HINGE LUCK BUUTON	1	PCS
	33G5012 SN B	TILP COVER	1	PCS
	34G1742 SN B	VESA COVER	1	PCS
	34G1748 VH B	BASE	1	PCS
	34G1749 SN B	BASE COVER	1	PCS
	34G1759 SN B	RISER-FRONT-COVER	1	PCS
	34G1760 SN B	RISER BACK COVER	1	PCS
	34G1761 VH B	RISER COVER TOP	1	PCS
	37G 551 2	HINGE ASSY(19")	1	PCS
		MYLAR FOR STAND		
	52G6025 11900	HOLDER	2	PCS
	M1G 130 5120	SCREW	4	PCS
	M1G 130 6 47	SCREW	2	PCS
	M1G 140 5225	SCREW 4X5MM	8	PCS
	Q1G 130 5120	SCREW 3*5mm	4	PCS
	Q1G 130 6120	SCREW (T3X6)	1	PCS
	Q1G 130 8 47	SCREW	8	PCS
	Q1G 330 6120	SCREW	2	PCS

15. Definition Of Pixel Defects

Type 1. 750GLG90E3T21Z D LM190E03-TLB2

Dot Defect

Bright Dot

Dots(sub-pixels) which appeared brightly in the screen when the LCM displayed with dark pattern.

- R,G or B 1 dot -----	0 Max
- Adjacent 2 dots -----	0 Max
- Total amount of Bright dots -----	0 Max
- Minimum distance of Bright dots -----	NA

Dark Dot

Dots(sub-pixels) which appeared darkly in the screen when the LCM displayed with bright pattern.

- 1 dot -----	4 Max
- Adjacent 2 dots -----	2 Max
- Total amount of Dark dot -----	4 Max
- Minimum distance of Dark dots -----	15mm

Total amount of Dot Defects -----5 Max(Combination)

- Note) a. Every dot herein means Sub-Pixel.(Each Red, Green, or Blue Color)
 b. Bright dot
 - Red or Blue dots damaged less than half size of sub-pixel are not defined as dot defects.
 - Green dots damaged less than one third size of sub-pixel are not defined as dot defects.
 c. Dark dot smaller than half size of sub-pixel is not counted as a dot defect.

Polarizer Defects

Items		Criteria
Scratches	Linear	$0.01 \leq W \leq 0.07, 1.0 \leq L \leq 10.0, N \leq 3$
Dent	Circular	$0.2 \leq D \leq 0.6, N \leq 3$

Where, W : Width
 L : Length
 D : Average diameter $= (a+b)/2$

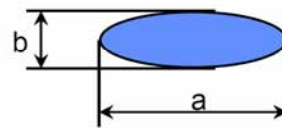

- Note)
 a. Average Diameter
 b. Linear : $a > 2b$, Circular : $a \leq 2b$

Note) continued

- c. Extraneous substances which can be wiped out, like Finger Print, Particles, are not considered as defects.
 d. Defects which are on the Black Matrix(outside of Active Area) are not considered as defects.

Foreign Material

Items	Criteria
Linear	$0.05 \leq W \leq 0.2, 0.3 \leq L \leq 3.0, N \leq 3$
Circular	$0.2 \leq D \leq 0.6, N \leq 3$

Where, W : Width
 L : Length
 D : Average diameter $= (a+b)/2$

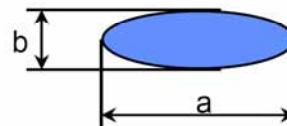

- Note)
 a. Average Diameter
 b. Linear : $a > 2b$, Circular : $a \leq 2b$

Line Defect

All kinds of line defects such as vertical, horizontal or cross are not allowed.

Bezel Appearance

Scratches, minor bents, stains, particles on the Bezel frame are not considered as a defect.

Others

Issues which is not defined in this criteria shall be discussed with both parties, Customer and Supplier, for better solution.

Type 2. 750GLG90E3T41Z D LM190E03-TLB4

Dot Defect

Bright Dot

Dots(sub-pixels) which appeared brightly in the screen when the LCM displayed with dark pattern.

- R,G or B 1 dot -----	0 Max
- Adjacent 2 dots -----	0 Max
- Total amount of Bright dots -----	0 Max
- Minimum distance of Bright dots -----	NA

Dark Dot

Dots(sub-pixels) which appeared darkly in the screen when the LCM displayed with bright pattern.

- 1 dot -----	4 Max
- Adjacent 2 dots -----	2 Max
- Total amount of Dark dot -----	4 Max
- Minimum distance of Dark dots -----	15mm

Total amount of Dot Defects -----5 Max(Combination)

Note) a. Every dot herein means Sub-Pixel.(Each Red, Green, or Blue Color)

b. Bright dot

- Red or Blue dots damaged less than half size of sub-pixel are not defined as dot defects.
- Green dots damaged less than one third size of sub-pixel are not defined as dot defects.

c. Dark dot smaller than half size of sub-pixel is not counted as a dot defect.

Polarizer Defects

Items		Criteria
Scratches	Linear	$0.01 \leq W \leq 0.07, 1.0 \leq L \leq 10.0, N \leq 3$
Dent	Circular	$0.2 \leq D \leq 0.6, N \leq 3$

Where, W : Width

L : Length

D : Average diameter $= (a+b)/2$

Note)

a. Average Diameter

b. Linear : $a > 2b$, Circular : $a \leq 2b$

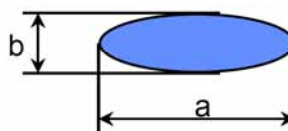

Note) continued

c. Extraneous substances which can be wiped out, like Finger Print, Particles, are not considered as defects.

d. Defects which are on the Black Matrix(outside of Active Area) are not considered as defects.

Foreign Material

Items	Criteria
Linear	$0.05 \leq W \leq 0.2, 0.3 \leq L \leq 3.0, N \leq 3$
Circular	$0.2 \leq D \leq 0.6, N \leq 3$

Where, W : Width
 L : Length
 D : Average diameter $= (a+b)/2$

Note)

a. Average Diameter

b. Linear : $a > 2b$, Circular : $a \leq 2b$

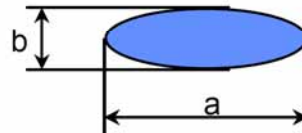

Line Defect

All kinds of line defects such as vertical, horizontal or cross are not allowed.

Bezel Appearance

Scratches, minor dents, stains, particles on the Bezel frame are not considered as a defect.

Others

Issues which is not defined in this criteria shall be discussed with both parties, Customer and Supplier, for better solution.

Type 3. 750GLS90EX1 Z LTM190EX-L01

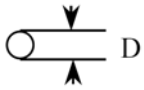
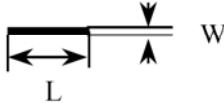
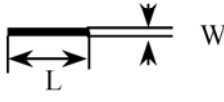
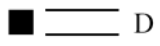
Defect Type	Accept (mm)	Reject (mm)
Dark / bright spot ^{*1} (foreign material, Stain, Dust) 	$0.1 < D \leq 0.8$ $N \leq 4$	$D > 0.8$ $N > 4$
Bright line (light lint), or dark line (dark lint / hair) 	$0.01 < W \leq 0.08$ $0.3 < L \leq 2.0$ $N \leq 4$	$W > 0.08$ $L > 2.0$ $N > 4$
Polarizer scratch 	$0.01 < W \leq 0.1$ $0.3 < L \leq 5.0$ $N \leq 3$	$W > 0.1$ $L > 5.0$ $N > 3$
Polarizer dent/bubble 	$D \leq 0.8$ $N \leq 3$	$D > 0.8$ $N > 3$
Maximum allowable number of defects	$N \leq 10$	$N > 10$

[D : diameter, W : width, L : length, N : count]

*1 : Translucent edge is ignored in measuring the diameter of spot.

Defect Type	Accept	Reject
<i>Bright dot (Fig. 1)</i>		
Random	$N \leq 0$	$N > 0$
Two Adjacent	$N \leq 0$	$N > 0$
Three Adjacent	$N \leq 0$	$N > 0$
<i>Dark dot (Fig. 2)</i>		
Random	$N \leq 5$	$N > 5$
Two Adjacent	$N \leq 2$	$N > 2$
Three Adjacent	$N \leq 1$	$N > 1$
<i>Maximum allowable number of dot defect</i>	$N \leq 5$	$N > 5$
<i>Minimum distance between defects, (Fig. 3)</i>		
<i>dark dot - to - dark dot</i>	$L \geq 5\text{mm}$	$L < 5\text{mm}$

[L : length, N : count]

Definitions/ Notes:

-A bright dot any Red, Green, or Blue pixel suck in the “On” mode.

Refer to the “Fig. 1” for detail information of bright dot defect definition.

- A dark dot any Red, Green, or Blue pixel suck in the “Off” mode.

Fig. 2. Dark dot defect description

【two adjacent】

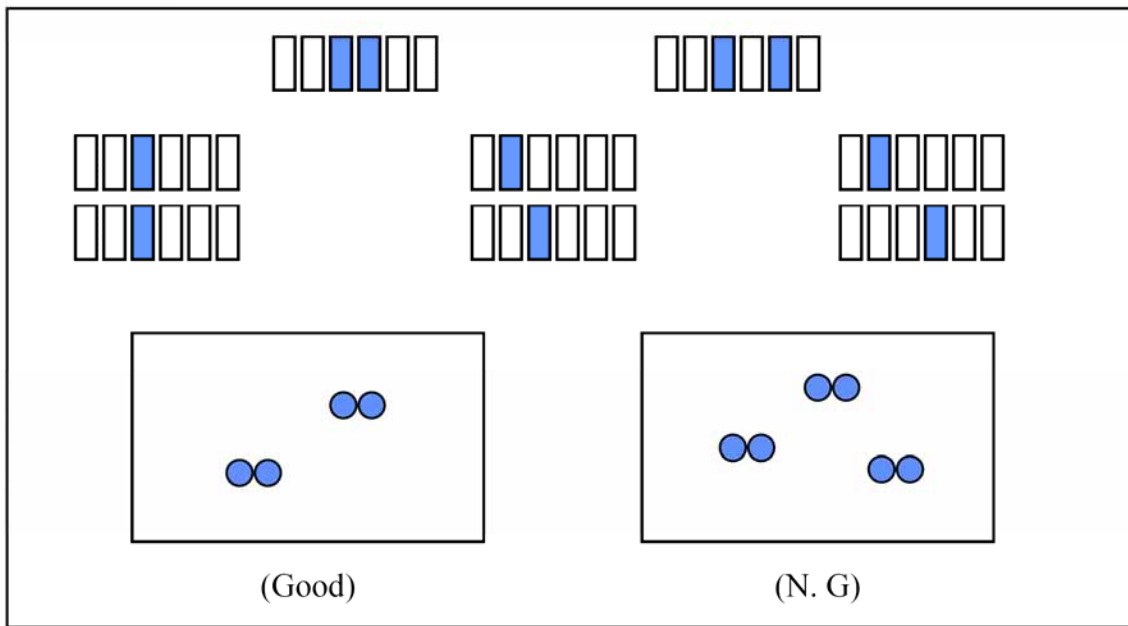

【three adjacent】

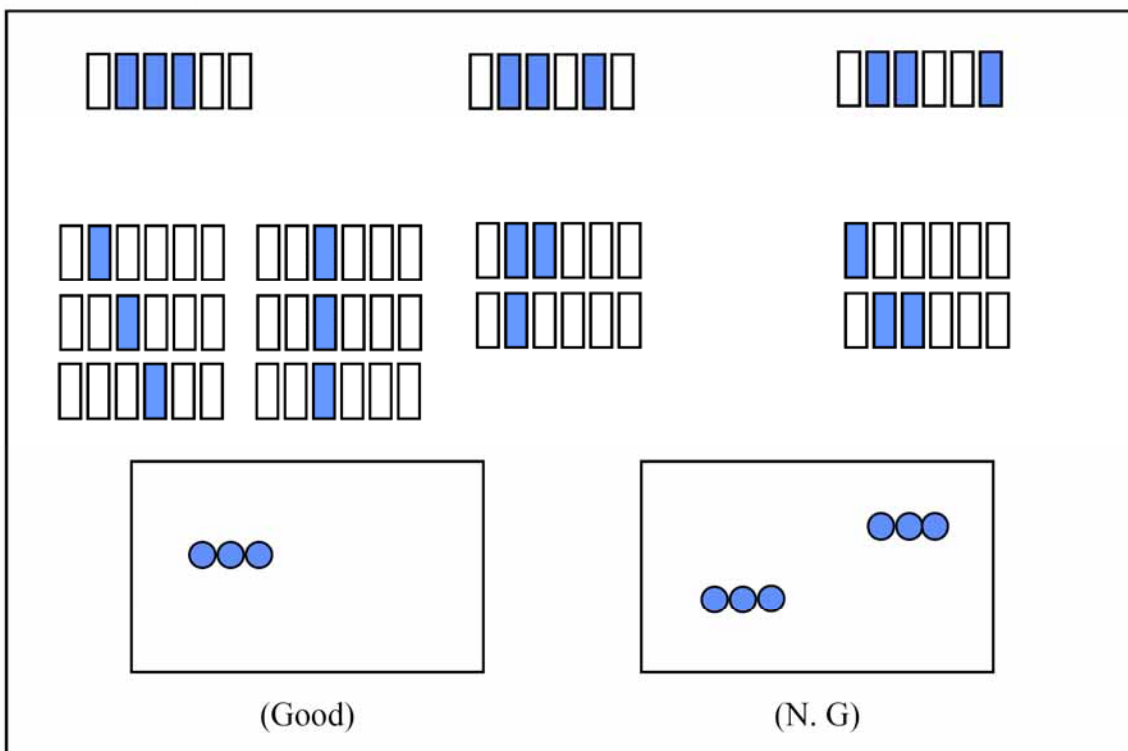

Fig. 3. Minimum distance between dot defects

【dark dot - to - dark dot】



- * Adjacent two & three dots in horizontal direction will be considered as one dot.
- * Minimum distance criteria is applied to the defect, which are not defined as adjacent dot(two or three) in the spec.
- * Will not considered the distance between bright dot & dark dot.
- * Will not considered the distance between dot & mechanical defect.

Type 4. 750GLS90X2111Z LTM190EX-L21

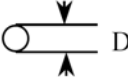
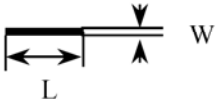
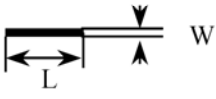
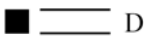
Defect Type	Accept (mm)	Reject (mm)
Dark / bright spot *1 (foreign material, Stain, Dust) 	$0.1 < D \leq 0.8$ $N \leq 4$	$D > 0.8$ $N > 4$
Bright line (light lint), or dark line (dark lint / hair) 	$0.01 < W \leq 0.08$ $0.3 < L \leq 2.0$ $N \leq 4$	$W > 0.08$ $L > 2.0$ $N > 4$
Polarizer scratch 	$0.01 < W \leq 0.1$ $0.3 < L \leq 5.0$ $N \leq 3$	$W > 0.1$ $L > 5.0$ $N > 3$
Polarizer dent/bubble 	$D \leq 0.8$ $N \leq 3$	$D > 0.8$ $N > 3$
Maximum allowable number of defects	$N \leq 10$	$N > 10$

[D : diameter, W : width, L : length, N : count]

*1 : Translucent edge is ignored in measuring the diameter of spot.

Defect Type	Accept	Reject
<i>Bright dot (Fig. 1)</i>		
Random	$N \leq 0$	$N > 0$
Two Adjacent	$N \leq 0$	$N > 0$
Three Adjacent	$N \leq 0$	$N > 0$
<i>Dark dot (Fig. 2)</i>		
Random	$N \leq 5$	$N > 5$
Two Adjacent	$N \leq 2$	$N > 2$
Three Adjacent	$N \leq 1$	$N > 1$
<i>Maximum allowable number of dot defect</i>	$N \leq 5$	$N > 5$
<i>Minimum distance between defects, (Fig. 3)</i>		
<i>dark dot - to - dark dot</i>	$L \geq 5\text{mm}$	$L < 5\text{mm}$

[L : length, N : count]

Definitions/ Notes:

- A bright dot any Red, Green, or Blue pixel suck in the “On” mode.
Refer to the “Fig. 1” for detail information of bright dot defect definition.
- A dark dot any Red, Green, or Blue pixel suck in the “Off” mode.

Fig. 2. Dark dot defect description

【two adjacent】

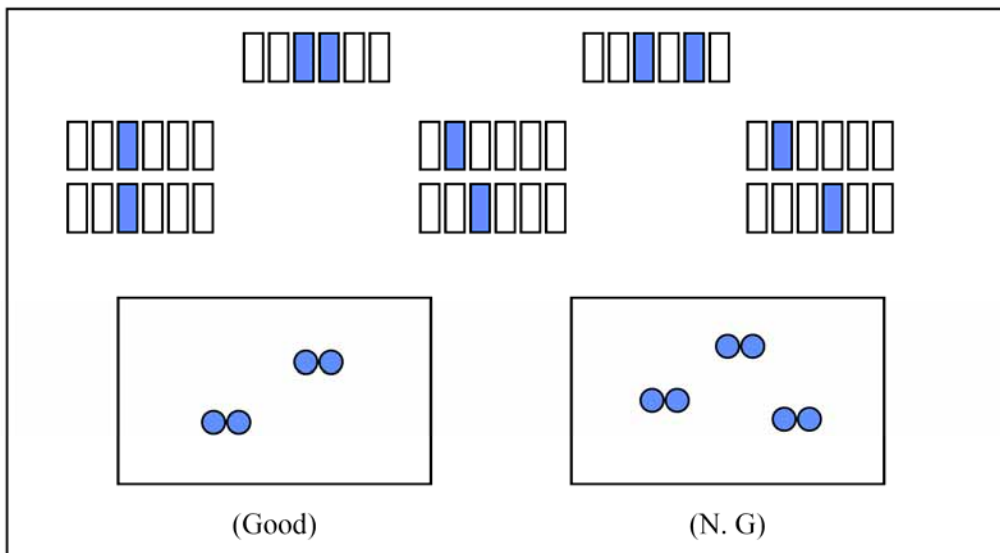

【three adjacent】

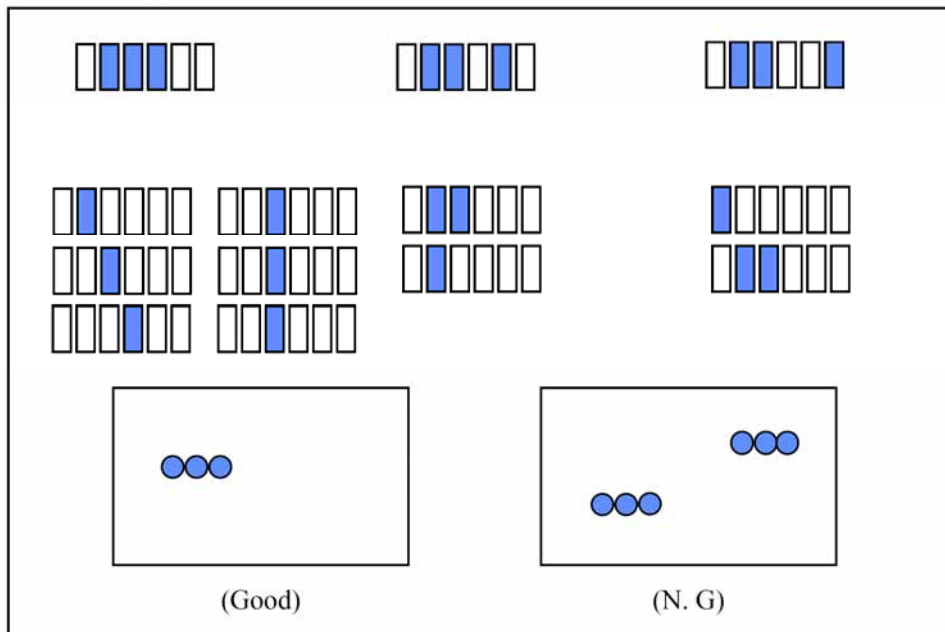

Fig. 3. Minimum distance between dot defects

【dark dot - to - dark dot】



- * Adjacent two & three dots in horizontal direction will be considered as one dot.
- * Minimum distance criteria is applied to the defect , which are not defined as adjacent dot(two or three) in the spec.
- * Will not considered the distance between bright dot & dark dot.
- * Will not considered the distance between dot & mechanical defect.