



# HP ZBook 17 G5 Mobile Workstation

## Maintenance and Service Guide

© Copyright 2018 HP Development Company, L.P.

AMD and AMD Radeon are trademarks of Advanced Micro Devices, Inc. Bluetooth is a trademark owned by its proprietor and used by HP Inc. under license. Intel Core, Intel, Intel Xeon, Intel vPro, and Thunderbolt are trademarks of Intel Corporation in the U.S. and other countries. Microsoft and Windows are trademarks of the Microsoft group of companies. NVIDIA is a trademark and/or registered trademark of NVIDIA Corporation in the U.S. and other countries.

The information contained herein is subject to change without notice. The only warranties for HP products and services are set forth in the express warranty statements accompanying such products and services. Nothing herein should be construed as constituting an additional warranty. HP shall not be liable for technical or editorial errors or omissions contained herein.

First Edition: May 2018

Document Part Number: L21785-001

### **Product notice**

This user guide describes features that are common to most models. Some features may not be available on your computer.

Not all features are available in all editions of Windows. This computer may require upgraded and/or separately purchased hardware, drivers and/or software to take full advantage of Windows functionality. Go to <http://www.microsoft.com> for details.

### **Software terms**

By installing, copying, downloading, or otherwise using any software product preinstalled on this computer, you agree to be bound by the terms of the HP End User License Agreement (EULA). If you do not accept these license terms, your sole remedy is to return the entire unused product (hardware and software) within 14 days for a full refund subject to the refund policy of your seller.

For any further information or to request a full refund of the price of the computer, please contact your seller.

## Important Notice about Customer Self-Repair Parts

---

 **CAUTION:** Your computer includes Customer Self-Repair parts and parts that should only be accessed by an authorized service provider. See Chapter 5, "Removal and replacement procedures for Customer Self-Repair parts," for details. Accessing parts described in Chapter 6, "Removal and replacement procedures for Authorized Service Provider only parts," can damage the computer or void your warranty.

---



## Safety warning notice

---

 **WARNING!** To reduce the possibility of heat-related injuries or of overheating the device, do not place the device directly on your lap or obstruct the device air vents. Use the device only on a hard, flat surface. Do not allow another hard surface, such as an adjoining optional printer, or a soft surface, such as pillows or rugs or clothing, to block airflow. Also, do not allow the AC adapter to contact the skin or a soft surface, such as pillows or rugs or clothing, during operation. The device and the AC adapter comply with the user-accessible surface temperature limits defined by the International Standard for Safety of Information Technology Equipment (IEC 60950-1).

---



---

# Table of contents

<b>1 Product description .....</b>	<b>1</b>
<b>2 Components .....</b>	<b>9</b>
Locating hardware .....	9
Locating software .....	9
Right .....	10
Left .....	12
Display .....	13
Keyboard area .....	14
TouchPad .....	14
Lights .....	16
Buttons, speakers, and fingerprint reader .....	18
Special keys .....	19
Action keys .....	20
Hot keys (select products only) .....	22
Bottom .....	23
Cover .....	24
Rear .....	25
Labels .....	26
<b>3 Illustrated parts catalog .....</b>	<b>28</b>
Computer major components .....	28
Display assembly subcomponents .....	33
Miscellaneous parts .....	35
<b>4 Removal and replacement procedures preliminary requirements .....</b>	<b>36</b>
Tools required .....	36
Service considerations .....	36
Plastic parts .....	36
Cables and connectors .....	37
Drive handling .....	37
Grounding guidelines .....	38
Electrostatic discharge damage .....	38
Packaging and transporting guidelines .....	39
Workstation guidelines .....	39
Equipment guidelines .....	40

<b>5 Removal and replacement procedures for Customer Self-Repair parts .....</b>	<b>41</b>
Component replacement procedures .....	41
Service door .....	41
Battery .....	43
Hard drive (HDD) .....	44
Solid-state drive (SSD) .....	46
ODD .....	48
Memory modules .....	51
SIM card .....	53
WWAN module .....	54
Keyboard .....	56
<b>6 Removal and replacement procedures for Authorized Service Provider parts .....</b>	<b>60</b>
Component replacement procedures .....	60
Middle cover .....	61
Fingerprint reader assembly .....	63
Smart card board .....	65
NFC module .....	67
TouchPad click board .....	68
Fans .....	70
System board .....	72
Heat sink .....	74
Discrete MXM daughter card .....	77
Speaker .....	79
Power button board .....	81
RTC battery .....	83
Solid-state drive (SSD) .....	84
Memory modules .....	86
Display assembly .....	89
Display assembly components .....	91
Top cover .....	99
<b>7 Troubleshooting guide .....</b>	<b>100</b>
Resources .....	101
General troubleshooting steps .....	101
Identify the issue .....	102
1. Understand the issue .....	102
Boot up sequence .....	102
Failure classification .....	102
2. Examine the environment .....	104



3. Perform a visual inspection of hardware .....	105
4. Update BIOS and drivers .....	105
Manually updating BIOS and drivers .....	105
Remotely deploying BIOS and drivers .....	105
Analyze the issue .....	105
5. Remove or uninstall recently added hardware, software .....	105
6. HP Hardware Diagnostics and Tools .....	106
HP PC Hardware Diagnostics (UEFI) .....	106
HP Support Assistant (HPSA) .....	108
HP BIOS Configuration Utility (BCU) .....	109
HP Image Diagnostic Tool .....	109
HP Thermal Monitor .....	109
Non HP diagnostics tools .....	109
7. Status lights, blinking light codes, troubleshooting lights, and POST error messages .....	110
Status lights .....	110
Blinking light codes .....	111
POST error messages .....	111
Power Good (Troubleshooting) lights .....	112
Resolve the issue .....	113
8. Hard reset .....	113
9. Soft reset (Default Settings) .....	115
10. Reseat cables and connections .....	115
11. Test with minimum configuration .....	116
Essential hardware configuration .....	116
Safe mode .....	116
12. Test with verified working configuration (hardware and/or operating system) ...	117
13. Replace the system board .....	117
Verify solution .....	118
Helpful Hints .....	118
At startup .....	118
During operation .....	119
Consulting with HP Service .....	119
Common issues and possible solutions .....	120
Power-on issues .....	120
No Power .....	120
Intermittent power-on, shutdown, reboot .....	122
AC adapter issue .....	123
Battery not recognized, not charging .....	123
Battery discharges too fast .....	125
Burnt smell .....	125

POST .....	126
No video (with power) .....	126
Blinking lights .....	127
Diagnostics error messages .....	127
BIOS password .....	129
Performance (OS) .....	129
Intermittent shutdown .....	130
Blue screen .....	131
Freeze at Windows Logo (hang/lockup) .....	133
Electromagnetic Interference (EMI) .....	134
No wake up .....	135
Unresponsive .....	136
Slow performance .....	136
HP Smart Adapter warning message .....	137
Incorrect time and date .....	137
Display .....	138
Display anomalies .....	138
Symptom .....	138
Quick check .....	139
HP PC Hardware Diagnostics (UEFI) for video test .....	139
Display assembly diagram .....	140
Dead pixel .....	140
No video (internal) .....	140
No video (external) .....	141
DisplayPort/VGA .....	141
HDMI .....	141
No or bad external video via docking .....	142
Incorrect or missing color/distorted image .....	142
Touch screen .....	143
I/O devices .....	144
Keyboard .....	144
Keyboard point stick .....	145
Keyboard backlight .....	145
TouchPad .....	146
Network Connectivity Ethernet (RJ-45 jack) .....	146
Network connectivity wireless (WLAN) .....	147
WWAN .....	148
USB .....	149
Smart card reader .....	150
Speaker, headphone - audio issues .....	151
Thunderbolt (TB) .....	152

Storage .....	153
Hard drive/solid-state drive not recognized .....	154
No boot to operating system (no read/write error) .....	154
Read-write error .....	155
Slow performance .....	155
Blue screen (BSOD) error .....	155
Noisy hard drive .....	156
Mechanical .....	157
Fan error message - 90B .....	157
Noise (sound) .....	158
Fan runs constantly .....	159
Thermal shutdown (hot) .....	160
Stuck power button .....	160
Additional information .....	161
Acronyms .....	161
Blinking lights and boot error codes .....	162
Processor not executing code .....	162
BIOS recovery code unable to find valid BIOS recovery image .....	162
Memory module error .....	162
Graphics Controller Error (No Controller) .....	163
Failure - System Board Error .....	163
Intel Trusted Execution Technology (TXT) Error .....	163
Sure Start unable to find valid BIOS Boot Block image .....	163
Sure Start has identified a problem (Manual Recovery Policy Set) .....	164
POST Error Messages and User Actions .....	164
Routine Maintenance for Performance Improvement .....	166
Common Blue Screen Error Messages .....	166
Error message list .....	166
Bug check symbolic names .....	166
Microsoft general troubleshooting of Windows bug check codes .....	167
Use Windows Debugging Tool .....	167
Windows Software Development Kit (SDK) .....	168
Display Issue: Pixel Anomalies .....	172
Cable management .....	173
Connector types .....	174
<b>8 Computer Setup (BIOS), TPM, and HP Sure Start .....</b>	<b>177</b>
Using Computer Setup .....	177
Starting Computer Setup .....	177
Using a USB keyboard or USB mouse to start Computer Setup (BIOS) .....	177
Navigating and selecting in Computer Setup .....	177

Restoring factory settings in Computer Setup .....	178
Updating the BIOS .....	178
Determining the BIOS version .....	178
Downloading a BIOS update .....	179
Changing the boot order using the f9 prompt .....	180
TPM BIOS settings (select products only) .....	180
Using HP Sure Start (select products only) .....	180
<b>9 Backing up, restoring, and recovering .....</b>	<b>181</b>
Creating recovery media and backups .....	181
Using HP Recovery media (select products only) .....	181
Using Windows tools .....	182
Using the HP Cloud Recovery Download Tool (select products only) .....	183
Restore and recovery .....	183
Recovering using HP Recovery Manager .....	183
What you need to know before you get started .....	183
Using the HP Recovery partition (select products only) .....	184
Using HP Recovery media to recover .....	185
Changing the computer boot order .....	185
Removing the HP Recovery partition (select products only) .....	185
<b>10 Using HP PC Hardware Diagnostics (UEFI) .....</b>	<b>186</b>
Downloading HP PC Hardware Diagnostics (UEFI) to a USB device .....	186
<b>11 Specifications .....</b>	<b>188</b>
Computer specifications .....	188
43.94 cm (17.3 in) display specifications .....	189
<b>12 Power cord set requirements .....</b>	<b>190</b>
Requirements for all countries .....	190
Requirements for specific countries and regions .....	190
<b>13 Statement of memory volatility .....</b>	<b>192</b>
Nonvolatile memory usage .....	194
Questions and answers .....	196
Using HP Sure Start (select models only) .....	197
<b>14 Recycling .....</b>	<b>198</b>
<b>Index .....</b>	<b>199</b>

# 1 Product description

Category	Description
<b>Product Name</b>	HP ZBook 17 G5 Mobile Workstation
<b>Processors</b>	<b>8th-generation Intel® Core™ quad-core processors:</b>  Intel Core i7-8750H, with Intel UHD Graphics 630 (2.2 GHz base frequency, up to 4.1 GHz with Intel Turbo Boost Technology, 9 MB cache, 6 cores)  Intel Core i7-8850H, with Intel UHD Graphics 630 (2.6 GHz base frequency, up to 4.0 GHz with Intel Turbo Boost Technology, 8 MB cache, 4 cores)  Intel Core i5-8400H, vPro™ processor with Intel UHD Graphics 630 (2.5 GHz base frequency, up to 4.2 GHz with Intel Turbo Boost Technology, 8 MB cache, 4 cores)  Intel Core i5-8300H, with Intel UHD Graphics 630 (2.6 GHz base frequency, up to 4.0 GHz with Intel Turbo Boost Technology, 8 MB cache, 4 cores)  <b>8th Generation Intel® XEON, hexa-core, BGA, processors:</b>  Intel Xeon E-2176M vPro processor with Intel UHD Graphics P630 (2.7 GHz base frequency, up to 4.4 GHz with Intel Turbo Boost Technology, 12 MB cache, 6 cores)  Xeon E-2186M vPro processor with Intel UHD Graphics P630 (2.9 GHz base frequency, up to 4.6 GHz with Intel Turbo Boost Technology, 12 MB cache, 6 cores)
<b>Chipset</b>	Integrated with processor  Cannon Lake PCH-H, CM 246
<b>Graphics</b>	GT2 Integrated Graphics  Can be configured or used with hybrid when GPU configured <ul style="list-style-type: none"><li>• For Core processors: Intel UHD graphics 630</li><li>• For Xeon processors: Intel UHD graphics P630</li></ul> Supports: <ul style="list-style-type: none"><li>• No Discrete Graphic</li><li>• Discrete only in BIOS</li><li>• NVIDIA® GC6 and GC OFF</li><li>• Hybrid (Switchable) Graphics</li><li>• NVIDIA Optimus Technology</li><li>• AMD™ Enduro Technology</li><li>• Open GL 4.5 / Open CL 1.2 / Vulkan 1.0</li><li>• DisplayPort 1.3 (supported through Thunderbolt 3 and mini-DP)</li></ul> Total displays supported up to four discrete; or three UMA (through the optional docking station); supports: <ul style="list-style-type: none"><li>• NVIDIA Mosaic Technology</li><li>• AMD Eyefinity</li></ul> <b>Discrete MXM daughter card:</b>

Category	Description
	<ul style="list-style-type: none"> <li>NVIDIA Quadro P1000, 4 GB GDDR5 (256 Mb x 32, 1.35 V, 8 Gbps, Qty 4) 128 bit FBW</li> <li>NVIDIA Quadro P2000, 4 GB GDDR5 (256 Mb x 32, 1.35 V, 8 Gbps, Qty 4) 128 bit FBW</li> <li>NVIDIA Quadro P3200, 6 GB GDDR5 (256 Mb x 32, 1.35 V, 8 Gbps, Qty 6) 192 bit FBW</li> <li>NVIDIA Quadro P4200, 8 GB GDDR5 (256 Mb x 32, 1.35 V, 8 Gbps, Qty 8) 256 bit FBW</li> <li>NVIDIA Quadro P5200, 16 GB GDDR5 (512 Mb x 16, 1.35 V, 8 Gbps, Qty 16) 256 bit FBW</li> <li>AMD Radeon™ Pro WX 4170, GL XT 4 GB GDDR5 (256 Mb x 32, 1.35 V, 8 Gbps, Qty 4) 128 bit FBW</li> </ul>
<b>Panel</b>	<p>Supports privacy filter and narrow bezel</p> <hr/> <p><b>39.6 cm (17.3 in), display panel</b>, LED backlight, 16:9 aspect ratio</p> <hr/> <p>High definition (HD) anti-glare (AG) LED SVA (1600×900), 220 nits, 60% CG, eDP, flat, no camera</p> <hr/> <p>HD, AG, LED SVA (1600×900), 220 nits, 60% CG, eDP, flat, with HD camera</p> <hr/> <p>HD, AG, LED SVA (1600×900), 220 nits, 60% CG, eDP, flat, with HD camera and IR camera</p> <hr/> <p>Full high definition FHD LED UWVA with ambient light sensor (1920×1080), AG, 300 nits, 72% CG, eDP, flat, without camera</p> <hr/> <p>FHD LED UWVA with ambient light sensor (1920×1080), AG, 300 nits, 72% CG, eDP, flat, with HD camera</p> <hr/> <p>FHD LED UWVA with ambient light sensor (1920×1080), AG, 300 nits, 72% CG, eDP, flat, with HD camera and IR camera</p> <hr/> <p>Ultra high definition (UHD) LED UWVA touch with ambient light sensor (3840 x 2160) 400 nits, 95% CG, eDP+PSR, flat, with HD camera and IR camera, includes touch and direct bonding, not available with WWAN</p> <hr/> <p>UHD, LED UWVA touch with ambient light sensor (3840 x 2160) 400 nits, 95% CG, eDP+PSR, flat, with HD camera, includes touch and direct bonding, not available with WWAN</p> <hr/> <p>UHD, LED AG, RG phosphors + B-LED, UWVA DreamColor — 10 bit (8+2 dithering) touch with ambient light sensor (3840 x 2160) 400 nits, 100% Adobe RGB</p> <hr/> <p>UHD, LED AG, RG phosphors + B-LED, UWVA DreamColor — 10 bit (8+2 dithering) touch with ambient light sensor (3840 x 2160) 400 nits, 100% Adobe RGB, HD camera</p> <hr/> <p>UHD, LED AG, RG phosphors + B-LED, UWVA DreamColor — 10 bit (8+2 dithering) touch with ambient light sensor (3840 x 2160) 400 nits, 100% Adobe RGB, HD camera and IR camera</p>
<b>Memory</b>	<p>Four memory module slots, three or four SODIMM module combination is only available with quad core processors</p> <hr/> <p>Two slots of memory is customer accessible/upgradeable</p> <hr/> <p><b>DDR4-2666 SODIMMs</b></p> <hr/> <p>Supports up to 64 GB of system RAM in the following configurations:</p> <ul style="list-style-type: none"> <li>65536 MB (16384 MB×4)</li> <li>32768 MB (16384 MB×2 or 8192MB x 4)</li> <li>16384 MB (16384 MB×1 or 8192 MB×2 or 4096 MB×4)</li> <li>8192 MB (8192 MB×1 or 4096 MB×2)</li> </ul> <hr/> <p><b>ECC DDR4-2666</b>, available with Xeon processors only</p> <ul style="list-style-type: none"> <li>65536 MB (16384 MB×4)</li> <li>32768 MB (16384 MB×2 or 8192MB x 4)</li> </ul>

Category	Description
	<ul style="list-style-type: none"> <li>16384 MB (16384 MB×1 or 8192 MB×2)</li> <li>8192 MB (8192 MB×1)</li> </ul>
<b>Primary storage</b>	<p><b>M.2 solid-state drives (2280):</b></p> <p><b>SATA:</b></p> <p>512 GB, SATA-3, SSD, TLC, FIPS-140–2</p> <p>256 GB, SATA-3, Self-encrypting drive, Opal 2, TLC</p> <p><b>PCIe:</b></p> <p>256 GB, NVMe, TLC</p> <p>256 GB, NVMe, TLC, Opal 2</p> <p>512 GB, NVMe, TLC</p> <p>512 GB, NVMe, TLC, Opal 2</p> <p>1 TB, NVMe, TLC</p> <p>2 TB, NVMe, TLC</p> <p>Intel 360 GB, PCIe, NVMe</p>
<b>Secondary storage</b>	<p><b>M.2 solid-state drives (2280):</b>, only available if primary M.2 is selected</p> <p><b>SATA:</b></p> <p>512 GB, SATA-3, SSD, TLC, FIPS-140–2</p> <p>256 GB, SATA-3, Self-encrypting drive, Opal 2, TLC</p> <p><b>PCIe:</b></p> <p>256 GB, NVMe, TLC</p> <p>256 GB, NVMe, TLC, Opal 2</p> <p>512 GB, NVMe, TLC</p> <p>512 GB, NVMe, TLC, Opal 2</p> <p>1 TB, NVMe, TLC</p> <p>2 TB, NVMe, TLC</p> <p>Intel 360 GB, NVMe</p>
<b>Third M.2 storage</b>	<p><b>M.2 solid-state drives (2280):</b> only available if primary M.2 and secondary M.2 are selected</p> <p><b>SATA:</b></p> <p>512 GB, SATA-3, SSD, TLC, FIPS-140–2</p> <p>256 GB, SATA-3, Self-encrypting drive, Opal 2, TLC</p> <p><b>PCIe:</b></p> <p>256 GB, NVMe, TLC</p> <p>256 GB, NVMe, TLC, Opal 2</p> <p>512 GB, NVMe, TLC</p>

Category	Description
	512 GB, NVMe, TLC, Opal 2
	1 TB, NVMe, TLC
	2 TB, NVMe, TLC
	Intel 360 GB, NVMe
<b>Primary 2.5" SATA storage</b>	<b>SATA 2.5" HDDs</b> supports SATA 7 mm/9.5 mm, 2.5" HDDs, primary 2.5" storage is not a required category if M.2 SSD is selected
	2 TB 5400 rpm, supports 3D DriveGuard
	2 TB 5400 rpm Hybrid Drive
	1 TB 7200 rpm
	1 TB 5400 rpm Hybrid Drive
	500 GB, 7200 rpm Self Encrypting Drive (SED, FIPS-140-2) or equivalent OPAL2, not available with Optane cache
	500 GB, 7200 rpm
	500 GB 7200 rpm SED OPAL2, not available with Optane cache
	500 GB 5400 rpm Hybrid 8 GB cache
	<b>2.5" SDD</b>
	256 GB SATA TLC
	1TB SATA TLC
	Primary HDD/SSD carrier only (no drive included) required selection if 2.5" SATA storage is not selected
<b>Fixed optical drive</b>	<b>9.0 mm SATA</b> supports E-SATA and drive inserts
	Blu-ray R/RE DVD +/-RW SuperMulti DL Drive
	Supports No ODD option
	Supports secondary drive, M.2 via SATA 2.5" drive
<b>Flash cache</b>	16 GB Intel Optane cache, only available if HDD (except FIPS or SED) and Windows 10 is selected AND a third M.2 storage is not selected
<b>Audio and video</b>	HP Bang & Olufsen Audio
	HP Noise Cancellation Software
	HP Clear Sound Amp
	Discrete Amp
	Skype for Business Certification
	Intel SST Audio
	Dual array and World-Facing microphones, dual microphone is tied to the camera
	Stereo speakers (2)
	Webcam HD 720p
	Webcam HD+IR RGB 720p
	Camera privacy shutter (only with non-touch camera panels)



Category	Description
	Supports WDR (Wide Dynamic Range)
	Support for models without camera
<b>Ethernet</b>	Intel Ethernet Connection I219-LM 10/100/1000 (vPro)
<b>Wireless networking</b>	<p><b>WPAN Bluetooth:</b></p> <p>Integrated wireless personal area network (WPAN) support for Bluetooth® 5.0 via combo card</p> <p><b>Wireless local area network (WLAN),</b> WLAN options via minicard</p> <p>Supports the following WLAN formats:</p> <p>Integrated Wireless options with single antennas (M.2 12x16 soldered down MIPI+BRI (Available with iAMT. MU-MIMO supported. WAVE 2 supported)</p> <ul style="list-style-type: none"> <li>Intel Wireless-AC 9560 802.11ac 2x2 WiFi + BT 5 Combo Adaptor (vPro). Available with iAMT. MU-MIMO supported. WAVE 2 supported.</li> <li>Intel Wireless-AC 9560 802.11ac 2x2 WiFi + BT 5 Combo Adaptor (non-vPro). Not available with iAMT. MU-MIMO supported. WAVE 2 supported.</li> </ul> <p>Two WLAN antennas built into top of display assembly</p> <p>Bluetooth Disabled IOPT, available with Combo WLAN</p> <p>WLAN Disabled IOPT, available with Combo WLAN</p> <p><b>Near-Field Communication (NFC):</b></p> <p>NXP NPC300 Near Field Communication Module (NFC Mirage WNC XR4V-1 [NXP NPC300 I2C 10 mm x 17 mm])</p> <p>NFC antenna</p> <p>Support for models without NFC</p> <p><b>Wireless wide area network (WWAN):</b></p> <p>Integrated wireless wide area network (WWAN) options by way of wireless module, SIM Module (3FF/micro SIM): (user accessible behind battery)</p> <p>Two WWAN antennas (worldwide 5 band, configured at top of display panel)</p> <p>Supports the following WWAN formats:</p> <ul style="list-style-type: none"> <li><b>Integrated WWAN options with dual antennas (M.2 30x42 socket USB2)</b> LTE CAT4: HP It4132, LTE/HSPA+ 4G Mobile BroadBand Module with GPS M.2</li> <li><b>Integrated WWAN options with dual antennas (M.2 30x42 socket PCIe)</b> LTE CAT9: Intel XMM 7360 LTE-Advanced LTE-Advanced/HSPA+ with GPS</li> </ul> <p>WWAN Antennas (2) (worldwide 5 band, configured at top of panel on all units except UHD)</p> <p>Support for models without WWAN</p> <p>Support for WWAN aftermarket option (AMO)</p>
<b>External card expansion</b>	Realtek Integrated SD UHS-II flash media slot- supports SD, SDHC, SDXC
<b>Ports</b>	<p>Two USB Type-C (Thunderbolt 3), Intel Titan Ridge; USB 3.1 + pass through DP 1.3 support + Thunderbolt 3 with PD</p> <p>Two USB 3.0 ports</p>

Category	Description
	USB 3.0 charging port
	HDMI 2.0 with discrete graphics, 1.4 with UMA
	Mini DisplayPort 1.3
	RJ-45/Ethernet
	Docking connector
	Audio-out (headphone)/audio-in (microphone) combo jack
	Multi-pin AC port
<b>Docking</b>	HP Thunderbolt Dock
	HP Thunderbolt 3 Dock
<b>Keyboard/ pointing devices</b>	<b>Keyboard:</b>
	Full sized Chiclet (Island-style) keyboard w/ separate numeric keypad:
	<ul style="list-style-type: none"> <li>• Dual point, non-backlit, spill resistant with drain</li> <li>• Dual point, backlit, spill resistant with drain, with HP Dura Keys</li> </ul>
	<b>TouchPad:</b>
	Glass with chemical etched surface
	Supports 2-way scroll, taps enabled by default, image sensor
	DreamColor calibrator, built in under the TouchPad, only applicable if DreamColor display is selected*
<b>Power requirements</b>	<b>Battery:</b>
	HP Long Life Lithium Polymer Soft Pack Battery, 6 cell, 95.6 WHr
	HP Fast Charge Technology
	<b>AC adapter:</b>
	200 W SLIM Smart AC Adapter
	<b>Power cord:</b>
	3 wire plug (C13), 1 m
<b>Security</b>	Security lock
	Trusted Platform Module (TPM) 2.0 (Infineon, soldered down)
	Touch fingerprint sensor (landed, touch with 8x8 sensor)
	Support for models without a fingerprint reader
	Smart Card reader (active)
	Preboot authentication (password, smart card)
	Drive Encryption preboot option - (Password, Fingerprint, Selected Smartcards)
<b>Operating system</b>	<b>Preinstalled:</b>
	Windows 10

Category	Description
	Windows 10 Home 64 Plus, NOT available for the following: <ul style="list-style-type: none"> <li>• Intel Core i7 with &gt;= 6 cores processor)</li> <li>• Intel Core i7 AND &gt; 16 GB RAM)</li> <li>• UHD</li> <li>• XEON processor</li> </ul>
	Windows 10 Home 64 Plus Single Language, NOT available for the following: <ul style="list-style-type: none"> <li>• Intel Core i7 with &gt;= 6 cores processor)</li> <li>• Intel Core i7 AND &gt; 16 GB RAM)</li> <li>• UHD</li> <li>• XEON processor</li> </ul>
	Windows 10 Home 64 High End Chinese Market CPPP, NOT available with XEON processors
	Windows 10 Home 64 Advanced, NOT available with XEON processors. ONLY available for the following: <ul style="list-style-type: none"> <li>• Intel Core i7 with &gt;= 6 cores processor)</li> <li>• Intel Core i7 AND &gt; 16 GB RAM)</li> <li>• UHD</li> </ul>
	Windows 10 Home 64 Advanced Single Language, NOT available with XEON processors. ONLY available for the following: <ul style="list-style-type: none"> <li>• Intel Core i7 with &gt;= 6 cores processor)</li> <li>• Intel Core i7 AND &gt; 16 GB RAM)</li> <li>• UHD</li> </ul>
	Windows 10 Pro 64, NOT available with XEON processors.
	Windows 10 Pro 64 Plus, NOT available with XEON processors.
	FreeDOS 2.0
	<b>Web only support:</b>
	Windows 10 Enterprise 64
	Windows 10 Enterprise 64 LTSB 1607
	<b>Restore Media:</b>
	Windows 10 DRDVD, available with any Win 10 OS
	Windows 10 Pro 64 OSDVD, available with Win 10 PRO OS
	<b>Certified:</b>
	Microsoft WHQL
	<b>Web-only support:</b>
	Windows 10 Enterprise 64
	Red Hat Linux 7
	Ubuntu Linux
<b>Serviceability</b>	<b>End user replaceable parts:</b>

<b>Category</b>	<b>Description</b>
	AC adapter
	Battery
	HDD/SDD
	Keyboard
	M.2 SSD
	Memory module
	ODD
	WLAN module
	WWAN module

---

## 2 Components

Your computer features top-rated components. This chapter provides details about your components, where they're located, and how they work.

### Locating hardware

To find out what hardware is installed on your computer:

- ▲ Type `device manager` in the taskbar search box, and then select the **Device Manager** app.

A list displays all the devices installed on your computer.

For information about system hardware components and the system BIOS version number, press `fn+esc` (select products only).

### Locating software

To find out what software is installed on your computer:





- ▲ Select the **Start** button.

– or –

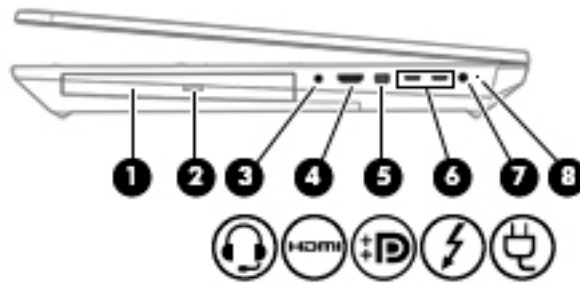
Right-click the **Start** button, and then select **Apps and Features**.

# Right







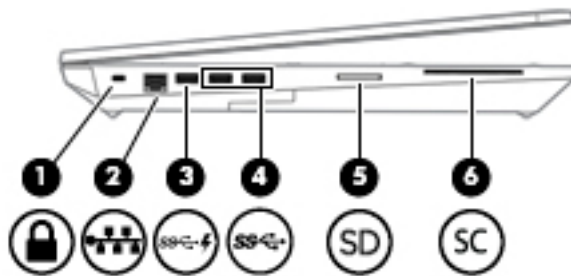

Component	Description
(1)	Optical drive (select products only) Depending on your computer model, reads an optical disc or reads and writes to an optical disc.
(2)	Optical drive eject button (select products only) Releases the optical drive disc tray.
(3) 	<p>Audio-out (headphone)/Audio-in (microphone) combo jack Connects optional powered stereo speakers, headphones, earbuds, a headset, or a television audio cable. Also connects an optional headset microphone. This jack does not support optional standalone microphones.</p> <p><b>WARNING!</b> To reduce the risk of personal injury, adjust the volume before putting on headphones, earbuds, or a headset. For additional safety information, refer to the <i>Regulatory, Safety, and Environmental Notices</i>.</p> <p>To access this guide:</p> <ul style="list-style-type: none"> <li>▲ Select the <b>Start</b> button, select <b>HP Help and Support</b>, and then select <b>HP Documentation</b>.</li> </ul> <p>– or –</p> <ul style="list-style-type: none"> <li>▲ Select the <b>Start</b> button, select <b>HP</b>, and then select <b>HP Documentation</b>.</li> </ul> <p><b>NOTE:</b> When a device is connected to the jack, the computer speakers are disabled.</p>
(4) 	<p>HDMI port Connects an optional video or audio device, such as a high-definition television, any compatible digital or audio component, or a high-speed High Definition Multimedia Interface (HDMI) device.</p>
(5) 	<p>Dual-Mode DisplayPort Connects an optional digital display device, such as a high-performance monitor or projector.</p>
(6) 	<p>USB Type-C power connector and Thunderbolt port with HP Sleep and Charge Connects an AC adapter that has a USB Type-C connector, supplying power to the computer and, if needed, charging the computer battery.</p> <p>– and –</p> <p>Connects and charges most USB devices that have a Type-C connector, such as a cell phone, camera, activity tracker, or smartwatch, and provides high-speed data transfer.</p> <p>– and –</p>

Component	Description
(7)  Power connector	<p>Connects a display device that has a USB Type-C connector, providing DisplayPort output.</p> <p><b>NOTE:</b> Your computer may also support a Thunderbolt docking station.</p> <p><b>NOTE:</b> Cables and/or adapters (purchased separately) may be required.</p>
(8) Battery light	<p>When AC power is connected:</p> <ul style="list-style-type: none"> <li>• White: The battery charge is greater than 90 percent.</li> <li>• Amber: The battery charge is from 0 to 90 percent.</li> <li>• Off: The battery is not charging.</li> </ul> <p>When AC power is disconnected (battery not charging):</p> <ul style="list-style-type: none"> <li>• Blinking amber: The battery has reached a low battery level. When the battery has reached a critical battery level, the battery light begins blinking rapidly.</li> <li>• Off: The battery is not charging.</li> </ul>

## Left



Component	Description
(1) 	<p>Security cable slot</p> <p>Attaches an optional security cable to the computer.</p> <p><b>NOTE:</b> The security cable is designed to act as a deterrent, but it may not prevent the computer from being mishandled or stolen.</p>
(2) 	<p>RJ-45 (network) jack/status lights</p> <p>Connects a network cable.</p> <ul style="list-style-type: none"> <li>• Green (left): The network is connected.</li> <li>• Amber (right): Activity is occurring on the network.</li> </ul>
(3) 	<p>USB SuperSpeed port with HP Sleep and Charge</p> <p>Connects a USB device, provides high-speed data transfer, and even when the computer is off, charges most products such as a cell phone, camera, activity tracker, or smartwatch.</p>
(4) 	<p>USB SuperSpeed ports (2)</p> <p>Connects a USB device, such as a cell phone, camera, activity tracker, or smartwatch, and provides high-speed data transfer.</p>
(5) 	<p>Memory card reader</p> <p>Reads optional memory cards that store, manage, share, or access information.</p> <p>To insert a card:</p> <ol style="list-style-type: none"> <li>1. Hold the card label-side up, with the connectors facing the computer.</li> <li>2. Insert the card into the memory card reader, and then press in on the card until it is firmly seated.</li> </ol> <p>To remove a card:</p> <ul style="list-style-type: none"> <li>▲ Press in on the card, and then remove it from the memory card reader.</li> </ul>
(6) 	<p>Smart card reader</p> <p>Supports optional smart cards.</p>



# Display

 **NOTE:** Refer to the illustration that most closely matches your computer.

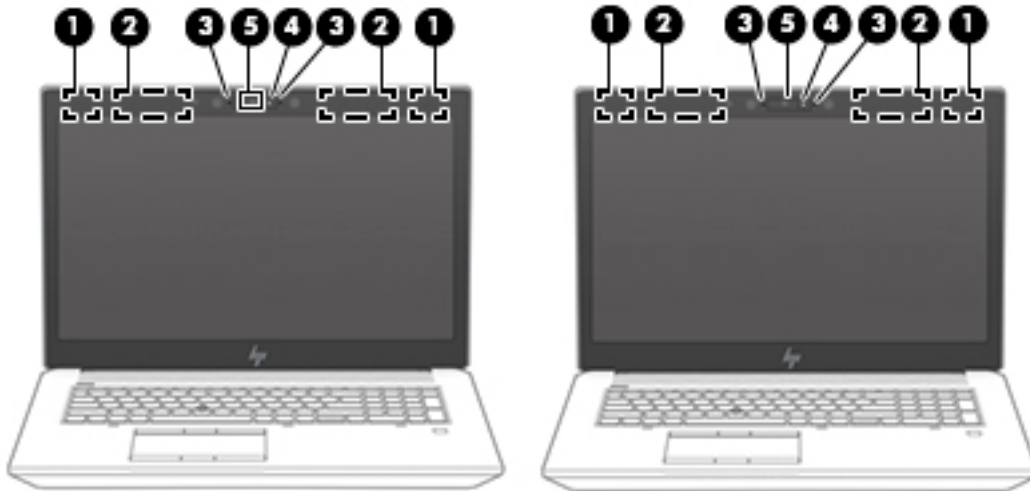

Component	Description
(1) WLAN antennas*	Send and receive wireless signals to communicate with wireless local area networks (WLANs).
(2) WWAN antennas*	Send and receive wireless signals to communicate with wireless wide area networks (WWANs).
(3) Internal microphones	Record sound.
(4) Camera light(s)	On: One or more cameras are in use.
(5) Camera(s)	Allow(s) you to video chat, record video, and record still images. <b>NOTE:</b> Camera functions vary depending on the camera hardware and software installed on your product.

\*The antennas are not visible from the outside of the computer. For optimal transmission, keep the areas immediately around the antennas free from obstructions.

For wireless regulatory notices, see the section of the *Regulatory, Safety, and Environmental Notices* that applies to your country or region.

To access this guide:

▲ Select the **Start** button, select **HP Help and Support**, and then select **HP Documentation**.

– or –

▲ Select the **Start** button, select **HP**, and then select **HP Documentation**.

# Keyboard area

## TouchPad

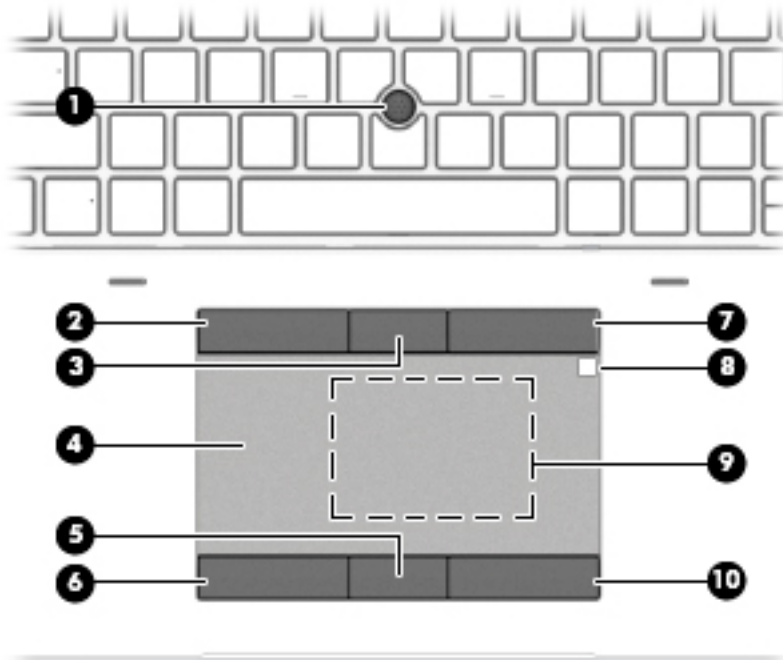

Component	Description
(1)	Pointing stick Moves the pointer on the screen.
(2)	Left pointing stick button Functions like the left button on an external mouse.
(3)	Center pointing stick button Functions like the center button on an external mouse.
(4)	TouchPad zone Reads your finger gestures to move the pointer or activate items on the screen.
(5)	Center pointing stick button Functions like the center button on an external mouse.
(6)	Left TouchPad button Functions like the left button on an external mouse.
(7)	Right TouchPad button Functions like the right button on an external mouse.
(8)	Near Field Communications (NFC) tapping area and antenna* Allows you to wirelessly share information when you tap it with an NFC-enabled device.
(9)	HP DreamColor sensor (select products only) A colorimeter that brings integrated color calibration to your display. This built-in measurement instrument provides the ability to recalibrate a DreamColor color preset without the use of an external measurement instrument. To select a color preset or launch the calibration tool, select the HP DreamColor icon in the Windows taskbar. Make a selection from the menu and follow the on-screen instructions. <b>NOTE:</b> For accurate calibration, keep the sensor window clean and free from obstructions.
(10)	Right pointing stick button Functions like the right button on an external mouse.

\*The antenna is not visible from the outside of the computer. For optimal transmission, keep the area immediately around the antenna free from obstructions.





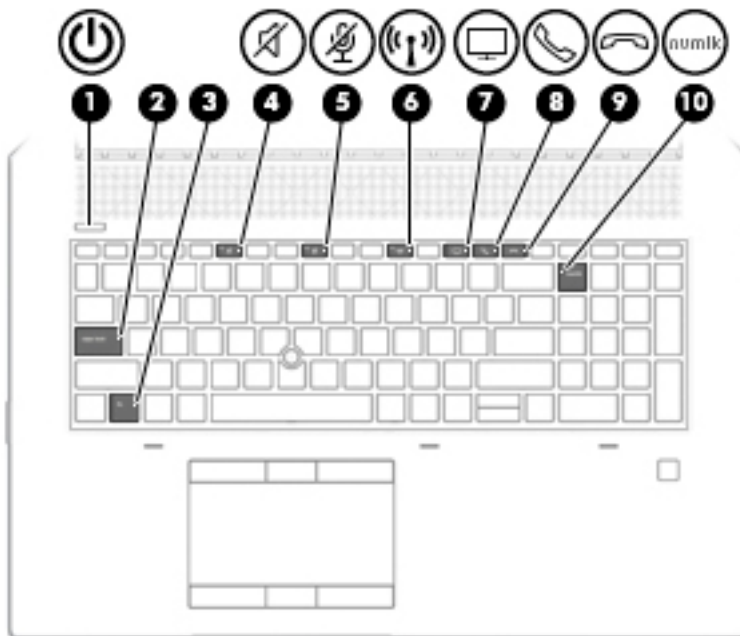

---

Component	Description
	For wireless regulatory notices, see the section of the <i>Regulatory, Safety, and Environmental Notices</i> that applies to your country or region.
	To access this guide:
	▲ Select the <b>Start</b> button, select <b>HP Help and Support</b> , and then select <b>HP Documentation</b> .
	– or –
	▲ Select the <b>Start</b> button, select <b>HP</b> , and then select <b>HP Documentation</b> .

---

## Lights





Component	Description
(1)  Power light	<ul style="list-style-type: none"> <li>On: The computer is on.</li> <li>Blinking: The computer is in the Sleep state, a power-saving state. The computer shuts off power to the display and other unneeded components.</li> <li>Off: The computer is off or in Hibernation. Hibernation is a power-saving state that uses the least amount of power.</li> </ul>
(2) Caps lock light	On: Caps lock is on, which switches the key input to all capital letters.
(3) Fn lock light	On: The <b>fn</b> key is locked. For more information, see <a href="#">Hot keys (select products only) on page 22</a> .
(4)  Mute light	<ul style="list-style-type: none"> <li>On: Computer sound is off.</li> <li>Off: Computer sound is on.</li> </ul>
(5)  Microphone mute light	<ul style="list-style-type: none"> <li>On: Microphone is off.</li> <li>Off: Microphone is on.</li> </ul>
(6)  Wireless light	<p>On: An integrated wireless device, such as a wireless local area network (WLAN) device and/or a Bluetooth® device, is on.</p> <p><b>NOTE:</b> On some models, the wireless light is amber when all wireless devices are off.</p>
(7)  Sharing or presenting light	On: Sharing is on.
(8)  Call answer light	On: Call answer is on.

Component	Description
(9)  Call end light	On: Call end is on.
(10) num lk Num lk light	On: Num lock is on.

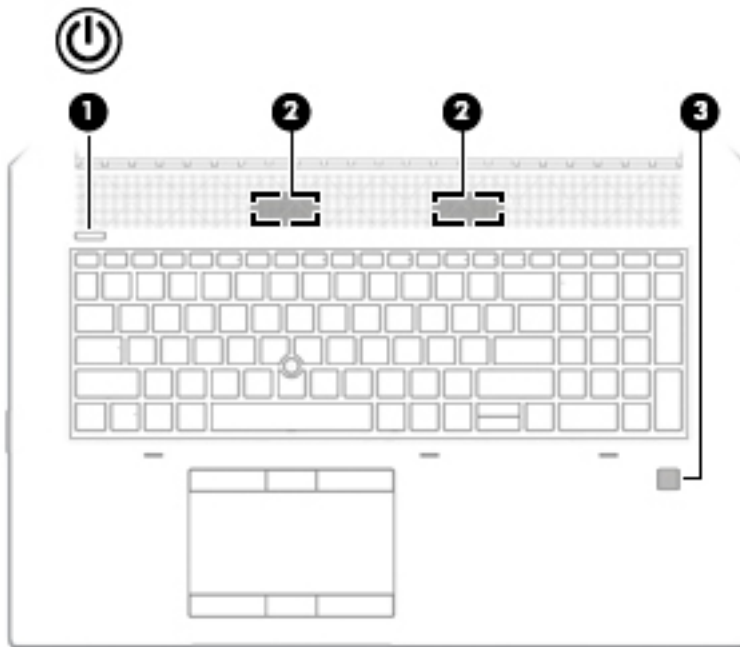
## Buttons, speakers, and fingerprint reader



Component	Description
<b>(1)</b>  Power button	<ul style="list-style-type: none"> <li>• When the computer is off, press the button to turn on the computer.</li> <li>• When the computer is on, press the button briefly to initiate Sleep.</li> <li>• When the computer is in the Sleep state, press the button briefly to exit Sleep.</li> <li>• When the computer is in Hibernation, press the button briefly to exit Hibernation.</li> </ul> <p><b>CAUTION:</b> Pressing and holding down the power button results in the loss of unsaved information.</p> <p>If the computer has stopped responding and shutdown procedures are ineffective, press and hold the power button for at least 5 seconds to turn off the computer.</p> <p>To learn more about your power settings, see your power options.</p> <p>▲ Right-click the <b>Power meter</b> icon  and then select <b>Power Options</b>.</p>
<b>(2)</b> Speakers	Produce sound.
<b>(3)</b> Fingerprint reader (select products only)	Allows a fingerprint logon to Windows, instead of a password logon.

## Special keys

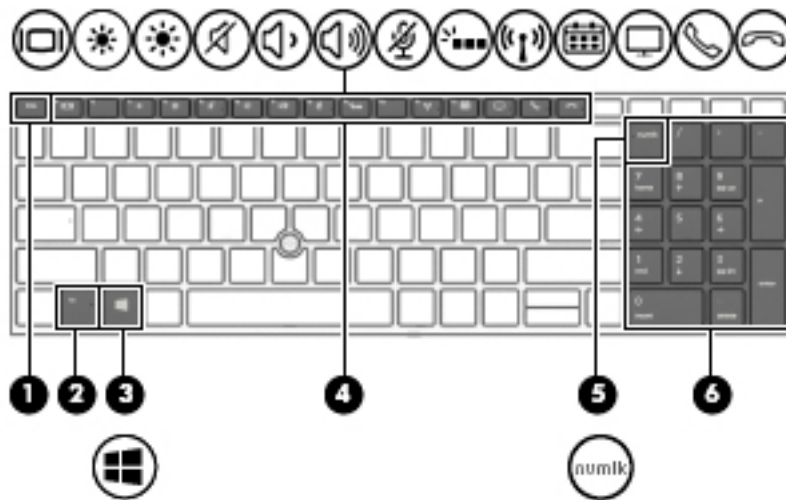









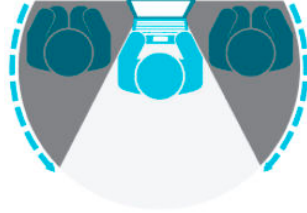



Component	Description
(1) <a href="#">esc</a> key	Displays system information when pressed in combination with the <a href="#">fn</a> key.
(2) <a href="#">fn</a> key	Executes frequently used system functions when pressed in combination with another key. Such key combinations are called <i>hot keys</i> .  See <a href="#">Hot keys (select products only)</a> on page 22.
(3)  Windows key	Opens the <b>Start</b> menu.  <b>NOTE:</b> Pressing the Windows key again will close the <b>Start</b> menu.
(4) Action keys	Execute frequently used system functions.  See <a href="#">Action keys</a> on page 20.
(5) <a href="#">num lk</a> key	Turns the embedded numeric keypad on and off when pressed in combination with the <a href="#">fn</a> key.  – or –  Turns the embedded numeric keypad on and off.  – or –  Alternates between the navigational and numeric functions on the integrated numeric keypad.
(6) Integrated numeric keypad	A separate keypad to the right of the alphabet keyboard. When <a href="#">num lk</a> is pressed, the integrated keypad can be used like an external numeric keypad.  <b>NOTE:</b> If the keypad function is active when the computer is turned off, that function is reinstated when the computer is turned back on.









## Action keys

An action key performs the function indicated by the icon on the key. To determine which keys are on your product, see [Special keys on page 19](#).

▲ To use an action key, press and hold the key.

Icon	Description
	Helps prevent side-angle viewing from onlookers. If needed, decrease or increase brightness for well-lit or darker environments. Press the key again to turn off the privacy screen. <b>NOTE:</b> To quickly turn on the highest privacy setting, press <b>fn+p</b> .
	
	Decreases the screen brightness incrementally as long as you hold down the key.
	Increases the screen brightness incrementally as long as you hold down the key.
	Turns the keyboard backlight off or on. <b>NOTE:</b> To conserve battery power, turn off this feature.
	Plays the previous track of an audio CD or the previous section of a DVD or a Blu-ray Disc (BD).
	Starts, pauses, or resumes playback of an audio CD, a DVD, or a BD.
	Plays the next track of an audio CD or the next section of a DVD or a BD.
	Stops audio or video playback of a CD, a DVD, or a BD.
	Decreases speaker volume incrementally while you hold down the key.
	Increases speaker volume incrementally while you hold down the key.
	Mutes the microphone.
	Mutes or restores speaker sound.



Icon	Description
	Turns the wireless feature on or off. <b>NOTE:</b> A wireless network must be set up before a wireless connection is possible.
	Turns the TouchPad and TouchPad light on and off.
	Switches the screen image among display devices connected to the system. For example, if a monitor is connected to the computer, repeatedly pressing the key alternates the screen image from computer display to monitor display to simultaneous display on both the computer and the monitor.
	Initiates Sleep, which saves your information in system memory. The display and other system components turn off and power is conserved. To exit Sleep, briefly press the power button. <b>CAUTION:</b> To reduce the risk of information loss, save your work before initiating Sleep.
	Provides quick access to your Skype for Business calendar. <b>NOTE:</b> This feature requires Skype® for Business or Lync® 2013 running on Microsoft Exchange or Office 365® servers.
	Turns the screen sharing function on or off. <b>NOTE:</b> This feature requires Skype for Business or Lync 2013 running on Microsoft Exchange or Office 365 servers.
	<ul style="list-style-type: none"> <li>• Answers a call.</li> <li>• Starts a call during a 1-on-1 chat.</li> <li>• Places a call on hold.</li> </ul> <b>NOTE:</b> This feature requires Skype for Business or Lync 2013 running on Microsoft Exchange or Office 365 servers.
	<ul style="list-style-type: none"> <li>• Ends a call.</li> <li>• Declines incoming calls.</li> <li>• Ends screen sharing.</li> </ul> <b>NOTE:</b> This feature requires Skype for Business or Lync 2013 running on Microsoft Exchange or Office 365 servers.

 **NOTE:** The action key feature is enabled at the factory. You can disable this feature by pressing and holding the **fn** key and the left **shift** key. The fn lock light will turn on. After you have disabled the action key feature, you can still perform each function by pressing the **fn** key in combination with the appropriate action key.

## Hot keys (select products only)

A hot key is the combination of the **fn** key and another key.

To use a hot key:

- ▲ Press the **fn** key, and then press one of the keys listed in the following table.

Key	Description
C	Turns on scroll lock.
E	Turns on the insert function.
R	Breaks the operation.
S	Sends a programming query.
W	Pauses the operation.

# Bottom

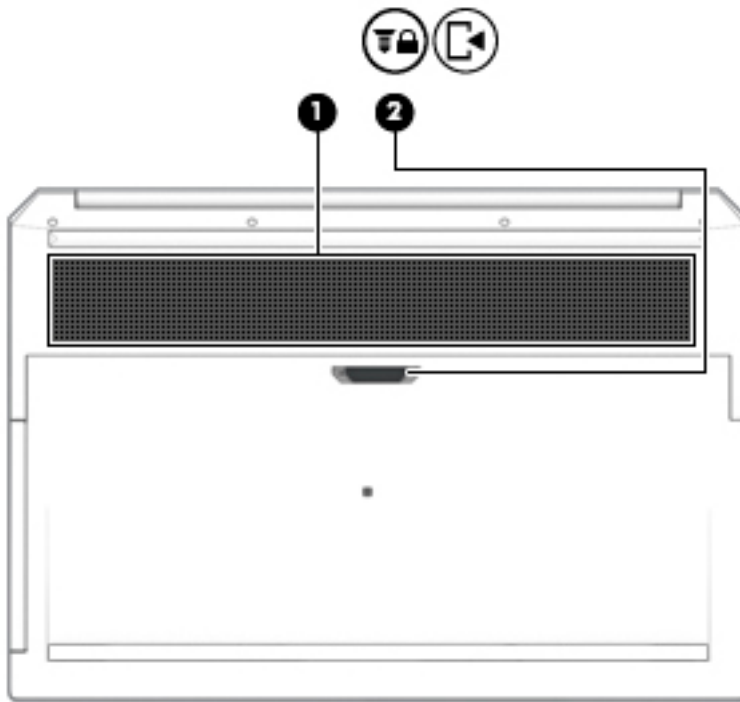

Component	Description
(1) Vent	Enables airflow to cool internal components. <b>NOTE:</b> The computer fan starts up automatically to cool internal components and prevent overheating. It is normal for the internal fan to cycle on and off during routine operation.
(2)  Service door release latch with lock screw	Releases the service door.

## Cover



<b>Component</b>	<b>Description</b>
Internal microphones (2)	Record sound.

## Rear



Component	Description
Vents	Enable airflow to cool internal components. <b>NOTE:</b> The computer fan starts up automatically to cool internal components and prevent overheating. It is normal for the internal fan to cycle on and off during routine operation.

# Labels

The labels affixed to the computer provide information you may need when you troubleshoot system problems or travel internationally with the computer. Labels may be in paper form or imprinted on the product.

 **IMPORTANT:** Check the following locations for the labels described in this section: the bottom of the computer, inside the battery bay, under the service door, on the back of the display, or on the bottom of a tablet kickstand.

- Service label—Provides important information to identify your computer. When contacting support, you may be asked for the serial number, the product number, or the model number. Locate this information before you contact support.

Your service label will resemble one of the examples shown below. Refer to the illustration that most closely matches the service label on your computer.

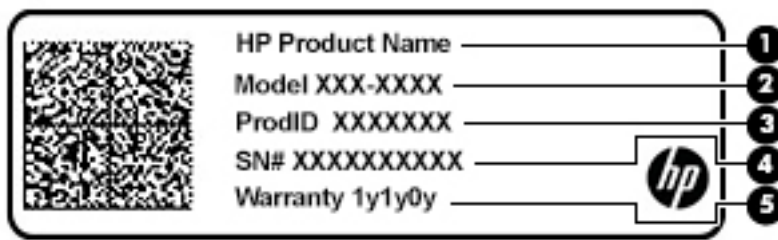

### Component

- (1) HP product name
- (2) Model number
- (3) Product ID
- (4) Serial number
- (5) Warranty period

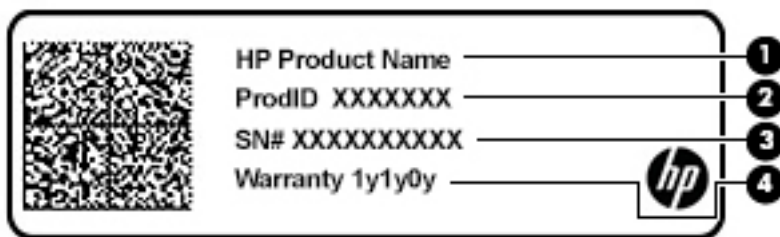

### Component

- (1) HP product name
- (2) Product ID

---

**Component**

---

**(3)** Serial number

---

**(4)** Warranty period

---

- Regulatory label(s)—Provide(s) regulatory information about the computer.
- Wireless certification label(s)—Provide(s) information about optional wireless devices and the approval markings for the countries or regions in which the devices have been approved for use.

---

## 3 Illustrated parts catalog

### Computer major components

---

 **NOTE:** HP continually improves and changes product parts. For complete and current information on supported parts for your computer, go to <http://partsurfer.hp.com>, select your country or region, and then follow the on-screen instructions.

 **NOTE:** Details about your computer, including model, serial number, product key, and length of warranty, are on the service tag at the bottom of your computer. See [Labels on page 26](#) for details.

---



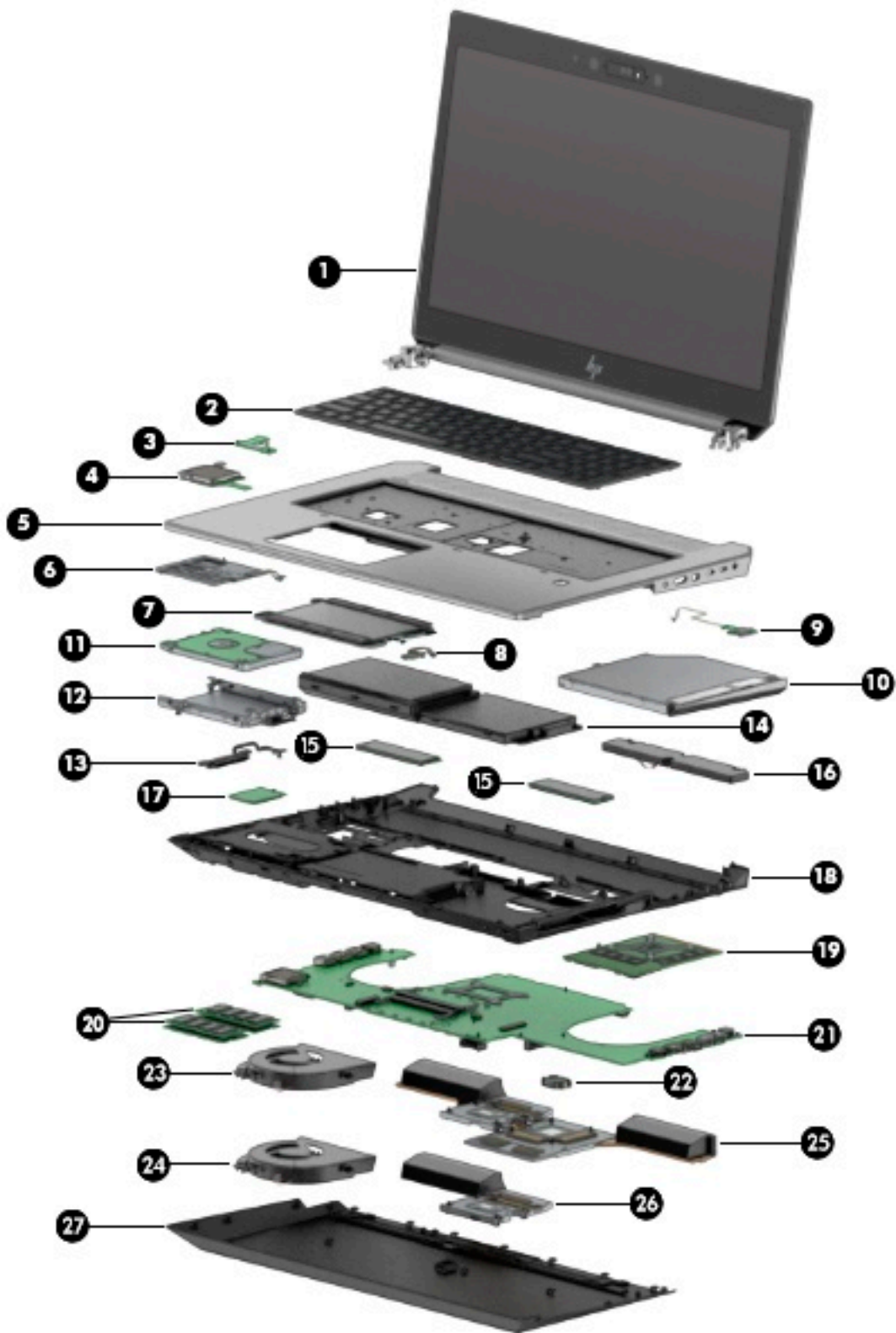

Item	Component	Spare part number
(1)	Display assembly, non-touch, 17.3"	

Item	Component	Spare part number
	Non-touch display assemblies are spared at the subcomponent level only. For more display assembly spare part information, see <a href="#">Display assembly subcomponents on page 33</a> .	
	<b>Display assembly 17.3"</b>	
	Touchscreen, UHD UWVA	L30407-001
	Touchscreen, UHD UWVA, IR	L30408-001
	Touchscreen, UWVA DreamColor	L28468-001
	Touchscreen, UWVA DreamColor, IR	L28469-001
<b>(2)</b>	<b>Keyboard</b>	L28407-xxx
	For a list of keyboard country codes, see <a href="#">Keyboard on page 56</a> .	
<b>(3)</b>	<b>Power button board</b>	L28466-001
<b>(4)</b>	<b>SSD storage board</b>	L30397-001
	<b>HDD storage board</b>	L30396-001
<b>(5)</b>	<b>Top cover</b>	L30661-001
	<b>NFC antenna</b> (not shown)	L30662-001
<b>(6)</b>	<b>Smart card board</b>	L14374-001
<b>(7)</b>	<b>TouchPad</b>	
	For use in models without DreamColor	L30663-001
	For use in models with DreamColor	L31320-001
<b>(8)</b>	<b>NFC module</b>	L02249-001
<b>(9)</b>	<b>Fingerprint reader</b> (includes cable)	L28662-001
<b>(10)</b>	<b>ODD</b>	L31315-001
<b>(11)</b>	<b>Hard drive</b>	
	1 TB, SATA, 7200 RPM, RAW, 7 mm	L06427-850
	2 TB, SATA, 5400 RPM, hybrid, 8 G, RAW, 7 mm	929167-850
	1 TB, SATA, 5400 RPM, hybrid, 8 G, 7 mm	924036-850
	2 TB, SATA, 5400 RPM, RAW, 7 mm, 2.5"	912487-850
	500 GB, 7200 RPM, SATA, SED, RAW, 7 mm	820573-001
	500 GB, 7200 RPM, SATA, FIPS, RAW, 7 mm	820572-001
	500 GB, 5400 RPM, SATA, hybrid, RAW, 7 mm	732000-001
	500 GB, 7200 RPM, 7 mm	703267-001
<b>(12)</b>	<b>HDD bracket</b> , part of the HDD hardware kit	L30394-001
<b>(13)</b>	<b>HDD connector</b> , part of the HDD hardware kit	L30394-001
<b>(14)</b>	<b>Battery</b> (6 cell 95 Wh 4.15 Ah LI)	L07044-855
<b>(15)</b>	<b>SSD</b>	

Item	Component	Spare part number
	1 TB, Z Turbo Drive	L28490-001
	256 GB, Z Turbo Drive	L28491-001
	512 GB, Z Turbo Drive	L28492-001
	1 TB, SATA, TLC	L30762-001
	256 GB, SATA, TLC	L30763-001
	512 GB, PCIe, SS, NVMe, TLC	L28488-001
	512 GB, PCIe, NVMe, Self-encrypting drive (SED), Opal 2, TLC	L28487-001
	512 GB, SATA-3, FIPS-140-2, TLC	L28489-001
	2 TB, PCIe, NVMe, TLC	L28486-001
	256 GB, PCIe, SATA-3, SED, Opal2, TLC	L28485-001
	256 GB, PCIe, NVMe, TLC	L28484-001
	256 GB, NVMe SED, Opal 2, TLC	L28483-001
	16 GB, IO	L28481-001
<b>(16)</b>	<b>Speaker</b> (includes cable)	L28477-001
<b>(17)</b>	<b>WWAN module</b>	
	Macan ME906S LTE with GPS M.2	845710-003
	HP IT4210 LTE/HSPA+ with GPS M.2	L15398-001
<b>(18)</b>	<b>Middle cover</b>	L28471-001
<b>(19)</b>	<b>Discrete MXM daughter card</b>	
	AMD Radeon Pro WX 4170 4 GB	L30654-001
	NVIDIA Quadro P1000 4 GB	L30655-001
	NVIDIA Quadro P2000 4 GB	L30656-001
	NVIDIA Quadro P3200 6 GB	L30657-001
	NVIDIA Quadro P4200 8 GB	L30658-001
	NVIDIA Quadro P5200 16 GB	L30659-001
<b>(20)</b>	<b>Memory module</b> (DDR-2400)	
	4 GB, 2666 MHz, 1.2 v, DDR4	L10598-850
	8 GB, 2666 MHz, 1.2 v, DDR4	937236-850
	16 GB, 2666 MHz, 1.2 v, DDR4	937438-850
	16 GB, 2666 MHz, 1.2 v, DDR4, ECC	L24981-001
	8 GB, 2666 MHz, 1.2 v, DDR4, ECC shared	L24983-001
<b>(21)</b>	<b>System board</b> (includes processor and replacement thermal material, see <a href="#">System board on page 72</a> )	
	All system boards use the following part numbers:	
	xxxxxx-001: Non-Windows operating systems	

<b>Item</b>	<b>Component</b>	<b>Spare part number</b>
	xxxxxx-601: Windows operating system	
	Intel Core i5-8300H processor	L28459-xx1
	Intel Core i5-8400H processor	L28460-xx1
	Intel Core i7-8750H processor	L28461-xx1
	Intel Core i7-8850H processor	L28462-xx1
	Intel Xeon E-2176M processor	L28457-xx1
	Intel Xeon E-2186M processor	L28458-xx1
<b>(22)</b>	<b>RTC battery</b>	L17255-001
<b>(23)</b>	<b>Right fan, GPU</b>	L30389-001
<b>(24)</b>	<b>Left fan, CPU</b>	L30388-001
<b>(25)</b>	<b>Heat sink</b>	L30393-001
	For use in models with discrete graphics F16M memory	
	<b>Heat sink</b>	L30391-001
	For use in models with discrete graphics N18P memory	
	<b>Heat sink</b>	L30392-001
	For use in models with discrete graphics N18E memory	
<b>(26)</b>	<b>Heat sink</b>	L30390-001
	For use in models with UMA graphics	
<b>(27)</b>	<b>Service cover</b>	L30395-001

## Display assembly subcomponents

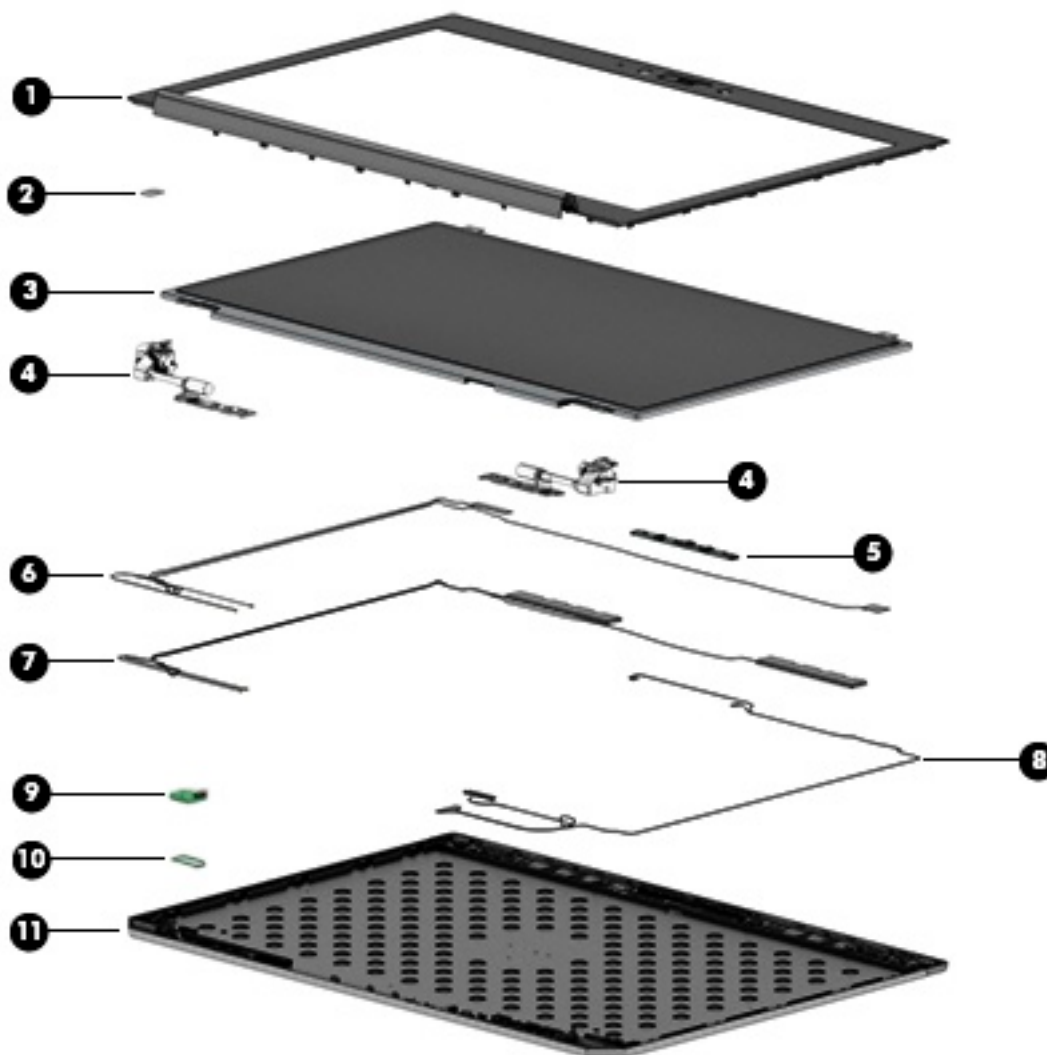

Item	Component	Spare part number
(1)	<b>Bezel</b>	
	For use in models without a webcam	L30403-001
	For use in models with an HD camera (includes camera shutter)	L30401-001
	For use in models with an IR camera (includes camera shutter)	L30402-001
	For use in models with an IR camera and backlight (includes camera shutter)	L31317-001
	For use in models with an HD camera and backlight (includes camera shutter)	L31316-001
	For use in models without a camera and backlight (includes camera shutter)	L31318-001
(2)	<b>Webcam cover</b>	L31319-001
(3)	<b>Raw display panel, 17.3</b>	
	FHD, AG, LED, UWVA	L30405-001

<b>Item</b>	<b>Component</b>	<b>Spare part number</b>
	HD+ AG LED SVA	L30406-001
<b>(4)</b>	<b>Hinges</b>	L28464-001
<b>(5)</b>	<b>Camera module</b>	
	HD camera	L32738-001
	IR camera	L32739-001
	<b>Microphone module</b> (not shown; includes double-sided tape)	L34855-001
<b>(6)</b>	<b>WWAN antenna</b> , part of four antenna kit	L30400-001
<b>(7)</b>	<b>WLAN antenna</b> , part of four antenna kit	L30400-001
<b>(8)</b>	<b>Display cable</b> , includes cables and adhesive	L30404-001
<b>(9)</b>	<b>DreamColor board</b> , includes cable and adhesive	L31321-001
<b>(10)</b>	<b>ALS sensor board</b>	L30665-001
<b>(11)</b>	<b>Display enclosure</b> (includes tape, gasket, and foam)	L28463-001

## Miscellaneous parts

Component	Spare part number
<b>AC adapter</b> 200 W PFC smart slim 4.5 mm	L00818-850
<b>Adapter</b> HP USB-C to VGA	831751-001
<b>Adapter</b> HP ZBook Thunderbolt 3 1 m cable	914966-001
<b>Adapter</b> HP USB-C to HDMI	831752-001
<b>Adapter</b> USB-C to DisplayPort	831753-001
<b>Adapter</b> USB to Gigabit RJ45	829941-001
<b>Adapter</b> HP HDMI to DVI	749038-001
<b>Bracket kit</b> , contains DDR shielding, ODD brackets, USB Type-C brackets, LCD connector brackets, and fingerprint reader brackets	L28479-001
<b>Cable kit</b> , for fingerprint reader, NFC module, and TouchPad	L28473-001
<b>Cable lock</b> , keyed 10 mm	840158-001
<b>Cable lock</b> , dual head keyed	840160-001
<b>Essential Messenger</b>	679922-001
<b>Headset</b> , stereo USB	840340-001
<b>Mouse</b> , comfort grip wireless	691922-001
<b>Mouse</b> , slim Bluetooth	746920-001
<b>Mouse</b> , HP USB laser	674318-001
<b>Mylar kit</b>	L34854-001
<b>ODD bezel</b> , with cable	L30398-001
<b>Plastics kit</b> , contains plastic placeholders for the fan, ODD, fingerprint reader, and SD card	L28480-001
<b>Rubber kit</b> , contains plastic placeholders for the fan, ODD, fingerprint reader, and SD card	L28476-001
<b>Screw kit</b>	L28478-001

---

# 4 Removal and replacement procedures preliminary requirements

## Tools required

You will need the following tools to complete the removal and replacement procedures:

- Phillips P0 screwdriver
- Torx T5 screwdriver
- Thin plastic prying tool

## Service considerations

The following sections include some of the considerations that you must keep in mind during disassembly and assembly procedures.



---

**NOTE:** As you remove each subassembly from the computer, place the subassembly (and all accompanying screws) away from the work area to prevent damage.

---

## Plastic parts



---

**CAUTION:** Using excessive force during disassembly and reassembly can damage plastic parts. Use care when handling the plastic

---



## Cables and connectors

---

**⚠ CAUTION:** When servicing the computer, be sure that cables are placed in their proper locations during the reassembly process. Improper cable placement can damage the computer.

---

Cables must be handled with extreme care to avoid damage. Apply only the tension required to unseat or seat the cables during removal and insertion. Handle cables by the connector whenever possible. In all cases, avoid bending, twisting, or tearing cables. Be sure that cables are routed in such a way that they cannot be caught or snagged by parts being removed or replaced. Handle flex cables with extreme care; these cables tear easily.

## Drive handling

---

**⚠ CAUTION:** Drives are fragile components that must be handled with care. To prevent damage to the computer, damage to a drive, or loss of information, observe these precautions:

---

Before removing or inserting a hard drive, shut down the computer. If you are unsure whether the computer is off or in Hibernation, turn the computer on, and then shut it down through the operating system.

Before handling a drive, be sure that you are discharged of static electricity. While handling a drive, avoid touching the connector.

Before removing a diskette drive or optical drive, be sure that a diskette or disc is not in the drive and be sure that the optical drive tray is closed.

Handle drives on surfaces covered with at least one inch of shock-proof foam.

Avoid dropping drives from any height onto any surface.

Avoid exposing an internal hard drive to products that have magnetic fields, such as monitors or speakers.

Avoid exposing an internal hard drive to products that have magnetic fields, such as monitors or speakers.

Avoid exposing a drive to temperature extremes or liquids.

If a drive must be mailed, place the drive in a bubble pack mailer or other suitable form of protective packaging and label the package "FRAGILE."

---

# Grounding guidelines

## Electrostatic discharge damage

Electronic components are sensitive to electrostatic discharge (ESD). Circuitry design and structure determine the degree of sensitivity. Networks built into many integrated circuits provide some protection, but in many cases, ESD contains enough power to alter device parameters or melt silicon junctions.

A discharge of static electricity from a finger or other conductor can destroy static-sensitive devices or microcircuitry. Even if the spark is neither felt nor heard, damage may have occurred.

An electronic device exposed to ESD may not be affected at all and can work perfectly throughout a normal cycle. Or the device may function normally for a while, then degrade in the internal layers, reducing its life expectancy.

**⚠ CAUTION:** To prevent damage to the computer when you are removing or installing internal components, observe these precautions:

Keep components in their electrostatic-safe containers until you are ready to install them.

Before touching an electronic component, discharge static electricity by using the guidelines described in this section.

Avoid touching pins, leads, and circuitry. Handle electronic components as little as possible.

If you remove a component, place it in an electrostatic-safe container.

The following table shows how humidity affects the electrostatic voltage levels generated by different activities.

**⚠ CAUTION:** A product can be degraded by as little as 700 V.

Typical electrostatic voltage levels			
Event	Relative humidity		
	10%	40%	55%
Walking across carpet	35,000 V	15,000 V	7,500 V
Walking across vinyl floor	12,000 V	5,000 V	3,000 V
Motions of bench worker	6,000 V	800 V	400 V
Removing DIPS from plastic tube	2,000 V	700 V	400 V
Removing DIPS from vinyl tray	11,500 V	4,000 V	2,000 V
Removing DIPS from Styrofoam	14,500 V	5,000 V	3,500 V
Removing bubble pack from PCB	26,500 V	20,000 V	7,000 V
Packing PCBs in foam-lined box	21,000 V	11,000 V	5,000 V

## Packaging and transporting guidelines

Follow these grounding guidelines when packaging and transporting equipment:

- To avoid hand contact, transport products in static-safe tubes, bags, or boxes.
- Protect ESD-sensitive parts and assemblies with conductive or approved containers or packaging.
- Keep ESD-sensitive parts in their containers until the parts arrive at static-free workstations.
- Place items on a grounded surface before removing items from their containers.
- Always be properly grounded when touching a component or assembly.
- Store reusable ESD-sensitive parts from assemblies in protective packaging or nonconductive foam.
- Use transporters and conveyors made of antistatic belts and roller bushings. Be sure that mechanized equipment used for moving materials is wired to ground and that proper materials are selected to avoid static charging. When grounding is not possible, use an ionizer to dissipate electric charges.

## Workstation guidelines

Follow these grounding workstation guidelines:

- Cover the workstation with approved static-shielding material.
- Use a wrist strap connected to a properly grounded work surface and use properly grounded tools and equipment.
- Use conductive field service tools, such as cutters, screwdrivers, and vacuums.
- When fixtures must directly contact dissipative surfaces, use fixtures made only of static safe materials.
- Keep the work area free of nonconductive materials, such as ordinary plastic assembly aids and Styrofoam.
- Handle ESD-sensitive components, parts, and assemblies by the case or PCM laminate. Handle these items only at static-free workstations.
- Avoid contact with pins, leads, or circuitry.
- Turn off power and input signals before inserting or removing connectors or test equipment.

## Equipment guidelines

Grounding equipment must include either a wrist strap or a foot strap at a grounded workstation.

- When seated, wear a wrist strap connected to a grounded system. Wrist straps are flexible straps with a minimum of one megohm  $\pm 10\%$  resistance in the ground cords. To provide proper ground, wear a strap snugly against the skin at all times. On grounded mats with banana-plug connectors, use alligator clips to connect a wrist strap.
- When standing, use foot straps and a grounded floor mat. Foot straps (heel, toe, or boot straps) can be used at standing workstations and are compatible with most types of shoes or boots. On conductive floors or dissipative floor mats, use foot straps on both feet with a minimum of one megohm resistance between the operator and ground. To be effective, the conductive must be worn in contact with the skin.

The following grounding equipment is recommended to prevent electrostatic damage:

- Antistatic tape
- Antistatic smocks, aprons, and sleeve protectors
- Conductive bins and other assembly or soldering aids
- Nonconductive foam
- Conductive tabletop workstations with ground cords of one megohm resistance
- Static-dissipative tables or floor mats with hard ties to the ground
- Field service kits
- Static awareness labels
- Material-handling packages
- Nonconductive plastic bags, tubes, or boxes
- Metal tote boxes
- Electrostatic voltage levels and protective materials

The following table lists the shielding protection provided by antistatic bags and floor mats.

Material	Use	Voltage protection level
Antistatic plastics	Bags	1,500 V
Carbon-loaded plastic	Floor mats	7,500 V
Metallized laminate	Floor mats	5,000 V

# 5 Removal and replacement procedures for Customer Self-Repair parts

This chapter provides removal and replacement procedures for Customer Self-Repair parts.

 **NOTE:** The Customer Self-Repair program is not available in all locations. Installing a part not supported by the Customer Self-Repair program may void your warranty. Check your warranty to determine if Customer Self-Repair is supported in your location.

## Component replacement procedures

 **NOTE:** Details about your computer, including model, serial number, product key, and length of warranty, are on the service tag at the bottom of your computer. See [Labels on page 26](#) for details.

 **NOTE:** HP continually improves and changes product parts. For complete and current information on supported parts for your computer, go to <http://partsurfer.hp.com>, select your country or region, and then follow the on-screen instructions.

There are as many as 16 screws that must be removed, replaced, and/or loosened when servicing Customer Self-Repair parts. Make special note of each screw size and location during removal and replacement.

## Service door

Description	Spare part number
Service door	L30395-001

Before removing the service door, follow these steps:

1. Turn off the computer. If you are unsure whether the computer is off or in Hibernation, turn the computer on, and then shut it down through the operating system.
2. Disconnect the power from the computer by unplugging the power cord from the computer.
3. Disconnect all external devices from the computer.

Remove the service door:

1. Turn the computer upside down on a flat surface.

2. Remove the optional lock screw **(1)**, slide the service door release latch **(2)** and then slide the service door to remove it **(3)**.

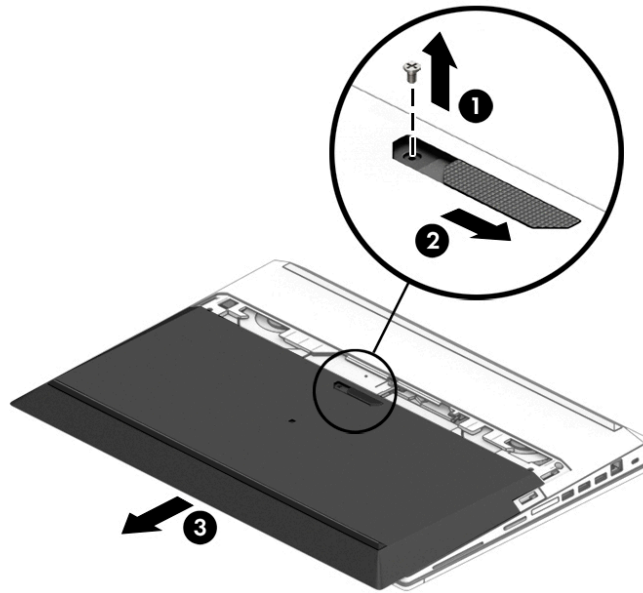

Reverse the removal procedures to install the service door.

## Battery

Description	Spare part number
<b>Battery</b> (6 cell 95 Wh 4.15 Ah LI)	L07044-855

Before removing the battery, follow these steps:

1. Shut down the computer. If you are unsure whether the computer is off or in Hibernation, turn the computer on, and then shut it down through the operating system.
2. Disconnect all external devices connected to the computer.
3. Disconnect the power from the computer by first unplugging the power cord from the AC outlet, and then unplugging the AC adapter from the computer.
4. Remove the service door (see [Service door on page 41](#)).

Remove the battery:

To remove the user-replaceable battery, refer to the steps and illustration below that most closely match your computer:

- ▲ Slide the battery release latches **(1)** and then pull the battery tab **(2)** up to remove the battery from the computer.

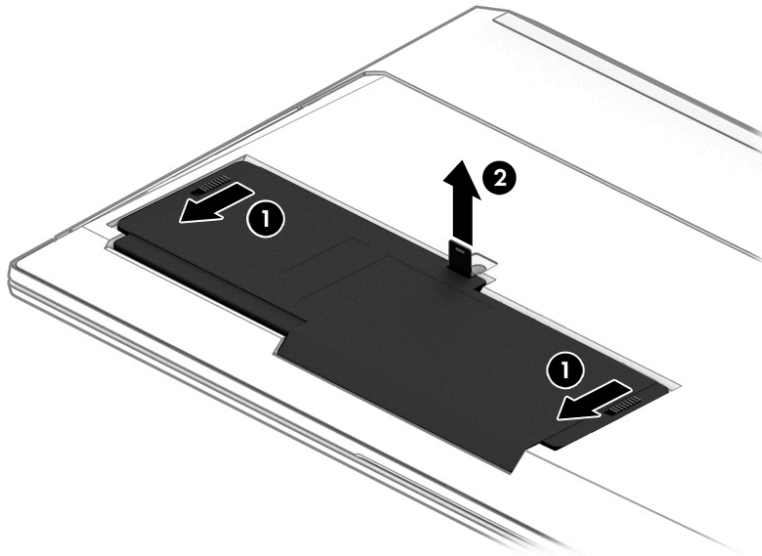

 **NOTE:** The battery release latches automatically returns to the original positions.

Reverse this procedure to install the battery module.

## Hard drive (HDD)

Description	Spare part number
1 TB, SATA, 7200 RPM, RAW, 7 mm	L06427-850
2 TB, SATA, 5400 RPM, hybrid, 8 G, RAW, 7 mm	929167-850
1 TB, SATA, 5400 RPM, hybrid, 8 G, 7 mm	924036-850
2 TB, SATA, 5400 RPM, RAW, 7 mm, 2.5"	912487-850
500 GB, 7200 RPM, SATA, SED, RAW, 7 mm	820573-001
500 GB, 7200 RPM, SATA, FIPS, RAW, 7 mm	820572-001
500 GB, 5400 RPM, SATA, hybrid, RAW, 7 mm	732000-001
500 GB, 7200 RPM, 7 mm	703267-001
<b>HDD bracket</b> , part of the HDD hardware kit	L30394-001
<b>HDD connector</b> , part of the HDD hardware kit	L30394-001

Before removing the hard drive, follow these steps:

1. Turn off the computer. If you are unsure whether the computer is off or in Hibernation, turn the computer on, and then shut it down through the operating system.
2. Disconnect the power from the computer by unplugging the power cord from the computer.
3. Disconnect all external devices from the computer.
4. Remove the bottom cover (see [Service door on page 41](#)).
5. Remove the battery (see [Battery on page 43](#)).

Remove the hard drive:

1. Release the 3 captive Phillips screws **(1)** that secure the drive to the system board.
2. Lift the hard drive release tab **(2)**



3. Lift the drive **(3)** to remove it.

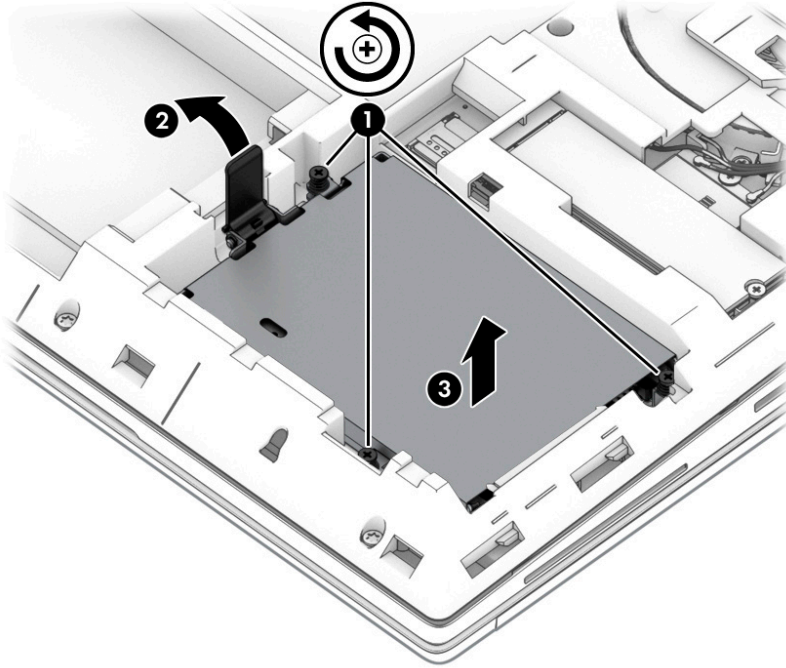

4. If it is necessary to replace the hard drive bracket, remove the four screws **(1)** on the bracket from the hard drive, and then lift the bracket straight up **(2)** and remove the bracket from the hard drive.

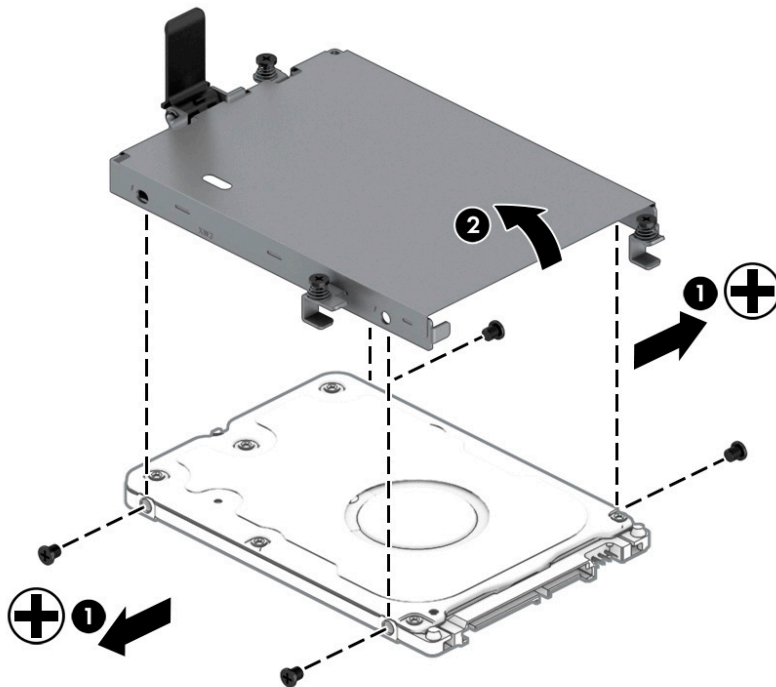

Reverse this procedure to install the hard drive.

## Solid-state drive (SSD)

Description	Spare part number
<b>SSD</b>	
1 TB, Z Turbo Drive	L28490-001
256 GB, Z Turbo Drive	L28491-001
512 GB, Z Turbo Drive	L28492-001
1 TB, SATA, TLC	L30762-001
256 GB, SATA, TLC	L30763-001
512 GB, PCIe, SS, NVMe, TLC	L28488-001
512 GB, PCIe, NVMe, Self-encrypting drive (SED), Opal 2, TLC	L28487-001
512 GB, SATA-3, FIPS-140-2, TLC	L28489-001
2 TB, PCIe, NVMe, TLC	L28486-001
256 GB, PCIe, SATA-3, SED, Opal2, TLC	L28485-001
256 GB, PCIe, NVMe, TLC	L28484-001
256 GB, NVMe SED, Opal 2, TLC	L28483-001
16 GB, IO	L28481-001



**NOTE:** An additional SSD slot is available under the system board. That part is not a customer self-repair part.

Before removing the solid-state drive, follow these steps:

1. Turn off the computer. If you are unsure whether the computer is off or in Hibernation, turn the computer on, and then shut it down through the operating system.
2. Disconnect the power from the computer by unplugging the power cord from the computer.
3. Disconnect all external devices from the computer.
4. Remove the bottom cover (see [Service door on page 41](#)).
5. Remove the battery (see [Battery on page 43](#)).

Remove the solid-state drive:

1. Remove the Phillips M2.0×2.0 screw **(1)** that secures the drive to the system board.

2. Remove the drive by pulling it away from the connector **(2)**.

 **NOTE:** M.2 solid-state drives are designed with notches to prevent incorrect insertion.

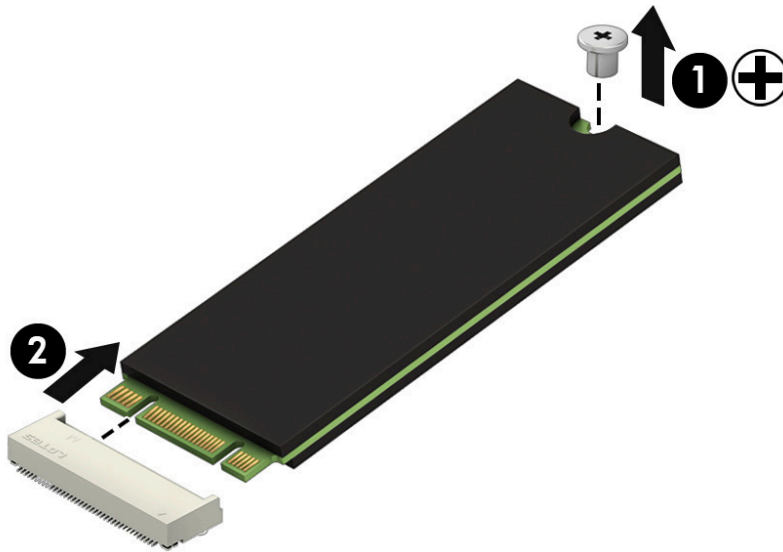

Reverse this procedure to install the solid-state drive.

## ODD

Description	Spare part number
ODD	L31315-001

Before removing the ODD, follow these steps:

1. Shut down the computer. If you are unsure whether the computer is off or in Hibernation, turn the computer on, and then shut it down through the operating system.
2. Disconnect all external devices connected to the computer.
3. Disconnect the power from the computer by first unplugging the power cord from the AC outlet, and then unplugging the AC adapter from the computer.
4. Remove the bottom cover (see [Service door on page 41](#)).
5. Remove the battery (see [Battery on page 43](#)).

Remove the ODD:

1. Remove the Phillips M2.0×2.0 screw **(1)** that secures the ODD to the computer.
2. Use a thin tool **(2)** to release the ODD from the computer.

3. Pull the ODD (3) away from the computer to remove it.

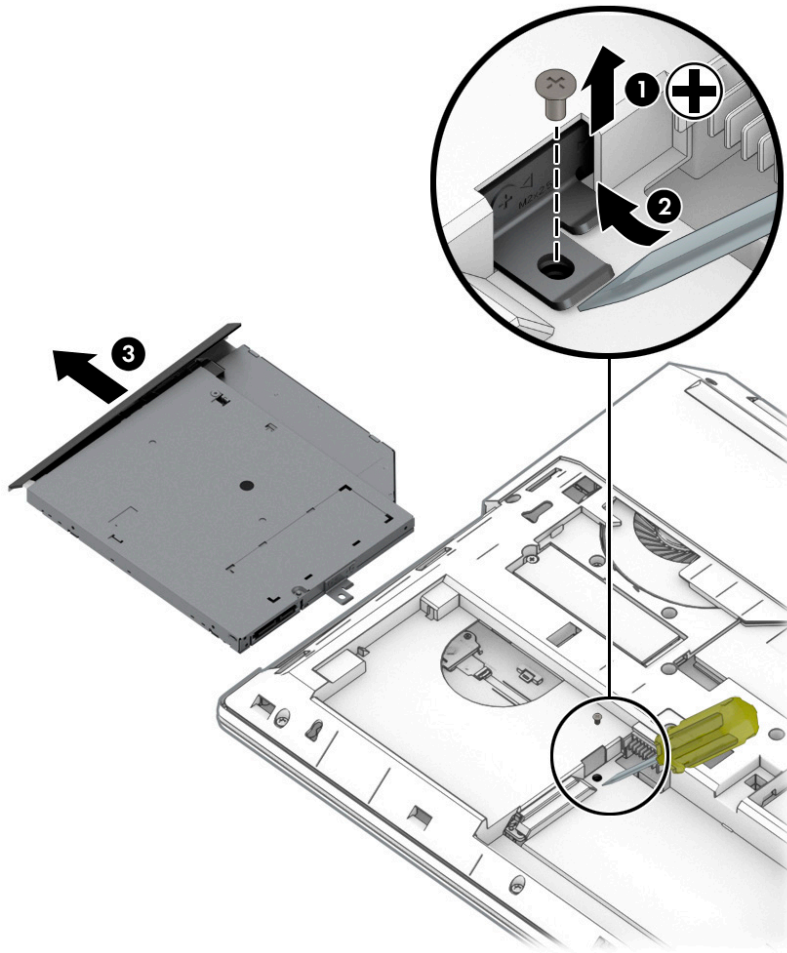

4. To remove the ODD bracket, remove the two screws **(1)** securing the bracket to the ODD, and then remove the bracket **(2)**.

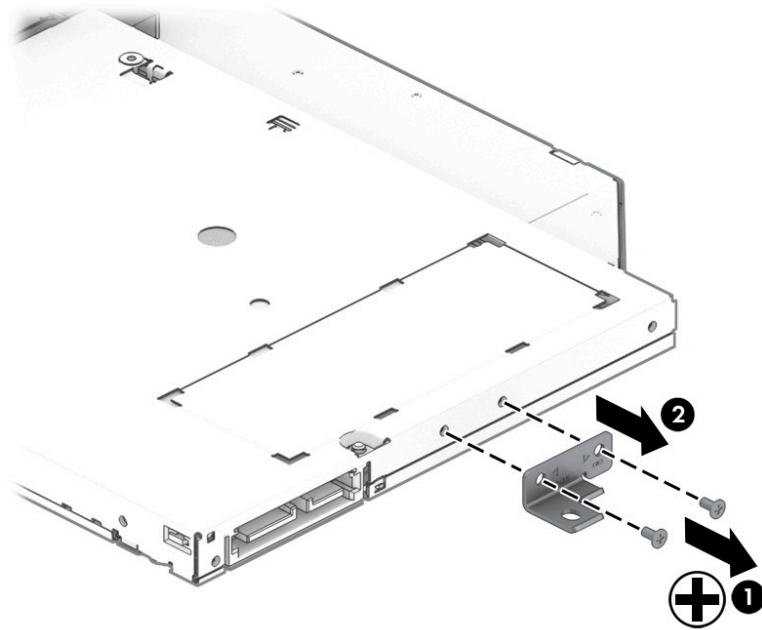

Reverse this procedure to install the ODD.

## Memory modules

 **NOTE:** Primary and expansion memory is installed in a side-by-side configuration in the bottom of the computer.

If only one memory module is installed, it must be installed in the socket labeled '1'.

 **NOTE:** Two additional memory slots are available under the system board. These are not customer self-repair parts.

Description	Spare part number
4 GB, 2666 MHz, 1.2 v, DDR4	L10598-850
8 GB, 2666 MHz, 1.2 v, DDR4	937236-850
16 GB, 2666 MHz, 1.2 v, DDR4	937438-850
16 GB, 2666 MHz, 1.2 v, DDR4, ECC	L24981-001
8 GB, 2666 MHz, 1.2 v, DDR4, ECC shared	L24983-001

### Update BIOS before adding memory modules

Before adding new memory, make sure you update the computer to the latest BIOS.

 **CAUTION:** Failure to update the computer to the latest BIOS prior to installing new memory may result in various system problems.

To update BIOS:

1. Navigate to [www.hp.com](http://www.hp.com).
2. Click **Support & Drivers** > click **Drivers & Software**.
3. In the **Enter a product name/number** box, type the computer model information, and then click **Search**.
4. Click the link for the computer model.
5. Select the operating system, and then click **Next**.
6. Under **Step 2: Select a Download**, click the **BIOS** link.
7. Click the link for the most recent BIOS.
8. Click the **Download** button, and then follow the on-screen instructions.

Before removing the memory module, follow these steps:

1. Shut down the computer. If you are unsure whether the computer is off or in Hibernation, turn the computer on, and then shut it down through the operating system.
2. Disconnect all external devices connected to the computer.
3. Disconnect the power from the computer by first unplugging the power cord from the AC outlet, and then unplugging the AC adapter from the computer.
4. Remove the bottom cover (see [Service door on page 41](#)).
5. Remove the battery (see [Battery on page 43](#)).

Remove the memory module:

1. Use a thin tool **(1)** to lift the memory shield, and then remove the shield **(2)**.

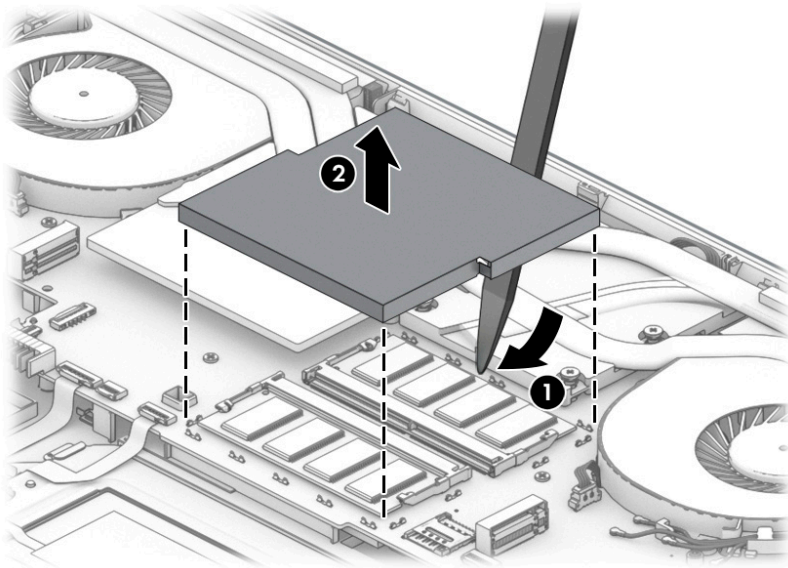

2. Spread the retaining tabs **(1)** on each side of the memory module slot to release the memory module. (The edge of the module opposite the slot rises away from the computer.)
3. Remove the memory module **(2)** by pulling the module away from the slot at an angle.

 **NOTE:** Memory modules are designed with a notch to prevent incorrect insertion into the memory module slot.

 **NOTE:** The computer uses two memory sockets. The socket labeled '2' houses the expansion memory module and the socket labeled '1' houses the primary memory module. The removal procedure is the same for both memory sockets.

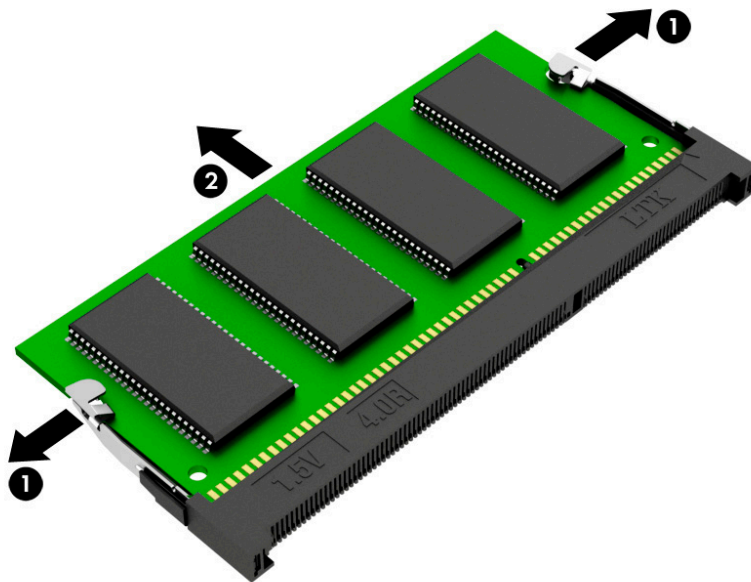

Reverse this procedure to install a memory module.



## SIM card

Before removing the SIM card, follow these steps:

1. Shut down the computer. If you are unsure whether the computer is off or in Hibernation, turn the computer on, and then shut it down through the operating system.
2. Disconnect all external devices connected to the computer.
3. Disconnect the power from the computer by first unplugging the power cord from the AC outlet, and then unplugging the AC adapter from the computer.
4. Remove the bottom cover (see [Service door on page 41](#)).
5. Remove the battery (see [Battery on page 43](#)).

Remove the SIM card:

1. Lift the SIM card bracket **(1)**.
2. Lift the SIM card **(2)** to remove it.

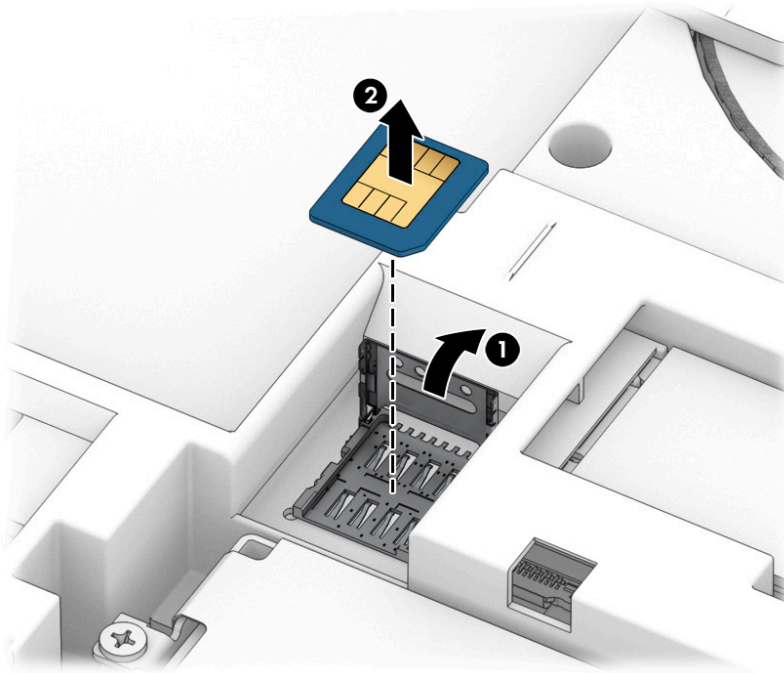

Reverse this procedure to install a SIM card.

## WWAN module

The WLAN module and WWAN module are not interchangeable.

The WWAN module is available on select models only.

Description	Spare part number
Macan ME906S LTE with GPS M.2	845710-003
HP IT4210 LTE/HSPA+ with GPS M.2	L15398-001

Before removing the WWAN module, follow these steps:

1. Shut down the computer. If you are unsure whether the computer is off or in Hibernation, turn the computer on, and then shut it down through the operating system.
2. Disconnect all external devices connected to the computer.
3. Disconnect the power from the computer by first unplugging the power cord from the AC outlet, and then unplugging the AC adapter from the computer.
4. Remove the bottom cover (see [Service door on page 41](#)).
5. Remove the battery (see [Battery on page 43](#)).



**NOTE:** The red WWAN antenna cable is connected to the WWAN module 'Main' terminal. The blue WWAN antenna cable is connected to the WWAN module 'Aux' terminal.

Remove the WWAN module:

1. Position the computer upside-down.
2. Remove the plastic cover **(1)** protecting the WWAN card.
3. Disconnect the WWAN antenna cables **(2)** from the terminals on the WWAN module.
4. Remove the Phillips M2.0×2.0 screw **(3)** that secures the WWAN module to the computer. (The edge of the module opposite the slot rises away from the computer.)

5. Remove the WWAN module (4) by pulling the module away from the slot at an angle.

 **NOTE:** WWAN modules are designed with a notch to prevent incorrect insertion.

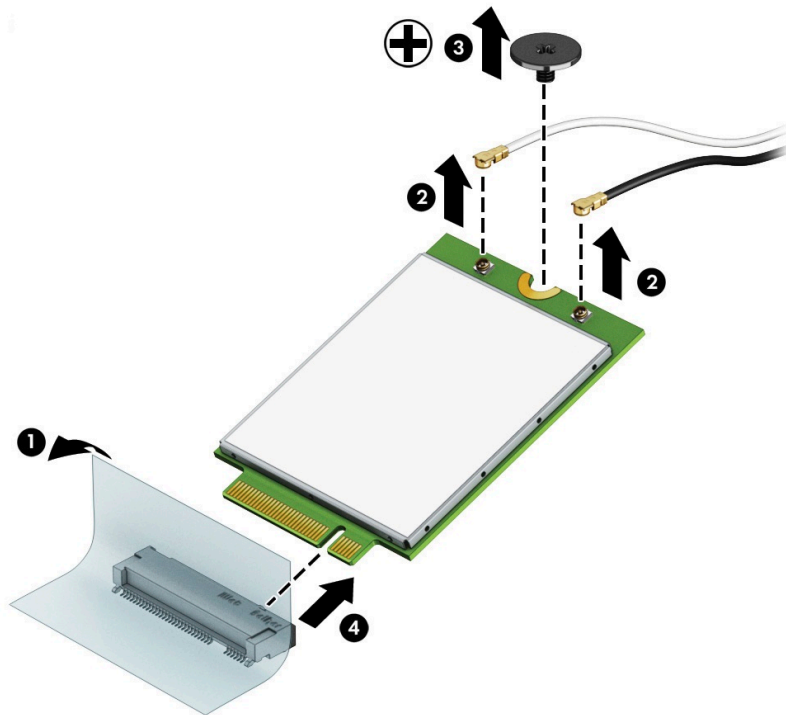

 **NOTE:** If the WWAN antennas are not connected to the terminals on the WWAN module, the protective sleeves must be installed on the antenna connectors, as shown in the following illustration.

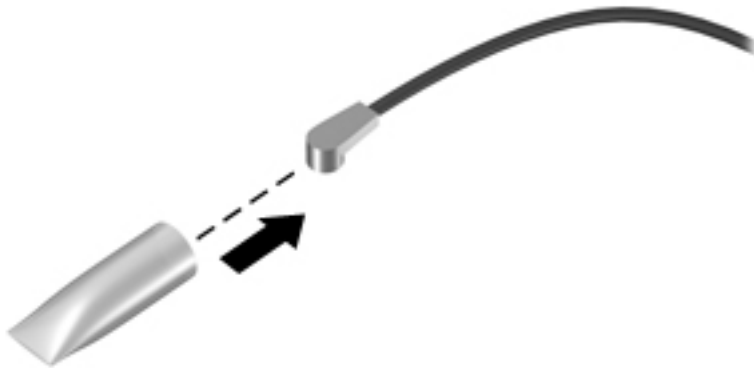

Reverse this procedure to install the WWAN module.

## Keyboard

Description	Spare part number	Description	Spare part number
For use in Africa (French)	L28407-FP1	For use in Japan	L28407-291
For use in Belgium	L28407-A41	For use in Latin America	L28407-161
For use in Brazil	L28407-201	For use in the Netherlands	L28407-B31
For use in Bulgaria	L28407-261	For use in Portugal	L28407-131
For use in Canada (English)	L28407-DB1	For use in Russia	L28407-251
For use in the Czech Republic and Slovenia	L28407-FL1	For use in Saudi Arabia	L28407-171
For use in Denmark	L28407-081	For use in Slovenia	L28407-BA1
For use in Denmark, Finland, and Norway	L28407-DH1	For use in South Korea	L28407-AD1
For use in France	L28407-051	For use in Spain	L28407-071
For use in Germany	L28407-041	For use in Sweden and Finland	L28407-B71
For use in Greece	L28407-151	For use in Switzerland	L28407-BG1
For use in Hungary	L28407-211	For use in Thailand	L28407-281
For use in Iceland	L28407-DD1	For use in Turkey	L28407-141
For use in India	L28407-D61	For use in Taiwan	L28407-AB1
For use in Israel	L28407-BB2	For use in the United Kingdom	L28407-031
For use in Italy	L28407-061	For use in the United States	L28407-001

Before removing the keyboard, follow these steps:

1. Turn off the computer. If you are unsure whether the computer is off or in Hibernation, turn the computer on, and then shut it down through the operating system.
2. Disconnect the power from the computer by unplugging the power cord from the computer.
3. Disconnect all external devices from the computer.
4. Remove the any smart cards and memory cards.
5. Remove the bottom cover (see [Service door on page 41](#)).
6. Remove the battery (see [Battery on page 43](#)).
7. Remove the memory modules (see [Memory modules on page 51](#)).
8. Remove the ODD (see [ODD on page 48](#)).
9. Remove the SSDs (see [Solid-state drive \(SSD\) on page 46](#)).

Remove the keyboard:

1. Remove the 3 Phillips PM2.5×8.0 screws that secure the keyboard.

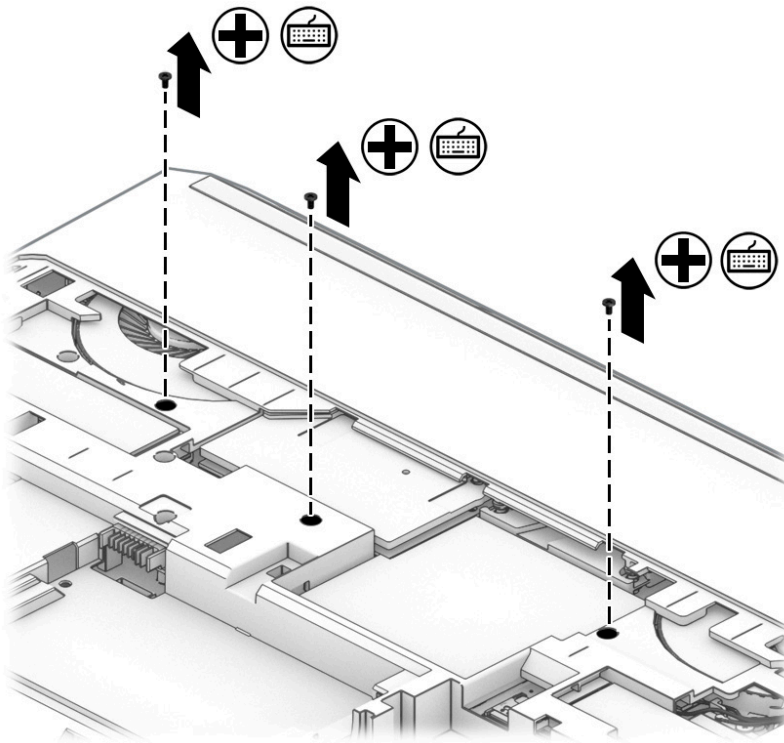

2. Use a thin plastic tool to release the keyboard from the bottom.

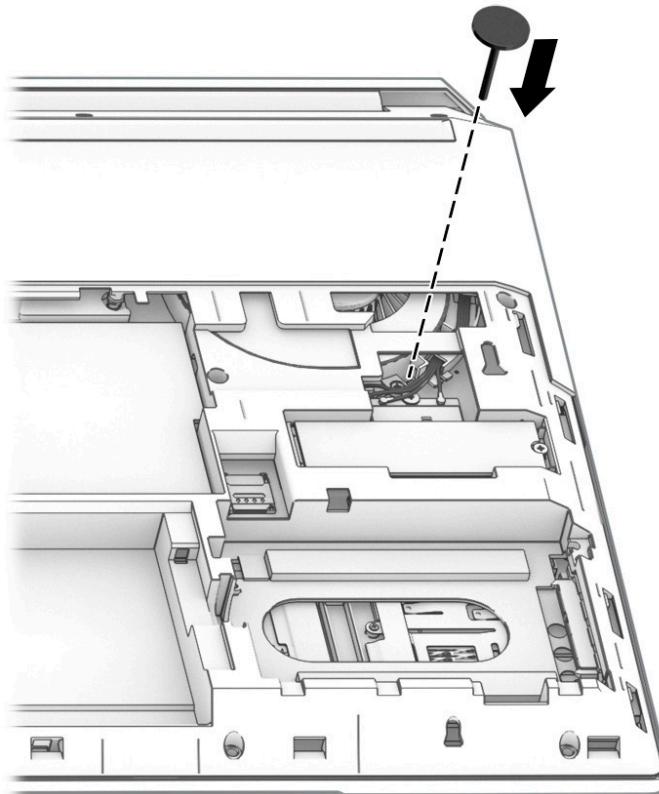

3. Turn over the computer, and then Insert a case utility tool **(1)** or similar thin, plastic tool between the front edge of the keyboard and the bottom cover.

4. Lift the back edge **(2)** of the keyboard until it separates from the front edge of the bottom cover.

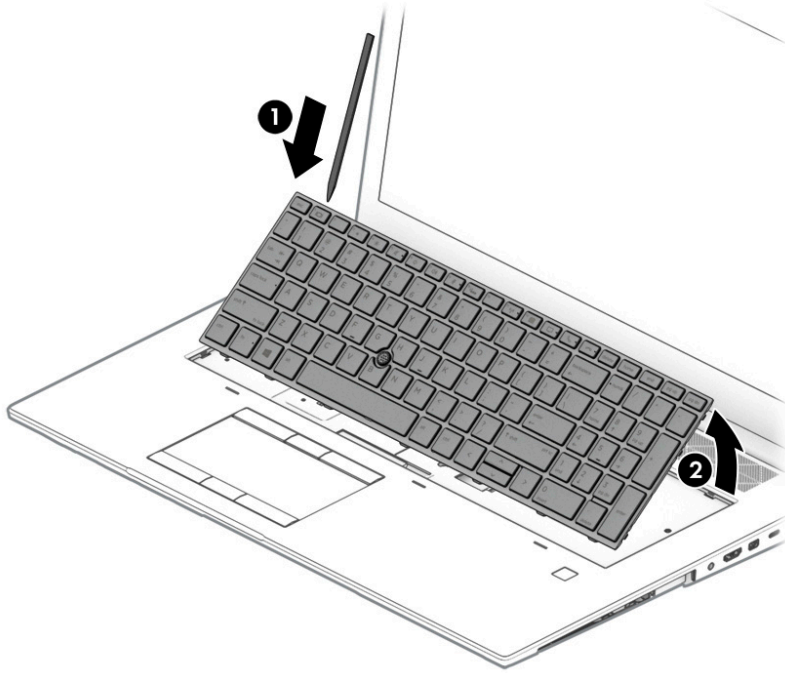

5. Rotate the keyboard face down **(1)**.
6. Release the zero insertion force (ZIF) connector **(2)**, and then disconnect the following cables **(3)** from the system board:
  - TouchPad button cable
  - Keyboard backlight cable
  - Keyboard cable

7. Remove the keyboard (4).

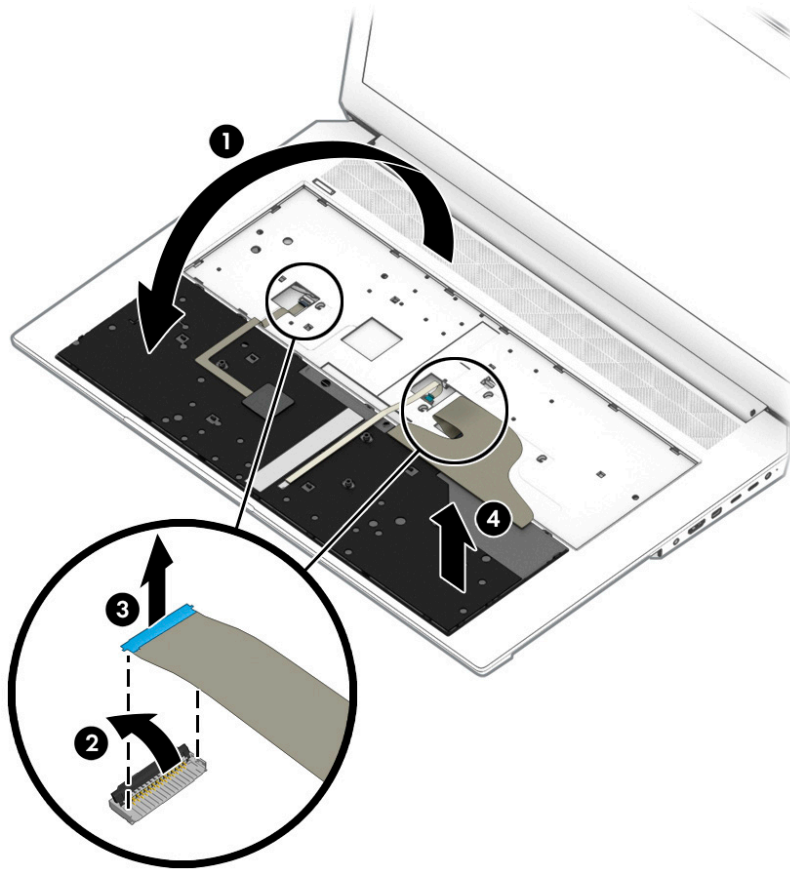

Reverse this procedure to install the keyboard.

---

## 6 Removal and replacement procedures for Authorized Service Provider parts

This chapter provides removal and replacement procedures for Authorized Service Provider only parts.

 **CAUTION:** Components described in this chapter should only be accessed by an authorized service provider. Accessing these parts can damage the computer or void the warranty.

**CAUTION:** This computer does not have user-replaceable parts. Only HP authorized service providers should perform the removal and replacement procedures described here. Accessing the internal part could damage the computer or void the warranty.

---

### Component replacement procedures

 **NOTE:** Details about your computer, including model, serial number, product key, and length of warranty, are on the service tag at the bottom of your computer. See [Labels on page 26](#) for details.

 **NOTE:** HP continually improves and changes product parts. For complete and current information on supported parts for your computer, go to <http://partsurfer.hp.com>, select your country or region, and then follow the on-screen instructions.

---

There are as many as 63 screws that must be removed, replaced, and/or loosened when servicing Authorized Service Provider only parts. Make special note of each screw size and location during removal and replacement.



## Middle cover

Description	Spare part number
Middle cover	L28471-001

Before removing the middle cover, follow these steps:

1. Turn off the computer. If you are unsure whether the computer is off or in Hibernation, turn the computer on, and then shut it down through the operating system.
2. Disconnect the power from the computer by unplugging the power cord from the computer.
3. Disconnect all external devices from the computer.
4. Remove the any smart cards and memory cards.
5. Remove the bottom cover (see [Service door on page 41](#)).
6. Remove the battery (see [Battery on page 43](#)).
7. Remove the memory modules (see [Memory modules on page 51](#)).
8. Remove the ODD (see [ODD on page 48](#)).
9. Remove the SSDs (see [Solid-state drive \(SSD\) on page 46](#)).

Remove the middle cover:

1. Remove the 3 M2\*2.5 Phillips head screws **(1)** in the ODD area.
2. Remove the M2\*8 Phillips head screws **(2)**.
3. Loosen the 4 Torx head screws **(3)** at the front.
4. Remove the 10 M2.5\*8 Torx head screws **(4)**.

5. Starting from the left side, use a thin plastic tool (5) to release the middle cover for the keyboard.

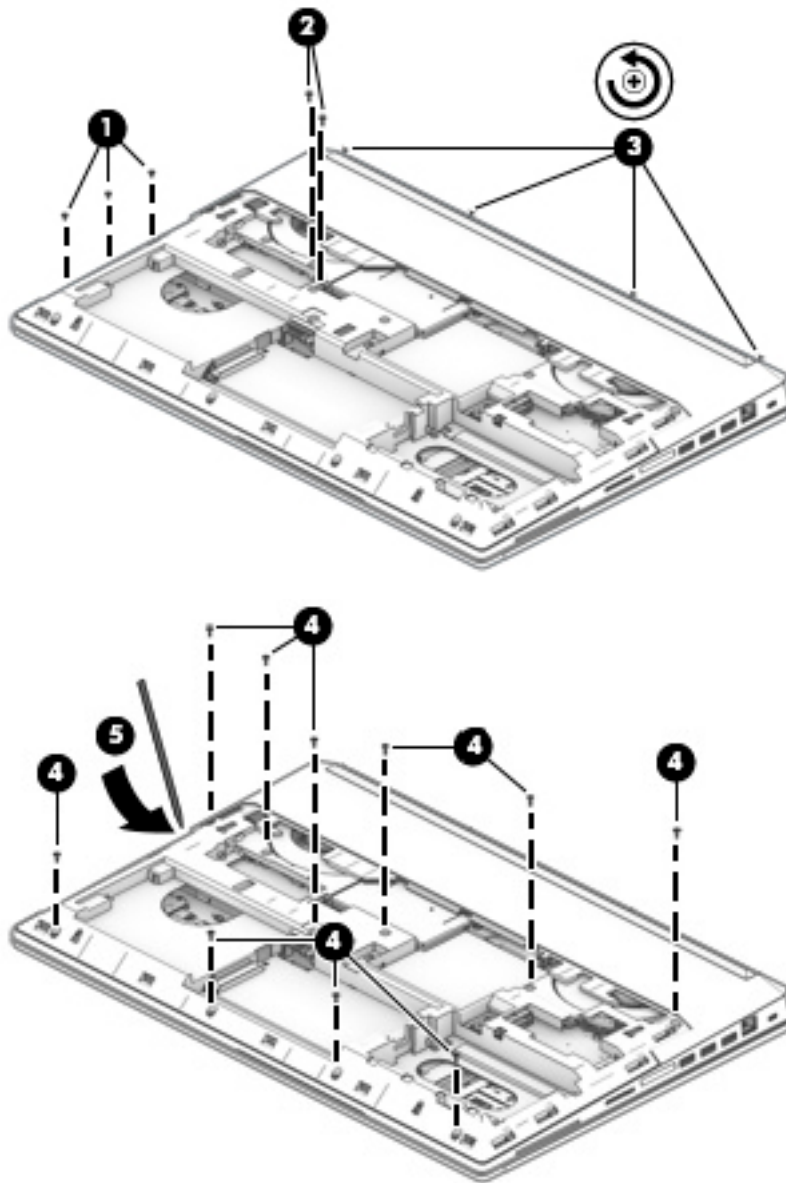

Reverse this procedure to install the middle cover.

## Fingerprint reader assembly

Description	Spare part number
Fingerprint reader assembly (includes cable)	L28662-001

Before removing the fingerprint reader assembly, follow these steps:

1. Turn off the computer. If you are unsure whether the computer is off or in Hibernation, turn the computer on, and then shut it down through the operating system.
2. Disconnect the power from the computer by unplugging the power cord from the computer.
3. Disconnect all external devices from the computer.
4. Remove the any smart cards and memory cards.
5. Remove the bottom cover (see [Service door on page 41](#)).
6. Remove the battery (see [Battery on page 43](#)).
7. Remove the memory modules (see [Memory modules on page 51](#)).
8. Remove the ODD (see [ODD on page 48](#)).
9. Remove the SSDs (see [Solid-state drive \(SSD\) on page 46](#)).
10. Remove the middle cover (see [Middle cover on page 61](#)).

Remove the fingerprint reader assembly:

1. Disconnect the fingerprint ribbon cable **(1)** from the system board.
2. Remove the Phillips M2.0×2.5 screw **(2)** that secures the fingerprint reader bracket to the computer.
3. Lift the bracket **(3)** from atop the fingerprint reader assembly.

4. Lift the thermal tape and remove the fingerprint reader (4) from the computer.

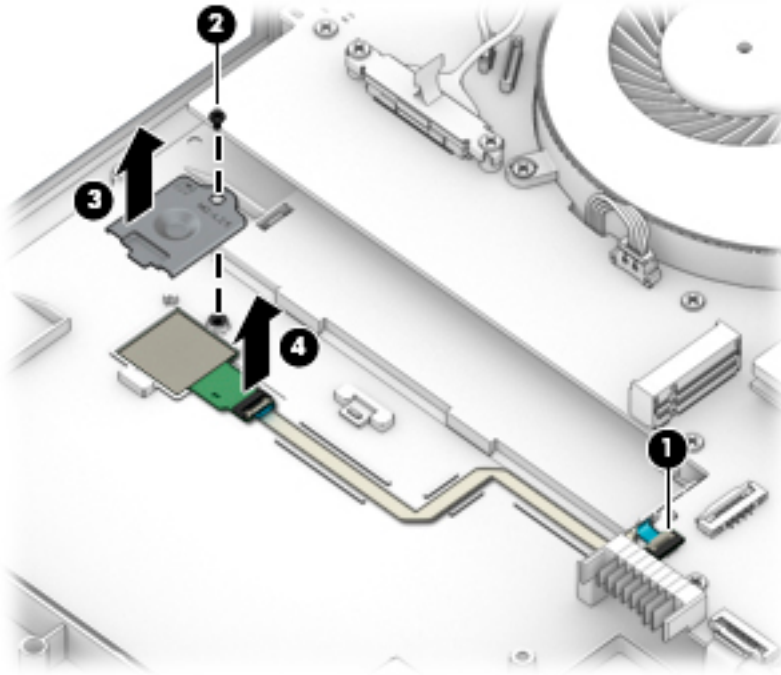

Reverse this procedure to install the fingerprint reader assembly.

## Smart card board

Description	Spare part number
Smart card board	L14374-001

Before removing the smart card board, follow these steps:

1. Turn off the computer. If you are unsure whether the computer is off or in Hibernation, turn the computer on, and then shut it down through the operating system.
2. Disconnect the power from the computer by unplugging the power cord from the computer.
3. Disconnect all external devices from the computer.
4. Remove the any smart cards and memory cards.
5. Remove the bottom cover (see [Service door on page 41](#)).
6. Remove the battery (see [Battery on page 43](#)).
7. Remove the memory modules (see [Memory modules on page 51](#)).
8. Remove the ODD (see [ODD on page 48](#)).
9. Remove the SSDs (see [Solid-state drive \(SSD\) on page 46](#)).
10. Remove the middle cover (see [Middle cover on page 61](#)).

Remove the smart card board:



**NOTE:** Before you remove the smart card board, make sure nothing (memory card or plastic insert) is inserted in the reader.

1. Remove the three Phillips M2.0x2.5 screws **(1)** that secure the smart card reader to the computer.
2. Disconnect the smart card reader cable **(2)** from the connector on the system board.

3. Remove the smart card board from the computer **(3)**.

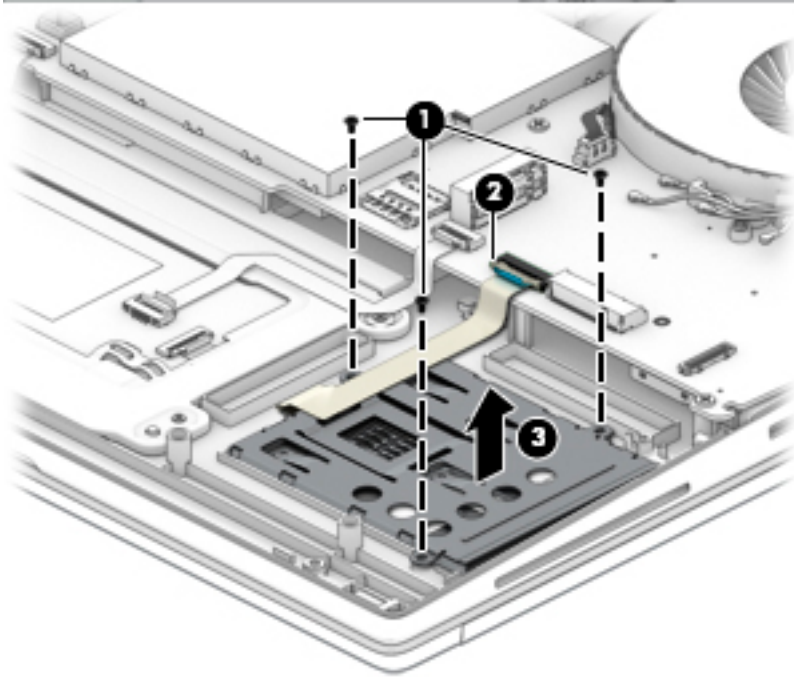

Reverse this procedure to install the smart card board.

## NFC module

Description	Spare part number
NFC module (includes antenna and TouchPad foam)	L02249-001

Before removing the NFC module, follow these steps:

1. Turn off the computer. If you are unsure whether the computer is off or in Hibernation, turn the computer on, and then shut it down through the operating system.
2. Disconnect the power from the computer by unplugging the power cord from the computer.
3. Disconnect all external devices from the computer.
4. Remove the any smart cards and memory cards.
5. Remove the bottom cover (see [Service door on page 41](#)).
6. Remove the battery (see [Battery on page 43](#)).
7. Remove the memory modules (see [Memory modules on page 51](#)).
8. Remove the ODD (see [ODD on page 48](#)).
9. Remove the SSDs (see [Solid-state drive \(SSD\) on page 46](#)).
10. Remove the middle cover (see [Middle cover on page 61](#)).

Remove the NFC module:

1. Disconnect the TouchPad cable **(1)** from the NFC module.
2. Disconnect the NFC cable **(2)** from the system board.
3. Use a tool **(3)** to release the NFC module from the adhesive securing it to the computer, and then remove the module from the computer.

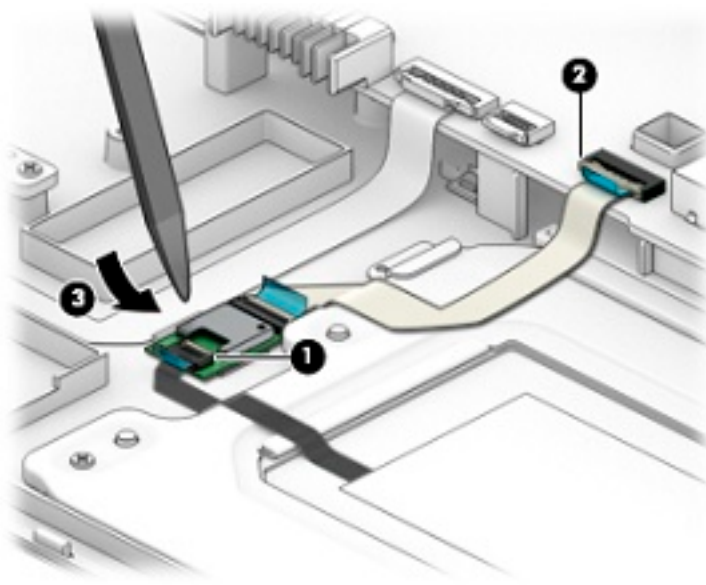

Reverse the removal procedures to install the NFC module.

## TouchPad click board

Description	Spare part number
<b>TouchPad click board</b>	
For use in models without DreamColor	L30663-001
For use in models with DreamColor	L31320-001
<b>TouchPad click board cable</b> (part of the cable kit)	L28473-001

Before removing the TouchPad click board, follow these steps:

1. Turn off the computer. If you are unsure whether the computer is off or in Hibernation, turn the computer on, and then shut it down through the operating system.
2. Disconnect the power from the computer by unplugging the power cord from the computer.
3. Disconnect all external devices from the computer.
4. Remove the any smart cards and memory cards.
5. Remove the bottom cover (see [Service door on page 41](#)).
6. Remove the battery (see [Battery on page 43](#)).
7. Remove the memory modules (see [Memory modules on page 51](#)).
8. Remove the ODD (see [ODD on page 48](#)).
9. Remove the SSDs (see [Solid-state drive \(SSD\) on page 46](#)).
10. Remove the middle cover (see [Middle cover on page 61](#)).

To remove the TouchPad click board:

1. Disconnect the TouchPad cable **(1)** from the system board.
2. Disconnect the NFC cable **(2)** from the system board.
3. Lift the cable **(3)** to clear the TouchPad click board.
4. Disconnect the TouchPad cable **(4)** from the NFC module.
5. Remove the 4 Phillips PM2.0×2.0 screws **(5)** that secure the TouchPad click board bracket to the computer.



6. Remove the board (6) from the computer.

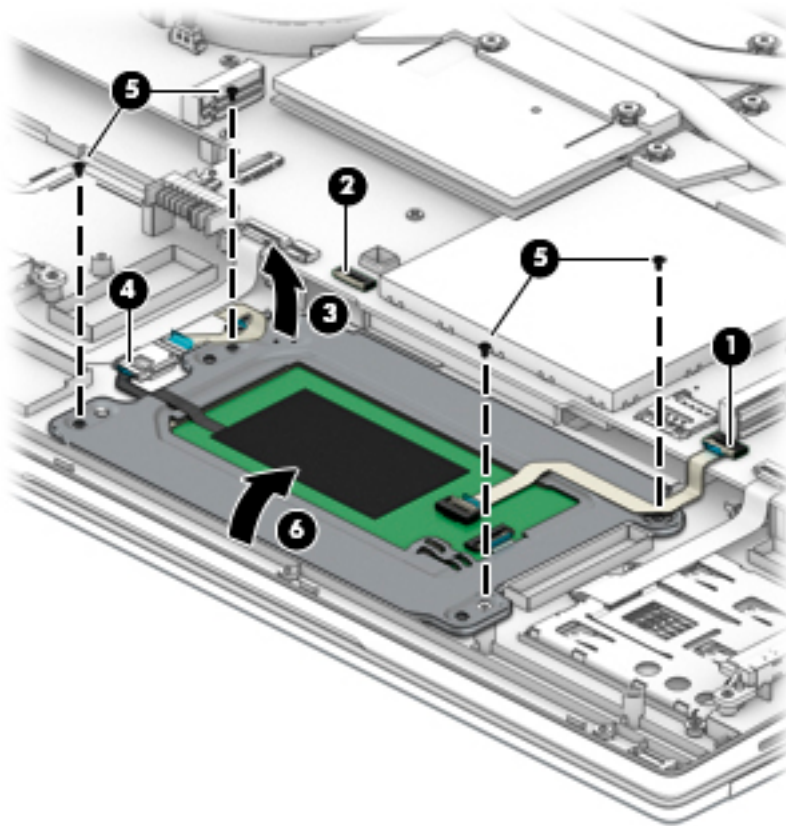

Reverse this procedure to install the TouchPad click board.

## Fans

Description	Spare part number
Right fan, GPU	L30389-001
Left fan, CPU	L30389-001



**NOTE:** Models with UMA graphics have only the left fan. Models with discrete graphics have both the left and right fans.

Before removing the fans, follow these steps:

1. Turn off the computer. If you are unsure whether the computer is off or in Hibernation, turn the computer on, and then shut it down through the operating system.
2. Disconnect the power from the computer by unplugging the power cord from the computer.
3. Disconnect all external devices from the computer.
4. Remove the any smart cards and memory cards.
5. Remove the bottom cover (see [Service door on page 41](#)).
6. Remove the battery (see [Battery on page 43](#)).
7. Remove the memory modules (see [Memory modules on page 51](#)).
8. Remove the ODD (see [ODD on page 48](#)).
9. Remove the SSDs (see [Solid-state drive \(SSD\) on page 46](#)).
10. Remove the middle cover (see [Middle cover on page 61](#)).

Remove the left fan:

1. Release the 3 captive screws **(1)** that secure the fan to the computer.
2. Release the WLAN and WWAN cables **(2)** from the fan.
3. Disconnect the fan cable **(3)** from the system board.

4. Remove the fan **(4)** from the computer.

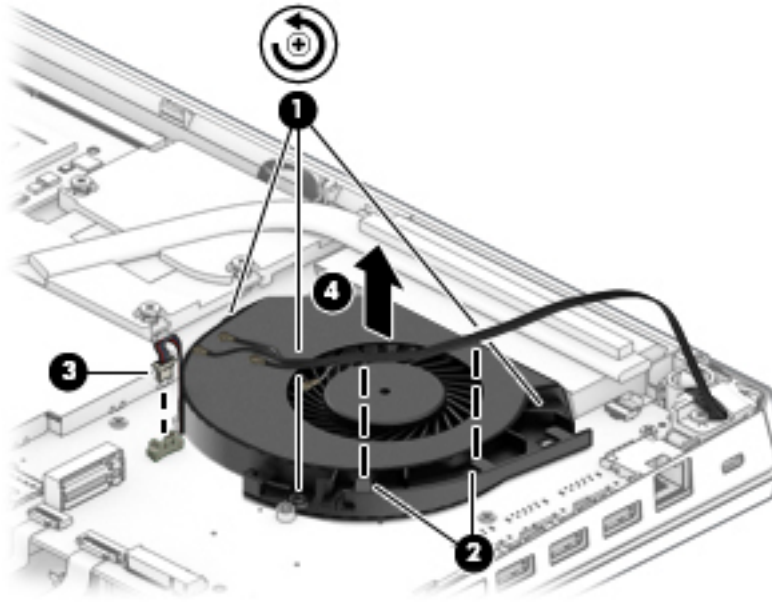

Remove the right fan.

1. Release the 2 captive screws **(1)** that secure the fan to the computer.
2. Release the display cables **(2)**.
3. Disconnect the fan cable **(3)**.
4. Remove the fan from the computer **(4)**.

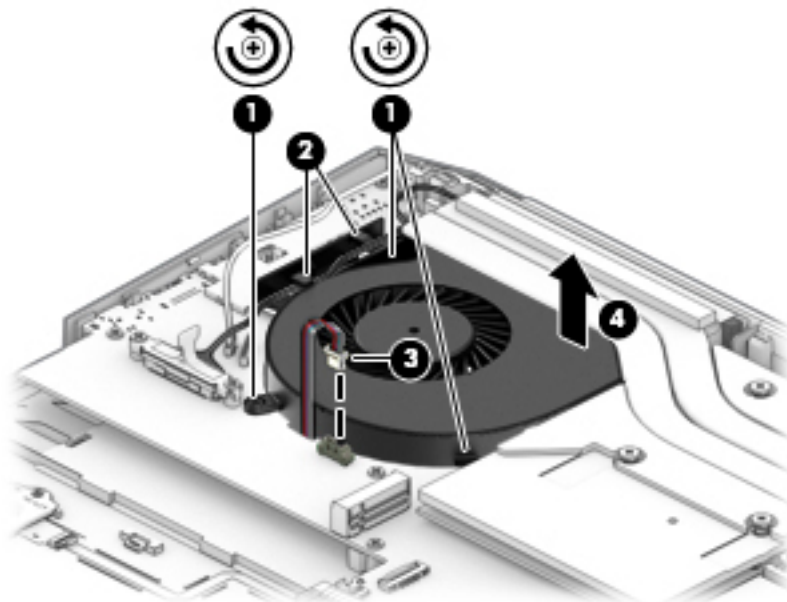

Reverse this procedure to install the fans.

## System board



**NOTE:** All system board spare part kits include replacement thermal material.

All system boards use the following part numbers:

xxxxxx-001: Non-Windows operating systems

xxxxxx-601: Windows operating system

Description	Spare part number
Intel Core i5-8300H processor	L28459-xx1
Intel Core i5-8400H processor	L28460-xx1
Intel Core i7-8750H processor	L28461-xx1
Intel Core i7-8850H processor	L28462-xx1
Intel Xeon E-2176M processor	L28457-xx1
Intel Xeon E-2186M processor	L28458-xx1

Before removing the system board, follow these steps:

1. Turn off the computer. If you are unsure whether the computer is off or in Hibernation, turn the computer on, and then shut it down through the operating system.
2. Disconnect the power from the computer by unplugging the power cord from the computer.
3. Disconnect all external devices from the computer.
4. Remove the any smart cards and memory cards.
5. Remove the bottom cover (see [Service door on page 41](#)).
6. Remove the battery (see [Battery on page 43](#)).
7. Remove the memory modules (see [Memory modules on page 51](#)).
8. Remove the ODD (see [ODD on page 48](#)).
9. Remove the SSDs (see [Solid-state drive \(SSD\) on page 46](#)).
10. Remove the middle cover (see [Middle cover on page 61](#)).
11. Remove the fans (see [Fans on page 70](#)).
12. Remove the keyboard (see [Keyboard on page 144](#)).

When replacing the system board, be sure to remove the following components (as applicable) from the defective system board and install on the replacement system board:

- Heat sink (see [Heat sink on page 74](#))
- RTC battery (see [RTC battery on page 83](#))
- SSD card on the bottom of the board (see [Solid-state drive \(SSD\) on page 84](#))
- Memory on the bottom of the board (see [Memory modules on page 86](#))
- TouchPad button cable

- Keyboard backlight cable
- Keyboard cable

Remove the system board:

1. Make sure to disconnect the following cables from the system board:

 **NOTE:** The WLAN/WWAN cables were disconnected when the left fan was removed.

**(1)** Display touch cable and ambient light sensor cable

**(2)** Display cable

**(3)** Speaker cables

**(4)** Power button cable

**(5)** Drive cable

**(6)** Smart card cable

**(7)** TouchPad cable

**(8)** NFC module cable

**(9)** DreamColor cable

**(10)** ODD cable

**(11)** Fingerprint reader cable

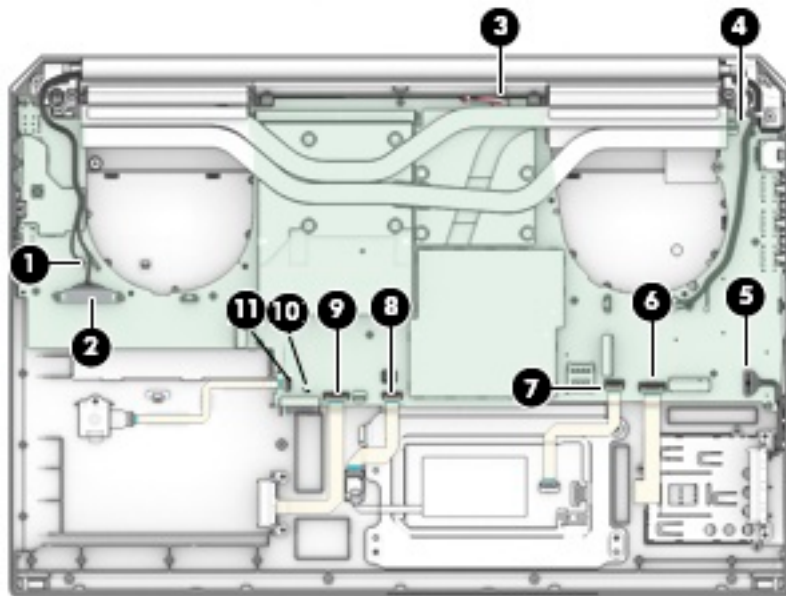

2. Remove the M2.5x4 Phillips head screws **(1)**.

3. Pull the system board (2) up and toward the right to disengage the connectors from the left side of the computer, and then lift out the system board (3).

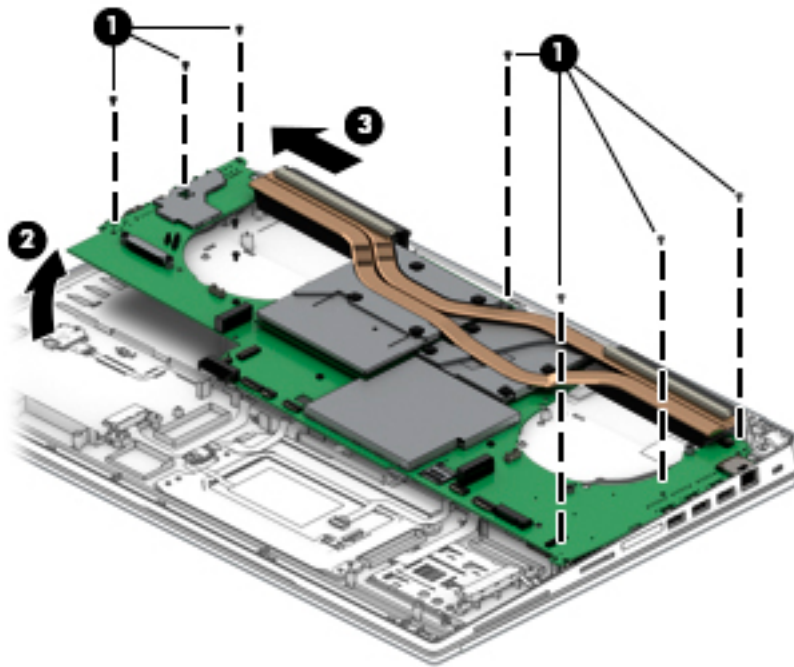

Reverse this procedure to install the system board.

## Heat sink

Description	Spare part number
<b>Heat sink</b>	
For use in models with discrete graphics F16M memory	L30393-001
For use in models with discrete graphics N18P memory	L30391-001
For use in models with discrete graphics N18E memory	L30392-001
For use in models with UMA graphics	L30390-001

Before removing the heat sink, follow these steps:

1. Turn off the computer. If you are unsure whether the computer is off or in Hibernation, turn the computer on, and then shut it down through the operating system.
2. Disconnect the power from the computer by unplugging the power cord from the computer.
3. Disconnect all external devices from the computer.
4. Remove the any smart cards and memory cards.
5. Remove the bottom cover (see [Service door on page 41](#)).
6. Remove the battery (see [Battery on page 43](#)).
7. Remove the memory modules (see [Memory modules on page 51](#)).
8. Remove the ODD (see [ODD on page 48](#)).

9. Remove the SSDs (see [Solid-state drive \(SSD\) on page 46](#)).
10. Remove the middle cover (see [Middle cover on page 61](#)).
11. Remove the fans (see [Fans on page 70](#)).

Remove the heat sink:

 **NOTE:** In the following steps, refer to the graphic that most closely resembles your heat sink.

1. Release the Phillips head screws (1) that secure the heat sink to the system board in the order stamped on the heatsink.
2. Remove the heat sink (2).

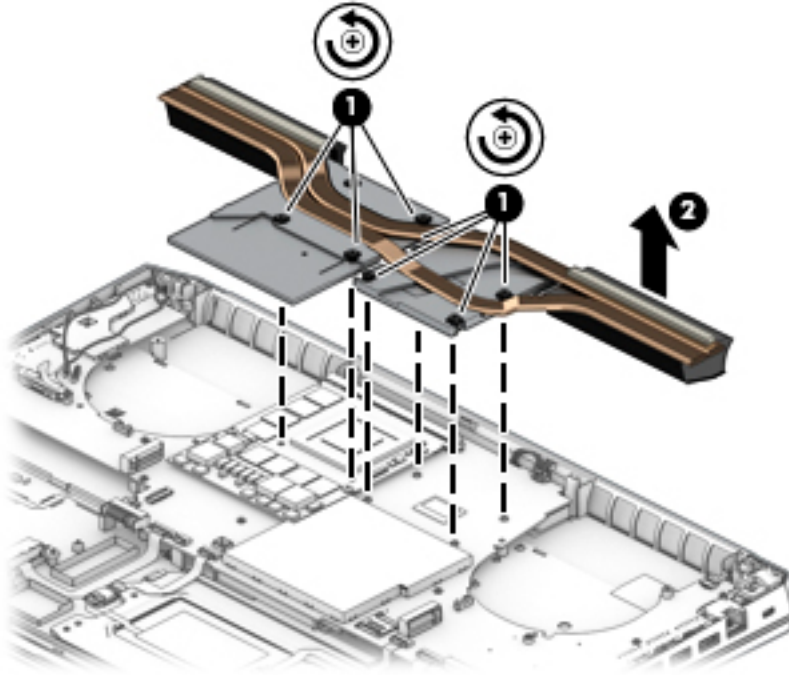

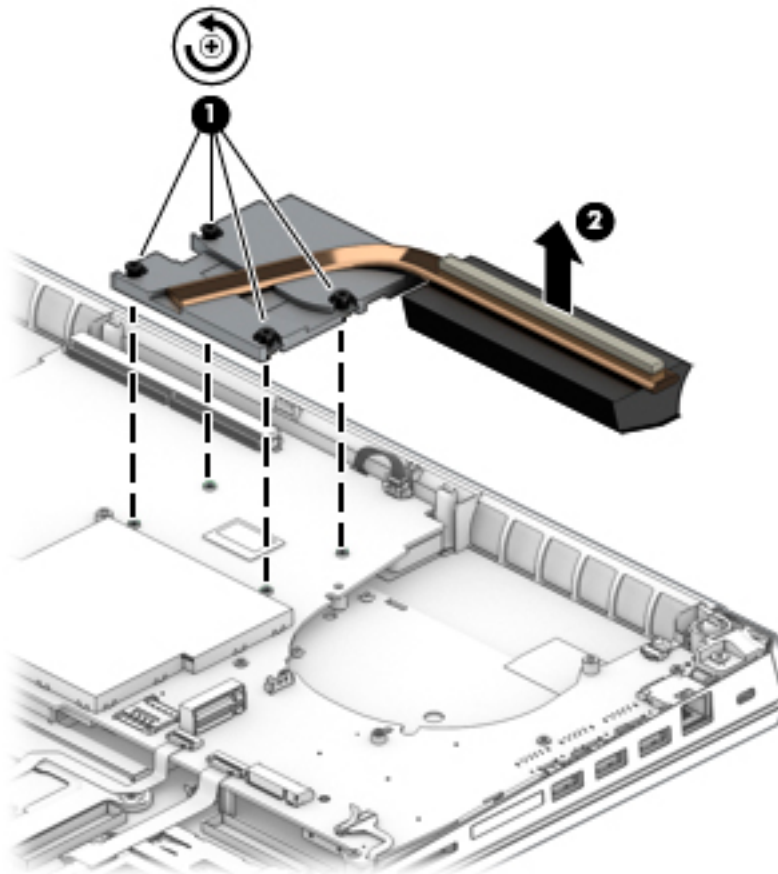

 **NOTE:** The thermal material must be thoroughly cleaned from the surfaces of the heat sink and the system board components each time the heat sink is removed. Thermal paste is used on the processor **(1)** and the heat sink section **(2)** that services it.

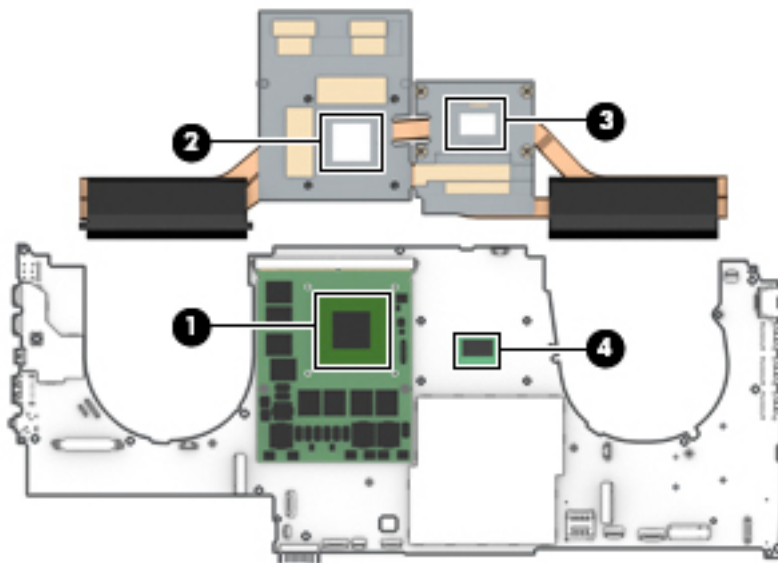



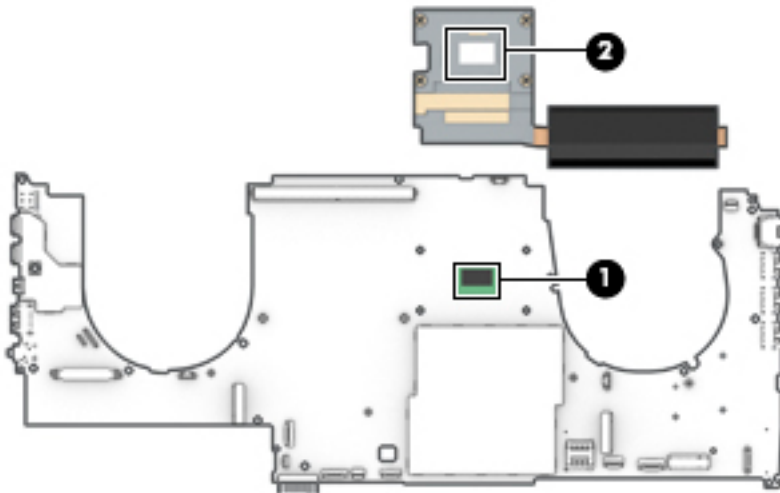

Reverse this procedure to install the heat sink.

## Discrete MXM daughter card

Description	Spare part number
AMD Radeon Pro WX 4170 4 GB	L30654-001
NVIDIA Quadro P1000 4 GB	L30655-001
NVIDIA Quadro P2000 4 GB	L30656-001
NVIDIA Quadro P3200 6 GB	L30657-001
NVIDIA Quadro P4200 8 GB	L30658-001
NVIDIA Quadro P5200 16 GB	L30659-001

Before removing the discrete MXM daughter card, follow these steps:

1. Turn off the computer. If you are unsure whether the computer is off or in Hibernation, turn the computer on, and then shut it down through the operating system.
2. Disconnect the power from the computer by unplugging the power cord from the computer.
3. Disconnect all external devices from the computer.
4. Remove the any smart cards and memory cards.
5. Remove the bottom cover (see [Service door on page 41](#)).
6. Remove the battery (see [Battery on page 43](#)).
7. Remove the memory modules (see [Memory modules on page 51](#)).
8. Remove the ODD (see [ODD on page 48](#)).
9. Remove the SSDs (see [Solid-state drive \(SSD\) on page 46](#)).
10. Remove the middle cover (see [Middle cover on page 61](#)).
11. Remove the fans (see [Fans on page 70](#)).
12. Remove the system board (see [System board on page 72](#)).

Remove the discrete MXM daughter card:

1. Remove the 2 Phillips head screws **(1)** that secure the MXM discrete graphics card to the system board.
2. Remove the MXM discrete graphics card **(2)**.

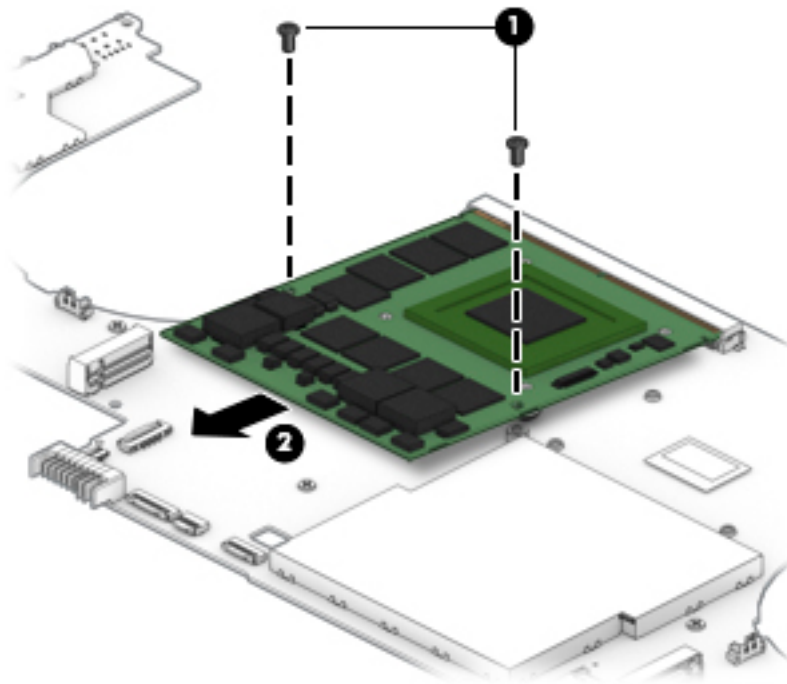

Reverse this procedure to install the discrete MXM daughter card.

## Speaker

Description	Spare part number
Speaker (includes cable)	L28477-001

Before removing the speaker, follow these steps:

1. Turn off the computer. If you are unsure whether the computer is off or in Hibernation, turn the computer on, and then shut it down through the operating system.
2. Disconnect the power from the computer by unplugging the power cord from the computer.
3. Disconnect all external devices from the computer.
4. Remove the any smart cards and memory cards.
5. Remove the bottom cover (see [Service door on page 41](#)).
6. Remove the battery (see [Battery on page 43](#)).
7. Remove the memory modules (see [Memory modules on page 51](#)).
8. Remove the ODD (see [ODD on page 48](#)).
9. Remove the SSDs (see [Solid-state drive \(SSD\) on page 46](#)).
10. Remove the middle cover (see [Middle cover on page 61](#)).
11. Remove the fans (see [Fans on page 70](#)).
12. Remove the system board (see [System board on page 72](#)).

Remove the speaker:

1. Remove the 3 Phillips M2.0×2.5 screws **(1)** that secure the speaker to the computer.

2. Lift the speaker **(2)** to remove it from the computer.

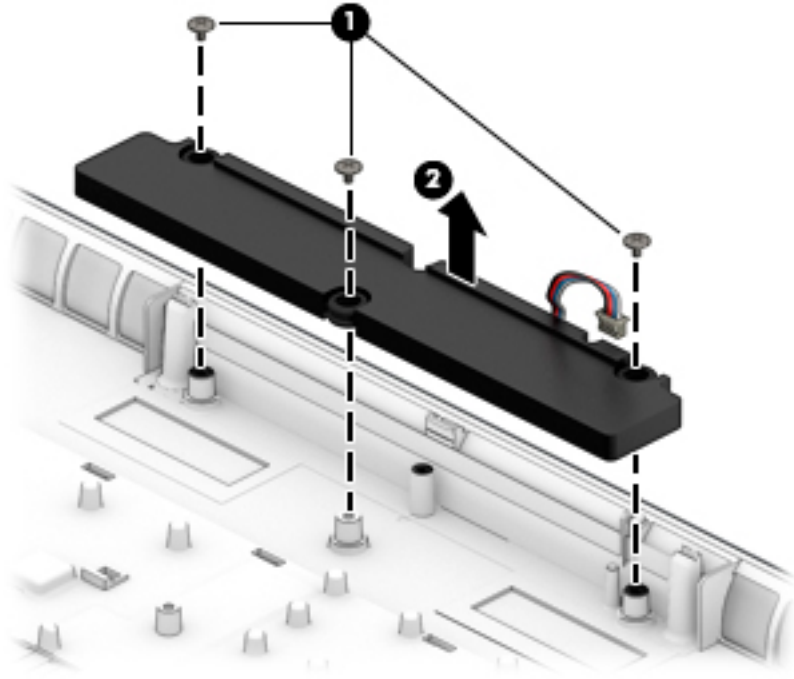

Reverse this procedure to install the speaker.

## Power button board

Description	Spare part number
Power button board	L28466-001

Before removing the power button board, follow these steps:

1. Turn off the computer. If you are unsure whether the computer is off or in Hibernation, turn the computer on, and then shut it down through the operating system.
2. Disconnect the power from the computer by unplugging the power cord from the computer.
3. Disconnect all external devices from the computer.
4. Remove the any smart cards and memory cards.
5. Remove the bottom cover (see [Service door on page 41](#)).
6. Remove the battery (see [Battery on page 43](#)).
7. Remove the memory modules (see [Memory modules on page 51](#)).
8. Remove the ODD (see [ODD on page 48](#)).
9. Remove the SSDs (see [Solid-state drive \(SSD\) on page 46](#)).
10. Remove the middle cover (see [Middle cover on page 61](#)).
11. Remove the fans (see [Fans on page 70](#)).
12. Remove the system board (see [System board on page 72](#)).

Remove the power button board:

1. Lift the thermal tape **(1)** covering the board.
2. Remove the 2 Phillips M2.5×5.0 screws **(2)** that secure the power button board.

3. Remove the power button board (3) from the computer.

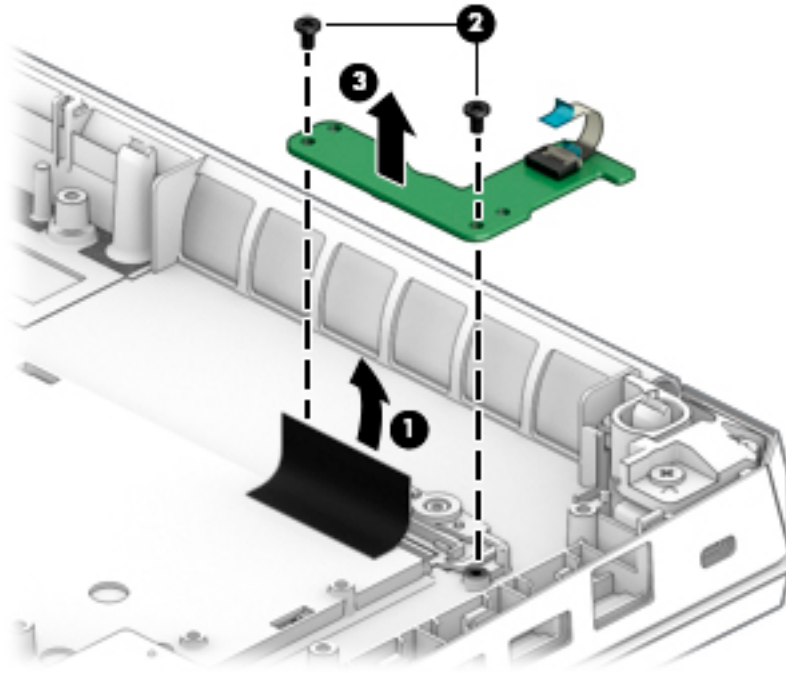

Reverse this procedure to install the power button board.

## RTC battery

Description	Spare part number
RTC battery	L17255-001

Before removing the RTC battery, follow these steps:

1. Turn off the computer. If you are unsure whether the computer is off or in Hibernation, turn the computer on, and then shut it down through the operating system.
2. Disconnect the power from the computer by unplugging the power cord from the computer.
3. Disconnect all external devices from the computer.
4. Remove the any smart cards and memory cards.
5. Remove the bottom cover (see [Service door on page 41](#)).
6. Remove the battery (see [Battery on page 43](#)).
7. Remove the memory modules (see [Memory modules on page 51](#)).
8. Remove the ODD (see [ODD on page 48](#)).
9. Remove the SSDs (see [Solid-state drive \(SSD\) on page 46](#)).
10. Remove the middle cover (see [Middle cover on page 61](#)).
11. Remove the fans (see [Fans on page 70](#)).
12. Remove the system board (see [System board on page 72](#)).

Remove the RTC battery:

1. Place the system board face down.
2. Using a flat tool **(1)**, pry the battery from the holder.
3. Lift the battery **(2)** from the computer.

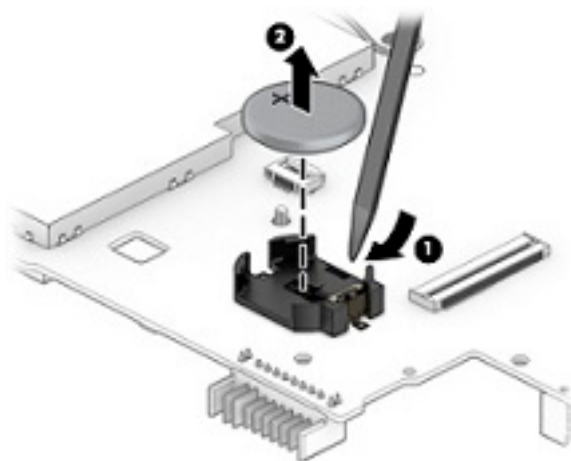

Reverse this procedure to install the RTC battery.

## Solid-state drive (SSD)

Description	Spare part number
<b>SSD</b>	
1 TB, Z Turbo Drive	L28490-001
256 GB, Z Turbo Drive	L28491-001
512 GB, Z Turbo Drive	L28492-001
1 TB, SATA, TLC	L30762-001
256 GB, SATA, TLC	L30763-001
512 GB, PCIe, SS, NVMe, TLC	L28488-001
512 GB, PCIe, NVMe, Self-encrypting drive (SED), Opal 2, TLC	L28487-001
512 GB, SATA-3, FIPS-140-2, TLC	L28489-001
2 TB, PCIe, NVMe, TLC	L28486-001
256 GB, PCIe, SATA-3, SED, Opal2, TLC	L28485-001
256 GB, PCIe, NVMe, TLC	L28484-001
256 GB, NVMe SED, Opal 2, TLC	L28483-001
16 GB, IO	L28481-001

 **NOTE:** An additional SSD slot is available on top of the system board. That slot is a customer self-repair part.

Before removing the solid-state drive, follow these steps:

1. Turn off the computer. If you are unsure whether the computer is off or in Hibernation, turn the computer on, and then shut it down through the operating system.
2. Disconnect the power from the computer by unplugging the power cord from the computer.
3. Disconnect all external devices from the computer.
4. Remove the bottom cover (see [Service door on page 41](#)).
5. Remove the battery (see [Battery on page 43](#)).
6. Remove the memory modules (see [Memory modules on page 51](#)).
7. Remove the ODD (see [ODD on page 48](#)).
8. Remove the SSDs (see [Solid-state drive \(SSD\) on page 46](#)).
9. Remove the middle cover (see [Middle cover on page 61](#)).
10. Remove the fans (see [Fans on page 70](#)).
11. Remove the system board (see [System board on page 72](#)).

Remove the solid-state drive:

1. Remove the Phillips M2.0×2.0 screw **(1)** that secures the drive to the system board.



2. Remove the drive by pulling it away from the connector (2).

 **NOTE:** M.2 solid-state drives are designed with notches to prevent incorrect insertion.

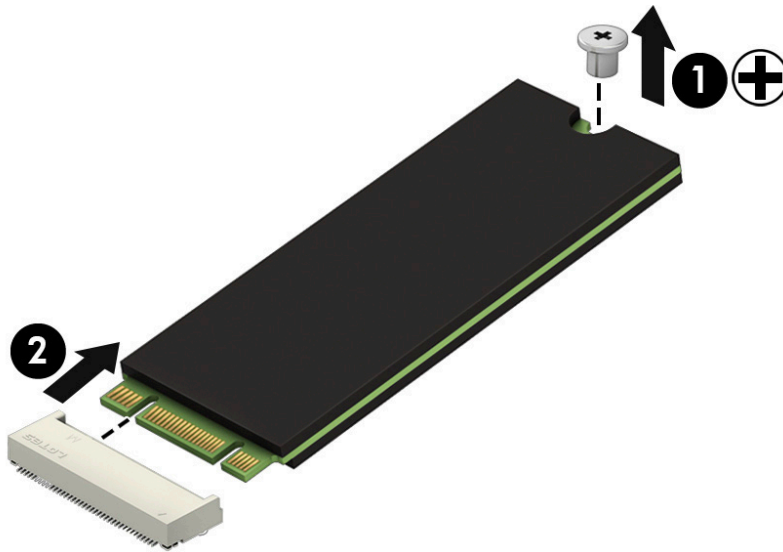

Reverse this procedure to install the solid-state drive.

## Memory modules

 **NOTE:** Primary and expansion memory is installed in a side-by-side configuration in the bottom of the computer.

If only one memory module is installed, it must be installed in the socket labeled '1'.

Description	Spare part number
4 GB, 2666 MHz, 1.2 v, DDR4	L10598-850
8 GB, 2666 MHz, 1.2 v, DDR4	937236-850
16 GB, 2666 MHz, 1.2 v, DDR4	937438-850
16 GB, 2666 MHz, 1.2 v, DDR4, ECC	L24981-001
8 GB, 2666 MHz, 1.2 v, DDR4, ECC shared	L24983-001

### Update BIOS before adding memory modules

Before adding new memory, make sure you update the computer to the latest BIOS.

 **CAUTION:** Failure to update the computer to the latest BIOS prior to installing new memory may result in various system problems.

To update BIOS:

1. Navigate to [www.hp.com](http://www.hp.com).
2. Click **Support & Drivers** > click **Drivers & Software**.
3. In the **Enter a product name/number** box, type the computer model information, and then click **Search**.
4. Click the link for the computer model.
5. Select the operating system, and then click **Next**.
6. Under **Step 2: Select a Download**, click the **BIOS** link.
7. Click the link for the most recent BIOS.
8. Click the **Download** button, and then follow the on-screen instructions.

Before removing the memory module, follow these steps:

1. Turn off the computer. If you are unsure whether the computer is off or in Hibernation, turn the computer on, and then shut it down through the operating system.
2. Disconnect the power from the computer by unplugging the power cord from the computer.
3. Disconnect all external devices from the computer.
4. Remove the any smart cards and memory cards.
5. Remove the bottom cover (see [Service door on page 41](#)).
6. Remove the battery (see [Battery on page 43](#)).
7. Remove the memory modules (see [Memory modules on page 51](#)).
8. Remove the ODD (see [ODD on page 48](#)).
9. Remove the SSDs (see [Solid-state drive \(SSD\) on page 46](#)).

10. Remove the middle cover (see [Middle cover on page 61](#)).
11. Remove the fans (see [Fans on page 70](#)).
12. Remove the system board (see [System board on page 72](#)).

Remove the memory module:

1. Use a thin tool (1) to lift the memory shield, and then remove the shield (2).

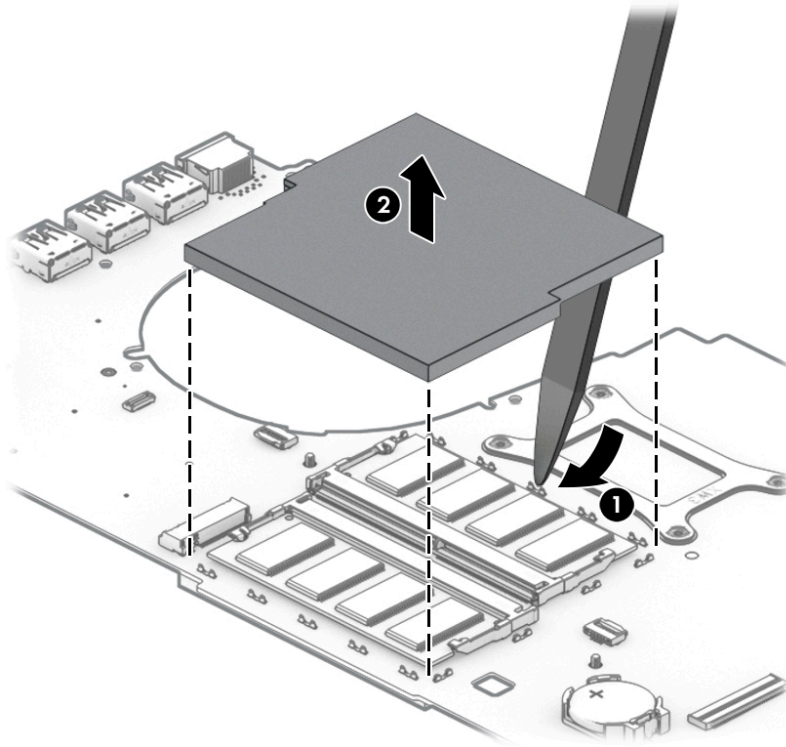

2. Spread the retaining tabs (1) on each side of the memory module slot to release the memory module. (The edge of the module opposite the slot rises away from the computer.)

3. Remove the memory module **(2)** by pulling the module away from the slot at an angle.

---

 **NOTE:** Memory modules are designed with a notch to prevent incorrect insertion into the memory module slot.

 **NOTE:** The computer uses two memory sockets. The socket labeled '2' houses the expansion memory module and the socket labeled '1' houses the primary memory module. The removal procedure is the same for both memory sockets.

---

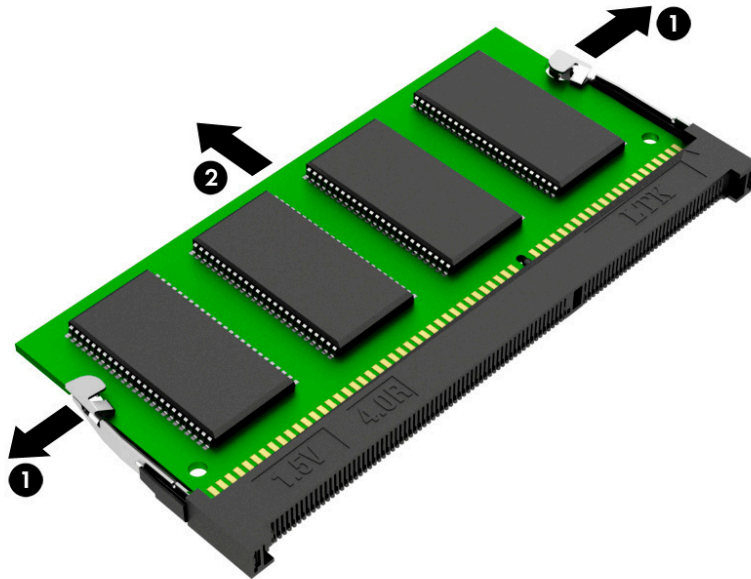

Reverse this procedure to install a memory module.

## Display assembly



**NOTE:** Touch displays are spared as a whole assembly only. Touch display assembly spare part information is available at [Computer major components on page 28](#). Non-touch displays are spared at the subcomponent level only. Additional display assembly spare part information is available at [Display assembly subcomponents on page 33](#).

Before removing the display assembly, follow these steps:

1. Turn off the computer. If you are unsure whether the computer is off or in Hibernation, turn the computer on, and then shut it down through the operating system.
2. Disconnect the power from the computer by unplugging the power cord from the computer.
3. Disconnect all external devices from the computer.
4. Remove the any smart cards and memory cards.
5. Remove the bottom cover (see [Service door on page 41](#)).
6. Remove the battery (see [Battery on page 43](#)).
7. Remove the memory modules (see [Memory modules on page 51](#)).
8. Remove the ODD (see [ODD on page 48](#)).
9. Remove the SSDs (see [Solid-state drive \(SSD\) on page 46](#)).
10. Remove the middle cover (see [Middle cover on page 61](#)).

Remove the display assembly:

1. Remove the 2 Phillips M2.5×5.0 screws **(1)** from the display cable bracket.
2. Disconnect the display cable **(2)**, and then release the cable **(3)**.
3. Disconnect the WLAN/WWAN cables **(4)**, and then release the cables **(5)** from the fan routing.
4. Remove the 6 Phillips M2.5×5.0 screws **(6)** from the display hinges.

5. Lift the display assembly **(7)** straight up and remove it.

**CAUTION:** When installing the display assembly, be sure that the wireless antenna cables are routed and arranged properly.

Failure to properly route the antennas can result in degradation of the computer's wireless performance.

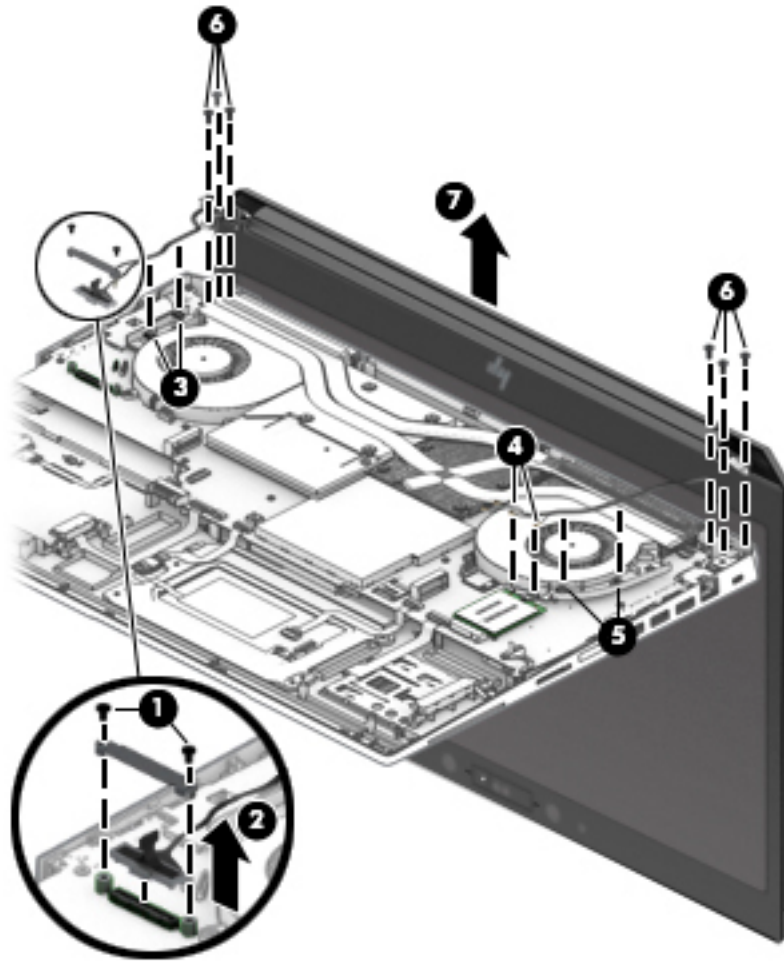

Reverse this procedure to reinstall the display assembly.

## Display assembly components

 **NOTE:** Display assemblies are spared at the subcomponent level only. Additional display assembly spare part information is available at [Display assembly subcomponents on page 33](#).

Before removing the display assembly, follow these steps:

1. Turn off the computer. If you are unsure whether the computer is off or in Hibernation, turn the computer on, and then shut it down through the operating system.
2. Disconnect the power from the computer by unplugging the power cord from the computer.
3. Disconnect all external devices from the computer.
4. Remove the any smart cards and memory cards.
5. Remove the bottom cover (see [Service door on page 41](#)).
6. Remove the battery (see [Battery on page 43](#)).
7. Remove the memory modules (see [Memory modules on page 51](#)).
8. Remove the ODD (see [ODD on page 48](#)).
9. Remove the SSDs (see [Solid-state drive \(SSD\) on page 46](#)).
10. Remove the middle cover (see [Middle cover on page 61](#)).
11. Remove the display (see [Display assembly on page 89](#)).

Remove the display assembly components:

1. To remove the display hinge cover, rotate top of hinge cover **(1)** away from display enclosure to disengage the tabs, and then pull the cover **(2)** off the enclosure.

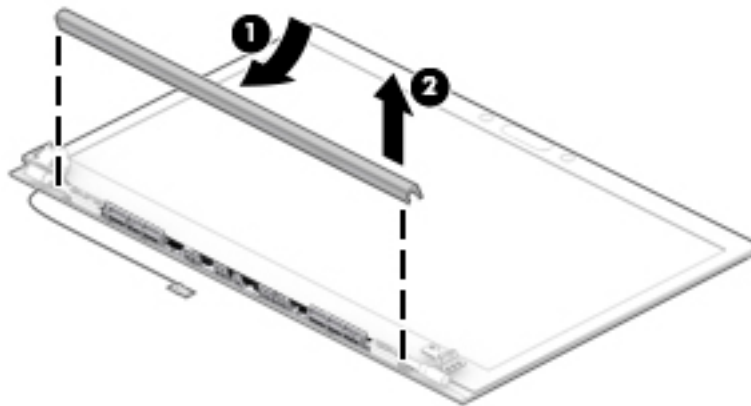

The display hinge cover (for non-privacy displays) is available in the Hinge Kit (for touch displays) using spare part number L14364-001. The display hinge cover (for non-touch displays) is available using spare part number L14365-001.

When installing the hinge cover, make sure all cables are routed correctly under the hinge cover and the hooks on the end of the cover are aligned correctly with the snaps on the bottom of the display **(1)**. Press the left **(2)**, and then right **(3)** middle sections of the hinge cover until it snaps into place.

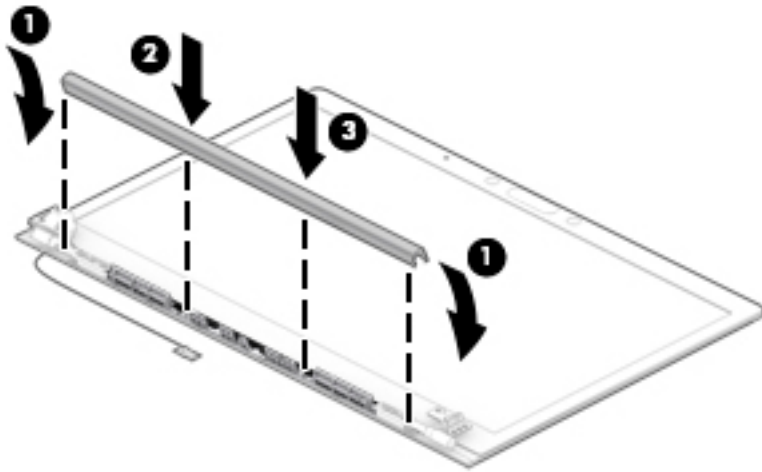

2. To remove the display bezel, flex the top **(1)** of the bezel, the inside edges of the left and right sides **(2)**, and then the bottom **(3)** of the bezel until it disengages from the display enclosure.
3. Remove the display bezel **(4)**.

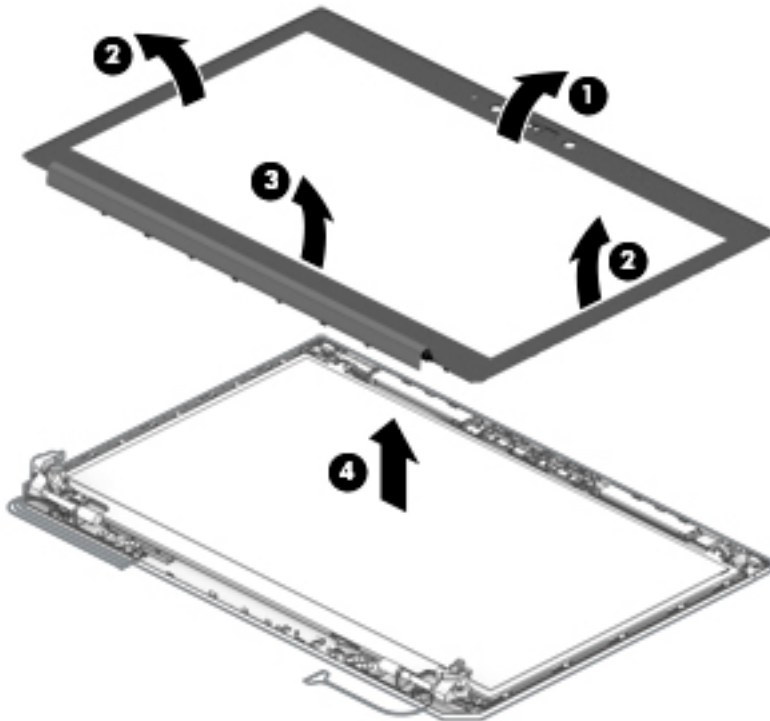

4. Two different camera modules are available. Refer to the following procedure appropriate for your computer if it is necessary to replace the camera module:
  - a. **HD camera or microphone module**  
Lift upward to disengage the module from the adhesive on the display enclosure **(1)**, disconnect the cable from the module **(2)**, and then remove the module from the display **(3)**.



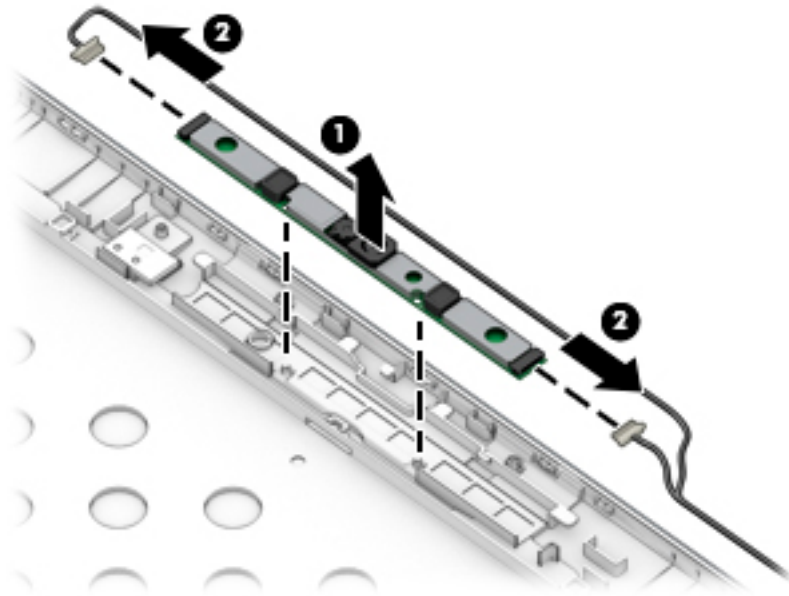

**b. IR camera**

Remove the tape from atop the module **(1)**, lift upward to disengage the module from the adhesive on the display enclosure **(2)**, disconnect the cables from the left and right sides of the module **(3)**, and then remove the camera module from the display **(4)**.

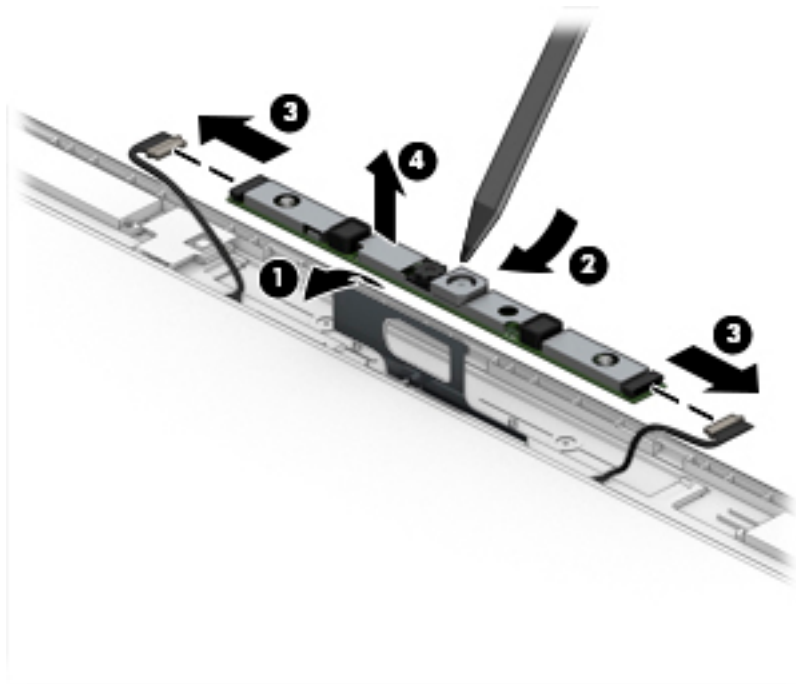

5. If it is necessary to remove the ambient light sensor board, disconnect the cable from the board **(1)**, lift upward to disengage the board from the adhesive on the display enclosure **(2)**, and then remove the board from the display **(3)**.

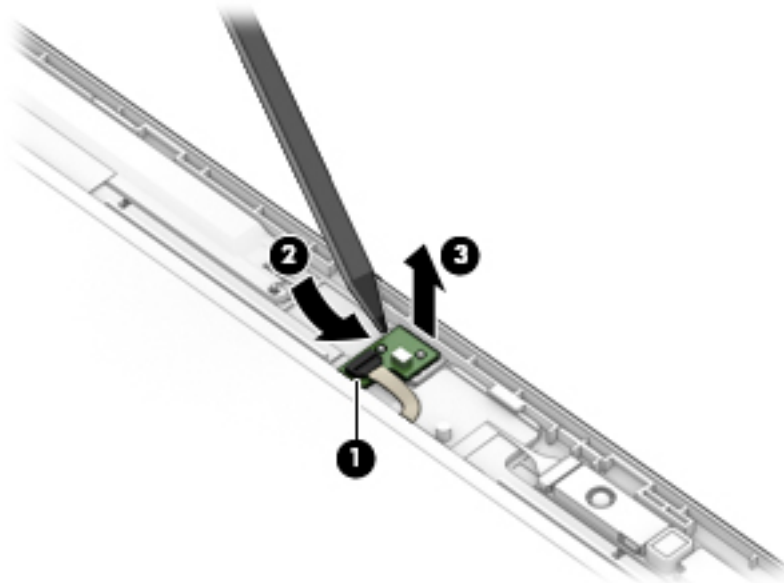

The ambient light sensor board is available using spare part number L15511-001.

6. If it is necessary to remove the display panel from the enclosure, remove the 4 Phillips M2.0×2.0 screws that secure the panel to the display enclosure.

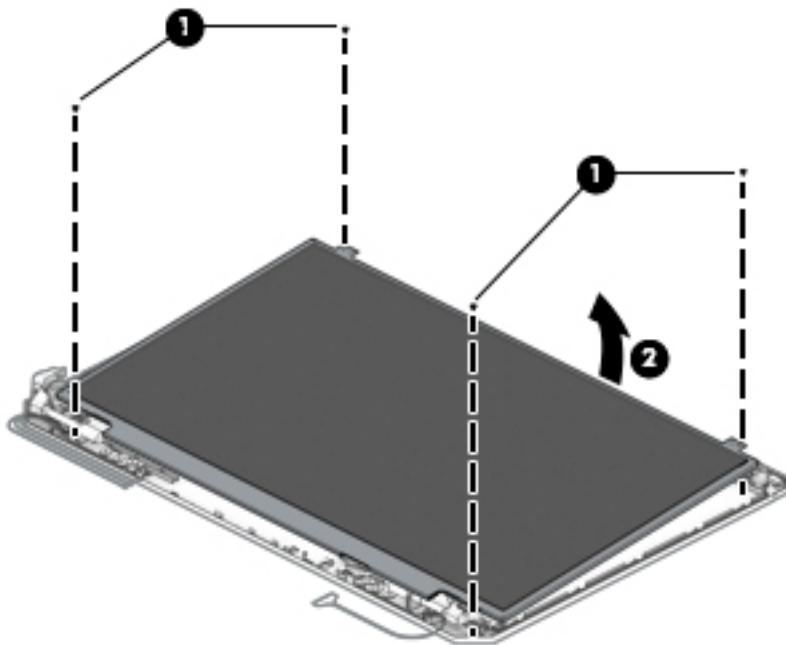

7. Rotate the display panel over onto the keyboard **(1)**.



**NOTE:** For additional details on removing the cable, see [Connector types on page 174](#).

8. On the back of the display panel, lift the tape from atop the connector (2), and then remove the panel (3).

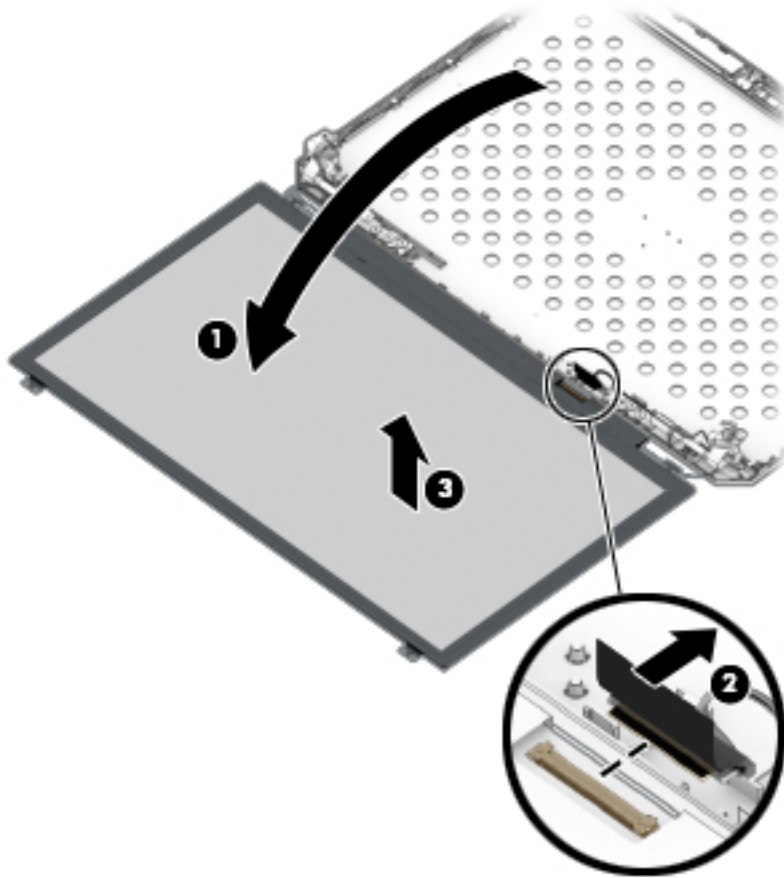

The raw display panel is available using the following spare part numbers:

 **NOTE:** Display panel kits include panel, touch module (as applicable), display cable, and interior panel bezel.

9. If it is necessary to replace the display hinges, remove the 4 Phillips M2.5x11.0 screws that secure each hinge (1), and then remove the hinges from the display enclosure (2).

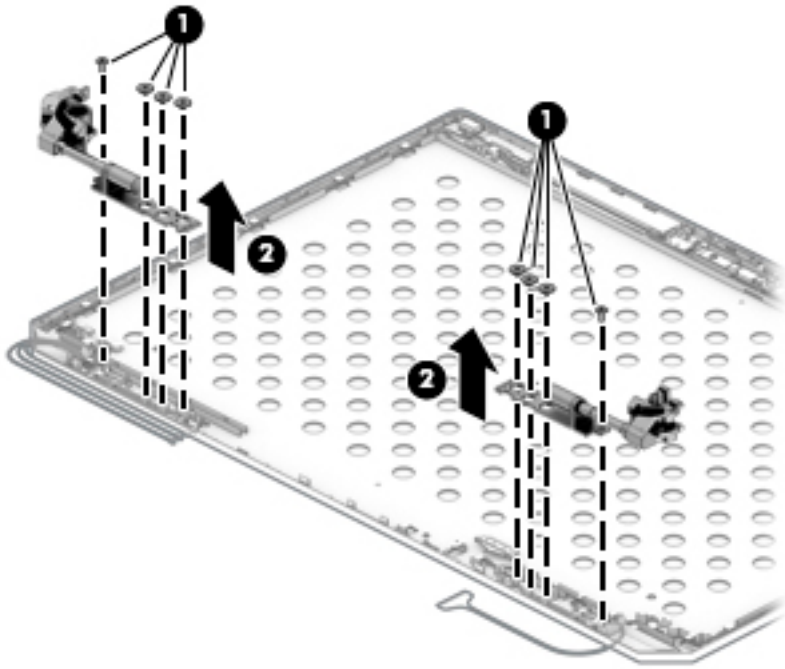

10. If it is necessary to replace the display cable, lift the cable from the routing path in the display enclosure.

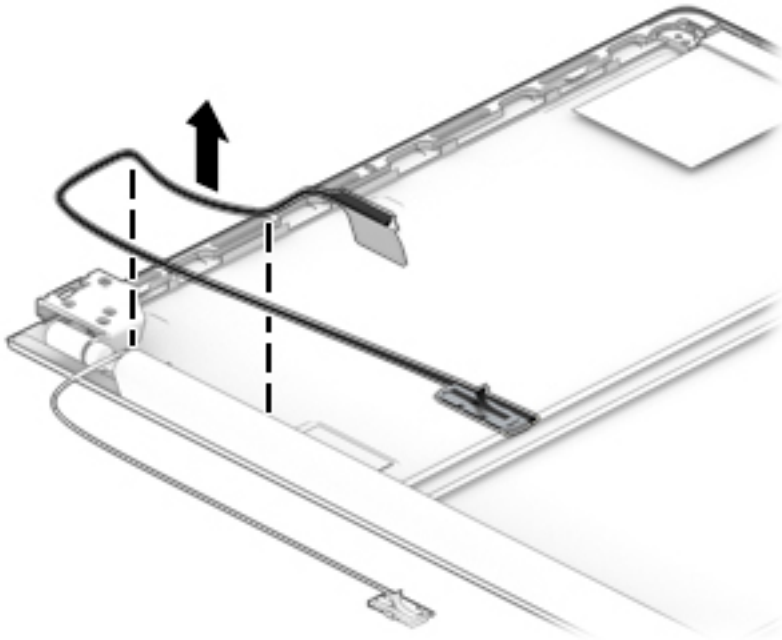

11. If it is necessary to replace the camera/ambient light sensor cable:

a. **HD camera models**

Disconnect the cable from the ambient light sensor board (1) and from the HD camera (2), and then remove the cable from the display enclosure (3).

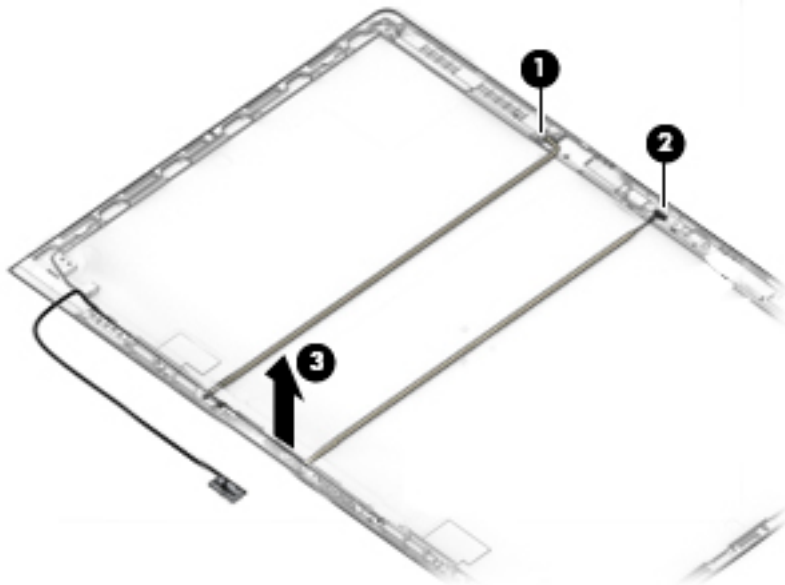

**b. IR camera models**

Disconnect the cable from the ambient light sensor board (1), from the left (2) and right (3) sides of the IR camera, and then remove the cable from the display enclosure (4).

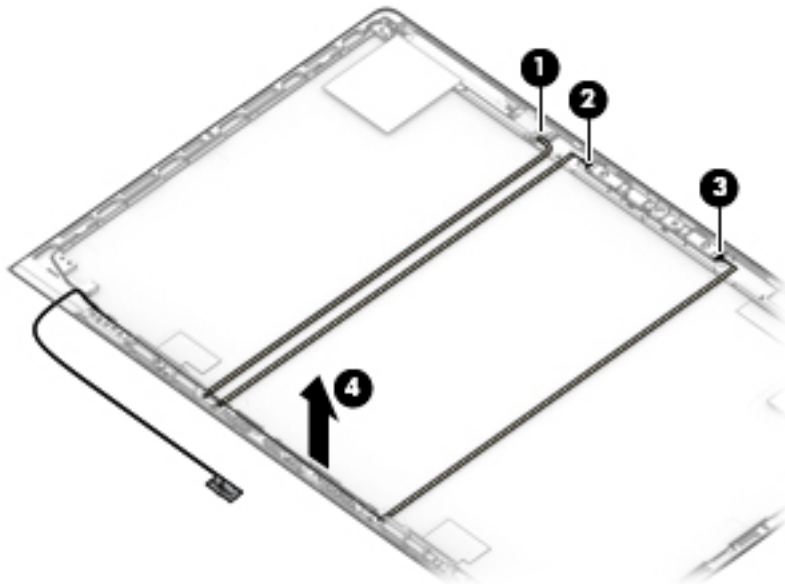

12. If it is necessary to replace the WLAN antenna cables, peel the antennas from the top of the display enclosure (1), remove the antenna cables from the routing path on the bottom of the display enclosure (2), and then remove the antenna cables (3).

 **NOTE:** The WLAN antennas are spared with the display enclosure.

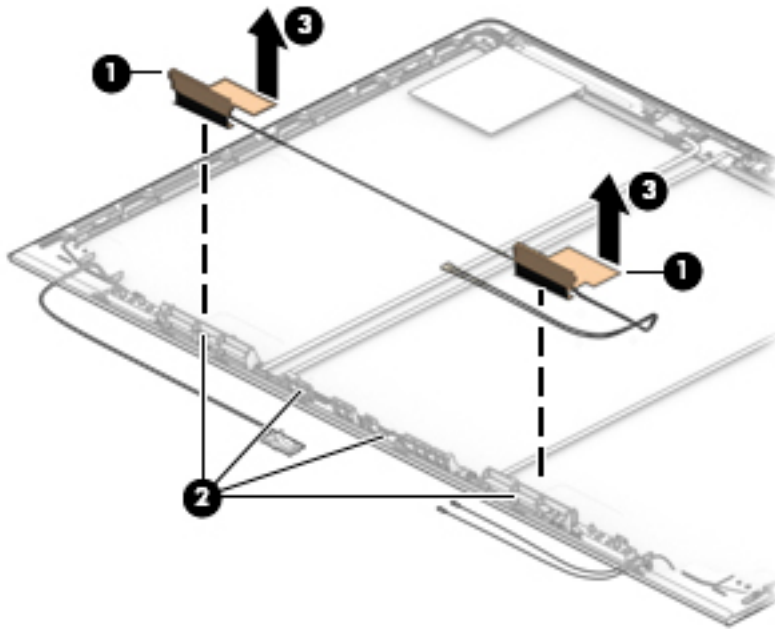

13. If it is necessary to replace the WWAN antenna cables, peel the antennas from the top of the display enclosure (1), remove the antenna cables from the bottom and sides of the display enclosure (2), and then remove the antenna cables (3).

 **NOTE:** The WWAN antennas are spared with the display enclosure.

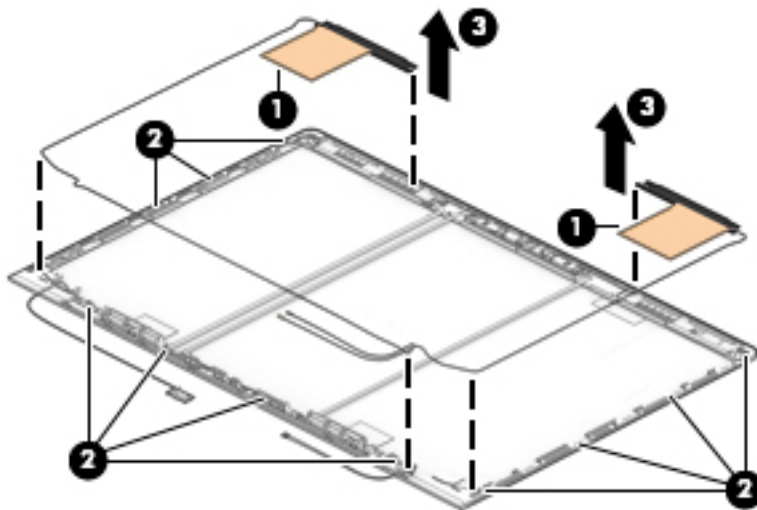

Reverse this procedure to reassemble the display assembly.

## Top cover

Description	Spare part number
Top cover (includes Mylar)	L17378-001

The top cover remains after removing all other spared parts from the computer.

---

# 7 Troubleshooting guide

This chapter is primarily focused on troubleshooting HP Mobile Workstations and HP Notebooks. The information is provided so that you can solve problems yourself or at least narrow down what may be causing the problem. Based on some of the most common symptoms, this chapter helps to identify logical steps and available resources or tools for resolving an issue. HP recommends that you follow the instructions carefully, observe safety precautions, and note any observations or results. Capturing this information may help identify and resolve the problem faster.

---

**⚠ WARNING!** To reduce the risk of electric shock or damage to the equipment:

- Do not disable the power cord grounding plug. The grounding plug is an important safety feature.
- Plug the power cord into a grounded (earthed) outlet that is easily accessible at all times.
- Disconnect power from the equipment by unplugging the power cord from the AC outlet.
- Before disassembling notebooks, always disconnect power and remove the battery.

**⚠ CAUTION:** Static electricity can damage the electronic components of the computer. To prevent damage to the computer, carefully observe the electrostatic discharge precautions.

- Discharge static electricity by briefly touching a grounded metal object before you begin.
- Work on a static-free mat.
- Wear a static strap to ensure that any accumulated electrostatic charge is discharged from your body to the ground.
- Create a common ground for the equipment you are working on by connecting the static-free mat, static strap, and peripheral units to that piece of equipment.
- Refer to the Electrostatic Discharge Section of the Maintenance & Service Guide for more information.

**CAUTION:** The computer includes customer self-repair parts and parts that should only be accessed by an authorized service provider. See the chapter titled "Removal and replacement procedures for Customer Self-Repair parts," for details. Accessing parts described in the chapter titled "Removal and replacement procedures for authorized service provider only parts" can damage the computer or void the computer warranty.

---



# Resources

HP Resource Tool	Description	Link
HP Elite Support	Provides live HP Premium support (available 24/7) to Elite computers.	<a href="http://www8.hp.com/us/en/ads/elite-products/overview.html">http://www8.hp.com/us/en/ads/elite-products/overview.html</a>
HP Support Center	Provides important support, such as warranty, support cases, drivers, Customer Advisories, Customer and Security Bulletins, and Product Change Notices.	<a href="http://h20565.www2.hp.com/portal/site/hpsc">http://h20565.www2.hp.com/portal/site/hpsc</a>
Subscribers Choice	Allows you to sign up for HP product updates.	<a href="http://www8.hp.com/us/en/subscribe/">http://www8.hp.com/us/en/subscribe/</a>
HP Support Forums	Provide discussions about HP products and issues.	<a href="http://h30434.www3.hp.com/psg/">http://h30434.www3.hp.com/psg/</a>
Service Access Workbench (SAW) (Available for technicians and Business Partners only)	Provides navigable content intended for use by internal and outsourced call center staff and can be a resource for support and product division professionals.	<a href="http://sawpro.atlanta.hp.com/km/saw/home.do">http://sawpro.atlanta.hp.com/km/saw/home.do</a>
Vendors' web sites	Provide additional information for associated components such as Intel (processor, WLAN), Microsoft (Windows 7/8/10), AMD/NVidia (GPU), and so on.	<a href="http://www.intel.com/content/www/us/en/homepage.html">http://www.intel.com/content/www/us/en/homepage.html</a> <a href="http://www.amd.com">http://www.amd.com</a> <a href="http://www.nvidia.com">http://www.nvidia.com</a>

## General troubleshooting steps

A basic logic should be used when troubleshooting computer issues. This section will help you become familiar with troubleshooting methodology and efficiently resolve problems. Proceed through the steps in the following table until the issue is resolved, and then move on to the next step that is relevant to the issue. For example, if you resolve a memory issue using the HP PC Diagnostics (UEFI) tool in step 6, you can then move on to step 10 to reseat the memory into its memory slot.



**NOTE:** General troubleshooting steps do not have to be followed in a specific order if an issue does not apply.

**Table 7-1 Troubleshooting methodology and general troubleshooting steps**

Identify issue	Analyze issue	Resolve issue	Verify solution
<a href="#">1. Understand the issue on page 102</a>	<a href="#">5. Remove or uninstall recently added hardware, software on page 105</a>	<a href="#">8. Hard reset on page 113</a>	<a href="#">Verify solution on page 118</a>
<a href="#">2. Examine the environment on page 104</a>	<a href="#">6. HP Hardware Diagnostics and Tools on page 106</a>	<a href="#">9. Soft reset (Default Settings) on page 115</a>	
<a href="#">3. Perform a visual inspection of hardware on page 105</a>	<a href="#">7. Status lights, blinking light codes, troubleshooting lights, and POST error messages on page 110</a>	<a href="#">10. Reseat cables and connections on page 115</a>	
<a href="#">4. Update BIOS and drivers on page 105</a>		<a href="#">11. Test with minimum configuration on page 116</a>	
		<a href="#">12. Test with verified working configuration (hardware and/or operating system) on page 117</a>	
		<a href="#">13. Replace the system board on page 117</a>	

# Identify the issue

## 1. Understand the issue

It is important to understand the issue that occurred, including related symptoms. It helps to understand the basic computer boot-up sequence as well as the failure itself. The boot-up sequence and associated failures are described below.

### Boot up sequence

The computer performs several steps after you press the power button or restart the computer.

It is important to understand where in the boot-up sequence the symptoms occur. The following table lists the phases of the boot-up sequence and explains the symptoms that may occur in each phase. For example, a blue screen error (BSOD) often occurs during the performance phase.

**Table 7-2 Boot-up sequence**

Item	Procedure
<b>Power-on</b>	After power button is pressed, the computer boots after all internal power rails (i.e., 5V, 3.3V) are stable.  Confirm that power lights are on fan is spinning.  Next step: If the computer experiences a power-on issue, see “Verify Power Good (Troubleshooting) lights” in <a href="#">No Power on page 120</a> .  Common issues: all lights are off; troubleshooting lights are on; does not boot; video is absent.
<b>POST (UEFI/BIOS)</b>	Power-On Self-Test (POST) verifies that hardware components (processor, hard drive, memory, etc.) are functional. When POST is complete, the HP logo displays briefly and then disappears.  If there are errors, the computer may exhibit blinking lights and POST error messages  Common issues: lights blink, error message appears, hangs.
<b>Performance (operating system)</b>	System boots to operating system, and Windows logo screen appears.  Common issues: hangs (lock up/freezes), blue screen, video distorted, driver conflict, slow performance, display issue (dead pixel), I/O issue (no speaker sound), wireless/audio unavailable, noise.  See <a href="#">Analyze the issue on page 105</a> table below for detailed troubleshooting information).

### Failure classification

Failure classification is a breakdown of different types of failures and symptoms that could occur during the boot-up sequence. Table 3 and table 4 represent the failure classification for common notebook failures.

Table 3 categorizes failures by the boot-up sequence.

1. Power-on: Common issues are No Power, Recycle/Reboot, etc.
2. POST: Common issues are No Boot (have power), Light Flash or Diagnostics Error.
3. Performance: Common issues are Intermittent Loss of Power, Blue Screen, Hang, etc. In many cases, issues may be identified and associated with a particular hardware (i.e., display, storage).

Table 4 categorizes failures by hardware.

4. Display
5. I/O devices (Input/Output)

- 6. Storage
- 7. Mechanical

A single symptom can be listed under different groups. For example, No Video can belong to (1) Power-on or (4) Display; but Flickering when powered should be listed in (4) Display. Or, in another example, a blue screen can be caused by a driver conflict in Performance (4), but it can also be caused by a defective hard drive under (6) Storage. Therefore, failures that share similar symptoms are noted.

If possible, make a record of the failure symptom, the phase of the boot-up sequence where the failure occurs, and the most likely location in the failure tree ([Table 7-3 Failure classification by boot-up sequence on page 103](#) and [Table 7-4 Failure classification by hardware devices and mechanical on page 104](#)). This will help isolate the issue and indicate the next steps. For example, when the computer is running the operating system, it may experience an issue with (4) Display, (5) I/O devices (keyboard, wireless, and so on), (6) Storage, or (7) Mechanical components (stuck buttons, thermal shutdown, and so on).

 **NOTE:** “Uncategorized” is used if an issue found is not listed. For example, Bluetooth is offered on certain hardware configurations; therefore, a Bluetooth issue can be classified under “I/O Device” if needed.

### Failure classification by boot-up sequence

**Table 7-3 Failure classification by boot-up sequence**

1. Power-on	2. POST	3. Performance
1. <a href="#">No Power on page 120</a>	1. <a href="#">No video (with power) on page 126</a>	1. <a href="#">Intermittent shutdown on page 130<sup>a</sup></a>
2. <a href="#">Intermittent power-on, shutdown, reboot on page 122<sup>a</sup></a>	2. <a href="#">Blinking lights on page 127</a>	2. <a href="#">Blue screen (BSOD) error on page 155<sup>b</sup></a>
3. <a href="#">AC adapter issue on page 123</a>	3. <a href="#">Diagnostics error messages on page 127</a>	3. <a href="#">Freeze at Windows Logo (hang/lockup) on page 133</a>
4. <a href="#">Battery not recognized, not charging on page 123</a>	4. <a href="#">BIOS password on page 129</a>	4. <a href="#">Electromagnetic Interference (EMI) on page 134</a>
5. <a href="#">Battery discharges too fast on page 125</a>		5. <a href="#">No wake up on page 135</a>
6. <a href="#">Burnt smell on page 125</a>		6. <a href="#">Unresponsive on page 136</a>
		7. <a href="#">Slow performance on page 136<sup>c</sup></a>
		8. <a href="#">HP Smart Adapter warning message on page 137</a>
		9. <a href="#">Incorrect time and date on page 137</a>

<sup>a,b,c</sup> similar symptoms

## Failure classification by hardware devices and mechanical

**Table 7-4 Failure classification by hardware devices and mechanical**

4. Display	5. I/O devices	6. Storage	7. Mechanical
1. <a href="#">Display anomalies on page 138</a>	1. <a href="#">Keyboard on page 144</a>	1. <a href="#">Hard drive/solid-state drive not recognized on page 154</a>	1. <a href="#">Fan error message - 90B on page 157</a>
2. <a href="#">Dead pixel on page 140</a>	2. <a href="#">Keyboard point stick on page 145</a>	2. <a href="#">No boot to operating system (no read/write error) on page 154</a>	2. <a href="#">Noise (sound) on page 158</a>
3. <a href="#">No video (internal) on page 140<sup>d</sup></a>	3. <a href="#">Keyboard backlight on page 145</a>	3. <a href="#">Read-write error on page 155</a>	3. <a href="#">Fan runs constantly on page 159</a>
4. <a href="#">No video (external) on page 141<sup>d</sup></a>	4. <a href="#">TouchPad on page 146</a>	4. <a href="#">Slow performance on page 136<sup>c</sup></a>	4. <a href="#">HP Thermal Monitor on page 109</a>
5. <a href="#">DisplayPort/VGA on page 141</a>	5. <a href="#">Network Connectivity Ethernet (RJ-45 jack) on page 146</a>	5. <a href="#">Blue screen (BSOD) error on page 155<sup>b</sup></a>	5. <a href="#">Stuck power button on page 160</a>
6. <a href="#">HDMI on page 141</a>	6. <a href="#">Network connectivity wireless (WLAN) on page 147</a>	6. <a href="#">Noisy hard drive on page 156</a>	
7. <a href="#">No or bad external video via docking on page 142</a>	7. <a href="#">WWAN on page 148</a>		
8. <a href="#">Incorrect or missing color/distorted image on page 142</a>	8. <a href="#">USB on page 149</a>		
9. <a href="#">Touch screen on page 143</a>	9. <a href="#">Smart card reader on page 150</a>		
	10. <a href="#">Speaker, headphone - audio issues on page 151</a>		
	11. <a href="#">Thunderbolt (TB) on page 152</a>		

<sup>b,c,d</sup> similar symptoms

## 2. Examine the environment

It is important to examine the computer's environment. If you can quickly identify the cause of the issue, fewer resolution steps may be needed. Perform the following environment inspections:

- Check all cables and connections to be sure that there are no loose connections.
- Confirm that power sources are good, such as wall power type/adaptor (110V/220V ac), power strip. Test with a verified working AC outlet.
- Check for compatibility issues between the computer and third-party devices, peripherals, noncertified devices, incompatible hardware (i.e., Mac OS device). Incompatibility can result in blue screen errors, improper operation, and so on.
- Isolate the computer from sources of electromagnetic interference (EMI), such as cell phones, 2-way radios, floor mats, fans (and other electronic motors). EMI may contribute to a display freeze issue or lock-up.

### 3. Perform a visual inspection of hardware

It is important to do a visual inspection of the hardware itself. Perform physical inspection of the computer:

- Look for abnormalities such as a cracked display, dented battery, broken latches for battery bay, keyboard key caps popped out, dust over connectors, liquid spill over keyboard, etc.
- Look for signs of drop, movement, or vibration that may cause internal and external loose connections.

### 4. Update BIOS and drivers

---

 **IMPORTANT:** Whenever possible, update to the latest BIOS, firmware, and drivers before troubleshooting.

Note that some customer company policies prohibit updates. Check your company policy before taking action.

The updates may include fixes for your computer issues, and they may also enhance system performance. HP continually improves the update process to make it easier. The BIOS update can be done locally through a manual process, through an automatic installation, or through a remote installation on multiple units.

#### *Manually updating BIOS and drivers*

- See the Computer Setup chapters to manually update BIOS and drivers.
- Refer to specific BIOS update installation instructions that accompany the download.

#### *Remotely deploying BIOS and drivers*

Instead of manually searching for and downloading each SoftPaq, users and IT personnel can use two tools to identify and download all appropriate SoftPaqs for the selected HP models.

- HP SoftPaq Download Manager (SDM) is a software tool designed to streamline the download, extraction, and installation process of SoftPaqs, including BIOS and drivers.
- HP System Software Manager (SSM) is a software tool designed to simplify the deployment of SoftPaqs to HP computers.

## Analyze the issue

### 5. Remove or uninstall recently added hardware, software

HP has designed this computer and validated it using a full-range hardware and software qualification matrix. If an issue appears to have started recently, it may be related to the recent addition of hardware or software. A good method to determine the root cause is to remove recently added components or uninstall applications one at a time and restart the computer when necessary.

---

 **IMPORTANT:** After you have completed the process of uninstalling hardware or software and are ready to reinstall, when installing a new device be sure that it is seated properly and all cables are correctly connected. After installing the device, restart the computer and make sure the new device is powered on. In addition, if the new device is a root cause of a problem, it could cause a conflict in drivers or incompatibility issues with other programs installed. For any new hardware you have added, be sure to install the latest drivers available from the device vendor website.

---

## 6. HP Hardware Diagnostics and Tools

HP offers different diagnostics and tools to diagnose hardware failure. This section describes how to use some of these tools. Make sure to check for the latest versions before use.

### HP PC Hardware Diagnostics (UEFI)

HP PC Hardware Diagnostics is a Unified Extensible Firmware Interface (UEFI) that allows you to run diagnostic tests to determine whether the computer hardware is functioning properly. The HP PC Hardware Diagnostics (UEFI) tool is built within BIOS (basic memory and hard drive diagnostics only), or within new hard drives themselves. These drives contain more advanced versions of the diagnostic tool than the BIOS-based version.

In addition, for HP authorized service partners and IT professionals who need to support a mixed environment of older and newer HP/Compaq PCs, the [http://www8.hp.com/us/en/campaigns/hpsupportassistant/pc-diags.html?jumpid=va\\_r602\\_us/en/any/pps/pl\\_ot\\_ob\\_ds\\_pd/HP\\_PC\\_Hardware\\_Diagnostics\\_cc/dt](http://www8.hp.com/us/en/campaigns/hpsupportassistant/pc-diags.html?jumpid=va_r602_us/en/any/pps/pl_ot_ob_ds_pd/HP_PC_Hardware_Diagnostics_cc/dt) is a diagnostic tool that supports a wide range of HP Desktop and Notebook computers.

The tool runs outside the operating system so that it can isolate hardware failures from issues that are caused by the operating system or other software components. In reality, many problems can be determined using this tool if the issue is a defective part or a loose connection (i.e., reseating keyboard cable after the tool reports a keyboard error).

The tool has three major functions:

- **System Tests** - Check the computer's hardware to assure everything is functioning properly. If your system won't boot into Windows, try the Quick System Test. For more comprehensive testing, use the Extensive System Test option. If the System Test did not detect a hardware problem, continue with the Component Tests.
- **Component Tests** – Focus on selected hardware components in your computer.
- **Firmware Management** – Update your computer's BIOS to the latest version (available separately) or roll back to a previous version.

To start HP PC Hardware Diagnostics (UEFI):

1. Turn on or restart the computer, quickly press the **esc** button on the computer, and then press **F2**. The BIOS searches three places for the diagnostic tools, in the following order:
  - a. Connected USB drive
  - b. Hard drive
  - c. BIOS

2. When the diagnostic tool opens, use the keyboard arrow keys to select the type of diagnostic test you want to run, and then follow the on-screen instructions.

Screen shot appearance may vary.

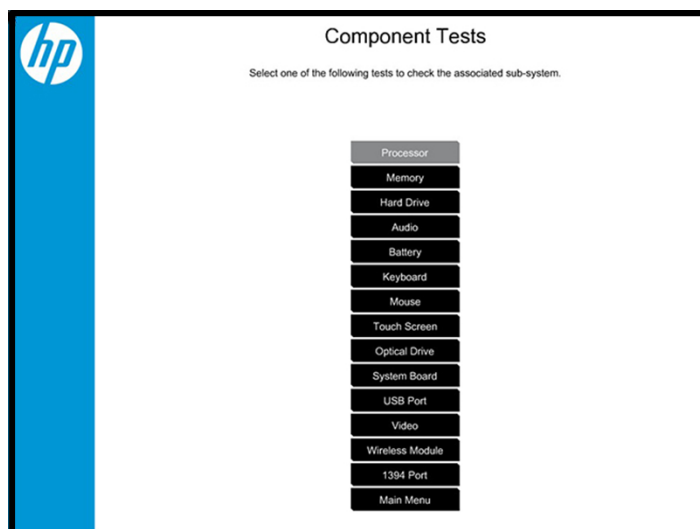
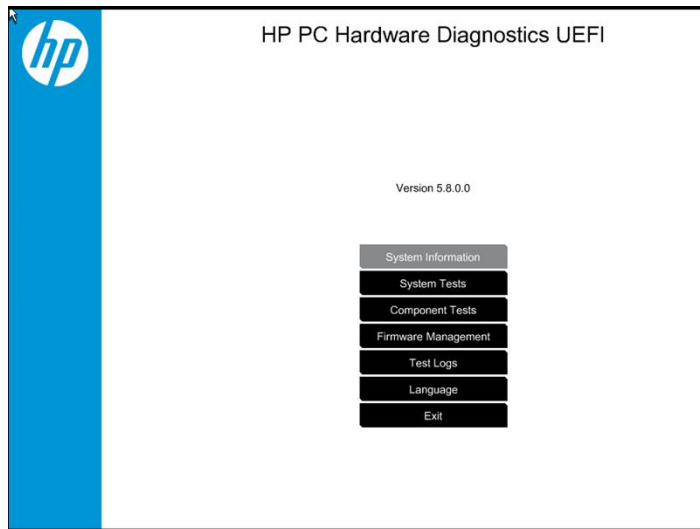

---

 **NOTE:** Users should utilize this tool, especially when the computer cannot boot to Windows.

 **NOTE:** If a component fails a test, write down the information so it is available when contacting support. The information is also available in **Test Logs** on the Main Menu.

---

For more information, see the chapter titled “Using HP PC Hardware Diagnostics (UEFI).”

## HP Support Assistant (HPSA)

HP Support Assistant (HPSA) helps you maintain peak performance and resolve problems through automatic updates, built-in diagnostics, and a variety of assistance options. HPSA is preinstalled on every new HP PC with Windows 7, Windows 8, or Windows 10. HP is continually improving this tool. Please verify the latest version is installed to receive the most benefit. For more information, see <http://www.hp.com/go/hpsupportassistant>.



**NOTE:** HPSA can be used only if the computer boots into Windows. If the computer does not boot into Windows, use HP PC Hardware Diagnostics (UEFI) instead.

HPSA also integrates diagnostics and tools that help resolve issues. See example screen shots as follows.

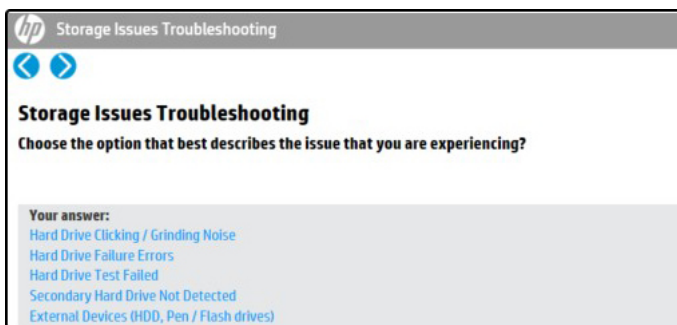
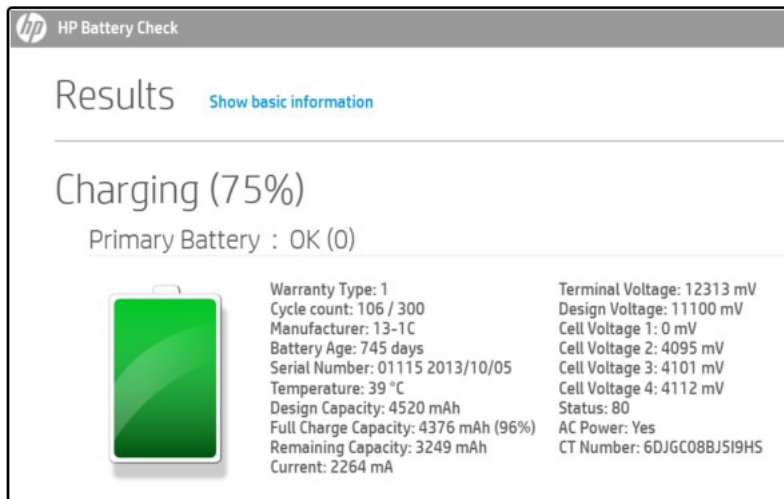
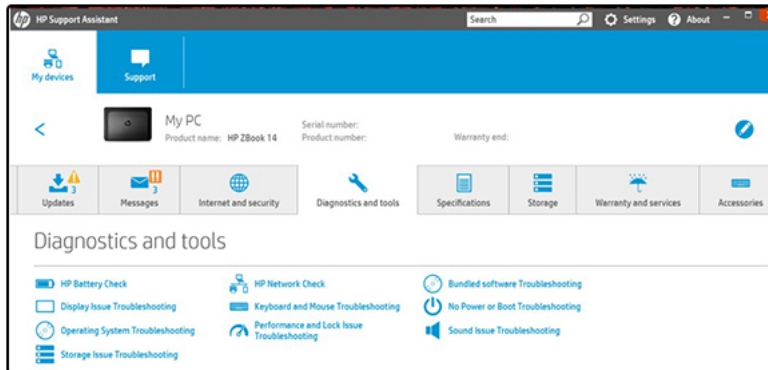



## HP BIOS Configuration Utility (BCU)

HP BCU is a free utility that captures the BIOS settings and their values. This tool provides a text file of the computer's BIOS configuration. This can help identify any settings that may be contributing to an issue.

In some cases, it may help to compare this BIOS text file to the default settings of the computer.

For more information, see the [http://ftp.hp.com/pub/caps-softpaq/cmit/whitepapers/BIOS\\_Configuration\\_UTILITY\\_User\\_Guide.pdf](http://ftp.hp.com/pub/caps-softpaq/cmit/whitepapers/BIOS_Configuration_UTILITY_User_Guide.pdf).



**NOTE:** HP recommends that you reset BIOS before trying BCU. Resetting the BIOS is always available and relatively quick to try, whereas BCU takes extra time and effort.

---

## HP Image Diagnostic Tool

Available to HP Authorized Support Partners (ASPs) and users from the <ftp://ftp.hp.com/pub/idr/ImageDiags/>, this tool collects information about the current state of the computer, including product serial number, platform and BIOS information, and information about user-installed software and hardware components. HP encourages you to review the report before sending it to support. The report may assist you with diagnostics and solutions to problems you encounter.

## HP Thermal Monitor



**NOTE:** Available only to authorized service providers/technicians.

---

Available only for HP internal use, HP Thermal Monitor can be used to stress the processor and GPU and monitor the temperature values of various components in the system. The components that are currently monitored include the processor, GPU, ACPI thermal zones, hard drive, and battery. The tool reads the temperatures of the components, logs the data, and helps to determine whether the computer would overheat in the event of thermal shutdown, fan spinning loud, etc.

## Non HP diagnostics tools

### *Windows-to-Go USB*

Windows-To-Go USB is a Microsoft-based tool for Enterprise editions of Windows that can help in troubleshooting. You can find a process online about how to create a live Windows USB drive. For more information, see <https://technet.microsoft.com/en-us/library/hh831833.aspx>.

### *Intel Processor Diagnostic Tool*

Determine what processor is in your computer and verify the processor operating frequency. The tool also tests specific processor features and performs a stress test on the processor. For more information, see [http://www.intel.com/support/processors/sb/CS-031726.htm?iid=subhdr+tools\\_procdiagtool](http://www.intel.com/support/processors/sb/CS-031726.htm?iid=subhdr+tools_procdiagtool).

## 7. Status lights, blinking light codes, troubleshooting lights, and POST error messages

Carefully observe any behavior the computer may be exhibiting: status lights, blinking lights, and POST error messages during boot. It is important to understand what these indicators mean.

### Status lights

See the chapter titled “External Component Identification” for light locations. The following table describes basic lights on the computer.

Component	Description
Power button	<p>When the computer is off, press the button to turn on the computer.</p> <p>When the computer is on, press the button briefly to initiate Sleep (Windows) or Suspend (Linux).</p> <p>When the computer is in the Sleep state, press the button briefly to exit Sleep (Windows) or Suspend (Linux).</p> <p>When the computer is in Hibernation, press the button briefly to exit Hibernation.</p> <p><b>CAUTION:</b> Pressing and holding down the power button results in the loss of unsaved information.</p> <p>If the computer has stopped responding and operating system shutdown procedures are ineffective, press and hold the power button.</p>
Front power light	<p>On: The computer is on.</p> <p>Blinking: The computer is in the Sleep state.</p> <p>Off: The computer is off.</p>
Front AC adapter and battery light	<p>White: The computer is connected to external power and the battery is charged from 90 to 99 percent.</p> <p>Amber: The computer is connected to external power and the battery is charged from 0 to 90 percent.</p> <p>Blinking amber: A battery that is the only available power source has reached a low battery level. When the battery reaches a critical battery level, the battery light begins blinking rapidly. By default, the critical battery level is defined in Power Options as 5%.</p> <p>Off: The battery is fully charged.</p>
Front hard drive light	<p>Blinking white: The hard drive is being accessed.</p> <p>Amber: HP 3D DriveGuard has temporarily parked the hard drive.</p>
Rear AC adapter light	<p>White: The computer is connected to external power.</p> <p>Off: The computer is not connected to external power.</p>

## Blinking light codes

During startup, the computer may not boot properly. If this occurs, blinking light codes that will help identify what is causing the issue. The computer uses the blinking lights below to identify a hardware component that reports an error during startup. For more information, see [Blinking lights and boot error codes on page 162](#).

**Table 7-5 Boot-error codes**

Blink codes	Error
Amber battery light: blinks 1 Hz continuously	Embedded controller unable to load firmware
Caps/num lock lights = 1 blink	Processor not executing code
Caps/num lock lights = 2 blinks	BIOS recovery code unable to find valid BIOS recovery image
Caps/num lock lights = 3 blinks	Memory module error
Caps/num lock lights = 4 blinks	Graphics controller error
Caps/num lock lights = 5 blinks	System board error
Caps/num lock lights = 6 blinks	Intel Trusted Execution Technology (TXT) Error
Caps/num lock lights = 7 blinks	Sure Start unable to find valid BIOS Boot Block image
Caps/num lock lights = 8 blinks	Sure Start has identified a problem (Manual Recovery Policy Set)

## POST error messages

The Power-On Self-Test (POST) is a series of diagnostic tests that runs automatically when the computer is powered on. If the POST encounters a problem, visual error messages are displayed before the operating system starts. POST checks the following items to ensure that the computer system is functioning properly:

- Memory
- Processors
- BIOS
- Mass storage devices
- Fans

The following table describes errors encountered during HP PC Hardware Diagnostics (UEFI).

**Table 7-6 System diagnostics failure codes and user actions**

Test description	Failure description	Error code	Suggested user actions
Startup Test	Memory module	200	Attempt to reseat the memory module and then repeat the test.  For details on troubleshooting issues related to the memory module, search for support documentation at <a href="http://www.hp.com/support">http://www.hp.com/support</a> .
Startup Test	Hard Disk 1 SMART	301	Attempt to reseat the hard drive and repeat the test. The hard drive may have failed.
Boot Device Manager	Boot device not found	3F0	Reset BIOS. Then reseat the hard drive and repeat the test.
BIOS Recovery	BIOS Recovery Occurred	500	This message indicates that BIOS recovery was completed successfully. No further action is required.

**Table 7-6 System diagnostics failure codes and user actions (continued)**

Test description	Failure description	Error code	Suggested user actions
BIOS Application	BIOS Application Error	501	The BIOS installation may have become corrupted. Download the latest version of the BIOS and install it.  If reinstalling the BIOS fails, contact support for further assistance.
CMOS Recovery	CMOS Recovery Occurred	502	This message indicates that CMOS recovery was completed successfully. No further action is required.
Battery Check	Primary Battery Replace	601	This message indicates that the primary battery has very low capacity. Search for support documentation at <a href="http://www.hp.com/support">http://www.hp.com/support</a> for details on using the HP Support Assistant to verify the battery capacity and, if necessary, order a replacement.
Wireless Modules	Not installed or responding	701	Reseat the wireless LAN adapter module and antennas.  Because seating or reseating a wireless LAN adapter is unique to each computer model, see the WLAN module removal section in the removal and replacement chapter for further details.  Contact support if third-party wireless adapters are installed in the computer.
Fan	Fan not operating correctly	90B	The system fan may be malfunctioning. Replace the fan.

### Power Good (Troubleshooting) lights

HP has added troubleshooting power lights to ZBook Gx Mobile Workstations (Studio, ZBook 15, and ZBook 17) to help troubleshoot power-on issues. The lights indicate when the system board power rails are unstable and/or the system needs a hardware reset.

#### Example



---

**Example**

---

These lights should be visible after removing the service door, middle cover, heatsink, discrete MXM daughter card, and thermal plastic.

---

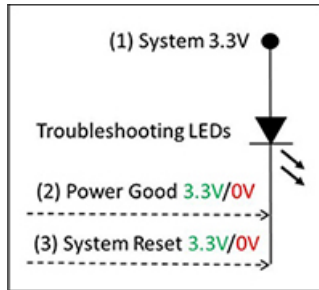

Troubleshooting LEDs diagram

---

- Example: System board is good. Lights that turn on briefly (< 1 second) and immediately turn off indicate normal function. In this case, system (3.3V), power good (3.3V), and system reset (3.3V) are all good and troubleshooting lights should not be lit. However, other external lights should be lit as normal afterward.

Troubleshooting lights	External lights	Action	Note
Off	On	Do not replace system board	No power-on issue
On	Off	Replace board	Power-on issue

- Example: System board needs replacement. When (1) system 3.3V exists, but one power rail is bad then (2) power good is low (0V), and troubleshooting lights will turn on.

After you press the system power button, troubleshooting lights will turn on for 5 seconds and turn off. The system external lights will not light up. Follow general troubleshooting steps (i.e., remove recently added hardware, test with minimum configuration, etc.) prior to replacing the system board.



## Resolve the issue

### 8. Hard reset

A hard reset (or forced reset) erases all information in the computer's memory and may restore functionality. Resetting the computer forces the system to clear and reestablish the connections between the BIOS and the hardware. For more information, see <http://support.hp.com/us-en/document/c01684768>.

Performing a hard reset might fix the following common conditions:

- Windows stops responding.
- Computer stops before Windows loads, indicated by incomplete boot-up, blinking cursor on a black background, and errors relating to operating system not found or a missing drive.
- Display suddenly goes blank and stays blank.
- Software freezes.
- Keyboard stops responding.
- The computer does not exit Sleep or Suspend state.
- An external device stops responding. Turn off the power to that device in addition to performing the steps in this document.

Before performing a hard reset, you must disconnect or remove all peripheral devices. You should start and test the computer by itself, and if the problem is not resolved, reconnect one peripheral device at a time. To resolve the startup or operational problem, run HP Support Assistant, or manually install all updated drivers from Microsoft and HP.

Before beginning, turn the computer over and look for a battery compartment door (service door). For 2015 platforms, the battery is considered removable but not accessible. See the battery section for how to remove/unplug the battery.

To perform a hard reset on a computer with a sealed or non removable battery, use the following steps:

1. Turn off the computer.
2. Remove the computer from any port replicator or docking station.
3. Disconnect all external connected peripheral devices such as USB storage devices, external displays, and printers.
4. Unplug the AC adapter from the computer.
5. Disconnect the battery.
6. Press and hold the power button for at least 15 seconds to drain residual power.
7. Reconnect the battery and plug the AC adapter back into the computer, but do not connect any of the peripheral devices.
8. Press the power button to turn on the computer.
9. If a startup menu appears, use the arrow keys to select **Start Windows Normally**, and then press the **Enter** key.
10. After reconnecting each of the peripheral devices, run Windows Update and HP Support Assistant to update all device drivers.

### **Clear CMOS**

CMOS refers to the battery-powered, semiconductor chip located on computer's system board. Notebooks store low-level settings like the system time and hardware settings in CMOS. Sometimes it is necessary to clear CMOS, which requires removing and reinserting the 3V RTC battery for a short period of time (a few minutes before reinserting), in addition to removing the AC adapter and battery.

---

 **NOTE:** Clearing the CMOS should only be performed for troubleshooting purposes. There is no reason to clear CMOS if the computer is working properly.

The notebook service door must be removed to access the CMOS battery. If the computer has a replaceable RTC battery, see the RTC battery replacement section for the battery removal/replacement.

---

## 9. Soft reset (Default Settings)

---

 **NOTE:** Some company policies prohibit updates or changes. Check whether the computer has custom BIOS settings before taking action.

---

If your computer is having issues booting, has errors during boot, is running into issues after adding hardware, or you are having other abnormal system behaviors that cannot be resolved through any other methods (i.e., hard reset), it may be necessary to reset the system BIOS to default settings.

To load BIOS to default settings: Reboot the computer, and then press **F10 > Main > Restore defaults**. For more information, see the BIOS F10 Setup technical white paper at <http://support.hp.com>, enter your computer model, and then go to **Manuals > White papers > HP PC BIOS F10 Setup Guide**.

## 10. Reseat cables and connections

---

 **NOTE:** Before disassembling the computer to reseat cables and connections, always disconnect power and remove the battery or disconnect a non removable battery.

---

Many problems are caused by improper connections or loose connections due to abnormal movement and vibration. See [Cable management on page 173](#) and [Connector types on page 174](#) for suggested cable management practices when removing and installing components.

You can access and reseat connections for Customer Self-Repair (CSR) parts (see the “Removal and replacement procedures for Customer Self-Repair parts” chapter for details). Examples of reseating hardware include:

- Reseating the battery into the battery bay can resolve no-battery found and no-charging issues.
- Reseating memory modules can resolve memory error, no-boot, and blue screen issues.
- Reseating the hard drive can resolve a POST error 3F0 (no boot device) issue (see [POST Error Messages and User Actions on page 164](#)).
- Reseating the keyboard cable can resolve an unrecognized keys error.
- Reseating the wireless module and antenna cable can resolve a wireless connection issue.

For field replaceable units (FRUs), authorized service providers can try the following steps (for more information, see the “Removal and replacement procedures for authorized service provider parts” chapter).

- Reseating the fan cable can fix POST error 90B (no fan detected) issue (see [POST Error Messages and User Actions on page 164](#)).
- Reseating the power cable can fix a no boot issue.
- Reseating the daughterboards (some models may have a power button board, VGA board, etc.) can resolve their functional issues.
- Reseating graphics cables and panel connectors can fix distorted/flickering video.
- Replacing thermal pads may resolve thermal power-down issue.

## 11. Test with minimum configuration

The factory-shipped computer (hardware configuration and preinstalled operating system image) is well tested and ready for use. Therefore, using the original factory hardware configuration and/or booting to operating system safe mode often resolves issues quickly.

- Disconnect any external USB storage, remove any discs in optical drives, remove the computer from a docking station, remove external video, etc.
- In addition to removing recently added components, the issue can be narrowed down further with a minimum configuration. For example, if HP PC Diagnostics reports a memory error, test one memory module at a time to isolate the defective module.
- If the computer does not successfully boot the operating system, booting to safe mode may help identify what may be causing the issue as described below.

### Essential hardware configuration



---

**NOTE:** This step is to be used by authorized service providers only. HP will not honor the warranty for a system tested with the system board removed without the heat sink, fan, etc.

---

If none of the steps above resolve the issue, start the computer with essential hardware only. The purpose is to remove as much as hardware as possible while still maintaining the computer's ability to turn on.

This essential configuration is often used to troubleshoot power-on related issues, such as no-boot, reboot, and freezing issues.

The essential hardware consists of the following:

- System board
- AC adapter (unplug nonremovable battery or remove battery)
- Processor (and heat sink/fan). (Processor may be integrated into the system board.)
- Memory (one verified working memory DIMM)
- Graphics card (if no VGA port is available on the system board). Platform may have both Intel integrated graphics and discrete graphics. Therefore, discrete graphics card may not be needed.
- External VGA monitor
- External USB keyboard
- External mouse



---

**NOTE:** After the service door is removed, disconnect all connections (internal keyboard, display, discrete GPU, hard drive/solid-state drive, daughterboards, etc.) to achieve the essential hardware configuration above. **DO NOT** disassemble the system board from its enclosure at this time.

---

Reverse the procedure above by reinstalling each piece of hardware removed, one piece at a time, and testing your computer after each installation. Since your computer works with only the essential hardware installed, those parts must be working properly. This means that one of the hardware components removed is causing the computer to not work properly. By installing each device back into the computer and testing each time, the failing hardware will eventually be identified.

### Safe mode

A driver conflict often results in a blue screen error message. Therefore, booting in safe mode can resolve many issues in Windows because safe mode forces the computer to load a limited version of Windows which



only contains essential files. Safe mode is useful for troubleshooting problems with programs and drivers that might not start correctly or that might prevent Windows from starting correctly.

If a problem does not reappear when you start in safe mode, eliminate the default settings and basic device drivers as possible causes. Refer to the links below for how to start your computer in safe mode:

- <http://support.hp.com/us-en/document/c01835750>
- <http://support.hp.com/us-en/document/c03439317>

## 12. Test with verified working configuration (hardware and/or operating system)

One troubleshooting technique that can quickly isolate an issue is using a verified working part while testing. A good example is to use an external keyboard, mouse, or VGA monitor when you have issues with an internal keyboard, TouchPad, or display. Testing with a verified working AC adapter can identify an error caused by a faulty one. Similarly, testing with a verified working operating system can determine bad behaviors of the current operating system. See [Non HP diagnostics tools on page 109](#) for instructions about obtaining and using a Windows-To-Go USB.



---

**NOTE:** In some situations, more than one item may contribute to a problem.

## 13. Replace the system board

The system board may be replaced only by authorized service providers. This should not be considered an initial step taken to resolve an issue. Review and perform all steps discussed previously before replacing the system board. [4. Update BIOS and drivers on page 105](#), [7. Status lights, blinking light codes, troubleshooting lights, and POST error messages on page 110](#), [8. Hard reset on page 113](#), and [9. Soft reset \(Default Settings\) on page 115](#), and/or [10. Reseat cables and connections on page 115](#) can resolve many system board issues without requiring the effort of replacing unnecessary hardware.

Review [Table 7-1 Troubleshooting methodology and general troubleshooting steps on page 101](#) for appropriate troubleshooting steps.



---

**IMPORTANT:** System board failure is not common. Do not replace the system board until you have tried all other troubleshooting options.



**NOTE:** Determine whether a previous service case might be related to the current problem. For example, a fan detection issue may be caused by a loose connection resulting from previous service.



**TIP:** Without an RTC battery (3V coin-cell battery), the computer automatically reboots. This is a useful feature when the power connector cable (between external AC adapter and system board) is defective.



**NOTE:** Most of the time, effective troubleshooting can prevent a system board replacement.

Items that may prevent resolution of the issue:

- The information provided about the issue omits key details, including any actions taken before the issue occurred.
  - BIOS, software, and drivers have not been updated.
  - Cables or connections are loose.
  - Technician is unaware of information available from the HP Support website (i.e., CA - Customer Advisory).
  - The issue is related to existing or known issues that may be identified in existing support articles.
  - Technician may have omitted steps in the provided repair instructions (e.g., Spare Part Replacement Instructions).
  - Skipping one of steps from Troubleshooting Methodology table results in No Defect Found (NDF)/No Fault Found (NFF)/No Issue Detected (NID) messages.
- 

## Verify solution

- Verify that the implemented solution works. Reboot the system or device and try to complete the task that produced the issue.
- If a part has been replaced, verify other basic functions. For example, GPU replacement requires keyboard removal. Therefore, it is good practice to verify all basic components to be sure that the solution is complete.
- Explain to the customer why the issue occurred and what was done to resolve it. If the solution you used was in an HP Public document, provide the document information to the customer, letting them know it can be located on [www.hp.com](http://www.hp.com). Also, tell them that there are other solutions available on the website. Advise the customer to check the website first when they have an issue. It may save them time calling in.
- Document the correct issue. Update the case with as many details as possible for other agents and engineering to analyze and study for lessons learned.

## Helpful Hints

After you become familiar with the general troubleshooting steps above ([General troubleshooting steps on page 101](#)), follow the helpful hints below before running diagnostics and troubleshooting.

### At startup



**TIP:** If you have installed an operating system other than the factory-installed operating system, go to <http://www.hp.com/go/quickspecs> and verify that it is supported on your system.

---

1. Be sure that the computer is plugged into a working AC outlet.
2. Be sure that power is connected to the docking station if a dock is used.
3. Be sure that the AC adapter light is on.
4. Be sure that the AC adapter is connected when you update BIOS to avoid BIOS corruption.
5. Be sure that the computer is turned on, the rear power light is solid white (connected to an external power source) and the front power light is solid white (normal operation).
6. Remove all optical and flash drives from your system before turning it on.

7. Be sure that the boot option is set to a working operating system drive.
8. Be sure that externally connected monitors are turned on and their power lights are on. Not all monitors are equipped with lights to indicate their functionality.
9. Turn up the brightness and contrast controls of a display or external display device if the screen is dim.

## During operation

1. To wake the computer:
  - a. Press the power button or any key on the keyboard.
  - b. If the system remains in the Sleep (Windows), Suspend (Linux), or Hibernate state, shut down the system by pressing and holding the power button for at least four seconds.
  - c. If the system does not shut down, unplug the power cord, wait a few seconds, and then plug it in again. Then press the power button again to restart the system. If it does not turn on, press the power button to start the computer.
2. Look for blinking lights on the computer. The blinking lights could be error codes that will help diagnose the problem.
3. Check all cables for loose or incorrect connections (external devices, power cords, dock, etc.).
4. After installing a non-Plug and Play expansion board or other option, reconfigure the computer. For example, if you upgrade to a solid-state drive, you may need to reconfigure the boot order.
5. Be sure that all required device drivers have been installed. For example, if you have connected a printer, you must install a printer driver.
6. If there is a network connection issue, plug another computer with a different cable into the network connection. There might be a problem with the network plug or cable.
7. If hardware has recently been installed, remove it and determine whether the computer functions properly.
8. If software has recently been installed, uninstall it and determine whether the computer functions properly.
9. If the screen is blank, confirm the display choice by pressing **Windows logo**  + **P** and set to screen only. Or plug an external monitor into a different video port on the computer if one is available and close the computer lid.
10. Verify that the latest version of BIOS, drivers, and software are installed. A new release might support new features or fix the problem.
11. Press the **caps lock** and/or **num lock** key. If the **caps lock** and/or **num lock** light toggles on or off, the keyboard is likely operating correctly.
12. Press the TouchPad On/Off button light. If the light toggles on or off, the TouchPad is likely operating correctly.

## Consulting with HP Service

If further HP support is required, a lot of the following information may be requested when you call, so it may be helpful to take notes.

- Technical support registration number (if applicable)
- Product serial number

- Product model name and number
- Product identification number
- Applicable error messages
- Add-on boards or hardware
- Third-party hardware or software
- Operating system type and revision level

## Common issues and possible solutions

This section contains common issues, symptoms, and a series of tables that describe possible solutions to issues from [Failure classification on page 102](#) tables. The following sections identify the issue with symptoms and solutions to resolve an issue.

### Power-on issues

#### No Power

When a unit experiences no power there are several contributing factors to consider. Be sure to consider all symptoms related to this behavior in troubleshooting.



Items	Procedures
<p><i>Symptoms</i></p> <ul style="list-style-type: none"> <li>• Computer does not start</li> <li>• Display is black or blank</li> <li>• No fan noise</li> <li>• No hard drive spinning</li> <li>• Lights do not glow</li> </ul>	<p><i>Possible causes</i></p> <ul style="list-style-type: none"> <li>Failed power input to the computer (external power source, AC adapter, faulty battery).</li> <li>Bad connection to the computer (bad power button, power connector).</li> <li>Defective parts (memory, hard drive, graphics) or failed system board.</li> </ul> <p><i>Troubleshooting steps</i></p> <p><b>Perform quick check</b></p> <p>Remove all external devices, including docking station.</p> <p>Verify external power source (<a href="#">2. Examine the environment on page 104</a>).</p> <p>Perform a hard reset (<a href="#">8. Hard reset on page 113</a>).</p>



#### Verify AC adapter

It is preferable to verify the battery before verifying the AC adapter. However, you can verify the AC adapter first, before opening the service door for a battery check.

- Verify AC adapter is compatible with product. Verify that the part number is for this computer if possible.
- Verify AC adapter and power cord are good (no physical damage, bent middle ID pin).
- Verify AC adapter works on a verified working computer.
- Plug in AC adapter and power on computer without battery.
- Inspect power port on computer side for any damage, dust, or debris.

Items	Procedures	
	<ul style="list-style-type: none"> <li>Check power light (<a href="#">7. Status lights, blinking light codes, troubleshooting lights, and POST error messages on page 110</a>). Rear power light indicates external power to the computer is good.</li> </ul>	
<p><b>NOTE:</b> Refer to battery replacement section for removing/replacing the battery</p>	<p><b>Verify battery condition/status</b></p> <ol style="list-style-type: none"> <li>Check battery condition (overall result, cycle life, voltage, etc.) using HP PC Hardware Diagnostics (UEFI) or HPSA tools.</li> <li>Verify that battery is installed properly in battery bay without a gap and that latch locks are tight (for models with removable batteries).</li> <li>Check battery status light (<a href="#">7. Status lights, blinking light codes, troubleshooting lights, and POST error messages on page 110</a>). Be sure that battery is not fully discharged, preventing system from booting.</li> <li>Determine whether the computer can turn on with battery only.</li> <li>Remove service door and test with a verified working battery. If the computer boots, inspect original battery before replacement.</li> <li>Test battery with a verified working computer to verify that it is OK.</li> <li>If there is still no boot, remove battery and boot on AC power only.</li> </ol>	
<p><b>The sections below are intended for authorized service providers/technicians.</b></p>		
<p><b>Verify AC adapter – voltage</b></p> <ol style="list-style-type: none"> <li>Measure DC voltage output that should be around 19.5 VDC and acceptable voltage range is from 18.5 – 20.5 VDC.</li> <li>If the DC voltage is out of range, replace the AC adapter.</li> </ol> <p><b>NOTE:</b> This action requires a digital voltmeter.</p>		
<p><b>NOTE:</b> 2015 mWS does not have the power cable between system board and power connector on chassis</p>	<p><b>Verify power button, power connector</b></p> <ol style="list-style-type: none"> <li>Be sure that power button is not stuck.</li> <li>Reseat power connector cable (if applicable).</li> <li>Replace new power connector cable (if the cable exists and is defective)</li> <li>To isolate faulty power connector cable and power button, technicians can short power-on pads/pins to power up the computer. Contact HP Engineering for this information.</li> </ol>	
	<p><b>Verify blinking lights</b> (<a href="#">7. Status lights, blinking light codes, troubleshooting lights, and POST error messages on page 110</a>)</p> <p>At this point, there should be sufficient power from the AC adapter to the system board. Expect to hear the fan spinning and see blinking lights or error messages (i.e., faulty memory, HDD, etc)</p>	
<p><b>Verify Power Good (Troubleshooting) lights</b></p> <ol style="list-style-type: none"> <li>Verify if the system board has power-on issue related. If there is no power-on issue, move to next steps. For more information, see <a href="#">Power Good (Troubleshooting) lights on page 112</a>.</li> <li>Verify all connections and reseat parts (<a href="#">10. Reseat cables and connections on page 115</a>).</li> </ol>		
<p><b>Verify system board</b></p>		

Items	Procedures
	<ol style="list-style-type: none"> <li>1. Test essential hardware configuration (<a href="#">11. Test with minimum configuration on page 116</a>, <a href="#">12. Test with verified working configuration (hardware and/or operating system) on page 117</a>, <a href="#">13. Replace the system board on page 117</a>) by removing nonessential parts.</li> <li>2. If there is still no boot, replace system board.</li> </ol>
<b>Tips and tricks</b>	<p>Computer automatically boots without pressing power button when RTC 3V battery has been removed. Therefore, after the service door and RTC 3V battery are removed, no need to press power button from top side.</p> <p>In essential hardware configuration, mWS G1 and G2 may require discrete GPU to boot. However, mWS G3 can boot with integrated graphics.</p>

## Intermittent power-on, shutdown, reboot

Items	Procedures
<i>Symptoms</i>	<i>Possible causes</i>
<ul style="list-style-type: none"> <li>• Does not always turn on</li> <li>• Intermittently hangs</li> <li>• Intermittently shuts down</li> <li>• Spontaneously reboots</li> </ul>	<p>Electrical short, fluctuating power source, unstable power rails, loose connections, bent pins, stray wires, dust, obvious damage, nearly faulty parts (bulging/leaking capacitor).</p> <p>Potentially will turn into a no power issue soon (<a href="#">No Power on page 120</a>).</p>
	<i>Troubleshooting steps</i>
	<ol style="list-style-type: none"> <li>1. Visually check power ports on both AC adapter and computer sides.</li> <li>2. Inspect power sources: <ol style="list-style-type: none"> <li>a. Verify AC adapter working correctly. Use a confirmed working adapter to test.</li> <li>b. Verify that battery is not depleted while system is in Sleep state. Test with a confirmed working battery.</li> </ol> </li> </ol>
<b>The sections below are intended for authorized service providers/technicians.</b>	
	<ol style="list-style-type: none"> <li>1. Follow actions in <a href="#">No Power on page 120</a>. <ol style="list-style-type: none"> <li>a. Be sure that AC adapter has correct DC voltage.</li> <li>b. Verify battery - test with a confirmed working battery.</li> <li>c. Verify that power button is not stuck.</li> <li>d. Verify that power connector is not loose.</li> <li>e. Verify that Power Good LEDs are solid.</li> <li>f. Remedy loose connections and reseat major components (processor, memory, GPU, hard drive/solid-state drive, etc).</li> </ol> </li> <li>2. Perform visual check for loose connections, bent pins, stray wires, dust, nearly faulty parts (bulging/leaking capacitor).</li> <li>3. Test <b>essential hardware configuration</b> (<a href="#">11. Test with minimum configuration on page 116</a>) <ol style="list-style-type: none"> <li>a. If system boots, reinstall nonessential hardware one component at a time to isolate issue.</li> <li>b. If system does not boot, replace essential hardware with verified working parts, one component at a time. If system still does not boot, replace system board.</li> </ol> </li> </ol>

## AC adapter issue

<b>Solution</b>	
<i>Symptoms</i>	<i>Possible causes</i>
<ul style="list-style-type: none"><li>No sign of power</li><li>No boot</li><li>No rear power light on the system</li><li>No front power light on the system</li><li>Battery does not charge when AC adapter is connected</li></ul>	AC adapter and others (i.e., external power source)
	<i>Troubleshooting steps</i>
	<b>Quick check</b>
	<ol style="list-style-type: none"><li>Verify external power source (<a href="#">2. Examine the environment on page 104</a>).</li><li>Remove all external devices, including docking station.</li><li>Perform a hard reset for the computer (<a href="#">8. Hard reset on page 113</a>).</li><li>Disconnect and reassemble the power cord and adapter in case the adapter experienced short circuit, over current, over temperature events.</li><li>Use a verified working adapter. If the computer operates normally, there is a problem with the original adapter.</li><li>Verify that the AC adapter works on a verified working computer. If the computer operates normally, there is no problem with the adapter. See <a href="#">HP Smart Adapter warning message on page 137</a> for further information.</li></ol>
	<b>Verify AC adapter</b>
	<ol style="list-style-type: none"><li>Remove working battery.</li><li>Verify that AC adapter is compatible with product. Verify that part number is for this computer if possible.</li><li>Inspect AC adapter and power cord for physical damage, bent middle ID pin.</li><li>Plug in AC adapter and power the computer without battery.</li><li>Inspect the power port on computer side for any damage, dust, debris.</li><li>Check power light (<a href="#">7. Status lights, blinking light codes, troubleshooting lights, and POST error messages on page 110</a>). Rear power light indicates that external power to the computer is good.</li><li>If there is still no rear power light or no boot, replace the AC adapter.</li></ol>
<b>Tips and tricks</b>	<p>The HP Smart AC adapter has a special pin in the middle, called the ID pin, for power rating and throttling purpose. If this pin is broken, the rear power light will be on but the power button and front power lights will blink continuously and the computer will not turn on. Third party AC adapter will not work on the computer.</p> <p>Use the AC adapter that came with the computer for better performance.</p>

## Battery not recognized, not charging

<b>Items</b>	<b>Procedures</b>
<i>Symptoms</i>	<i>Possible causes</i>
<ul style="list-style-type: none"><li>No battery status light</li><li>Blinking amber (critically low battery level)</li><li>No boot without AC adapter</li></ul>	Defective AC adapter and/or battery.
	<b>NOTE:</b> Before proceeding, verify that the computer can boot to BIOS or Windows with a good AC adapter.
	<i>Troubleshooting steps</i>

Items	Procedures
	<p><b>Visual inspections</b></p> <ol style="list-style-type: none"> <li>1. Inspect battery connectors for any signs of damage.</li> <li>2. Verify that battery is installed properly in battery bay without gap or obstructions and latch locks are tight. Reseat battery (for models with removable batteries).</li> <li>3. Determine whether battery gets hot (batteries heat up when charging, but not too hot to touch).</li> </ol> <p><b>Check battery warranty</b> to see whether the battery is new or its warranty is expired. Battery capacity degrades over time.</p> <p><b>Verify front battery status light</b></p> <ol style="list-style-type: none"> <li>1. Battery status light is off: battery not recognized.</li> <li>2. Battery status light is blinking amber: critically low battery level.</li> </ol> <p><b>Reset</b></p> <ol style="list-style-type: none"> <li>1. Hard reset (<a href="#">8. Hard reset on page 113</a>)</li> <li>2. Soft reset (<a href="#">9. Soft reset (Default Settings) on page 115</a>)</li> </ol> <p><b>Verify AC adapter</b></p> <ol style="list-style-type: none"> <li>1. Determine whether the computer needs the AC adapter to boot and operate. Sometimes, intermittently bad AC adapter and loose connection between adapter and computer results in inability to charge battery which causes short run time.</li> <li>2. Inspect AC adapter to verify that it is functioning.</li> <li>3. Test with a working AC adapter and confirm whether battery is charging.</li> <li>4. Be sure that battery is fully charged (AC adapter plugged in at least 2.5 hours).</li> </ol> <p><b>Diagnostics:</b> HP tools will report results such as passed, calibrate, weak, replace, no battery and unknown, and suggest corresponding actions.</p> <p><b>Use HP Hardware Diagnostics (UEFI)</b> (<a href="#">6. HP Hardware Diagnostics and Tools on page 106</a>)</p> <ul style="list-style-type: none"> <li>• HP PC Hardware Diagnostics (UEFI) is a good tool to use to isolate and determine faulty battery, especially for quickly discharging (short life) battery.</li> </ul> <p><b>Use HP Support Assistant tools in Windows</b> (<a href="#">HP Support Assistant (HPSA) on page 108</a>)</p> <ol style="list-style-type: none"> <li>1. Verify that battery is recognized and charging.</li> <li>2. Verify battery condition if battery cycle life is over specs (i.e., long life of 1000-cycle life and 3-year warranty). Battery may have premature capacity loss within its cycle life or warranty.</li> <li>3. If issue remains, test with a verified working battery and verify battery status lights and battery conditions.</li> <li>4. If issue remains, replace system board.</li> <li>5. Verify the new replacement.</li> </ol>
<b>Tips and tricks</b>	<p>See the computer user guide for instructions regarding battery maintenance and increasing battery life. Also reference <a href="http://support.hp.com/us-en/document/c01297640?jumpid=hpr_r1002_usen_link3">http://support.hp.com/us-en/document/c01297640?jumpid=hpr_r1002_usen_link3</a>.</p>



## Battery discharges too fast

Items	Procedures
<i>Symptoms</i>	<i>Possible causes</i>
Battery has good status light but discharges too fast	AC adapter and/or battery.
	<i>Troubleshooting steps</i>
	<b>Verify AC adapter</b>
	Determine whether the computer needs the AC adapter to boot and operate. Sometimes, intermittently bad AC adapter and loose connection between adapter and computer results in inability to charge battery and causes short run time.
	<ol style="list-style-type: none"><li>1. Inspect AC adapter to verify that it is working.</li><li>2. Test with AC adapter alone and with a verified working AC adapter.</li></ol>
	<b>Verify battery:</b> Battery capacity can degrade over time, so check the warranty coverage. Run a battery test to confirm if issue is hardware-related.
	<ol style="list-style-type: none"><li>1. Review battery power plans in <b>Control Panel &gt; Power Options</b> that may consume more energy and discharge battery faster. Resetting default to <b>Power Saver</b> option can conserve battery power.</li><li>2. Determine whether any graphics processing is running.</li><li>3. Verify battery maintenance and operations. Leaving the battery at a high level of charge in a high-temperature environment for extended periods accelerates the loss of capacity.</li><li>4. Test and calibrate battery using HP PC Hardware Diagnostics (UEFI).</li><li>5. Verify battery life cycle using HP Support Assistant tool.</li></ol>
	If battery cycle life is over specs (long life battery of 1000-cycle life and 3-year warranty), battery may have capacity loss beyond its lifecycle or warranty.
	<ol style="list-style-type: none"><li>6. Compare discharge time with a verified working battery (remove AC adapter) using <b>Hardware Diagnostics (UEFI) &gt; Hard Drive Tests &gt; Extensive Test &gt; Loop until error</b>.</li></ol>
<b>Tips and tricks</b>	To conserve battery power, turn off Wireless On-Off button and other peripherals/USB devices, applications, processes (in Task Manager) when not in use; also, reduce screen brightness.  Follow HP instructions of how to maintain battery and increase battery life. Also reference <a href="http://support.hp.com/us-en/document/c01297640?jumpid=hpr_r1002_usen_link3">http://support.hp.com/us-en/document/c01297640?jumpid=hpr_r1002_usen_link3</a> .

## Burnt smell

Items	Procedures
<i>Symptoms</i>	<i>Possible causes</i>
Emits smoke, burnt smell	Defective on-board components.
	<i>Troubleshooting steps</i>
	<b>General visual inspection</b>
	<ol style="list-style-type: none"><li>1. Disconnect the computer from power source (AC adapter and battery).</li></ol>

Items	Procedures
	<ol style="list-style-type: none"> <li>Inspect for visual damage on AC adapter and battery. Test on a known working computer to isolate issue. If issue follows AC adapter or battery, replace it.</li> <li>Inspect any sign of liquid spill on the computer (back of keyboard).</li> </ol>
<b>The sections below are intended for authorized service providers/technicians.</b>	
	<p><b>Further inspection on components</b></p> <ol style="list-style-type: none"> <li>Inspect further sources internally after disassembling chassis, such as burnt or damaged components.</li> <li>If the issue persists, replace boards, AC adapter, and battery for safety concern and report issues to HP.</li> </ol>

## POST

### No video (with power)

Items	Procedures
<i>Symptoms</i>	<i>Possible causes</i>
<ul style="list-style-type: none"> <li>No video (black/blank image) but have power</li> <li>Light activity</li> <li>No error messages</li> <li>Fan noise</li> <li>Hard drive light blinking and hard drive noise</li> </ul>	<ul style="list-style-type: none"> <li>Failed display</li> <li>Failed critical components (memory, hard drive, system board)</li> <li>Loose connection</li> <li>Recently added hardware</li> </ul> <p><b>NOTE:</b> Assume the computer has not previously been set up for multiple displays.</p>
	<i>Troubleshooting steps</i>
	<p><b>Quick check</b></p> <ol style="list-style-type: none"> <li>Verify that system light activity is OK.</li> <li>Remove all external devices, including docking station. Recently added hardware and/or applications may cause graphics driver conflict and result in loss of video.</li> <li>Perform hardware reset (<a href="#">8. Hard reset on page 113</a>) and verify that HP Logo is presented correctly on display screen when pressing <b>F10</b>.</li> <li>Test with external monitor via VGA port (or DisplayPort, HDMI, etc). Press power button and close the computer lid to force video output to external video. If unsuccessful, contact HP service.</li> <li>If external video is OK, update BIOS, software, and drivers (<a href="#">4. Update BIOS and drivers on page 105</a>) and perform soft reset (<a href="#">9. Soft reset (Default Settings) on page 115</a>) if needed. Go to next step to verify display.</li> </ol>
	<p><b>Verify display</b></p> <ul style="list-style-type: none"> <li>When booting to Windows, determine whether image appears on display screen (via Windows Screen Solutions or <a href="#">Windows logo</a>  + <b>P</b> for display switcher).</li> <li>If there is video on display, disconnect external display device, open the computer lid and restart.</li> </ul>
<b>The sections below are intended for authorized service providers/technicians.</b>	

Items	Procedures
	<ol style="list-style-type: none"> <li>1. Verify Power Good lights are on to be sure that system board power is functional.</li> <li>2. Reseat display cable connection on system board.</li> <li>3. Reseat display cable connection on display panel side.</li> <li>4. Examine and reseat major components, such as hard drive, memory.</li> <li>5. Test with minimum configuration (<a href="#">11. Test with minimum configuration on page 116</a>) by removing hard drive to isolate operating system issues and testing video in F10 Setup.</li> <li>6. If video is present, restart and retest the computer.</li> <li>7. If video is present but bad, go to <a href="#">Display on page 138</a> section.</li> <li>8. If issue persists (no video), test with external video.</li> <li>9. If issue persists, test or replace a confirmed working display.</li> <li>10. If issue persists, replace discrete graphics card.</li> <li>11. If issue persists, replace system board due to defective video function.</li> </ol>
<b>Tips and tricks</b>	Swipe a metal piece (screwdriver) over wireless/mute buttons to act as if closing lid to force video output to external display device. See the “External component identification – Display” section for location of the magnetic sensor.

## Blinking lights

Items	Procedures
<p><i>Symptoms</i></p> <p>Lights blink on keyboard <a href="#">caps lock/num lock</a> keys</p>	<p><i>Possible causes</i></p> <p>Blinking lights on startup usually indicate a problem with basic functionality of a critical component (processor, BIOS, graphics cards, memory, etc.) due to loose connection, defective parts, or recently added parts.</p> <p><i>Troubleshooting steps</i></p> <ol style="list-style-type: none"> <li>1. Check for any blink patterns. Count the number of blinks in a sequence, followed by a pause for a few seconds.</li> <li>2. See Status, Blinking Lights, and Error Message (<a href="#">7. Status lights, blinking light codes, troubleshooting lights, and POST error messages on page 110</a>) for corrective actions.</li> <li>3. If internal hardware components (memory, hard drive, etc.) have been recently added, a component may not be connected properly. Remove and reseat new components (<a href="#">10. Reseat cables and connections on page 115</a>) one at a time.</li> </ol>
<b>Note</b>	Since the display may not be functional, lights are used to indicate an error.

## Diagnostics error messages

Items	Procedures
<p><i>Symptoms</i></p> <ul style="list-style-type: none"> <li>• Computer has power</li> <li>• POST error message displays (Windows logo has not yet appeared)</li> </ul>	<p><i>Possible causes</i></p> <p>Diagnostic error messages indicate a problem. There may be a problem with the instruction being sent from the BIOS to a hardware component (e.g., keyboard failures), or incompatible hardware. Can usually be resolved by installing updated firmware for the component.</p>

Items	Procedures
	<p data-bbox="635 220 829 247"><i>Troubleshooting steps</i></p> <ol data-bbox="635 268 1428 346" style="list-style-type: none"><li data-bbox="635 268 1428 346">1. See <a href="#">7. Status lights, blinking light codes, troubleshooting lights, and POST error messages on page 110</a> for corrective actions. An example of a POST error message is shown below.</li></ol> <div data-bbox="694 373 1444 640" style="border: 1px solid black; background-color: #0070C0; color: white; padding: 10px;"><p data-bbox="702 378 941 403"><b>Boot Device Not Found</b></p><p data-bbox="702 447 1236 472">Please install an operating system on your hard disk.</p><p data-bbox="702 493 869 518">Hard Disk - (3F0)</p><p data-bbox="702 539 949 564">F2 System Diagnostics</p><p data-bbox="702 609 1412 634">For more information, please visit: <a href="http://www.hp.com/go/techcenter/startup">www.hp.com/go/techcenter/startup</a></p></div> <ol data-bbox="635 672 1428 882" style="list-style-type: none"><li data-bbox="635 672 1428 724">2. If there is power, you may be able to access BIOS. Reset BIOS to its default condition. (<a href="#">9. Soft reset (Default Settings) on page 115</a>)</li><li data-bbox="635 745 1428 798">3. Restore hardware to its original condition (i.e., bootable solid-state drive instead of hard drive).</li><li data-bbox="635 819 1428 844">4. Reseat suspected components and verify connection.</li><li data-bbox="635 865 1428 890">5. Test suspected components using HP PC Hardware Diagnostics (UEFI) tool.</li></ol>
<b>Note</b>	An Error Message means the system has finished BIOS hardware validation and is ready to launch the <b>Startup Menu</b> . To access the <b>Startup Menu</b> for further options, press the <b>Esc</b> key while restarting the computer.

## BIOS password

Items	Procedures
<i>Symptoms</i>	<i>Possible causes</i>
Some sections are unavailable (grayed out)	BIOS administration password is required.
	<i>Troubleshooting steps</i>
	<ol style="list-style-type: none"><li>1. Review F10 BIOS Setup Overview to determine which features must be enabled.</li><li>2. Your BIOS settings may be managed by a BIOS administrator password setup.</li><li>3. If you lost or forgot user password, contact your IT personnel.</li><li>4. If you lost or forgot administrator password, contact HP service to reset the password. This process requires a unique UUID.</li></ol>
<b>Reference</b>	<b>HP F10 Setup Overview</b> <a href="http://h10032.www1.hp.com/ctg/Manual/c04460979">http://h10032.www1.hp.com/ctg/Manual/c04460979</a> <a href="http://h10032.www1.hp.com/ctg/Manual/c04685655">http://h10032.www1.hp.com/ctg/Manual/c04685655</a> 2015 Business PC models – see the BIOS F10 Setup technical white paper at <a href="http://support.hp.com">http://support.hp.com</a> , enter your computer model, and then go to <b>Manuals &gt; White papers &gt; HP PC BIOS F10 Setup Guide</b> .

## Performance (OS)



**NOTE:** Most software problems occur as a result of the following:

- The application was not installed or configured correctly.
- There is insufficient memory available to run the application.
- There is a conflict between applications.

Make sure that all the needed device drivers are installed.

If an operating system other than the factory operating system is installed, check whether the operating system is supported and the application is certified for the version of the operating system.

HP ships and supports Windows 7 with BIOS Legacy boot mode and Windows 8, 10 with BIOS UEFI boot mode. Therefore, HP recommends that you switch BIOS boot mode from Legacy to UEFI Native for clean Windows 8, 10 installations, or to UEFI Hybrid (if available) for upgrading the option from Windows 7 to Windows 8, 10. UEFI Windows 8, 10 avoids many unexpected behaviors (i.e., blue screen error, graphics/video issues) in the BIOS Legacy setting.

## Intermittent shutdown

Items	Procedures
<i>Symptoms</i> <ul style="list-style-type: none"><li>• Shutdown during startup</li><li>• Shutdown during operation</li></ul>	<i>Possible causes</i> <p>It is often difficult to troubleshoot an intermittent issue. Possible causes include the following:</p> <p>Power-related issue: defective or insufficient power sources, poor connection.</p> <p>OS Custom Setting: Energy Saver (Power Management).</p> <p>Thermal-related issue: thermal sensors reach limits.</p> <p>Hardware related issue: voltage, out-of-range current; electrical short.</p>
	<i>Troubleshooting steps</i> <ol style="list-style-type: none"><li>1. Update BIOS and drivers. (<a href="#">4. Update BIOS and drivers on page 105</a>)</li><li>2. Perform hard reset (<a href="#">8. Hard reset on page 113</a>)</li><li>3. Perform soft reset (<a href="#">9. Soft reset (Default Settings) on page 115</a>)</li></ol>
	<b>Power related issue</b> <ol style="list-style-type: none"><li>1. Verify functionality of AC adapter alone. If no functionality, test with a verified working adapter.</li><li>2. Verify battery alone. Verify that battery is not depleted. Test battery using HP PC Hardware Diagnostics (UEFI) tool.</li><li>3. Verify connection of power button, power cable.</li></ol>
	<b>OS custom settings</b> <ol style="list-style-type: none"><li>1. Advise users to reset power options and close all applications that are not in use, including applications in the background.</li><li>2. Test with a confirmed working operating system to isolate custom settings by users or any conflicting applications that cause shutdown.</li></ol>
<b>The sections below are intended for authorized service providers/technicians.</b>	
	<b>Thermal-related issue</b> <ol style="list-style-type: none"><li>1. Verify thermal condition:<ol style="list-style-type: none"><li>a. Test fan using HP PC Hardware Diagnostics (UEFI) tool (<a href="#">6. HP Hardware Diagnostics and Tools on page 106</a>)</li><li>b. Check fan and connection. Reseat fan cable.</li><li>c. Be sure that no obstructions or dust are in heat sink fan, fin, or vent.</li><li>d. Test with a verified working fan.</li><li>e. Remove old thermal compound and pads and replace with new compound and pads.</li></ol></li><li>2. Verify thermal solution:<ul style="list-style-type: none"><li>○ Use Thermal Monitor tool (available only to authorized service providers/ technicians) to perform stress test (processor and GPU) (<a href="#">6. HP Hardware Diagnostics and Tools on page 106</a>) and verify that thermal sensors are within limits after thermal condition is serviced.</li></ul></li></ol>
	<b>Hardware related issue</b> <ol style="list-style-type: none"><li>1. Check for any signs of loose connections, bent pins, stray wires, dust, nearly faulty parts (bulging/leaking capacitor).</li></ol>

Items	Procedures
	<ol style="list-style-type: none"> <li>2. Verify that lights are solid.</li> <li>3. If shutdown is reproducible, test essential hardware configuration: <ol style="list-style-type: none"> <li>a. If no issue with hardware configuration, reinstall one non essential component at a time to determine faulty hardware.</li> <li>b. If issue persists, replace essential hardware with a confirmed working part, one at a time. If no boot, replace system board.</li> </ol> </li> </ol>
<b>Tips and tricks</b>	Intermittent issue is difficult to reproduce and troubleshoot. It is important to record details on shutdown frequencies, system configuration (3D video application) and operating conditions.

## Blue screen

Items	Procedures
<p><i>Symptoms</i></p> <ul style="list-style-type: none"> <li>• Have power, light activity, fan spinning</li> <li>• HP Logo displays briefly</li> <li>• Fails to boot into Windows operating system, displays blue screen, and then crashes, restarts, or stops responding</li> </ul>	<p><i>Possible causes</i></p> <p>Recent changes: conflict of instructions from multiple programs or just added hardware.</p> <p>Incompatible hardware and driver.</p> <p>Poor connection (hard drive, memory).</p> <p>Hardware malfunctioning due to overheating (GPU, processor).</p> <p>Defective hardware (memory, hard drive).</p>
<b>Important Notes &amp; Resources</b>	<p><i>Troubleshooting steps</i></p> <p>There are many different ways to troubleshoot a blue screen error. Therefore, you need to identify working configuration (Windows 7/8/10) and specific symptoms of the failure in order to narrow down the issue. Refer to <a href="#">Blue screen (BSOD) error on page 155</a>.</p>
	<p><b>Recommended resources</b></p> <p>Microsoft knowledge base:</p> <p><a href="http://windows.microsoft.com/en-us/windows-8/resolve-windows-blue-screen-errors">http://windows.microsoft.com/en-us/windows-8/resolve-windows-blue-screen-errors</a></p> <p>For more information search for HP Troubleshooting Error Messages on a blue screen at <a href="http://www.hp.com">http://www.hp.com</a>.</p>

### Overview of General Troubleshooting Steps for a blue screen error

1. Note the blue screen error message and what activity was performed at the time.
2. Perform a hard reset ([8. Hard reset on page 113](#)) after disconnecting all external peripherals.
3. Reset BIOS to default ([9. Soft reset \(Default Settings\) on page 115](#)) to prevent booting to another device.
4. Run HP Hardware Diagnostics ([6. HP Hardware Diagnostics and Tools on page 106](#)) to isolate major faulty hardware issues.

- HP PC Hardware Diagnostics (UEFI) tool to test hard drive, memory and system.
  - Thermal Monitor (available only to authorized service providers/technicians) tool to monitor temperature limits of processor and GPU. See “HP Thermal Monitor” in [6. HP Hardware Diagnostics and Tools on page 106](#).
5. Remove or undo recently added hardware ([5. Remove or uninstall recently added hardware, software on page 105](#)). For example, incompatible memory or new solid-state drive storage.
  6. Reseat cables and connections ([10. Reseat cables and connections on page 115](#)). Pay attention to proper installation of memory and hard drive.
  7. Verify that a minimum of at least 100 MB of free space is available on your Windows partition.
  8. If you can start Windows:
    - a. Update BIOS and drivers ([4. Update BIOS and drivers on page 105](#)) to support updates for incompatibilities.
    - b. Get all the latest updates, using Windows Update.
    - c. Undo recent changes:
      - Startup using Last Known Good Configuration.
      - Use System Restore.
      - Roll back device driver in Device Manager.
    - d. Check for specific Error Message. See [Common Blue Screen Error Messages on page 166](#).
    - e. Boot to safe mode ([11. Test with minimum configuration on page 116](#)) to troubleshoot issues.
  9. If you cannot start Windows:
    - a. Boot to safe mode. ([11. Test with minimum configuration on page 116](#))
    - b. Use Startup Repair to fix Windows startup files.
    - c. Undo recent changes using System Restore to revert to a previous “working” state.
    - d. Check for specific STOP error by analyzing Crash Dump (retrieved via a bootable USB). See [Use Windows Debugging Tool on page 167](#).
    - e. Restore computer using System Recovery or image backup to factory settings.
  10. Lastly, test with essential hardware configuration ([11. Test with minimum configuration on page 116](#)) along with a verified working operating system (i.e., USB Windows-To-Go), if available, to isolate the software issue.

### Tips & tricks

In some cases, the computer may reboot automatically before you have time to read the blue screen.

To identify the error message itself, disable the automatic restart using one of the following methods:

Right-click on **My Computer**, and then select **Properties** > **Advanced**. Under **Startup and Recovery**, select **Settings**. Clear the **Automatically Restart** check box.



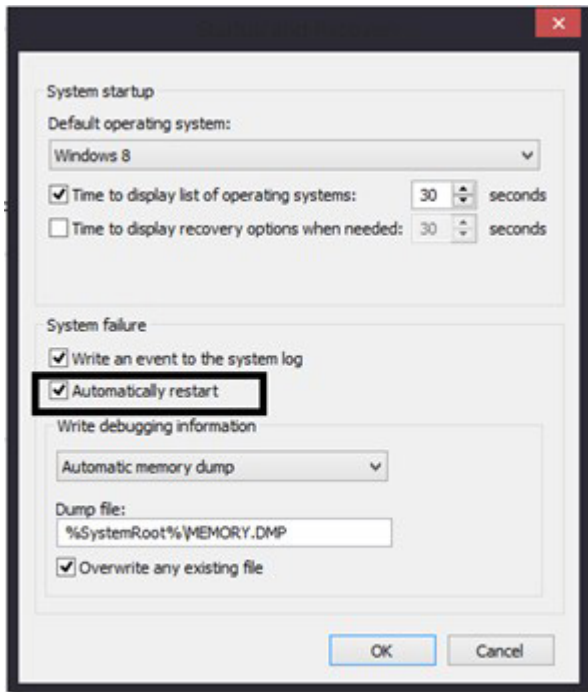

### Windows Advanced Boot Option

Windows 7:

1. Press **F8** to open the Windows Advanced Boot Option screen.
2. Select **Disable automatic restart on system failure** to view error messages.

Windows 8:

1. Press **F11** (System Recovery) to open the Windows Advanced Boot Option screen.
2. Select **Startup Settings** to view error messages.

### Freeze at Windows Logo (hang/lockup)

Items	Procedures
<p><i>Symptoms</i></p> <ul style="list-style-type: none"> <li>• Has power, light activity, fan spinning</li> <li>• HP Logo displays briefly</li> <li>• Attempt to boot to operating system and freeze/hang at Windows logo</li> <li>• No response to pressing <b>num lock</b> or <b>caps lock</b> key</li> </ul>	<p><i>Possible causes</i></p> <p>Conflict of instructions from multiple programs or drivers; installing a new hardware or program that is not compatible (may also cause a blue screen error—see blue screen issue).</p>

Items	Procedures
	<p data-bbox="699 541 896 569"><i>Troubleshooting steps</i></p> <p data-bbox="699 585 1353 613">Follow suggested steps below one at a time to verify normal boot process:</p> <ol data-bbox="699 632 1407 1291" style="list-style-type: none"> <li>1. Disconnect all external peripherals, and perform a hard reset (<a href="#">8. Hard reset on page 113</a>).</li> <li>2. Perform soft reset (<a href="#">9. Soft reset (Default Settings) on page 115</a>).</li> <li>3. Update BIOS and drivers (<a href="#">4. Update BIOS and drivers on page 105</a>). <ol data-bbox="746 793 1216 863" style="list-style-type: none"> <li>a. Roll back to previous version may be necessary.</li> <li>b. Go to safe mode to install drivers.</li> </ol> </li> <li>4. Run Hardware Diagnostics (<a href="#">6. HP Hardware Diagnostics and Tools on page 106</a>) to isolate hardware issue.</li> <li>5. Undo recent changes in Windows (<a href="#">5. Remove or uninstall recently added hardware, software on page 105</a>).</li> <li>6. Reseat cables and connections (<a href="#">10. Reseat cables and connections on page 115</a>).</li> <li>7. Start Windows in safe mode (<a href="#">11. Test with minimum configuration on page 116</a>).</li> <li>8. Use Startup Repair Windows to fix Windows damaged files.</li> <li>9. Test with essential hardware configuration (<a href="#">11. Test with minimum configuration on page 116</a>) along with a verified working operating system (i.e., USB Windows-To-Go) if available to isolate the software issue.</li> </ol> <p data-bbox="252 1318 386 1346"><b>Tips and tricks</b></p> <p data-bbox="699 1318 1398 1346">For more information, see <a href="http://support.hp.com/us-en/document/c03671001">http://support.hp.com/us-en/document/c03671001</a>.</p>

## Electromagnetic Interference (EMI)

Items	Procedures
<p data-bbox="252 1545 347 1572"><i>Symptoms</i></p> <p data-bbox="252 1591 558 1644">System locks up, freezes in certain physical area or location</p>	<p data-bbox="609 1545 746 1572"><i>Possible causes</i></p> <p data-bbox="609 1591 919 1619">Electromagnetic interference (EMI).</p> <hr/> <p data-bbox="609 1640 807 1667"><i>Troubleshooting steps</i></p> <ol data-bbox="609 1686 1433 1854" style="list-style-type: none"> <li>1. See (<a href="#">2. Examine the environment on page 104</a>). Pay attention to external power source, high-frequency signals such as cell phones, microwave ovens.</li> <li>2. Move the computer to different locations nearby to determine where it fails and where it does not fail.</li> <li>3. Test with a verified working computer in original factory configuration.</li> </ol>

Items	Procedures
	4. Consult with support.

## No wake up

Items	Procedures
<i>Symptoms</i>	<i>Possible causes</i>
When resuming from a power management state the computer may display:	Power-saving mode; multiple-display setting.
<i>Troubleshooting steps</i>	<i>Troubleshooting steps</i>
<ul style="list-style-type: none"> <li>• Blank screen</li> <li>• Some light activity</li> </ul>	<ol style="list-style-type: none"> <li>1. Verify that front power light (<a href="#">7. Status lights, blinking light codes, troubleshooting lights, and POST error messages on page 110</a>) is blinking (indicating Sleep state). Press power button to exit Sleep.</li> <li>2. Reset BIOS to default (associated with <b>OS Power Management in Power Menu</b>) (<a href="#">4. Update BIOS and drivers on page 105</a>)</li> <li>3. Verify power management settings in Windows <b>Power Options</b>. Disable Sleep options if the issue is resolved.</li> </ol>

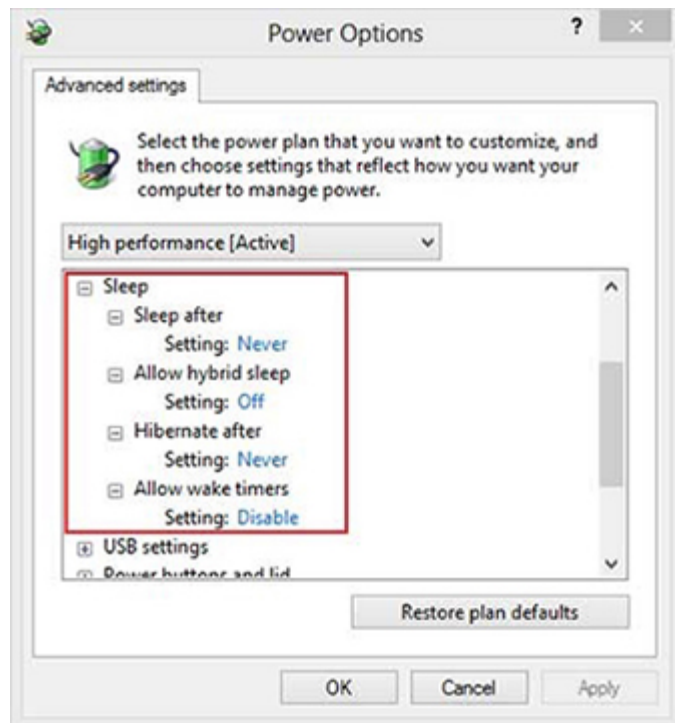

4. Screen saver is set. Press any key or touch TouchPad to resume.
5. Verify that Display Choice is set to external video only. Toggle screen control key combination **Fn + F4** or **Windows logo**  **+P**.

<b>Tips and tricks</b>	If you are using a docking station, set your notebook display as a primary display. When the computer is undocked, you may think it is in a power-saving state, but the screen image may actually display on an external display device in the docking configuration.
------------------------	---

## Unresponsive

Items	Procedures
<i>Symptom</i>	<i>Possible causes</i>
Unresponsive	Program in use has stopped responding to commands.
	<i>Troubleshooting steps</i>
	<ol style="list-style-type: none"><li>1. If possible, use the Windows Task Manager to isolate and terminate the offending process.</li><li>2. Attempt the normal Windows shutdown procedure.</li><li>3. Restart the computer using the power button.</li></ol>

## Slow performance

Items	Procedures
<i>Symptom</i>	<i>Possible causes</i>
Slow performance when performing small tasks, or even in idle mode	Processor is hot or hard drive is full.
	<i>Troubleshooting steps</i>
	<b>Processor is hot</b>
	<ol style="list-style-type: none"><li>1. Verify that airflow to the computer is not blocked.</li><li>2. Verify that chassis fans are connected and working properly. Some fans operate only when needed.</li><li>3. Verify that the processor heat sink is installed properly.</li></ol>
	<b>Hard drive is full</b>
	<ol style="list-style-type: none"><li>1. Transfer data from the hard drive to create more space on the hard drive. Microsoft recommends at least 200 MB to sync system files.</li><li>2. Perform disk defragmentation to consolidate fragmented data on the hard drive so it will work more efficiently.</li></ol>
	Also see <a href="#">Slow performance on page 155</a> .
<b>Tips and tricks</b>	See <a href="#">Routine Maintenance for Performance Improvement on page 166</a> ). See <a href="http://windows.microsoft.com/en-us/windows-8/free-up-disk-space">http://windows.microsoft.com/en-us/windows-8/free-up-disk-space</a> . See <a href="http://windows.microsoft.com/en-us/windows/optimize-windows-better-performance#optimize-windows-better-performance=windows-vista">http://windows.microsoft.com/en-us/windows/optimize-windows-better-performance#optimize-windows-better-performance=windows-vista</a> .

## HP Smart Adapter warning message

Items	Procedures
<i>Symptom</i>	<i>Possible causes</i>
Warning message displayed in Window	Less powerful AC adapter, BIOS out of date.
	
	<i>Troubleshooting steps</i>
	<ol style="list-style-type: none"><li>1. Update BIOS that may contain a table that assigns an appropriate adapter for a certain configuration.</li><li>2. Update the latest <b>HP Hotkey Support</b> software from Drivers website.</li><li>3. Verify sufficient power source (where adapter is connected).</li><li>4. Use appropriate AC adapter (often supplied with system) for optimum system performance.</li><li>5. Test with a verified working AC adapter.</li><li>6. Test the adapter on a verified working computer.</li><li>7. Contact HP for configuration details.</li></ol>
<b>Note</b>	<p><b>HP Smart AC adapter warning message:</b> informs you that as power demands increase, the notebook may not perform at full capacity, which may result in longer battery-charging time. In cases of extreme power demands, the system may also throttle back the processor, or with systems that have a discrete video sub-system, a video balance mode may occur to further balance the power needs of the system.</p> <p>System processor functions always have priority over battery charging, so charging delays will occur first.</p>

## Incorrect time and date

Item	Procedure
<i>Symptom</i>	<i>Possible cause</i>
Incorrect date and time	Real-time clock (RTC) battery might need replacement.
	<i>Troubleshooting steps</i>
	<ol style="list-style-type: none"><li>1. Reset the date and time in the operating system Control Panel.</li><li>2. Replace the RTC battery.</li></ol>

---

Item	Procedure
	3. Verify that date and time are correct.

---

## Display

### Display anomalies

The display panel is a field replaceable unit (FRU) and must be replaced by only authorized technicians. However, HP highly recommends that users and technicians observe specific symptom vs. generic symptoms and utilize the HP PC Hardware Diagnostics (UEFI) tool before any replacement.

#### Symptom

Common display issues with symptoms:

- Blank/black video
- Incorrect/missing color/distorted image
- Flickering image
- Vertical lines (due to LDVS, decreased signal integrity, and data loss)
- Dead pixel (due to display liquid, internal transistor, etc.)
- Horizontal lines (due to video memory)
- Distorted when hot (due to thermal issue)
- Cracked screen/image (physical damage)
- Light leakage/bleeding
- Contact support for assistance.
- Humming noise (due to frequency settings)
- Contact support for assistance.

---

#### Display anomalies

---

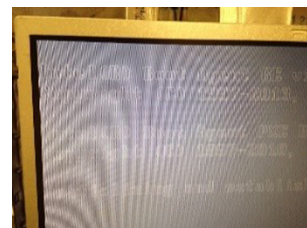
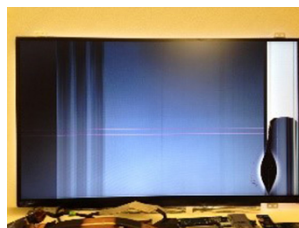

---

## Display anomalies

---

Cracked screen

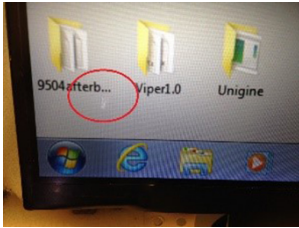

Dead pixel

Cracked image

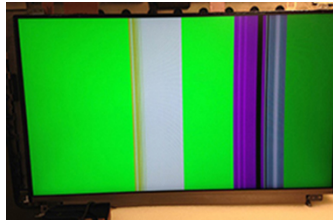

Vertical lines

Blurred image

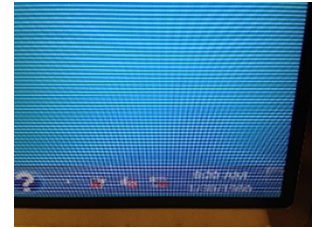

Horizontal lines

---

### Quick check

- Visually examine the display for cracked screen, liquid crystal leak, dirty spots on glass, etc.
- Reset and update BIOS and docking firmware.
- Update operating system (OS), graphics/video drivers (Intel/AMD/NVidia, etc).

For custom images, HP highly recommends upgrading or installing Windows in UEFI mode (or Legacy disabled) to fully support hybrid graphics and avoid unexpected behaviors (i.e., blue screen error, graphics/video issues) in the BIOS Legacy setting.

- Configure Windows settings (Power options, Screen brightness, Personalization, Screen resolution, etc.).
- Test with a verified working external display.
- Boot to Windows in safe mode.
- Test with a verified working operating system (i.e., shipping image).

### HP PC Hardware Diagnostics (UEFI) for video test

Use this tool to quickly determine if the display issue is related to a real hardware issue.

To start HP PC Hardware Diagnostics (UEFI) ([6. HP Hardware Diagnostics and Tools on page 106](#)), when the computer is at boot, press the **F2** key, select **Component Tests**, and then select **Video**.

There are three options:

- **Video Memory Check:** to test video memory
- **Palette Check:** to test the three video color components (red, green, blue)
- **Dead Pixel Check:** to check dead pixels in eight different colors (Dead Pixel Check is available with the “HP PC Diagnostics 3-in-1 USB Key” tool)

Review the video troubleshooting in the Display section below for specific issues and possible solutions. For additional information about display problems, refer to documentation provided by the product manufacturer.

## Display assembly diagram

The display assembly diagram shows basic video components: system board, graphics cards, display cables, display connectors, operating system (OS), graphics driver, and LCD display panel. Any component or a combination of these components can contribute to a video issue.

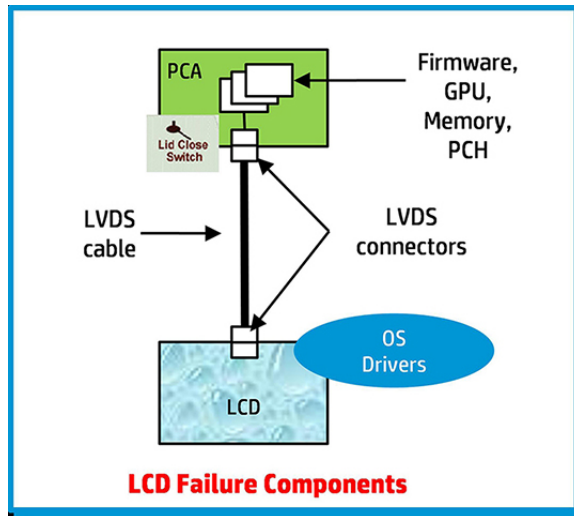

**NOTE:** The lid close switch is a Hall-effect sensor located in the top cover. When the display is closed, the sensor acts like a switch is closed. A notebook can force a video output to an external monitor, or go to hibernation or standby mode through power management. If the display screen does not light up when the display is open, the lid close switch (Hall-effect sensor) could be faulty.

## Dead pixel

Display panel may show one or more pixels that are not properly lit when displaying a single color over the screen area. Use HP PC Hardware Diagnostics (UEFI) tool to determine those defective pixels. There is no solution for dead pixels. Refer to [Display Issue: Pixel Anomalies on page 172](#) for the HP dead pixel policy.

## No video (internal)

Items	Procedures
<i>Symptoms</i>	<i>Possible causes</i>
No internal video with certain programs (i.e., video-intensive games)	Display resolution, brightness, faulty lid switch, running a program requiring a higher resolution than the display screen can support.  Faulty lid switch may put the system into Sleep or Hibernation mode.
	<i>Troubleshooting steps</i>
	Use an external monitor with higher resolution.  Test with external monitor using HDMI or HP port. Press the power button and close the computer lid to force video output to external video. If there is still no video, contact support.
<b>References</b>	See section <a href="#">No video (with power) on page 126</a> for display information.



## No video (external)

Items	Procedures
<i>Symptom</i>	<i>Possible causes</i>
No image on external monitor	External monitor, resolution, display configuration, drivers.
	<i>Troubleshooting steps</i>
	<ol style="list-style-type: none"><li>1. Be sure external monitor is compatible with the computer.</li><li>2. Be sure that external monitor is turned on.</li><li>3. Press any key to get out power saving mode.</li><li>4. Adjust the brightness of the monitor.</li><li>5. Test with a verified working monitor.</li><li>6. Test the monitor via internal ports (VGA, DP ports).</li><li>7. Install latest video driver.</li><li>8. Reset the screen resolution as described in the documentation.</li><li>9. Configure display choice, and then force output to external video by closing the notebook lid or pressing <b>Fn + F4</b> to switch screen output.</li></ol>

## DisplayPort/VGA

See [No video \(external\) on page 141](#).

## HDMI

Items	Procedures
<i>Symptoms</i>	<i>Possible causes</i>
<ul style="list-style-type: none"><li>• Display issue</li><li>• Sound issue</li></ul>	Cable, connection, settings.
	<i>Troubleshooting steps</i>
	<b>Quick Check</b>
	<ol style="list-style-type: none"><li>1. Verify HDMI device input source is set correctly (i.e., HDMI1).</li><li>2. Be sure you are using the correct HDMI cable.</li><li>3. Check connection and reconnect the HDMI cable.</li><li>4. Verify if sound output is configured correctly in <b>Control Panel &gt; Sound Manager</b>.</li></ol>
	<ol style="list-style-type: none"><li>1. Perform hard reset (<a href="#">4. Update BIOS and drivers on page 105</a>).</li><li>2. Update BIOS and drivers (<a href="#">4. Update BIOS and drivers on page 105</a>) when sound is heard but no video on HDTV.</li></ol>
<b>References</b>	<a href="http://support.hp.com/us-en/document/c01186408">http://support.hp.com/us-en/document/c01186408</a>

## No or bad external video via docking

Items	Procedures
<i>Symptoms</i>	<i>Possible causes</i>
No or bad image on external monitor via ports of docking station (VGA, DP, TB, display port, etc.)	Rooted from system board, software/drivers, dock connectors, docking station hardware/firmware, dock video ports (DP, VGA, etc).
	<i>Troubleshooting steps</i>
	<ol style="list-style-type: none"><li>1. Be sure that external monitor is powered on.</li><li>2. Be sure that external monitor is compatible with the computer.</li><li>3. If applicable, plug the dock in different Type-C ports.  For more information, see the technical white paper titled "HP ZBook 65/150/200 W Thunderbolt 3 Dock User Guide." Go to <a href="http://support.hp.com/">http://support.hp.com/</a>, enter your model number, and then click <b>Manuals &gt; Technical white papers</b>.</li><li>4. If the screen image is distorted, try a DP-to-VGA adapter. Connect the adapter to each DisplayPort and VGA port of the dock.</li><li>5. Test the monitor via internal ports (VGA, DP, HDMI, etc.).</li><li>6. Verify that dock connectors of the notebook and the dock are clean, without dust, debris (e.g., using air duster).</li><li>7. Ideally, use a verified working operating system/system connected to the dock to isolate the issue of the current operating system.</li><li>8. Ideally, use a verified working docking station to isolate the faulty dock.</li><li>9. Update latest dock firmware. Be sure to follow the installation instructions carefully. You may want to try a DP-to-VGA adapter if you have a distorted screen image. Connect the adapter to each DisplayPort of the dock. If you still cannot update the dock, attempt to update it on a confirmed working notebook before having the dock replaced.</li></ol>
<b>Note</b>	See the technical white paper titled "Multiple displays on HP ZBook Mobile Workstations" from HP platform support website. Go to <a href="http://support.hp.com/">http://support.hp.com/</a> , enter your model number, and then click <b>Manuals &gt; Technical white papers</b> .

## Incorrect or missing color/distorted image

Items	Procedures
<i>Symptoms</i>	<i>Possible causes</i>
System works normally but the display shows:	Loose connection, display cable, display, graphics card.
<ul style="list-style-type: none"><li>• Missing or strange color</li><li>• Image distortion</li></ul>	<i>Troubleshooting steps</i>
	<b>Verify with external monitor (i.e., VGA)</b>
	<ol style="list-style-type: none"><li>1. Use combination <b>Fn + F4</b> to enable output to external monitor.</li><li>2. Close the lid.</li></ol>
	If the external monitor also shows incorrect color, it is graphics card issue. Test with a verified working graphics card.
	<b>Verify display cable and cable connection</b> —Display disassembly is required.  Be sure that external display cables are not pinched or damaged.

Items	Procedures
	<p>Be sure that external display cables have good connection at both ends (system board and display panel).</p> <ul style="list-style-type: none"> <li>• If moving cables affects the image, it is display cable. Test with a confirmed working cable.</li> <li>• If moving cables does not affect the image, is display issue. Test with a confirmed working display</li> </ul>

## Touch screen

Items	Procedures
<i>Symptoms</i>	<i>Possible causes</i>
Unresponsive	Dirt and smudge, driver, touch display configuration, power management.
Inaccurate	<i>Troubleshooting steps</i>
	<b>Quick check</b>
	Turn off the computer, spray glass cleaner onto a soft, damp cloth, and gently wipe the screen to remove dirt and smudge.
	<b>NOTE:</b> Do not spray cleaner directly onto the screen.

Configure the touch display in **Control Panel > Tablet PC Settings**

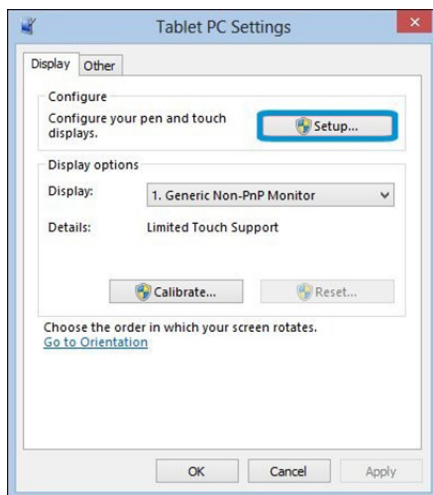

1. Restart the computer.
2. Verify touch screen and graphics drivers.
3. Configure the touch display to identify the screen as a touch screen as shown in the image at left.
4. Calibrate the screen and reset if touch functionality is still not working correctly.
5. Perform diagnostic test in HP Hardware Diagnostics under **Component Tests > Touch Screen**.  
  
If the diagnostics tests pass but the touch screen still does not respond, continue following the steps.
6. Adjust the power management settings for your touch screen.  
  
If the touch screen stops working after waking from sleep, adjust the power management settings so that the touch screen device stays active while the computer is in sleep mode.
7. Perform Microsoft System Restore and restore to a time when the system was working.
8. Perform HP System Recovery if none of the above actions resolves the issue.

### References

<https://support.hp.com/us-en/document/c03488148>

## I/O devices



### NOTE:

- Make sure external devices are supported and compliant (i.e., USB Type C, Thunderbolt 3, PCI Express, etc).
- If you have problems with external devices not provided by HP, contact device manufacturers for compatibility and latest drivers prior to troubleshooting (i.e., USB devices, Thunderbolt devices, PCI Express Card reader, VGA/Display/HDMI monitors, Speakers, etc).
- Be sure I/O devices are properly inserted into the I/O ports, and then be sure the I/O devices are recognized by Windows Device Manager.

## Keyboard

Items	Procedures
<i>Symptoms</i>	<i>Possible causes</i>
Keystrokes not recognized	Dust trapped under keycap, loose keycap, loose keyboard connection, defective keyboard.
Characters not matched	
	<i>Troubleshooting steps</i>
	<ol style="list-style-type: none"><li>1. Inspect the keyboard for any signs of dust, liquid, or debris trapped under sticky keys that might prevent keystroke recognition.</li><li>2. Check for incomplete connection between keyboard and system board by verifying that <b>caps lock</b> or <b>num lock</b> light turns on when key is pressed.</li><li>3. Verify whether the keyboard is recognized in Windows Device Manager and verify whether the keyboard driver is installed properly.</li><li>4. Test with a working external keyboard (i.e., USB keyboard).  Also test in Windows for special keys (<b>Caps Lock</b>, <b>Shift</b>, <b>Ctrl</b>, <b>Fn</b>, <b>Windows</b>, <b>Alt</b>) if necessary.</li><li>5. Test with HP PC Hardware Diagnostics (UEFI) to isolate a hardware issue from a software issue.</li><li>6. Verify that BIOS is up to date. If so, resetting BIOS to default may help.</li><li>7. Test with verified working operating system or restore operating system to be sure that the issue is not caused by different language settings, sticky keys feature, etc.</li><li>8. Verify that keyboard flex cables are fully inserted and in good condition.</li></ol>
<b>The sections below are intended for authorized service providers/technicians.</b>	
	<ol style="list-style-type: none"><li>1. Verify if keyboard flex cable is in good condition (no delamination or torn cable end, no missing or cracked tracks, pads).</li><li>2. Verify keyboard flex cable ends are fully inserted and aligned with connectors on system board, and those connector tabs are properly closed. Reseat cables.</li><li>3. Replace new internal keyboard and retest.</li></ol>
<b>Tips and tricks</b>	A key only works when pressed with force. Inspect and remove debris trapped under keycap.

## Keyboard point stick

Items	Procedures
<i>Symptom</i>	<i>Possible causes</i>
Point stick not working properly	Dust trapped under point stick, loose point stick cap.
	<i>Troubleshooting steps</i>
	<ol style="list-style-type: none"><li>1. Inspect any signs of dust, liquid spill that prevent point stick from working.</li><li>2. Check whether point stick cap is loose and reseal it if necessary.</li></ol>

The sections below are intended for authorized service providers/technicians.

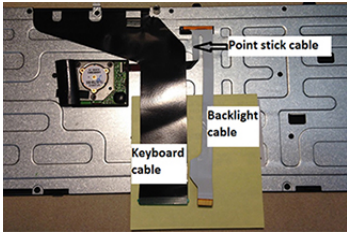

1. Verify whether keyboard flex cables are in good condition (no delamination or torn cable end, no missing or cracked tracks, pads).
2. Verify keyboard flex cable ends are fully inserted and aligned with connectors on system board and back of keyboard and that connector tabs are properly closed.
3. Reseat point stick cables.

Example of back of keyboard, including keyboard, point stick, and backlight cables.

## Keyboard backlight

Items	Procedures
<i>Symptom</i>	<i>Possible causes</i>
Backlight function not working properly	Backlight disabled, loose connection.
	<i>Troubleshooting steps</i>
	<b>NOTE:</b> Not all notebook computers have backlit keyboards. A keyboard function key lets you turn the light on and off. Verify if backlit feature is not disabled by pressing a combination of <b>Fn + Backlit</b> key.

The sections below are intended for authorized service providers/technicians.

1. Verify if backlight flex cables are in good condition (no delamination or torn cable end, no missing or cracked tracks, pads).
2. Verify backlight flex cable ends are fully inserted and aligned with connectors on system board and that connector tabs are properly closed.
3. Reseat backlight cable.

## TouchPad

Items	Procedures
<i>Symptoms</i>	<i>Possible causes</i>
Not working properly	On/Off enabled, driver, settings.
	<i>Troubleshooting steps</i>
	<ol style="list-style-type: none"> <li>1. Ensure TouchPad On/Off light is not amber (disabled). Double touch to enable.</li> <li>2. Verify if TouchPad device is listed in <b>Device Manager &gt; Mice and other pointing devices</b>.</li> <li>3. Install the latest TouchPad driver.</li> <li>4. Adjust TouchPad settings (<b>Control Panel &gt; Mouse</b>).</li> <li>5. Test TouchPad controller using the HP PC Hardware Diagnostics (UEFI) tool (<b>F2 &gt; Component Tests &gt; Mouse Test &gt; Pointer Test &amp; Drag and Drop Test</b>).</li> </ol>
<b>The sections below are intended for authorized service providers/technicians.</b>	
	<ol style="list-style-type: none"> <li>1. Check the TouchPad cable for damage or a loose connection, and then reseal the TouchPad cable.</li> <li>2. If issue persists, replace the TouchPad and verify the change.</li> </ol>

## Network Connectivity Ethernet (RJ-45 jack)

Items	Procedures
<i>Symptoms</i>	<i>Possible causes</i>
<ul style="list-style-type: none"> <li>• Unable to find networks (yellow bang)</li> <li>• Connection dropouts</li> <li>• Slow performance</li> </ul>	Network source, cable, connection, RJ-45 port, driver, settings.
	<i>Troubleshooting steps</i>
	<b>Quick Check:</b> verify the network status lights that supposed to flash when there is network activity.
<p>HP Support Assistant tool - No network detected in HPSA</p> 	<ol style="list-style-type: none"> <li>1. Turn off the computer's wireless feature (press wireless button).</li> <li>2. Verify that networking source with recommended distance to the base is less than 300 feet.</li> <li>3. Examine the Ethernet cable for damage. Test with a verified working cable.</li> <li>4. Test with different networks and jacks and check with IT for hardware compatibility settings.</li> <li>5. Connect a verified working RJ-45 cable directly to the computer to isolate other related issues (e.g., router, switch, docking station).</li> <li>6. Verify Ethernet port lights (RJ-45): <ul style="list-style-type: none"> <li>– Green (left): network is connected.</li> <li>– Amber (right): network is showing activity.</li> </ul> </li> <li>7. Test with HP Support Assistant in Windows.</li> </ol>

Items	Procedures
	<ol style="list-style-type: none"> <li>8. Diagnose with HP PC Hardware Diagnostics (UEFI) to isolate a hardware issue from a software issue.</li> <li>9. Examine Ethernet ports on the computer, docking station, and wall for damage, dust, obstructions.</li> <li>10. <b>Update drivers:</b> Verify that Ethernet module is displayed in Device Manager and be sure that device driver is up to date. If updating drivers does not help, try rolling back to previous drivers.</li> <li>11. <b>Reset BIOS to Default:</b> If other devices can connect to network, but computer cannot connect, a BIOS setting might be the cause of the problem. Restore BIOS to default.</li> <li>12. Test with verified working operating system or perform operating system recovery to verify that the issue is not caused by customized settings.</li> <li>13. Replace system board and verify that the issue is fixed.</li> </ol>

## Network connectivity wireless (WLAN)

Items	Procedures
<p><i>Symptoms</i></p> <ul style="list-style-type: none"> <li>• Unable to find networks (yellow bang)</li> <li>• Connection dropouts</li> <li>• Slow performance</li> </ul>	<p><i>Possible causes</i></p> <p>Network source, cable, connection, wireless module, driver, settings.</p>
<p>HP Support Assistant tool - No network detected in HPSA</p>  <p>The screenshot shows the HP Network Check utility window. It displays a 'Network status' section with a red 'X' icon and a 'Connection Status' section with a red warning triangle. The main area shows 'Possible Root Causes' with two items: 'No network detected (10)' and 'No preferred networks selected (20)', both with green checkmarks. A 'Network Information' button is at the bottom left, and a 'Get Assistance' button is at the bottom right.</p>	<p><i>Troubleshooting steps</i></p> <ol style="list-style-type: none"> <li>1. Turn off the computer's wired network (remove RJ-45 cable).</li> <li>2. Examine environment for interference, such as cell phone or microwave, that may emit high frequencies (above 1 GHz).</li> <li>3. Verify wireless source by moving computer closer to the wireless base/ router.</li> <li>4. Test with different wireless networks and check with your IT department for hardware compatibility, settings.</li> <li>5. Verify that the wireless light is on. If the light is amber, press the wireless button to enable the wireless device.</li> <li>6. Test with HP Support Assistant in Windows.</li> <li>7. Diagnose with HP PC Hardware Diagnostics (UEFI) to isolate a hardware issue from a software issue.</li> <li>8. <b>Update drivers:</b> Verify that wireless module is displayed in Device Manager and be sure that wireless drivers are up to date using <a href="http://www.hp.com">www.hp.com</a> or HP Support Assistant. If updating drivers does not help, try rolling back to previous drivers.</li> <li>9. <b>Reset BIOS to Default:</b> If other devices can connect to your wireless network, but your computer cannot connect, a BIOS setting might be the cause of the problem. Restore BIOS to default.</li> <li>10. Configure power management advanced settings as necessary.</li> </ol>

Wireless Adapter Properties - U-APSD support

In the example to the left, **U-APSD support** (Unscheduled Automatic Power Save Delivery) is changed to **Disabled** to resolve an incompatible access

---

**Items****Procedures**

---

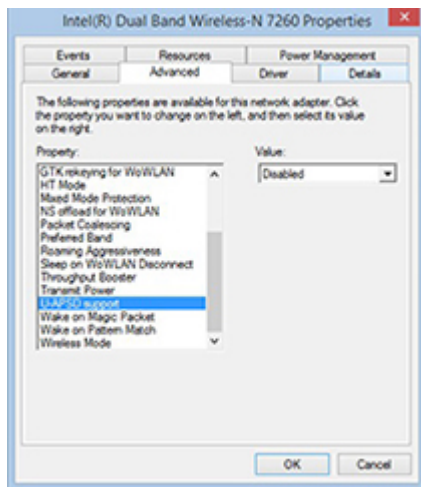

point. If disabling U-APSD improves the throughput issue, check with the access point provider for updated firmware that resolves the issue.

11. Test with verified working operating system or perform operating system recovery to verify that the issue is not caused by customized settings.
12. Test with a verified working wireless module.

---

**The sections below are intended for authorized service providers/technicians.**

1. Verify that the wireless module and its antenna cables are fully inserted and in good condition (see WLAN module removal and replacement section). Reseat wireless module and antenna connection.
2. Verify module antenna cable connection are not loose.
3. Verify antenna cables are properly connected to the MAIN and AUX terminals (see WLAN module removal and replacement section).

---

## WWAN

---

**Items****Procedures**

---

*Symptom*

*Possible causes*

Unable to find networks/service

Network source, cable, connection, driver, settings.

*Troubleshooting steps*

1. Update to the latest driver and utility.
2. Check with network service provider for signal coverage.
3. Make sure signal strength is good.
4. Make sure your service is active.

---

**The sections below are intended for authorized service providers/technicians.**

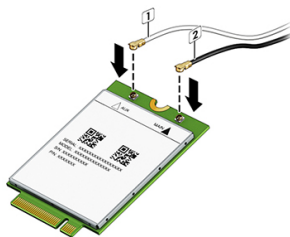

- Verify module and antenna cable connections are not loose.
- Verify antenna cables are properly connected to the correct terminals. For example, the antenna cable labeled "1" connects to the "Main" terminal labeled "1". The antenna cable labeled "2" connects to the "Aux" terminal labeled "2".

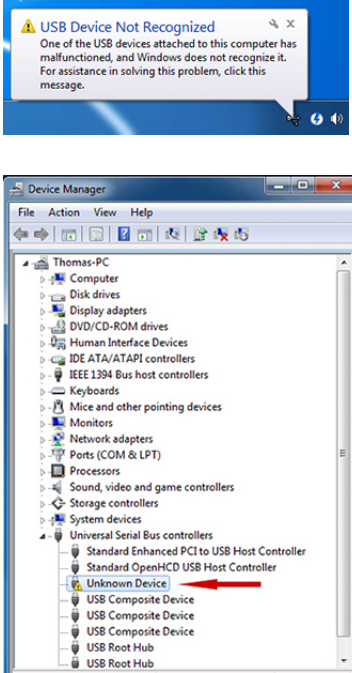

Items	Procedures
<p><i>Symptoms</i></p> <ul style="list-style-type: none"> <li>• USB devices are not recognized</li> <li>• USB devices are not charging</li> </ul>	<p><i>Possible causes</i></p> <p>USB devices do not have the latest software drivers, port insufficient power, or not compliant.</p> <p><b>NOTE:</b> USB Type-C uses a different connector entirely</p>
<p>Examples of USB device Not Recognized</p>	<p><i>Troubleshooting steps</i></p>
 <p>The top image shows a Windows error dialog box titled "USB Device Not Recognized" with a yellow warning icon. The text inside reads: "One of the USB devices attached to this computer has malfunctioned, and Windows does not recognize it. For assistance in solving this problem, click this message." The bottom image shows a screenshot of the Windows Device Manager window. The tree view is expanded to "Universal Serial Bus controllers", and an "Unknown Device" is highlighted with a red arrow. Other devices listed include "Standard Enhanced PCI to USB Host Controller", "Standard OpenHDC USB Host Controller", "USB Composite Device", and "USB Root Hub".</p>	<ol style="list-style-type: none"> <li>1. Unplug USB device and/or restart the computer (wait for 2-5 minutes) to reset USB port/hub in case of power surge.</li> <li>2. Soft Reset (<a href="#">9. Soft reset (Default Settings) on page 115</a>) and verify if USB device is recognized.</li> <li>3. Verify if USB device is recognized in <b>Device Manager &gt; Universal Serial Bus Controller</b>, or USB is recognized without Yellow bang.</li> <li>4. Verify if the latest USB driver or/and USB chipset driver are installed. USB driver could be removed and reinstalled.</li> <li>5. Make sure USB device is supported, for example, USB 3.0 device requires more power drawn (0.9A) from USB port than USB 2.0 device (0.5A). As a result, identify USB charging port to be used for charging a USB device, or an external AC power adapter may be required for an external USB storage to work properly.</li> <li>6. Test with verified working USB devices (keyboard, mouse, USB key) to make sure USB ports are functional.</li> <li>7. Test USB device on a verified working computer to make sure USB device is not malfunctioning.</li> </ol>

## Smart card reader

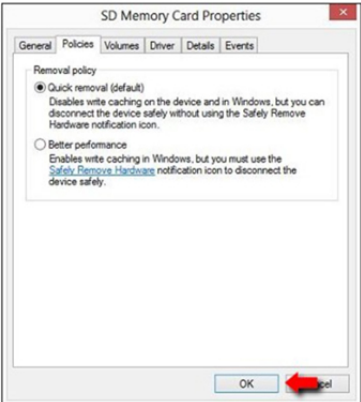
Items	Procedures
<p><i>Symptoms</i></p> <ul style="list-style-type: none"><li>• Not recognized</li><li>• Unable to write</li></ul>	<p><i>Possible causes</i></p> <p>Physical damage, incorrect insertion, dirt, driver, malfunctioning card reader.</p> <p><b>NOTE:</b> Some cards have a read/write security switch on the card. Make sure that switch is set to “write enabled” before attempting to write data to it.</p>
<p>Card Reader Removal Policy</p> 	<p><i>Troubleshooting steps</i></p> <ol style="list-style-type: none"><li>1. Verify card reader removal policy.</li><li>2. Make sure there is no physical damage to the card.</li><li>3. Inspect the ends of the memory cards for dirt or material closing a hole or spoiling a metal contact. Clean the contacts with a lint-free cloth and small amounts of isopropyl alcohol. Replace the memory card if necessary.</li><li>4. Reinstall and update the drivers for the card reader.</li><li>5. Make sure the smart card reader is compliant with ISO 7816 Class A, B, and C.</li><li>6. Reinsert the card reader with correct face as described in its documentation.</li><li>7. Check reader function with a verified working card.</li></ol>
	<p><b>CAUTION:</b> If the card reader has an in-use indicator light, do not insert or remove memory cards while the light is flashing. Doing so may cause loss of data on the card or may permanently damage the card reader.</p>

## Speaker, headphone - audio issues

Items	Procedures
<p><i>Symptoms</i></p> <ul style="list-style-type: none"> <li>No sound from external or internal speakers</li> <li>Distorted sound, too soft, too loud, intermittent</li> </ul>	<p><i>Possible causes</i></p> <p>Volume turned down, sound card not recognized, malfunctioning hardware, electronic interference.</p> <hr/> <p><i>Troubleshooting steps</i></p> <ol style="list-style-type: none"> <li>Remove any device connected to the Audio jack to enable the internal speaker.</li> <li>Close all open programs.</li> <li>Adjust volume by pressing <b>Fn + F6/F7</b>. Be sure that volume button light is not amber (mute). <ul style="list-style-type: none"> <li>- or -</li> <li>Adjust Windows volume control by clicking the speaker icon on the Windows taskbar. Be sure that the sound is not muted.</li> </ul> </li> <li>Verify that sound card is detected in Windows Device Manager.</li> <li>Reinstall the <b>latest audio driver</b>.</li> <li>Test audio device using HP PC Hardware Diagnostics (UEFI) tool (<b>F2 &gt; Component Tests &gt; Audio</b>).</li> <li>Test with a verified working operating system. If issue is resolved, restore full operating system.</li> <li>Test with verified working external speakers or headset.</li> <li>Reseat internal speaker connections.</li> <li>Test with verified working internal speakers.</li> <li>Replace internal speakers.</li> </ol>
No sound from headphones	<ol style="list-style-type: none"> <li>Adjust volume by pressing <b>Fn + F6/F7</b>. Be sure that volume button light is not amber (mute). Or adjust Windows volume control by clicking the speaker icon on the Windows taskbar. Be sure that the sound it not muted.</li> <li>Check headphone cable connection.</li> <li>Test with a verified working audio board.</li> <li>Replace audio board and verify the change.</li> </ol>
No sound from external speakers	<ol style="list-style-type: none"> <li>Verify that external speakers are turned on.</li> <li>Disconnect headphones from headphone jack.</li> <li>Adjust volume by pressing <b>Fn + F6/F7</b>. Be sure that volume button light is not amber (mute). <ul style="list-style-type: none"> <li>- or -</li> <li>Adjust Windows volume control by clicking the speaker icon on the Windows taskbar. Be sure that the sound is not muted.</li> </ul> </li> <li>Check for possible interference devices nearby that may impact the audio (cell phone or portable communications handset.)</li> </ol>

## Thunderbolt (TB)

---

Items	Procedures
<i>Symptom</i>	<i>Possible causes</i>
Thunderbolt device not working	BIOS, drivers, and user settings.

---

### *Troubleshooting steps*

1. Update to the latest BIOS and choose appropriate TB Port settings.
2. Reset **User Account Settings** to default.
3. Update Intel Thunderbolt software that includes firmware version (for TB controller), driver version (operating system driver), and application version.

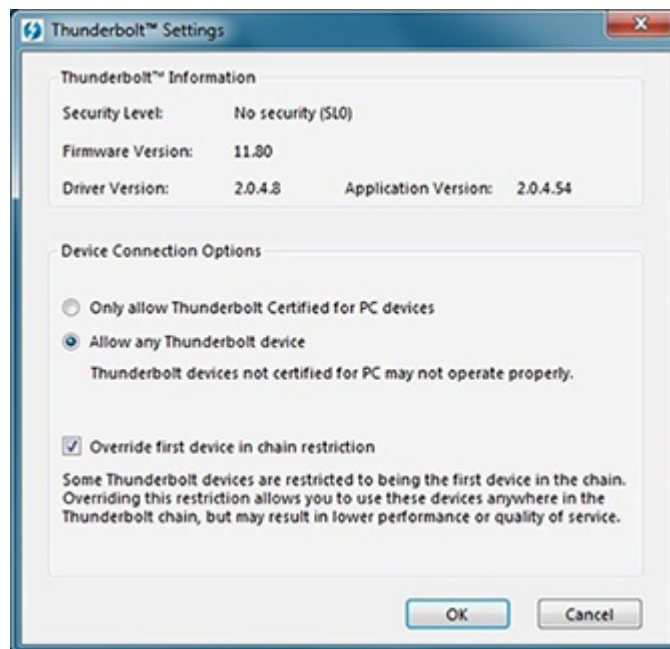

4. Verify that TB device is detected in Windows Device Manager.
5. Verify TB port, cable and connection.
6. Test with a verified working TB board, if possible.

**NOTE:** Thunderbolt is new technology. Thunderbolt cable and Thunderbolt device must be compatible with Windows. To determine whether your device is Thunderbolt Certified for Windows, see <https://thunderbolttechnology.net/products>.

---

## Storage



### NOTE:

- Back up all critical data prior to drive troubleshooting.
- Prior to contacting support, HP recommends that you run a drive (HDD, SSD, M.2 drive) test using the HP PC Hardware Diagnostics (UEFI) tool on the suspected failed drive.
- Diagnose the hard drive using BIOS, Diagnostics built in the shipping image, or an external USB ([http://www8.hp.com/us/en/campaigns/hpsupportassistant/pc-diags.html?jumpid=va\\_r602\\_us/en/any/pps/pl\\_ot\\_ob\\_ds\\_pd/HP\\_PC\\_Hardware\\_Diagnostics\\_cc/dt](http://www8.hp.com/us/en/campaigns/hpsupportassistant/pc-diags.html?jumpid=va_r602_us/en/any/pps/pl_ot_ob_ds_pd/HP_PC_Hardware_Diagnostics_cc/dt)).
- The drive quick test is recommended to quickly (less than 10 minutes) identify the malfunctioning drive. If the issue still exists, run Extensive Test (more than 2 hours, or loop mode, which will run until an error occurs).
- If any test fails, record failure code and contact support for instructions on how to order a replacement hard drive.
- If all of the tests pass, the hard drive is not damaged. As a rule, HP will not replace a hard drive under warranty that does not fail the HP Hard Drive Self-Test.
- If there is no physical problem with the hard drive (or memory), then try reinstalling the Windows operating system to troubleshoot the problem.

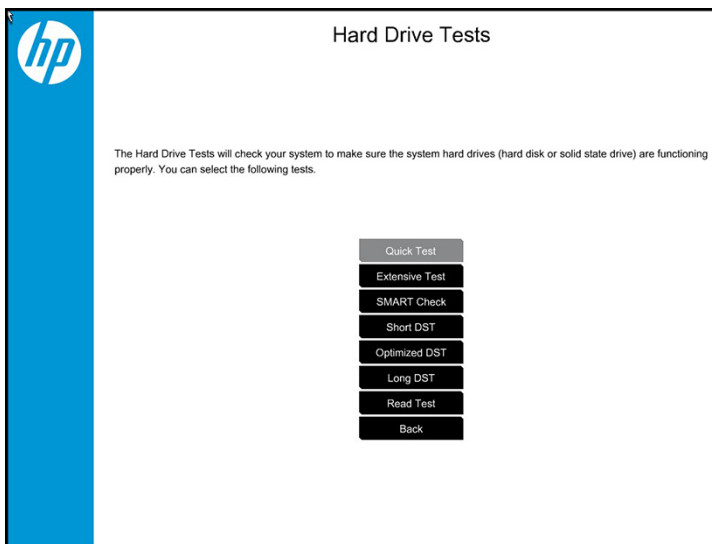

## Hard drive/solid-state drive not recognized

Items	Procedures
<i>Symptom</i>	<i>Possible causes</i>
Hard drive is not recognized during POST	Loose connection, faulty hard drive, faulty drive configuration/BIOS setting.
	<i>Troubleshooting steps</i>
	<ol style="list-style-type: none"><li>1. Perform a hard reset (<a href="#">8. Hard reset on page 113</a>).</li><li>2. Reset BIOS to default.</li><li>3. Verify hard drive connection and flex cable. Reseat hard drive and cable connection. For multiple storage devices, keep the primary drive with the operating system and remove other devices.</li><li>4. Use the HP Hardware Diagnostics tool to verify the drive is recognized and test it.</li><li>5. If the hard drive fails diagnostics, record failure and have the drive replaced.</li><li>6. Identify when the issue is related to software. If the hard drive passes diagnostics, test the drive on a verified working computer. If the failure follows the drive, reinstall the operating system to make sure software is not an issue.</li><li>7. Test with a verified working hard drive. If it is still not recognized, the system board is faulty.</li></ol>
	<b>NOTE:</b> If the drive is seen in BIOS and Diagnostics, try a secure erase prior to replacing a drive as this may resolve related issues.

## No boot to operating system (no read/write error)

Items	Procedures
<i>Symptoms</i>	<i>Possible causes</i>
<ul style="list-style-type: none"><li>• Post error message: Boot Device not found (3F0)</li><li>• Hang when booting to operating system</li></ul>	Operating system, loose connection, faulty hard drive, BIOS configuration, Secure Boot.
	<i>Troubleshooting steps</i>
	<ol style="list-style-type: none"><li>1. Verify if Secure Boot is enabled in BIOS. Secure Boot prevents legacy boot devices from starting the computer, including bootable CDs and DVDs. For more information, see <a href="http://support.hp.com/us-en/document/c03653226">http://support.hp.com/us-en/document/c03653226</a>.</li><li>2. Reset BIOS to default. Be sure that BIOS <b>Boot Mode</b> in <b>Boot Option</b> is set up properly for bootable device and its operating system (i.e., UEFI Native for Windows 8).  Another example, choosing <b>Legacy Boot Order</b> for an UEFI device will cause "Boot Device not found (3F0)" error.</li><li>3. Verify hard drive connection and flex cable. Reseat connection. For multiple storage devices, keep the primary drive with the operating system and remove other devices.</li><li>4. Use PC Hardware Diagnostics tool to test. Record failure code and have the hard drive replaced.</li><li>5. If there is no error, reinstall the operating system using HP Restore.</li><li>6. Test with a verified working operating system hard drive, if available.</li></ol>
<b>Note</b>	If there is a hard drive POST error message, see <a href="#">POST Error Messages and User Actions on page 164</a> .

## Read-write error

Items	Procedures
<i>Symptoms</i>	<i>Possible causes</i>
<ul style="list-style-type: none"><li>Post error message (i.e., error code 301)</li><li>Hang when working on data, files, documents</li></ul>	Loose connection, faulty hardware.
	<i>Troubleshooting steps</i>
	<ol style="list-style-type: none"><li>Perform a hard reset (<a href="#">8. Hard reset on page 113</a>).</li><li>Reset BIOS to default (<a href="#">9. Soft reset (Default Settings) on page 115</a>).</li><li>Verify drive connection and flex cable. Reseat connection (<a href="#">10. Reseat cables and connections on page 115</a>).</li><li>Use the HP Hardware Diagnostics tool to test. If failed, record failure code and have the hard drive replaced.</li><li>If no error with HP PC Hardware Diagnostics (UEFI) tool, try to repair the hard drive and its files in Windows (using command "<code>CHKDSK /f /r /x</code>"). Use HP Restore to reinstall the operating system, if needed.</li><li>Test with a verified working hard drive. If it is not recognized, the system board is faulty.</li></ol>
<b>Note</b>	If there is a hard drive POST error message, see <a href="#">POST Error Messages and User Actions on page 164</a> .

## Slow performance

Items	Procedures
<i>Symptoms</i>	<i>Possible causes</i>
Slow performance even when performing small read/write operations	Operating system files, hard drive is full.
	<i>Troubleshooting steps</i>
	<ol style="list-style-type: none"><li>Transfer data from the hard drive to create more space. Microsoft recommends at least 200 MB to sync system files.</li><li>Perform disk defragmentation to consolidate fragmented data on the hard drive so it will work more efficiently.</li></ol> <p><b>NOTE:</b> Do not defrag an SSD.</p>
<b>Tips &amp; tricks</b>	For optimal system performance, you need to place your operating system and all of your most commonly used applications and files in the fastest hard drive (solid-state drive) and fastest areas on the drive (primary partition of 200 GB max).
	See <a href="#">Routine Maintenance for Performance Improvement on page 166</a> .

## Blue screen (BSOD) error

Faulty hard drive may cause blue screen error. Perform the drive tests using the HP Diagnostics Tool to make sure the drive is functional. If all of the tests pass, see [Common Blue Screen Error Messages on page 166](#) for detailed troubleshooting steps.

## Noisy hard drive



**IMPORTANT:** An SSD has no moving parts, so it does not make loud or clicking noise.

Depending on type and rotational speed, some hard drives will make more noise than others.

Not all noises are related to the fan or hard drive.

Items	Procedures
<i>Symptoms</i>	<i>Possible causes</i>
<ul style="list-style-type: none"><li>• Loud noise from hard drive</li></ul>	BIOS, hard drive firmware, driver, faulty drive, power supply (AC adapter).
<ul style="list-style-type: none"><li>• Clicking noise from hard drive</li></ul>	<i>Troubleshooting steps</i>
<ul style="list-style-type: none"><li>• Still boots to operating system and operates normally</li></ul>	<ol style="list-style-type: none"><li>1. Update BIOS and hard drive firmware.</li><li>2. Examine AC adapter to be sure that it is not faulty or overloaded. Disconnect all peripherals (USB storages, dock, etc.).</li><li>3. Remove hard drive to isolate the noise.</li><li>4. Test the hard drive on a verified working computer if the noise continues. If the hard drive makes the same noise or clicking sounds, the sounds are either normal sounds for the hard drive or a fault with the hard drive.</li><li>5. Verify original hard drive connection and flex cable. Reseat hard drive and connection.</li><li>6. Run HP PC Hardware Diagnostics (UEFI). If failed, record failure code and have the hard drive replaced.</li><li>7. If no error with HP PC Hardware Diagnostics (UEFI), perform disk defragmentation (some hard drives make a clicking noise when highly fragmented).</li></ol>
<b>Tips &amp; tricks</b>	For optimal system performance, place your operating system and all of your most commonly used applications and files on the fastest hard drive or solid-state drive and on the fastest areas on the drive (primary partition of 200 GB max).  See <a href="#">Routine Maintenance for Performance Improvement on page 166</a> .



# Mechanical

## Fan error message - 90B

Items	Procedures
<p><i>Symptoms</i></p> <p>Fan error 90B at boot</p> <p><b>CAUTION:</b> May lead to system shutdown, data loss or possible system damage.</p>	<p><i>Possible causes</i></p> <p>Defective fan; out-of-date BIOS.</p> <ul style="list-style-type: none"><li>• The system fan is not spinning or not spinning properly (loose connection, fan is stuck or defective).</li><li>• The temperature inside the case is too high, and the fan cannot spin fast enough to remove the heat due to an obstruction to air flow.</li></ul> <div data-bbox="699 590 1422 884" style="border: 1px solid black; padding: 5px;"><p>The system has detected that a cooling fan is not operating correctly.</p><p>Continued operation is not recommended and may cause unpredictable behavior that could result in random shutdown, data loss or possible system damage. The system will shut down in 15 seconds. To prevent shutdown and continue operation, press the enter key now.</p><p>System Fan (90B) ENTER – Continue Startup</p><p>For more information, please visit: <a href="http://www.hp.com/go/techcenter/startup">www.hp.com/go/techcenter/startup</a></p></div>
	<p><i>Troubleshooting steps</i></p> <p><b>General actions</b></p> <ol style="list-style-type: none"><li>1. Update BIOS and drivers (<a href="#">4. Update BIOS and drivers on page 105</a>) or reset BIOS to default. BIOS may implement new fan characteristics and updates for other components.</li><li>2. Perform a hard reset (<a href="#">8. Hard reset on page 113</a>). Performing a hard reset can reset recorded thermal values in memory.</li></ol> <p><b>Thermal-related issue</b></p> <ol style="list-style-type: none"><li>1. Verify thermal condition:<ol style="list-style-type: none"><li>a. Check fan and connection. Reseat fan cable.</li><li>b. Be sure that no obstructions or dust are in heat sink fan, fin, or vent.</li><li>c. Test fan using HP PC Hardware Diagnostics (UEFI) tool (<a href="#">6. HP Hardware Diagnostics and Tools on page 106</a>). Be sure that the fan is not producing loud noise and that fan blades spin correctly.</li><li>d. Test with a verified working fan.</li><li>e. Remove old thermal compound and pads, and replace properly with new pads.</li></ol></li><li>2. Verify thermal solution<ul style="list-style-type: none"><li>▲ Use Thermal Monitor tool (available only to authorized service providers/ technicians) to run stress test (processor and GPU) and verify that thermal sensors are within limits after thermal condition is serviced.</li></ul></li></ol>
<p><b>Note</b></p>	<p>BIOS currently omits fan presence detection to shorten boot time delay less than four seconds. Therefore, the fan error is generated based on previous boot to operating system that found system fan error.</p> <p>Fan often is part of thermal solution, including heat sink, fin/ muffler, and thermal grease. Fan replacement requires reboot and fan function verification using HP PC Hardware Diagnostics (UEFI) tool.</p>

Items	Procedures
	See <a href="https://support.hp.com/us-en/document/c01657439">https://support.hp.com/us-en/document/c01657439</a> .



## Noise (sound)

Items	Procedures
<i>Symptoms</i>	<i>Possible causes</i>
Computer emits abnormal noise	Aside from basic components (power adapter/supply, fan, speaker, hard drive, optical drive, display panel, external devices), it is also common for electronic components to produce noise.
	<i>Troubleshooting steps</i>
	<ol style="list-style-type: none"> <li>1. Inspect external power source and change to verified working one.</li> <li>2. Determine whether the noise comes from AC power adapter. Test with a verified working AC adapter.</li> </ol>
	Disconnect external devices and all cables connected to the computer to isolate issue to computer only.
<b>Noisy fan</b>	Determine whether the noise comes from the fan. Disconnect the fan briefly to isolate whether noise originates from fan. If noise is absent with fan disconnected, refer to <a href="#">Fan runs constantly on page 159</a> .
<b>Noisy hard drive</b>	Determine whether the noise comes from the hard drive. See <a href="#">Noisy hard drive on page 156</a> .
<b>Noisy optical drive</b>	<ol style="list-style-type: none"> <li>1. Determine whether the noise comes from an optical drive.</li> <li>2. Remove CD/DVD from the optical drive.</li> </ol>
<b>Noisy speaker</b>	<ol style="list-style-type: none"> <li>1. Determine whether the noise comes from speaker.</li> <li>2. Test with a verified working external headset/speaker.</li> </ol>
<b>Noisy display</b>	Determine whether the noise comes from display panel (humming noise). Change display frequency settings. See <a href="#">Display on page 138</a> .
<b>The section below is intended for authorized service providers/technicians.</b>	
	<ol style="list-style-type: none"> <li>1. After disassembling the chassis, inspect components of the interior for excessive wear or damage.</li> <li>2. If noise issues persist, proceed with process of elimination for battery, AC adapter, or boards.</li> </ol>

## Fan runs constantly

Items	Procedures
<i>Symptoms</i>	<i>Possible causes</i>
<ul style="list-style-type: none"><li>• Fan never stops running</li><li>• Generates heat</li><li>• Decreased computer performance</li></ul>	<ul style="list-style-type: none"><li>• BIOS not up to date.</li><li>• Thermal condition (fan, air flow)--fan may not be defective but must run constantly to remove excess heat generated by electrical components.</li><li>• Inappropriate configuration.</li></ul>
	<i>Troubleshooting steps</i>
	<b>General actions</b>
	<ol style="list-style-type: none"><li>1. Verify whether BIOS is set to <b>Fan Always on while on AC Power</b> F10 Setup. When booting the computer, press <b>F10</b> to open Setup, and then select <b>Advanced &gt; Built-In Device Options Menu</b>.</li><li>2. Update BIOS and drivers (<a href="#">4. Update BIOS and drivers on page 105</a>) and reset BIOS to default. BIOS may implement new fan characteristics and updates for other components.</li><li>3. Perform a hard reset (<a href="#">8. Hard reset on page 113</a>). Performing a hard reset can reset recorded thermal values in memory.</li></ol>
	<b>Thermal-related issue</b>
	<ol style="list-style-type: none"><li>1. Verify fan is spinning. Reseat fan cable before moving to next step.<ol style="list-style-type: none"><li>a. Check fan and connection. Reseat fan cable.</li><li>b. Be sure that no obstructions or dust are in heat sink fan, heat sink fin, or vent.</li><li>c. Test fan using HP PC Hardware Diagnostics (UEFI) tool (<a href="#">6. HP Hardware Diagnostics and Tools on page 106</a>). Be sure that the fan is not producing loud noise and that fan blades spin correctly.</li><li>d. Test with a verified working fan.</li><li>e. Replace the fan.</li></ol></li><li>2. Verify thermal solution<p>Use Thermal Monitor tool (available only to authorized service providers/technicians) (<a href="#">HP Thermal Monitor on page 109</a>) to run stress test (processor and GPU) and verify that thermal sensors are within limits after thermal condition is serviced.</p></li></ol>
	<b>User configuration</b>
	Change Power Options in Windows (i.e., choosing <b>Balanced mode</b> instead of <b>High performance</b> ). High performance and extensive graphics may cause the fan run constantly to release the heat.
<b>Notes</b>	<p>BIOS currently omits fan presence detection to shorten boot time delay less than four seconds. Therefore, the fan error is generated based on previous boot to operating system that found system fan error.</p> <p>Fan often is part of thermal solution, including heat sink, heat sink fin/muffler, and thermal grease. Fan replacement requires reboot and fan function verification using HP PC Hardware Diagnostics (UEFI) tool.</p> <p>For more information, see the following links:</p> <ul style="list-style-type: none"><li>• <a href="http://support.hp.com/us-en/document/c01007591">http://support.hp.com/us-en/document/c01007591</a>.</li><li>• <a href="https://support.hp.com/us-en/document/c01657439">https://support.hp.com/us-en/document/c01657439</a>.</li></ul>

## Thermal shutdown (hot)

Items	Procedures
<p><i>Symptoms</i></p> <p>Similar to fan runs constantly issue (<a href="#">Fan runs constantly on page 159</a>)</p> <ul style="list-style-type: none"> <li>• System shutdown</li> <li>• Abnormal heat</li> <li>• Continually running fan</li> <li>• Decreased computer performance</li> </ul>	<p><i>Possible causes</i></p> <p>BIOS not up to date, thermal condition (fan, air flow)</p> <hr/> <p><i>Troubleshooting steps</i></p> <ol style="list-style-type: none"> <li>1. Update BIOS and drivers (<a href="#">4. Update BIOS and drivers on page 105</a>) and reset BIOS to default. BIOS may implement new fan characteristics and updates for other component.</li> <li>2. Perform a hard reset (<a href="#">8. Hard reset on page 113</a>). Performing a hard reset can reset recorded thermal values in memory.</li> <li>3. Determine whether you are using a correct AC adapter.</li> <li>4. Be sure to turn power off completely when putting a notebook in a travel bag.</li> </ol>
 	<p><b>Thermal-related issue</b></p> <ol style="list-style-type: none"> <li>1. Verify thermal condition: <ol style="list-style-type: none"> <li>a. Check fan and connection. Reseat fan cable.</li> <li>b. Be sure that no obstructions or dust are in heat sink fan, fin, or vent.</li> <li>c. Be sure that the notebook is not sitting on a hot surface that blocks vent intakes.</li> <li>d. Test fan using HP PC Hardware Diagnostics (UEFI) tool (<a href="#">6. HP Hardware Diagnostics and Tools on page 106</a>). Be sure that the fan is not producing a loud noise and that fan blades spin correctly.</li> <li>e. Test with a verified working fan.</li> <li>f. Remove old thermal compound and pads, and replace properly with new pads.</li> </ol> </li> <li>2. Verify thermal solution: <ul style="list-style-type: none"> <li>○ Use Thermal Monitor tool (available only to authorized service providers/technicians) to run stress test (processor and GPU) and verify that thermal sensors are within limits after thermal condition is serviced.</li> </ul> </li> </ol>
<b>Note</b>	See <a href="https://support.hp.com/us-en/document/c01657439">https://support.hp.com/us-en/document/c01657439</a> .

## Stuck power button

Items	Procedures
<p><i>Symptoms</i></p> <ul style="list-style-type: none"> <li>• Rear power indicator light is on</li> <li>• Will not turn on when power button is pressed</li> <li>• Automatically powers on</li> </ul>	<p><i>Possible causes</i></p> <p>Sticky or defective power button.</p> <hr/> <p><i>Troubleshooting steps</i></p> <p><b>General actions</b></p> <ol style="list-style-type: none"> <li>1. Perform a hard reset (<a href="#">8. Hard reset on page 113</a>).</li> <li>2. Perform a soft reset if system can turn on.</li> </ol>
<b>The sections below are intended for authorized service providers/technicians.</b>	
	<ol style="list-style-type: none"> <li>1. Disassemble the unit.</li> <li>2. Inspect power button on the top cover and on the system board to make sure these buttons moves freely.</li> </ol>

## Additional information

The following sections provide additional information that can be used during the troubleshooting process.

### Acronyms

The following acronyms are used in this chapter.

**Blue screen (BSOD)**—A Windows error screen that can occur if a problem causes your computer to shut down or restart unexpectedly. When you experience this type of error, you will not be able to see items such as the Start menu or the taskbar when your computer is turned on. Instead you might see a blue screen with a message that your computer ran into a problem and needs to restart.

**CPU**—Central processing unit

**DIMM**—Dual in-line memory module

**Daughterboard**—Type of circuit board that plugs into or is attached to the system board or similar expansion card to extend its features and services.

**GPU**—Graphics processor unit

**GTS**—General Troubleshooting Step

**HDD**—Hard drive

**KB**—Keyboard

**LVDS**—Low-Voltage Differential Signaling

**MSG**—Maintenance and Service Guide

**mWS**—Mobile Workstations

**WS**—Workstations

**OS**—Operating system

**PC**—Personal computer

**POST**—Power-On Self-Test

**SSD**—Solid-state drive

**TSG**—Troubleshooting Guide

**UEFI**—Unified Extensible Firmware Interface

**WLAN**—Wireless local area network

**WWAN**—Wireless wide area network

## Blinking lights and boot error codes

The information below is from the white paper <http://h10032.www1.hp.com/ctg/Manual/c04685655>.

In some cases, when the host processor is not executing code or does not have the necessary code to drive the display, light blink codes inform you of a problem.

**Table 7-7 Boot-error codes**

Blink codes	Error
Amber battery light: blinks 1 Hz continuously	Embedded Controller unable to load firmware
Caps/num lock lights = 1 blink	Processor not executing code
Caps/num lock lights = 2 blinks	BIOS recovery code unable to find valid BIOS recovery image
Caps/num lock lights = 3 blinks	Memory module error
Caps/num lock lights = 4 blinks	Graphics controller error
Caps/num lock lights = 5 blinks	System board error
Caps/num lock lights = 6 blinks	Intel Trusted Execution Technology (TXT) Error
Caps/num lock lights = 7 blinks	Sure Start unable to find valid BIOS Boot Block image
Caps/num lock lights = 8 blinks	Sure Start has identified a problem (Manual Recovery Policy Set)

### Processor not executing code

This computer has experienced a problem due to the failure of certain code to execute, resulting in a failed startup of the processor. The issue could be related to the processor or the system board in the computer. If the processor is socketed, be sure that the processor is seated correctly in the socket. If this error reoccurs, refer to [General troubleshooting steps on page 101](#).

 **NOTE:** The computer will attempt to notify you of this problem through a series of blinking lights. When you attempt to turn on the computer from an “Off” or “Hibernated” state, lights associated with the [caps lock](#) and [num lock](#) keys will both **blink once** followed by a pause, and then continue in a repeating pattern.

### BIOS recovery code unable to find valid BIOS recovery image

This computer has experienced a problem in locating a valid BIOS image, resulting in a failed startup. This problem may be resolved by placing a clean copy of the system BIOS on a USB key or in the appropriate hard drive directory and performing a reboot. If this error reoccurs, refer to [General troubleshooting steps on page 101](#).

 **NOTE:** The computer will attempt to notify you of this problem through a series of blinking lights. When you attempt to turn on the computer from an “Off” or “Hibernated” state, lights associated with the [caps lock](#) and [num lock](#) keys will both **blink twice** followed by a pause, and then continue in a repeating pattern.

### Memory module error

This computer has experienced a memory initialization problem resulting in a failed startup. This issue may be related to the memory modules in the computer. This problem may be resolved by ensuring that memory modules are correctly inserted and seated. If this error reoccurs, a service event is required to determine the source of the error (memory modules or system board) and take the appropriate corrective action.

---

 **NOTE:** The computer will attempt to notify you of this problem through a series of blinking lights. When you attempt to turn on the computer from an “Off” or “Hibernated” state, lights associated with the [caps lock](#) and [num lock](#) keys will both **blink three times** followed by a pause, then continue in a repeating pattern.

---

## Graphics Controller Error (No Controller)

This computer has experienced a graphics controller initialization problem resulting in a failed startup. This issue may be related to the graphics controller in your machine. This problem may be resolved by ensuring that the graphics controller module is seated correctly in machines with modular graphics. If this error reoccurs, a service event is required to identify the source of the error and take the appropriate corrective action.

---

 **NOTE:** The computer will attempt to notify you of this problem through a series of blinking lights. When you attempt to turn on the computer from an “Off” or “Hibernated” state, lights associated with the [caps lock](#) and [num lock](#) keys will both **blink four times** followed by a pause, then continue in a repeating pattern.

---

## Failure - System Board Error

This computer has experienced a system board initialization problem resulting in a failed startup. This issue may be related to the system board in the computer. A service event is required to identify the source of the error and take the appropriate corrective action.

---

 **NOTE:** The computer will attempt to notify you of this problem through a series of blinking lights. When you attempt to turn on the computer from an “Off” or “Hibernated” state, lights associated with the [caps lock](#) and [num lock](#) keys will both **blink five times** followed by a pause, then continue in a repeating pattern.

---

## Intel Trusted Execution Technology (TXT) Error

This computer has experienced a problem related to the Intel Trusted Execution Technology resulting in a failed startup. The error occurs when all of the following are true:

- The Intel Trusted Execution Technology (TXT) has been enabled on the computer.
- Policies have been set to prevent startup if the BIOS measurement has changed.
- The BIOS measurement has changed.

For more information about Intel TXT, go to <http://www.intel.com/content/dam/www/public/us/en/documents/white-papers/trusted-execution-technology-security-paper.pdf>.

A service event is required to resolve this issue.

---

 **NOTE:** The computer will attempt to notify you of this problem through a series of blinking lights. When you attempt to turn on the computer from an “Off” or “Hibernated” state, lights associated with the [caps lock](#) and [num lock](#) keys will both **blink six times** followed by a pause, then continue in a repeating pattern.

---

## Sure Start unable to find valid BIOS Boot Block image

This computer has experienced a problem in locating a valid BIOS image, resulting in a failed startup. A service event is required to identify the source of the error and take appropriate corrective action.

---

 **NOTE:** The computer will attempt to notify you of this problem through a series of blinking lights. When you attempt to turn on the computer from an “Off” or “Hibernated” state, lights associated with the [caps lock](#) and [num lock](#) keys will both **blink seven times** followed by a pause, then continue in a repeating pattern.

---

## Sure Start has identified a problem (Manual Recovery Policy Set)

This computer has experienced a problem in locating a valid BIOS image, resulting in a failed startup. HP Sure Start will normally repair this type of issue; however, on this computer HP Sure Start has been configured to operate in manual mode key sequence. To proceed with the repair, press and hold the following keys: <ESC> +<UP arrow>+<DOWN arrow>. To avoid the need for this manual recovery step, set the HP Sure Start recovery policy to automatic. If this error reoccurs, a service event is required to identify the source of the error and take appropriate corrective action.



**NOTE:** The computer will attempt to notify you of this problem through a series of blinking lights. When you attempt to turn on the computer from an “Off” or “Hibernated” state, lights associated with the **caps lock** and **num lock** keys will both **blink eight times** followed by a pause, then continue in a repeating pattern.

## POST Error Messages and User Actions

Test description	Failure descriptions	Error code	Possible user actions
Product information	Invalid value	00A	Contact support for assistance.
Startup test	Memory module	200	Attempt to reseat the memory module and then repeat the test.  Search <a href="http://www.hp.com/support">http://www.hp.com/support</a> for details on troubleshooting issues related to the memory module.  If the memory module still fails, contact support.
Startup test	Hard Disk 1 SMART	301	Attempt to reseat the hard drive and repeat the test.  The hard disk drive may have failed. Contact support for assistance.
Startup test	Hard Disk 2 SMART	302	The hard drive may have failed. Contact support for assistance.
Startup test	Hard Disk 1 Quick	303	The hard drive may have failed. Contact support for assistance.
Startup test	Hard Disk 2 Quick	304	The hard drive may have failed. Contact support for assistance.
Run-in test	Memory module	200	Attempt to reseat the memory module and then repeat the test.  Search <a href="http://www.hp.com/support">http://www.hp.com/support</a> for details on troubleshooting issues related to the memory module.  If the memory module still fails, contact support.
Run-in test	Hard Disk 1 SMART	301	Attempt to reseat the hard drive and repeat the test.  The hard drive may have failed. Contact support for assistance.
Run-in test	Hard Disk 2 SMART	302	The hard drive may have failed. Contact support for assistance.
Run-in test	Hard Disk 1 Quick	303	The hard drive may have failed. Contact support for assistance.
Run-in test	Hard Disk 2 Quick	304	The hard drive may have failed. Contact support for assistance.
Hard Disk Test	Hard Disk 1 SMART	301	Attempt to reseat the hard drive and repeat the test.  The hard drive may have failed. Contact support for assistance.
Hard Disk Test	Hard Disk 2 SMART	302	The hard drive may have failed. Contact support for assistance.
Hard Disk Test	Hard Disk 1 Quick	303	The hard drive may have failed. Contact support for assistance.
Hard Disk Test	Hard Disk 2 Quick	304	The hard drive may have failed. Contact support for assistance.
Hard Disk Test	Hard Disk 1 Full	305	The hard drive may have failed. Contact support for assistance.



Test description	Failure descriptions	Error code	Possible user actions
Hard Disk Test	Hard Disk 2 Full	306	The hard drive may have failed. Contact support for assistance.
Boot Device Manager	Boot device not found	3F0	Indicates a potential problem with the hard drive. Please run the hard drive test.  See <a href="https://support.hp.com/emea_africa-en/document/c01443371">https://support.hp.com/emea_africa-en/document/c01443371</a> for more information.
Boot Device Manager	Hard Disk 1 Error	3F1	Indicates a potential problem with the hard drive. Run the hard drive test.  See <a href="https://support.hp.com/emea_africa-en/document/c01443371">https://support.hp.com/emea_africa-en/document/c01443371</a> for more information.
Boot Device Manager	Hard Disk 2 Error	3F2	Indicates a potential problem with the hard drive. Run the hard drive test.  See <a href="https://support.hp.com/emea_africa-en/document/c01443371">https://support.hp.com/emea_africa-en/document/c01443371</a> for more information.
Boot Device Manager	Hard Disk 1 SMART	301	Indicates a potential problem with the hard drive. Run the hard drive test.  See <a href="https://support.hp.com/emea_africa-en/document/c01443371">https://support.hp.com/emea_africa-en/document/c01443371</a> for more information.
Boot Device Manager	Hard Disk 2 SMART	302	Indicates a potential problem with the hard drive. Run the hard drive test.  See <a href="https://support.hp.com/emea_africa-en/document/c01443371">https://support.hp.com/emea_africa-en/document/c01443371</a> for more information.
BIOS Recovery	BIOS Recovery Occurred	500	This message indicates that BIOS recovery was completed successfully. No further action is required.
BIOS Application	BIOS Application Error	501	The BIOS installation may have become corrupted. Download the latest version of the BIOS and install it. See <a href="#">4. Update BIOS and drivers on page 105</a> for more information.  If reinstalling the BIOS fails, contact support for further assistance.
CMOS Recovery	CMOS Recovery Occurred	502	This message indicates that CMOS recovery was completed successfully. No further action is required.
Battery Check	Primary Battery Replace	601	This indicates that the primary battery has very low capacity.  Search <a href="http://www.hp.com/support">http://www.hp.com/support</a> for details on using the HP Support Assistant to verify the battery capacity and, if necessary, order a replacement.
Battery Check	Secondary Battery Replace	602	This indicates that the secondary battery has very low capacity.  Search <a href="http://www.hp.com/support">http://www.hp.com/support</a> for details on using the HP Support Assistant to verify the battery capacity and, if necessary, order a replacement.
Wireless Module	Not installed or responding	701	Reseat the wireless LAN adapter module, if your notebook supports it.  Because seating or reseating a wireless LAN adapter is unique to each computer model. For more information, see the chapter titled "Removal and replacement procedures for Customer Self-Repair parts."
Fan	Fan not operating correctly	90B	The system fan may be malfunctioning.  For information on troubleshooting heat-related issues, see <a href="http://support.hp.com/us-en/document/c01007591">http://support.hp.com/us-en/document/c01007591</a> .  A hard reset can sometimes restore the system fan to working order. See <a href="https://support.hp.com/us-en/document/c01684768">https://support.hp.com/us-en/document/c01684768</a> for details.  If the system fan continues to malfunction, contact support.

## Routine Maintenance for Performance Improvement

The following table presents a summary of the suggested times for performing the routine maintenance tasks described in this document.

Tasks	Weekly	Monthly	Occasionally
Perform a system tune up.	X		
Run Windows Update.	X		
Scan for and remove viruses.	X		
Scan for and remove spyware and adware.	X		
Empty the Recycle Bin.	X		
Delete temporary Internet files.	X		
Back up user files.		X	
Create a restore point.		X	
Defragment the hard drive.		X	
Run Scan Disk.		X	
Clean the exterior of the computer.			X
Close programs that are not being used.			X
Prevent programs from loading at startup.			X

## Common Blue Screen Error Messages

### Error message list

The following image shows an example of one possible “[https://msdn.microsoft.com/en-us/library/windows/hardware/hh994433\(v=vs.85\).aspx](https://msdn.microsoft.com/en-us/library/windows/hardware/hh994433(v=vs.85).aspx)” from Microsoft:

```
STOP: 0x00000079 (0x00000002, 0x00000001, 0x00000002,
0x00000000)

Mismatched kernel and hal image.

Beginning dump of physical memory
Physical memory dump complete. Contact your system
administrator or technical support group.
```

The hexadecimal number following the word "STOP" is called the bug check code or Stop code. This is the most important item on the screen.

### Bug check symbolic names

Each bug check code also has an associated symbolic name. In the example, the screen shows [https://msdn.microsoft.com/en-us/library/windows/hardware/ff559209\(v=vs.85\).aspx](https://msdn.microsoft.com/en-us/library/windows/hardware/ff559209(v=vs.85).aspx) (MISMATCHED\_HAL).

## Microsoft general troubleshooting of Windows bug check codes

- If you recently added hardware to the system, try removing or replacing it. Or check with the manufacturer to see if any patches are available.
- Try running HP PC Hardware Diagnostics (UEFI).
- Check with the manufacturer to see if an updated system BIOS or firmware is available.
- Be sure that any expansion board is properly seated and all cables are completely connected.
- Confirm that any new hardware that is installed is compatible with the installed version of Windows.
- If new device drivers or system services have been added recently, try removing or updating them.



---

**NOTE:** Use safe mode when removing or disabling components. Safe mode loads only the minimum required drivers and system services during the Windows startup. To enter safe mode, restart your computer and press **F8** at the menu that displays the operating system choices. At the resulting **Windows Advanced Options** menu, choose **Safe Mode**.

---

- Run a virus detection program. Viruses can infect all types of hard drives formatted for Windows, and resulting drive corruption can generate system bug check codes. Be sure that the virus detection program checks the Master Boot Record for infections.
- Verify that the system has the latest service pack installed. To detect which service pack, if any, is installed on your system, click **Start**, click **Run**, type `winver`, and then press **Enter**. The **About Windows** dialog box displays the Windows version number and the version number of the service pack, if one has been installed.
- Disable BIOS memory options such as caching or shadowing.
- Check the System Log and Application Log in Event Viewer to see if any additional error messages have been logged recently. These might pinpoint the cause of the error.

## Use Windows Debugging Tool

The [https://msdn.microsoft.com/library/windows/hardware/ff551063%20\(v=vs.85\).aspx](https://msdn.microsoft.com/library/windows/hardware/ff551063%20(v=vs.85).aspx) is one of the primary tools used by Microsoft software developers to analyze and resolve errors that result in memory dumps. Use the tool to determine the cause of the error. Follow general steps for downloading, setting up, and using the Windows 10 debugging tool. A similar process is used for Windows 7 or Windows 8.



---

**NOTE:** The following screen shots provide only an example of the tool. Specifics shown are not representative of all applications of the debugging tool. This is a Microsoft tool supported by Microsoft.

---

## Windows Software Development Kit (SDK)

1. Download the SDK from the following link:  
<https://dev.windows.com/en-US/downloads/windows-10-sdk>
2. Set up the SDK in the configuration window (Windows 10 shown).

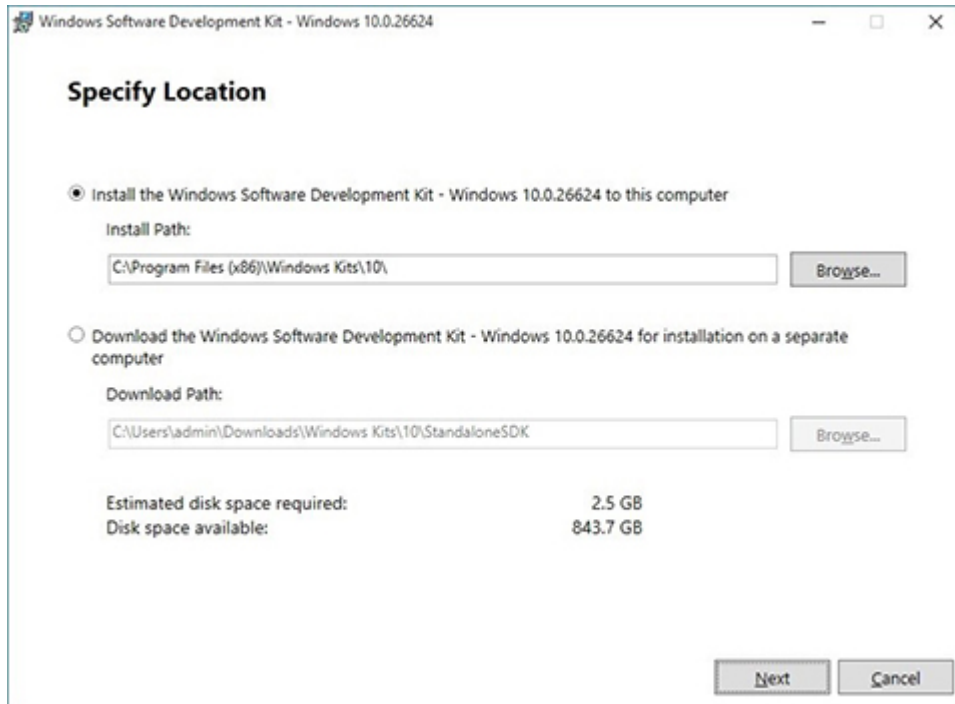

3. Select features to install.

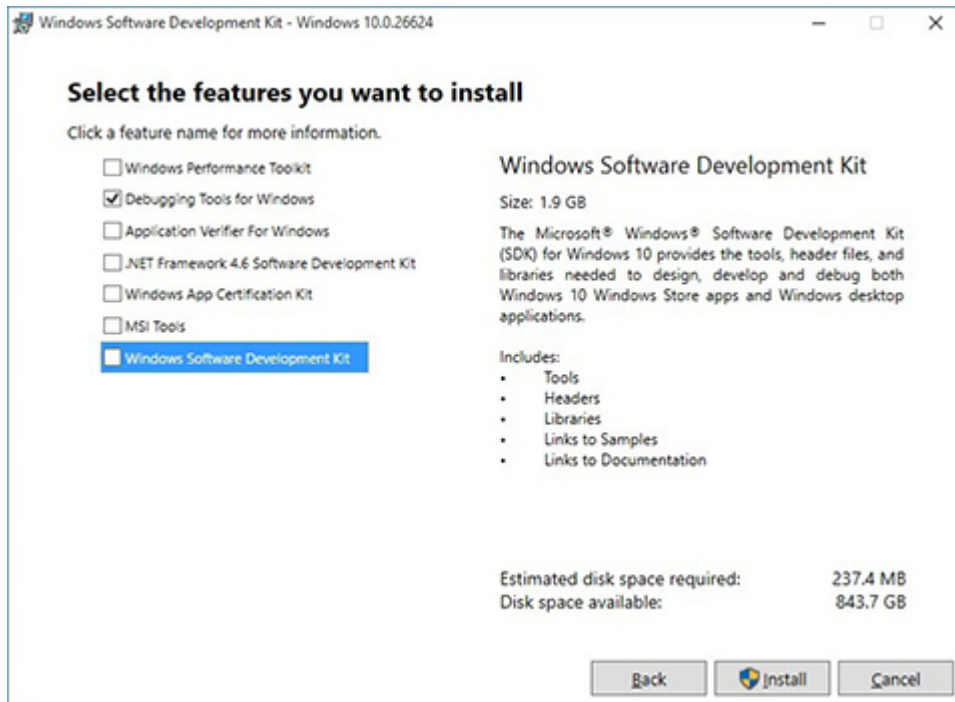

4. Run the SDK as an administrator.

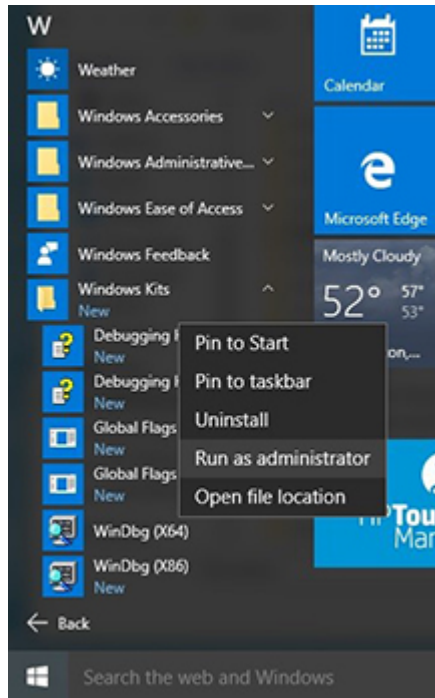

5. Set the symbol path. Select **File > Symbol File Path**.

- In the **Symbol path** box, type `SRV*C:\Windows\symbol_cache*http://msdl.microsoft.com/download/symbols`.
- Save the workspace.

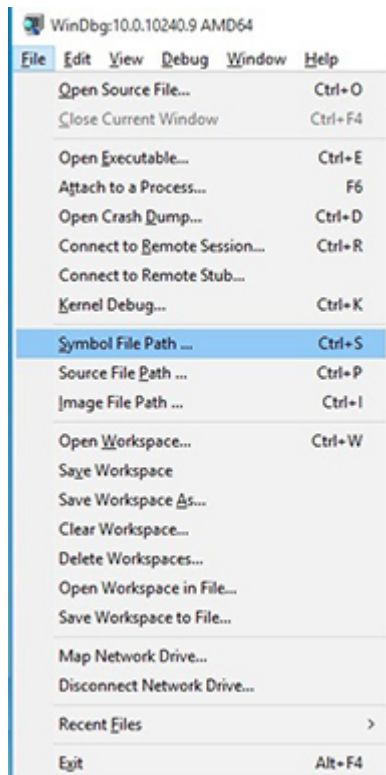

6. Open the crash dump file.

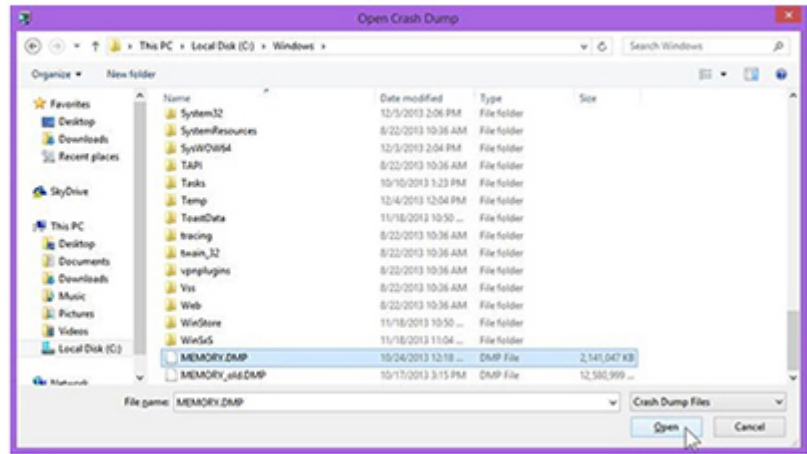
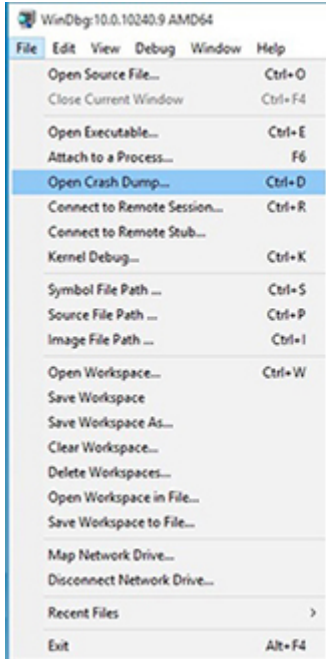

- Analyze the file. In the following memory dump sample, look for Bug Check 0x3B. The ATKMAG driver needs to be investigated for further root cause.

Lookup for Bug Check 0xC2.

```
1: kd> !analyze -v
.....
*                                     *
*                               Bugcheck Analysis                               *
*                                     *
.....

SYSTEM_SERVICE_EXCEPTION (3b)
An exception happened while executing a system service routine.
Arguments:
Arg1: 0000000c00000005, Exception code that caused the bugcheck
Arg2: fffff8006d927acf, Address of the instruction which caused the bugcheck
Arg3: fffffd00020e4e500, Address of the context record for the exception that caused the bugcheck
Arg4: 0000000000000000, zero.

Debugging Details:
-----
BUGCHECK_P1: c0000005
BUGCHECK_P2: fffff8006d927acf
BUGCHECK_P3: fffffd00020e4e500
BUGCHECK_P4: 0
EXCEPTION_CODE: (NTSTATUS) 0xc0000005 - The instruction at 0x%p referenced memory at 0x%p. The memory

FAULTING_IP:
atikmpag+2facf
fffff800`6d927acf 4539bc2434030000 cmp     dword ptr [r12+334h],r15d
...

SYMBOL_STACK_INDEX: 0
SYMBOL_NAME: atikmpag+2facf
FOLLOWUP_NAME: MachineOwner
MODULE_NAME: atikmpag
IMAGE_NAME: atikmpag.sys
DEBUG_FLR_IMAGE_TIMESTAMP: 55479b42
STACK_COMMAND: .cxr 0xffffd00020e4e500 ; kb
BUCKET_ID_FUNC_OFFSET: 2facf
FAILURE_BUCKET_ID: 0x3b_atikmpag!Unknown_Function
BUCKET_ID: 0x3b_atikmpag!Unknown_Function
PRIMARY_PROBLEM_CLASS: 0x3b_atikmpag!Unknown_Function
ANALYSIS_SOURCE: KM
FAILURE_ID_HASH_STRING: km:0x3b_atikmpag!unknown_function
FAILURE_ID_HASH: {adb00875-801c-005a-68e8-645bb2f2c848}
```

```
Command - Dump C:\Windows\MEMORY.DMP - WinDbg.6.3.9600.16384 AMD64
.....
Loading User Symbols
Loading unloaded module list
.....
*                                     *
*                               Bugcheck Analysis                               *
*                                     *
.....

Use !analyze -v to get detailed debugging information.
BugCheck C2, {7, 1205, 1159400, fffff0001137350}
*** ERROR: Module load completed but symbols could not be loaded for nldr.sys
Probably caused by : NETIO.SYS ( NETIO! ?? ::FNODOBFN::'string'+797c )

Followup: MachineOwner
-----
<----->
0: kd>
```

## Display Issue: Pixel Anomalies

All HP notebook displays adhere to strict quality and reliability specifications. A small percentage of display panels may have minor cosmetic manufacturing anomalies or irregularities such as bright or dark dots in the viewable area. These cosmetic imperfections are common to all display panel types and are not specific to any HP model or product line.

All display panel defects should be examined at the highest possible resolution using both the brightest and darkest possible backgrounds, because some sub-pixel failures may not be readily visible under certain conditions.

- Type 1: Bright dot on a dark background = Always On
- Type 2: Dark dot on a bright background = Always Off
- Combination = in any combination and any color that are always on or off

Use the HP PC Hardware Diagnostics (UEFI) tool to determine numbers of pixels and their distance. HP uses the following set of criteria when damaged displays are submitted for warranty coverage.

Source: <http://support.hp.com/us-en/document/c00035844>

**Table 7-8 Electrical defect allowances**

Panel resolution	Accept	Reject
<b>Sub-pixel faults</b>		
VGA, SVGA, SD, WSVGA, XGA, 720p, SD+, WXGA, HD	N ≤ 2 Type 1 N ≤ 2 Type 2	N ≥ 3 Type 1
WXGA+, SXGA+, HD+, SXGA+	N ≤ 3 Type 1 N ≤ 3 Type 2	N ≥ 4 Type 1
WSXGA+, UXGA, FHD, WUXGA	N ≤ 4 Type 1 N ≤ 4 Type 2	N ≥ 5 Type 1
QHD, QHD+, WQXGA, UD	N ≤ 5 Type 1 N ≤ 5 Type 2	N ≥ 6 Type 1
<b>Electrical defect clusters (defects within a 5x5 pixel block)</b>		
Minimum distance between ANY allowable defects (unless otherwise specified)	S ≥ 25 mm	S < 25 mm
Cluster with 2 or more sub-pixels with sub-pixel faults		Not allowed
Dim lines		Not allowed
Cross line(s) on/off		Not allowed
Horizontal line(s) on/off		Not allowed
Vertical line(s) on/off		Not allowed

 **NOTE:** All LCD panel defects should be examined at the highest possible resolution using both the brightest and darkest possible backgrounds, as some sub-pixel failures may not be readily visible under certain conditions.

 **NOTE:** Contact support for assistance if issues are not listed.



## Cable management

Proper routing of the internal cables is critical to the operation of the computer. Follow good cable management practices when removing and installing components.

- Handle cables with care to avoid damage.
- Apply only the tension required to seat or unseat cables during insertion or removal from the connector.
- When possible, handle cables by the connector or pull-strap.
- Route cables in such a way that they cannot be caught or snagged by parts being removed or replaced.
- Keep cables away from direct contact with major heat sources, such as the heat sink. (Some air flow guides have a cable guide that lets you route cables safely around the heat sink.)
- Do not jam cables on top of daughterboards or memory modules (DIMMs). Circuit cards and DIMMs are not designed to take excessive pressure.
- Keep cables clear of any movable or rotating parts (such as a fan) to prevent them from being cut or crimped when the component is lowered into its normal position.
- In all cases, avoid bending or twisting the cables. Do not bend any cable sharply. A sharp bend can break the internal wires.
- Do not rely on components like the keyboard or service door to push cables down internally. Always position the cables to lay properly by themselves or in the cable guides and chassis areas designed for cable routing.

---

 **CAUTION:** Always release connector latch before removing the cable. Otherwise, pulling the cable could damage the cable pins and result in a failed device.

---

## Connector types

 **IMPORTANT:** Connector pins and connector gold fingers should not be touched directly with bare hands.

There are several different types of connectors on the system board with different requirements for cable removal or insertion.

### Flex cable

When connecting flex cables to a ZIF connector, rotate the latch to 90 degrees, push the cable completely, evenly into the connector, and then close the latch.

When removing flex cables from a ZIF connector on the system board, the latch must be released before the cable can be removed. Always follow these steps:

1. Flip the connector latch 90 degrees to release the cable.
2. Grasp the cable end of the connector and pull it straight out.

 **CAUTION:** Always release connector latch before removing the cable. Otherwise, pulling the cable could damage the cable pins and result in a failed device.

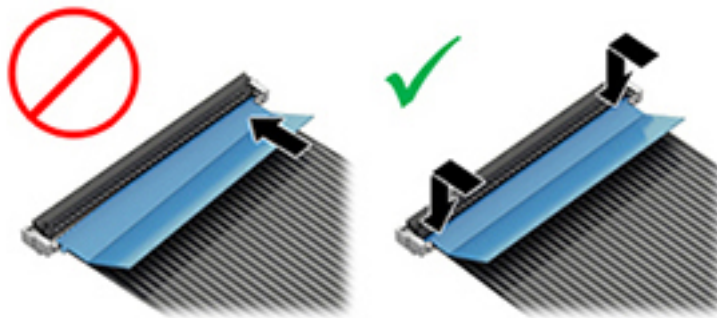

### Horizontal installation cable

Use flat tool to pull connector evenly. Do not pull on cable to remove.

Slide connector into receptacle on same horizontal plane as board and use flat tool to push evenly into receptacle.

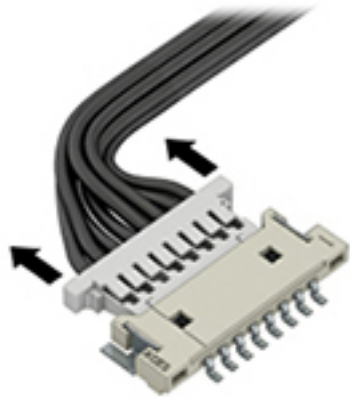

### **Multi-pin horizontal insert connector (LVDS cable to display panel)**

Insert procedure:

1. Slide connector evenly into receptacle on same horizontal plane as PCB connector.
2. Pull lock bar to insert and push both side connector horizontally to firmly lock.
3. Tape down lock bar over the panel to hold in position.

Reverse the procedure above to remove the connector:

1. Remove tape.
2. Pull up bar (pull tape) and release the lock with the PCB connector.
3. Pull to the direction in parallel with PCB to withdraw the connector.

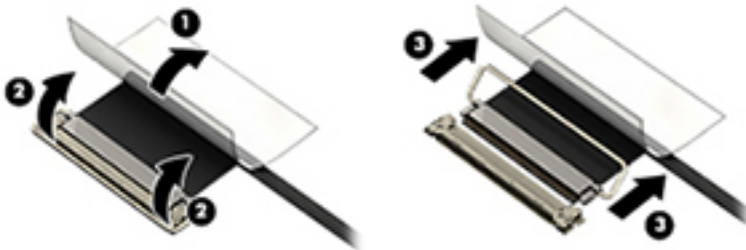

### **Multi-pin vertical insert connector (LVDS cable to system board)**

- Remove the connector gasket prior to removing the connector.
- If the connector has a plastic pull tab, use the tab to disconnect. Otherwise, use flat tool under the connector to remove evenly. Do not pull on the cable to remove.
- Press evenly when reseating/reconnecting/installing the connector.

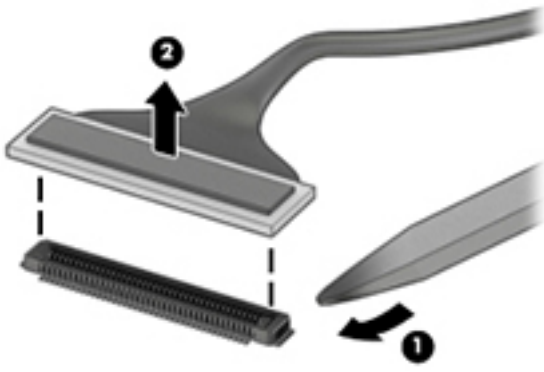

For more information about cable management, see [Cable management on page 173](#).

---

# 8 Computer Setup (BIOS), TPM, and HP Sure Start

## Using Computer Setup

Computer Setup, or Basic Input/Output System (BIOS), controls communication between all the input and output devices on the system (such as disk drives, display, keyboard, mouse, and printer). Computer Setup includes settings for the types of devices installed, the startup sequence of the computer, and the amount of system and extended memory.



**NOTE:** Use extreme care when making changes in Computer Setup. Errors can prevent the computer from operating properly.

---

## Starting Computer Setup

- ▲ Turn on or restart the computer, and when the HP logo appears, press **f10** to enter Computer Setup.

## Using a USB keyboard or USB mouse to start Computer Setup (BIOS)

You can start Computer Setup by using a keyboard or mouse connected to a USB port, but you must first disable FastBoot.

1. Turn on or restart the computer, and when the HP logo appears, press **f9** to enter the Boot Device Options menu.
2. Clear the check box for **Fast Boot**.
3. To save your changes and exit, select the **Save** icon in the lower-right corner of the screen, and then follow the on-screen instructions.

– or –

Select **Main**, select **Save Changes and Exit**, and then press **enter**.

Your changes go into effect when the computer restarts.

## Navigating and selecting in Computer Setup

- To select a menu or a menu item, use the **tab** key and the keyboard arrow keys and then press **enter**, or use a pointing device to select the item.
- To scroll up and down, select the up arrow or the down arrow in the upper-right corner of the screen, or use the up arrow key or the down arrow key on the keyboard.
- To close open dialog boxes and return to the main Computer Setup screen, press **esc**, and then follow the on-screen instructions.

To exit Computer Setup menus, choose one of the following methods:

- To exit Computer Setup menus without saving your changes:  
Select the **Exit** icon in the lower-right corner of the screen, and then follow the on-screen instructions.  
– or –  
Select **Main**, select **Ignore Changes and Exit**, and then press **enter**.
- To save your changes and exit Computer Setup menus:  
Select the **Save** icon in the lower-right corner of the screen, and then follow the on-screen instructions.  
– or –  
Select **Main**, select **Save Changes and Exit**, and then press **enter**.

Your changes go into effect when the computer restarts.

## Restoring factory settings in Computer Setup

---

 **NOTE:** Restoring defaults will not change the hard drive mode.

---

To return all settings in Computer Setup to the values that were set at the factory, follow these steps:

1. Start Computer Setup. See [Starting Computer Setup on page 177](#).
2. Select **Main**, and then select **Apply Factory Defaults and Exit**.

---

 **NOTE:** On select products, the selections may display **Restore Defaults** instead of **Apply Factory Defaults and Exit**.

---

3. Follow the on-screen instructions.
4. To save your changes and exit, select the **Save** icon in the lower-right corner of the screen, and then follow the on-screen instructions.  
– or –  
Select **Main**, select **Save Changes and Exit**, and then press **enter**.

Your changes go into effect when the computer restarts.

---

 **NOTE:** Your password settings and security settings are not changed when you restore the factory settings.

---

## Updating the BIOS

Updated versions of the BIOS may be available on the HP website.

Most BIOS updates on the HP website are packaged in compressed files called *SoftPaqs*.

Some download packages contain a file named *Readme.txt*, which contains information regarding installing and troubleshooting the file.

## Determining the BIOS version

To decide whether you need to update Computer Setup (BIOS), first determine the BIOS version on your computer.

BIOS version information (also known as *ROM date* and *System BIOS*) can be accessed by pressing **fn+esc** (if you are already in Windows) or by using Computer Setup.

1. Start Computer Setup. See [Starting Computer Setup on page 177](#).
2. Select **Main**, and then select **System Information**.
3. To exit Computer Setup without saving your changes, select the **Exit** icon in the lower-right corner of the screen, and then follow the on-screen instructions.

– or –

Select **Main**, select **Ignore Changes and Exit**, and then press [enter](#).

To check for later BIOS versions, see [Downloading a BIOS update on page 179](#).

## Downloading a BIOS update

---

 **CAUTION:** To reduce the risk of damage to the computer or an unsuccessful installation, download and install a BIOS update only when the computer is connected to reliable external power using the AC adapter. Do not download or install a BIOS update while the computer is running on battery power, docked in an optional docking device, or connected to an optional power source. During the download and installation, follow these instructions:

Do not disconnect power on the computer by unplugging the power cord from the AC outlet.

Do not shut down the computer or initiate Sleep.

Do not insert, remove, connect, or disconnect any device, cable, or cord.

---

1. Type `support` in the taskbar search box, and then select the HP Support Assistant app.  
– or –  
Select the question mark icon in the taskbar.
2. Select **Updates**, and then select **Check for updates and messages**.
3. Follow the on-screen instructions.
4. At the download area, follow these steps:
  - a. Identify the most recent BIOS update and compare it to the BIOS version currently installed on your computer. Make a note of the date, name, or other identifier. You may need this information to locate the update later, after it has been downloaded to your hard drive.
  - b. Follow the on-screen instructions to download your selection to the hard drive.  
  
Make a note of the path to the location on your hard drive where the BIOS update is downloaded. You will need to access this path when you are ready to install the update.

---

 **NOTE:** If you connect your computer to a network, consult the network administrator before installing any software updates, especially system BIOS updates.

---

BIOS installation procedures vary. Follow any instructions that are displayed on the screen after the download is complete. If no instructions are displayed, follow these steps:

1. Type `file` in the taskbar search box, and then select **File Explorer**.
2. Select your hard drive designation. The hard drive designation is typically Local Disk (C:).
3. Using the hard drive path you recorded earlier, open the folder that contains the update.
4. Double-click the file that has an `.exe` extension (for example, *filename.exe*).  
  
The BIOS installation begins.
5. Complete the installation by following the on-screen instructions.



---

**NOTE:** After a message on the screen reports a successful installation, you can delete the downloaded file from your hard drive.

---

## Changing the boot order using the f9 prompt

To dynamically choose a boot device for the current startup sequence, follow these steps:

1. Access the Boot Device Options menu:
  - Turn on or restart the computer, and when the HP logo appears, press **f9** to enter the Boot Device Options menu.
2. Select a boot device, press **enter**, and then follow the on-screen instructions.

## TPM BIOS settings (select products only)



---

**IMPORTANT:** Before enabling Trusted Platform Module (TPM) functionality on this system, you must ensure that your intended use of TPM complies with relevant local laws, regulations and policies, and approvals or licenses must be obtained if applicable. For any compliance issues arising from your operation/usage of TPM which violates the above mentioned requirement, you shall bear all the liabilities wholly and solely. HP will not be responsible for any related liabilities.

---

TPM provides additional security for your computer. You can modify the TPM settings in Computer Setup (BIOS).



---

**NOTE:** If you change the TPM setting to Hidden, TPM is not visible in the operating system.

---

To access TPM settings in Computer Setup:

1. Start Computer Setup. See [Starting Computer Setup on page 177](#).
2. Select **Security**, select **TPM Embedded Security**, and then follow the on-screen instructions.

## Using HP Sure Start (select products only)

Select computer models are configured with HP Sure Start, a technology that monitors the computer's BIOS for attacks or corruption. If the BIOS becomes corrupted or is attacked, HP Sure Start automatically restores the BIOS to its previously safe state, without user intervention.

HP Sure Start is configured and already enabled so that most users can use the HP Sure Start default configuration. The default configuration can be customized by advanced users.

To access the latest documentation on HP Sure Start, go to <http://www.hp.com/support>. Select **Find your product**, and then follow the on-screen instructions.



# 9 Backing up, restoring, and recovering

This chapter provides information about the following processes. The information in the chapter is standard procedure for most products.

- Creating recovery media and backups
- Restoring and recovering your system

For additional information, refer to the HP Support Assistant app.

▲ Type `support` in the taskbar search box, and then select the **HP Support Assistant** app.

– or –

Select the question mark icon in the taskbar.

 **IMPORTANT:** If you will be performing recovery procedures on a tablet, the tablet battery must be at least 70% charged before you start the recovery process.

**IMPORTANT:** For a tablet with a detachable keyboard, connect the tablet to the keyboard base before beginning any recovery process.

## Creating recovery media and backups

The following methods of creating recovery media and backups are available on select products only. Choose the available method according to your computer model.

- Use HP Recovery Manager to create HP Recovery media after you successfully set up the computer. This step creates a backup of the HP Recovery partition on the computer. The backup can be used to reinstall the original operating system in cases where the hard drive is corrupted or has been replaced. For information on creating recovery media, see [Using HP Recovery media \(select products only\) on page 181](#). For information on the recovery options that are available using the recovery media, see [Using Windows tools on page 182](#).
- Use Windows tools to create system restore points and create backups of personal information. See [Using Windows tools on page 182](#).

 **NOTE:** If storage is 32 GB or less, Microsoft System Restore is disabled by default.

- On select products, use the HP Cloud Recovery Download Tool to create a bootable USB flash drive for your HP recovery media. For more information, see [Using the HP Cloud Recovery Download Tool \(select products only\) on page 183](#).

## Using HP Recovery media (select products only)

If possible, check for the presence of the Recovery partition and the Windows partition. Right-click the **Start** button, select **File Explorer**, and then select **This PC**.

- If your computer does not list the Windows partition and the Recovery partition, you can obtain recovery media for your system from support. You can find contact information on the HP website. Go to <http://www.hp.com/support>, select your country or region, and follow the on-screen instructions.
- If your computer does list the Recovery partition and the Windows partition, you can use HP Recovery Manager to create recovery media after you successfully set up the computer. HP Recovery media can be

used to perform system recovery if the hard drive becomes corrupted. System recovery reinstalls the original operating system and software programs that were installed at the factory and then configures the settings for the programs. HP Recovery media can also be used to customize the system or restore the factory image if you replace the hard drive.

- Only one set of recovery media can be created. Handle these recovery tools carefully, and keep them in a safe place.
- HP Recovery Manager examines the computer and determines the required storage capacity for the media that will be required.
- To create recovery discs, your computer must have an optical drive with DVD writer capability, and you must use only high-quality blank DVD-R, DVD+R, DVD-R DL, or DVD+R DL discs. Do not use rewritable discs such as CD±RW, DVD±RW, double-layer DVD±RW, or BD-RE (rewritable Blu-ray) discs; they are not compatible with HP Recovery Manager software. Or, instead, you can use a high-quality blank USB flash drive.
- If your computer does not include an integrated optical drive with DVD writer capability, but you would like to create DVD recovery media, you can use an external optical drive (purchased separately) to create recovery discs. If you use an external optical drive, it must be connected directly to a USB port on the computer; the drive cannot be connected to a USB port on an external device, such as a USB hub. If you cannot create DVD media yourself, you can obtain recovery discs for your computer from HP. You can find contact information on the HP website. Go to <http://www.hp.com/support>, select your country or region, and follow the on-screen instructions.
- Be sure that the computer is connected to AC power before you begin creating the recovery media.
- The creation process can take an hour or more. Do not interrupt the creation process.
- If necessary, you can exit the program before you have finished creating all of the recovery DVDs. HP Recovery Manager will finish burning the current DVD. The next time you start HP Recovery Manager, you will be prompted to continue.

To create HP Recovery media using HP recovery manager:



**IMPORTANT:** For a tablet with a detachable keyboard, connect the tablet to the keyboard base before beginning these steps.

1. Type `recovery` in the taskbar search box, and then select **HP Recovery Manager**.
2. Select **Create recovery media**, and then follow the on-screen instructions.

If you ever need to recover the system, see [Recovering using HP Recovery Manager on page 183](#).

## Using Windows tools

You can create recovery media, system restore points, and backups of personal information using Windows tools.



**NOTE:** If storage is 32 GB or less, Microsoft System Restore is disabled by default.

For more information and steps, see the Get Help app.

- ▲ Select the **Start** button, and then select the **Get Help** app.



**NOTE:** You must be connected to the Internet to access the Get Help app.

## Using the HP Cloud Recovery Download Tool (select products only)

To create HP Recovery media using the HP Cloud Recovery Download Tool:

1. Go to <http://www.hp.com/support>.
2. Select **Software and Drivers**, and then follow the on-screen instructions.

## Restore and recovery

There are several options for recovering your system. Choose the method that best matches your situation and level of expertise:

 **IMPORTANT:** Not all methods are available on all products.

- Windows offers several options for restoring from backup, refreshing the computer, and resetting the computer to its original state. For more information see the Get Help app.
  - ▲ Select the **Start** button, and then select the **Get Help** app.

 **NOTE:** You must be connected to the Internet to access the Get Help app.

- If you need to correct a problem with a preinstalled application or driver, use the Reinstall drivers and/or applications option (select products only) of HP Recovery Manager to reinstall the individual application or driver.
  - ▲ Type `recovery` in the taskbar search box, select **HP Recovery Manager**, select **Reinstall drivers and/or applications**, and then follow the on-screen instructions.
- If you want to recover the Windows partition to original factory content, you can choose the System Recovery option from the HP Recovery partition (select products only) or use the HP Recovery media. For more information, see [Recovering using HP Recovery Manager on page 183](#). If you have not already created recovery media, see [Using HP Recovery media \(select products only\) on page 181](#).
- On select products, if you want to recover the computer's original factory partition and content, or if you have replaced the hard drive, you can use the Factory Reset option of HP Recovery media. For more information, see [Recovering using HP Recovery Manager on page 183](#).
- On select products, if you want to remove the Recovery partition to reclaim hard drive space, HP Recovery Manager offers the Remove Recovery Partition option.

For more information, see [Removing the HP Recovery partition \(select products only\) on page 185](#).

## Recovering using HP Recovery Manager

HP Recovery Manager software allows you to recover the computer to its original factory state by using the HP Recovery media that you either created or that you obtained from HP, or by using the HP Recovery partition (select products only). If you have not already created recovery media, see [Using HP Recovery media \(select products only\) on page 181](#).

## What you need to know before you get started

- HP Recovery Manager recovers only software that was installed at the factory. For software not provided with this computer, you must either download the software from the manufacturer's website or reinstall the software from the media provided by the manufacturer.

---

 **IMPORTANT:** Recovery through HP Recovery Manager should be used as a final attempt to correct computer issues.

---

- HP Recovery media must be used if the computer hard drive fails. If you have not already created recovery media, see [Using HP Recovery media \(select products only\) on page 181](#).
- To use the Factory Reset option (select products only), you must use HP Recovery media. If you have not already created recovery media, see [Using HP Recovery media \(select products only\) on page 181](#).
- If your computer does not allow the creation of HP Recovery media or if the HP Recovery media does not work, you can obtain recovery media for your system from support. You can find contact information from the HP website. Go to <http://www.hp.com/support>, select your country or region, and follow the on-screen instructions.

---

 **IMPORTANT:** HP Recovery Manager does not automatically provide backups of your personal data. Before beginning recovery, back up any personal data you want to retain.

---

Using HP Recovery media, you can choose from one of the following recovery options:

---

 **NOTE:** Only the options available for your computer display when you start the recovery process.

---

- System Recovery—Reinstalls the original operating system, and then configures the settings for the programs that were installed at the factory.
- Factory Reset—Restores the computer to its original factory state by deleting all information from the hard drive and re-creating the partitions. Then it reinstalls the operating system and the software that was installed at the factory.

The HP Recovery partition (select products only) allows System Recovery only.

## Using the HP Recovery partition (select products only)

The HP Recovery partition allows you to perform a system recovery without the need for recovery discs or a recovery USB flash drive. This type of recovery can be used only if the hard drive is still working.

To start HP Recovery Manager from the HP Recovery partition:

---

 **IMPORTANT:** For a tablet with a detachable keyboard, connect the tablet to the keyboard base before beginning these steps (select products only).

---

1. Type `recovery` in the taskbar search box, select **HP Recovery Manager**, and then select **Windows Recovery Environment**.

– or –

For computers or tablets with keyboards attached, press **f11** while the computer boots, or press and hold **f11** as you press the power button.

For tablets without keyboards:

- Turn on or restart the tablet, and then quickly hold down the volume up button; then select **f11**.

– or –

- Turn on or restart the tablet, and then quickly hold down the volume down button; then select **f11**.

2. Select **Troubleshoot** from the boot options menu.
3. Select **Recovery Manager**, and then follow the on-screen instructions.

## Using HP Recovery media to recover

You can use HP Recovery media to recover the original system. This method can be used if your system does not have an HP Recovery partition or if the hard drive is not working properly.

1. If possible, back up all personal files.
2. Insert the HP Recovery media, and then restart the computer.

---

 **NOTE:** If the computer does not automatically restart in HP Recovery Manager, change the computer boot order. See [Changing the computer boot order on page 185](#).

---

3. Follow the on-screen instructions.

## Changing the computer boot order

If your computer does not restart in HP Recovery Manager, you can change the computer boot order, which is the order of devices listed in BIOS where the computer looks for startup information. You can change the selection to an optical drive or a USB flash drive.

To change the boot order:

---

 **IMPORTANT:** For a tablet with a detachable keyboard, connect the tablet to the keyboard base before beginning these steps.

---

1. Insert the HP Recovery media.
2. Access the system **Startup** menu.

For computers or tablets with keyboards attached:

- ▲ Turn on or restart the computer or tablet, quickly press **esc**, and then press **f9** for boot options.

For tablets without keyboards:

- ▲ Turn on or restart the tablet, and then quickly hold down the volume up button; then select **f9**.

– or –

Turn on or restart the tablet, and then quickly hold down the volume down button; then select **f9**.

3. Select the optical drive or USB flash drive from which you want to boot.
4. Follow the on-screen instructions.

## Removing the HP Recovery partition (select products only)

HP Recovery Manager software allows you to remove the HP Recovery partition to free up hard drive space.

---

 **IMPORTANT:** After you remove the HP Recovery partition, you will not be able to perform System Recovery or create HP Recovery media from the HP Recovery partition. So before you remove the Recovery partition, create HP Recovery media; see [Using HP Recovery media \(select products only\) on page 181](#).

---

 **NOTE:** The Remove Recovery Partition option is only available on products that support this function.

---

Follow these steps to remove the HP Recovery partition:

1. Type `recovery` in the taskbar search box, and then select **HP Recovery Manager**.
2. Select **Remove Recovery Partition**, and then follow the on-screen instructions.

---

# 10 Using HP PC Hardware Diagnostics (UEFI)

HP PC Hardware Diagnostics is a Unified Extensible Firmware Interface (UEFI) that allows you to run diagnostic tests to determine whether the computer hardware is functioning properly. The tool runs outside the operating system so that it can isolate hardware failures from issues that are caused by the operating system or other software components.

When HP PC Hardware Diagnostics (UEFI) detects a failure that requires hardware replacement, a 24-digit Failure ID code is generated. This ID code can then be provided to support to help determine how to correct the problem.

---

 **NOTE:** To start diagnostics on a convertible computer, your computer must be in notebook mode and you must use the keyboard attached.

---

To start HP PC Hardware Diagnostics (UEFI), follow these steps:

1. Turn on or restart the computer, and quickly press *esc*.
2. Press *f2*.

The BIOS searches three places for the diagnostic tools, in the following order:

- a. Connected USB drive

---

 **NOTE:** To download the HP PC Hardware Diagnostics (UEFI) tool to a USB drive, see [Downloading HP PC Hardware Diagnostics \(UEFI\) to a USB device on page 186](#).

---

- b. Hard drive

- c. BIOS

3. When the diagnostic tool opens, select the type of diagnostic test you want to run, and then follow the on-screen instructions.

---

 **NOTE:** If you need to stop a diagnostic test, press *esc*.

---

## Downloading HP PC Hardware Diagnostics (UEFI) to a USB device

---

 **NOTE:** The HP PC Hardware Diagnostics (UEFI) download instructions are provided in English only, and you must use a Windows computer to download and create the HP UEFI support environment because only .exe files are offered.

---

There are two options to download HP PC Hardware Diagnostics to a USB device.

### Download the latest UEFI version

1. Go to <http://www.hp.com/go/techcenter/pcdiags>. The HP PC Diagnostics home page is displayed.
2. In the HP PC Hardware Diagnostics section, select the **Download** link, and then select **Run**.

### Download any version of UEFI for a specific product

1. Go to <http://www.hp.com/support>.
2. Select **Get software and drivers**.

3. Enter the product name or number.

– or –

Select **Identify now** to let HP automatically detect your product.

4. Select your computer, and then select your operating system.
5. In the **Diagnostic** section, follow the on-screen instructions to select and download the UEFI version you want.

#### **Additional BIOS crisis recovery tool**

HP provides a BIOS crisis recovery tool through the HP PC Hardware Diagnostics 3-in-1 USB key. This tool can be used by HP authorized service providers to recover systems that have failed due to a corrupted BIOS. For more information about using the 3-in-1 USB key for BIOS crisis recovery, go to <http://www.hp.com/go/techcenter/pcdiags>. Additional information is included in the web-based training offered by HP University. See the modules that cover HP PC Hardware Diagnostics (UEFI).

# 11 Specifications

## Computer specifications

	Metric	U.S.
<b>Dimensions</b>		
Depth	288.4 mm	11.35 in
Width	416 mm	16.4 in
Height (non-touch)	33.5 mm	1.3 in
Height (touch)	33.8 mm	1.3 in
<b>Weight</b>		
	3.2 kg to 3.4 kg	7.04 lbs to 7.48 lbs
<b>Input power</b>		
Operating voltage	19.5 V dc @ 10.3 A – 200 W	
Operating current	10.3 A	
<b>Temperature</b>		
Operating (not writing to optical disc)	0°C to 35°C	32°F to 95°F
Operating (writing to optical disc)	5°C to 35°C	41°F to 95°F
Nonoperating	-20°C to 60°C	-4°F to 140°F
<b>Relative humidity</b>		
Operating	10% to 90%	
Nonoperating	5% to 95%	
<b>Maximum altitude (unpressurized)</b>		
Operating (14.7 to 10.1 psia)	-15 m to 3,048 m	50 ft to 10,000 ft
Nonoperating (14.7 to 4.4 psia)	-15 m to 12,192 m	-50 ft to 40,000 ft
<b>Shock</b>		
Operating	125 g, 2 ms, half-sine	
Nonoperating	200 g, 2 ms, half-sine	
<b>Random vibration</b>		
Operating	0.75 g zero-to-peak, 10 Hz to 500 Hz, 0.25 oct/min sweep rate	
Nonoperating	1.50 g zero-to-peak, 10 Hz to 500 Hz, 0.5 oct/min sweep rate	
<b>NOTE:</b> Applicable product safety standards specify thermal limits for plastic surfaces. The computer operates well within this range of temperatures.		



## 43. 94 cm (17.3 in) display specifications

	<b>Metric</b>	<b>U.S.</b>
Active diagonal size	43. 94 cm	17.3 in
Resolution	HD: 1600 x 900 FHD: 1920 x 1080 UHD: 3840×2160	
Surface treatment	Anti-glare (except touch screen)	
Brightness	FHD (45% CG): 220 nits FHD (72% CG): 300 nits UHD: (95% CG) 400 nits	
Viewing angle	UWVA	
Backlight	LED	
Aspect ratio	16:9	
Display panel interface	eDP (220 nit) eDP+PSR (400 nit)	

# 12 Power cord set requirements

The wide-range input feature of the computer permits it to operate from any line voltage from 100 to 120 volts AC, or from 220 to 240 volts AC.

The 3-conductor power cord set included with the computer meets the requirements for use in the country or region where the equipment is purchased.

Power cord sets for use in other countries and regions must meet the requirements of the country or region where the computer is used.

## Requirements for all countries

The following requirements are applicable to all countries and regions:

- The length of the power cord set must be at least **1.0 m** (3.3 ft) and no more than **2.0 m** (6.5 ft).
- All power cord sets must be approved by an acceptable accredited agency responsible for evaluation in the country or region where the power cord set will be used.
- The power cord sets must have a minimum current capacity of 10 amps and a nominal voltage rating of 125 or 250 V AC, as required by the power system of each country or region.
- The appliance coupler must meet the mechanical configuration of an EN 60 320/IEC 320 Standard Sheet C13 connector for mating with the appliance inlet on the back of the computer.

## Requirements for specific countries and regions

Country/region	Accredited agency	Applicable note number
Australia	EANSW	1
Austria	OVE	1
Belgium	CEBC	1
Canada	CSA	2
Denmark	DEMKO	1
Finland	FIMKO	1
France	UTE	1
Germany	VDE	1
Italy	IMQ	1
Japan	METI	3
The Netherlands	KEMA	1
Norway	NEMKO	1
The People's Republic of China	COC	5
South Korea	EK	4

Country/region	Accredited agency	Applicable note number
Sweden	SEMKO	1
Switzerland	SEV	1
Taiwan	BSMI	4
The United Kingdom	BSI	1
The United States	UL	2

1. The flexible cord must be Type H05VV-F, 3-conductor, 1.0-mm<sup>2</sup> conductor size. Power cord set fittings (appliance coupler and wall plug) must bear the certification mark of the agency responsible for evaluation in the country or region where it will be used.
2. The flexible cord must be Type SPT-3 or equivalent, No. 18 AWG, 3-conductor. The wall plug must be a two-pole grounding type with a NEMA 5-15P (15 A, 125 V) or NEMA 6-15P (15 A, 250 V) configuration.
3. The appliance coupler, flexible cord, and wall plug must bear a “T” mark and registration number in accordance with the Japanese Dentori Law. The flexible cord must be Type VCT or VCTF, 3-conductor, 1.00-mm<sup>2</sup> conductor size. The wall plug must be a two-pole grounding type with a Japanese Industrial Standard C8303 (7 A, 125 V) configuration.
4. The flexible cord must be Type RVV, 3-conductor, 0.75-mm<sup>2</sup> conductor size. Power cord set fittings (appliance coupler and wall plug) must bear the certification mark of the agency responsible for evaluation in the country or region where it will be used.
5. The flexible cord must be Type VCTF, 3-conductor, 0.75-mm<sup>2</sup> conductor size. Power cord set fittings (appliance coupler and wall plug) must bear the certification mark of the agency responsible for evaluation in the country or region where it will be used.

# 13 Statement of memory volatility

The purpose of this chapter is to provide general information regarding nonvolatile memory in HP Business computers. This chapter also provides general instructions for restoring nonvolatile memory that can contain personal data after the system has been powered off and the hard drive has been removed.

HP Business computer products that use Intel®-based or AMD®-based system boards contain volatile DDR memory. The amount of nonvolatile memory present in the system depends upon the system configuration. Intel-based and AMD-based system boards contain nonvolatile memory subcomponents as originally shipped from HP, assuming that no subsequent modifications have been made to the system and assuming that no applications, features, or functionality have been added to or installed on the system.

Following system shutdown and removal of all power sources from an HP Business computer system, personal data can remain on volatile system memory (DIMMs) for a finite period of time and will also remain in nonvolatile memory. Use the steps below to remove personal data from the computer, including the nonvolatile memory found in Intel-based and AMD-based system boards.

---

 **NOTE:** If your tablet has a keyboard base, connect to the keyboard base before beginning steps in this chapter.

---

## Current BIOS steps

1. Follow steps (a) through (l) below to restore the nonvolatile memory that can contain personal data. Restoring or reprogramming nonvolatile memory that does not store personal data is neither necessary nor recommended.
  - a. Turn on or restart the computer, and then press **esc** while the “Press the ESC key for Startup Menu” message is displayed at the bottom of the screen.

---

 **NOTE:** If the system has a BIOS administrator password, enter the password at the prompt.

---

- b. Select **Main**, select **Apply Factory Defaults and Exit**, and then select **Yes** to load defaults.  
The computer will reboot.
  - c. During the reboot, press **esc** while the “Press the ESC key for Startup Menu” message is displayed at the bottom of the screen.

---

 **NOTE:** If the system has a BIOS administrator password, enter the password at the prompt.

---

- d. Select the **Security** menu, select **Restore Security Settings to Factory Defaults**, and then select **Yes** to restore security level defaults.  
The computer will reboot.
  - e. During the reboot, press **esc** while the “Press the ESC key for Startup Menu” message is displayed at the bottom of the screen.

---

 **NOTE:** If the system has a BIOS administrator password, enter the password at the prompt.

---

- f. If an asset or ownership tag is set, select the **Security** menu and scroll down to the **Utilities** menu. Select **System IDs**, and then select **Asset Tracking Number**. Clear the tag, and then make the selection to return to the prior menu.

- g.** If a DriveLock password is set, select the **Security** menu, and scroll down to **Hard Drive Utilities** under the **Utilities** menu. Select **Hard Drive Utilities**, select **DriveLock**, then uncheck the checkbox for **DriveLock password on restart**. Select **OK** to proceed.
  - h.** Select the **Main** menu, and then select **Reset BIOS Security to factory default**. Click **Yes** at the warning message.

The computer will reboot.
  - i.** During the reboot, press **esc** while the “Press the ESC key for Startup Menu” message is displayed at the bottom of the screen.
- 
-  **NOTE:** If the system has a BIOS administrator password, enter the password at the prompt.
- 
- j.** Select the **Main** menu, select **Apply Factory Defaults and Exit**, select **Yes** to save changes and exit, and then select **Shutdown**.
  - k.** Reboot the system. If the system has a Trusted Platform Module (TPM) and/or fingerprint reader, one or two prompts will appear—one to clear the TPM and the other to Reset Fingerprint Sensor; press or tap **F1** to accept or **F2** to reject.
  - l.** Remove all power and system batteries for at least 24 hours.
- 2.** Complete one of the following:
- Remove and retain the storage drive.
  - or –
  - Clear the drive contents by using a third party utility designed to erase data from an SSD.
  - or –
  - Clear the contents of the drive by using the following BIOS Setup Secure Erase command option steps:

---

 **IMPORTANT:** If you clear data using Secure Erase, it cannot be recovered.

---

- a.** Turn on or restart the computer, and then press **esc** while the “Press the ESC key for Startup Menu” message is displayed at the bottom of the screen.
- b.** Select the **Security** menu and scroll down to the **Utilities** menu.
- c.** Select **Hard Drive Utilities**.
- d.** Under **Utilities**, select **Secure Erase**, select the hard drive storing the data you want to clear, and then follow the on-screen instructions to continue.

## Nonvolatile memory usage

Nonvolatile Memory Type	Amount (Size)	Does this memory store customer data?	Does this memory retain data when power is removed?	What is the purpose of this memory?	How is data input into this memory?	How is this memory write-protected?
HP Sure Start flash (select models only)	8 MBytes	No	Yes	Provides protected backup of critical System BIOS code, EC firmware, and critical computer configuration data for select platforms that support HP Sure Start.  For more information, see <a href="#">Using HP Sure Start (select models only) on page 197</a> .	Data cannot be written to this device via the host processor. The content is managed solely by the HP Sure Start Embedded Controller.	This memory is protected by the HP Sure Start Embedded Controller.
Real Time Clock (RTC) battery backed-up CMOS configuration memory	256 Bytes	No	Yes	Stores system date and time and noncritical data.	RTC battery backed-up CMOS is programmed using the Computer Setup (BIOS), or changing the Microsoft Windows date & time.	This memory is not write-protected.
Controller (NIC) EEPROM	64 KBytes (not customer accessible)	No	Yes	Stores NIC configuration and NIC firmware.	NIC EEPROM is programmed using a utility from the NIC vendor that can be run from DOS.	A utility is required to write data to this memory and is available from the NIC vendor. Writing data to this ROM in an inappropriate manner will render the NIC non-functional.
DIMM Serial Presence Detect (SPD) configuration data	256 Bytes per memory module, 128 Bytes programmable (not customer accessible)	No	Yes	Stores memory module information.	DIMM SPD is programmed by the memory vendor.	Data cannot be written to this memory when the module is installed in a computer. The specific write-protection method varies by memory vendor.
System BIOS	9 MBytes	Yes	Yes	Stores system BIOS code and computer configuration data.	System BIOS code is programmed at the factory. Code is updated when the system BIOS is updated. Configuration data and settings are input using the Computer Setup (BIOS) or a custom utility.	<b>NOTE:</b> Writing data to this ROM in an inappropriate manner can render the computer non-functional.  A utility is required for writing data to this memory and is available on the HP website; go to <a href="http://www.hp.com/support">http://www.hp.com/support</a> . Select <b>Find your</b>

Nonvolatile Memory Type	Amount (Size)	Does this memory store customer data?	Does this memory retain data when power is removed?	What is the purpose of this memory?	How is data input into this memory?	How is this memory write-protected?
Intel Management Engine Firmware (present only in select Elite or Z models. For more information, go to <a href="http://www.hp.com/support">http://www.hp.com/support</a> . Select <b>Find your product</b> , and then follow the on-screen instructions.)	1.5 MBytes or 7 MBytes	Yes	Yes	Stores Management Engine Code, Settings, Provisioning Data and iAMT third-party data store.	Management Engine Code is programmed at the factory. Code is updated via Intel secure firmware update utility. Unique Provisioning Data can be entered at the factory or by an administrator using the Management Engine (MEBx) setup utility. The third party data store contents can be populated by a remote management console or local applications that have been registered by an administrator to have access to the space.	<b>product</b> , and then follow the on-screen instructions.  The Intel chipset is configured to enforce hardware protection to block all direct read/write access to this area. An Intel utility is required for updating the firmware. Only firmware updates digitally signed by Intel can be applied using this utility.
Bluetooth flash (select products only)	2 Mbit	No	Yes	Stores Bluetooth configuration and firmware.	Bluetooth flash is programmed at the factory. Tools for writing data to this memory are not publicly available but can be obtained from the silicon vendor.	A utility is required for writing data to this memory and is made available through newer versions of the driver whenever the flash requires an upgrade.
802.11 WLAN EEPROM	4 Kbit to 8 Kbit	No	Yes	Stores configuration and calibration data.	802.11 WLAN EEPROM is programmed at the factory. Tools for writing data to this memory are not made public.	A utility is required for writing data to this memory and is typically not made available to the public unless a firmware upgrade is necessary to address a unique issue.
Webcam (select products only)	64 Kbit	No	Yes	Stores webcam configuration and firmware.	Webcam memory is programmed using a utility from the device manufacturer that can be run from Windows.	A utility is required for writing data to this memory and is typically not made available to the public unless a firmware upgrade is necessary to address a unique issue.
Fingerprint reader (select products only)	512 KByte flash	Yes	Yes	Stores fingerprint templates.	Fingerprint reader memory is programmed by user enrollment in HP ProtectTools Security Manager.	Only a digitally signed application can make the call to write to the flash.

## Questions and answers

### 1. How can the BIOS settings be restored (returned to factory settings)?



**IMPORTANT:** Restore defaults does not securely erase any data on your hard drive. See question and answer 6 for steps to securely erase data.

Restore defaults does not reset the Custom Secure Boot keys. See question and answer 7 for information about resetting the keys.

- a. Turn on or restart the computer, and then press **esc** while the “Press the ESC key for Startup Menu” message is displayed at the bottom of the screen.
- b. Select **Main**, and then select **Apply Factory Defaults and Exit**.
- c. Follow the on-screen instructions.
- d. Select **Main**, select **Save Changes and Exit**, and then follow the on-screen instructions.

### 2. What is a UEFI BIOS, and how is it different from a legacy BIOS?

The Unified Extensible Firmware Interface (UEFI) BIOS is an industry-standard software interface between the platform firmware and an operating system (OS). It is a replacement for the older BIOS architecture, but supports much of the legacy BIOS functionality.

Like the legacy BIOS, the UEFI BIOS provides an interface to display the system information and configuration settings and to change the configuration of your computer before an OS is loaded. BIOS provides a secure run-time environment that supports a Graphic User Interface (GUI). In this environment, you can use either a pointing device (Touchscreen, TouchPad, pointing stick, or USB mouse) or the keyboard to navigate and make menu and configuration selections. The UEFI BIOS also contains basic system diagnostics.

The UEFI BIOS provides functionality beyond that of the legacy BIOS. In addition, the UEFI BIOS works to initialize the computer’s hardware before loading and executing the OS; the run-time environment allows the loading and execution of software programs from storage devices to provide more functionality, such as advanced hardware diagnostics (with the ability to display more detailed system information) and advanced firmware management and recovery software.

HP has provided options in Computer Setup (BIOS) to allow you to run in legacy BIOS, if required by the operating system. Examples of this requirement would be if you upgrade or downgrade the OS.

### 3. Where does the UEFI BIOS reside?

The UEFI BIOS resides on a flash memory chip. A utility is required to write to the chip.

### 4. What kind of configuration data is stored on the DIMM Serial Presence Detect (SPD) memory module? How would this data be written?

The DIMM SPD memory contains information about the memory module, such as size, serial number, data width, speed/timing, voltage, and thermal information. This information is written by the module manufacturer and stored on an EEPROM. This EEPROM cannot be written to when the memory module is installed in a computer. Third-party tools do exist that can write to the EEPROM when the memory module is not installed in a computer. Various third-party tools are available to read SPD memory.

### 5. What is meant by “Restore the nonvolatile memory found in Intel-based system boards”?

This message relates to clearing the Real Time Clock (RTC) CMOS memory that contains computer configuration data.

### 6. How can the BIOS security be reset to factory defaults and data erased?



---

 **IMPORTANT:** Resetting will result in the loss of information.

These steps will not reset Custom Secure Boot Keys. See question and answer 7 for information about resetting the keys.

---

- a. Turn on or restart the computer, and then press **esc** while the “Press the ESC key for Startup Menu” message is displayed at the bottom of the screen.
- b. Select **Main**, and then select **Reset Security to Factory Defaults**.
- c. Follow the on-screen instructions.
- d. Select **Main**, select **Save Changes and Exit**, and then follow the on-screen instructions.

#### 7. How can the Custom Secure Boot Keys be reset?

Secure Boot is a feature to ensure that only authenticated code can start on a platform. If you enabled Secure Boot and created Custom Secure Boot Keys, simply disabling Secure Boot will not clear the keys. You must also select to clear the Custom Secure Boot Keys. Use the same Secure Boot access procedure you used to create the Custom Secure Boot Keys, but make the selection to clear or delete all Secure Boot Keys.

- a. Turn on or restart the computer, and then press **esc** while the “Press the ESC key for Startup Menu” message is displayed at the bottom of the screen.
- b. Select the **Security** menu, select **Secure Boot Configuration**, and then follow the on-screen instructions.
- c. At the **Secure Boot Configuration** window, select **Secure Boot**, select **Clear Secure Boot Keys**, and then follow the on-screen instructions to continue.

## Using HP Sure Start (select models only)

Select computer models are configured with HP Sure Start, a technology that continuously monitors your computer's BIOS for attacks or corruption. If the BIOS becomes corrupted or is attacked, HP Sure Start restores the BIOS to its previously safe state, without user intervention. Those select computer models ship with HP Sure Start configured and enabled. HP Sure Start is configured and already enabled so that most users can use the HP Sure Start default configuration. The default configuration can be customized by advanced users.

To access the latest documentation on HP Sure Start, go to <http://www.hp.com/support>. Select **Find your product**, and then follow the on-screen instructions.

---

# 14 Recycling

When a non-rechargeable or rechargeable battery has reached the end of its useful life, do not dispose of the battery in general household waste. Follow the local laws and regulations in your area for battery disposal.

HP encourages customers to recycle used electronic hardware, HP original print cartridges, and rechargeable batteries. For more information about recycling programs, see the HP Web site at <http://www.hp.com/recycle>.

# Index

## Symbols/Numerics

`product description  
ethernet 5

## A

AC adapter, spare part numbers 35

action keys 20  
  identifying 20  
  keyboard backlight 20  
  mute 20  
  next 20  
  pause 20  
  play 20  
  privacy screen 20  
  screen brightness 20  
  speaker volume 20  
  stop 20  
  switch screen image 21  
  using 20  
  wireless 21

antennas  
  disconnecting 54

audio  
  adjusting volume 20  
audio, product description 4  
audio-out (headphone)/audio-in  
(microphone) combo jack,  
  identifying 10

## B

backups 181  
battery  
  removal 43  
  spare part number 43  
  spare part numbers 30, 43  
battery light 11  
bezel  
  spare part number 33  
BIOS  
  determining version 178  
  downloading an update 179  
  updating 178  
Bluetooth label 27

boot order  
  changing 185  
  changing using the f9 prompt  
  180

bottom 27  
buttons  
  center pointing stick 14  
  left TouchPad 14  
  optical drive eject 10  
  power 18  
  right TouchPad 14

## C

call answer light 16  
call end light 17  
camera 13  
  identifying 13  
camera light, identifying 13  
camera module  
  removal 92  
  spare part number 34  
caps lock light, identifying 16  
chipset, product description 1  
components  
  bottom 23  
  display 13  
  front 24  
  keyboard area 14  
  left side 12  
  rear 25  
  right side 10  
computer major components 28  
Computer Setup  
  navigating and selecting 177  
  restoring factory settings 178  
  using a USB keyboard or USB  
  mouse to start Computer  
  Setup 177  
computer setup 177  
computer specifications 188  
connector, power 10, 11

## D

display assembly  
  removal 89, 91

  spare part numbers 89, 91  
  subcomponents 33  
display bezel  
  removal 92  
display components 13  
display enclosure  
  spare part number 34  
display hinge  
  removal 94  
display panel  
  product description 2  
display specifications 189  
docking  
  product description 6  
Dual-Mode DisplayPort, identifying  
  10

## E

esc key, identifying 19  
ethernet  
  product description 5  
external card expansion  
  product description 5

## F

fan  
  removal 70  
  spare part number 70  
fans  
  spare part number 32, 70  
fingerprint reader  
  spare part number 30  
fingerprint reader assembly  
  removal 63  
  spare part number 63  
fingerprint reader, identifying 18  
fixed optical drive  
  product description 4  
flash cache  
  product description 4  
fn key, identifying 19  
fn lock light, identifying 16

- G**
  - graphics card
    - spare part number 31
  - graphics, product description 1
- H**
  - hardware, locating 9
  - HDD
    - removal 44
    - spare part number 30
    - spare part numbers 44
  - HDD bracket
    - spare part number 30, 44
  - HDD connector
    - spare part number 30, 44
  - HDD storage board
    - spare part number 30
  - HDMI port, identifying 10
  - heat sink
    - removal 74
    - spare part number 32, 74
  - hinge
    - removal 94
  - hot keys
    - microphone mute 20
  - hotkeys, using 22
  - HP HDMI to DVI adapter, spare part numbers 35
  - HP PC Hardware Diagnostics (UEFI) using 186
  - HP Recovery Manager
    - correcting boot problems 185
    - starting 184
  - HP Recovery media
    - recovery 185
    - using 181
  - HP Recovery partition
    - recovery 184
    - removing 185
  - HP Sure Start 197
  - HP USB-C to HDMI adapter, spare part numbers 35
  - HP USB-C to VGA adapter, spare part numbers 35
  - HP ZBook Thunderbolt 3 1 m cable, spare part numbers 35
- I**
  - integrated numeric keypad, identifying 19
- internal microphones, identifying 13, 24
- J**
  - jacks
    - audio-out (headphone)/audio-in (microphone) combo 10
    - network 12
    - RJ-45 (network) 12
- K**
  - keyboard
    - product description 6
    - removal 56
    - spare part number 30, 56
  - keyboard backlight
    - action key 20
  - keypad
    - integrated numeric 19
  - keys
    - action 20
    - esc 19
    - fn 19
    - num lock 19
    - Windows 19
- L**
  - labels
    - Bluetooth 27
    - regulatory 27
    - serial number 26
    - service 26
    - wireless certification 27
    - WLAN 27
  - latches
    - service door release 23
  - left side components 12
  - lights
    - AC adapter and battery 11
    - battery 11
    - call answer 16
    - call end 17
    - camera 13
    - caps lock 16
    - fn lock 16
    - microphone mute 16
    - num lock 17
    - power 16
    - RJ-45 (network) 12
    - sharing or presenting 16
    - wireless 16
- M**
  - memory
    - nonvolatile 192
    - product description 2
    - volatile 192
  - memory card reader, identifying 12
  - memory module
    - removal 51, 86
    - spare part number 31
    - spare part numbers 51, 86
  - microphone
    - product description 4
  - microphone module
    - spare part number 34
  - microphone mute key, identifying 20
  - microphone mute light, identifying 16
  - middle cover
    - removal 61
    - spare part number 31, 61
    - spare part numbers 61
  - minimized image recovery 184
  - minimized image, creating 183
  - model name 1
  - mute volume action key 20
  - MXM discrete graphics card
    - removal 77
    - spare part number 77
- N**
  - network jack, identifying 12
  - next track action key 20
  - NFC antenna
    - spare part number 30
  - NFC module
    - removal 67
    - spare part number 67
    - spare part numbers 30
  - NFC tapping area, identifying 14
  - nonvolatile memory 192
  - num lock light 17
- O**
  - ODD
    - removal 48
    - spare part number 30, 48
  - operating system, product description 6

- optical drive eject button, identifying 10
- optical drive, identifying 10
- original system recovery 183
- P**
- pause action key 20
- play action key 20
- pointing device, product description 6
- pointing stick, identifying 14
- ports
  - Dual-Mode DisplayPort 10
  - HDMI 10
  - product description 5
  - USB SuperSpeed 12
  - USB SuperSpeed port with HP Sleep and Charge 12
  - USB Type-C power connector and Thunderbolt port with HP Sleep and Charge 10
- power button board
  - removal 81
  - spare part number 30, 81
- power button, identifying 18
- power connector
  - identifying 11
  - identifying USB Type-C 10
- power cord
  - set requirements 190
- power lights 16
- power requirements, product description 6
- primary SATA storage
  - product description 4
- primary storage
  - product description 3
- privacy screen action key, identifying 20
- processors, product description 1
- product description
  - audio 4
  - chipset 1
  - display panel 2
  - docking 6
  - external card expansion 5
  - fixed optical drive 4
  - flash cache 4
  - graphics 1
  - keyboard 6
  - memory 2
  - microphone 4
  - operating system 6
  - pointing device 6
  - ports 5
  - power requirements 6
  - primary SATA storage 4
  - primary storage 3
  - processors 1
  - product name 1
  - secondary storage 3
  - security 6
  - serviceability 7
  - third storage 3
  - video 4
  - wireless networking 5
- product name 1
- product name and number, computer 26
- R**
- raw panel
  - spare part number 33
- recover
  - options 183
- recovery
  - discs 182, 185
  - HP Recovery Manager 183
  - media 185
  - starting 184
  - supported discs 182
  - system 183
  - USB flash drive 185
  - using HP Recovery media 182
- recovery media
  - creating using HP Recovery Manager 182
  - using 181
- recovery partition
  - removing 185
- regulatory information
  - regulatory label 27
  - wireless certification labels 27
- removal/replacement
  - procedures 41, 60
- removing personal data from volatile system memory 192
- right side components 10
- RJ-45 (network) jack, identifying 12
- RJ-45 (network) lights, identifying 12
- RTC battery
  - removal 83
  - spare part number 32, 83
- S**
- screen brightness action keys 20
- screw kit, spare part number 35
- secondary storage
  - product description 3
- security cable slot, identifying 12
- security, product description 6
- sensor
  - DreamColor 14
- serial number, computer 26
- service door
  - removing 41
- service door release latch 23
- service doorr
  - spare part number 41
- service dover
  - spare part number 32
- service labels, locating 26
- serviceability, product description 7
- setup utility
  - navigating and selecting 177
  - restoring factory settings 178
- sharing or presenting light, identifying 16
- SIM card
  - removal 53
  - spare part numbers 53
- slots
  - security cable 12
  - smart card 12
- smart card board
  - removal 65
  - spare part number 30, 65
- smart card slot, identifying 12
- software installed, locating 9
- solid-state drive
  - removal 46, 84
  - spare part numbers 46, 84
- speaker
  - removal 79
  - spare part number 31, 79
- speaker volume action keys 20
- speakers, identifying 18
- special keys, using 19

- specifications
  - computer 188
  - display 189
- SSD
  - spare part numbers 30, 46, 84
- SSD storage board
  - spare part number 30
- stop action key 20
- supported discs, recovery 182
- Sure Start
  - using 180
- switch screen image action key 21
- system board
  - removal 72
  - spare part number 31
  - spare part numbers 72
- system memory, removing personal data from volatile 192
- system recovery 183
- system restore point
  - creating 182
- system restore point, creating 181

## T

- third storage
  - product description 3
- Thunderbolt port with HP Sleep and Charge
  - identifying USB Type-C 10
- top cover
  - removal 99
  - spare part number 30, 99
- TouchPad
  - buttons 14
  - removing 68
  - spare part number 30, 68
- TouchPad buttons
  - identifying 14
- TouchPad click board
  - illustrated 68
  - removing 68
  - spare part number 68
- TouchPad click board cable
  - illustrated 68
- TouchPad zone
  - identifying 14
- TPM settings 180
- traveling with the computer 27

## U

- USB SuperSpeed port with HP Sleep and Charge, identifying 12
- USB SuperSpeed port, identifying 12
- USB to Gigabit RJ45 adapter, spare part numbers 35
- USB Type-C power connector and Thunderbolt port with HP Sleep and Charge, identifying 10
- USB-C to DisplayPort adapter, spare part numbers 35

## V

- vent, identifying 23
- vents, identifying 25
- video
  - Dual-Mode DisplayPort 10
- video, product description 4
- volume
  - adjusting 20
  - mute 20

## W

- webcam cover
  - spare part number 33
- Windows
  - system restore point 181, 182
- Windows key, identifying 19
- Windows tools
  - using 182
- wireless action key 21
- wireless antennas
  - disconnecting 54
- wireless antennas, identifying 13
- wireless certification label 27
- wireless light, identifying 16
- wireless networking
  - product description 5
- WLAN antenna
  - spare part number 34
- WLAN antennas, identifying 13
- WLAN device 27
- WLAN label 27
- WWAN antenna
  - spare part number 34
- WWAN antennas, identifying 13
- WWAN module
  - removal 54
  - spare part number 31, 54