



Film capacitors

Metallized polypropylene film capacitors (MKP)

Series/Type: **B32656S, B32658S**

Date: December 2021

Snubber (wound)**Typical applications**

- IGBT
- Snubbing

Climatic

- Max. operating temperature: 110 °C
- Climatic category (IEC 60068-1:2013): 55/100/56

Construction

- Dielectric: polypropylene (PP)
- Wound capacitor technology with internal series connection
- Plastic case (UL 94 V-0)
- Epoxy resin sealing (UL 94 V-0)

Features

- High pulse strength and high contact reliability
- Very low inductance
- RoHS-compatible
- AEC-Q200D on request

Terminals

- Strap terminals, tinned copper or brass
(max. torque 10 Nm)

Marking

Manufacturer's logo, ordering code, style (MKP)
rated capacitance (coded), cap. tolerance (code letter),
rated DC voltage, date of manufacture (coded)

Delivery mode

- Bulk (untaped)

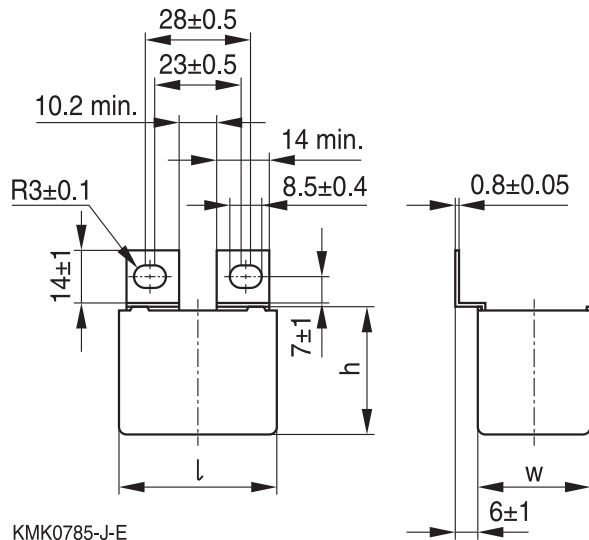
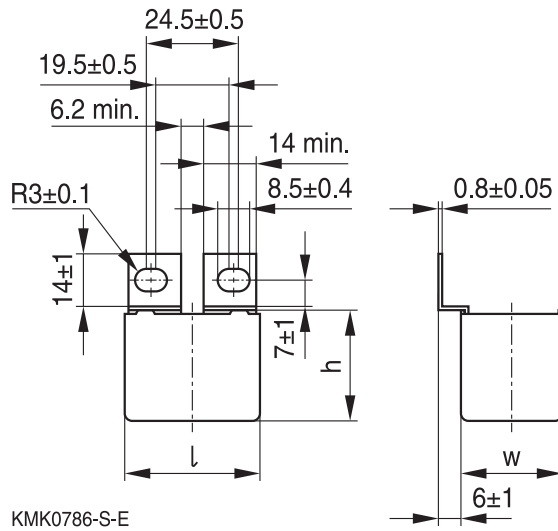
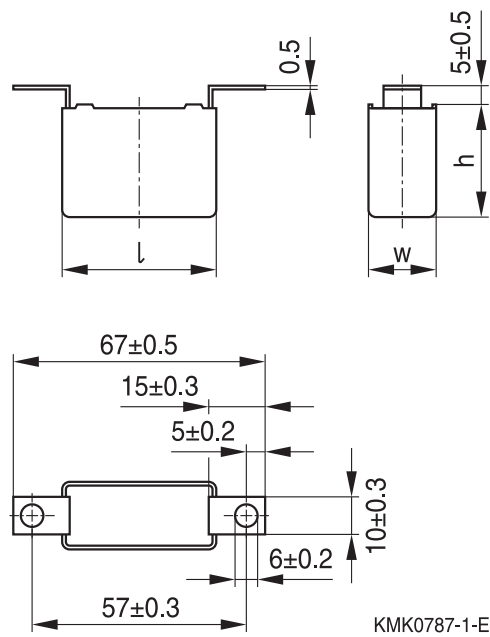
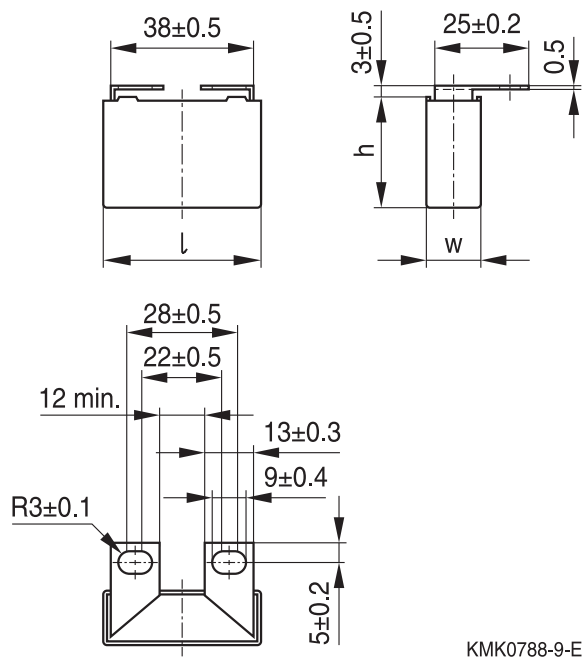
Dimensional drawings
T1 (code no. 561)

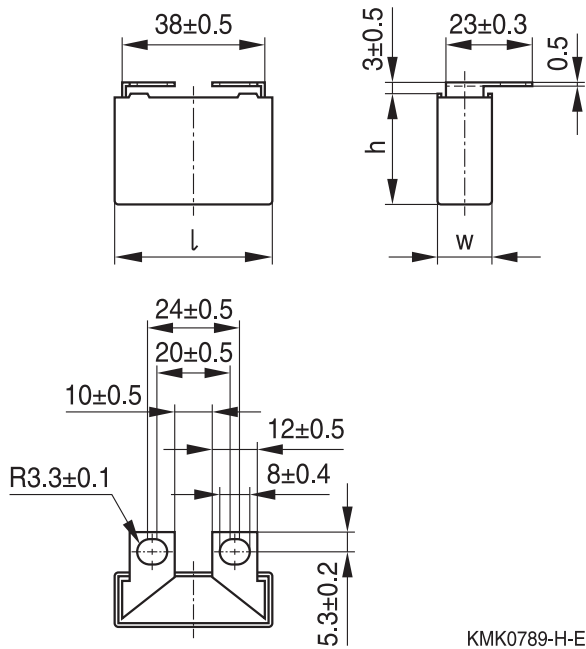
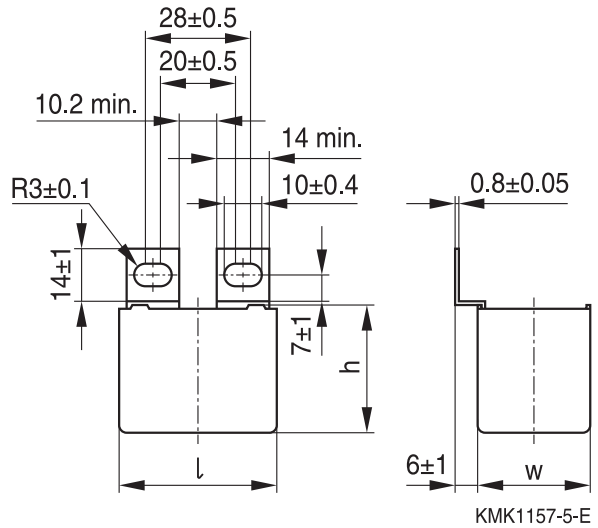
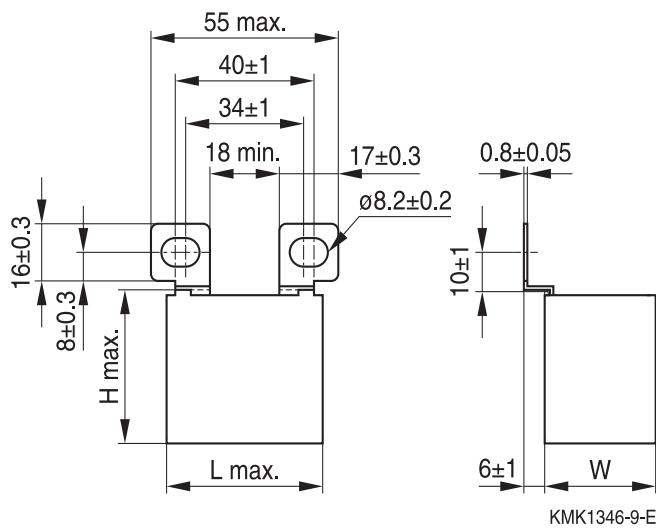
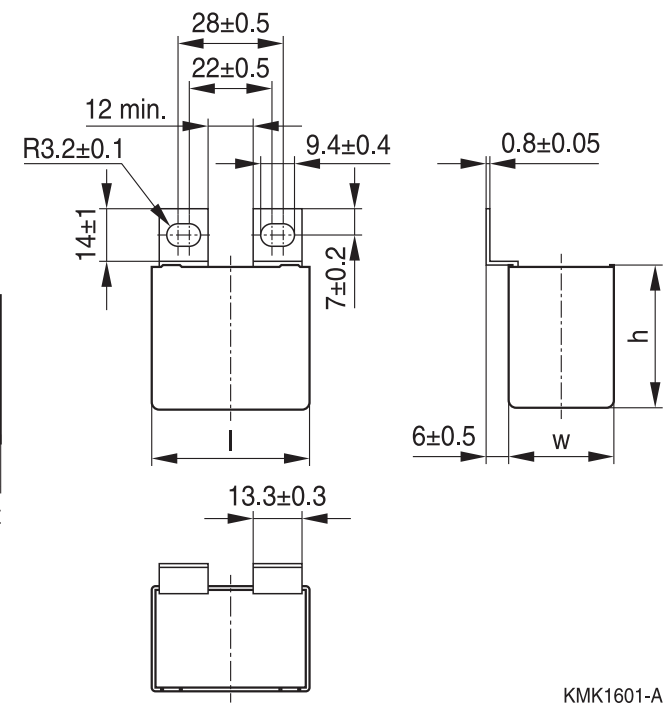
T2 (code no. 562)

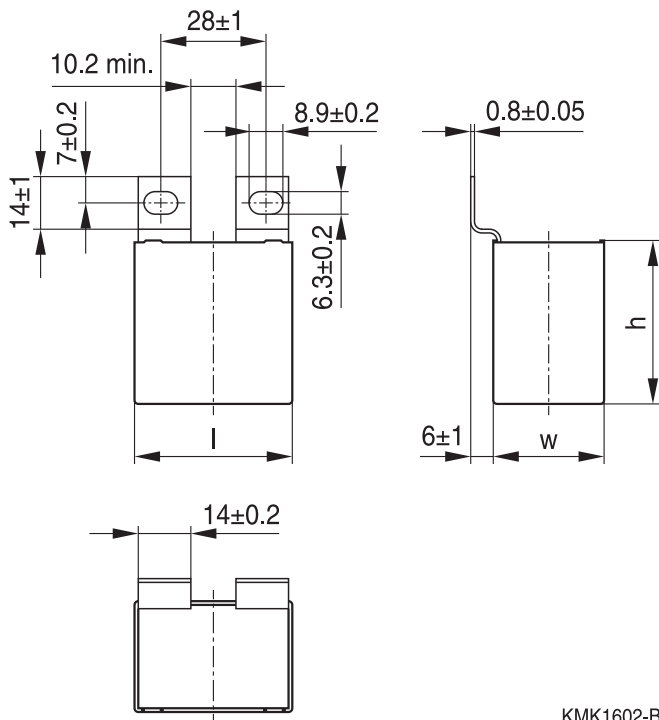
T3 (code no. 563)

T4 (code no. 564)

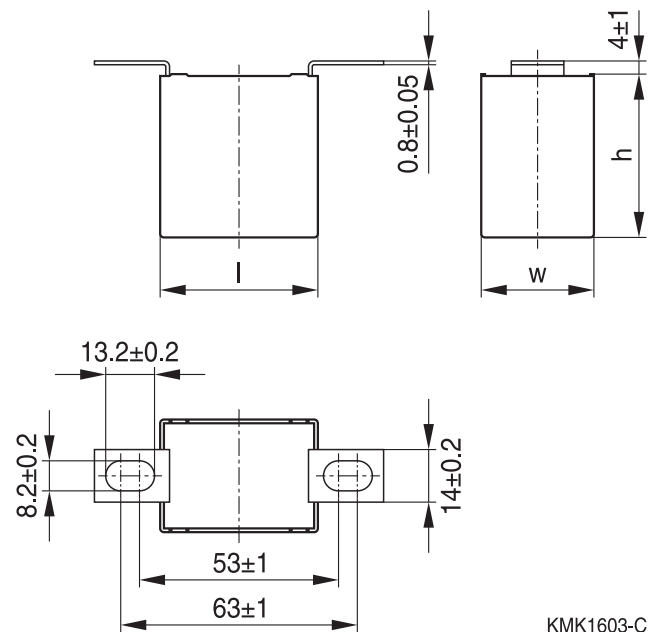
Dimensional drawings
T5 (code no. 565)

T6 (code no. 566)

T7 (code no. 577)

T8 (code no. 408)

Dimensional drawings
T9 (code no. 409)

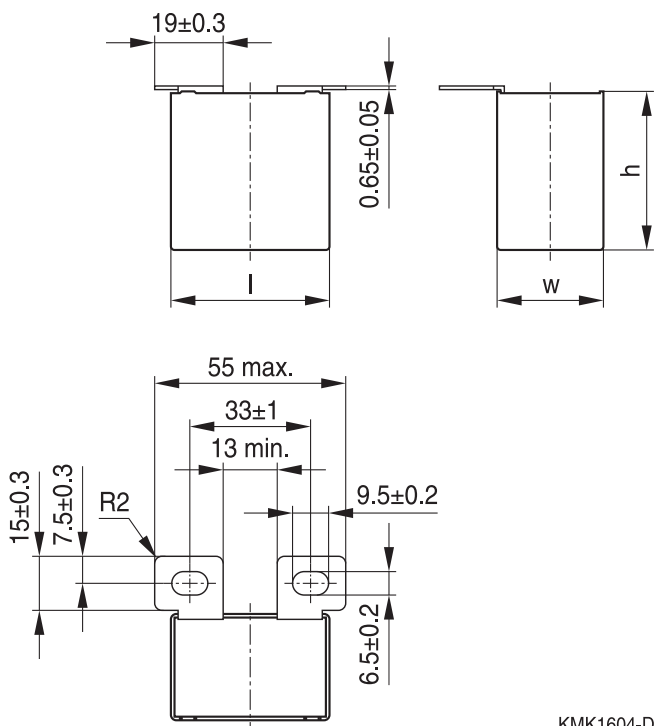
KMK1602-B

T10 (code no. 410)

KMK1603-C

T11 (code no. 411)

KMK1604-D

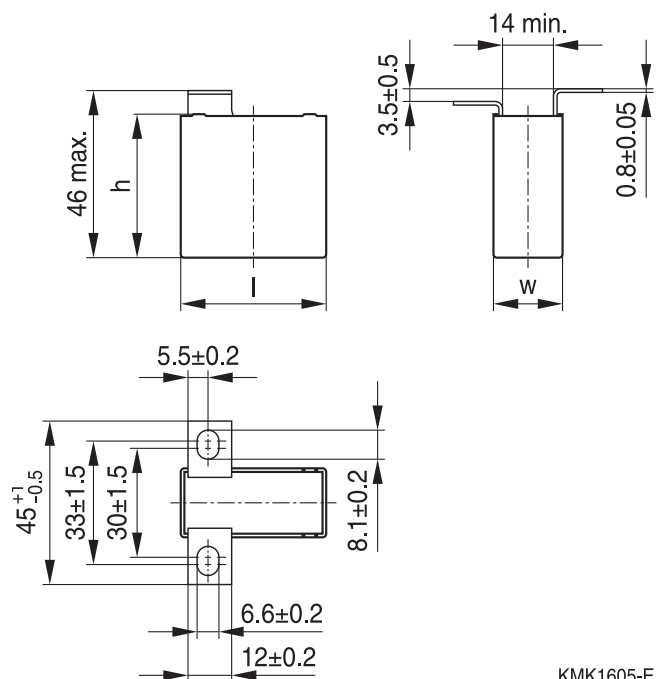
T12 (code no. 412)

KMK1605-E

Dimensional drawings

T14 (code no. 414)

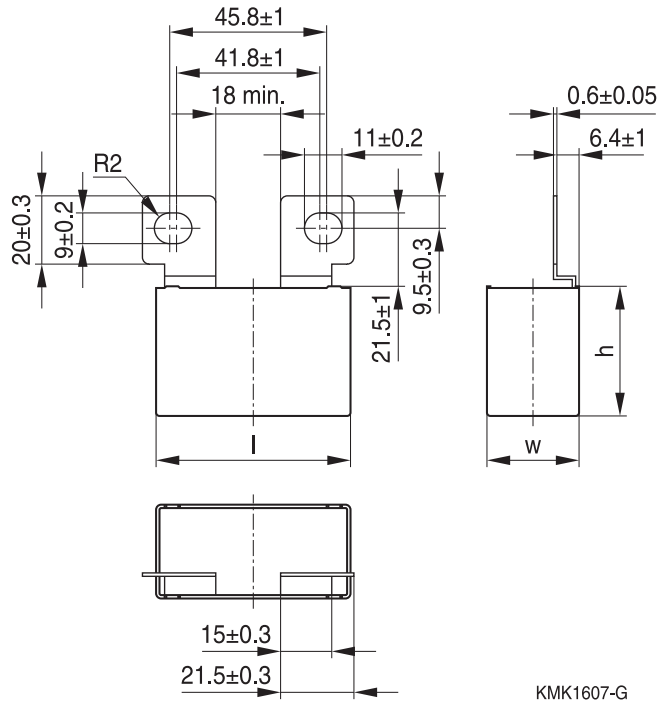

T15 (code no. 415)

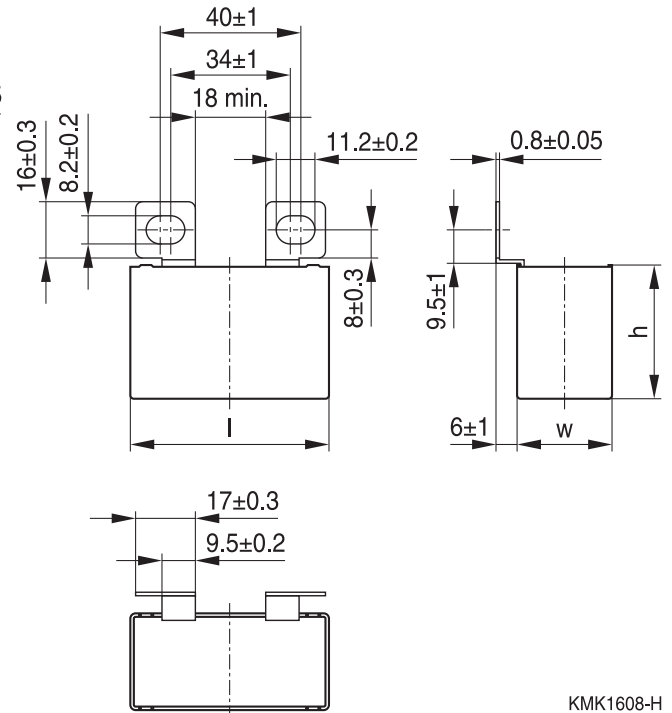

T16 (code no. 416)

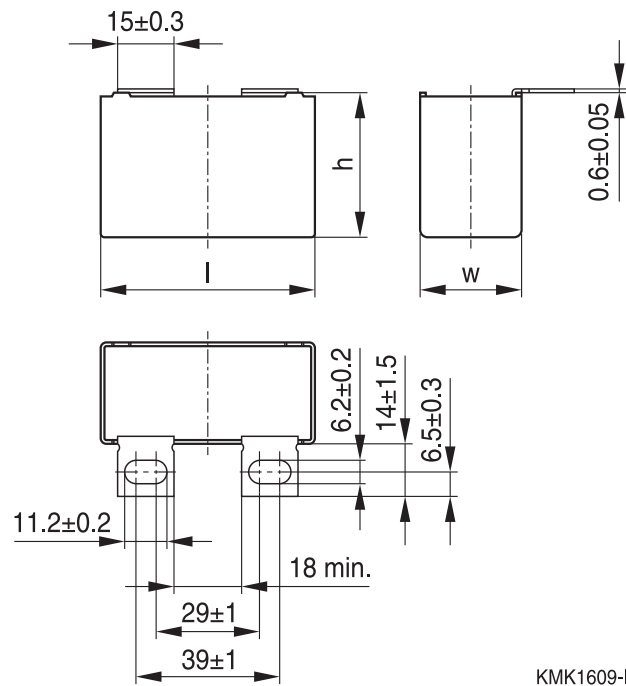

T17 (code no. 417)

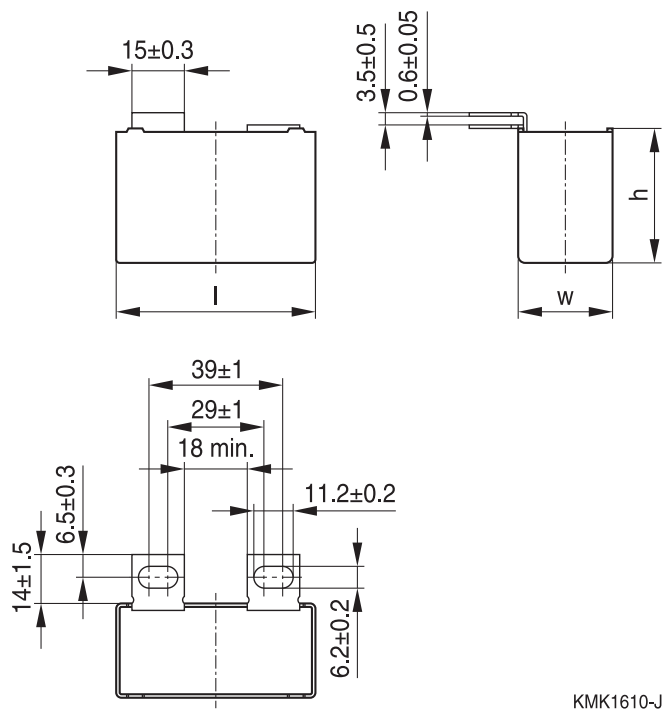

Dimensional drawings

T18 (code no. 418)

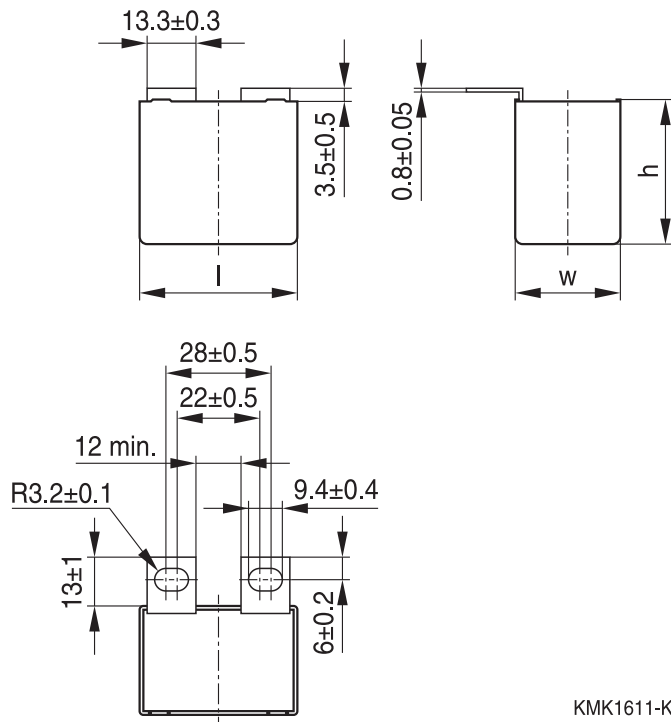

Overview of available types

Type	B32656S					B32658S				
V_R (V DC)	850	1000	1250	1700	2000	850	1000	1250	1700	2000
V_{RMS} (V AC)	450	480	500	750	800	450	480	500	750	800
C_R (nF)										
68										
100										
120										
150										
220										
270										
330										
390										
470										
560										
680										
820										
900										
1000										
1200										
1400										
1500										
1800										
2200										
2700										
3000										
3300										
4000										
4200										
4500										
4700										
5000										
5600										

Ordering codes and packing units

V _R	V _{RMS} f ≤ 1kHz	C _R	Max. dimensions w x h x l	I _{RMS} 100 kHz	ESR _{typ} 100 kHz	Ordering code (composition see below)	Ter- minal	pcs./ MOQ		
V DC	V AC	nF	mm	A	mΩ					
850	450	560	14.0 x 25.0 x 42.0	8.0	9.0	B32656S8564+408	T8	288		
		560	14.0 x 25.0 x 42.0	8.0	9.0	B32656S8564+418	T18	288		
		560	14.0 x 25.0 x 42.0	8.0	9.0	B32656S8564+563	T3	168		
		560	14.0 x 25.0 x 42.0	8.0	9.0	B32656S8564+564	T4	288		
		560	14.0 x 25.0 x 42.0	8.0	9.0	B32656S8564+565	T5	288		
		680	16.0 x 28.5 x 42.0	9.5	7.0	B32656S8684+408	T8	192		
		680	16.0 x 28.5 x 42.0	9.5	7.0	B32656S8684+409	T9	192		
		680	16.0 x 28.5 x 42.0	9.5	7.0	B32656S8684+411	T11	128		
		680	16.0 x 28.5 x 42.0	9.5	7.0	B32656S8684+418	T18	192		
		680	16.0 x 28.5 x 42.0	9.5	7.0	B32656S8684+561	T1	192		
		680	16.0 x 28.5 x 42.0	9.5	7.0	B32656S8684+562	T2	192		
		680	16.0 x 28.5 x 42.0	9.5	7.0	B32656S8684+563	T3	144		
		680	16.0 x 28.5 x 42.0	9.5	7.0	B32656S8684+564	T4	192		
		680	16.0 x 28.5 x 42.0	9.5	7.0	B32656S8684+565	T5	192		
		680	16.0 x 28.5 x 42.0	9.5	7.0	B32656S8684+566	T6	192		
		680	16.0 x 28.5 x 42.0	9.5	7.0	B32656S8684+577	T7	180		
		820	16.0 x 28.5 x 42.0	10.0	16.0 x 28.5 x 42.0	10.0	6.0	B32656S8824+408	T8	192
		820	16.0 x 28.5 x 42.0	10.0	16.0 x 28.5 x 42.0	10.0	6.0	B32656S8824+409	T9	192
		820	16.0 x 28.5 x 42.0	10.0	16.0 x 28.5 x 42.0	10.0	6.0	B32656S8824+411	T11	128
		820	16.0 x 28.5 x 42.0	10.0	16.0 x 28.5 x 42.0	10.0	6.0	B32656S8824+418	T18	192
		820	16.0 x 28.5 x 42.0	10.0	16.0 x 28.5 x 42.0	10.0	6.0	B32656S8824+561	T1	192
		820	16.0 x 28.5 x 42.0	10.0	16.0 x 28.5 x 42.0	10.0	6.0	B32656S8824+562	T2	192
		820	16.0 x 28.5 x 42.0	10.0	16.0 x 28.5 x 42.0	10.0	6.0	B32656S8824+563	T3	144
		820	16.0 x 28.5 x 42.0	10.0	16.0 x 28.5 x 42.0	10.0	6.0	B32656S8824+564	T4	192
		820	16.0 x 28.5 x 42.0	10.0	16.0 x 28.5 x 42.0	10.0	6.0	B32656S8824+565	T5	192
		820	16.0 x 28.5 x 42.0	10.0	16.0 x 28.5 x 42.0	10.0	6.0	B32656S8824+566	T6	192
		820	16.0 x 28.5 x 42.0	10.0	16.0 x 28.5 x 42.0	10.0	6.0	B32656S8824+577	T7	180

MOQ = Minimum Order Quantity, consisting of 4 packing units.

Further E series and intermediate capacitance values on request.

Composition of ordering code

+ = Capacitance tolerance code:

K = ±10%

J = ±5%

Ordering codes and packing units

V_R	V_{RMS} $f \leq 1\text{kHz}$	C_R	Max. dimensions w x h x l	I_{RMS} 100 kHz	ESR_{typ} 100 kHz	Ordering code (composition see below)	Ter- minal	pcs./ MOQ		
V DC	V AC	nF	mm	A	m Ω					
850	450	1000	18.0 x 32.5 x 42.0	11.5	6.0	B32656S8105+408	T8	140		
		1000	18.0 x 32.5 x 42.0	11.5	6.0	B32656S8105+409	T9	140		
		1000	18.0 x 32.5 x 42.0	11.5	6.0	B32656S8105+411	T11	112		
		1000	18.0 x 32.5 x 42.0	11.5	6.0	B32656S8105+418	T18	140		
		1000	18.0 x 32.5 x 42.0	11.5	6.0	B32656S8105+561	T1	140		
		1000	18.0 x 32.5 x 42.0	11.5	6.0	B32656S8105+562	T2	140		
		1000	18.0 x 32.5 x 42.0	11.5	6.0	B32656S8105+563	T3	120		
		1000	18.0 x 32.5 x 42.0	11.5	6.0	B32656S8105+564	T4	128		
		1000	18.0 x 32.5 x 42.0	11.5	6.0	B32656S8105+565	T5	128		
		1000	18.0 x 32.5 x 42.0	11.5	6.0	B32656S8105+566	T6	140		
		1000	18.0 x 32.5 x 42.0	11.5	6.0	B32656S8105+577	T7	156		
		1200	18.0 x 32.5 x 42.0	12.5	18.0 x 32.5 x 42.0	12.5	5.0	B32656S8125+408	T8	140
		1200	18.0 x 32.5 x 42.0	12.5	18.0 x 32.5 x 42.0	12.5	5.0	B32656S8125+409	T9	140
		1200	18.0 x 32.5 x 42.0	12.5	18.0 x 32.5 x 42.0	12.5	5.0	B32656S8125+411	T11	112
		1200	18.0 x 32.5 x 42.0	12.5	18.0 x 32.5 x 42.0	12.5	5.0	B32656S8125+418	T18	140
		1200	18.0 x 32.5 x 42.0	12.5	18.0 x 32.5 x 42.0	12.5	5.0	B32656S8125+561	T1	140
		1200	18.0 x 32.5 x 42.0	12.5	18.0 x 32.5 x 42.0	12.5	5.0	B32656S8125+562	T2	140
		1200	18.0 x 32.5 x 42.0	12.5	18.0 x 32.5 x 42.0	12.5	5.0	B32656S8125+563	T3	120
		1200	18.0 x 32.5 x 42.0	12.5	18.0 x 32.5 x 42.0	12.5	5.0	B32656S8125+564	T4	128
		1200	18.0 x 32.5 x 42.0	12.5	18.0 x 32.5 x 42.0	12.5	5.0	B32656S8125+565	T5	128
		1200	18.0 x 32.5 x 42.0	12.5	18.0 x 32.5 x 42.0	12.5	5.0	B32656S8125+566	T6	140
		1200	18.0 x 32.5 x 42.0	12.5	18.0 x 32.5 x 42.0	12.5	5.0	B32656S8125+577	T7	156
		1500	31.0 x 26.5 x 43.6	14.0	31.0 x 26.5 x 43.6	14.0	5.0	B32656S8155+408	T8	128
		1500	31.0 x 26.5 x 43.6	14.0	31.0 x 26.5 x 43.6	14.0	5.0	B32656S8155+409	T9	128
		1500	31.0 x 26.5 x 43.6	14.0	31.0 x 26.5 x 43.6	14.0	5.0	B32656S8155+418	T18	128
		1500	31.0 x 26.5 x 43.6	14.0	31.0 x 26.5 x 43.6	14.0	5.0	B32656S8155+561	T1	128
		1500	31.0 x 26.5 x 43.6	14.0	31.0 x 26.5 x 43.6	14.0	5.0	B32656S8155+562	T2	128
		1500	31.0 x 26.5 x 43.6	14.0	31.0 x 26.5 x 43.6	14.0	5.0	B32656S8155+563	T3	72
		1500	31.0 x 26.5 x 43.6	14.0	31.0 x 26.5 x 43.6	14.0	5.0	B32656S8155+566	T6	128
		1500	31.0 x 26.5 x 43.6	14.0	31.0 x 26.5 x 43.6	14.0	5.0	B32656S8155+577	T7	84

MOQ = Minimum Order Quantity, consisting of 4 packing units.

Further E series and intermediate capacitance values on request.

Composition of ordering code

+ = Capacitance tolerance code:

K = $\pm 10\%$

J = $\pm 5\%$

Metallized polypropylene film capacitors (MKP)
B32656S
Snubber (wound)
Ordering codes and packing units

V_R	V_{RMS} $f \leq 1\text{kHz}$	C_R	Max. dimensions w x h x l	I_{RMS} 100 kHz	ESR_{typ} 100 kHz	Ordering code (composition see below)	Ter- minal	pcs./ MOQ
V DC	V AC	nF	mm	A	m Ω			
850	450	1800	28.0 x 37.0 x 42.0	15.5	4.5	B32656S8185+408	T8	108
		1800	28.0 x 37.0 x 42.0	15.5	4.5	B32656S8185+409	T9	108
		1800	28.0 x 37.0 x 42.0	15.5	4.5	B32656S8185+410	T10	80
		1800	28.0 x 37.0 x 42.0	15.5	4.5	B32656S8185+411	T11	72
		1800	28.0 x 37.0 x 42.0	15.5	4.5	B32656S8185+418	T18	108
		1800	28.0 x 37.0 x 42.0	15.5	4.5	B32656S8185+561	T1	108
		1800	28.0 x 37.0 x 42.0	15.5	4.5	B32656S8185+562	T2	108
		1800	28.0 x 37.0 x 42.0	15.5	4.5	B32656S8185+563	T3	96
		1800	28.0 x 37.0 x 42.0	15.5	4.5	B32656S8185+566	T6	108
		1800	28.0 x 37.0 x 42.0	15.5	4.5	B32656S8185+577	T7	96
		2200	30.0 x 45.0 x 42.0	17.0	4.0	B32656S8225+408	T8	48
		2200	30.0 x 45.0 x 42.0	17.0	4.0	B32656S8225+409	T9	48
		2200	30.0 x 45.0 x 42.0	17.0	4.0	B32656S8225+410	T10	80
		2200	30.0 x 45.0 x 42.0	17.0	4.0	B32656S8225+411	T11	64
		2200	30.0 x 45.0 x 42.0	17.0	4.0	B32656S8225+418	T18	48
		2200	30.0 x 45.0 x 42.0	17.0	4.0	B32656S8225+561	T1	48
		2200	30.0 x 45.0 x 42.0	17.0	4.0	B32656S8225+562	T2	48
		2200	30.0 x 45.0 x 42.0	17.0	4.0	B32656S8225+563	T3	96
		2200	30.0 x 45.0 x 42.0	17.0	4.0	B32656S8225+566	T6	48
		2200	30.0 x 45.0 x 42.0	17.0	4.0	B32656S8225+577	T7	96
		2700	30.0 x 45.0 x 42.0	20.0	3.7	B32656S8275+408	T8	48
		2700	30.0 x 45.0 x 42.0	20.0	3.7	B32656S8275+409	T9	48
		2700	30.0 x 45.0 x 42.0	20.0	3.7	B32656S8275+410	T10	80
		2700	30.0 x 45.0 x 42.0	20.0	3.7	B32656S8275+411	T11	64
		2700	30.0 x 45.0 x 42.0	20.0	3.7	B32656S8275+418	T18	48
		2700	30.0 x 45.0 x 42.0	20.0	3.7	B32656S8275+561	T1	48
		2700	30.0 x 45.0 x 42.0	20.0	3.7	B32656S8275+562	T2	48
		2700	30.0 x 45.0 x 42.0	20.0	3.7	B32656S8275+563	T3	96
		2700	30.0 x 45.0 x 42.0	20.0	3.7	B32656S8275+566	T6	48
		2700	30.0 x 45.0 x 42.0	20.0	3.7	B32656S8275+577	T7	96

MOQ = Minimum Order Quantity, consisting of 4 packing units.

Further E series and intermediate capacitance values on request.

Composition of ordering code

+ = Capacitance tolerance code:

K = $\pm 10\%$

J = $\pm 5\%$

Metallized polypropylene film capacitors (MKP)
B32656S
Snubber (wound)
Ordering codes and packing units

V_R	V_{RMS} $f \leq 1\text{kHz}$	C_R	Max. dimensions w x h x l	I_{RMS} 100 kHz	ESR_{typ} 100 kHz	Ordering code (composition see below)	Ter- minal	pcs./ MOQ
V DC	V AC	nF	mm	A	m Ω			
850	450	3300	33.0 x 48.0 x 43.0	23.0	3.3	B32656S8335+408	T8	84
		3300	33.0 x 48.0 x 43.0	23.0	3.3	B32656S8335+409	T9	84
		3300	33.0 x 48.0 x 43.0	23.0	3.3	B32656S8335+410	T10	60
		3300	33.0 x 48.0 x 43.0	23.0	3.3	B32656S8335+411	T11	56
		3300	33.0 x 48.0 x 43.0	23.0	3.3	B32656S8335+418	T18	84
		3300	33.0 x 48.0 x 43.0	23.0	3.3	B32656S8335+561	T1	84
		3300	33.0 x 48.0 x 43.0	23.0	3.3	B32656S8335+562	T2	84
		3300	33.0 x 48.0 x 43.0	23.0	3.3	B32656S8335+563	T3	64
		3300	33.0 x 48.0 x 43.0	23.0	3.3	B32656S8335+566	T6	84
		3300	33.0 x 48.0 x 43.0	23.0	3.3	B32656S8335+577	T7	84
1000	480	330	14.0 x 25.0 x 42.0	7.0	13.0	B32656S0334+408	T8	288
		330	14.0 x 25.0 x 42.0	7.0	13.0	B32656S0334+418	T18	288
		330	14.0 x 25.0 x 42.0	7.0	13.0	B32656S0334+563	T3	168
		330	14.0 x 25.0 x 42.0	7.0	13.0	B32656S0334+564	T4	288
		330	14.0 x 25.0 x 42.0	7.0	13.0	B32656S0334+565	T5	288
		390	14.0 x 25.0 x 42.0	7.5	11.0	B32656S0394+408	T8	288
		390	14.0 x 25.0 x 42.0	7.5	11.0	B32656S0394+418	T18	288
		390	14.0 x 25.0 x 42.0	7.5	11.0	B32656S0394+563	T3	168
		390	14.0 x 25.0 x 42.0	7.5	11.0	B32656S0394+564	T4	288
		390	14.0 x 25.0 x 42.0	7.5	11.0	B32656S0394+565	T5	288
		470	14.0 x 25.0 x 42.0	8.0	10.0	B32656S0474+408	T8	288
		470	14.0 x 25.0 x 42.0	8.0	10.0	B32656S0474+418	T18	288
		470	14.0 x 25.0 x 42.0	8.0	10.0	B32656S0474+563	T3	168
		470	14.0 x 25.0 x 42.0	8.0	10.0	B32656S0474+564	T4	288
		470	14.0 x 25.0 x 42.0	8.0	10.0	B32656S0474+565	T5	288
		560	16.0 x 28.5 x 42.0	9.0	8.0	B32656S0564+408	T8	192
		560	16.0 x 28.5 x 42.0	9.0	8.0	B32656S0564+409	T9	192
		560	16.0 x 28.5 x 42.0	9.0	8.0	B32656S0564+411	T11	128
		560	16.0 x 28.5 x 42.0	9.0	8.0	B32656S0564+418	T18	192

MOQ = Minimum Order Quantity, consisting of 4 packing units.

Further E series and intermediate capacitance values on request.

Composition of ordering code

+ = Capacitance tolerance code:

K = $\pm 10\%$

J = $\pm 5\%$

Metallized polypropylene film capacitors (MKP)
B32656S
Snubber (wound)
Ordering codes and packing units

V_R	V_{RMS} $f \leq 1\text{kHz}$	C_R	Max. dimensions w x h x l	I_{RMS} 100 kHz	ESR_{typ} 100 kHz	Ordering code (composition see below)	Ter- minal	pcs./ MOQ
V DC	V AC	nF	mm	A	m Ω			
1000	480	560	16.0 x 28.5 x 42.0	9.0	8.0	B32656S0564+561	T1	192
		560	16.0 x 28.5 x 42.0	9.0	8.0	B32656S0564+562	T2	192
		560	16.0 x 28.5 x 42.0	9.0	8.0	B32656S0564+563	T3	144
		560	16.0 x 28.5 x 42.0	9.0	8.0	B32656S0564+564	T4	192
		560	16.0 x 28.5 x 42.0	9.0	8.0	B32656S0564+565	T5	192
		560	16.0 x 28.5 x 42.0	9.0	8.0	B32656S0564+566	T6	192
		560	16.0 x 28.5 x 42.0	9.0	8.0	B32656S0564+577	T7	180
		680	16.0 x 28.5 x 42.0	10.5	6.5	B32656S0684+408	T8	192
		680	16.0 x 28.5 x 42.0	10.5	6.5	B32656S0684+409	T9	192
		680	16.0 x 28.5 x 42.0	10.5	6.5	B32656S0684+411	T11	128
		680	16.0 x 28.5 x 42.0	10.5	6.5	B32656S0684+418	T18	192
		680	16.0 x 28.5 x 42.0	10.5	6.5	B32656S0684+561	T1	192
		680	16.0 x 28.5 x 42.0	10.5	6.5	B32656S0684+562	T2	192
		680	16.0 x 28.5 x 42.0	10.5	6.5	B32656S0684+563	T3	144
		680	16.0 x 28.5 x 42.0	10.5	6.5	B32656S0684+564	T4	192
		680	16.0 x 28.5 x 42.0	10.5	6.5	B32656S0684+565	T5	192
		680	16.0 x 28.5 x 42.0	10.5	6.5	B32656S0684+566	T6	192
		680	16.0 x 28.5 x 42.0	10.5	6.5	B32656S0684+577	T7	180
		680	19.0 x 37.5 x 42.0	18.0	3.0	B32656S0684+412*	T12	264
		820	18.0 x 32.5 x 42.0	11.5	6.0	B32656S0824+408	T8	140
		820	18.0 x 32.5 x 42.0	11.5	6.0	B32656S0824+409	T9	140
		820	18.0 x 32.5 x 42.0	11.5	6.0	B32656S0824+411	T11	112
		820	18.0 x 32.5 x 42.0	11.5	6.0	B32656S0824+418	T18	140
		820	18.0 x 32.5 x 42.0	11.5	6.0	B32656S0824+561	T1	140
		820	18.0 x 32.5 x 42.0	11.5	6.0	B32656S0824+562	T2	140
		820	18.0 x 32.5 x 42.0	11.5	6.0	B32656S0824+563	T3	120
		820	18.0 x 32.5 x 42.0	11.5	6.0	B32656S0824+564	T4	128
		820	18.0 x 32.5 x 42.0	11.5	6.0	B32656S0824+565	T5	128
		820	18.0 x 32.5 x 42.0	11.5	6.0	B32656S0824+566	T6	140
		820	18.0 x 32.5 x 42.0	11.5	6.0	B32656S0824+577	T7	156

MOQ = Minimum Order Quantity, consisting of 4 packing units.

Further E series and intermediate capacitance values on request.

Composition of ordering code

+ = Capacitance tolerance code:

K = $\pm 10\%$

J = $\pm 5\%$

* This part is affected by "Dual Use" regulations according to the law of the country the production site is located in. Deliveries of such products are subject to prior approval of the respective local authorities based on customer declarations. The delivery to certain countries may be restricted.

Ordering codes and packing units

V_R	V_{RMS} $f \leq 1\text{kHz}$	C_R	Max. dimensions w x h x l	I_{RMS} 100 kHz	ESR_{typ} 100 kHz	Ordering code (composition see below)	Ter- minal	pcs./ MOQ		
V DC	V AC	nF	mm	A	m Ω					
1000	480	1000	20.0 x 39.5 x 42.0	13.0	6.0	B32656S0105+408	T8	96		
		1000	20.0 x 39.5 x 42.0	13.0	6.0	B32656S0105+409	T9	96		
		1000	20.0 x 39.5 x 42.0	13.0	6.0	B32656S0105+410	T10	120		
		1000	20.0 x 39.5 x 42.0	13.0	6.0	B32656S0105+411	T11	96		
		1000	20.0 x 39.5 x 42.0	13.0	6.0	B32656S0105+418	T18	96		
		1000	20.0 x 39.5 x 42.0	13.0	6.0	B32656S0105+561	T1	96		
		1000	20.0 x 39.5 x 42.0	13.0	6.0	B32656S0105+562	T2	96		
		1000	20.0 x 39.5 x 42.0	13.0	6.0	B32656S0105+563	T3	104		
		1000	20.0 x 39.5 x 42.0	13.0	6.0	B32656S0105+564	T4	96		
		1000	20.0 x 39.5 x 42.0	13.0	6.0	B32656S0105+565	T5	96		
		1000	20.0 x 39.5 x 42.0	13.0	6.0	B32656S0105+566	T6	96		
		1000	20.0 x 39.5 x 42.0	13.0	6.0	B32656S0105+577	T7	144		
		1200	480	1200	20.0 x 39.5 x 42.0	14.0	5.0	B32656S0125+408	T8	96
				1200	20.0 x 39.5 x 42.0	14.0	5.0	B32656S0125+409	T9	96
				1200	20.0 x 39.5 x 42.0	14.0	5.0	B32656S0125+410	T10	120
				1200	20.0 x 39.5 x 42.0	14.0	5.0	B32656S0125+411	T11	96
				1200	20.0 x 39.5 x 42.0	14.0	5.0	B32656S0125+418	T18	96
				1200	20.0 x 39.5 x 42.0	14.0	5.0	B32656S0125+561	T1	96
				1200	20.0 x 39.5 x 42.0	14.0	5.0	B32656S0125+562	T2	96
				1200	20.0 x 39.5 x 42.0	14.0	5.0	B32656S0125+563	T3	104
				1200	20.0 x 39.5 x 42.0	14.0	5.0	B32656S0125+564	T4	96
				1200	20.0 x 39.5 x 42.0	14.0	5.0	B32656S0125+565	T5	96
				1200	20.0 x 39.5 x 42.0	14.0	5.0	B32656S0125+566	T6	96
				1200	20.0 x 39.5 x 42.0	14.0	5.0	B32656S0125+577	T7	144
		1500	480	1500	30.0 x 45.0 x 42.0	16.5	5.0	B32656S0155+408	T8	48
				1500	30.0 x 45.0 x 42.0	16.5	5.0	B32656S0155+409	T9	48
				1500	30.0 x 45.0 x 42.0	16.5	5.0	B32656S0155+410	T10	80
				1500	30.0 x 45.0 x 42.0	16.5	5.0	B32656S0155+411	T11	64
				1500	30.0 x 45.0 x 42.0	16.5	5.0	B32656S0155+418	T18	48
				1500	30.0 x 45.0 x 42.0	16.5	5.0	B32656S0155+561	T1	48
				1500	30.0 x 45.0 x 42.0	16.5	5.0	B32656S0155+562	T2	48
				1500	30.0 x 45.0 x 42.0	16.5	5.0	B32656S0155+563	T3	96
				1500	30.0 x 45.0 x 42.0	16.5	5.0	B32656S0155+566	T6	48
				1500	30.0 x 45.0 x 42.0	16.5	5.0	B32656S0155+577	T7	96

MOQ = Minimum Order Quantity, consisting of 4 packing units.

Further E series and intermediate capacitance values on request.

Composition of ordering code

+ = Capacitance tolerance code:

K = $\pm 10\%$

J = $\pm 5\%$

Metallized polypropylene film capacitors (MKP)
B32656S
Snubber (wound)
Ordering codes and packing units

V_R	V_{RMS} $f \leq 1\text{kHz}$	C_R	Max. dimensions w x h x l	I_{RMS} 100 kHz	ESR_{typ} 100 kHz	Ordering code (composition see below)	Ter- minal	pcs./ MOQ
V DC	V AC	nF	mm	A	m Ω			
1000	480	1800	30.0 x 45.0 x 42.0	17.0	4.5	B32656S0185+408	T8	48
		1800	30.0 x 45.0 x 42.0	17.0	4.5	B32656S0185+409	T9	48
		1800	30.0 x 45.0 x 42.0	17.0	4.5	B32656S0185+410	T10	48
		1800	30.0 x 45.0 x 42.0	17.0	4.5	B32656S0185+411	T11	64
		1800	30.0 x 45.0 x 42.0	17.0	4.5	B32656S0185+418	T18	48
		1800	30.0 x 45.0 x 42.0	17.0	4.5	B32656S0185+561	T1	48
		1800	30.0 x 45.0 x 42.0	17.0	4.5	B32656S0185+562	T2	48
		1800	30.0 x 45.0 x 42.0	17.0	4.5	B32656S0185+563	T3	96
		1800	30.0 x 45.0 x 42.0	17.0	4.5	B32656S0185+566	T6	48
		1800	30.0 x 45.0 x 42.0	17.0	4.5	B32656S0185+577	T7	96
		2200	30.0 x 45.0 x 42.0	19.0	4.0	B32656S0225+408	T8	48
		2200	30.0 x 45.0 x 42.0	19.0	4.0	B32656S0225+409	T9	48
		2200	30.0 x 45.0 x 42.0	19.0	4.0	B32656S0225+410	T10	80
		2200	30.0 x 45.0 x 42.0	19.0	4.0	B32656S0225+411	T11	64
		2200	30.0 x 45.0 x 42.0	19.0	4.0	B32656S0225+418	T18	48
		2200	30.0 x 45.0 x 42.0	19.0	4.0	B32656S0225+561	T1	48
		2200	30.0 x 45.0 x 42.0	19.0	4.0	B32656S0225+562	T2	48
		2200	30.0 x 45.0 x 42.0	19.0	4.0	B32656S0225+563	T3	96
		2200	30.0 x 45.0 x 42.0	19.0	4.0	B32656S0225+566	T6	48
		2200	30.0 x 45.0 x 42.0	19.0	4.0	B32656S0225+577	T7	96
		2700	33.0 x 48.0 x 43.0	22.0	3.3	B32656S0275+408	T8	84
		2700	33.0 x 48.0 x 43.0	22.0	3.3	B32656S0275+409	T9	84
		2700	33.0 x 48.0 x 43.0	22.0	3.3	B32656S0275+410	T10	60
		2700	33.0 x 48.0 x 43.0	22.0	3.3	B32656S0275+411	T11	56
		2700	33.0 x 48.0 x 43.0	22.0	3.3	B32656S0275+418	T18	84
		2700	33.0 x 48.0 x 43.0	22.0	3.3	B32656S0275+561	T1	84
		2700	33.0 x 48.0 x 43.0	22.0	3.3	B32656S0275+562	T2	84
		2700	33.0 x 48.0 x 43.0	22.0	3.3	B32656S0275+563	T3	64
		2700	33.0 x 48.0 x 43.0	22.0	3.3	B32656S0275+566	T6	84
		2700	33.0 x 48.0 x 43.0	22.0	3.3	B32656S0275+577	T7	84

MOQ = Minimum Order Quantity, consisting of 4 packing units.

Further E series and intermediate capacitance values on request.

Composition of ordering code

+ = Capacitance tolerance code:

K = $\pm 10\%$

J = $\pm 5\%$

Metallized polypropylene film capacitors (MKP)
B32656S
Snubber (wound)
Ordering codes and packing units

V _R	V _{RMS} f ≤ 1kHz	C _R	Max. dimensions w x h x l	I _{RMS} 100 kHz	ESR _{typ} 100 kHz	Ordering code (composition see below)	Ter- minal	pcs./ MOQ
V DC	V AC	nF	mm	A	mΩ			
1250	500	220	14.0 x 25.0 x 42.0	7.0	11.5	B32656S7224+408	T8	288
		220	14.0 x 25.0 x 42.0	7.0	11.5	B32656S7224+418	T18	288
		220	14.0 x 25.0 x 42.0	7.0	11.5	B32656S7224+563	T3	168
		220	14.0 x 25.0 x 42.0	7.0	11.5	B32656S7224+564	T4	288
		220	14.0 x 25.0 x 42.0	7.0	11.5	B32656S7224+565	T5	288
		270	14.0 x 25.0 x 42.0	8.0	10.0	B32656S7274+408	T8	288
		270	14.0 x 25.0 x 42.0	8.0	10.0	B32656S7274+418	T18	288
		270	14.0 x 25.0 x 42.0	8.0	10.0	B32656S7274+563	T3	168
		270	14.0 x 25.0 x 42.0	8.0	10.0	B32656S7274+564	T4	288
		270	14.0 x 25.0 x 42.0	8.0	10.0	B32656S7274+565	T5	288
		330	16.0 x 28.5 x 42.0	8.5	9.5	B32656S7334+408	T8	192
		330	16.0 x 28.5 x 42.0	8.5	9.5	B32656S7334+409	T9	192
		330	16.0 x 28.5 x 42.0	8.5	9.5	B32656S7334+411	T11	128
		330	16.0 x 28.5 x 42.0	8.5	9.5	B32656S7334+418	T18	192
		330	16.0 x 28.5 x 42.0	8.5	9.5	B32656S7334+561	T1	192
		330	16.0 x 28.5 x 42.0	8.5	9.5	B32656S7334+562	T2	192
		330	16.0 x 28.5 x 42.0	8.5	9.5	B32656S7334+563	T3	144
		330	16.0 x 28.5 x 42.0	8.5	9.5	B32656S7334+564	T4	192
		330	16.0 x 28.5 x 42.0	8.5	9.5	B32656S7334+565	T5	192
		330	16.0 x 28.5 x 42.0	8.5	9.5	B32656S7334+566	T6	192
		330	16.0 x 28.5 x 42.0	8.5	9.5	B32656S7334+577	T7	180
		390	18.0 x 32.5 x 42.0	9.0	9.0	B32656S7394+408	T8	140
		390	18.0 x 32.5 x 42.0	9.0	9.0	B32656S7394+409	T9	140
		390	18.0 x 32.5 x 42.0	9.0	9.0	B32656S7394+411	T11	112
		390	18.0 x 32.5 x 42.0	9.0	9.0	B32656S7394+418	T18	140
		390	18.0 x 32.5 x 42.0	9.0	9.0	B32656S7394+561	T1	140
		390	18.0 x 32.5 x 42.0	9.0	9.0	B32656S7394+562	T2	140
		390	18.0 x 32.5 x 42.0	9.0	9.0	B32656S7394+563	T3	120
		390	18.0 x 32.5 x 42.0	9.0	9.0	B32656S7394+564	T4	128
		390	18.0 x 32.5 x 42.0	9.0	9.0	B32656S7394+565	T5	128
		390	18.0 x 32.5 x 42.0	9.0	9.0	B32656S7394+566	T6	140
		390	18.0 x 32.5 x 42.0	9.0	9.0	B32656S7394+577	T7	156

MOQ = Minimum Order Quantity, consisting of 4 packing units.

Further E series and intermediate capacitance values on request.

Composition of ordering code

+ = Capacitance tolerance code:

K = ±10%

J = ±5%

Ordering codes and packing units

V_R	V_{RMS} $f \leq 1\text{kHz}$	C_R	Max. dimensions w x h x l	I_{RMS} 100 kHz	ESR_{typ} 100 kHz	Ordering code (composition see below)	Ter- minal	pcs./ MOQ
V DC	V AC	nF	mm	A	m Ω			
1250	500	470	18.0 x 32.5 x 42.0	9.0	8.5	B32656S7474+408	T8	140
		470	18.0 x 32.5 x 42.0	9.0	8.5	B32656S7474+409	T9	140
		470	18.0 x 32.5 x 42.0	9.0	8.5	B32656S7474+411	T11	112
		470	18.0 x 32.5 x 42.0	9.0	8.5	B32656S7474+418	T18	140
		470	18.0 x 32.5 x 42.0	9.0	8.5	B32656S7474+561	T1	140
		470	18.0 x 32.5 x 42.0	9.0	8.5	B32656S7474+562	T2	140
		470	18.0 x 32.5 x 42.0	9.0	8.5	B32656S7474+563	T3	120
		470	18.0 x 32.5 x 42.0	9.0	8.5	B32656S7474+564	T4	128
		470	18.0 x 32.5 x 42.0	9.0	8.5	B32656S7474+565	T5	128
		470	18.0 x 32.5 x 42.0	9.0	8.5	B32656S7474+566	T6	140
		470	18.0 x 32.5 x 42.0	9.0	8.5	B32656S7474+577	T7	156
		470	19.0 x 37.5 x 42.0	17.0	4.0	B32656S7474+412*	T12	264
		560	20.0 x 39.5 x 42.0	11.0	7.0	B32656S7564+408	T8	96
		560	20.0 x 39.5 x 42.0	11.0	7.0	B32656S7564+409	T9	96
		560	20.0 x 39.5 x 42.0	11.0	7.0	B32656S7564+410	T10	120
		560	20.0 x 39.5 x 42.0	11.0	7.0	B32656S7564+411	T11	96
		560	20.0 x 39.5 x 42.0	11.0	7.0	B32656S7564+418	T18	96
		560	20.0 x 39.5 x 42.0	11.0	7.0	B32656S7564+561	T1	96
		560	20.0 x 39.5 x 42.0	11.0	7.0	B32656S7564+562	T2	96
		560	20.0 x 39.5 x 42.0	11.0	7.0	B32656S7564+563	T3	104
		560	20.0 x 39.5 x 42.0	11.0	7.0	B32656S7564+564	T4	96
		560	20.0 x 39.5 x 42.0	11.0	7.0	B32656S7564+565	T5	96
		560	20.0 x 39.5 x 42.0	11.0	7.0	B32656S7564+566	T6	96
		560	20.0 x 39.5 x 42.0	11.0	7.0	B32656S7564+577	T7	144
		680	20.0 x 39.5 x 42.0	13.0	6.0	B32656S7684+408	T8	96
		680	20.0 x 39.5 x 42.0	13.0	6.0	B32656S7684+409	T9	96
		680	20.0 x 39.5 x 42.0	13.0	6.0	B32656S7684+410	T10	120
		680	20.0 x 39.5 x 42.0	13.0	6.0	B32656S7684+411	T11	96
		680	20.0 x 39.5 x 42.0	13.0	6.0	B32656S7684+418	T18	96
		680	20.0 x 39.5 x 42.0	13.0	6.0	B32656S7684+561	T1	96
		680	20.0 x 39.5 x 42.0	13.0	6.0	B32656S7684+562	T2	96

MOQ = Minimum Order Quantity, consisting of 4 packing units.

Further E series and intermediate capacitance values on request.

Composition of ordering code

+ = Capacitance tolerance code:

K = $\pm 10\%$

J = $\pm 5\%$

* This part is affected by "Dual Use" regulations according to the law of the country the production site is located in. Deliveries of such products are subject to prior approval of the respective local authorities based on customer declarations. The delivery to certain countries may be restricted.

Metallized polypropylene film capacitors (MKP)
B32656S
Snubber (wound)
Ordering codes and packing units

V_R	V_{RMS} $f \leq 1\text{kHz}$	C_R	Max. dimensions w x h x l	I_{RMS} 100 kHz	ESR_{typ} 100 kHz	Ordering code (composition see below)	Ter- minal	pcs./ MOQ
V DC	V AC	nF	mm	A	m Ω			
1250	500	680	20.0 x 39.5 x 42.0	13.0	6.0	B32656S7684+563	T3	104
		680	20.0 x 39.5 x 42.0	13.0	6.0	B32656S7684+564	T4	96
		680	20.0 x 39.5 x 42.0	13.0	6.0	B32656S7684+565	T5	96
		680	20.0 x 39.5 x 42.0	13.0	6.0	B32656S7684+566	T6	96
		680	20.0 x 39.5 x 42.0	13.0	6.0	B32656S7684+577	T7	144
		820	28.0 x 37.0 x 42.0	14.0	5.5	B32656S7824+408	T8	108
		820	28.0 x 37.0 x 42.0	14.0	5.5	B32656S7824+409	T9	108
		820	28.0 x 37.0 x 42.0	14.0	5.5	B32656S7824+410	T10	80
		820	28.0 x 37.0 x 42.0	14.0	5.5	B32656S7824+411	T11	72
		820	28.0 x 37.0 x 42.0	14.0	5.5	B32656S7824+418	T18	108
		820	28.0 x 37.0 x 42.0	14.0	5.5	B32656S7824+561	T1	108
		820	28.0 x 37.0 x 42.0	14.0	5.5	B32656S7824+562	T2	108
		820	28.0 x 37.0 x 42.0	14.0	5.5	B32656S7824+563	T3	96
		820	28.0 x 37.0 x 42.0	14.0	5.5	B32656S7824+566	T6	108
		820	28.0 x 37.0 x 42.0	14.0	5.5	B32656S7824+577	T7	96
		1000	28.0 x 37.0 x 42.0	15.5	5.0	B32656S7105+408	T8	108
		1000	28.0 x 37.0 x 42.0	15.5	5.0	B32656S7105+409	T9	108
		1000	28.0 x 37.0 x 42.0	15.5	5.0	B32656S7105+410	T10	80
		1000	28.0 x 37.0 x 42.0	15.5	5.0	B32656S7105+411	T11	72
		1000	28.0 x 37.0 x 42.0	15.5	5.0	B32656S7105+418	T18	108
		1000	28.0 x 37.0 x 42.0	15.5	5.0	B32656S7105+561	T1	108
		1000	28.0 x 37.0 x 42.0	15.5	5.0	B32656S7105+562	T2	108
		1000	28.0 x 37.0 x 42.0	15.5	5.0	B32656S7105+563	T3	96
		1000	28.0 x 37.0 x 42.0	15.5	5.0	B32656S7105+566	T6	108
		1000	28.0 x 37.0 x 42.0	15.5	5.0	B32656S7105+577	T7	96
		1200	30.0 x 45.0 x 42.0	17.0	4.5	B32656S7125+408	T8	48
		1200	30.0 x 45.0 x 42.0	17.0	4.5	B32656S7125+409	T9	48
		1200	30.0 x 45.0 x 42.0	17.0	4.5	B32656S7125+410	T10	80
		1200	30.0 x 45.0 x 42.0	17.0	4.5	B32656S7125+411	T11	64
		1200	30.0 x 45.0 x 42.0	17.0	4.5	B32656S7125+418	T18	48

MOQ = Minimum Order Quantity, consisting of 4 packing units.

Further E series and intermediate capacitance values on request.

Composition of ordering code

+ = Capacitance tolerance code:

K = $\pm 10\%$

J = $\pm 5\%$

Metallized polypropylene film capacitors (MKP)
B32656S
Snubber (wound)
Ordering codes and packing units

V_R	V_{RMS} $f \leq 1\text{kHz}$	C_R	Max. dimensions w x h x l	I_{RMS} 100 kHz	ESR_{typ} 100 kHz	Ordering code (composition see below)	Ter- minal	pcs./ MOQ		
V DC	V AC	nF	mm	A	m Ω					
1250	500	1200	30.0 x 45.0 x 42.0	17.0	4.5	B32656S7125+561	T1	48		
		1200	30.0 x 45.0 x 42.0	17.0	4.5	B32656S7125+562	T2	48		
		1200	30.0 x 45.0 x 42.0	17.0	4.5	B32656S7125+563	T3	96		
		1200	30.0 x 45.0 x 42.0	17.0	4.5	B32656S7125+566	T6	48		
		1200	30.0 x 45.0 x 42.0	17.0	4.5	B32656S7125+577	T7	96		
		1500	30.0 x 45.0 x 42.0	19.0	4.0	B32656S7155+408	T8	48		
		1500	30.0 x 45.0 x 42.0	19.0	4.0	B32656S7155+409	T9	48		
		1500	30.0 x 45.0 x 42.0	19.0	4.0	B32656S7155+410	T10	80		
		1500	30.0 x 45.0 x 42.0	19.0	4.0	B32656S7155+411	T11	64		
		1500	30.0 x 45.0 x 42.0	19.0	4.0	B32656S7155+418	T18	48		
		1500	30.0 x 45.0 x 42.0	19.0	4.0	B32656S7155+561	T1	48		
		1500	30.0 x 45.0 x 42.0	19.0	4.0	B32656S7155+562	T2	48		
		1500	30.0 x 45.0 x 42.0	19.0	4.0	B32656S7155+563	T3	96		
		1500	30.0 x 45.0 x 42.0	19.0	4.0	B32656S7155+566	T6	48		
		1500	30.0 x 45.0 x 42.0	19.0	4.0	B32656S7155+577	T7	96		
		1800	33.0 x 48.0 x 43.0	22.0	3.5	B32656S7185+408	T8	84		
		1800	33.0 x 48.0 x 43.0	22.0	3.5	B32656S7185+409	T9	84		
		1800	33.0 x 48.0 x 43.0	22.0	3.5	B32656S7185+410	T10	60		
		1800	33.0 x 48.0 x 43.0	22.0	3.5	B32656S7185+411	T11	56		
		1800	33.0 x 48.0 x 43.0	22.0	3.5	B32656S7185+418	T18	84		
		1800	33.0 x 48.0 x 43.0	22.0	3.5	B32656S7185+561	T1	84		
		1800	33.0 x 48.0 x 43.0	22.0	3.5	B32656S7185+562	T2	84		
		1800	33.0 x 48.0 x 43.0	22.0	3.5	B32656S7185+563	T3	64		
		1800	33.0 x 48.0 x 43.0	22.0	3.5	B32656S7185+566	T6	84		
		1800	33.0 x 48.0 x 43.0	22.0	3.5	B32656S7185+577	T7	84		
		1700	750	120	14.0 x 25.0 x 42.0	6.5	14.0	B32656S1124+408	T8	288
				120	14.0 x 25.0 x 42.0	6.5	14.0	B32656S1124+418	T18	288
				120	14.0 x 25.0 x 42.0	6.5	14.0	B32656S1124+563	T3	168
120	14.0 x 25.0 x 42.0			6.5	14.0	B32656S1124+564	T4	288		
120	14.0 x 25.0 x 42.0			6.5	14.0	B32656S1124+565	T5	288		

MOQ = Minimum Order Quantity, consisting of 4 packing units.

Further E series and intermediate capacitance values on request.

Composition of ordering code

+ = Capacitance tolerance code:

K = $\pm 10\%$

J = $\pm 5\%$

Ordering codes and packing units

V_R	V_{RMS} $f \leq 1\text{kHz}$	C_R	Max. dimensions w x h x l	I_{RMS} 100 kHz	ESR_{typ} 100 kHz	Ordering code (composition see below)	Ter- minal	pcs./ MOQ
V DC	V AC	nF	mm	A	m Ω			
1700	750	150	14.0 x 25.0 x 42.0	7.0	13.0	B32656S1154+408	T8	288
		150	14.0 x 25.0 x 42.0	7.0	13.0	B32656S1154+418	T18	288
		150	14.0 x 25.0 x 42.0	7.0	13.0	B32656S1154+563	T3	168
		150	14.0 x 25.0 x 42.0	7.0	13.0	B32656S1154+564	T4	288
		150	14.0 x 25.0 x 42.0	7.0	13.0	B32656S1154+565	T5	288
		220	16.0 x 28.5 x 42.0	8.5	10.5	B32656S1224+408	T8	192
		220	16.0 x 28.5 x 42.0	8.5	10.5	B32656S1224+409	T9	192
		220	16.0 x 28.5 x 42.0	8.5	10.5	B32656S1224+411	T11	128
		220	16.0 x 28.5 x 42.0	8.5	10.5	B32656S1224+418	T18	192
		220	16.0 x 28.5 x 42.0	8.5	10.5	B32656S1224+561	T1	192
		220	16.0 x 28.5 x 42.0	8.5	10.5	B32656S1224+562	T2	192
		220	16.0 x 28.5 x 42.0	8.5	10.5	B32656S1224+563	T3	144
		220	16.0 x 28.5 x 42.0	8.5	10.5	B32656S1224+564	T4	192
		220	16.0 x 28.5 x 42.0	8.5	10.5	B32656S1224+565	T5	192
		220	16.0 x 28.5 x 42.0	8.5	10.5	B32656S1224+566	T6	192
		220	16.0 x 28.5 x 42.0	8.5	10.5	B32656S1224+577	T7	180
		270	18.0 x 32.5 x 42.0	9.5	9.0	B32656S1274+408	T8	140
		270	18.0 x 32.5 x 42.0	9.5	9.0	B32656S1274+409	T9	140
		270	18.0 x 32.5 x 42.0	9.5	9.0	B32656S1274+411	T11	112
		270	18.0 x 32.5 x 42.0	9.5	9.0	B32656S1274+418	T18	140
		270	18.0 x 32.5 x 42.0	9.5	9.0	B32656S1274+561	T1	140
		270	18.0 x 32.5 x 42.0	9.5	9.0	B32656S1274+562	T2	140
		270	18.0 x 32.5 x 42.0	9.5	9.0	B32656S1274+563	T3	120
		270	18.0 x 32.5 x 42.0	9.5	9.0	B32656S1274+564	T4	128
		270	18.0 x 32.5 x 42.0	9.5	9.0	B32656S1274+565	T5	128
		270	18.0 x 32.5 x 42.0	9.5	9.0	B32656S1274+566	T6	140
		270	18.0 x 32.5 x 42.0	9.5	9.0	B32656S1274+577	T7	156
		330	20.0 x 39.5 x 42.0	12.0	8.0	B32656S1334+408	T8	96
		330	20.0 x 39.5 x 42.0	12.0	8.0	B32656S1334+409	T9	96
		330	20.0 x 39.5 x 42.0	12.0	8.0	B32656S1334+410	T10	120
		330	20.0 x 39.5 x 42.0	12.0	8.0	B32656S1334+411	T11	96
		330	20.0 x 39.5 x 42.0	12.0	8.0	B32656S1334+418	T18	96
		330	20.0 x 39.5 x 42.0	12.0	8.0	B32656S1334+561	T1	96
330	20.0 x 39.5 x 42.0	12.0	8.0	B32656S1334+562	T2	96		

MOQ = Minimum Order Quantity, consisting of 4 packing units.

Further E series and intermediate capacitance values on request.

Composition of ordering code

+ = Capacitance tolerance code:

K = $\pm 10\%$

J = $\pm 5\%$

Ordering codes and packing units

V_R	V_{RMS} $f \leq 1\text{kHz}$	C_R	Max. dimensions w x h x l	I_{RMS} 100 kHz	ESR_{typ} 100 kHz	Ordering code (composition see below)	Ter- minal	pcs./ MOQ
V DC	V AC	nF	mm	A	m Ω			
1700	750	330	20.0 x 39.5 x 42.0	12.0	8.0	B32656S1334+563	T3	104
		330	20.0 x 39.5 x 42.0	12.0	8.0	B32656S1334+564	T4	96
		330	20.0 x 39.5 x 42.0	12.0	8.0	B32656S1334+565	T5	96
		330	20.0 x 39.5 x 42.0	12.0	8.0	B32656S1334+566	T6	96
		330	20.0 x 39.5 x 42.0	12.0	8.0	B32656S1334+577	T7	144
		390	28.0 x 37.0 x 42.0	13.5	7.0	B32656S1394+408	T8	108
		390	28.0 x 37.0 x 42.0	13.5	7.0	B32656S1394+409	T9	108
		390	28.0 x 37.0 x 42.0	13.5	7.0	B32656S1394+410	T10	80
		390	28.0 x 37.0 x 42.0	13.5	7.0	B32656S1394+411	T11	72
		390	28.0 x 37.0 x 42.0	13.5	7.0	B32656S1394+418	T18	108
		390	28.0 x 37.0 x 42.0	13.5	7.0	B32656S1394+561	T1	108
		390	28.0 x 37.0 x 42.0	13.5	7.0	B32656S1394+562	T2	108
		390	28.0 x 37.0 x 42.0	13.5	7.0	B32656S1394+563	T3	96
		390	28.0 x 37.0 x 42.0	13.5	7.0	B32656S1394+566	T6	108
		390	28.0 x 37.0 x 42.0	13.5	7.0	B32656S1394+577	T7	96
		470	28.0 x 37.0 x 42.0	14.5	6.0	B32656S1474+408	T8	108
		470	28.0 x 37.0 x 42.0	14.5	6.0	B32656S1474+409	T9	108
		470	28.0 x 37.0 x 42.0	14.5	6.0	B32656S1474+410	T10	72
		470	28.0 x 37.0 x 42.0	14.5	6.0	B32656S1474+411	T11	108
		470	28.0 x 37.0 x 42.0	14.5	6.0	B32656S1474+418	T18	108
		470	28.0 x 37.0 x 42.0	14.5	6.0	B32656S1474+561	T1	108
		470	28.0 x 37.0 x 42.0	14.5	6.0	B32656S1474+562	T2	108
		470	28.0 x 37.0 x 42.0	14.5	6.0	B32656S1474+563	T3	96
		470	28.0 x 37.0 x 42.0	14.5	6.0	B32656S1474+566	T6	108
		470	28.0 x 37.0 x 42.0	14.5	6.0	B32656S1474+577	T7	96
		560	30.0 x 45.0 x 42.0	16.5	5.5	B32656S1564+408	T8	48
		560	30.0 x 45.0 x 42.0	16.5	5.5	B32656S1564+409	T9	48
		560	30.0 x 45.0 x 42.0	16.5	5.5	B32656S1564+410	T10	80
		560	30.0 x 45.0 x 42.0	16.5	5.5	B32656S1564+411	T11	64
		560	30.0 x 45.0 x 42.0	16.5	5.5	B32656S1564+418	T18	48
		560	30.0 x 45.0 x 42.0	16.5	5.5	B32656S1564+561	T1	48
		560	30.0 x 45.0 x 42.0	16.5	5.5	B32656S1564+562	T2	48
		560	30.0 x 45.0 x 42.0	16.5	5.5	B32656S1564+563	T3	96
560	30.0 x 45.0 x 42.0	16.5	5.5	B32656S1564+566	T6	48		
560	30.0 x 45.0 x 42.0	16.5	5.5	B32656S1564+577	T7	96		

MOQ = Minimum Order Quantity, consisting of 4 packing units.

Further E series and intermediate capacitance values on request.

Composition of ordering code

+ = Capacitance tolerance code:

K = $\pm 10\%$

J = $\pm 5\%$

Metallized polypropylene film capacitors (MKP)
B32656S
Snubber (wound)
Ordering codes and packing units

V_R	V_{RMS} $f \leq 1\text{kHz}$	C_R	Max. dimensions $w \times h \times l$	I_{RMS} 100 kHz	ESR_{typ} 100 kHz	Ordering code (composition see below)	Ter- minal	pcs./ MOQ
V DC	V AC	nF	mm	A	m Ω			
1700	750	680	30.0 x 45.0 x 42.0	18.0	5.0	B32656S1684+408	T8	48
		680	30.0 x 45.0 x 42.0	18.0	5.0	B32656S1684+409	T9	48
		680	30.0 x 45.0 x 42.0	18.0	5.0	B32656S1684+410	T10	80
		680	30.0 x 45.0 x 42.0	18.0	5.0	B32656S1684+411	T11	64
		680	30.0 x 45.0 x 42.0	18.0	5.0	B32656S1684+418	T18	48
		680	30.0 x 45.0 x 42.0	18.0	5.0	B32656S1684+561	T1	48
		680	30.0 x 45.0 x 42.0	18.0	5.0	B32656S1684+562	T2	48
		680	30.0 x 45.0 x 42.0	18.0	5.0	B32656S1684+563	T3	96
		680	30.0 x 45.0 x 42.0	18.0	5.0	B32656S1684+566	T6	48
		680	30.0 x 45.0 x 42.0	18.0	5.0	B32656S1684+577	T7	96
		820	33.0 x 48.0 x 43.0	20.0	4.0	B32656S1824+408	T8	84
		820	33.0 x 48.0 x 43.0	20.0	4.0	B32656S1824+409	T9	84
		820	33.0 x 48.0 x 43.0	20.0	4.0	B32656S1824+410	T10	60
		820	33.0 x 48.0 x 43.0	20.0	4.0	B32656S1824+411	T11	56
		820	33.0 x 48.0 x 43.0	20.0	4.0	B32656S1824+418	T18	84
		820	33.0 x 48.0 x 43.0	20.0	4.0	B32656S1824+561	T1	84
		820	33.0 x 48.0 x 43.0	20.0	4.0	B32656S1824+562	T2	84
		820	33.0 x 48.0 x 43.0	20.0	4.0	B32656S1824+563	T3	64
		820	33.0 x 48.0 x 43.0	20.0	4.0	B32656S1824+566	T6	84
		820	33.0 x 48.0 x 43.0	20.0	4.0	B32656S1824+577	T7	84
2000	800	68	14.0 x 25.0 x 42.0	6.0	17.0	B32656S2683+408	T8	288
		68	14.0 x 25.0 x 42.0	6.0	17.0	B32656S2683+418	T18	288
		68	14.0 x 25.0 x 42.0	6.0	17.0	B32656S2683+563	T3	168
		68	14.0 x 25.0 x 42.0	6.0	17.0	B32656S2683+564	T4	288
		68	14.0 x 25.0 x 42.0	6.0	17.0	B32656S2683+565	T5	288
		100	14.0 x 25.0 x 42.0	6.5	15.0	B32656S2104+408	T8	288
		100	14.0 x 25.0 x 42.0	6.5	15.0	B32656S2104+418	T18	288
		100	14.0 x 25.0 x 42.0	6.5	15.0	B32656S2104+563	T3	168
		100	14.0 x 25.0 x 42.0	6.5	15.0	B32656S2104+564	T4	288
		100	14.0 x 25.0 x 42.0	6.5	15.0	B32656S2104+565	T5	288
		120	16.0 x 28.5 x 42.0	7.0	14.0	B32656S2124+408	T8	192
		120	16.0 x 28.5 x 42.0	7.0	14.0	B32656S2124+409	T9	192
		120	16.0 x 28.5 x 42.0	7.0	14.0	B32656S2124+411	T11	128
		120	16.0 x 28.5 x 42.0	7.0	14.0	B32656S2124+418	T18	192

MOQ = Minimum Order Quantity, consisting of 4 packing units.

Further E series and intermediate capacitance values on request.

Composition of ordering code

+ = Capacitance tolerance code:

K = $\pm 10\%$

J = $\pm 5\%$

Metallized polypropylene film capacitors (MKP)
B32656S
Snubber (wound)
Ordering codes and packing units

V _R	V _{RMS} f ≤ 1kHz	C _R	Max. dimensions w x h x l	I _{RMS} 100 kHz	ESR _{typ} 100 kHz	Ordering code (composition see below)	Ter- minal	pcs./ MOQ
V DC	V AC	nF	mm	A	mΩ			
2000	800	120	16.0 x 28.5 x 42.0	7.0	14.0	B32656S2124+561	T1	192
		120	16.0 x 28.5 x 42.0	7.0	14.0	B32656S2124+562	T2	192
		120	16.0 x 28.5 x 42.0	7.0	14.0	B32656S2124+563	T3	144
		120	16.0 x 28.5 x 42.0	7.0	14.0	B32656S2124+564	T4	192
		120	16.0 x 28.5 x 42.0	7.0	14.0	B32656S2124+565	T5	192
		120	16.0 x 28.5 x 42.0	7.0	14.0	B32656S2124+566	T6	192
		120	16.0 x 28.5 x 42.0	7.0	14.0	B32656S2124+577	T7	180
		150	18.0 x 32.5 x 42.0	8.0	13.0	B32656S2154+408	T8	140
		150	18.0 x 32.5 x 42.0	8.0	13.0	B32656S2154+409	T9	140
		150	18.0 x 32.5 x 42.0	8.0	13.0	B32656S2154+411	T11	112
		150	18.0 x 32.5 x 42.0	8.0	13.0	B32656S2154+418	T18	140
		150	18.0 x 32.5 x 42.0	8.0	13.0	B32656S2154+561	T1	140
		150	18.0 x 32.5 x 42.0	8.0	13.0	B32656S2154+562	T2	140
		150	18.0 x 32.5 x 42.0	8.0	13.0	B32656S2154+563	T3	120
		150	18.0 x 32.5 x 42.0	8.0	13.0	B32656S2154+564	T4	128
		150	18.0 x 32.5 x 42.0	8.0	13.0	B32656S2154+565	T5	128
		150	18.0 x 32.5 x 42.0	8.0	13.0	B32656S2154+566	T6	140
		150	18.0 x 32.5 x 42.0	8.0	13.0	B32656S2154+577	T7	156
		220	20.0 x 39.5 x 42.0	11.0	9.0	B32656S2224+408	T8	96
		220	20.0 x 39.5 x 42.0	11.0	9.0	B32656S2224+409	T9	96
		220	20.0 x 39.5 x 42.0	11.0	9.0	B32656S2224+410	T10	120
		220	20.0 x 39.5 x 42.0	11.0	9.0	B32656S2224+411	T11	96
		220	20.0 x 39.5 x 42.0	11.0	9.0	B32656S2224+418	T18	96
		220	20.0 x 39.5 x 42.0	11.0	9.0	B32656S2224+561	T1	96
		220	20.0 x 39.5 x 42.0	11.0	9.0	B32656S2224+562	T2	96
		220	20.0 x 39.5 x 42.0	11.0	9.0	B32656S2224+563	T3	104
		220	20.0 x 39.5 x 42.0	11.0	9.0	B32656S2224+564	T4	96
		220	20.0 x 39.5 x 42.0	11.0	9.0	B32656S2224+565	T5	96
		220	20.0 x 39.5 x 42.0	11.0	9.0	B32656S2224+566	T6	96
		220	20.0 x 39.5 x 42.0	11.0	9.0	B32656S2224+577	T7	144
		270	28.0 x 37.0 x 42.0	12.5	8.0	B32656S2274+408	T8	108
		270	28.0 x 37.0 x 42.0	12.5	8.0	B32656S2274+409	T9	108
		270	28.0 x 37.0 x 42.0	12.5	8.0	B32656S2274+410	T10	80
		270	28.0 x 37.0 x 42.0	12.5	8.0	B32656S2274+411	T11	72

MOQ = Minimum Order Quantity, consisting of 4 packing units.

Further E series and intermediate capacitance values on request.

Composition of ordering code

+ = Capacitance tolerance code:

K = ±10%

J = ±5%

Metallized polypropylene film capacitors (MKP)
B32656S
Snubber (wound)
Ordering codes and packing units

V_R	V_{RMS} $f \leq 1\text{kHz}$	C_R	Max. dimensions $w \times h \times l$	I_{RMS} 100 kHz	ESR_{typ} 100 kHz	Ordering code (composition see below)	Ter- minal	pcs./ MOQ
V DC	V AC	nF	mm	A	m Ω			
2000	800	270	28.0 x 37.0 x 42.0	12.5	8.0	B32656S2274+418	T18	108
		270	28.0 x 37.0 x 42.0	12.5	8.0	B32656S2274+561	T1	108
		270	28.0 x 37.0 x 42.0	12.5	8.0	B32656S2274+562	T2	108
		270	28.0 x 37.0 x 42.0	12.5	8.0	B32656S2274+563	T3	96
		270	28.0 x 37.0 x 42.0	12.5	8.0	B32656S2274+566	T6	108
		270	28.0 x 37.0 x 42.0	12.5	8.0	B32656S2274+577	T7	96
		330	28.0 x 37.0 x 42.0	14.0	6.5	B32656S2334+408	T8	108
		330	28.0 x 37.0 x 42.0	14.0	6.5	B32656S2334+409	T9	108
		330	28.0 x 37.0 x 42.0	14.0	6.5	B32656S2334+410	T10	80
		330	28.0 x 37.0 x 42.0	14.0	6.5	B32656S2334+411	T11	72
		330	28.0 x 37.0 x 42.0	14.0	6.5	B32656S2334+418	T18	108
		330	28.0 x 37.0 x 42.0	14.0	6.5	B32656S2334+561	T1	108
		330	28.0 x 37.0 x 42.0	14.0	6.5	B32656S2334+562	T2	108
		330	28.0 x 37.0 x 42.0	14.0	6.5	B32656S2334+563	T3	96
		330	28.0 x 37.0 x 42.0	14.0	6.5	B32656S2334+566	T6	108
		330	28.0 x 37.0 x 42.0	14.0	6.5	B32656S2334+577	T7	96
		390	30.0 x 45.0 x 42.0	15.0	6.5	B32656S2394+408	T8	48
		390	30.0 x 45.0 x 42.0	15.0	6.5	B32656S2394+409	T9	48
		390	30.0 x 45.0 x 42.0	15.0	6.5	B32656S2394+410	T10	80
		390	30.0 x 45.0 x 42.0	15.0	6.5	B32656S2394+411	T11	64
		390	30.0 x 45.0 x 42.0	15.0	6.5	B32656S2394+418	T18	48
		390	30.0 x 45.0 x 42.0	15.0	6.5	B32656S2394+561	T1	48
		390	30.0 x 45.0 x 42.0	15.0	6.5	B32656S2394+562	T2	48
		390	30.0 x 45.0 x 42.0	15.0	6.5	B32656S2394+563	T3	96
		390	30.0 x 45.0 x 42.0	15.0	6.5	B32656S2394+566	T6	48
		390	30.0 x 45.0 x 42.0	15.0	6.5	B32656S2394+577	T7	96
		470	30.0 x 45.0 x 42.0	17.0	5.5	B32656S2474+408	T8	48
		470	30.0 x 45.0 x 42.0	17.0	5.5	B32656S2474+409	T9	48
		470	30.0 x 45.0 x 42.0	17.0	5.5	B32656S2474+410	T10	80
		470	30.0 x 45.0 x 42.0	17.0	5.5	B32656S2474+411	T11	64
		470	30.0 x 45.0 x 42.0	17.0	5.5	B32656S2474+418	T18	48
		470	30.0 x 45.0 x 42.0	17.0	5.5	B32656S2474+561	T1	48
		470	30.0 x 45.0 x 42.0	17.0	5.5	B32656S2474+562	T2	48

MOQ = Minimum Order Quantity, consisting of 4 packing units.

Further E series and intermediate capacitance values on request.

Composition of ordering code

+ = Capacitance tolerance code:

K = $\pm 10\%$

J = $\pm 5\%$

Ordering codes and packing units

V_R	V_{RMS} $f \leq 1\text{kHz}$	C_R	Max. dimensions w x h x l	I_{RMS} 100 kHz	ESR_{typ} 100 kHz	Ordering code (composition see below)	Ter- minal	pcs./ MOQ
V DC	V AC	nF	mm	A	m Ω			
2000	800	470	30.0 x 45.0 x 42.0	17.0	5.5	B32656S2474+563	T3	96
		470	30.0 x 45.0 x 42.0	17.0	5.5	B32656S2474+566	T6	48
		470	30.0 x 45.0 x 42.0	17.0	5.5	B32656S2474+577	T7	96
		560	33.0 x 48.0 x 43.0	19.0	4.5	B32656S2564+408	T8	84
		560	33.0 x 48.0 x 43.0	19.0	4.5	B32656S2564+409	T9	84
		560	33.0 x 48.0 x 43.0	19.0	4.5	B32656S2564+410	T10	60
		560	33.0 x 48.0 x 43.0	19.0	4.5	B32656S2564+411	T11	56
		560	33.0 x 48.0 x 43.0	19.0	4.5	B32656S2564+418	T18	84
		560	33.0 x 48.0 x 43.0	19.0	4.5	B32656S2564+561	T1	84
		560	33.0 x 48.0 x 43.0	19.0	4.5	B32656S2564+562	T2	84
		560	33.0 x 48.0 x 43.0	19.0	4.5	B32656S2564+563	T3	64
		560	33.0 x 48.0 x 43.0	19.0	4.5	B32656S2564+566	T6	84
		560	33.0 x 48.0 x 43.0	19.0	4.5	B32656S2564+577	T7	84

MOQ = Minimum Order Quantity, consisting of 4 packing units.

Further E series and intermediate capacitance values on request.

Composition of ordering code

+ = Capacitance tolerance code:

K = ± 10

J = $\pm 5\%$

Metallized polypropylene film capacitors (MKP)
B32658S
Snubber (wound)
Ordering codes and packing units

V_R	V_{RMS} $f \leq 1\text{kHz}$	C_R	Max. dimensions w x h x l	I_{RMS} 100 kHz	ESR_{typ} 100 kHz	Ordering code (composition see below)	Ter- minal	pcs./ MOQ
V DC	V AC	nF	mm	A	m Ω			
850	450	1500	22.5 x 33.0 x 57.5	12.0	7.0	B32658S8155+414	T14	88
		1500	22.5 x 33.0 x 57.5	12.0	7.0	B32658S8155+416	T16	88
		1800	22.5 x 33.0 x 57.5	13.0	6.5	B32658S8185+414	T14	88
		1800	22.5 x 33.0 x 57.5	13.0	6.5	B32658S8185+416	T16	88
		2200	22.5 x 33.0 x 57.5	14.5	5.5	B32658S8225+414	T14	88
		2200	22.5 x 33.0 x 57.5	14.5	5.5	B32658S8225+416	T16	88
		2700	27.0 x 39.5 x 57.5	18.0	5.0	B32658S8275+414	T14	72
		2700	27.0 x 39.5 x 57.5	18.0	5.0	B32658S8275+415	T15	72
		2700	27.0 x 39.5 x 57.5	18.0	5.0	B32658S8275+416	T16	72
		2700	27.0 x 39.5 x 57.5	18.0	5.0	B32658S8275+417	T17	72
		3000	27.0 x 39.5 x 57.5	19.0	4.5	B32658S8305+414	T14	72
		3000	27.0 x 39.5 x 57.5	19.0	4.5	B32658S8305+415	T15	72
		3000	27.0 x 39.5 x 57.5	19.0	4.5	B32658S8305+416	T16	72
		3000	27.0 x 39.5 x 57.5	19.0	4.5	B32658S8305+417	T17	72
		3300	27.0 x 39.5 x 57.5	19.0	4.5	B32658S8335K414	T14	72
		3300	27.0 x 39.5 x 57.5	19.0	4.5	B32658S8335K415	T15	72
		3300	27.0 x 39.5 x 57.5	19.0	4.5	B32658S8335K416	T16	72
		3300	27.0 x 39.5 x 57.5	19.0	4.5	B32658S8335K417	T17	72
		4000	30.0 x 45.0 x 57.5	21.0	4.0	B32658S8405+414	T14	64
		4000	30.0 x 45.0 x 57.5	21.0	4.0	B32658S8405+415	T15	64
		4000	30.0 x 45.0 x 57.5	21.0	4.0	B32658S8405+416	T16	64
		4000	30.0 x 45.0 x 57.5	21.0	4.0	B32658S8405+417	T17	64
		4500	30.0 x 45.0 x 57.5	22.0	3.7	B32658S8455+414	T14	64
		4500	30.0 x 45.0 x 57.5	22.0	3.7	B32658S8455+415	T15	64
		4500	30.0 x 45.0 x 57.5	22.0	3.7	B32658S8455+416	T16	64
		4500	30.0 x 45.0 x 57.5	22.0	3.7	B32658S8455+417	T17	64
		4700	35.0 x 50.0 x 57.5	23.0	3.5	B32658S8475+414	T14	56
		4700	35.0 x 50.0 x 57.5	23.0	3.5	B32658S8475+415	T15	56
		4700	35.0 x 50.0 x 57.5	23.0	3.5	B32658S8475+416	T16	56
		4700	35.0 x 50.0 x 57.5	23.0	3.5	B32658S8475+417	T17	56

MOQ = Minimum Order Quantity, consisting of 4 packing units.

Further E series and intermediate capacitance values on request.

Composition of ordering code

+ = Capacitance tolerance code:

K = $\pm 10\%$

J = $\pm 5\%$

Metallized polypropylene film capacitors (MKP)
B32658S
Snubber (wound)
Ordering codes and packing units

V_R	V_{RMS} $f \leq 1\text{kHz}$	C_R	Max. dimensions w x h x l	I_{RMS} 100 kHz	ESR_{typ} 100 kHz	Ordering code (composition see below)	Ter- minal	pcs./ MOQ
V DC	V AC	nF	mm	A	m Ω			
850	450	5000	35.0 x 50.0 x 57.5	24.0	3.2	B32658S8505+414	T14	56
		5000	35.0 x 50.0 x 57.5	24.0	3.2	B32658S8505+415	T15	56
		5000	35.0 x 50.0 x 57.5	24.0	3.2	B32658S8505+416	T16	56
		5000	35.0 x 50.0 x 57.5	24.0	3.2	B32658S8505+417	T17	56
		5600	35.0 x 50.0 x 57.5	27.0	2.8	B32658S8565+414	T14	56
		5600	35.0 x 50.0 x 57.5	27.0	2.8	B32658S8565+415	T15	56
		5600	35.0 x 50.0 x 57.5	27.0	2.8	B32658S8565+416	T16	56
		5600	35.0 x 50.0 x 57.5	27.0	2.8	B32658S8565+417	T17	56
1000	480	1000	22.5 x 33.0 x 57.5	11.0	8.0	B32658S0105+414	T14	88
		1000	22.5 x 33.0 x 57.5	11.0	8.0	B32658S0105+416	T16	88
		1500	22.5 x 33.0 x 57.5	13.5	6.5	B32658S0155+414	T14	88
		1500	22.5 x 33.0 x 57.5	13.5	6.5	B32658S0155+416	T16	88
		1800	27.0 x 39.5 x 57.5	15.5	6.0	B32658S0185+414	T14	72
		1800	27.0 x 39.5 x 57.5	15.5	6.0	B32658S0185+415	T15	72
		1800	27.0 x 39.5 x 57.5	15.5	6.0	B32658S0185+416	T16	72
		1800	27.0 x 39.5 x 57.5	15.5	6.0	B32658S0185+417	T17	72
		2200	27.0 x 39.5 x 57.5	17.0	5.0	B32658S0225+414	T14	72
		2200	27.0 x 39.5 x 57.5	17.0	5.0	B32658S0225+415	T15	72
		2200	27.0 x 39.5 x 57.5	17.0	5.0	B32658S0225+416	T16	72
		2200	27.0 x 39.5 x 57.5	17.0	5.0	B32658S0225+417	T17	72
		2700	30.0 x 45.0 x 57.5	20.0	4.5	B32658S0275+414	T14	64
		2700	30.0 x 45.0 x 57.5	20.0	4.5	B32658S0275+415	T15	64
		2700	30.0 x 45.0 x 57.5	20.0	4.5	B32658S0275+416	T16	64
		2700	30.0 x 45.0 x 57.5	20.0	4.5	B32658S0275+417	T17	64
		3000	30.0 x 45.0 x 57.5	21.0	4.0	B32658S0305+414	T14	64
		3000	30.0 x 45.0 x 57.5	21.0	4.0	B32658S0305+415	T15	64
		3000	30.0 x 45.0 x 57.5	21.0	4.0	B32658S0305+416	T16	64
		3000	30.0 x 45.0 x 57.5	21.0	4.0	B32658S0305+417	T17	64
3300	35.0 x 50.0 x 57.5	22.0	4.0	B32658S0335+414	T14	56		
3300	35.0 x 50.0 x 57.5	22.0	4.0	B32658S0335+415	T15	56		
3300	35.0 x 50.0 x 57.5	22.0	4.0	B32658S0335+416	T16	56		
3300	35.0 x 50.0 x 57.5	22.0	4.0	B32658S0335+417	T17	56		

MOQ = Minimum Order Quantity, consisting of 4 packing units.

Further E series and intermediate capacitance values on request.

Composition of ordering code

+ = Capacitance tolerance code:

K = $\pm 10\%$

J = $\pm 5\%$

Metallized polypropylene film capacitors (MKP)
B32658S
Snubber (wound)
Ordering codes and packing units

V_R	V_{RMS} $f \leq 1\text{kHz}$	C_R	Max. dimensions w x h x l	I_{RMS} 100 kHz	ESR_{typ} 100 kHz	Ordering code (composition see below)	Ter- minal	pcs./ MOQ
V DC	V AC	nF	mm	A	m Ω			
1000	480	4000	35.0 x 50.0 x 57.5	24.0	3.5	B32658S0405+414	T14	56
		4000	35.0 x 50.0 x 57.5	24.0	3.5	B32658S0405+415	T15	56
		4000	35.0 x 50.0 x 57.5	24.0	3.5	B32658S0405+416	T16	56
		4000	35.0 x 50.0 x 57.5	24.0	3.5	B32658S0405+417	T17	56
		4200	35.0 x 50.0 x 57.5	24.0	3.5	B32658S0425+414	T14	56
		4200	35.0 x 50.0 x 57.5	24.0	3.5	B32658S0425+415	T15	56
		4200	35.0 x 50.0 x 57.5	24.0	3.5	B32658S0425+416	T16	56
		4200	35.0 x 50.0 x 57.5	24.0	3.5	B32658S0425+417	T17	56
1250	500	820	22.5 x 33.0 x 57.5	11.5	7.5	B32658S7824+414	T14	88
		820	22.5 x 33.0 x 57.5	11.5	7.5	B32658S7824+416	T16	88
		1000	22.5 x 33.0 x 57.5	12.5	7.0	B32658S7105+414	T14	88
		1000	22.5 x 33.0 x 57.5	12.5	7.0	B32658S7105+416	T16	88
		1200	27.0 x 39.5 x 57.5	14.5	7.0	B32658S7125+414	T14	72
		1200	27.0 x 39.5 x 57.5	14.5	7.0	B32658S7125+415	T15	72
		1200	27.0 x 39.5 x 57.5	14.5	7.0	B32658S7125+416	T16	72
		1200	27.0 x 39.5 x 57.5	14.5	7.0	B32658S7125+417	T17	72
		1500	27.0 x 39.5 x 57.5	15.0	6.5	B32658S7155+414	T14	72
		1500	27.0 x 39.5 x 57.5	15.0	6.5	B32658S7155+415	T15	72
		1500	27.0 x 39.5 x 57.5	15.0	6.5	B32658S7155+416	T16	72
		1500	27.0 x 39.5 x 57.5	15.0	6.5	B32658S7155+417	T17	72
		1800	27.0 x 39.5 x 57.5	16.5	5.5	B32658S7185+414	T14	72
		1800	27.0 x 39.5 x 57.5	16.5	5.5	B32658S7185+415	T15	72
		1800	27.0 x 39.5 x 57.5	16.5	5.5	B32658S7185+416	T16	72
		1800	27.0 x 39.5 x 57.5	16.5	5.5	B32658S7185+417	T17	72
		2200	30.0 x 45.0 x 57.5	19.0	4.7	B32658S7225+414	T14	64
		2200	30.0 x 45.0 x 57.5	19.0	4.7	B32658S7225+415	T15	64
		2200	30.0 x 45.0 x 57.5	19.0	4.7	B32658S7225+416	T16	64
		2200	30.0 x 45.0 x 57.5	19.0	4.7	B32658S7225+417	T17	64
2700	35.0 x 50.0 x 57.5	22.0	4.0	B32658S7275+414	T14	56		
2700	35.0 x 50.0 x 57.5	22.0	4.0	B32658S7275+415	T15	56		
2700	35.0 x 50.0 x 57.5	22.0	4.0	B32658S7275+416	T16	56		
2700	35.0 x 50.0 x 57.5	22.0	4.0	B32658S7275+417	T17	56		

MOQ = Minimum Order Quantity, consisting of 4 packing units.

Further E series and intermediate capacitance values on request.

Composition of ordering code

+ = Capacitance tolerance code:

K = $\pm 10\%$

J = $\pm 5\%$

Metallized polypropylene film capacitors (MKP)
B32658S
Snubber (wound)
Ordering codes and packing units

V_R	V_{RMS} $f \leq 1\text{kHz}$	C_R	Max. dimensions w x h x l	I_{RMS} 100 kHz	ESR_{typ} 100 kHz	Ordering code (composition see below)	Ter- minal	pcs./ MOQ
V DC	V AC	nF	mm	A	m Ω			
1250	500	3000	35.0 x 50.0 x 57.5	24.0	3.5	B32658S7305+414	T14	56
		3000	35.0 x 50.0 x 57.5	24.0	3.5	B32658S7305+415	T15	56
		3000	35.0 x 50.0 x 57.5	24.0	3.5	B32658S7305+416	T16	56
		3000	35.0 x 50.0 x 57.5	24.0	3.5	B32658S7305+417	T17	56
1700	750	470	22.5 x 33.0 x 57.5	11.5	9.0	B32658S1474+414	T14	88
		470	22.5 x 33.0 x 57.5	11.5	9.0	B32658S1474+416	T16	88
		680	27.0 x 39.5 x 57.5	14.5	7.5	B32658S1684+414	T14	72
		680	27.0 x 39.5 x 57.5	14.5	7.5	B32658S1684+415	T15	72
		680	27.0 x 39.5 x 57.5	14.5	7.5	B32658S1684+416	T16	72
		680	27.0 x 39.5 x 57.5	14.5	7.5	B32658S1684+417	T17	72
		1000	30.0 x 45.0 x 57.5	16.5	6.7	B32658S1105+414	T14	64
		1000	30.0 x 45.0 x 57.5	16.5	6.7	B32658S1105+415	T15	64
		1000	30.0 x 45.0 x 57.5	16.5	6.7	B32658S1105+416	T16	64
		1000	30.0 x 45.0 x 57.5	16.5	6.7	B32658S1105+417	T17	64
		1200	35.0 x 50.0 x 57.5	18.5	6.2	B32658S1125+414	T14	56
		1200	35.0 x 50.0 x 57.5	18.5	6.2	B32658S1125+415	T15	56
		1200	35.0 x 50.0 x 57.5	18.5	6.2	B32658S1125+416	T16	56
		1200	35.0 x 50.0 x 57.5	18.5	6.2	B32658S1125+417	T17	56
		1400	35.0 x 50.0 x 57.5	20.0	5.5	B32658S1145+414	T14	56
		1400	35.0 x 50.0 x 57.5	20.0	5.5	B32658S1145+415	T15	56
1400	35.0 x 50.0 x 57.5	20.0	5.5	B32658S1145+416	T16	56		
1400	35.0 x 50.0 x 57.5	20.0	5.5	B32658S1145+417	T17	56		
2000	800	330	22.5 x 33.0 x 57.5	11.5	9.0	B32658S2334+414	T14	88
		330	22.5 x 33.0 x 57.5	11.5	9.0	B32658S2334+416	T16	88
		470	27.0 x 39.5 x 57.5	14.0	8.0	B32658S2474+414	T14	72
		470	27.0 x 39.5 x 57.5	14.0	8.0	B32658S2474+415	T15	72
		470	27.0 x 39.5 x 57.5	14.0	8.0	B32658S2474+416	T16	72
		470	27.0 x 39.5 x 57.5	14.0	8.0	B32658S2474+417	T17	72
		680	30.0 x 45.0 x 57.5	16.5	7.0	B32658S2684+414	T14	64
		680	30.0 x 45.0 x 57.5	16.5	7.0	B32658S2684+415	T15	64
		680	30.0 x 45.0 x 57.5	16.5	7.0	B32658S2684+416	T16	64
		680	30.0 x 45.0 x 57.5	16.5	7.0	B32658S2684+417	T17	64

MOQ = Minimum Order Quantity, consisting of 4 packing units.

Further E series and intermediate capacitance values on request.

Composition of ordering code

+ = Capacitance tolerance code:

K = $\pm 10\%$

J = $\pm 5\%$

Metallized polypropylene film capacitors (MKP)
B32658S
Snubber (wound)
Ordering codes and packing units

V_R	V_{RMS} $f \leq 1\text{kHz}$	C_R	Max. dimensions w x h x l	I_{RMS} 100 kHz	ESR_{typ} 100 kHz	Ordering code (composition see below)	Ter- minal	pcs./ MOQ
V DC	V AC	nF	mm	A	m Ω			
2000	800	820	35.0 x 50.0 x 57.5	18.0	6.5	B32658S2824+414	T14	56
		820	35.0 x 50.0 x 57.5	18.0	6.5	B32658S2824+415	T15	56
		820	35.0 x 50.0 x 57.5	18.0	6.5	B32658S2824+416	T16	56
		820	35.0 x 50.0 x 57.5	18.0	6.5	B32658S2824+417	T17	56
		900	35.0 x 50.0 x 57.5	19.0	6.0	B32658S2904+414	T14	56
		900	35.0 x 50.0 x 57.5	19.0	6.0	B32658S2904+415	T15	56
		900	35.0 x 50.0 x 57.5	19.0	6.0	B32658S2904+416	T16	56
		900	35.0 x 50.0 x 57.5	19.0	6.0	B32658S2904+417	T17	56

MOQ = Minimum Order Quantity, consisting of 4 packing units.

Further E series and intermediate capacitance values on request.

Composition of ordering code

+ = Capacitance tolerance code:

K = $\pm 10\%$

J = $\pm 5\%$

Metallized polypropylene film capacitors (MKP)
B32656S, B32658S
Snubber (wound)
Technical data

Reference standard: IEC 60384-16:2005 and AEC-Q200D. All data given at T = 20 °C, unless otherwise specified.

Operating temperature range	Max. operating temperature $T_{op,max}$ +110 °C Upper category temperature T_{max} +100 °C Lower category temperature T_{min} -55 °C Rated temperature T_R +85 °C			
Dissipation factor $\tan \delta$ (in 10^{-3}) at 20 °C (upper limit values)	at	$C_R \leq 0.1 \mu F$	$0.1 \mu F < C_R \leq 1 \mu F$	$C_R > 1 \mu F$
	1 kHz	–	0.5	0.5
	10 kHz	–	0.8	1.5
	100 kHz	5.0	–	–
Insulation resistance R_{ins} or time constant $\tau = C_R \cdot R_{ins}$ at 20 °C, rel. humidity $\leq 65\%$ (minimum as-delivered values)	$C_R \leq 0.33 \mu F$		$C_R > 0.33 \mu F$	
	100 G Ω		30000 s	
DC test voltage	$1.6 \cdot V_R$, 2 s			
Category voltage V_C (continuous operation with V_{DC} or V_{AC} at $f \leq 1$ kHz)	T_{op} (°C)	DC voltage derating	AC voltage derating	
	$T_{op} \leq 85$ $85 < T_{op} \leq 110$	$V_C = V_R$ $V_C = V_R \cdot (165 - T_{op}) / 80$	$V_{C,RMS} = V_{RMS}$ $V_{C,RMS} = V_{RMS} \cdot (165 - T_{op}) / 80$	
Operating voltage V_{op} for short operating periods (V_{DC} or V_{AC} at $f \leq 1$ kHz)	T_{op} (°C)	DC voltage (max. hours)	AC voltage (max. hours)	
	$T_{op} \leq 85$ $85 < T_{op} \leq 100$	$V_{op} = 1.25 \cdot V_C$ (2000 h) $V_{op} = 1.25 \cdot V_C$ (1000 h)	$V_{op} = 1.0 \cdot V_{C,RMS}$ (2000 h) $V_{op} = 1.0 \cdot V_{C,RMS}$ (1000 h)	
Biased humidity	1000 h / 40 °C / 93% relative humidity with $V_{R,DC}$			
Limit values after biased humidity test	Capacitance change $ \Delta C/C $		$\leq 3\%$	
	Dissipation factor change		$\leq 0.5 \cdot 10^{-3}$ (at 1 kHz) $\leq 1.0 \cdot 10^{-3}$ (at 10 kHz)	
Reliability: Failure rate λ Service life t_{SL}	1000 h / 40 °C / 93% relative humidity with $V_{R,DC}$			
	1 fit ($\leq 1 \cdot 10^{-9}/h$) at $0.5 \cdot V_R$, 40 °C 200 000 h at $1.0 \cdot V_R$, $T_{op} = 85$ °C Considered self heating for this product family is 15 °C. For conversion to other operating conditions and temperatures, refer to chapter "Quality, 2 Reliability".			
Failure criteria: Total failure Failure due to variation of parameters	Insulation resistance R_{ins} or time constant $\tau = C_R \cdot R_{ins}$		$\geq 50\%$ of minimum as-delivered values	
	Short circuit or open circuit			
	Capacitance change $ \Delta C/C $		$> 10\%$	
	Dissipation factor $\tan \delta$		$> 4 \cdot$ upper limit value	
	Insulation resistance R_{ins} or time constant $\tau = C_R \cdot R_{ins}$		$< 1500 M\Omega$ ($C_R \leq 0.33 \mu F$) $< 500 s$ ($C_R > 0.33 \mu F$)	

Pulse handling capability

"dV/dt" represents the maximum permissible voltage change per unit of time for non-sinusoidal voltages, expressed in V/ μ s.

"k₀" represents the maximum permissible pulse characteristic of the waveform applied to the capacitor, expressed in V²/ μ s.

Note:

The values of dV/dt and k₀ provided below must not be exceeded in order to avoid damaging the capacitor.

dV/dt and k₀ values B32656S

V _R (V DC)	V _{RMS} (V AC)	dV/dt in V/ μ s	k ₀ in V ² / μ s
850	450	400	680 000
1000	480	450	900 000
1250	500	500	1 250 000
1700	750	600	1 920 000
2000	800	700	2 800 000

dV/dt and k₀ values B32658S

V _R (V DC)	V _{RMS} (V AC)	dV/dt in V/ μ s	k ₀ in V ² / μ s
850	450	275	467 500
1000	480	300	600 000
1250	500	350	875 000
1700	750	400	1 360 000
2000	800	475	1 900 000

Impedance Z versus frequency f
(typical values)

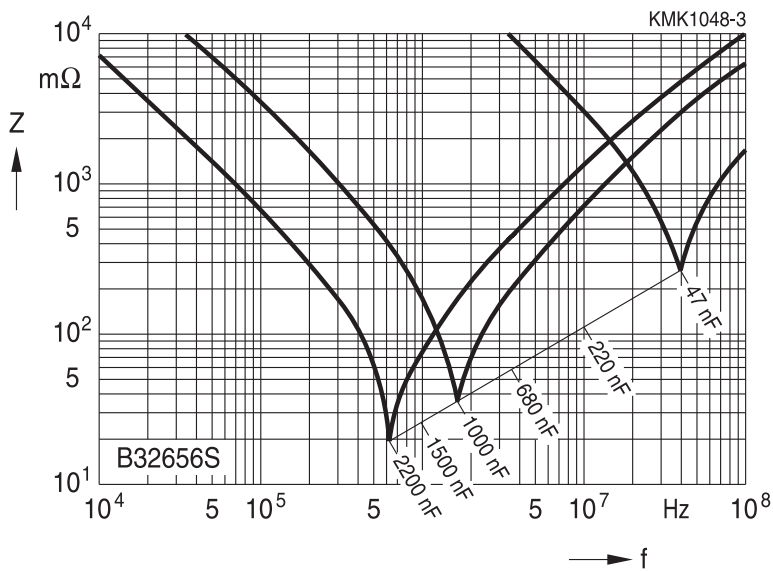

Permissible AC voltage V_{RMS} versus frequency f (for sinusoidal waveforms, $T_A \leq 90\text{ }^\circ\text{C}$)

 For $T_A > 90\text{ }^\circ\text{C}$, please refer to "General technical information", section 3.2.3.

850 V DC/450 V AC

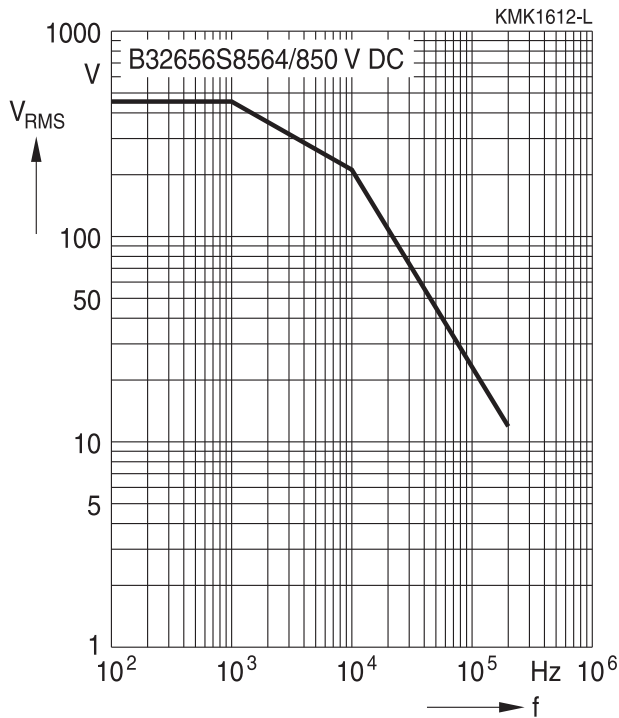

850 V DC/450 V AC

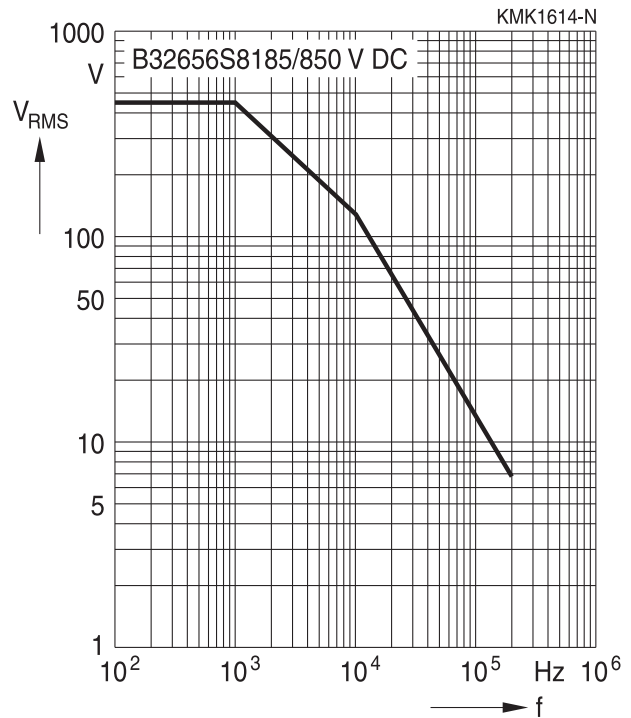

850 V DC/450 V AC

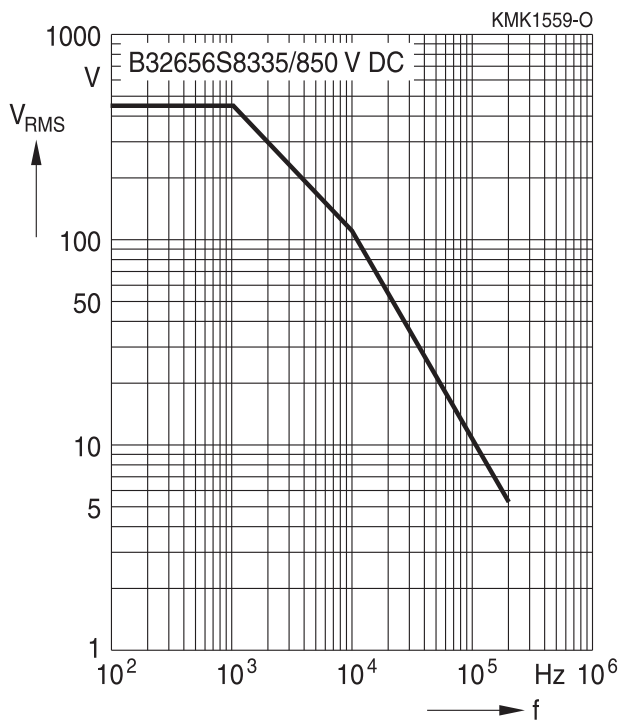

Permissible AC voltage V_{RMS} versus frequency f (for sinusoidal waveforms, $T_A \leq 90\text{ }^\circ\text{C}$)

For $T_A > 90\text{ }^\circ\text{C}$, please refer to "General technical information", section 3.2.3.

1000 V DC/480 V AC

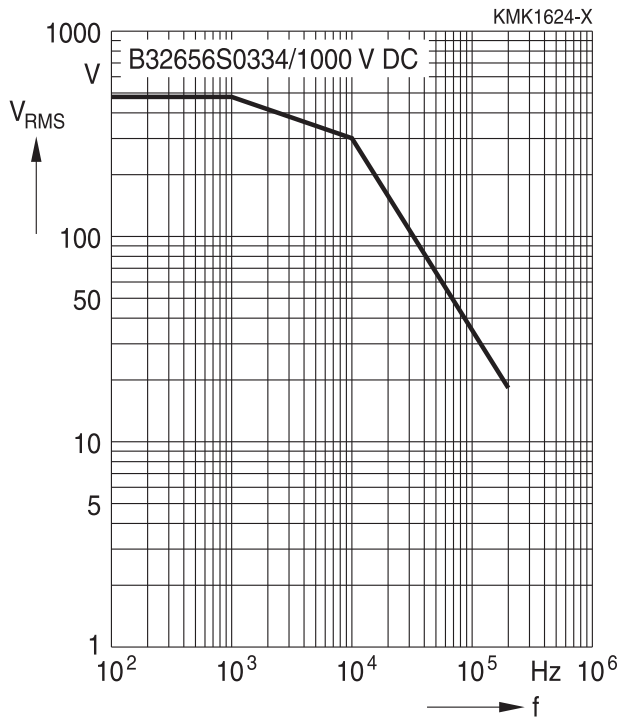

1000 V DC/480 V AC

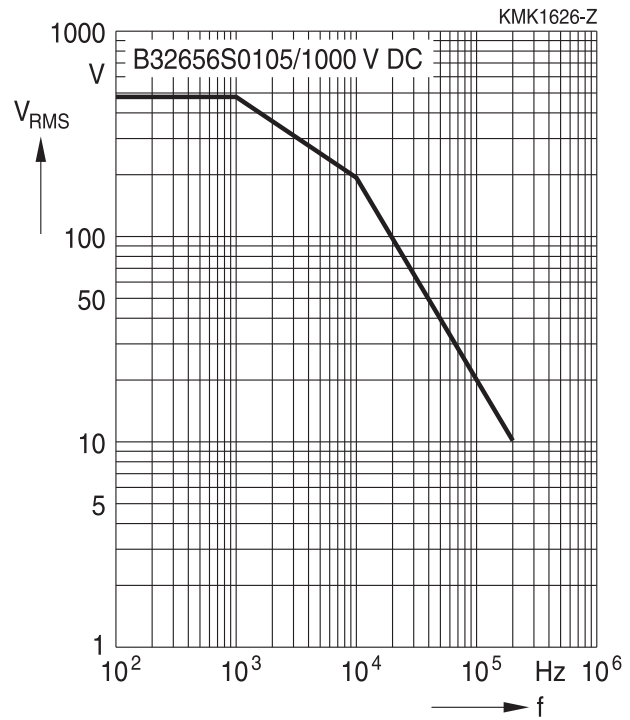

1000 V DC/480 V AC

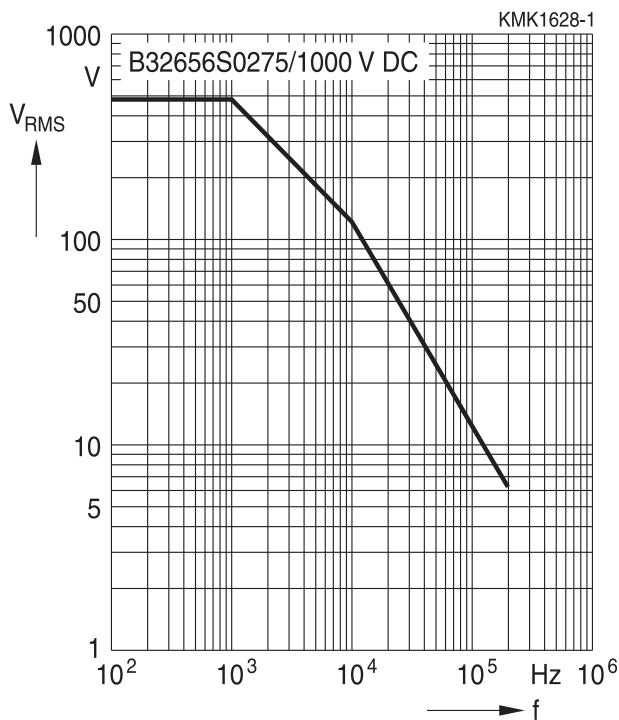

Permissible AC voltage V_{RMS} versus frequency f (for sinusoidal waveforms, $T_A \leq 90\text{ }^\circ\text{C}$)

 For $T_A > 90\text{ }^\circ\text{C}$, please refer to "General technical information", section 3.2.3.

1250 V DC/500 V AC

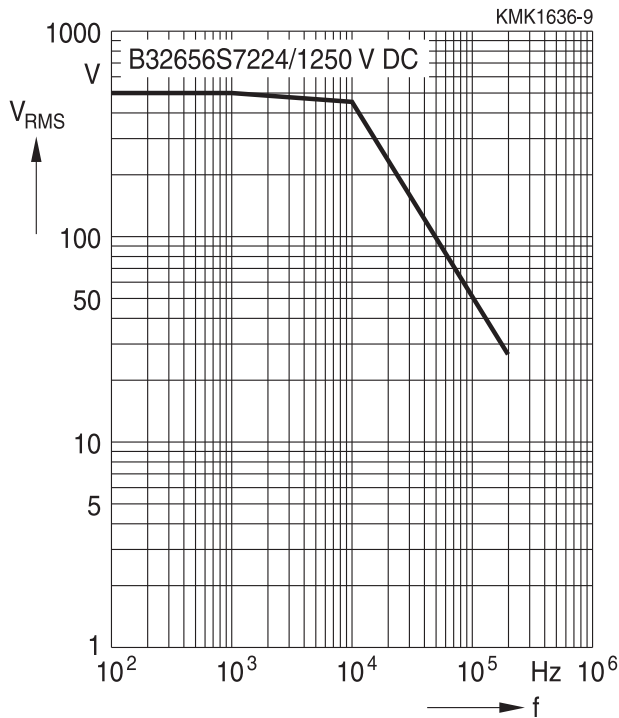

1250 V DC/500 V AC

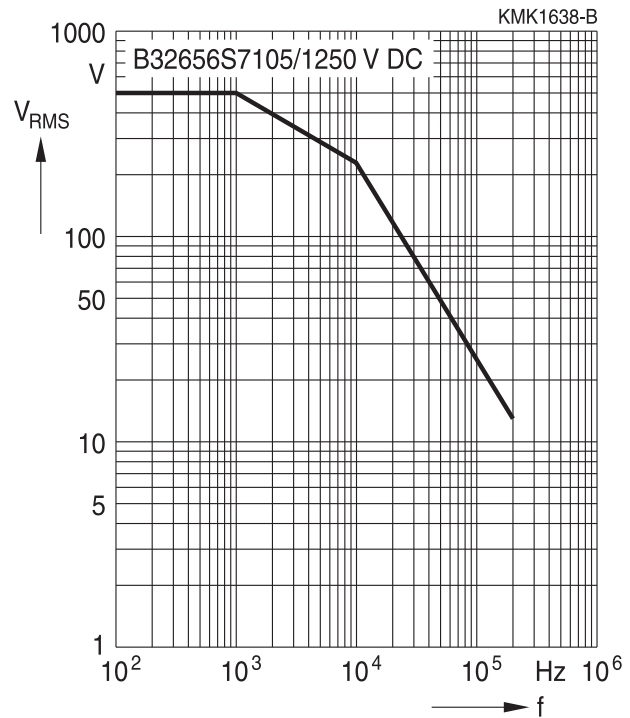

1250 V DC/500 V AC

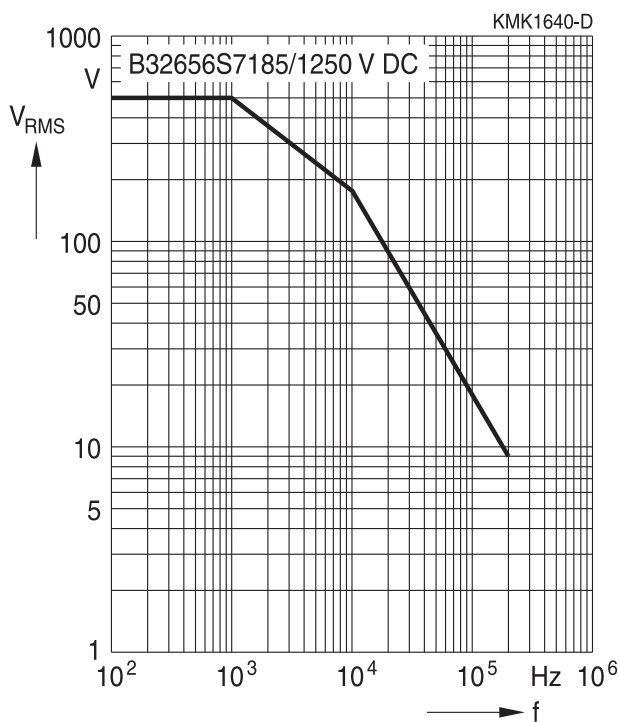

Permissible AC voltage V_{RMS} versus frequency f (for sinusoidal waveforms, $T_A \leq 90\text{ }^\circ\text{C}$)

For $T_A > 90\text{ }^\circ\text{C}$, please refer to "General technical information", section 3.2.3.

1700 V DC/750 V AC

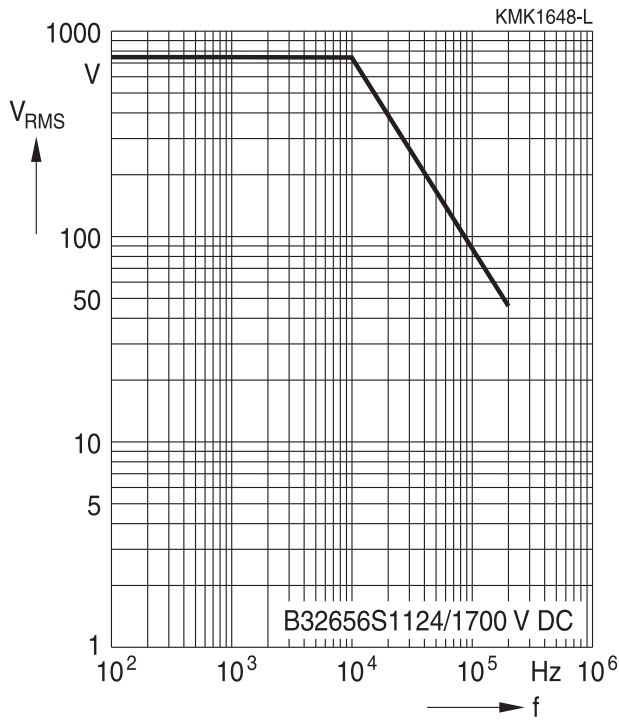

1700 V DC/750 V AC

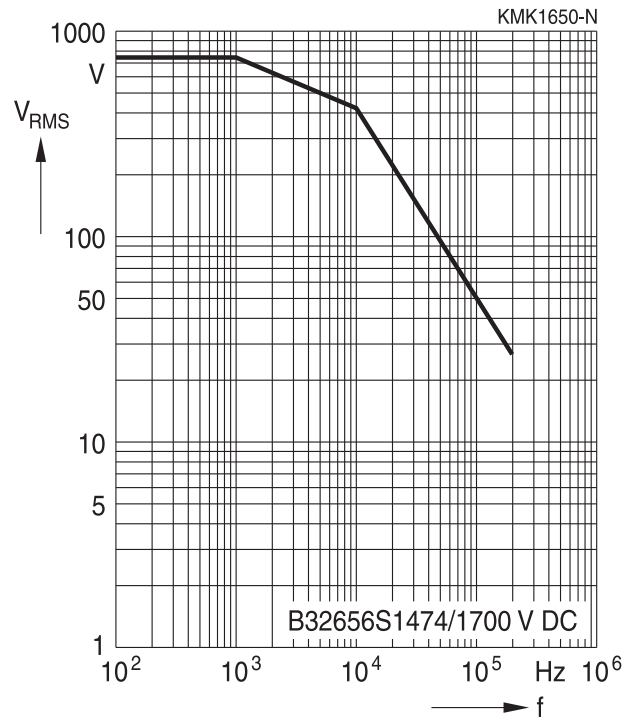

1700 V DC/750 V AC

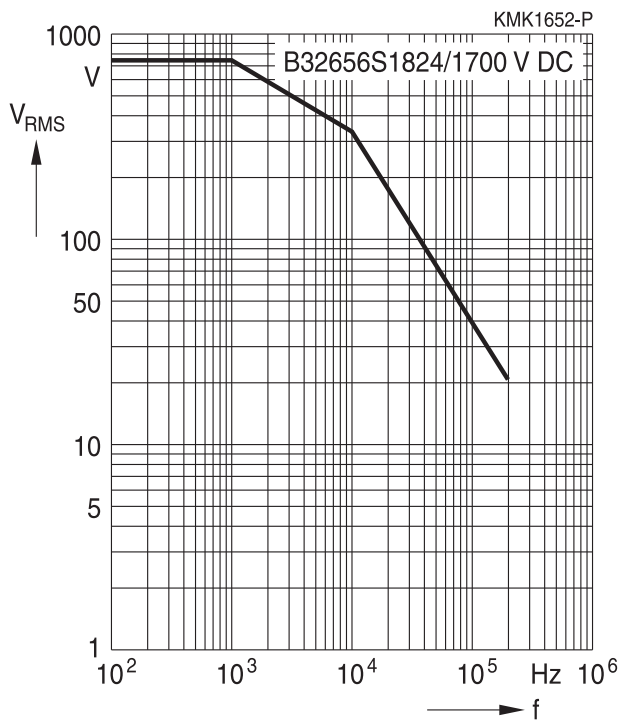

Permissible AC voltage V_{RMS} versus frequency f (for sinusoidal waveforms, $T_A \leq 90\text{ }^\circ\text{C}$)

 For $T_A > 90\text{ }^\circ\text{C}$, please refer to "General technical information", section 3.2.3.

2000 V DC/800 V AC

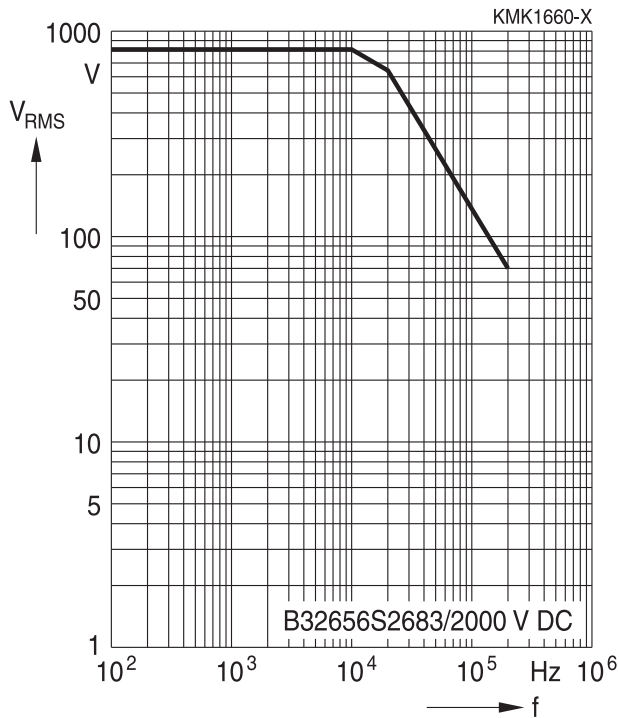

2000 V DC/800 V AC

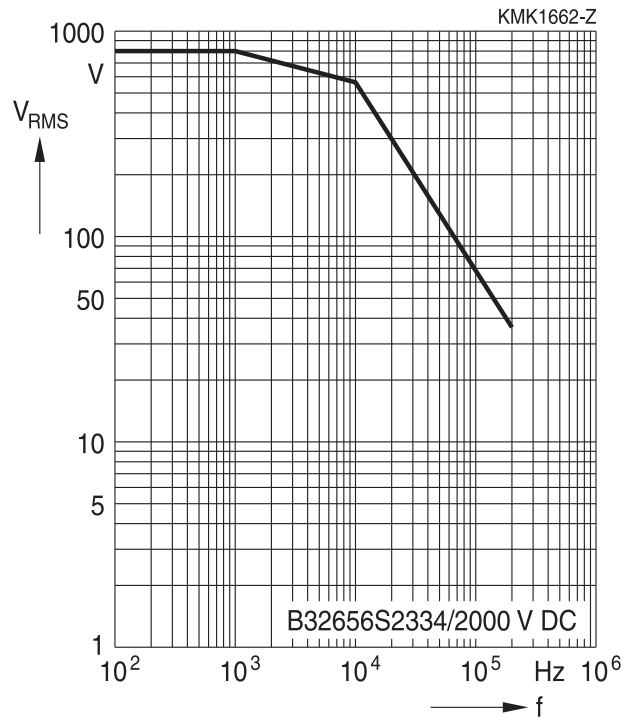

2000 V DC/800 V AC

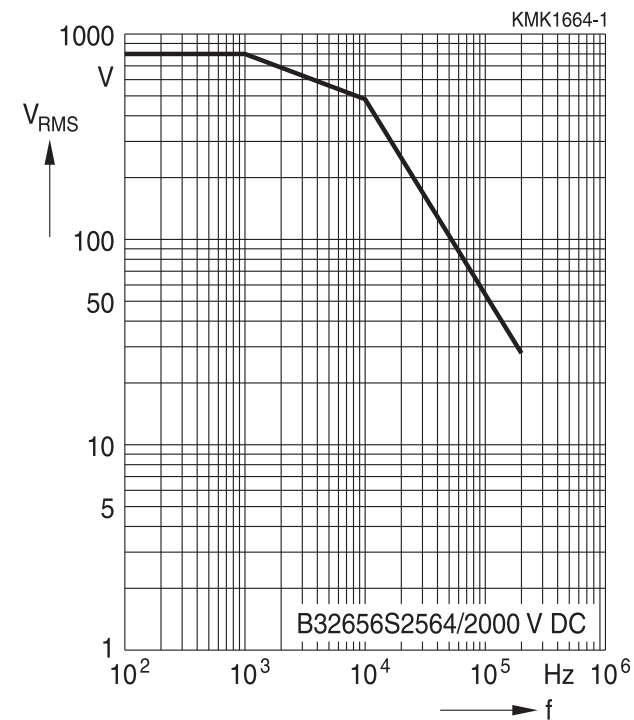

Permissible AC voltage V_{RMS} versus frequency f (for sinusoidal waveforms, $T_A \leq 90\text{ }^\circ\text{C}$)

For $T_A > 90\text{ }^\circ\text{C}$, please refer to "General technical information", section 3.2.3.

850 V DC/450 V AC

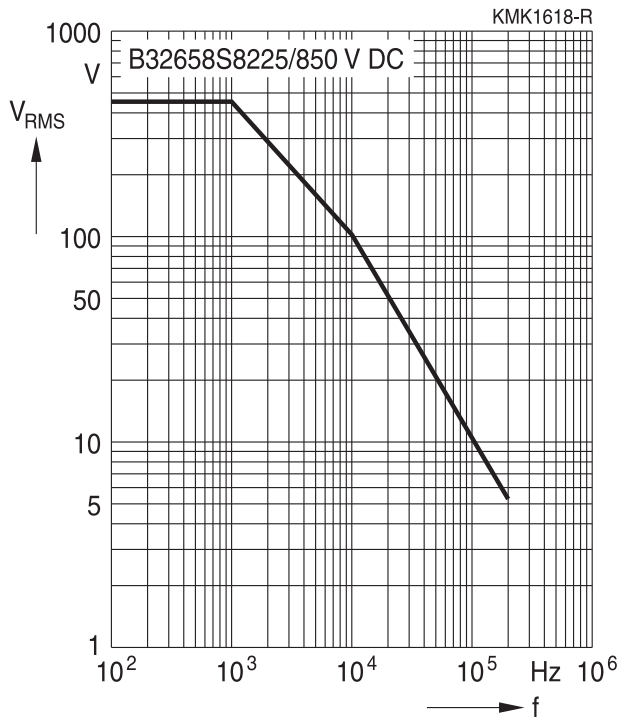

850 V DC/450 V AC

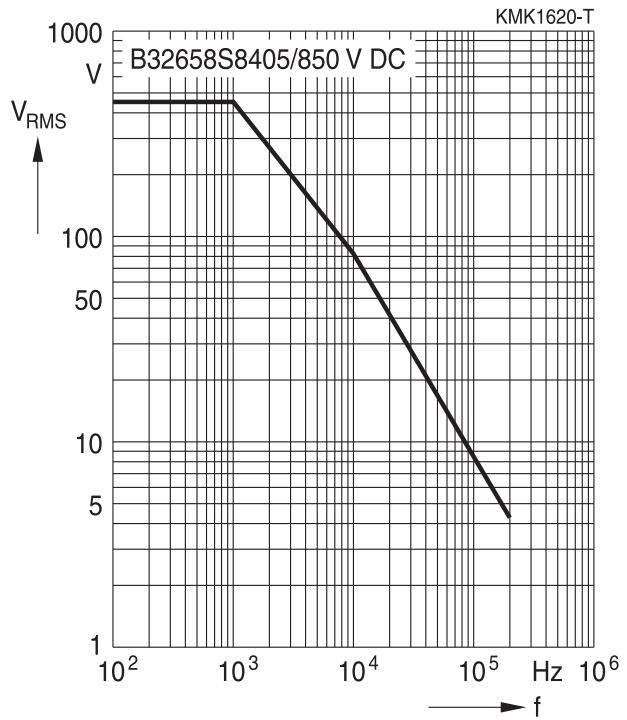

850 V DC/450 V AC

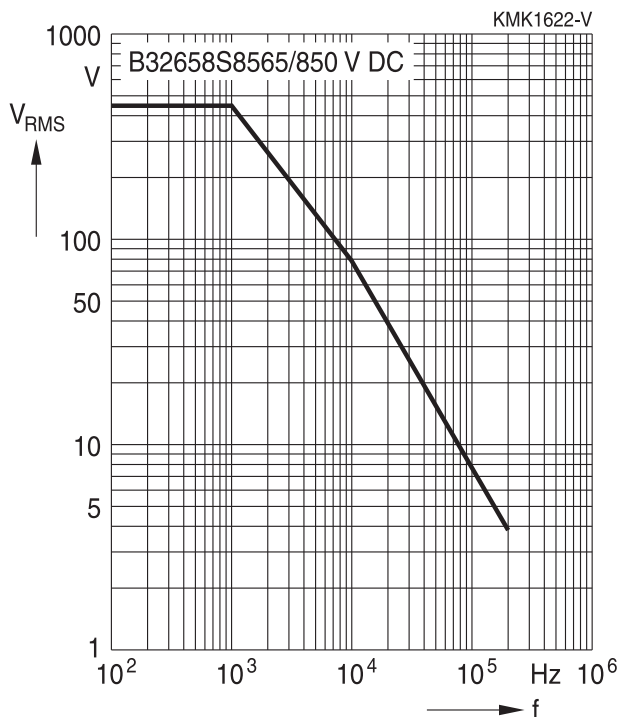

Permissible AC voltage V_{RMS} versus frequency f (for sinusoidal waveforms, $T_A \leq 90\text{ }^\circ\text{C}$)

 For $T_A > 90\text{ }^\circ\text{C}$, please refer to "General technical information", section 3.2.3.

1000 V DC/480 V AC

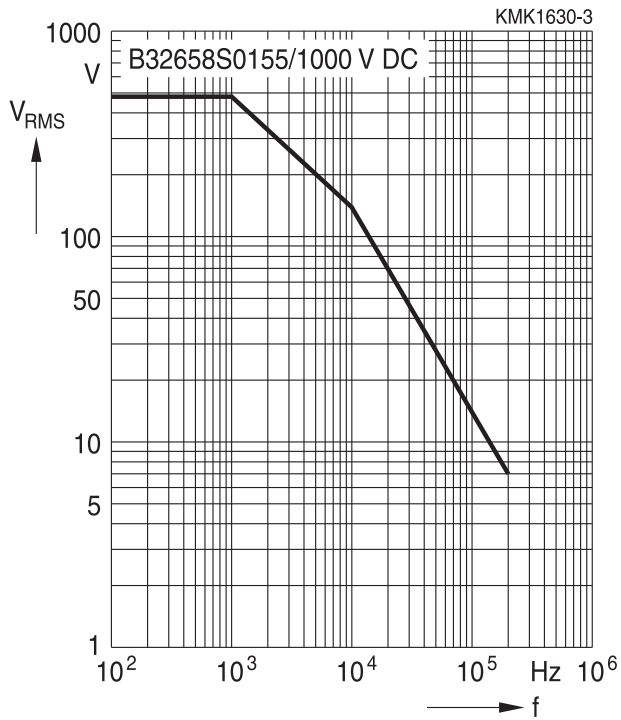

1000 V DC/480 V AC

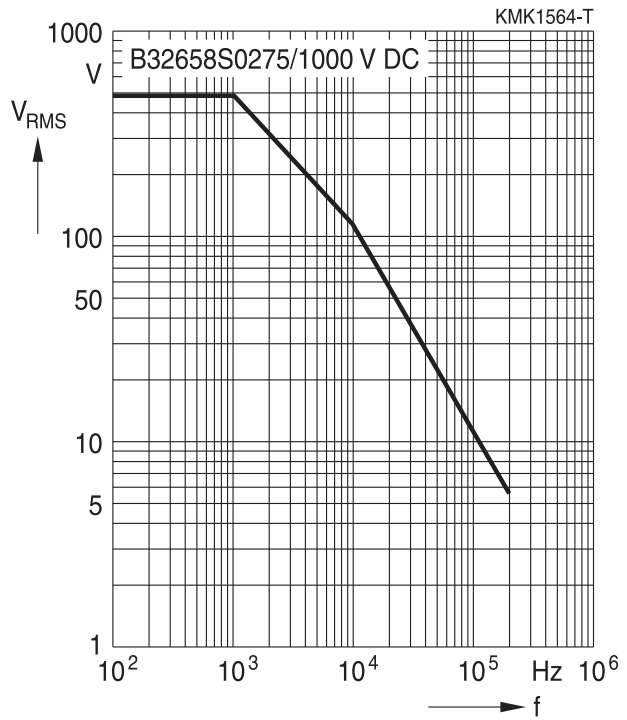

1000 V DC/480 V AC

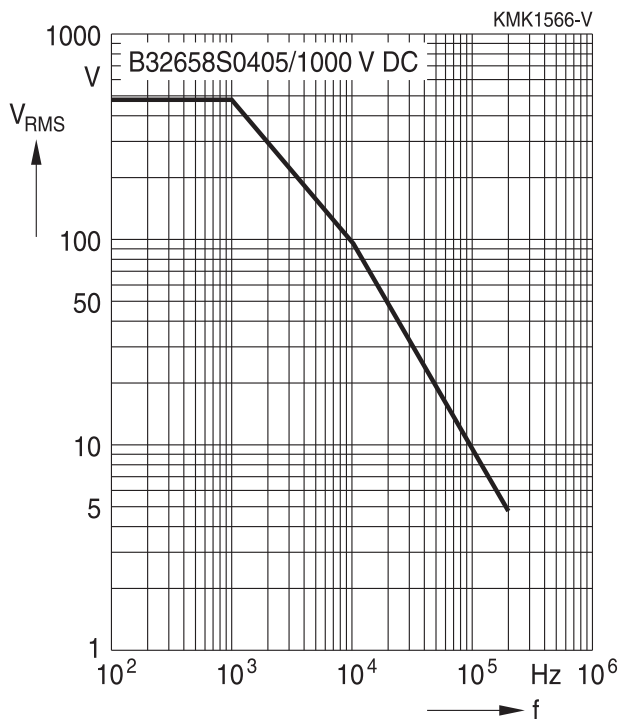

Permissible AC voltage V_{RMS} versus frequency f (for sinusoidal waveforms, $T_A \leq 90\text{ }^\circ\text{C}$)

For $T_A > 90\text{ }^\circ\text{C}$, please refer to "General technical information", section 3.2.3.

1250 V DC/500 V AC

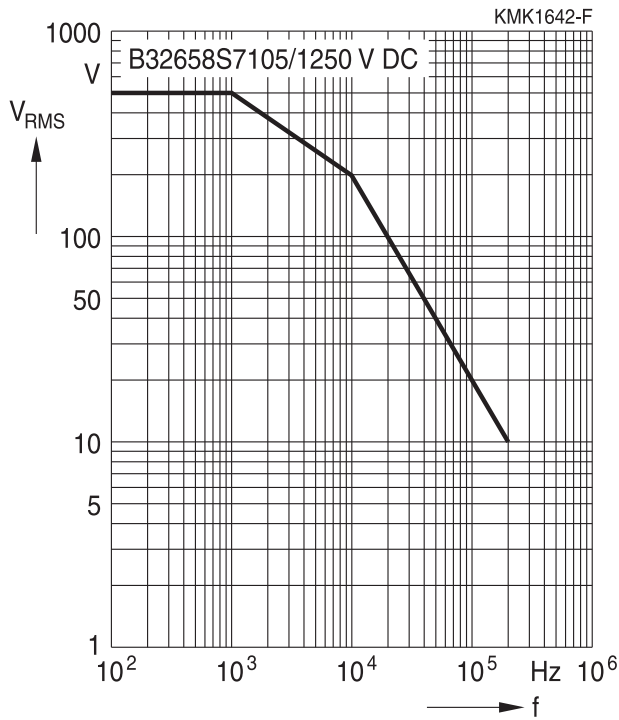

1250 V DC/500 V AC

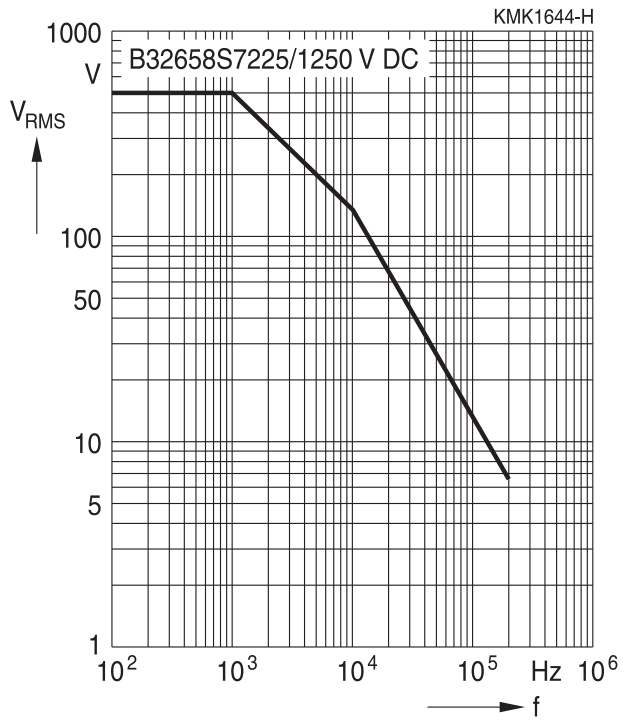

1250 V DC/500 V AC

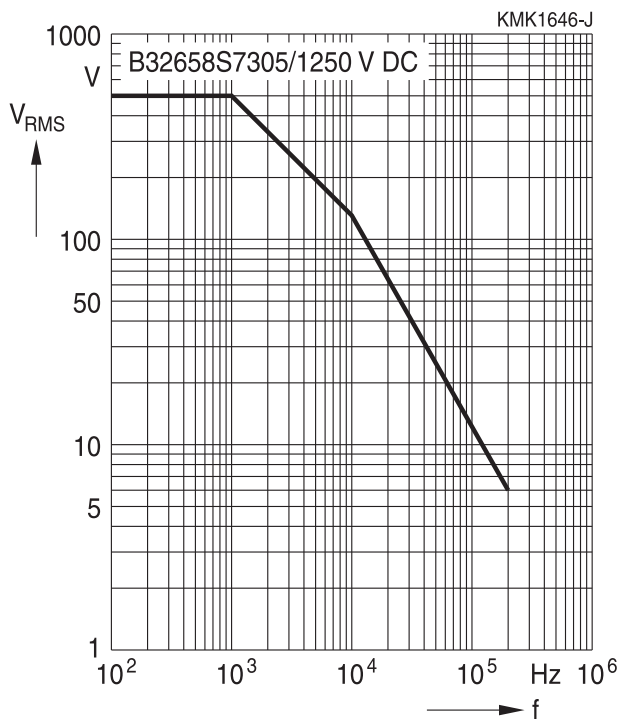

Permissible AC voltage V_{RMS} versus frequency f (for sinusoidal waveforms, $T_A \leq 90\text{ }^\circ\text{C}$)

 For $T_A > 90\text{ }^\circ\text{C}$, please refer to "General technical information", section 3.2.3.

1700 V DC/750 V AC

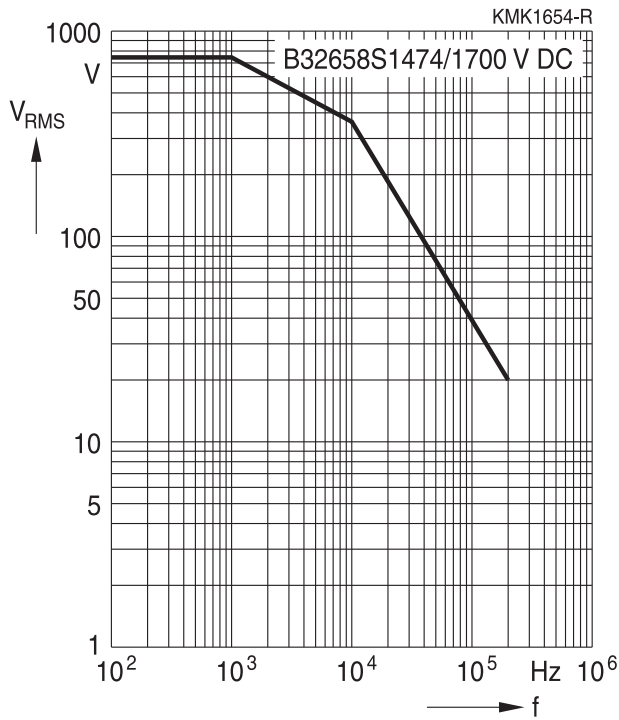

1700 V DC/750 V AC

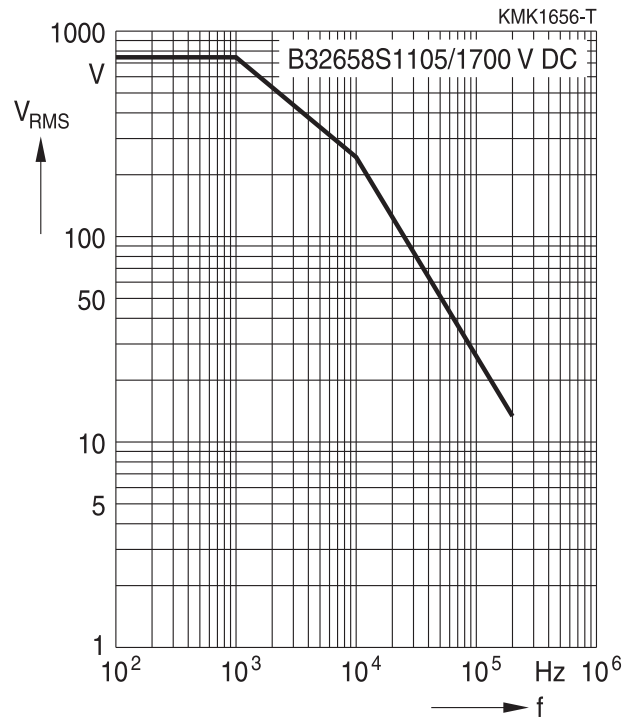

1700 V DC/750 V AC

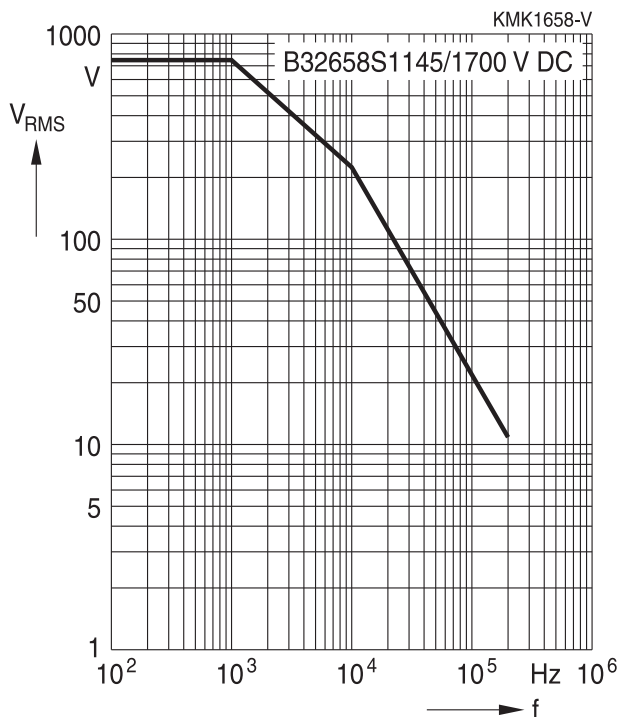

Permissible AC voltage V_{RMS} versus frequency f (for sinusoidal waveforms, $T_A \leq 90\text{ }^\circ\text{C}$)

For $T_A > 90\text{ }^\circ\text{C}$, please refer to "General technical information", section 3.2.3.

2000 V DC/800 V AC

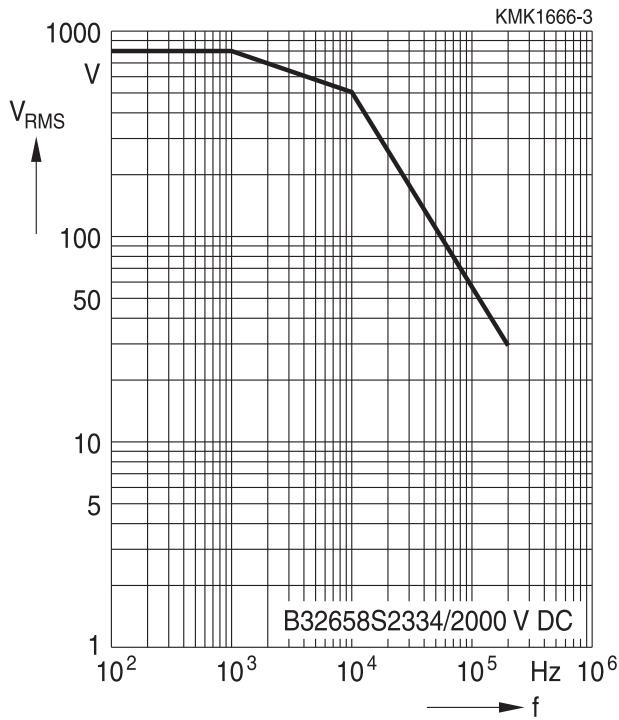

2000 V DC/800 V AC

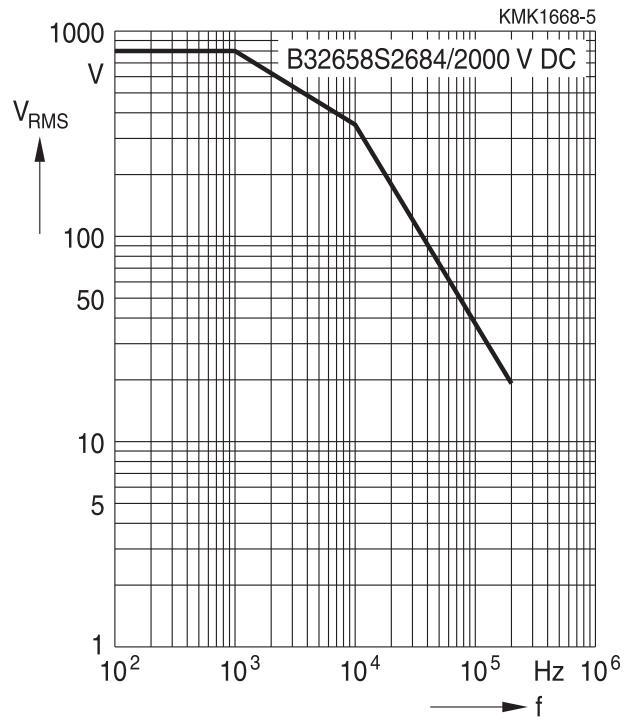

2000 V DC/800 V AC

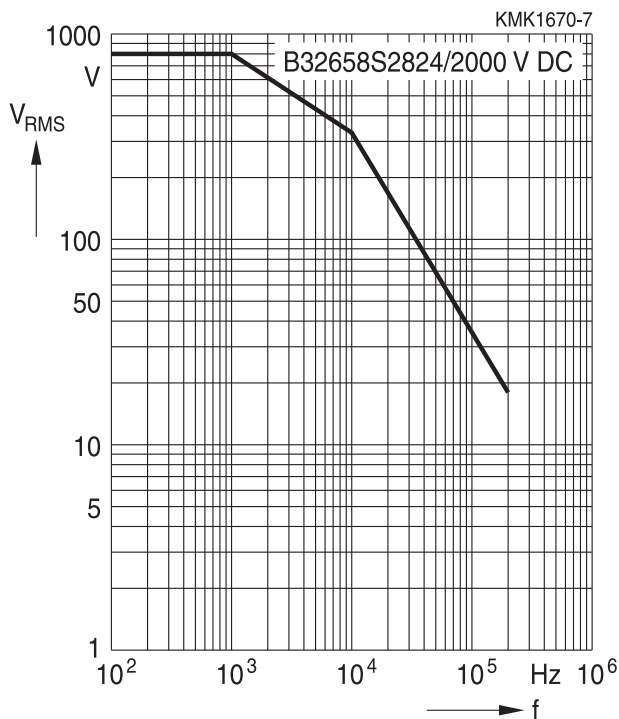

Metallized polypropylene film capacitors (MKP) B32656S
Snubber (wound)

Permissible current I_{RMS} versus frequency f (for sinusoidal waveforms, $T_A \leq 90\text{ }^\circ\text{C}$)

For $T_A > 90\text{ }^\circ\text{C}$, please use derating factor F_T .

850 V DC/450 V AC

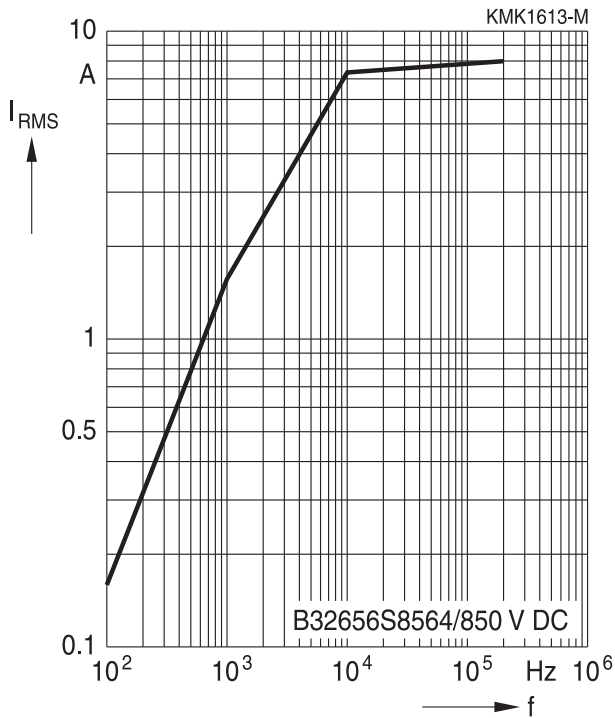

850 V DC/450 V AC

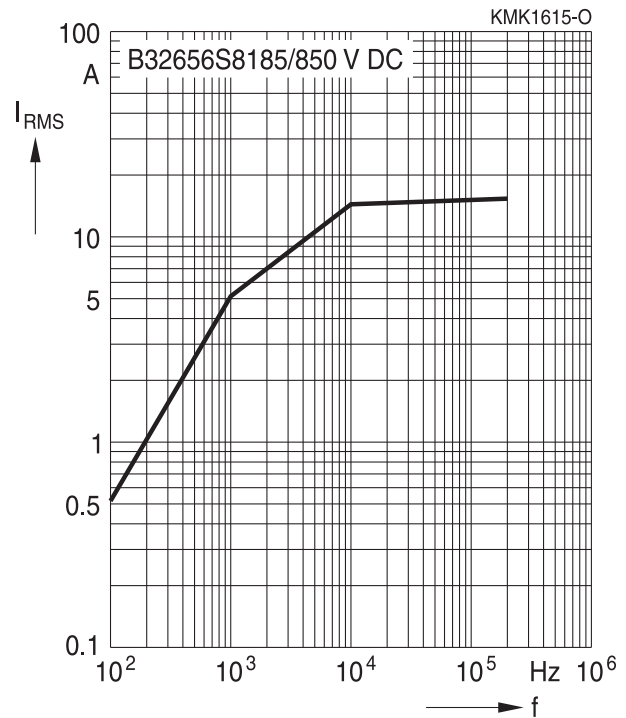

850 V DC/450 V AC

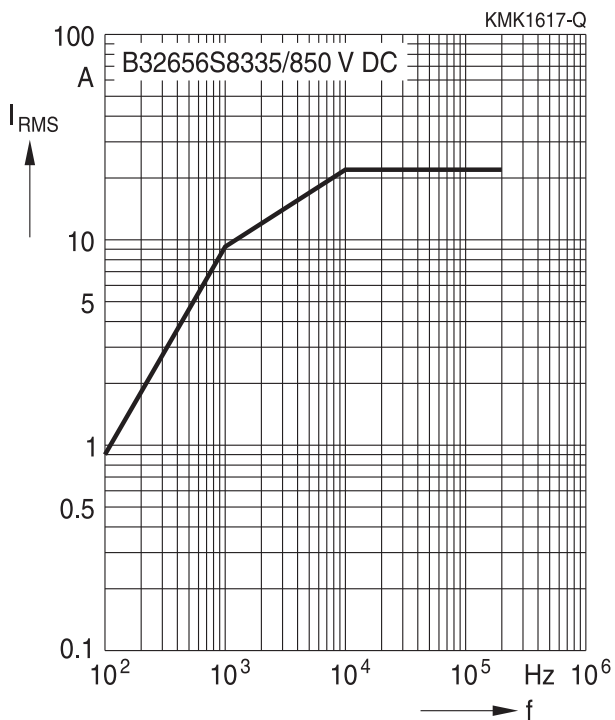

Permissible current I_{RMS} versus frequency f (for sinusoidal waveforms, $T_A \leq 90\text{ }^\circ\text{C}$)

 For $T_A > 90\text{ }^\circ\text{C}$, please use derating factor F_T .

1000 V DC/480 V AC

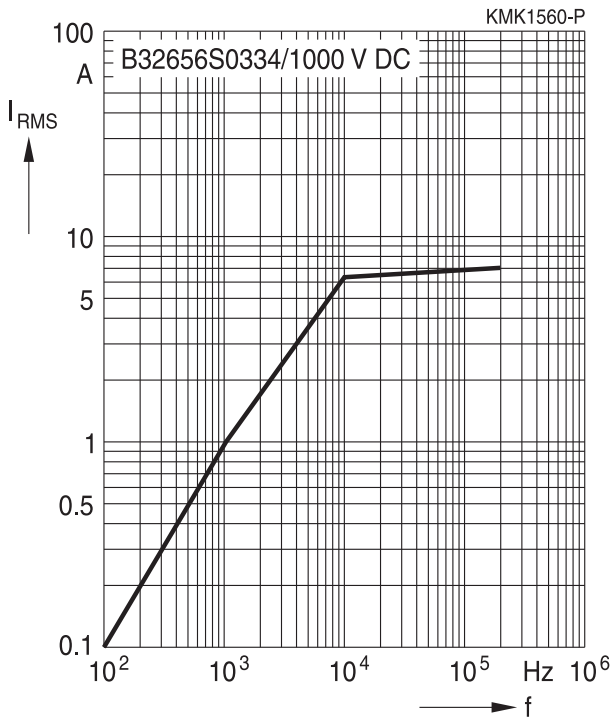

1000 V DC/480 V AC

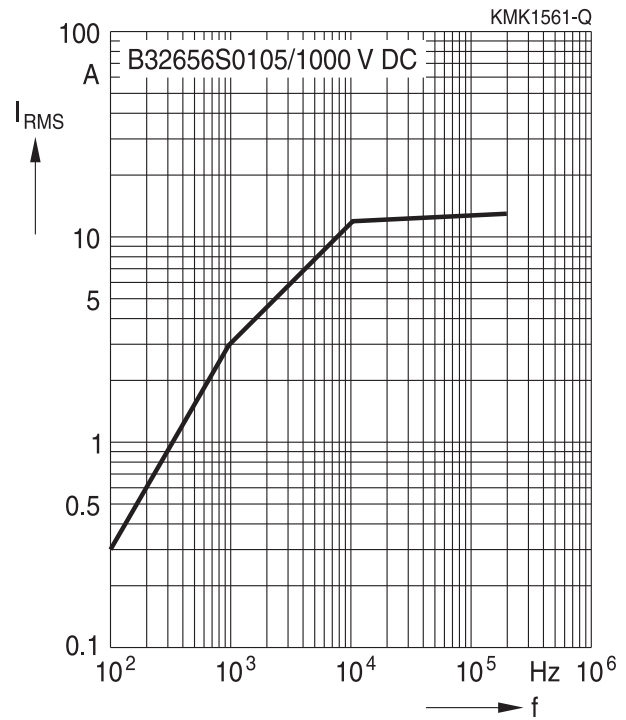

1000 V DC/480 V AC

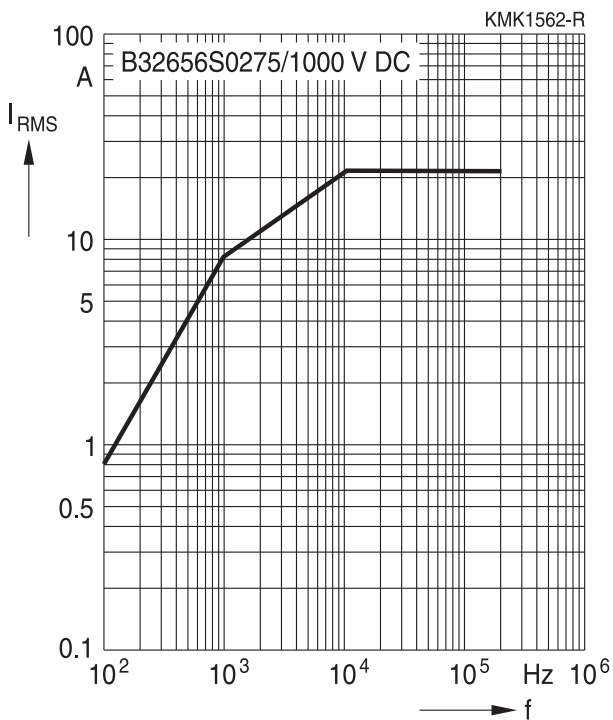

Permissible current I_{RMS} versus frequency f (for sinusoidal waveforms, $T_A \leq 90\text{ }^\circ\text{C}$)

 For $T_A > 90\text{ }^\circ\text{C}$, please use derating factor F_T .

1250 V DC/500 V AC

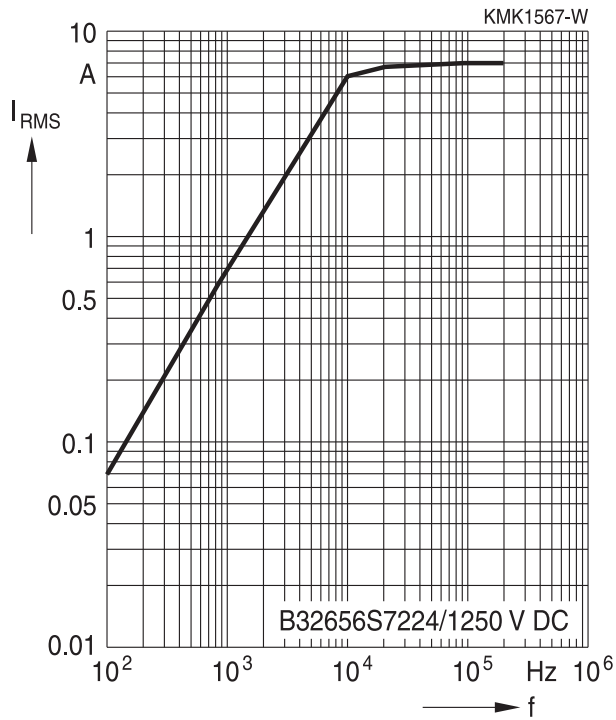

1250 V DC/500 V AC

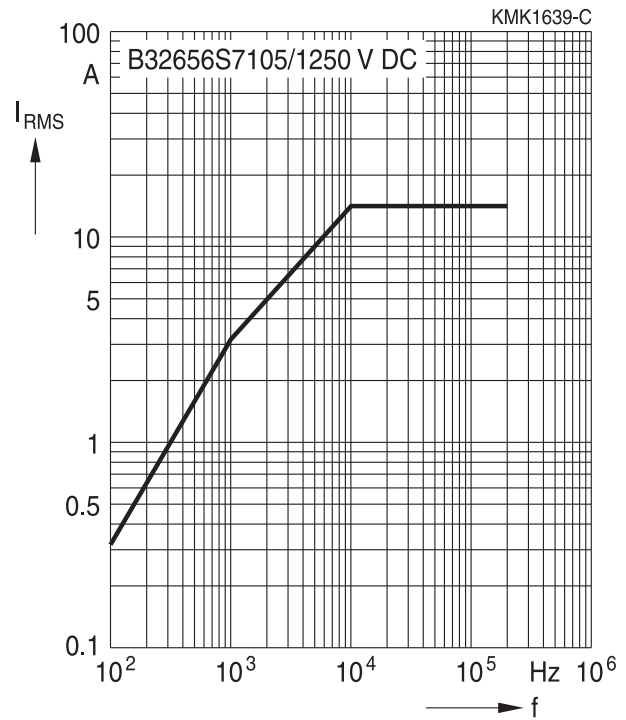

1250 V DC/500 V AC

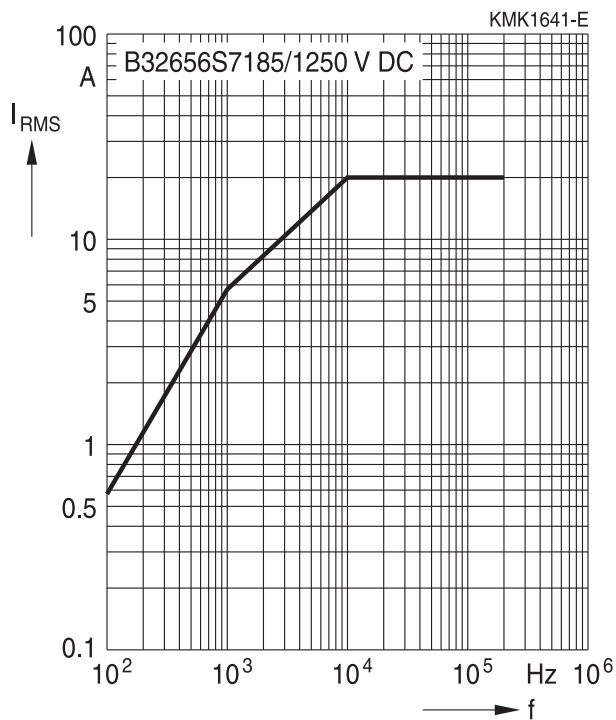

Permissible current I_{RMS} versus frequency f (for sinusoidal waveforms, $T_A \leq 90\text{ }^\circ\text{C}$)

 For $T_A > 90\text{ }^\circ\text{C}$, please use derating factor F_T .

1700 V DC/750 V AC

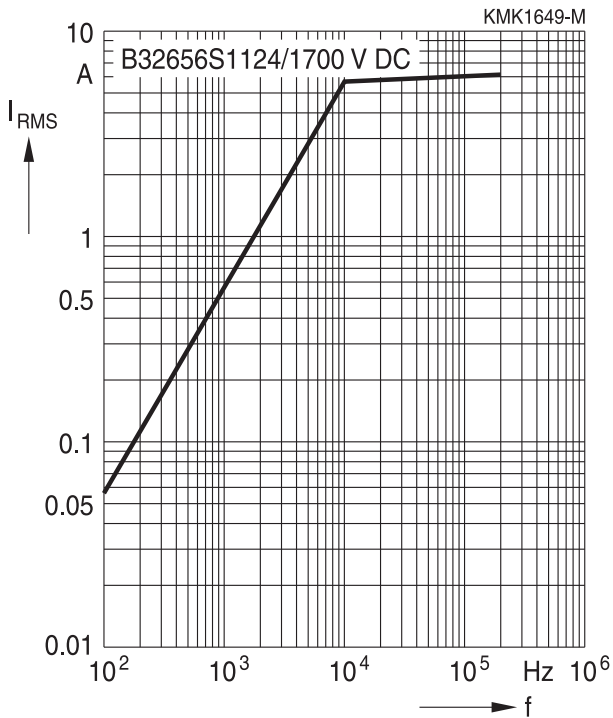

1700 V DC/750 V AC

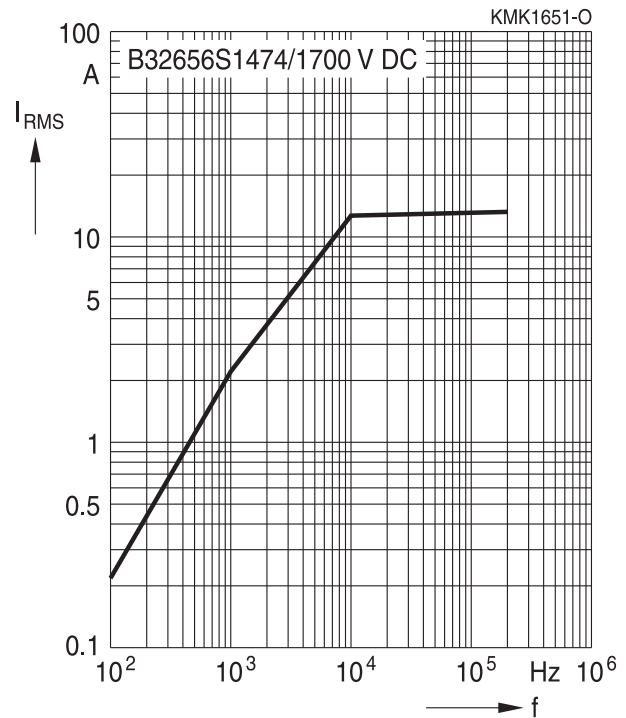

1700 V DC/750 V AC

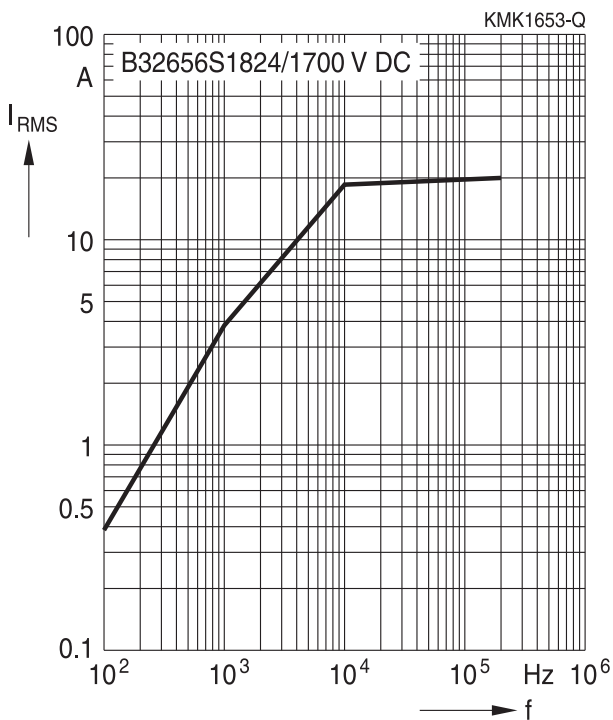

Permissible current I_{RMS} versus frequency f (for sinusoidal waveforms, $T_A \leq 90\text{ }^\circ\text{C}$)

 For $T_A > 90\text{ }^\circ\text{C}$, please use derating factor F_T .

2000 V DC/800 V AC

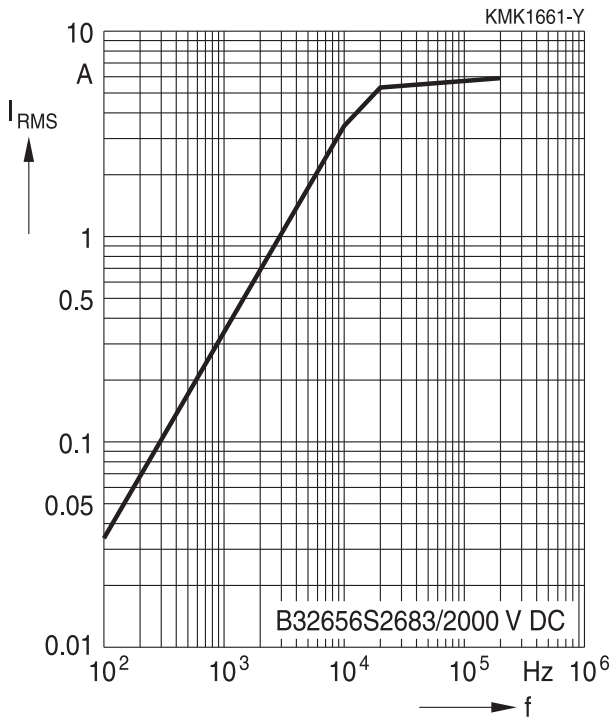

2000 V DC/800 V AC

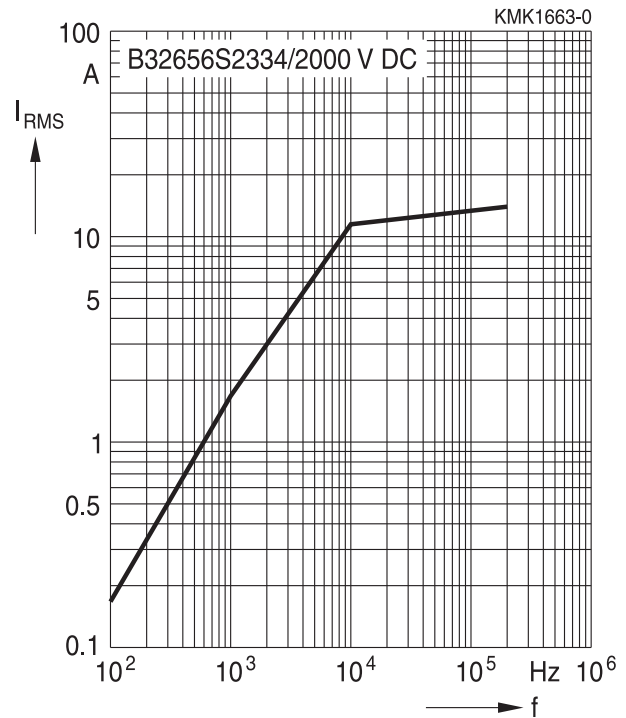

2000 V DC/800 V AC

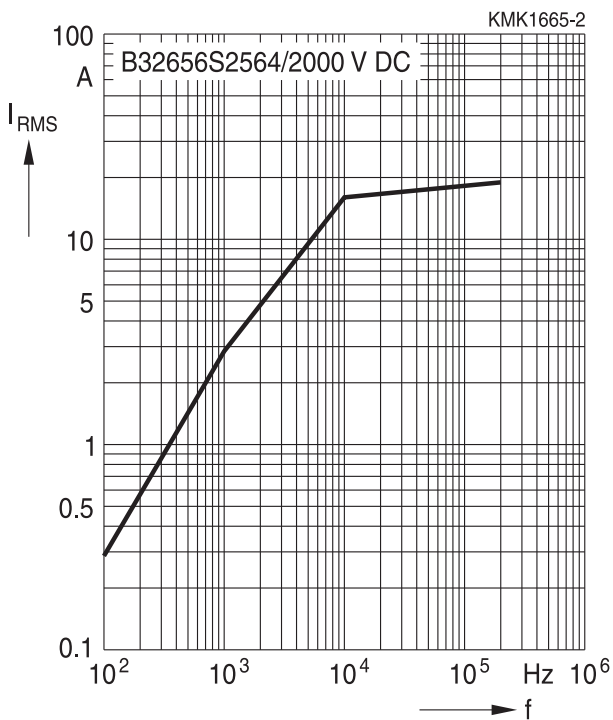

Permissible current I_{RMS} versus frequency f (for sinusoidal waveforms, $T_A \leq 90\text{ }^\circ\text{C}$)

 For $T_A > 90\text{ }^\circ\text{C}$, please use derating factor F_T .

850 V DC/450 V AC

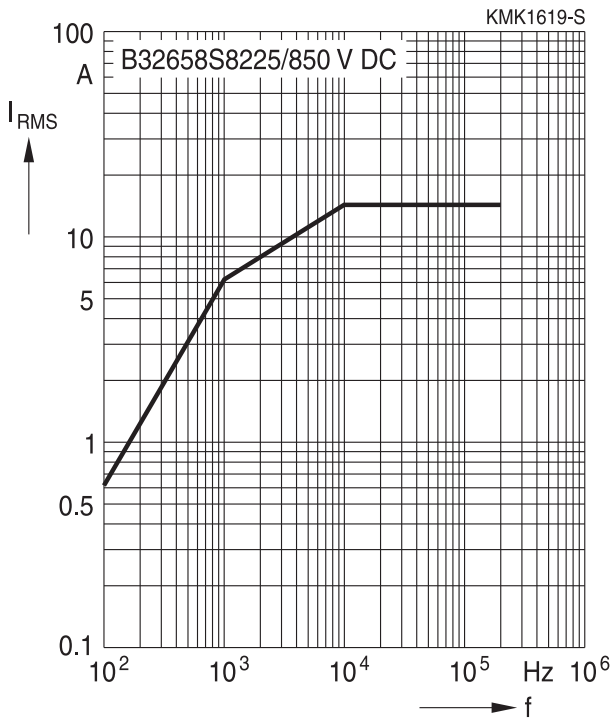

850 V DC/450 V AC

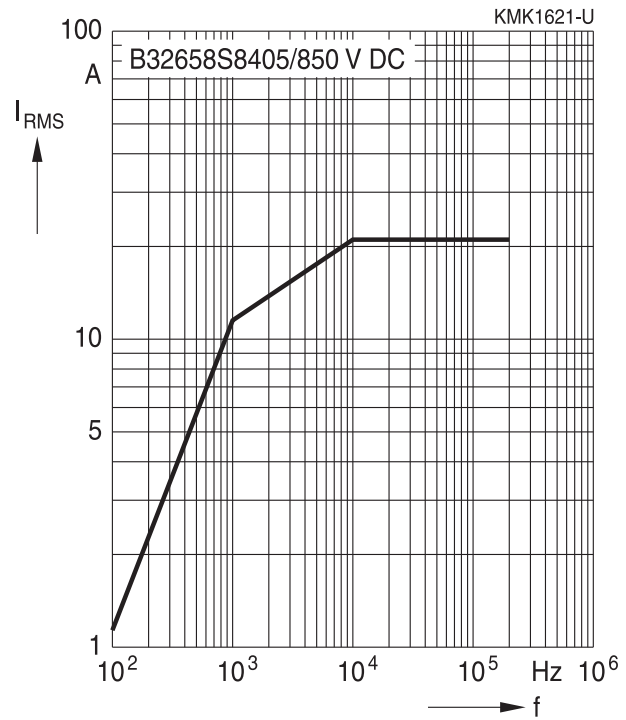

850 V DC/450 V AC

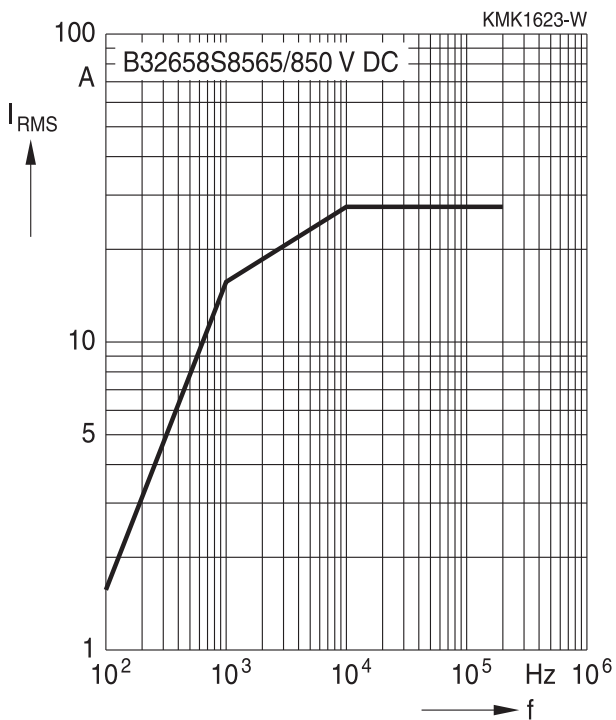

Permissible current I_{RMS} versus frequency f (for sinusoidal waveforms, $T_A \leq 90\text{ }^\circ\text{C}$)

For $T_A > 90\text{ }^\circ\text{C}$, please use derating factor F_T .

1000 V DC/480 V AC

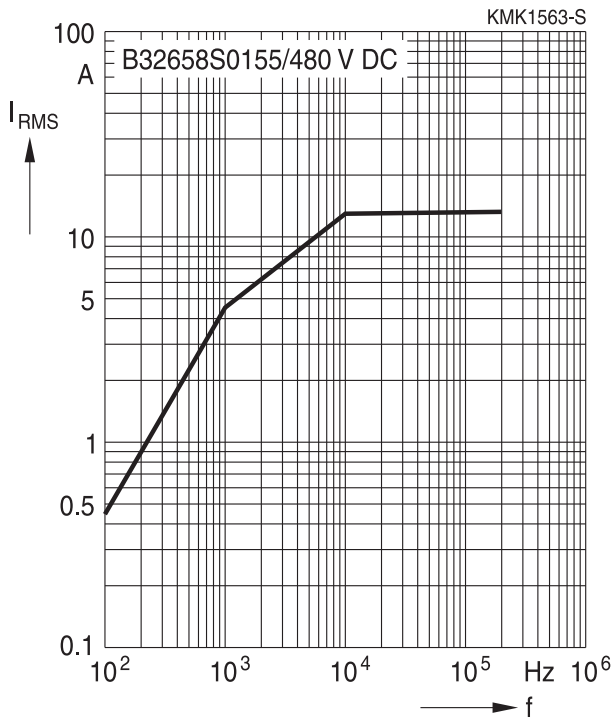

1000 V DC/480 V AC

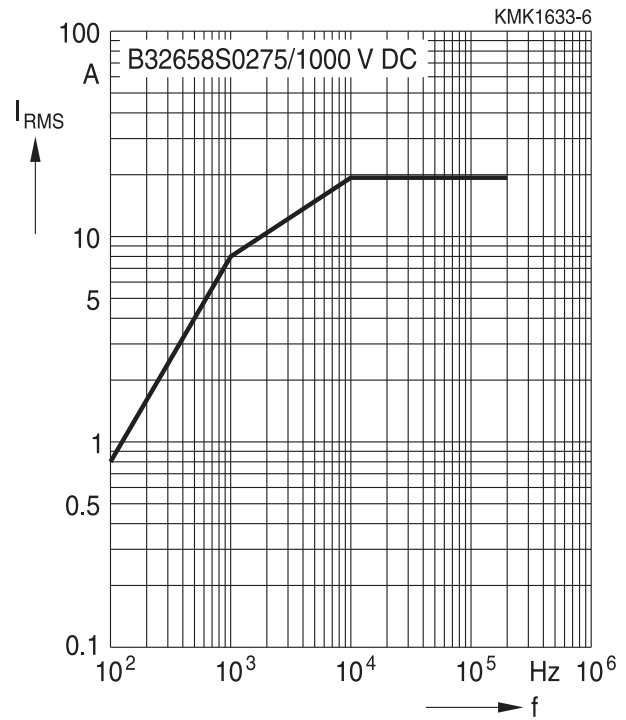

1000 V DC/480 V AC

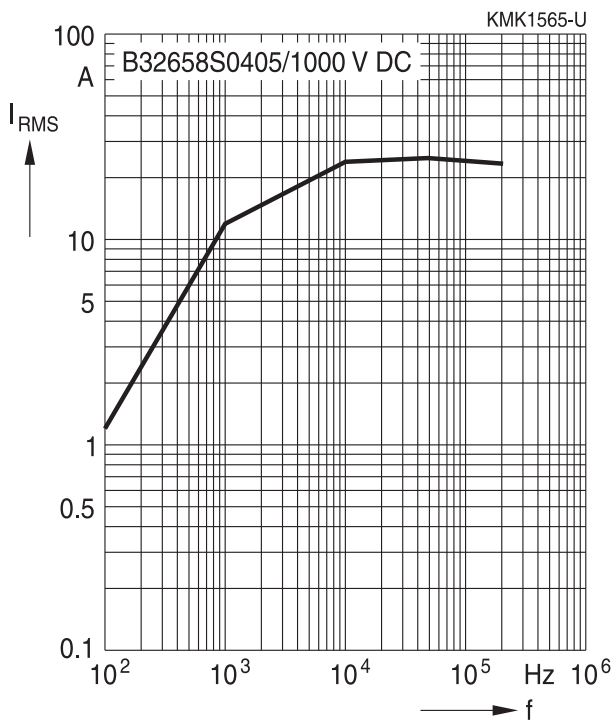

Permissible current I_{RMS} versus frequency f (for sinusoidal waveforms, $T_A \leq 90\text{ }^\circ\text{C}$)

For $T_A > 90\text{ }^\circ\text{C}$, please use derating factor F_T .

1250 V DC/500 V AC

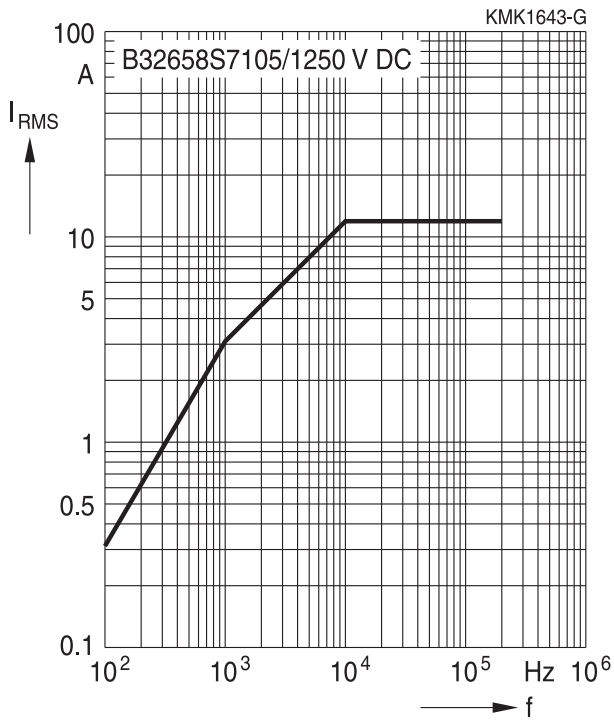

1250 V DC/500 V AC

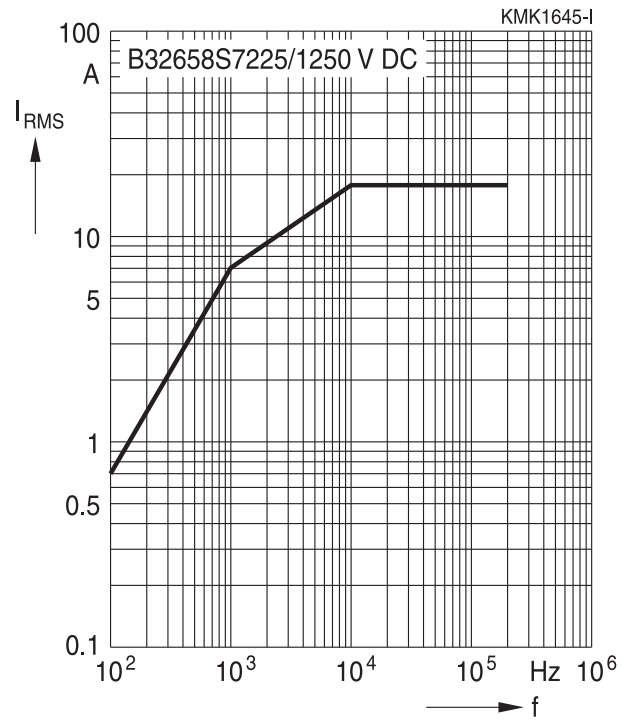

1250 V DC/500 V AC

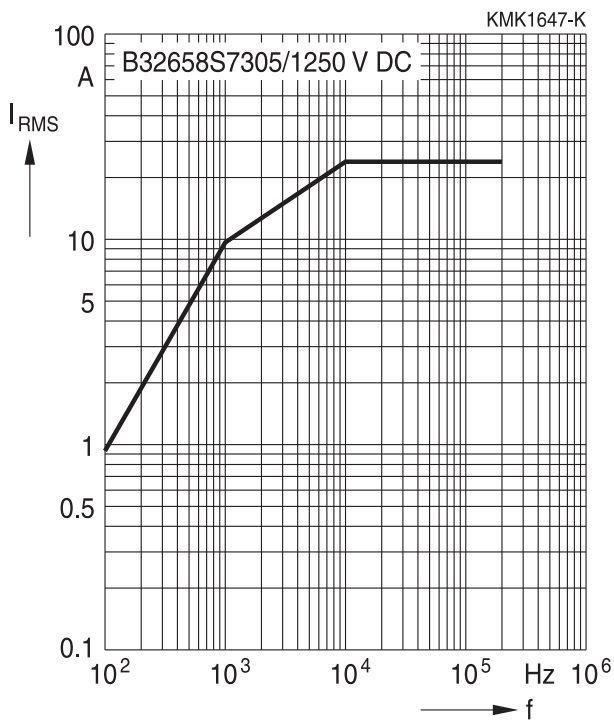

Permissible current I_{RMS} versus frequency f (for sinusoidal waveforms, $T_A \leq 90\text{ }^\circ\text{C}$)

For $T_A > 90\text{ }^\circ\text{C}$, please use derating factor F_T .

1700 V DC/750 V AC

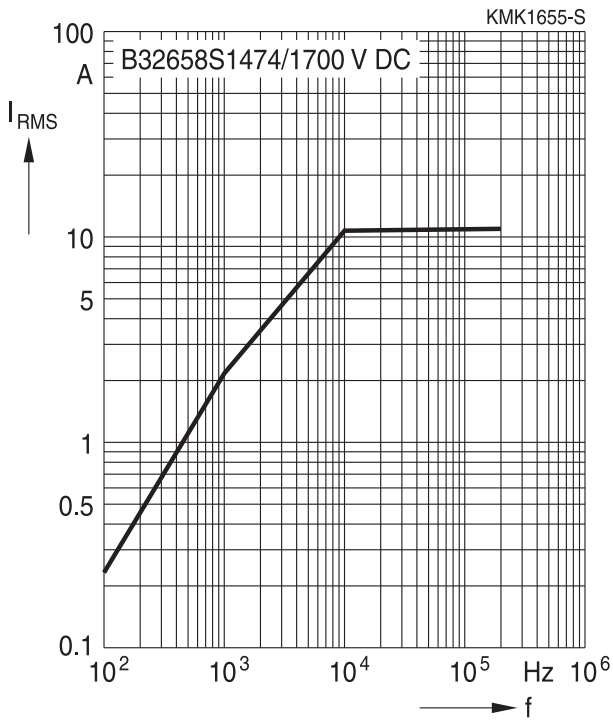

1700 V DC/750 V AC

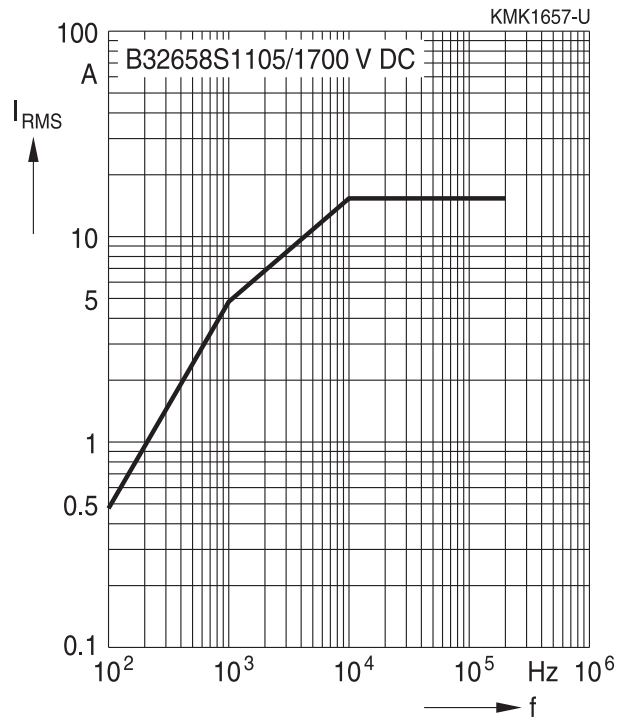

1700 V DC/750 V AC

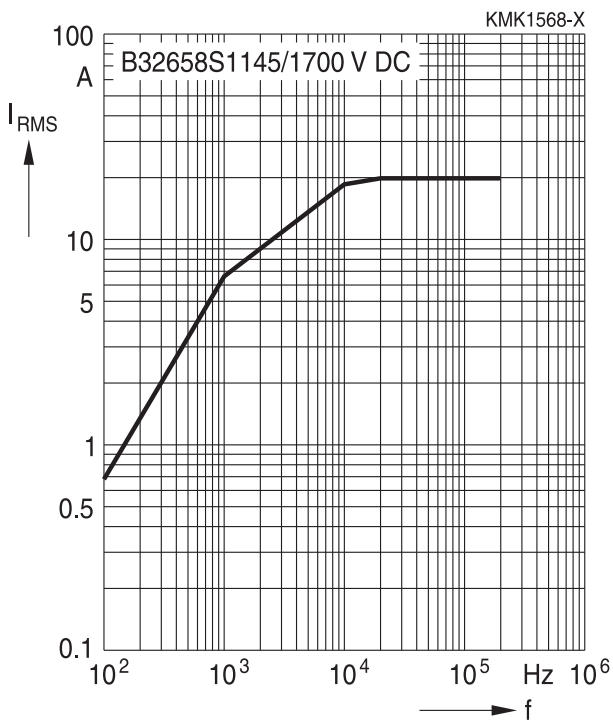

Permissible current I_{RMS} versus frequency f (for sinusoidal waveforms, $T_A \leq 90\text{ }^\circ\text{C}$)

For $T_A > 90\text{ }^\circ\text{C}$, please use derating factor F_T .

2000 V DC/800 V AC

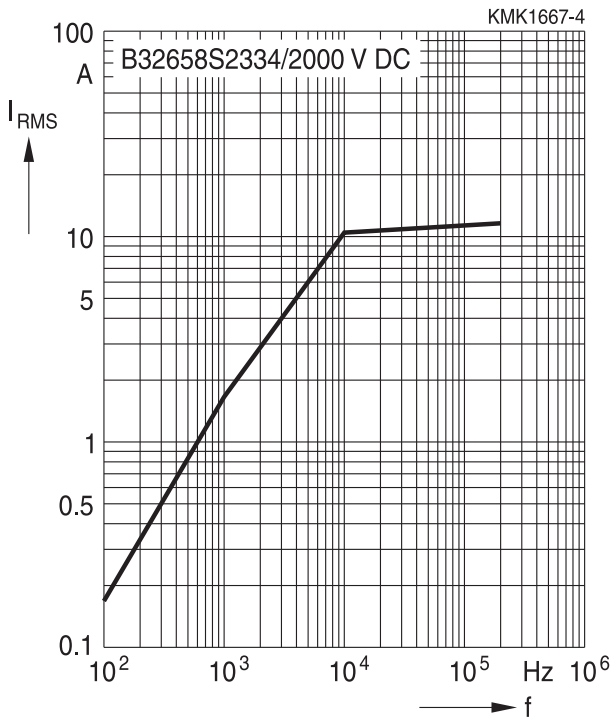

2000 V DC/800 V AC

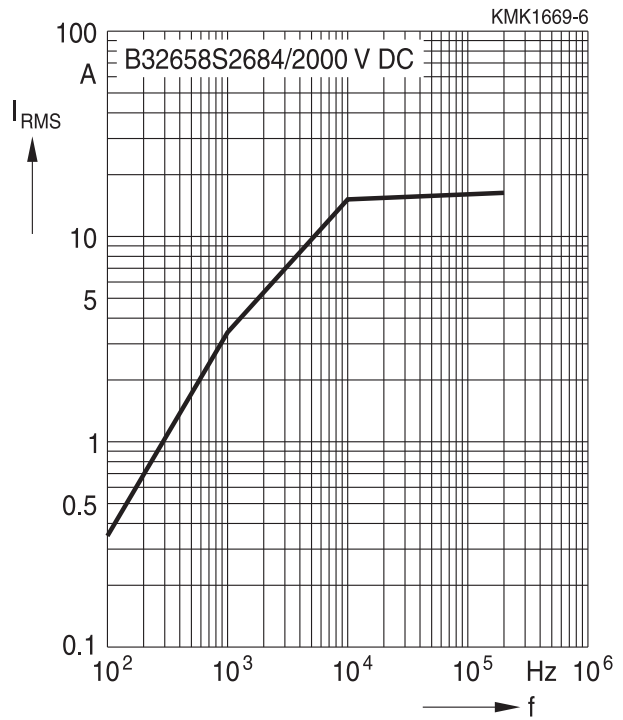

2000 V DC/800 V AC

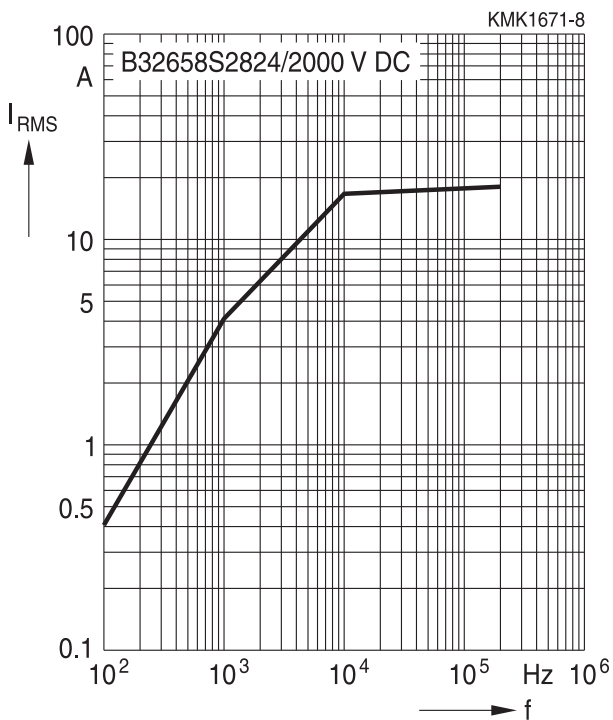

Maximum AC voltage (V_{RMS}), current (I_{RMS}) versus frequency and temperature for $T_A > 90\text{ }^\circ\text{C}$

The graphs described in the previous section for the permissible AC voltage (V_{RMS}) or current (I_{RMS}) versus frequency are given for a maximum ambient temperature $T_A \leq 90\text{ }^\circ\text{C}$. In case of higher ambient temperatures (T_A), the self-heating (ΔT) of the component must be reduced to avoid that temperature of the component ($T_{op} = T_A + \Delta T$) reaches values above maximum operating temperature.

The factor F_T shall be applied in the following way:

$$I_{RMS}(T_A) = I_{RMS, T_A \leq 90\text{ }^\circ\text{C}} \cdot F_T(T_A)$$

$$V_{RMS}(T_A) = V_{RMS, T_A \leq 90\text{ }^\circ\text{C}} \cdot F_T(T_A)$$

And F_T is given by the following curve:

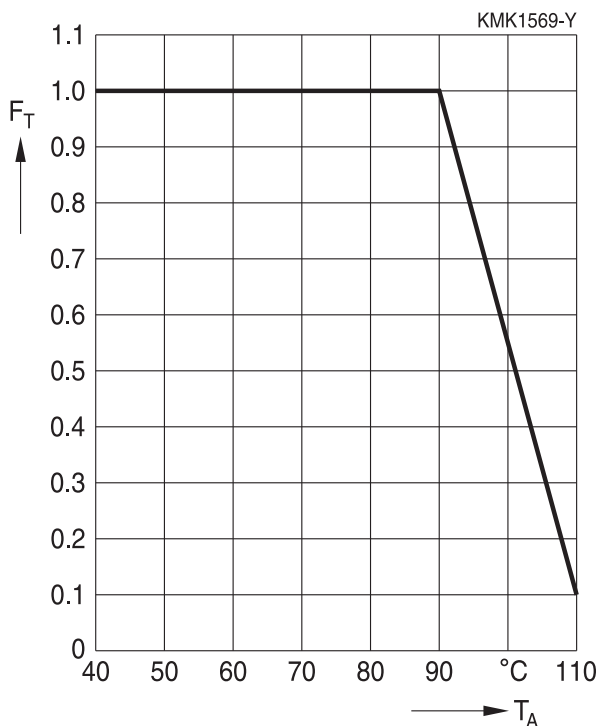
Curves characteristics (I_{RMS} derating versus temperature)

Maximum I_{RMS} current as function of the ambient temperature: $I_{RMS}(T_A) = \text{Factor} \times I_{RMS}(90\text{ }^\circ\text{C})$

Testing and Standards

Test	Reference	Conditions of test	Performance requirements
Electrical parameters	IEC 60384-16:2005	Voltage proof, $1.6 V_R$, 1 minute Insulation resistance, R_{ins} Capacitance, C Dissipation factor, $\tan \delta$	Within specified limits
Robustness of terminations	IEC 60068-2-21:2006	Only tests Ua1 (20N) and Ud	Capacitance and $\tan \delta$ within specified limits
Rapid change of temperature	IEC 60384-16:2005	T_A = lower category temperature T_B = upper category temperature Five cycles, duration $t = 30$ min	$ \Delta C/C_0 \leq 2\%$ $ \Delta \tan \delta \leq 0.002$ $R_{ins} \geq 50\%$ of initial limit
Vibration	IEC 60384-16:2005	Test F_C : vibration sinusoidal Displacement: 0.75 mm Acceleration: 98 m/s^2 Frequency: 10 Hz ... 500 Hz Test duration: 3 orthogonal axes, 2 hours each axe	No visible damage
Bump	IEC 60384-16:2005	Test Eb: Total 4000 bumps with 390 m/s^2 mounted on PCB Duration: 6 ms	No visible damage $ \Delta C/C_0 \leq 2\%$ $ \Delta \tan \delta \leq 0.002$ $R_{ins} \geq 50\%$ of initial limit
Climatic sequence	IEC 60384-16:2005	Dry heat $T_b[T_B] / 16$ h Damp heat cyclic, 1 st cycle +55 °C / 24 h / 95% ... 100% RH Cold $T_a[T_A] / 2$ h Damp heat cyclic, 5 cycles +55 °C / 24 h / 95% ... 100% RH	No visible damage $ \Delta C/C_0 \leq 3\%$ $ \Delta \tan \delta \leq 0.003$ $R_{ins} \geq 50\%$ of initial limit
Damp heat, steady state	IEC 60384-16:2005	Test Ca 40 °C / 93% RH / 56 days	No visible damage $ \Delta C/C_0 \leq 3\%$ $ \Delta \tan \delta \leq 0.002$ $R_{ins} \geq 50\%$ of initial limit
Advanced biased humidity		60 °C / 95% RH / 1000 hours with V_R DC	No visible damage $ \Delta C/C_0 \leq 10\%$ $ \Delta \tan \delta \leq 0.002$ $R_{ins} \geq 50\%$ of initial limit
Endurance A		85 °C / $1.25 V_R$ / 2000 hours	No visible damage $ \Delta C/C_0 \leq 3\%$ $ \Delta \tan \delta \leq 0.002$ $R_{ins} \geq 50\%$ of initial limit
Endurance B		110 °C / $1.25 V_C$ / 2000 hours	No visible damage $ \Delta C/C_0 \leq 3\%$ $ \Delta \tan \delta \leq 0.002$ $R_{ins} \geq 50\%$ of initial limit

Mounting guidelines

1 Soldering

1.1 Solderability of leads

The solderability of terminal leads is tested to IEC 60068-2-20:2008, test Ta, method 1.

Before a solderability test is carried out, terminals are subjected to accelerated ageing (to IEC 60068-2-2:2007, test Ba: 4 h exposure to dry heat at 155 °C). Since the ageing temperature is far higher than the upper category temperature of the capacitors, the terminal wires should be cut off from the capacitor before the ageing procedure to prevent the solderability being impaired by the products of any capacitor decomposition that might occur.

Solder bath temperature	235 ±5 °C
Soldering time	2.0 ±0.5 s
Immersion depth	2.0 +0/−0.5 mm from capacitor body or seating plane
Evaluation criteria:	
Visual inspection	Wetting of wire surface by new solder ≥90%, free-flowing solder

1.2 Resistance to soldering heat

Resistance to soldering heat is tested to IEC 60068-2-20:2008, test Tb, method 1. Conditions:

Series		Solder bath temperature	Soldering time
MKT	boxed (except 2.5 × 6.5 × 7.2 mm) coated uncoated (lead spacing >10 mm)	260 ±5 °C	10 ±1 s
MFP MKP	(lead spacing >7.5 mm)		
MKT	boxed (case 2.5 × 6.5 × 7.2 mm)		5 ±1 s
MKT	(lead spacing ≤7.5 mm)		<4 s
MKT	uncoated (lead spacing ≤10 mm) insulated (B32559)		recommended soldering profile for MKT uncoated (lead spacing ≤10 mm) and insulated (B32559)

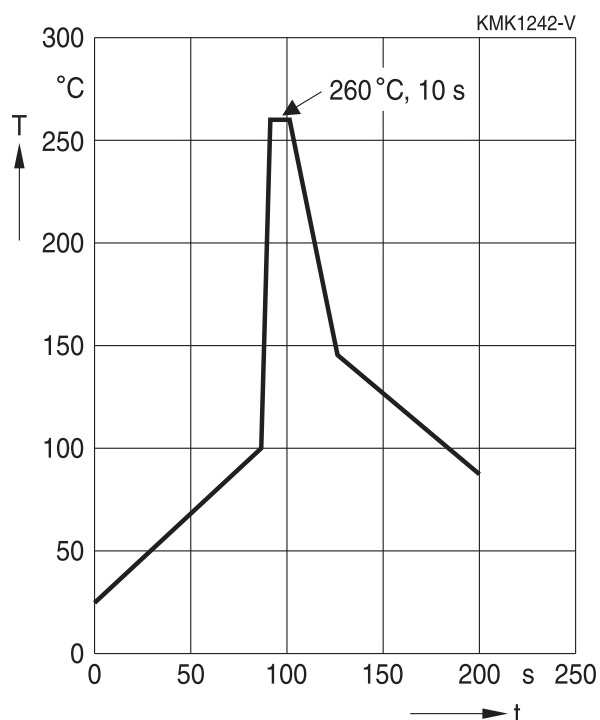

Immersion depth	2.0 +0/-0.5 mm from capacitor body or seating plane
Shield	Heat-absorbing board, (1.5 ±0.5) mm thick, between capacitor body and liquid solder
Evaluation criteria:	
Visual inspection	No visible damage
$\Delta C/C_0$	2% for MKT/MKP/MFP 5% for EMI suppression capacitors
$\tan \delta$	As specified in sectional specification

1.3 General notes on soldering

Permissible heat exposure loads on film capacitors are primarily characterized by the upper category temperature T_{max} . Long exposure to temperatures above this type-related temperature limit can lead to changes in the plastic dielectric and thus change irreversibly a capacitor's electrical characteristics. For short exposures (as in practical soldering processes) the heat load (and thus the possible effects on a capacitor) will also depend on other factors like:

- Pre-heating temperature and time
- Forced cooling immediately after soldering
- Terminal characteristics:
diameter, length, thermal resistance, special configurations (e.g. crimping)
- Height of capacitor above solder bath
- Shadowing by neighboring components
- Additional heating due to heat dissipation by neighboring components
- Use of solder-resist coatings

The overheating associated with some of these factors can usually be reduced by suitable countermeasures. For example, if a pre-heating step cannot be avoided, an additional or reinforced cooling process may possibly have to be included.

Recommendations

As a reference, the recommended wave soldering profile for our film capacitors is as follows:

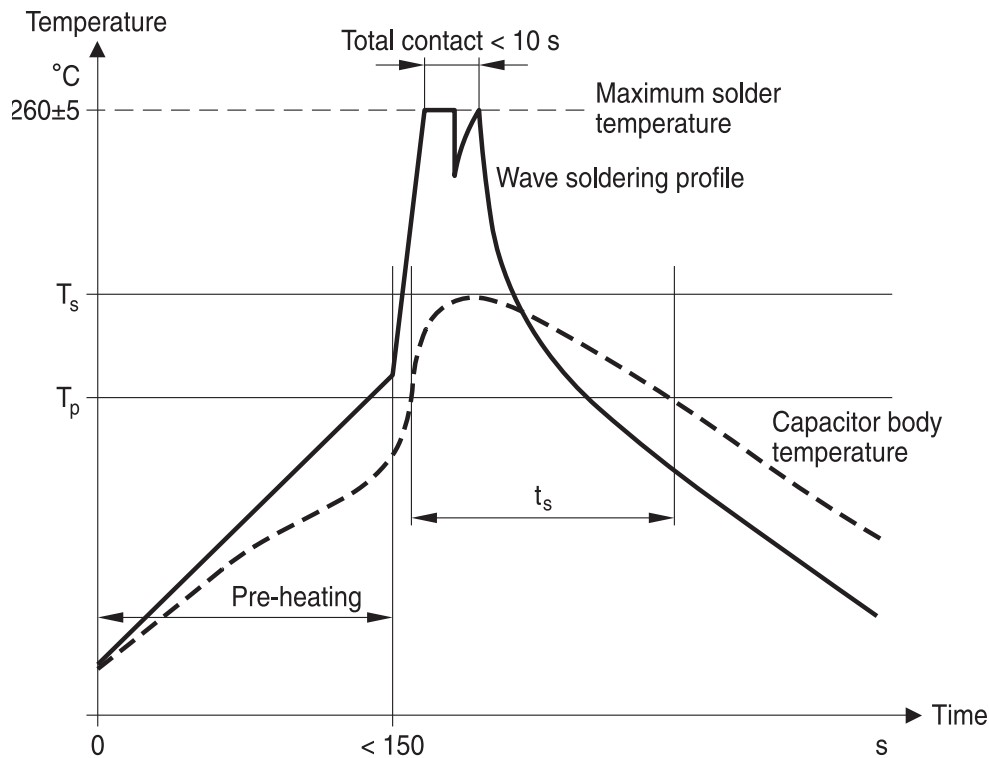

T_s : Capacitor body maximum temperature at wave soldering

T_p : Capacitor body maximum temperature at pre-heating

KMK1745-A-E

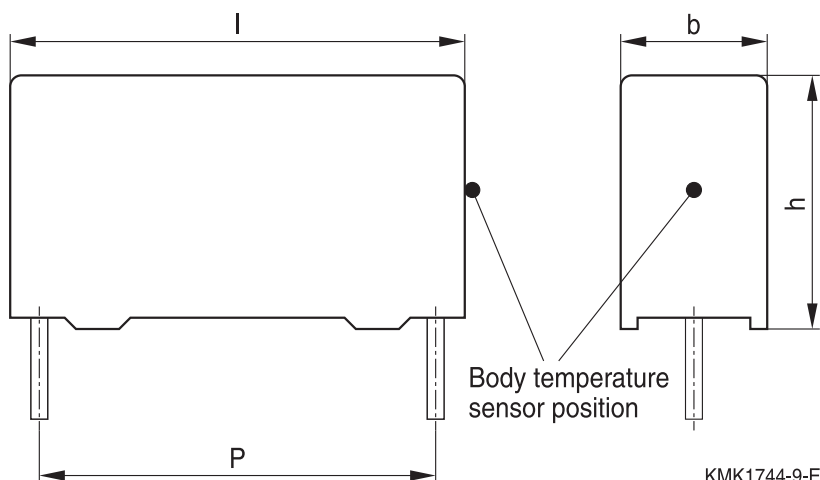

KMK1744-9-E

Snubber (wound)

Body temperature should follow the description below:

- MKP capacitor
 - During pre-heating: $T_p \leq 110 \text{ }^\circ\text{C}$
 - During soldering: $T_s \leq 120 \text{ }^\circ\text{C}$, $t_s \leq 45 \text{ s}$
- MKT capacitor
 - During pre-heating: $T_p \leq 125 \text{ }^\circ\text{C}$
 - During soldering: $T_s \leq 160 \text{ }^\circ\text{C}$, $t_s \leq 45 \text{ s}$

When SMD components are used together with leaded ones, the film capacitors should not pass into the SMD adhesive curing oven. The leaded components should be assembled after the SMD curing step.

Leaded film capacitors are not suitable for reflow soldering.

In order to ensure proper conditions for manual or selective soldering, the body temperature of the capacitor (T_s) must be $\leq 120 \text{ }^\circ\text{C}$.

One recommended condition for manual soldering is that the tip of the soldering iron should be $< 360 \text{ }^\circ\text{C}$ and the soldering contact time should be no longer than 3 seconds.

For uncoated MKT capacitors with lead spacings $\leq 10 \text{ mm}$ (B32560/B32561) the following measures are recommended:

- pre-heating to not more than $110 \text{ }^\circ\text{C}$ in the preheater phase
- rapid cooling after soldering

Please refer to our Film Capacitors Data Book in case more details are needed.

Cautions and warnings

- Do not exceed the upper category temperature (UCT).
- Do not apply any mechanical stress to the capacitor terminals.
- Avoid any compressive, tensile or flexural stress.
- Do not move the capacitor after it has been soldered to the PC board.
- Do not pick up the PC board by the soldered capacitor.
- Do not place the capacitor on a PC board whose PTH hole spacing differs from the specified lead spacing.
- Do not exceed the specified time or temperature limits during soldering.
- Avoid external energy inputs, such as fire or electricity.
- Avoid overload of the capacitors.
- Consult us if application is with severe temperature and humidity condition.
- There are no serviceable or repairable parts inside the capacitor. Opening the capacitor or any attempts to open or repair the capacitor will void the warranty and liability of TDK Electronics.
- Please note that the standards referred to in this publication may have been revised in the meantime.

The table below summarizes the safety instructions that must always be observed. A detailed description can be found in the relevant sections of the chapters "General technical information" and "Mounting guidelines".

Topic	Safety information	Reference chapter "General technical information"
Storage conditions	Make sure that capacitors are stored within the specified range of time, temperature and humidity conditions.	4.5 "Storage conditions"
Flammability	Avoid external energy, such as fire or electricity (passive flammability), avoid overload of the capacitors (active flammability) and consider the flammability of materials.	5.3 "Flammability"
Resistance to vibration	Do not exceed the tested ability to withstand vibration. The capacitors are tested to IEC 60068-2-6:2007. TDK Electronics offers film capacitors specially designed for operation under more severe vibration regimes such as those found in automotive applications. Consult our catalog "Film Capacitors for Automotive Electronics".	5.2 "Resistance to vibration"
Soldering	Do not exceed the specified time or temperature limits during soldering.	1 "Soldering"
Cleaning	Use only suitable solvents for cleaning capacitors.	2 "Cleaning"
Embedding of capacitors in finished assemblies	When embedding finished circuit assemblies in plastic resins, chemical and thermal influences must be taken into account. Caution: Consult us first, if you also wish to embed other uncoated component types!	3 "Embedding of capacitors in finished assemblies"

Display of ordering codes for TDK Electronics products

The ordering code for one and the same product can be represented differently in data sheets, data books, other publications, on the company website, or in order-related documents such as shipping notes, order confirmations and product labels. The varying representations of the ordering codes are due to different processes employed and do not affect the specifications of the respective products.

Detailed information can be found on the Internet under www.tdk-electronics.tdk.com/orderingcodes.

Correlation of data sheet values and modelling tool outputs

Data sheet values and results of design tools may deviate as they have not been derived in the same context.

While data sheets show individual parameter statements without considering a possible dependency to other parameters. Tools model a complete given scenario as input and processed inside the tool.

Furthermore as we constantly strive to improve our models, the results of tools can change over time and be a non-binding indication only.

Symbols and terms

Symbol	English	German
α	Heat transfer coefficient	Wärmeübergangszahl
α_C	Temperature coefficient of capacitance	Temperaturkoeffizient der Kapazität
A	Capacitor surface area	Kondensatoroberfläche
β_C	Humidity coefficient of capacitance	Feuchtekoeffizient der Kapazität
C	Capacitance	Kapazität
C_R	Rated capacitance	Nennkapazität
ΔC	Absolute capacitance change	Absolute Kapazitätsänderung
$\Delta C/C$	Relative capacitance change (relative deviation of actual value)	Relative Kapazitätsänderung (relative Abweichung vom Ist-Wert)
$\Delta C/C_R$	Capacitance tolerance (relative deviation from rated capacitance)	Kapazitätstoleranz (relative Abweichung vom Nennwert)
dt	Time differential	Differentielle Zeit
Δt	Time interval	Zeitintervall
ΔT	Absolute temperature change (self-heating)	Absolute Temperaturänderung (Selbsterwärmung)
$\Delta \tan \delta$	Absolute change of dissipation factor	Absolute Änderung des Verlustfaktors
ΔV	Absolute voltage change	Absolute Spannungsänderung
dV/dt	Time differential of voltage function (rate of voltage rise)	Differentielle Spannungsänderung (Spannungsflankensteilheit)
$\Delta V/\Delta t$	Voltage change per time interval	Spannungsänderung pro Zeitintervall
E	Activation energy for diffusion	Aktivierungsenergie zur Diffusion
ESL	Self-inductance	Eigeninduktivität
ESR	Equivalent series resistance	Ersatz-Serienwiderstand
f	Frequency	Frequenz
f_1	Frequency limit for reducing permissible AC voltage due to thermal limits	Grenzfrequenz für thermisch bedingte Reduzierung der zulässigen Wechsel- spannung
f_2	Frequency limit for reducing permissible AC voltage due to current limit	Grenzfrequenz für strombedingte Redu- zierung der zulässigen Wechselspannung
f_r	Resonant frequency	Resonanzfrequenz
F_D	Thermal acceleration factor for diffusion	Therm. Beschleunigungsfaktor zur Diffusion
F_T	Derating factor	Deratingfaktor
i	Current (peak)	Stromspitze
I_C	Category current (max. continuous current)	Kategoriestrom (max. Dauerstrom)
I_{RMS}	(Sinusoidal) alternating current, root-mean- square value	(Sinusförmiger) Wechselstrom
i_z	Capacitance drift	Inkonstanz der Kapazität
k_0	Pulse characteristic	Impulskenwert
L_S	Series inductance	Serieninduktivität
λ	Failure rate	Ausfallrate
λ_0	Constant failure rate during useful service life	Konstante Ausfallrate in der Nutzungsphase

Symbol	English	German
λ_{test}	Failure rate, determined by tests	Experimentell ermittelte Ausfallrate
P_{diss}	Dissipated power	Abgegebene Verlustleistung
P_{gen}	Generated power	Erzeugte Verlustleistung
Q	Heat energy	Wärmeenergie
ρ	Density of water vapor in air	Dichte von Wasserdampf in Luft
R	Universal molar constant for gases	Allg. Molarkonstante für Gas
R	Ohmic resistance of discharge circuit	Ohmscher Widerstand des Entladekreises
R_i	Internal resistance	Innenwiderstand
R_{ins}	Insulation resistance	Isolationswiderstand
R_p	Parallel resistance	Parallelwiderstand
R_s	Series resistance	Serienwiderstand
S	severity (humidity test)	Schärfegrad (Feuchtetest)
t	Time	Zeit
T	Temperature	Temperatur
τ	Time constant	Zeitkonstante
$\tan \delta$	Dissipation factor	Verlustfaktor
$\tan \delta_D$	Dielectric component of dissipation factor	Dielektrischer Anteil des Verlustfaktors
$\tan \delta_P$	Parallel component of dissipation factor	Parallelanteil des Verlustfaktors
$\tan \delta_S$	Series component of dissipation factor	Serienanteil des Verlustfaktors
T_A	Temperature of the air surrounding the component	Temperatur der Luft, die das Bauteil umgibt
T_{max}	Upper category temperature	Obere Kategorietemperatur
T_{min}	Lower category temperature	Untere Kategorietemperatur
t_{OL}	Operating life at operating temperature and voltage	Betriebszeit bei Betriebstemperatur und -spannung
T_{op}	Operating temperature, $T_A + \Delta T$	Betriebstemperatur, $T_A + \Delta T$
T_R	Rated temperature	Nenntemperatur
T_{ref}	Reference temperature	Referenztemperatur
t_{SL}	Reference service life	Referenz-Lebensdauer
V_{AC}	AC voltage	Wechselspannung
V_C	Category voltage	Kategoriespannung
$V_{\text{C,RMS}}$	Category AC voltage	(Sinusförmige) Kategorie-Wechselspannung
V_{CD}	Corona-discharge onset voltage	Teilentlade-Einsatzspannung
V_{ch}	Charging voltage	Ladespannung
V_{DC}	DC voltage	Gleichspannung
V_{FB}	Fly-back capacitor voltage	Spannung (Flyback)
V_i	Input voltage	Eingangsspannung
V_o	Output voltage	Ausgangsspannung
V_{op}	Operating voltage	Betriebsspannung
V_p	Peak pulse voltage	Impuls-Spitzenspannung
V_{pp}	Peak-to-peak voltage Impedance	Spannungshub

Metallized polypropylene film capacitors (MKP)
B32656S, B32658S
Snubber (wound)

Symbol	English	German
V_R	Rated voltage	Nennspannung
\hat{V}_R	Amplitude of rated AC voltage	Amplitude der Nenn-Wechselspannung
V_{RMS}	(Sinusoidal) alternating voltage, root-mean-square value	(Sinusförmige) Wechselspannung
V_{SC}	S-correction voltage	Spannung bei Anwendung "S-correction"
V_{sn}	Snubber capacitor voltage	Spannung bei Anwendung "Beschaltung"
Z	Impedance	Scheinwiderstand
e	Lead spacing	Rastermaß

Important notes

The following applies to all products named in this publication:

1. Some parts of this publication contain **statements about the suitability of our products for certain areas of application**. These statements are based on our knowledge of typical requirements that are often placed on our products in the areas of application concerned. We nevertheless expressly point out **that such statements cannot be regarded as binding statements about the suitability of our products for a particular customer application**. As a rule, we are either unfamiliar with individual customer applications or less familiar with them than the customers themselves. For these reasons, it is always ultimately incumbent on the customer to check and decide whether a product with the properties described in the product specification is suitable for use in a particular customer application.
2. We also point out that **in individual cases, a malfunction of electronic components or failure before the end of their usual service life cannot be completely ruled out in the current state of the art, even if they are operated as specified**. In customer applications requiring a very high level of operational safety and especially in customer applications in which the malfunction or failure of an electronic component could endanger human life or health (e.g. in accident prevention or life-saving systems), it must therefore be ensured by means of suitable design of the customer application or other action taken by the customer (e.g. installation of protective circuitry or redundancy) that no injury or damage is sustained by third parties in the event of malfunction or failure of an electronic component.
3. **The warnings, cautions and product-specific notes must be observed.**
4. In order to satisfy certain technical requirements, **some of the products described in this publication may contain substances subject to restrictions in certain jurisdictions (e.g. because they are classed as hazardous)**. Useful information on this will be found in our Material Data Sheets on the Internet (www.tdk-electronics.tdk.com/material). Should you have any more detailed questions, please contact our sales offices.
5. We constantly strive to improve our products. Consequently, **the products described in this publication may change from time to time**. The same is true of the corresponding product specifications. Please check therefore to what extent product descriptions and specifications contained in this publication are still applicable before or when you place an order.
We also **reserve the right to discontinue production and delivery of products**. Consequently, we cannot guarantee that all products named in this publication will always be available. The aforementioned does not apply in the case of individual agreements deviating from the foregoing for customer-specific products.
6. Unless otherwise agreed in individual contracts, **all orders are subject to our General Terms and Conditions of Supply**.

Important notes

7. **Our manufacturing sites serving the automotive business apply the IATF 16949 standard.** The IATF certifications confirm our compliance with requirements regarding the quality management system in the automotive industry. Referring to customer requirements and customer specific requirements (“CSR”) TDK always has and will continue to have the policy of respecting individual agreements. Even if IATF 16949 may appear to support the acceptance of unilateral requirements, we hereby like to emphasize that **only requirements mutually agreed upon can and will be implemented in our Quality Management System.** For clarification purposes we like to point out that obligations from IATF 16949 shall only become legally binding if individually agreed upon.
8. The trade names EPCOS, CarXield, CeraCharge, CeraDiode, CeraLink, CeraPad, CeraPlas, CSMP, CTVS, DeltaCap, DigiSiMic, ExoCore, FilterCap, FormFit, LeaXield, MiniBlue, MiniCell, MKD, MKK, ModCap, MotorCap, PCC, PhaseCap, PhaseCube, PhaseMod, PhiCap, PowerHap, PQSine, PQvar, SIFERRIT, SIFI, SIKOREL, SilverCap, SIMDAD, SiMic, SIMID, SineFormer, SIOV, ThermoFuse, WindCap, XieldCap are **trademarks registered or pending** in Europe and in other countries. Further information will be found on the Internet at www.tdk-electronics.tdk.com/trademarks.

Release 2020-06