



User Guide

Wire-Free Security Camera System

Contents

| | |
|------------------------------|----|
| About This Guide | 1 |
| Introduction | 2 |
| Appearance-Camera | 3 |
| Appearance-Hub | 4 |
| Charge the Battery | 7 |
| Set Up Your Camera | 8 |
| Install a microSD Card | 10 |
| Mount Your Camera | 11 |
| Main Hub Controls | 12 |
| Main Camera Controls | 16 |
| Check Battery Status | 18 |
| Set Privacy Zones | 19 |

| | |
|---------------------------------|----|
| Night Vision Mode | 20 |
| Camera Detection & Alerts | 21 |
| Detection Recordings | 24 |
| Manual Recording..... | 25 |
| Privacy Mode | 26 |
| Clips Settings..... | 27 |
| Share Camera..... | 28 |
| Smart Actions..... | 29 |
| Check Me Page | 32 |
| Authentication..... | 33 |

About This Guide

This guide provides a brief introduction to the Smart Wire-Free Security Camera System and the Tapo app, as well as regulatory information.

Please note that features available in Tapo may vary by model and software version. Tapo availability may also vary by region. All images, steps, and descriptions in this guide are only examples and may not reflect your actual Tapo Camera experience.

Conventions

In this guide, the following convention is used:

| Convention | Description |
|------------------|--|
| Blue | Key information appears in teal, including management page text such as menus, items, buttons and so on. |
| <u>Underline</u> | Hyperlinks are in teal and underlined. You can click to redirect to a website. |
| 📌Note: | Ignoring this type of note might result in a malfunction or damage to the device. |

More Info

- Specifications can be found on the product page at <https://www.tapo.com>.
- Our Technical Support and troubleshooting information can be found at <https://www.tapo.com/support/>.

Introduction

Install anywhere with long battery life.

Tapo Wire-Free Security Camera System is designed to be used outdoors. Its rechargeable and removable battery with a low-power protocol extends your usage. No wires means you can place the camera wherever you like. The camera is equipped with the starlight sensor and the spotlights, catching more colors. The highly-sensitive starlight sensor captures higher-quality images even in low-light conditions. The integrated spotlights help enhance your security view with vivid colors even at night.

- **2K QHD** – Now with 1.7 times more pixels than 1080p, providing clearer videos and photos.
- **180 Day Long Battery Life** – The rechargeable and removable battery with a low-power protocol extends your usage.

*180-day battery life is based on TP-Link's laboratory testing with 10-20 triggered events per day. Actual battery life may vary based on device settings, use, and environmental factors.

- **Wire-Free Placement** – No wires means you can place the cameras almost anywhere inside or outside - whatever works for you.
- **Smart AI Detection** – Detect multiple event types with smart AI algorithms. Adjust the sensitivity according to your needs.
- **Sound and Light Alarm** – Trigger sound and light as an alarm when motion is detected.
- **Full-Color Night Vision** – Enhance your security view with vivid colors even at night with the integrated spotlights.
- **Starlight Sensor** – The highly-sensitive starlight sensor captures higher-quality images even in low-light conditions.
- **Motion Detection** – Get instant notifications when your camera detects motion.
- **Weatherproof** – Helps Tapo cameras perform well even in harsh environments with rain and dust.
- **Two-Way Audio** – Communicate with others with the built-in microphone and speaker.
- **Flexible Storage Choices** – Save recorded videos on the hub-installed microSD card (up to 256 GB) or by using Tapo Care cloud storage services.

*microSD card needs to be purchased separately.

**Subscribe for cloud storage at <https://www.tapo.com/tapocare/>.

Appearance-Camera

Front

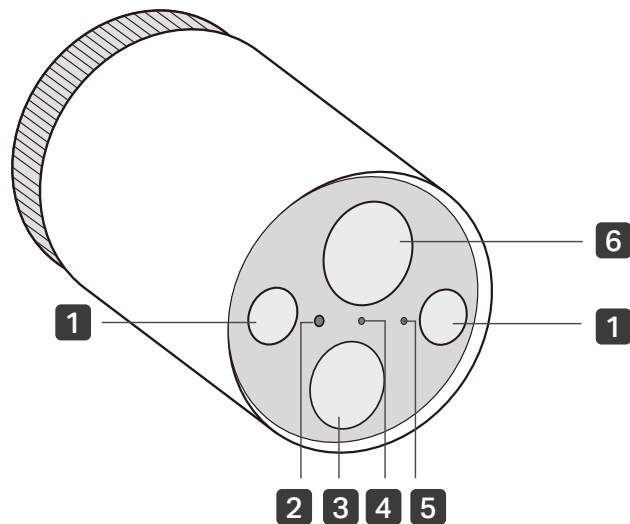

1 Spotlights

2 Light Sensor

3 Motion Sensor

4 Status LED

Indicate the status of your camera.

5 Microphone

6 Lens

Back

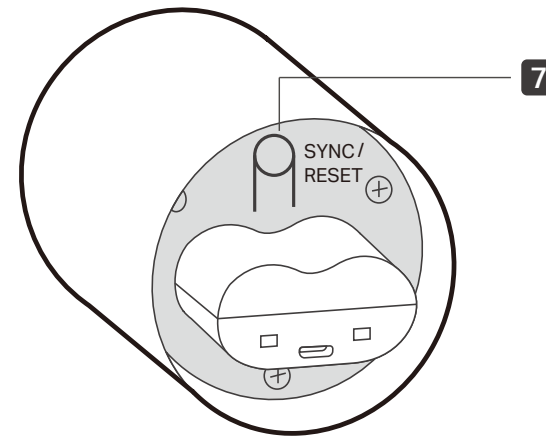

7 SYNC/RESET Button

While the camera is powered on:

Press for 1 second: Pair with the hub

Press and hold for about 5 seconds: Reset the camera

Appearance-Hub

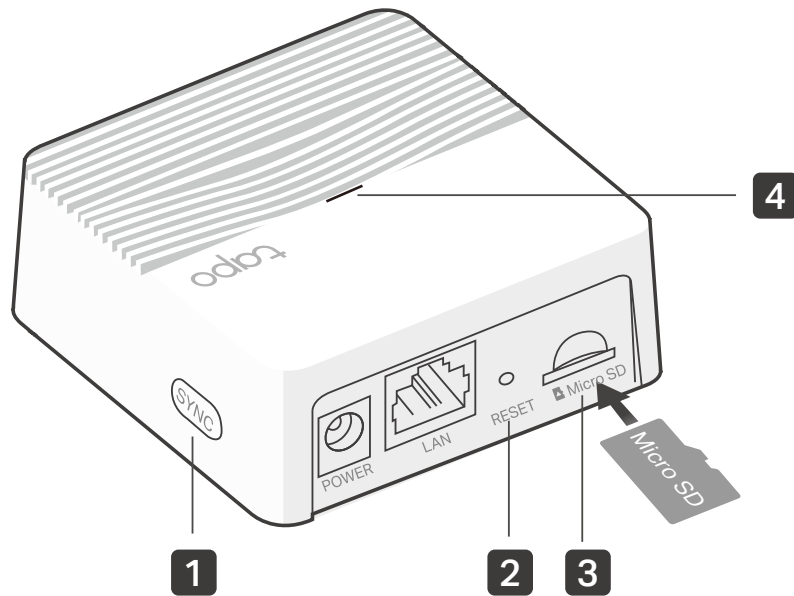

1 SYNC

Press to pair with the camera, or silence the hub when it rings.

2 RESET

Press and hold for about 5 seconds until the hub LED quickly blinks red to reset the hub.

3 microSD Card Slot

Insert a microSD card to record camera videos locally. Initialize the microSD card within the Tapo app first.

↑microSD card not included.

4 Status LED

Indicate the status of your hub.

Hub Status LED

| | |
|------------------------|------------------------|
| Solid red | Starting up |
| Blinking red and green | Ready for setup |
| Solid amber | Connected to router |
| Solid green | Connected to the cloud |
| Blinking green slowly | Pairing |
| Blinking red quickly | Hub resetting |
| Blinking green quickly | Hub updating |

Camera Status LED

| | |
|----------------------------|------------------------|
| Solid Red | Starting up |
| Blinking red and green | Ready for pairing |
| Blinking green slowly | Pairing |
| Solid amber | Connected to the hub |
| Solid green | Connected to the cloud |
| Blinking red quickly | Camera resetting |
| Blinking green quickly | Camera updating |
| Blinking red once a minute | Low battery |
| Blinking red slowly | Offline |

Charge the Battery

Method 1:

Connect the battery to a power source.

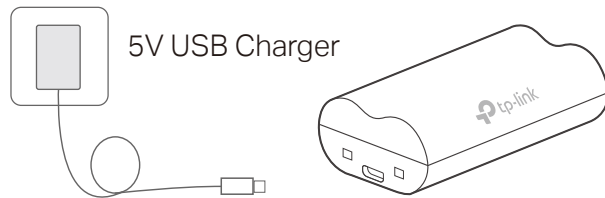

- **Charging:** Solid amber
- **Fully charged:** Solid green

Method 2:

Insert the battery into the camera, and then connect the camera to a power source.

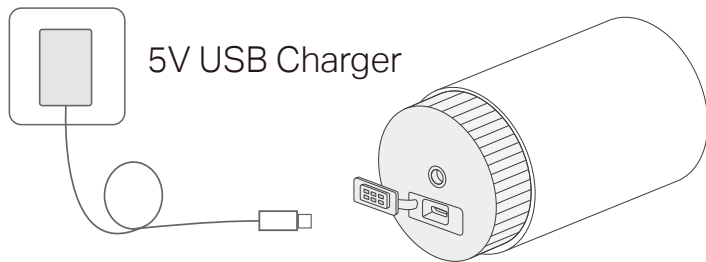

Set Up Your Camera

Follow the steps below to get started with your new hub and camera.

Step 1. Download Tapo App

Get the Tapo app from the App Store or Google Play, or by scanning the QR code below.



OR



Step 2. Log In

Open the app, and log in with your TP-Link ID. If you don't have an account, create one first.

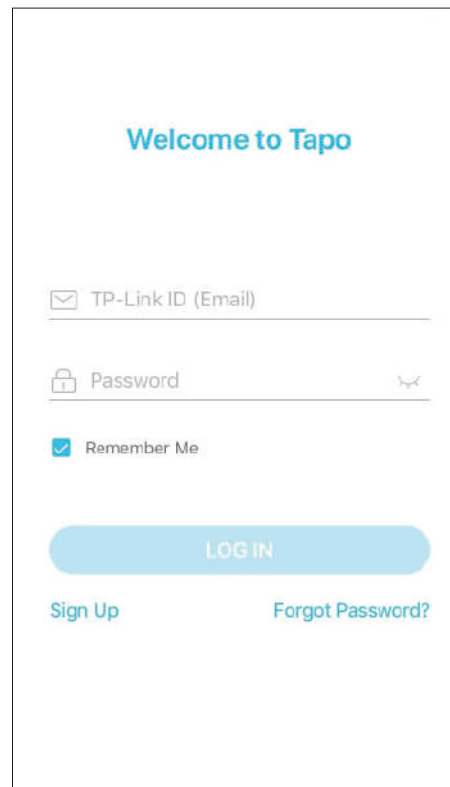

Step 3. Add Your Hub First

Tap the ⊕ button in the app and select your model. Follow app instructions to set up your hub.

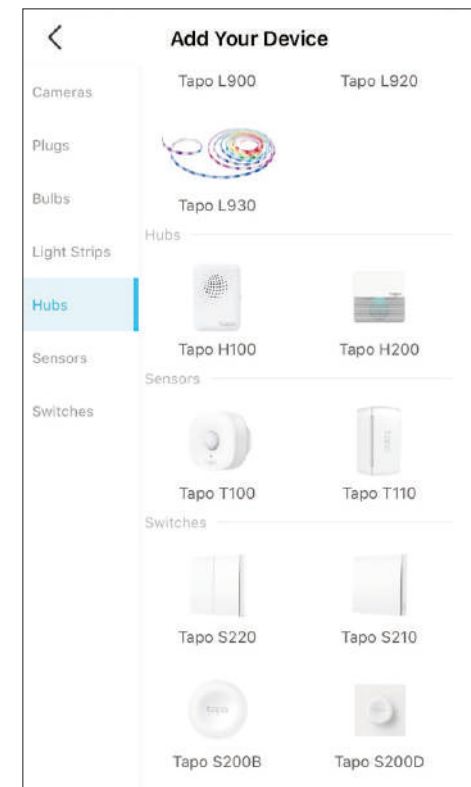

Step 4. Add Your Camera

Tap the ⊕ button in the app and select your model.
Follow app instructions to set up your camera.



Install a microSD Card

If you want the camera to record videos locally, insert a microSD card to your hub.

Initialize the microSD card within the Tapo app.

You can go to [Camera Settings](#) > [microSD Card](#) in the Tapo app to check the card status or format your card.

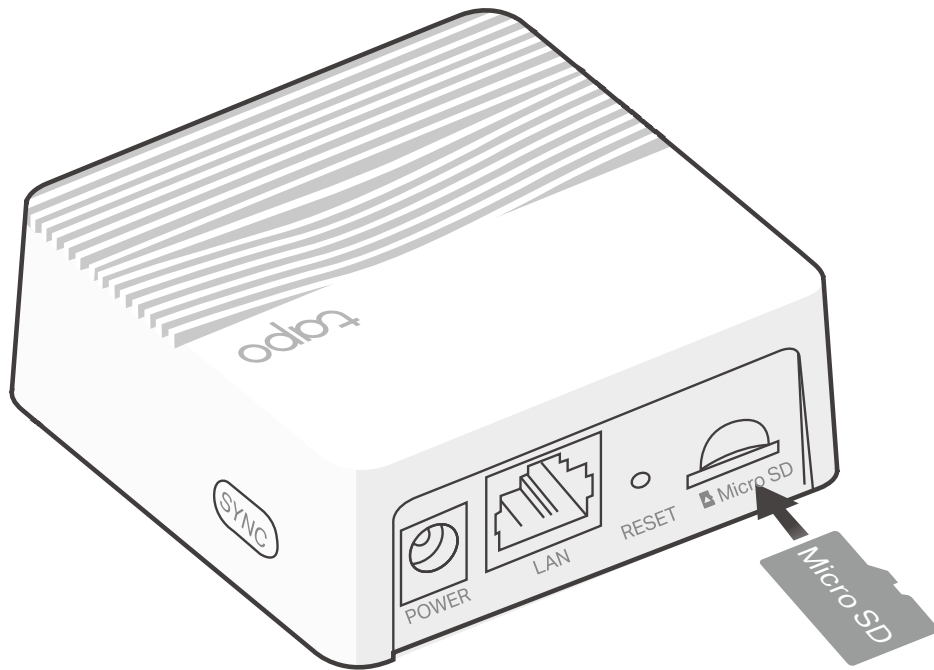

Mount Your Camera

When you finish adding your camera in the Tapo app, you can place your camera on a flat surface, or mount it on a wall or ceiling with the provided mounting template and screws.

Step 1. Drill Holes

Stick the mounting template to the desired mounting place. Drill 3 screw holes according to the template.

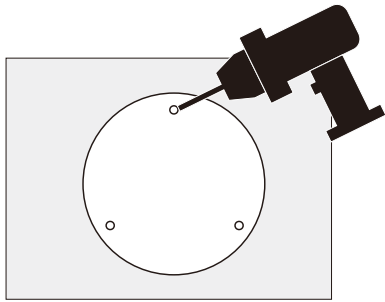

Step 2. Install the Bracket

Insert three anchors into the holes and use the screws to affix the bracket over the anchors.

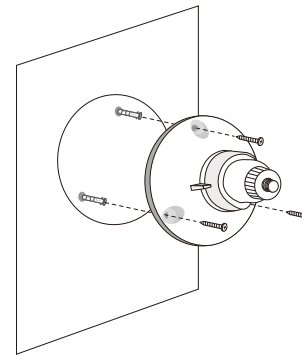

Step 3. Mount Camera

Install the camera to the mounting bracket, and adjust the camera angle.

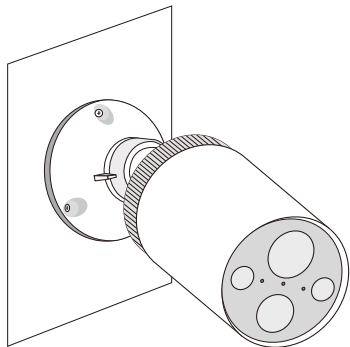

Size of Screws

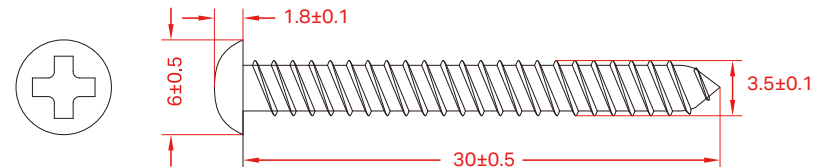

Main Hub Controls

After you successfully set up the hub and camera, you will see your devices listed on the home page. You can view and manage your hub from anywhere at any time with the Tapo app.

Home Page

This page lists all the devices you've added and you can view them directly and manage them easily. Tap the hub to enter the [Status](#) page.

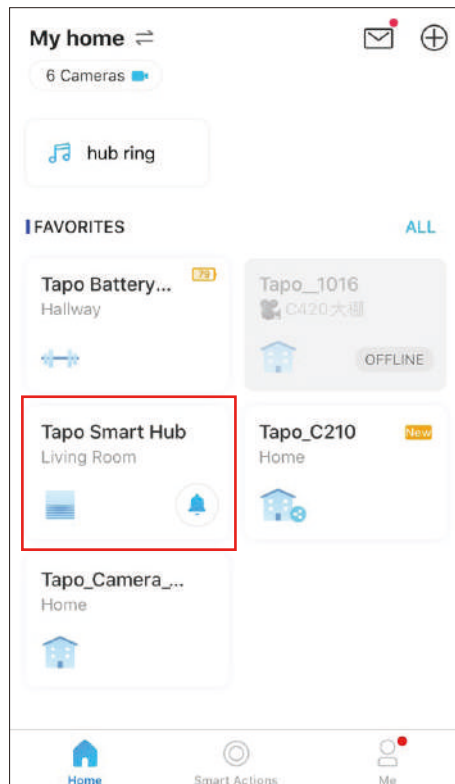

Status Page

You can tap to sound an alarm. When it alarms, you can tap to silence the alarm.

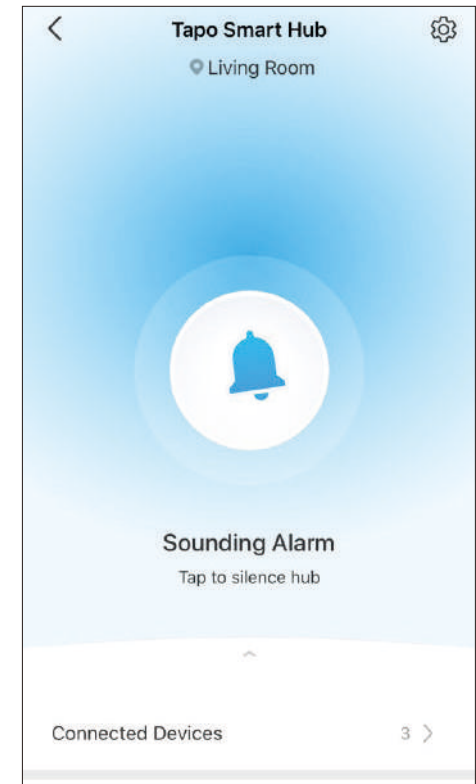
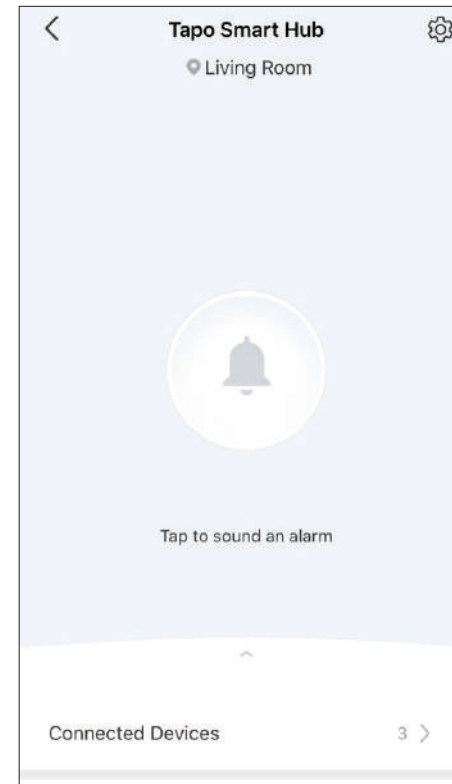

Check Connected Devices

Slide up to check connected devices to the hub. You can also add more devices.

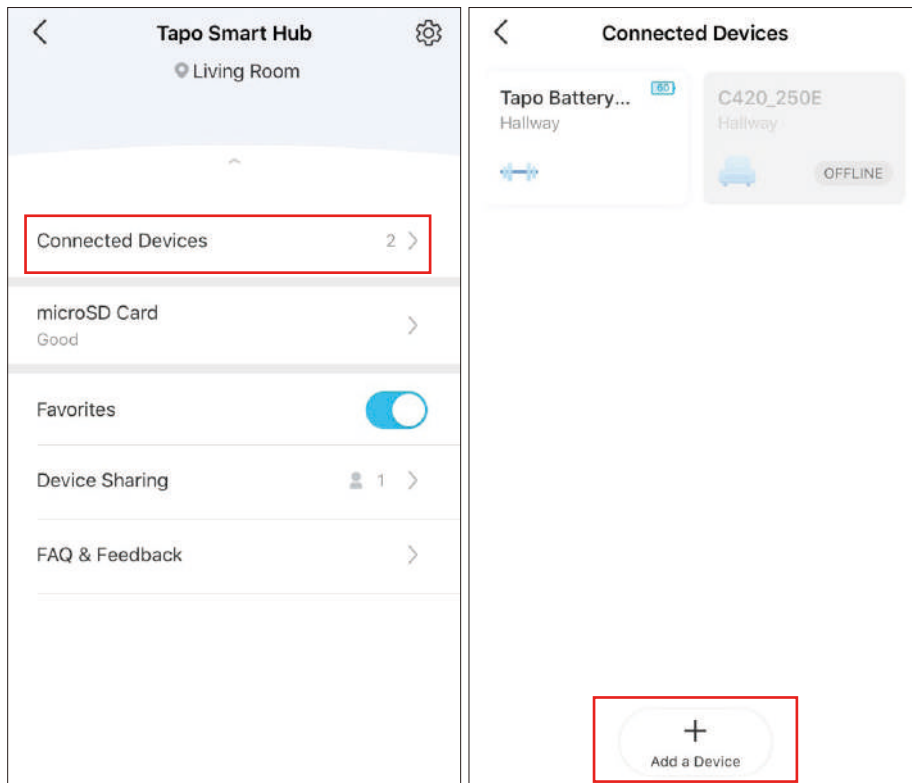

Check microSD Card Status and Storage

You can turn on [Loop Recording](#) if you want new recordings to overwrite previous recordings when storage is not enough. You can also check how much storage is used and the storage used by each connected camera/doorbell. Tap [Format](#) when you want to format your microSD card.

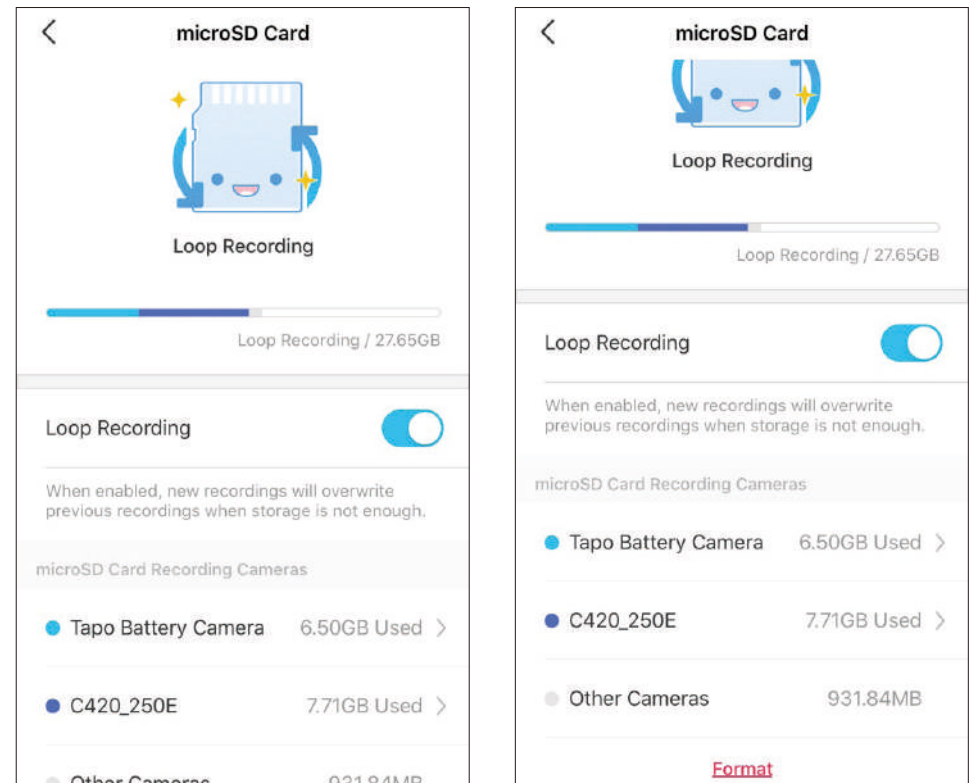

Share Your Hub

You can invite your family members to manage your Tapo devices together by entering the TP-Link ID (email) you want to share the devices with.

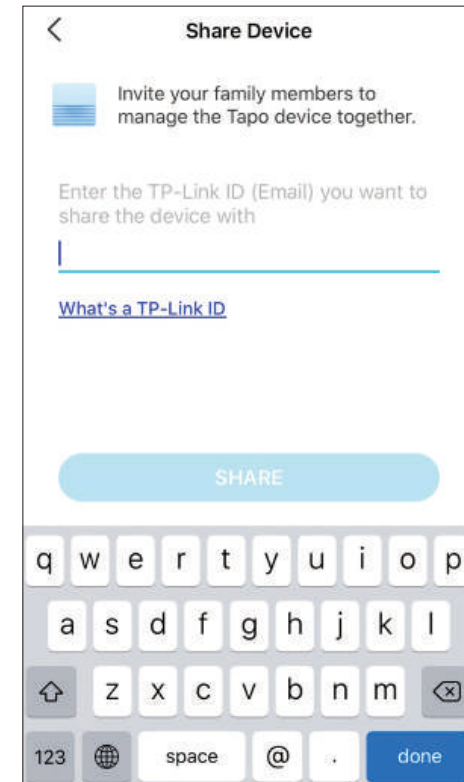
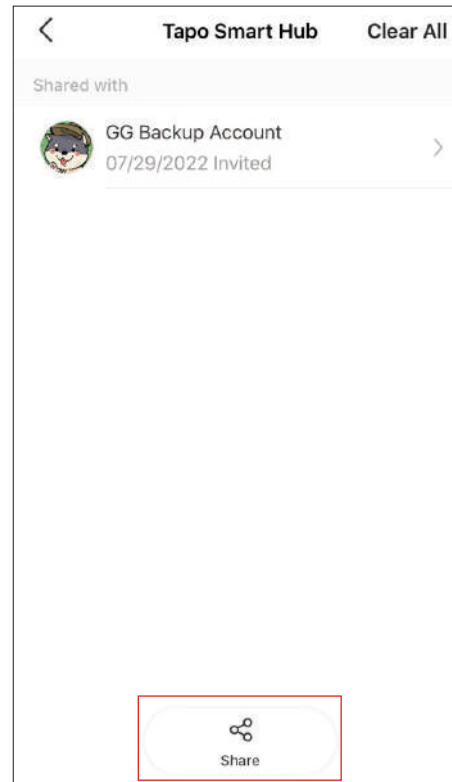
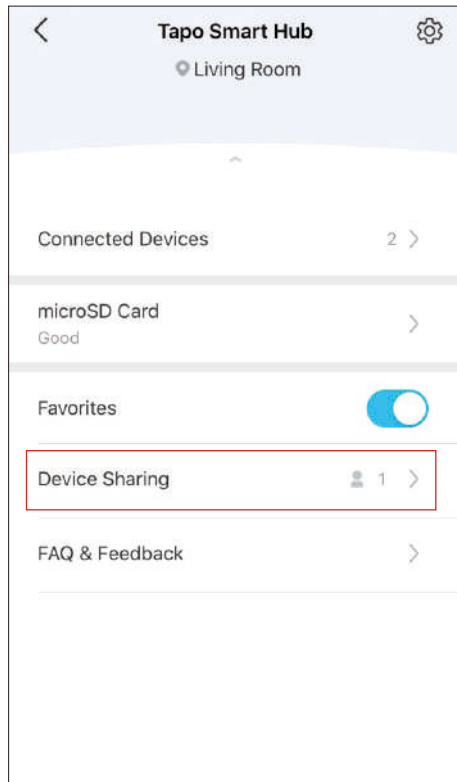

Hub Settings

On [Status](#) page, tap  to enter the settings page. You can change your device name and location, set siren, turn on/off status LED, set auto reboot time, etc.

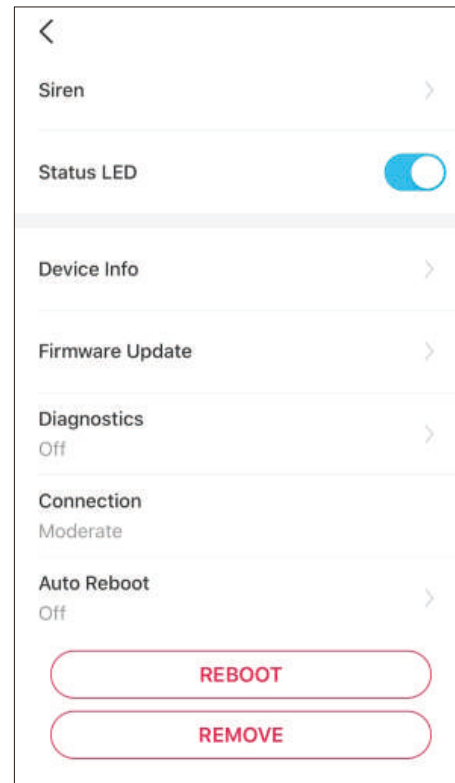
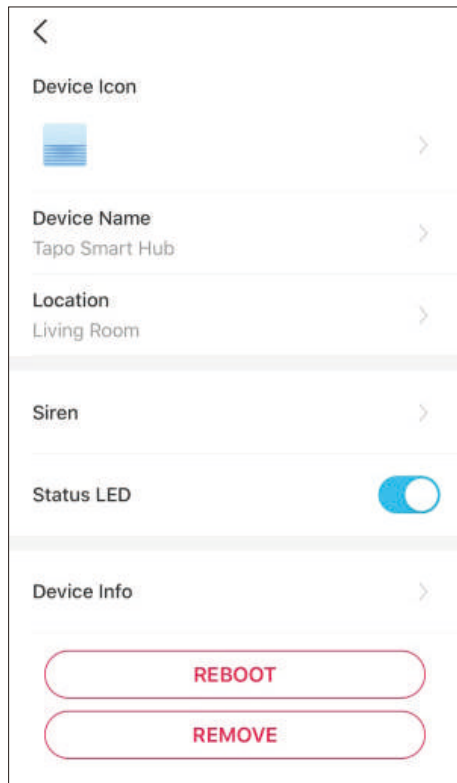

Main Camera Controls

After you successfully set up the camera, you will see your camera listed on the home page. You can view and manage your camera from anywhere at any time with the Tapo app.

Home Page

This page lists all your cameras you've added and you can view them directly and manage them easily. Tap the camera or go to [Camera Preview](#) > [Manage](#) to enter the [Live View](#) page.

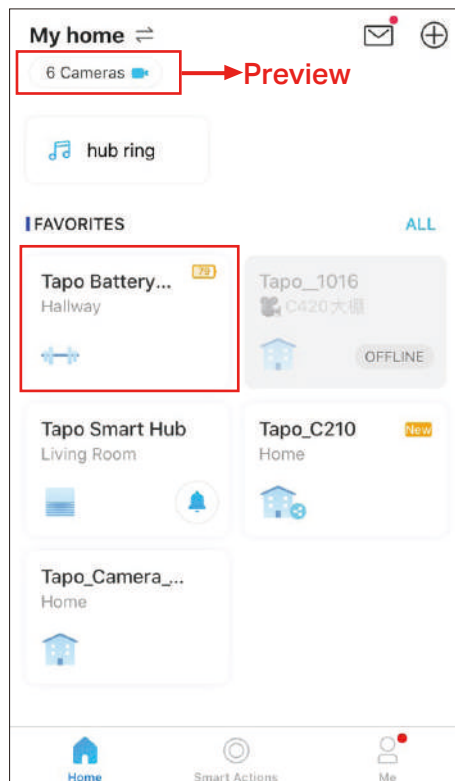

Live View

Talk or Voice Call: Communicate with loved ones

Privacy Mode: Enable to temporarily shut down the surveillance for privacy

Alarm On/Off: Turn on to get noticed when motion detected

Playback & Memory: Check all recordings and saved moments

Video Quality

Day/Night Mode

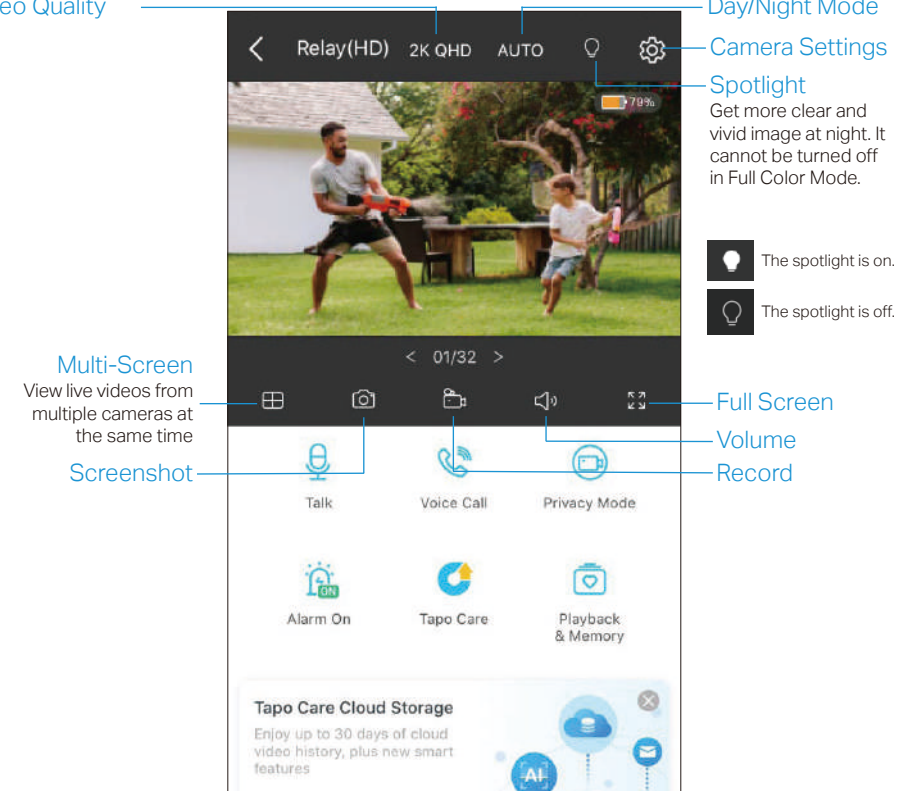

Camera Settings

Spotlight

Get more clear and vivid image at night. It cannot be turned off in Full Color Mode.

The spotlight is on.

The spotlight is off.

Multi-Screen

View live videos from multiple cameras at the same time

Screenshot

Full Screen

Volume

Record

Camera Settings

On [Live View](#) page, tap  to enter the [Camera Settings](#) page. You can change your camera name, set Night Mode settings, customize detection settings and recording schedules, turn on/off notifications, set activity zones, remove camera, etc.

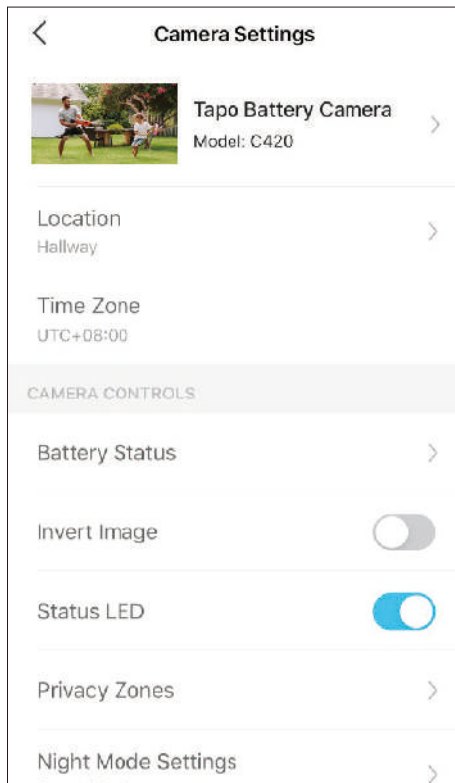

Check Battery Status

Check current battery status, and set power saving mode as you like to save battery.

Show Battery Status on Live View

Go to [Camera Settings](#) page and tap [Battery Status](#). You can set whether to show battery status on [Live View](#).

Set Power Saving Mode

Set when to turn on [Power Saving Mode](#) to save battery.

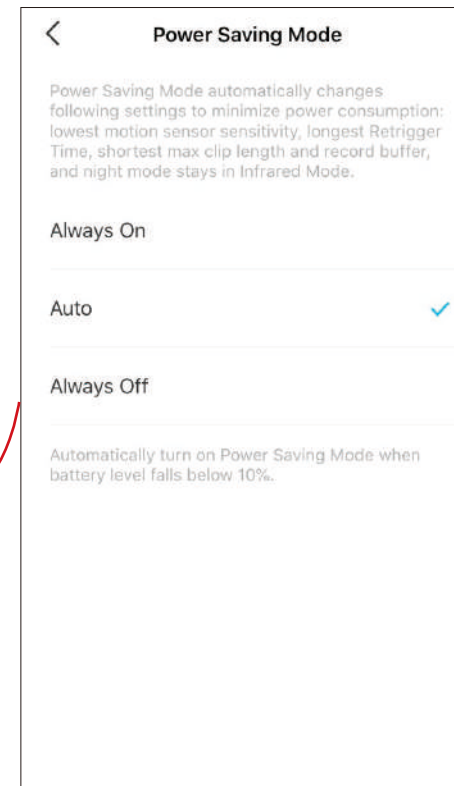
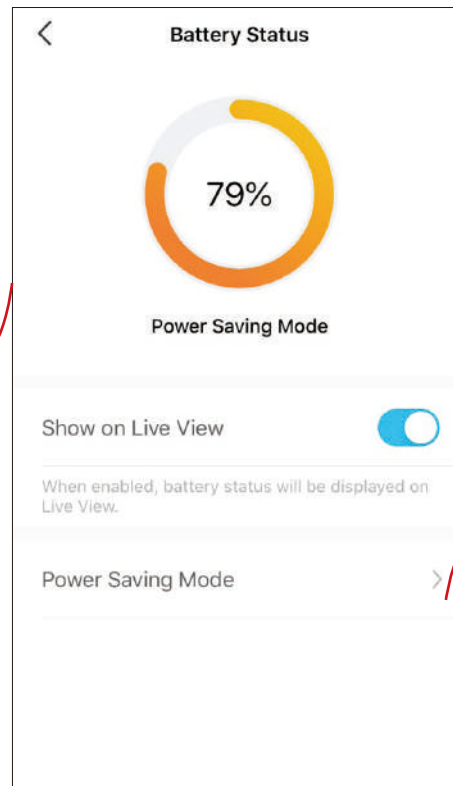
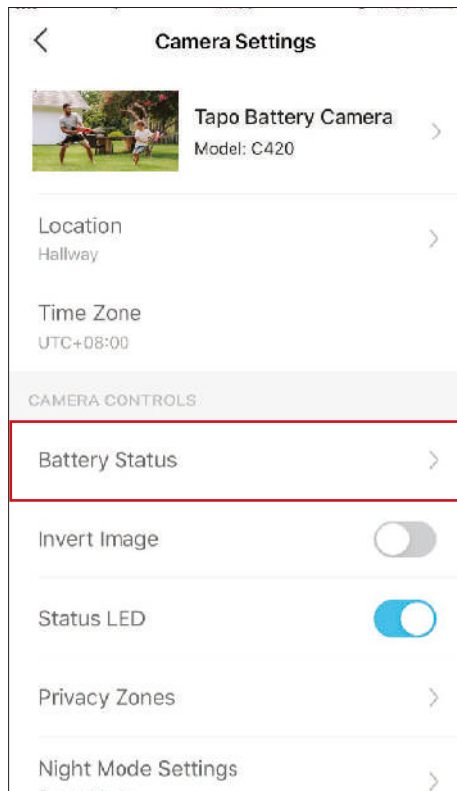

Set Privacy Zones

Privacy zones cannot be viewed or monitored to protect your privacy.

Customize Privacy Zones

Go to [Camera Settings](#) page and tap [Privacy Zones](#). You can set zones that cannot be monitored.

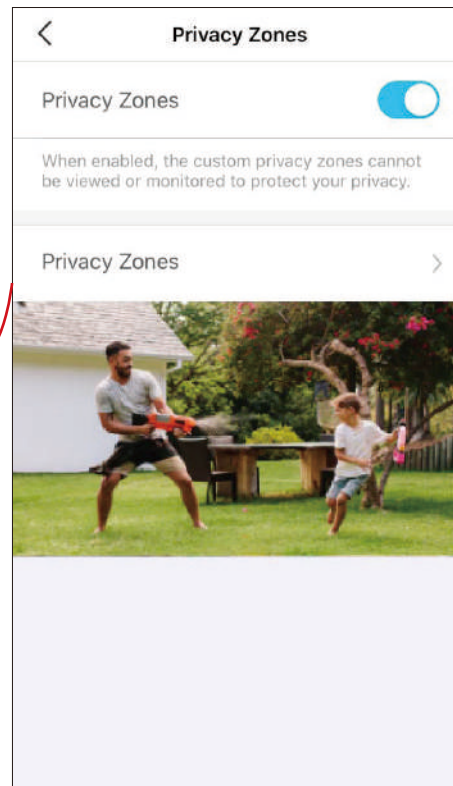
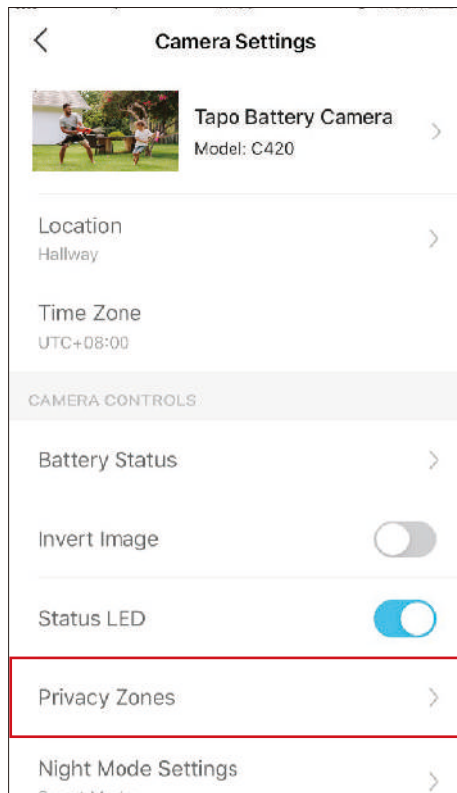

Night Vision Mode

Unlike standard cameras' black and white night view, this smart wire-free camera is equipped with a high-resolution sensor and spotlights, helping enhance your security view with vivid colors even at night. You can choose a preferred night mode and adjust the white light brightness as needed.

Select Night Mode

Go to [Camera Settings](#) > [Night Mode Settings](#), and select your preferred night mode.

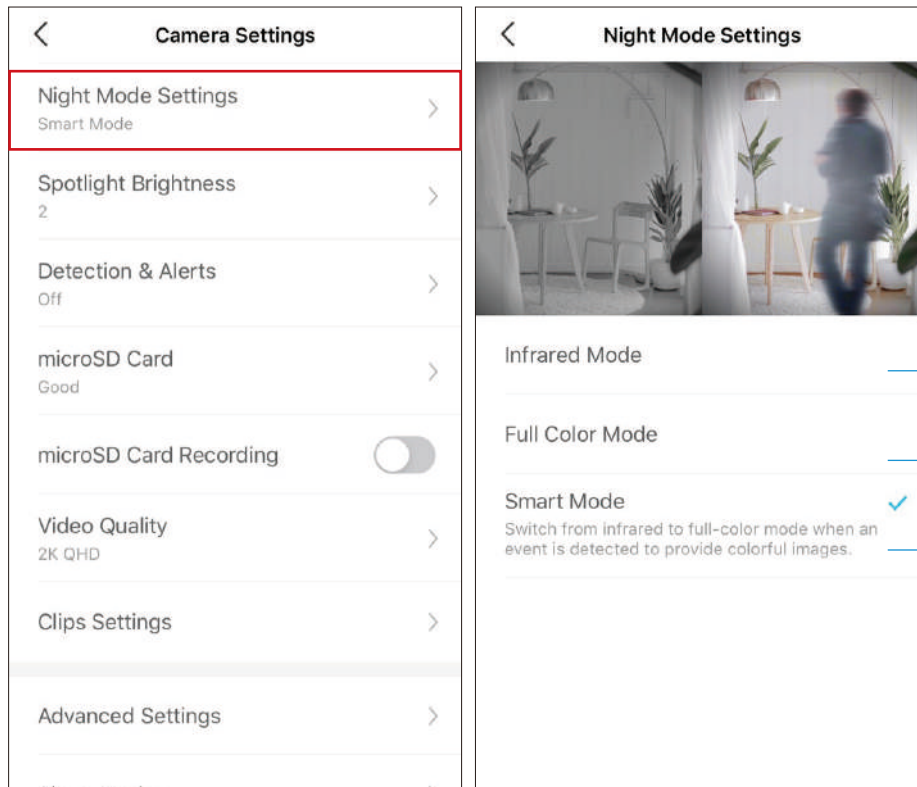

Infrared Mode

Only use the infrared light to create black-and-white images at night.

Full Color Mode

Only use the spotlights to see things vividly in full color at night. The white light will be on.

Smart Mode

Typically run on Infrared Mode and switch automatically to Full Color Mode when motion is detected. The white light will be on in Full Color Mode.

Camera Detection & Alerts

Receive notifications and check feeds when the camera detects a motion or person/pet/vehicle. Insert a microSD card or subscribe to Tapo Care to record the clips when activity detected. Otherwise, you can only receive the notifications.

■Note: Initialize the SD card on the Tapo app before using it.

Step 1: Turn On Detection

Go to [Camera Settings](#) page and tap [Detection & Alerts](#) to turn on the detection and customize motion zones and sensitivity.

AI Detection

When your camera detects person/pet/vehicle, it will send you notifications or even sound an alarm. You can adjust the detection sensitivity.

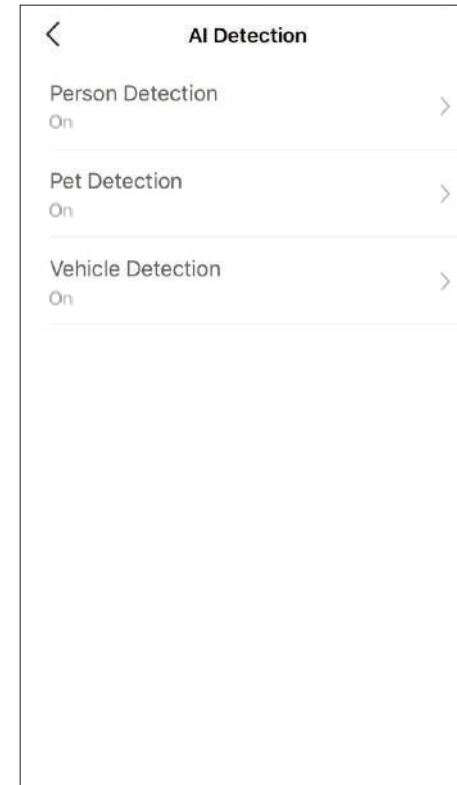
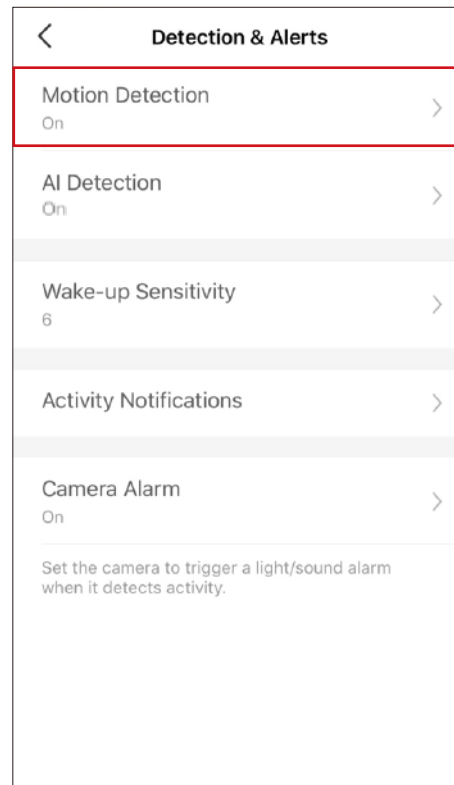
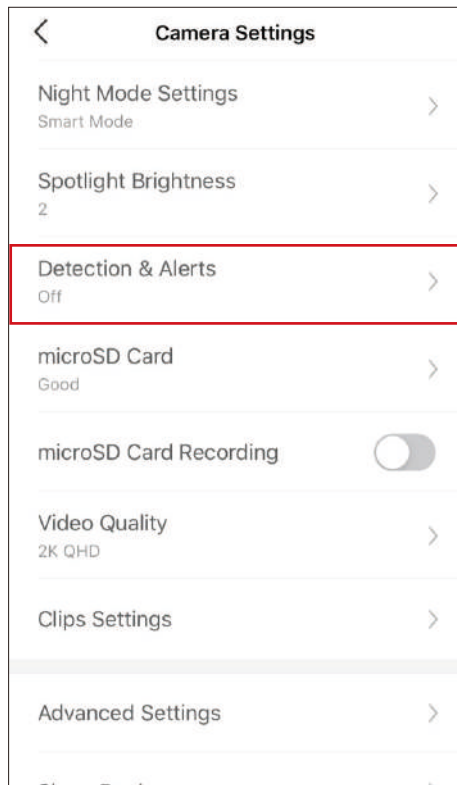

Wake-up Sensitivity

Your battery-powered camera only wakes up and starts recording when motion is detected. You can set how easily the camera wakes up.

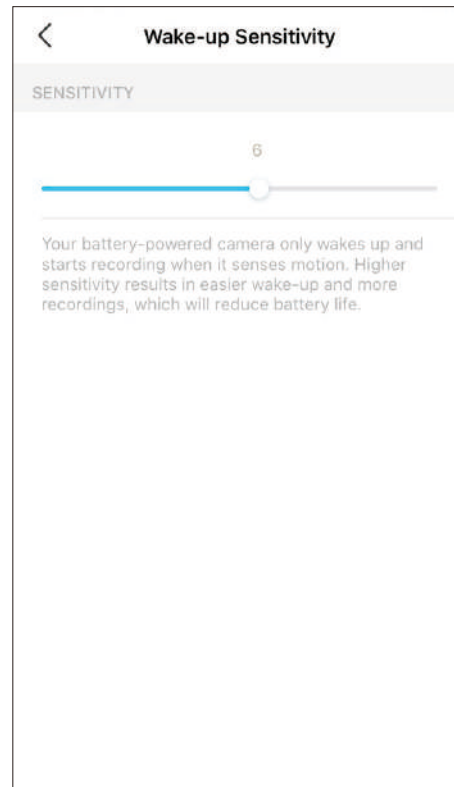
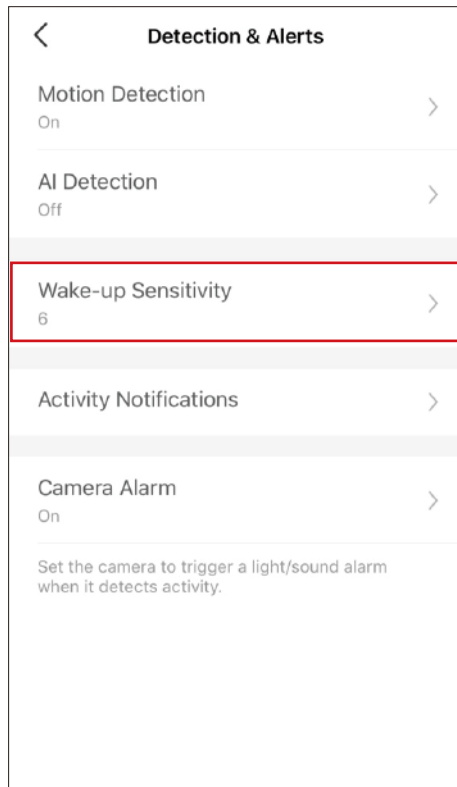

Camera Alarm

Customize [Camera Alarm](#) settings to trigger a light/sound alarm to frighten away unwanted visitors when your camera detects activities. You can also set the [Alarm Schedule](#) as needed.

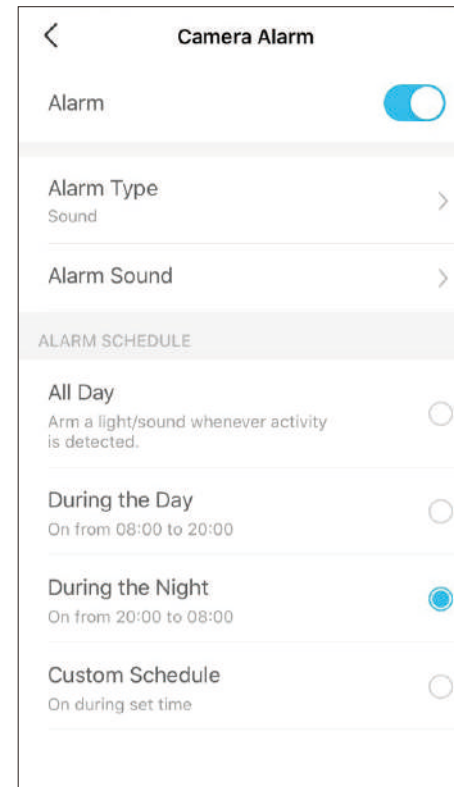

Turn On Activity Notifications

Turn on [Activity Notifications](#) to get instant alerts when your camera detects activities. You can customize the time when the camera sends you notifications.

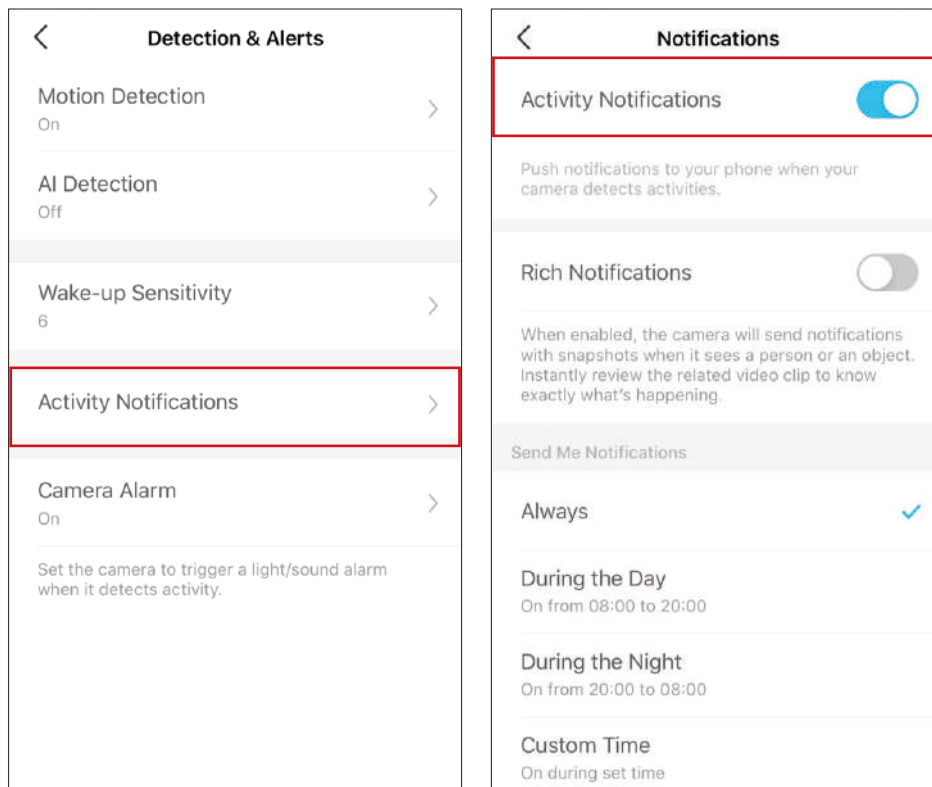

Step 5: Check Recordings

On the [Live View](#) page, tap  to find all recordings. Tap the colored sections or the video clips below to check the activity detected.

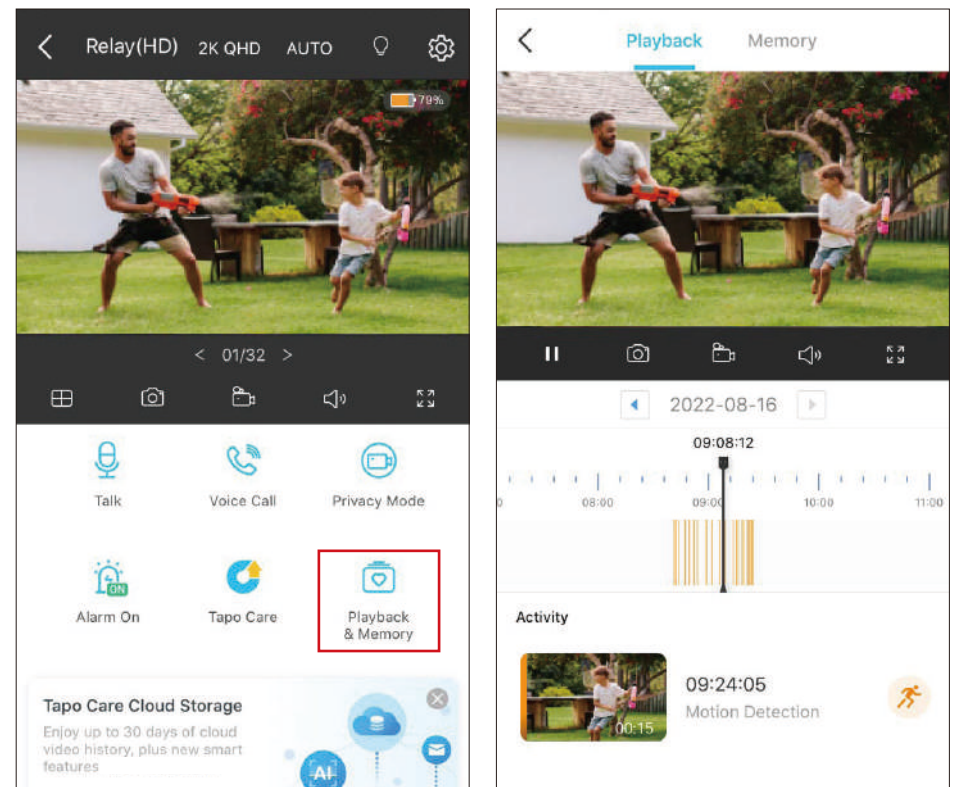

Detection Recordings

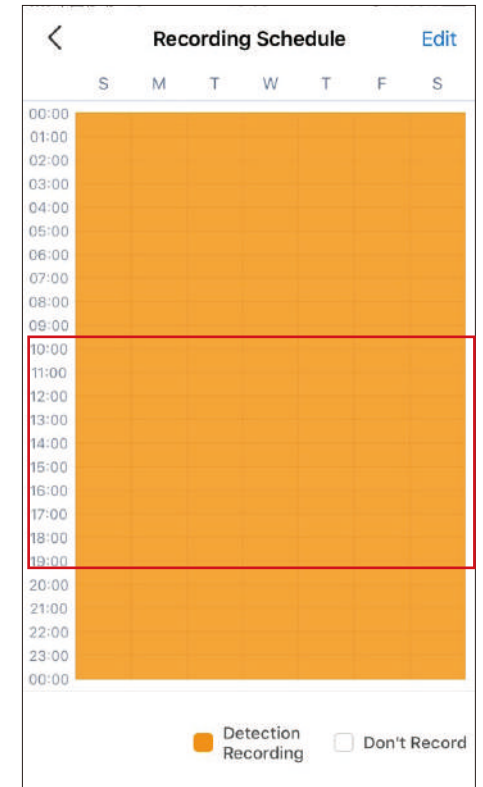
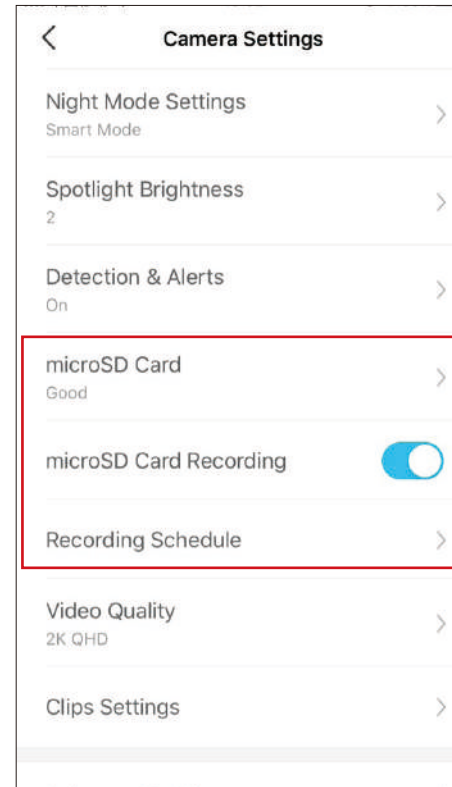
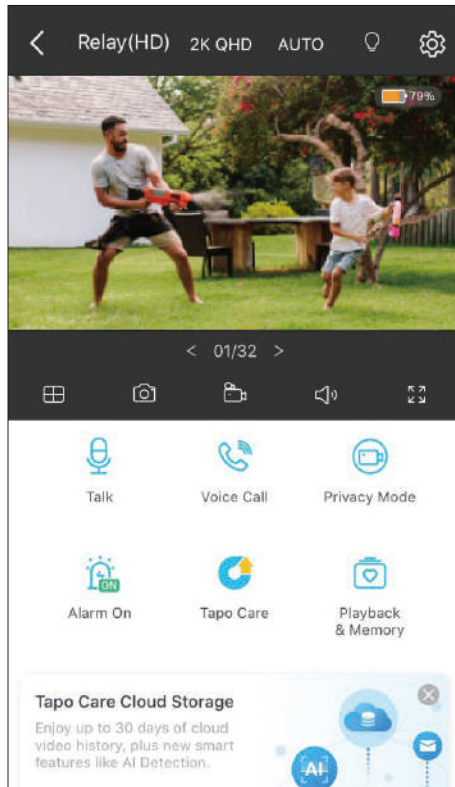

Start recording when events are detected. You need a microSD card or subscribe to Tapo Care to save videos. It's suggested to initialize the SD card on the app before using it.

1. On the [Live View](#) page, tap  to enter the [Camera Settings](#) page.
2. Toggle on to enable the [microSD Recording](#) function and set the [Recording Schedule](#) for 24-hour Recording as needed.



Manual Recording

When watching live or playback, you can take screenshots and record video clips anytime you want. Photos and videos you take will appear in the [Memory](#) page, and you can download them to your phone or share with your family.

1. On the [Live View](#) or [Playback](#) page, tap  to take photos and tap  to record video clips.

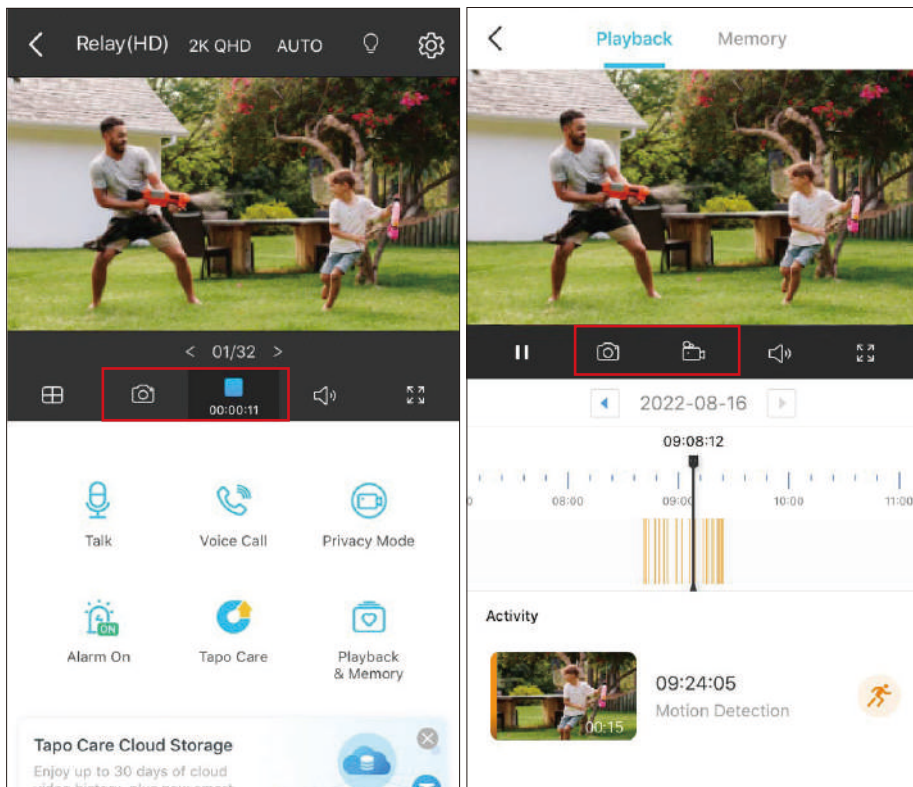

2. Go to [LIVE View](#) page, tap  and enter [Memory](#) page, or go to [Me](#) > [Camera Memory](#) to view, download, and share photos and videos you take.

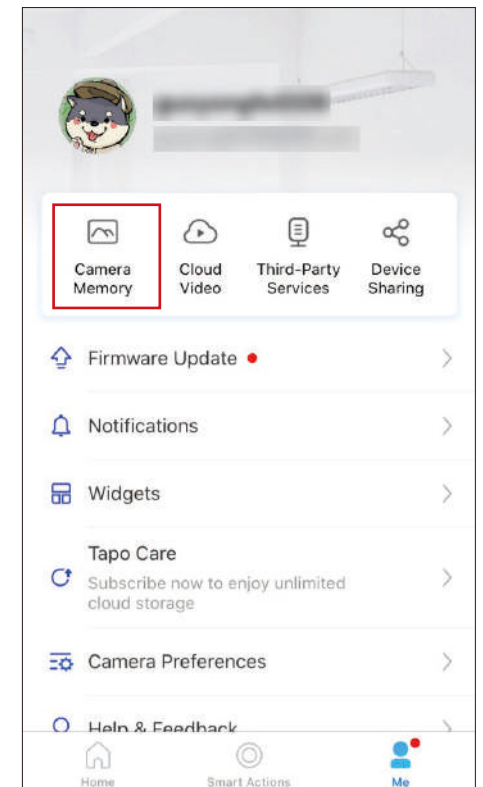
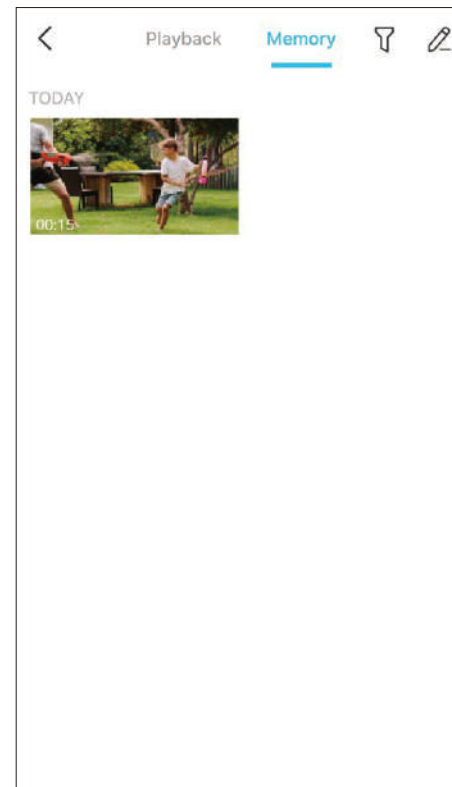

Privacy Mode

On the [Live View](#) page, tap  to enable the Privacy Mode. When enabled, streaming and recording functions will be temporarily disabled to protect your privacy. You can tap [Exit Privacy Mode](#) to exit Privacy Mode and the camera will be back to work. You can also go to [Camera Settings >](#) [Auto Privacy Mode](#) to enable privacy mode when charging the camera.

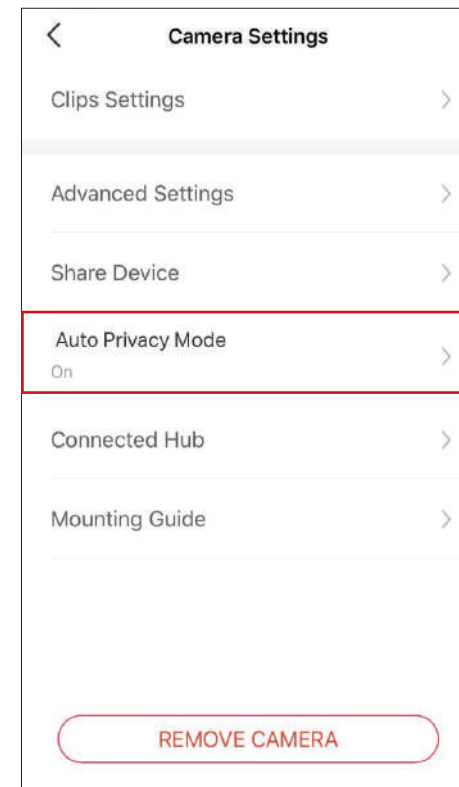
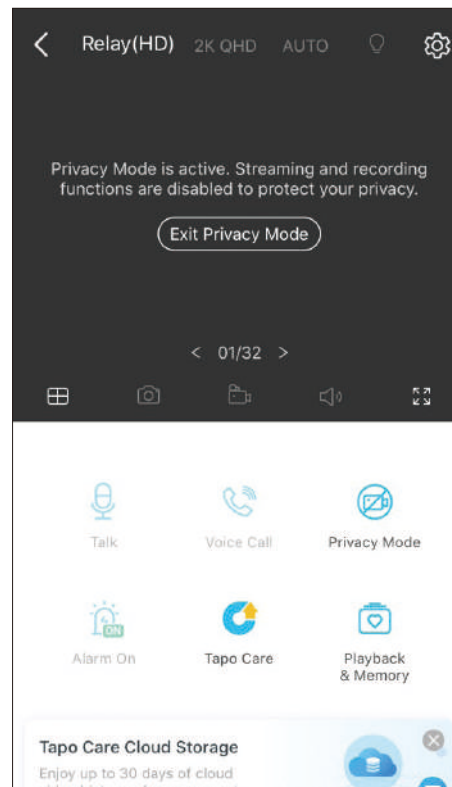
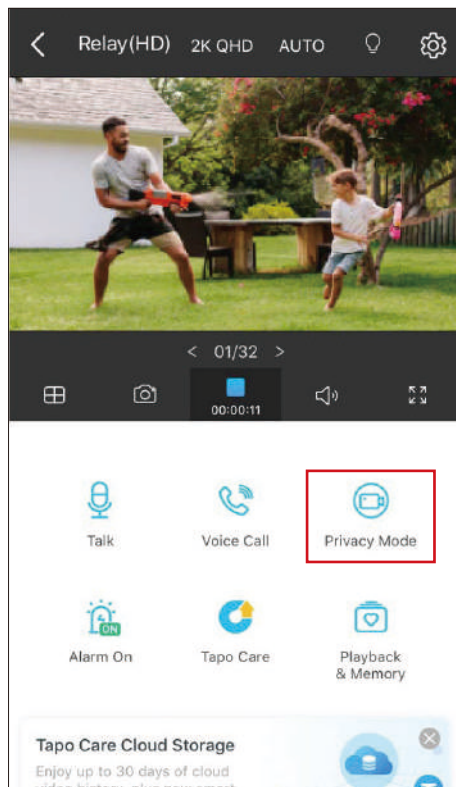

Clips Settings

You can set the Retrigger Time, Record Buffer and Maximum Clip Length as you like. You could extend the battery life by setting longer retrigger time, and reduced record buffer and clip length.

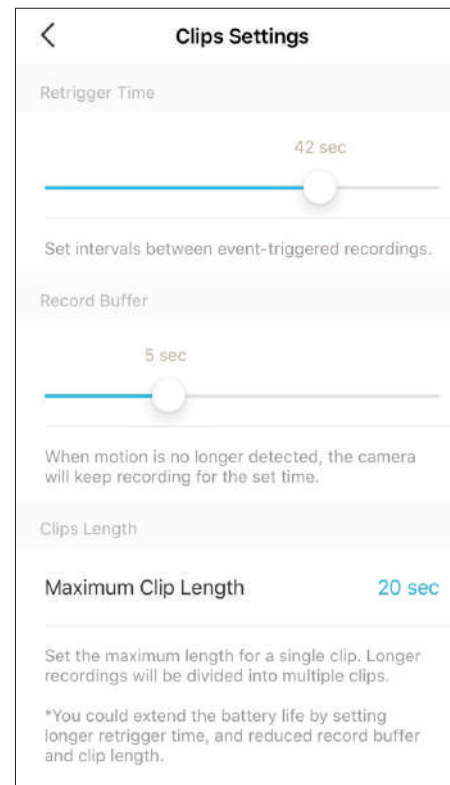
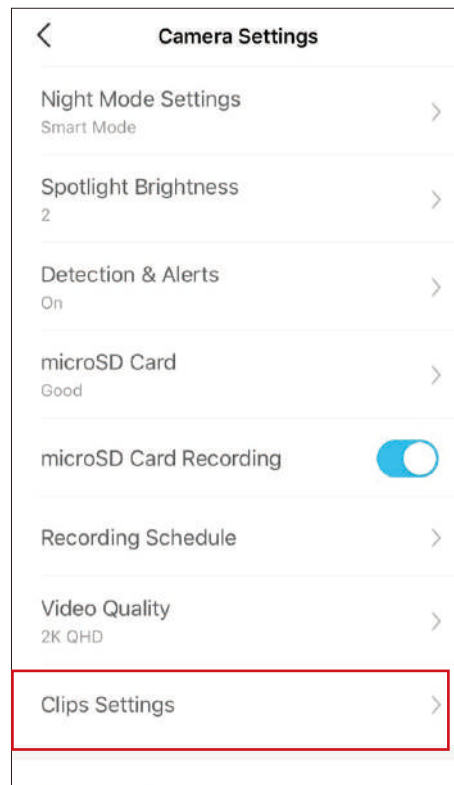

Share Camera

You can invite your family members to manage your Tapo devices together by entering the TP-Link ID (email) you want to share the devices with.

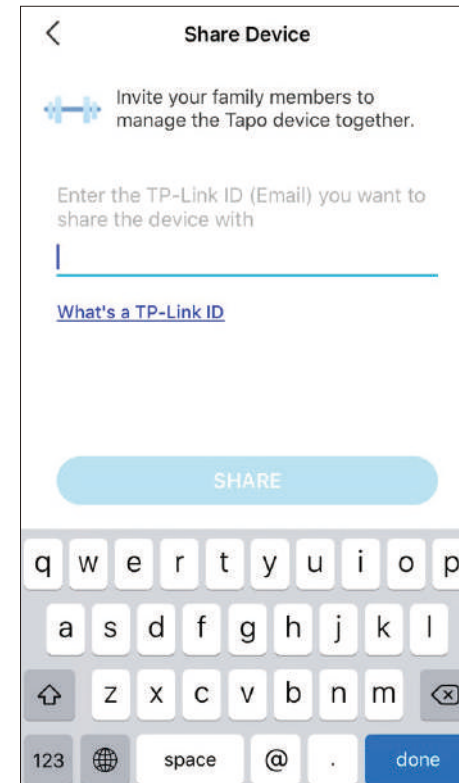
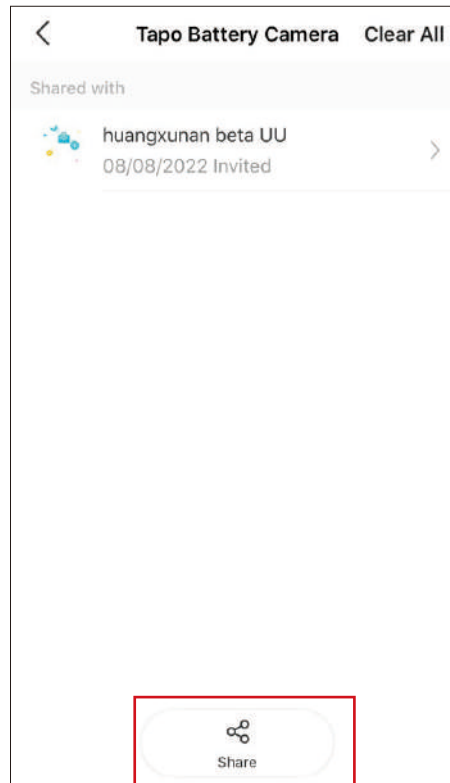
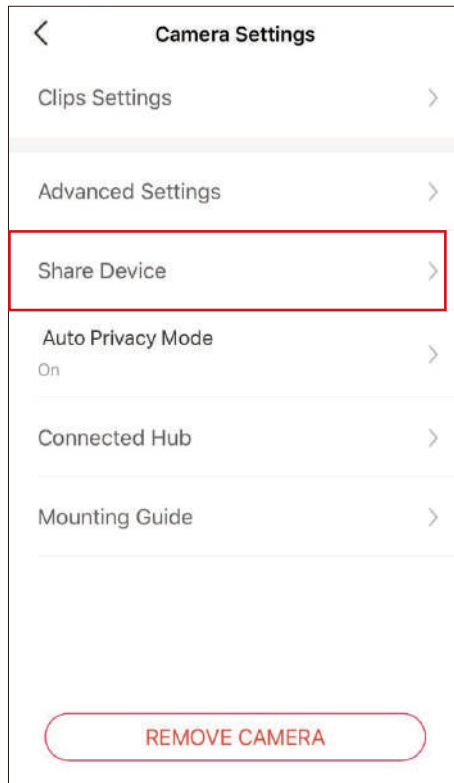

Smart Actions

Smart Actions automate repetitive tasks, allowing you to blaze through tedium with utmost ease. Set everything up once and never have to worry about it again. With Smart Actions, giving your home that level of intelligence is a snap. Shortcut lets you perform an action with a simple tap. Automation allows you to automate tasks to be performed at a set time. e.g. Turn on the lamp plugged into your Tapo smart plug when your camera detects motion.

Option 1: Edit based on the routine actions

1. Go to the [Smart Actions](#) page and you will see the [Routine Actions](#) (Shortcut or Automation).

2. Tap on a routine action. Tap [EDIT](#) to change the settings as needed and tap [APPLY](#) to save changes.

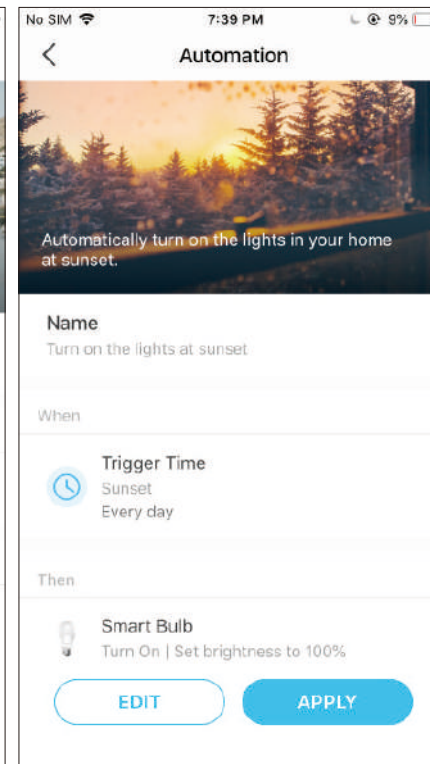
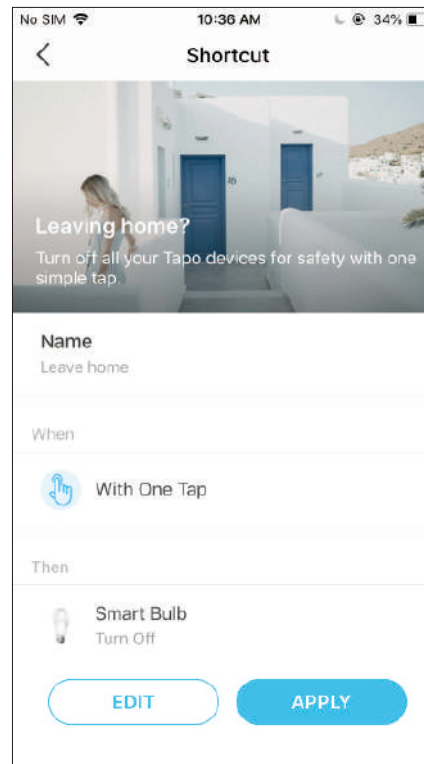
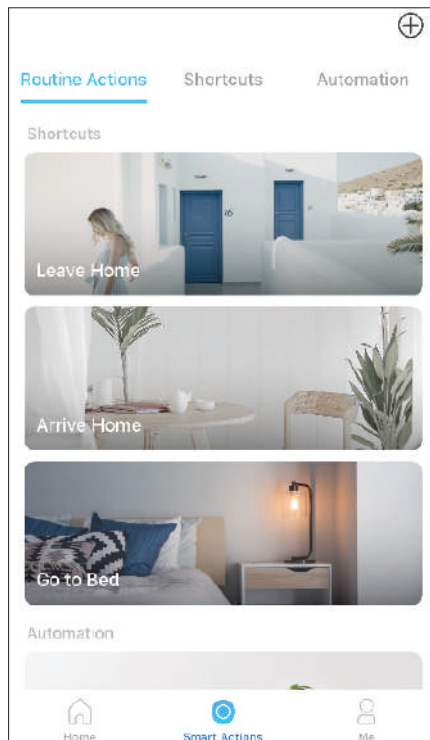

Option 2: Create your own shortcuts

1. Go to [Shortcuts](#) page. Tap + on the top right to add a simple and smart action.

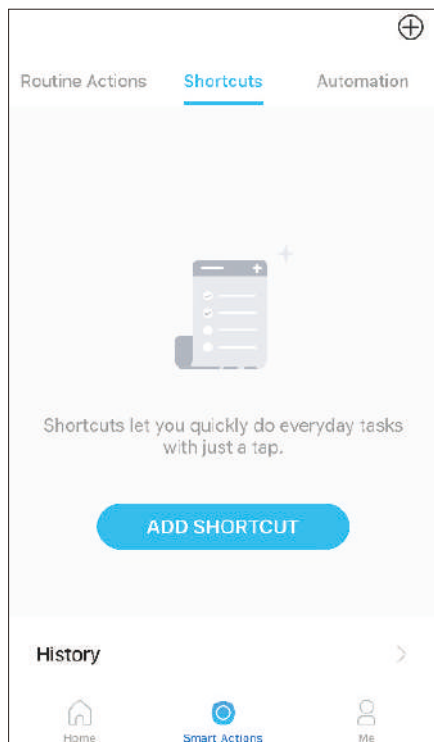

2. Add an action and choose whether to delay the action.

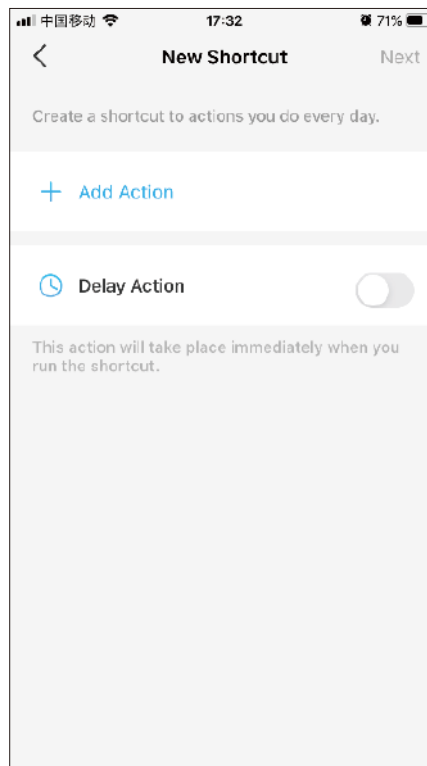

3. Name your shortcut and choose an icon. Tap [Done](#) to save all the settings.

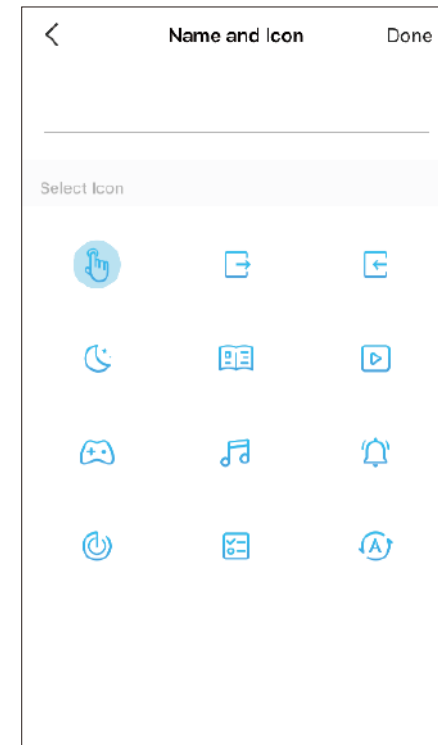

Option 3: Create your own actions

1. Go to [Automation](#) page. Tap + on the top right to add a simple and smart action.

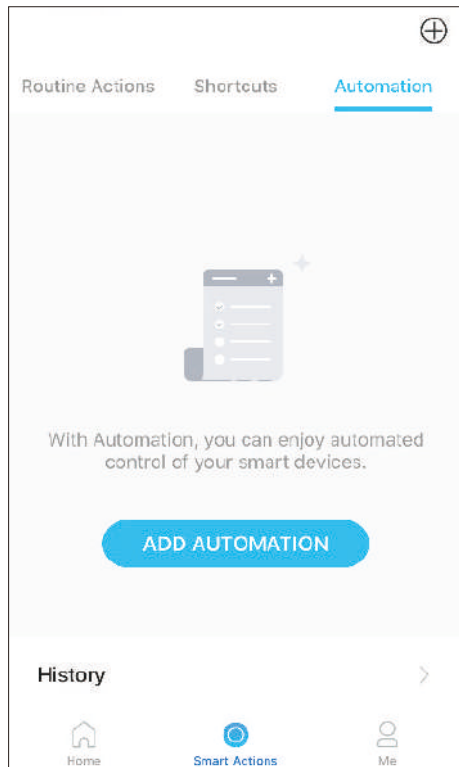

2. Name the new action. Tap + to add conditions ([When](#)) like the trigger time, and tap + to add tasks ([Then](#)) like turning on the switch.

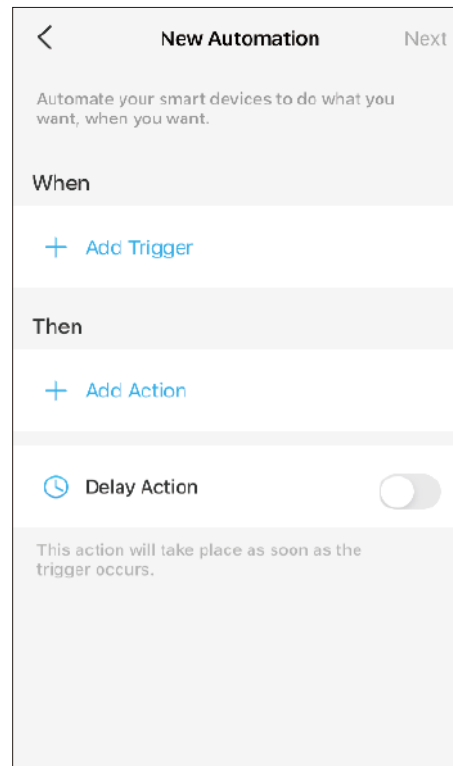

3. Name your automation and set the effective time for the automation. Tap [Done](#) to save all the settings.

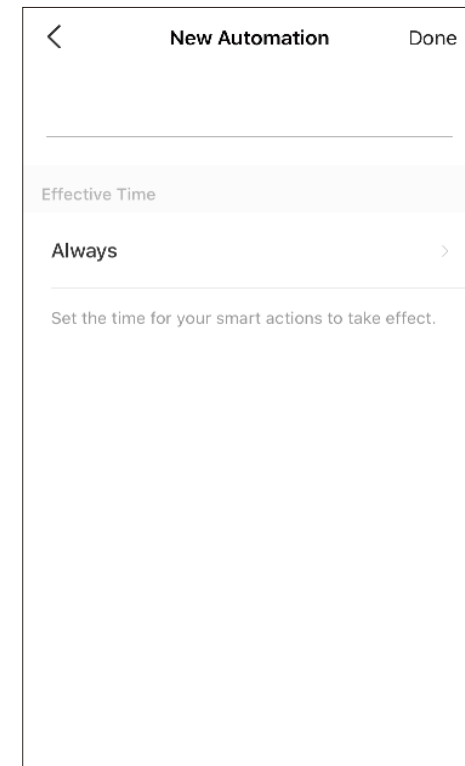

Check Me Page

On this page, you can edit your account, quickly check the memorable moments you saved, set up connections with third-party services, subscribe to Tapo Care, set useful widgets, or find the FAQs related to the Tapo app.

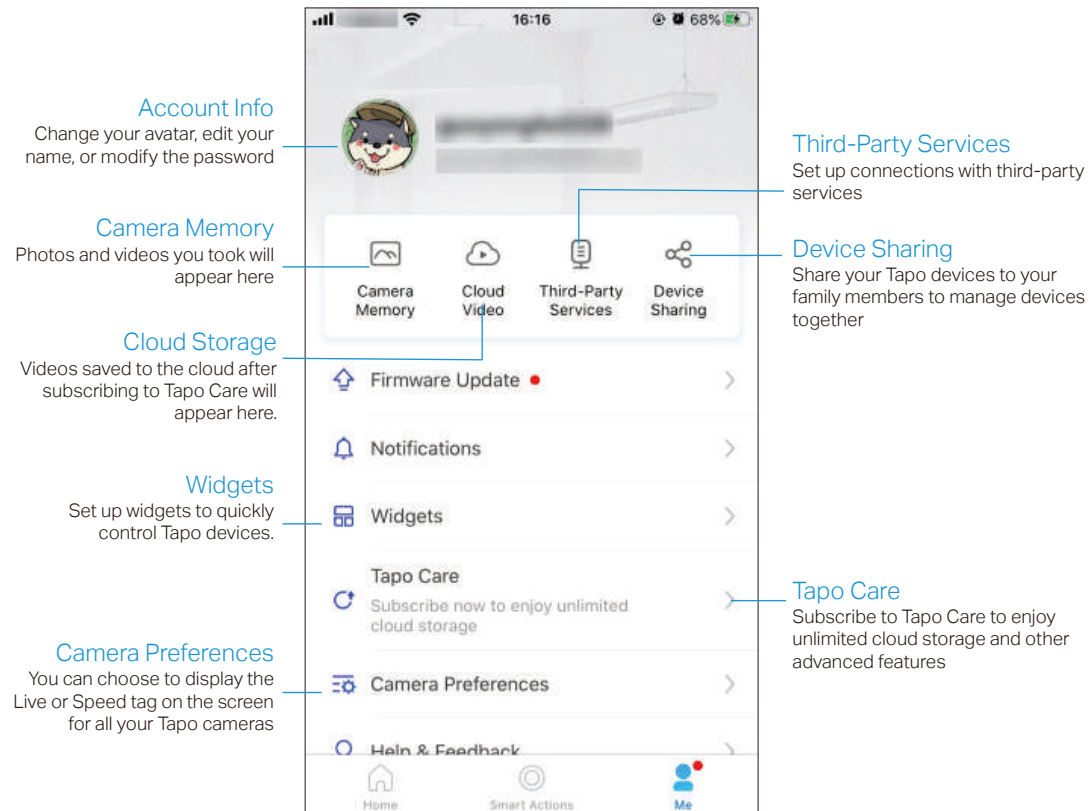

Authentication

FCC compliance information statement



Product Name: Smart Wire-Free Security Camera System

Model Number: Tapo C420S2/S1

| Component Name | Model |
|----------------|-------------|
| AC ADAPTER | T090085-2B1 |
| USB ADAPTER | A8-501000 |

Responsible Party:

TP-Link USA Corporation

Address: 10 Mauchly, Irvine, CA 926181

Website: <http://www.tp-link.com/us/>

Tel: +1 626 333 0234

Fax: +1 909 527 6804

E-mail: sales.usa@tp-link.com

This equipment has been tested and found to comply with the limits for a Class B digital device, pursuant to part 15 of the FCC Rules. These limits are designed to provide reasonable protection against harmful interference in a residential installation. This equipment generates, uses and can radiate radio frequency energy and, if not installed and used in accordance with the instructions, may cause harmful interference to radio communications. However, there is no guarantee that interference will not occur in a particular installation. If this equipment does cause harmful interference to radio or television reception, which can be determined by turning the equipment off and on, the user is encouraged to try to correct the interference by one or more of the following measures:

- Reorient or relocate the receiving antenna.
- Increase the separation between the equipment and receiver.
- Connect the equipment into an outlet on a circuit different from that to which the receiver is connected.
- Consult the dealer or an experienced radio/ TV technician for help.

This device complies with part 15 of the FCC Rules. Operation is subject to the following two conditions:

1. This device may not cause harmful interference.
2. This device must accept any interference received, including interference that may cause undesired operation.

Any changes or modifications not expressly approved by the party responsible for compliance could void the user's authority to operate the equipment.

Note: The manufacturer is not responsible for any radio or TV interference caused by unauthorized modifications to this equipment. Such modifications could void the user's authority to operate the equipment.

FCC RF Radiation Exposure Statement

This equipment complies with FCC RF radiation exposure limits set forth for an uncontrolled environment. This device and its antenna must not be co-located or operating in conjunction with any other antenna or transmitter.

"To comply with FCC RF exposure compliance requirements, this grant is applicable to only Mobile Configurations. The antennas used for this transmitter must be installed to provide a separation distance of at least 20 cm from all persons and must not be co-located or operating in conjunction with any other antenna or transmitter."

We, **TP-Link USA Corporation**, has determined that the equipment shown as above has been shown to comply with the applicable technical standards, FCC part 15. There is no unauthorized change is made in the equipment and the equipment is properly maintained and operated.

Issue Date: 2022-08-16

FCC compliance information statement

Product Name: AC ADAPTER

Model Number: T090085-2B1

Product Name: USB ADAPTER

Model Number: A8-501000

Responsible Party:

TP-Link USA Corporation

Address: 10 Mauchly, Irvine, CA 926181

Website: <http://www.tp-link.com/us/>

Tel: +1 626 333 0234

Fax: +1 909 527 6804

E-mail: sales.usa@tp-link.com

This equipment has been tested and found to comply with the limits for a Class B digital device, pursuant to part 15 of the FCC Rules. These limits are designed to provide reasonable protection against harmful interference in a residential installation. This equipment generates, uses and can radiate radio frequency energy and, if not installed and used in accordance with the instructions, may cause harmful interference to radio communications. However, there is no guarantee that interference will not occur in a particular installation. If this equipment does cause harmful interference to radio or television reception, which can be determined by turning the equipment off and on, the user is encouraged to try to correct the interference by one or more of the following measures:

- Increase the separation between the equipment and receiver.
- Connect the equipment into an outlet on a circuit different from that to which the receiver is connected.
- Consult the dealer or an experienced radio/ TV technician for help.

This device complies with part 15 of the FCC Rules. Operation is subject to the following two conditions:

1. This device may not cause harmful interference.
2. This device must accept any interference received, including interference that may cause undesired operation.

Any changes or modifications not expressly approved by the party responsible for compliance could void the user's authority to operate the equipment.

We, **TP-Link USA Corporation**, has determined that the equipment shown as above has been shown to comply with the applicable technical standards, FCC part 15. There is no unauthorized change is made in the equipment and the equipment is properly maintained and operated.

Issue Date: 2022-08-16

CE Mark Warning



This is a class B product. In a domestic environment, this product may cause radio interference, in which case the user may be required to take adequate measures.

OPERATING FREQUENCY (the maximum transmitted power)

2412MHz—2472MHz (20dBm)

EU Declaration of Conformity

TP-Link hereby declares that the device is in compliance with the essential requirements and other relevant provisions of directives 2014/53/EU, 2009/125/EC, 2011/65/EU and (EU)2015/863.

The original EU declaration of conformity may be found at <https://www.tapo.com/en/support/ce/>

RF Exposure Information

This device meets the EU requirements (2014/53/EU Article 3.1a) on the limitation of exposure of the general public to electromagnetic fields by way of health protection.

The device complies with RF specifications when the device used at 20 cm from your body.



UK Declaration of Conformity

TP-Link hereby declares that the device is in compliance with the essential requirements and other relevant provisions of the Radio Equipment Regulations 2017.

The original UK declaration of conformity may be found at <https://www.tapo.com/support/ukca/>

Canadian Compliance Statement

This device contains licence-exempt transmitter(s)/receiver(s) that comply with Innovation, Science and Economic Development Canada's licence-exempt RSS(s). Operation is subject to the following two conditions:

1. This device may not cause interference.

2. This device must accept any interference, including interference that may cause undesired operation of the device.

L'émetteur/récepteur exempt de licence contenu dans le présent appareil est conforme aux CNR d'Innovation, Sciences et Développement économique Canada applicables aux appareils radio exempts de licence. L'exploitation est autorisée aux deux conditions suivantes :

1. l'appareil ne doit pas produire de brouillage;
2. l'utilisateur de l'appareil doit accepter tout brouillage radioélectrique subi, même si le brouillage est susceptible d'en compromettre le fonctionnement

Radiation Exposure Statement:

This equipment complies with IC radiation exposure limits set forth for an uncontrolled environment. This equipment should be installed and operated with minimum distance 20cm between the radiator & your body.

Déclaration d'exposition aux radiations:

Cet équipement est conforme aux limites d'exposition aux rayonnements IC établies pour un environnement non contrôlé. Cet équipement doit être installé et utilisé avec un minimum de 20 cm de distance entre la source de rayonnement et votre corps.

Industry Canada Statement

CAN ICES-3 (B)/NMB-3(B)

Korea Warning Statements:

당해 무선설비는 운용중 전파혼신 가능성이 있음.

NCC Notice

注意!

取得審驗證明之低功率射頻器材，非經核准，公司、商號或使用者均不得擅自變更頻率、加大功率或變更原設計之特性及功能。

低功率射頻器材之使用不得影響飛航安全及干擾合法通信；經發現有干擾現象時，應立即停用，並改善至無干擾時方得繼續使用。

前述合法通信，指依電信管理法規定作業之無線電通信。

低功率射頻器材須忍受合法通信或工業、科學及醫療用電波輻射性電機設備之干擾。

BSMI Notice

安全諮詢及注意事項

- 請使用原裝電源供應器或只能按照本產品注明的電源類型使用本產品。
- 清潔本產品之前請先拔掉電源線。請勿使用液體、噴霧清潔劑或濕布進行清潔。
- 注意防潮，請勿將水或其他液體潑灑到本產品上。
- 插槽與開口供通風使用，以確保本產品的操作可靠並防止過熱，請勿堵塞或覆蓋開口。
- 請勿將本產品置放於靠近熱源的地方。除非有正常的通風，否則不可放在密閉位置中。
- 請不要私自打開機殼，不要嘗試自行維修本產品，請由授權的專業人士進行此項工作。

限用物質含有情況標示聲明書

| | | | | | | |
|---|--|----------------------|----------------------|---|---|---|
| 設備名稱：Smart Wire-Free Security Camera System | | | | 型號（型式）：Tapo C420S2/S1 | | |
| Equipment name | | | | Type designation (Type) | | |
| 單元 Unit | 限用物質及其化學符號 Restricted substances and its chemical symbols | | | | | |
| | 鉛 Lead (Pb) | 汞 Mercury (Hg) | 鎘 Cadmium (Cd) | 六價鉻 Hexavalent chromium (Cr ⁺⁶) | 多溴聯苯 Polybrominated biphenyls (PBB) | 多溴二苯醚 Polybrominated diphenyl ethers (PBDE) |
| PCB | ○ | ○ | ○ | ○ | ○ | ○ |
| 外殼 | ○ | ○ | ○ | ○ | ○ | ○ |
| 電源供應器 | — | ○ | ○ | ○ | ○ | ○ |
| 其他及其 配件 | — | ○ | ○ | ○ | ○ | ○ |

備考 1. “超出 0.1 wt %” 及 “超出 0.01 wt %” 係指限用物質之百分比含量超出百分比含量基準值

Note 1: “Exceeding 0.1 wt %” and “exceeding 0.01 wt %” indicate that the percentage content of the restricted substance exceeds the reference percentage value of presence condition.

備考 2. “○” 係指該項限用物質之百分比含量未超出百分比含量基準值。

Note 2: “○” indicates that the percentage content of the restricted substance does not exceed the percentage of reference value of presence.

備考 3. “—” 係指該項限用物質為排除項目。

Note 3: The “—” indicates that the restricted substance corresponds to the exemption.



Продукт сертифіковано згідно с правилами системи УкрСЕПРО на відповідність вимогам нормативних документів та вимогам, що передбачені чинними законодавчими актами України.



Safety Information

- Do not use damaged charger or USB cable to charge the device. Do not use any other chargers than those recommended.
- Do not use the device where wireless devices are not allowed.
- Adapter shall be easily accessible.
- Use only power supplies which are provided by manufacturer and in the original packing of this product. If you have any questions, please don't hesitate to contact us.
- Keep the device away from fire or hot environments. DO NOT immerse in water or any other liquid.
- Do not disassemble, repair or modify the product.
- Do not place near automatically controlled devices such as fire alarms. Radio waves emitted from this product may cause such devices to malfunction resulting in an accident.
- Observe restrictions on using wireless products in fuel depots, chemical plants or when blasting operations are in progress.

- Do not use liquid to clean the product. Only use a dry cloth.
- Never put metal objects inside the product. If a metal object enters the product turn off the circuit breaker and contact an authorised electrician.
- This product is not intended to be used when providing medical care. Consult the manufacturer of any personal medical devices, such as pacemakers or hearing aids to determine if they are adequately shielded from external RF (radio frequency) energy.
- Do not use this product in health care facilities. Hospitals or health care facilities may be using equipment that could be sensitive to external RF energy.
- Do not place heavy objects on top of the product.
- When you leave the product unused for a long time unplug the product from the power outlet.
- Product should be kept away from heat sources such as radiators, cookers etc. - it should not be placed in places where the temperature is less than -20 degrees or greater than 45 degrees.
- This product may interfere with other electronic products such as TV, radios, personal computers, phones or other wireless devices.
- Always follow the local waste and recycle laws when you get rid of the used battery.

CAUTION!





Risk of fire or explosion
if the battery is replaced by an incorrect type

CAUTION!

Avoid replacement of a battery with an incorrect type that can defeat a safeguard. Avoid disposal of a battery into fire or a hot oven, or mechanically crushing or cutting of a battery, that can result in an explosion.
Do not leave a battery in an extremely high temperature surrounding environment that can result in an explosion or the leakage of flammable liquid or gas; Do not leave a battery subjected to extremely low air pressure that may result in an explosion or the leakage of flammable liquid or gas.

Please read and follow the above safety information when operating the device. We cannot guarantee that no accidents or damage will occur due to improper use of the device. Please use this product with care and operate at your own risk.

Explanation of the symbols on the product label

| Symbol | Explanation |
|--|--|
|  | DC voltage |
|  | Indoor use only |
|   | <p>RECYCLING</p> <p>This product bears the selective sorting symbol for Waste electrical and electronic equipment (WEEE). This means that this product must be handled pursuant to European directive 2012/19/EU in order to be recycled or dismantled to minimize its impact on the environment.</p> <p>User has the choice to give his product to a competent recycling organization or to the retailer when he buys a new electrical or electronic equipment.</p> |