



Dreamus Corp.

APPROVAL SHEET

SE300			
NO	MODEL	FREQUENCY	
1	HWI-ABG-SE300	WIFI 2.4GHz/BT	2400 ~ 2500 MHz
		WIFI 5GHz	5170 ~ 5825 MHz

SUPPLIER			CUSTOMER		
Engineer	Review	Approved	Engineer	Review	Approved
					
23/02/17		23/02/17			



HANWOOL TECHNOLOGY CO., LTD
#1002 IT303-DONG, PUCHONTECHNOPARK III 36-1
SAMJUNG-DONG, OHJUNG-GU, KYOUNG GI-DO, KOREA
TEL: 032) 624-2555
FAX: 032) 624-2559

HISTORY SHEET

ITEM	CARRIER ANTENNA	Developed by	Kyoung-Min Lee	
Part Name	HWI-ABG-SE300	Director		
Rev. No.	Date	Description		Etc.
0	2023-02-17	Initial Version		

ANTENNA SPECIFICATION

1. MODEL: HWI-ABG-SE300

2. APPLICATION:

This specification is provided for WIFI 2.4, 5GHz, BT ANTENNA.

3 ANTENNA used condition

■Portable ■Fixing ■Movement ■Out-door ■In-door ■Etc()

4. ANTENNA Drawing

#3. Attached : Drawing paper

5. Electrical specification and performance

Satisfied next data with real used or similar environment conditions.

No.	ELECTRICAL DATA	SPECIFICATIONS		REMARK
5. 1	FREQUENCY RANGE	WIFI 2.4GHz /BT	2400 ~ 2500 MHz	
		WIFI 5GHz	5170 ~ 5825 MHz	
5. 2	IMPEDANCE	50 Ω NOMINAL		
5. 3	V. S. W. R	WIFI 2.4GHz /BT	Less than 1 : 1.70	#1. Attached
		WIFI 5GHz	Less than 1 : 2.45	
5. 4	PEAK GAIN	WIFI 2.4GHz /BT	-2.30 dBi	#2. Attached
		WIFI 5GHz	-3.19 dBi	
5. 5	RADIATION PATTERN	OMNI - DIRECTIONAL		
5. 6	POLARIZATION	LINEAR		

6. Hardware specification and mechanical

No.	MECHANICAL	SPECIFICATIONS	REMARK
2. 6. 1	Carrier Size [W X H X T]	40.3 X 9.5 X 9.5 (mm)	

7. SINUSOIDAL VIBRATION

Vibration Frequencies : 5- 55 Hz (1 cycle)

Sweep Rate : 1 cycle/min

Maximum Amplitude : A - 1 mm

Maximum Acceleration: 2 g

Measuring method

Antenna is combined in the test equipment.

The vibration is done X and Y direction (left, right, up and down) according to below image.

It continued for 2 hours each direction.

8. OPERATING TEMPERATURE

Temperature : - 40℃ / +70℃

Demands : Set Antenna and Cable for 72 hours each temperature.

No visual and mechanical changes.

The fitting and mold will be unchanged mechanically during the test.

The antenna shall satisfy the electrical data

9. HUMIDITY

Condition : 95% / +70℃

Measuring method

Antenna is placed in climatic chamber for 72 hours.

Antenna is taken out from the chamber and measured

after another 24 hours in room temperature

Demands : No visual and mechanical changes.

The fitting and mold will be unchanged mechanically during the test.

The antenna shall satisfy the electrical data.

10. TEST and Q/C

This specification is according to fixed demands and suitable Hanwool technology Q/C provision.

But it is possible to skip No. 7~9 demands, after consultation with buyer.

- #1. Attached : VSWR

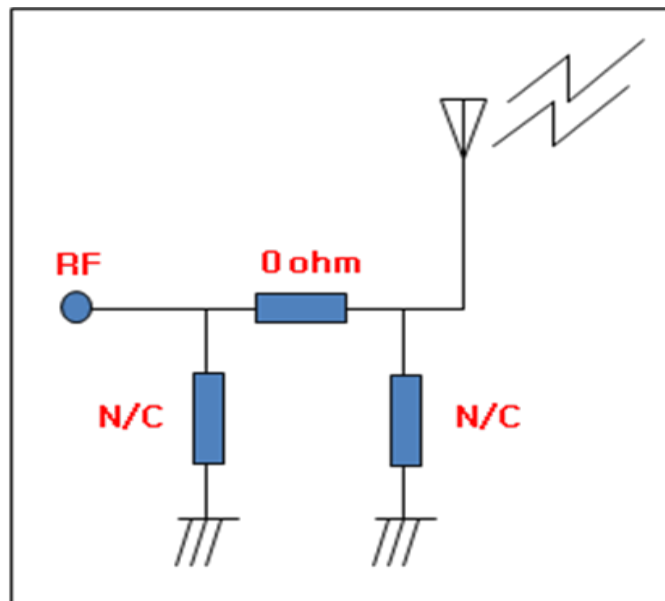
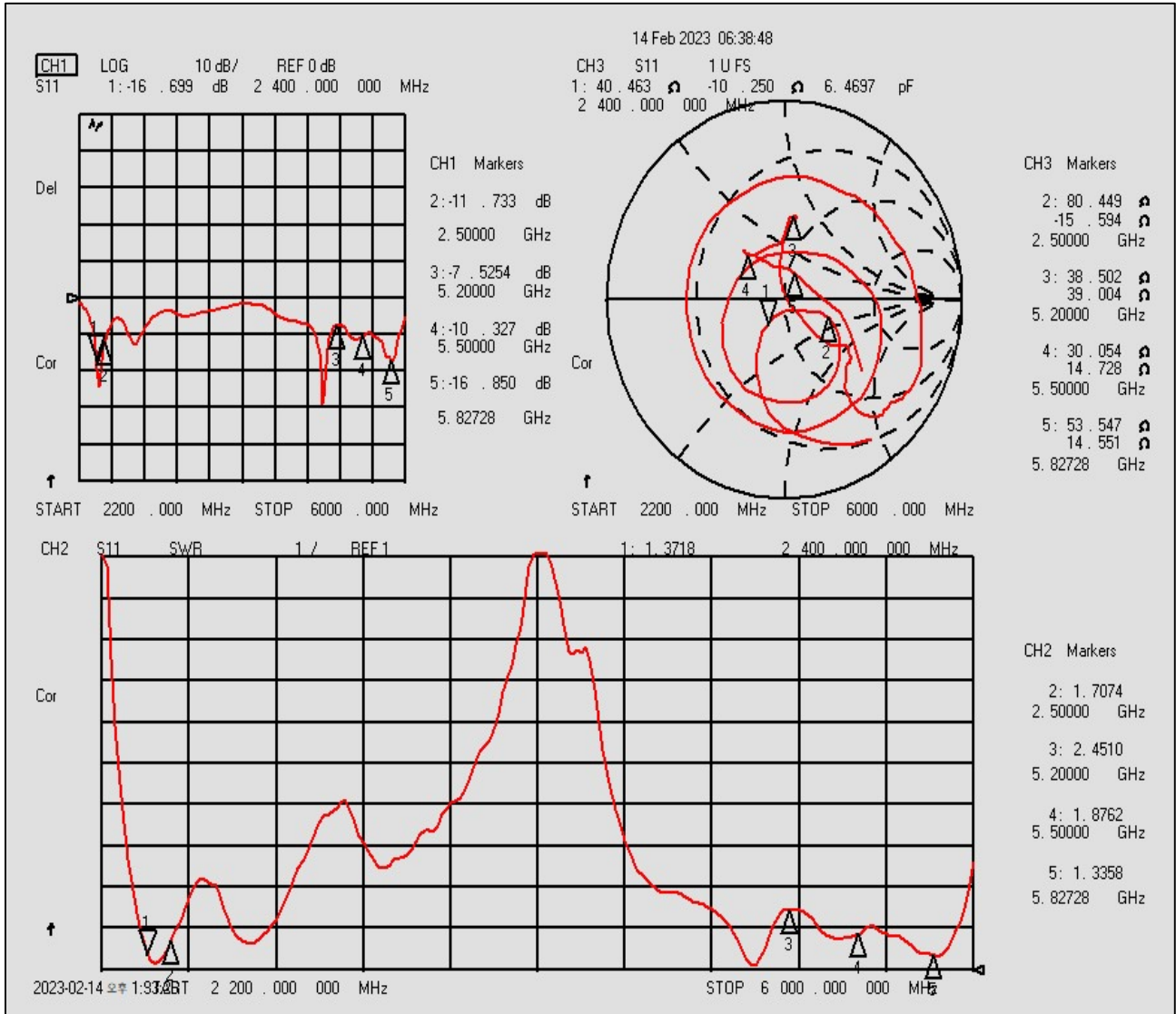

2021-03-22 오후 3:27:07 **KTM** Calibration Wi-Fi Select Frequency WI-FI Motor

Measurement Setup Angle Step 15 Measurement Pol H+V POL **START** **STOP** **EXIT** User Info Print

Data HV Sum Line H Line V Line Polar Plan Plan - Horizontal Plan - Vertical

H plan E1 plan E2 plan

Hor+Ver Horizontal Vertical H plan E1 plan E2 plan

Frequency[MHz]	PeakValue	Theta[deg]	Phi[deg]	MinValue	Theta[deg]	Phi[deg]	3D Avg[dBi]	2D Avg[dBi]	Efficiency[%]
2400.000	-3.604	60	255	-25.565	120	60	-9.761	0	10.517%
2412.000	-3.321	60	255	-24.760	120	60	-9.647	0	10.796%
2424.000	-2.679	60	255	-23.362	165	240	-9.109	0	12.219%
2436.000	-2.905	60	255	-24.029	165	240	-9.329	0	11.617%
2448.000	-2.550	60	255	-24.588	75	15	-8.965	0	12.632%
2460.000	-2.478	60	255	-25.435	15	60	-8.848	0	12.979%
2472.000	-2.307	60	255	-25.808	75	15	-8.736	0	13.316%
2480.000	-2.761	60	255	-25.874	165	225	-9.080	0	12.303%
2485.000	-2.771	60	255	-25.452	75	15	-8.966	0	12.629%

Frequency Add Delete Sort Save File Save as Open Delete Screen capture Result Summary Report Select Graph 3D Graph

- #2. Attached : RADIATION PATTERN(GAIN)_WIFI 2.4GHZ/BT

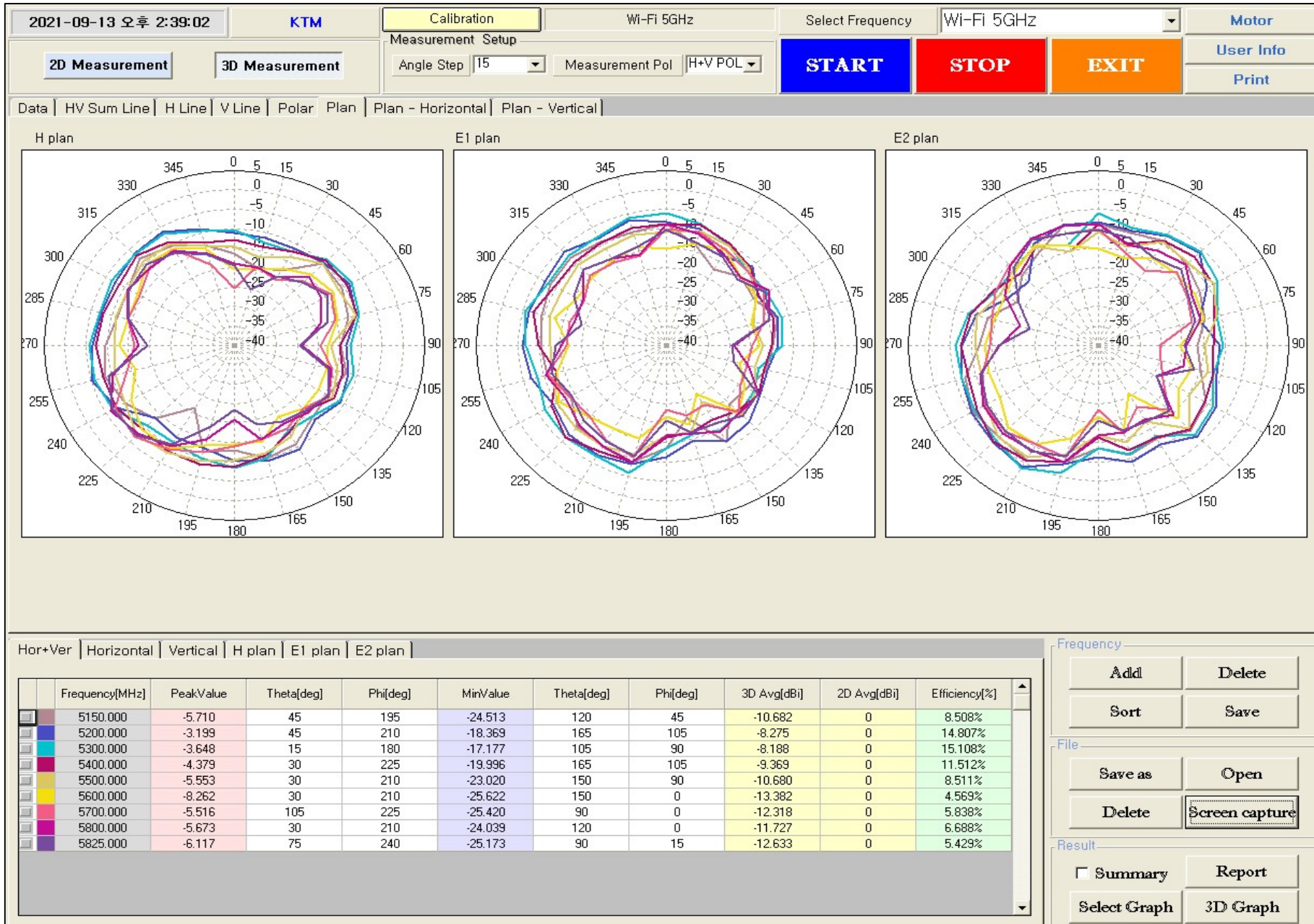

- #3. Attached : RADIATION PATTERN(GAIN)_ WIFI 5GHz

No	Revision Note	Checked	Date
△			

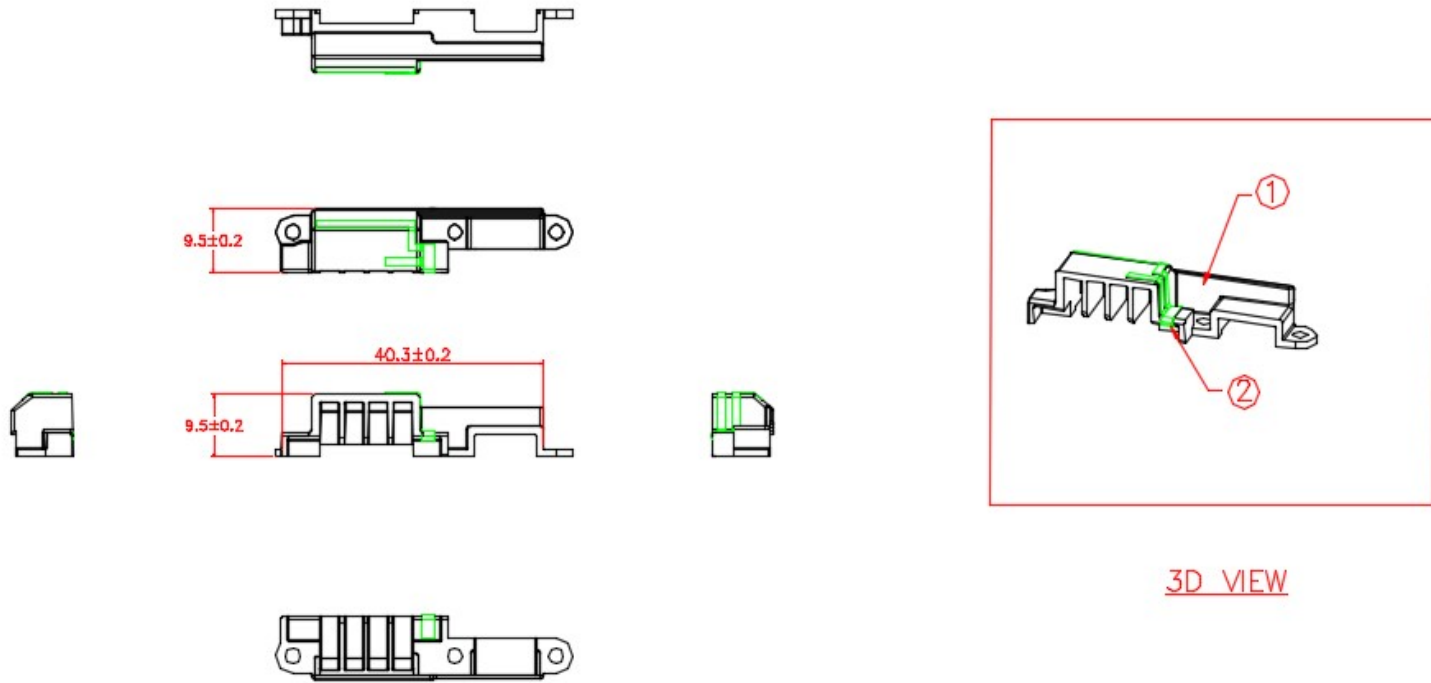

3D VIEW

2	PATTERN	LPS	2
1	CARRIER	PC-LG화학 SC1004	1
No	Part Name	Material Description	Q'ty
Scale	Unit	Title	ASSY
1/1	mm	Drawn by	Checked by
Decimal	Angle	J.O,LJM	CG Nam
.X ±0.1			
XX ±0.05	N/A	221227-50	
		Model	HWI-ABG-SE300
		File Name	드림머스
Hanwool Technology			