



UNISEN™

IMMERSIVE SOUND LED LCD HDTV with Integrated Sound Projector

MODELS

154 Series

164 Series

265 Series

OWNER'S GUIDE

- For questions:
 - Visit our website at www.mitsubishi-tv.com.
 - E-mail us at MDEAservice@mdea.com.
 - Call Consumer Relations at 800-332-2119 for operational or connection assistance.
- For information on **System Reset**, please see the back cover.
- To order replacement or additional remote controls, visit our website at www.mitsuparts.com or call 800-553-7278.
- **265 Series.** IR emitter cables for NetCommand home-theater control are available for purchase from Mitsubishi. Call 800-553-7278 and request either part number 242D483020 (two-ended cable) or part number 299P254020 (four-ended cable).



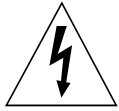

CAUTION

RISK OF ELECTRIC SHOCK
DO NOT OPEN



CAUTION: TO REDUCE THE RISK OF ELECTRIC SHOCK, DO NOT REMOVE COVER (OR BACK). NO USER SERVICEABLE PARTS INSIDE. REFER SERVICING TO QUALIFIED SERVICE PERSONNEL.

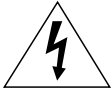

The lightning flash with arrowhead symbol within an equilateral triangle is intended to alert the user of the presence of uninsulated "dangerous voltage" within the product's enclosure that may be of sufficient magnitude to constitute a risk of electric shock to persons.



The exclamation point within an equilateral triangle is intended to alert the user to the presence of important operating and maintenance (servicing) instructions in the literature accompanying the product.

WARNING: This product shall be connected to a MAINS socket outlet with a protective earthing connection.

MAINS DISCONNECTION: The mains plug is used as the disconnect device. The mains plug shall remain readily operable.

WARNING: To reduce the risk of fire or electric shock, do not expose this apparatus to rain or moisture.

This apparatus shall not be exposed to dripping or splashing and no objects filled with liquids, such as vases, shall be placed on the apparatus.

WARNING: This product contains chemicals known to the State of California to cause cancer and/or birth defects or other reproductive harm.

TV WEIGHT: This TV is heavy. Exercise extreme care when lifting or moving it. Lift or move the TV with a minimum of two adults. To prevent damage to the TV, avoid jarring or moving it while it is turned on. Always power off your TV, unplug the power cord, and disconnect all cables before moving it.

Note: Features and specifications described in this owner's guide are subject to change without notice.

FCC Declaration of Conformity

Product: LCD Flat Panel HDTV
Models: LT-55154
LT-40164, LT-46164, LT-55164
LT-46265, LT-55265
Responsible Party: Mitsubishi Digital Electronics
America, Inc.
9351 Jeronimo Road
Irvine, CA 92618-1904
Telephone: (800) 332-2119

This device complies with Part 15 of the FCC Rules. Operation is subject to the following two conditions:

- (1) This device may not cause harmful interference, and
- (2) This device must accept any interference received, including interference that may cause undesired operation.

Note: This equipment has been tested and found to comply with the limits for a Class B digital device, pursuant to part 15 of the FCC Rules. These limits are designed to provide reasonable protection against harmful interference in a residential installation. This equipment generates, uses and can radiate radio frequency energy and, if not installed and used in accordance with the instructions, may cause harmful interference to radio communications. However, there is no guarantee that interference will not occur in a particular installation. If this equipment does cause harmful interference to radio or television reception, which can be determined by turning the equipment off and on, the user is encouraged to try to correct the interference by one or more of the following measures:

- Reorient or relocate the receiving antenna.
- Increase the separation between the equipment and the receiver.
- Connect the equipment into an outlet on a circuit different from that to which the receiver is connected.
- Consult the dealer or an experienced radio/TV technician for help.

Changes or modifications not expressly approved by Mitsubishi could cause harmful interference and would void the user's authority to operate this equipment.

Contents

Important Information About Your TV

Installation and Operating Notes	4
Important Safety Instructions.	5
Stand Installation	6
Wall-Mounting	7

1 Basic Setup and Operation

Package Contents	9
Before You Begin	10
First-Time Power-On.	10
TV Controls	11
Remote Control	11
The TOOLS Key and Menu	12
TV Control Panel	13
POWER Indicator	13
Setting Up TV Inputs.	14
Basic TV Operation.	16
Using the TV with a Personal Computer	19

2 TV Connections

Before You Begin	21
Connection Types and Audio/Video Quality	21
Inputs and Outputs.	22
Cable Routing	22
HDMI Device.	24
Y Pb Pr Component Video Device	25
DVI Video Device	25
Antenna or Cable TV Service.	26
Composite Video Device.	26
VCR or DVD Recorder to an Antenna or Wall Outlet Cable	26
A/V Receiver	27
A/V Receiver with HDMI Output.	27
Supplemental Audio Connections	28

3 TV Features

Sleep Timer	29
FAV (Favorite Channels).	29
ChannelView Channel Listings.	30
Status Display	31
Using an External Sound System.	32
Picture Shape and Display Formats	33
Camera Images and Music Files	34
USB Source Devices.	34
Photos and Motion Video as Composite Video	36
Using an Audio-Only Device	36
Wireless Audio Playback.	37

Sound Projector	38
StreamTV™ Internet Media	42
Introduction to Home-Theater Control	45

4 TV Menus

Main Menu.	46
Picture.	46
Sound.	49
Captions	51
Setup	52
Inputs	55
Lock	57

5 NetCommand IR Control

About NetCommand IR Control	60
IR Emitters.	61
NetCommand Setup.	62
Operating NetCommand-Controlled Devices	63

6 NetCommand IR Control of an A/V Receiver

Controlling an A/V Receiver after NetCommand Setup	67
Setting Up A/V Receiver Control Power and Volume	68
Automatic Audio/Video Switching Over an HDMI Connection.	69

Appendices

Appendix A: Programming the Remote Control	73
Appendix B: Bypassing the Parental Lock	79
Appendix C: HDMI Control of CEC Devices	81
Appendix D: TV Care	84
Appendix E: Troubleshooting	85

Trademark and License Information	92
--	----

Warranty	99
---------------------------	----

Network Service Disclaimer	100
---	-----

Index	101
------------------------	-----

Important Information About Your TV

For Your Records

Record the model number, serial number, and purchase date of your TV. The model and serial numbers are on the back of the TV. Refer to this page when requesting assistance with the TV.

MODEL NUMBER _____

SERIAL NUMBER _____

PURCHASE DATE _____

RETAILER NAME _____

LOCATION _____

Installation and Operating Notes

Custom cabinet installation must allow for proper air circulation around the television.

NOTE TO CATV SYSTEM INSTALLER: THIS REMINDER IS PROVIDED TO CALL THE CATV SYSTEM INSTALLER'S ATTENTION TO ARTICLE 820-40 OF THE NEC THAT PROVIDES GUIDELINES FOR THE PROPER GROUNDING AND, IN PARTICULAR, SPECIFIES THAT THE CABLE GROUND SHALL BE CONNECTED TO THE GROUNDING SYSTEM OF THE BUILDING, AS CLOSE TO THE POINT OF CABLE ENTRY AS PRACTICAL.

TV Software

Do not attempt to update the software of this TV with software or USB drives not provided by or authorized by Mitsubishi Digital Electronics America, Inc. Non-authorized software may damage the TV and will not be covered by the warranty.

Children and TV Viewing

The American Academy of Pediatrics discourages television viewing for children younger than two years of age.

If Your TV Gets Damaged

Crystalline liquid may leak from the LCD panel and broken glass may be scattered.

CAUTION: The crystalline liquid is toxic. Avoid contact with your skin, eyes, or mouth. DO NOT touch the broken glass or crystalline liquid. DO NOT get glass fragments or crystalline liquid into eyes or mouth. Should either contact your eyes or mouth, rinse the contacted area thoroughly with water and consult your doctor.

Disposal of Your TV

The LCD panel contains a small amount of crystalline liquid which is toxic and should not be touched.

DO NOT dispose of the TV with general household waste. For disposal or recycling information, contact your local authorities or the Electronic Industries Alliance at www.eiae.org.

Important Safety Instructions

Please read the following safeguards for your TV and retain for future reference. Always follow all warnings and instructions marked on the television.

- 1) Read these instructions.
- 2) Keep these instructions.
- 3) Heed all warnings.
- 4) Follow all instructions.
- 5) Do not use this apparatus near water.
- 6) Clean only with dry cloth.
- 7) Do not block any ventilation openings. Install in accordance with the manufacturer's instructions.
- 8) Do not install near any heat sources such as radiators, heat registers, stoves, or other apparatus (including amplifiers) that produce heat.
- 9) Do not defeat the safety purpose of the polarized or grounding-type plug. A polarized plug has two blades with one wider than the other. A grounding type plug has two blades and a third grounding prong. The wide blade or the third prong are provided for your safety. If the provided plug does not fit into your outlet, consult an electrician for replacement of the obsolete outlet.
- 10) Protect the power cord from being walked on or pinched particularly at plugs, convenience receptacles, and the point where they exit from the apparatus.
- 11) Only use attachments/accessories specified by the manufacturer.
- 12) Use only with the cart, stand, tripod, bracket, or table specified by the manufacturer, or sold with the apparatus. When a cart is used, use caution when moving the cart/apparatus combination to avoid injury from tip-over.
- 13) Unplug this apparatus during lightning storms or when unused for long periods of time.
- 14) Refer all servicing to qualified service personnel. Servicing is required when the apparatus has been damaged in any way, such as power-supply cord or plug is damaged, liquid has been spilled or objects have fallen into the apparatus, the apparatus has been exposed to rain or moisture, does not operate normally, or has been dropped.



EXAMPLE OF ANTENNA GROUNDING

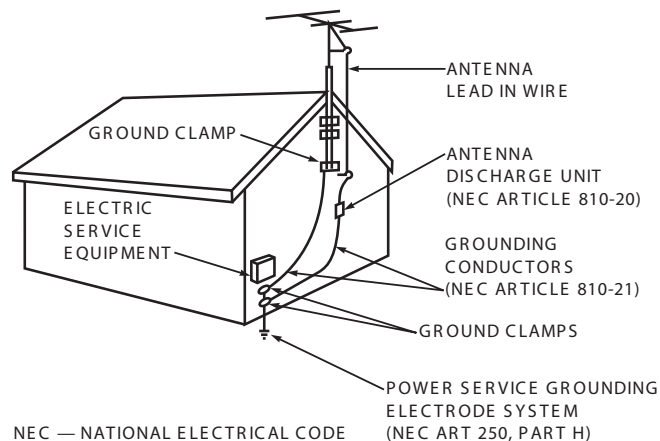

Outdoor Antenna Grounding

If an outside antenna or cable system is connected to the TV, be sure the antenna or cable system is grounded so as to provide some protection against voltage surges and built-up static charges.

Replacement Parts

When replacement parts are required, be sure the service technician has used replacement parts specified by the manufacturer or have the same characteristics as the original part. Unauthorized substitutions may result in fire, electric shock or other hazards.

Stand Installation

CAUTION

- Using this TV with other than the authorized accessories may cause the TV to become unstable, which can cause damage to the product or possible injury.
- At least **TWO PEOPLE** are required to install the stand. Support the TV near the corners as shown. Failure to follow these recommendations may result in personal injury and damage to the product.

Note

- **40- or 46-inch TV:** If planning to wall-mount the TV, there is no need to install the stand.
- **55-inch TV:** The TV comes from the factory with the stand pre-installed.

Required: Phillips Screwdriver 

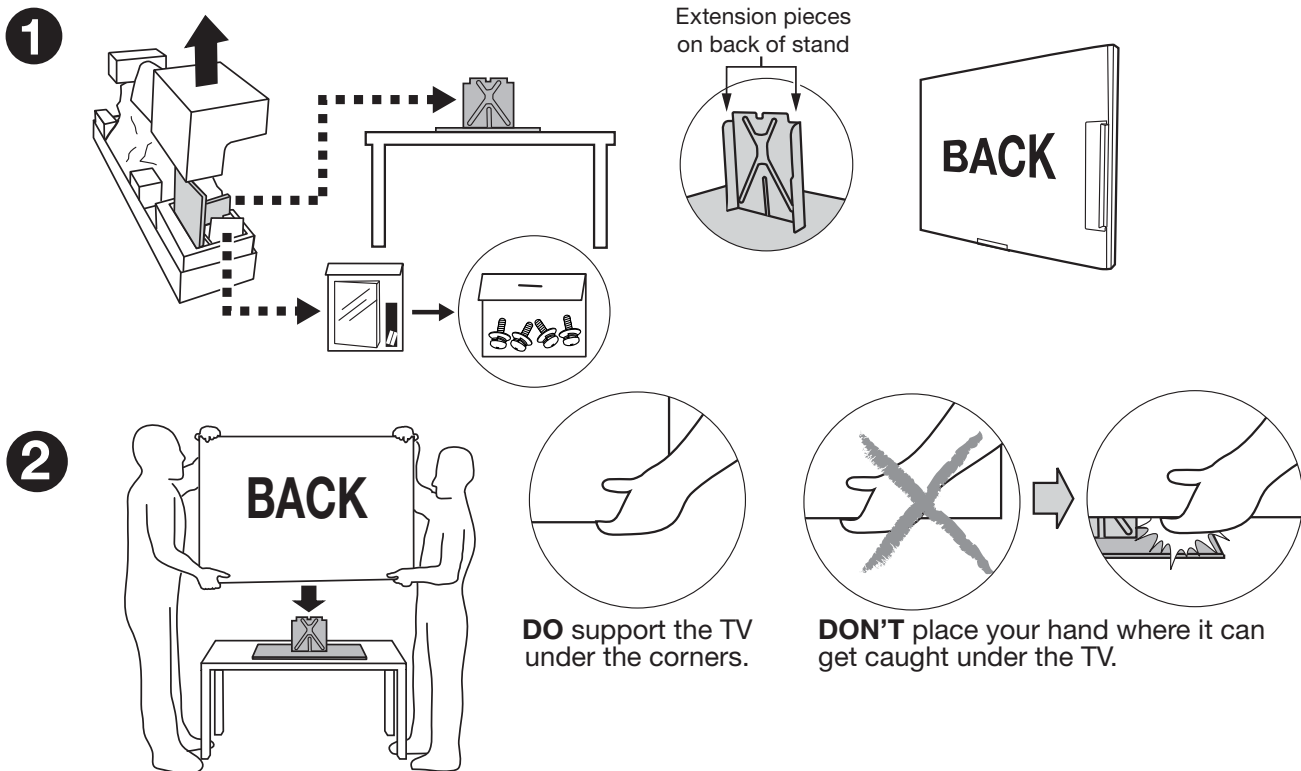

Two adults are required to lift the TV.

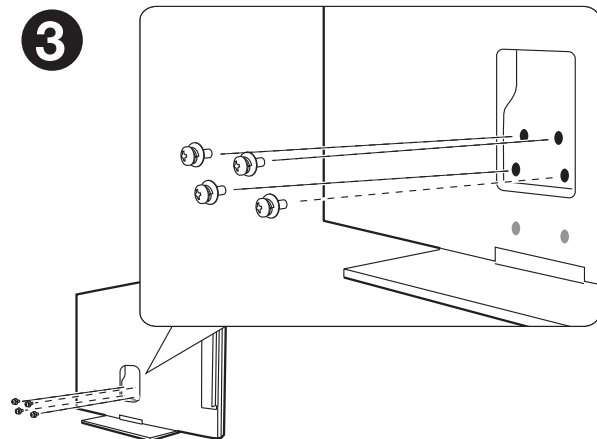

Repacking the Stand

CAUTION. Place the stand in the foam insert with the extension pieces facing away from the TV. Otherwise, the TV will be damaged in transit.

Protect the TV and stand with the original packing material.

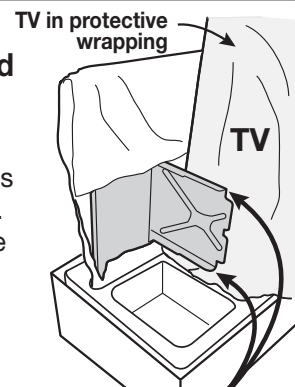

Extension pieces on stand must face out, away from TV.

Wall-Mounting

To order a wall-mount kit, please contact Peerless Industries, Inc. at (800) 473-3753 or visit www.peerlessmounts.com. Order wall-mount kit model ST650.

To order a wall-mount kit from Mitsubishi Digital Electronics America, Inc., please visit www.mitsuparts.com or call (800) 553-7278.

Complete installation instructions are included with the kit.

Stand Removal Prior to Wall-Mounting

CAUTION

At least **TWO PEOPLE** are needed to safely remove the stand. Have one person hold the TV while the other person removes the stand. Failure to follow these recommendations may result in personal injury and damage to the product.

Note

- **55-inch TV:** Remove the factory-installed stand prior to wall-mounting.
- **40- or 46-inch TV:** If you installed the stand for table-top use, follow these instructions to remove it prior to wall-mounting the TV.

1. Disconnect the TV's AC power cord from the AC power outlet.
2. Spread the protective sheet that was wrapped around the TV on a flat, even surface, such as a sturdy table. The protective sheet will help prevent damage to the display.

IMPORTANT: To avoid damaging the screen, make sure there are no foreign objects under or on top of the protective sheet.

3. Position one person on each side of the TV (left and right sides). Have each person firmly grasp their side of the TV and gently place it face down on the protective sheet with the display stand hanging over the edge of the table. See the illustration to the right.
4. Use a magnetic philips screwdriver to remove the stand screws from the recessed holes (see illustration to right). **Note:** A regular screwdriver can be used with a separate magnetic pick-up tool.
5. While one person holds the TV with both hands, have the other person grasp the stand (see illustration to the right) and remove the stand by pulling it away from the TV in the direction of the large arrow shown in both illustrations.

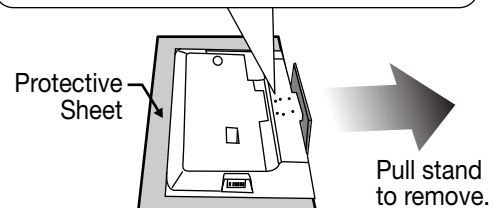
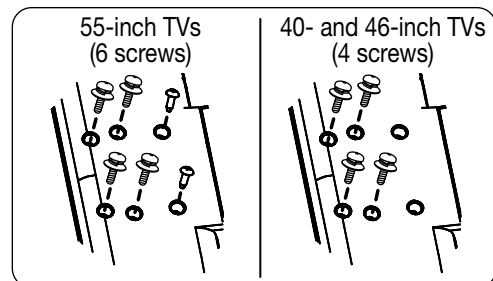
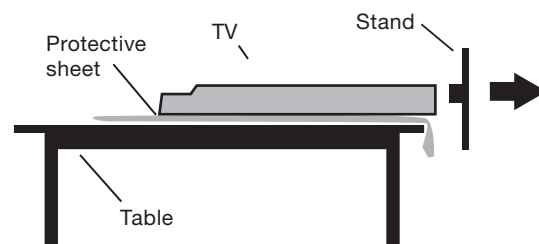

Special Features of Your TV

Your new high-definition widescreen television has many special features that make it the perfect center of your home entertainment system, including:

1080p High-Definition LCD Display System

Your Mitsubishi LED LCD HDTV uses a full 1920 x 1080 LCD panel to create the picture you see on the screen. All images are displayed at 1080p. The TV uses new Plush 1080p[®] 5G digital video processing to convert lower-resolution signals to 1080p for display.

True120Hz and True240Hz

True120Hz (154 and 164 series) and True240Hz (265 series) make fast-moving images appear smoother and more fluid, free from motion blur. It does this by doubling the traditional progressive scan frame rate and creates new frames of video between the traditional frames to create smoother moving images. True120Hz/True240Hz also smooth film judder (image vibration) that may be present in film-based content such as movies.

16:9 Widescreen Picture Format

Enjoy a full theatrical experience in the comfort of your home. View pictures as film directors intended them. Digital TV broadcasts, DVDs and newer video game consoles support this widescreen format.

Integrated HDTV Tuner

Your widescreen Mitsubishi HDTV has an internal HDTV tuner able to receive both over-the-air HDTV broadcasts (received via an antenna) and non-scrambled digital cable broadcasts, including non-scrambled HDTV cable programming.

High-Definition Video Inputs

- **Component Video Inputs.** Also called Y/Pb/Pr inputs, these inputs receive standard analog video formats of 480i, 480p, 720p, and 1080i high-definition signals. This provides a high level of flexibility when connecting DVD players/recorders, cable boxes, and satellite receivers.
- **HDMI Inputs.** These inputs accept digital 480i, 480p, 720p, 1080i, and 1080p video signals plus bitstream and PCM digital stereo signals. The HDMI[™] inputs can also accept a variety of PC signals and resolutions.

Used with an adapter, these inputs also accept compatible digital DVI video signals. HDMI inputs provide additional high-performance, high-definition connections for maximum flexibility in your choice of home theater products. The HDMI inputs are HDCP copy-protection compatible.

Easy Connect Auto Input Sensing

Easy Connect[™] Auto Input Sensing automatically recognizes when you plug in a device and prompts you to assign a name to it.

Home-Theater Control

HDMI Control

Available on all models. HDMI devices with Consumer Electronics Control (CEC) capabilities may be compatible with the TV's HDMI Control feature. Compatible devices can receive control signals through the HDMI connection, allowing the TV's remote control to operate some functions of these devices.

NetCommand with IR Learning

265 Series. NetCommand[®] supports IR (infrared) control of products such as VCRs, DVD players, cable boxes, and satellite receivers. NetCommand can "learn" remote control signals directly from many devices, allowing you to create a customized NetCommand-controlled home-theater system.

Sound Projector

Sound Projector technology uses the TV's bank of speakers to create a simulated surround sound effect by reflecting sound off the room walls.

StreamTV[™] Internet

StreamTV brings many popular internet applications to your TV. Among them is the VUDU[™] movie service, offering the largest on-demand HD movie selection anywhere, featuring full 1080p and 5.1 surround sound. VUDU allows you to enjoy movies with no store visits, no mailing, no late fees and no subscriptions.

ENERGY STAR[®]

This is an ENERGY STAR[®] qualified TV. Products that earn the ENERGY STAR prevent greenhouse gas emissions by meeting strict energy efficiency guidelines set by the U.S. Environmental Protection Agency and the U.S. Department of Energy.









This TV uses power within ENERGY STAR guidelines except when Picture Mode is set to **Brilliant**.

1

Basic Setup and Operation

Package Contents

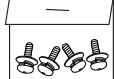
Please take a moment to review the following list of items to ensure that you have received everything.

Remote Control	
Two AA Batteries	
Basic Owner's Guide	
Quick Setup Guide	
Product Registration Card	
Power Cord	
Cable Ties	
Stand Screws (40- and 46-inch TVs only)	
265 Series. Calibration Microphone	

Installing the Remote Control Batteries

1. Remove the remote control's back cover by gently pressing in the tab and lifting off the cover.
2. Load the batteries, making sure the polarities (+) and (-) are correct. For best results, insert the negative (-) end first.
3. Snap the cover back in place.

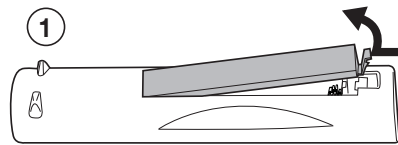

The remote control requires two AA alkaline batteries.

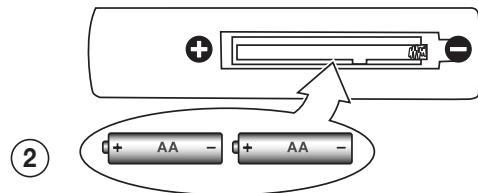

2

Before You Begin

1. Review the important safety, installation, and operating information at the beginning of this book.
2. Choose a location for your TV.
 - See the stand-installation or wall-mounting requirements starting on page 6.
 - Allow at least four inches of space on all sides of the TV to help prevent overheating. Overheating may cause premature failure of the TV.
 - Avoid locations where light may reflect off the screen.
3. Install the batteries in the remote control.
4. Plug the TV into an AC power outlet.

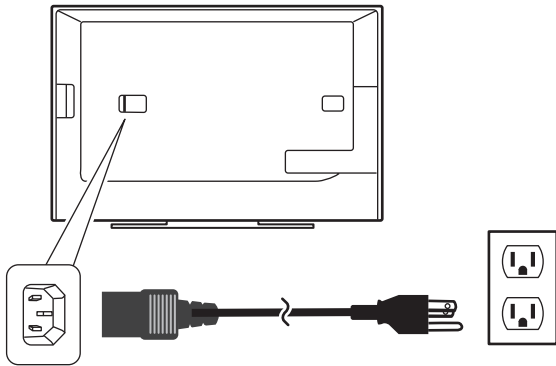

TV power connection

TV Tips





Turning the TV On or Off

- Point the emitter (bulb) end of the remote control at the front of the TV and press the **POWER** button.
- Press the **POWER** button on the TV control panel.

Controlling Sound Volume

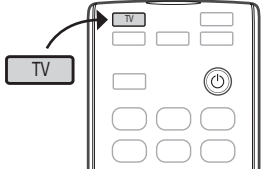
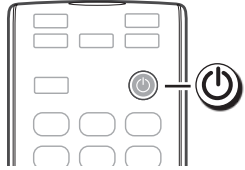
- Press **VOL** to adjust the sound level.
- See also “Controlling A/V Receiver Sound Volume” on page 32.

First-Time Power-On

1. Press the **TV** key to ensure that the remote control is in TV mode.
 
2. Aim the emitter end of the remote control at the TV and press the **POWER** key. Wait for the **Welcome** screen.
 
3. If you wish to change the menu language to **Español**, press **▼**.
 
4. Press **▶** to move to the energy-mode selections. Select **Home**.
 
5. Press **▶** to highlight **EXIT**. Press **ENTER** to clear the menu.
 

Welcome Screen Energy Options

- Mitsubishi recommends the **Home** setting, which uses power within ENERGY STAR[®] guidelines.
- The **Retail** setting looks best under bright lighting. In this mode, the TV uses power in excess of ENERGY STAR guidelines.

This table compares energy choices offered in the **Welcome** screen.

	Home	Retail
Picture Mode	Bright	Brilliant
Backlight Level	Reduced Brightness	Full Brightness

TV Controls

Remote Control

For more on use and care of the remote control, see page 84.

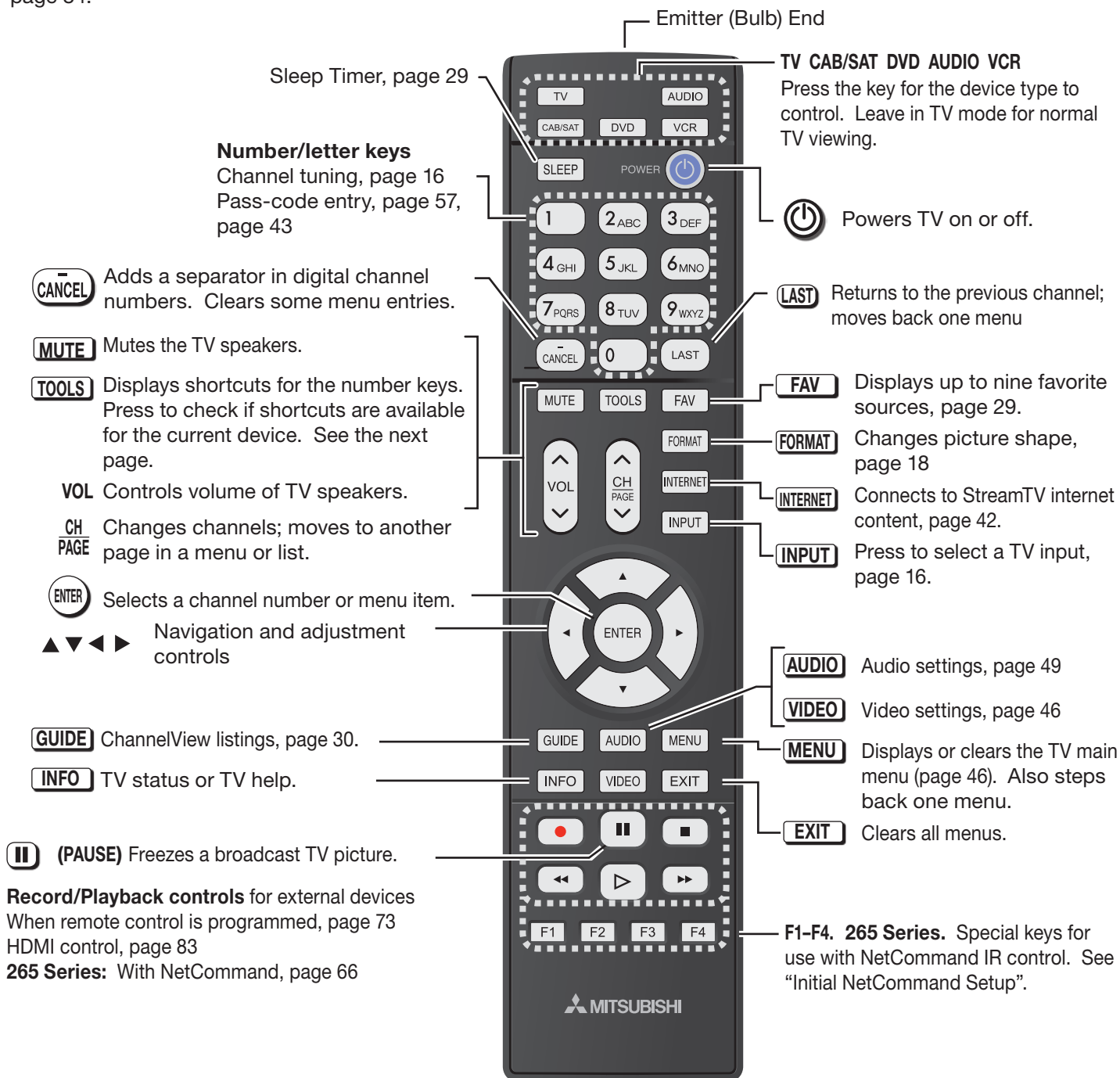

Note: To operate other audio/video devices using the TV's remote control, use any of these methods:

- See Appendix A, "Programming the Remote Control."
- For HDMI devices compatible with the TV's HDMI Control feature, see Appendix C.

• 265 Series

- See page 60 for NetCommand IR "Learning" of device keys.
- For use of specific keys with NetCommand-controlled devices, see "Special Operation Methods," page 64.

TV Controls, continued

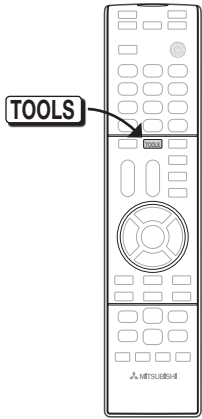

The **TOOLS** Key and Menu

Press the **TOOLS** key to check for shortcuts. The **Tools** menu lists shortcut keys for common functions. Press the number key to activate the shortcut. See the sample menu below.

- Shortcuts specific to the current device are in the third column.
- Shortcuts may be available for a CEC-enabled device. See Appendix C, “HDMI Control of CEC Devices,” page 81.
- **265 Series.** After setting up NetCommand control for a device, check the **Tools** menu for shortcuts. See page 62.

Tools

PICTURE	SOUND	TV
1 Brilliant	2 Sub-woofer	3 CC
4 Natural	5 Surround	6
7 Backlight	8 Night	9

Sample Tools menu

Device-Specific Shortcuts
Availability varies, depending on equipment features and setup.

3 CC. Turns closed captions on/off	page 51
---	---------

Picture Shortcuts

1 Picture Mode Brilliant	page 46
4 Picture Mode Natural	
164 and 265 Series. Brilliant and Natural Picture Modes are the default choices. If your installer has set up special Picture Modes in the Picture > Advanced menu, select them from this menu.	page 48
7 Backlight turns off the backlight. Press any number key to turn the backlight back on.	---

Sound Shortcuts

2 Subwoofer. Turns on or off audio to a connected subwoofer.	page 50
5 Surround. Selects Sound Mode Surround	page 50
8 Night. Selects Sound Mode Night	

TV Controls, continued

TV Control Panel

Buttons on the control panel duplicate some keys on the remote control.

- To display the main menu, press **INPUT** and **VOL+** simultaneously for about 10 seconds. Press and hold **INPUT** and **VOL+** for 10 seconds to clear the menu.
- Refer to **left labels** when no TV menus are displayed.
- Refer to **right labels** when using TV menus or after activating a special function.

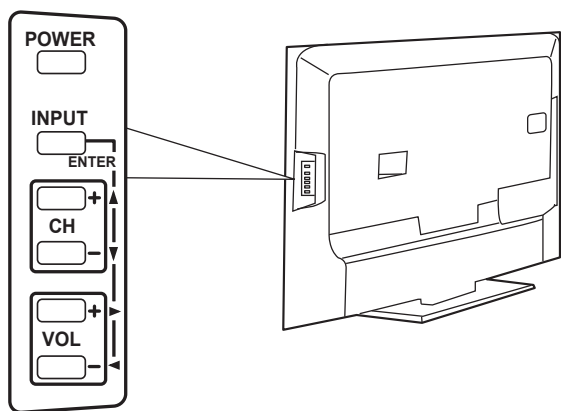

TV control panel

System Reset

If the TV fails to respond to the remote control, the control-panel buttons, or will not power on/off, perform System Reset. Recent setting changes made before using System Reset may be lost.

To perform System Reset, press and hold the **POWER** button on the control panel for 10 seconds.

Panel-Lock Release

- To release the Panel Lock using the TV control panel, press and hold the **INPUT** button on the control panel for ten seconds. If the TV is off, press the **POWER** button to make it power on.
- To activate the Panel Lock, use the **Lock** menu, page 59.

POWER Indicator

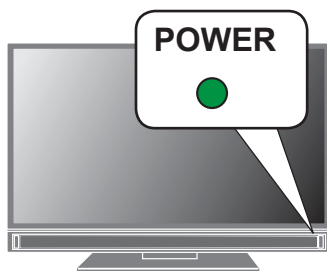

Key

- Off
- Steady On
- ◐ Slow Blinking
- ⊙ Fast Blinking

LED Color	TV Condition
None ○	TV is powered off. Normal operation.
Green ●	TV is powered on. Normal operation.
Green ◐	TV powered off, auto-on TV Timer is set. Normal operation. TV can be turned on at any time.
Red/ Yellow ⊙	TV may require service. <ul style="list-style-type: none"> Hold power button on front panel for 10 seconds to reset TV. If LED continues to flash red and yellow after reset, turn off the TV and unplug it from the AC power source. Wait one minute and then plug the set back in. If LED continues to flash red and yellow, go to www.mitsubishi-tv.com or call 1-800-332-2119 to receive Authorized Service Center information. <p>You may be asked to count how many times the LED flashes each color to assist in troubleshooting.</p>

Setting Up TV Inputs

Using the ANT (Antenna) Input

If using an antenna or direct cable service (no cable box), connect the incoming coaxial cable to the TV's **ANT** input. Refer to page 26.

You must perform a channel scan to enable reception of digital channels. If you skip this step, the TV will receive only analog channels. The channel scan will search for high-definition and standard-definition channels available in your area.

Memorizing Channels with Channel Scan

For the ANT input

To start channel memorization

1. Power on the TV.
2. Press **MENU** and open the **Setup > Channel** menu.



Start channel memorization from the **Setup > Channel** menu.

3. Press **▼** to enter the menu.
4. Highlight **Ant Air** if connected to an over-the-air antenna. Highlight **Ant Cable** for service over direct cable (no cable box). Press **ENTER** to add a check.

✓ Ant Air
Ant Cable
5. Select the scan type.
 - For first-time setup, highlight **All channels**.
 - To scan for channels not already in memory, highlight **New only**. Press **ENTER** to add a check.

✓ All channels
New only
6. Highlight **Scan** and press **ENTER**. Channel memorization may take up to 15 minutes to complete.

Scan

To stop channel memorization before completion, press **CANCEL**.

At any time after Channel Scan,

- Use the **Setup > Channel > Edit** menu (page 53) to add or delete individual channels from memory.
- Perform an additive scan with the **New only** option to add channels not already in memory.
- Repeat the **All channels** scan if you move the TV to a new geographic area with a different channel line-up or reposition the antenna.

Setting Up Inputs with Auto Input Sensing

1. Power on the TV.
2. Power on the devices to ensure detection.
3. Connect one device to the TV, making note of the TV input jack.

The TV will display the **New Device Found** screen if the connection type is detectable.

4. Highlight the device type in the on-screen list and press **ENTER**. The name you select here will appear in the **Input Selection** menu.



Sample **New Device Found** screen.

Important Note for NetCommand Users

265 Series. Be sure to select the correct device type here. Although you can change the device type later using the **Inputs > Name** menu, any “learned” NetCommand IR codes will be erased when you make the change.

5. Press **EXIT** to close the **New Device Found** screen.
6. Repeat the preceding steps for each additional device you want to add.

Setting Up TV Inputs, continued

About Auto Input Sensing

This TV's Easy Connect™ Auto Input Sensing feature detects the following connections automatically:

- Analog video jacks from inputs 1, 2, and 3
- HDMI inputs (when powered on)
- USB device containing photo and music files (JPG and MP3 formats).

Auto Input Sensing for Most Devices

When you first connect a device, the TV will:

- a. Detect the connected device and automatically switch to it.
- b. Prompt you to identify the device type.
- c. Repeat these steps for other newly detected devices.

When You First Connect a Device

- **Most Device Types.** Select the device type from the on-screen list. The device type you select here will appear as an icon in the **Input Selection** menu.
- **A/V Receiver.** For an HDMI-equipped A/V receiver, select **AVR** from the list of device types if the A/V receiver is not recognized automatically.
- **HDMI CEC Devices Compatible with the TV's HDMI Control Feature.** Compatible CEC-enabled HDMI-equipped devices are often recognized automatically by the TV. HDMI Control may allow you to control some functions of a CEC-enabled device. See Appendix C, "HDMI Control of CEC Devices."



New Device Found screen for a device with HDMI control enabled. Select **On** if you want to enable the TV's HDMI control of the device. In some cases, as in the example above, you will also be prompted to select a device name.

Tips on Auto Sensing

- Choose a different name for each input.
- The antenna input (**ANT**) is never detected, although you can turn off the unused antenna input in the **Inputs > Name** menu.
- Change the device type displayed in the **Input Selection** menu by using the **Inputs > Name** menu (page 55).
- Some HDMI devices can automatically tell the TV what name to use in the **Input Selection** menu and you will be unable to change the name.
- The TV is unable to detect a new connection if the current input is USB, *Bluetooth*®, or internet. Switch to a different input before connecting.
- **265 series.** Any "learned" NetCommand IR codes will be erased if you change the device type in the **Inputs > Name** menu.

Reactivating Auto Input Sensing for an HDMI Input

After you disconnect an HDMI device, Auto Input Sensing is temporarily disabled. Perform these steps:

1. Disconnect the HDMI device.
2. Delete the removed HDMI device in the **Inputs > Name** menu (see "Removing an HDMI Device," page 83).
3. Connect the new device and the **New Device Found** screen will display.

Basic TV Operation

Selecting an Input to Watch

1. Press **INPUT**.

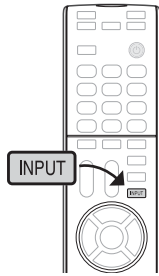

2. Press ◀ ▶ and ▼ to highlight an input icon.



Sample Input selection menu, DVD input selected

3. Press **ENTER** to switch to the input.
4. To control the input device, use the device's remote control or see "Introduction to Home-Theater Control," page 45.

Note: In most cases, to see a named icon for a connected device (as in the samples), you must first assign a name either

- When the device is first connected and the **New Device Found** menu offers a choice of names.
- By using the **Inputs > Name** menu to assign or change a name at any time after the TV has detected the connection.

More About the Input Selection Menu

- To assign helpful names to the icons, see the **Inputs > Name** menu, page 55.
- To remove unwanted Antenna, Bluetooth®, or HDMI device icons from the **Input Selection** menu, see the **Inputs > Name** menu, page 55.
- To rearrange the icons, see the **Inputs > Order** menu, page 56.

Watching Broadcast TV

TV Connected to an Antenna or Direct Cable Service (no cable box)

Note: Perform channel memorization to enable reception of digital channels. See page 14.

1. Press **INPUT** to display the **Input Selection** menu.
2. Highlight the antenna or cable icon and press **ENTER**.

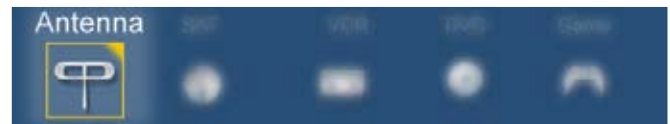

Sample Input Selection menu, antenna input selected

3. To tune to a channel from the **ANT** input, use any of these methods.
 - Enter the channel number using the number keys on the remote control and press **ENTER**. For a two-part digital channel, such as 3-1, press 3 **CANCEL** 1 **ENTER**.
 - Press **CH** to change channels one channel at a time.
 - Press and hold **CH** to speed through channels.
 - Press **LAST** to return to the previous channel.
 - Use the Fav (Favorites) feature to tune to up to nine favorite channels. See page 29.
 - Press **GUIDE** to display ChannelView channel listings, highlight a channel number, and press **ENTER** to tune.
 - Set up ChannelView custom channel banks and use the **CH** ^/∨ key to tune to predefined groups of channels. See page 30.

Basic TV Operation, continued

Picture Settings

- To get the best picture under different viewing conditions, set the Picture Mode first before changing other video settings. See page 46.

- Press **VIDEO**.
- Press **▼ ▲** until **Picture Mode** displays.

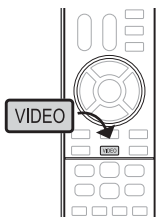

- Press **◀ ▶** to make one of these selections:

Name	When to Use
Brilliant	Under bright light
Game	With gaming consoles (inputs named Game or PC only)
Bright	For most daytime viewing
Natural	For most nighttime viewing

- Press **▼ ▲** to display the name of another adjustment.
- Press **◀ ▶** to make the adjustment.
- Press **EXIT** to clear the display.

Additional picture options are available through these menus:

Menu Name	Page
Picture > Video	46
Picture > Picture Plus	47
Picture > Perfect (265 Series)	48
Picture > Advanced (164 and 265 Series)	48

Basic Audio Controls

Controlling Sound Volume

- Press **VOL** to adjust the sound level of the TV speakers.
- Control subwoofer volume with an on-screen slider. See page 49. Set **Sound > Global > Subwoofer** to **On** to make this adjustment available.
- See also “Controlling A/V Receiver Sound Volume” on page 32.

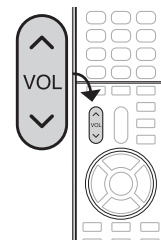

Changing Audio Settings (TV Speakers Only)

- Press **AUDIO**.
- Press **▼ ▲** to find the adjustment you want. See page 49.
- Press **◀ ▶** to change.



Changing the Audio Output

To switch from the internal TV speakers to an external sound system,

- Press **AUDIO**.
- Press **▼ ▲** to display the **TV Speakers** option.
- Press **◀ ▶** to change to **Off**.

TV Care

See page 84.

Assistance

- For troubleshooting, service, and product support, see Appendix E, starting on page 85.
- For warranty information, see page 99.

Basic TV Operation, continued

The FORMAT Key and Picture Shape

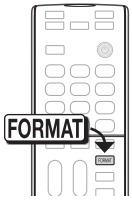

Repeatedly press the **FORMAT** key to cycle through displays for the current program. The TV will remember the format you last used on each input.

For details, see page 33

Important

Black bars at the edges of the screen are common in HD pictures. Black bars are not a defect of the TV.

- Black bars are added by broadcasters to fill the 16:9 screen area while preserving the original aspect ratio of the picture.
- Your cable box, satellite receiver, or other device may also be altering the broadcast picture. If your device offers output in native format, try using it with Mitsubishi picture formats.

Sample Uses of the FORMAT Key

You can use the **FORMAT** key to reduce or eliminate black areas at the edges of the picture.



Squarish 4:3 image is narrower than the 16:9 screen; unused areas at the sides are filled with black.

Press
FORMAT

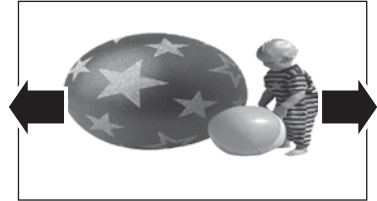

Wide Expand mode stretches the picture sideways to fill the screen.



Wide 2.35:1 anamorphic DVD image; unused areas at the top and bottom are filled with black (letterbox effect).

Press
FORMAT



Zoom mode. The picture fills the screen. All four edges are cropped in this mode.

More TV Features

Feature	Page
Parental controls (Lock menu)	57
Audio Lock (controls your sound system with the TV's remote control left in TV mode.)	74
TV Clock. Set the TV Clock if you plan to use the TV Timer (page 52) or ChannelView (page 30).	52
Favorite channels or sources	29
ChannelView and custom channel collections	30
Changing the input names that appear in the Input Selection menu (Inputs > Name menu)	55
Digital camera images and mp3 music files	34
164 and 265 Series. Listening to a wireless audio device with the TV speakers	37
StreamTV™ internet access	42

Feature	Page
Programming the remote control to operate other A/V devices	73
Controlling compatible devices using HDMI CEC control	81
265 Series. Controlling A/V devices with Net-Command	60

Using the TV with a Personal Computer

Connecting a Computer to the TV

Use one of the connection methods listed below based on your computer's video output.

Computer Video Output	Video Connection	Audio Connection
Digital DVI	DVI-to-HDMI cable or an HDMI cable with a DVI-to-HDMI adapter	Analog audio cable with mini plugs
HDMI	HDMI-to-HDMI cable	No additional audio connection is required.

IMPORTANT

This TV accepts digital computer video signals only. This TV is not compatible with VGA (analog) computer video.



1. Connect the computer's digital signal output to one of the TV's HDMI jacks. See the connection diagrams for the method suited to your equipment.
2. Connect the computer's audio output using one of these options:
 - For digital DVI video signals, connect the analog audio output to the TV's **DVI/PC AUDIO INPUT** jack.
 - For HDMI signals, no additional audio connection is required.

Note: If you are unable to hear audio from the computer, there may be an incompatibility in the computer's hardware, software, or internal settings. Consult a trained computer technician for advice.

3. Power on the TV and computer. The TV will detect the connection and display the **New Device Found** screen.
4. In the **New Device Found** screen, press ▲ ▼ to highlight **PC** in the list of device types. It is important to use the name **PC** so that the TV processes the PC signal correctly.
5. Highlight **EXIT** and press **ENTER** to close the **New Device Found** screen.

Note: If your computer provides digital audio output (coaxial or optical), you can connect it directly to a digital A/V receiver and bypass the TV.

HDMI Connection

Mitsubishi recommends using high-speed HDMI cables to connect newer devices incorporating HDMI technology.

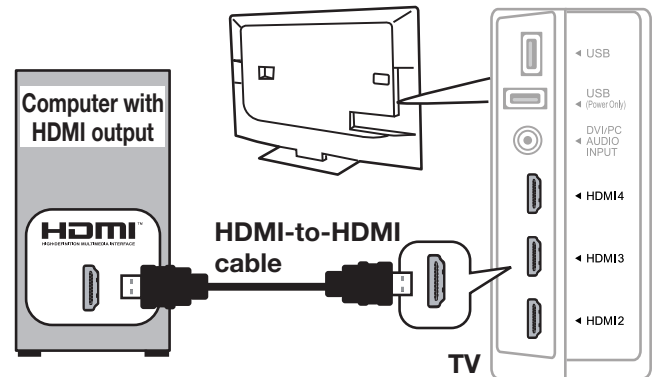

An HDMI-to-HDMI connection carries all video and audio on a single cable.

HDMI and Digital Surround Sound

The TV's HDMI inputs can receive digital surround sound from an HDMI device. Use an HDMI connection if you want to hear digital surround sound from the TV's internal speaker array.

DVI Video Connection

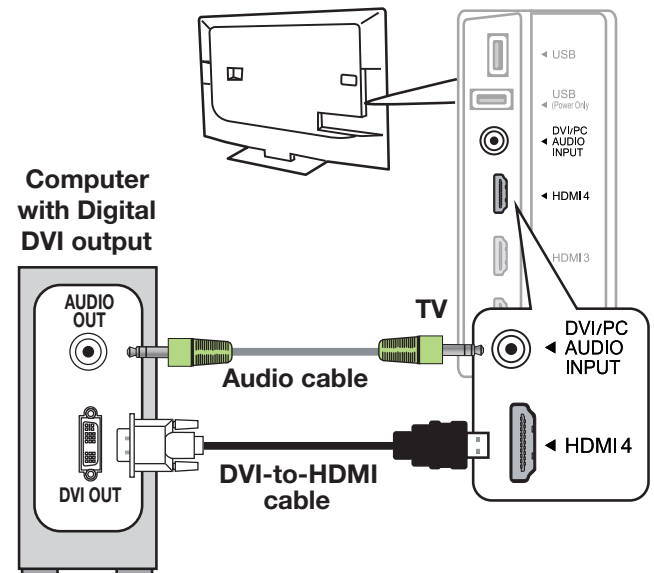

A DVI connection from a personal computer requires a separate audio connection.

Using the TV with a Personal Computer

Computer Video Adjustments

1. Power on the computer.
2. Select **PC** from the **Input Selection** menu. To do this, press **INPUT** to open the **Input Selection** menu, move the highlight to the PC icon, and press **ENTER**.
3. Working from the computer, change the resolution of the computer image. View the computer image on the TV and maximize the computer resolution while maintaining a suitable aspect ratio for the image.
4. Perform TV video adjustments. Press **VIDEO** repeatedly to access video-adjustment options.
5. Press **FORMAT** repeatedly to find the picture shape best suited to the image. See the chart on this page showing how different computer resolutions can be displayed on the TV.

Distortion in Computer Images

Computer images may show distortion when viewed on the TV, e.g., lines that should be straight may appear slightly curved.

Image Resolution

Your Mitsubishi TV can display the resolutions shown in the chart from standard VGA (640 x 480) through 1920 x 1080 signals at a refresh rate of 60 Hz.

In most cases, the computer will select the best resolution match to display on the TV. You can override this setting if you wish. Refer to your computer operating system's instructions for information on changing the screen resolution.

You may need to restart the computer for changes to take effect.

Tip

Set the computer's screen saver to display a pattern after several minutes of inactivity. This acts as a reminder that the TV is powered on.

Computer Display Formats

Press **FORMAT** repeatedly to cycle through the TV displays available for your computer's video signal.

Computer Signal	As Displayed on TV Screen			
	Original Format	4 X 3 Standard	16 X 9 Standard	Zoom
VGA 640 X 480				
SVGA 800 X 600				

Original Format	Standard	Zoom
XGA 1024 X 768		
PC 720p 1280 X 720		
WXGA 1360 X 768		
SXGA 1280 X 1024		

Original Format	Standard
PC 1080p 1920 X 1080	

2 TV Connections

Before You Begin

Auto Input Sensing

The TV's Auto Input Sensing feature automatically recognizes many connections and prompts you to identify the type of device connected. See page 15 for more on Auto Input Sensing.

Connection Types

Use the connection types available on your input devices that will give the best video quality. For example, choose HDMI over component video; choose component video over composite video.

Picture Quality

For best picture quality, route signals directly from the source device to the TV whenever possible.

Surround Sound

- To use the surround sound capabilities of the TV's speaker array, you must connect the digital surround sound source to the TV on either
 - An HDMI input
 - The **ANT** antenna input
- For best surround sound audio quality from an external sound system, route audio-carrying cables from the source device directly to your sound system.

IMPORTANT

Accessory items such as cables, adapters, splitters, or combiners required for TV connections are not supplied with the TV. These items are available at most electronics stores.

Connection Types and Audio/Video Quality

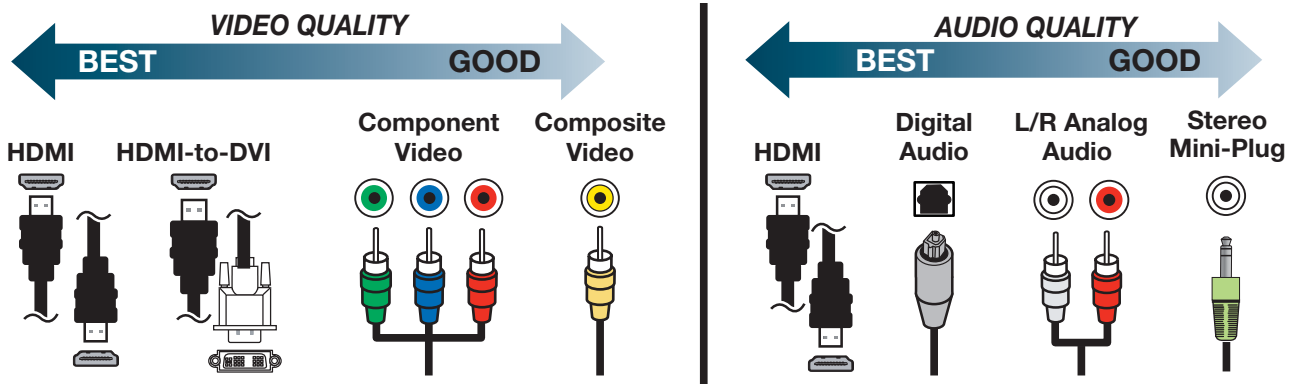

Inputs and Outputs

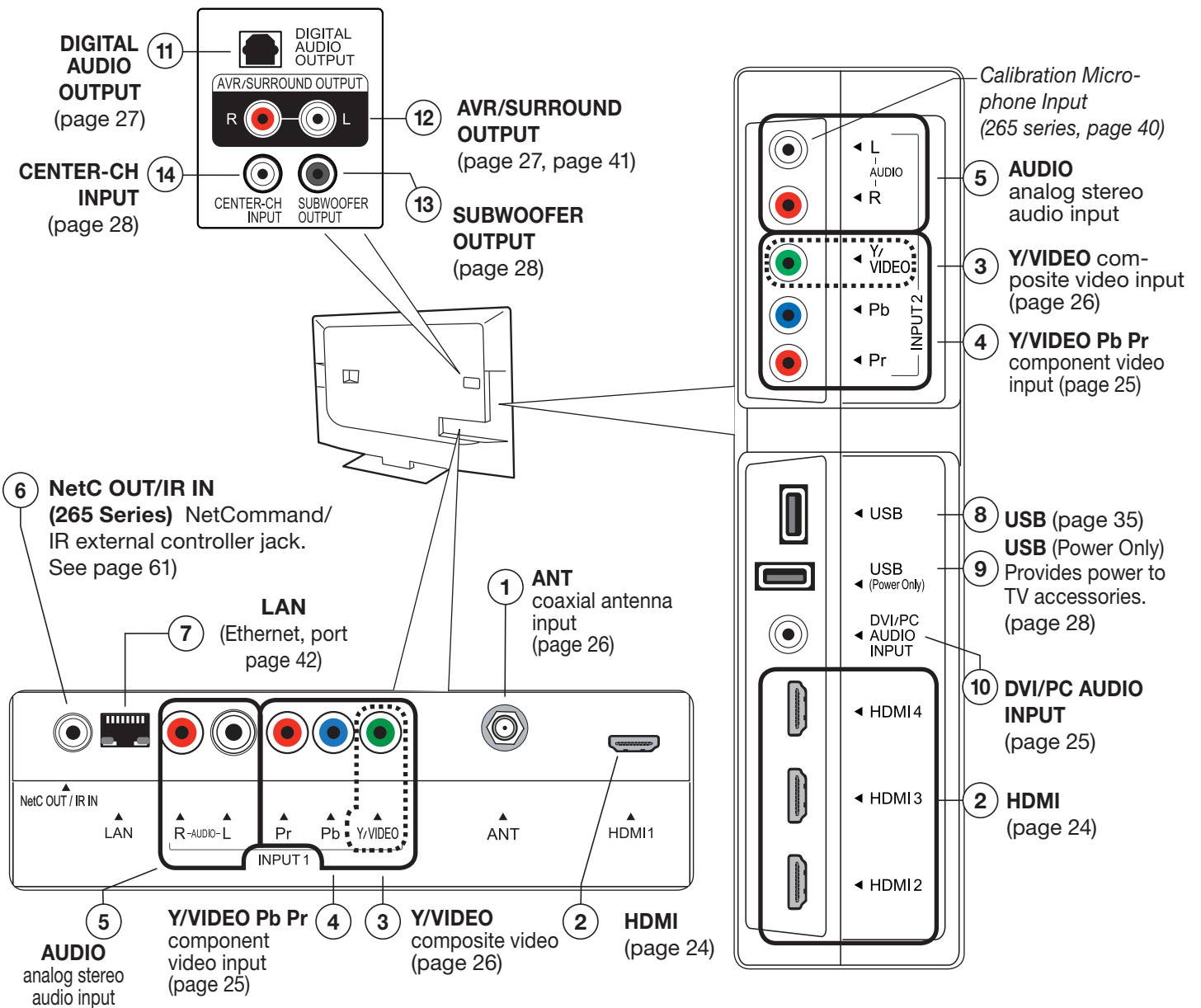

Cable Routing

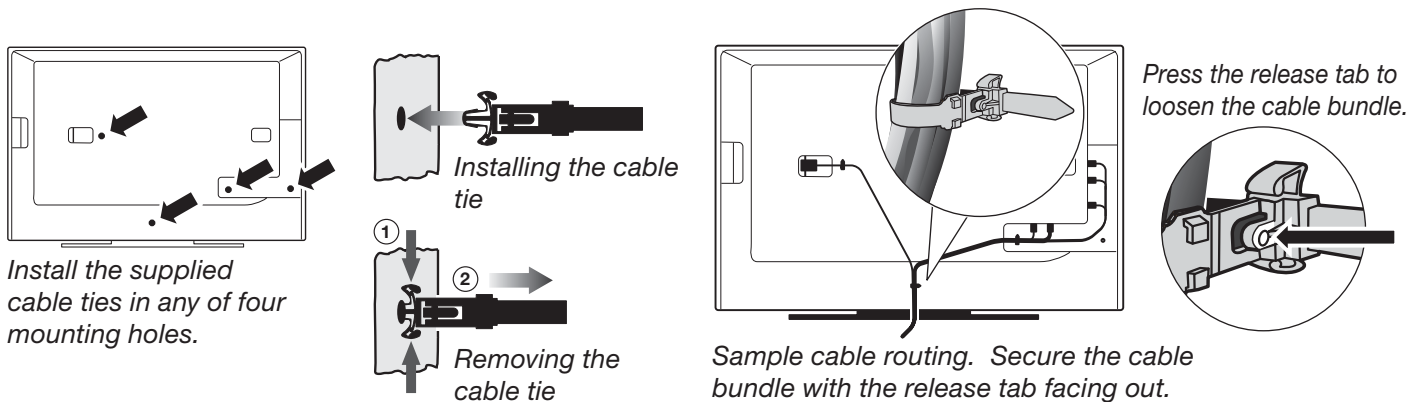

Inputs and Outputs, continued

1. ANT (Antenna)

Connect your main antenna or direct cable service (without a cable box) to **ANT**. The **ANT** input can receive digital and analog over-the-air channels from a VHF/UHF antenna or non-scrambled digital/analog cable source.

2. HDMI® Inputs (High-Definition Multimedia Interface)

The HDMI inputs support uncompressed standard and high-definition digital video formats, bitstream Dolby Digital 5.1, and PCM digital stereo audio.

Mitsubishi recommends you use high-speed HDMI cables to connect newer source devices incorporating HDMI technology. High-speed cables bring you the full benefits of Deep Color and **x.v.Color**.

These HDMI inputs can also accept digital DVI video signals. To connect a device's DVI output to the TV's HDMI input, use an HDMI-to-DVI adapter or cable plus an analog audio. Connect the audio cable to the **DVI/PC AUDIO INPUT** jack on the TV to receive audio from your DVI device.

Use the HDMI inputs to connect to CEA-861 HDMI compliant devices such as a high-definition receiver or DVD player. These inputs support 480i, 480p, 720p, 1080i, and 1080p video formats.

The TV's HDMI inputs are compatible with many DVI-D and HDMI computer video signals.

These inputs are HDCP (High-Bandwidth Digital Copy Protection) compliant.

HDMI Cable Categories

HDMI cables are available as Standard and High-Speed types.

- **High-Speed HDMI Cables.** Newer DVD players, video games, and set-top boxes require High-Speed HDMI cables, suitable for clock frequencies up to 340 MHz or data rates of up to 10.2 gigabits per second. Use high-speed cables for 1080p HD signals carrying extended color encodings (i.e., 30 or more bits, also called Deep Color). High-Speed HDMI cables are also suitable for standard HDTV signals.
- **Standard HDMI Cables.** Standard HDMI cables may be unmarked. They are suitable for standard HDTV 720p, 1080i, and 1080p signals with 8-bit color depth. Use Standard HDMI cables for clock frequencies up to 74.25 MHz or data rates of up to 2.23 gigabits per second.

3. Y/VIDEO (Composite Video)

Use the adjacent **AUDIO R** and **L** inputs if you wish to send audio to the TV.

4. Y/VIDEO Pb Pr (Component Video)

Use the adjacent **AUDIO R** and **L** jacks if you wish to send audio to the TV.

5. AUDIO

Analog stereo inputs for use in conjunction with adjacent composite or component video jacks.

6. NetC Out/IR IN

265 Series

As an output: Connect IR emitters to this jack to send NetCommand control signals to external IR-controlled devices.

As an input: Accepts control signals from an external controller when set up by your professional installer.

7. LAN

Use the **LAN** Ethernet jack for streaming internet video to the TV. See page 42 for setup. Visit www.VUDU.com for details about VUDU™ service.

8. USB

The TV can read JPEG photo files and mp3 music files from a USB storage device connected to this input.

154 Series. Connect a compatible wireless adapter to stream internet content to the TV (page 42).

9. USB (Power Only)

Standard USB 5-volt, 500-milliamp power output you can use to supply power to an accessory device, such as a wireless subwoofer (page 28).

10. DVI/PC INPUT AUDIO

Connect a DVI device to one of the TV's HDMI inputs and use this jack to send analog audio to the TV.

11. DIGITAL AUDIO OUTPUT

This output sends Dolby Digital or PCM digital audio to your digital A/V surround sound receiver. Incoming analog audio is converted by the TV to PCM digital audio. If you have a digital A/V receiver, in most cases this is the only audio connection needed between the TV and your A/V receiver.

Inputs and Outputs, continued

12. AVR/SURROUND OUTPUT

- Sends analog audio of the current program to an analog A/V surround sound receiver or stereo system. Digital audio from digital channels and HDMI devices is converted to analog audio by the TV for output on this jack. This is the only audio connection needed to the TV if using an analog A/V receiver or stereo system.

Note: If connecting headphones, set **Sound > Global > Analog Audio Out** to **Variable**.

- For a fuller surround sound effect, connect external rear speakers to this output to supplement the TV's speaker array. Set **Sound > Global > Analog Audio Out** to **Rear**.

13. SUBWOOFER OUTPUT

Connect a powered subwoofer to this input to complement effects from the TV's speaker array. Set **Sound > Global > Subwoofer** to **On** to enable this output.

14. CENTER CH INPUT

Connect your A/V receiver's center channel output to this input to make the TV speakers output center-channel sound. Set **Sound > Global > Center Channel** to **On** to enable this input. See **Sound > Audio > TV Speakers > Center** page 49.

Auto Input Sensing

The TV's Auto Input Sensing feature automatically recognizes some connections and prompts you to identify the device type. See page 15.

HDMI Device

Commonly used with an HDTV Cable Box, Satellite Receiver, or DVD/Blu-ray Player

Required: HDMI-to-HDMI cable.

Connect an HDMI cable from the TV to the device's HDMI output. HDMI-connectable devices provide video and audio through a single cable.

Mitsubishi recommends using high-speed HDMI cables to connect newer devices incorporating HDMI technology. See "HDMI Cable Categories" on the previous page for more on HDMI cable types.

Note: The HDMI connection supports copy protection (HDCP).

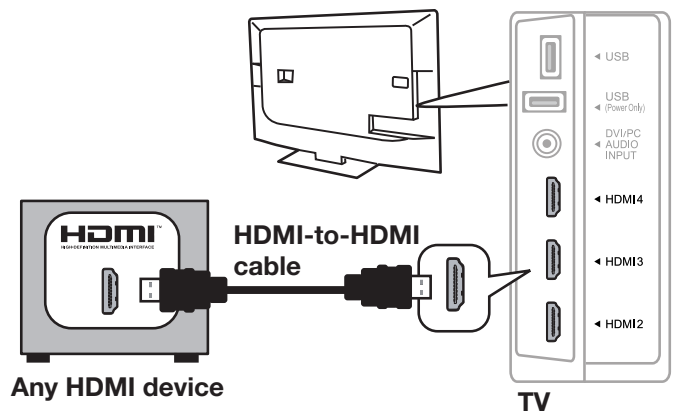

IMPORTANT

HDMI and Digital Surround Sound

Use an HDMI connection if you want to hear digital surround sound from the TV's internal speaker array. The TV's HDMI inputs can receive digital surround sound from an HDMI device.

Y Pb Pr Component Video Device

Commonly used with an HDTV Cable Box, Satellite Receiver, or DVD/Blu-ray Player

If your source device has an HDMI output, use the connections for HDMI devices described on the opposite page instead of component video.

Required:

- RCA-type component video cables
- Left/right analog audio cables.

Note: To hear digital surround sound from an A/V receiver, connect the digital audio output from the device directly to your digital A/V receiver.

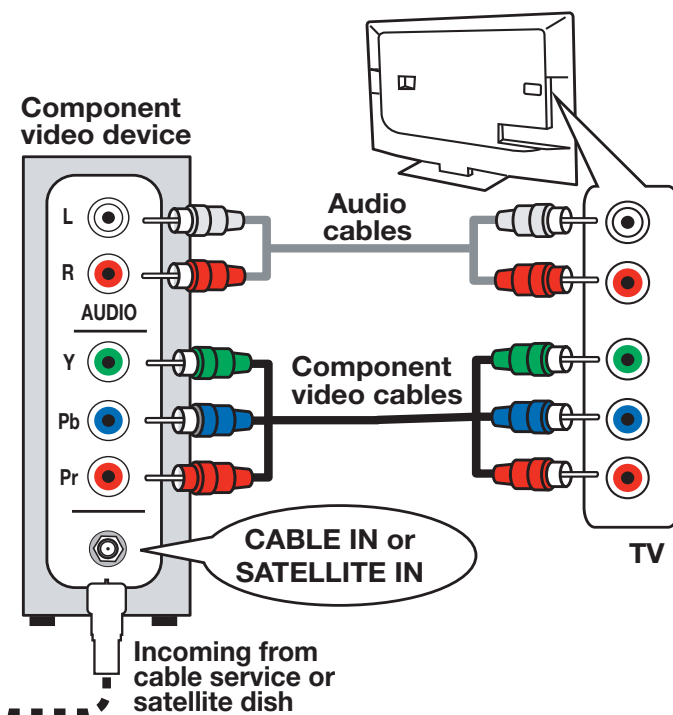

DVI Video Device

Commonly used with a Cable Box, Satellite Receiver, or DVD Player

Connect a DVI device (digital only) to one of the TV's HDMI input jacks.

Required:

- Analog stereo audio cables
- DVI-to-HDMI cable or DVI/HDMI adapter and HDMI cable

If you are using a DVI/HDMI adapter, it is important to connect the adapter to the DVI device for best performance.

Some devices require connection to an analog input first in order to view on-screen menus and to select DVI as the output. Please review your equipment instructions for DVI connectivity and compatibility.

Note: The HDMI connection supports copy protection (HDCP).

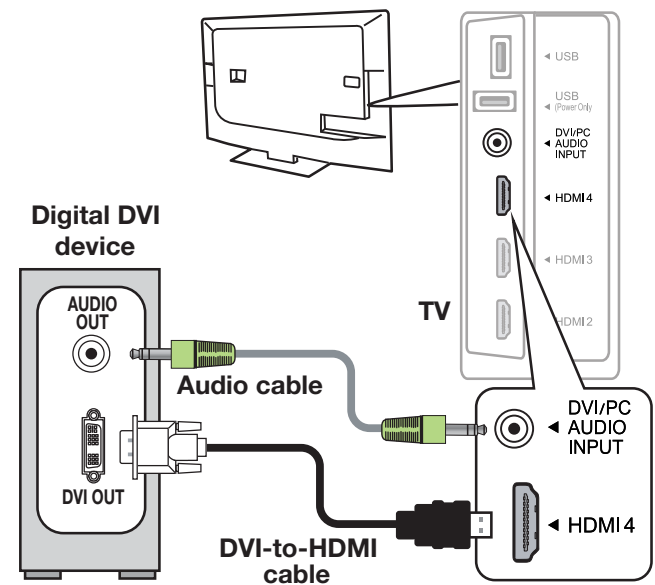

Antenna or Cable TV Service

Connect the incoming cable to the TV's **ANT** input.

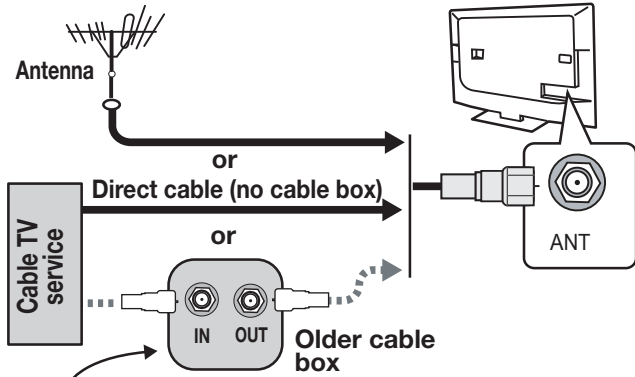

Not recommended. Other connection types provide better quality audio and video.

VCR or DVD Recorder to an Antenna or Wall Outlet Cable

Required:

1. Video cables
 - 1a. Component video cables (red/blue/green) **or**
 - 1b. Composite video cable (usually yellow)
2. Left/right analog audio cables.
3. Two-way RF splitter
4. Two coaxial cables

Note:

- Use composite video only if component video or HDMI are unavailable.
- If your recording device has an analog-only tuner, you must use a digital converter box to enable recording of digital broadcasts.

Composite Video Device

VCR or other device with composite video output

Required:

- Composite video cable (usually yellow)
- Analog stereo audio cables.

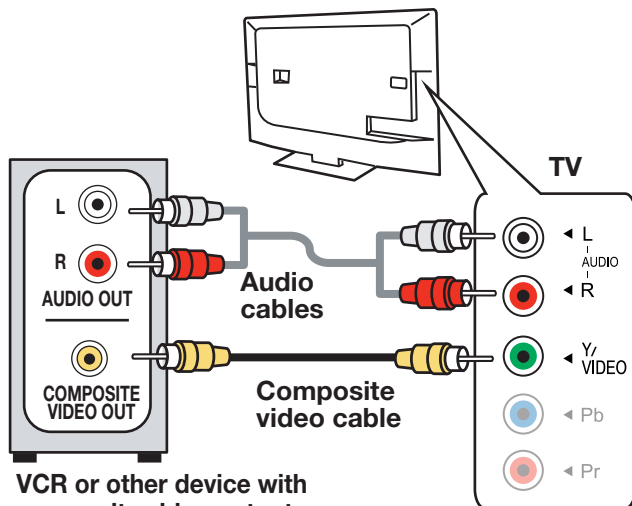

VCR or other device with composite video output

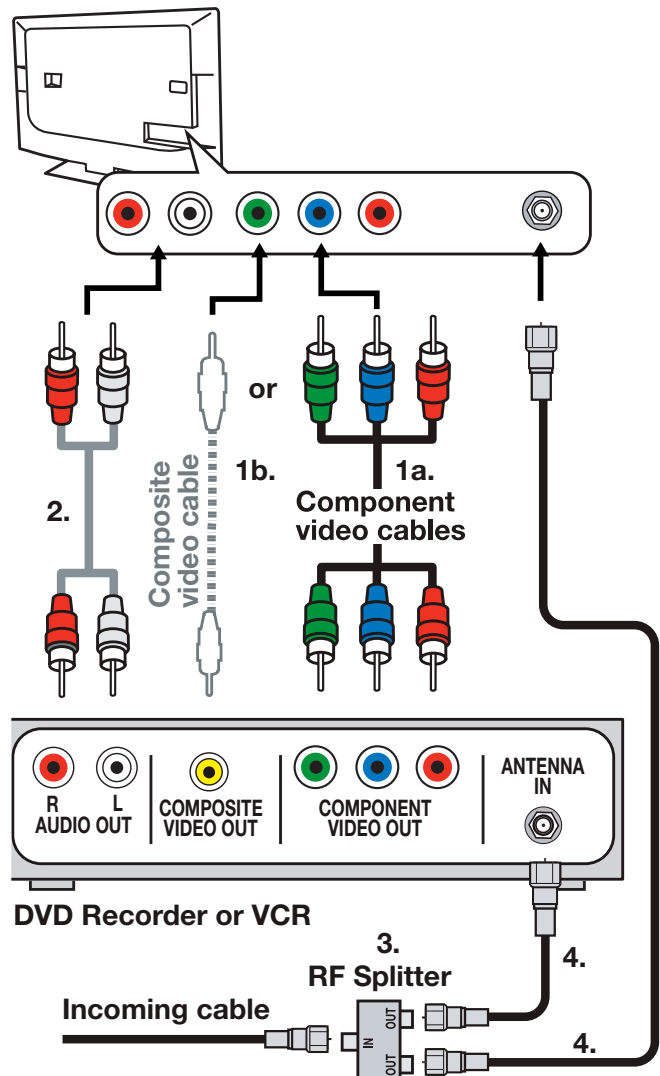

A/V Receiver

Most setups require either a digital audio cable or analog stereo audio cables. To send audio from TV channels received on the **ANT** input or devices connected directly to the TV, you must use one of the connections shown below.

The TV makes all audio available in digital and analog formats:

- Analog audio coming into the TV is available as output in digital stereo format on the **DIGITAL AUDIO OUTPUT** jack.
- Digital incoming audio is available as analog output on the **AVR/SURROUND OUTPUT L** and **R** jacks.

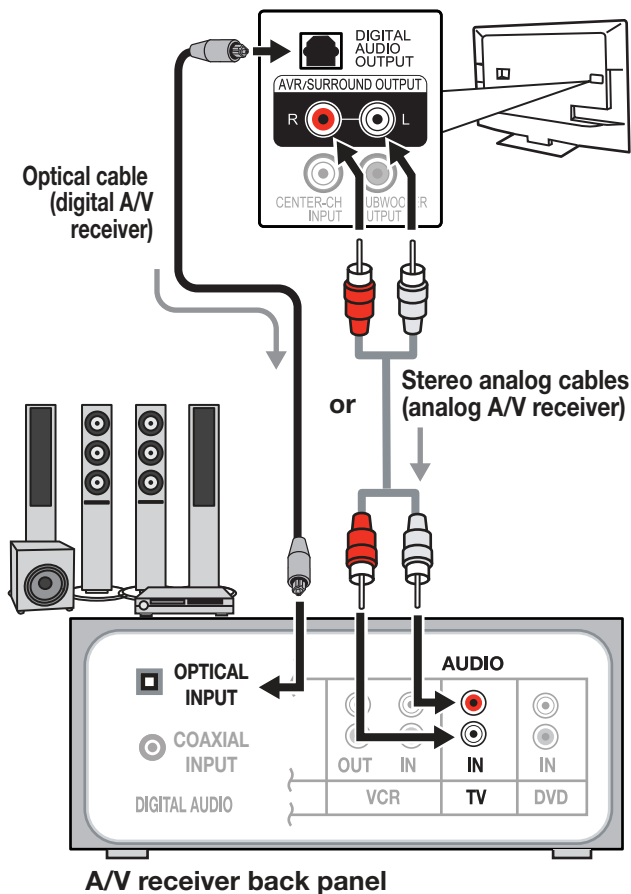

Note:

- On rare occasions, an HDMI signal may be copy-restricted and cannot be output from the TV as a digital signal. To hear these copy-protected signals through the A/V receiver, use the connection for an analog A/V receiver.
- Check the A/V receiver's Owner's Guide for information concerning use of the digital input and switching between digital sound and analog stereo sound from the TV.

A/V Receiver with HDMI Output

Required: One HDMI-to-HDMI cable

This option allows you to view content from devices connected to an A/V receiver. The A/V receiver can send audio and video to the TV over a single HDMI cable. You can use an HDMI connection as described here in addition to an audio connection from the TV's audio output. The optional audio connection allows you to hear, through the A/V receiver, devices connected to the TV only, e.g., an antenna on the **ANT** input.

- You may be able to use the TV's remote control (in **TV** mode) to operate connected CEC-enabled HDMI devices. Experiment with your equipment to determine which functions are available to the TV's remote control. See Appendix C, page 81.
- **265 Series:** This setup allows you to use NetCommand-controlled audio and video switching over the HDMI cable. See "Automatic Audio/Video Switching Over an HDMI Connection" on page 69.
- **265 Series:** To use NetCommand to supplement HDMI control of a CEC-enabled A/V receiver, note the recommendations under "More About Using an HDMI Connection," page 69.

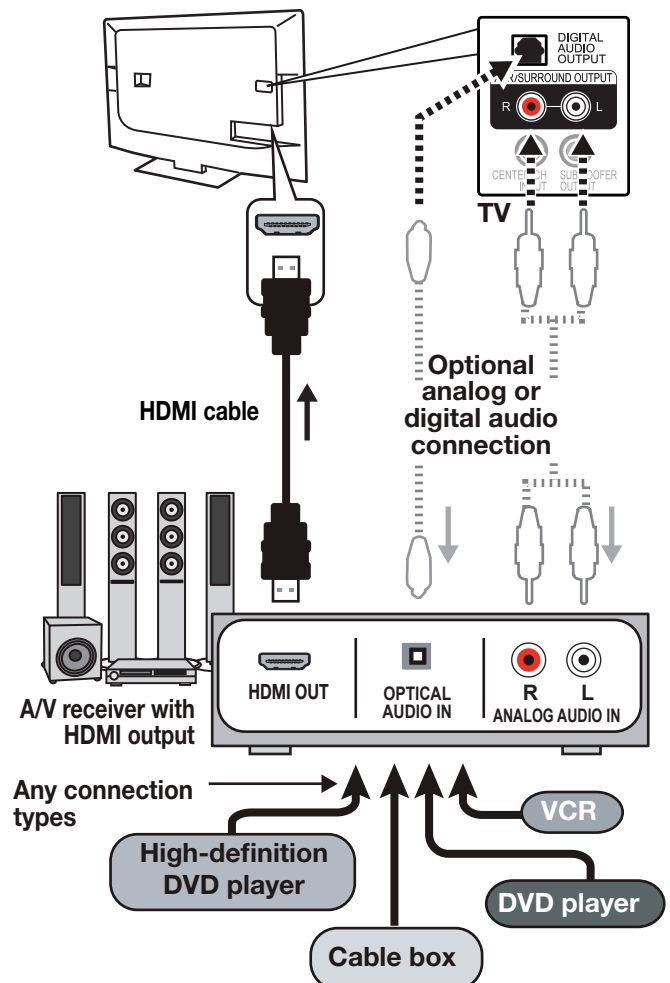

Supplemental Audio Connections

Adding a Subwoofer

Add a subwoofer to complement the TV speakers with a fuller bass sound.

- After connecting a subwoofer, you must enable the TV's subwoofer output in the TV's **Sound** menu. Go to **Sound > Global > Subwoofer** and set it to **On**.

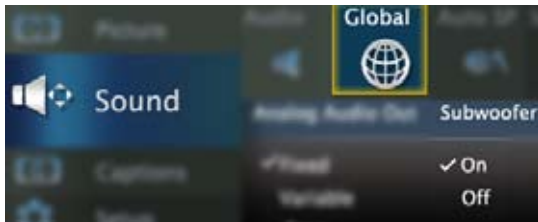

- To control subwoofer volume, press the **AUDIO** key and then press **▼** to find the subwoofer volume slider. Press **◀ ▶** to change the volume.

Subwoofer with Audio Cable

Connect the subwoofer directly to the TV's **SUBWOOFER OUTPUT**.

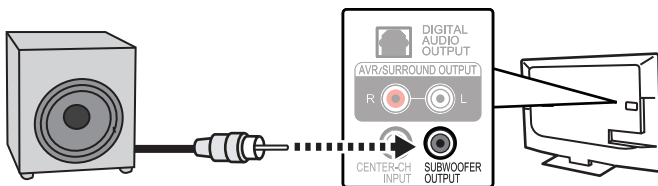

Wireless Subwoofer

Mitsubishi recommends Polk Audio Wireless Subwoofer model PSW i8m. The transmitter module can be conveniently powered from the TV's USB power port. Connect an audio cable to the transmitter to supply audio from the TV's **SUBWOOFER OUTPUT**.

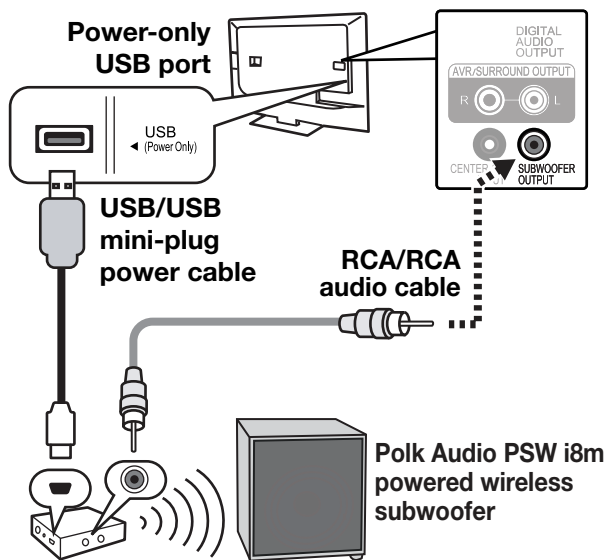

Using the TV Speakers as a Center Channel

If using an external surround sound system, you can make the TV's speakers provide center channel sound. Your A/V receiver must have a center channel pre out that can supply an amplified center-channel signal to the TV.

- Connect your A/V receiver's HDMI output and center channel pre out to the TV as shown.

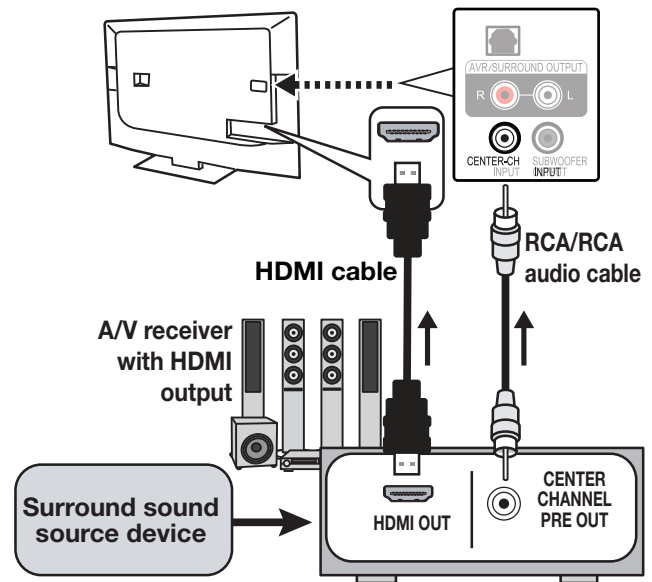

- Turn on the A/V receiver's center channel pre out if needed. See the A/V receiver's instruction manual.
- Press the **VOL** key to adjust TV volume to about level 30.
- Enable the TV's center channel mode:
 - Go to **Sound > Global** and set **Center Channel** to **On**.

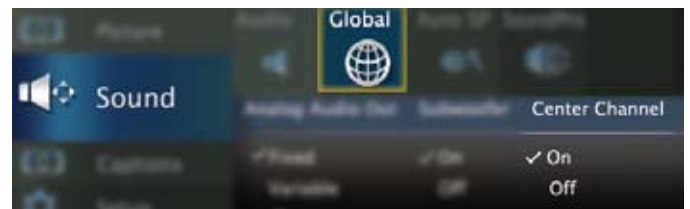

- Press the **AUDIO** key and press **▼** to display the **TV Speakers** option. Press **▶** to select **Center**.
- To balance volume:
 - Power on the A/V receiver and TV.
 - Compare the volume of the TV's center channel with the rest of the sound system. If the TV volume needs adjustment,
 - Turn on the TV speakers. Press **AUDIO** and press **▼** to display the **TV Speakers** option. Press **▶** to select **On**.
 - Adjust TV volume using the **VOL** key.
 - Return the TV to center channel mode. Press **AUDIO** and press **▼** to display the **TV Speakers** option. Press **▶** to select **Center**.
 - Compare the sound volume. Repeat this adjustment if needed.

3 TV Features

Sleep Timer

The Sleep Timer turns the TV off after the length of time you set. To set the TV to turn on at a certain time of day, see the **Setup > Timer** menu on page 52.

Setting the Sleep Timer

1. Press **SLEEP**.

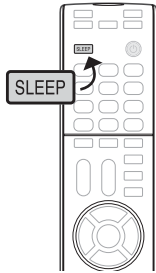

2. Press **SLEEP** additional times to increase the time in 30-minute increments up to the maximum of 120 minutes.
3. Press **EXIT** to clear the screen immediately. Otherwise the screen will clear after five seconds of inactivity.

Viewing or Changing the Sleep Timer

1. Press **SLEEP** to display the on-screen message.
2. Press **SLEEP** additional times to change the time before the TV powers off. To cancel the Sleep Timer, press **SLEEP** repeatedly until **OFF** is displayed.

FAV (Favorite Channels)

The **FAV** key gives you quick access to favorite program sources. Sources can be channels from the **ANT** input or devices connected to the TV. You can store up to nine favorites.

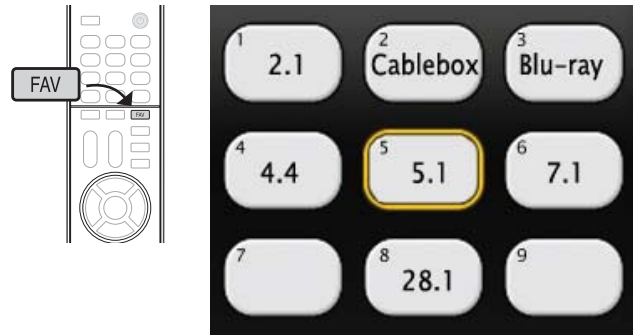

Sample Favorites menu. Switch to favorite channels or inputs using number keys.

Adding

1. Press **INPUT** and switch the TV to the input you want to add. If adding a channel, switch to the **ANT** input and tune to the channel.
2. Press the **FAV** key.
3. Move the highlight to the number position you want to assign to the channel or input.
4. Press **ENTER**.

Removing

1. While watching TV, press the **FAV** key.
2. In the **Favorites** menu, highlight the channel or input you want to remove.
3. Press **CANCEL**.

Selecting

1. While watching TV, press the **FAV** key.
2. Move the highlight to the item you want and press **ENTER**. For a shortcut, just press the number key for the channel or input.

ChannelView Channel Listings

ChannelView displays program descriptions sent by broadcasters. This information may be unavailable in some areas.

About ChannelView

ChannelView™ shows memorized channels on the **ANT** input. It displays channel names and program information for digital channels. No program information is displayed for analog channels.

ChannelView allows you to set up three banks of custom channels for convenient access. You can save groups of channels by content (e.g., news, sports, children's programming) or by TV user.

Note: You must first set the TV Clock (page 52) to receive ChannelView listings.



ChannelView, "All" tab. Programs are listed on the right.

Using ChannelView Listings

Task	Action
Display/hide ChannelView listings (ANT input only).	Press GUIDE .
Move through channels one by one.	Press ▲ or ▼ .
Move through channels quickly.	Press CH .
Jump to listings for a specific channel.	Enter the channel number. Press CANCEL to add a dash; press twice to clear the channel number.
Tune to a highlighted channel.	Press ENTER .
Update program information for a highlighted digital channel.	Press the INFO key (the screen may briefly go blank).
Display program descriptions, if available. The description will appear at the bottom of the screen.	<ol style="list-style-type: none"> 1. Press ▶ to move into the program area. 2. Press ▲▼ to move between programs.
Display more program description for the current channel (if available).	Press INFO .

ChannelView Custom Channel Banks

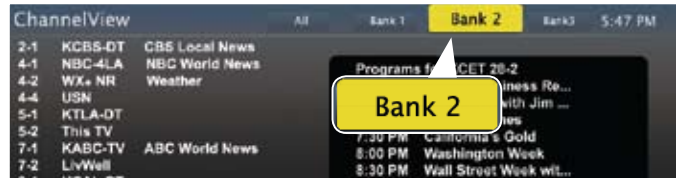

Select a channel bank to customize.

1. Press **GUIDE** to display ChannelView.
2. Press **MENU** to move the highlight to the bank header.
3. Press **◀▶** to select Bank 1, 2, or 3.
4. With the bank name highlighted, press **ENTER** to enter setup mode where you can select channels to include in the bank.
5. Press **EXIT** when finished with setup.

Task	Action
Move between banks	Press ◀▶ .
Move into the channel list	Press ▼ .
Add or delete a channel from the bank	<ul style="list-style-type: none"> • Highlight the channel and press ENTER. A check indicates the channel has been added. • Press ENTER again to clear the check and remove the channel.
Remove all channels from the selected bank	Press CANCEL .
Enter or exit setup mode	Press MENU .

Using Custom Channel Banks

- While watching TV, press **CH**. The TV will tune only to channels stored in the current bank.
- To change to a different channel bank:
 1. Press **GUIDE**.
 2. Press **MENU**.
 3. Press **◀▶**.
 4. Press **EXIT**.
- To allow tuning to any channel in memory, select the **All** bank.

Status Display

Press the **INFO** key to see the on-screen status display. The most common displays are shown here.

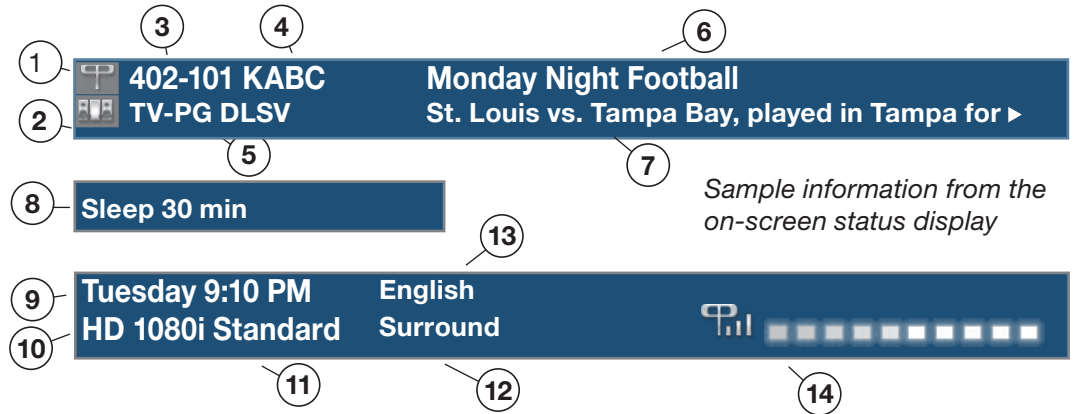
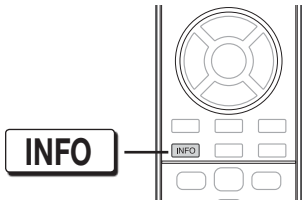

Sample information from the on-screen status display

About Channel Numbers

Channel Numbers for Over-the-Air Reception or Reception by Direct Cable

Note: All signals are automatically converted to 1080p for display.

Standard-Definition Analog Channels

Cable Reception Channel 3



Receiving Standard-Definition Analog Signal (480i)

Standard-Definition Digital Channels

Over-the-Air Antenna Reception Main Channel 7 Sub-Channel 1



Receiving Standard-Definition Digital Signal (SD)

High-Definition Digital Channels

Over-the-Air Antenna Reception Main Channel 7 Sub-Channel 1



Receiving High-Definition Digital Signal (HD)

1. Current Input
2. Audio Indicator. Key:
 - TV speakers
 - External sound system
 - Mute
3. Channel number (antenna source only)
Digital channel includes major and sub-channel numbers.
4. Digital channel name (if broadcast); antenna source only.
5. V-Chip rating
 - Antenna source only for digital signal
 - Antenna or **VIDEO** composite jack for analog signal
6. Program name (if broadcast); digital source only
7. Program description (if broadcast); digital source, antenna only. Press the **INFO** key additional times to see more of the description.
8. Sleep Timer remaining time
9. Day and time
10. Signal type being received. See "Signal Definitions" on this page.
11. Screen format in use
12. Program audio indicator (antenna source only)
13. Available language (digital source, antenna only)
14. Signal-strength indicator (digital source, antenna only)

Signal Definitions

480i: Standard-definition, older type interlaced signals from the **ANT** input, composite **VIDEO**, component **Y Pb Pr**, or **HDMI** jacks.

480p: Standard-definition progressive-scan DVD signals on component **Y Pb Pr** or **HDMI** jacks.

720p and 1080i: High-definition signals received through component **Y Pb Pr** or **HDMI** jacks. These signals are always 16:9 (widescreen).

1080p: High-definition signals from a PC or Blu-ray player; HDMI inputs only.

SD 4:3: Standard-definition squarish-screen-format signals from digital channels on the **ANT** input.

SD 16:9: Standard-definition widescreen-format signals from digital channels on the **ANT** input.

HD 16:9: High-definition 16:9 widescreen signals from digital channels on the **ANT** input.

Using an External Sound System

Redirecting Audio Output

Selecting the Audio Output

1. Press **AUDIO**.
2. Press **▲** to show the **TV Speakers** option.
3. Press **▶** to select either **On** (to hear sound from the TV speakers) or **Off** (to hear sound from an external sound system).

Choose **Center** if using the TV speakers to supplement audio from an external sound system. See page 28.



Disconnecting an A/V Receiver

When you disconnect an A/V receiver, change the **TV Speakers** setting to **On** to hear sound from the TV speakers. Use either the remote control's **AUDIO** key or the **Sound > Audio > TV Speakers** menu.

Controlling A/V Receiver Sound Volume

Use one of the methods below to control sound volume from an A/V receiver.

With a Standard TV Setup

- **Recommended Method:** Program the TV's remote control for your A/V receiver and enable the Audio Lock feature. See page 74.
- Program the TV's remote control for your A/V receiver and set the control mode to **AUDIO**. Return the control mode to **TV** to control the TV.
- Use the remote control that came with the A/V receiver.

With HDMI Control (CEC-Enabled HDMI A/V Receiver)

The TV's remote control may control some functions of the A/V receiver. See Appendix C, "HDMI Control of CEC Devices," page 81.

With NetCommand IR Control

265 Series. Set up NetCommand control of the A/V receiver's volume functions in the **Inputs > AVR** menu. The TV's remote will then control A/V receiver volume. See page 68.

Picture Shape and Display Formats

Format Definitions

Note: See page 18 for use of the **FORMAT** key to apply the formats described here.

Standard: The full-screen format used by HDTV signals. Use this format to display anamorphic DVDs with a 1.78:1 or 1.85:1 aspect ratio. Anamorphic DVDs with a 2.35:1 aspect ratio are displayed correctly but with top and bottom black bars. Squarish (4:3) images are stretched evenly from side to side. Available for all signals.

Expand: Enlarges the picture to fill the screen by cropping the top and bottom; useful for reducing the letter box top and bottom bars of non-anamorphic DVD images.

Zoom: Enlarges the picture to fill the screen by cropping the sides, top, and bottom to eliminate black bars.

- **480i/480p and SD 4:3 signals:** Eliminates top and bottom bars on anamorphic DVDs with a 2.35:1 aspect ratio.
- **720p, 1080i, SD 16:9, and HD signals:** Eliminates bars added to squarish 4:3 images.

Stretch: Stretches a squarish 4:3 image across the screen to display the entire image with less distortion than the Standard format.

Stretch Plus: Similar to Stretch, but minimizes distortion on the sides by expanding the picture to crop off portions of the top and bottom. Use ▲ ▼ to adjust the vertical position of the picture.







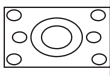
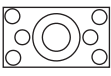

Narrow: Displays narrow 4:3 images in their original shape. Adds black side bars to fill the screen.

Wide Expand: Enlarges the picture, cropping the image on both sides. Removes or reduces black side bars added to narrow images converted to 16:9 signals for digital broadcast.

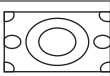
Note: All high-definition channels send wide-screen (16:9) signals, but not all programming was created for the widescreen format. The broadcaster may stretch the image or add side bars to fill the widescreen area.

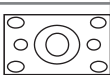
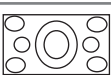
Full Native: Displays all pixels in the original image

Effect of Mitsubishi Formats on Picture Types

Original Signal ▶ TV Display Format ↓	Non-anamorphic or SD 4:3	Anamorphic DVD
Standard	 Distorted; Not recommended.	 Recommended
Expand	 Recommended for letterbox. See Note 1.	 Distorted; not recommended. See Note 1.
Zoom	 Distorted; Not recommended. See Note 1.	 Recommended for anamorphic 2.35:1 images. See Note 1.
Stretch	 Recommended for standard broadcasts. See Note 1.	 Distorted; not recommended. See Note 1.
Stretch Plus	 Recommended for standard broadcasts. See Note 1.	 Distorted; not recommended. See Note 1.
Narrow	 See Note 1	 Distorted; not recommended. See Note 1.

Note 1: Available for 480i, 480p, and digital SD 4:3 signals only.

Original Signal	Display Formats
SD 16:9 or HD Digital 720p, 1080i, 1080p Signal	Wide Expand Recommended to remove side bars.
(except 720p)	Zoom Recommended to remove bars from the top, bottom, and sides.
	Full Native Best for computer or game images (component and HDMI only)

TV Display Formats. Press the **FORMAT** key repeatedly to see different displays for the current program. Press the **INFO** key to see the name of the format in use.

DVD Image Definitions

Image information may be stated on the DVD case. Some DVDs support both formats described below.

Anamorphic (or Enhanced for WideScreen TV) Indicates DVDs recorded to show widescreen images properly on 16:9 TV sets using the TV's **Standard** format mode (recommended).

Non-Anamorphic (or 4:3, 1.33:1, Letter Box, or Full Screen)

Indicates DVDs recorded for viewing on squarish TV screens. They may be full screen (4:3 or 1.33:1) which crops movies to fit the narrow TV, or letter box, which adds black top and bottom bars.

Camera Images and Music Files

- The TV can read photo and music files from a USB device. Photos must be in JPEG format and music files must be in mp3 format. To play music files while displaying a photo slide show, see “USB Media Setup Menu” on the opposite page.
- The TV can display still images or motion video from a camera through the **Y/VIDEO** port. See page 36.
- To play music through the TV speakers from an audio-only device, see “Using an Audio-Only Device,” page 36.
- **164 and 265 Series.** The TV can play music wirelessly using *Bluetooth*® technology.

USB Source Devices

The USB Media Player Menu

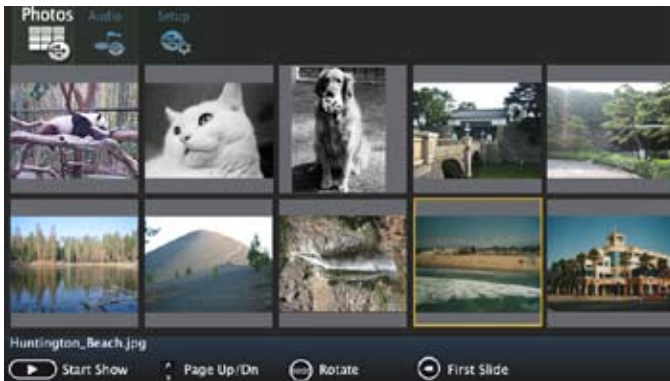

USB Media menu, Photos option selected

Displaying the Menu

1. Back up the data on your USB drive before connecting it to the TV. Mitsubishi is not responsible for any file damage or data loss.
2. Connect your USB drive to the TV's USB port.
The **USB Media Player** menu displays while files are being read. Wait until icons appear in the menu before continuing.

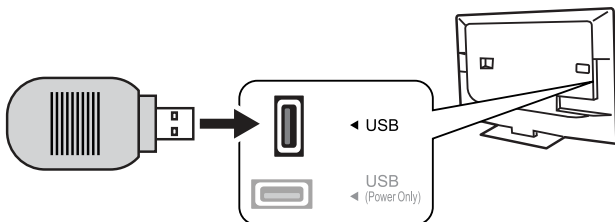

3. When the **USB Media Player** icons display, highlight one of these choices and press **ENTER**.

	Photos View photos or play a slide show
	Audio Listen to audio tracks or a playlist.
	Setup Perform setup for a slide show or playlist. If music and image files are both present, lets you play a slide show with music.

Notes on Using the USB Port

- The TV ignores all commands while reading files.
- Large files or high-capacity storage devices may take a long time to display.
- The TV can read files up to 10 MB in size with a maximum of 2,500 files stored on the device. The FAT16 or FAT32 file system is recommended.
- Use a USB drive instead of a card reader.
- Back up the data on your USB drive before connecting it to the TV. Mitsubishi is not responsible for any file damage or data loss.

Note: Some manufacturers' devices may be incompatible with the TV. If the TV is unable to display your photos, you can:

- Transfer files to a different USB device.
- Use your digital camera's composite video output. See page 36.

Picture Files Compatible with the USB Port

- Still images recorded on digital cameras using the Exchangeable Image File Format, version 2.1 (EXIF 2.1) standard for digital still cameras and Design Rules for Camera File Systems version 1.0 (DCF 1.0)
- Some images opened and resaved on a computer may not play back or may not display in the thumbnail list. This happens if the files were resaved in an incompatible format.
- Full path file names can be no longer than 50 characters and must end in a .jpg extension. Only the first 20 of the 50 characters will display.

The TV can read JPEG files as created by the camera. If you edit a picture file on a computer and resave the image, the TV may be unable to read the resaved file.

Camera Images and Music Files, continued



Using the Photos and Audio Menus

Use these keys with your photo and audio files.

Key	For Photos or Audio Tracks
	<ul style="list-style-type: none"> Moves the highlight left/right through icons to select Photos, Audio, or Setup. Moves the highlight from item to item.
or ENTER	Plays the slide show or playlist starting from the highlighted item.
	Pauses a slide show or playlist.
	Stops a slide show or playlist.
	<ul style="list-style-type: none"> Highlights the first or last item on the current page. Skips to the previous or next item during play.
	<ul style="list-style-type: none"> Displays the previous or next page of items. Skips immediately to the previous or next item during play.
GUIDE	Rotates an image clockwise in 90° increments.
INFO	Displays the item name during play. Press EXIT to clear.
EXIT	Clears file information from the screen.
MENU	Displays the main menu; stops play.
INPUT	Displays the Input Selection menu; stops play.



USB Media Setup Menu

Use the **USB Media Setup** menu to set up play of a slide show or playlist.

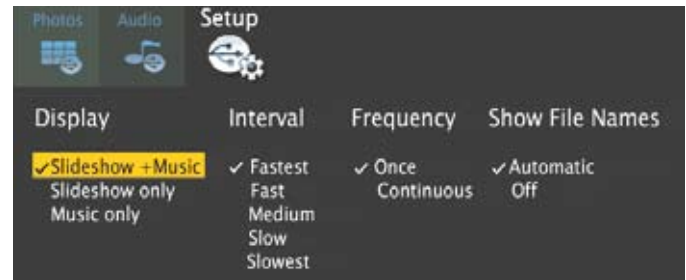

- If JPEG image files and mp3 files are both on the USB device, choose from:
 - **Slideshow + Music**
 - **Slideshow only**
 - **Music only**
- Interval.** Select the type of time interval for display of each slide. The intervals may be longer for larger files than for smaller ones.
- Frequency.** Select the number of times (frequency) to play the complete slide show and/or playlist.
- Show File Names.** Choose **Automatic** or **Off**.
- Press **EXIT** to close the **USB Media Setup** menu and return to the **USB Media Player** menu.

IMPORTANT

Always stop playback with (STOP) or change to a different TV input before disconnecting your USB device.

Camera Images and Music Files, continued

Photos and Motion Video as Composite Video

Connect the camera to the TV using a composite video cable and control the slide show or movie through the camera. The display resolution will be standard-definition (480i).

1. Refer to the owner's manual supplied with the camera for instructions needed for this setup.
2. Set the camera's output signal type to **NTSC** and put the camera into playback mode.
3. With the camera still turned on, connect your digital camera's composite video cable (usually yellow) to the TV's **Y/VIDEO** jack. To hear audio, connect the camera's audio output cable to the **AUDIO L** jack.

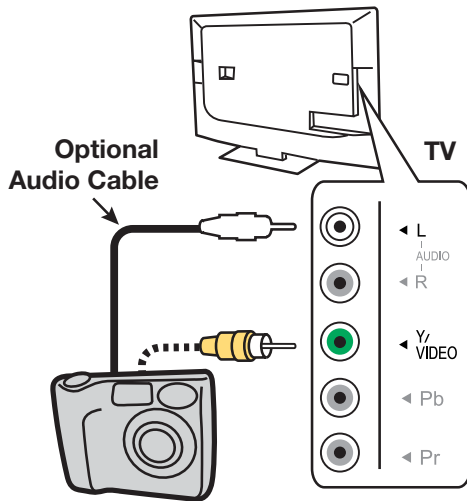

Camera connection using a composite video cable

4. When the **New Device Found** screen displays, assign the name **Camcorder**.
5. Press **EXIT** to close the **New Device Found** screen.
6. Highlight the icon for the camera input and press **ENTER**.



7. If viewing photos, control the slideshow from the camera. Advance through the images manually or check if the camera can advance automatically.

Using an Audio-Only Device

To use the TV speakers with an audio device such as an MP3 or CD player with analog output, follow these steps.

1. Insert an unused RCA-style connector into the **Y/VIDEO** jack associated with the TV's analog audio input. The presence of this connector activates the TV's auto-detection.
2. When the TV detects the **Y/VIDEO** connector, it will display the **New Device Found** screen. Name the new input **CD/Audio** or **MP3 Player**.
3. Connect left (white) and right (red) audio cables from **AUDIO OUT** on the device to **AUDIO L** and **R** on the TV.
4. Keep the connector in the **VIDEO/Y** jack while using the audio-only device.

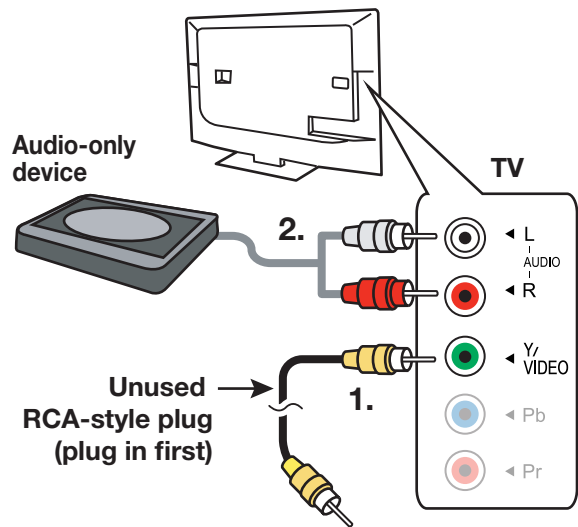

Camera Images and Music Files, continued

Wireless Audio Playback

164 and 265 Series. The TV's built-in speaker array can play audio from a handheld device using *Bluetooth*® A2DP (stereo audio) wireless technology.

Note: Make sure the TV is on any input other than the USB port before starting *Bluetooth* pairing. Press the **INPUT** key to change.

Pairing the TV with an Audio Playback Device

1. Turn on the wireless device you wish to use for playback. Turn off all other wireless devices in the area as the TV can pair with only one device at a time.
2. Press **INPUT** to display the **Input Selection** menu.

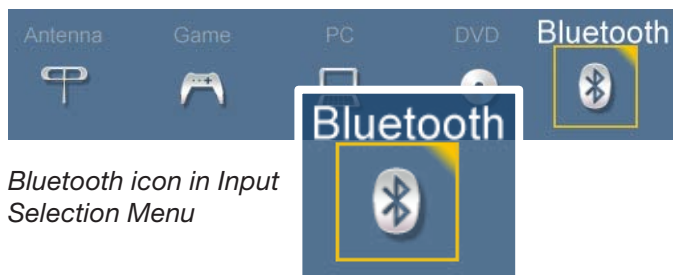

Bluetooth icon in Input Selection Menu

3. Highlight the **Bluetooth** icon and press **ENTER**.
4. Pair your device with the TV and then connect. Some devices pair and connect automatically, while others require you to enter the TV pass code displayed.
5. Use keys on the TV's remote control to control playback. Not all keys work for all devices.

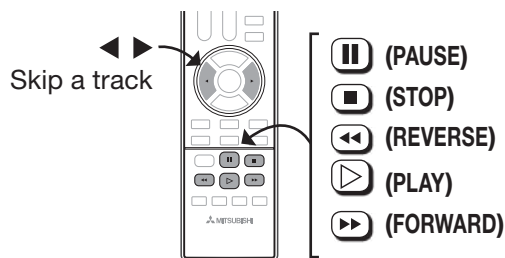

Resetting Bluetooth Pairing or Connection

Perform this reset if the audio device does not connect properly to the TV.

1. If the audio device has been previously paired with the TV, delete the TV from the device's paired list.
2. Go to the TV's **Inputs > Name** menu and highlight the *Bluetooth* icon. Press **ENTER** to select **Off**.
3. Press **EXIT**.
4. Go to the **Inputs > Name** menu and highlight the *Bluetooth* icon. Press **ENTER** to select **On**.
5. Press **EXIT**.

Tips for Wireless Playback

- Selecting the **Bluetooth** icon at a later time will connect the TV again to the paired device.
- If the paired device is not available, the TV will accept pairing from a different device.
- Once connection is lost, the TV will power off after five minutes without receiving a signal.
- To clear a paired device, turn off the **Bluetooth** icon (**Inputs > Name** menu) or pair the TV with a different device.
- To remove the **Bluetooth** icon from the **Input Selection** menu, turn off the icon in the **Inputs > Name** menu.



Remove the Bluetooth icon from the Input Selection menu by turning off Bluetooth in the Input > Name menu.

Sound Projector

This setup is unnecessary if using the TV speakers as a center channel. See page 28.

Sound Projector Technology

The TV's built-in speaker array can be adjusted to reflect sound off the room walls to create a surround sound effect. Setup can be performed either manually or automatically.

- To create the surround sound effect, the room walls must reflect sound and not be covered with sound-absorbent material.
- Repeat the setup procedure if you reconfigure the room's walls or furnishings.

Before You Begin

Positioning the TV

- Center the seating area in front of the TV and at least six feet away from it.
- Arrangements that give good results:

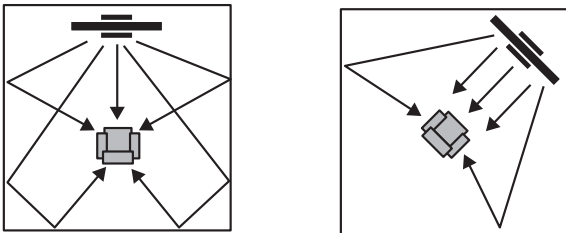

- If the room is an odd shape, locate the TV to take best advantage of wall reflections.

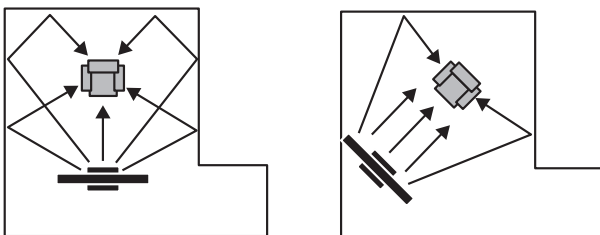

- Avoid locations that may distort sound reflections.

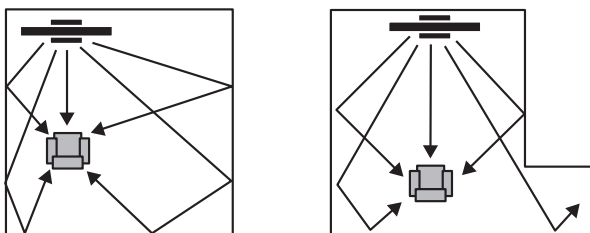

Connecting the TV

To hear digital surround sound, the TV must be connected to a digital surround sound source. The TV can receive digital surround sound from:

- Any HDMI jack
- The **ANT** input (from some digital broadcasts)

Other stereo connections will provide Dolby Pro Logic surround sound.

Basic Manual Setup

Note: **265 Series.** If you have already performed Auto setup, do not make manual adjustments. Doing so will erase all settings created during Auto setup.

- Press **MENU** and go to **Sound > SoundPro**.

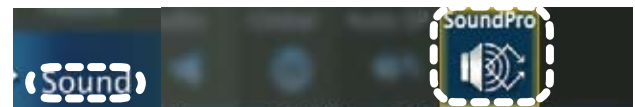

- Enter the room dimensions and layout information requested in the screen. To change measurements, press **▲▼** or enter numbers on the remote control's keypad.



- Press **EXIT** to exit and save settings.
- Play some sample audio to check sound quality. If further adjustment is needed, use the **Custom** menu as described next.

Custom Menu

Use the **Custom** menu after defining the room layout.

For a room with large areas of curtains that might affect sound reflection, do the following:

- Open the curtains fully to improve sound reflection.
- Set angles by performing the procedure in "Adjusting Beam Angles."
- Close the curtains.
- Set levels by performing the procedure in "Adjusting Levels."

Sound Projector, continued

- From the **Sound > SoundPro** menu go to the **CUSTOM** menu.

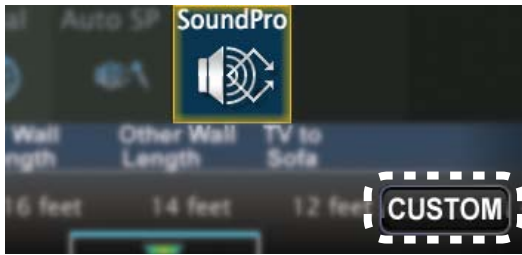

- Position yourself in your usual viewing location. Remain in this position, looking at the TV, while making the following adjustments.
- Adjusting Beam Angles**
 - Adjust **Center Beam Angle** until sound is about equal in both ears.
 - Adjust **Left Beam Angle** to maximize sound heard from the front left side.
 - Adjust **Right Beam Angle** to maximize sound heard from the front right side.
 - Adjust **Left Surround Beam Angle** to where the sound seems to come from the left rear side. If this cannot be achieved, make the setting the same as that for Left Beam Angle.
 - Adjust **Right Surround Beam Angle** to where the sound seems to come from the right rear side. If this cannot be achieved, make the setting the same as that for Right Beam Angle.
- Adjusting Levels**
 - Adjust **Center Level** to the mid level.
 - Adjust the following levels one at a time so that each one sounds about the same as the center level:
 - Left Level**
 - Right Level**
 - Left Surround Level**
 - Right Surround Level**
 - Check all sound levels by quickly switching between them using **▲ ▼**.
 - Readjust individual levels in small increments and recheck as above until all sound levels seem about the same.
- Adjusting an External Subwoofer**

Note: Set **Sound > Global > Subwoofer** to **On** to make this adjustment available.

- Play sample video or music containing low-frequency bass sound.
- Press **AUDIO**. Use **▲ ▼** to display the **Subwoofer** option.
- Press **◀ ▶** to adjust the subwoofer volume.

How to Make Adjustments in the Custom Menu

- Press **▲ ▼** to select an audio beam; colors of the adjusters correspond to audio beams in the on-screen diagram.
- Press **◀ ▶** to redirect the audio beam or change the sound level.

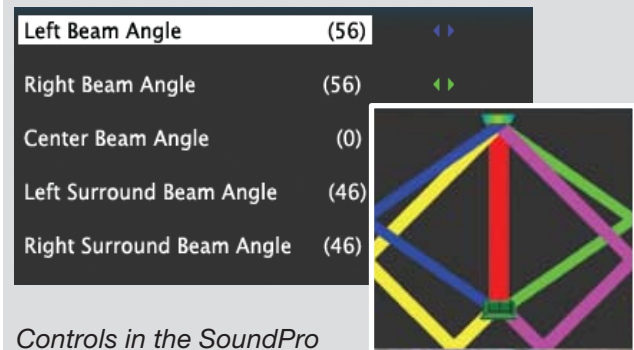

Controls in the **SoundPro > Custom** menu adjust the direction and focus of the TV's sound output.

At extreme beam angles, adjustment may be limited and the image on screen may not accurately represent the sound beams.



Adjust the volume level of individual audio beams using sliders in the **SoundPro > Custom** menu.

Resetting Angle and Level Values in the Custom Menu

Follow these steps to return settings to the default values.

- Press **EXIT** to clear all menus.
- Press **MENU**. Go to the **Sound > SoundPro** menu and press **ENTER**.
- Change any setting (e.g., **TV Location**).
- Press **EXIT** to clear all menus.
- Press **MENU**. Go to the **Sound > SoundPro** menu and press **ENTER**.
- Enter the correct values for the room layout.
- Return to the **CUSTOM** menu to adjust angles and levels.

Sound Projector, continued

Auto Setup

265 Series

Auto setup uses the included calibration microphone to optimize Sound Projector performance for most room conditions.

Initial Preparation

1. Position and connect the TV as described under "Before You Begin," page 38.
2. Power on the TV and external subwoofer, if any.
3. Plug the microphone cable into the TV's **INPUT 3** left audio jack.

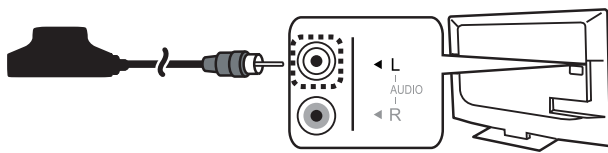

4. Place the microphone as described in the guidelines on this page.

Start Auto Setup

5. Press **MENU** and go to **Sound > AutoSP**.



6. Highlight **START** and press **ENTER**.



7. Quietly exit the room right away. The calibration sequence will start in a few seconds and may be loud. It is important to leave the room as your presence will interfere with the calibration process.
8. Wait for completion of setup before returning to the room.
9. Play some sample audio material to check the sound quality.

Note: Do not perform manual adjustments after running Auto setup, as this will erase all settings defined during Auto setup.

10. Store the microphone out of direct sunlight and away from heat.

Microphone Placement

- Make sure there are no large obstacles between the TV and microphone.
- Place the microphone
 - On a flat, level surface at least six feet away from the front of the TV.
 - On a tripod or on the backrest of your seating.
 - At the same height yours ears would be when watching TV. The height must be within 3 vertical feet of the height of the TV's speaker array.
 - Centered in front of the TV, not off to the side.

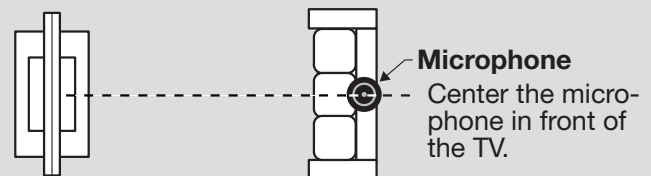
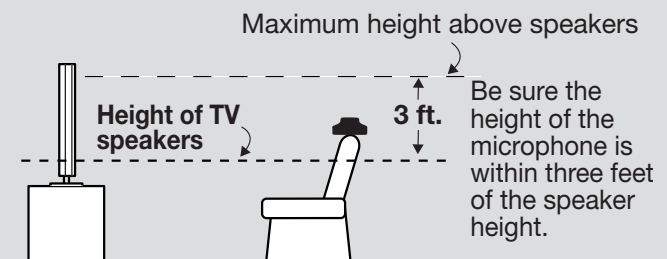
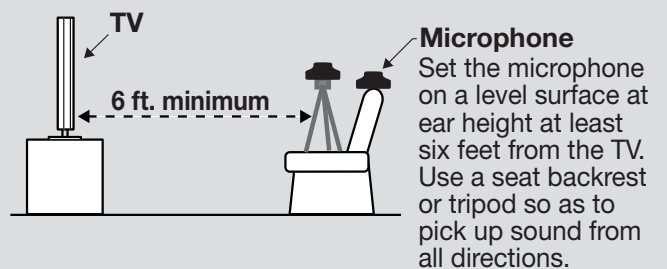

Sound Projector, continued

External Rear Speakers

You may wish to supplement surround sound from the TV with external rear speakers. External speakers can fill in rear sound if your room lacks a rear wall suitable for reflecting sound. The addition of wireless rear speakers is a convenient way to enhance rear sound. Mitsubishi recommends Polk Audio's F/X Wireless Surround system.

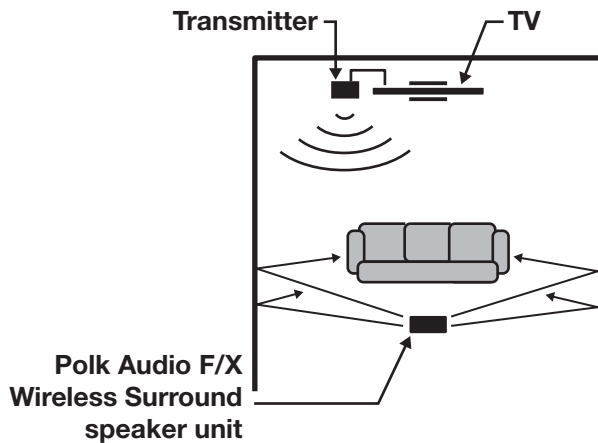

Sample room layout without a back wall suitable for rear sound reflections

1. Position the external speakers as needed for rear sound.
2. Connect analog audio output from the TV to the Polk Audio F/X Wireless Surround transmitter.
3. Power on the TV, speakers, and transmitter.
4. Set **Sound > Global > Analog Audio Out** to **Rear**.

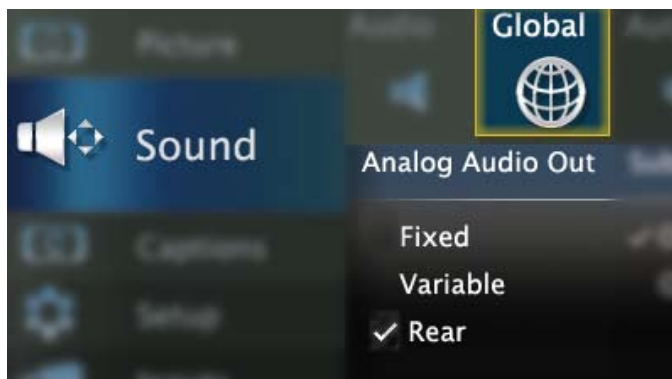

5. Adjust the sound output. Go to the **Sound > SoundPro > CUSTOM** menu. Review the instructions in "Custom Menu," page 38.
 - a. Adjust beam angles for the left, right, and center beams. Because the external speakers output left and right surround beams and they do not appear in the adjustment image.
 - b. Adjust volume levels for all audio beams., including the left and right surround beams.

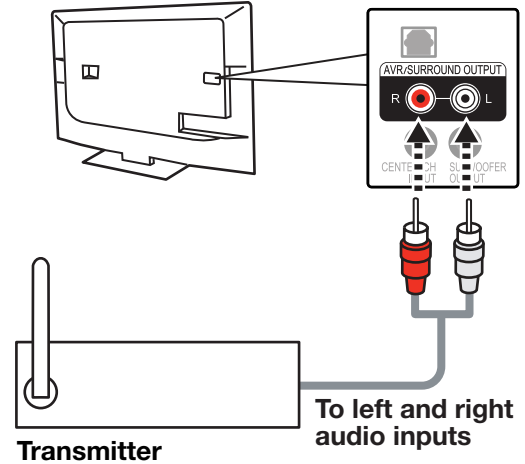

Connecting the transmitter to the TV

6. Play sample audio to check the sound. Repeat any of the adjustments as needed.

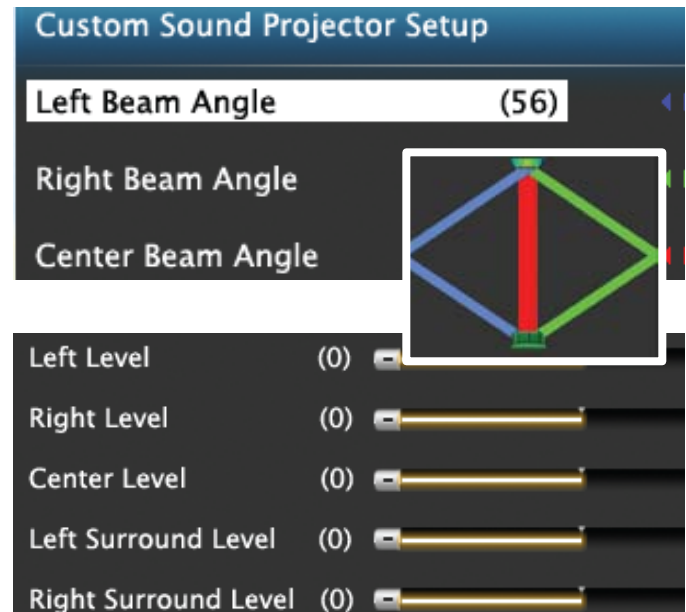

Sound Projector adjustments when using external rear speakers.

StreamTV™ Internet Media

Internet services provided by VUDU™ Apps let you access many popular on-line applications. In addition to free content, VUDU's movie service lets you buy and rent movies through the TV. Visit www.VUDU.com to learn more about available movie titles, prices, and services offered. For a list of recommended routers and switches, see the **Support > FAQ** section at VUDU.com.

Note: From time to time you may notice changes to the internet interface as new features are added.

Required for StreamTV internet media:

- Broadband internet service (at least 2 Mbps for SD, 4 Mbps for HD, and 8 Mbps for 1080p HDX)
- Ethernet cable **or** to connect a 154 series TV wirelessly, an AzureWave AW-NU231 USB wireless adapter.
- Computer access to the VUDU.com website (required for initial account activation).
- A credit card for rental and purchase transactions from VUDU's movie service.

Home Network Setup

Before using StreamTV internet media, you must connect the TV to the internet using one of these methods.

Note: Make sure the TV is on any input other than the USB port. Press the **INPUT** key to change.

Ethernet Connection

DHCP (automatic)

1. Connect the TV to your network router with a Category-5 Ethernet cable (not supplied).

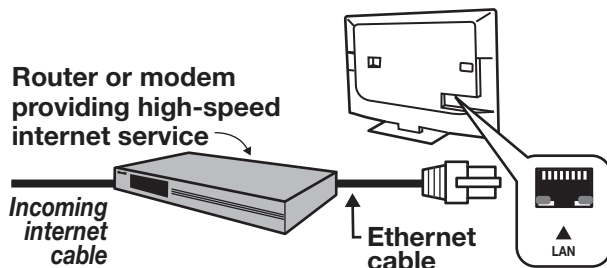

2. Open the **Setup > Network** menu to review settings.

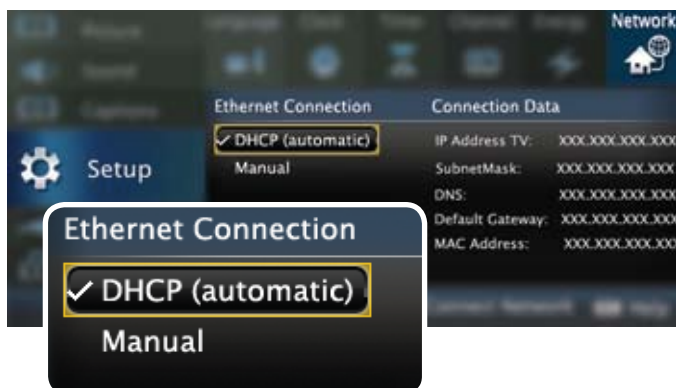

Setup > Network, DHCP connection

3. Press **EXIT** to clear the menu.

Manual

Note: Manual setup is available only for a wired connection.

1. Connect the TV to your network router with a Category-5 Ethernet cable (not supplied).
2. In the **Setup > Network** menu, highlight **Manual** and press **ENTER**.
3. Press **▶** to move to the **Connection Data** area.
4. Input the connection data.
5. After entering connection data, press **ENTER** to connect.
6. Change any of the following if needed:
 - Default Gateway
 - DNS
 - Subnet Mask

StreamTV™ Internet Media, continued

Wireless Connection

- **164 and 265 series** models have built-in wireless capabilities and can communicate directly with your wireless router.
- **154 series** TVs require an AzureWave AW-NU231 USB wireless adapter.

1. Disconnect the Ethernet cable if present.
2. For a 154 series TV, connect the USB wireless adapter.

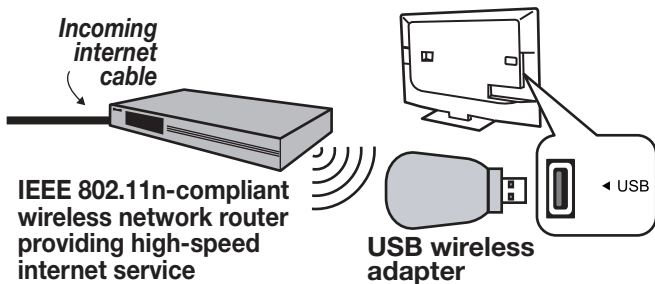

154 Series TV. A USB wireless adapter is required for wireless connection.

3. Open the **Setup > Network** menu. After a few moments, detected networks will appear listed on the screen in order of signal strength.



Setup > Network menu, manual connection

4. Highlight the desired network and press **ENTER** to connect. A check will appear next to the connected network. Press **CH/PAGE** to see more networks if the list fills more than one screen.



Setup > Network menu after connecting. The active network is checked and connection data displays.

5. If connecting to a secure network, enter the network key or password when prompted. Special remote control keys you may need:

Key	Use for
1	Digit 1 and special characters !@#\$%^*_ - += . SPACE ?
CANCEL	<ul style="list-style-type: none"> • Clears the password box of an old entry from a prior session. • Deletes one character during password entry.
LAST	Toggles between upper and lower case

6. Press **ENTER** to connect.

Note: If you notice interference from the TV's internal wireless components, turn off the TV's transmitter. Open the **Setup > Network** menu. Select **Off** and press **ENTER**.

To reconnect later, open the **Setup > Network** menu, highlight the network, and press **ENTER**.

StreamTV™ Internet Media, continued

Using StreamTV Internet Media

1. After establishing internet connectivity as described in “Home Network Setup,” page 42, switch the TV to any input other than *Bluetooth*® or USB.
2. Press the **INTERNET** key to display services from VUDU Apps.
3. Press **ENTER** to launch an application.

Getting Started with VUDU Movies

1. After establishing internet connectivity as described in “Home Network Setup,” page 42, switch the TV to any input other than *Bluetooth*® or USB.
2. Press the **INTERNET** key to display services from VUDU Apps.
3. Select the VUDU movie service.
4. Browse the VUDU movie catalog and offerings.
5. When you are ready to rent or buy a movie, you will be prompted to activate your VUDU account. Follow the on-screen instructions and use a computer to go to **www.VUDU.com/activation**. A credit card is required for activation.

Once your account is activated, you can rent and buy movies using only the TV and the TV’s remote control.

Troubleshooting

If You Are Unable to Connect to the Internet

- Check all power and data connections.
- If you can reach the internet with a computer or other device on the same internet service used by the TV, consult the router or modem owner’s guide for reset instructions.
- If you cannot reach the internet, contact your service provider. You may be asked for network information such as the TV’s IP address. Go to the **Setup > Network** menu to see connection data.

For Further Assistance

- If you are having trouble connecting your TV or accessing internet applications, contact Mitsubishi Customer Care at 1-800-332-2119.
- If you are having difficulty with your VUDU account, contact VUDU Customer Care at www.VUDU.com/support.
- See more troubleshooting tips in Appendix E.

Using VUDU Apps and VUDU Movies

Navigate VUDU’s menus with the keys on the TV’s remote control. Browse the movie catalog, watch movie previews, set parental controls, and rent or buy movies.

CANCEL. Acts like the backspace key during text entry.

ENTER

- Selects a menu item.
- Launches an application from the VUDU Apps menu.
- In VUDU’s movie service, use during video playback to see options.



- Directional navigation
- In VUDU Apps, press ▲ ▼ to display more applications.

GUIDE. In VUDU’s movie service, returns to the VUDU home menu.

INFO. In VUDU’s movie service, works like the VUDU **MORE** key. Displays more options for the current selection if available.

F2. Displays the VUDU system menu if available.

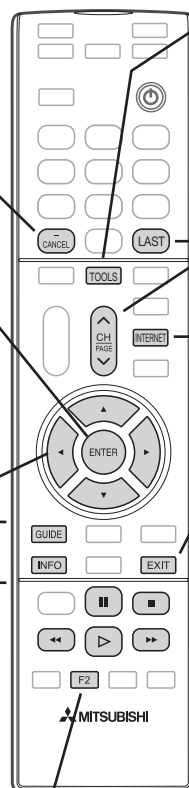

TOOLS. Use the **Tools** menu to perform A/V reset while in VUDU movies or some VUDU Apps.

LAST

- Goes to the previous screen.
- Stops video playback and returns to the previous menu.

CH/PAGE. Jumps to the previous or next page of menu items.

INTERNET. Displays the VUDU Apps internet menu. Switch the TV to any input other than *Bluetooth*® or USB before connecting to the internet.

EXIT.

- Depending on context:
- Closes the internet menu.
- Goes to the VUDU home page.

In VUDU’s movie service:

PLAY/PAUSE

Starts or pauses video playback.

FAST FORWARD/REVERSE

- Press to search scenes forward or back.
- Press additional times to speed up search.
- Press opposite key to slow and pause search.

STOP

Stops video playback and returns to the previous menu.

For assistance call 1(800) 332-2119

Introduction to Home-Theater Control

This TV offers a choice of home-theater-control systems. This summary offers some examples of the control methods available using the **TV's remote control**. You may wish to use one or more of these methods in your home theater after completing Auto Input Sensing.

Source device connected directly to the TV

Remote Control Programming (Any Connection Type)

Program the remote control to operate the A/V device. To control the device, set the remote control to the correct mode for the device type. See Appendix A, "Programming the Remote Control." In the case of an A/V receiver, use the Audio Lock feature, page 74.

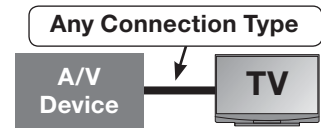

CEC-Enabled HDMI Device (HDMI Connection Only)

See Appendix C, "HDMI Control of CEC Devices," page 81.

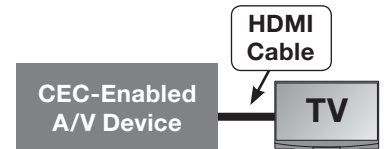

265 Series. NetCommand IR Control (Any Connection Type)

Set up NetCommand IR control of the device's keys as desired. See "IR Emitters," page 61, and "Initial NetCommand Setup," page 62.

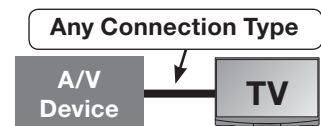

Source device connected to an A/V receiver connected to the TV

CEC-Enabled HDMI A/V Receiver

The TV's remote control may operate some functions of a connected A/V device. You can switch to the device by selecting its icon in the TV's **Input Selection** menu. See Appendix C, "HDMI Control of CEC Devices," page 81.

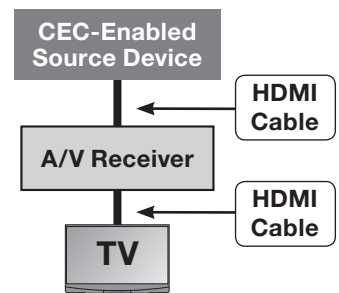

265 Series: A/V Receiver with HDMI Output (no CEC)

1. Set up NetCommand IR control of the **A/V receiver's** keys as desired. See "IR Emitters," page 61, and "Setting Up A/V Receiver Control," page 68.
2. Set up NetCommand IR control of the **source device's** keys as desired. See "NetCommand Control of a Device Connected to an HDMI A/V Receiver," page 71.

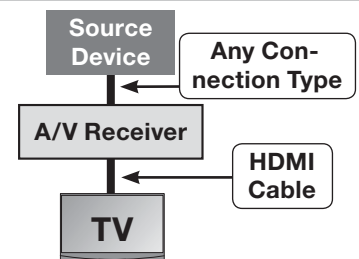







4

TV Menus

Main Menu

Press **MENU** on the remote control to open the main menu.

	Picture	Picture settings.	46		Setup	Basic TV setup.	52
	Sound	Sound settings.	49		Inputs	Name assignments for TV inputs, HDMI Control setup 265 Series . NetCommand IR “learning.”	55
	Captions	Closed captions on/and off; caption displays.	51		Lock	Setting a pass code and restrictions TV use. Disabling the control-panel buttons.	57

 **Picture**

Assign a name to the TV input before making video adjustments (use the **New Device Found** or **Inputs > Name** menu). Adjustments will be reset to the defaults if you rename the input after making adjustments.

Picture **Video**

Settings in this menu are saved for the current input only.

To make Video adjustments while watching TV and without using the menu:

1. Press the **VIDEO** key.
2. Press **▲▼** to select a video option.
3. Press **◀▶** to change the setting.

Picture Mode	Brilliant	For use under bright light; unavailable when the current input is named Game or PC .	Set the Picture Mode first before changing other video settings, as some settings are stored independently for each Picture Mode. Use Picture Modes to get the best image under different viewing conditions.
	Game	Optimizes picture and video processing for gaming consoles. Available only when the name of the input is Game or PC .	
	Bright	For most daytime viewing and x.v.Color sources	
	Natural	For most nighttime viewing and x.v.Color sources	
	Special	Advanced Modes. Contact your professional installer for setup or see page 48.	
	ISF Day, ISF Night	164 series: Special/ADV 265 series: ISF Day/ADV1, ISF Night/ADV2	



Picture, continued

Contrast	<ul style="list-style-type: none"> Low contrast shows a variety of shades in darker images In most home lighting situations, medium contrast looks best. High contrast shows darker images more uniformly black and makes colors appear more vibrant. High contrast is good for brightly lit environments. 	Adjusts the white-to-black level. Settings are stored independently for each Picture Mode.	
Brightness	Adjusts overall picture brightness. Settings are stored independently for each Picture Mode.		
Color	Adjusts overall color intensity from monochromatic to fully saturated.		
Tint	Adjusts the red-to-green ratio.		
Sharpness	Adjusts picture detail and clarity.		
Color Temp	High	Gives white images a cool cast. May provide the most realistic picture under bright lighting.	Adjusts the white balance. Settings are stored independently for each Picture Mode.
	Low	Gives white images a warm cast. Natural/Color Temp at the low setting displays video at approximately the 6500K industry standard for NTSC pictures.	
Video Noise	High, Medium, Low, Off	<ul style="list-style-type: none"> High. For poor-quality signals. Medium. For moderate noise reduction. Low. For good-quality signals. Off. Leaves the picture unaltered. 	Reduces minor noise (graininess) in the picture.
EdgeEnhance (164, 265 series)	On, Off	EdgeEnhance™ adds special edge enhancements to make the image appear sharper.	
DeepField Imager (164, 265 series)	On, Off	DeepField™ Imager dynamically enhances black levels in portions of the screen to provide strong contrast with detail over mixed screen content.	
	Demo	For comparison, displays a split picture to show On (right side) and Off (left side).	
Backlight	Adjusts peak brightness of the backlight. Applies uniformly to all inputs. Press ENTER to turn the backlight on or off.		

Picture > Picture+ (Picture Plus)



Screensaver	On, Off	Select On to display a screensaver pattern while playing an audio-only input. To use this feature, the input must either <ul style="list-style-type: none"> Be named as an audio source (e.g., CD, MP3 Player, Bluetooth) or Be the antenna input tuned to an audio-only signal.
Film Mode	Auto, Off	480i and 1080i signals only. In Auto , the TV automatically detects and applies film-decoding correction to movies filmed at 24 frames per second. Try the Off setting if images show many jagged edges. Setting saved by input.



Picture, continued

True 120 Hz (154, 164 series)

True 240 Hz (265 series)

When active, reduces motion blur in action scenes but may show pixel structure during slower motion or in still images. Works in conjunction with Film Mode. The adjustment side of the screen only shows changes if the content was a film source shot at 24 frames per second.



Press ◀ ▶ to make adjustments.

Test Picture

Displays a test picture.



Picture > Reset



- Resets sound and picture adjustments for the current input. Highlight the **Reset** icon and press **ENTER** twice to perform reset.
- **Reset** has no effect on universal settings (**Balance, Listen To, Language**) or on **Advanced** picture settings.

Picture > Perfect



(PerfectColor, 265 series)

PerfectColor Sliders Adjusts the saturation (intensity) of six colors for the current image source.

PerfectTint Sliders Adjusts six hues for the current image source

Using PerfectColor:

Highlight the Perfect icon and press **ENTER** to display the **PerfectColor** menu. Settings are retained independently for each TV input.

Using PerfectTint:

- To switch between PerfectColor™ and PerfectTint™ adjustments, highlight **PerfectColor/PerfectTint** and press ◀ ▶.
- Press ▲ ▼ to move from one color bar to the next.
- Press ◀ ▶ to change settings.
- Press **CANCEL** to restore default settings.
- Press **MENU** to return to the main menu.

Picture > Advanced (164 and 265 series)



Picture > Advanced allows you to save highly customized picture adjustments for each input. **Mitsubishi recommends these adjustments be made only by a trained professional installer.**



1. Press **MENU**. Under **Picture**, highlight the **Advanced** icon and press **ENTER**.
2. With **Picture Mode** (the first option) highlighted, press **ENTER** to change from blank (undefined) to **ADV**.
265 Series: Choose **ADV1** (daytime settings) or **ADV2** (nighttime settings).
3. Use ▲ ▼ to highlight an option you wish to change and press **ENTER** to see the adjustment display.
4. Press ◀ ▶ to change settings.
5. Use ▲ ▼ to navigate to additional options and press ◀ ▶ to change settings.
6. Press **MENU** to return to the **Picture > Advanced** menu and save the adjustments for the current input. Press **EXIT** to close the menu..

To use the custom Picture Mode at a later time

Press **MENU** and go to **Picture > Video > Picture Mode** and:

For assistance call 1(800) 332-2119



Picture, continued

164 Series <ul style="list-style-type: none"> Select SPECIAL if settings were saved by your professional installer. Otherwise select ADV. 	265 Series <ul style="list-style-type: none"> Select ISF Day or ISF Night if settings were saved by your professional installer. Otherwise select ADV1 or ADV2.
--	--

To return to the default values for Advanced

Display the **Picture > Advanced** menu and:

164 Series Highlight RESET Pic Mode and press ENTER .	265 Series <ol style="list-style-type: none"> Highlight the Advanced mode to change. Highlight RESET Pic Mode and press ENTER. You must perform the reset separately for both ADV1 and ADV2 <p>Note: Custom ISF Day and ISF Night settings made by your professional installer are locked for protection and cannot be reset by this method.</p>
---	---



Sound

Sound Audio



Settings in this menu are saved for the current input only with the exception of **Balance** and **Subwoofer**, which apply to all inputs.

To make Audio adjustments while watching TV and without using the menu:

- Press the **AUDIO** key.
- Press **▲▼** to select an audio option.
- Press **◀▶** to change the setting.

TV Speakers	On	Turns on the internal TV speakers.
	Off	Turns off the internal TV speakers so you hear sound only from a connected A/V receiver. Note: When you disconnect an A/V receiver, be sure to change the Sound setting to TV to hear sound from the TV speakers.
	Center	Makes the TV's speaker array act as a center channel. See "Using the TV Speakers as a Center Channel," page 28. Notes: <ul style="list-style-type: none"> Set Sound > Global > Center Channel to On to make this setting available. To de-activate the center channel, change this setting to On or Off.
Bass	Controls volume of low-pitched sound from the TV speakers.	
Treble	Controls volume of high-pitched sound from the TV speakers.	
Balance	Controls audio balance between the right and left TV speakers	
Subwoofer	[Subwoofer level adjustment]	Adjusts the volume level of a connected subwoofer. Note: Set Sound > Global > Subwoofer to On to make this adjustment available.



Sound, continued

Sound Mode	Stereo	No special audio effects from the TV speakers
	Surround	Modifies audio from the TV speakers. <ul style="list-style-type: none"> For monaural (non-stereo) programs, creates a simulated stereo effect. For stereo programs, creates a simulated surround sound effect. The TV's speaker array plays surround sound if available.
	Music	Optimizes the TV's speaker array for music listening.
	Night	Focuses the TV's speaker array to a single point to limit sound heard by others outside the room. Press ENTER to adjust the focal point (Night Angle).
Level Sound	On, Off	Reduces differences in sound volume between programming segments, such as the difference between regular broadcast programs and commercial segments.
Listen To (applies only to analog channels from the ANT input)	Stereo	The TV plays stereo broadcasts in stereo and mono broadcasts in mono. The word Stereo is displayed when you tune to a channel broadcasting in stereo.
	Mono	Reduces background noise. Use when receiving a weak stereo audio signal. All audio is played as mono.
	SAP (Second Audio Program)	Selects an additional monaural sound track not audible during normal TV viewing. The SAP signal might be related to the program (such as a sound track in a foreign language), or it might be unrelated (such as a weather report). If an SAP signal is broadcast, the letters SAP are displayed when you tune to the channel.

Sound Global



Settings in this menu apply to all inputs.

Analog Audio Out

These settings affect audio from the **AVR/SURROUND OUTPUT** jacks.

Fixed	Use with an analog A/V receiver. Control volume from the A/V receiver. The volume of the audio output signal is fixed and is unaffected by the TV's volume control.
Variable	Use with headphones. Adjust headphone volume using the TV's volume controls. When set to Variable , the audio output signal is adjustable from the TV's volume controls.
Rear	Sends left and right rear audio to external speakers. Use when supplementing the TV's speaker array with external rear speakers. See "External Rear Speakers," page 41.

Subwoofer Select **On** to turn on audio to a connected subwoofer. Set to **Off** if no subwoofer is connected.

Center Channel **On** allows the TV's speakers to complement your external sound system as a center channel. Set to **Off** if not in use.

Sound Auto SP



265 Series. Performs auto calibration of the Sound Projector speaker array. See "Auto Setup," page 40.

Sound SoundPro



Lets you set up the Sound Projector speaker array manually. See page 38.

 **Captions**

Captions on Digital Channels

The TV can decode captions from the **ANT** input only. Broadcasters can send up to six different captioning selections or can send analog captions for a program that originated in analog format. A TV station may broadcast only one or two types of captions or none at all.

Captions on Analog Channels

The TV can decode captions from the **ANT** input and the composite **VIDEO** jacks. Broadcasters can send either standard closed captions or text service. Standard closed captions follow the dialogue of the program and display in a small section of the screen. Text-service closed captions often contain information such as weather or news and cover a large portion of the screen.

IMPORTANT

- Analog text-service options display a large black or gray box on the screen when no caption signal is being broadcast.
- The content of captions is determined by the broadcaster. If captions show strange characters, misspellings, or odd grammar, it is not a malfunction of the TV.
- Closed-caption signals are not available through HDMI or component jacks. See the menus for devices connected to these inputs for closed-caption decoding.

Captions Services



Service	On if Mute, On, Off	On if Mute: Displays digital closed-caption signal Caption 1 (digital) or CC1 (analog) when audio from the TV speakers is muted. While watching TV, press MUTE to turn closed captions on/off.
Digital	Caption 1–Caption 6	Caption signals sent by the broadcaster.
Analog	CC 1–CC 4 Text 1–Text 4	<ul style="list-style-type: none"> • CC 1–CC 4. Standard closed-caption signals • Text 1–Text 4. Text-service signals

Captions Font



Style	As Broadcast or choice of font styles (digital captions only)	As Broadcast changes settings to those selected by the captions provider, or, if none, to the TV's own caption defaults. Use one of the font styles to give digital captions a custom appearance.
Size	Large, Medium, Small	Large is recommended.

Captions Color



Font	White, Black, Magenta, etc.	Recommendations for digital captions: <ul style="list-style-type: none"> • A white font on a black translucent background makes an easy-to-read combination. • Use contrasting colors for captions and background.
Opacity	Translucent, Opaque, Flashing, Transparent	
Background	White, Black, Magenta, etc.	
Opacity (Background)	Translucent, Opaque, Flashing, Transparent	

 **Setup**
Setup **Language**

Menu	English Spanish	Displays on-screen menus in either English or Spanish.
Antenna Digital Audio	Selects the current language for a digital program from the ANT input. Each digital program may include up to seven language choices or there may be no language choice offered.	

Setup **Clock**

Set the TV clock to:

- Use the TV Timer to power on the TV automatically at a preset time
- Receive correct updates to ChannelView listings

Note: When the Daylight Saving Time change occurs, you must open this menu and set the TV's clock ahead or back.

Time	Highlight the Clock icon and press ENTER or ▼ to highlight the time. To edit time and date:	
	<ul style="list-style-type: none"> • Press ENTER to select the item to change. 	
Date	<ul style="list-style-type: none"> • Press ▲▼ to change values. Press ENTER to confirm entries. • Press ◀▶ to move to another column. 	
Time Zone	Eastern, Central, Mountain, Pacific , etc. The correct time zone is required for accurate ChannelView updates.	
Daylight Savings	Off, On	Select the setting for your area (required for accurate ChannelView updates).

Setup **Timer**

The Timer tells the TV to power on automatically at a time you set. Use this menu to set a day, time, input, and channel for the Timer. If the TV is already on at the set time, the TV will automatically change to the designated channel or input.

- The TV clock must be set before you can use the Timer feature.
- As a reminder that the TV Timer is set, the TV **POWER** indicator flashes slowly while the TV is powered off.
- When the Timer turns on the TV, press any key on the remote control to keep it from turning off after five minutes.

Timer	On, Off	Select On to enable the Timer.
Day	Daily, Mon-Fri , (every) Sunday , (every) Monday , (every) Tuesday , etc.	Select the day or days of the week for the Timer to turn on the TV.
Time	To set the time for the TV to come on:	
	<ol style="list-style-type: none"> 1. Highlighted the time and press ENTER. 2. Press ▲▼ to change values. Press ENTER to confirm entries. 	
Device	Ant, DVD, VCR , etc. Select the input you want displayed when the TV comes on. Choose from the defined and enabled inputs that appear in the Input Selection menu.	
Channel	If the source is the ANT input, press ▲▼ to select a channel number or press and hold to scroll quickly.	



Setup, continued

Setup Channel



Ant Air, Ant Cable

All Channels, New Only

Scan

You must perform a channel scan to receive digital channels. The scan searches for broadcast channels and adds them to TV memory. To start channel scan:

1. Highlight one of the input selections based on your connection to the **ANT input**:
 - **Air** when connected to an indoor or outdoor antenna.
 - **Cable** when connected to direct cable (no cable box)
2. Select the scan type.
 - Select **All Channels** for an initial scan or after moving the TV to an new area with a different channel line-up.
 - Select **New Only** to search for channels newly broadcasting since the previous scan.
3. Press **▶** to highlight **SCAN**.
4. Press **ENTER** to start channel memorization.

See below for additional notes on Scan.

Edit

After channel scan, **Edit** lets you add and delete memorized channels. Memorized channels are those you can tune using the **CH** key. Edit the channel list to limit tuning to channels you watch.

- Press **CH/PAGE** to jump to the next or previous page of channel numbers.
- Press **▲ ▼ ◀ ▶** to move through all channel numbers, one at a time.

Adding/Deleting Channels Using the Channel Edit Menu

- Channels marked with a check are in memory.
- To add or delete a channel from memory, highlight the channel number and press **ENTER**.
- To add a single digital channel not in the list, see the notes under **Scan** on this page.
- Digital channels are listed by virtual channel number with the physical channel number shown in small gray text.
 - **Virtual Channel Number** (digital channels only).
A channel number sent by a local broadcaster.
 - **Physical Digital Channel Number.** The channel number officially assigned to the actual broadcast frequency; shown on screen in gray text.

Notes on Scan and Channel Memorization

- Channel memorization may take up to 15 minutes to complete.
- To stop channel memorization before completion, press **CANCEL**. Channels already added are retained.
- When watching TV, press **CH** to move through memorized channels. Press and hold **CH** to speed through channels.
- To add a digital channel that does not appear in the **Edit** menu without performing channel memorization:
 1. Look up the physical channel number for the new digital channel. See the website www.antennaweb.org for help.
 2. Press **INPUT** and select the **ANT** input.
 3. Use the number and **CANCEL** keys to enter the physical channel number followed by “-1” and **ENTER**. For example, for physical channel 36,

3 6 CANCEL 1 **ENTER**.

 The TV will search for a digital channel on the channel 36 frequency. When it finds the channel, it will:
 - a. Add the channel to memory.
 - b. Change the channel number to the virtual channel number sent by the broadcaster.
 - c. Add to memory any associated sub-channels.
- Rememorize channels if you move the TV to a different geographic area with a different channel line-up.

**Setup, continued****Setup****Energy**

Blue Glow. (265 series). Select **On** to see blue accent lighting when the TV is powered on.

Setup**Network**

See “Home Network Setup” on page 42 for use of this menu.

Ethernet Connection**DHCP (automatic), Manual****[Connection Data]****Wireless Connection****[Network ID]****[Connection Data]**

Off. Turns off the radio receiver. Use this option if there is RF interference with other devices.

 **Inputs**
Inputs **Name**

INPUT and HDMI jacks:
Cable box, Cam(corder), CD, DVD (DVD, DVD2, Blu-ray), DVR, Game (Game, PS, Xbox, Wii), Media Box, PC, Satellite, AVR On/Off (ANT, Bluetooth only)

INPUT jacks only:
CD/Audio, MP3 Player, VCR

HDMI jacks only:
PC, AVR, Delete

- Lets you assign or change names of inputs appearing in the **Input Selection** menu. Highlight an input and press **ENTER** multiple times to cycle through the name choices.
- Lets you turn the **Ant** and **Bluetooth** inputs **On/Off** to display or hide them in the **Input Selection** menu; highlight the input and press **ENTER** to switch between **On** and **Off**. A paired device is cleared from memory when the **Bluetooth** icon is turned off.
- Lets you delete unused HDMI inputs from the **Input Selection** menu.
- A CEC-enabled tuner can be named either **Cable Box** or **Satellite**.
- A CEC-enabled DVD player can be named **DVD, DVD2, or Blu-ray**.

General Notes for the Inputs > Name Menu

When you change an input name and then exit the **Name** menu:

- The name is changed
- The icon in the **Input Selection** menu is changed
- Audio and video settings are changed to the defaults for the new device type.
- **265 Series:** All previous NetCommand IR “learning” for the input is erased.

Notes for HDMI devices

- **Disconnecting an HDMI device:** When you disconnect an HDMI device, the icon remains in the **Input Selection** menu until you remove it. Select **Delete** in the **Inputs > Name** menu to remove an unwanted icon for an HDMI input.

- If the **New Device Found** screen does not display as expected when you connect an HDMI device, see “Reactivating Auto Input Sensing for an HDMI Input,” page 15.
- **HDMI Control and CEC-Enabled Devices:** See Appendix C, “HDMI Control of CEC Devices,” page 81.
- **If case of CEC conflicts:** Turn off CEC signals in one of these ways:
 - Turn off the TV’s HDMI Control signals to the device (**Inputs > HDMI Control** menu).
 - Turn off each device’s internal CEC capability.
 See Appendix C for the TV’s HDMI Control or, to turn on/off a specific device’s response to CEC signals, see the device owner’s manual.

Inputs **Learn** **265 Series.** Sets up or changes NetCommand IR control of the current device. See “About NetCommand IR Control,” page 60.



Inputs **AVR** **265 Series.** Sets up or changes NetCommand IR control of an A/V receiver. See “NetCommand IR Control of an A/V Receiver” on page 67.



Inputs **HDMI Control**



On, Off Select **On** or **Off** to enable or disable the TV’s control of a CEC-enabled device. See Appendix C for use of this feature.

 **Inputs, continued****Inputs** **Order**

Lets you rearrange icons in the **Input Selection** menu.

1. Press ▲▼◀▶ to highlight an input icon.
2. Press ENTER to confirm the selection.
3. Press ▲▼◀▶ to drag the icon to the desired position.
4. Press ENTER to confirm the new position.





Inputs **Demo**

See demonstrations showcasing selected TV features.



Lock

TV Locks

	Parental <i>Lock by Program Ratings</i> Restricts access using U.S.-based ratings sent by broadcasters.
	Time <i>Lock by Time</i> Restricts TV use by time of day.
	Channel <i>Lock by Channel</i> Blocks access to the channels you specify.
	Panel <i>Lock Control Panel</i> Disables the buttons on the TV's control panel. Use this feature if small children in the home try to press buttons on the control panel.
	Other <i>Lock by Other Program Ratings</i> Restricts access using non-U.S.-based ratings sent by broadcasters.

Pass Code

Setting a Pass Code

You are prompted to enter a pass code whenever you select **Lock** on the main menu. To set a pass code for the first time:

1. Press **MENU** and highlight **Lock**. A screen prompting you for a pass code will display.
2. Input a four-digit pass code using the number keys on the remote control.
 - Press **CANCEL** to delete a number and move back one space.
 - Press **MENU** or **EXIT** to close the menu without setting a pass code.
3. Press **ENTER** to confirm the pass code.

Resetting a Pass Code

See the procedure in Appendix B.

Parental Menu

The TV comes from the factory with the rating locks turned off and with pre-set U.S. ratings TV-PG and movie rating PG. You must turn on blocking for U.S. ratings to activate these rating restrictions. Use the **Lock > Parental** menu to change the level of blocking with U.S. ratings.

Any time you change the channel or device, it may take up to five seconds for the rating restrictions to take effect.

Other Menu (Alternate Rating System)

This TV can recognize new rating systems that may come into effect in the future. The **Other** menu allows you to block digital programming when such systems come into effect. The **Start Time** and **Stop Time** options in the **Parental** menu apply to U.S.-based ratings only and do not affect alternate rating systems.

The first time you tune to a channel broadcasting an alternate rating system, the TV defaults to the most restrictive setting if the **Lock** menu > **Other Lock** option is set to **On**. Use this menu to change the allowed rating if you are unable to watch a program rated with an alternate system.

Bypassing TV Locks

- If you try to watch a blocked program or channel or the TV is locked by time, a notice will appear prompting you for a pass code. To use the TV, input your four-digit pass code and press **ENTER**.
 - To reactivate the locks after using a pass code, power the TV off and then on.
 - To reactivate only the parent ratings lock, change to a different channel or device.
- If a program is blocked, you can still use the TV without entering a pass code. Change to a channel airing an allowed program or change to another device.

Important Notes on Rating Locks

- **Parental** menu rating locks apply only to channels and signals received on the **ANT** and composite **VIDEO** jacks.
- **Other** menu rating locks apply only to digital channels received on **ANT**.
- When viewing a cable box, satellite receiver, or other device connected to the component **Y Pb Pr** or **HDMI** inputs, check the device's owner's guide for parental locks.

**Lock, continued****Lock Parental**

Lock Disables or enables blocking based on V-Chip signals and the U.S. rating system.

TV Rating Highlight the rating level you wish to change and press **ENTER** to block it (🔒) or allow it (🔓). You can apply supplemental content blocking to the age-based ratings by using the TV content categories. (**FV, D, L, S, V**)

Lock	TV Rating	FV	D	L	S	V	Movie Rating	Start Time
✓ Off	🔓 TV-Y						🔓 G	12:00 PM
On	🔓 TV-Y7	🔓					🔓 PG	Stop Time
	🔓 TV-G						🔓 PG-13	12:00 PM
	🔓 TV-PG		🔓	🔓	🔓	🔓	🔓 R	
	🔒 TV-14		🔒	🔒	🔒	🔒	🔒 NC-17	
	🔒 TV-MA		🔒	🔒	🔒	🔒	🔒 X	
							🔒 Not rated	

Movie Rating

Highlight the rating level you wish to change and press **ENTER** to block it (🔒) or allow it (🔓). You can apply supplemental blocking to the age-based ratings by using the TV content categories below.

Start Time/ Stop Time

Sets the time of day for enforcement of rating restrictions chosen in the **Parental** menu. To make rating restrictions active 24 hours a day, make **Start Time** and **Stop Time** the same.

1. Highlight the start time or stop time.
2. Press **ENTER** to start editing.
3. Press **▲ ▼** to make changes.
4. Press **ENTER** to confirm changes.

TV Program Ratings

TV Age-Based Ratings	
TV-Y	Youth. For children under 7.
TV-Y7	Youth 7 and older.
TV-G	General Audience. For the entire family.
TV-PG	Parental Guidance. Parental Guidance recommended; may not be suitable for some children.
TV-14	Adolescent 14 and older. Not recommended for children under 14.
TV-MA	Mature Audience. For adults only.
TV Content Categories	
FV	Fantasy Violence. Applies to TV-Y7 only.
D	Sexual Dialog. Applies in differing degrees to TV-PG and TV-14.
L	Adult Language. Applies in differing degrees to TV-PG, TV-14, and TV-MA.
S	Sexual Situations. Applies in differing degrees to TV-PG, TV-14, and TV-MA.
V	Violence (graphic or realistic). Applies in differing degrees to TV-PG, TV-14, and TV-MA.

Movie Ratings

G	General Audience. Designed for the entire family.
PG	Parental Guidance. Parental Guidance recommended; may not be suitable for some children.
PG-13	Parental Guidance, 13 and Older. Not recommended for children under 13.
R	Restricted. Restricted in theaters to 17 years old and older unless accompanied by an adult.
NC-17	No Children 17 or Under. Restricted in theaters to 18 years old and older.
X	Adult. Designed for and restricted in theaters to adult audiences only.
Not Rated	No MPAA rating assigned



Lock, continued

Lock Time



Blocks all use of the TV during the time period you specify. You must enter a pass code to use the TV when the time lock is in effect. After releasing the lock with the pass code, the lock does not go back into effect until the next time the TV is powered on.

Lock by Time Enables/disables **Lock by Time**.

Lock Time, Unlock Time To set the lock and unlock times:

1. Highlight the lock or unlock time.
2. Press **ENTER** to start editing.
3. Press **▲ ▼** to make changes.
4. Press **ENTER** to confirm changes.

Note: To make Lock by Time active 24 hours a day, make **Start Time** and **Stop Time** the same.

Lock Channel



The **Channel Lock** menu lists channels currently in memory (see page 53). Highlight a channel and press **ENTER** to lock (🔒) or allow (🔓) the channel. Channels locks will be cleared the next time you perform a channel scan.

Lock Panel



Off, On **On** locks and **Off** unlocks the buttons on the TV's control panel. Use this option if small children try to press TV buttons.

- To release the Panel Lock from the TV's control panel, press and hold the **INPUT** button for ten seconds. If the TV is powered off, press **POWER** after the lock releases to make the TV power on.
- To reactivate the lock, return to this menu and change the setting to **On**.

Lock Other



Other Menu Options (alternate rating system)

This TV can recognize new rating systems that may come into effect in the future. Such alternate rating systems will apply only to digital programming received on the **ANT** input.

Lock	On, Off	Enables/disables program blocking.
System	The rating system available for the channel	
Group	Rating groups available in the rating system shown on the screen. Rating groups are defined by the rating system in effect.	
Rating	Rating restrictions available in the selected rating system and group. Highlight the rating and press ENTER to check (block) or uncheck (allow) rated content.	

5

NetCommand IR Control

About NetCommand IR Control

- **NetCommand IR home-theater control is available on 265 series TVs.**
- **IR emitter cables are available for purchase from Mitsubishi.** Visit www.mitsuparts.com or call 800-553-7278 and request one of the following:
 - **242D483020** (two-ended cable)
 - **299P254020** (four-ended cable).
- NetCommand setup is optional.
- You can perform NetCommand setup for a device any time after the TV has detected the device.
- NetCommand operates by sending remote control signals from the TV to your other devices via the

IR (infrared) emitters, telling the devices to play, record, change inputs, adjust volume, change channels, or perform other functions. All this is accomplished with the TV's remote control left in TV mode.

- You may wish to use NetCommand IR control to supplement control of CEC-enabled devices.

Important Note on NetCommand

Be sure to connect the IR emitter cable to the TV and properly place the emitters so that NetCommand can control your devices.

IR Emitters

Placement

The NetCommand system uses emitters connected to the **IR–NetCommand Output** jack to control other devices such as DVD players, cable boxes, satellite receivers, and VCRs.

IR emitter cables are available for purchase from Mitsubishi. Request either part number 242D483020 (two-ended cable) or part number 299P254020 (four-ended cable).

1. Connect the plug end of the IR emitter cable to the **IR–NetCommand Output** jack on the TV back panel.
2. When the **New Device Found** screen displays, highlight **IR–NetCommand Output**.



The **New Device Found** screen displays when you connect the IR emitter.

3. Highlight **EXIT** and press **ENTER**.
 4. Position the emitter end with the emitter bulb facing the device's remote control sensor. The bulb emits infrared light in a cone-shaped pattern. Place the bulb far enough from the sensor to allow the cone pattern to reach the sensor.
- In some cases, the emitter works better facing downward from the top of the device. Experiment to find what works best.
5. Secure the emitter ends in place using double-sided tape.

IMPORTANT

Position IR emitters so that each device's sensor "sees" the signal from only one emitter. Otherwise, a device receiving signals from multiple sources (remote controls, IR emitters) may not respond at all.

6. Place any unused ends behind the devices to prevent stray signals from reaching the IR sensors.

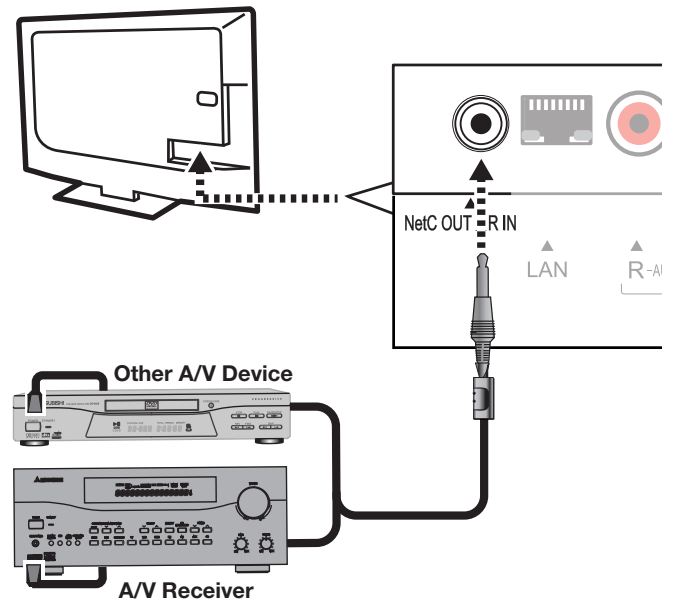

Connecting IR–NetCommand Output

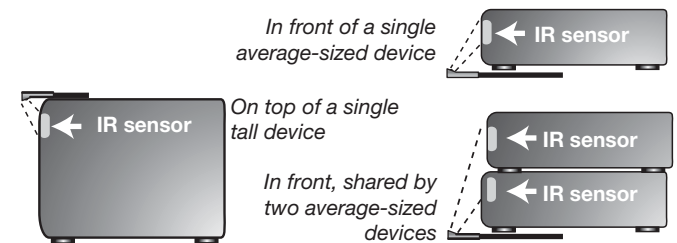

Place IR emitters so the signal can be "seen" by the IR sensor on each device.

If You are Unable to Locate a Device's IR Sensor

- The IR sensor is usually behind the plastic window of the front display panel. Using a flashlight, you may be able to see it as a round or square cutout.
- If you cannot see the sensor and the device's Owner's Guide does not specify the location, do the following using the device's remote control.
 1. Starting at one end of the plastic window, hold the device's remote control about one-half inch from the front of the device and press the **POWER** key.
 2. If the device does not respond, move the remote control one inch toward the center and try again. Repeat until the device responds.
 3. Repeat the previous steps starting at the other end of the window. The sensor is between these two points.

For assistance call 1(800) 332-2119

NetCommand Setup

Initial NetCommand Setup

To perform this procedure, you need:

- The remote controls for both the TV and the device you want to control.
- An IR emitter cable available from Mitsubishi.

Note: To set up an A/V receiver, see “Setting Up A/V Receiver Control,” page 68.

1. Connect and position the IR emitters for the devices you wish to control. See “IR Emitters” on the previous page.
2. Set the **TV’s** remote control to **TV** mode and power on the TV.

NetCommand and Device-Specific Keys

Device-specific keys are those which have no equivalent on the TV’s remote control. Use any of these methods to set up NetCommand control for these keys.

- **TOOLS** Menu. In some cases, the TV will, by default, assign a key to the **TOOLS** menu. See the table below.

Examples of Default NetCommand Assignments in the TOOLS Menu		
Cable Box, Satellite Receiver	3	MENU
	9	ON DEMAND
DVD, DVR, Blu-ray	3	SETUP
	6	TOP MENU
	9	ANGLE
VCR	3	MENU
	6	INPUT
A/V Receiver	3	MENU
	6	SURROUND

NetCommand’s default setup assigns some device-specific keys to the **TOOLS** menu when “learned.” These key functions are accessible only with the **TOOLS** key.

- **F** Keys. There are four **F** keys, **F1** through **F4**, which you can assign to any function on the device’s remote control. For a cable box, “learn” the **F** keys as the **A, B, C, D** keys.
- **Arbitrary Key Assignment.** You can assign a device key arbitrarily to any “unlearned” key on the TV’s remote control. Make a note of the key name and function for later reference.

3. Switch the TV to the desired input to control. Press **INPUT**, highlight the input icon, and press **ENTER**.
4. Open the NetCommand **Inputs > Learn** menu.
5. The first function highlighted in the **Learn** screen is always **Power On**. Aim the **TV’s** remote control at the TV and press **ENTER** to begin learning for that function.
6. When the **Power On** text starts flashing, aim the **device’s** remote control at the TV and hold the **POWER** key until a check mark appears next to **Power On**.
 - If the text stops flashing before the check mark appears, repeat the previous step.
 - To remove the key from NetCommand control, press the **CANCEL** key while the key name is highlighted.
 - To verify the device’s response to the IR code, press **ENTER** to send out the code.

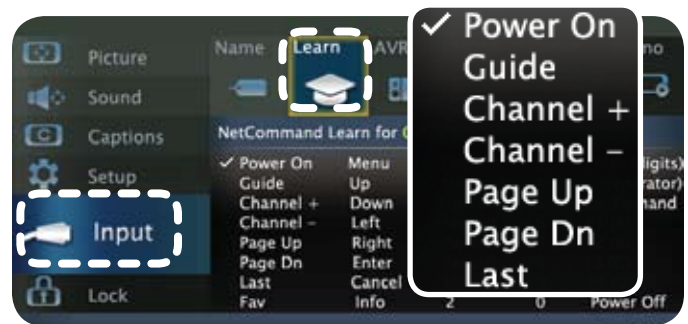

Inputs > Learn screen. Key names marked with a check have been “learned.”

*Some device-specific keys, such as **MENU**, are available only from the **TOOLS** menu after “learning.”*

7. Use navigation keys on the **TV’s** remote control to highlight other keys on the list. Repeat steps 5 and 6 for each additional function you wish to control through NetCommand.
8. If the device has a separate **POWER OFF** key, use navigation keys on the **TV’s** remote to highlight **Power Off**. Repeat the earlier steps to “learn” the **POWER OFF** key.
If the device has no POWER OFF key, skip this step.
9. Press **EXIT** to finish NetCommand “learning” for the current device.

NetCommand Setup, continued

Adding or Removing Device Keys from NetCommand Control

After performing initial setup, you can add or remove individual keys under NetCommand control.

1. Switch the TV to the device. Press **INPUT**, highlight the device's icon, and press **ENTER**.
2. Open the **Inputs** menu and highlight the **Learn** icon.
3. When the **Learn** screen displays:
 - **To add keys:** Continue as described earlier under "Initial NetCommand Setup" on the opposite page.
 - **To delete keys:** Highlight the name of the key you wish to delete and press **CANCEL** on the **TV's** remote control. Clears the check mark.

Operating NetCommand-Controlled Devices

Controlling Most Device Types

As an example of NetCommand control, if you are watching your cable box and you wish to tune to the next channel higher, press **CHANNEL UP**. NetCommand then sends the "learned" channel-up control signal to the cable box.

1. Perform NetCommand setup for the device as described in this chapter.
2. When you wish to use the device, press **INPUT**.
3. Highlight the icon for the device.
4. Press **ENTER** to switch the TV to the device.

Note: if you have set up automatic input switching for the A/V receiver, the A/V receiver will automatically switch to the correct input for the device.

5. To operate the device using the **TV's** remote control, press the **TV** key to put the remote control into TV mode.
6. Point the remote control at the **TV** (not the device) and press the key for the desired function.
7. Press the **TOOLS** key to access additional key functions you may have "learned" for the device.

Operating NetCommand-Controlled Devices, continued

Special Operation Methods

Key Name in Learning Screen	Special Operation Description and Setup	How to Use
Power On	<p>Manual Power On/Off</p> <p>Use for devices that have only one POWER key.</p>	<ol style="list-style-type: none"> 1. Press INPUT. 2. Highlight the icon for the device to be powered on or off. 3. With the Input Selection menu still displayed, press POWER to send the power signal; you may need to press POWER twice. <p>Note: If you press POWER without the Input Selection menu displayed, the TV will turn off.</p> <ol style="list-style-type: none"> 4. Press ENTER to switch the TV to the device.
Power On Power Off	<p>Automatic Power On/Off</p> <p>This feature is only for devices that have separate POWER ON and POWER OFF keys on their original remote controls. If your device does not have a separate POWER OFF key, do not use the Power Off learning position; use only the Manual Power ON/OFF method described above.</p> <p>In the NetCommand Learn screen:</p> <ol style="list-style-type: none"> a. “Learn” the Power On command in the Power On learning position. b. “Learn” the Power Off command in the Power Off learning position. 	<ul style="list-style-type: none"> • To Power On the Device <ol style="list-style-type: none"> 1. Press INPUT. 2. Highlight the icon for the device to be powered on or off. 3. Press ENTER to switch the TV to the device and NetCommand will send the Power On command to the device. • To Power Off the Device When you turn the TV off, the TV sends all learned Power Off commands to all devices.
Menu	<p>Displaying a Menu for the Current Device</p> <p>“Learn” the MENU key on the original remote in the Menu learning position.</p>	Press TOOLS and number 3 to send the menu signal to the device.
Guide	<p>Displaying the On-Screen Program Guide (cable box or satellite receiver)</p> <ol style="list-style-type: none"> 1. “Learn” the GUIDE key on the original remote in the Guide learning position. 2. Learn the PAGE UP and PAGE DOWN keys of the original remote in the Page Up and Page Down learning positions. 	<ol style="list-style-type: none"> 1. While watching the device, press GUIDE to display the guide. 2. Press PAGE to send the Page Up/Dn commands for the guide.
Enter	<p>ENTER-Key Functions (cable boxes, satellite receivers, etc.)</p> <p>Some devices have two keys that have “enter” functions. One key is for menus and is often labelled SELECT or OK. A second key is for use with number keys for direct channel selection. NetCommand uses the same ENTER key for both operations.</p> <p>When ENTER has a menu or guide function or when the original remote control uses the same key for menus and channel selection: Learn the ENTER, SELECT, or OK key in the NetCommand Enter learning position.</p>	<ol style="list-style-type: none"> 1. Press MENU or GUIDE to display the device’s menu or guide. 2. Press ENTER within the menu and NetCommand will send the Enter signal for menus.

Operating NetCommand-Controlled Devices, continued













Key Name in Learning Screen	Special Operation Description and Setup	How to Use
Enter (digits)	<p>When ENTER is for channel changes, i.e., the original remote control has a separate ENTER key for this function):</p> <p>Learn the ENTER key for channel selection in the NetCommand Enter (digits) learning position. Use this learning position only if the original remote control has separate keys for Enter in menus and Enter for channel selection.</p>	<p>Press digit key(s) and then press ENTER. NetCommand will send the Enter signal for channel selection.</p>
Cancel	<p>CANCEL as the Cancel or Exit Function</p> <p>“Learn” the Cancel or Exit function in the NetCommand Cancel learning position</p>	<ol style="list-style-type: none"> 1. Press MENU or GUIDE to display the menu or guide. 2. Press CANCEL and NetCommand will send the Cancel or Exit signal.
— (separator)	<p>The symbol “—” can serve as the separator between a digital channel’s main and sub-channel digits, e.g., digital channel 12-1 (main channel is 12, sub-channel is 1).</p> <p>“Learn” the channel separator function in the NetCommand — (separator) learning position.</p>	<p>Press digit key(s) and press CANCEL. NetCommand will send the channel-separator signal.</p>

Operating NetCommand-Controlled Devices, continued

NetCommand Specialized Device Keys

Refer to this chart when “learning” device keys. “Learn” some, all, or none of the keys used for each device type.

See page 64 for more on keys marked in the “Special Operation Method” column.

Key Name in Learning Screen	Function	Name on TV Remote Control	See Special Operation Method Table
Power On	Power On or Power ON/OFF (toggle)		✓
Guide	On-Screen Program Guide or DVD Disc Menus	GUIDE	✓
Channel +/Skip +	Next Channel Higher/Skip Forward (Disc)		
Channel -/Skip -	Next Channel Lower/Skip Backward (Disc)		
Page Up	Page Up in Guides		
Page Dn	Page Down in Guides		
Last	Last Channel Recall	LAST	
Fav	Favorites	FAV	
Menu	Menu	MENU	
Up, Down, Left, Right	Arrow up, arrow down, arrow left, arrow right	▲, ▼, ◀, ▶	
Enter	Enter or Select (menus)		✓
Cancel	Cancel or erase (menus)		✓
Info	On-screen status display or information display	INFO	Require two keypresses
Play	Start playback		
Stop	Stop playback		
Forward	Fast Forward		
Rewind	Rewind/Fast Reverse		
Pause	Pause playback		
Record	Start Recording		
1, 2, 3, 4, 5, 6, 7, 8, 9, 0	Digits	1, 2, 3, 4, 5, 6, 7, 8, 9, 0	
Enter (digits)	Use after entering digits to tune to a channel by number		✓
- (separator)	Adds digital channel separator between main channel number and sub-channel number		✓
F1	Assign your choice of specialized functions.	F1	
F2		F2	
F3		F3	
F4		F4	
Power Off	Power Off		✓

6 NetCommand IR Control of an A/V Receiver

NetCommand IR home-theater control is available on 265 series TVs. See the description of NetCommand on “About NetCommand IR Control,” page 60.

Two levels of NetCommand A/V receiver control are available through the **Inputs > AVR** menu.

- **Power and volume.** See the next page.
- **Automatic audio and video switching over HDMI.** See “Setup to Control Automatic Audio and Video Switching via HDMI,” page 70.

Note: To set up control of other device types, see “Initial NetCommand Setup,” page 62.

Controlling an A/V Receiver after NetCommand Setup

Switching Audio to and from the A/V Receiver

1. Press **AUDIO**.
2. Press **▲** to show the **TV Speakers** option.
3. Press **▶** to select either **On** (sound through TV speakers) or **Off** (sound through A/V receiver).

Controlling A/V Receiver Power

With Any Connection Type

1. Press **AUDIO**.
2. Press **▲▼** to show the **TV Speakers** option.
3. Press **▶** to select **Off**.
4. Point the remote control at the **TV** (not the A/V receiver) and press **POWER** to power the A/V receiver on or off.

With an HDMI Connection

1. Press **INPUT**.
2. Highlight the A/V receiver icon.
3. Press **POWER**.

Controlling Other A/V Receiver Functions

- With the A/V receiver powered on and selected, the TV’s remote control operates the volume and mute functions.
- If you have performed setup to control A/V receiver switching over HDMI, when you switch to a device in the **Input Selection** menu, the A/V receiver will automatically switch to the correct audio input for the device.

Note: Connect the HDMI cable between the TV and A/V receiver first before performing NetCommand setup for the A/V receiver. If you perform NetCommand setup and then later connect the cable, the NetCommand setup will be lost.

Setting Up A/V Receiver Control

Power and Volume

Perform this setup to control A/V receiver power and volume with the TV's remote control.

To perform this setup you need:

- The remote controls for both the TV and the A/V receiver.
- An IR emitter cable available from Mitsubishi.

Before You Begin

1. Connect your A/V receiver to the TV and any additional devices.
2. Connect the IR emitter cable to the TV and position the IR emitter where it can send signals to the A/V receiver. See "IR Emitters," page 61.
3. Set the **TV's** remote control to **TV** mode.

Setup to Control A/V Receiver Power and Volume

1. Open the **Inputs > AVR** menu.
2. The first function highlighted in the **AVR** screen is always **Power**. Aim the **TV's** remote control at the TV and press **ENTER** to begin learning for **Power**.

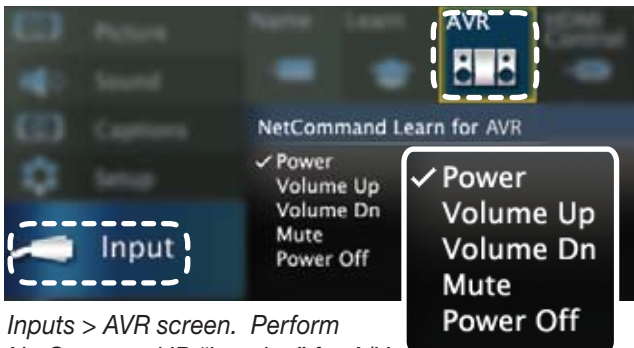

Inputs > AVR screen. Perform NetCommand IR "learning" for A/V receiver power and volume keys.

3. When the **Power** text starts flashing, aim the **A/V receiver's** remote control at the TV and hold the **POWER** or **POWER ON** key until a check mark appears next to **Power**.
 - If the text stops flashing before the check mark appears, repeat this step.
 - To remove the key from NetCommand control, press the **CANCEL** key while the key name is highlighted.
4. Press the **▼** key on the **TV's** remote control to highlight other keys in the list. Repeat steps 2 and 3 for each additional function you wish to control through NetCommand.
5. If the A/V receiver has a separate **POWER OFF** key, press **▼** on the **TV's** remote to highlight **Power Off**. Repeat steps 2 and 3 to "learn" the **POWER OFF** key. **If the device has no POWER OFF key, skip this step.**
6. When finished "learning" the power and volume keys, press **EXIT** to watch TV or continue NetCommand setup if using an HDMI connection. See "Automatic Audio/Video Switching Over an HDMI Connection" on the opposite page

Setting Up A/V Receiver Control, continued

Automatic Audio/Video Switching Over an HDMI Connection

If your A/V receiver has an HDMI output, it may be convenient to send audio and video to the TV over a single HDMI cable through the A/V receiver. The following setup enables the A/V receiver to switch automatically to the correct input when you select a device in the TV's **Input Selection** menu. The connected source devices can be analog, digital, or a mixture of the two.

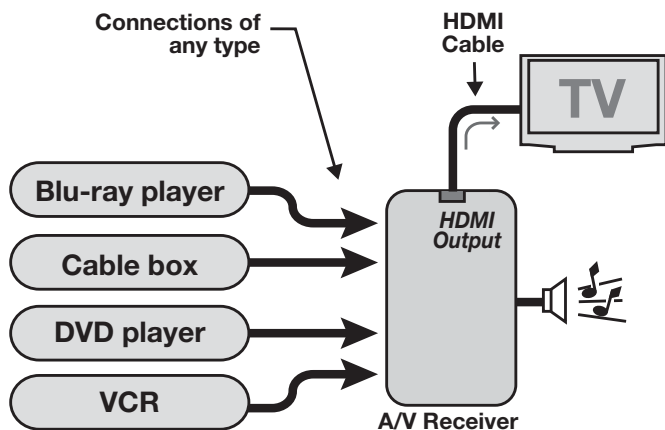

Use NetCommand to switch an A/V receiver automatically to the correct audio and video inputs for a device (available only with an HDMI output to the TV as shown).

More About Using an HDMI Connection

- Audio from devices connected directly to the TV can be heard from the TV speakers only. To send audio to the A/V receiver from such devices, use one of the optional audio connections shown in the diagram on the next page. For example, use an optional audio connection if you wish to use the A/V receiver speakers to hear audio from:
 - The **ANT** input
 - A game or camcorder connected to the TV.
- To use NetCommand to supplement HDMI control of a CEC-enabled A/V receiver, the recommended setup sequence is:
 1. Connect the HDMI cable.
 2. Enable HDMI control (**New Device Found** screen).
 3. Connect the secondary digital audio cable, if desired.
 4. Perform NetCommand setup.

If you perform A/V receiver NetCommand setup first and then later connect an HDMI cable, the NetCommand setup will be lost.
- In some cases, audio from a device connected to the A/V receiver may not be passed over the HDMI cable to the TV speakers. In these cases you must use the A/V receiver speakers to hear audio.

Setting Up A/V Receiver Control, continued

Before You Begin

To complete these steps you will need:

- The remote controls for both the TV and the A/V receiver.
- An IR emitter cable available from Mitsubishi.
- An HDMI-to-HDMI cable to connect the A/V receiver to the TV and cables necessary to connect devices to the A/V receiver.

1. Connect the A/V receiver to the TV with an HDMI-to-HDMI cable. Do not connect the optional audio cable at this time.
2. If desired, enable HDMI Control of a CEC-enabled A/V receiver. See Appendix C, "HDMI Control of CEC Devices."
3. Connect your audio/video devices to the A/V receiver. Note the name of the device connected

to each A/V receiver input. This information will be needed later to set up NetCommand's automatic input switching.

4. If using an optional audio cable between the TV and A/V receiver, connect it. Set up NetCommand control of the A/V receiver's TV audio input when setting up automatic switching in the next procedure.
5. Connect the IR emitter cable to the TV and position the IR emitter where it can send signals to the A/V receiver. See "IR Emitters," page 61.

Setup to Control Automatic Audio and Video Switching via HDMI

When this setup is complete, the "learned" A/V receiver input will appear in the TV's **Input Selection** menu as a selectable input.

1. Set the **TV's** remote control to TV mode.
2. Navigate to the **Inputs > AVR** menu.

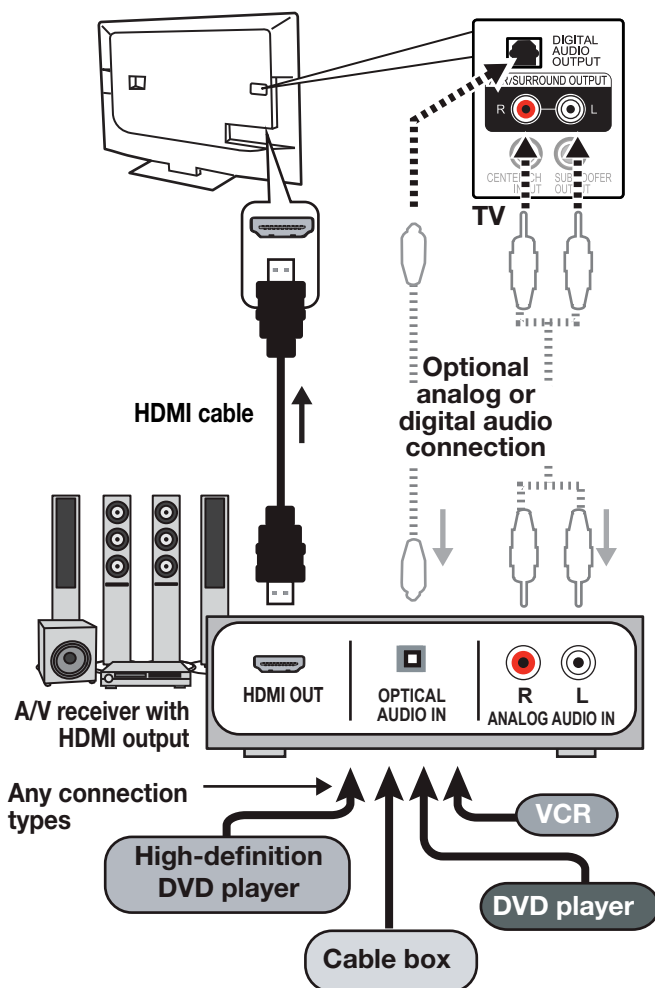

Multiple video inputs through a single HDMI cable.. The optional audio connection allows you to hear, through the A/V receiver, devices connected to the TV only, e.g., an antenna on the **ANT** input.

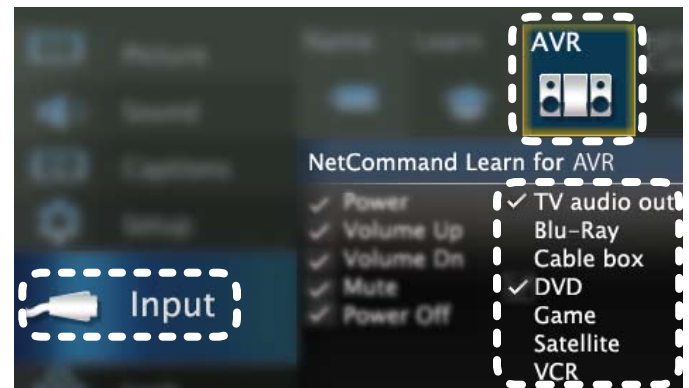

To set up A/V switching over HDMI, choose your A/V receiver input from a list.

3. In the **Inputs > AVR** menu, highlight the name of the A/V receiver input to control. In this example, it is the **DVD** input.
4. Press **ENTER** on the **TV's** remote control.
5. While the text **DVD** is flashing, press and hold the **DVD INPUT** key on the **A/V receiver's** remote control.
6. When a check appears next to **DVD**, release the **DVD INPUT** key.
 - If the text stops flashing before the check mark appears, repeat this step.
 - To erase the IR code just "learned," press **CANCEL** while the name is highlighted.
7. If using an optional audio cable between the TV and A/V receiver, "learn" the **TV AUDIO OUT** key to enable automatic switching of audio from sources connected to the TV only.
8. If there are no more devices to set up, highlight **EXIT** and press **ENTER** or continue to set up additional A/V receiver audio/video sources.

For assistance call 1(800) 332-2119

Setting Up A/V Receiver Control, continued

NetCommand Control of a Device Connected to an HDMI A/V Receiver

Use this setup to have NetCommand control a device sending audio and video through the A/V receiver to the TV via HDMI.

You must have already completed the procedure under “Setup to Control Automatic Audio and Video Switching via HDMI” on the opposite page. That procedure placed an icon in the **Input Selection** menu for the device (input) connected to the A/V receiver.

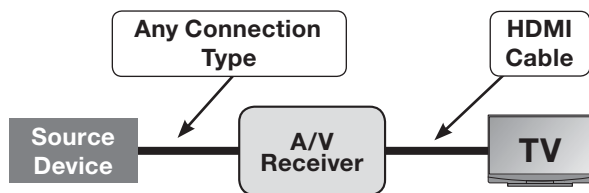

1. Set up NetCommand control of A/V receiver audio/video switching via HDMI as described on the opposite page.
2. Press **EXIT** to close any open menus and return to normal TV viewing.
3. Press **INPUT**.
4. Highlight the icon for the A/V receiver input you wish to control.
5. Press **ENTER** to switch the TV to the A/V receiver and the A/V receiver to the input.
6. Open the **Inputs > Learn** menu.
7. Perform NetCommand “learning” for the connected device by following the steps in “Initial NetCommand Setup,” page 62.

Appendices

Appendix A: Programming the Remote Control	73
Appendix B: Bypassing the Parental Lock	79
Appendix C: HDMI Control of CEC Devices	81
Appendix D: TV Care	84
Appendix E: Troubleshooting	85

Appendix A: Programming the Remote Control

This appendix explains programming the TV's remote control to operate other A/V devices. This is distinct from NetCommand or HDMI CEC.

Functions Available for Other A/V Devices

The TV's remote control can be programmed to operate other types and brands of A/V products. The functions performed in each device mode vary depending on the product. Not all functions work for all models. The most common functions available are listed on this page.

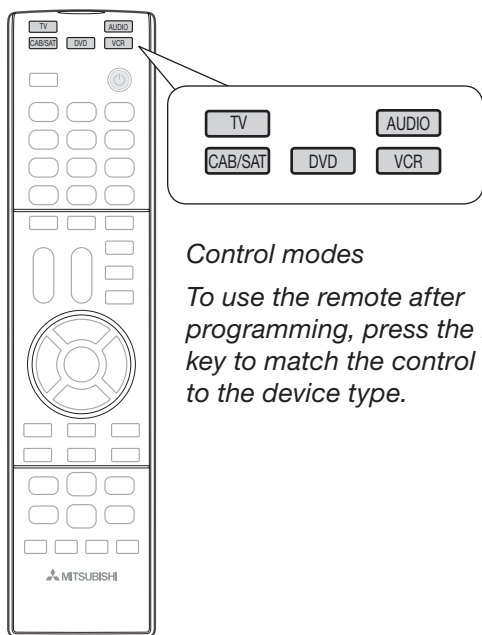

Control modes

To use the remote after programming, press the mode key to match the control mode to the device type.

VCRs and DVRs

- | | |
|--|---|
| <ul style="list-style-type: none"> • CHANNEL UP/DN • POWER • SLEEP • (▶▶) (FAST FORWARD) • () (PAUSE) • (▶) (PLAY) | <ul style="list-style-type: none"> • (●) (RECORD) • (◀◀) (REVERSE) • (■) (STOP) • GUIDE (DVR only) • MENU (DVR only) • 0-9 Number Buttons |
|--|---|

Mitsubishi VCRs are compatible with some additional keys.

Cable Boxes and Satellite Receivers

(not all functions for all models)

- | | |
|--|--|
| <ul style="list-style-type: none"> • PAGE UP/DOWN • CANCEL • CHANNEL UP/DN • ENTER • GUIDE • POWER • ▲▼◀▶ • LAST (ENTER; for channels on some models) • 0-9 Number Keys • F1-F4 (A, B, C, D keys on some models) | <p>The record/playback keys:</p> <ul style="list-style-type: none"> • (▶▶) (FAST FORWARD) • () (PAUSE) • (▶) (PLAY) • (●) (RECORD) • (◀◀) (REVERSE) • (■) (STOP) |
|--|--|

A/V Receivers

- | | |
|--|--|
| <ul style="list-style-type: none"> • MUTE • POWER • SLEEP • VOLUME • 0-9 Number Buttons | <ul style="list-style-type: none"> • Direct Input Selection buttons: numbers and LAST (on some Mitsubishi models) |
|--|--|

CD Players

(not all functions for all models)

- | | |
|--|--|
| <ul style="list-style-type: none"> • SLEEP • (▶▶) (FAST FORWARD) • () (PAUSE) • (▶) (PLAY) | <ul style="list-style-type: none"> • (◀◀) (REVERSE) • (■) (STOP) • 0-9 Number Buttons |
|--|--|

DVD Players

(not all functions for all models)

- | | |
|---|--|
| <ul style="list-style-type: none"> • CANCEL (on some models) • CHANNEL UP/DN (for track skip on some models) • ENTER • MENU • POWER • SLEEP • ▲▼◀▶ | <ul style="list-style-type: none"> • (▶▶) (FAST FORWARD) • () (PAUSE) • (▶) (PLAY) • (●) (RECORD) • (◀◀) (REVERSE) • (■) (STOP) • 0-9 Number Keys |
|---|--|

IMPORTANT



Some manufacturers may change their products or they may use more than one remote control system. The TV's remote control may be unable to operate your A/V equipment in these cases.

Appendix A: Programming the Remote Control, continued

Programming the Remote Control

1. Press one of the upper buttons on the remote control to change to the correct mode for the product you want to control. Refer to the table below. Only one of each device type can be controlled in each mode.

Mode	Affected Device
CAB/SAT	Cable Box DTV Receiver Satellite Receiver
VCR	VCR DVR DVD Player/Recorder
DVD	DVD Player/Recorder DVR VCR
AUDIO	A/V Receiver Audio Amplifier CD Player

2. Press and hold **POWER** on the remote control for several seconds until the key blinks twice and goes off.
3. Release the **POWER** key.
4. Enter the first five-digit code listed for your equipment in the reference tables that follow.
If you need to start over or wish to exit programming mode, temporarily change to a different device mode.
5. Point the remote control at the equipment and press **POWER**. If the product has no power on/off function, press a different key, such as  (**PLAY**),  (**STOP**), **VOLUME UP**, or **MUTE**.
 - If the equipment responds, the remote control is properly programmed.
 - If the equipment does not respond, repeat steps 4 and 5 with the next five-digit code listed for your equipment.
6. Once you have found the correct code, write it in the space below for future reference.

Mode	Device Type	Code
CABLE/SAT		
VCR		
DVD		
AUDIO		

IMPORTANT

You may need to reprogram the remote control after changing the batteries. Record the codes for each mode in the space provided to make this faster.

Code Verification

To determine the code programmed for any mode:

1. Set the mode to the one you wish to verify.
2. Press and hold **POWER** on the remote control for several seconds until the key blinks twice and goes off.
3. Press keys **9 9 0**
4. Press **1** and count the blinks of the power key. Write down the number of blinks as the first digit of the code.
5. Repeat step 4 for the second, third, fourth, and fifth digits of the code.

Audio Lock: Universal A/V Receiver Control

With Audio Lock enabled, the remote control operates volume and mute on an A/V receiver in all control modes. Activate Audio Lock if you always use an A/V receiver with your TV and other A/V equipment.

1. Program **AUDIO** mode for your A/V receiver as described in “Programming the Remote Control” on this page.
2. With the remote control in **AUDIO** mode, hold **POWER** on the remote control for several seconds until the key blinks twice and goes off.
3. Press keys **9 9 3 ENTER**
The **POWER** key will blink twice to indicate Audio Lock is active.

To Reset the Remote Control to Operate Volume and Mute for the TV Speakers

1. Press and hold **POWER** for several seconds until it blinks twice and goes off.
2. Press keys **9 9 3 VOLUME UP**.
The **POWER** key will blink four times to indicate Audio Lock has cleared.

Appendix A: Programming the Remote Control, continued

Audio Amplifiers	
Altec	41742
Lansing	
Anthem	42220
Bel Canto Design	41583
Cary Audio Design	41879
Classe	41461
Denon	42134
Durabrand	41561
Flextronics	41879
Halcro	41934
Harman/Kardon	40892
Krell	42463, 41837
Left Coast	40892
Lenoxx	41561
Lexicon	41802, 41145
Marantz	42138, 40892
Mark Levinson	42405, 41483
Parasound	42245, 41934
Philips	40892
Polk Audio	42242, 40892

Cable Boxes	
Amino	11822, 11602
Bright House	11877, 11376
Cable One	11877, 11376
Cablevision	11877, 11376
Charter	12187, 11877, 11376
Cisco	11982, 11877, 10877
Comcast	12576, 11982, 11877, 11376
Cox	11877, 11376
Digeo	12187, 11187
Director	10476
General Instrument	10476
Homecast	12301
i3 Micro	11602
Insight	11877, 11376
Jerrold	10476
Knology	11877
Mediacom	11877, 11376
Motorola	11376, 11187, 10476
Myrio	11822, 11602
Pace	11982, 11877, 11376
Panasonic	11982
Pioneer	11877, 10877
RCN	11376

Cable Boxes	
Rogers	11877
Scientific Atlanta	11877, 10877
Sejin	11602
Shaw	11376
Sony	11006
Suddenlink	11877, 11376
Time Warner	12187, 11877, 11376
Tivo	12576

CD Players	
Burmester	40420
California Audio Labs	40029
DKK	40000
Garrard	40420
Harman/Kardon	41202, 40173, 40083
Integra	40101
JVC	41294, 40072
Kenwood	40626, 40028
KLH	41318
Koss	41317
LG	41208
Magnavox	40038
Marantz	40626, 40038, 40029
McIntosh	41703
MCS	40029
MGA	40083
Miro	40000
Mitsubishi	40098, 40083
MTC	40420
NAD	41208
Onkyo	41327, 40101
Optimus	40420, 40000
Panasonic	40752, 40388, 40029
Parasound	40420
Philips	40626
Pioneer	41087
Proceed	40420
Quasar	40029
RCA	40420, 40053
Realistic	40420
Rotel	40420
Sherwood	41950
Sony	41364, 40490, 40185, 40100, 40000
Tascam	40420
TDK	41208
Teac	40420
Technics	40029

CD Players	
Victor	40072
Wards	40053
Yamaha	41292, 40490, 40036

Audio Accessories	
Apple	41115
Denon	42502
Vizio	42454
Yamaha	42458

Video Accessories	
ADB	12586, 12254
Amino	12482, 11673, 11615, 11481
AT&T	10858
Cisco	12517, 12345
KoolConnect	11481
Motorola	12378, 10858
Scientific Atlanta	12517, 12345, 10858
SureWest	11481
Verizon	12378

A/V Receivers	
Aiwa	41641, 41405, 41388
Alco	41390
AMC	41077
Anam	41609
Arcam	41189
Audiotronic	41189
Audiovox	41390
B & K	40820
Bose	41933, 41841, 41629, 41253, 41229, 40639
Carver	41189
Denon	42857, 42279
Electrohome	42026
Harman/Kardon	42443, 42241, 41306, 41304, 40891
iLive	42013
Insignia	42175, 42169, 41893, 41077, 41030
Integra	41805, 41320, 41298
iSymphony	42258, 42018
JBL	41306
JVC	42331, 42239, 42040, 41495, 41374
Kenwood	41570, 41569, 41313
KLH	41428, 41412, 41390
LG	42284, 42197, 41293
Magnavox	41514, 41269, 41189

Appendix A: Programming the Remote Control, continued

A/V Receivers	
Marantz	42114, 41289, 41269, 41189
McIntosh	41289
Micromega	41189
Mitsubishi	41957, 41922, 41921, 41920, 41393
Myryad	41189
Nakamichi	41313
Onkyo	41805, 41531, 41320, 41298, 40842
Optimus	41023
Panasonic	41763, 41633, 41548, 41518, 41316, 41308, 41288, 41275, 42967, 42452, 42221, 41764
Philips	42470, 42459, 42311, 41269, 41266, 41189, 40891
Pioneer	41935, 41384, 41023, 40630
Polk Audio	42270, 41289
Proscan	41254
RCA	42041, 41609, 41511, 41390, 41254, 41023
Samsung	41868, 41500, 41304, 41295
Sherwood	42169, 41905, 41653, 41077
Sherwood Newcastle	42169
Sony	41759, 41758, 41658, 41622, 41558, 41441, 41258, 41058, 42522, 42216, 42172, 41858, 41822
Stereophonics	41023
Sunfire	41313
Teac	41390
Technics	41518, 41308
Thorens	41189
Toshiba	41788
Venturer	41390
Yamaha	41476, 41376, 41375, 41331, 41276, 41176, 40376, 40176, 42471, 42467, 42061, 41815
Zenith	41293

Satellite Receivers	
Bell ExpressVu	10775
Crossdigital	11109

Satellite Receivers	
DirecTV	11749, 11377, 11142, 10749, 10639, 10566, 10392, 10247, 1856, 11609, 11442, 11414, 11109, 11076
Dish Network System	11775, 11505, 10775
Dishpro	11775, 11505, 10775
Echostar	11775, 11505, 10775
Expressvu	11775, 10775
GE	10566
General Instrument	10869
GOI	11775, 10775
HTS	11775, 10775
Hughes Network Systems	11749, 11442, 11142, 10749
Jerrold	10869
JVC	11775, 10775
LG	11414
Mitsubishi	10749
Motorola	10869
Next Level	10869
Panasonic	10701, 10247
Philips	11749, 11442, 11142, 11076, 10749
Proscan	10566, 10392
RadioShack	10869
RCA	10566, 10392, 10143
Samsung	11609, 11442, 11377, 11276, 11109
Sony	10639
Star Choice	10869
Tivo	11442, 11142
Toshiba	11749, 10790, 10749
Voom	10869
Zenith	11856

VCRs	
ABS	21972
Accurian	20000
Admiral	20048
Adventura	20000
Aiko	20278
Aiwa	20037, 20000
Alienware	21972
Allegro	20039
America Action	20278
American High	20035

VCRs	
Audiovox	20278, 20037
Calix	20037
Canon	20035
Carver	20081
CCE	20278
Citizen	20278, 20037
Craig	20037
Crosley	20081, 20000
Curtis Mathes	20278, 20162, 20060, 20035
CyberPower	21972
Daewoo	20278, 20045
Dell	21972
Denon	20042
DirecTV	20739
Durabrand	20039, 20038
Dynatech	20000
Electrohome	20043, 20037
Electroponic	20037
Emerex	20032
Emerson	21593, 20593, 20278, 20043, 20037, 20000
Fuji	20035, 20033
Funai	21593, 20593, 20000
Garrard	20000
Gateway	21972
GE	20060, 20035
GFM	21593
Go Video	20614
GoldStar	20038, 20037
Gradiente	20000
Harley Davidson	20000
Harman/Kardon	20081, 20038
Headquarter	20046
Hewlett Packard	21972
Hitachi	20042, 20000
Howard Computers	21972
HP	21972
Hughes Network Systems	20739, 20042
Humax	20739
Hush	21972
iBUYPOWER	21972
Instant Replay	20035
JVC	20067
KEC	20278, 20037
Kenwood	20067, 20038

Appendix A: Programming the Remote Control, continued

VCRs	
Kodak	20037, 20035
Linksys	21972
Lloyd's	20000
LXI	20037
Magnasonic	20593
Magnavox	21593, 20593, 20081, 20039, 20035, 20000
Marantz	20081, 20035
Marta	20037
Matsushita	20162, 20035
Media Center PC	21972
MEI	20035
Memorex	20162, 20048, 20046, 20039, 20037, 20035, 20000
MGA	20043
Microsoft	21972
Mind	21972
Minolta	20042
Mitsubishi	20173, 20067, 20043
Motorola	20048, 20035
MTC	20000
Multitech	20000
NEC	20067, 20038
Nikko	20037
Niveus Media	21972
Northgate	21972
Olympus	20035
Optimus	21062, 20593, 20162, 20048, 20037
Panasonic	21062, 20616, 20614, 20162, 20035
Penney	20042, 20038, 20037, 20035
Pentax	20042
Philco	20035
Philips	21181, 21081, 20739, 20618, 20081, 20035
Pilot	20037
Pioneer	20067
Polk Audio	20081
Portland	20278
Presidian	21593
Proscan	20060
Pulsar	20039
Quarter	20046
Quartz	20046
Quasar	20162, 20035
RadioShack	20000
Radix	20037
Randex	20037

VCRs	
RCA	20880, 20060, 20042
Realistic	20048, 20046, 20037, 20035, 20000
ReplayTV	20616, 20614
Ricavision	21972
Runco	20039
Samsung	20739, 20045
Sanky	20048, 20039
Sansui	20067, 20000
Sanyo	20046
Scott	20045, 20043
Sears	20046, 20042, 20037, 20035, 20000
Sharp	20848, 20048
Sonic Blue	20616, 20614
Sony	21972, 21032, 20636, 20035, 20033, 20032, 20000
Stack 9	21972
STS	20042
Sylvania	21593, 20593, 20081, 20043, 20035, 20000
Symphonic	21593, 20593, 20000
Systemax	21972
Tagar Systems	21972
Tashiko	20037
Teac	20000
Technics	20162, 20035
Teknika	20037, 20035, 20000
Thomas	20000
Tivo	20739, 20636, 20618
Toshiba	21972, 21008, 20045, 20043
Totevision	20037
Touch	21972
Vector	20045
Vector Research	20038
Video Concepts	20045
Videomagic	20037
Viewsonic	21972
Villain	20000
Voodoo	21972
Wards	20081, 20060, 20048, 20042, 20035, 20000
XR-1000	20035, 20000
Yamaha	20038
Zenith	21139, 20039, 20037, 20033, 20000
ZT Group	21972

DVD Players	
Accurian	30675
Adcom	31094
Aiwa	30641
Akai	31089, 30770, 30695
Alco	30790
Allegro	30869
Apex Digital	31061, 31056, 31020, 31004, 30797, 30796, 30794, 30755, 30672
Arrgo	31023
Astar	31489
Audiovox	31041, 30790
B & K	30662
BBK	31224
Bel Canto Design	31571
Blue Parade	30571
Broksonic	30695
California Audio Labs	30490
Cinea	30831
CineVision	30869, 30833
Citizen	32116, 31587, 31277, 30695
Coby	31628, 31351, 31177, 31165, 31107, 31086, 30852, 30778
Craig	30831
Curtis Mathes	31087
CyberHome	31537, 31502, 31129, 31024, 31023, 30874, 30816
Daewoo	31172, 31169, 30869, 30833, 30784
Denon	32258, 30634, 30490
Disney	31270, 30675
Durabrand	31127, 31023
DVD2000	30521
Electrohome	32116
Emerson	30675, 30591
Enterprise	30591
Fisher	30670
Funai	30675
Gateway	31077
GE	30815, 30522
GFM	30675
Go Video	31075, 31044, 30869, 30833, 30744, 30741, 30715
GoldStar	30869, 30741
Grundig	30539

Appendix A: Programming the Remote Control, continued

DVD Players	
Harman/ Kardon	31229, 30702, 30582
Helios	32192, 32080
Hello Kitty	30831
Hitachi	30664, 30573
Hiteker	30672
Humax	31588, 31500
iLo	31472, 31348
Initial	31472
Insignia	32596, 32428, 32095, 30675
Integra	32147, 31769, 30627, 30571
JBL	30702
JVC	32365, 31602, 31550, 31275, 31164, 30867, 30623, 30558
jWin	31049
Kawasaki	30790
Kenwood	30534, 30490
KLH	31020, 30790
Lenox	31127
LG	31602, 30869, 30741, 30591
LiteOn	31656, 31058
Magnavox	31506, 31472, 31354, 31177, 30675, 30646, 30539, 30503
Marantz	32414, 30539
McIntosh	31273
Memorex	32213, 31270, 30831, 30695
Microsoft	32083, 30522
Mintek	31472
Mitsubishi	31521, 30521
Myryad	30894
NAD	32572, 30741
Norcent	31107, 31003
Olevia	32331
Onkyo	32147, 31769, 30627, 30503
Oppo	32545, 32185, 31224, 30575
Panasonic	31762, 31641, 31579, 30703, 30632, 30503, 30490
Philco	30675
Philips	32084, 32056, 31340,, 31267, 30675, 30646, 30539, 30503, 32434, 31506, 31354
PianoDisc	31024

DVD Players	
Pioneer	31571, 31512, 31460, 30632, 30631, 30571, 30525, 30142
	32442
Polaroid	31086, 31061, 31020
Polk Audio	30539
Portland	30770
Presidian	30675
Proceed	30672
Proscan	30522
ProVision	30778
RCA	32213, 31769, 30822, 30790, 30571, 30522
Rio	30869
Rotel	31178, 30623
Sampo	30752
Samsung	32069, 31470, 31075, 31044, 30820, 30573, 30490, 30199
	32556, 32489, 32369, 32329
Sansui	30695
Sanyo	30873, 30695, 30670
Schneider	30646
Sharp	32250, 31256, 30752, 30675, 30630
Sherwood	31077, 31043, 30770, 30633
Sherwood Newcastle	31077
Shinsonic	30533
Sonic Blue	30869
Sony	31633, 31536, 31516, 31431, 31070, 31033, 30864, 30533
Sylvania	30675
Symphonic	30675
TAG McLaren	30894
Teac	30790
Technics	30703, 30490
Theta Digital	30571
Tivo	31512, 31503
Toshiba	31769, 31588, 31515, 31510, 31503, 31154, 30695, 30503
	32277, 32006, 31608
Urban Con- cepts	30503
Venturer	30790
Vizio	32563, 31226, 31064
Xbox	32083, 30522

DVD Players	
Yamaha	32558, 32298, 30817, 30646, 30545, 30539, 30490
Zenith	30869, 30741, 30591, 30503

Blu-ray and HD-DVD	
Denon	32258
Insignia	32596, 32428, 30675
Integra	32147, 31769
JVC	32365
LG	31602, 30741
Magnavox	30675
Marantz	32414
Microsoft	32083
NAD	32572
Olevia	32331
Onkyo	32147, 31769
Oppo	32545
Panasonic	31641
Philips	32434, 32084
Pioneer	32442, 30142
RCA	31769
Samsung	30199
Sharp	32250
Sony	31516
Sylvania	30675
Toshiba	31769, 31515
Vizio	32563
Xbox	32083
Yamaha	32298

Appendix B: Bypassing the Parental Lock

Lock Bypass Instructions Have Been Filed for Future Reference

IMPORTANT

Cut along the dotted line and file bypass instructions in a safe place for future reference.

Mitsubishi Home Theater TV

154 Series
164 Series
265 Series

Bypassing the Parental Lock

After you set the lock, you must use your pass code to:

- View a locked program
- View a locked channel
- View the locked TV
- Cancel the lock
- Enter the **Lock** menus

If you forget your pass code, you can view the locked TV without entering your pass code. When prompted for the pass code, press the number **9** and **LAST** keys on the TV remote control at the same time. This process temporarily unlocks the TV.

When entering the **Lock** menu, you will be prompted to enter a pass code.

- To change the pass code, press **9** and **LAST** at the same time. Either enter a new pass code to open the **Lock** menu and make changes or press **EXIT** to close the menu.
- If any of the locks are turned on and you exit the menus when prompted for a new code, the old code and all lock settings will be retained.
- If all locks are turned off and you exit the menus when prompted for a new code, then the previous code will be erased.

IMPORTANT

When changing or deleting your pass code, you must use the remote control included with this TV. You cannot use a Mitsubishi remote control from another component or a “universal” remote.

This page intentionally left blank

Appendix C: HDMI Control of CEC Devices

Many new HDMI devices have a feature called Consumer Electronics Control (CEC) or HDMI Control. HDMI Control allows one device, such as the TV, to control other devices, such as an A/V receiver or disc player. Use of CEC is optional.

Each manufacturer chooses which CEC functions to support so it is difficult to predict which devices and features are compatible with Mitsubishi's HDMI Control. You may find that CEC functions for a specific device are limited.

To use HDMI Control, you must enable it in both the TV and the device.

- **In the TV.** Enable HDMI control from the **New Device Found** screen or from the **Inputs > HDMI Control** menu.
- **In the Device.** Most devices with HDMI CEC compatibility let you turn it on or off in the device menus, where it is typically listed as "HDMI Control."

Enabling HDMI Control of CEC Devices

To ensure proper detection

- Power on HDMI devices before connecting them to the TV.
 - Connect and set up HDMI devices one at a time.
1. Power on the device and allow it to complete the power-on sequence (boot up). Stop any playback.
 2. Connect the device to one of the TV's HDMI inputs.
 3. When the TV detects the connection, the **New Device Found** screen will appear.

Note: See "If the New Device Found Screen Has No HDMI Control Option" on this page if there is no HDMI Control option.

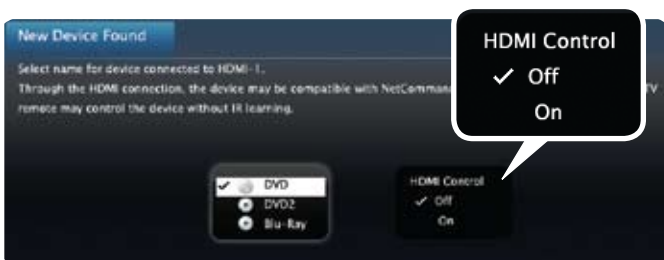

New Device Found screen with HDMI Control option. This screen displays only if the device's HDMI Control is enabled.

4. If prompted for a name, highlight a name for the device and press **ENTER** to add a check. The device itself may later override the name assigned.
5. Highlight **On** and press **ENTER** to add a check.



7. Highlight **EXIT** and press **ENTER** to close the **New Device Found** screen.

Note: At any time after completing Auto Input Sensing, you can set the TV's HDMI control on or off in the **Inputs > HDMI Control** menu.

8. **265 Series.** To supplement HDMI control with NetCommand IR control, see page 60.

If the New Device Found Screen Has No HDMI Control Option

If the **New Device Found** screen shows no option for HDMI Control, one of these conditions applies:

- **HDMI Control is turned off in the menus of the new device**
Action:
 - a. Highlight **EXIT** and press **ENTER** to close the **New Device Found** screen.
 - b. Display the device's setup menus and enable the device's CEC capabilities.
 - c. Wait for the TV's **New Device Found** screen to appear again.
 - d. If the **New Device Found** screen does not appear, power off the device. Power on the device and wait for the **New Device Found** screen to display with the HDMI Control option.
- **The HDMI cable cannot support CEC**
Action: Upgrade your HDMI cable to one that supports CEC.
- **The device does not have CEC compatibility**
Action:
 - Control the device with its own remote control or program the TV's remote control to operate the device.
 - **265 Series.** Use the TV's NetCommand IR control (page 60).

Appendix C: HDMI Control of CEC Devices, continued

HDMI Control of an HDMI A/V Receiver and Connected Devices

Note: Connect the A/V receiver to the TV with an HDMI cable before making other connections.

1. Enable HDMI Control for the A/V receiver as described in “Enabling HDMI Control of CEC Devices” on the previous page.
2. Power on the HDMI device you wish to connect to the A/V receiver (such as a disc player, cable box, or satellite receiver). Allow the device to complete the power-on sequence (boot up). Stop playback if the device starts playing.
3. Connect the device to the A/V receiver with an HDMI cable.
4. Select the device's HDMI input on the A/V receiver's front panel controls or remote control.
5. When the TV detects the connection, the **New Device Found** screen will appear.

Note: If the TV is unable to detect the device, either the device's CEC capability is not enabled or the device is not CEC compatible. Enable HDMI control through the device's menus before continuing. You may need to temporarily connect the device directly to the TV to view device menus.

6. Highlight **On** and press **ENTER** to add a check.



7. Highlight **EXIT** and press **ENTER** to close the **New Device Found** screen.
8. Optional: Connect the TV's **DIGITAL AUDIO OUTPUT** to an input on the A/V receiver. Use this additional connection if:
 - You want the ability to switch between the A/V receiver speakers and the TV speakers.
 - You want to use the A/V receiver to listen to devices connected to the TV only, e.g., an antenna input or camcorder.
9. **265 Series.** If desired, perform NetCommand IR Learning to supplement CEC functions. You must first connect and place IR emitters for the devices. See page 60.

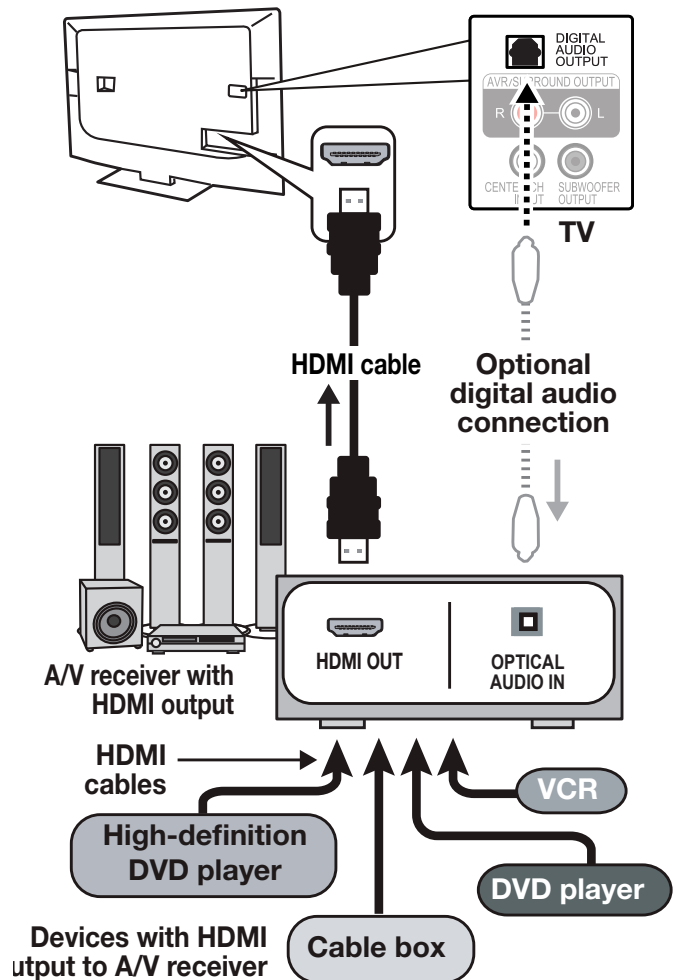

Connecting HDMI devices. The optional digital audio connection allows you to hear audio through the A/V receiver from devices connected to the TV only.

Appendix C: HDMI Control of CEC Devices, continued

Resolving CEC Conflicts

Because each manufacturer selects which CEC functions to support, some devices can conflict with other devices. If control conflicts arise, you can:

- Turn off TV control of an individual CEC-enabled device (see below).
- Turn off CEC in the setup menu of one of the devices.

Turning Off the TV's HDMI Control of a CEC Device

1. Press **MENU** on the TV remote control.
2. Highlight **Inputs > HDMI Control**.
3. Move to the device name and press **ENTER** to select **Off** to turn off the TV's ability to control the device.
4. Press **EXIT** to clear the menu.



Inputs > HDMI Control menu

Removing an HDMI Device

1. Power off the device.
2. Disconnect the HDMI cable.
3. Press **MENU** on the TV remote control to enter the TV main menu.
4. Go to **Inputs > Name**.
5. Highlight the HDMI input name and press **ENTER** to select **Delete**.
6. Press **EXIT** to clear the menus.

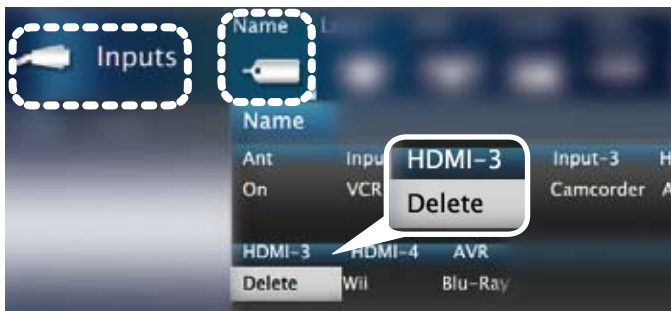

Inputs > Name menu with **Delete** selected for HDMI-3.

Using HDMI Control

As an example of using HDMI Control, press **PLAY** on the device itself to:

- Power on the TV
- Switch to the device (no need to display the **Input Selection** menu)
- Begin play of the device

Direct Keys

Test your equipment with the TV's remote control to find additional supported commands. See the table below for commands that may be available, depending on the individual device.

CEC-enabled VCR, DVD, and DVR functions that may be available:

Record/Playback	Menu Navigation	Channel Tuning	Other
		CH	GUIDE
	ENTER	Digits 0-9, CANCEL	TOOLS Check the TOOLS menu for supported functions.
	CANCEL (to cancel)	ENTER	

If you have a CEC-enabled A/V receiver, CEC-enabled devices connected to the A/V receiver with an HDMI cable may also be controllable. They can be selected from the TV's **Input Selection** menu.

CEC-enabled A/V receiver functions that may be available:

- Try the **VOL**, **MUTE**, and menu-navigation keys.
- To open the A/V receiver menu, follow these steps:
 1. While watching TV, press **AUDIO**.
 2. Press **▲** until the **TV Speakers** option displays.
 3. Press **▶** to select **Off** (to send audio to the A/V receiver).
 4. Press **INPUT** and highlight the A/V receiver icon in the **Input Selection** menu.
 5. Press **TOOLS**.
 6. Select **Menu** from the **Tools** menu.

Appendix D: TV Care

Cleaning Recommendations

Normally, light dusting with a dry, non-scratching duster will keep your TV clean. If cleaning beyond this is needed, please use the following guidelines:

First, turn off the TV and unplug the power cord from the power outlet.

Occasionally clean dust build-up from the air-intake grilles on the back and sides of the TV. Clean using a vacuum cleaner with a brush attachment.

Top and Sides of the TV

- Gently wipe down your TV with a soft, non-abrasive cloth such as cotton flannel, microfiber, or a clean cloth diaper, lightly moistened with water. Dry with a second dry, soft, non-abrasive cloth.

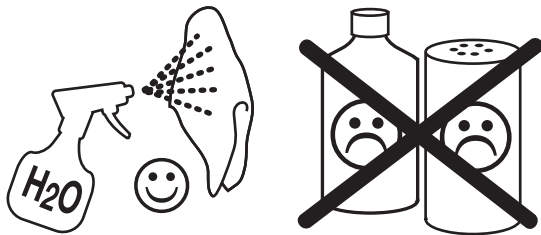

- For oily dirt, add a few drops of mild liquid detergent, such as dishwashing detergent, to the water used to moisten the cloth. Rinse with a second cloth moistened only with water. Dry with a third dry, soft, non-abrasive cloth.

Screen

IMPORTANT

DO NOT apply any type of liquid to the surface of the TV screen.

- **Use only a soft, dry cloth to clean the LCD screen. Do not use any liquids.**
- Wipe the screen gently with an up and down motion.
- Clean the entire screen evenly, not just sections of the screen.

General Cleaning Precautions

- DO NOT allow liquid to enter the TV through the ventilation slots or any crevice.
- DO NOT use any strong or abrasive cleaners, as these can scratch the surfaces.
- DO NOT use any cleaners containing ammonia, bleach, alcohol, benzene, or thinners, as these can dull the surfaces.
- DO NOT spray liquids or cleaners directly on the TV's surfaces.
- DO NOT scrub or rub the TV harshly. Wipe it gently.

Care of the Remote Control

Remote Control Tips

- For longer life, use alkaline batteries.
- Do not mix old and new batteries.
- Be within 20 feet of the equipment.
- Do not press two or more keys at the same time unless instructed to do so.
- Do not allow the unit to get wet or become heated.
- Keep the unit out of direct sunlight.
- Avoid dropping on hard surfaces.
- Do not use harsh chemicals to clean. Use only a soft, lightly moistened cloth.

Resetting the Remote Control

If TV mode is selected and the TV does not respond properly, reset the remote control.

1. Press and hold **POWER** for several seconds until the mode indicator blinks twice and goes off.
2. Release the **POWER** key.
3. Press keys **0 0 9 3 5** and the mode indicator will blink twice when you finish entering the code. When entering the code, pause for a moment between each key press to ensure it is recognized.

Low-Battery Indicator

If you press a key and the mode indicator blinks five times, replace the remote control's batteries.

Appendix E: Troubleshooting

TV Reset Comparison Guide

You can resolve many common TV problems using the reset functions described in the following table. See also the troubleshooting suggestions later in this appendix.

IMPORTANT

Before you change sound or picture settings: If picture or sound settings seem wrong for a broadcast

channel (a channel from the **ANT** input, a cable box, or satellite receiver), first check other channels from the same input before changing settings. If most other channels from the same input seem correct, there is likely a problem with the broadcast rather than with the TV. Use care in this case, as changes you make to fix problems on individual channels also affect all other channels on the same input.

Reset Name	When to Use	How to Use	Resulting Action
Format	If the picture shape (aspect ratio) seems incorrect, use the FORMAT key to change the shape of the picture.	Press FORMAT to cycle through the aspect ratios available for the signal.	The last-used format for a signal type is memorized for each input. The next time the same input and signal type are viewed, the last-used format will be recalled.
PerfectColor™/ PerfectTint™ Reset (265 Series) (for the single input currently being watched)	When the color intensities seem out of balance, use the PerfectColor/PerfectTint reset to reset the color balances to the original factory settings. Both PerfectColor and PerfectTint are reset at the same time.	<ol style="list-style-type: none"> 1. While viewing the input to be reset, press MENU and go to Picture > Perfect. 2. Press ENTER to display the PerfectColor adjustment screen. 3. Press CANCEL to reset the colors. 	All PerfectColor/PerfectTint sliders are reset to the original center position. The PerfectColor/PerfectTint settings for other inputs remain unchanged.
A/V Memory Reset (for the single current input)	When audio and/or video settings for a single input seem incorrect, use A/V Memory Reset to return the input to the original factory settings.	<p>During General TV Viewing</p> <ol style="list-style-type: none"> 1. While viewing the input to reset, press MENU and go to Picture > Reset. 2. Press ENTER to highlight Reset. 3. Press ENTER again to reset. <p>While Using VUDU Movies and Some VUDU Apps Press TOOLS and 3.</p>	All Audio and Video settings for the individual input are reset except for the global settings for audio Balance, Listen To, Language, True 120 Hz/True 240 Hz, and settings in the Picture > Advanced menu.

Service and Customer Support

Service

If you are unable to correct a problem with your TV, consult your Mitsubishi dealer or Mitsubishi Consumer Relations at (800) 332-2119.

- DO NOT adjust any controls other than those described in this Owner's Guide.
- DO NOT remove the protective back cover of your TV.

Customer Support

- To order replacement or additional remote controls, visit our website at www.mitsuparts.com or call (800) 553-7278.
- For questions:
 - ◆ Call Consumer Relations at 800-332-2119.
 - ◆ E-mail: MDEAservice@mdea.com
 - ◆ Website: www.mitsubishi-tv.com

Appendix E: Troubleshooting, continued

Reset Name	When to Use	How to Use	Resulting Action
A/V Reset (for all inputs)	To reset audio and video adjustments for all inputs to the original factory settings.	While viewing the TV, press the control-panel buttons INPUT and VOLUME DOWN at the same time for at least two seconds.	All Audio and Video settings are returned to the original factory settings, including global settings not affected by Picture > Reset .
Channel Memorization	To erase and re-memorize channels on the ANT input.	<ol style="list-style-type: none"> 1. While viewing the TV, press MENU to display the main menu. 2. Navigate to the Setup > Channel menu. 3. Highlight the reception mode, e.g. Ant Air. 4. Select All channels. 5. Highlight Scan. 6. Press ENTER to start channel memorization. 	All previously memorized channels for the antenna input are erased and a new set of memorized channels is created. To add or delete individual channels, see the Setup > Channel > Edit menu instructions on page 53.
Lock Menu Pass Code	To change your Lock menu pass code	See the cutout page from Appendix B, page 79.	Allows establishment of a new code.
Control-Panel Lock Release	To re-enable the control-panel buttons after activation of the Control-Panel Lock	Press and hold the INPUT button on the control panel for ten seconds. If the TV is powered off, you can then press the POWER button to turn it on.	Allows the control panel to be unlocked if the remote control is misplaced.
Auto Input Sensing for HDMI	If the New Device Found screen does not appear when you connect an HDMI device.	<ol style="list-style-type: none"> 1. Disconnect the HDMI device. 2. Delete the HDMI input in the Inputs > Name menu (see page 55). 3. Power on and connect the new device. 	The New Device Found screen will display.
System Reset	If the TV does not turn on or off, does not respond to the remote control or control-panel buttons, or has audio but no video.	Press and hold the POWER button on the control panel for ten seconds.	The TV will turn off. Power on the TV and the green LED will flash quickly for about one minute. The changes you made most recently, before using SYSTEM RESET , may be lost.
TV Reset IMPORTANT: Use this reset only if other troubleshooting has been unsuccessful.	<p>To reset all consumer-accessible settings and all memories to the original factory defaults.</p> <p>Use TV Reset if the TV can respond to controls but TV behavior is abnormal.</p> <p>CAUTION: All owner-performed setups and adjustments will be erased.</p>	<ol style="list-style-type: none"> 1. While viewing the TV, press MENU to display the TV main menu. 2. With the main menu displayed, press number keys 1 2 3 to display the Reset menu. 3. READ THE ON-SCREEN WARNING AND INSTRUCTIONS. <ul style="list-style-type: none"> • If you do not wish to use this reset, press EXIT or MENU to back out. • If you do wish to use the reset, press ENTER to erase all memories and settings. 	The TV will start the initialization process and then turn off. Power on the TV and the front green LED will start flashing. All memory and settings outlined in this Owner's Guide will need to be set again.

Appendix E: Troubleshooting, continued

Reset Name	When to Use	How to Use	Resulting Action
VUDU Reset VUDU Account Password	You have forgotten your account password.	Using a computer, go to www.VUDU.com .	Reset your account password from the VUDU website (requires access to e-mail).
VUDU Reset Parental Controls Pass Code	You have forgotten your pass code.	Call VUDU Customer Care at 1-888-554-VUDU (8838).	VUDU Customer Care will reset your pass code.

General TV Operation		
	Symptom	Remarks
1.	The TV remote control does not work.	<ul style="list-style-type: none"> • Check that the batteries are fresh and installed correctly. • Check that the control mode on the remote is set to TV. • Be no more than 20 feet from the TV when using the remote control. • Program the remote control to operate the TV or other device. • Reset the remote control. See “Resetting the Remote Control,” page 84.
2.	When I try to use the remote control, the POWER key blinks five times.	Replace the batteries.
3.	TV does not respond to the remote control or to control-panel buttons and TV will not power on or off.	<ul style="list-style-type: none"> • Unplug the AC power cord for 10 seconds. • Press and hold the POWER button on the control panel to perform system reset.
4.	When a device is selected from the Input Selection menu, the screen is blue or black (no signal source).	<ul style="list-style-type: none"> • Make sure the selected device is turned on. • Begin play of the device.
5.	You have forgotten your Lock menu pass code.	See “Bypassing the Parental Lock”, Appendix B.
6.	Rating restrictions are not working.	Open the Lock > Parental menu and: <ul style="list-style-type: none"> • Verify that the ratings locks are active. • Check the Lock Time/Unlock Time to check if rating restrictions are disabled. • Rating restrictions apply only to content on the ANT input.
7.	On-screen displays appear each time you change a function.	Normal TV operation.
8.	A warning message appeared on screen stating, “TV will shut down in a few seconds. Please check if the air flow is blocked.”	<ul style="list-style-type: none"> • Internal TV temperature has exceeded proper levels. Cool the room. • The TV has overheated. Clear blocked air vents and ensure at least four inches of clearance on all sides of the TV.
9.	I have turned on CEC for my HDMI devices but control is erratic and I wish to disable it.	<ul style="list-style-type: none"> • First turn off the TV’s HDMI control for the specific device. Open the Inputs > HDMI Control menu, select the device, select Off. • Disable CEC on the device itself. See the device’s instructions. • If the problem persists, do the following: <ol style="list-style-type: none"> 1. Disconnect the device from the TV. 2. Open the Inputs > Name menu and select Delete for the device. 3. Reconnect the device to the TV and Auto Input Sensing will recognize the device with CEC disabled.

Appendix E: Troubleshooting, continued

TV Channels		
	Symptom	Remarks
1.	The TV takes several seconds to respond to channel changes.	<ul style="list-style-type: none"> It is normal for digital channels to take longer to tune in. Press ENTER after entering a channel number to minimize delays. Use a 4-digit number for an over-the-air digital channel. Use a 6-digit number for digital cable channels if your cable service is able to recognize 6-digit channel numbers.
2.	You cannot access a channel.	<ul style="list-style-type: none"> Use number keys instead of CH. Be sure the channel you want to view is in memory. Check that the TV is switched to the correct device or antenna for that channel by pressing the INPUT key. Make sure the Lock > Parental menu lock is set to Off. If you cannot tune to a virtual digital channel even though the TV has already memorized digital channels, tune to the physical channel number used by the broadcaster. The virtual channel will then be automatically added to memory. You may be trying to tune to an analog channel that is no longer broadcasting.
3.	When ChannelView list is displayed, information appears incomplete	<ul style="list-style-type: none"> Press INFO to update the display for the highlighted channel. Program information is displayed only for the currently tuned channel. Available information is sent from the broadcaster or cable provider. No other data is available. Make sure the TV clock is set correctly.

TV Power On/Off		
	Symptom	Remarks
1.	TV takes an excessively long time to power on.	When powered on, the TV needs time to boot up, just as a computer does.
2.	You cannot program the TV to turn on automatically (Timer function)	<ul style="list-style-type: none"> The TV may be locked. The clock may not be set.
3.	TV turned itself off and the light on the front panel started to blink.	<ul style="list-style-type: none"> Momentary power fluctuation can cause the TV to turn off to prevent damage. Wait for the green light to stop flashing and turn the TV on again. If the TV does not stay on, press the POWER button on the control panel for at least eight seconds to perform System Reset. If this happens frequently, obtain an AC line power conditioner/surge protector. An unusual digital signal may have been received, triggering a protection circuit. Wait for the light to stop flashing and turn TV on.
4.	TV will not power off.	Press the POWER button on the control panel for ten seconds to perform System Reset.

Appendix E: Troubleshooting, continued

Picture		
	Symptom	Remarks
1.	Picture does not look like a high-definition picture.	Not all signals are high-definition signals. To receive high-definition programming from your cable or satellite provider, you must subscribe to the provider's high-definition service. Some over-the-air broadcasts are in high-definition and can be received with a high-quality antenna suited to your location.
2.	TV has sound but no picture.	<ul style="list-style-type: none"> • Press MENU on the remote control. If the menu displays, then there is a problem with the incoming signal. • Check that all video inputs are plugged in firmly. • Press and hold the POWER button on the control panel for ten seconds to perform System Reset.
3.	You cannot view a picture when playing a VHS tape.	Check your VCR's owner's guide for further troubleshooting.
4.	VCR or DVD player's on-screen menus jitter up and down.	Stop playback. Possible cause: Many VCRs and DVD players provide on-screen menus at only half-resolution that may appear to jitter up and down.
5.	When viewing a stopped VCR, white lines are rolling on the screen.	<ul style="list-style-type: none"> • Turn off video mute for the VCR. • Begin playing the tape. • Change the VCR input from Line 1 to the VCR antenna input.
6.	A color program appears as a black and white image, or the colors are dim, or the screen is black.	The PerfectColor color balance has been incorrectly set. Reset the PerfectColor balance.
7.	Picture from an HDMI input is noisy (poor quality).	Upgrade a standard (unmarked) HDMI cable to a high-speed HDMI cable.
8.	The image from a computer appears distorted when viewed on the TV.	<ul style="list-style-type: none"> • Normal TV operation. The TV does not correct distortion in the picture from a computer because the correction process may cut off the edges of the image. • The aspect ratio may be wrong for the image. Press FORMAT to change.

Appendix E: Troubleshooting, continued

Sound		
	Symptom	Remarks
1.	There is no sound even when the volume is turned up.	<ul style="list-style-type: none"> Check if the MUTE key is on. The TV's analog Listen to setting may be set to SAP (analog program from the ANT input) but no SAP is being broadcast. Check that the Sound > Audio > TV Speakers option is set to On to hear sound from the TV speakers. Possibly the TV Speakers option is Off or set to Center but there is no A/V receiver connected. If using an A/V receiver, check that the Sound > Audio > TV Speakers option is set to Off to hear sound from the A/V receiver speakers. Press and hold the POWER button on the control panel for 10 seconds to perform System Reset. The language selected in the Setup > Antenna Digital Audio menu is not being broadcast for the current program.
2.	The sound does not match the screen picture.	The TV's analog Listen to setting may be set to SAP (analog program from the ANT input).
3.	The sound from my A/V receiver does not match the screen picture (I should hear the correct audio from my A/V receiver).	<ul style="list-style-type: none"> Check that DIGITAL AUDIO OUTPUT and/or AVR/SURROUND OUTPUT on TV's connection panel is connected to the A/V receiver. Without this connection, devices connected only to the TV (and not the A/V receiver) can be heard only from the TV speakers. Note that this includes the ANT input, a device (such as a camcorder) connected to the TV, and any other device sending audio to the TV only. If using a NetCommand-controlled A/V receiver, NetCommand may be selecting the wrong A/V receiver audio input. Check the A/V receiver's NetCommand setup in the Inputs > AVR menu.
4.	Cannot select an audio-only device; it does not appear in the Input Selection menu.	Plug an unused video plug into the Y/VIDEO jack to activate Auto Input Sensing. Assign the name CD/Audio or MP3 to make the audio device selectable in the Input Selection menu.
5..	Sound is coming from the TV speakers instead of the A/V receiver.	<ul style="list-style-type: none"> Connect the TV's AUDIO OUT to the A/V receiver. Change TV Speakers setting to Off or Center.

Appendix E: Troubleshooting, continued

NetCommand IR Control (NetCommand-equipped models only)	
Symptom	Remarks
1. NetCommand unable to learn specific device keys.	<ul style="list-style-type: none"> • A/V Device does not use IR format for remote control signal. ITT and RF formats cannot be learned. • Room lighting may affect the signal. Have the remotes very close (6 inches or less) to the TV during Learning. • Some, but not all, device key functions can be learned by NetCommand. For example, POWER and PLAY may be learned, but other functions may not. • The signal from the remote control may not be strong enough. Insert fresh batteries and try Learning again. • The key was “learned” correctly but can be accessed only from the Tools menu.
2. The A/V receiver is the selected audio source but there is no sound.	<p>A/V Receiver Set Up for Audio and Video Switching over HDMI</p> <ul style="list-style-type: none"> - Check to see if the A/V Receiver power is turned on. - If the device is connected only to the TV (e.g., on ANT or a front panel input), verify that the TV's AUDIO OUTPUT is connected to the A/V receiver and the correct key has been “learned.” - The A/V receiver is not switching properly because you have not learned the IR codes for the A/V receiver inputs to which your devices are connected.
3. There is no sound or picture from the A/V receiver for my DVD player or other device connected to the A/V receiver; the A/V receiver should be sending video to the TV over an HDMI cable. (A/V Receiver Set Up for Audio and Video Switching over HDMI)	The NetCommand A/V receiver setup is not switching audio and video inputs properly because you did not “learn” the A/V receiver's IR codes for the device inputs. See “Automatic Audio/Video Switching Over an HDMI Connection,” page 69.
4. I've selected my DVD player or other surround sound device in combination with the TV speakers but hear no sound from the TV speakers.	A/V Receiver Set Up for Audio and Video Switching over HDMI With your DVD player connected to the A/V receiver, only video is passed from the A/V receiver to the TV because of copy-protection restrictions on the HDMI signal
5. I “learned” the RECORD key for my VCR/DVR but when I pressed the RECORD key, the VCR/DVR did not record anything.	Check that the VCR or DVR is receiving a signal directly from your cable box or satellite receiver.

Trademark and License Information

LICENSOR'S SUPPLIERS DO NOT MAKE OR PASS ON TO END USER OR ANY OTHER THIRD PARTY, ANY EXPRESS, IMPLIED OR STATUTORY WARRANTY OR REPRESENTATION ON BEHALF OF SUCH SUPPLIERS, INCLUDING, BUT NOT LIMITED TO THE IMPLIED WARRANTIES OF NON-INFRINGEMENT, TITLE, MERCHANTABILITY OR FITNESS FOR A PARTICULAR PURPOSE.



Manufactured under license from Cambridge Mechatronics Ltd.
Rapidfire and the 1... logo are trademarks of Cambridge Mechatronics Ltd

The *Bluetooth*[®] word mark and logos are registered trademarks owned by Bluetooth SIG, Inc. and any use of such marks by Mitsubishi Electric is under license. Other trademarks and trade names are those of their respective owners.

Manufactured under license from Dolby Laboratories. Dolby is a trademark of Dolby Laboratories.

ENERGY STAR[®] and the ENERGY STAR mark are registered U.S. marks. ENERGY STAR is a registered mark owned by the U.S. government.

HDMI[®], the HDMI Logo, and High-Definition Multimedia Interface are trademarks or registered trademarks of HDMI Licensing LLC in the United States and other countries.



Imaging Science Foundation Certified Calibration Controls

The software in this TV is based in part on the work of the Independent JPEG Group, copyright © 1991-1998, Thomas G. Lane, all rights reserved.

VUDU_{TM} is a trademark of VUDU, Inc.

“x.v.Color” and the “x.v.Color” logo are trademarks of Sony Corporation.

ChannelView[™], DeepField[™] Imager, Easy Connect[™], EdgeEnhance[™], NetCommand[®], PerfectColor[™], PerfectTint[™], Plush 1080p@ 5G, StreamTV[™], Unisen[™] are trademarks of Mitsubishi Digital Electronics America, Inc.

Mitsubishi TV Software

END-USER LICENSE AGREEMENT FOR EMBEDDED SOFTWARE

IMPORTANT – READ CAREFULLY: This License Agreement is a legal agreement between you (either an individual or an entity) and Mitsubishi Digital Electronics America, Inc. (MDEA) for all software pre installed and/or provided along with this television (“Software”). By utilizing this television and Software, you agree to be bound by the terms of this License Agreement.

The Software is protected by United States copyright laws and international treaty provisions, as well as other intellectual property laws and treaties. The Software is licensed, not sold.

1. **LICENSE GRANT.** MDEA grants you a non-exclusive, non-transferable, limited right and license to use one copy of the Software only with the Mitsubishi television model that included this owner’s guide and owned by you.

2. **RIGHTS AND LIMITATIONS.**

Software Not for Resale. You may not resell or otherwise transfer for value the Software, except in conjunction with a sale of the TV that Software has been pre installed.

Prohibition on Reverse Engineering, Decompilation and Disassembly. The Software contains trade secrets or other proprietary material in its human perceivable form and to protect them, you may not reverse engineer, decompile, or disassemble, or otherwise reduce the Software to any human perceivable form, except to the extent that the foregoing restriction is expressly prohibited by applicable law.

Separation of Components. The Software is licensed as a single product. Its component parts may not be separated for use on more than one TV.

No Rental. You may not rent, lease, lend, or sublicense the Software.

Trademarks. This License Agreement does not grant you any rights to any trademarks of MDEA.

3. **VIOLATIONS.** You understand that any use, copying or transfer of the Software, except as permitted pursuant to this License, may subject you to serious criminal and civil penalties including damages and an award to MDEA of attorneys’ fees in connection with any violation of this License. You further understand that you may be held legally responsible for any copyright infringement or other violation of intellectual property rights that is caused, encouraged, or induced by your failure to abide by the terms of the License. This license is effective until terminated, and will terminate immediately without notice from MDEA or judicial resolution if you fail to comply with any provision of this License.

4. **COPYRIGHT.** All title and intellectual property rights in and to the Software (including but not limited to any images, photographs, animations, video, audio, music, text, and “applets” incorporated into the Software), and any accompanying printed materials are owned by or licensed to MDEA. All title and intellectual property rights in and to the content which may be accessed through use of the Software is the property of the respective content owner and may be protected by applicable copyright or other intellectual property laws and treaties. This License Agreement grants you no rights to use such content, except that you own the media on which the Software is recorded, but MDEA and its licensors retain ownership of the Software itself. All rights not expressly granted are reserved by MDEA.

5. **EXPORT RESTRICTIONS.** MDEA is licensing the Software for use within the United States. You agree that you will not export or re-export the Software. You specifically agree not to export or re-export the Software: (i) to any country to which the U.S. has embargoed or restricted the export of goods or services, which currently include, but are not necessarily limited to Cuba, Iran, Iraq, Libya, North Korea, Sudan, and Syria, or to any national of any such country, wherever located, who intends to transmit or transport the Software back to such country; (ii) to any person or entity who you know or have reason to know will utilize the Software in the design, development, or production of nuclear, chemical, or biological weapons; or (iii) to any person or entity who has been prohibited from participating in U.S. export transactions by any federal agency of the U.S. government. You warrant and represent that neither the BXA nor any other U.S. federal agency has suspended, revoked, or denied your export privileges.

6. **DISCLAIMER OF WARRANTY. EXCEPT AS OTHERWISE PROVIDED IN THIS LICENSE OR IN THE LIMITED WARRANTY APPLICABLE TO THE TV, MDEA MAKES NO OTHER WARRANTIES OF ANY KIND WHATSOEVER REGARDING THE SOFTWARE AND HEREBY EXPRESSLY DISCLAIMS ALL WARRANTIES OF ANY KIND WHATSOEVER, EXPRESS OR IMPLIED, WITH RESPECT TO THE SOFTWARE. ALL IMPLIED WARRANTIES, INCLUDING, WITHOUT LIMITATION, THE IMPLIED WARRANTIES OF MERCHANTABILITY AND FITNESS FOR A PARTICULAR PURPOSE ARE HEREBY EXPRESSLY DISCLAIMED BY MDEA. IN NO EVENT SHALL MDEA BE LIABLE TO YOU OR ANY THIRD PARTIES, IN CONTRACT, IN TORT OR OTHERWISE, FOR ANY DIRECT, INDIRECT, SPECIAL, INCIDENTAL OR CONSEQUENTIAL DAMAGES OF ANY KIND OR NATURE. BECAUSE SOME JURISDICTIONS DO NOT ALLOW THE EXCLUSION OR LIMITATION OF IMPLIED WARRANTIES, THE ABOVE LIMITATION MAY NOT APPLY TO YOU.**

7. **LIMITATION OF LIABILITY. MDEA SHALL NOT, UNDER ANY CIRCUMSTANCES BE LIABLE TO YOU OR ANY THIRD PARTIES FOR ANY DAMAGES OF ANY NATURE, WHETHER INDIRECT, SPECIAL, INCIDENTAL, CONSEQUENTIAL OR OTHERWISE, INCLUDING, BUT NOT LIMITED TO, ANY CLAIMS FOR LOST PROFITS, LOSS OF GOOD WILL OR EXPENDITURES MADE OR COMMITTED FOR IN RELIANCE ON THE CONTINUATION OF THIS LICENSE. YOU AGREE THAT NEITHER MDEA’S BREACH OF THIS LICENSE NOR ITS FAILURE TO REPAIR A DEFECT, ERROR OR BUG SHALL CONSTITUTE A FAILURE OF THE ESSENTIAL PURPOSE OF THIS LICENSE. BECAUSE SOME JURISDICTIONS DO NOT ALLOW THE EXCLUSION OR LIMITATION OF LIABILITY FOR CONSEQUENTIAL OR INCIDENTAL DAMAGES, THE ABOVE LIMITATIONS MAY NOT APPLY TO YOU. MDEA’s liability to you for direct damages for any cause whatsoever and regardless of the form of the action, will be limited to the money paid by you for the TV (based on fair market value of the TV) that caused the damages.**

8. **GENERAL.** This License Agreement will be governed by the laws of the State of California.

WARNING: This product contains chemicals known to the State of California to cause cancer and/or birth defects or other reproductive harm.

For assistance call 1(800) 332-2119

GNU GENERAL PUBLIC LICENSE

Version 3, 29 June 2007

Copyright © 2007 Free Software Foundation, Inc. <<http://fsf.org/>>

Everyone is permitted to copy and distribute verbatim copies of this license document, but changing it is not allowed.

Preamble

The GNU General Public License is a free, copyleft license for software and other kinds of works.

The licenses for most software and other practical works are designed to take away your freedom to share and change the works. By contrast, the GNU General Public License is intended to guarantee your freedom to share and change all versions of a program—to make sure it remains free software for all its users. We, the Free Software Foundation, use the GNU General Public License for most of our software; it applies also to any other work released this way by its authors. You can apply it to your programs, too.

When we speak of free software, we are referring to freedom, not price. Our General Public Licenses are designed to make sure that you have the freedom to distribute copies of free software (and charge for them if you wish), that you receive source code or can get it if you want it, that you can change the software or use pieces of it in new free programs, and that you know you can do these things.

To protect your rights, we need to prevent others from denying you these rights or asking you to surrender the rights. Therefore, you have certain responsibilities if you distribute copies of the software, or if you modify it: responsibilities to respect the freedom of others.

For example, if you distribute copies of such a program, whether gratis or for a fee, you must pass on to the recipients the same freedoms that you received. You must make sure that they, too, receive or can get the source code. And you must show them these terms so they know their rights.

Developers that use the GNU GPL protect your rights with two steps: (1) assert copyright on the software, and (2) offer you this License giving you legal permission to copy, distribute and/or modify it.

For the developers' and authors' protection, the GPL clearly explains that there is no warranty for this free software. For both users' and authors' sake, the GPL requires that modified versions be marked as changed, so that their problems will not be attributed erroneously to authors of previous versions.

Some devices are designed to deny users access to install or run modified versions of the software inside them, although the manufacturer can do so. This is fundamentally incompatible with the aim of protecting users' freedom to change the software. The systematic pattern of such abuse occurs in the area of products for individuals to use, which is precisely where it is most unacceptable. Therefore, we have designed this version of the GPL to prohibit the practice for those products. If such problems arise substantially in other domains, we stand ready to extend this provision to those domains in future versions of the GPL, as needed to protect the freedom of users.

Finally, every program is threatened constantly by software patents. States should not allow patents to restrict development and use of software on general-purpose computers, but in those that do, we wish to avoid the special danger that patents applied to a free program could make it effectively proprietary. To prevent this, the GPL assures that patents cannot be used to render the program non-free.

The precise terms and conditions for copying, distribution and modification follow.

TERMS AND CONDITIONS

0. Definitions.

"This License" refers to version 3 of the GNU General Public License.

"Copyright" also means copyright-like laws that apply to other kinds of works, such as semiconductor masks.

"The Program" refers to any copyrightable work licensed under this License. Each licensee is addressed as "you". "Licensees" and "recipients" may be individuals or organizations.

To "modify" a work means to copy from or adapt all or part of the work in a fashion requiring copyright permission, other than the making of an exact copy. The resulting work is called a "modified version" of the earlier work or a work "based on" the earlier work.

A "covered work" means either the unmodified Program or a work based on the Program.

To "propagate" a work means to do anything with it that, without permission, would make you directly or secondarily liable for infringement under applicable copyright law, except executing it on a computer or modifying a private copy. Propagation includes copying, distribution (with or without modification), making available to the public, and in some countries other activities as well.

To "convey" a work means any kind of propagation that enables other parties to make or receive copies. Mere interaction with a user through a computer network, with no transfer of a copy, is not conveying.

An interactive user interface displays "Appropriate Legal Notices" to the extent that it includes a convenient and prominently visible feature that (1) displays an appropriate copyright notice, and (2) tells the user that there is no warranty for the work (except to the extent that warranties are provided), that licensees may convey the work under this License, and how to view a copy of this License. If the interface presents a list of user commands or options, such as a menu, a prominent item in the list meets this criterion.

1. Source Code.

The "source code" for a work means the preferred form of the work for making modifications to it. "Object code" means any non-source form of a work.

A "Standard Interface" means an interface that either is an official standard defined by a recognized standards body, or, in the case of interfaces specified for a particular programming language, one that is widely used among developers working in that language.

The "System Libraries" of an executable work include anything, other than the work as a whole, that (a) is included in the normal form of packaging a Major Component, but which is not part of that Major Component, and (b) serves only to enable use of the work with that Major Component, or to implement a Standard Interface for which an implementation is available to the public in source code form. A "Major Component", in this context, means a major essential component (kernel, window system, and so on) of the specific operating system (if any) on which the executable work runs, or a compiler used to produce the work, or an object code interpreter used to run it.

The "Corresponding Source" for a work in object code form means all the source code needed to generate, install, and (for an executable work) run the object code and to modify the work, including scripts to control those activities. However, it does not include the work's System Libraries, or general-purpose tools or generally available free programs which are used unmodified in performing those activities but which are not part of the work. For example, Corresponding Source includes interface definition files associated with source files for the work, and the source code for shared libraries and dynamically linked subprograms that the work is specifically designed to require, such as by intimate data communication or control flow between those subprograms and other parts of the work.

The Corresponding Source need not include anything that users can regenerate automatically from other parts of the Corresponding Source.

The Corresponding Source for a work in source code form is that same work.

2. Basic Permissions.

All rights granted under this License are granted for the term of copyright on the Program, and are irrevocable provided the stated conditions are met. This License explicitly affirms your unlimited permission to run the unmodified Program. The output from running a covered work is covered by this License only if the output, given its content, constitutes a covered work. This License acknowledges your rights of fair use or other equivalent, as provided by copyright law.

You may make, run and propagate covered works that you do not convey, without conditions so long as your license otherwise remains in force. You may convey covered works to others for the sole purpose of having them make modifications exclusively for you, or provide you with facilities for running those works, provided that you comply with the terms of this License in conveying all material for which you do not control copyright. Those thus making or running the covered works for you must do so exclusively on your behalf, under your direction and control, on terms that prohibit them from making any copies of your copyrighted material outside their relationship with you.

Conveying under any other circumstances is permitted solely under the conditions stated below. Sublicensing is not allowed; section 10 makes it unnecessary.

3. Protecting Users' Legal Rights From Anti-Circumvention Law.

No covered work shall be deemed part of an effective technological measure under any applicable law fulfilling obligations under article 11 of the WIPO copyright treaty adopted on 20 December 1996, or similar laws prohibiting or restricting circumvention of such measures.

When you convey a covered work, you waive any legal power to forbid circumvention of technological measures to the extent such circumvention is effected by exercising rights under this License with respect to the covered work, and you disclaim any intention to limit operation or modification of the work as a means of enforcing, against the work's users, your or third parties' legal rights to forbid circumvention of technological measures.

If you are interested in obtaining open source code for this product, please contact Mitsubishi at (800) 332-2119. A nominal handling and mailing charge may apply.

For assistance call 1(800) 332-2119

4. Conveying Verbatim Copies.

You may convey verbatim copies of the Program's source code as you receive it, in any medium, provided that you conspicuously and appropriately publish on each copy an appropriate copyright notice; keep intact all notices stating that this License and any non-permissive terms added in accord with section 7 apply to the code; keep intact all notices of the absence of any warranty; and give all recipients a copy of this License along with the Program.

You may charge any price or no price for each copy that you convey, and you may offer support or warranty protection for a fee.

5. Conveying Modified Source Versions.

You may convey a work based on the Program, or the modifications to produce it from the Program, in the form of source code under the terms of section 4, provided that you also meet all of these conditions:

- The work must carry prominent notices stating that you modified it, and giving a relevant date.
- The work must carry prominent notices stating that it is released under this License and any conditions added under section 7. This requirement modifies the requirement in section 4 to "keep intact all notices".
- You must license the entire work, as a whole, under this License to anyone who comes into possession of a copy. This License will therefore apply, along with any applicable section 7 additional terms, to the whole of the work, and all its parts, regardless of how they are packaged. This License gives no permission to license the work in any other way, but it does not invalidate such permission if you have separately received it.
- If the work has interactive user interfaces, each must display Appropriate Legal Notices; however, if the Program has interactive interfaces that do not display Appropriate Legal Notices, your work need not make them do so.

A compilation of a covered work with other separate and independent works, which are not by their nature extensions of the covered work, and which are not combined with it such as to form a larger program, in or on a volume of a storage or distribution medium, is called an "aggregate" if the compilation and its resulting copyright are not used to limit the access or legal rights of the compilation's users beyond what the individual works permit. Inclusion of a covered work in an aggregate does not cause this License to apply to the other parts of the aggregate.

6. Conveying Non-Source Forms.

You may convey a covered work in object code form under the terms of sections 4 and 5, provided that you also convey the machine-readable Corresponding Source under the terms of this License, in one of these ways:

- Convey the object code in, or embodied in, a physical product (including a physical distribution medium), accompanied by the Corresponding Source fixed on a durable physical medium customarily used for software interchange.
- Convey the object code in, or embodied in, a physical product (including a physical distribution medium), accompanied by a written offer, valid for at least three years and valid for as long as you offer spare parts or customer support for that product model, to give anyone who possesses the object code either (1) a copy of the Corresponding Source for all the software in the product that is covered by this License, on a durable physical medium customarily used for software interchange, for a price no more than your reasonable cost of physically performing this conveying of source, or (2) access to copy the Corresponding Source from a network server at no charge.
- Convey individual copies of the object code with a copy of the written offer to provide the Corresponding Source. This alternative is allowed only occasionally and noncommercially, and only if you received the object code with such an offer, in accord with subsection 6b.
- Convey the object code by offering access from a designated place (gratis or for a charge), and offer equivalent access to the Corresponding Source in the same way through the same place at no further charge. You need not require recipients to copy the Corresponding Source along with the object code. If the place to copy the object code is a network server, the Corresponding Source may be on a different server (operated by you or a third party) that supports equivalent copying facilities, provided you maintain clear directions next to the object code saying where to find the Corresponding Source. Regardless of what server hosts the Corresponding Source, you remain obligated to ensure that it is available for as long as needed to satisfy these requirements.
- Convey the object code using peer-to-peer transmission, provided you inform other peers where the object code and Corresponding Source of the work are being offered to the general public at no charge under subsection 6d.

A separable portion of the object code, whose source code is excluded from the Corresponding Source as a System Library, need not be included in conveying the object code work.

A "User Product" is either (1) a "consumer product", which means any tangible personal property which is normally used for personal, family, or household purposes, or (2) anything designed or sold for incorporation into a dwelling. In determining whether a product is a consumer product, doubtful cases shall be resolved in favor of coverage. For a particular product received by a particular user, "normally used" refers to a typical or common use of that class of product, regardless of the status of the particular user or of the way in which the particular user actually uses, or expects or is expected to use, the product. A product is a consumer product regardless of whether the product has substantial commercial, industrial or non-consumer uses, unless such uses represent the only significant mode of use of the product.

"Installation Information" for a User Product means any methods, procedures, authorization keys, or other information required to install and execute modified versions of a covered work in that User Product from a modified version of its Corresponding Source. The information must suffice to ensure that the continued functioning of the modified object code is in no case prevented or interfered with solely because modification has been made.

If you convey an object code work under this section in, or with, or specifically for use in, a User Product, and the conveying occurs as part of a transaction in which the right of possession and use of the User Product is transferred to the recipient in perpetuity or for a fixed term (regardless of how the transaction is characterized), the Corresponding Source conveyed under this section must be accompanied by the Installation Information. But this requirement does not apply if neither you nor any third party retains the ability to install modified object code on the User Product (for example, the work has been installed in ROM).

The requirement to provide Installation Information does not include a requirement to continue to provide support service, warranty, or updates for a work that has been modified or installed by the recipient, or for the User Product in which it has been modified or installed. Access to a network may be denied when the modification itself materially and adversely affects the operation of the network or violates the rules and protocols for communication across the network.

Corresponding Source conveyed, and Installation Information provided, in accord with this section must be in a format that is publicly documented (and with an implementation available to the public in source code form), and must require no special password or key for unpacking, reading or copying.

7. Additional Terms.

"Additional permissions" are terms that supplement the terms of this License by making exceptions from one or more of its conditions. Additional permissions that are applicable to the entire Program shall be treated as though they were included in this License, to the extent that they are valid under applicable law. If additional permissions apply only to part of the Program, that part may be used separately under those permissions, but the entire Program remains governed by this License without regard to the additional permissions.

When you convey a copy of a covered work, you may at your option remove any additional permissions from that copy, or from any part of it. (Additional permissions may be written to require their own removal in certain cases when you modify the work.) You may place additional permissions on material, added by you to a covered work, for which you have or can give appropriate copyright permission.

Notwithstanding any other provision of this License, for material you add to a covered work, you may (if authorized by the copyright holders of that material) supplement the terms of this License with terms:

- Disclaiming warranty or limiting liability differently from the terms of sections 15 and 16 of this License; or
- Requiring preservation of specified reasonable legal notices or author attributions in that material or in the Appropriate Legal Notices displayed by works containing it; or
- Prohibiting misrepresentation of the origin of that material, or requiring that modified versions of such material be marked in reasonable ways as different from the original version; or
- Limiting the use for publicity purposes of names of licensors or authors of the material; or
- Declining to grant rights under trademark law for use of some trade names, trademarks, or service marks; or
- Requiring indemnification of licensors and authors of that material by anyone who conveys the material (or modified versions of it) with contractual assumptions of liability to the recipient, for any liability that these contractual assumptions directly impose on those licensors and authors.

All other non-permissive additional terms are considered "further restrictions" within the meaning of section 10. If the Program as you received it, or any part of it, contains a notice stating that it is governed by this License along with a term that is a further restriction, you may remove that term. If a license document contains a further restriction but permits relicensing or conveying under this License, you may add to a covered work material governed by the terms of that license document, provided that the further restriction does not survive such relicensing or conveying.

If you add terms to a covered work in accord with this section, you must place, in the relevant source files, a statement of the additional terms that apply to those files, or a notice indicating where to find the applicable terms.

Additional terms, permissive or non-permissive, may be stated in the form of a separately written license, or stated as exceptions; the above requirements apply either way.

8. Termination.

You may not propagate or modify a covered work except as expressly provided under this License. Any attempt otherwise to propagate or modify it is void, and will automatically terminate your rights under this License (including any patent licenses granted under the third paragraph of section 11).

However, if you cease all violation of this License, then your license from a particular copyright holder is reinstated (a) provisionally, unless and until the copyright holder explicitly and finally terminates your license, and (b) permanently, if the copyright holder fails to notify you of the violation by some reasonable means prior to 60 days after the cessation.

Moreover, your license from a particular copyright holder is reinstated permanently if the copyright holder notifies you of the violation by some reasonable means, this is the first time you have received notice of violation of this License (for any work) from that copyright holder, and you cure the violation prior to 30 days after your receipt of the notice.

Termination of your rights under this section does not terminate the licenses of parties who have received copies or rights from you under this License. If your rights have been terminated and not permanently reinstated, you do not qualify to receive new licenses for the same material under section 10.

9. Acceptance Not Required for Having Copies.

You are not required to accept this License in order to receive or run a copy of the Program. Ancillary propagation of a covered work occurring solely as a consequence of using peer-to-peer transmission to receive a copy likewise does not require acceptance. However, nothing other than this License grants you permission to propagate or modify any covered work. These actions infringe copyright if you do not accept this License. Therefore, by modifying or propagating a covered work, you indicate your acceptance of this License to do so.

10. Automatic Licensing of Downstream Recipients.

Each time you convey a covered work, the recipient automatically receives a license from the original licensors, to run, modify and propagate that work, subject to this License. You are not responsible for enforcing compliance by third parties with this License.

An "entity transaction" is a transaction transferring control of an organization, or substantially all assets of one, or subdividing an organization, or merging organizations. If propagation of a covered work results from an entity transaction, each party to that transaction who receives a copy of the work also receives whatever licenses to the work the party's predecessor in interest had or could give under the previous paragraph, plus a right to possession of the Corresponding Source of the work from the predecessor in interest, if the predecessor has it or can get it with reasonable efforts.

You may not impose any further restrictions on the exercise of the rights granted or affirmed under this License. For example, you may not impose a license fee, royalty, or other charge for exercise of rights granted under this License, and you may not initiate litigation (including a cross-claim or counterclaim in a lawsuit) alleging that any patent claim is infringed by making, using, selling, offering for sale, or importing the Program or any portion of it.

11. Patents.

A "contributor" is a copyright holder who authorizes use under this License of the Program or a work on which the Program is based. The work thus licensed is called the contributor's "contributor version".

A contributor's "essential patent claims" are all patent claims owned or controlled by the contributor, whether already acquired or hereafter acquired, that would be infringed by some manner, permitted by this License, of making, using, or selling its contributor version, but do not include claims that would be infringed only as a consequence of further modification of the contributor version. For purposes of this definition, "control" includes the right to grant patent sublicenses in a manner consistent with the requirements of this License.

Each contributor grants you a non-exclusive, worldwide, royalty-free patent license under the contributor's essential patent claims, to make, use, sell, offer for sale, import and otherwise run, modify and propagate the contents of its contributor version.

In the following three paragraphs, a "patent license" is any express agreement or commitment, however denominated, not to enforce a patent (such as an express permission to practice a patent or covenant not to sue for patent infringement). To "grant" such a patent license to a party means to make such an agreement or commitment not to enforce a patent against the party.

If you convey a covered work, knowingly relying on a patent license, and the Corresponding Source of the work is not available for anyone to copy, free of charge and under the terms of this License, through a publicly available network server or other readily accessible means, then you must either (1) cause the Corresponding Source to be so available, or (2) arrange to deprive yourself of the benefit of the patent license for this particular work, or (3) arrange, in a manner consistent with the requirements of this License, to extend the patent license to downstream recipients. "Knowingly relying" means you have actual knowledge that, but for the patent license, your conveying the covered work in a country, or your recipient's use of the covered work in a country, would infringe one or more identifiable patents in that country that you have reason to believe are valid.

If, pursuant to or in connection with a single transaction or arrangement, you convey, or propagate by procuring conveyance of, a covered work, and grant a patent license to some of the parties receiving the covered work authorizing them to use, propagate, modify or convey a specific copy of the covered work, then the patent license you grant is automatically extended to all recipients of the covered work and works based on it.

A patent license is "discriminatory" if it does not include within the scope of its coverage, prohibits the exercise of, or is conditioned on the non-exercise of one or more of the rights that are specifically granted under this License. You may not convey a covered work if you are a party to an arrangement with a third party that is in the business of distributing software, under which you make payment to the third party based on the extent of your activity of conveying the work, and under which the third party grants, to any of the parties who would receive the covered work from you, a discriminatory patent license (a) in connection with copies of the covered work conveyed by you (or copies made from those copies), or (b) primarily for and in connection with specific products or compilations that contain the covered work, unless you entered into that arrangement, or that patent license was granted, prior to 28 March 2007.

Nothing in this License shall be construed as excluding or limiting any implied license or other defenses to infringement that may otherwise be available to you under applicable patent law.

12. No Surrender of Others' Freedom.

If conditions are imposed on you (whether by court order, agreement or otherwise) that contradict the conditions of this License, they do not excuse you from the conditions of this License. If you cannot convey a covered work so as to satisfy simultaneously your obligations under this License and any other pertinent obligations, then as a consequence you may not convey it at all. For example, if you agree to terms that obligate you to collect a royalty for further conveying from those to whom you convey the Program, the only way you could satisfy both those terms and this License would be to refrain entirely from conveying the Program.

13. Use with the GNU Affero General Public License.

Notwithstanding any other provision of this License, you have permission to link or combine any covered work with a work licensed under version 3 of the GNU Affero General Public License into a single combined work, and to convey the resulting work. The terms of this License will continue to apply to the part which is the covered work, but the special requirements of the GNU Affero General Public License, section 13, concerning interaction through a network will apply to the combination as such.

14. Revised Versions of this License.

The Free Software Foundation may publish revised and/or new versions of the GNU General Public License from time to time. Such new versions will be similar in spirit to the present version, but may differ in detail to address new problems or concerns.

Each version is given a distinguishing version number. If the Program specifies that a certain numbered version of the GNU General Public License "or any later version" applies to it, you have the option of following the terms and conditions either of that numbered version or of any later version published by the Free Software Foundation. If the Program does not specify a version number of the GNU General Public License, you may choose any version ever published by the Free Software Foundation.

If the Program specifies that a proxy can decide which future versions of the GNU General Public License can be used, that proxy's public statement of acceptance of a version permanently authorizes you to choose that version for the Program.

Later license versions may give you additional or different permissions. However, no additional obligations are imposed on any author or copyright holder as a result of your choosing to follow a later version.

15. Disclaimer of Warranty.

THERE IS NO WARRANTY FOR THE PROGRAM, TO THE EXTENT PERMITTED BY APPLICABLE LAW. EXCEPT WHEN OTHERWISE STATED IN WRITING THE COPYRIGHT HOLDERS AND/OR OTHER PARTIES PROVIDE THE PROGRAM "AS IS" WITHOUT WARRANTY OF ANY KIND, EITHER EXPRESSED OR IMPLIED, INCLUDING, BUT NOT LIMITED TO, THE IMPLIED WARRANTIES OF MERCHANTABILITY AND FITNESS FOR A PARTICULAR PURPOSE. THE ENTIRE RISK AS TO THE QUALITY AND PERFORMANCE OF THE PROGRAM IS WITH YOU. SHOULD THE PROGRAM PROVE DEFECTIVE, YOU ASSUME THE COST OF ALL NECESSARY SERVICING, REPAIR OR CORRECTION.

16. Limitation of Liability.

IN NO EVENT UNLESS REQUIRED BY APPLICABLE LAW OR AGREED TO IN WRITING WILL ANY COPYRIGHT HOLDER, OR ANY OTHER PARTY WHO MODIFIES AND/OR CONVEYS THE PROGRAM AS PERMITTED ABOVE, BE LIABLE TO YOU FOR DAMAGES, INCLUDING ANY GENERAL, SPECIAL, INCIDENTAL OR CONSEQUENTIAL DAMAGES ARISING OUT OF THE USE OR INABILITY TO USE THE PROGRAM (INCLUDING BUT NOT LIMITED TO LOSS OF DATA OR DATA BEING RENDERED INACCURATE OR LOSSES SUSTAINED BY YOU OR THIRD PARTIES OR A FAILURE OF THE PROGRAM TO OPERATE WITH ANY OTHER PROGRAMS), EVEN IF SUCH HOLDER OR OTHER PARTY HAS BEEN ADVISED OF THE POSSIBILITY OF SUCH DAMAGES.

17. Interpretation of Sections 15 and 16.

If the disclaimer of warranty and limitation of liability provided above cannot be given local legal effect according to their terms, reviewing courts shall apply local law that most closely approximates an absolute waiver of all civil liability in connection with the Program, unless a warranty or assumption of liability accompanies a copy of the Program in return for a fee.

For assistance call 1(800) 332-2119

GNU General Public License

Version 2, June 1991

Copyright (C) 1989, 1991 Free Software Foundation, Inc.
675 Mass Ave, Cambridge, MA 02139, USA

Everyone is permitted to copy and distribute verbatim copies of this license document, but changing it is not allowed.

Preamble

The licenses for most software are designed to take away your freedom to share and change it. By contrast, the GNU General Public License is intended to guarantee your freedom to share and change free software--to make sure the software is free for all its users. This General Public License applies to most of the Free Software Foundation's software and to any other program whose authors commit to using it. (Some other Free Software Foundation software is covered by the GNU Library General Public License instead.) You can apply it to your programs, too.

When we speak of free software, we are referring to freedom, not price. Our General Public Licenses are designed to make sure that you have the freedom to distribute copies of free software (and charge for this service if you wish), that you receive source code or can get it if you want it, that you can change the software or use pieces of it in new free programs; and that you know you can do these things.

To protect your rights, we need to make restrictions that forbid anyone to deny you these rights or to ask you to surrender the rights. These restrictions translate to certain responsibilities for you if you distribute copies of the software, or if you modify it.

For example, if you distribute copies of such a program, whether gratis or for a fee, you must give the recipients all the rights that you have. You must make sure that they, too, receive or can get the source code. And you must show them these terms so they know their rights.

We protect your rights with two steps: (1) copyright the software, and (2) offer you this license which gives you legal permission to copy, distribute and/or modify the software.

Also, for each author's protection and ours, we want to make certain that everyone understands that there is no warranty for this free software. If the software is modified by someone else and passed on, we want its recipients to know that what they have is not the original, so that any problems introduced by others will not reflect on the original authors' reputations.

Finally, any free program is threatened constantly by software patents. We wish to avoid the danger that redistributors of a free program will individually obtain patent licenses, in effect making the program proprietary. To prevent this, we have made it clear that any patent must be licensed for everyone's free use or not licensed at all.

The precise terms and conditions for copying, distribution and modification follow.

GNU GENERAL PUBLIC LICENSE TERMS AND CONDITIONS FOR COPYING, DISTRIBUTION AND MODIFICATION

0. This License applies to any program or other work which contains a notice placed by the copyright holder saying it may be distributed under the terms of this General Public License. The "Program", below, refers to any such program or work, and a "work based on the Program" means either the Program or any derivative work under copyright law: that is to say, a work containing the Program or a portion of it, either verbatim or with modifications and/or translated into another language. (Hereinafter, translation is included without limitation in the term "modification".) Each licensee is addressed as "you".

Activities other than copying, distribution and modification are not covered by this License; they are outside its scope. The act of running the Program is not restricted, and the output from the Program is covered only if its contents constitute a work based on the Program (independent of having been made by running the Program). Whether that is true depends on what the Program does.

1. You may copy and distribute verbatim copies of the Program's source code as you receive it, in any medium, provided that you conspicuously and appropriately publish on each copy an appropriate copyright notice and disclaimer of warranty; keep intact all the notices that refer to this License and to the absence of any warranty; and give any other recipients of the Program a copy of this License along with the Program.

You may charge a fee for the physical act of transferring a copy, and you may at your option offer warranty protection in exchange for a fee.

2. You may modify your copy or copies of the Program or any portion of it, thus forming a work based on the Program, and copy and distribute such modifications or work under the terms of Section 1 above, provided that you also meet all of these conditions:

- a) You must cause the modified files to carry prominent notices stating that you changed the files and the date of any change.
- b) You must cause any work that you distribute or publish, that in whole or in part contains or is derived from the Program or any part thereof, to be licensed as a whole at no charge to all third parties under the terms of this License.
- c) If the modified program normally reads commands interactively when run, you must cause it, when started running for such interactive use in the most ordinary way, to print or display an announcement including an appropriate copyright notice and a notice that there is no warranty (or else, saying that you provide a warranty) and that users may redistribute the program under these conditions, and telling the user how to view a copy of this License. (Exception: if the Program itself is interactive but does not normally print such an announcement, your work based on the Program is not required to print an announcement.)

These requirements apply to the modified work as a whole. If identifiable sections of that work are not derived from the Program, and can be reasonably considered independent and separate works in themselves, then this License, and its terms, do not apply to those sections when you distribute them as separate works. But when you distribute the same sections as part of a whole which is a work based on the Program, the distribution of the whole must be on the terms of this License, whose permissions for other licensees extend to the entire whole, and thus to each and every part regardless of who wrote it.

Thus, it is not the intent of this section to claim rights or contest your rights to work written entirely by you; rather, the intent is to exercise the right to control the distribution of derivative or collective works based on the Program.

In addition, mere aggregation of another work not based on the Program with the Program (or with a work based on the Program) on a volume of a storage or distribution medium does not bring the other work under the scope of this License.

3. You may copy and distribute the Program (or a work based on it, under Section 2) in object code or executable form under the terms of Sections 1 and 2 above provided that you also do one of the following:

- a) Accompany it with the complete corresponding machine-readable source code, which must be distributed under the terms of Sections 1 and 2 above on

For assistance call 1(800) 332-2119

a medium customarily used for software interchange; or,

b) Accompany it with a written offer, valid for at least three years, to give any third party, for a charge no more than your cost of physically performing source distribution, a complete machine-readable copy of the corresponding source code, to be distributed under the terms of Sections 1 and 2 above on a medium customarily used for software interchange; or,

c) Accompany it with the information you received as to the offer to distribute corresponding source code. (This alternative is allowed only for noncommercial distribution and only if you received the program in object code or executable form with such an offer, in accord with Subsection b above.)

The source code for a work means the preferred form of the work for making modifications to it. For an executable work, complete source code means all the source code for all modules it contains, plus any associated interface definition files, plus the scripts used to control compilation and installation of the executable. However, as a special exception, the source code distributed need not include anything that is normally distributed (in either source or binary form) with the major components (compiler, kernel, and so on) of the operating system on which the executable runs, unless that component itself accompanies the executable.

If distribution of executable or object code is made by offering access to copy from a designated place, then offering equivalent access to copy the source code from the same place counts as distribution of the source code, even though third parties are not compelled to copy the source along with the object code.

4. You may not copy, modify, sublicense, or distribute the Program except as expressly provided under this License. Any attempt otherwise to copy, modify, sublicense or distribute the Program is void, and will automatically terminate your rights under this License. However, parties who have received copies, or rights, from you under this License will not have their licenses terminated so long as such parties remain in full compliance.

5. You are not required to accept this License, since you have not signed it. However, nothing else grants you permission to modify or distribute the Program or its derivative works. These actions are prohibited by law if you do not accept this License. Therefore, by modifying or distributing the Program (or any work based on the Program), you indicate your acceptance of this License to do so, and all its terms and conditions for copying, distributing or modifying the Program or works based on it.

6. Each time you redistribute the Program (or any work based on the Program), the recipient automatically receives a license from the original licensor to copy, distribute or modify the Program subject to these terms and conditions. You may not impose any further restrictions on the recipients' exercise of the rights granted herein. You are not responsible for enforcing compliance by third parties to this License.

7. If, as a consequence of a court judgment or allegation of patent infringement or for any other reason (not limited to patent issues), conditions are imposed on you (whether by court order, agreement or otherwise) that contradict the conditions of this License, they do not excuse you from the conditions of this License. If you cannot distribute so as to satisfy simultaneously your obligations under this License and any other pertinent obligations, then as a consequence you may not distribute the Program at all. For example, if a patent license would not permit royalty-free redistribution of the Program by all those who receive copies directly or indirectly through you, then the only way you could satisfy both it and this License would be to refrain entirely from distribution of the Program.

If any portion of this section is held invalid or unenforceable under any particular circumstance, the balance of the section is intended to apply and the section as a whole is intended to apply in other circumstances.

It is not the purpose of this section to induce you to infringe any patents or other property right claims or to contest validity of any such claims; this section has the sole purpose of protecting the integrity of the free software distribution system, which is implemented by public license practices. Many people have made generous contributions to the wide range of software distributed through that system in reliance on consistent application of that system; it is up to the author/donor to decide if he or she is willing to distribute software through any other system and a licensee cannot impose that choice.

This section is intended to make thoroughly clear what is believed to be a consequence of the rest of this License.

8. If the distribution and/or use of the Program is restricted in certain countries either by patents or by copyrighted interfaces, the original copyright holder who places the Program under this License may add an explicit geographical distribution limitation excluding those countries, so that distribution is permitted only in or among countries not thus excluded. In such case, this License incorporates the limitation as if written in the body of this License.

9. The Free Software Foundation may publish revised and/or new versions of the General Public License from time to time. Such new versions will be similar in spirit to the present version, but may differ in detail to address new problems or concerns.

Each version is given a distinguishing version number. If the Program specifies a version number of this License which applies to it and "any later version", you have the option of following the terms and conditions either of that version or of any later version published by the Free Software Foundation. If the Program does not specify a version number of this License, you may choose any version ever published by the Free Software Foundation.

10. If you wish to incorporate parts of the Program into other free programs whose distribution conditions are different, write to the author to ask for permission. For software which is copyrighted by the Free Software Foundation, write to the Free Software Foundation; we sometimes make exceptions for this. Our decision will be guided by the two goals of preserving the free status of all derivatives of our free software and of promoting the sharing and reuse of software generally.

NO WARRANTY

11. BECAUSE THE PROGRAM IS LICENSED FREE OF CHARGE, THERE IS NO WARRANTY FOR THE PROGRAM, TO THE EXTENT PERMITTED BY APPLICABLE LAW. EXCEPT WHEN OTHERWISE STATED IN WRITING THE COPYRIGHT HOLDERS AND/OR OTHER PARTIES PROVIDE THE PROGRAM "AS IS" WITHOUT WARRANTY OF ANY KIND, EITHER EXPRESSED OR IMPLIED, INCLUDING, BUT NOT LIMITED TO, THE IMPLIED WARRANTIES OF MERCHANTABILITY AND FITNESS FOR A PARTICULAR PURPOSE. THE ENTIRE RISK AS TO THE QUALITY AND PERFORMANCE OF THE PROGRAM IS WITH YOU. SHOULD THE PROGRAM PROVE DEFECTIVE, YOU ASSUME THE COST OF ALL NECESSARY SERVICING, REPAIR OR CORRECTION.

12. IN NO EVENT UNLESS REQUIRED BY APPLICABLE LAW OR AGREED TO IN WRITING WILL ANY COPYRIGHT HOLDER, OR ANY OTHER PARTY WHO MAY MODIFY AND/OR REDISTRIBUTE THE PROGRAM AS PERMITTED ABOVE, BE LIABLE TO YOU FOR DAMAGES, INCLUDING ANY GENERAL, SPECIAL, INCIDENTAL OR CONSEQUENTIAL DAMAGES ARISING OUT OF THE USE OR INABILITY TO USE THE PROGRAM (INCLUDING BUT NOT LIMITED TO LOSS OF DATA OR DATA BEING RENDERED INACCURATE OR LOSSES SUSTAINED BY YOU OR THIRD PARTIES OR A FAILURE OF THE PROGRAM TO OPERATE WITH ANY OTHER PROGRAMS), EVEN IF SUCH HOLDER OR OTHER PARTY HAS BEEN ADVISED OF THE POSSIBILITY OF SUCH DAMAGES.

Mitsubishi LCD Flat Panel HDTV Limited Warranty

MITSUBISHI DIGITAL ELECTRONICS AMERICA, INC. (“MDEA”) warrants to the original purchaser of this LCD Flat Panel HDTV that if purchased from an authorized MITSUBISHI Audio/Video Dealer, should it prove defective by reason of improper workmanship and/or material:

a. Parts. All parts (except any software incorporated into this HDTV) are warranted for a period of one year from the date of the original purchase at retail. We will repair or replace, at our option, any defective part without charge for the part. Parts used for replacement may be replaced with those of like kind and quality and may be new or remanufactured. Parts used for replacement are warranted for the remainder of the original warranty period.

b. Embedded Software. MDEA warrants that all software incorporated into this HDTV (the “Embedded Software”) will perform in accordance with the functional description of Embedded Software in all material respects, but MDEA does not warrant that the Embedded Software is error-free. The warranty contained in this section shall continue for a period of one year, from the date of the original purchase from the authorized dealer. If, after prompt notice within the warranty period, MDEA determines that the Embedded Software has failed to perform in accordance with such functional description in all material respects and if such failure is not due to accident, misuse, modification or misapplication of the Embedded Software, then MDEA shall modify or replace the nonconforming Embedded Software at no charge to you, which at MDEA’s sole discretion may be fulfilled by means of modification or replacement software contained on a replacement memory card for Consumer installation. The foregoing shall be MDEA’s sole obligation to you under this limited warranty. All rights under this limited warranty on the Embedded Software also subject to your compliance with the terms of the Software License Agreement applicable to this HDTV, and this limited warranty on the Embedded Software shall be null and void if the Embedded Software is modified or changed in any manner except as specifically authorized by MDEA.

c. Labor. For certain items that are designed to be replaced by the consumer, including (but not limited to) some Embedded Software, the consumer is solely responsible for any replacement labor. For all other parts, we will provide the labor for a warranty repair by an authorized MITSUBISHI service center without charge for one year from the original date of purchase at retail.

d. Notice. To obtain warranty service, you must notify an authorized MITSUBISHI service center of any defect within the applicable warranty time period.

BEFORE REQUESTING SERVICE, please review the TV owner’s guide to insure proper installation and correct customer control adjustment. If the problem persists, please arrange for warranty service.

1. TO OBTAIN WARRANTY SERVICE:

a. Contact your nearest authorized MITSUBISHI service center whose name and address can be obtained from your MITSUBISHI dealer, by writing to the address provided below, calling MDEA at 800-332-2119, or using the support feature of our website at www.Mitsubishi-tv.com.

b. Warranty service will be provided in your home or, if required, at an authorized service shop, provided that your television is located within the geographic territory customarily covered by an authorized MITSUBISHI service center. If not, you must either deliver your television to an authorized service location at your own expense, or pay for any travel and/or transportation costs the service center may charge to and from you home. Actual service labor will be provided without charge.

c. Proof of purchase from an authorized MITSUBISHI dealer is required when requesting warranty service. Present your sales receipt or other document which establishes proof and date of purchase. **THE RETURN OF THE OWNER REGISTRATION CARD IS NOT A CONDITION OF WARRANTY COVERAGE.** However, please return the Owner Registration Card so that we can contact you should a question of safety arise which could affect you.

2. THIS LIMITED WARRANTY DOES NOT COVER:

a. Up to .01% pixel outages (small dot picture elements that are dark or incorrectly illuminated).

b. Cosmetic damage or any other damage where such damage is caused by unauthorized modification, alteration, repairs to or service of the product by anyone other than an authorized MITSUBISHI service center; physical abuse to or misuse of the product (or any product damaged by excessive physical or electrical stress); any products that have had a serial number or any part thereof altered, defaced or removed; product use in any manner contrary to the Owner’s Guide; freight damage; or any damage caused by acts of God or other factors beyond the reasonable control of MDEA, such as power surge damage caused by electrical system or damages caused by use of third party mounting brackets or stands. This limited warranty also excludes service calls where no defect in the product covered under this warranty is found, service calls related to unsatisfactory audio or visual reception or signal unless caused by a defect in the product that is covered under this limited warranty, all costs, expenses or any other damages arising from product installation, removal from or re-installation into custom installations or on

For assistance call 1(800) 332-2119

wall mountings, or set-ups, any adjustments of user controls (including contrast, brightness, color, tint, fine tuning, sharpness), other adjustment necessary to prepare the unit for display or use, connection with any external audio receiver, antenna, cable or satellite systems, or service of products purchased or serviced outside the U.S.A. Please consult the operating instructions contained in the Owner's Guide furnished with the product for information regarding user controls.

3. ANY EXPRESS WARRANTY NOT PROVIDED HEREIN, AND ANY REMEDY WHICH, BUT FOR THIS PROVISION, MIGHT ARISE BY IMPLICATION OR OPERATION OF LAW, IS HEREBY EXCLUDED AND DISCLAIMED. THE IMPLIED WARRANTIES OF MERCHANTABILITY AND OF FITNESS FOR ANY PARTICULAR PURPOSE ARE EXPRESSLY LIMITED TO A TERM OF ONE YEAR.

4. UNDER NO CIRCUMSTANCES SHALL MDEA BE LIABLE TO PURCHASER OR ANY OTHER PERSON FOR ANY INCIDENTAL, SPECIAL OR CONSEQUENTIAL DAMAGES, WHETHER ARISING OUT OF BREACH OF WARRANTY, BREACH OF CONTRACT, OR OTHERWISE.

5. Some states do not allow limitations on how long an implied warranty lasts, or the exclusion or limitation of incidental, special, or consequential damages, so the above limitations or exclusions may not apply to you.

6. This limited warranty gives you specific legal rights, and you may also have other rights which vary from state to state.

7. In the event of any dispute under this limited warranty, jurisdiction and venue for resolving that dispute will be in the state where the television was purchased and the laws of such state will govern. In no event shall Mitsubishi have any liability, including with out limitation, for general, consequential, incidental, or special damages for loss, destruction, damage or corruption of recorded data, media or software resulting from use of this television, or cost of recovery of lost data, media or software therefore.

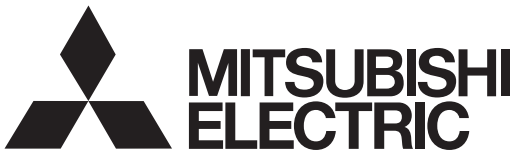

MITSUBISHI DIGITAL ELECTRONICS AMERICA, INC.
9351 Jeronimo Road
Irvine, CA 92618-1904

Network Service Disclaimer

Third party content and services, including without limitation home entertainment services by VUDU, Inc., are provided in accordance with whatever terms and conditions are established by the third party providers and agreed to by you. Mitsubishi Digital Electronics America ("MDEA") has no control over any such third parties or any agreement you reach with them. MDEA has no control over the networks or transmission facilities by which content and services are provided by third parties. Your connection to the internet may vary in availability and quality. Customer service questions are to be directed to the third-party provider, not MDEA.

MDEA DOES NOT WARRANT CONTENT OR SERVICES PROVIDED BY ANY THIRD PARTY, EITHER EXPRESSLY OR IMPLIEDLY, FOR ANY PURPOSE. MDEA DOES NOT WARRANT THAT ANY THIRD PARTY SERVICE WILL REMAIN AVAILABLE FOR ANY PERIOD OF TIME OR THAT IT WILL BE SATISFACTORY, UNINTERRUPTED OR ERROR FREE. MDEA EXPRESSLY DISCLAIMS ANY IMPLIED WARRANTIES, INCLUDING BUT NOT LIMITED TO, WARRANTIES OF MERCHANTABILITY OR FITNESS FOR A PARTICULAR PURPOSE WITH RESPECT TO ANY THIRD PARTY CONTENT AND SERVICES.

MDEA WILL NOT, UNDER ANY CIRCUMSTANCES, BE LIABLE, WHETHER IN CONTRACT OR TORT OR OTHER LEGAL THEORY, FOR ANY DIRECT, INDIRECT, INCIDENTAL, SPECIAL OR CONSEQUENTIAL DAMAGES, ATTORNEY FEES, EXPENSES, OR ANY OTHER DAMAGES ARISING OUT OF, OR IN CONNECTION WITH, YOUR USE OF ANY CONTENT OR SERVICE THAT IS PROVIDED TO YOU BY ANY THIRD PARTY, EVEN IF ADVISED OF THE POSSIBILITY OF SUCH DAMAGES.

For assistance call 1(800) 332-2119

Index

- A**
- Accent Lighting 54
 - Anamorphic Picture Format 33
 - Antenna Input (ANT) 23
 - Setting Up 14
 - Signal Strength for Digital Channels 31
 - Audio Lock (A/V receiver control) 74
 - Auto Input Sensing 15
 - Auto-Off (Sleep Timer) 29
 - Auto-On (Timer) 52
 - A/V Receiver
 - and TV's Remote Control 73
 - Audio Lock 74
 - Center Channel 28
 - Connecting 23, 24, 27
 - Controlling Sound Volume 32
 - Disconnecting Analog 32
 - NetCommand IR Control 67, 68
 - Controlling a Device Connected to the A/V Receiver 45, 71
 - Video and Audio Switching via HDMI 70
- B**
- Backlight 10, 47
 - Batteries 9
 - Blue Glow 54
 - Bluetooth Audio Playback 37
 - Brightness (picture adjustment) 47
- C**
- Cable Box
 - and TV's Remote Control 73
 - Connecting 25
 - Captions Menu 51
 - CD Player 36
 - CEC (Consumer Electronics Control) 8, 45, 81
 - A/V Receiver 32, 82
 - Troubleshooting 87
 - Center Channel 28
 - Channels
 - antennaweb.org 53
 - Favorites (Fav) 29
 - Physical/Virtual Channel Numbers 53
 - Scan (memorize) 14, 53
 - Troubleshooting 88
 - Tuning 16
 - ChannelView™ Channel Listings 30
 - Cleaning 84
 - Clock, Set Date and Time 52
 - Closed Captions 51
 - Color Adjustments
 - Menu Controls 47
 - Reset Color 48, 85
 - Computer 19, 20
 - Contrast 47
 - Control Panel 13
 - Control Panel Lock 13, 59
- D**
- Date. *See* Clock
 - Default Settings, Returning to 85
 - DIGITAL AUDIO OUTPUT 23
 - DVD Player
 - and TV's Remote Control 73
 - Connecting 24, 25
 - DVI Device, Connecting 19, 25
- F**
- FAV (Favorite Channels) 29
 - Film Mode 47
 - FORMAT (picture shape) 18
 - Freeze Picture (PAUSE key) 11
 - Front Panel
 - Blue Glow Accent Lighting 54
 - Controls 13
 - Full Native 18, 33
- G**
- Game
 - Game Picture Mode 46
 - HDMI Cables for Games 23
 - GUIDE Key
 - ChannelView 30
 - HDMI Control 83
 - NetCommand Control 64, 66
- H**
- HD (High-Definition) Signal) 31
 - HDMI
 - Changing Out an HDMI Device and Auto Input Sensing 15
 - Connecting an HDMI Device 19, 24
 - A/V Receiver with HDMI 27
 - HDMI Cable Types 23
 - HDMI Control of CEC Devices 81
 - HDMI Jack 23
 - Removing an HDMI Device from the Activity Menu 55
 - Headphones 50
- I**
- INFO Key
 - ChannelView 30
 - Status Display 31
 - INPUT Key/Input Selection Menu
 - Change Input Name 55
 - Choose Viewing Source 16
 - NetCommand-Controlled Switching of A/V Receiver Inputs 64
 - Removing a Disconnected HDMI Device 55
 - Internet 42
 - IR Emitter Placement 61
- L**
- Language
 - Changing the Menu Language 52
 - In Digital Programs 52
 - SAP (Second Audio Program) 50
 - Learn 55. *See also* NetCommand IR Control
 - Letter Box Image Display 33
 - Level Sound 50
 - Light (front panel) 13
 - Listen To 50
 - Listings 30
 - Lock TV
 - Bypassing the Lock 79
 - Lock by Channel 59
 - Lock by Ratings 58
 - Lock by Time 59
 - Lock Control Panel 59
 - Preset V-Chip Blocking 57
- M**
- Memorizing Channels 14, 53
 - Add Single Channel to Memory 53
 - MP3 Player (audio-only connection) 36
 - MUTE Key 11
- N**
- NetCommand IR Control
 - About 60
 - A/V Receiver Control 68
 - Initial Setup for Most Devices 62
 - Operating 63
 - Troubleshooting 91
- P**
- Pass Code
 - Resetting 79
 - Setting 57
 - VUDU Password 87
 - PerfectColor 48
 - Photo Viewing 35
 - Picture
 - Picture Menu Adjustments 46
 - Picture Quality and Film Mode 47
 - Shape (format) 18, 20, 33
 - Troubleshooting 89
 - Power On/Off
 - Troubleshooting 88

R

- Ratings (TV and Movie) 58
- Remote Control
 - Keys and Functions 11
 - Programming Instructions 74
 - Reset 84
- Reset
 - A/V Memory Reset (for the current input) 85
 - A/V Reset (for all inputs) 86
 - HDMI Auto Input Sensing 15
 - Pass Code 79
 - PerfectColor/PerfectTint 85
 - Remote Control 84
 - Remote Control Audio Lock 74
 - System Reset 13
 - TV Reset Comparison Guide 85

S

- Safety Instructions 4, 5
- SAP (second audio program) 50
- Satellite Receiver
 - and the Remote Control 73
 - Connecting 19, 24, 25
- Scan (memorize channels) 53
- ScreenSaver 47
- SD (Standard-Definition Signal) 31
- Service and Support 85
- Signal Definitions 31
- Signal Strength Indicator 31
- Sleep Timer 29
- Sound
 - Controlling A/V Receiver Volume (NetCommand) 68
 - Audio Lock 74
 - Level Sound 50
 - Menu Adjustments 49
- Sound Mode (audio effects) 50
- Sound Projector 38
- Standard-Definition Signal 31
- Stand Installation 6
- Status Display 31
- Stereo System. *See* A/V Receiver
- Stream TV 42
- Subwoofer 28, 49, 50
- Surround Sound
 - Rear Speakers 41
 - Simulated Surround Sound 50
 - Sound Projector 38
 - TV Audio Outputs 24
- System Reset 13, 86

T

- Time. *See* Clock
- Timer (auto-on) 52
- Time Zone. *See* Clock
- Tools Menu 12
- Troubleshooting 85

U

- USB Port 23
 - Auto Detection 15
 - File Types 34
 - Locations 22
 - USB Media Player Menu 35
 - Wireless Network Adapter 43
 - Wireless Subwoofer 28

V

- V-Chip Ratings
 - Definitions 58
 - In Status Display 31
- VCR
 - Connecting 26
 - Troubleshooting 89
- Video from a Digital Camera 36
- Video Game. *See* Game
- VUDU Movie Service 44, 87

W

- Wall-Mounting 7
- Wireless Adapter 43



Website:

www.mitsubishi-tv.com

E-mail:

MDEAservice@mdea.com

For questions, call Consumer Relations at

800-332-2119

**To order replacement or additional
remote controls,**

Visit our website www.mitsuparts.com

or call

800-553-7278

SYSTEM RESET

If the TV does not respond to the remote control, control-panel buttons, or will not power on/off, press and hold the **POWER** button on the control panel for ten seconds.

The TV will turn off. Power on the TV and the green LED will flash quickly for about one minute. Recent settings changes may be lost.