

**GE**  
Lighting  
A SAVANT COMPANY

**GRAPHICS APPROVAL**  
Approvals designate all items on checklist have been reviewed & are correct in addition to other organizational responsibilities.

REVIEWED DATE	SIGNATURE	PACKAGING GRAPHICS

Proof Reading - Spelling     Website  
 Proof against TDS request     Graphics Printability

SKU LISTING INFO:	93129894 NPI CYNC Thermostate 6421602
REVISION (DATE) PA:	1 (05-26-21) CN
BAR CODE SPEC:	<input type="checkbox"/> 100% No BWR <input type="checkbox"/> 80% No BWR <input checked="" type="checkbox"/> N/A
INSERT (IF SHARED):	None
SUPPLIER PROJECT:	N/A
PRINT METHOD:	<input type="checkbox"/> Offset/Litho <input checked="" type="checkbox"/> Flexo (direct)
GE DIE:	DL-61236
PK (VERSION):	PK-00107047-1



# PC93129894 TRC



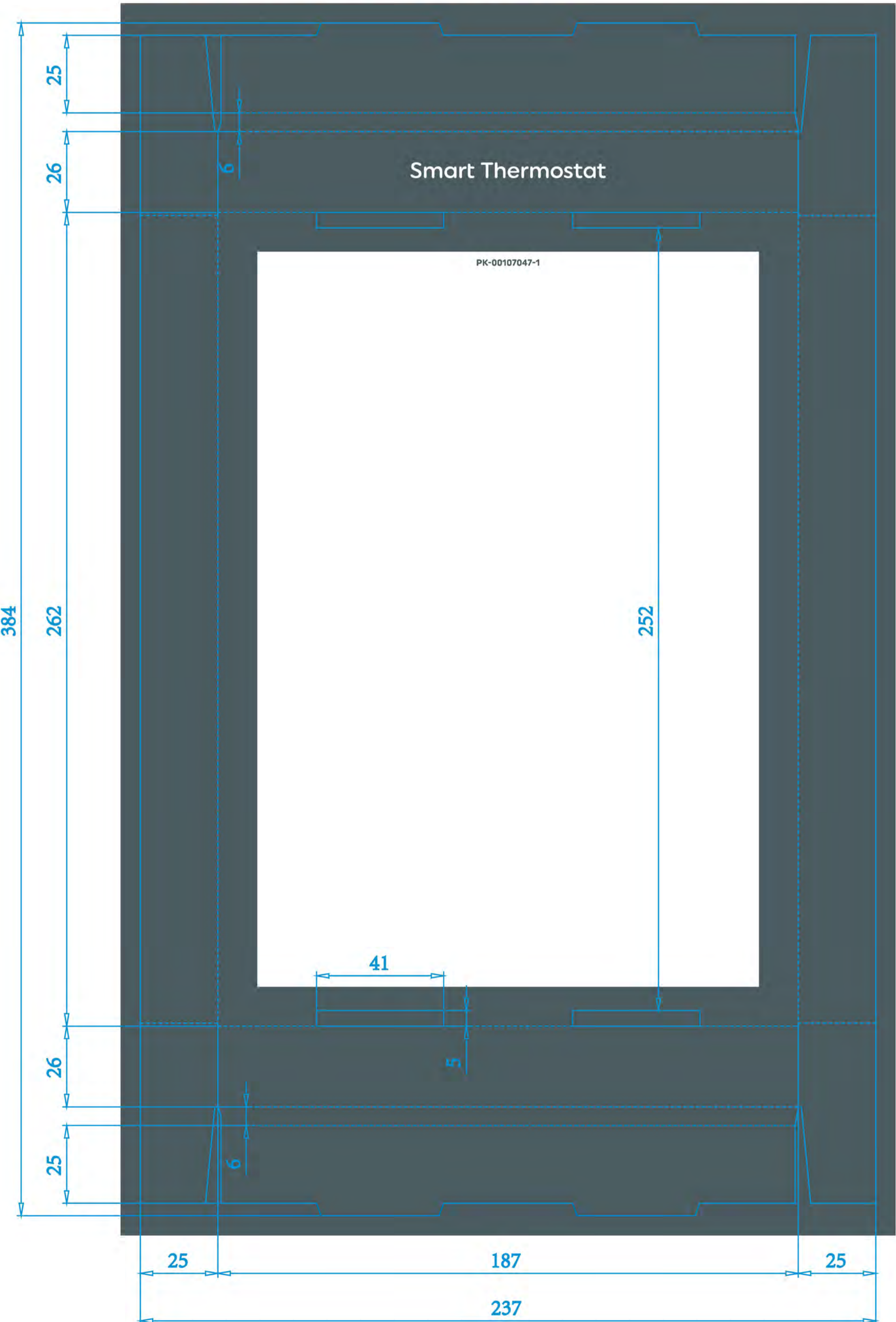





**THIS ART IS SUPPLIED AT 100% SCALE  
DO NOT RESIZE, RESHAPE OR ALTER**



<b>GE</b> Lighting A SAVANT COMPANY		<b>GRAPHICS APPROVAL</b> Approvals designate all items on checklist have been reviewed & are correct in addition to other organizational responsibilities.	<b>SKU LISTING INFO:</b> 93129894 NPI CYNCThermostat 6421602
REVIEWED DATE: _____ SIGNATURE: _____ PACKAGING GRAPHICS: _____		<input type="checkbox"/> Proof Reading - Spelling <input type="checkbox"/> Website	<b>REVISION (DATE) PA:</b> 1 (05-26-21) CN
<input type="checkbox"/> Proof against TDS request <input type="checkbox"/> Graphics Printability		<input type="checkbox"/> 100% No BWR <input type="checkbox"/> 80% No BWR <input checked="" type="checkbox"/> N/A	<b>BAR CODE SPEC:</b>
		<input type="checkbox"/> Offset/Litho <input checked="" type="checkbox"/> Flexo (direct)	<b>INSERT (IF SHARED):</b> None
			<b>SUPPLIER PROJECT:</b> N/A
			<b>PRINT METHOD:</b>
			<b>GE DIE:</b> DL-30982
			<b>PK (VERSION):</b> PK-00107048-1

# PC93129894 HSC

THIS ART IS SUPPLIED AT 100% SCALE  
DO NOT RESIZE, RESHAPE OR ALTER

<p>264</p> <p>98</p>	<p>QTY: 3</p> 	<p>PK-00107048-1</p>	<p><b>CYNCT SMART THERMOSTAT</b></p> <p>GE is a trademark of General Electric Company. Used under trademark license.</p>	
<p>185</p>	<p> <b>QTY: 3</b></p> <p><b>CYNCT SMART THERMOSTAT</b></p> <p>Manufactured for Savant Technologies LLC Nela Park Cleveland, Ohio 44112-1719 Made in China</p> <p>GE is a trademark of General Electric Company. Used under trademark license.</p> 	<p> <b>QTY: 3</b></p> <p><b>CYNCT SMART THERMOSTAT</b></p> <p>Manufactured for Savant Technologies LLC Nela Park Cleveland, Ohio 44112-1719 Made in China</p> <p>GE is a trademark of General Electric Company. Used under trademark license.</p> 	<p> <b>QTY: 3</b></p> <p><b>CYNCT SMART THERMOSTAT</b></p> <p>Manufactured for Savant Technologies LLC Nela Park Cleveland, Ohio 44112-1719 Made in China</p> <p>GE is a trademark of General Electric Company. Used under trademark license.</p> 	<p> <b>QTY: 3</b></p> <p><b>CYNCT SMART THERMOSTAT</b></p> <p>Manufactured for Savant Technologies LLC Nela Park Cleveland, Ohio 44112-1719 Made in China</p> <p>GE is a trademark of General Electric Company. Used under trademark license.</p> 
<p>30</p>	<p>270</p>	<p>195</p>	<p>958.5</p>	



**GE**  
**Lighting**  
 A SAVANT COMPANY

**GRAPHICS APPR OVAL**  
 Approvals designate all items on checklist have been reviewed & are correct in addition to other organizational responsibilities.

REVIEWED DATE	SIGNATURE	PACKAGING GRAPHICS

Proof Reading - Spelling     Website  
 Proof against TDS request     Graphics Printability

SKU LISTING INFO:	93129894 NPI CYNCR Thermostate 6421602
REVISION (DATE) PA:	1 (05-27-21) CN
BAR CODE SPEC:	<input type="checkbox"/> 100% No BWR <input type="checkbox"/> 80% No BWR <input checked="" type="checkbox"/> N/A
INSERT (IF SHARED):	NONE
SUPPLIER PROJECT:	N/A
PRINT METHOD:	<input type="checkbox"/> Offset/Litho <input type="checkbox"/> Flexo (direct)
GE DIE	NOT CONTROLLED
PK (VERSION):	PK-00107051-1

# PC93129894 QSG

THIS ART IS SUPPLIED AT 100% SCALE  
 DO NOT RESIZE, RESHAPE OR ALTER

4.5"

4.5"

Let's See What Your Smart Thermostat Can Do

**Takes control of your climate**

Schedule your Smart Thermostat in the **Cync App** to optimize your comfort and maximize energy savings

**Makes comfort more consistent**

Pair your Smart Thermostat with a **room sensor** (sold separately) to provide comfortable temperatures throughout your home

**Helps set your perfect scenes**

Create **scenes** in the **Cync App** with your Smart Thermostat and Cync or C by GE Smart Bulbs to create the perfect environment, like a going to bed scene that slowly dims the lights as the temperature decreases.

PK-00107051-1



**GE**  
Lighting  
A SAVANT COMPANY

**GRAPHICS APPR OVAL**

Approvals designate all items on checklist have been reviewed & are correct in addition to other organizational responsibilities.

REVIEWED DATE	SIGNATURE	PACKAGING GRAPHICS
---------------	-----------	--------------------

- |  |  |
|--|--|
| <input type="checkbox"/> Proof Reading - Spelling  | <input type="checkbox"/> Website               |
| <input type="checkbox"/> Proof against TDS request | <input type="checkbox"/> Graphics Printability |

SKU LISTING INFO:	93129894 NPI CYNCR Thermostate 6421602
REVISION (DATE) PA:	1 (05-27-21) CN
BAR CODE SPEC:	<input type="checkbox"/> 100% No BWR <input type="checkbox"/> 80% No BWR <input checked="" type="checkbox"/> N/A
INSERT (IF SHARED):	NONE
SUPPLIER PROJECT:	N/A
PRINT METHOD:	<input type="checkbox"/> Offset/Litho <input type="checkbox"/> Flexo (direct)
GE DIE	NOT CONTROLLED
PK (VERSION):	PK-00107051-1

# PC93129894 QSG

THIS ART IS SUPPLIED AT 100% SCALE  
DO NOT RESIZE, RESHAPE OR ALTER

4.5"

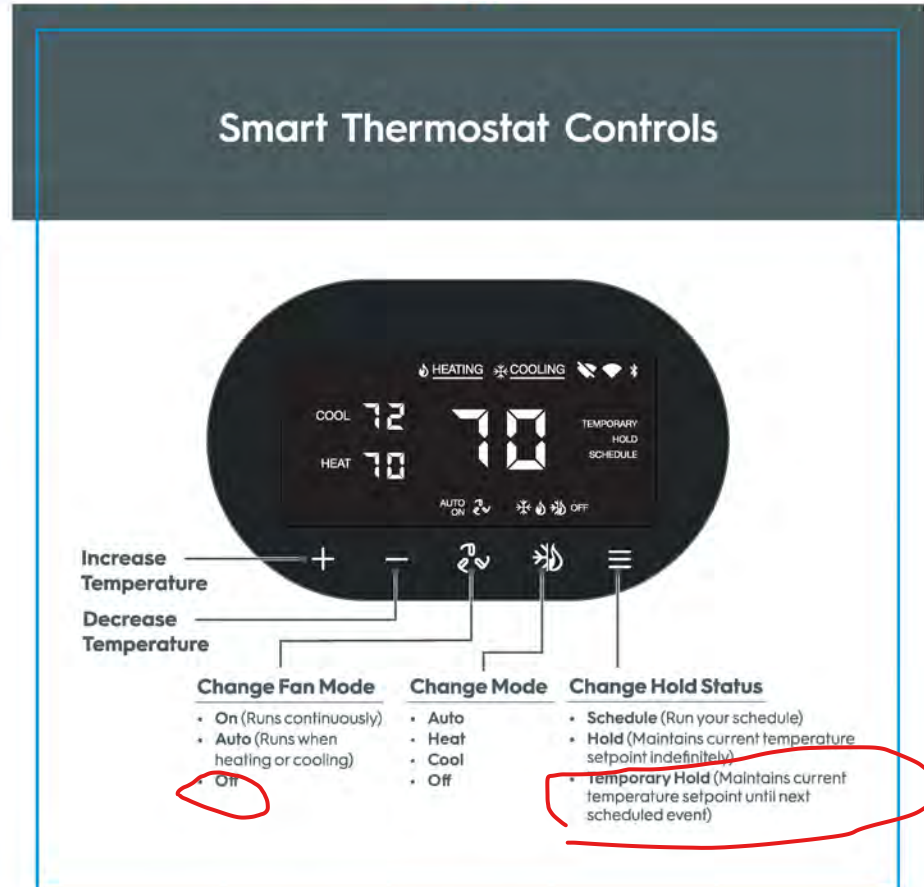

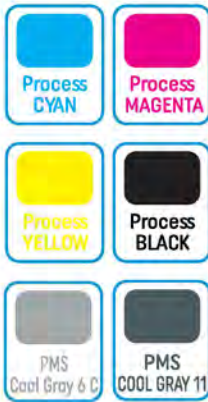

**GE**  
Lighting  
A SAVANT COMPANY

**GRAPHICS APPR OVAL**

Approvals designate all items on checklist have been reviewed & are correct in addition to other organizational responsibilities.

REVIEWED DATE	SIGNATURE	PACKAGING GRAPHICS

Proof Reading - Spelling     Website  
 Proof against TDS request     Graphics Printability

SKU LISTING INFO:	93129894 NPI CYNC Thermostate 6421602
REVISION (DATE) PA:	1 (05-27-21) CN
BAR CODE SPEC:	<input type="checkbox"/> 100% No BWR <input type="checkbox"/> 80% No BWR <input checked="" type="checkbox"/> N/A
INSERT (IF SHARED):	NONE
SUPPLIER PROJECT:	N/A
PRINT METHOD:	<input type="checkbox"/> Offset/Litho <input type="checkbox"/> Flexo (direct)
GE DIE:	NOT CONTROLLED
PK (VERSION):	PK-00107052-1

4.5"

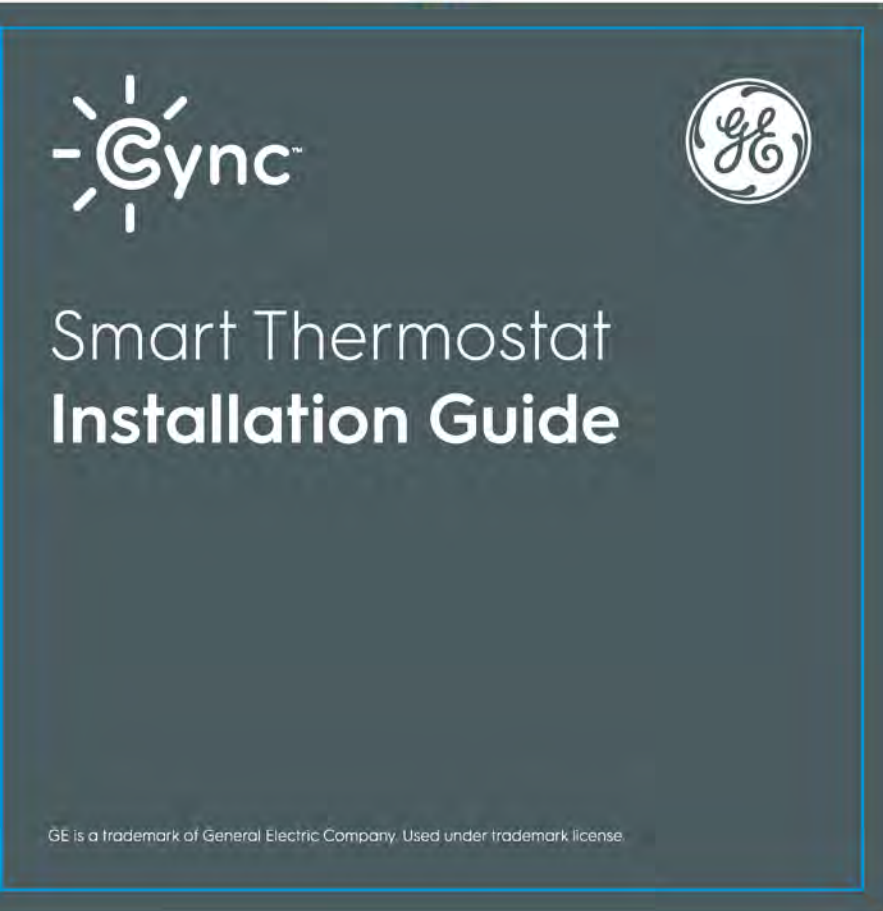

**PC93129894 ING**

**THIS ART IS SUPPLIED AT 100% SCALE  
DO NOT RESIZE, RESHAPE OR ALTER**

4.5"

		<b>GE</b> <b>Lighting</b> A SAVANT COMPANY	<b>GRAPHICS APPR OVAL</b> Approvals designate all items on checklist have been reviewed & are correct in addition to other organizational responsibilities.	SKU LISTING INFO:	93129894 NPI CYNC Thermostate 6421602	
				REVISION (DATE) PA:	1 (05-27-21) CN	
		REVIEWED DATE	SIGNATURE	PACKAGING GRAPHICS	BAR CODE SPEC:	<input type="checkbox"/> 100% No BWR <input type="checkbox"/> 80% No BWR <input checked="" type="checkbox"/> N/A
			INSERT (IF SHARED):			NONE
			SUPPLIER PROJECT:			N/A
<input type="checkbox"/> Proof Reading - Spelling <input type="checkbox"/> Website <input type="checkbox"/> Proof against TDS request <input type="checkbox"/> Graphics Printability			PRINT METHOD:			<input type="checkbox"/> Offset/Litho <input type="checkbox"/> Flexo (direct)
			GE DIE:			NOT CONTROLLED
			PK (VERSION):			PK-00107052-1



		<b>GE</b> <b>Lighting</b> A SAVANT COMPANY	<b>GRAPHICS APPR OVAL</b> Approvals designate all items on checklist have been reviewed & are correct in addition to other organizational responsibilities.	SKU LISTING INFO:	93129894 NPI CYNC Thermostate 6421602	
				REVISION (DATE) PA:	1 (05-27-21) CN	
		REVIEWED DATE	SIGNATURE	PACKAGING GRAPHICS	BAR CODE SPEC:	<input type="checkbox"/> 100% No BWR <input type="checkbox"/> 80% No BWR <input checked="" type="checkbox"/> N/A
			INSERT (IF SHARED):			NONE
			SUPPLIER PROJECT:			N/A
<input type="checkbox"/> Proof Reading - Spelling <input type="checkbox"/> Website <input type="checkbox"/> Proof against TDS request <input type="checkbox"/> Graphics Printability			PRINT METHOD:			<input type="checkbox"/> Offset/Litho <input type="checkbox"/> Flexo (direct)
			GE DIE:			NOT CONTROLLED
			PK (VERSION):			PK-00107052-1

# PC93129894 ING

THIS ART IS SUPPLIED AT 100% SCALE  
DO NOT RESIZE, RESHAPE OR ALTER

4.5"

4.5"

<h3>Compatibility Requirements</h3> <p>The Cync™ Smart Thermostat works with most central residential heating and cooling systems.</p> <p><b>Heating:</b> Up to 2 stages</p> <p><b>Cooling:</b> Up to 2 stages</p> <p><b>Heat Pumps:</b> Up to 4 heating stages and up to 2 cooling stages</p>	<h3>Simple DIY Set Up</h3> <div style="margin-bottom: 10px;">  <p><b>STEP 1</b> Download the Cync App, powered by Savant, on your smartphone</p> </div> <div style="margin-bottom: 10px;">  <p><b>STEP 2</b> Install your Thermostat</p> </div> <div>  <p><b>STEP 3</b> Add your Thermostat to the Cync App <b>NOTE:</b> If you're installing the thermostat without the Cync App, skip to page 16 for setup instructions</p> </div> <p style="text-align: center; font-size: small;">For set up help, visit <a href="http://support.gelighting.com">support.gelighting.com</a> or call 1-844-302-2943</p>
--	---

2

3

# PC93129894 ING

THIS ART IS SUPPLIED AT 100% SCALE  
DO NOT RESIZE, RESHAPE OR ALTER

4.5"

4.5"

		<b>GE</b> <b>Lighting</b> A SAVANT COMPANY	<b>GRAPHICS APPR OVAL</b> Approvals designate all items on checklist have been reviewed & are correct in addition to other organizational responsibilities.	<b>SKU LISTING INFO:</b> 93129894 NPI CYNC Thermostate 6421602
				<b>REVISION (DATE) PA:</b> 1 (05-27-21) CN
		REVIEWED DATE: _____ SIGNATURE: _____ PACKAGING GRAPHICS: _____	<b>BAR CODE SPEC:</b> <input type="checkbox"/> 100% No BWR <input type="checkbox"/> 80% No BWR <input checked="" type="checkbox"/> N/A	<b>INSERT (IF SHARED):</b> NONE
<input type="checkbox"/> Proof Reading - Spelling <input type="checkbox"/> Website <input type="checkbox"/> Proof against TDS request <input type="checkbox"/> Graphics Printability			<b>SUPPLIER PROJECT:</b> N/A	<b>PRINT METHOD:</b> <input type="checkbox"/> Offset/Litho <input type="checkbox"/> Flexo (direct)
			<b>GE DIE:</b> NOT CONTROLLED	<b>PK (VERSION):</b> PK-00107052-1

		<b>GE</b> <b>Lighting</b> A SAVANT COMPANY	<b>GRAPHICS APPR OVAL</b> Approvals designate all items on checklist have been reviewed & are correct in addition to other organizational responsibilities.	<b>SKU LISTING INFO:</b> 93129894 NPI CYNC Thermostate 6421602
				<b>REVISION (DATE) PA:</b> 1 (05-27-21) CN
		REVIEWED DATE: _____ SIGNATURE: _____ PACKAGING GRAPHICS: _____	<b>BAR CODE SPEC:</b> <input type="checkbox"/> 100% No BWR <input type="checkbox"/> 80% No BWR <input checked="" type="checkbox"/> N/A	<b>INSERT (IF SHARED):</b> NONE
<input type="checkbox"/> Proof Reading - Spelling <input type="checkbox"/> Website <input type="checkbox"/> Proof against TDS request <input type="checkbox"/> Graphics Printability			<b>SUPPLIER PROJECT:</b> N/A	<b>PRINT METHOD:</b> <input type="checkbox"/> Offset/Litho <input type="checkbox"/> Flexo (direct)
			<b>GE DIE:</b> NOT CONTROLLED	<b>PK (VERSION):</b> PK-00107052-1

# PC93129894 ING

THIS ART IS SUPPLIED AT 100% SCALE  
DO NOT RESIZE, RESHAPE OR ALTER

4.5"
4.5"

Let's Do It

**YOU'LL NEED**



Phillips Screwdriver



Drill for Installing Anchors (1/4" drill bit)



Pencil

**INCLUDED**



Thermostat



Back Plate



Trim Plate (Optional)



Power Extender Kit (Required when C-wire isn't present)



2 Screws & 2 Wall Anchors



Wire Labels

4.5"
4.5"

# PC93129894 ING

THIS ART IS SUPPLIED AT 100% SCALE  
DO NOT RESIZE, RESHAPE OR ALTER

		<b>GE</b> <b>Lighting</b> A SAVANT COMPANY	<b>GRAPHICS APPR OVAL</b> Approvals designate all items on checklist have been reviewed & are correct in addition to other organizational responsibilities.	<b>SKU LISTING INFO:</b> 93129894 NPI CYNC Thermostate 6421602
				<b>REVISION (DATE) PA:</b> 1 (05-27-21) CN
		REVIEWED DATE SIGNATURE PACKAGING GRAPHICS		<b>BAR CODE SPEC:</b> <input type="checkbox"/> 100% No BWR <input type="checkbox"/> 80% No BWR <input checked="" type="checkbox"/> N/A
		<input type="checkbox"/> Proof Reading - Spelling <input type="checkbox"/> Website <input type="checkbox"/> Proof against TDS request <input type="checkbox"/> Graphics Printability		<b>INSERT (IF SHARED):</b> NONE
				<b>SUPPLIER PROJECT:</b> N/A
				<b>PRINT METHOD:</b> <input type="checkbox"/> Offset/Litho <input type="checkbox"/> Flexo (direct)
				<b>GE DIE:</b> NOT CONTROLLED
				<b>PK (VERSION):</b> PK-00107052-1

		<b>GE</b> <b>Lighting</b> A SAVANT COMPANY	<b>GRAPHICS APPR OVAL</b> Approvals designate all items on checklist have been reviewed & are correct in addition to other organizational responsibilities.	<b>SKU LISTING INFO:</b> 93129894 NPI CYNC Thermostate 6421602
				<b>REVISION (DATE) PA:</b> 1 (05-27-21) CN
		REVIEWED DATE SIGNATURE PACKAGING GRAPHICS		<b>BAR CODE SPEC:</b> <input type="checkbox"/> 100% No BWR <input type="checkbox"/> 80% No BWR <input checked="" type="checkbox"/> N/A
		<input type="checkbox"/> Proof Reading - Spelling <input type="checkbox"/> Website <input type="checkbox"/> Proof against TDS request <input type="checkbox"/> Graphics Printability		<b>INSERT (IF SHARED):</b> NONE
				<b>SUPPLIER PROJECT:</b> N/A
				<b>PRINT METHOD:</b> <input type="checkbox"/> Offset/Litho <input type="checkbox"/> Flexo (direct)
				<b>GE DIE:</b> NOT CONTROLLED
				<b>PK (VERSION):</b> PK-00107052-1





# PC93129894 ING

THIS ART IS SUPPLIED AT 100% SCALE  
DO NOT RESIZE, RESHAPE OR ALTER

# PC93129894 ING

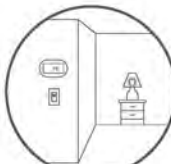
THIS ART IS SUPPLIED AT 100% SCALE  
DO NOT RESIZE, RESHAPE OR ALTER

4.5"
4.5"

Choosing a Location	BEFORE YOU DO ANYTHING! Turn Off the Power!
<p>To ensure proper temperature and humidity reading, please install your thermostat in a location that meets the following requirements:</p> <div style="display: grid; grid-template-columns: 1fr 1fr; gap: 10px;"> <div style="text-align: center;">             On an interior wall         </div> <div style="text-align: center;">             4' to 6' above the floor         </div> <div style="text-align: center;">             Away from grills and registers or other heating and cooling sources         </div> <div style="text-align: center;">             Out of direct sunlight         </div> </div>	<div style="text-align: center;">  </div> <p><b>STEP 1</b> Power off your HVAC System.</p> <p>Before doing anything, power off your system. Check for a master switch at your HVAC equipment. If there isn't a master switch, please turn off the power at the circuit breaker box.</p> <p style="text-align: center; font-size: small;">For set up help, visit <a href="http://support.gelighting.com">support.gelighting.com</a> or call 1-844-302-2943</p>
6	7

4.5"
4.5"



		<b>GE</b> <b>Lighting</b> A SAVANT COMPANY	<b>GRAPHICS APPR OVAL</b> Approvals designate all items on checklist have been reviewed & are correct in addition to other organizational responsibilities.	<b>SKU LISTING INFO:</b> 93129894 NPI CYNC Thermostate 6421602
				<b>REVISION (DATE) PA:</b> 1 (05-27-21) CN
		REVIEWED DATE SIGNATURE PACKAGING GRAPHICS	<b>BAR CODE SPEC:</b> <input type="checkbox"/> 100% No BWR <input type="checkbox"/> 80% No BWR <input checked="" type="checkbox"/> N/A	<b>INSERT (IF SHARED):</b> NONE
<input type="checkbox"/> Proof Reading - Spelling <input type="checkbox"/> Website <input type="checkbox"/> Proof against TDS request <input type="checkbox"/> Graphics Printability			<b>SUPPLIER PROJECT:</b> N/A	<b>PRINT METHOD:</b> <input type="checkbox"/> Offset/Litho <input type="checkbox"/> Flexo (direct)
			<b>GE DIE:</b> NOT CONTROLLED	<b>PK (VERSION):</b> PK-00107052-1

		<b>GE</b> <b>Lighting</b> A SAVANT COMPANY	<b>GRAPHICS APPR OVAL</b> Approvals designate all items on checklist have been reviewed & are correct in addition to other organizational responsibilities.	<b>SKU LISTING INFO:</b> 93129894 NPI CYNC Thermostate 6421602
				<b>REVISION (DATE) PA:</b> 1 (05-27-21) CN
		REVIEWED DATE SIGNATURE PACKAGING GRAPHICS	<b>BAR CODE SPEC:</b> <input type="checkbox"/> 100% No BWR <input type="checkbox"/> 80% No BWR <input checked="" type="checkbox"/> N/A	<b>INSERT (IF SHARED):</b> NONE
<input type="checkbox"/> Proof Reading - Spelling <input type="checkbox"/> Website <input type="checkbox"/> Proof against TDS request <input type="checkbox"/> Graphics Printability			<b>SUPPLIER PROJECT:</b> N/A	<b>PRINT METHOD:</b> <input type="checkbox"/> Offset/Litho <input type="checkbox"/> Flexo (direct)
			<b>GE DIE:</b> NOT CONTROLLED	<b>PK (VERSION):</b> PK-00107052-1

# PC93129894 ING

THIS ART IS SUPPLIED AT 100% SCALE  
DO NOT RESIZE, RESHAPE OR ALTER

4.5"

### Label the Wires

**STEP 1**

Remove the cover from the old thermostat. If you don't see screws on the thermostat, it should just pull off.

▲ *If the old thermostat has 110/120V wires with wire nuts, it is a high voltage system and not compatible with the Cync™ Thermostat.*

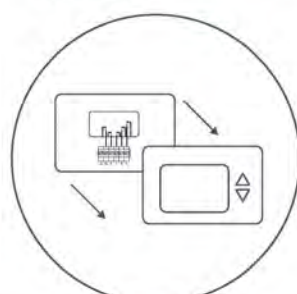

**STEP 2**

Please take a picture of the wires coming out of the wall for reference later.

**STEP 3**

Using the wire labels provided, label each wire based on where it's connected to the old thermostat base

**NOTE:** if your thermostat is using "W" and "Y" terminals, please use the "W1" and "Y1" labels, respectively

If you don't have a common wire, labeled "C", please go to *Install Power Extender Kit* on page 16.  
If you used the common wire, labeled "C" above, please go to the next page.

8

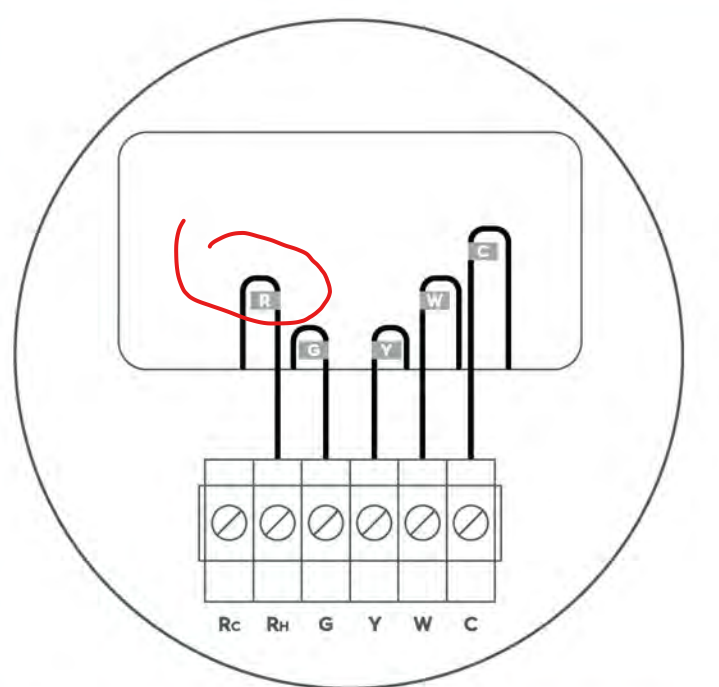

Rc Rh G Y W C

For set up help, visit [support.gelighting.com](http://support.gelighting.com) or call 1-844-302-2943

9

4.5"

# PC93129894 ING

THIS ART IS SUPPLIED AT 100% SCALE  
DO NOT RESIZE, RESHAPE OR ALTER

		<b>GE</b> <b>Lighting</b> A SAVANT COMPANY	<b>GRAPHICS APPR OVAL</b> Approvals designate all items on checklist have been reviewed & are correct in addition to other organizational responsibilities.	SKU LISTING INFO:	93129894 NPI CYNC Thermostate 6421602	
				REVISION (DATE) PA:	1 (05-27-21) CN	
		REVIEWED DATE	SIGNATURE	PACKAGING GRAPHICS	BAR CODE SPEC:	<input type="checkbox"/> 100% No BWR <input type="checkbox"/> 80% No BWR <input checked="" type="checkbox"/> N/A
			INSERT (IF SHARED): NONE			
			SUPPLIER PROJECT: N/A			
			PRINT METHOD: <input type="checkbox"/> Offset/Litho <input type="checkbox"/> Flexo (direct)			
			GE DIE: NOT CONTROLLED			
			PK (VERSION): PK-00107052-1			
<input type="checkbox"/> Proof Reading - Spelling <input type="checkbox"/> Website <input type="checkbox"/> Proof against TDS request <input type="checkbox"/> Graphics Printability						

		<b>GE</b> <b>Lighting</b> A SAVANT COMPANY	<b>GRAPHICS APPR OVAL</b> Approvals designate all items on checklist have been reviewed & are correct in addition to other organizational responsibilities.	SKU LISTING INFO:	93129894 NPI CYNC Thermostate 6421602	
				REVISION (DATE) PA:	1 (05-27-21) CN	
		REVIEWED DATE	SIGNATURE	PACKAGING GRAPHICS	BAR CODE SPEC:	<input type="checkbox"/> 100% No BWR <input type="checkbox"/> 80% No BWR <input checked="" type="checkbox"/> N/A
			INSERT (IF SHARED): NONE			
			SUPPLIER PROJECT: N/A			
			PRINT METHOD: <input type="checkbox"/> Offset/Litho <input type="checkbox"/> Flexo (direct)			
			GE DIE: NOT CONTROLLED			
			PK (VERSION): PK-00107052-1			
<input type="checkbox"/> Proof Reading - Spelling <input type="checkbox"/> Website <input type="checkbox"/> Proof against TDS request <input type="checkbox"/> Graphics Printability						

# PC93129894 ING

THIS ART IS SUPPLIED AT 100% SCALE  
DO NOT RESIZE, RESHAPE OR ALTER

4.5"

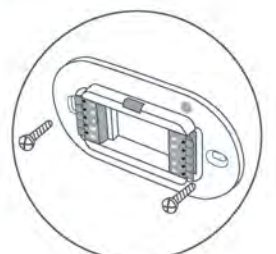
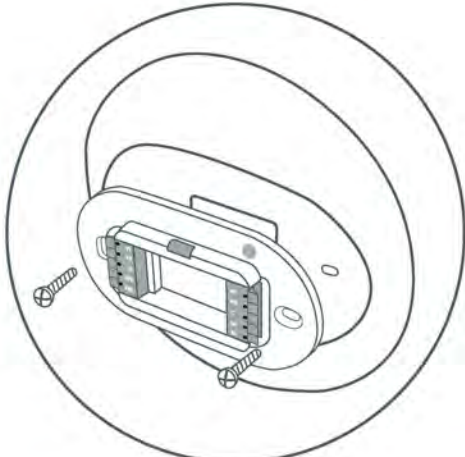
4.5"	4.5"
<h3>Attach Back Plate To Wall</h3> <p><b>STEP 1</b> Remove the old thermostat base by unscrewing it from the wall. Be sure the wires don't fall back into the wall.</p> <p><b>STEP 2</b> Position the back plate on the wall and use the built-in level to make sure it's straight. Mark the mounting locations on the wall with a pencil. If installing in a new location, follow the location recommendations on page 6.</p> <p><b>STEP 3</b> Drill mounting holes for the drywall anchors using 1/4" drill bit.</p> <p><b>STEP 4</b> Insert the wall anchors and position the back plate so that it aligns with the mounting holes. If the mounting holes from your old thermostat are still visible, proceed to the <b>Attach Trim Plate To Wall</b> instructions on page 11. If the back plate covers the old holes, insert and tighten the screws with a Phillips screwdriver and proceed to the <b>Connect Wires</b> step on the next page.</p> 	<h3>Attach Trim Plate To Wall (optional)</h3> <p><b>STEP 1</b> If the trim plate is needed, place it between the back plate and the wall and then secure the back plate to the wall using the provided screws. You may have to center the trim plate with the back plate before tightening the screws down.</p>  <p>For set up help, visit <a href="http://support.gelighting.com">support.gelighting.com</a> or call 1-844-302-2943</p>
4.5"	4.5"

# PC93129894 ING

THIS ART IS SUPPLIED AT 100% SCALE  
DO NOT RESIZE, RESHAPE OR ALTER

		<b>GE</b> <b>Lighting</b> A SAVANT COMPANY	<b>GRAPHICS APPR OVAL</b> Approvals designate all items on checklist have been reviewed & are correct in addition to other organizational responsibilities.	SKU LISTING INFO:	93129894 NPI CYNC Thermostate 6421602
				REVISION (DATE) PA:	1 (05-27-21) CN
				BAR CODE SPEC:	<input type="checkbox"/> 100% No BWR <input type="checkbox"/> 80% No BWR <input checked="" type="checkbox"/> N/A
REVIEWED DATE		SIGNATURE	PACKAGING GRAPHICS	INSERT (IF SHARED):	NONE
<input type="checkbox"/> Proof Reading - Spelling		<input type="checkbox"/> Website		SUPPLIER PROJECT:	N/A
<input type="checkbox"/> Proof against TDS request		<input type="checkbox"/> Graphics Printability		PRINT METHOD:	<input type="checkbox"/> Offset/Litho <input type="checkbox"/> Flexo (direct)
				GE DIE:	NOT CONTROLLED
				PK (VERSION):	PK-00107052-1

		<b>GE</b> <b>Lighting</b> A SAVANT COMPANY	<b>GRAPHICS APPR OVAL</b> Approvals designate all items on checklist have been reviewed & are correct in addition to other organizational responsibilities.	SKU LISTING INFO:	93129894 NPI CYNC Thermostate 6421602
				REVISION (DATE) PA:	1 (05-27-21) CN
				BAR CODE SPEC:	<input type="checkbox"/> 100% No BWR <input type="checkbox"/> 80% No BWR <input checked="" type="checkbox"/> N/A
REVIEWED DATE		SIGNATURE	PACKAGING GRAPHICS	INSERT (IF SHARED):	NONE
<input type="checkbox"/> Proof Reading - Spelling		<input type="checkbox"/> Website		SUPPLIER PROJECT:	N/A
<input type="checkbox"/> Proof against TDS request		<input type="checkbox"/> Graphics Printability		PRINT METHOD:	<input type="checkbox"/> Offset/Litho <input type="checkbox"/> Flexo (direct)
				GE DIE:	NOT CONTROLLED
				PK (VERSION):	PK-00107052-1

# PC93129894 ING

THIS ART IS SUPPLIED AT 100% SCALE  
DO NOT RESIZE, RESHAPE OR ALTER

4.5"
4.5"

### Connect Wires

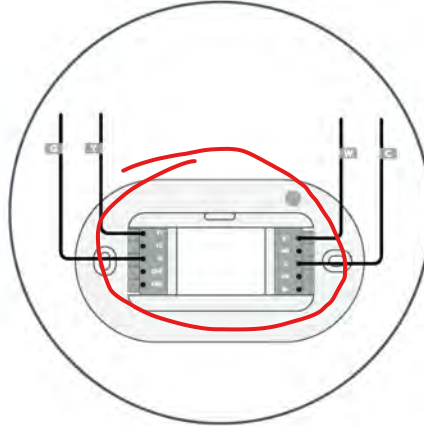

**STEP 1**

Press the lever to slide the wire into the terminal. The lever will stay depressed when the wire is in the terminal.

Insert Y Label into Y1 terminal  
Insert W Label into W1 terminal  
Insert G Label into G terminal  
Insert C Label into C terminal

Once inserted, give the wire a little tug to ensure it is securely in place. To release, press the lever of the terminal block and pull out the wire. Once all the wires are installed, try and push excess wires back into the wall

**STEP 2**

Attach the Cync™ thermostat to the wall plate.

12

### Turn the Power Back On



**STEP 1**

Power on your HVAC equipment and your Cync™ Thermostat will automatically power on.

**STEP 2**

Follow the directions in the Cync™ App to finish the setup process.

For set up help, visit [support.gelighting.com](http://support.gelighting.com) or call 1-844-302-2943

### Congratulations!

You've completed the Thermostat installation

13

# PC93129894 ING

THIS ART IS SUPPLIED AT 100% SCALE  
DO NOT RESIZE, RESHAPE OR ALTER

4.5"

		<b>GE</b> <b>Lighting</b> A SAVANT COMPANY	<b>GRAPHICS APPR OVAL</b> Approvals designate all items on checklist have been reviewed & are correct in addition to other organizational responsibilities.	SKU LISTING INFO:	93129894 NPI CYNCR Thermostate 6421602
				REVISION (DATE) PA:	1 (05-27-21) CN
				BAR CODE SPEC:	<input type="checkbox"/> 100% No BWR <input type="checkbox"/> 80% No BWR <input checked="" type="checkbox"/> N/A
REVIEWED DATE		SIGNATURE	PACKAGING GRAPHICS	INSERT (IF SHARED):	NONE
<input type="checkbox"/> Proof Reading - Spelling		<input type="checkbox"/> Website		SUPPLIER PROJECT:	N/A
<input type="checkbox"/> Proof against TDS request		<input type="checkbox"/> Graphics Printability		PRINT METHOD:	<input type="checkbox"/> Offset/Litho <input type="checkbox"/> Flexo (direct)
				GE DIE:	NOT CONTROLLED
				PK (VERSION):	PK-00107052-1

		<b>GE</b> <b>Lighting</b> A SAVANT COMPANY	<b>GRAPHICS APPR OVAL</b> Approvals designate all items on checklist have been reviewed & are correct in addition to other organizational responsibilities.	SKU LISTING INFO:	93129894 NPI CYNCR Thermostate 6421602
				REVISION (DATE) PA:	1 (05-27-21) CN
				BAR CODE SPEC:	<input type="checkbox"/> 100% No BWR <input type="checkbox"/> 80% No BWR <input checked="" type="checkbox"/> N/A
REVIEWED DATE		SIGNATURE	PACKAGING GRAPHICS	INSERT (IF SHARED):	NONE
<input type="checkbox"/> Proof Reading - Spelling		<input type="checkbox"/> Website		SUPPLIER PROJECT:	N/A
<input type="checkbox"/> Proof against TDS request		<input type="checkbox"/> Graphics Printability		PRINT METHOD:	<input type="checkbox"/> Offset/Litho <input type="checkbox"/> Flexo (direct)
				GE DIE:	NOT CONTROLLED
				PK (VERSION):	PK-00107052-1

# PC93129894 ING

THIS ART IS SUPPLIED AT 100% SCALE  
DO NOT RESIZE, RESHAPE OR ALTER

4.5"

4.5"

## Optimize The Temperature In The Room

(Room Sensor sold separately)

The optional Room Sensors (sold separately) measures the temperature away from your thermostat. Place the sensors in the rooms you spend the most time in during the day.

Set the schedules in the Cync App so that your HVAC adjusts temperature to the room you're in during different times of day.

Morning/Afternoon: Home Office

Evening: Family Room

Nighttime: Bedroom

Group your thermostat with Cync smart lights and create bedtime/wake up scenes that adjust the lighting and temperature in your bedroom.



14

4.5"

4.5"

## Enable Your Voice Assistant

Click **settings** in the Cync App. Then click the **voice assistant** you'd like to enable and follow the in-app setup instructions.

### AMAZON ALEXA

To set up, open the Alexa app, search for the Cync skill, follow the setup instructions.

### TRY THIS...

Alexa, turn the heat off.  
Alexa, set temperature to 68 degrees.

### HEY GOOGLE

To set up, open the Hey Google or Google Home app, search for the Cync action, follow the setup instructions.

### TRY THIS...

Hey Google, set temperature to 72 degrees.  
Hey Google, I'm leaving.  
Hey Google, turn on air conditioning

For set up help, visit [support.gelighting.com](http://support.gelighting.com) or call 1-844-302-2943

Amazon, Alexa, and all related logos are trademarks of Amazon.com, Inc. or its affiliates.  
Google and other related marks and logos are trademarks of Google LLC.

15

# PC93129894 ING

THIS ART IS SUPPLIED AT 100% SCALE  
DO NOT RESIZE, RESHAPE OR ALTER

		<b>GE</b> <b>Lighting</b> A SAVANT COMPANY <b>GRAPHICS APPR OVAL</b> Approvals designate all items on checklist have been reviewed & are correct in addition to other organizational responsibilities.	<b>SKU LISTING INFO:</b> 93129894 NPI CYNC Thermostate 6421602 <b>REVISION (DATE) PA:</b> 1 (05-27-21) CN <b>BAR CODE SPEC:</b> <input type="checkbox"/> 100% No BWR <input type="checkbox"/> 80% No BWR <input checked="" type="checkbox"/> N/A <b>INSERT (IF SHARED):</b> NONE <b>SUPPLIER PROJECT:</b> N/A <b>PRINT METHOD:</b> <input type="checkbox"/> Offset/Litho <input type="checkbox"/> Flexo (direct) <b>GE DIE:</b> NOT CONTROLLED <b>PK (VERSION):</b> PK-00107052-1
			<b>REVIEWED DATE:</b> _____ <b>SIGNATURE:</b> _____ <b>PACKAGING GRAPHICS:</b> _____
			<input type="checkbox"/> Proof Reading - Spelling <input type="checkbox"/> Website <input type="checkbox"/> Proof against TDS request <input type="checkbox"/> Graphics Printability

		<b>GE</b> <b>Lighting</b> A SAVANT COMPANY <b>GRAPHICS APPR OVAL</b> Approvals designate all items on checklist have been reviewed & are correct in addition to other organizational responsibilities.	<b>SKU LISTING INFO:</b> 93129894 NPI CYNC Thermostate 6421602 <b>REVISION (DATE) PA:</b> 1 (05-27-21) CN <b>BAR CODE SPEC:</b> <input type="checkbox"/> 100% No BWR <input type="checkbox"/> 80% No BWR <input checked="" type="checkbox"/> N/A <b>INSERT (IF SHARED):</b> NONE <b>SUPPLIER PROJECT:</b> N/A <b>PRINT METHOD:</b> <input type="checkbox"/> Offset/Litho <input type="checkbox"/> Flexo (direct) <b>GE DIE:</b> NOT CONTROLLED <b>PK (VERSION):</b> PK-00107052-1
			<b>REVIEWED DATE:</b> _____ <b>SIGNATURE:</b> _____ <b>PACKAGING GRAPHICS:</b> _____
			<input type="checkbox"/> Proof Reading - Spelling <input type="checkbox"/> Website <input type="checkbox"/> Proof against TDS request <input type="checkbox"/> Graphics Printability

# PC93129894 ING

THIS ART IS SUPPLIED AT 100% SCALE  
DO NOT RESIZE, RESHAPE OR ALTER

4.5"

4.5"

## Installation Without Using The Cync App

You can set up your thermostat without the Cync App. Follow the set up steps below.

Please note the default is a conventional system with single stage heating and cooling.

To select a different HVAC System Type, press and hold the "+" and "-" buttons simultaneously for 10 seconds.

The current temperature digits will show a code 01 through 09

Using the up/down arrows to select the correct system below

- 01** - Single Stage Conventional Cooling
- 02** - Single stage Conventional Heating
- 03** - Single Stage Conventional Heating/Cooling

- 04** - Single Compressor Heat Pump (1-AUX)
- 05** - Two Compressors of 2 Speed Compressor Heat Pump (1-AUX)
- 06** - Two Compressors or 2 Speed Heat Pump (2-AUX)
- 07** - Two Stage Conventional Cooling
- 08** - Two Stage Conventional Heating
- 09** - Two Stage Conventional Heating/Cooling

Once the preferred code is selected, press and hold the "+" and "-" buttons simultaneously for 5 seconds

Please note features like schedule will not be enabled until the thermostat is commissioned

For set up help, visit [support.gelighting.com](http://support.gelighting.com) or call 1-844-302-2943

4.5"

4.5"

## Install Power Extender Kit (PEK)

In some cases there may not be enough wires running to your new Cync™ thermostat, so to provide power to your new thermostat, the PEK is used to provide power to your new Cync™ thermostat.

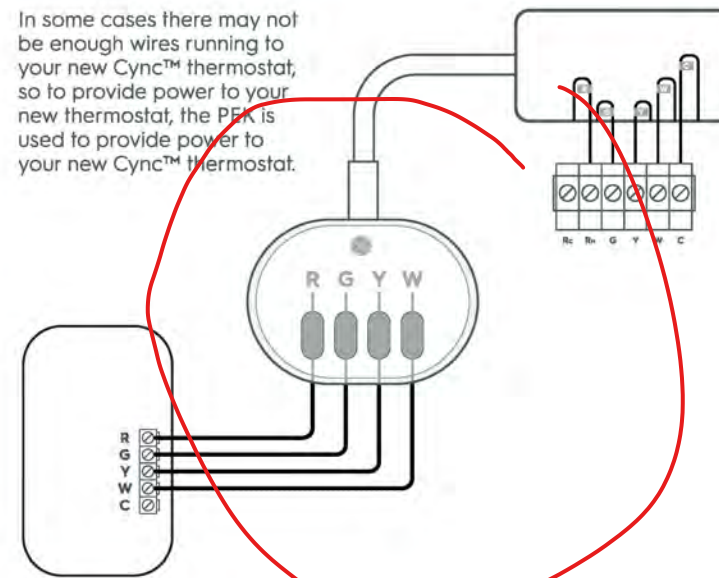

# PC93129894 ING

THIS ART IS SUPPLIED AT 100% SCALE  
DO NOT RESIZE, RESHAPE OR ALTER

		<b>GE</b> <b>Lighting</b> A SAVANT COMPANY	<b>GRAPHICS APPR OVAL</b> Approvals designate all items on checklist have been reviewed & are correct in addition to other organizational responsibilities.	<b>SKU LISTING INFO:</b> 93129894 NPI CYNC Thermostate 6421602
				<b>REVISION (DATE) PA:</b> 1 (05-27-21) CN
		<input type="checkbox"/> Proof Reading - Spelling <input type="checkbox"/> Website <input type="checkbox"/> Proof against TDS request <input type="checkbox"/> Graphics Printability	<b>BAR CODE SPEC:</b> <input type="checkbox"/> 100% No BWR <input type="checkbox"/> 80% No BWR <input checked="" type="checkbox"/> N/A	<b>INSERT (IF SHARED):</b> NONE
REVIEWED DATE: _____ SIGNATURE: _____ PACKAGING GRAPHICS: _____		<b>SUPPLIER PROJECT:</b> N/A	<b>PRINT METHOD:</b> <input type="checkbox"/> Offset/Litho <input type="checkbox"/> Flexo (direct)	<b>GE DIE:</b> NOT CONTROLLED
		<b>PK (VERSION):</b> PK-00107052-1		

		<b>GE</b> <b>Lighting</b> A SAVANT COMPANY	<b>GRAPHICS APPR OVAL</b> Approvals designate all items on checklist have been reviewed & are correct in addition to other organizational responsibilities.	<b>SKU LISTING INFO:</b> 93129894 NPI CYNC Thermostate 6421602
				<b>REVISION (DATE) PA:</b> 1 (05-27-21) CN
		<input type="checkbox"/> Proof Reading - Spelling <input type="checkbox"/> Website <input type="checkbox"/> Proof against TDS request <input type="checkbox"/> Graphics Printability	<b>BAR CODE SPEC:</b> <input type="checkbox"/> 100% No BWR <input type="checkbox"/> 80% No BWR <input checked="" type="checkbox"/> N/A	<b>INSERT (IF SHARED):</b> NONE
REVIEWED DATE: _____ SIGNATURE: _____ PACKAGING GRAPHICS: _____		<b>SUPPLIER PROJECT:</b> N/A	<b>PRINT METHOD:</b> <input type="checkbox"/> Offset/Litho <input type="checkbox"/> Flexo (direct)	<b>GE DIE:</b> NOT CONTROLLED
		<b>PK (VERSION):</b> PK-00107052-1		

# PC93129894 ING

THIS ART IS SUPPLIED AT 100% SCALE  
DO NOT RESIZE, RESHAPE OR ALTER

4.5"	4.5"	4.5"	4.5"
<b>Check Your Wiring Configuration</b>	<b>Locate Your HVAC System</b>		
	<p><b>STEP 1</b> The Power Extender Kit requires your system to have either of the following: 4 wires W/WI, Y/YI, G, and R (or Re or RH) or 3 wires Y/YI, G, and R (or Re or RH)</p> <p><b>STEP 2</b> Do you have these wires?</p> <p><b>IF YES:</b> Continue to the NEXT PAGE The Power Extender Kit will work with your system!</p> <p><b>IF NO:</b> Your wiring is not compatible with the Cync thermostat.</p>		
	<p><b>STEP 1</b> Take your Power Extender Kit, wire labels, tools, your smartphone, and go to your HVAC system.</p> <p>For set up help, visit <a href="http://support.gelighting.com">support.gelighting.com</a> or call 1-844-302-2943</p>		
18	19		

# PC93129894 ING

THIS ART IS SUPPLIED AT 100% SCALE  
DO NOT RESIZE, RESHAPE OR ALTER

		<b>GE</b> <b>Lighting</b> A SAVANT COMPANY	<b>GRAPHICS APPR OVAL</b> Approvals designate all items on checklist have been reviewed & are correct in addition to other organizational responsibilities.	<b>SKU LISTING INFO:</b> 93129894 NPI CYNC Thermostate 6421602
				<b>REVISION (DATE) PA:</b> 1 (05-27-21) CN
		REVIEWED DATE: _____ SIGNATURE: _____ PACKAGING GRAPHICS: _____	<b>BAR CODE SPEC:</b> <input type="checkbox"/> 100% No BWR <input type="checkbox"/> 80% No BWR <input checked="" type="checkbox"/> N/A	<b>INSERT (IF SHARED):</b> NONE
<input type="checkbox"/> Proof Reading - Spelling <input type="checkbox"/> Website <input type="checkbox"/> Proof against TDS request <input type="checkbox"/> Graphics Printability			<b>SUPPLIER PROJECT:</b> N/A	
			<b>PRINT METHOD:</b> <input type="checkbox"/> Offset/Litho <input type="checkbox"/> Flexo (direct)	
			<b>GE DIE:</b> NOT CONTROLLED	
			<b>PK (VERSION):</b> PK-00107052-1	

		<b>GE</b> <b>Lighting</b> A SAVANT COMPANY	<b>GRAPHICS APPR OVAL</b> Approvals designate all items on checklist have been reviewed & are correct in addition to other organizational responsibilities.	<b>SKU LISTING INFO:</b> 93129894 NPI CYNC Thermostate 6421602
				<b>REVISION (DATE) PA:</b> 1 (05-27-21) CN
		REVIEWED DATE: _____ SIGNATURE: _____ PACKAGING GRAPHICS: _____	<b>BAR CODE SPEC:</b> <input type="checkbox"/> 100% No BWR <input type="checkbox"/> 80% No BWR <input checked="" type="checkbox"/> N/A	<b>INSERT (IF SHARED):</b> NONE
<input type="checkbox"/> Proof Reading - Spelling <input type="checkbox"/> Website <input type="checkbox"/> Proof against TDS request <input type="checkbox"/> Graphics Printability			<b>SUPPLIER PROJECT:</b> N/A	
			<b>PRINT METHOD:</b> <input type="checkbox"/> Offset/Litho <input type="checkbox"/> Flexo (direct)	
			<b>GE DIE:</b> NOT CONTROLLED	
			<b>PK (VERSION):</b> PK-00107052-1	

# PC93129894 ING

THIS ART IS SUPPLIED AT 100% SCALE  
DO NOT RESIZE, RESHAPE OR ALTER

# PC93129894 ING

THIS ART IS SUPPLIED AT 100% SCALE  
DO NOT RESIZE, RESHAPE OR ALTER

4.5"
4.5"

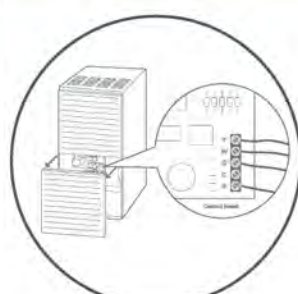
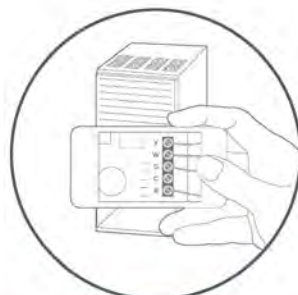
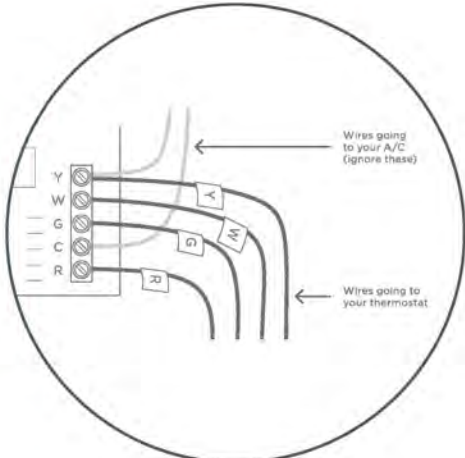
Locate The Thermostat Wiring Inside Your HVAC System	Label The Wires
<div style="display: flex; align-items: center;"> <div style="width: 20%; text-align: center;">  </div> <div> <p><b>STEP 1</b></p> <p>Open your HVAC system's cover to reveal the control board.</p> <p><b>▲ WARNING:</b> HVAC systems contain high voltage wires. Use caution when working with the control board.</p> </div> </div> <div style="display: flex; align-items: center; margin-top: 20px;"> <div style="width: 20%; text-align: center;">  </div> <div> <p><b>STEP 2</b></p> <p>Take a picture of the wires connected to your control board. You may need to reference this photo later on.</p> </div> </div>	<div style="text-align: center;">  </div> <p><b>STEP 1</b></p> <p>Label only the R, Y or YI, G, and W or WI wires with the matching labels provided. If you have more than one wire going into these terminals, only label those going to your thermostat.</p>
20	For set up help, visit <a href="http://support.gelighting.com">support.gelighting.com</a> or call 1-844-302-2943 21

		<b>GE</b> <b>Lighting</b> A SAVANT COMPANY	<b>GRAPHICS APPR OVAL</b> Approvals designate all items on checklist have been reviewed & are correct in addition to other organizational responsibilities.	SKU LISTING INFO:	93129894 NPI CYNC Thermostate 6421602	
				REVISION (DATE) PA:	1 (05-27-21) CN	
		REVIEWED DATE	SIGNATURE	PACKAGING GRAPHICS	BAR CODE SPEC:	<input type="checkbox"/> 100% No BWR <input type="checkbox"/> 80% No BWR <input checked="" type="checkbox"/> N/A
			INSERT (IF SHARED):			NONE
			SUPPLIER PROJECT:			N/A
<input type="checkbox"/> Proof Reading - Spelling <input type="checkbox"/> Website <input type="checkbox"/> Proof against TDS request <input type="checkbox"/> Graphics Printability			PRINT METHOD:			<input type="checkbox"/> Offset/Litho <input type="checkbox"/> Flexo (direct)
			GE DIE:			NOT CONTROLLED
			PK (VERSION):			PK-00107052-1

		<b>GE</b> <b>Lighting</b> A SAVANT COMPANY	<b>GRAPHICS APPR OVAL</b> Approvals designate all items on checklist have been reviewed & are correct in addition to other organizational responsibilities.	SKU LISTING INFO:	93129894 NPI CYNC Thermostate 6421602	
				REVISION (DATE) PA:	1 (05-27-21) CN	
		REVIEWED DATE	SIGNATURE	PACKAGING GRAPHICS	BAR CODE SPEC:	<input type="checkbox"/> 100% No BWR <input type="checkbox"/> 80% No BWR <input checked="" type="checkbox"/> N/A
			INSERT (IF SHARED):			NONE
			SUPPLIER PROJECT:			N/A
<input type="checkbox"/> Proof Reading - Spelling <input type="checkbox"/> Website <input type="checkbox"/> Proof against TDS request <input type="checkbox"/> Graphics Printability			PRINT METHOD:			<input type="checkbox"/> Offset/Litho <input type="checkbox"/> Flexo (direct)
			GE DIE:			NOT CONTROLLED
			PK (VERSION):			PK-00107052-1

# PC93129894 ING

THIS ART IS SUPPLIED AT 100% SCALE  
DO NOT RESIZE, RESHAPE OR ALTER

# PC93129894 ING

THIS ART IS SUPPLIED AT 100% SCALE  
DO NOT RESIZE, RESHAPE OR ALTER

4.5"
4.5"

Disconnect the Wires

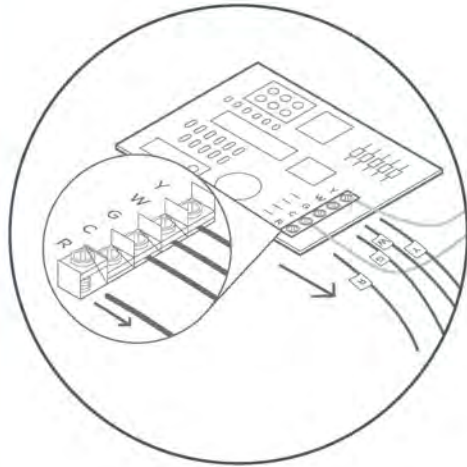

**STEP 1**

Disconnect the wires labeled R, Y, G, and W from the control board.

For set up help, visit [support.gelighting.com](http://support.gelighting.com) or call 1-844-302-2943

22

Insert the Wires Into the PEK

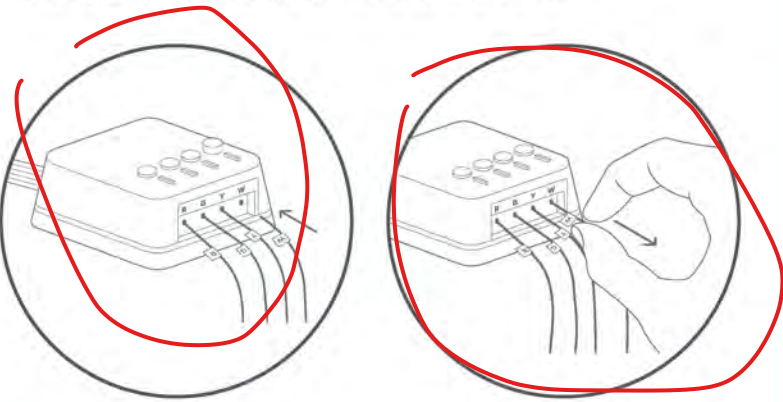

Connect the wires you disconnected from the control board into their matching gray terminal blocks on the Power Extender Kit.

23



		<b>GE</b> <b>Lighting</b> A SAVANT COMPANY	<b>GRAPHICS APPR OVAL</b> Approvals designate all items on checklist have been reviewed & are correct in addition to other organizational responsibilities.	<b>SKU LISTING INFO:</b> 93129894 NPI CYNC Thermostate 6421602
				<b>REVISION (DATE) PA:</b> 1 (05-27-21) CN
		REVIEWED DATE: _____ SIGNATURE: _____ PACKAGING GRAPHICS: _____	<b>BAR CODE SPEC:</b> <input type="checkbox"/> 100% No BWR <input type="checkbox"/> 80% No BWR <input checked="" type="checkbox"/> N/A	<b>INSERT (IF SHARED):</b> NONE
<input type="checkbox"/> Proof Reading - Spelling <input type="checkbox"/> Website <input type="checkbox"/> Proof against TDS request <input type="checkbox"/> Graphics Printability			<b>SUPPLIER PROJECT:</b> N/A	
			<b>PRINT METHOD:</b> <input type="checkbox"/> Offset/Litho <input type="checkbox"/> Flexo (direct)	
			<b>GE DIE:</b> NOT CONTROLLED	
			<b>PK (VERSION):</b> PK-00107052-1	

		<b>GE</b> <b>Lighting</b> A SAVANT COMPANY	<b>GRAPHICS APPR OVAL</b> Approvals designate all items on checklist have been reviewed & are correct in addition to other organizational responsibilities.	<b>SKU LISTING INFO:</b> 93129894 NPI CYNC Thermostate 6421602
				<b>REVISION (DATE) PA:</b> 1 (05-27-21) CN
		REVIEWED DATE: _____ SIGNATURE: _____ PACKAGING GRAPHICS: _____	<b>BAR CODE SPEC:</b> <input type="checkbox"/> 100% No BWR <input type="checkbox"/> 80% No BWR <input checked="" type="checkbox"/> N/A	<b>INSERT (IF SHARED):</b> NONE
<input type="checkbox"/> Proof Reading - Spelling <input type="checkbox"/> Website <input type="checkbox"/> Proof against TDS request <input type="checkbox"/> Graphics Printability			<b>SUPPLIER PROJECT:</b> N/A	
			<b>PRINT METHOD:</b> <input type="checkbox"/> Offset/Litho <input type="checkbox"/> Flexo (direct)	
			<b>GE DIE:</b> NOT CONTROLLED	
			<b>PK (VERSION):</b> PK-00107052-1	

# PC93129894 ING

THIS ART IS SUPPLIED AT 100% SCALE  
DO NOT RESIZE, RESHAPE OR ALTER

4.5"
4.5"

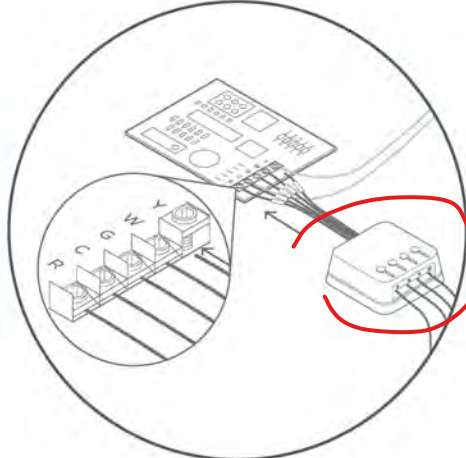
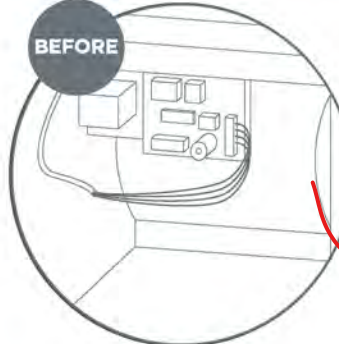
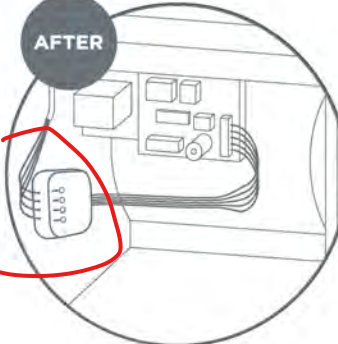
PEK Installation	Check Power Extender Kit Installation
<div style="text-align: center;">  </div> <p><b>STEP 1</b> Once again, tug on the wires gently to ensure they are securely connected.</p>	<p>Check that you have installed the Power Extender Kit correctly. It should be installed between your thermostat wiring and your control board.</p> <div style="display: flex; justify-content: space-around;"> <div style="text-align: center;"> <p><b>BEFORE</b></p>  </div> <div style="text-align: center;"> <p><b>AFTER</b></p>  </div> </div> <p style="text-align: center; font-size: small;">For set up help, visit <a href="http://support.gelighting.com">support.gelighting.com</a> or call 1-844-302-2943</p>

4.5"
4.5"

# PC93129894 ING

THIS ART IS SUPPLIED AT 100% SCALE  
DO NOT RESIZE, RESHAPE OR ALTER

		<b>GE</b> <b>Lighting</b> A SAVANT COMPANY	<b>GRAPHICS APPR OVAL</b> Approvals designate all items on checklist have been reviewed & are correct in addition to other organizational responsibilities.	SKU LISTING INFO:	93129894 NPI CYNC Thermostate 6421602
				REVISION (DATE) PA:	1 (05-27-21) CN
				BAR CODE SPEC:	<input type="checkbox"/> 100% No BWR <input type="checkbox"/> 80% No BWR <input checked="" type="checkbox"/> N/A
REVIEWED DATE		SIGNATURE	PACKAGING GRAPHICS	INSERT (IF SHARED):	NONE
<input type="checkbox"/> Proof Reading - Spelling		<input type="checkbox"/> Website		SUPPLIER PROJECT:	N/A
<input type="checkbox"/> Proof against TDS request		<input type="checkbox"/> Graphics Printability		PRINT METHOD:	<input type="checkbox"/> Offset/Litho <input type="checkbox"/> Flexo (direct)
				GE DIE:	NOT CONTROLLED
				PK (VERSION):	PK-00107052-1

		<b>GE</b> <b>Lighting</b> A SAVANT COMPANY	<b>GRAPHICS APPR OVAL</b> Approvals designate all items on checklist have been reviewed & are correct in addition to other organizational responsibilities.	SKU LISTING INFO:	93129894 NPI CYNC Thermostate 6421602
				REVISION (DATE) PA:	1 (05-27-21) CN
				BAR CODE SPEC:	<input type="checkbox"/> 100% No BWR <input type="checkbox"/> 80% No BWR <input checked="" type="checkbox"/> N/A
REVIEWED DATE		SIGNATURE	PACKAGING GRAPHICS	INSERT (IF SHARED):	NONE
<input type="checkbox"/> Proof Reading - Spelling		<input type="checkbox"/> Website		SUPPLIER PROJECT:	N/A
<input type="checkbox"/> Proof against TDS request		<input type="checkbox"/> Graphics Printability		PRINT METHOD:	<input type="checkbox"/> Offset/Litho <input type="checkbox"/> Flexo (direct)
				GE DIE:	NOT CONTROLLED
				PK (VERSION):	PK-00107052-1

# PC93129894 ING

THIS ART IS SUPPLIED AT 100% SCALE  
DO NOT RESIZE, RESHAPE OR ALTER

## Mount The PEK

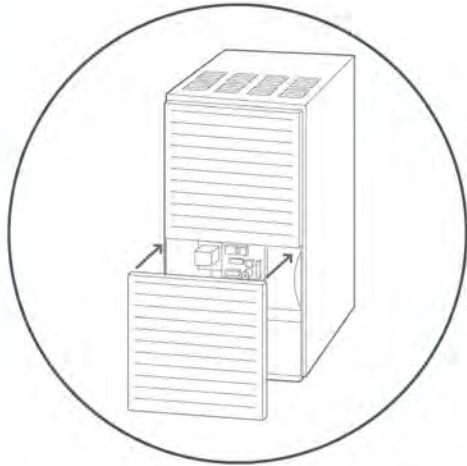

**STEP 1**

Mount the Power Extender Kit inside your HVAC system using the integrated magnet, taking care not to strain the wires. Close the HVAC cover panel securely and return to your thermostat.

***TIP:** Make sure your HVAC panel is fully closed. Some systems will not turn on if the cover panel has not been closed properly.*

Return to page 10 to complete thermostat installation

26

27

# PC93129894 ING

THIS ART IS SUPPLIED AT 100% SCALE  
DO NOT RESIZE, RESHAPE OR ALTER



**GE**  
Lighting  
A SAVANT COMPANY

**GRAPHICS APPR OVAL**

Approvals designate all items on checklist have been reviewed & are correct in addition to other organizational responsibilities.

REVIEWED DATE	SIGNATURE	PACKAGING GRAPHICS

Proof Reading - Spelling     Website  
 Proof against TDS request     Graphics Printability

SKU LISTING INFO:	93129894 NPI CYNC Thermostate 6421602
REVISION (DATE) PA:	1 (05-27-21) CN
BAR CODE SPEC:	<input type="checkbox"/> 100% No BWR <input type="checkbox"/> 80% No BWR <input checked="" type="checkbox"/> N/A
INSERT (IF SHARED):	NONE
SUPPLIER PROJECT:	N/A
PRINT METHOD:	<input type="checkbox"/> Offset/Litho <input type="checkbox"/> Flexo (direct)
GE DIE	NOT CONTROLLED
PK (VERSION):	PK-00107052-1

# PC93129894 ING

**THIS ART IS SUPPLIED AT 100% SCALE  
DO NOT RESIZE, RESHAPE OR ALTER**

4.5"

4.5"

Like your new Thermostat?  
Share your experience!

Leave a review where you purchased the product.

★★★★★

PK-00107052-1

GE is a trademark of General Electric Company. Used under trademark license.