

Thorward antenna commissioning report

Customer name: ADS

Project name: E306WH

日期: 2024. 5. 16

项目联系方式

Customer contact:
Mobile phone:
Mail box:

Soward structure:

Mobile phone:

Tel: 0755-29985185

Mail box: yangwende@szsward.com

Soward RF: Wende Yeung

Mobile: 176 7457 9060

Tel: 0755-29985185

Mail box: yangwende@szsward.com

Project profile

1. Project description

Item antenna number	Machine subtype
2	recorder
Machine shell material: plastic shell	

2. Antenna brief

Antenna number	name	Operating frequency band/MHZ	Material/Structure
1	WIFI	2400-2500MHZ	FPC
2	BT	2400-2500MHZ	FPC

Antenna layout

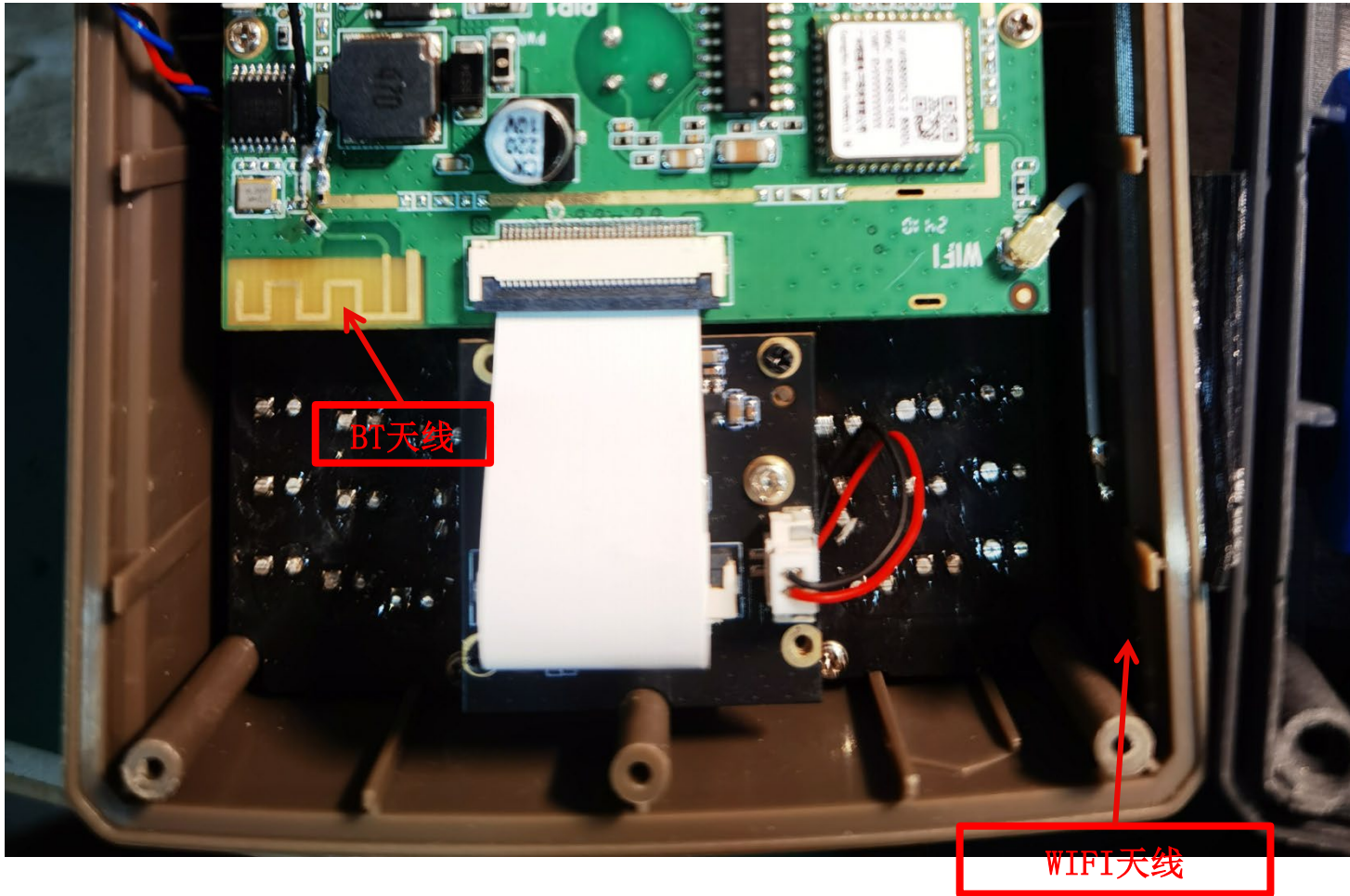

Antenna Size:

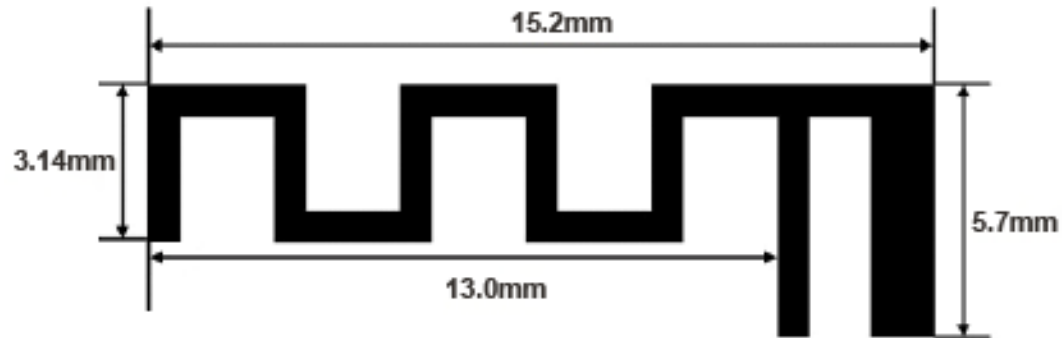

BT Antenna S11

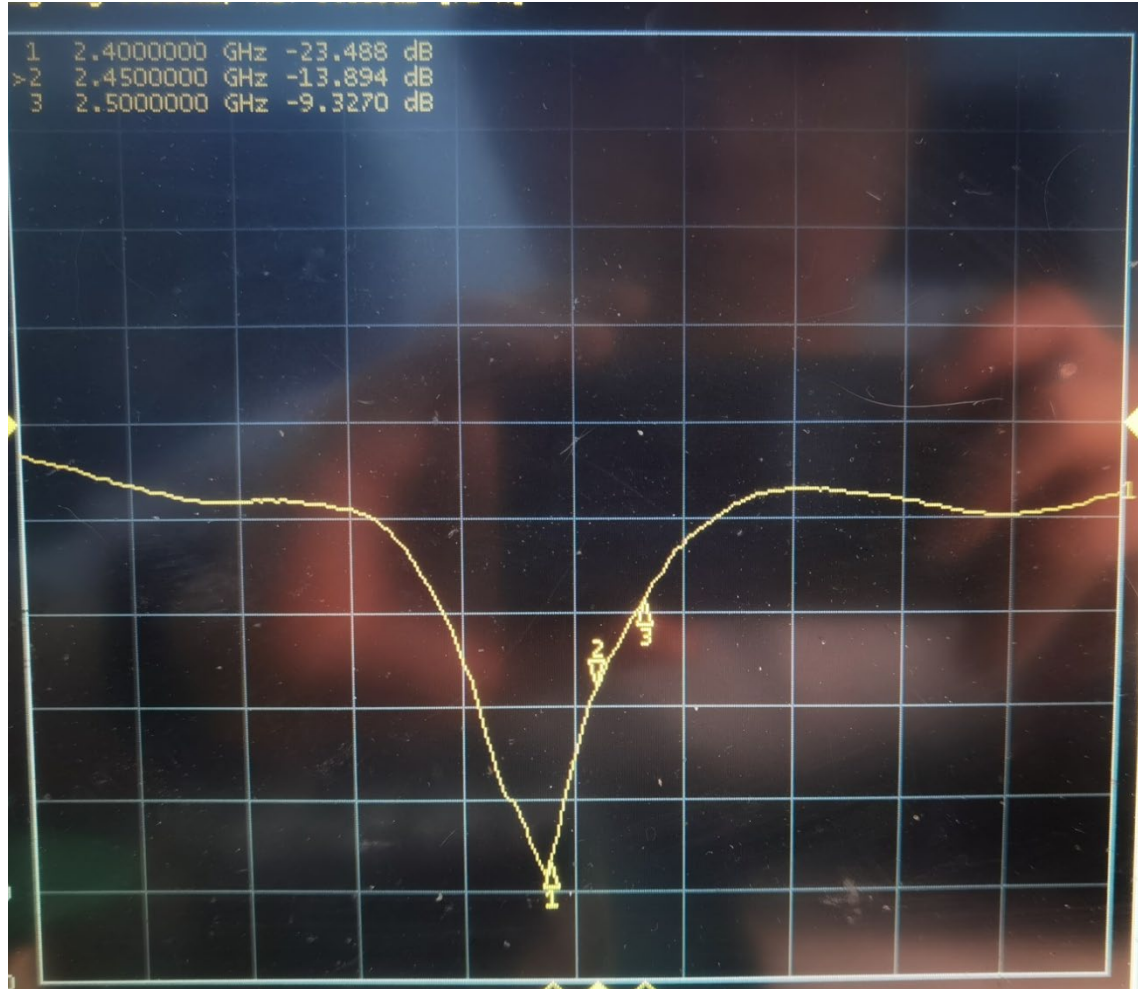

antenna S11

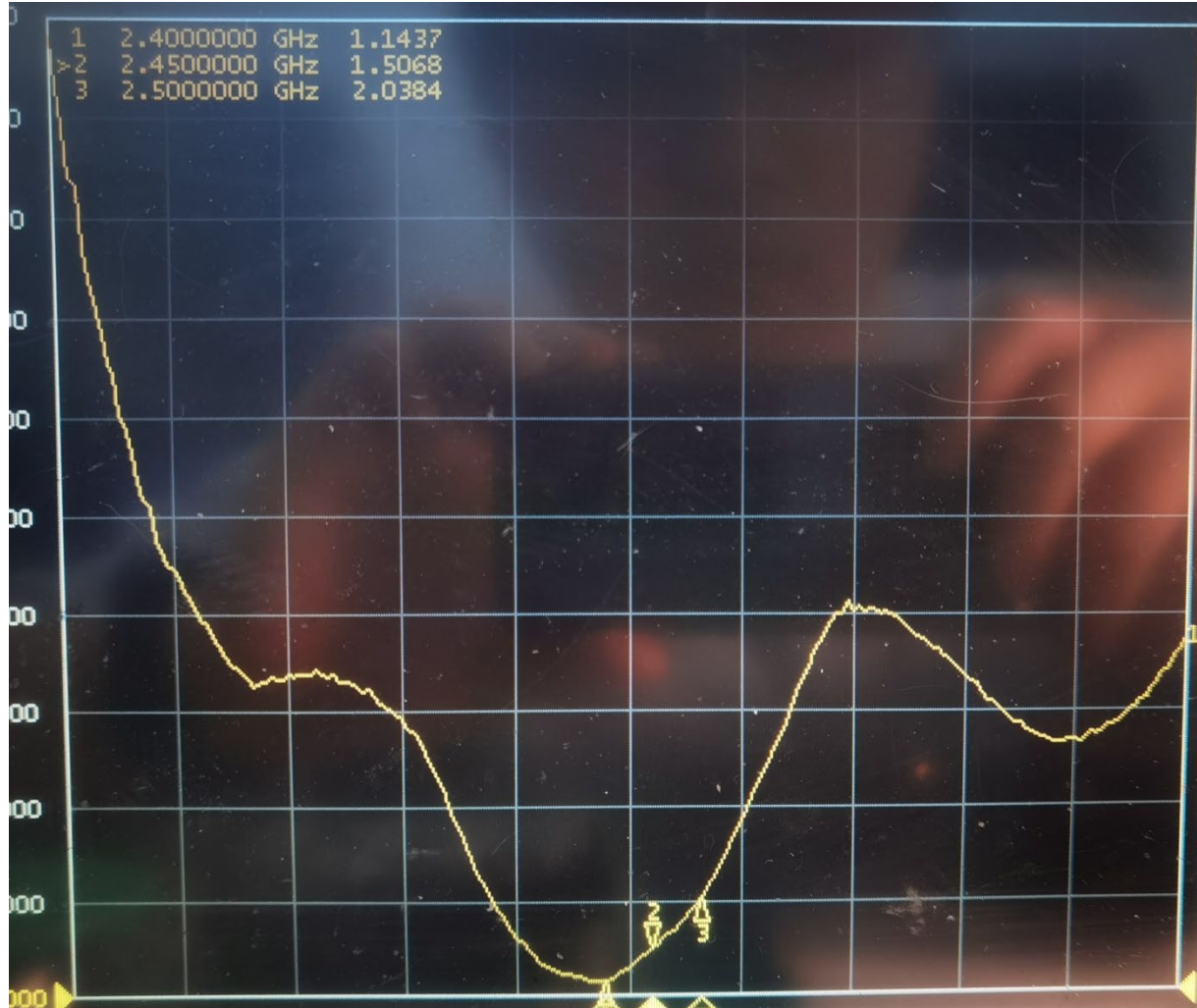

Building B, Hexi Hangcheng Industrial Zone, No. 135 Qianjin No. 2 Road, Baoan District, Shenzhen

BT efficiency

Passive Test For 2.4G												
Freq (MHz)	Effi (%)	Effi (dB)	Gain (dBi)	Gain (dBd)	UHS (%)	DHIS (%)	Max (dB)	Min (dB)	Directivity (dBi)	Beamwidth (3dB)	AttH (dB)	AttV (dB)
2400	19.18	-7.17	-1.59	-3.74	10.026	9.152	-1.59	-16.57	5.58	0	48.4	47.97
2410	19.18	-7.17	-1.47	-3.62	9.601	9.577	-1.47	-16.18	5.7	30	48.44	48.08
2420	20.51	-6.88	-1.01	-3.16	10.149	10.357	-1.01	-14.93	5.88	30	48.89	48.62
2430	22.92	-6.4	-0.58	-2.73	11.374	11.548	-0.58	-16.08	5.82	30	48.94	48.66
2440	24.11	-6.18	-0.42	-2.57	11.961	12.145	-0.42	-17	5.76	60	49.18	48.91
2450	22.71	-6.44	-0.61	-2.76	11.417	11.288	-0.61	-17.92	5.83	60	49.12	48.82
2460	22.44	-6.49	-1.02	-3.17	11.376	11.064	-1.02	-19.17	5.47	60	48.97	48.67
2470	19.36	-7.13	-1.61	-3.76	10.024	9.336	-1.61	-19.58	5.53	60	48.83	48.47
2480	19.87	-7.02	-1.35	-3.5	10.542	9.33	-1.35	-19.88	5.67	60	49.36	49
2490	21.18	-6.74	-1.03	-3.18	11.474	9.704	-1.03	-23.43	5.71	60	49.06	48.81
2500	23.11	-6.36	-0.63	-2.78	12.657	10.455	-0.63	-20.57	5.74	60	49.77	49.56

2400.000MHz

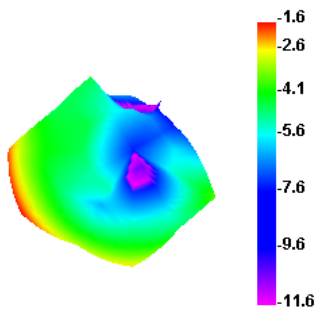

2450.000MHz

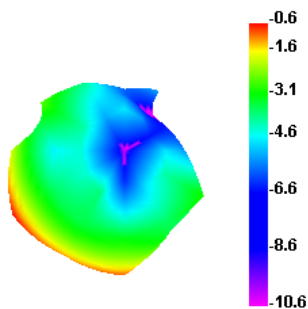

2500.000MHz

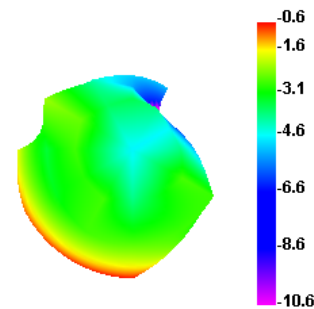

Note: 1. This report is based on the actual commissioning and testing of the commissioning prototype, including environmental treatment, antenna position and assembly position of each device

Cannot be changed at will;

2. If there is any change in the materials used by the prototype, please timely report to our company for re-verification;

3. List of sensitive devices:

TP (material, coating, wiring, etc.)

Screen (amplifier circuit, LED, wiring design, etc.)

Shell material (antenna assembly method, structural interference, shell material, antenna position height and area, etc.)

Motherboard (motherboard conduction, RF circuit matching, PA, dual power, filter, LNA, power circuit, etc.)

Camera, battery, motor, MIC, fingerprint recognition module, etc

4. Due to the small number of commissioning prototypes or only one, some probability problems can not be completely found, it is recommended to troubleshoot the problem points in small batches of trial production before mass production (such as flashing screen, loudspeaker noise, TP jump point, black screen death, signal diving, etc.)