

# Shenzhen Huntkey Electric Co., Ltd

## TEST REPORT

**SCOPE OF WORK**  
EMC TESTING-SCA109

**REPORT NUMBER**  
210506172GZU-001

**ISSUE DATE**                      **[REVISED DATE]**  
22-May-2023                      [-----]

**PAGES**  
23

**DOCUMENT CONTROL NUMBER**  
FCC Part 15C -d  
© 2017 INTERTEK



## TEST REPORT

Applicant Name & Address : Shenzhen Huntkey Electric Co., Ltd  
Huntkey Industrial Park,XueXiang Village,Bantian Street,LONGGANG  
DISTRICT,518129,ShenZhen,Guangdong,China

Manufacturing Site : 1:Shenzhen Huntkey Electronics Co., Ltd  
Huntkey Industrial Park,XueXiang Village,Bantian Street,LONGGANG  
DISTRICT,518129,ShenZhen,Guangdong,China  
2:HEYUAN HUNTKEY INDUSTRIAL CO., LTD.  
Block D, Huntkey Industrial Park No.18, Longling Industrial Area  
Yuancheng District Heyuan Guangdong 517000 China

Intertek Report No: 210506172GZU-001  
FCC ID: 2AVYR-SCA109

## Test standards

**47 CFR PART 15 Subpart C:2021**

## Sample Description

Product : Wireless charger  
Model No. : SCA109  
Electrical Rating : Input: 125V, 60Hz, 0.8A  
Output:  
USB port: DC 5V/2.4A  
Wireless charge: up to 10W

Serial No. : Not Labeled  
Date Received : 06 May 2021  
Date Test : 15 January 2022-20 January 2022  
Conducted

Prepared and Checked By

*Richard Liu*

Richard Liu

Engineer

Approved By:

*Dean Liu*

Dean Liu

Project Engineer

This report is for the exclusive use of Intertek's Client and is provided pursuant to the agreement between Intertek and its Client. Intertek's responsibility and liability are limited to the terms and conditions of the agreement. Intertek assumes no liability to any party, other than to the Client in accordance with the agreement, for any loss, expense or damage occasioned by the use of this report. Only the Client is authorized to permit copying or distribution of this report and then only in its entirety. Any use of the Intertek name or one of its marks for the sale or advertisement of the tested material, product or service must first be approved in writing by Intertek. The observations and test results in this report are relevant only to the sample tested. This report by itself does not imply that the material, product, or service is or has ever been under an Intertek certification program.

**TEST REPORT**

**CONTENT**

**TEST REPORT ..... 1**

**CONTENT ..... 3**

**1.0 TEST RESULT SUMMARY ..... 4**

**2.0 GENERAL DESCRIPTION..... 5**

    2.1 PRODUCT DESCRIPTION .....5

    2.2 RELATED SUBMITTAL(S) GRANTS .....5

    2.3 TEST METHODOLOGY .....5

    2.4 TEST FACILITY.....5

**3.0 SYSTEM TEST CONFIGURATION ..... 6**

    3.1 JUSTIFICATION .....6

    3.2 EUT EXERCISING SOFTWARE.....7

    3.3 SPECIAL ACCESSORIES .....7

    3.4 MEASUREMENT UNCERTAINTY.....7

    3.5 EQUIPMENT MODIFICATION .....8

    3.6 SUPPORT EQUIPMENT LIST AND DESCRIPTION .....8

**4.0 RADIATED EMISSION ..... 10**

**5.0 OCCUPIED BANDWIDTH..... 19**

**6.0 CONDUCTED EMISSION TEST ..... 21**

**7.0 TEST EQUIPMENT LIST ..... 24**

## TEST REPORT

### 1.0 TEST RESULT SUMMARY

Test Item	Test Requirement	Test Method	Result
Conducted disturbance voltage at mains ports	FCC PART 15 C section 15.207	ANSI C63.10: Clause 6.2	PASS
Radiated Emission	FCC PART 15 C section 15.209	ANSI C63.10: Clause 6.4 & 6.5	PASS
20dB Bandwidth	FCC PART 15 C section 15.215	FCC PART 15 C section 15.215	PASS

Remark:

When determining the test results, measurement uncertainty of tests has been considered.

## TEST REPORT

### 2.0 General Description

#### 2.1 Product Description

Operating Frequency	112.8kHz-146.1kHz
Type of Modulation:	MSK
Antenna Type	Inductive loop coil antenna
Power Supply:	Input: 125V, 60Hz, 0.8A Output: USB port: DC 5V/2.4A Wireless charge: up to 10W
Power cord:	1m x 2 wires unshielded cable

#### 2.2 Related Submittal(s) Grants

This is an application for certification of:  
DCD-Part 15 Low Power Transmitter below 1705kHz

Remaining portions are subject to the following procedures:  
The USB Charging function: FCC SDOC requirement (Refer to report 210506172GZU-003).

#### 2.3 Test Methodology

Both AC mains line-conducted and radiated emission measurements were performed according to the procedures in ANSI C63.10. Radiated emission measurement was performed in semi-anechoic chamber and conducted emission measurement was performed in shield room. For radiated emission measurement, preliminary scans and final tests were performed in the semi-anechoic chamber to determine the worst case modes. All radiated tests were performed at an antenna to EUT distance of 3 meters, unless stated otherwise.

#### 2.4 Test Facility

All tests were performed at:  
Intertek Testing Services Shenzhen Ltd. Guangzhou Branch  
Room102/104, No 203, KeZhu Road, Science City, GETDD Guangzhou, China  
Except Conducted Emissions was performed at:

## TEST REPORT

Room 02, & 101/E201/E301/E401/E501/E601/E701/E801 of Room 01 1-8/F., No. 7-2. Caipin Road, Science City, GETDD, Guangzhou, Guangdong, China

A2LA Certificate Number 0078.10

Intertek Testing Services Shenzhen Ltd. Guangzhou Branch is accredited by A2LA and Listed in FCC website. FCC accredited test labs may perform both Certification testing under Parts 15 and 18 and Declaration of Conformity testing.

### 3.0 System Test Configuration

#### 3.1 Justification

For emissions testing, the equipment under test (EUT) setup to transmit continuously to simplify the measurement methodology. Care was taken to ensure proper power supply voltages during testing. It was powered by AC 125V/60Hz supply.

When below 30MHz, the measurement antenna was positioned with its plane perpendicular to the ground at the specified distance. When perpendicular to the ground plane, the lowest height of the magnetic antenna was 1 m above the ground and was positioned at 3m distance from the EUT. During testing the loop antenna was rotated about its vertical axis for maximum response at each azimuth and also investigated with the loop positioned in the horizontal plane. For each measurement antenna alignment, the EUT shall be rotated through 0° to 360° on a turntable.

When above 30MHz, the antenna height and polarization are varied during the search for maximum signal level. The antenna height is varied from 1 to 4 meters. Radiated emissions are taken at three meters unless the signal level is too low for measurement at that distance. If necessary, a pre-amplifier is used and/or the test is conducted at a closer distance.

All readings are extrapolated back to the equivalent three meter reading using inverse scaling with distance. The spurious emissions more than 20 dB below the permissible value are not reported.

For an intentional radiator, the spectrum shall be investigated from the lowest radio frequency signal generated in the device, without going below 9 kHz, up to at least the frequency shown in the following table:

Frequency range of radiated emission measurements

Lowest frequency generated in the device	Upper frequency range of measurement
9 kHz to below 10 GHz	10 <sup>th</sup> harmonic of highest fundamental frequency or to 40 GHz, whichever is lower
At or above 10 GHz to below 30 GHz	5 <sup>th</sup> harmonic of highest fundamental frequency or to 100 GHz, whichever is lower
At or above 30 GHz	5 <sup>th</sup> harmonic of highest fundamental frequency or to 200 GHz, whichever is lower, unless otherwise specified

## TEST REPORT

Number of fundamental frequencies to be tested in EUT transmit band

Frequency range in which device operates	Number of frequencies	Location in frequency range of operation
1 MHz or less	1	Middle
1 MHz to 10 MHz	2	1 near top and 1 near bottom
More than 10 MHz	3	1 near top, 1 near middle and 1 near bottom

### 3.2 EUT Exercising Software

N/A

### 3.3 Special Accessories

N/A

### 3.4 Measurement Uncertainty

No.	Item	Measurement Uncertainty
1	Conduction Emission (9 kHz-150 kHz)	2.79 dB
2	Conduction Emission (150 kHz-30 MHz)	2.75 dB
3	Disturbance Power (30 MHz-300 MHz)	3.04 dB
4	Radiated Emission (9 kHz-30 MHz)	4.24 dB
5	Radiated Emission (30 MHz-1 GHz)	4.80dB
6	Radiated Emission (1 GHz-6 GHz)	4.97 dB
7	Radiated Emission (6 GHz-18 GHz)	4.89 dB
8	20 dB Bandwidth	2.3%

The measurement uncertainty describes the overall uncertainty of the given measured value during the operation of the EUT.

Measurement uncertainty is calculated in accordance with ETSI TR 100 028-2001.

The measurement uncertainty is given with a confidence of 95%, k=2.

When determining of the test conclusion, the Measurement Uncertainty of test has been considered.

Uncertainty and Compliance – Unless the standard specifically states that measured values are to be extended by the measurement uncertainty in determining compliance, all compliance determinations are based on the actual measured value

## TEST REPORT

### 3.5 Equipment Modification

Any modifications installed previous to testing by Shenzhen Huntkey Electric Co., Ltd will be incorporated in each production model sold / leased in the United States.

No modifications were installed by Intertek Testing Services Shenzhen Ltd. Guangzhou Branch.

### 3.6 Support Equipment List and Description

This product was tested with corresponding support equipment as below:

Support Equipment:

Equipment	Model No.	Rating	Supplier
WPT client	Tx-test2	DC 12V/0.83A,DC 7.5V/1.06A,DC 5V/1A	Shenzhen Huntkey Electric Co., Ltd
1 <sup>st</sup> Cement resistance	--	2 Ω	Intertek
2 <sup>nd</sup> Cement resistance	--	2 Ω	Intertek

Cable:

Description	Model No.	Cable length/type	Supplied by
1 <sup>st</sup> Electric wire	--	0.8 m(unshielded)	Intertek
2 <sup>nd</sup> Electric wire	--	0.8 m(unshielded)	Intertek

**Remark:** the WPT client was one of typical client devices, it's selected such that the EUT was fully exercised at maximum power from its transmitter. It will not be sold together.

To investigate the maximum EMI emission characteristics generates from EUT, the test system was pre-scanning tested based on the consideration of following EUT operation mode or test configuration mode which possible have effect on EMI emission level. Each of these EUT operation mode(s) or test configuration mode(s) mentioned above evaluated respectively

Pre-test mode	Description	
Standby Mode	kept transmitting continuously	
Charging Mode	CH: Low	WPT client is full load power mode, half full load power mode and saturated charging mode respectively, keep transmitting continuously.
	CH: Middle	
	CH: High	

For AC port Conducted Emission:

Pre-test all modes listed above, find the worst case as: wireless charging at low channel for WPT client is full load power mode.

For Radiated Emission:



## TEST REPORT

Pre-test all modes listed above, find the worst case as: wireless charging at low channel for WPT client is full load power mode.

**TEST REPORT**

**4.0 Radiated Emission**

Test Requirement:

FCC PART 15 C section 15.209 (a)(f)

§ 15.209 (a) Except as provided elsewhere in this subpart, the emissions from an intentional radiator shall not exceed the field strength levels specified in the following table:

Frequency (MHz)	Field strength (microvolts/meter)	Measurement distance (meters)
0.009-0.490	2400/F(kHz)	300
0.490-1.705	24000/F(kHz)	30
1.705-30.0	30	30
30-88	100**	3
88-216	150**	3
216-960	200**	3
Above 960	500	3

Field strength limits(below 30MHz) at 30 m and 300 m changed to 3 m by formula:

$$\text{Limit}_{3\text{m}}(\text{dB}\mu\text{V}) = \text{Limit}_{30\text{m}}(\text{dB}\mu\text{V}) + 40 * \log(30\text{m}/3\text{m})$$

$$\text{Limit}_{3\text{m}}(\text{dB}\mu\text{V}) = \text{Limit}_{300\text{m}}(\text{dB}\mu\text{V}) + 40 * \log(300\text{m}/3\text{m})$$

Frequency (MHz)	Field Strength (dBμV/m @ 3m)
0.009-0.490	128-93.8
0.490-1.705	73.8-62.9
1.705-30.0	69.5
30-88	40
88-216	43.5
216-960	46
Above 960	54

(f) In accordance with §15.33(a), in some cases the emissions from an intentional radiator must be measured to beyond the tenth harmonic of the highest fundamental frequency designed to be emitted by the intentional radiator because of the incorporation of a digital device. If measurements above the tenth harmonic are so required, the radiated emissions above the tenth harmonic shall comply with the general radiated emission limits applicable to the incorporated digital device, as shown in §15.109 and as based on the frequency of the emission being measured, or, except for emissions contained in the restricted frequency bands shown in §15.205, the limit on spurious emissions specified for the intentional radiator, whichever is the higher limit. Emissions which must be measured above the tenth harmonic of the highest fundamental frequency designed to be emitted by the intentional radiator and which fall within the restricted bands shall comply with the general radiated emission

## TEST REPORT

	limits in §15.109 that are applicable to the incorporated digital device.
Test Method:	ANSI C63.10: Clause 6.4 and 6.5.
Test Status:	Pre-Scan has been conducted to determine the worst-case mode from all possible configuration.
Test site:	Measurement Distance: 3m (Semi-Anechoic Chamber)
Detector:	Quasi-Peak detector: RBW=200 Hz for 9 kHz to 150 kHz RBW=9 kHz for 150 kHz to 30 MHz RBW=120 kHz for 30 MHz to 1GHz Sweep = auto Trace = max hold
Field Strength Calculation:	The field strength is calculated by adding the reading on the Spectrum Analyzer to the factors associated with preamplifiers (if any), antennas, cables, pulse desensitization and average factors (when specified limit is in average and measurements are made with peak detectors). A sample calculation is included below: $FS = RA + AF + CF - AG + PD + AV$ $FS = RA + \text{Correct Factor} + AV$ FS = Field Strength in dB $\mu$ V/m
Where:	RA = Receiver Amplitude (including preamplifier) in dB $\mu$ V AF = Antenna Factor in dB CF = Cable Attenuation Factor in dB AG = Amplifier Gain in dB PD = Pulse Desensitization in dB AV = Average Factor in -dB Correct Factor = AF + CF - AG + PD

In the radiated emission table which follows, the reading shown on the data table may reflect the preamplifier gain. An example of the calculations, where the reading does not reflect the preamplifier gain, follows:

$$FS = RA + AF + CF - AG + PD + AV$$

Assume a receiver reading of 62.0 dB $\mu$ V is obtained. The antenna factor of 7.4 dB and cable factor of 1.6 dB is added. The amplifier gain of 29 dB is subtracted. The pulse desensitization factor of the spectrum analyzer was 0 dB, and the resultant average factor was -10 dB. The net field strength for comparison to the appropriate emission limit is 32 dB $\mu$ V/m.

$$RA = 62.0 \text{ dB}\mu\text{V}$$

$$AF = 7.4 \text{ dB}$$

$$CF = 1.6 \text{ dB}$$

$$AG = 29.0 \text{ dB}$$

$$PD = 0 \text{ dB}$$

$$AV = -10 \text{ dB}$$

$$\text{Correct Factor} = 7.4 + 1.6 - 29.0 + 0 = -20 \text{ dB}$$

$$FS = 62 + (-20) + (-10) = 32 \text{ dB}\mu\text{V/m}$$

**TEST REPORT**

Section 15.205 Restricted bands of operation.

MHz	MHz	MHz	GHz
0.090 - 0.110	16.42 - 16.423	399.9 - 410	4.5 - 5.15
<sup>1</sup> 0.495 - 0.505	16.69475 - 16.69525	608 - 614	5.35 - 5.46
2.1735 - 2.1905	16.80425 - 16.80475	960 - 1240	7.25 - 7.75
4.125 - 4.128	25.5 - 25.67	1300 - 1427	8.025 - 8.5
4.17725 - 4.17775	37.5 - 38.25	1435 - 1626.5	9.0 - 9.2
4.20725 - 4.20775	73 - 74.6	1645.5 - 1646.5	9.3 - 9.5
6.215 - 6.218	74.8 - 75.2	1660 - 1710	10.6 - 12.7
6.26775 - 6.26825	108 - 121.94	1718.8 - 1722.2	13.25 - 13.4
6.31175 - 6.31225	123 - 138	2200 - 2300	14.47 - 14.5
8.291 - 8.294	149.9 - 150.05	2310 - 2390	15.35 - 16.2
8.362 - 8.366	156.52475 -	2483.5 - 2500	17.7 - 21.4
8.37625 - 8.38675	156.52525	2655 - 2900	22.01 - 23.12
8.41425 - 8.41475	156.7 - 156.9	3260 - 3267	23.6 - 24.0
12.29 - 12.293	162.0125 - 167.17	3332 - 3339	31.2 - 31.8
12.51975 - 12.52025	167.72 - 173.2	3345.8 - 3358	36.43 - 36.5
12.57675 - 12.57725	240 - 285	3600 - 4400	
13.36 - 13.41	322 - 335.4		

The field strength of emissions appearing within these frequency bands shall not exceed the limits shown in 15.209.

**TEST REPORT**

Test Configuration:

1) 9 kHz to 30 MHz emissions:

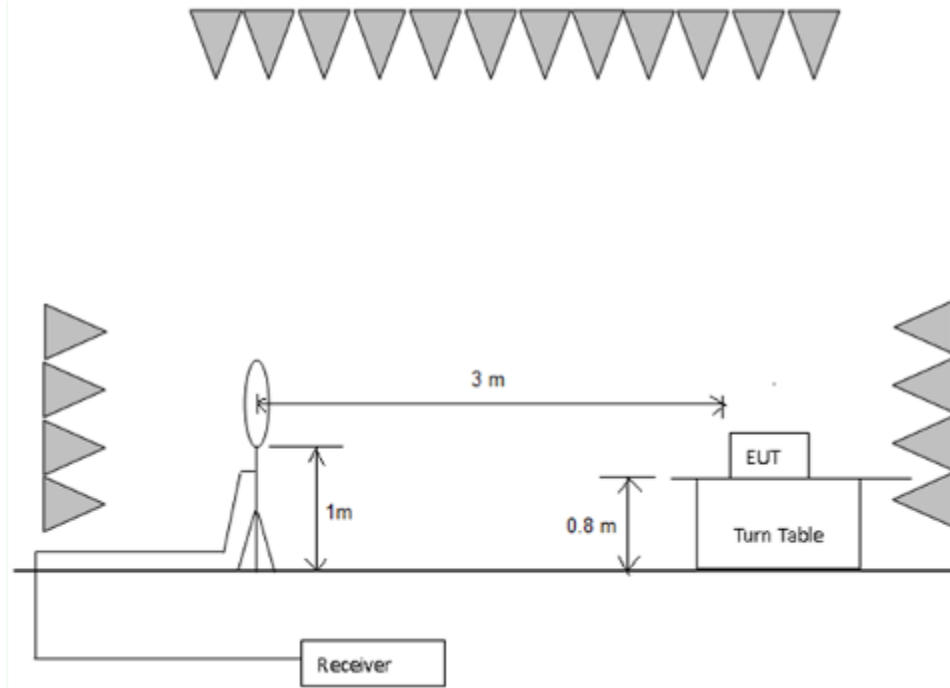

2) 30 MHz to 1 GHz emissions:

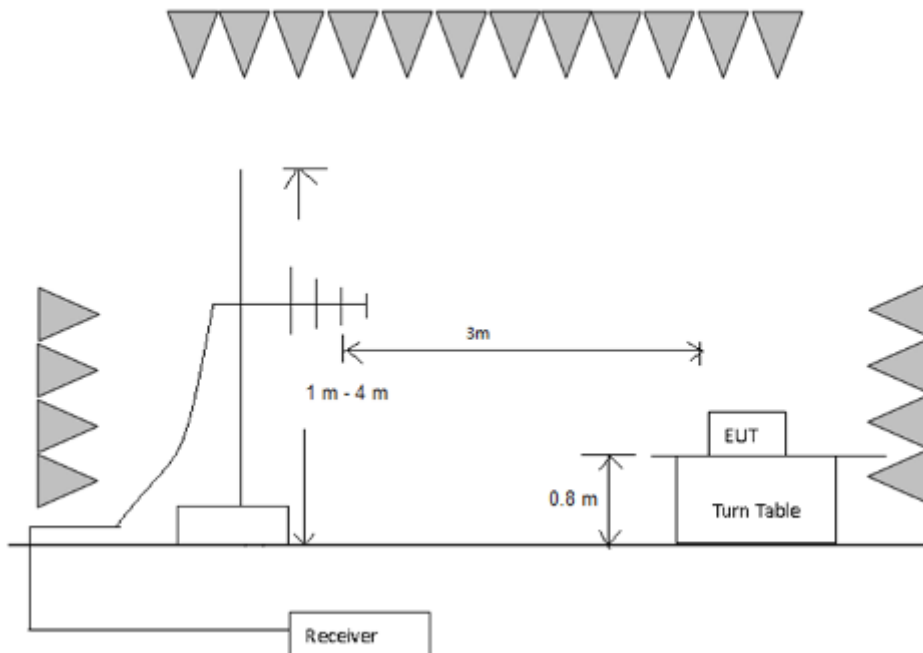

## TEST REPORT

### Test Procedure:

1) 9 kHz to 30 MHz emissions:

For testing performed with the loop antenna. The Lowest of the loop was positioned 1 m above the ground and positioned with its plane vertical at the special distance from the EUT. During testing the loop was rotated about its vertical axis for maximum response at each azimuth and also investigated with the loop positioned in the horizontal plane.

2) 30 MHz to 1 GHz emissions:

For testing performed with the bi-log type antenna. The measurement is performed with the EUT rotated 360°, the antenna height scanned between 1m and 4m, and the antenna rotated to repeat the measurement for both the horizontal and vertical antenna polarizations.

3) The receiver was scanned from 9 kHz to 1 GHz. When an emission was found, the table was rotated to produce the maximum signal strength. An initial pre-scan was performed for in peak detection mode using the receiver. The EUT was measured for both the Horizontal and Vertical polarities and performed a pre-test three orthogonal planes. For intentional radiators, measurements of the variation of the input power or the radiated signal level of the fundamental frequency component of the emission, as appropriate, shall be performed with the supply voltage varied between 85% and 115% of the nominal rated supply voltage. The worst case emissions were reported.

### Used Test Equipment List:

3m Semi-Anechoic Chamber, EMI Test Receiver (9 kHz~7 GHz), Signal and Spectrum Analyzer (10 Hz~40 GHz), Loop antenna (9 kHz-30 MHz). TRILOG Super Broadband test Antenna(30 MHz-3 GHz) (RX), Refer to Clause 4 Test Equipment List for details.

**TEST REPORT**

**Radiated Emissions (Below 30 MHz)**

**Horizontal:**

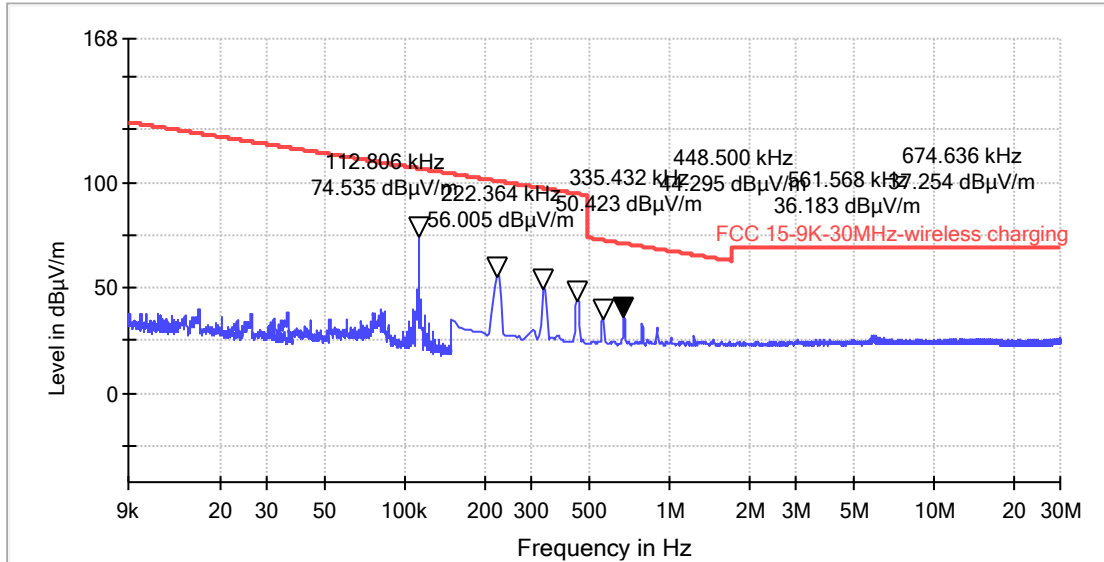

Frequency (MHz)	PK Reading Level (dBµV)	Correction factors (dB/m)	PK Emission Level (dBµV/m)	Limit (dBµV/m)	Margin (dB)
0.113	54.0	20.5	74.5	106.5	32.0
0.222	35.5	20.5	56.0	100.7	44.7
0.335	29.8	20.6	50.4	97.1	46.7
0.449	23.7	20.6	44.3	94.5	50.2
0.562	15.4	20.8	36.2	72.6	36.4
0.675	16.6	20.7	37.3	71.0	33.7

**TEST REPORT**

**Vertical:**

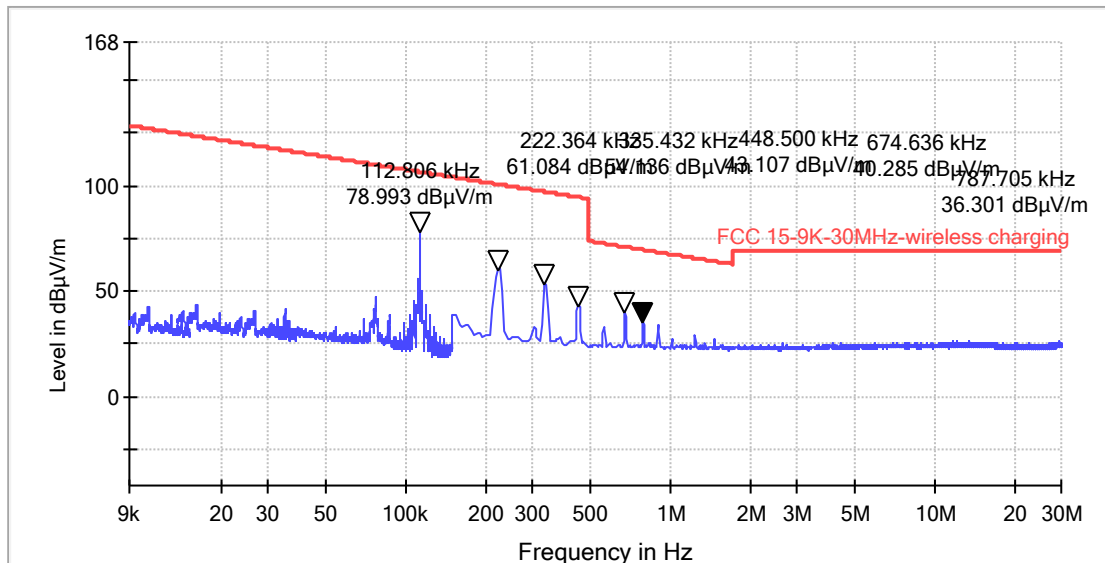

Frequency (MHz)	PK Reading Level (dBµV)	Correction factors (dB/m)	PK Emission Level (dBµV/m)	Limit (dBµV/m)	Margin (dB)
0.113	58.5	20.5	79.0	106.5	27.5
0.222	40.6	20.5	61.1	100.7	39.6
0.335	33.5	20.6	54.1	97.1	43.0
0.449	22.5	20.6	43.1	94.5	51.4
0.675	19.6	20.7	40.3	71.0	30.7
0.788	15.6	20.7	36.3	69.7	33.4

The emission limits shown in the above table are based on measurements employing a CISPR quasi-peak detector except for the frequency bands 9-90 kHz, 110-490 kHz and above 1000 MHz. Radiated emission limits in these three bands are based on measurements employing an average detector.

**Remark:**

1. Corr. (dB) = Antenna Factor (dB) + Cable Loss (dB)
2. Level (dBµV/m) = Corr. (dB) + Read Level (dBµV)
3. Margin (dB) = Limit (dBµV/m) –Level (dBµV/m)
4. Only record the date closed to limit
5. The emission is worst case on Vertical
6. When Peak emission level was below AV or QP limit, the AV and QP emission level did not be recorded.



**TEST REPORT**

30 MHz~1 GHz Spurious Emissions. Quasi-Peak Measurement

**Horizontal:**

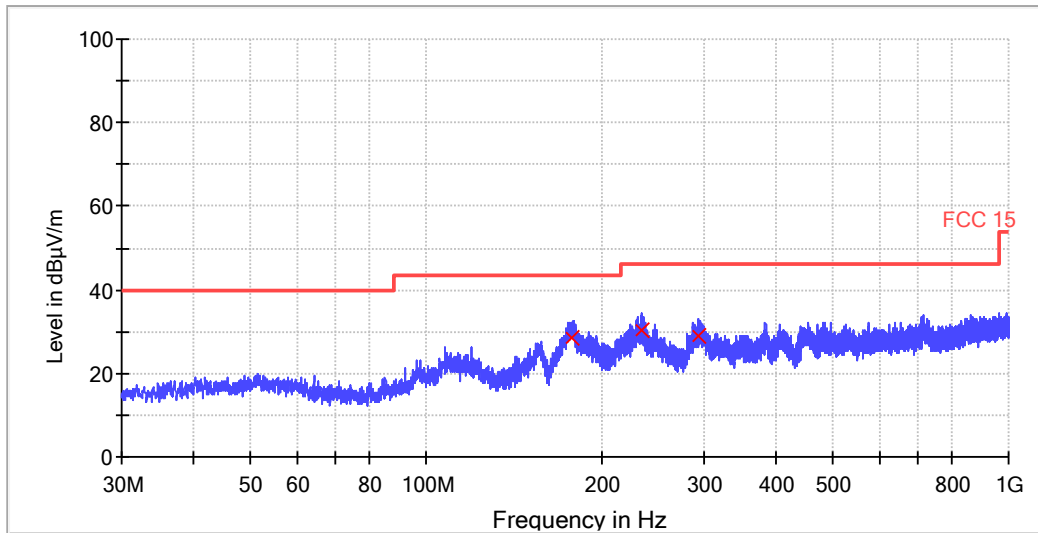

**QP**

Frequency (MHz)	Quasi Peak (dBµV/m)	Bandwidth (kHz)	Pol	Corr. (dB)	Margin - QPK (dB)	Limit - QPK (dBµV/m)
178.080000	28.6	120.000	H	11.1	14.9	43.5
234.360000	30.2	120.000	H	13.9	15.9	46.0
293.200000	29.0	120.000	H	15.8	17.1	46.0

**Remark:**

Final Test Level = Receiver Reading + Correction Factor

Correction Factor = Antenna Factor + Cable Loss.

**TEST REPORT**

**Vertical:**

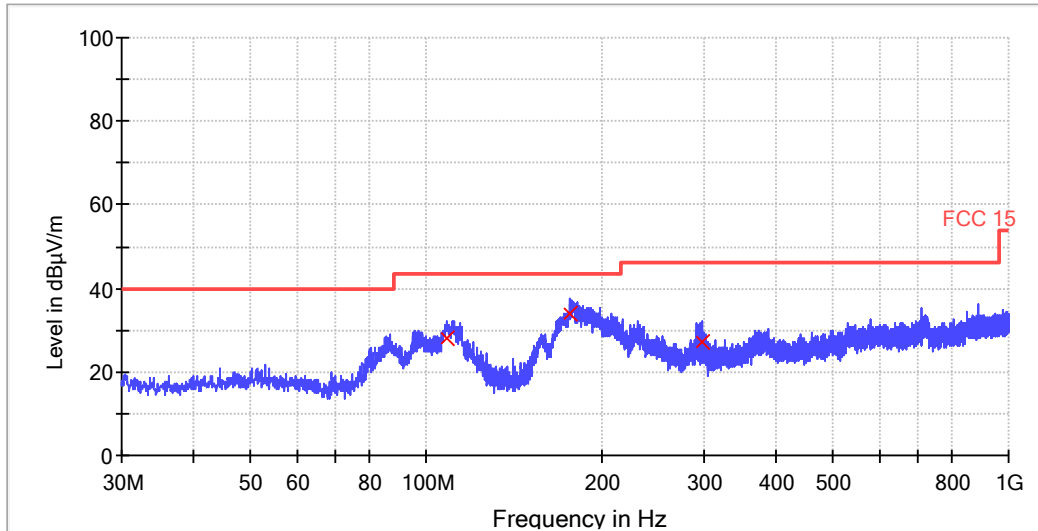

**QP**

Frequency (MHz)	Quasi Peak (dBµV/m)	Bandwidth (kHz)	Pol	Corr. (dB)	Margin - QPK (dB)	Limit - QPK (dBµV/m)
108.440000	27.9	120.000	V	12.2	15.6	43.5
176.920000	33.9	120.000	V	11.0	9.6	43.5
297.960000	27.4	120.000	V	15.9	18.6	46.0

Remark:

Final Test Level = Receiver Reading + Correction Factor

Correction Factor = Antenna Factor + Cable Loss.

**TEST REPORT**

**5.0 Occupied Bandwidth**

Test Method: FCC PART 15 C section 15.215  
 Test Status: Test in transmitting mode.  
 Requirements: Bandwidth may otherwise be specified in the specific rule section under which the equipment operates, is contained within the frequency band designated in the rule section under which the equipment is operated.  
 Method of measurement: The useful radiated emission from the EUT was detected by the spectrum analyzer with peak detector. Record the 99% bandwidth of the main frequency.

Used Test Equipment List  
 Spectrum Analyzer. Refer to Clause 7 Test Equipment List for details.

Test result:

Test Channel	bandwidth	Limit
Lowest channel (112.80kHz)	0.76 kHz	/
Highest channel (146.10kHz)	0.78 kHz	

**TEST REPORT**

Lowest channel (112.78kHz)

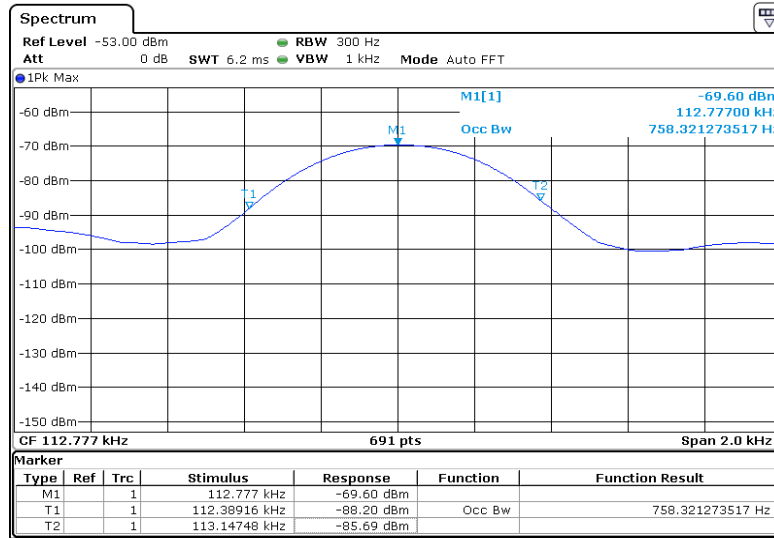

Highest channel (146.10kHz)

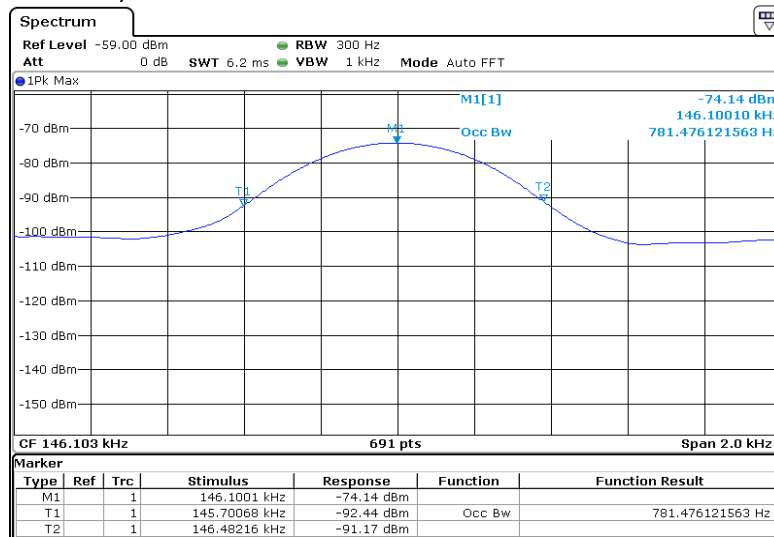

## TEST REPORT

### 6.0 Conducted Emission Test

Test Configuration:

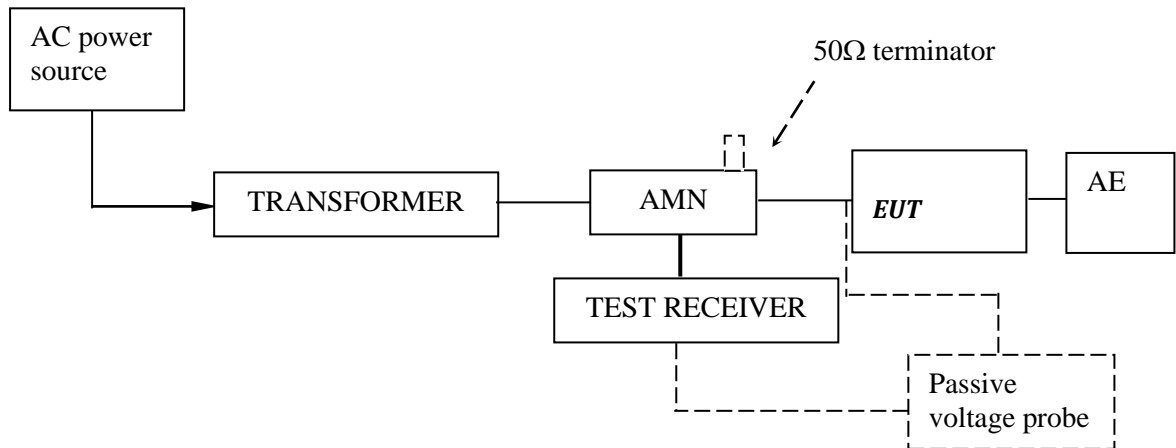

#### Test Setup and Procedure:

Test was performed according to ANSI C63.10 Clause 6.2. The EUT was set to achieve the maximum emission level. The mains terminal disturbance voltage was measured with the EUT in a shielded room. The EUT was connected to AC power source through an Artificial Mains Network which provides a 50Ω linear impedance. Artificial hand is used if appropriate (for handheld apparatus). The load/control terminal disturbance voltage was measured with passive voltage probe if appropriate.

The table-top EUT was placed on a 0.8m high non-metallic table above earthed ground plane (Ground Reference Plane). And for floor standing EUT, was placed on a 0.1m high non-metallic supported on GRP. The EUT keeps a distance of at least 0.8m from any other of the metallic surface. The Artificial Mains Network is situated at a distance of 0.8m from the EUT.

During the test, mains lead of EUT excess 0.8m was folded back and forth parallel to the lead so as to form a horizontal bundle with a length between 0.3m and 0.4m

The bandwidth of test receiver was set at 9 kHz. The frequency range from 150 kHz to 30MHz was checked.

**TEST REPORT**

Test Data and Curve

At main terminal: Pass

Tested Wire: Live

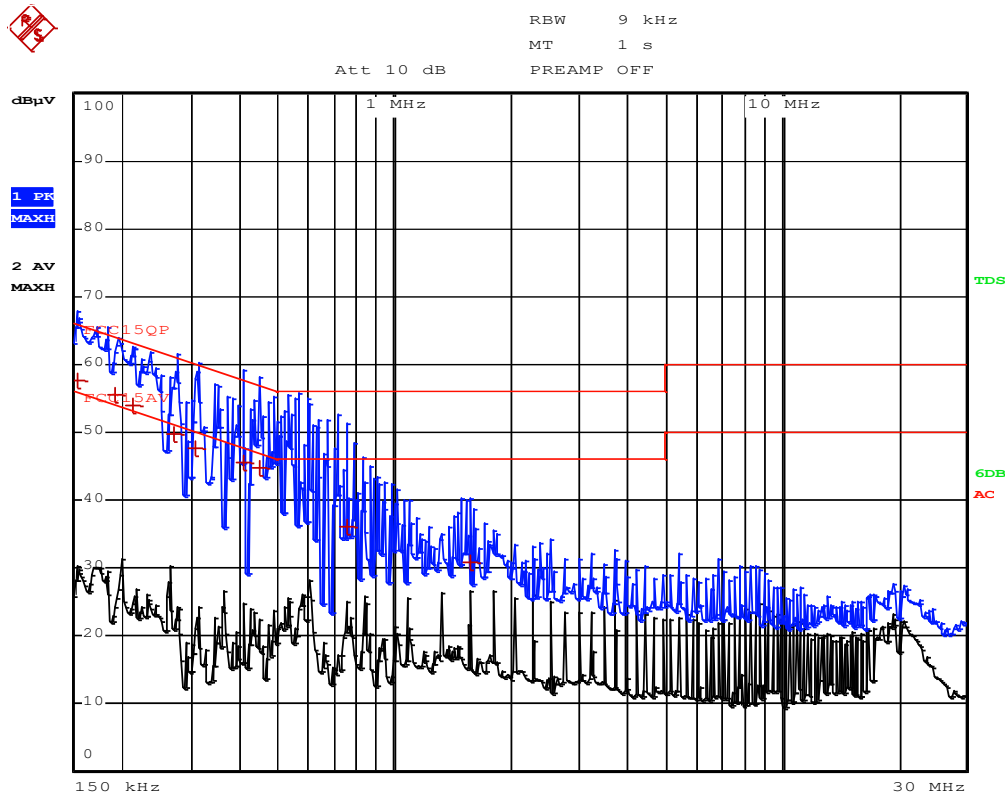

EDIT PEAK LIST (Final Measurement Results)				
Trace1:		FCC15QP		
Trace2:		FCC15AV		
Trace3:		---		
TRACE	FREQUENCY	LEVEL dBµV		DELTA LIMIT dB
1 Quasi Peak	154 kHz	57.64 L1		-8.13
1 Quasi Peak	194 kHz	55.59 L1		-8.26
1 Quasi Peak	214 kHz	53.91 L1		-9.13
1 Quasi Peak	274 kHz	49.64 L1		-11.35
1 Quasi Peak	310 kHz	47.59 L1		-12.37
1 Quasi Peak	406 kHz	45.66 L1		-12.06
1 Quasi Peak	446 kHz	44.85 L1		-12.09
1 Quasi Peak	754 kHz	36.10 L1		-19.89
1 Quasi Peak	1.574 MHz	30.83 L1		-25.16

Remark:

1. Corr. (dB) = LISN Factor (dB) + Cable Loss (dB)
2. Level (dBµV) = Corr. (dB) + Read Level (dBµV)
3. Delta Limit (dB) = Level (dBµV)-Limit (dBµV)

**TEST REPORT**

Tested Wire: Neutral

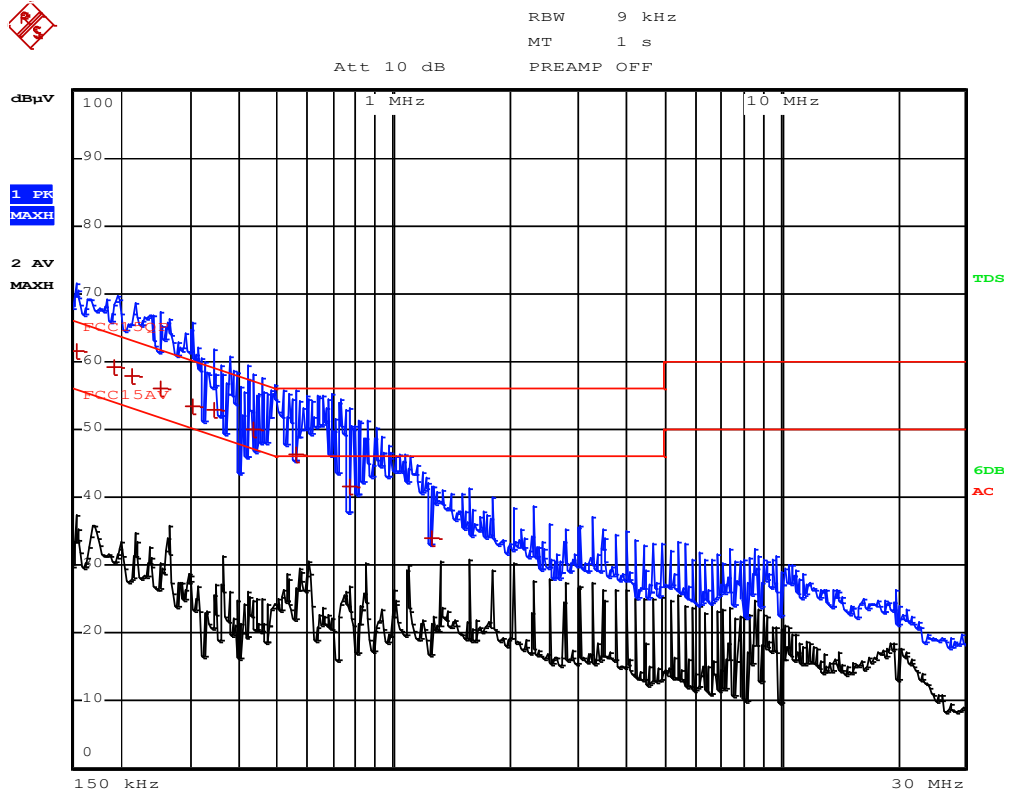

EDIT PEAK LIST (Final Measurement Results)				
TRACE	FREQUENCY	LEVEL dBµV		DELTA LIMIT dB
Trace1:	FCC15QP			
Trace2:	FCC15AV			
Trace3:	---			
1	Quasi Peak	154 kHz	61.58 L1	-4.19
1	Quasi Peak	194 kHz	59.14 L1	-4.72
1	Quasi Peak	214 kHz	57.88 L1	-5.16
1	Quasi Peak	250 kHz	55.93 L1	-5.82
1	Quasi Peak	302 kHz	53.44 L1	-6.74
1	Quasi Peak	342 kHz	52.89 L1	-6.26
1	Quasi Peak	434 kHz	49.87 L1	-7.30
1	Quasi Peak	558 kHz	46.29 L1	-9.70
1	Quasi Peak	774 kHz	41.71 L1	-14.28
1	Quasi Peak	1.262 MHz	34.01 L1	-21.98

**Remark:**

1. Corr. (dB) = LISN Factor (dB) + Cable Loss (dB)
2. Level (dBµV) = Corr. (dB) + Read Level (dBµV)
3. Delta Limit (dB) = Level (dBµV)-Limit (dBµV)

## TEST REPORT

### 7.0 Test Equipment List

#### Conducted Disturbance-Mains Terminal(1)

Equipment No.	Equipment	Model	Manufacturer	Cal. Due date (DD-MM-YYYY)	Calibration Interval
EM080-05	EMI receiver	ESCI	R&S	15/07/2022	1Y
EM006-05	LISN	ENV216	R&S	06/06/2022	1Y
SA047-112	Digital Temperature-Humidity Recorder	RS210	YIJIE	22/11/2022	1Y
EM004-04	EMC shield Room	8m×3m×3m	Zhongyu	06/01/2023	1Y

#### Radiated Disturbance (9 kHz-30 MHz)

Equipment No.	Equipment	Model	Manufacturer	Cal. Due date (DD-MM-YYYY)	Calibration Interval
EM030-04	3m Semi-Anechoic Chamber	9×6×6 m3	ETS-LINDGREN	06/04/2022	1Y
EM031-02	EMI Test Receiver (9 kHz~7 GHz)	R&S ESR7	R&S	16/11/2022	1Y
EM011-04	Loop antenna (9 kHz-30 MHz)	HFH2-Z2	R&S	25/06/2022	1Y
EM031-02-01	Coaxial cable	/	R&S	05/04/2022	1Y
SA047-118	Digital Temperature-Humidity Recorder	RS210	YIJIE	21/07/2022	1Y
EM045-01-01	EMC32 software (RE/RS)	V10.01.00	R&S	N/A	N/A

#### Radiated Disturbance (30 MHz-1 GHz)

Equipment No.	Equipment	Model	Manufacturer	Cal. Due date (DD-MM-YYYY)	Calibration Interval
EM030-04	3m Semi-Anechoic Chamber	9×6×6 m3	ETS-LINDGREN	6/04/2022	1Y
EM031-02	EMI Test Receiver (9 kHz~7 GHz)	R&S ESR7	R&S	16/11/2022	1Y
EM033-01	TRILOG Super Broadband test Antenna (30MHz-3GHz)	VULB 9163	SCHWARZBECK	18/10/2022	1Y
EM031-02-01	Coaxial cable	/	R&S	5/04/2022	1Y
EM036-01	Common-mode absorbing clamp	CMAD 20B	TESEQ	18/07/2022	1Y
SA047-118	Digital Temperature-Humidity Recorder	RS210	YIJIE	21/07/2022	1Y
EM045-01-01	EMC32 software (RE/RS)	V10.01.00	R&S	N/A	N/A

#### 20dB Bandwidth:

EM031-03	Signal and Spectrum Analyzer (10 Hz~40 GHz)	R&S FSV40	R&S	2022/12/23	1Y
----------	---	-----------	-----	------------	----

\*\*\*\*\*End of the test report\*\*\*\*\*