

80cm induction cooktop with TotalFlex, ActiveTouch, Hob2Hood, PowerBoost and Individual Zone Timer
RRP AUS \$5,399.00



Product Details

FEATURES

TotalFlex

TotalFlex allows you to place pans anywhere on the surface and it will respond to your movement.

ActiveTouch

With ActiveTouch, illuminated controls correspond to your pan placement for intuitive cooking.

Hob2Hood

Hob2Hood automatically adjusts your hood settings so you can focus on creating delicious dishes.

PowerBoost

PowerBoost provides an instant burst of heat that is perfect for boiling potatoes or searing steak.

Auto Pot Detection

Pot detection sensors illuminate the controls that match the cooking zone.

Pause Function

The pause function sets zones to the lowest setting to keep dishes warm and prevent overcooking.

Child lock

BENEFITS

COOK ANYWHERE ON THE SURFACE

TotalFlex provides you with the flexibility to cook several dishes at the same time. Once turned on, you can place, move and arrange pots and pans anywhere on its responsive glass surface and it will detect and respond to your movement for the best induction power.

INTUITIVE CONTROL AT A TOUCH

With ActiveTouch, the corresponding slider control automatically lights up when a pan is set down on the hob. All you need to do is select your desired temperature with the swipe of your finger, and enjoy intuitive cooking with delicious results.

A FRESHER KITCHEN. HANDS-FREE.

The wireless Hob2Hood function automatically adjusts your hood settings based on how you are cooking, leaving your hands free to focus on the food. The hood lights will automatically illuminate when your hob turns on and the fan speed will adjust depending on how powerfully you are cooking.

INSTANT BOIL

No more waiting around for pots to boil. PowerBoost provides an instant burst of heat that boils water in under 90 seconds, even faster than an electric kettle. Its perfect for high-heat tasks like boiling potatoes or searing steak.

WHY NOT HIT PAUSE

The pause function is useful if your cooking is interrupted. At the touch of a button all cooking zones will be reduced to the lowest heat setting to ensure dishes stay warm, but don't overcook.

Specifications

PRODUCT PROFILE

Domestic warranty details (yrs)	5
Cooktop type	full induction
Materials/Colour	black
Trim finish	bevelled sides only

CONTROLS

Controls of Cooktops	slide touch pad
Position of controls	front
Functions of Cooktops	automatic warm up,cooking timer with acoustic signal,acoustic signal,booster,pause,Hob2Hood
Indicators/display	3 level residual heat indicator
Features of Cooktop	minute minder,safety child lock,function lock,sound off,automatic pan sensing
Timer of Cooktop	Minute minder

DIMENSIONS

Total product height (mm)	48
Total product width (mm)	780
Total product depth (mm)	520
Cut out width (mm)	750
Cut out depth (mm)	490

ELEMENTS/BURNERS

LEFT FRONT ZONE

Left front zone	induction
Left front Watts	2000
Left front boost watts	3000
Left front diameter mm	220

LEFT REAR ZONE

Left rear zone	induction
Left rear watts	2000
Left rear diameter mm	220

CENTRE FRONT ZONE

Centre front zone	induction
Centre front Watts	2000
Centre front diameter mm	220

CENTRE REAR ZONE

Centre rear zone	induction
Centre rear Watts	2000
Centre rear diameter mm	220

RIGHT FRONT ZONE

Right front zone	induction
Right front Watts	2000
Right front diameter mm	220

RIGHT REAR ZONE

Right rear zone	induction
Right rear watts	2000
Right rear diameter mm	220

ELECTRICAL SPECIFICATIONS

Connected load KW	7.35
Type of connection	hardwired

SHIPPING

Shipping Volume (m3)	0.06145
----------------------	---------

SHIPPING

Shipping Weight (Kg)	22.92
----------------------	-------

Pack Dimensions Height (mm)	118
-----------------------------	-----

Pack Dimension Width (mm)	868
---------------------------	-----

Pack Dimension Depth (mm)	600
---------------------------	-----

Dimensions

PSGBHO170DE0003N

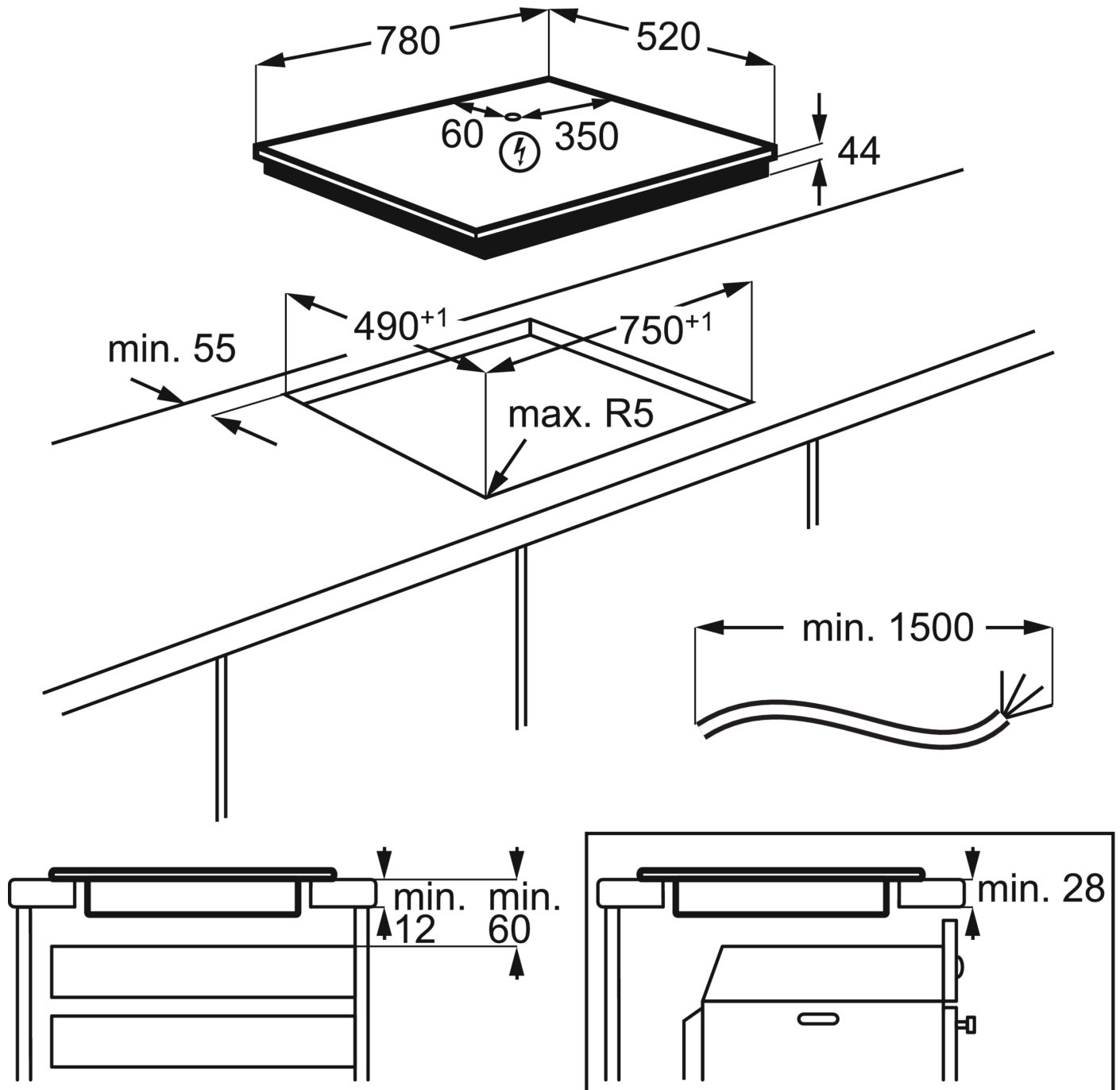

Terms and Conditions

IMPORTANT

This is a guide of product dimensions only. For complete installation instructions, refer to the manual provided with product.

PRODUCT INFORMATION

The descriptors and illustrations in this publication apply to the specific products and models described as at the date of issue. Under our policy of continuous product development, product specifications may change without notice. Prospective purchasers should therefore check with their retailer to ensure this publication correctly describes the products that are being offered for sale. All information supplied is to be used for general reference purposes only and is on the understanding that Electrolux Home Products Pty Ltd (Australia) and Electrolux (NZ) Ltd (New Zealand) will not be liable for any loss, liability or damage of whatever kind arising as a result of reliance on such information. Colours of products illustrated are as close as printing limitations allow. Electrolux will at all times comply with its obligations pursuant to law including Trade Practices (Australian Consumer Law) Act and Regulations.

WARRANTY

Electrolux Home Products warrants that for domestic applications the AEG appliances featured are free from defects in materials and workmanship for 5 years (3 months warranty for commercial applications). All warranties are subject to the conditions set out in the warranty card accompanying the product when purchased.

ELECTROLUX HOME PRODUCTS AUSTRALIA

telephone: 1300 363 664

fax: 1800 350 067

email: customercare@aegaustralia.com.au

web: www.aeg.com/au

ELECTROLUX HOME PRODUCTS NEW ZEALAND

telephone: 0800 10 66 10

fax: 09 573 2221

email: customercare@electrolux.co.nz

web: www.aeg.com/au