



Refrigerator

User manual

Free Standing Appliance

SAMSUNG

Contents

Safety information	3
What you need to know about the safety instructions	3
Important safety symbols and precautions:	5
Important safety precautions	6
How to minimize the energy consumption	8
This appliance is intended to be used in household and similar applications such as	9
Additional tips for proper usage	9
Instructions about the WEEE	10
Severe warnings	11
Installation and Usage cautions	17
Installation	20
Refrigerator at a glance	20
Step-by-step installation	23
Operations	26
Feature panel	26
Special features	28
Maintenance	31
Handle and care	31
Cleaning	32
Replacement	32
Troubleshooting	33
General	33
Do you hear abnormal sounds from the refrigerator?	35

Safety information

Before using your new Samsung Refrigerator, please read this manual thoroughly to ensure that you know how to operate the features and functions that your new appliance offers safely and efficiently.

What you need to know about the safety instructions

- Warnings and Important Safety Instructions in this manual do not cover all possible conditions and situations that may occur. It is your responsibility to use common sense, caution, and care when installing, maintaining, and operating your appliance.
- Because these following operating instructions cover various models, the characteristics of your refrigerator may differ slightly from those described in this manual and not all warning signs may be applicable. If you have any questions or concerns, contact your nearest service center or find help and information online at www.samsung.com.
- R-600a or R-134a is used as a refrigerant. Check the compressor label on the rear of the appliance or the rating label inside the fridge to see which refrigerant is used for your appliance. When this product contains flammable gas (Refrigerant R-600a), contact your local authority in regard to safe disposal of this product.
- In order to avoid the creation of a flammable gas-air mixture if a leak in the refrigerating circuit occurs, the size of the room in which the appliance may be sited depends on the amount of refrigerant used.

Safety information

- Never start up an appliance showing any signs of damage. If in doubt, consult your dealer. The room must be 1 m³ in size for every 8 g of R-600a refrigerant inside the appliance. The amount of refrigerant in your particular appliance is shown on the identification plate inside the appliance.
- Refrigerant squirting out of the pipes could ignite or cause an eye injury. When refrigerant leaks from the pipe, avoid any naked flames and move anything flammable away from the product and ventilate the room immediately.
 - Failing to do so may result in fire or explosion.
- It is hazardous for anyone other than an Authorised Service Person to service this appliance. In Queensland - the authorized Service Person MUST hold a Gas Work Authorisation or Licence for hydrocarbon refrigerants, to carry out Servicing or repairs which involve the removal of covers. (For Australia only)



Important safety symbols and precautions:

Please follow all safety instructions in this manual. This manual uses the following safety symbols.

WARNING

Hazards or unsafe practices that may result in **severe personal injury, property damage, and/or death.**

CAUTION

Hazards or unsafe practices that may result in **severe personal injury and/or property damage.**

NOTE

Useful information that helps users understand or benefit from the refrigerator.

These warning signs are here to prevent injury to you and others.

Please follow them carefully.

After reading this section, keep it in a safe place for future reference.



Safety information

Important safety precautions



Warning; Risk of fire / flammable materials

WARNING

- When positioning the appliance, ensure the supply cord is not trapped or damaged.
- Do not locate multiple portable socket-outlets or portable power supplies at the rear of the appliance.
- Fill with potable water only.
- Keep ventilation openings, in the appliance enclosure or in the built-in structure, clear of obstruction.
- Do not use mechanical devices or any other means to accelerate the defrosting process, other than those recommended by the manufacturer.
- Do not damage the refrigerant circuit.
- Do not use electrical appliances inside the food storage compartments of the appliance, unless they are of the type recommended by the manufacturer.
- This appliance is not intended for use by persons (including children) with reduced physical, sensory, or mental capabilities, or those who lack experience and knowledge, unless they have been given supervision or instruction concerning the use of the appliance by a person responsible for their safety.

- This appliance can be used by children aged from 8 years and above and persons with reduced physical, sensory or mental capabilities or lack of experience and knowledge if they have been given supervision or instruction concerning use of the appliance in a safe way and understand the hazards involved. Children shall not play with the appliance. Cleaning and user maintenance shall not be made by children without supervision. Children aged from 3 to 8 years are allowed to load and unload refrigerating appliances.
- If the supply cord is damaged, it must be replaced by the manufacturer, its service agent or similarly qualified persons in order to avoid a hazard.
- The socket must be easily accessible so that the appliance can be quickly disconnected from the supply in an emergency.
 - It must be outside the area of the rear of the appliance.
- Do not store explosive substances such as aerosol cans with a flammable propellant in this appliance.
- If the product is equipped with LED lamps, do not disassemble the Lamp Covers and LED lamps yourself.
 - Contact a Samsung service center.
 - Use only the LED Lamps provided by the manufacturer or its service agents.
- For the most efficient use of energy, please keep the all inner fittings such as baskets, drawers, shelves on the position supplied by manufacturer.
- To get the best energy efficiency of this product, please leave all shelves, drawers and baskets on their original position.

Safety information

How to minimize the energy consumption

- Install the appliance in a cool, dry room with adequate ventilation.
- Ensure that it is not exposed to direct sunlight and never put it near a direct source of heat (radiator, for example).
 - Not to block any vents or grilles is recommended for energy efficiency.
 - Allow warm food to cool down before placing it in the appliance.
 - Put frozen food in the refrigerator to thaw. You can then use the low temperatures of the frozen products to cool food in the refrigerator.
 - Do not keep the door of the appliance open for too long when putting food in or taking food out.
 - The shorter time for which the door is open, the less ice will form in the freezer.
 - Clean the rear of the refrigerator regularly. Dust increases energy consumption.
 - Do not set temperature colder than necessary.
 - Ensure sufficient air exhaust at the refrigerator base and at the back wall of the refrigerator. Do not cover air vent openings.
 - Allow clearance to the right, left, back and top when installing. This will help reduce power consumption and keep your energy bills lower.
- We recommend the value of clearance to be :
 - Right, left, and back side: more than 50 mm
 - Top side: more than 100 mm

This appliance is intended to be used in household and similar applications such as

- staff kitchen areas in shops, offices and other working environments;
- farm houses and by clients in hotels, motels and other residential type environments;
- bed and breakfast type environments;
- catering and similar non-retail applications.

Additional tips for proper usage

- In the event of a power failure, call the local office of your electric company and ask how long the failure is going to last.
 - Most power failures that are corrected in an hour or two will not affect your refrigerator temperatures. However, you should minimize the number of door openings while the power is off.
 - Should the power failure last more than 24 hours, remove and discard all frozen food.
- The refrigerator might not operate consistently (frozen contents can thaw or temperatures can become too warm in the frozen food compartment) if sited for an extended period of time in a location where ambient air temperatures are constantly above the temperatures for which the appliance is designed.
- In case of particular foods, keeping it under refrigeration can have a bad effect on preservation due to its properties.

Safety information

- Temperature rise during defrosting complies with ISO requirements. If you want to prevent an undue rise in the temperature of frozen food while the appliance defrosts, wrap the frozen food in several layers of newspaper.
- Do not re-freeze frozen foods that have thawed completely.
- The temperature of two star section (sections) or compartment (compartments) which have two star symbol (☆☆) is slightly higher than other freezer compartment (compartments). The two star section (sections) or compartment (compartments) is (are) based on the instruction and/or the condition as delivered.

Instructions about the WEEE



Correct Disposal of This Product (Waste Electrical & Electronic Equipment) (Applicable in countries with separate collection systems)

This marking on the product, accessories or literature indicates that the product and its electronic accessories (e.g. charger, headset, USB cable) should not be disposed of with other household waste at the end of their working life. To prevent possible harm to the environment or human health from uncontrolled waste disposal, please separate these items from other types of waste and recycle them responsibly to promote the sustainable reuse of material resources.

Household users should contact either the retailer where they purchased this product, or their local government office, for details of where and how they can take these items for environmentally safe recycling.

Business users should contact their supplier and check the terms and conditions of the purchase contract. This product and its electronic accessories should not be mixed with other commercial wastes for disposal.

Severe warnings

WARNING

- Connect the power plug in the proper position with the cord hanging down.
- Do not insert the power plug into a wall socket with wet hands.
- If the wall socket is loose, do not insert the power plug. Plug the power plug into the wall socket firmly.
- Never unplug your refrigerator by pulling on the power cord. Always grip the plug firmly and pull straight out from the outlet.
- Do not bend the power cord excessively or place heavy objects on it.
- The appliance must be positioned so that the plug is accessible after installation.
- Do not plug several appliances and the refrigerator into the same multiple power strip. The refrigerator should always be plugged into its own individual electrical outlet which has a voltage rating that matches the voltage listed on the refrigerator's rating plate.
- This provides the best performance and also prevents overloading of house wiring circuits, which could overheat the wires and cause a fire hazard.
 - Failing to do so may result in an electric shock or fire due to electric leakage.
- If the refrigerator emits a burning smell or smoke, unplug the refrigerator immediately and contact a Samsung service center.
 - Failing to do so may result in an electric or fire hazards.

Safety information

- Do not spray water directly on the inside or outside of the refrigerator.
 - There is a risk of fire or electric shock.
- Do not use benzene, thinner, or Clorox (bleach) to clean the refrigerator.
 - There is a risk of fire or electric shock.
- If large amounts of dust or water enter the refrigerator, disconnect the power plug and contact a Samsung Electronics service center.
 - Otherwise there is a risk of fire.
- You must ground the refrigerator to prevent any power leakages or electric shocks caused by current leakage from the refrigerator.
 - Current leakage may result in an electric shock, fire, explosion, or problems with the product.
 - Never use gas pipes, telephone lines, or other potential lightning attractors as an electrical ground.
- This refrigerator is for storing food only.
 - Do not store pharmaceutical products, scientific materials, or temperature sensitive products, flammable objects in the refrigerator.(benzene, thinner, propane gas, alcohol, ether, LP gas, Ginseng and other such products)
- Fill the water tank and ice cube trays with potable water only (tap water, mineral water, or purified water).
 - Do not fill the tank with tea, juice, or a sports drink. They can damage the refrigerator.

-
- Children should be supervised to ensure that they do not play with the appliance.
 - Keep fingers out of “pinch point” areas. Clearances between the doors and cabinet are necessarily small. Be careful when you open the doors if children are in the area.
 - Keep all packaging materials well out of the reach of children, as packaging materials can be dangerous to children.
 - If a child places a bag over his or her head, the child could suffocate.
 - Do not let children go inside the refrigerator.
 - It can cause death from suffocation by entrapment or personal injury.
 - Do not let children hang on the door or door bins. A serious injury may occur.
 - Do not let children step on a drawer.
 - The drawer may break and cause them to slip.
 - Do not install this appliance in a humid, oily or dusty location, or in a location exposed to direct sunlight or to water (rain drops).
 - Deteriorated insulation on electrical parts may cause an electric shock or fire.
 - Do not install this appliance in a location where gas may leak.
 - This may result in an electric shock or fire.
 - Do not install this appliance near a heater or flammable material.

Safety information

- If your refrigerator needs to be repaired or reinstalled, contact your nearest Samsung service center.
 - Failing to do so may result in an electric shock, fire, problems with the product, or injury.
 - Unauthorized modifications can cause safety problems. To reverse an unauthorized modification, we will charge the full cost of parts and labor.
 - If the interior or exterior LED lamp has gone out, contact your nearest Samsung service center.
- Do not insert hands, feet, or metal objects (such as chopsticks, etc.) into the bottom or the back of the refrigerator.
 - This may result in an electric shock or injury.
 - Any sharp edges may cause a personal injury.
- Do not stand on top of the appliance or place objects (such as laundry, lighted candles, lighted cigarettes, dishes, chemicals, metal objects, etc.) on the appliance. This may result in an electric shock, fire, problems with the product, or injury. Do not put a container filled with water on the appliance.
 - If spilled, there is a risk of fire or electric shock.
- Do not overfill the refrigerator with food.
 - When you open the door, an item may fall out and cause personal injury or material damage.
- Do not place or use electrical appliances inside the refrigerator/freezer, unless they are of a type recommended by the manufacturer.

-
- Do not use a hair dryer to dry the inside of the refrigerator. Do not place a lighted candle in the refrigerator to remove bad odors.
 - This may result in an electric shock or fire.
 - Do not put a fridge shelf into the refrigerator upside down. The shelf stopper will not work.
 - The glass shelf could fall and cause personal injury.
 - Bottles should be stored tightly together so that they do not fall over or out.
 - Do not touch the inside walls of the freezer or products stored in the freezer with wet hands.
 - This may cause frostbite.
 - Ensure that none of the pipes on the back of the refrigerator are damaged prior to disposal.
 - If a gas leak is detected, avoid any naked flames or potential sources of ignition, and air the room in which the appliance is standing for several minutes.
 - Do not touch the appliance or power cord.
 - Do not use a ventilating fan.
 - A spark may result in an explosion or fire.
 - Never stare directly at the UV LED lamp for long periods of time.
 - This may result in eye strain due to the ultraviolet rays.
 - This product contains R-600a, a flammable gas, which is used as the refrigerant. Contact your local authorities regarding safe disposal of this product.
 - This refrigerator must be properly located and installed in accordance with the instructions in this manual before you use it.
 - Use only the Ice tray provided with the refrigerator.

Safety information

- When moving the refrigerator, be careful not to roll over or damage the power cord.
 - This may result in an electric shock or fire.
- When transporting and installing the appliance, care should be taken to ensure that no parts of the refrigerating circuit are damaged.
 - Refrigerant leaking from the pipe work could ignite or cause an eye injury. If a leak is detected, avoid any naked flames or potential sources of ignition and air the room in which the appliance is standing for several minutes.
 - This appliance contains a small amount of isobutane refrigerant (R-600a), a natural gas with high environmental compatibility that is, however, also flammable.
- Cyclopentane is used in the insulation. The gases in the insulation material require a special disposal procedure. Please contact your local authorities in regard to the environmentally safe disposal of this product.
- When disposing of this refrigerator, remove the door/door seals and door latch so that small children or animals cannot become trapped inside. Children should be supervised to ensure that they do not play with the appliance.
 - If trapped inside, the child could be injured or suffocate to death.
- If you won't be using the refrigerator for a very long period of time, (3 weeks or more) empty the refrigerator, unplug it, wipe excess moisture from the inside walls, and leave the doors open to prevent odors and mold.

Installation and Usage cautions

CAUTION

- Allow sufficient space around the refrigerator and install it on a flat surface.
 - Keep the ventilation space in the appliance enclosure or mounting structure clear of obstructions.
- It is strongly recommended you have a qualified technician or service company install the refrigerator.
 - Failing to do so may result in an electric shock, fire, explosion, problems with the product, or injury.
- Service Warranty and Modification.
 - Any changes or modifications performed by a 3rd party on this finished appliance are not covered under Samsung warranty service, nor is Samsung responsible for safety issues that result from 3rd party modifications.
- Before cleaning or performing maintenance, unplug the appliance from the wall socket.
 - Failing to do so may result in an electric shock or fire.
- Do not clean glass shelves or covers with warm water when they are cold. Glass shelves and covers may break if exposed to sudden temperature changes or impacts such as bumping or dropping.

Safety information

- Do not keep vegetable oil in your refrigerator's door bins. The oil can solidify, making it foul-tasting and difficult to use. In addition, the open container can leak and the leaked oil can cause the door bin to crack. After opening an oil container, it is best to keep the container in a cool and shaded place such as a cupboard or pantry.
 - Examples of vegetable oil: olive oil, corn oil, grape-seed oil, etc.
- Do not put glass containers or bottles or carbonated beverages into the freezer.
 - The container may freeze and break, and this may result in injury.
- Do not re-freeze frozen foods that have thawed completely.
- Do not strike or apply excessive force to any glass surface.
 - Broken glass may result in a personal injury and/or property damage.
- If the refrigerator is disconnected from the power supply, you should wait for at least five minutes before plugging it back in.
- Please dispose of the packaging material from this product in an environmentally friendly manner.
- Do not store flammable stuff nearby the refrigerator.
- Do not install the appliance nearby the voltage stabilizer.
- Do not use a candle on top of the appliance when a blackout.
- Do not use a hooking power by direct tapping from the electric line.

-
- Do not install this appliance in a humid, oily or dusty location, in a location exposed to direct sunlight and water (rain drops)
 - Deteriorated insulation on electrical parts may cause an electric shock or fire.

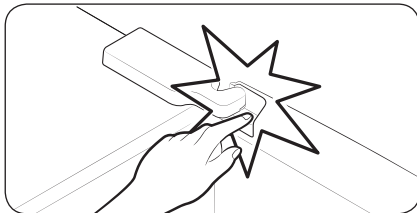

- Be careful that your fingers are not caught in.

Installation

Follow these instructions carefully to ensure a proper installation of this refrigerator and to prevent accidents before using it.

⚠ WARNING

- Use the refrigerator only for its intended purpose as described in this manual.
- Any servicing must be performed by a qualified technician.
- Dispose of the product packaging material in compliance with the local regulations.

Refrigerator at a glance

📖 NOTE

The actual image and provided component parts of the refrigerator may differ, depending on the model and the country.

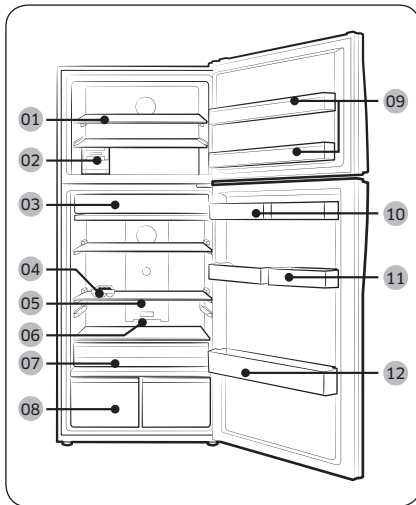

- 01 Shelf Fre *
- 02 Ice Maker *
- 03 Fresh Room *
- 04 Egg bin
- 05 Slide Shelf
- 06 Deodorizer *
- 07 Movable VEG Box *
- 08 Vegetable Drawer *
- 09 Freezer bin
- 10 Water Tank *
- 11 Multi Storage Basket *
- 12 Bottle bin

* applicable models only

Optional accessories *

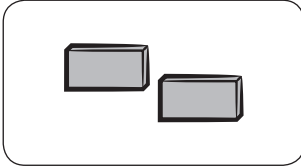

Spacer: This helps keep the refrigerator cool.

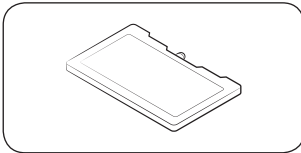

Cool pack: This helps keep the refrigerator cool.

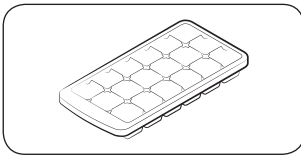

Ice tray: Used to make ice.

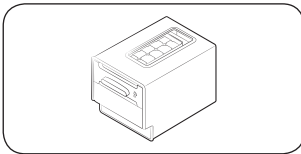

Twist Ice Maker: Used to make ice.

* Your refrigerator may not include optional accessories listed above. Provision of optional accessories depends on the model and the country.

Installation

To secure more room for storage in the freezer compartment

Remove one or more optional accessories such as cool pack(s), shelf or shelves, twist ice maker(s), ice storage bins and their supports, all of which can be removed manually without a tool.

- These optional accessories do not affect thermal and mechanical performance.
- A declared storage volume of the freezer is based on the nonexistence of those optional accessories.
- To remove both ice makers, remove the right-handed one first (applicable to Ice Max models).
- For best energy efficiency, make sure all of shelves, drawers, and baskets are placed in their original position.

Load limit indicator (applicable models only)

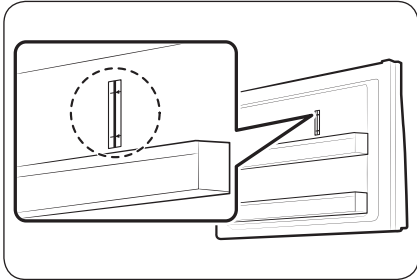

The refrigerator has a load limit indicator on the top right side of the freezer compartment.

⚠ CAUTION

- Do not put or keep food items over the load limit indicator. Otherwise, energy efficiency may be affected.

Step-by-step installation

STEP 1 Select a site

Site requirements:

- Solid, level surface without carpeting or flooring that may obstruct ventilation
- Away from direct sunlight
- Adequate room for opening and closing the door
- Away from a heat source
- Room for maintenance and servicing
- Temperature range: between 10 °C and 43 °C

Clearance

See the pictures and table below for space requirements for installation.

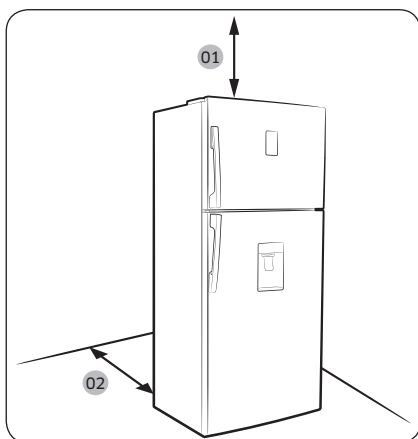

Model	A	B	C
RT42, RT38	1275	1001	115°
RT39, RT35	1275	1001	115°
RT37, RT32	1221	1040	135°
RT34, RT29	1221	1040	135°

(unit: mm)

01 100 mm

02 more than 50 mm recommended

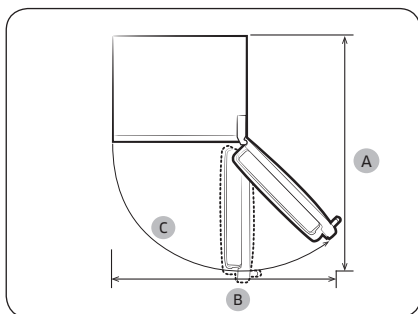

Installation

STEP 2 Spacing (applicable models only)

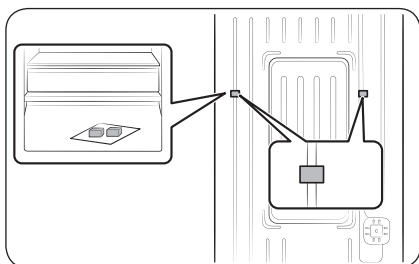

1. Open the door and locate the provided spacers (x2).
2. Unpack both spacers and attach them to the rear of the refrigerator as shown. They help ventilate air to the rear wall and save power consumption.

STEP 3 Flooring

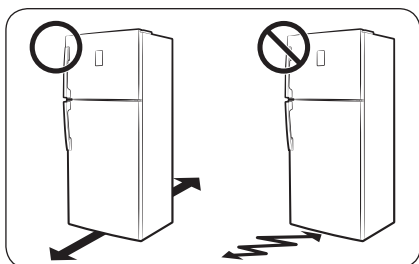

- The surface to install the refrigerator must support a fully loaded refrigerator, or approximately 90 kg.
- To protect the floor, put a large piece of cardboard on each leg of the refrigerator.
- Once the refrigerator is in its final position, do not move it unless necessary to protect the floor. If you have to, use a thick paper or cloth such as old carpets along the movement path.

STEP 4 Adjust the levelling feet

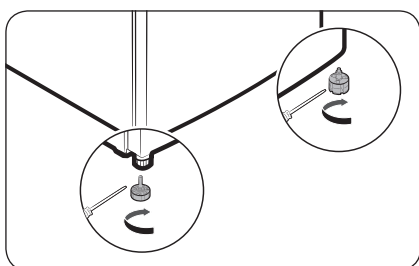

Level the refrigerator by manually adjusting the levelling feet. Turn the levelling feet clockwise to lower the position, or turn counter clockwise to raise. For safety reasons, adjust the front side a little higher than the rear side.

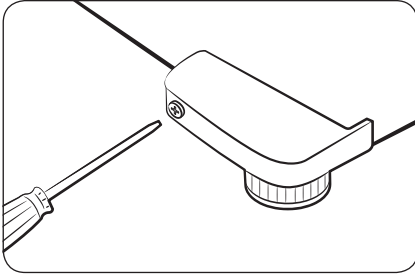

⚠ CAUTION

Before moving the refrigerator, make sure to turn the levelling feet counter clockwise so that the bottom of the refrigerator at least 66 mm from the floor.

STEP 5 Initial settings

By completing the following steps, the refrigerator should be fully functioning.

1. Plug the power cord into the wall socket to turn the refrigerator on.
2. Open the door, and check if the interior light lights up.
3. Set the temperature to the coldest, and wait for about an hour. Then, the freezer will be slightly chilled, and the motor will run smoothly.
4. Wait until the refrigerator reaches the set temperature. Now the refrigerator is ready for use.

STEP 6 Final check

When installation is complete, confirm that:

- The refrigerator is plugged into an electrical outlet and grounded properly.
- The refrigerator is installed on a flat, level surface with a reasonable clearance from the wall or the cabinet.
- The refrigerator is level and is sitting firmly on the floor.
- The door opens and closes freely, and the interior light turns on automatically when you open the door.

Operations

Feature panel

Fridge

To ensure optimal performance, we recommend setting the temperature to **Optimal** or ******.

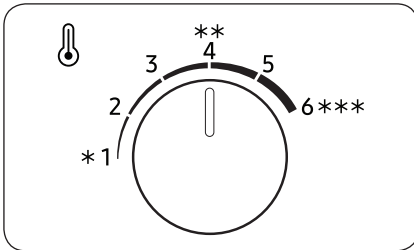

- To decrease the temperature for strong cooling, set the temperature control to level 5-6.
- To increase the temperature for weak cooling, set the temperature control to level 1-2.

⚠ CAUTION

- If the room temperature is lower than 10 °C, do not set the refrigerator's Temperature Controller to 1-2. This may cause problems with the cooling performance.
- When the room temperature is higher than 35 °C, set the Fridge Temperature Controller on 4-6. This may also cause problems with the cooling performance.

Freezer

To make ice in summer (above 35 °C), set the freezer temperature to **Optimal**.

RT35/38

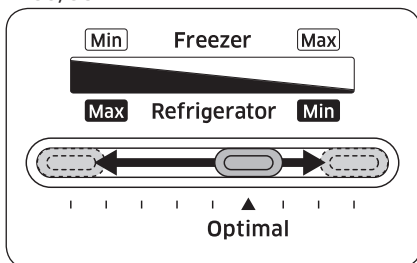

- To increase the temperature, slide/turn the temperature control to the right.
- To decrease the temperature, slide/turn the temperature control to the left. In winter, slide/turn the temperature control to the right-most end.

RT29/32

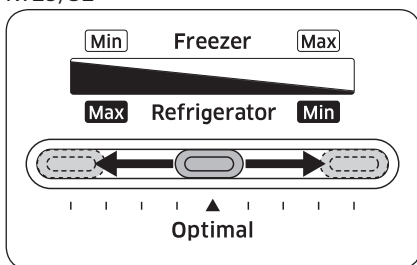

⚠ CAUTION

- To prevent system failure or food spoiling, do not set the temperature to the right-most end (minimum) in summer (above 35 °C).
- Do not store glass bottles containing liquid in the freezer. Glass bottles will crack or break into pieces when the liquid freezes.

Operations

Special features

The actual image and special functions of your refrigerator may differ, depending on the model and the country.

Ice making (applicable models only)

Twist ice maker

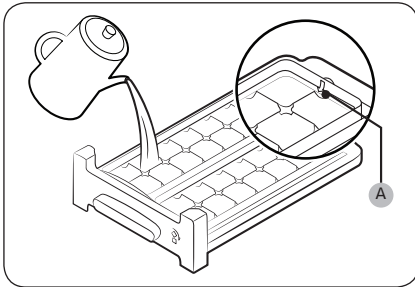

1. Open the freezer door, and slide open the ice tray.
2. Fill the tray with water up to the **maximum level (A)** marked on the inner rear of the tray.
3. Slide the tray back into position.

NOTE

The ice making time depends on your temperature settings.

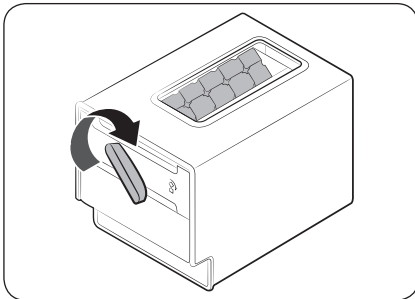

NOTE

- Make sure the ice cube storage bin is in place under the ice tray.
- To dispense the ice cubes, turn the handle of the bin to the right to empty half of the ice cubes into the bin. Then, turn it to the left to empty the other half.
- Take out the bin by slightly twisting and pulling to the front.

Tray type

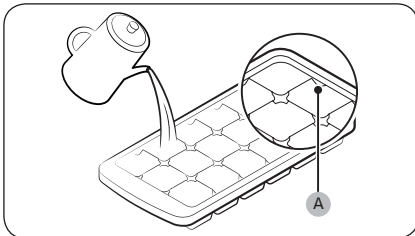

To make ice cubes, fill the tray with water up to the **maximum level (A)** marked on the inner rear of the tray.

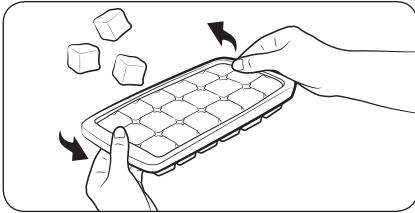

To empty the ice tray, hold both ends of the tray and gently twist to remove the ice cubes.

Water dispenser (applicable models only)

With the water dispenser, you can dispense water without opening the fridge door. The water tank must be filled with potable water before use.

To fill the water tank with potable water

Open the door and locate the water tank that is located in the door shelf area.

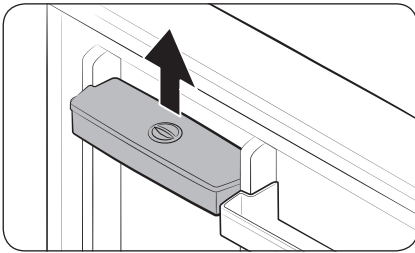

1. Hold the handgrips on both sides of the water tank and lift up to remove.

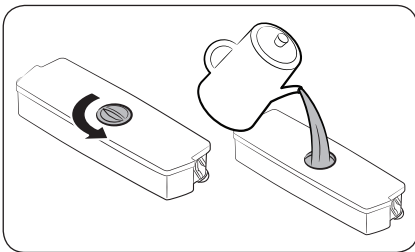

2. Fill the water tank with potable water up to 2.3 liters. You can remove either the top cap or the cover and pour water.

NOTE

For first-time use, clean inside the water tank.

Operations

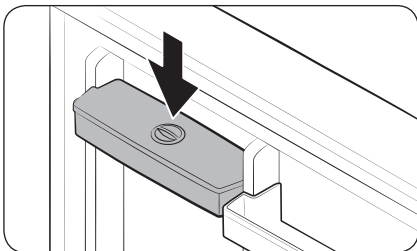

3. Reinsert the water tank and close the door. Make sure the water outlet of the water tank faces forward.

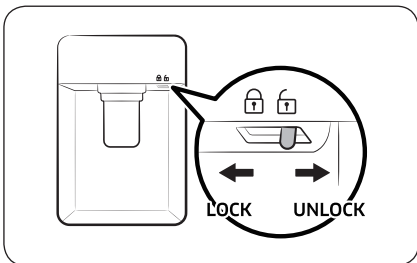

4. Put a water glass under the water outlet of the dispenser, and gently push the dispenser lever to dispense water. Make sure the water dispenser is unlocked.

CAUTION

- The water dispenser is designed to dispense potable water. Fill the water tank only with potable water. Do not fill with any other liquids.
- Do not fill the water tank excessively, which causes an overflow.
- Do not try to fill the water tank without removing it from the door.
- Make sure that water tank is seated properly.
- Do not use the refrigerator without the water tank. This may reduce performance and efficiency.
- To prevent water bouncing, make sure the glass is in line with the dispenser lever.

NOTE

To secure more room, you can use the water tank to store food. In this case, remove the lid of the tank.

Maintenance

Handle and care

Freezer and fridge shelves

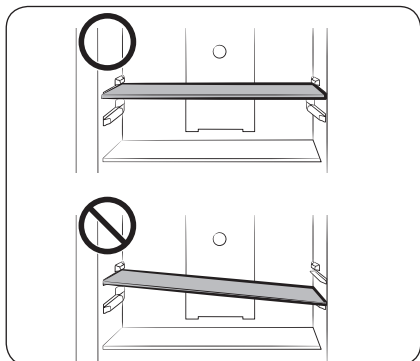

- To remove a shelf, first open the door completely. Pull the shelf forward, lift up, and then pull out.
- When reinserting the shelf, make sure the “Front” label of the shelf faces forward.
- Do not attempt to tilt the shelf into position.

Door bins

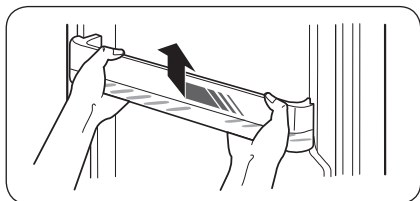

Slightly lift up and pull out the door bin.

⚠ CAUTION

To prevent accidents, empty the door bins before removing.

Maintenance

Cleaning

Regularly use a dry cloth to remove all foreign substances such as dust or water from the power plug terminals and contact points.

1. Unplug the power cord of the refrigerator.
2. Use a moistened soft lint-free cloth or paper towel to clean the refrigerator's interior and exterior.
3. When done, use a dry cloth or paper towel to dry well.
4. Plug in the power cord of the refrigerator to turn the refrigerator on.

NOTE

If you have removed any removable parts such as shelves for cleaning, refer to the overall layout in the What's included section to make sure you have reinserted correctly.

WARNING

- Do not use benzene, thinner, or home/car detergent such as Clorox™ for cleaning purposes. They may damage the surface of the refrigerator and cause a fire.
- Do not spray water onto the refrigerator. This may cause electric shock.
- Do not put fingers or other objects into the dispenser hole.

Replacement

Deodorizer filter (applicable models only)

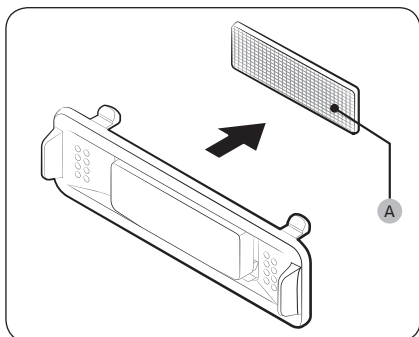

While holding the top and bottom sides of the filter case, unlock the filter case to reveal the **deodorizer filter (A)**. Replace the filter, and then reinsert the case.

Lamps

The lamps are not user-serviceable. To replace the lamps of the refrigerator, contact a local Samsung service centre.

Troubleshooting

If you encounter an abnormal situation with the refrigerator, first check the table below and try the suggestions.

General

Temperature

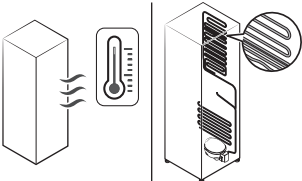
Symptom	Possible causes	Solution
Fridge does not operate. Fridge temperature is warm.	<ul style="list-style-type: none"> Power cord is not plugged in properly. 	<ul style="list-style-type: none"> Properly plug in the power cord.
	<ul style="list-style-type: none"> Temperature control is not set correctly. 	<ul style="list-style-type: none"> Set the temperature lower.
	<ul style="list-style-type: none"> Refrigerator is located near a heat source or direct sunlight. 	<ul style="list-style-type: none"> Keep the refrigerator away from direct sunlight or a heat source.
	<ul style="list-style-type: none"> Not enough clearance between refrigerator and sides/rear. 	<ul style="list-style-type: none"> We recommend that the gap between the refrigerator and nearby walls (or cabinets) is more than 50 mm.
	<ul style="list-style-type: none"> Vacation mode is activated. 	<ul style="list-style-type: none"> Deactivate vacation mode.
	<ul style="list-style-type: none"> The refrigerator is overloaded. Food is blocking the refrigerator vents. 	<ul style="list-style-type: none"> Do not overload the refrigerator. Do not allow food to block ventilation.
Fridge is over-cooling.	<ul style="list-style-type: none"> Temperature control is not set correctly. 	<ul style="list-style-type: none"> Set the temperature higher.
Interior wall is hot.	<ul style="list-style-type: none"> Refrigerator has heat-proof piping in the interior wall. 	<ul style="list-style-type: none"> To prevent condensation from forming, the refrigerator has heat-proof piping in the front corners. If the ambient temperature rises, this equipment may not work effectively. This is not a system failure. 

Troubleshooting

Odors

Symptom	Possible causes	Solution
Refrigerator has odors.	• Spoiled food.	• Clean the refrigerator and remove any spoiled food.
	• Food with strong odors.	• Make sure strong smelling food is wrapped airtight.

Condensation

Symptom	Possible causes	Solution
Condensation forms on the interior walls.	• If door is left open, moisture enters the refrigerator.	• Remove the moisture and do not open the door for a long time.
	• Food with high moisture content.	• Make sure food is wrapped airtight.

Do you hear abnormal sounds from the refrigerator?

Before calling for service, review the checkpoints below. Any service calls related to normal sounds will be charged to the user.

These sounds are normal.

- When starting or ending an operation, the refrigerator may make sounds similar to a car engine igniting. As the operation stabilizes, the sounds will decrease.

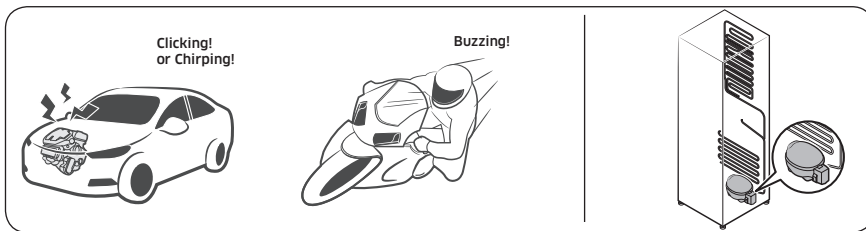

- While the fan is operating, these sounds may occur. When the refrigerator reaches the set temperature, no fan sound will occur.

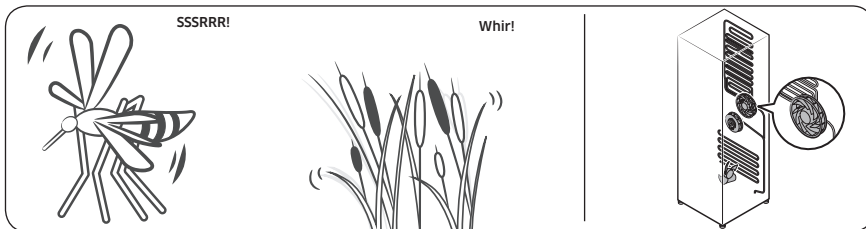

- During a defrost cycle, water may drip on the defrost heater, causing sizzling sounds.



Troubleshooting

- As the refrigerator cools or freezes, refrigerant gas moves through sealed pipes, causing bubbling sounds.

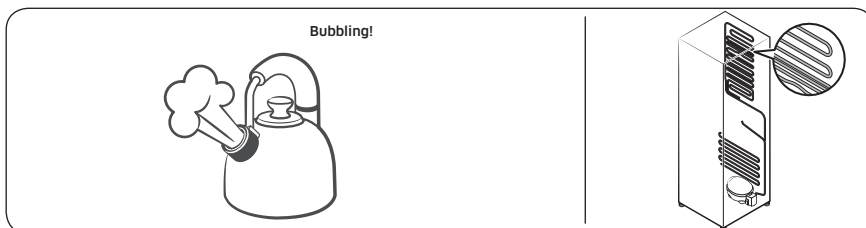

- As the refrigerator temperature increases or decreases, plastic parts contract and expand, creating knocking noises. These noises occur during the defrosting cycle or when electronic parts are working.

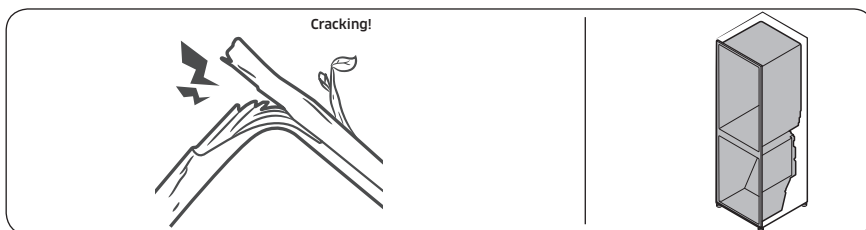

- For ice maker models: When the water valve opens to fill the ice maker, buzzing sounds may occur.
- Due to pressure equalizing when opening and closing the refrigerator door, whooshing sounds may occur.

Memo

Memo

Memo

Contact SAMSUNG WORLD WIDE

If you have any questions or comments relating to Samsung products, please contact the SAMSUNG customer care center.

Country	Contact Center	Web Site
AUSTRALIA	1300 362 603 (Other) 1300 425 299 (HHP)	www.samsung.com/au/support
NEW ZEALAND	0800 726 786 (All Product) 0800 6 726 786 (Support for Smart Mobile Devices)	www.samsung.com/nz/support



DA68-03721W-00