

# SAMSUNG

# Product Guide

## 6300 Series Laundry

Available in White, Champagne and Platinum



# Table of Contents

## WF45B6300 - Front Load Washer

### Product Overview

Product Overview 4

Carousel Image Order 5

### Product Messaging

Features and Benefits 9

Lifestyle Images 15

### Product Specs

Related Products and Accessories 19

Spec Sheet 20

Energy Guide 21

User Manual and Warranty 22

**Feature Icons 24**

## DVE45B6300 - Electric Dryer

## DVG45B6300 - Gas Dryer

### Product Overview

Product Overview 26

Carousel Image Order 27

### Product Messaging

Features and Benefits 31

### Product Specs

Related Products and Accessories 36

Spec Sheets 37

User Manual and Warranty 39

**Feature Icons 41**



# Product Overview

---

**WF45B6300AW**

**WF45B6300AC**

**WF45B6300AP**

**4.5 cu. ft. Large Capacity Smart Front Load Washer  
with Super Speed Wash**

# Product Overview

## Product Title

4.5 cu. ft. Large Capacity Smart Front Load Washer with Super Speed Wash

## Product Short Description (213 Characters)

Samsung's new 4.5 cu. ft. large capacity Front Load Washer washes full loads with full performance in 28 minutes\* and with Wi-Fi, allows you to receive end of cycle alerts and schedule laundry from your smartphone.\*\*

## Product Long Description (291 Characters)

Samsung's new 4.5 cu. ft. large capacity Front Load Washer features Super Speed Wash, so you can wash full loads with full performance in just 28 minutes,\* and has built-in Wi-Fi so you can receive end of cycle alerts and remotely start, stop, and schedule laundry right from your smartphone.\*\*

\*Based on using Super Speed on a Normal cycle with an 8lb load.

\*\*Requires wireless network, Samsung account and SmartThings App. Available on Android and iOS devices.

## Available Colors



### White

Model Number: WF45B6300AW

UPC: 887276627434



### Champagne

Model Number: WF45B6300AC

UPC: 887276627403



### Platinum

Model Number: WF45B6300AP

UPC: 887276627410



# Carousel Image Order

## WF45B6300AW

Easy Ads links

Retail.com: <https://dam.gettyimages.com/p/z0c3461/external?o=AND&q=WF45B6300AW%20Carousel%20Images%20RCOM>  
Samsung.com: <https://dam.gettyimages.com/p/z0c3461/external?o=AND&q=WF45B6300AW%20Carousel%20Images%20SCOM>  
360 Spin: <https://dam.gettyimages.com/p/z0c3461/external?o=AND&q=WF45B6300AW%20360%20Spins>





# Carousel Image Order

## WF45B6300AC

Easy Ads links

Retail.com: <https://dam.gettyimages.com/p/z0c3461/external?o=AND&q=WF45B6300AC%20Carousel%20Images%20RCOM>  
Samsung.com: <https://dam.gettyimages.com/p/z0c3461/external?o=AND&q=WF45B6300AC%20Carousel%20Images%20SCOM>  
360 Spin: <https://dam.gettyimages.com/p/z0c3461/external?o=AND&q=WF45B6300AC%20360%20Spins>

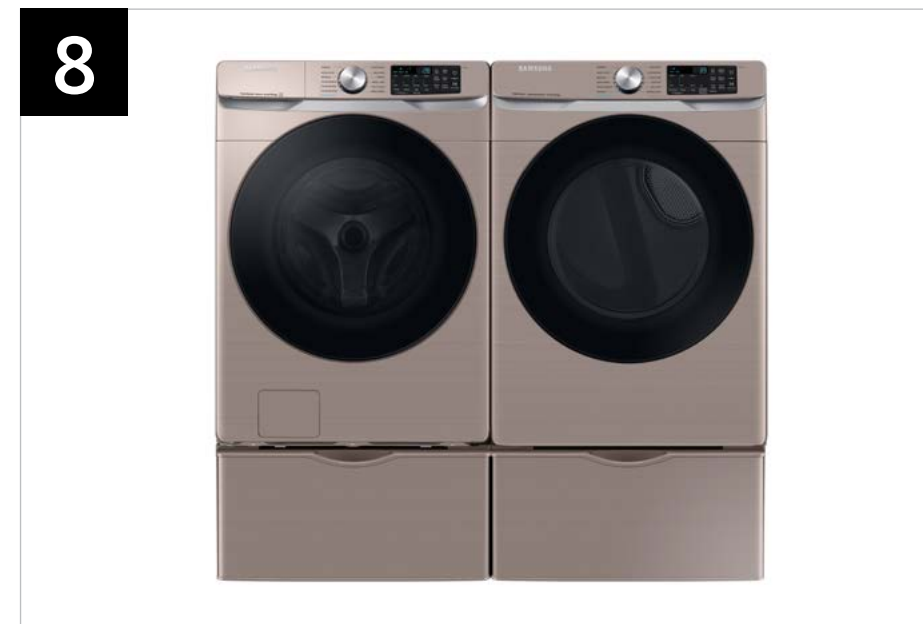
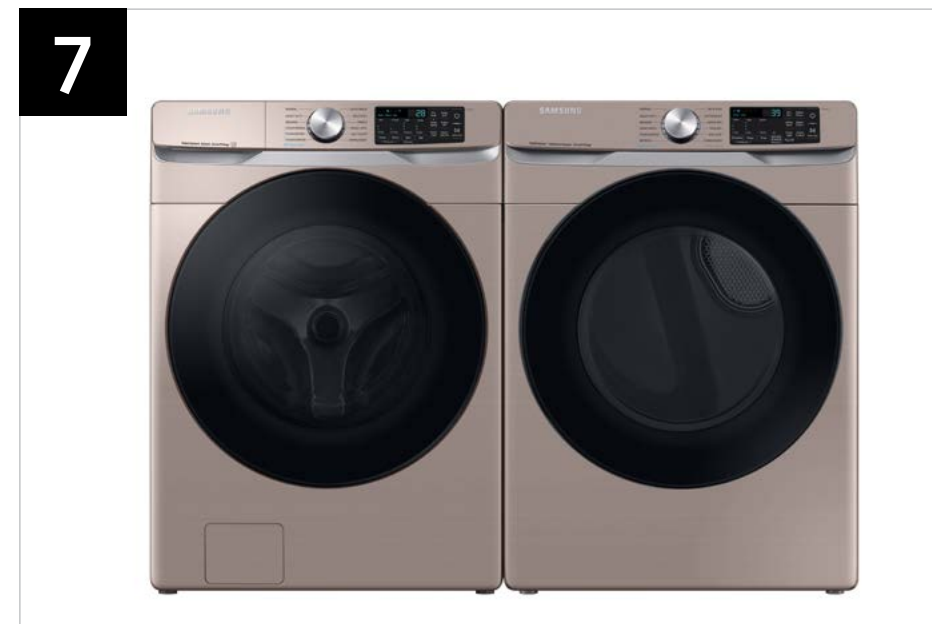
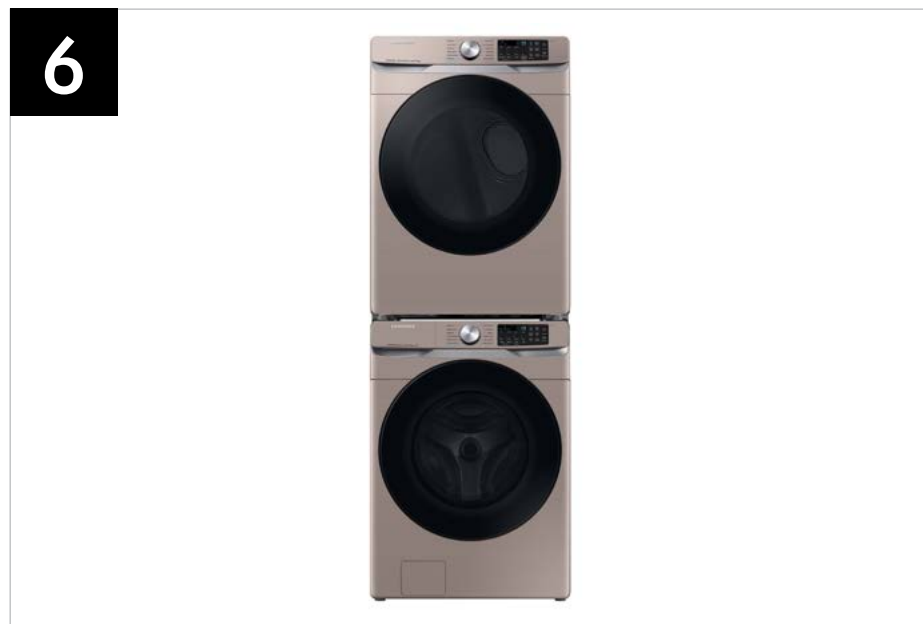



# Carousel Image Order

## WF45B6300AP

Easy Ads links

Retail.com: <https://dam.gettyimages.com/p/z0c3461/external?o=AND&q=WF45B6300AP%20Carousel%20Images%20RCOM>  
 Samsung.com: <https://dam.gettyimages.com/p/z0c3461/external?o=AND&q=WF45B6300AP%20Carousel%20Images%20SCOM>  
 360 Spin: <https://dam.gettyimages.com/p/z0c3461/external?o=AND&q=WF45B6300AP%20360%20Spins>



# Product Messaging

---

**WF45B6300AW**

**WF45B6300AC**



**WF45B6300AP**

**4.5 cu. ft. Large Capacity Smart Front Load Washer  
with Super Speed Wash**



**Features and Benefits:  
WF45B6300\***

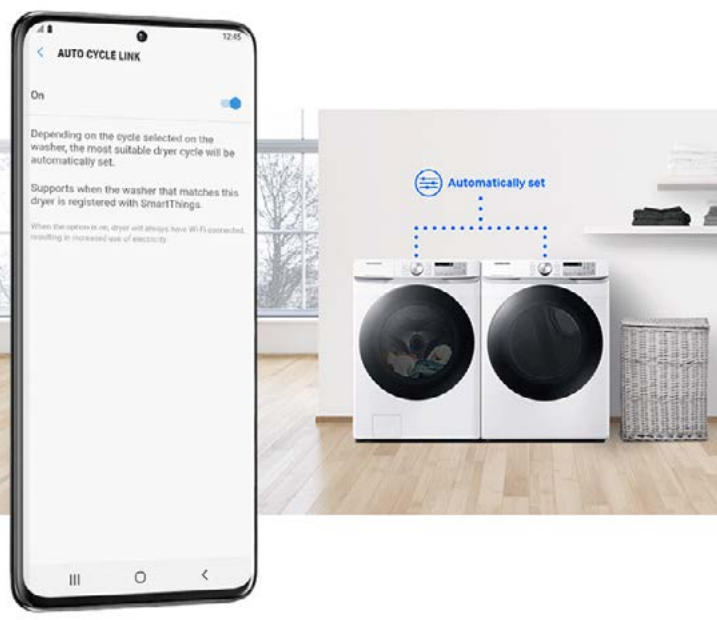

White Washer Easy Ads link: <https://dam.gettyimages.com/p/z0c3461/external?o=AND&q=WF45B6300AW%20Below%20the%20Fold>  
 Champagne Washer Easy Ads link: <https://dam.gettyimages.com/p/z0c3461/external?o=AND&q=WF45B6300AC%20Below%20the%20Fold>  
 Platinum Washer Easy Ads link: <https://dam.gettyimages.com/p/z0c3461/external?o=AND&q=WF45B6300AP%20Below%20the%20Fold>

Headline	Feature Name	Long Body Copy	Short Body Copy	Associated Image
<p><b>Wash a full load in just 28 minutes*</b></p>	<p><b>Super Speed Wash</b></p>	<p>Wash a full load of laundry in just 28 minutes,* without sacrificing cleaning performance.                      *Based on using Super Speed on a Normal cycle with an 8lb load.</p>	<p>Fast, thorough washing in just 28 minutes.*                      *Based on using Super Speed on a Normal cycle with an 8lb load.</p>	
<p><b>Control in the palm of your hand</b></p>	<p><b>Wi-Fi Connectivity</b></p>	<p>Wi-Fi connected so you can receive end of cycle alerts, remotely start or stop your wash, schedule cycles on your time, and more, right from your smartphone with the SmartThings App.*                      *Requires wireless network, Samsung account and SmartThings App. Available on Android and iOS devices.</p>	<p>Receive end of cycle alerts, remotely start, schedule, and more, from your smartphone with the SmartThings App.*                      *Requires wireless network, Samsung account and SmartThings App. Available on Android and iOS devices.</p>	
<p><b>Purchase with confidence</b></p>	<p><b>20-Year Motor Warranty</b></p>	<p>Purchase with confidence any Samsung Washer model with a Digital Inverter Motor and receive a 20 year warranty on the motor.*                      *20-year warranty limited to the Digital Inverter Motor of washers purchased on 7/1/2022 or later. Purchase receipt indicating purchase date required for a claim. Additional restrictions and limitations apply, see warranty for details.</p>	<p>Purchase with confidence any Samsung Washer model with a Digital Inverter Motor and receive a 20 year warranty on the motor.*                      *20-year warranty limited to the Digital Inverter Motor of washers purchased on 7/1/2022 or later. Purchase receipt indicating purchase date required for a claim. Additional restrictions and limitations apply, see warranty for details.</p>	



**Features and Benefits:  
WF45B6300\* (Continued)**



White Washer Easy Ads link: <https://dam.gettyimages.com/p/z0c3461/external?o=AND&q=WF45B6300AW%20Below%20the%20Fold>  
 Champagne Washer Easy Ads link: <https://dam.gettyimages.com/p/z0c3461/external?o=AND&q=WF45B6300AC%20Below%20the%20Fold>  
 Platinum Washer Easy Ads link: <https://dam.gettyimages.com/p/z0c3461/external?o=AND&q=WF45B6300AP%20Below%20the%20Fold>

Headline	Feature Name	Long Body Copy	Short Body Copy	Associated Image
Gently remove stains	Steam	The power of steam lets you gently remove stains without any time-consuming pretreatments. Steam is released from the drum so every item in the load is thoroughly saturated, ensuring a deep clean.	The power of steam lets you gently remove stains without any time-consuming pretreatments.	
N/A	Energy Star Most Efficient	Our washers are recognized by the EPA in delivering cutting-edge energy efficiency along with the latest in technological innovation.* <small>*Visit <a href="http://www.energystar.gov">www.energystar.gov</a> for more information on ENERGY STAR® guidelines.</small>	Recognized for delivering cutting-edge energy efficiency and innovation.* <small>*Visit <a href="http://www.energystar.gov">www.energystar.gov</a> for more information on ENERGY STAR® guidelines.</small>	
Fit more for fewer loads	Large 4.5 cu. ft. Capacity	Fewer loads, less time in the laundry room, and more time doing the things you love.	Fewer loads, less time in the laundry room.	



## Features and Benefits: WF45B6300\* (Continued)



White Washer Easy Ads link: <https://dam.gettyimages.com/p/z0c3461/external?o=AND&q=WF45B6300AW%20Below%20the%20Fold>  
 Champagne Washer Easy Ads link: <https://dam.gettyimages.com/p/z0c3461/external?o=AND&q=WF45B6300AC%20Below%20the%20Fold>  
 Platinum Washer Easy Ads link: <https://dam.gettyimages.com/p/z0c3461/external?o=AND&q=WF45B6300AP%20Below%20the%20Fold>

Headline	Feature Name	Long Body Copy	Short Body Copy	Associated Image
<p><b>Open the door to a fresher washer</b></p>	<p><b>Antimicrobial Technology</b></p>	<p>The inside of the washer is treated with antimicrobial technology to help keep it smelling fresh.*</p> <p><small>*Antimicrobial treatment does not protect users or other items against bacteria, viruses, germs, or other disease organisms.</small></p>	<p>Keep your drum smelling fresh with antimicrobial technology.*</p> <p><small>*Antimicrobial treatment does not protect users or other items against bacteria, viruses, germs, or other disease organisms.</small></p>	
<p><b>Premium design for an elevated look</b></p>	<p><b>Scratch-Resistant Tempered Glass Door</b></p>	<p>Our sleek, new flat-panel door will elevate any laundry space and with scratch-resistant tempered glass, it combines an ultra-premium design with a durable finish.</p>	<p>Sleek and scratch-resistant, our new flat-panel door will elevate any laundry space.</p>	
<p><b>Space-saving design</b></p>	<p><b>Closet-Depth Fit*</b></p>	<p>Perfect for any laundry space, this washer has a shallower depth for an easy installation into closets without sacrificing any washing capacity.*</p> <p><small>*Designed to fit a 39" installation depth.</small></p>	<p>A shallower depth allows for an easy installation into closets without sacrificing washing capacity.*</p> <p><small>*Designed to fit a 39" installation depth.</small></p>	



**Features and Benefits:  
WF45B6300\* (Continued)**

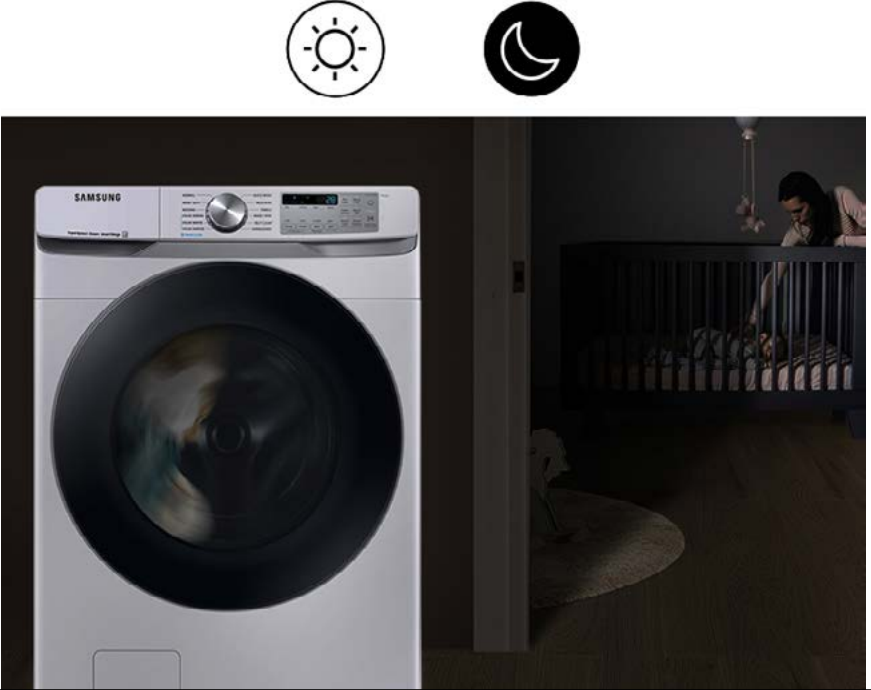

White Washer Easy Ads link: <https://dam.gettyimages.com/p/z0c3461/external?o=AND&q=WF45B6300AW%20Below%20the%20Fold>  
 Champagne Washer Easy Ads link: <https://dam.gettyimages.com/p/z0c3461/external?o=AND&q=WF45B6300AC%20Below%20the%20Fold>  
 Platinum Washer Easy Ads link: <https://dam.gettyimages.com/p/z0c3461/external?o=AND&q=WF45B6300AP%20Below%20the%20Fold>

Headline	Feature Name	Long Body Copy	Short Body Copy	Associated Image
<p><b>Quiet washing anytime, any place</b></p>	<p><b>Vibration Reduction Technology+</b></p>	<p>Do your laundry without disturbing anyone. Innovative Vibration Reduction Technology+ reduces noise and vibration for quiet washing at any time and in any place.</p>	<p>Reduces noise and vibration for quiet washing.</p>	
<p>N/A</p>	<p><b>Swirl+ Drum Interior</b></p>	<p>Improved drum pattern extracts more water more quickly during the rinsing cycle and prevents fabrics from snagging during washing.</p>	<p>Improved drum pattern extracts more water more quickly.</p>	
<p><b>Keep your washer fresh and clean</b></p>	<p><b>Self Clean+</b></p>	<p>Self Clean+ cleans the inside of your washer to keep it smelling fresh and will also remind you every 40 wash cycles when it is time for a cleaning.</p>	<p>Self Clean+ cleans the inside of your washer and will remind you every 40 cycles when it is time for a cleaning.</p>	



**Features and Benefits:  
WF45B6300\* (Continued)**

White Washer Easy Ads link: <https://dam.gettyimages.com/p/z0c3461/external?o=AND&q=WF45B6300AW%20Below%20the%20Fold>  
 Champagne Washer Easy Ads link: <https://dam.gettyimages.com/p/z0c3461/external?o=AND&q=WF45B6300AC%20Below%20the%20Fold>  
 Platinum Washer Easy Ads link: <https://dam.gettyimages.com/p/z0c3461/external?o=AND&q=WF45B6300AP%20Below%20the%20Fold>

Headline	Feature Name	Long Body Copy	Short Body Copy	Associated Image
<p><b>Easier use, for everyone</b></p>	<p><b>ADA Compliant</b></p>	<p>With use of a Samsung Riser,* your washer or dryer is compliant with the Americans with Disabilities Act (ADA), making loading and unloading much easier.</p> <p><small>*ADA Compliant when using 27" wide riser. (Riser model codes: WE272NW, WE272NC, WE272NV)</small></p>	<p>Designed for easy use for everyone.*</p> <p><small>*ADA Compliant when using 27" wide riser. (Riser model codes: WE272NW, WE272NC, WE272NV)</small></p>	
<p><b>Perfect pair</b></p>	<p><b>Matching Accessories</b></p>	<p>Round out your laundry setup with a matching dryer, pedestal, riser, and more.</p>	<p>N/A</p>	

# Lifestyle Images

---

**WF45B6300AW**

**WF45B6300AC**

**WF45B6300AP**

**4.5 cu. ft. Large Capacity Smart Front Load Washer  
with Super Speed Wash**



# Lifestyle Images

Easy Ads link

<https://dam.gettyimages.com/p/z0c3461/external?o=AND&q=WF45B6300%20Lifestyle%20Images>



White 6300 Pair



Champagne 6300 Pair



Platinum 6300 Pair



White 6300 Pair



Champagne 6300 Pair



Platinum 6300 Pair



# Lifestyle Images

Easy Ads link

<https://dam.gettyimages.com/p/z0c3461/external?o=AND&q=WF45B6300%20Lifestyle%20Images>



White 6300 Pair



Champagne 6300 Pair



Platinum 6300 Pair



White 6300 Pair



Champagne 6300 Pair



Platinum 6300 Pair



# Lifestyle Images

Easy Ads link

<https://dam.gettyimages.com/p/z0c3461/external?o=AND&q=WF45B6300%20Lifestyle%20Images>



White 6300 Pair



Champagne 6300 Pair



Platinum 6300 Pair

# Product Specs

---

**WF45B6300AW**

**WF45B6300AC**

**WF45B6300AP**

**4.5 cu. ft. Large Capacity Smart Front Load Washer  
with Super Speed Wash**



## Related Products and Accessories

Dryer Series	Pedestal	Riser	Stacking Kit
DVE45B6300W DVG45B6300W DVE45B6300C DVG45B6300C DVE45B6300P DVG45B6300P	WE402NW WE402NC WE402NP	WE272NW WE272NC	SKK-8K

# Spec Sheet

Easy Ads link

<https://dam.gettyimages.com/p/z0c3461/external?o=AND&q=WF45B6300%20Spec%20Sheet>

**WF45B6300AW | WF45B6300AC | WF45B6300AP**  
Samsung 4.5 cu. ft. Large Capacity Smart Front Load Washer with Super Speed Wash



**Available Colors**

- White  
WF45B6300AW
- Champagne  
WF45B6300AC
- Platinum  
WF45B6300AP

**Features**

- Super Speed Wash
- Wi-Fi Connectivity<sup>1</sup>
- Steam
- ENERGY STAR<sup>®</sup> Most Efficient
- Large 4.5 cu. ft. Capacity
- Antimicrobial Technology
- Scratch-Resistant Tempered Glass Door
- Closet-Depth Fit<sup>2</sup>
- Vibration Reduction Technology<sup>3</sup>
- Swirl<sup>®</sup> Drum Interior
- Self Clean<sup>+</sup>
- ADA Compliant<sup>3</sup>
- Accessibility (AUI, Braille)
- Stackable
- Internal Water Heater
- 1200 RPM Maximum Spin Speed
- Direct Drive Motor
- 23 Total Washing Cycles
- 9 Additional Washing Options

**Specifications**

**23 Total Washing Cycles:**  
Normal, Heavy Duty, Bedding, Quick Wash, Delicates, Towels, Rinse + Spin, Self Clean+, Steam Sanitize, Steam Normal, Steam Whites, Downloads, Permanent Press, Activewear, Wool, Eco Cold, Colors, Outdoor, Denim, Steam Allergen, Power Steam, Steam Bulky, Power Rinse

**9 Additional Washing Options:**  
Pre Soak, Steam, Delay End, Smart Control, Super Speed, Smart Care, Sound, Child Lock, Spin Only

**5 Temperature Settings:**  
Hot, Warmer, Warm, Cool, Cold

**5 Spin Settings:**  
High, Medium, Low, Extra Low, No Spin

**5 Soil Settings:**  
Heavy, Heavy Medium, Normal, Medium Low, Light

**Warranty**  
One (1) Year Parts and Labor  
Three (3) Years Stainless Steel Tub (Part Only)  
Twenty (20) Years; Washing DIT (Digital Inverter Motor) Motor Part (Part Only)

**Product Dimensions & Weight (WxHxD)**  
Dimensions: 27" x 38 3/4" x 31 1/8"  
Weight: 200.6 lbs

**Shipping Dimensions & Weight (WxHxD)**  
Dimensions: 29 1/8" x 42 1/8" x 34 1/8"  
Weight: 205 lbs

**Optional Accessories**

Model #	UPC Code
White Pedestal WE402NW	887276310152
Champagne Pedestal WE402NC	887276310121
Platinum Pedestal WE402NP	887276310158
White Riser WE272NW	887276197647
Champagne Riser WE272NC	887276393940
Stacking Kit SKK-8K	887276344034

**Matching Electric Dryer**

Model #	UPC Code
White DVE45B6300W	887276628035
Champagne DVE45B6300C	887276628004
Platinum DVE45B6300P	887276628011

**Matching Gas Dryer**

Model #	UPC Code
White DVG45B6300W	887276628073
Champagne DVG45B6300C	887276628042
Platinum DVG45B6300P	887276628059

**Convenience**

- Child Lock
- Dispenser Trays: Main Wash, Softener, Bleach

**Ratings**

Most Efficient 2022

CEE Tier 3  
IMEF = 3.1  
IWF = 2.9  
92 kWh/yr

**Electrical Requirements**  
120 V / 60 Hz  
15 Amps

<sup>1</sup>Requires wireless network, Samsung account and Samsung SmartThings App. The Samsung Smart Things App supports Android OS 4.0 (ICS) or later, which is optimized for Samsung smartphones (Galaxy S and Galaxy Note series). This app also supports iOS 7 or later for iPhone models. Samsung SmartThings App available in App Store and Play Store.  
<sup>2</sup>Designed to fit a 39" installation depth.  
<sup>3</sup>ADA Compliant when using 27" wide riser. (Riser model codes: WE272NW, WE272NC)

**SAMSUNG**

Washer Spec Sheet - page 1

**WF45B6300AW | WF45B6300AC | WF45B6300AP**  
Samsung 4.5 cu. ft. Large Capacity Smart Front Load Washer with Super Speed Wash

**Installation Specifications – Side-by-Side**  
If the washer and dryer are installed together or the dryer alone, the closet front must have two unobstructed air openings for a combined minimum total area of 72-inch<sup>2</sup>. Your washer alone does not require a specific air opening.

**Alcove or closet installation**  
Minimum clearance for alcove and alcove installations:

**Connection Dimensions**  
Back view of washer

**LEGEND:**  
● Cold Water Connection  
● Hot Water Connection

Actual color may vary. Design, specifications, and color availability are subject to change without notice. Non-metric weights and measurements are approximate.  
©2023 Samsung Electronics America, Inc., 50 Challenger Road, Ridgefield Park, NJ 07660. Tel: 800-SAMSUNG, samsung.com. Samsung is a registered trademark of Samsung Electronics Co., Ltd.

**SAMSUNG**

Washer Spec Sheet - page 2

**WF45B6300AW | WF45B6300AC | WF45B6300AP**  
Samsung 4.5 cu. ft. Large Capacity Smart Front Load Washer with Super Speed Wash

**Installation Specifications – Stacked Pair**  
Clearances indicated are for stacked pairs. The closet front must have two unobstructed air openings for a combined minimum total area of 72-inch<sup>2</sup>.

**Connection Dimensions**  
Back and side views of stacked pair

**LEGEND:**  
● Cold Water Connection  
● Hot Water Connection  
● Gas Connection

Actual color may vary. Design, specifications, and color availability are subject to change without notice. Non-metric weights and measurements are approximate.  
©2023 Samsung Electronics America, Inc., 50 Challenger Road, Ridgefield Park, NJ 07660. Tel: 800-SAMSUNG, samsung.com. Samsung is a registered trademark of Samsung Electronics Co., Ltd.

**SAMSUNG**

Washer Spec Sheet - page 3



# Energy Guide

Easy Ads link

<https://dam.gettyimages.com/p/z0c3461/external?o=AND&q=WF45B6300A%20Energy%20Guide>

U.S. Government Federal law prohibits removal of this label before consumer purchase.

# ENERGYGUIDE

Clothes Washer Capacity Class: Standard Samsung Models WF45B63\*\*A\* Capacity (tub volume): 4.5 cubic feet

**Compare ONLY to other labels with yellow numbers.**  
Labels with yellow numbers are based on the same test procedures.

**Estimated Yearly Energy Cost**  
(when used with an electric water heater)

**\$11**



\$8 Cost Range of Similar Models \$51

**93 kWh**  
Estimated Yearly Electricity Use

**\$9**  
Estimated Yearly Energy Cost  
(when used with a natural gas water heater)

- Your cost will depend on your utility rates and use.
- Cost range based only on standard capacity models.
- Estimated energy cost based on six wash loads a week and a national average electricity cost of 12 cents per kWh and natural gas cost of \$1.09 per therm.

ftc.gov/energy

DC68-04096F-00

Energy Guide

# User Manual and Warranty

## Easy Ads link

<https://dam.gettyimages.com/p/z0c3461/external?o=AND&q=WF45B6300%20User%20Manual>

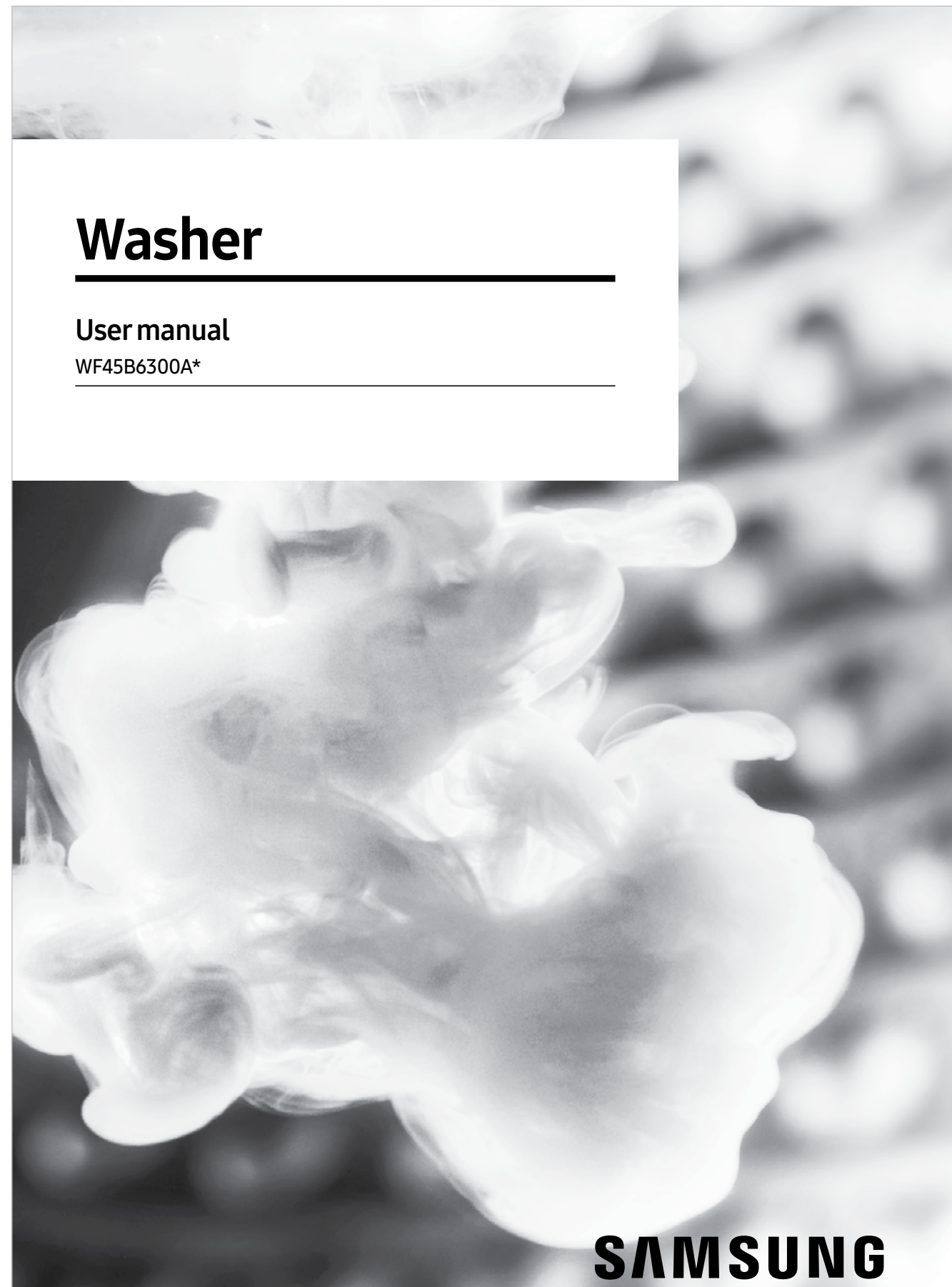

User Manual

## Easy Ads link

<https://dam.gettyimages.com/p/z0c3461/external?o=AND&q=WF45B6300%20Warranty>

### LIMITED WARRANTY (U.S.A.) – SAMSUNG WASHER

**Models:**  
WF45B6300AW  
WF45B6300AC  
WF45B6300AP

#### LIMITED WARRANTY TO ORIGINAL PURCHASER WITH PROOF OF PURCHASE

This SAMSUNG brand product, as supplied and distributed by SAMSUNG ELECTRONICS AMERICA, INC. (SAMSUNG) and delivered new, in the original carton to the original consumer purchaser, is warranted by SAMSUNG against manufacturing defects in materials or workmanship for the limited warranty period, starting from the date of original purchase, of:

**One (1) year Parts and labor**  
**Three (3) years Stainless tub part (Part Only)**  
**Twenty (20) years; Washing DIT (Digital Inverter Motor) motor part (Part Only)**

This limited warranty is valid only on products purchased and used in the United States that have been installed, operated, and maintained according to the instructions attached to or furnished with the product. To receive warranty service, the purchaser must contact SAMSUNG at the address or phone number provided below for problem determination and service procedures. Warranty service can only be performed by a SAMSUNG authorized service center. The original dated bill of sale must be presented upon request as proof of purchase to SAMSUNG or SAMSUNG's authorized service center to receive warranty service.

SAMSUNG will provide in-home service within the contiguous United States during the warranty period at no charge, subject to availability of SAMSUNG authorized servicers within the customer's geographic area. If in-home service is not available, SAMSUNG may elect, at its option, to provide transportation of the product to and from an authorized service center. If the product is located in an area where service by a SAMSUNG authorized servicer is not available, you may be responsible for a trip charge or require to bring the product to a SAMSUNG authorized service center for service.

To receive in-home service, product must be unobstructed and accessible to the service agent.

During the applicable warranty period, a product will be repaired, replaced, or the purchase price refunded, at the sole option of SAMSUNG. SAMSUNG may use new or reconditioned parts in repairing a product, or replace the product with a new or reconditioned product. Replacement parts and products are warranted for the remaining portion of the original product's warranty or ninety (90) days, whichever is longer. All replaced parts and products are the property of SAMSUNG and you must return them to SAMSUNG.

This limited warranty covers manufacturing defects in materials or workmanship encountered in normal household, noncommercial use of this product and shall not cover the following: damage that occurs in shipment, delivery, installation, and uses for which this product was not intended; damage caused by unauthorized modification or alteration of the product; product where the original factory serial numbers have been removed, defaced, changed in any way, or cannot be readily determined; cosmetic

Warranty



# Feature Icons

---

**WF45B6300AW**

**WF45B6300AC**

**WF45B6300AP**

**4.5 cu. ft. Large Capacity Smart Front Load Washer  
with Super Speed Wash**

# Feature Icons

## Easy Ads link

<https://dam.gettyimages.com/p/z0c3461/external?o=AND&q=WF45B6300%20Icons>



Super Speed Wash

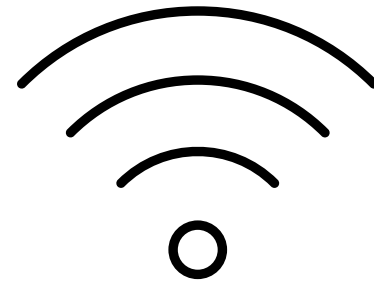

Wi-Fi Connectivity

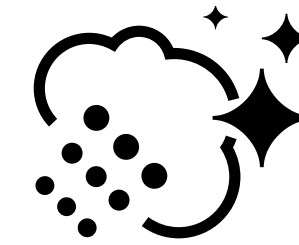

Steam



Energy Star Most Efficient

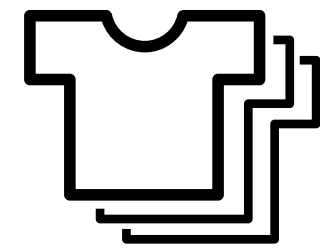

Large 4.5 cu. ft. Capacity

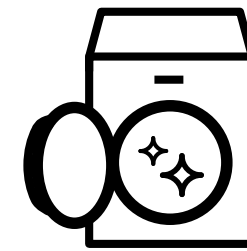

Antimicrobial Technology

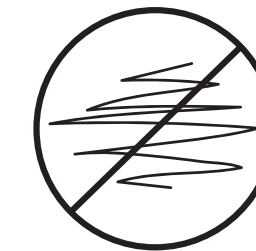

Scratch-Resistant  
Tempered Glass Door



20-Year Motor Warranty\*

\*20-year warranty limited to the Digital Inverter Motor of washers purchased on 7/1/2022 or later. Purchase receipt indicating purchase date required for a claim. Additional restrictions and limitations apply, see warranty for details.



# Product Overview

---

**DVE45B6300W / DVG45B6300W**

**DVE45B6300C / DVG45B6300C**

**DVE45B6300P / DVG45B6300P**

**7.5 cu. ft. Smart Electric Dryer with Steam Sanitize+**

**7.5 cu. ft. Smart Gas Dryer with Steam Sanitize+**

# Product Overview

## Product Titles

DVE45B6300W, DVE45B6300C, DVE45B6300P - 7.5 cu. ft. Smart Electric Dryer with Steam Sanitize+  
DVG45B6300W, DVG45B6300C, DVG45B6300P - 7.5 cu. ft. Smart Gas Dryer with Steam Sanitize+

## Product Short Description (208 Characters)

Samsung's new 7.5 cu. ft. dryer allows you to remotely start or stop your cycle and schedule laundry on your time, and more, right from your smartphone.\* Steam Sanitize+ eliminates 99.9% of germs and bacteria.\*\*

## Product Long Description (317 Characters)

Samsung's new 7.5 cu. ft. dryer allows you to remotely start or stop your cycle, schedule laundry on your time, receive end of cycle alerts, and more, right from your smartphone.\* Steam Sanitize+ eliminates 99.9% of germs and bacteria,\*\* while Multi-Steam technology relaxes and smooths away wrinkles from everyday wear.

\*Requires wireless network, Samsung account and SmartThings App. The Samsung SmartThings App supports Android OS 4.0 (ICS) or later which is optimized for Samsung smartphones (Galaxy S and Galaxy Note series). This app also supports iOS 7 or later for iPhone models. SmartThings App available in App Store and Play Store. Only monitoring enabled on Gas Dryers for safety reasons.

\*\*Based on internal testing and independently verified by Intertek.

## Available Colors



### White

Electric Dryer Model Number: DVE45B6300W  
Electric Dryer UPC: 887276628035  
Gas Dryer Model Number: DVG45B6300W  
Gas Dryer UPC: 887276628073



### Champagne

Electric Dryer Model Number: DVE45B6300C  
Electric Dryer UPC: 887276628004  
Gas Dryer Model Number: DVG45B6300C  
Gas Dryer UPC: 887276628042



### Platinum

Electric Dryer Model Number: DVE45B6300P  
Electric Dryer UPC: 887276628011  
Gas Dryer Model Number: DVG45B6300P  
Gas Dryer UPC: 887276628059





# Carousel Image Order

## DVE45B6300W / DVG45B6300W

### Easy Ads links

**Retail.com:** <https://dam.gettyimages.com/p/z0c3461/external?o=AND&q=DVE45B6300W%20Carousel%20Images%20RCOM>  
**Samsung.com:** <https://dam.gettyimages.com/p/z0c3461/external?o=AND&q=DVE45B6300W%20Carousel%20Images%20SCOM>  
**360 Spin: DVE45B6300W** <https://dam.gettyimages.com/p/z0c3461/external?o=AND&q=DVE45B6300W%20360%20Spins>  
**DVG45B6300W** <https://dam.gettyimages.com/p/z0c3461/external?o=AND&q=DVG45B6300W%20360%20Spins>

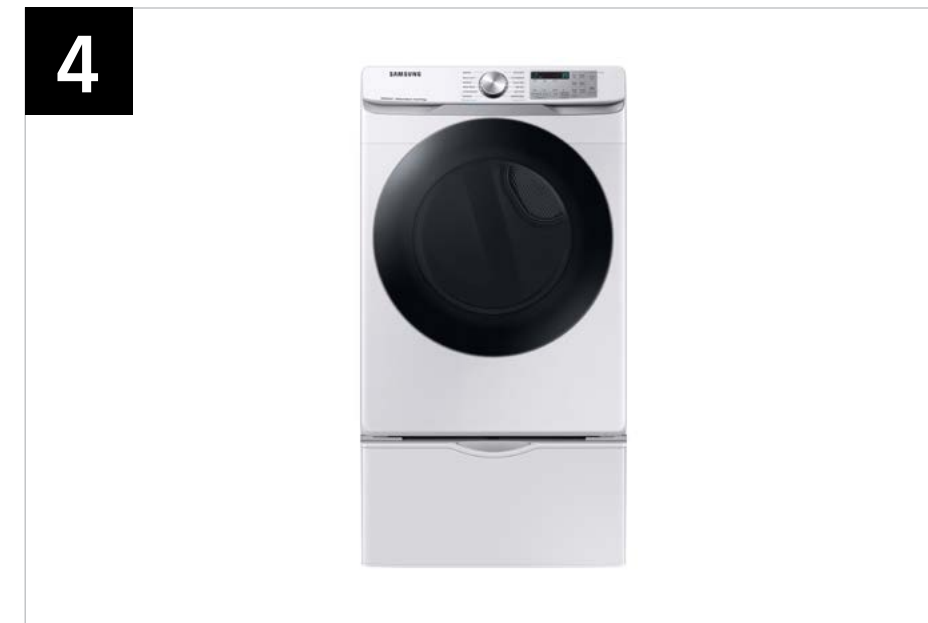



# Carousel Image Order

## DVE45B6300C / DVG45B6300C

### Easy Ads links

**Retail.com:** <https://dam.gettyimages.com/p/z0c3461/external?o=AND&q=DVE45B6300C%20Carousel%20Images%20RCOM>  
**Samsung.com:** <https://dam.gettyimages.com/p/z0c3461/external?o=AND&q=DVE45B6300C%20Carousel%20Images%20SCOM>  
**360 Spin: DVE45B6300C** <https://dam.gettyimages.com/p/z0c3461/external?o=AND&q=DVE45B6300C%20360%20Spins>  
**DVG45B6300C** <https://dam.gettyimages.com/p/z0c3461/external?o=AND&q=DVG45B6300C%20360%20Spins>

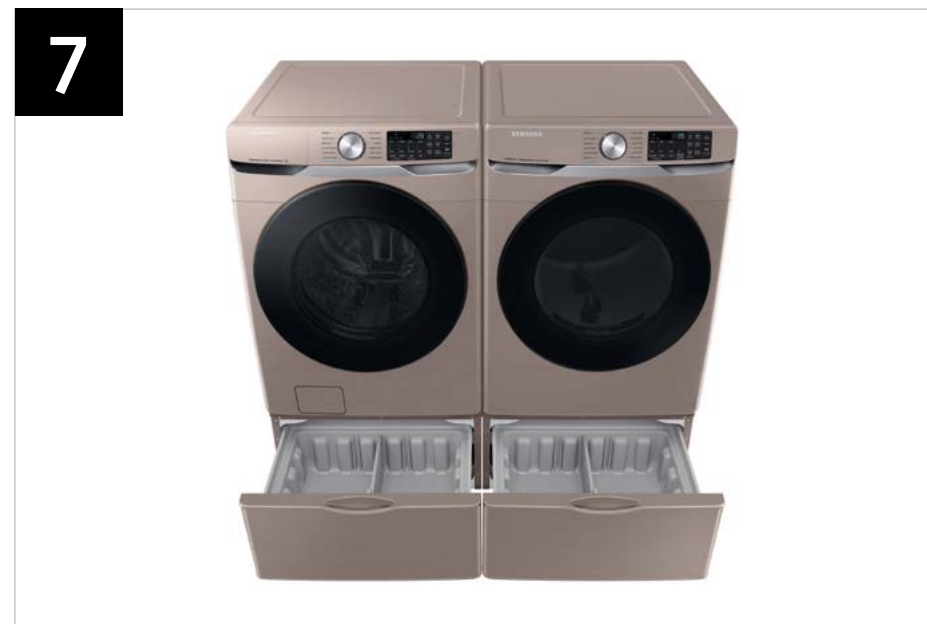
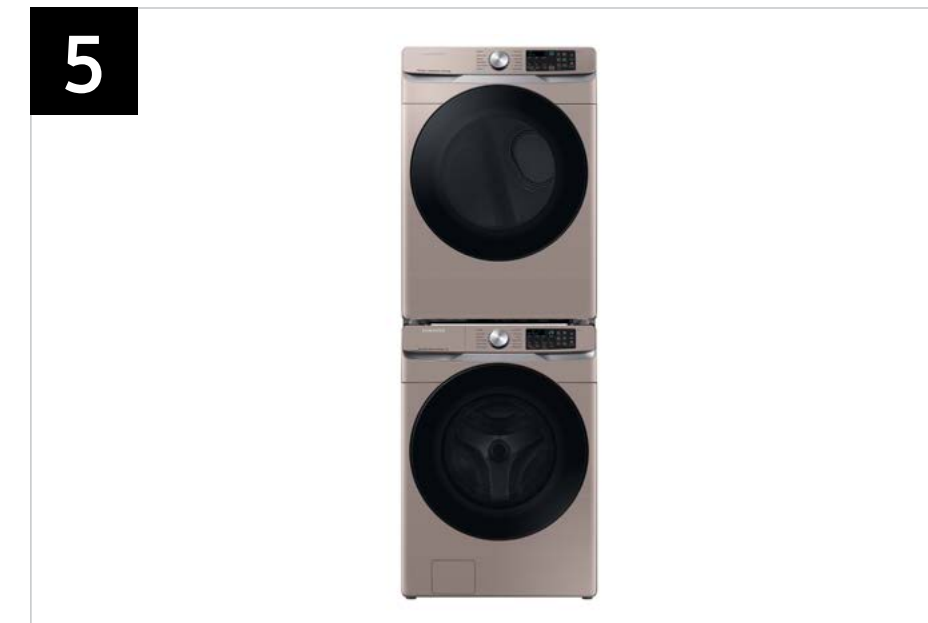
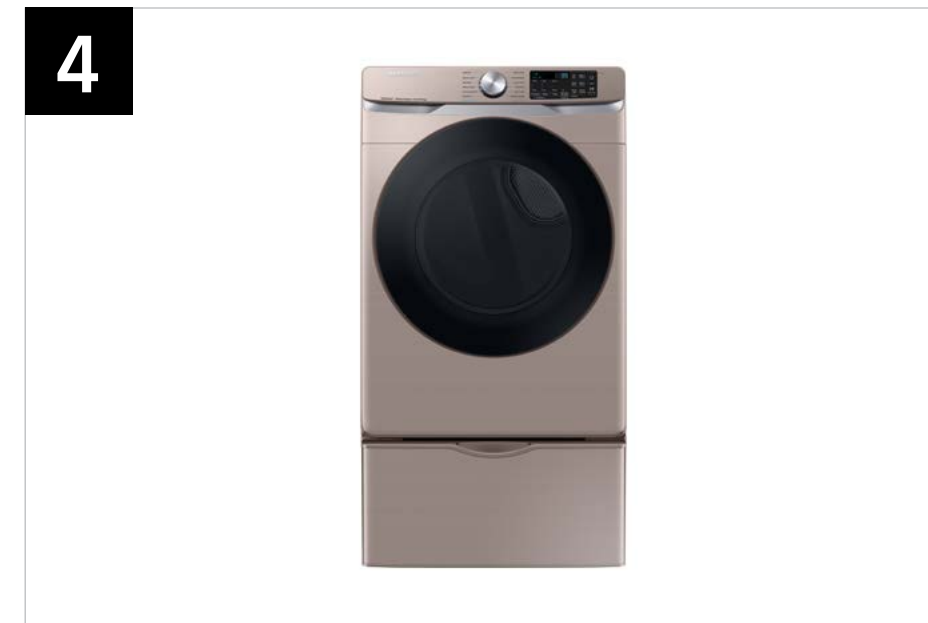



# Carousel Image Order

## DVE45B6300P / DVG45B6300P

### Easy Ads links

**Retail.com:** <https://dam.gettyimages.com/p/z0c3461/external?o=AND&q=DVE45B6300P%20Carousel%20Images%20RCOM>  
**Samsung.com:** <https://dam.gettyimages.com/p/z0c3461/external?o=AND&q=DVE45B6300P%20Carousel%20Images%20SCOM>  
**360 Spin: DVE45B6300P** <https://dam.gettyimages.com/p/z0c3461/external?o=AND&q=DVE45B6300P%20360%20Spins>  
**DVG45B6300P** <https://dam.gettyimages.com/p/z0c3461/external?o=AND&q=DVG45B6300P%20360%20Spins>



# Product Messaging

---

**DVE45B6300W / DVG45B6300W**

**DVE45B6300C / DVG45B6300C**

**DVE45B6300P / DVG45B6300P**



**7.5 cu. ft. Smart Electric Dryer with Steam Sanitize+**

**7.5 cu. ft. Smart Gas Dryer with Steam Sanitize+**



**Features and Benefits:  
DVE(G)45B6300\***

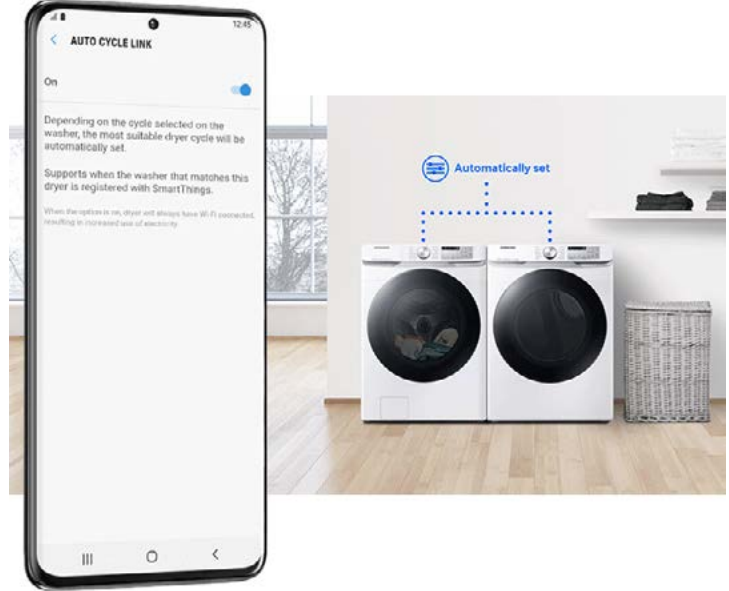

White Dryer Easy Ads link: <https://dam.gettyimages.com/p/z0c3461/external?o=AND&q=DVE45B6300W%20Below%20the%20Fold>  
 Champagne Dryer Easy Ads link: <https://dam.gettyimages.com/p/z0c3461/external?o=AND&q=DVE45B6300C%20Below%20the%20Fold>  
 Platinum Dryer Easy Ads link: <https://dam.gettyimages.com/p/z0c3461/external?o=AND&q=DVE45B6300P%20Below%20the%20Fold>

Headline	Feature Name	Long Body Copy	Short Body Copy	Associated Image
<p><b>Control in the palm of your hand</b></p>	<p><b>Wi-Fi Connectivity</b></p>	<p>Wi-Fi connected so you can receive end of cycle alerts, remotely start or stop your drying, schedule cycles on your time, and more, right from your smartphone with the SmartThings App.*</p> <p><small>*Requires wireless network, Samsung account and SmartThings App. The Samsung SmartThings App supports Android OS 4.0 (ICS) or later which is optimized for Samsung smartphones (Galaxy S and Galaxy Note series). This app also supports iOS 7 or later for iPhone models. SmartThings App available in App Store and Play Store. Only monitoring enabled on Gas Dryers for safety reasons.</small></p>	<p>Receive end of cycle alerts, remotely start, schedule, and more, from your smartphone with the SmartThings App.*</p> <p><small>*Requires wireless network, Samsung account and SmartThings App. The Samsung SmartThings App supports Android OS 4.0 (ICS) or later which is optimized for Samsung smartphones (Galaxy S and Galaxy Note series). This app also supports iOS 7 or later for iPhone models. SmartThings App available in App Store and Play Store. Only monitoring enabled on Gas Dryers for safety reasons.</small></p>	
<p><b>Freshen up clothes</b></p>	<p><b>Steam Sanitize+</b></p>	<p>The Steam Sanitize+ cycle removes 99.9% of germs and bacteria, over 95% of pollen, and kills 100% of dust mites.* Multi-Steam Technology steams away wrinkles, odors, and static.</p> <p><small>*Based on internal testing and independently verified by Intertek.</small></p>	<p>Steams away 99.9% of germs and bacteria,* while also reducing wrinkles and odors.</p> <p><small>*Based on internal testing and independently verified by Intertek.</small></p>	
<p><b>Worry-free drying</b></p>	<p><b>Sensor Dry</b></p>	<p>Automatically optimizes the time and temperature of your drying cycle to protect your clothes from heat damage, while avoiding excess energy use.</p>	<p>Helps prevent overdrying for optimal fabric care.</p>	



**Features and Benefits:  
DVE(G)45B6300\* (Continued)**



White Dryer Easy Ads link: <https://dam.gettyimages.com/p/z0c3461/external?o=AND&q=DVE45B6300W%20Below%20the%20Fold>  
 Champagne Dryer Easy Ads link: <https://dam.gettyimages.com/p/z0c3461/external?o=AND&q=DVE45B6300C%20Below%20the%20Fold>  
 Platinum Dryer Easy Ads link: <https://dam.gettyimages.com/p/z0c3461/external?o=AND&q=DVE45B6300P%20Below%20the%20Fold>

Headline	Feature Name	Long Body Copy	Short Body Copy	Associated Image
<p><b>Premium design for an elevated look</b></p>	<p><b>Scratch-Resistant Tempered Glass Door</b></p>	<p>Our sleek, new flat-panel door will elevate any laundry space and with scratch-resistant tempered glass, it combines an ultra-premium design with a durable finish.</p>	<p>Sleek and scratch-resistant, our new flat-panel door will elevate any laundry space.</p>	
<p>N/A</p>	<p><b>Interior Drum Light</b></p>	<p>Put an end to stray socks or smaller laundry items that are hard to spot. An interior drum light brightly illuminates your laundry and the rest of the interior, so you can quickly and safely check your dryer's contents.</p>	<p>Put an end to stray socks or small items that are hard to spot.</p>	
<p><b>Flexible opening</b></p>	<p><b>Reversible Door</b></p>	<p>Choose the direction your dryer door opens to better suit your laundry room layout.</p>	<p>Choose the direction your dryer door opens.</p>	



**Features and Benefits:  
DVE(G)45B6300\* (Continued)**

White Dryer Easy Ads link: <https://dam.gettyimages.com/p/z0c3461/external?o=AND&q=DVE45B6300W%20Below%20the%20Fold>  
 Champagne Dryer Easy Ads link: <https://dam.gettyimages.com/p/z0c3461/external?o=AND&q=DVE45B6300C%20Below%20the%20Fold>  
 Platinum Dryer Easy Ads link: <https://dam.gettyimages.com/p/z0c3461/external?o=AND&q=DVE45B6300P%20Below%20the%20Fold>

Headline	Feature Name	Long Body Copy	Short Body Copy	Associated Image
<p><b>Fit more for fewer loads</b></p>	<p><b>Large 7.5 cu. ft. Capacity</b></p>	<p>Fewer loads, less time in the laundry room, and more time doing the things you love.</p>	<p>Fewer loads, less time in the laundry room.</p>	
<p><b>Stop the fluff</b></p>	<p><b>Lint Filter Indicator</b></p>	<p>Stop worrying about lint or fluff building up and blocking your dryer’s air intake. The Filter Check Indicator light on the control panel will provide you with a helpful reminder when it is time to clean the filter, so your dryer maintains optimal performance.</p>	<p>The Filter Check Indicator light lets you know when it is time to clean the filter.</p>	
<p><b>Easier use, for everyone</b></p>	<p><b>ADA Compliant</b></p>	<p>With use of a Samsung Riser,* your washer or dryer is compliant with the Americans with Disabilities Act (ADA), making loading and unloading much easier.</p> <p><small>*ADA Compliant when using 27" wide riser. (Riser model codes: WE272NV, WE272NW, WE272NC)</small></p>	<p>Designed for easy use for everyone.*</p> <p><small>*ADA Compliant when using 27" wide riser. (Riser model codes: WE272NV, WE272NW, WE272NC)</small></p>	

**Features and Benefits:  
DVE(G)45B6300\* (Continued)**

White Dryer Easy Ads link: <https://dam.gettyimages.com/p/z0c3461/external?o=AND&q=DVE45B6300W%20Below%20the%20Fold>  
 Champagne Dryer Easy Ads link: <https://dam.gettyimages.com/p/z0c3461/external?o=AND&q=DVE45B6300C%20Below%20the%20Fold>  
 Platinum Dryer Easy Ads link: <https://dam.gettyimages.com/p/z0c3461/external?o=AND&q=DVE45B6300P%20Below%20the%20Fold>

Headline	Feature Name	Long Body Copy	Short Body Copy	Associated Image
Perfect pair	Matching Accessories	Round out your laundry setup with a matching washer, pedestal, riser and more.	N/A	



# Product Specs

---

**DVE45B6300W / DVG45B6300W**

**DVE45B6300C / DVG45B6300C**

**DVE45B6300P / DVG45B6300P**

**7.5 cu. ft. Smart Electric Dryer with Steam Sanitize+**

**7.5 cu. ft. Smart Gas Dryer with Steam Sanitize+**

## Related Products and Accessories

Washer Series	Pedestal	Riser	Stacking Kit	Gas to Propane Converter Kit	Side Vent Kit
WF45B6300AW WF45B6300AC WF45B6300AP	WE402NW WE402NC WE402NP	WE272NW WE272NC	SKK-8K	LPKIT-4	DV-2A



# Spec Sheet

## Easy Ads link

<https://dam.gettyimages.com/p/z0c3461/external?o=AND&q=DVE45B6300%20Spec%20Sheet>

**DVE45B6300W | DVE45B6300C | DVE45B6300P**  
Samsung 7.5 cu. ft. Smart Electric Dryer with Steam Sanitize+



**Available Colors**

- White  
DVE45B6300W
- Champagne  
DVE45B6300C
- Platinum  
DVE45B6300P

**Features**

- Wi-Fi Connectivity<sup>1</sup>
- Steam Sanitize+
- Sensor Dry
- Scratch-Resistant Tempered Glass Door
- Interior Drum Light
- Reversible Door
- Large 7.5 cu. ft. Capacity
- Lint Filter Indicator
- ADA Compliant<sup>2</sup>
- Accessibility (AUI, Braille)
- 21 Total Drying Cycles
- 10 Options
- 5 Temperature Settings
- 4-Way Venting (Back, Bottom, Left, Right)

**Specifications**

**21 Total Drying Cycles:**  
Refresh, Steam Sanitize+, Normal, Heavy Duty, Permanent Press, Activewear, Bedding, Delicates, Time Dry, Air Fluff, Quick Dry, Downloaded, Wrinkle Away, Eco Normal, Towels, Wool, Sanitize, Shirts, Denim, Low Temp, Rack Dry

**10 Options:**  
Damp Alert, Wrinkle Prevent, Smart Control, Adjust Time (Up), Adjust Time (Down), Eco Dry, Sound, Drum Light, Smart Care, Child Lock

**5 Temperature Settings:**  
High, Medium High, Medium, Medium Low, Low

**5 Dry Levels:**  
More Dry, Normal-More Dry, Normal Dry, Normal-Less Dry, Less Dry

**Warranty**  
One (1) Year Parts and Labor

**Product Dimensions & Weight (WxHxD)**  
Dimensions: 27" x 38 1/4" x 31 1/8"  
Weight: 116.8 lbs

**Shipping Dimensions & Weight (WxHxD)**  
Dimensions: 29 1/8" x 42 1/16" x 33 1/2"  
Weight: 123.5 lbs

Electric Dryer	Model #	UPC Code	Optional Accessories	Model #	UPC Code
White	DVE45B6300W	887276628035	White Pedestal	WE402NW	887276310152
Champagne	DVE45B6300C	887276628004	Champagne Pedestal	WE402NC	887276310121
Platinum	DVE45B6300P	887276628011	Platinum Pedestal	WE402NP	887276310138
White Riser	WE272NW	887276197647	White Riser	WE272NW	887276197647
Champagne Riser	WE272NC	887276393940	Champagne Riser	WE272NC	887276393940
Stacking Kit	SKK-8K	887276344034	Stacking Kit	SKK-8K	887276344034
Vent Kit	DV-2A	887276146416	Vent Kit	DV-2A	887276146416

**Matching Washer**

White	WF45B6300AW	887276627434
Champagne	WF45B6300AC	887276627403
Platinum	WF45B6300AP	887276627410

**Convenience**

- Child Lock
- Filter Check Indicator

**Ratings**  
644 kWh/yr

**Electrical Requirements**  
240 V / 60 Hz  
30 Amps

<sup>1</sup>Requires wireless network, Samsung account and SmartThings App. The Samsung SmartThings App supports Android OS 4.0 (ICS) or later which is optimized for Samsung smartphones (Galaxy S and Galaxy Note series). This app also supports iOS 7 or later for iPhone models. SmartThings App available in App Store and Play Store. Only monitoring enabled on Gas Dryers for safety reasons.  
<sup>2</sup>ADA Compliant when using 27" wide riser. (Riser model codes: WE272NW, WE272NC)

**SAMSUNG**

Electric Dryer Spec Sheet - page 1

**DVE45B6300W | DVE45B6300C | DVE45B6300P**  
Samsung 7.5 cu. ft. Smart Electric Dryer with Steam Sanitize+

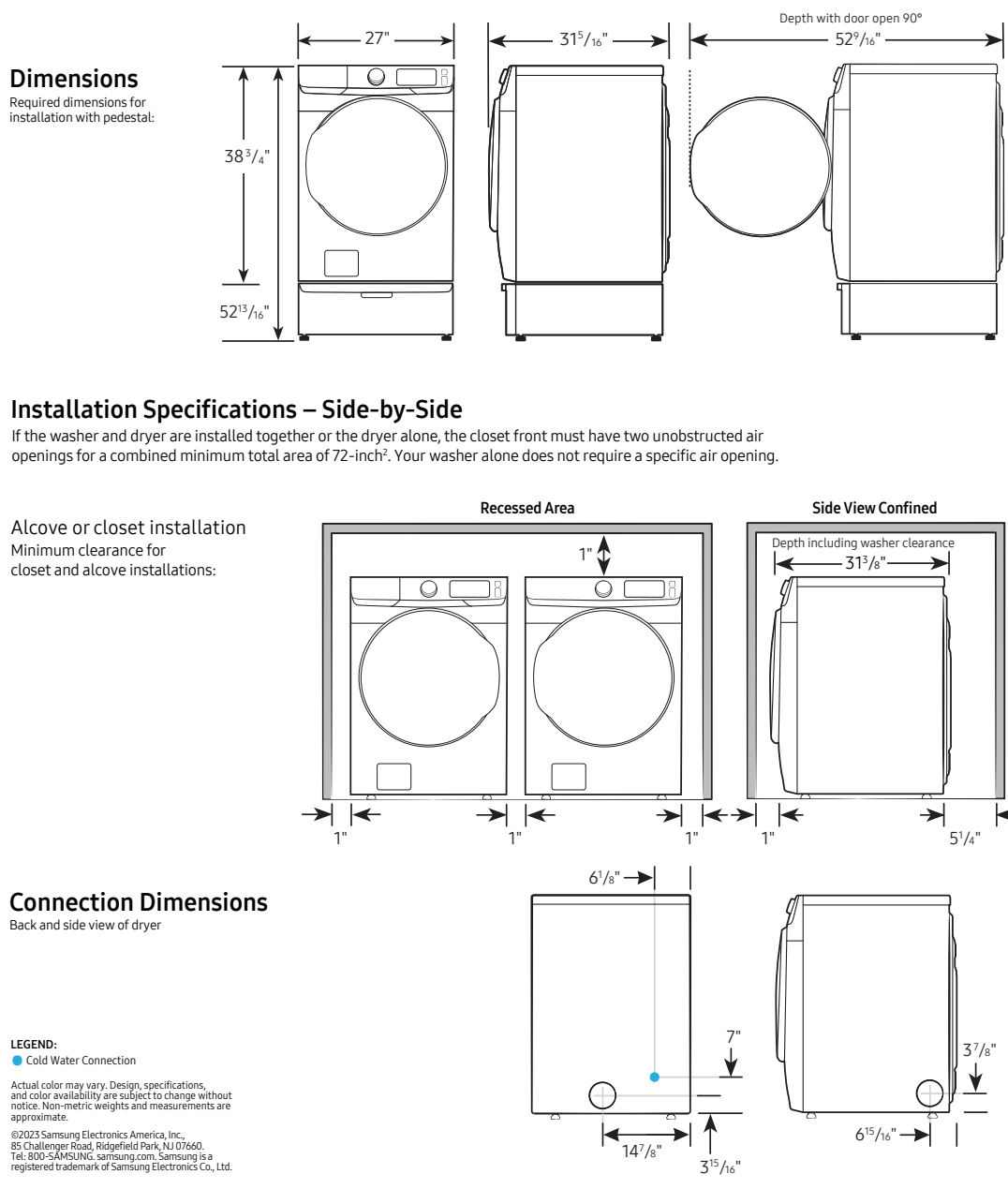

**Dimensions**  
Required dimensions for installation with pedestal:

**Installation Specifications – Side-by-Side**  
If the washer and dryer are installed together or the dryer alone, the closet front must have two unobstructed air openings for a combined minimum total area of 72-inch<sup>2</sup>. Your washer alone does not require a specific air opening.

**Alcove or closet installation**  
Minimum clearance for closet and alcove installations:

**Connection Dimensions**  
Back and side view of dryer

**LEGEND:**  
● Cold Water Connection  
● Hot Water Connection

Actual color may vary. Design, specifications, and color availability are subject to change without notice. Non-metric weights and measurements are approximate.  
©2023 Samsung Electronics America, Inc., 85 Challenger Road, Ridgefield Park, NJ 07663. Tel: 800-SAMSUNG, samsung.com. Samsung is a registered trademark of Samsung Electronics Co., Ltd.

**SAMSUNG**

Electric Dryer Spec Sheet - page 2

**DVE45B6300W | DVE45B6300C | DVE45B6300P**  
Samsung 7.5 cu. ft. Smart Electric Dryer with Steam Sanitize+

**Installation Specifications – Stacked Pair**  
Clearances indicated are for stacked pairs. The closet front must have two unobstructed air openings for a combined minimum total area of 72-inch<sup>2</sup>.

**Connection Dimensions**  
Back and side views of stacked pair

**LEGEND:**  
● Cold Water Connection  
● Hot Water Connection

Actual color may vary. Design, specifications, and color availability are subject to change without notice. Non-metric weights and measurements are approximate.  
©2023 Samsung Electronics America, Inc., 85 Challenger Road, Ridgefield Park, NJ 07663. Tel: 800-SAMSUNG, samsung.com. Samsung is a registered trademark of Samsung Electronics Co., Ltd.

**SAMSUNG**

Electric Dryer Spec Sheet - page 3

# Spec Sheet

## Easy Ads link

<https://dam.gettyimages.com/p/z0c3461/external?o=AND&q=DVG45B6300%20Spec%20Sheet>

**DVG45B6300W | DVG45B6300C | DVG45B6300P**  
**Samsung 7.5 cu. ft. Smart Gas Dryer with Steam Sanitize+**



**Available Colors**

- White  
DVG45B6300W
- Champagne  
DVG45B6300C
- Platinum  
DVG45B6300P

**Features**

- Wi-Fi Connectivity<sup>1</sup>
- Steam Sanitize+
- Sensor Dry
- Scratch-Resistant Tempered Glass Door
- Interior Drum Light
- Reversible Door
- Large 7.5 cu. ft. Capacity
- Lint Filter Indicator
- ADA Compliant<sup>2</sup>
- Accessibility (AUI, Braille)
- 21 Total Drying Cycles
- 10 Options
- 5 Temperature Settings
- 3-Way Venting (Back, Bottom, Left)

**Specifications**

**21 Total Drying Cycles:** Refresh, Steam Sanitize+, Normal, Heavy Duty, Permanent Press, Activewear, Bedding, Delicates, Time Dry, Air Fluff, Quick Dry, Downloaded, Wrinkle Away, Eco Normal, Towels, Wool, Sanitize, Shirts, Denim, Low Temp, Rack Dry

**10 Options:** Damp Alert, Wrinkle Prevent, Smart Control, Adjust Time (Up), Adjust Time (Down), Eco Dry, Sound, Drum Light, Smart Care, Child Lock

**5 Temperature Settings:** High, Medium High, Medium, Medium Low, Low

**5 Dry Levels:** More Dry, Normal-More Dry, Normal Dry, Normal-Less Dry, Less Dry

**Warranty**  
 One (1) Year Parts and Labor

**Product Dimensions & Weight (WxHxD)**  
 Dimensions: 27" x 38 3/4" x 31 1/8"  
 Weight: 116.8 lbs

**Shipping Dimensions & Weight (WxHxD)**  
 Dimensions: 29 1/8" x 42 1/16" x 33 1/2"  
 Weight: 123.5 lbs

Gas Dryer	Model #	UPC Code	Optional Accessories	Model #	UPC Code
White	DVG45B6300W	887276628073	White Pedestal	WE402NW	887276310152
Champagne	DVG45B6300C	887276628042	Champagne Pedestal	WE402NC	887276310121
Platinum	DVG45B6300P	887276628059	Platinum Pedestal	WE402NP	887276310138
White Riser	WE272NW	887276197647	White Riser	WE272NW	887276197647
Champagne Riser	WE272NC	887276393940	Champagne Riser	WE272NC	887276393940
Stacking Kit	SKV-8K	887276344034	Stacking Kit	SKV-8K	887276344034
Vent Kit	DV-2A	887276146416	Vent Kit	DV-2A	887276146416
Gas to Propane Converter Kit	LPKIT-4	887276352787	Gas to Propane Converter Kit	LPKIT-4	887276352787

**Matching Washer**

White	WF45B6300AW	887276627434
Champagne	WF45B6300AC	887276627403
Platinum	WF45B6300AP	887276627410

**Convenience**

- Child Lock
- Filter Check Indicator

**Electrical Requirements**

120 V / 60 Hz  
 15 Amps

<sup>1</sup>Requires wireless network, Samsung account and SmartThings App. The Samsung SmartThings App supports Android OS 4.0 (ICS) or later which is optimized for Samsung smartphones (Galaxy S and Galaxy Note series). This app also supports iOS 7 or later for iPhone models. SmartThings App available in App Store and Play Store. Only monitoring enabled on Gas Dryers for safety reasons.  
<sup>2</sup>ADA Compliant when using 27" wide riser. (Riser model codes: WE272NW, WE272NC)

**SAMSUNG**

Gas Dryer Spec Sheet - page 1

**DVG45B6300W | DVG45B6300C | DVG45B6300P**  
**Samsung 7.5 cu. ft. Smart Gas Dryer with Steam Sanitize+**

**Dimensions**  
 Required dimensions for installation with pedestal:

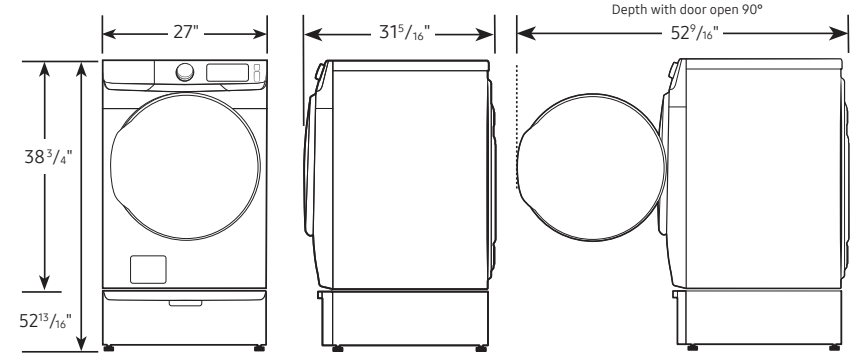

**Installation Specifications – Side-by-Side**  
 If the washer and dryer are installed together or the dryer alone, the closet front must have two unobstructed air openings for a combined minimum total area of 72-inch<sup>2</sup>. Your washer alone does not require a specific air opening.

Alcove or closet installation  
 Minimum clearance for closet and alcove installations:

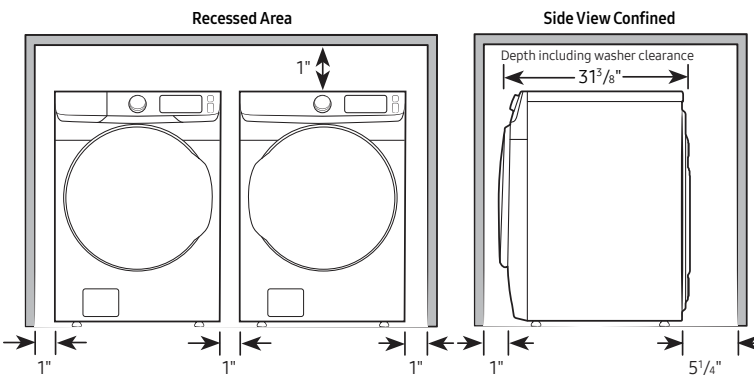

**Connection Dimensions**  
 Back and side view of dryer

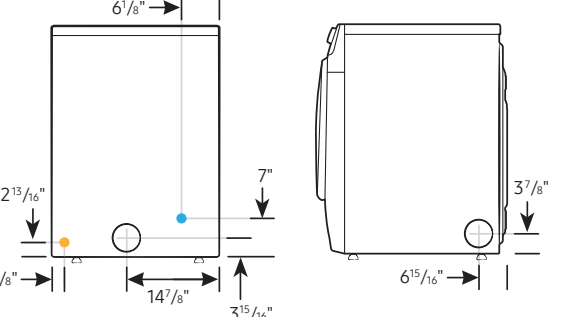

**LEGEND:**

- Cold Water Connection
- Hot Water Connection
- Gas Connection

Actual color may vary. Design, specifications, and color availability are subject to change without notice. Non-metric weights and measurements are approximate.  
 ©2023 Samsung Electronics America, Inc.  
 85 Challenger Road, Basking Ridge, NJ 07005.  
 Tel: 800-SAMSUNG, samsung.com. Samsung is a registered trademark of Samsung Electronics Co., Ltd.

**SAMSUNG**

Gas Dryer Spec Sheet - page 2

**DVG45B6300W | DVG45B6300C | DVG45B6300P**  
**Samsung 7.5 cu. ft. Smart Gas Dryer with Steam Sanitize+**

**Installation Specifications – Stacked Pair**  
 Clearances indicated are for stacked pairs. The closet front must have two unobstructed air openings for a combined minimum total area of 72-inch<sup>2</sup>.

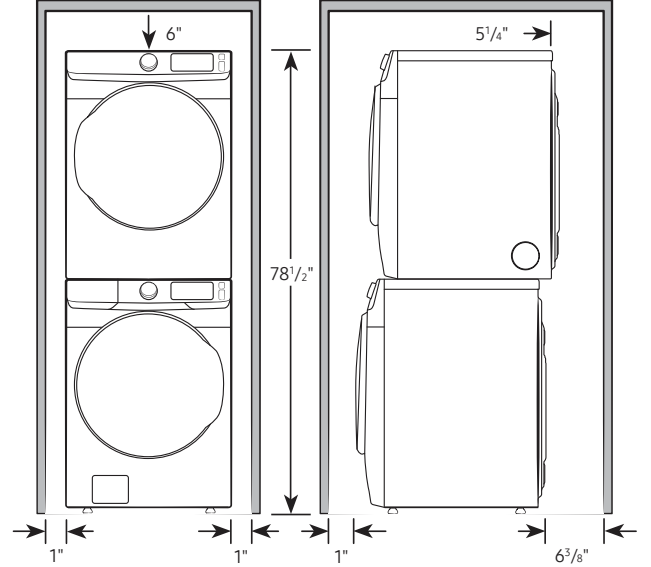

**Connection Dimensions**  
 Back and side views of stacked pair

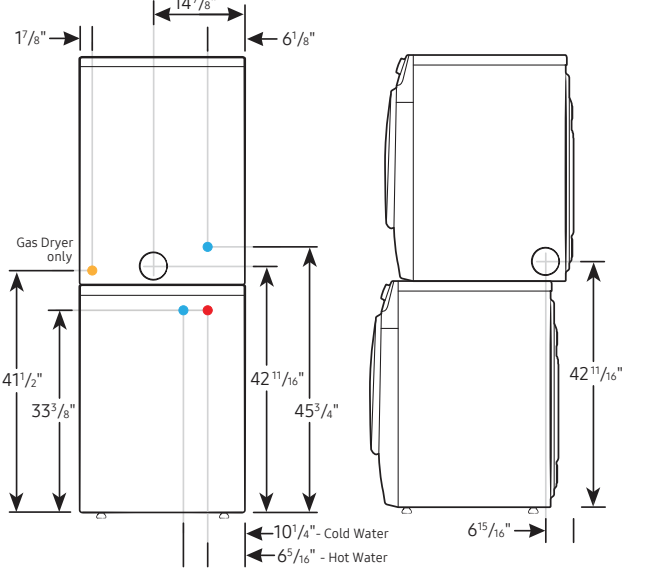

**LEGEND:**

- Cold Water Connection
- Hot Water Connection
- Gas Connection

Actual color may vary. Design, specifications, and color availability are subject to change without notice. Non-metric weights and measurements are approximate.  
 ©2023 Samsung Electronics America, Inc.  
 85 Challenger Road, Basking Ridge, NJ 07005.  
 Tel: 800-SAMSUNG, samsung.com. Samsung is a registered trademark of Samsung Electronics Co., Ltd.

**SAMSUNG**

Gas Dryer Spec Sheet - page 3



# User Manual and Warranty

## Easy Ads link

<https://dam.gettyimages.com/p/z0c3461/external?o=AND&q=DVE45B6300%20User%20Manual>

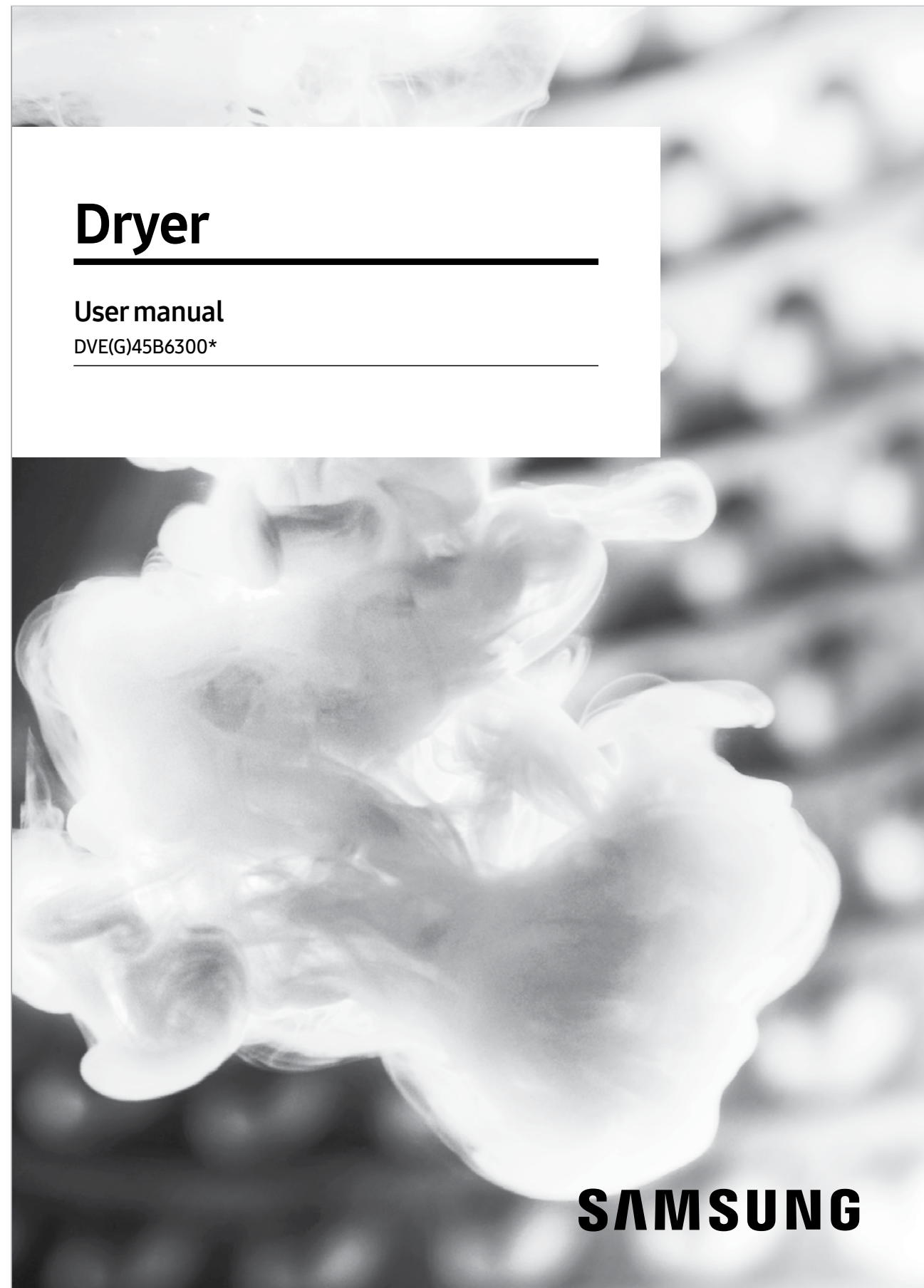

User Manual - Electric and Gas Dryers

## Easy Ads link

<https://dam.gettyimages.com/p/z0c3461/external?o=AND&q=DVE45B6300%20Warranty>

### Warranty (U.S.A) – Samsung Dryer

#### Models:

DVE(G)45B6300W  
DVE(G)45B6300C  
DVE(G)45B6300P

#### LIMITED WARRANTY TO ORIGINAL PURCHASER WITH PROOF OF PURCHASE

This SAMSUNG brand product, as supplied and distributed by SAMSUNG ELECTRONICS AMERICA, INC. (SAMSUNG) and delivered new, in the original carton to the original consumer purchaser, is warranted by SAMSUNG against manufacturing defects in materials or workmanship for the limited warranty period, starting from the date of original purchase, of:

#### One (1) Year All Parts and Labor

This limited warranty is valid only on products purchased and used in the United States that have been installed, operated, and maintained according to the instructions attached to or furnished with the product. To receive warranty service, the purchaser must contact SAMSUNG at the address or phone number provided below for problem determination and service procedures. Warranty service can only be performed by a SAMSUNG authorized service center. The original dated bill of sale must be presented upon request as proof of purchase to SAMSUNG or SAMSUNG's authorized service center to receive warranty service.

SAMSUNG will provide in-home service within the contiguous United States during the warranty period at no charge, subject to availability of SAMSUNG authorized servicers within the customer's geographic area. If in-home service is not available, SAMSUNG may elect, at its option, to provide transportation of the product to and from an authorized service center. If the product is located in an area where service by a SAMSUNG authorized servicer is not available, you may be responsible for a trip charge or required to bring the product to a SAMSUNG authorized service center for service.

To receive in-home service, product must be unobstructed and accessible to the service agent.

During the applicable warranty period, a product will be repaired, replaced, or the purchase price refunded, at the sole option of SAMSUNG. SAMSUNG may use new or reconditioned parts in repairing a product, or replace the product with a new or reconditioned product. Replacement parts and products are warranted for the remaining portion of the original product's warranty or ninety (90) days, whichever is longer. All replaced parts and products are the property of SAMSUNG and you must return them to SAMSUNG.

Warranty - Electric and Gas Dryers

# Feature Icons

---

**DVE45B6300W / DVG45B6300W**

**DVE45B6300C / DVG45B6300C**

**DVE45B6300P / DVG45B6300P**

**7.5 cu. ft. Smart Electric Dryer with Steam Sanitize+**

**7.5 cu. ft. Smart Gas Dryer with Steam Sanitize+**



# Feature Icons

## Easy Ads link

<https://dam.gettyimages.com/p/z0c3461/external?o=AND&q=DVE45B6300%20Icons>

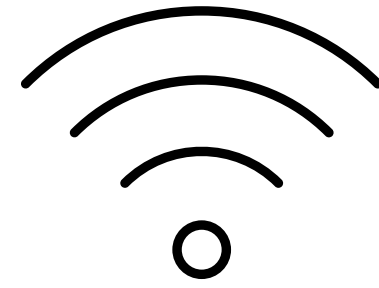

Wi-Fi Connectivity

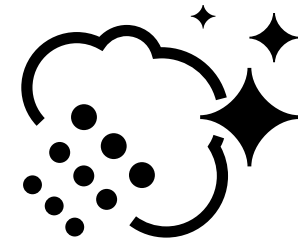

Steam Sanitize+

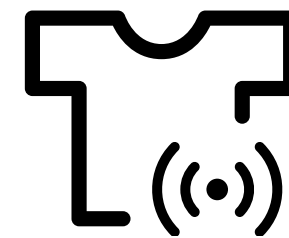

Sensor Dry

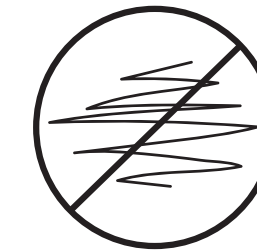

Scratch-Resistant  
Tempered Glass Door

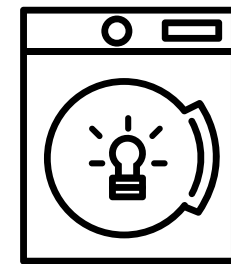

Interior Drum Light

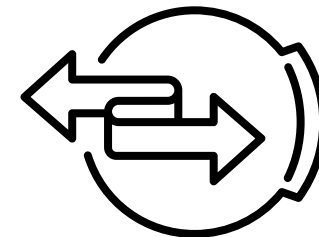

Reversible Doors

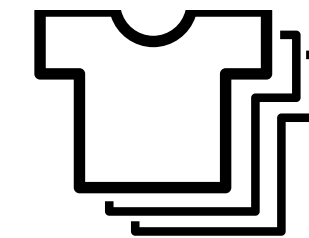

Large 7.5 cu. ft.  
Capacity

**SAMSUNG**