

AOC

LCD Monitor User Manual

U32U1 LED backlight

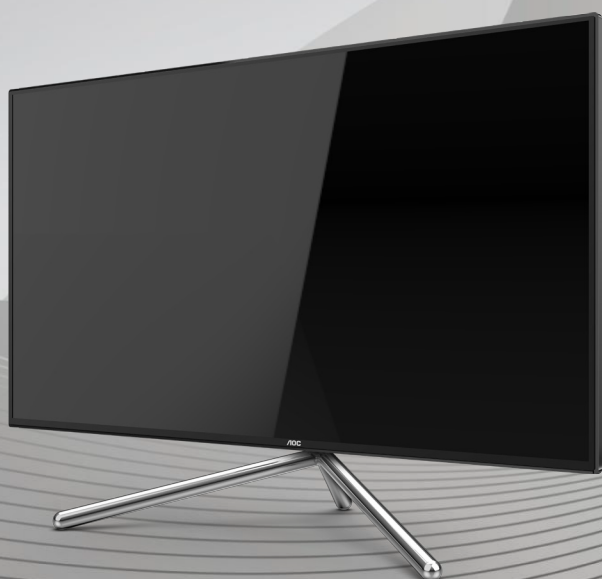

HDMI[®]

www.aoc.com

©2019 AOC. All Rights Reserved.

Safety	1
National Conventions	1
Power	2
Installation	3
Cleaning	4
Other	5
Setup	6
Contents in Box	6
Setup Stand & Base	7
Adjusting the monitor	8
Connecting the Monitor	9
HDR	10
Adjusting	11
Hotkeys	11
OSD Key Guide (Menu)	13
OSD Setting	15
Luminance	16
Image Setup	17
Color Setup	18
Picture Boost	20
Extra	21
OSD Setup	22
LED Indicator	23
Drivers	24
i-Menu (Screen+)	24
e-Saver	25
Troubleshoot	26
Specification	27
General Specification	27
Preset Display Modes	28
Pin Assignments	29
Plug and Play	30

Safety

National Conventions

The following subsections describe notational conventions used in this document.

Notes, Cautions, and Warnings

Throughout this guide, blocks of text may be accompanied by an icon and printed in bold type or in italic type. These blocks are notes, cautions, and warnings, and they are used as follows:



NOTE: A NOTE indicates important information that helps you make better use of your computer system.



CAUTION: A CAUTION indicates either potential damage to hardware or loss of data and tells you how to avoid the problem.





WARNING: A WARNING indicates the potential for bodily harm and tells you how to avoid the problem. Some warnings may appear in alternate formats and may be unaccompanied by an icon. In such cases, the specific presentation of the warning is mandated by regulatory authority.

Power

 The monitor should be operated only from the type of power source indicated on the label. If you are not sure of the type of power supplied to your home, consult your dealer or local power company.

 The monitor is equipped with a three-pronged grounded plug, a plug with a third (grounding) pin. This plug will fit only into a grounded power outlet as a safety feature. If your outlet does not accommodate the three-wire plug, have an electrician install the correct outlet, or use an adapter to ground the appliance safely. Do not defeat the safety purpose of the grounded plug.

 Unplug the unit during a lightning storm or when it will not be used for long periods of time. This will protect the monitor from damage due to power surges.

 Do not overload power strips and extension cords. Overloading can result in fire or electric shock.

 To ensure satisfactory operation, use the monitor only with UL listed computers which have appropriate configured receptacles marked between 100-240V AC, Min. 5A.

 The wall socket shall be installed near the equipment and shall be easily accessible.

 For use only with the attached power adapter
Manufacturer: Delta Electronics, Inc. Model: ADP-180TB F

Installation

! Do not place the monitor on an unstable cart, stand, tripod, bracket, or table. If the monitor falls, it can injure a person and cause serious damage to this product. Use only a cart, stand, tripod, bracket, or table recommended by the manufacturer or sold with this product. Follow the manufacturer's instructions when installing the product and use mounting accessories recommended by the manufacturer. A product and cart combination should be moved with care.

! Never push any object into the slot on the monitor cabinet. It could damage circuit parts causing a fire or electric shock. Never spill liquids on the monitor.

! Do not place the front of the product on the floor.

! If you mount the monitor on a wall or shelf, use a mounting kit approved by the manufacturer and follow the kit instructions.

! Leave some space around the monitor as shown below. Otherwise, air-circulation may be inadequate hence overheating may cause a fire or damage to the monitor.

See below the recommended ventilation areas around the monitor when the monitor is installed on the wall or on the stand:

Installed with stand

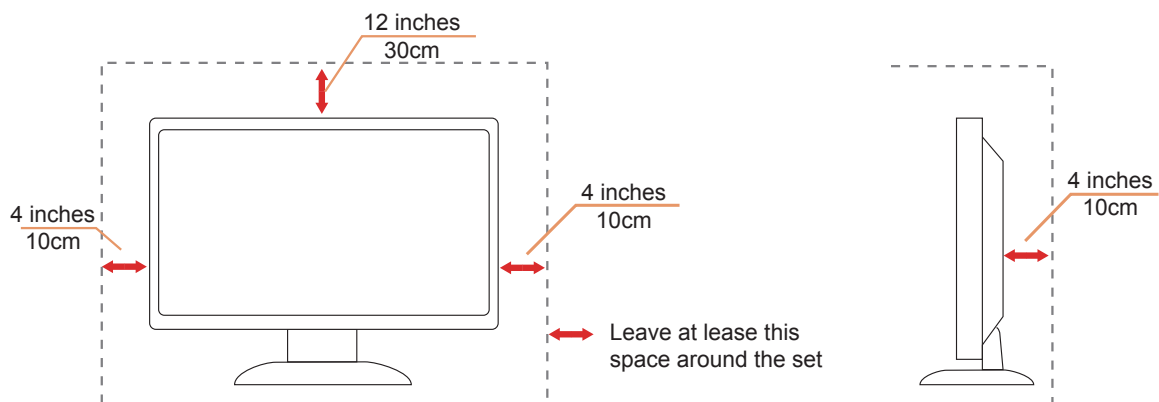

Cleaning

⚠ Clean the cabinet regularly with cloth. You can use soft-detergent to wipe out the stain, instead of strong-detergent which will cauterize the product cabinet.

⚠ When cleaning, make sure no detergent is leaked into the product. The cleaning cloth should not be too rough as it will scratch the screen surface.

⚠ Please disconnect the power cord before cleaning the product.



Other

 If the product is emitting a strange smell, sound or smoke, disconnect the power plug IMMEDIATELY and contact a Service Center.

 Make sure that the ventilating openings are not blocked by a table or curtain.

 Do not engage the LCD monitor in severe vibration or high impact conditions during operation.

 Do not knock or drop the monitor during operation or transportation.

Setup

Contents in Box

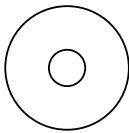
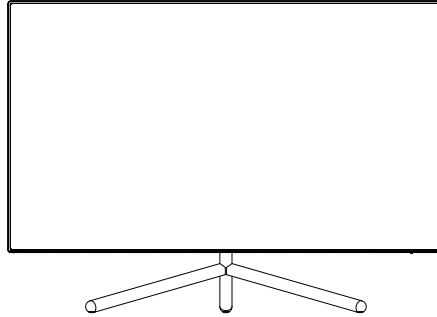

CD Manual



Warranty card



Power Cable



Adapter



HDMI Cable



DP Cable



USB Cable

★ Not all signal cables (DP, HDMI, USB cables) will be provided for all countries and regions. Please check with the local dealer or AOC branch office for confirmation.

Setup Stand & Base

Please setup or remove the base following the steps as below.

Setup:

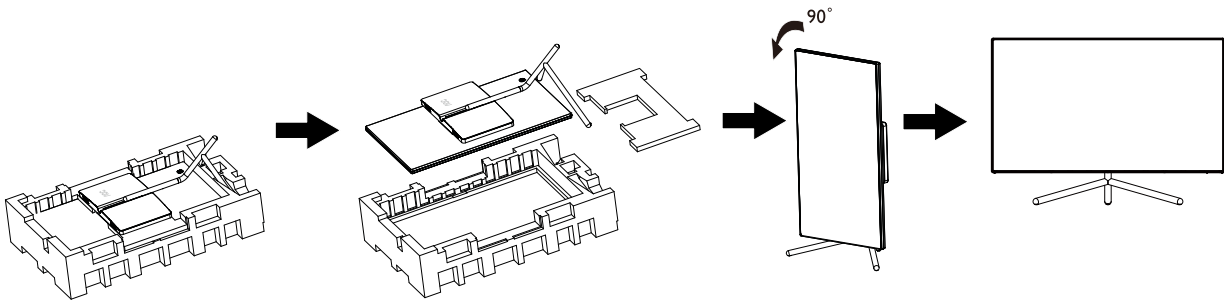

Remove:

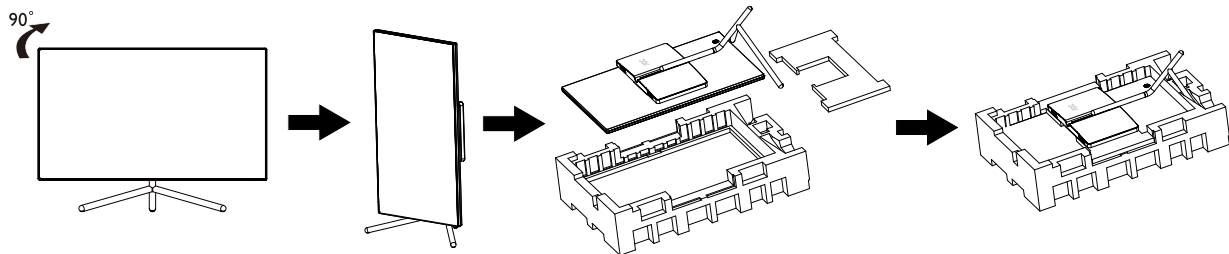

Adjusting the monitor

For optimal viewing it is recommended to look at the full face of the monitor, then adjust the monitor's angle to your own preference.

Hold the stand so you will not topple the monitor when you change the monitor's angle.

You are able to adjust the monitor as below:

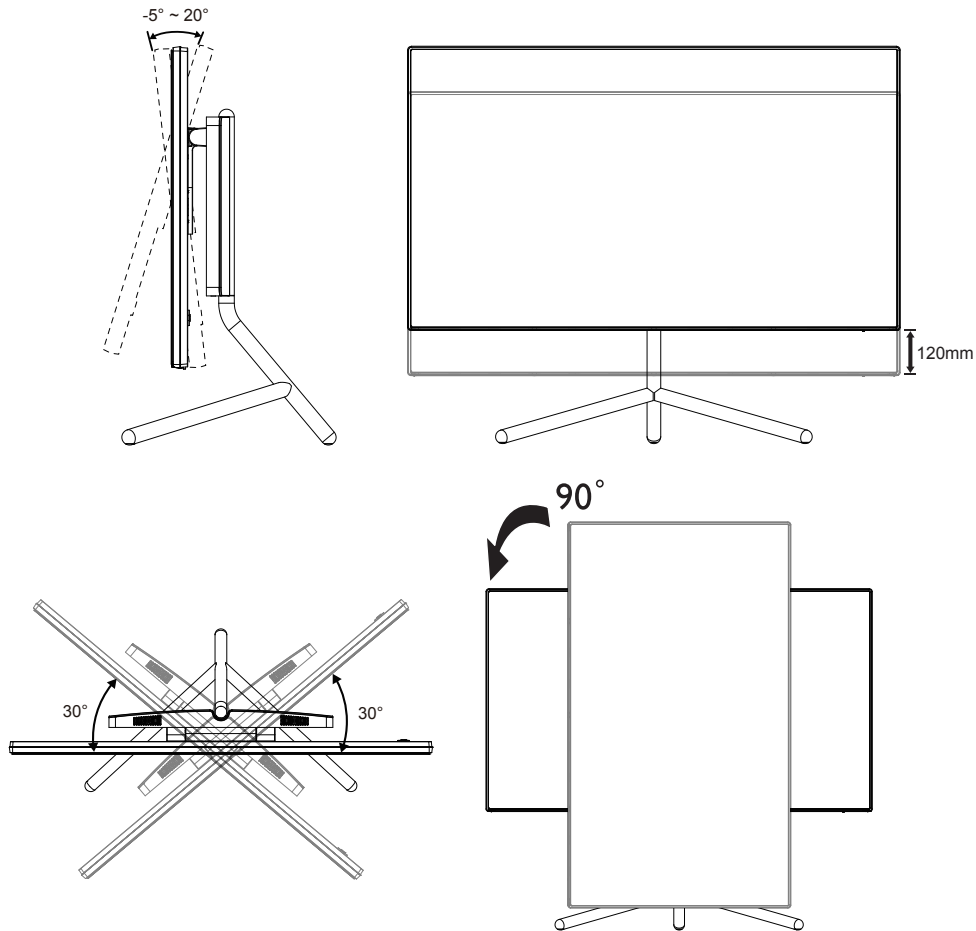

 **NOTE:**

Do not touch the LCD screen when you change the angle. It may cause damage or break the LCD screen.

Connecting the Monitor

Cable Connections In Back of Monitor and Computer:

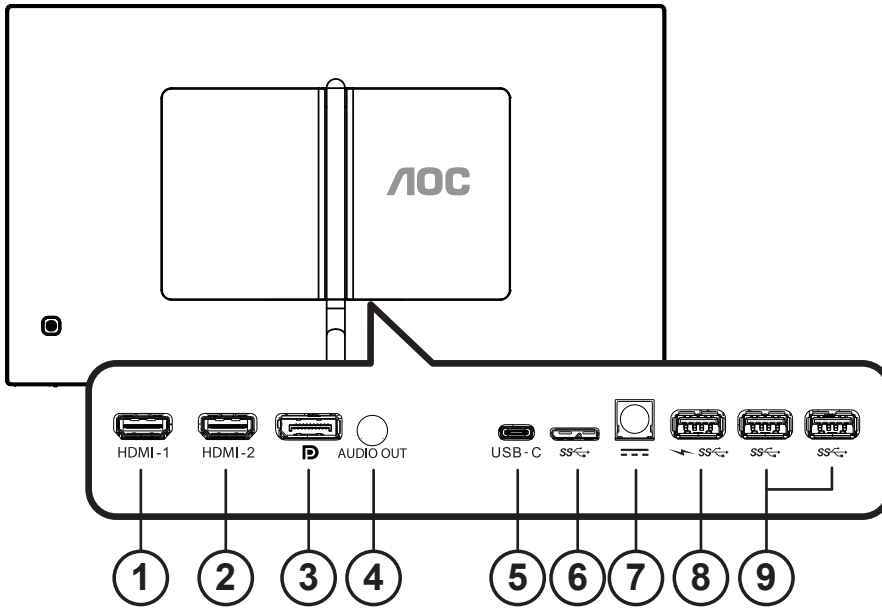

1. HDMI-1
2. HDMI-2
3. DP
4. Audio out
5. USB-C
6. USB upstream
7. Power
8. USB3.2 Gen1 downstream + fast charging(BC1.2)
9. USB3.2 Gen1 downstream

Connect to PC

1. Connect the power cord to the back of the display firmly.
2. Turn off your computer and unplug its power cable.
3. Connect the display signal cable to the video connector on the back of your computer.
4. Plug the power cord of your computer and your display into a nearby outlet.
5. Turn on your computer and display.

If your monitor displays an image, installation is complete. If it does not display an image, please refer Troubleshooting.

To protect equipment, always turn off the PC and LCD monitor before connecting.

Note:

When using the USB-C PD, be careful of the temperature of the rear cover. Do not touch the rear cover and move the monitor during use to avoid hurt.

HDR

It is compatible with input signals in HDR 600 format.

The display may automatically activate the HDR function if the player and content are compatible. Please contact the device manufacturer and the content provider for information on the compatibility of your device and content. Please select "OFF" for the HDR function when you have no need for automatical activation function.

Note:

1. No special setting is needed for the DisplayPort/HDMI interface in WIN10 versions lower (older) than V1703.
2. Only the HDMI interface is available and the DisplayPort interface cannot function in WIN10 version V1703.
3. 3840x2160 @50Hz /60Hz not suggestion used in PC device only for UHD player or Xbox-ones / PS4-Pro.
 - a. The display resolution is set to 3840*2160, and HDR is preset to ON. Under these conditions, the screen may slightly dim, indicating HDR has been activated.
 - b. After entering an application, the best HDR effect can be achieved when the resolution is changed to 3840*2160 (if available).

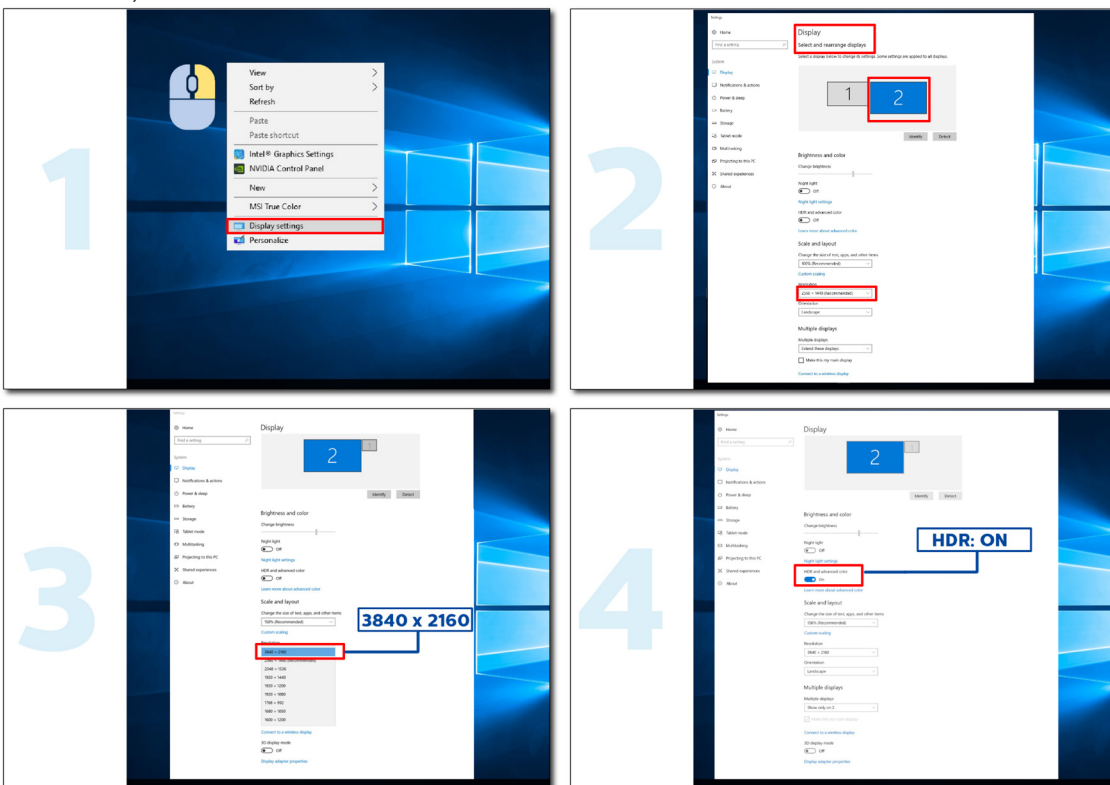

Adjusting

Hotkeys

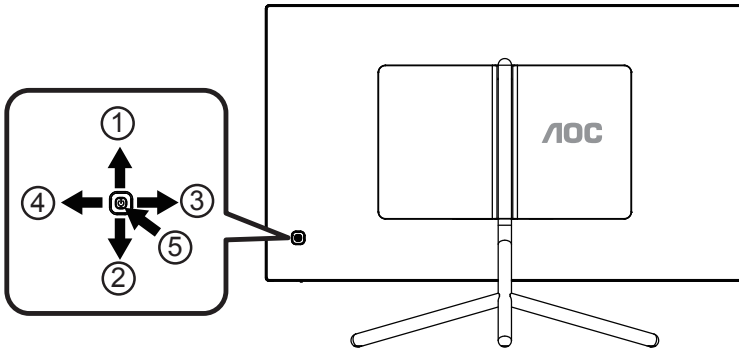

1	Source/Up
2	Eco/DCR/Down
3	Clear Vision/Left
4	Volume/Right
5	Power/Menu/Enter

Menu/Enter/Power

When there is no OSD, Press to display the OSD or confirm the selection. Press about 2 second to turn off the monitor.

Volume/Right

When there is no OSD, Press Volume button to active volume adjustment bar, Press Left or Right to adjust volume.

Source/Up

When the OSD is closed, press Source/Up button will be Source hot key function.

Eco /DCR/Down

When there is no OSD, Press this button to enter Eco/DCR adjustment. Then press Left or Right button to choose different Eco/DCR.

Clear Vision

1. When there is no OSD, Press the “Left” button to activate Clear Vision.
2. Use the “Left” or “Right” buttons to select between weak, medium, strong, or off settings. Default setting is always “off”.

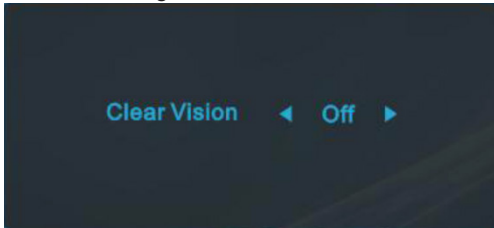

3. Press and hold “Left” button for 5 seconds to activate the Clear Vision Demo, and a message of “Clear Vision Demo: on” will be display on the screen for a duration of 5 seconds. Press and hold “Left” button for 5 seconds again, Clear Vision Demo will be off.

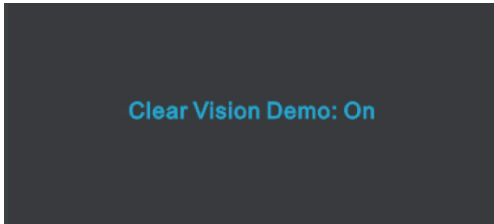

Clear Vision function provides the best image viewing experience by converting low resolution and blurry images into clear and vivid images.

Clear Vision	Off	Adjust the Clear Vision
	Weak	
	Medium	
	Strong	
Clear Vision Demo	On or Off	Disable or Enable Demo

OSD Key Guide (Menu)

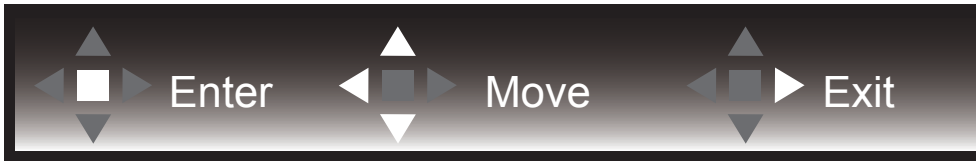

Enter : Use Enter key to enter the next OSD level
Move : Use Left / Up / Down key to move OSD selection
Exit : Use Right key to exit OSD

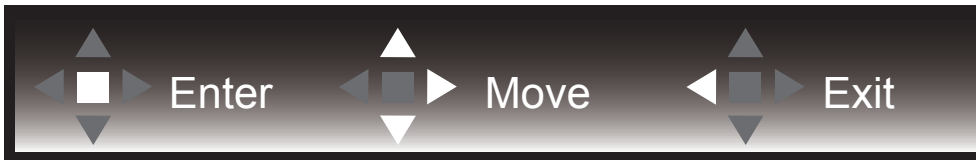

Enter : Use Enter key to enter the next OSD level
Move : Use Right / Up / Down key to move OSD selection
Exit : Use Left key to exit OSD

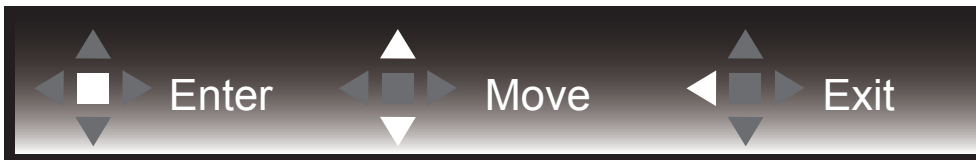

Enter : Use Enter key to enter the next OSD level
Move : Use Up / Down key to move OSD selection
Exit : Use Left key to exit OSD



Move : Use Left / Right / Up / Down Key to move OSD selection



Exit : Use Left key to exit OSD to previous OSD level
Enter : Use Right key to enter next OSD level
Select : Use Up / Down key to move OSD selection



Enter : Use Enter key to apply the OSD setting and back to previous OSD level
Select : Use Down key to adjust OSD setting



Select : Use Up / Down key to adjust OSD setting



Enter : Use Enter key to exit OSD to previous OSD level

Select : Use Left / Right key to adjust OSD setting

OSD Setting

Basic and simple instruction on the control keys.

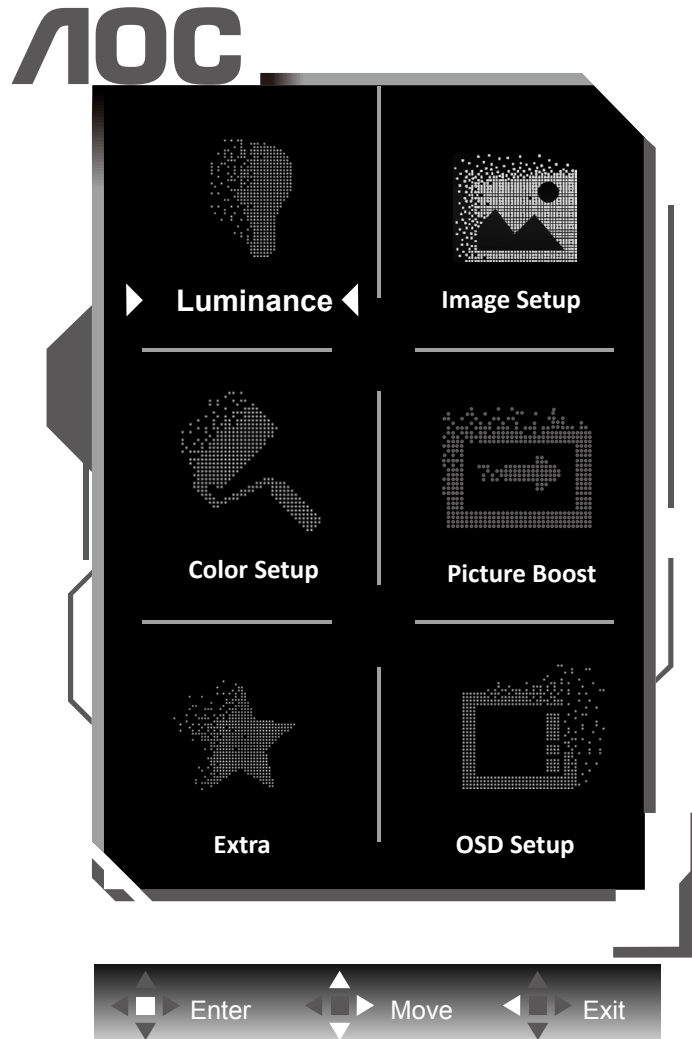

- 1). Press the MENU-button to activate the OSD window.
- 2). Follow Key Guide to move or select (adjust) OSD settings
- 3). OSD Lock/Unlock Function: To lock or unlock the OSD, press and hold the Down-button for 10s while OSD function is not active.

Notes:

- 1). If the product has only one signal input, the item of "Input Select" is disable to adjust.
- 2). ECO modes (except Standard mode), DCR and DCB mode , for these states that only one state can exist.

Luminance

AOC



	Contrast	0-100	Contrast from Digital-register.
	Brightness	0-100	Backlight Adjustment
	Gamma	Gamma1	Adjust to Gamma 1
		Gamma2	Adjust to Gamma 2
		Gamma3	Adjust to Gamma 3
DCR	Off/On	Disable/ Enable dynamic contrast ratio	

Note:

When "HDR/HDR Mode" under "Image Setup" is set to "non-off", all items under "Luminance" cannot be adjusted.

Image Setup

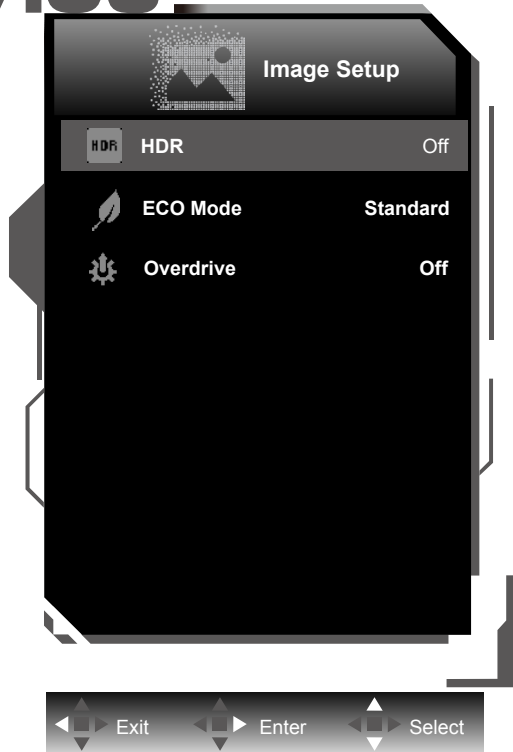

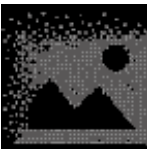
	HDR/HDR Mode	Off / DisplayHDR / HDR Picture / HDR Movie / HDR Game	Select HDR Mode. Note: When HDR is detected, the HDR option is displayed for adjustment. When HDR is not detected, the HDR Mode option is displayed for adjustment.
	ECO Mode	Standard	Standard Mode
		Text	Text Mode
		Internet	Internet Mode
		Game	Game Mode
		Movie	Movie Mode
		Sports	Sports Mode
		Reading	Reading Mode
		Uniformity	Uniformity Mode
	Overdrive	Weak	Adjust the response time
		Medium	
		Strong	
Off			

Color Setup



The image shows a simulated AOC Color Setup menu. The menu is dark-themed with white text and icons. At the top, there is a lightbulb icon and the text 'Color Setup'. Below this, several settings are listed with their current values. At the bottom, there is a navigation bar with three buttons: 'Exit', 'Enter', and 'Select', each with a corresponding directional arrow icon.

Setting	Value
LowBlue Mode	Off
Color Temp.	Warm
DCB Mode	Off
DCB Demo	Off
Red	50
Green	50
Blue	50
Saturation	
Hue	

Navigation: Exit, Enter, Select

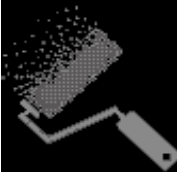
	LowBlue Mode	Multimedia		Decrease the blue light ratio by controlling color temperature. Remark: Only Reading mode is certified to meet the requirements of TÜV Rheinland's "Low Blue Light Content" standards.
		Internet		
		Office		
		Reading		
		Off		
	Color Temp.	Warm		Recall Warm Color Temperature from EEPROM.
		Normal		Recall Normal Color Temperature from EEPROM.
		Cool		Recall Cool Color Temperature from EEPROM.
		sRGB		Recall sRGB Color Temperature from EEPROM.
		User		Restore User Color Temperature from EEPROM.
	DCB Mode	Full Enhance	On or Off	Disable or Enable Full Enhance Mode
		Nature Skin	On or Off	Disable or Enable Nature Skin Mode
		Green Field	On or Off	Disable or Enable Green Field Mode
		Sky-blue	On or Off	Disable or Enable Sky-blue Mode
		AutoDetect	On or Off	Disable or Enable AutoDetect Mode
	DCB Demo		On or Off	Disable or Enable Demo
	Red		0-100	Red gain from Digital-register.
	Green		0-100	Green gain from Digital-register.
	Blue		0-100	Blue gain from Digital-register.
	Saturation		R 0 ~ 100 G 0 ~ 100 B 0 ~ 100 C 0 ~ 100 Y 0 ~ 100 M 0 ~ 100	Saturation Adjustment
Hue		R 0 ~ 100 G 0 ~ 100 B 0 ~ 100 C 0 ~ 100 Y 0 ~ 100 M 0 ~ 100	Hue Adjustment	

Note:

When "HDR/HDR Mode" under "Image Setup" is set to "non-off", all items under "Color Setup" cannot be adjusted.

Note:

To reduce the risk of eye strain and neck/arm/back/shoulder pain from using the monitor for long periods of time, we suggest you to :

1. Set the screen about 20 to 28 inches(50-70cm)from your eyes.
2. Blink frequently to moisten breaks of rewet your eyes when working with the monitor.
3. Take regular and frequent breaks for 20 minutes every two hours.
4. Look away from your monitor and gaze at a distant object at feet away for at least 20 seconds during the breaks.
5. Preform stretches to relieve tension in the neck/arm/back/shoulders during the breaks.

Picture Boost

AOC

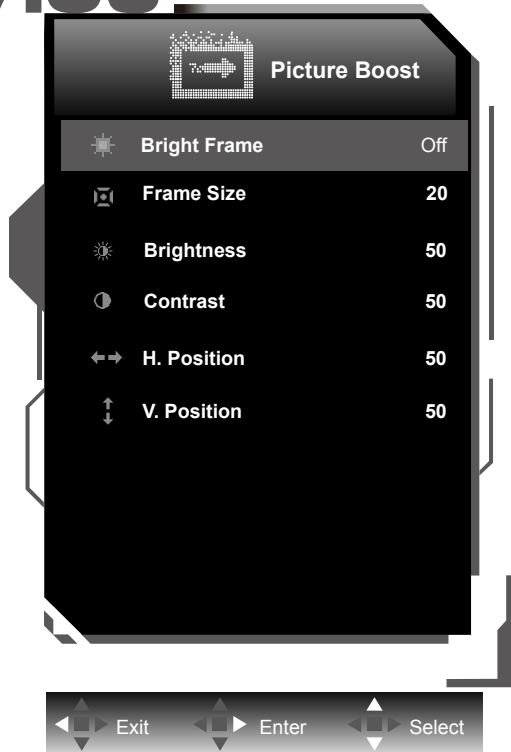



	Bright Frame	On or Off	Disable or Enable Bright Frame
	Frame Size	14-100	Adjust Frame Size
	Brightness	0-100	Adjust Frame Brightness
	Contrast	0-100	Adjust Frame Contrast
	H. position	0-100	Adjust Frame horizontal Position
	V. position	0-100	Adjust Frame vertical Position

Note:

Adjust the brightness, contrast, and position of the Bright Frame for better viewing experience.

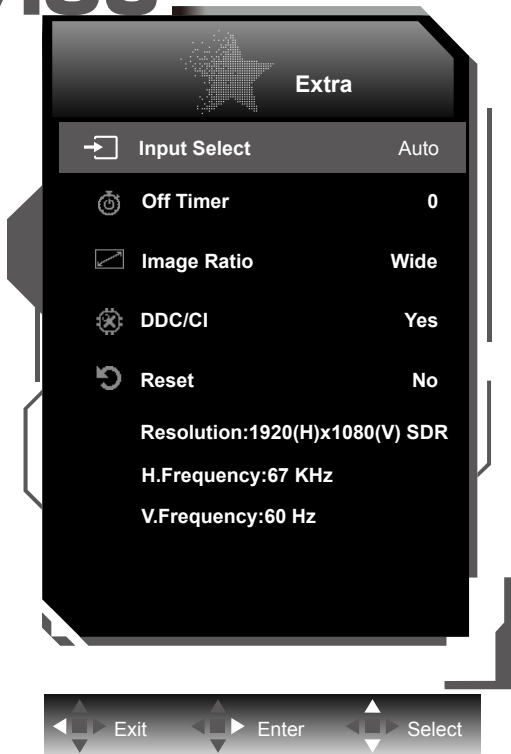
Extra



	Input Select		Select Input Signal Source
	Off timer	0-24hrs	Select DC off time
	Image Ratio	Wide / 4:3 / 1:1 / Movie1 / Movie2	Select image ratio for display.
	DDC/CI	Yes or No	Turn ON/OFF DDC/CI Support
	Reset	Yes or No	Reset the menu to default

OSD Setup

AOC

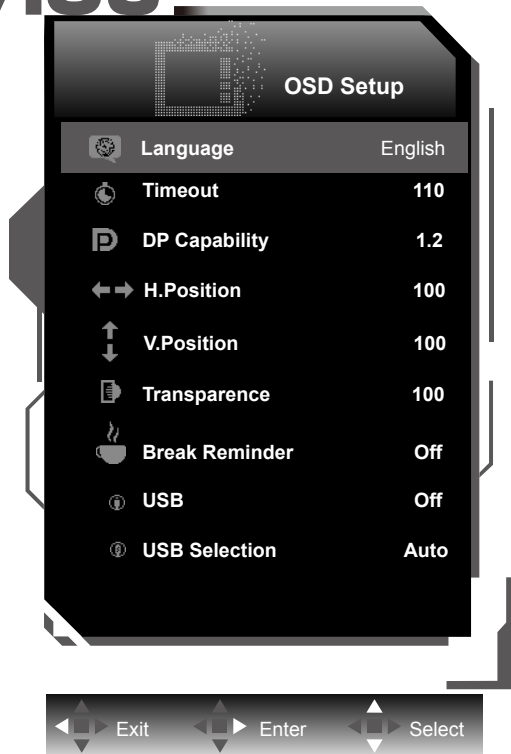

	Language		Select the OSD language
	Timeout	5-120	Adjust the OSD Timeout
	DP Capability	1.1/1.2/1.4	Please be noted that only DP1.2/DP1.4 support HDR function.
	H. Position	0-100	Adjust the horizontal position of OSD
	V. Position	0-100	Adjust the vertical position of OSD
	Transparence	0-100	Adjust the transparence of OSD
	Break Reminder	On or Off	Break reminder if the user continuously work for more than 1hrs
	USB	3.0 / 2.0 / Off	Select USB type.
	USB Selection	Auto / USB C / USB up	Select USB input source.

Note:

If the DP video content supports DP1.2/DP1.4, please select DP1.2/DP1.4 for DP Capability; otherwise, please select DP1.1.

LED Indicator

Status	LED Color
Full Power Mode	White
Active-off Mode	Orange

Drivers

i-Menu (Screen+)



Welcome to "i-Menu" software by AOC. i-Menu makes it easy to adjust your monitor display setting by using on screen menus instead of the OSD button on the monitor. To complete installation, please follow the installation guide. The software Supported operating systems: Windows 10, Windows 8, Windows 7.

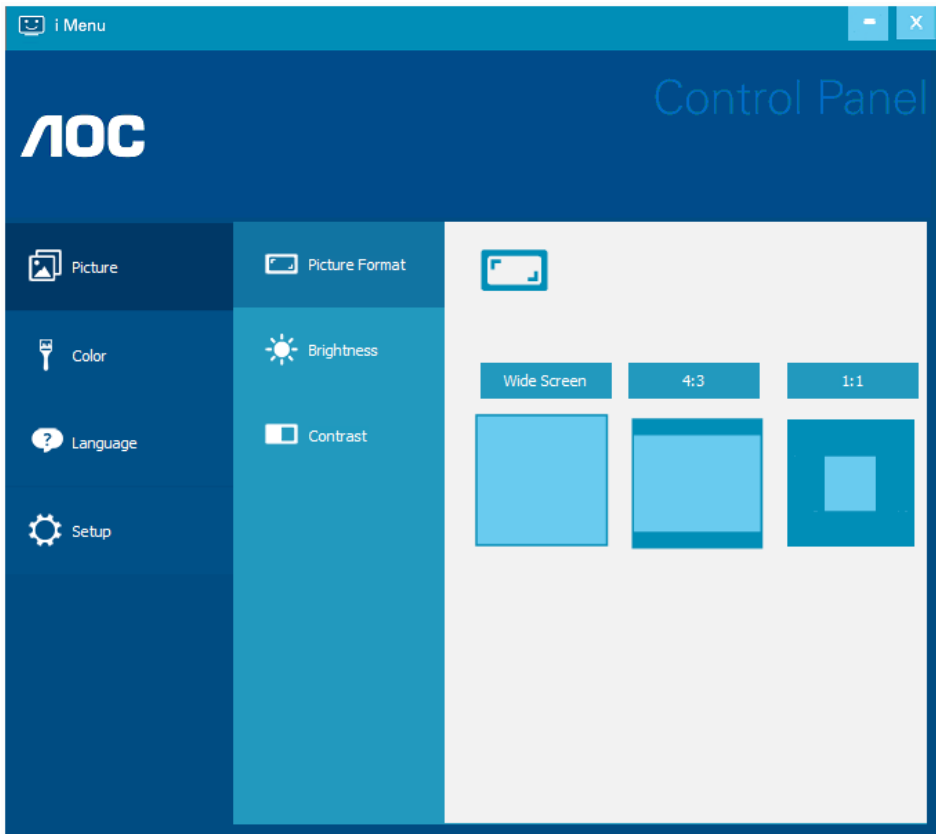

Screen+ can be turned on via i-Menu. It is a desktop screen splitting tool, it splits the desktop into different panels, and each panel displays a different window. You only need to drag the window to a corresponding panel when you want to access it. It supports multiple monitor display to make your task easier.

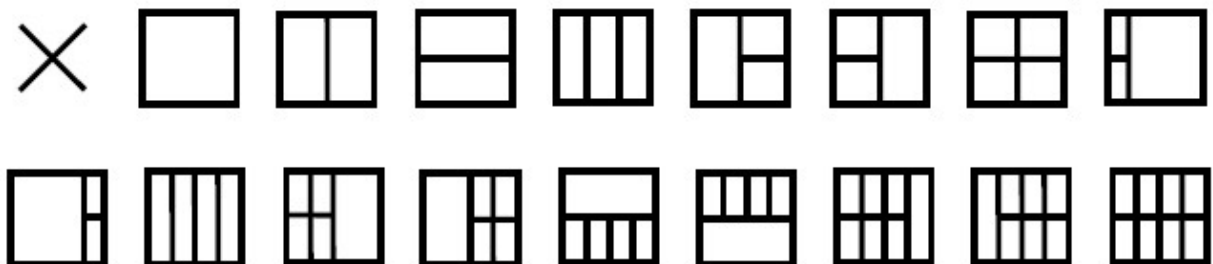

e-Saver



Welcome to use AOC e-Saver monitor power management software! The AOC e-Saver features Smart Shutdown functions for your monitors, allows your monitor to timely shutdown when PC unit is at any status (On, Off, Sleep or Screen Saver); the actual shutdown time depends on your preferences (see example below).

Please click on “driver/e-Saver/setup.exe” to start installing the e-Saver software, follow the install wizard to complete software installation.

Under each of the four PC status, you may choose from the pull-down menu the desired time (in minutes) you're your monitor to automatically shut down. The example above illustrated:

- 1). The monitor will never shutdown when the PC is powered on.
- 2). The monitor will automatically shutdown 5 minutes after the PC is powered off.
- 3). The monitor will automatically shutdown 10 minutes after the PC is in sleep/stand-by mode.
- 4). The monitor will automatically shutdown 20 minutes after the screen saver appears.

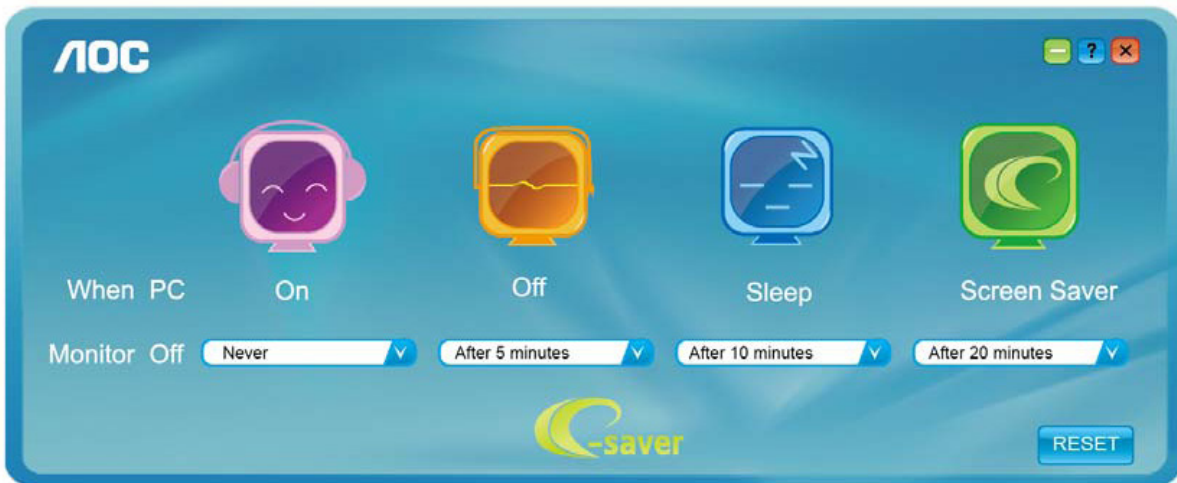

You can click “RESET” to set the e-Saver to its default settings like below.

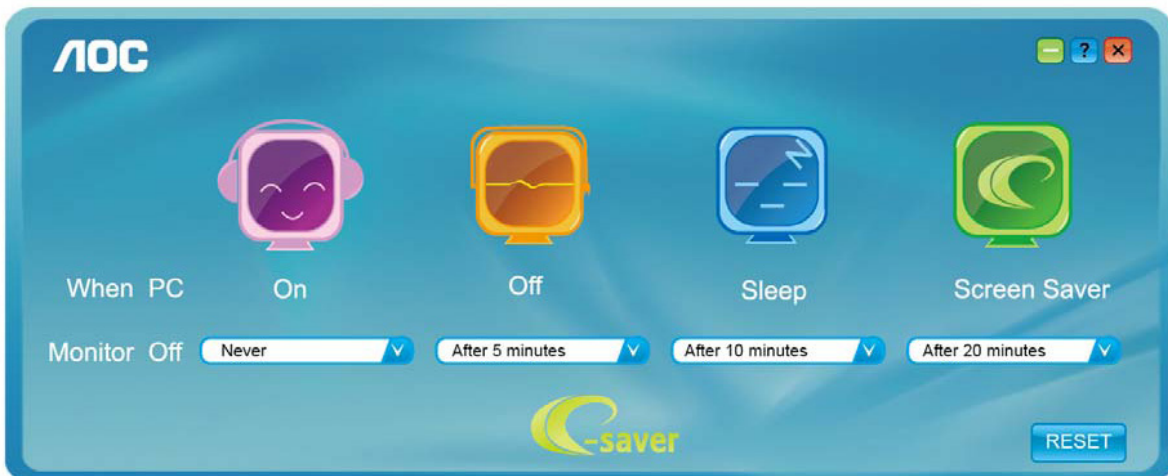

Troubleshoot

Problem & Question	Possible Solutions
Power LED Is Not ON	Make sure the power button is ON and the Power Cord is properly connected to a grounded power outlet and to the monitor.
No images on the screen	<ul style="list-style-type: none"> • Is the power cord connected properly? Check the power cord connection and power supply. • Is the cable connected correctly? (Connected using the HDMI cable) Check the HDMI cable connection. (Connected using the DP cable) Check the DP cable connection. *HDMI/DP input is not available on every model. • If the power is on, reboot the computer to see the initial screen (the login screen), which can be seen. If the initial screen (the login screen) appears, boot the computer in the applicable mode (the safe mode for Windows 7/8/10) and then change the frequency of the video card. (Refer to the Setting the Optimal Resolution) If the initial screen (the login screen) does not appear, contact the Service Center or your dealer. • Can you see "Input Not Supported" on the screen? You can see this message when the signal from the video card exceeds the maximum resolution and frequency that the monitor can handle properly. Adjust the maximum resolution and frequency that the monitor can handle properly. • Make sure the AOC Monitor Drivers are installed.
Picture Is Fuzzy & Has Ghosting Shadowing Problem	Adjust the Contrast and Brightness Controls. Press to auto adjust. Make sure you are not using an extension cable or switch box. We recommend plugging the monitor directly to the video card output connector on the back.
Picture Bounces, Flickers Or Wave Pattern Appears In The Picture	Move electrical devices that may cause electrical interference as far away from the monitor as possible. Use the maximum refresh rate your monitor is capable of at the resolution you are using.
Monitor Is Stuck In Active Off-Mode"	The Computer Power Switch should be in the ON position. The Computer Video Card should be snugly fitted in its slot. Make sure the monitor's video cable is properly connected to the computer. Inspect the monitor's video cable and make sure no pin is bent. Make sure your computer is operational by hitting the CAPS LOCK key on the keyboard while observing the CAPS LOCK LED. The LED should either turn ON or OFF after hitting the CAPS LOCK key.
Missing one of the primary colors (RED, GREEN, or BLUE)	Inspect the monitor's video cable and make sure that no pin is damaged. Make sure the monitor's video cable is properly connected to the computer.
Picture has color defects (white does not look white)	Adjust RGB color or select desired color temperature.
Horizontal or vertical disturbances on the screen	Use Windows 7/8/10 shut-down mode to adjust CLOCK and FOCUS. Press to auto-adjust.
Regulation & Service	Please refer to Regulation & Service Information which is in the CD manual or www.aoc.com (to find the model you purchase in your country and to find Regulation & Service Information in Support page.

Specification

General Specification

Panel	Model name	U32U1		
	Driving system	TFT Color LCD		
	Viewable Image Size	80.0 cm diagonal		
	Pixel pitch	0.18159mm(H) x 0.18159mm(V)		
	Video	HDMI Interface & DP Interface		
	Separate Sync.	H/V TTL		
	Display Color	1.07 Billion		
Others	Horizontal scan range	30K - 160KHz		
	Horizontal scan Size(Maximum)	697.31mm		
	Vertical scan range	23~75 Hz		
	Vertical Scan Size(Maximum)	392.23mm		
	Product with packaging (WxHxD)	718.2 x 633.4 x 276.7 mm		
	Optimal preset resolution	3840x2160@60Hz		
	Plug & Play	VESA DDC2B/CI		
	Input Connector	HDMI/DP/USB-C/USB up		
	Power Source	19.5Vdc, 9.23A		
	Power Consumption	Typical(default brightness and contrast)	60W	
Max. (brightness = 100, contrast =100)		≤230W		
Power saving		≤0.5W		
Physical Characteristics	Connector Type	HDMI/ DP/ USB-C/ Audio out		
	Signal Cable Type	Detachable		
Environmental	Temperature	Operating	0° ~ 40°	
		Non-Operating	-25° ~ 55°	
	Humidity	Operating	10% ~ 85% (non-condensing)	
		Non-Operating	5% ~ 93% (non-condensing)	
	Altitude	Operating	0~ 5000 m (0~ 16404ft)	
		Non-Operating	0~ 12192m (0~ 40000ft)	

Preset Display Modes

STANDARD	RESOLUTION	HORIZONTAL FREQUENCY(kHz)	VERTICAL FREQUENCY(Hz)
VGA	640x480@60Hz	31.469	59.94
VGA	640x480@67Hz	35	66.667
VGA	640x480@72Hz	37.861	72.809
VGA	640x480@75Hz	37.5	75
DOS MODE	720x400@70Hz	31.469	70.087
DOS MODE	720x480@60Hz	29.855	59.710
SD	720x576@50Hz	31.25	50
SVGA	800x600@56Hz	35.156	56.25
SVGA	800x600@60Hz	37.879	60.317
SVGA	800x600@72Hz	48.077	72.188
SVGA	800x600@75Hz	46.875	75
SVGA	832x624@75Hz	49.725	74.551
XGA	1024x768@60Hz	48.363	60.004
XGA	1024x768@70Hz	56.476	70.069
XGA	1024x768@75Hz	60.023	75.029
SXGA	1280x1024@60Hz	63.981	60.02
SXGA	1280x1024@75Hz	79.975	75.025
Full HD	1920x1080@60Hz	67.5	60
FHD	1920x1080@100Hz	113.221	99.93
FHD	1920x1080@120Hz	137.26	119.982
QHD	2560x1440@60Hz	88.787	59.951
UHD	3840x2160@30Hz	65.688	30
UHD	3840x2160@60Hz	133.312	60

Note:

The resolution supported by USB2.0 is 3840x2160@60Hz. When you switch to USB3.0, the resolution supported will be 3840x2160 @ 30Hz.

Pin Assignments



19-Pin Color Display Signal Cable

Pin No.	Signal Name	Pin No.	Signal Name	Pin No.	Signal Name
1.	TMDS Data 2+	9.	TMDS Data 0-	17.	DDC/CEC Ground
2.	TMDS Data 2 Shield	10.	TMDS Clock +	18.	+5V Power
3.	TMDS Data 2-	11.	TMDS Clock Shield	19.	Hot Plug Detect
4.	TMDS Data 1+	12.	TMDS Clock-		
5.	TMDS Data 1Shield	13.	CEC		
6.	TMDS Data 1-	14.	Reserved (N.C. on device)		
7.	TMDS Data 0+	15.	SCL		
8.	TMDS Data 0 Shield	16.	SDA		

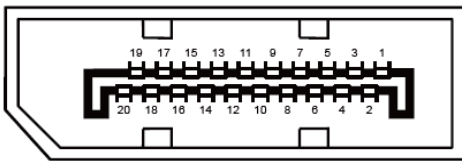

20-Pin Color Display Signal Cable

Pin No.	Signal Name	Pin No.	Signal Name
1	ML_Lane 3 (n)	11	GND
2	GND	12	ML_Lane 0 (p)
3	ML_Lane 3 (p)	13	CONFIG1
4	ML_Lane 2 (n)	14	CONFIG2
5	GND	15	AUX_CH(p)
6	ML_Lane 2 (p)	16	GND
7	ML_Lane 1 (n)	17	AUX_CH(n)
8	GND	18	Hot Plug Detect
9	ML_Lane 1 (p)	19	Return DP_PWR
10	ML_Lane 0 (n)	20	DP_PWR

Plug and Play

Plug & Play DDC2B Feature

This monitor is equipped with VESA DDC2B capabilities according to the VESA DDC STANDARD. It allows the monitor to inform the host system of its identity and, depending on the level of DDC used, communicate additional information about its display capabilities.

The DDC2B is a bi-directional data channel based on the I2C protocol. The host can request EDID information over the DDC2B channel.