



**6dB Bandwidth and 99% Occupied Bandwidth Plot on Configuration IEEE 802.11ax 20MHz / Nss 1
MCS 0 / 1S4T CDD / Ant. 3 / CH144 / 5720 MHz (EBW3 & OBW3)**

802.11ax HEW20_Nss1,(MCS0)_4TX

EBW

5720MHz Straddle 5.725-5.85GHz

11/07/2020

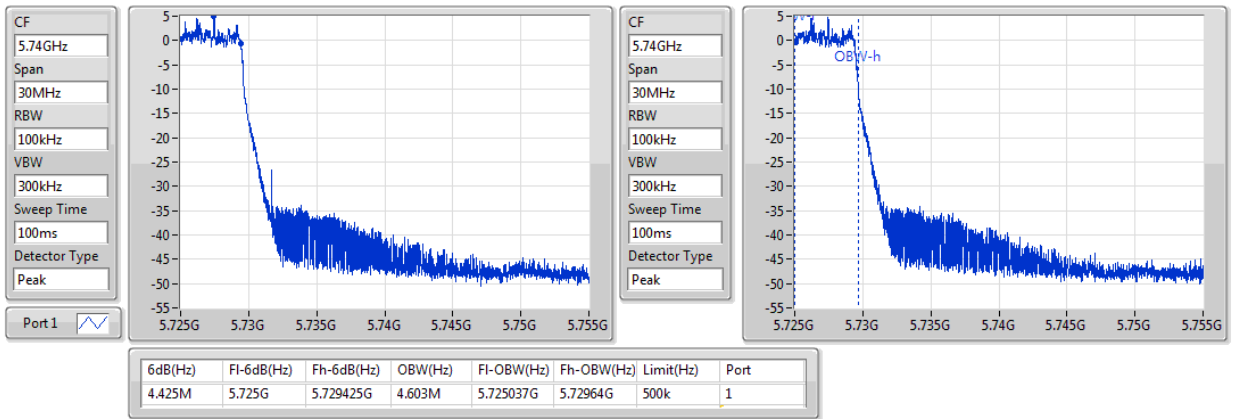

**6dB Bandwidth and 99% Occupied Bandwidth Plot on Configuration IEEE 802.11ax 20MHz / Nss 1
MCS 0 / 1S4T CDD / Ant. 4 / CH144 / 5720 MHz (EBW3 & OBW3)**

802.11ax HEW20_Nss1,(MCS0)_4TX

EBW

5720MHz Straddle 5.725-5.85GHz

11/07/2020

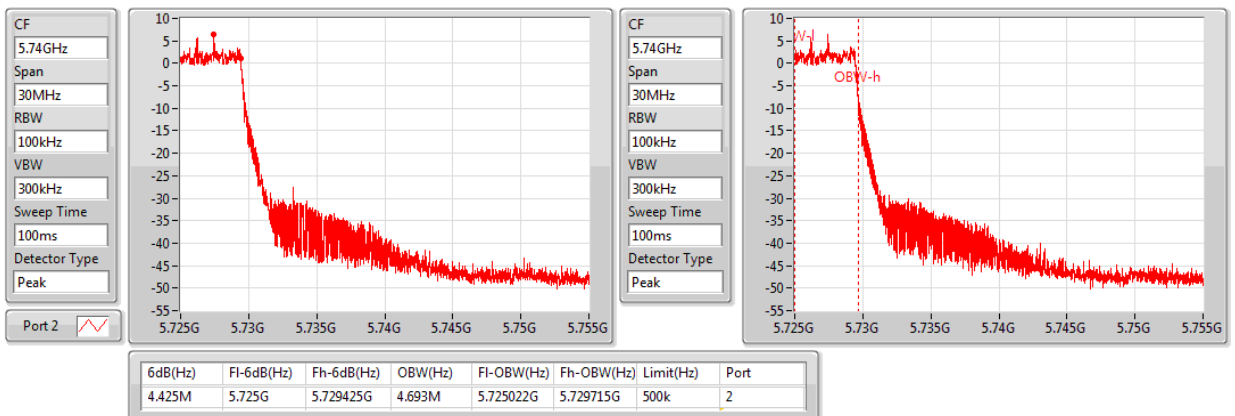



6dB Bandwidth and 99% Occupied Bandwidth Plot on Configuration IEEE 802.11ax 20MHz / Nss 1 MCS 0 / 1S4T CDD / Ant. 5 / CH144 / 5720 MHz (EBW3 & OBW3)

802.11ax HEW20_Nss1,(MCS0)_4TX

EBW

5720MHz Straddle 5.725-5.85GHz

11/07/2020

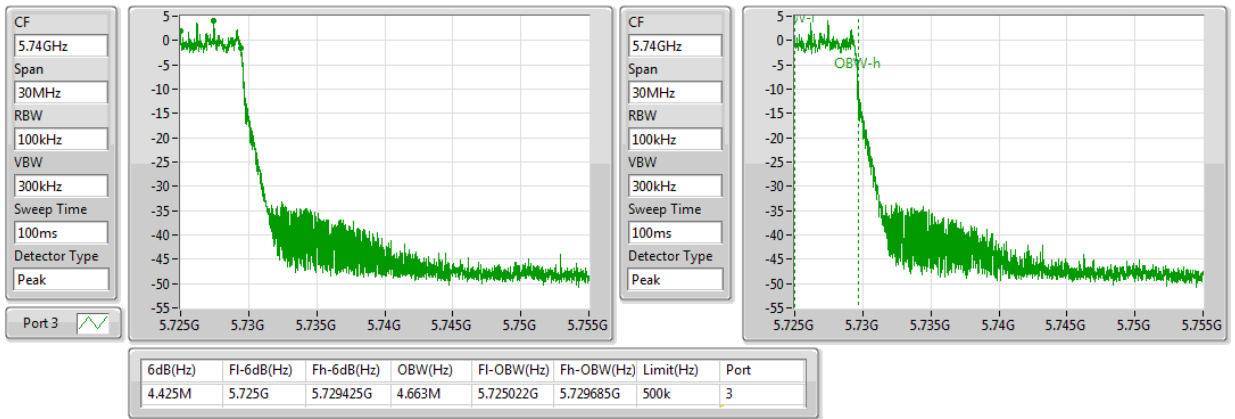

6dB Bandwidth and 99% Occupied Bandwidth Plot on Configuration IEEE 802.11ax 20MHz / Nss 1 MCS 0 / 1S4T CDD / Ant. 6 / CH144 / 5720 MHz (EBW3 & OBW3)

802.11ax HEW20_Nss1,(MCS0)_4TX

EBW

5720MHz Straddle 5.725-5.85GHz

11/07/2020

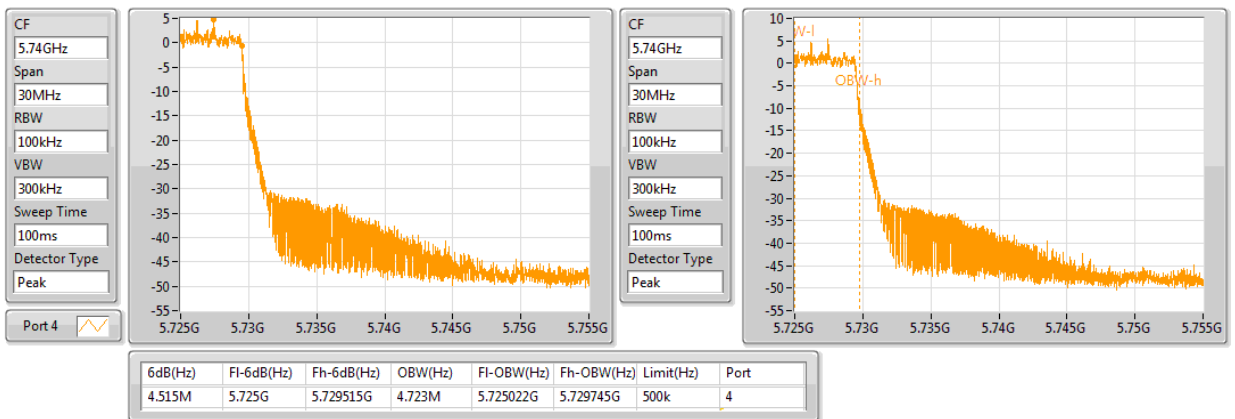



**26dB Bandwidth and 99% Occupied Bandwidth Plot on Configuration IEEE 802.11ax 20MHz / Nss 1
MCS 0 / 1S4T TXBF / Ant. 3 / CH144 (EBW2c & OBW2c) / 5720 MHz**

802.11ax HEW20-BF_Nss1,(MCS0)_4TX

EBW

5720MHz Straddle 5.47-5.725GHz

11/07/2020

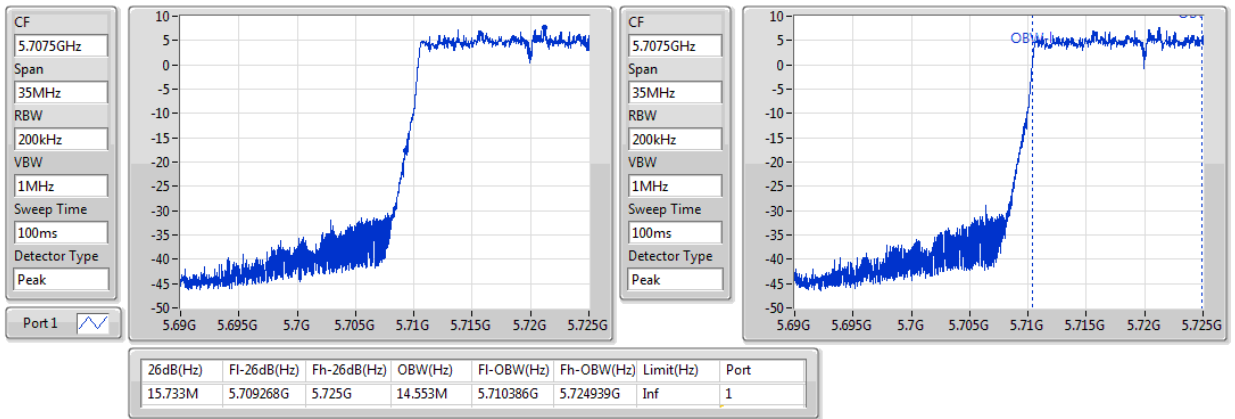

**26dB Bandwidth and 99% Occupied Bandwidth Plot on Configuration IEEE 802.11ax 20MHz / Nss 1
MCS 0 / 1S4T TXBF / Ant. 4 / CH144 (EBW2c & OBW2c) / 5720 MHz**

802.11ax HEW20-BF_Nss1,(MCS0)_4TX

EBW

5720MHz Straddle 5.47-5.725GHz

11/07/2020

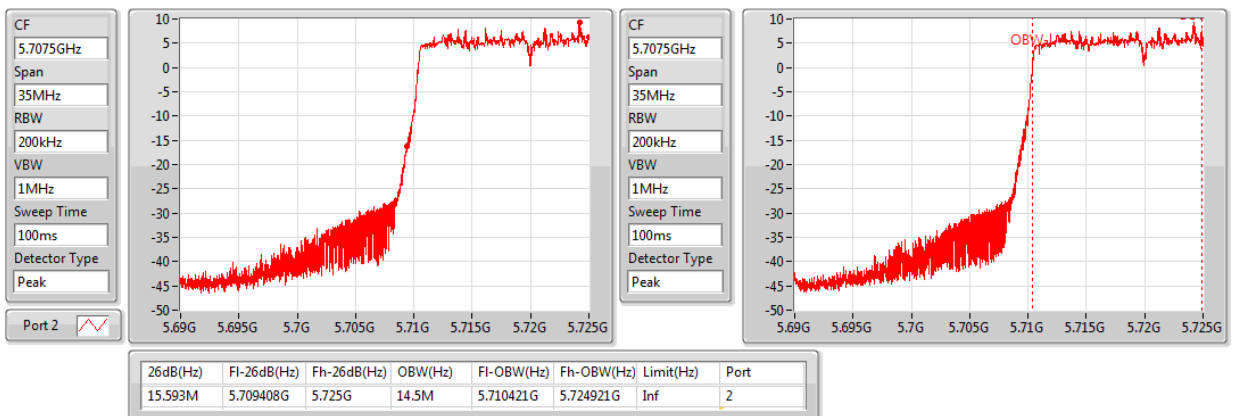



**26dB Bandwidth and 99% Occupied Bandwidth Plot on Configuration IEEE 802.11ax 20MHz / Nss 1
MCS 0 / 1S4T TXBF / Ant. 5 / CH144 / 5720 MHz (EBW2c & OBW2c)**

802.11ax HEW20-BF_Nss1,(MCS0)_4TX

EBW

5720MHz Straddle 5.47-5.725GHz

11/07/2020

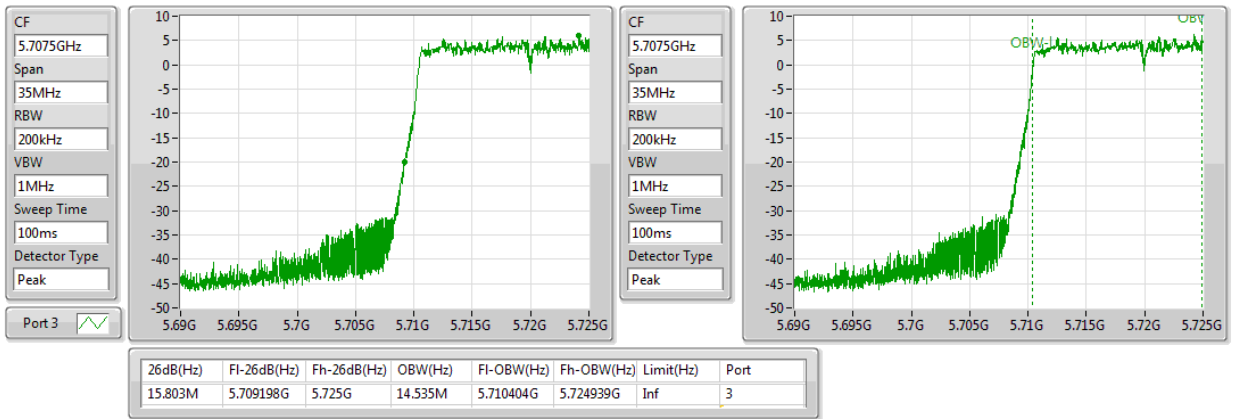

**26dB Bandwidth and 99% Occupied Bandwidth Plot on Configuration IEEE 802.11ax 20MHz / Nss 1
MCS 0 / 1S4T TXBF / Ant. 6 / CH144 / 5720 MHz (EBW2c & OBW2c)**

802.11ax HEW20-BF_Nss1,(MCS0)_4TX

EBW

5720MHz Straddle 5.47-5.725GHz

11/07/2020

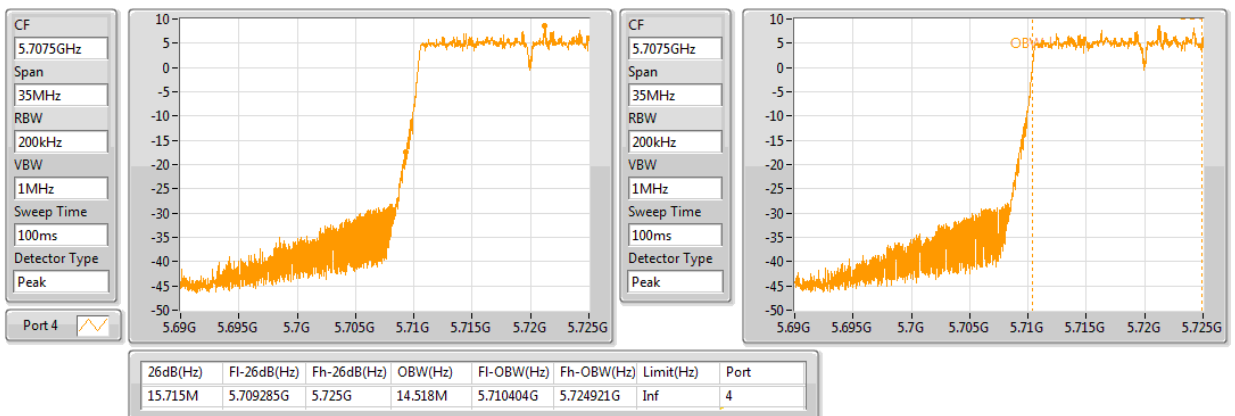



6dB Bandwidth and 99% Occupied Bandwidth Plot on Configuration IEEE 802.11ax 20MHz / Nss 1 MCS 0 / 1S4T TXBF / Ant. 3 / CH144/ 5720 MHz (EBW3 & OBW3)

802.11ax HEW20-BF_Nss1,(MCS0)_4TX

EBW

5720MHz Straddle 5.725-5.85GHz

11/07/2020

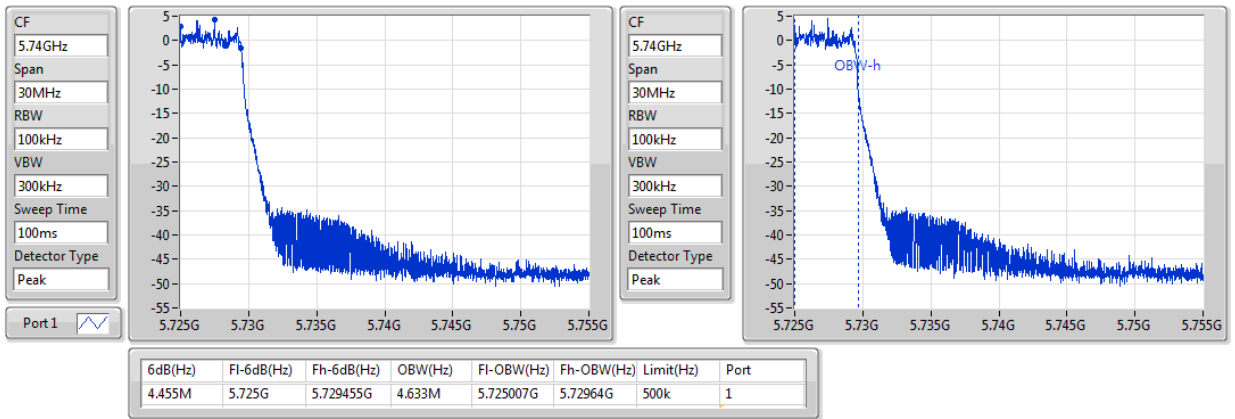

6dB Bandwidth and 99% Occupied Bandwidth Plot on Configuration IEEE 802.11ax 20MHz / Nss 1 MCS 0 / 1S4T TXBF / Ant. 4 / CH144 / 5720 MHz (EBW3 & OBW3)

802.11ax HEW20-BF_Nss1,(MCS0)_4TX

EBW

5720MHz Straddle 5.725-5.85GHz

11/07/2020

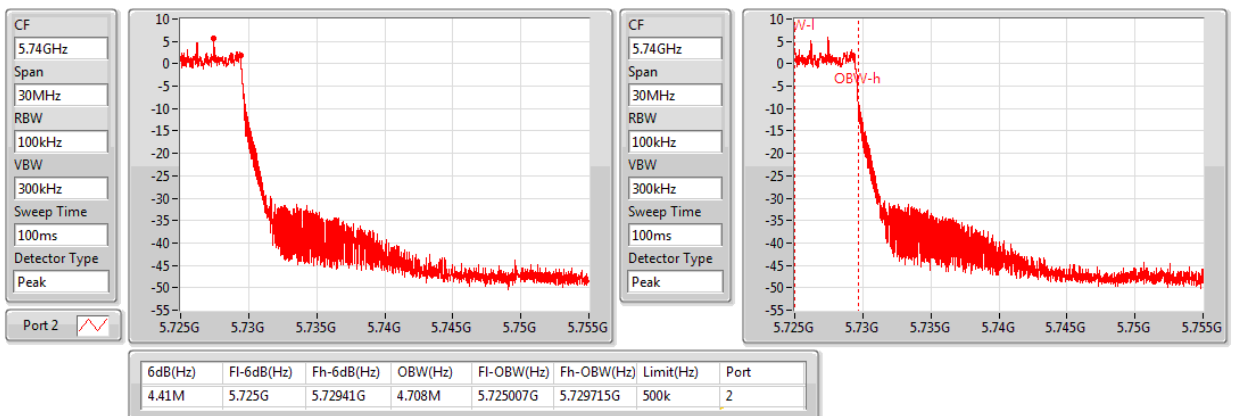



6dB Bandwidth and 99% Occupied Bandwidth Plot on Configuration IEEE 802.11ax 20MHz / Nss 1 MCS 0 / 1S4T TXBF / Ant. 5 / CH144 / 5720 MHz (EBW3 & OBW3)

802.11ax HEW20-BF_Nss1,(MCS0)_4TX

EBW

5720MHz Straddle 5.725-5.85GHz

11/07/2020

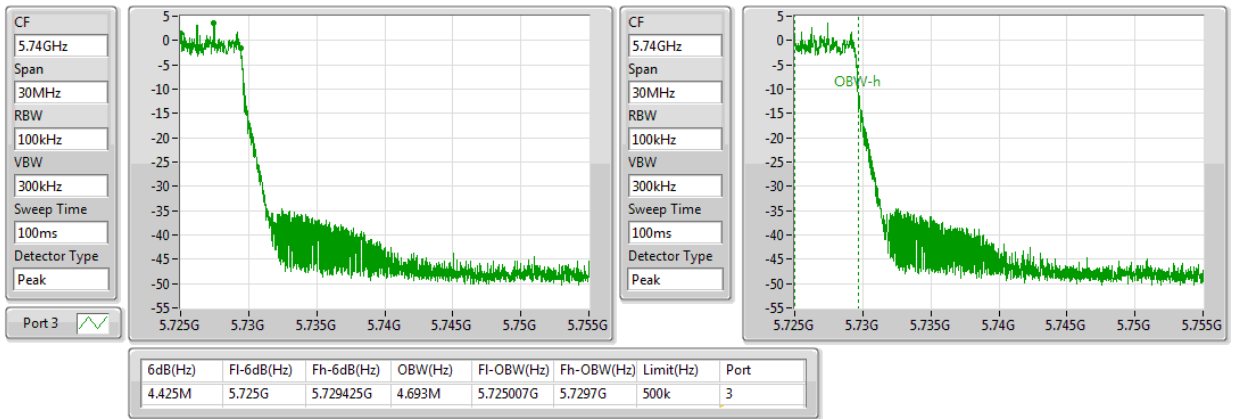

6dB Bandwidth and 99% Occupied Bandwidth Plot on Configuration IEEE 802.11ax 20MHz / Nss 1 MCS 0 / 1S4T TXBF / Ant. 6 / CH144 / 5720 MHz (EBW3 & OBW3)

802.11ax HEW20-BF_Nss1,(MCS0)_4TX

EBW

5720MHz Straddle 5.725-5.85GHz

11/07/2020

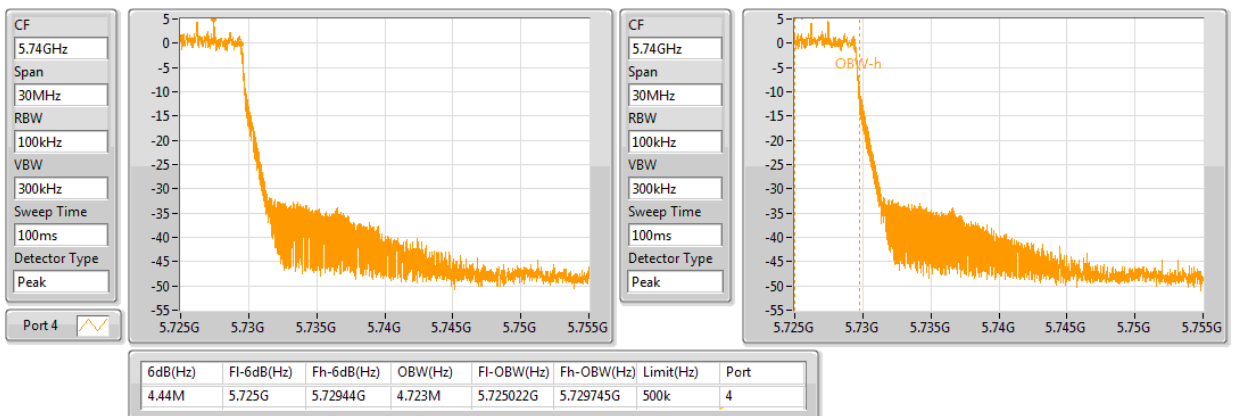



**26dB Bandwidth and 99% Occupied Bandwidth Plot on Configuration IEEE 802.11ax 20MHz / Nss 2
MCS 0 / 2S4T TXBF / Ant. 3 / CH144 / 5720 MHz (EBW2c & OBW2c)**

802.11ax HEW20-BF_Nss2,(MCS0)_4TX

EBW

5720MHz Straddle 5.47-5.725GHz

11/07/2020

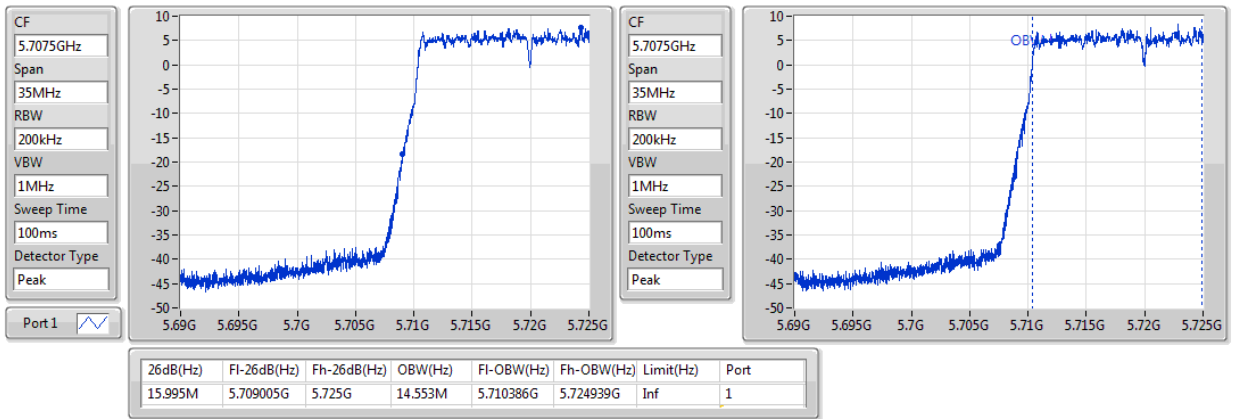

**26dB Bandwidth and 99% Occupied Bandwidth Plot on Configuration IEEE 802.11ax 20MHz / Nss 2
MCS 0 / 2S4T TXBF / Ant. 4 / CH144 / 5720 MHz (EBW2c & OBW2c)**

802.11ax HEW20-BF_Nss2,(MCS0)_4TX

EBW

5720MHz Straddle 5.47-5.725GHz

11/07/2020

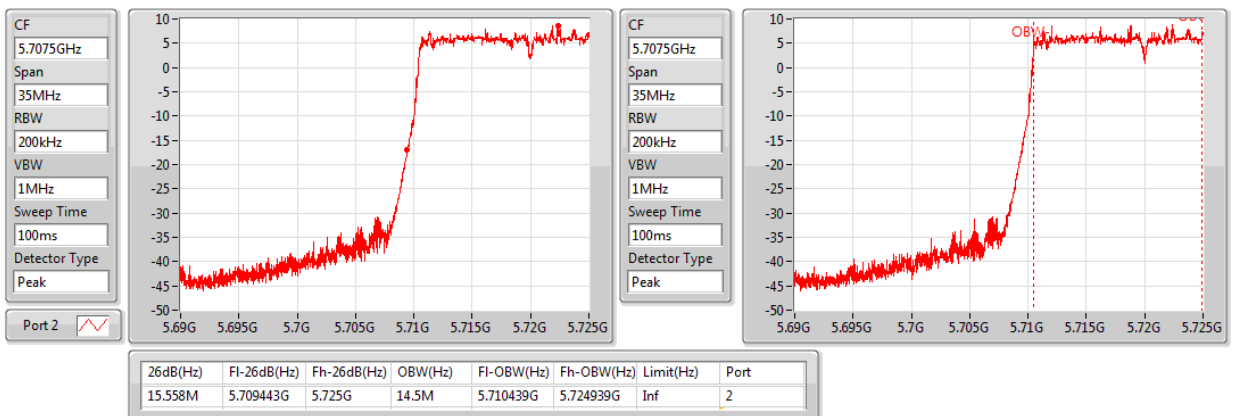



26dB Bandwidth and 99% Occupied Bandwidth Plot on Configuration IEEE 802.11ax 20MHz / Nss 2 MCS 0 / 2S4T TXBF / Ant. 5 / CH144 / 5720 MHz (EBW2c & OBW2c)

802.11ax HEW20-BF_Nss2,(MCS0)_4TX

EBW

5720MHz Straddle 5.47-5.725GHz

11/07/2020

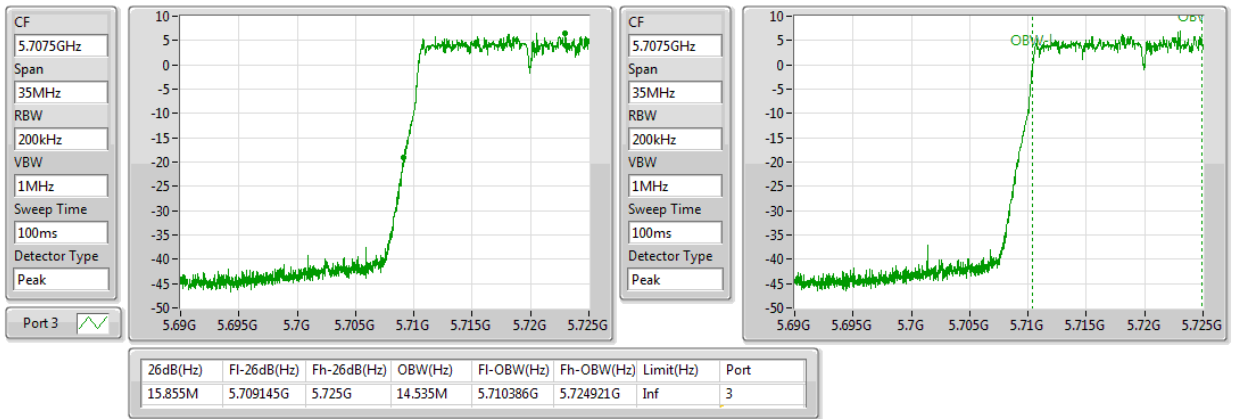

26dB Bandwidth and 99% Occupied Bandwidth Plot on Configuration IEEE 802.11ax 20MHz / Nss 2 MCS 0 / 2S4T TXBF / Ant. 6 / CH144 / 5720 MHz (EBW2c & OBW2c)

802.11ax HEW20-BF_Nss2,(MCS0)_4TX

EBW

5720MHz Straddle 5.47-5.725GHz

11/07/2020

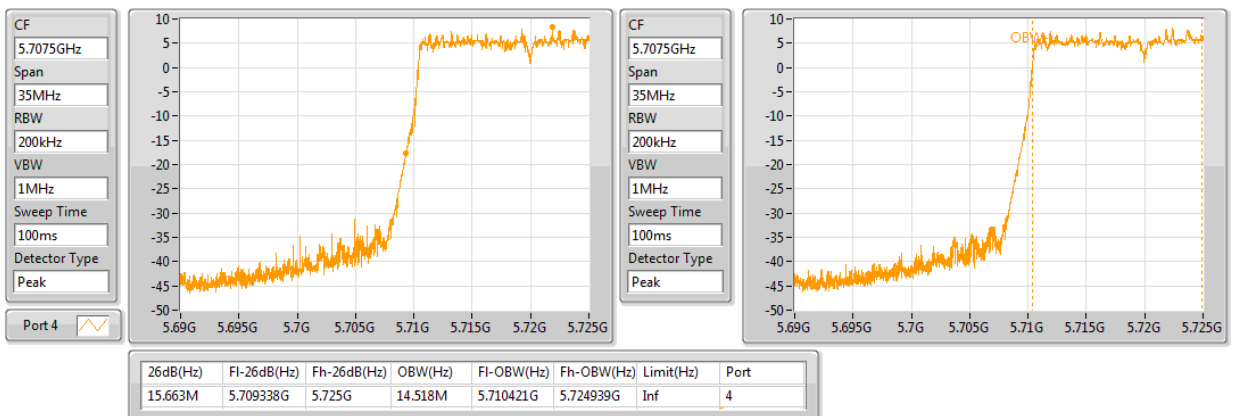



**6dB Bandwidth and 99% Occupied Bandwidth Plot on Configuration IEEE 802.11ax 20MHz / Nss 2
MCS 0 / 2S4T TXBF / Ant. 3 / CH144 / 5720 MHz (EBW3 & OBW3)**

802.11ax HEW20-BF_Nss2,(MCS0)_4TX

EBW

5720MHz Straddle 5.725-5.85GHz

11/07/2020

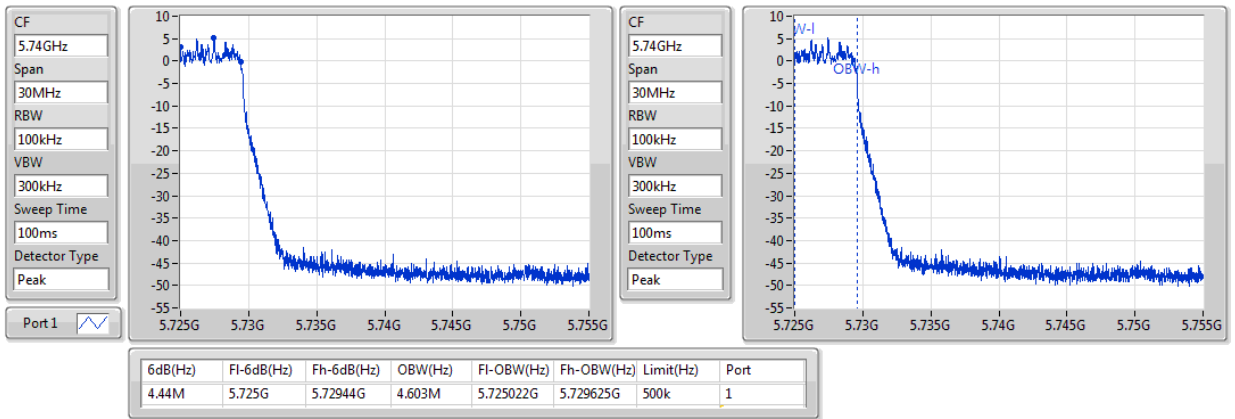

**6dB Bandwidth and 99% Occupied Bandwidth Plot on Configuration IEEE 802.11ax 20MHz / Nss 2
MCS 0 / 2S4T TXBF / Ant. 4 / CH144 / 5720 MHz (EBW3 & OBW3)**

802.11ax HEW20-BF_Nss2,(MCS0)_4TX

EBW

5720MHz Straddle 5.725-5.85GHz

11/07/2020

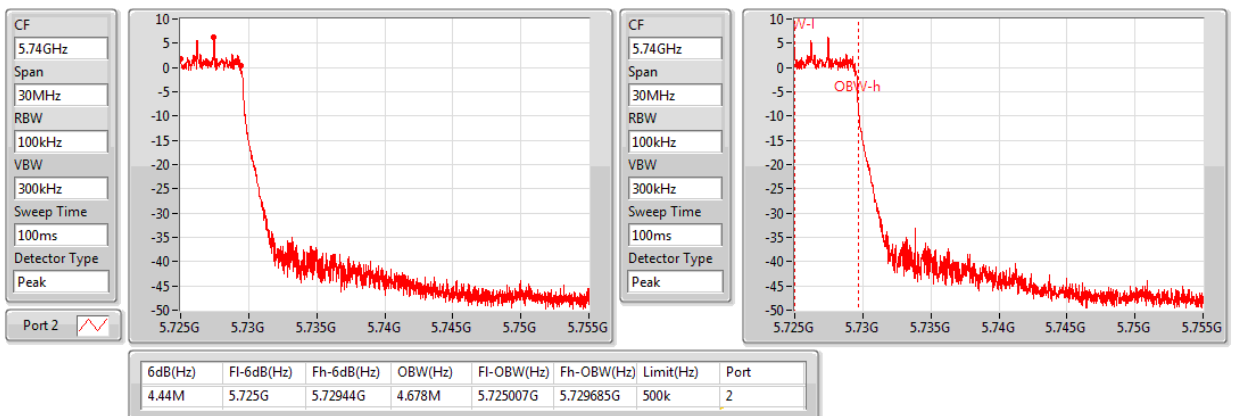



**6dB Bandwidth and 99% Occupied Bandwidth Plot on Configuration IEEE 802.11ax 20MHz / Nss 2
MCS 0 / 2S4T TXBF / Ant. 5 / CH144 / 5720 MHz (EBW3 & OBW3)**

802.11ax HEW20-BF_Nss2,(MCS0)_4TX

EBW

5720MHz Straddle 5.725-5.85GHz

11/07/2020

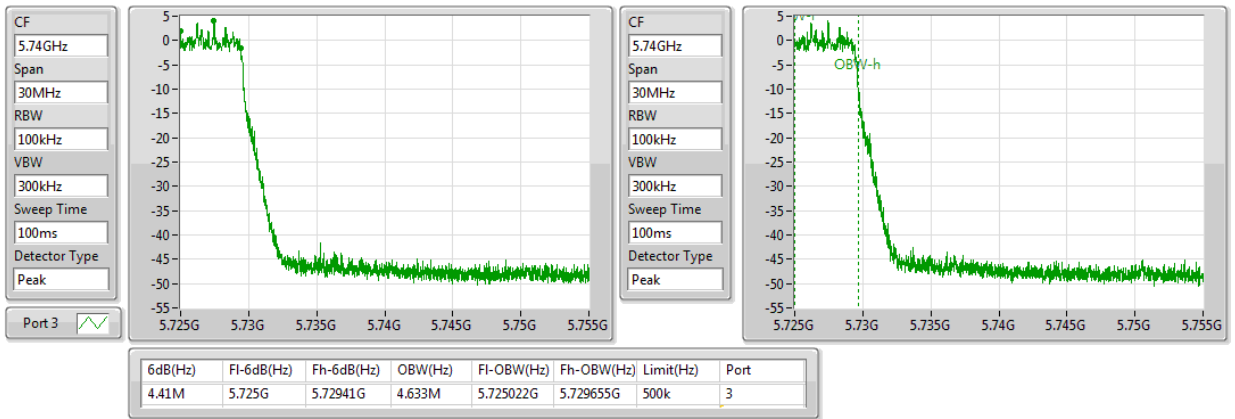

**6dB Bandwidth and 99% Occupied Bandwidth Plot on Configuration IEEE 802.11ax 20MHz / Nss 2
MCS 0 / 2S4T TXBF / Ant. 6 / CH144 / 5720 MHz (EBW3 & OBW3)**

802.11ax HEW20-BF_Nss2,(MCS0)_4TX

EBW

5720MHz Straddle 5.725-5.85GHz

11/07/2020

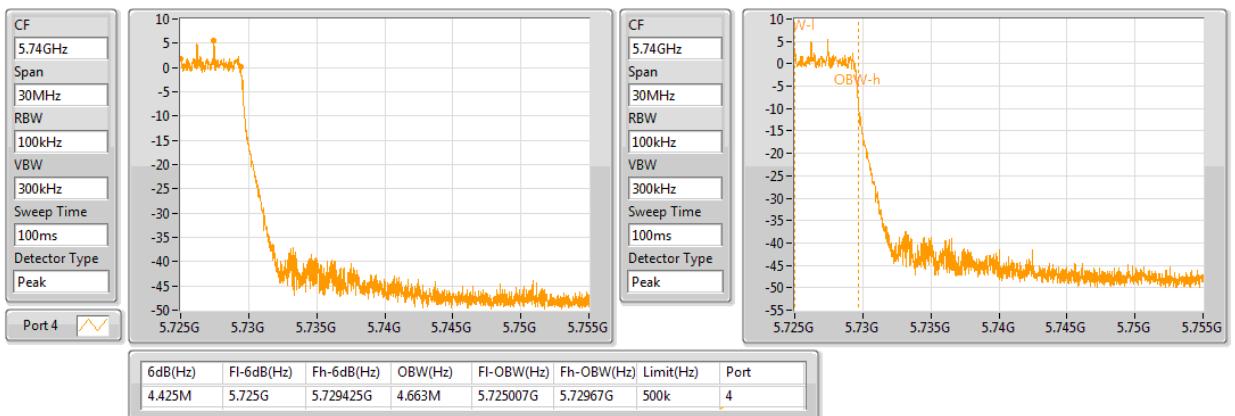



26dB Bandwidth and 99% Occupied Bandwidth Plot on Configuration IEEE 802.11ax 20MHz / Nss 3 MCS 0 / 3S4T TXBF / Ant. 3 / CH144 / 5720 MHz (EBW2c & OBW2c)

802.11ax HEW20-BF_Nss3,(MCS0)_4TX

EBW

5720MHz Straddle 5.47-5.725GHz

11/07/2020

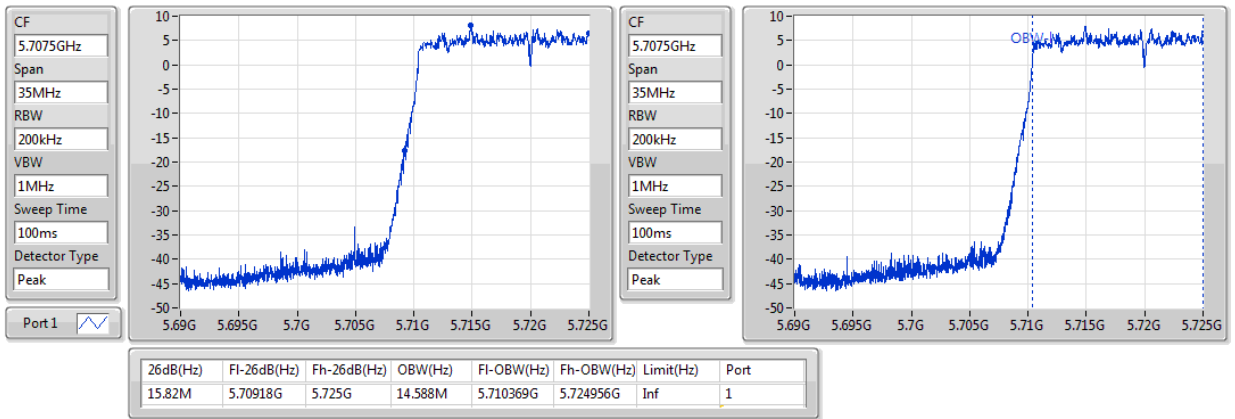

26dB Bandwidth and 99% Occupied Bandwidth Plot on Configuration IEEE 802.11ax 20MHz / Nss 3 MCS 0 / 3S4T TXBF / Ant. 4 / CH144 / 5720 MHz (EBW2c & OBW2c)

802.11ax HEW20-BF_Nss3,(MCS0)_4TX

EBW

5720MHz Straddle 5.47-5.725GHz

11/07/2020

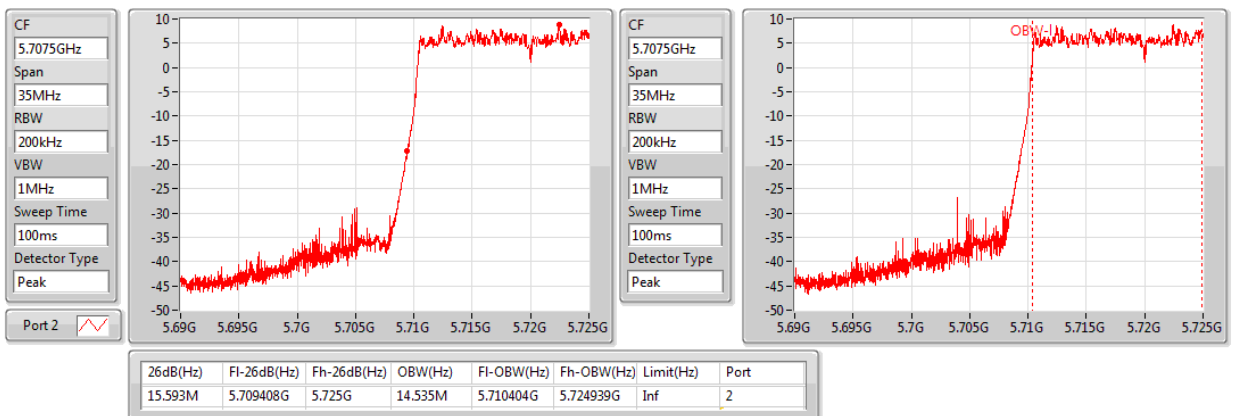



**26dB Bandwidth and 99% Occupied Bandwidth Plot on Configuration IEEE 802.11ax 20MHz / Nss 3
MCS 0 / 3S4T TXBF / Ant. 5 / CH144 / 5720 MHz (EBW2c & OBW2c)**

802.11ax HEW20-BF_Nss3,(MCS0)_4TX

EBW

5720MHz Straddle 5.47-5.725GHz

11/07/2020

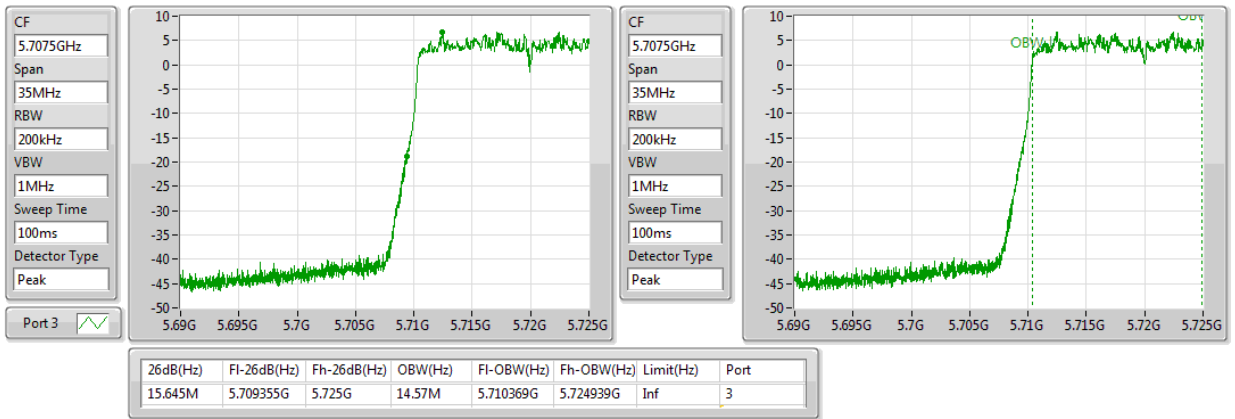

**26dB Bandwidth and 99% Occupied Bandwidth Plot on Configuration IEEE 802.11ax 20MHz / Nss 3
MCS 0 / 3S4T TXBF / Ant. 6 / CH144 / 5720 MHz (EBW2c & OBW2c)**

802.11ax HEW20-BF_Nss3,(MCS0)_4TX

EBW

5720MHz Straddle 5.47-5.725GHz

11/07/2020

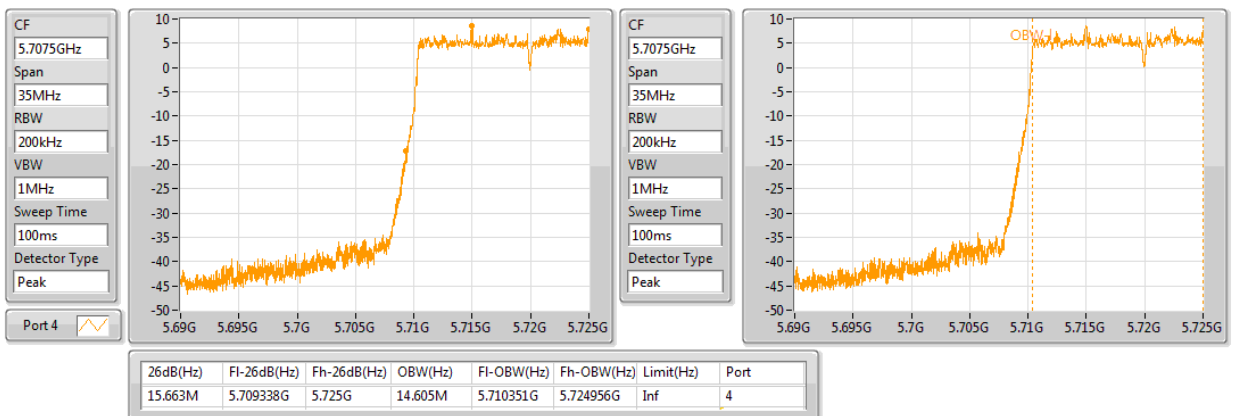



**6dB Bandwidth and 99% Occupied Bandwidth Plot on Configuration IEEE 802.11ax 20MHz / Nss 3
MCS 0 / 3S4T TXBF / Ant. 3 / CH144 / 5720 MHz (EBW3 & OBW3)**

802.11ax HEW20-BF_Nss3,(MCS0)_4TX

EBW

5720MHz Straddle 5.725-5.85GHz

11/07/2020

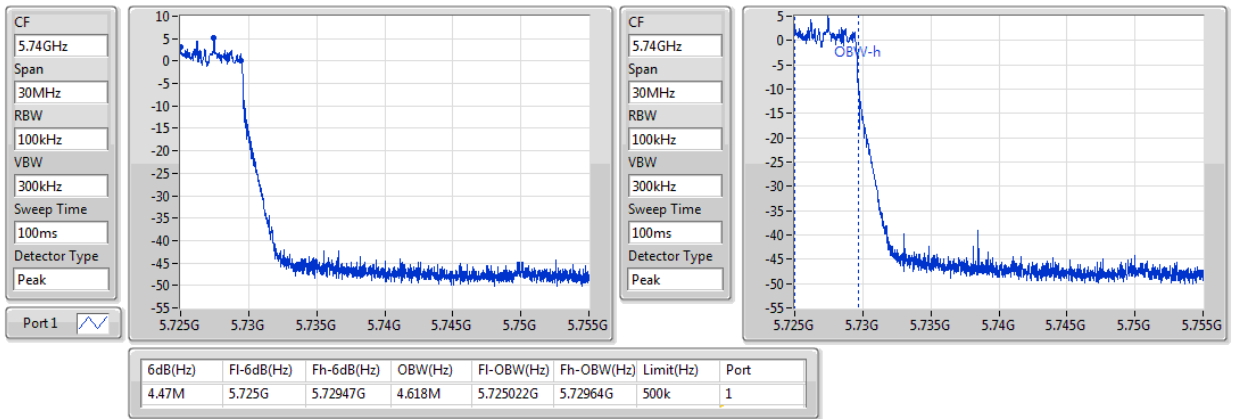

**6dB Bandwidth and 99% Occupied Bandwidth Plot on Configuration IEEE 802.11ax 20MHz / Nss 3
MCS 0 / 3S4T TXBF / Ant. 4 / CH144 / 5720 MHz (EBW3 & OBW3)**

802.11ax HEW20-BF_Nss3,(MCS0)_4TX

EBW

5720MHz Straddle 5.725-5.85GHz

11/07/2020

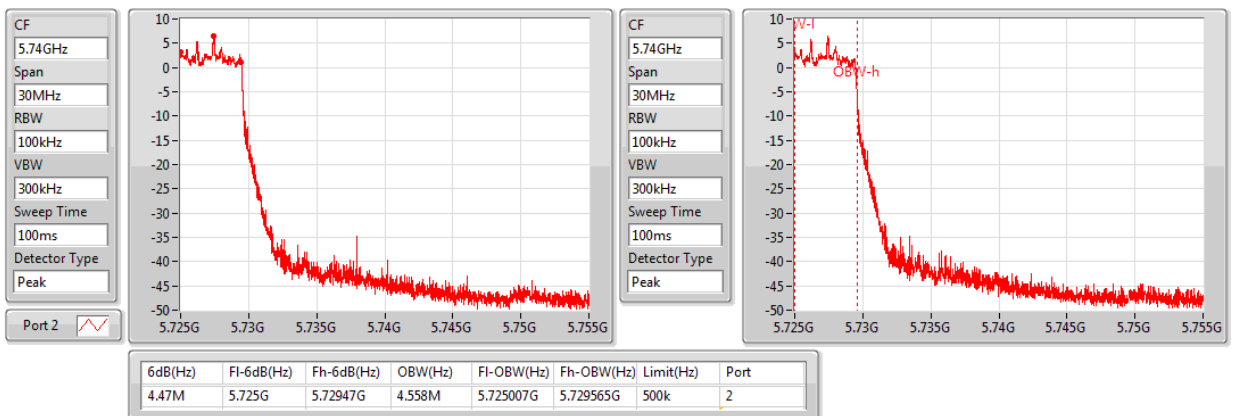



6dB Bandwidth and 99% Occupied Bandwidth Plot on Configuration IEEE 802.11ax 20MHz / Nss 3 MCS 0 / 3S4T TXBF / Ant. 5 / CH144 / 5720 MHz (EBW3 & OBW3)

802.11ax HEW20-BF_Nss3,(MCS0)_4TX

EBW

5720MHz Straddle 5.725-5.85GHz

11/07/2020

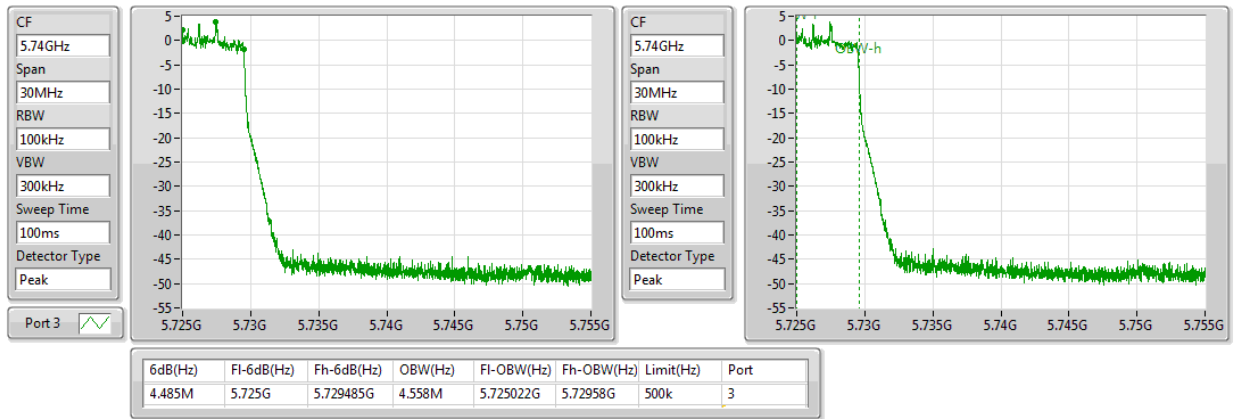

6dB Bandwidth and 99% Occupied Bandwidth Plot on Configuration IEEE 802.11ax 20MHz / Nss 3 MCS 0 / 3S4T TXBF / Ant. 6 / CH144 / 5720 MHz (EBW3 & OBW3)

802.11ax HEW20-BF_Nss3,(MCS0)_4TX

EBW

5720MHz Straddle 5.725-5.85GHz

11/07/2020

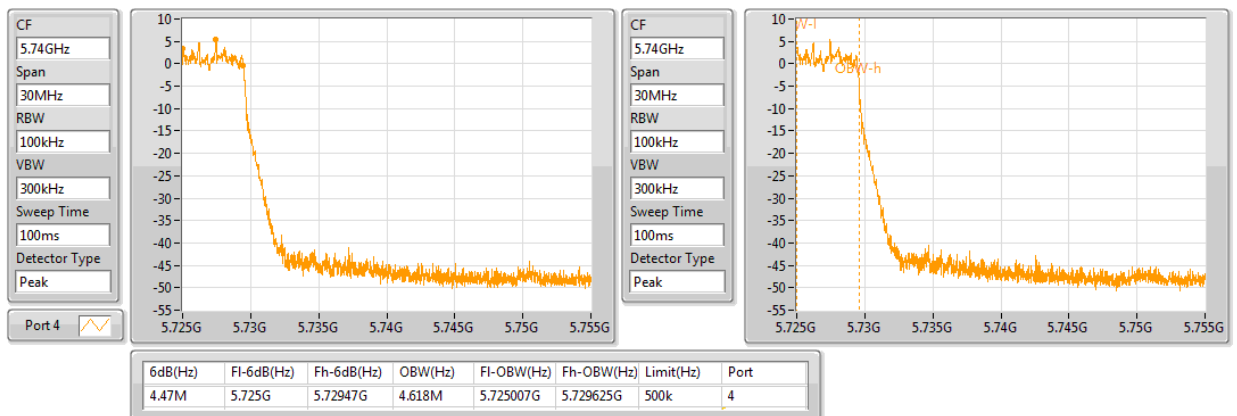



Configuration IEEE 802.11ax 40MHz

Emission Bandwidth (MHz)										
Mode	Number of Transmit Chains (NTX)	Frequency	EBW2c for 26dB Emission Bandwidth (MHz), EBW3 for 6dB Emission Bandwidth (MHz)							
			Ant. 3		Ant. 4		Ant. 5		Ant. 6	
			EBW2c	EBW3	EBW2c	EBW3	EBW2c	EBW3	EBW2c	EBW3
802.11ax 40MHz (CDD)	1 stream 4TX	5710 MHz	35.100	3.900	35.025	3.855	34.913	3.855	34.988	3.735
802.11ax 40MHz (TXBF)	1 stream 4TX	5710 MHz	35.138	3.885	35.063	3.840	34.950	3.855	34.988	3.765
802.11ax 40MHz (TXBF)	2 stream 4TX	5710 MHz	35.063	3.735	35.138	3.705	35.063	3.780	35.213	3.720
802.11ax 40MHz (TXBF)	3 stream 4TX	5710 MHz	35.063	3.795	35.250	3.795	34.988	3.750	35.063	3.630

99% Occupied Bandwidth (MHz)										
Mode	Number of Transmit Chains (NTX)	Frequency	99% Occupied Bandwidth (MHz)							
			Ant. 3		Ant. 4		Ant. 5		Ant. 6	
			OBW2c	OBW3	OBW2c	OBW3	OBW2c	OBW3	OBW2c	OBW3
802.11ax 40MHz (CDD)	1 stream 4TX	5710 MHz	33.733	4.048	33.658	4.078	33.658	4.063	33.658	4.063
802.11ax 40MHz (TXBF)	1 stream 4TX	5710 MHz	33.696	4.048	33.658	4.078	33.658	4.048	33.658	4.063
802.11ax 40MHz (TXBF)	2 stream 4TX	5710 MHz	33.696	4.048	33.696	4.048	33.696	4.033	33.696	4.063
802.11ax 40MHz (TXBF)	3 stream 4TX	5710 MHz	33.696	4.078	33.621	4.048	33.658	4.048	33.621	4.033



26dB Bandwidth and 99% Occupied Bandwidth Plot on Configuration IEEE 802.11ax 40MHz / Nss 1 MCS 0 / 1S4T CDD / Ant. 3 / CH142 / 5710 MHz (EBW2c & OBW2c)

802.11ax HEW40_Nss1,(MCS0)_4TX

EBW

5710MHz Straddle 5.47-5.725GHz

11/07/2020

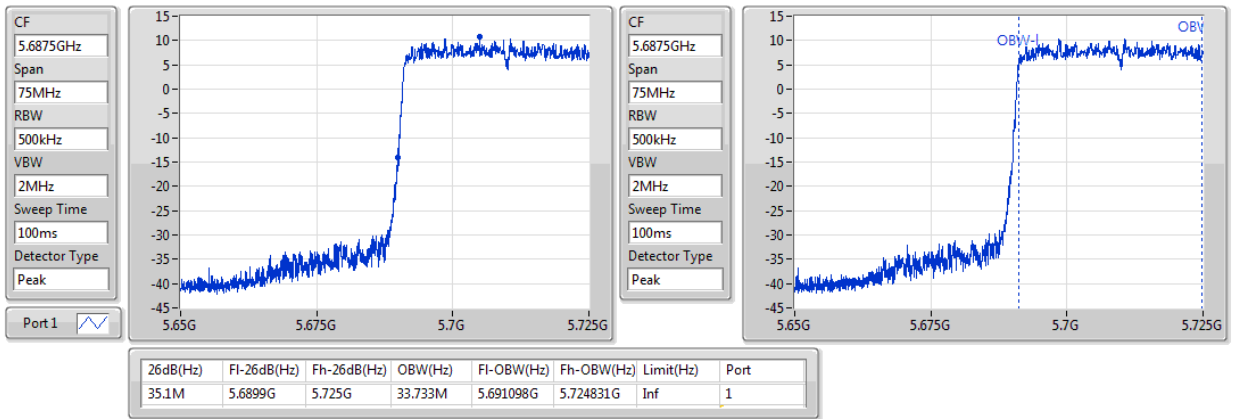

26dB Bandwidth and 99% Occupied Bandwidth Plot on Configuration IEEE 802.11ax 40MHz / Nss 1 MCS 0 / 1S4T CDD / Ant. 4 / CH142 / 5710 MHz (EBW2c & OBW2c)

802.11ax HEW40_Nss1,(MCS0)_4TX

EBW

5710MHz Straddle 5.47-5.725GHz

11/07/2020

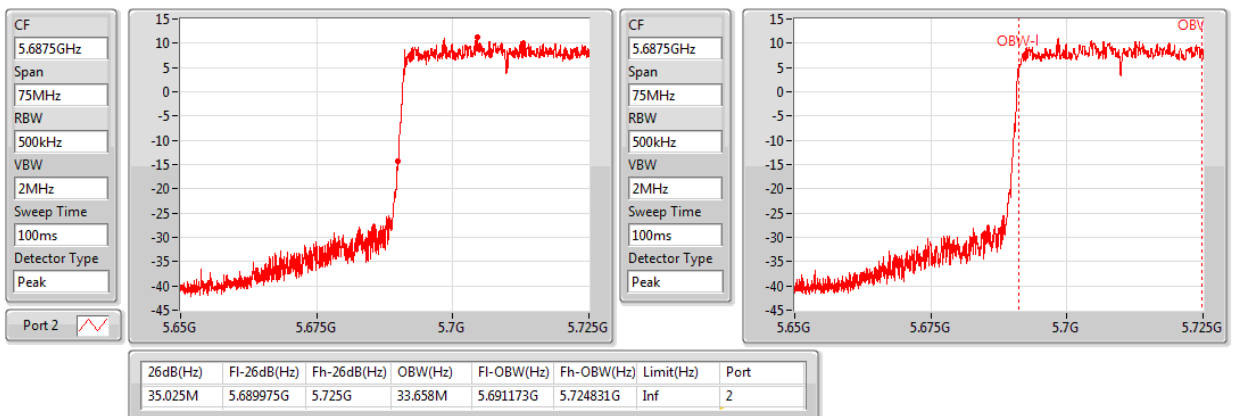



26dB Bandwidth and 99% Occupied Bandwidth Plot on Configuration IEEE 802.11ax 40MHz / Nss 1 MCS 0 / 1S4T CDD / Ant. 5 / CH142 / 5710 MHz (EBW2c & OBW2c)

802.11ax HEW40_Nss1,(MCS0)_4TX

EBW

5710MHz Straddle 5.47-5.725GHz

11/07/2020

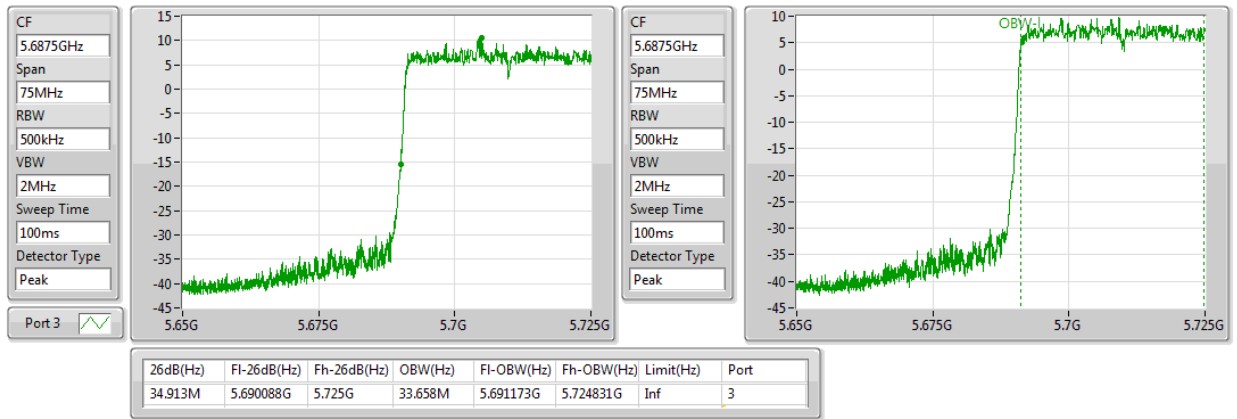

26dB Bandwidth and 99% Occupied Bandwidth Plot on Configuration IEEE 802.11ax 40MHz / Nss 1 MCS 0 / 1S4T CDD / Ant. 6 / CH142 / 5710 MHz (EBW2c & OBW2c)

802.11ax HEW40_Nss1,(MCS0)_4TX

EBW

5710MHz Straddle 5.47-5.725GHz

11/07/2020

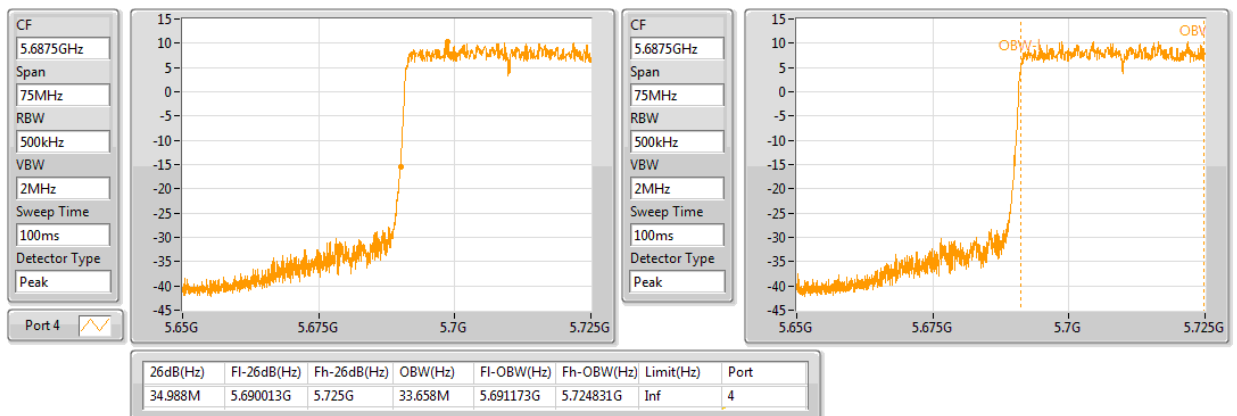



6dB Bandwidth and 99% Occupied Bandwidth Plot on Configuration IEEE 802.11ax 40MHz / Nss 1 MCS 0 / 1S4T CDD / Ant. 3 / CH142 / 5710 MHz (EBW3 & OBW3)

802.11ax HEW40_Nss1,(MCS0)_4TX

EBW

5710MHz Straddle 5.725-5.85GHz

11/07/2020

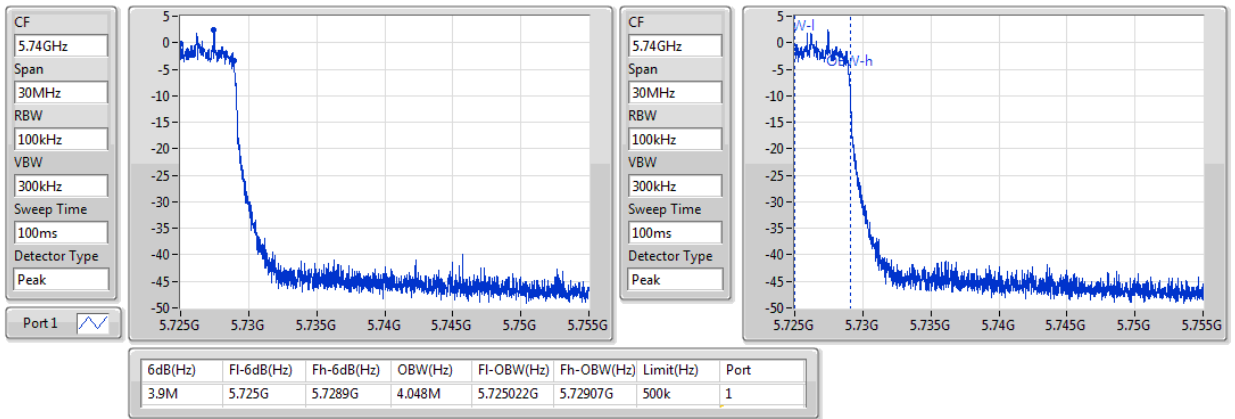

6dB Bandwidth and 99% Occupied Bandwidth Plot on Configuration IEEE 802.11ax 40MHz / Nss 1 MCS 0 / 1S4T CDD / Ant. 4 / CH142 / 5710 MHz (EBW3 & OBW3)

802.11ax HEW40_Nss1,(MCS0)_4TX

EBW

5710MHz Straddle 5.725-5.85GHz

11/07/2020

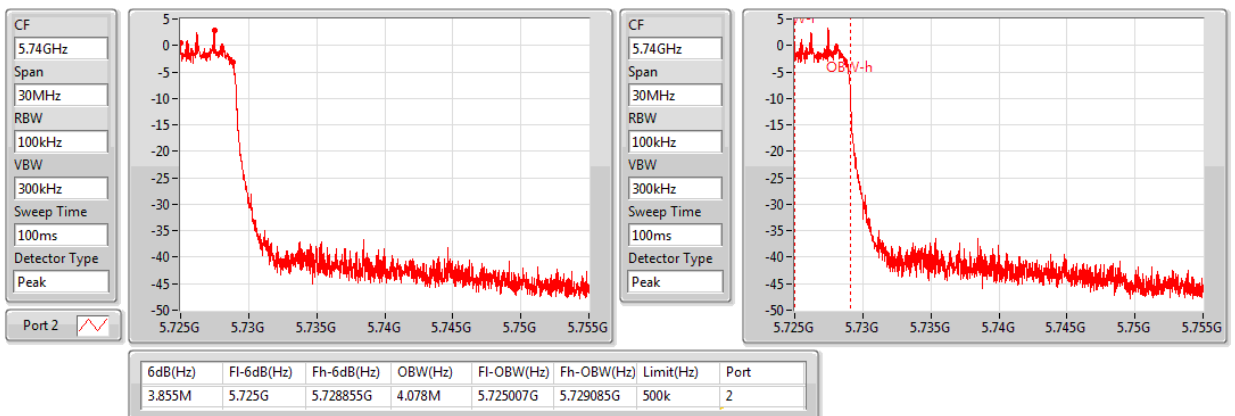



6dB Bandwidth and 99% Occupied Bandwidth Plot on Configuration IEEE 802.11ax 40MHz / Nss 1 MCS 0 / 1S4T CDD / Ant. 5 / CH142 / 5710 MHz (EBW3 & OBW3)

802.11ax HEW40_Nss1,(MCS0)_4TX

EBW

5710MHz Straddle 5.725-5.85GHz

11/07/2020

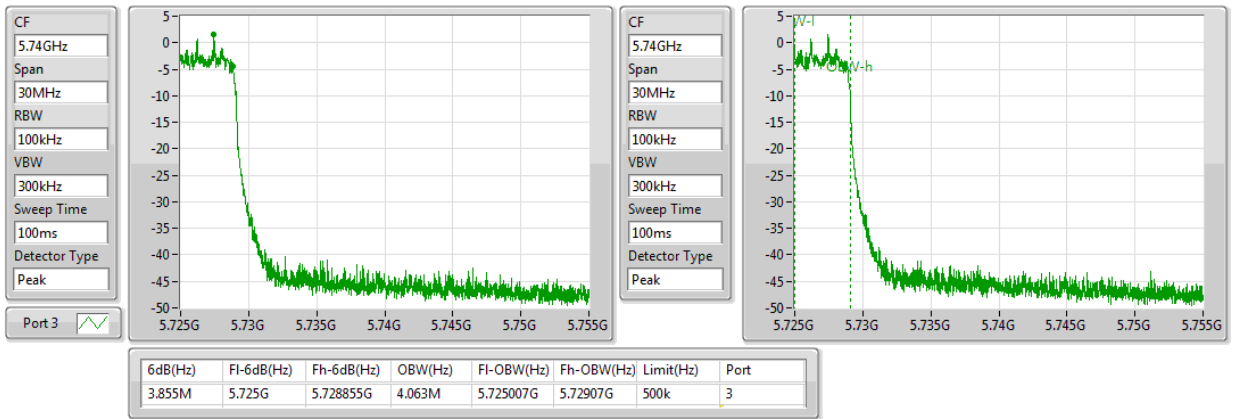

6dB Bandwidth and 99% Occupied Bandwidth Plot on Configuration IEEE 802.11ax 40MHz / Nss 1 MCS 0 / 1S4T CDD / Ant. 6 / CH142 / 5710 MHz (EBW3 & OBW3)

802.11ax HEW40_Nss1,(MCS0)_4TX

EBW

5710MHz Straddle 5.725-5.85GHz

11/07/2020

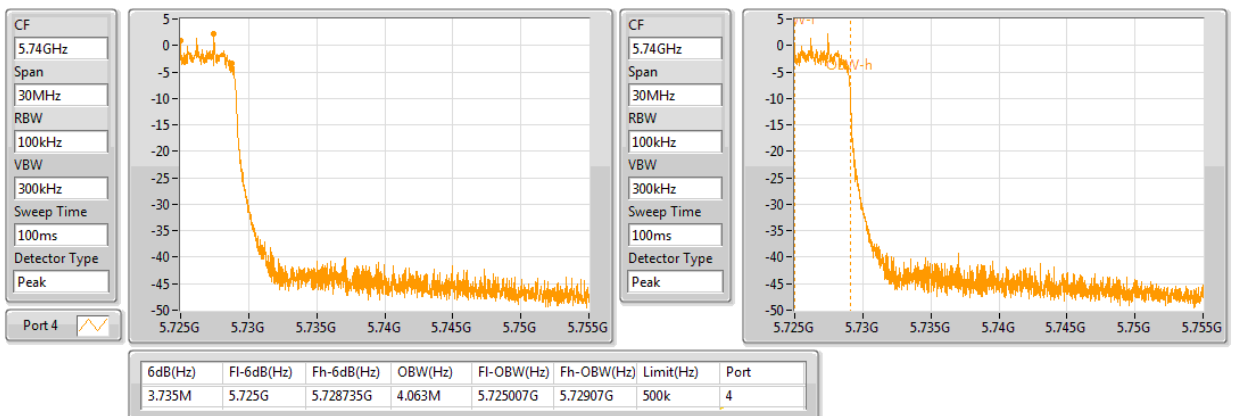



26dB Bandwidth and 99% Occupied Bandwidth Plot on Configuration IEEE 802.11ax 40MHz / Nss 1 MCS 0 / 1S4T TXBF / Ant. 3 / CH142 / 5710 MHz (EBW2c & OBW2c)

802.11ax HEW40-BF_Nss1,(MCS0)_4TX

EBW

5710MHz Straddle 5.47-5.725GHz

11/07/2020

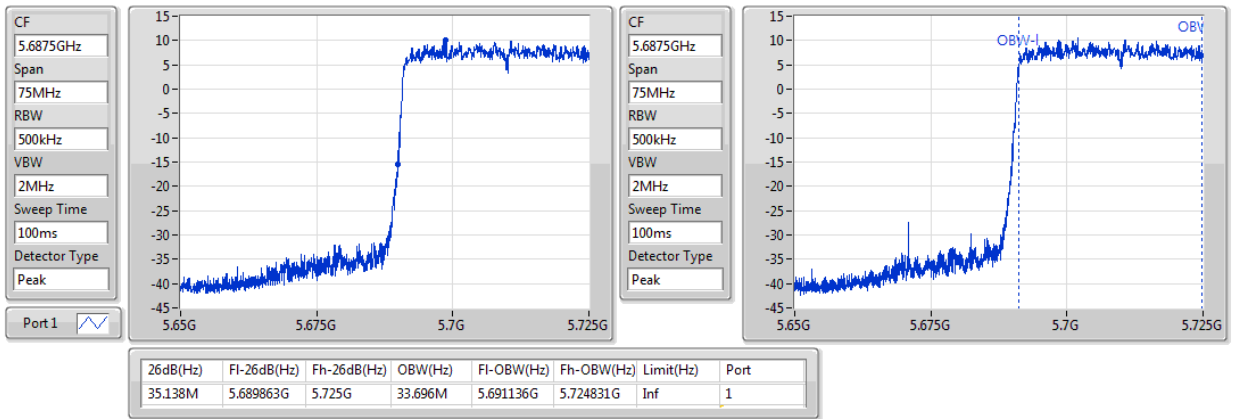

26dB Bandwidth and 99% Occupied Bandwidth Plot on Configuration IEEE 802.11ax 40MHz / Nss 1 MCS 0 / 1S4T TXBF / Ant. 4 / CH142 / 5710 MHz (EBW2c & OBW2c)

802.11ax HEW40-BF_Nss1,(MCS0)_4TX

EBW

5710MHz Straddle 5.47-5.725GHz

11/07/2020

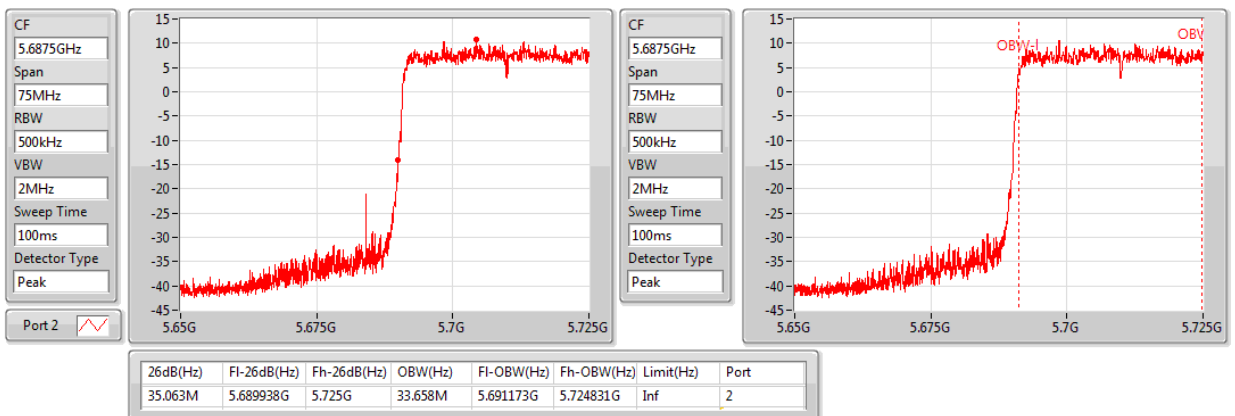



26dB Bandwidth and 99% Occupied Bandwidth Plot on Configuration IEEE 802.11ax 40MHz / Nss 1 MCS 0 / 1S4T TXBF / Ant. 5 / CH142 / 5710 MHz (EBW2c & OBW2c)

802.11ax HEW40-BF_Nss1,(MCS0)_4TX

EBW

5710MHz Straddle 5.47-5.725GHz

11/07/2020

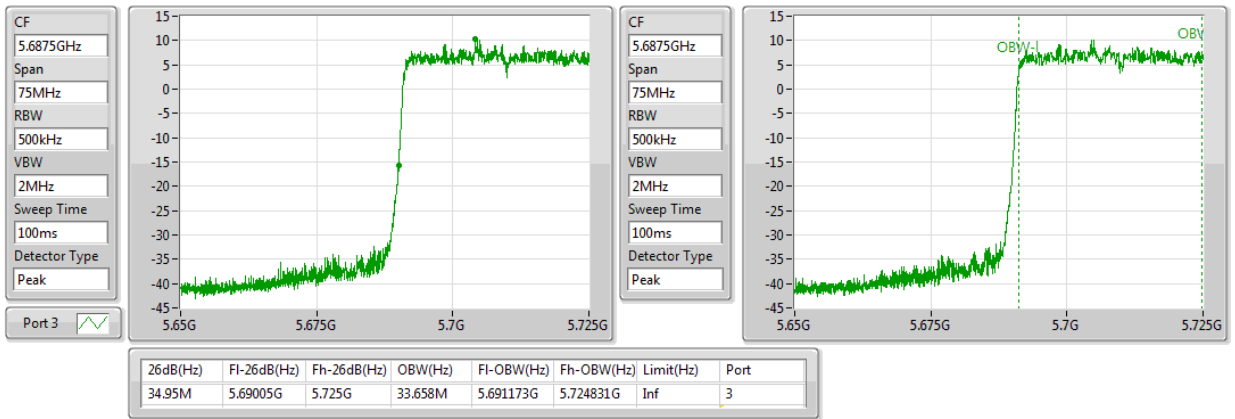

26dB Bandwidth and 99% Occupied Bandwidth Plot on Configuration IEEE 802.11ax 40MHz / Nss 1 MCS 0 / 1S4T TXBF / Ant. 6 / CH142 / 5710 MHz (EBW2c & OBW2c)

802.11ax HEW40-BF_Nss1,(MCS0)_4TX

EBW

5710MHz Straddle 5.47-5.725GHz

11/07/2020

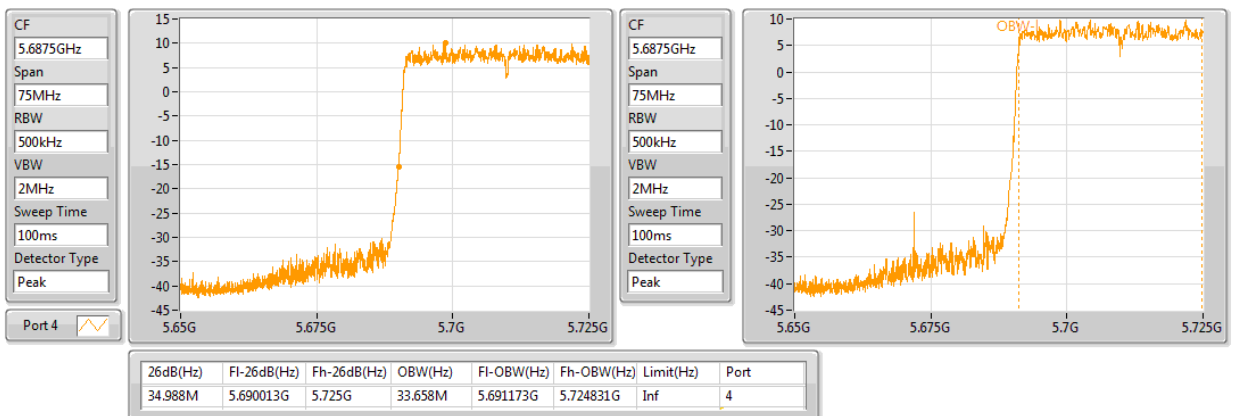



**6dB Bandwidth and 99% Occupied Bandwidth Plot on Configuration IEEE 802.11ax 40MHz / Nss 1
MCS 0 / 1S4T TXBF / Ant. 3 / CH142 / 5710 MHz (EBW3 & OBW3)**

802.11ax HEW40-BF_Nss1,(MCS0)_4TX

EBW

5710MHz Straddle 5.725-5.85GHz

11/07/2020

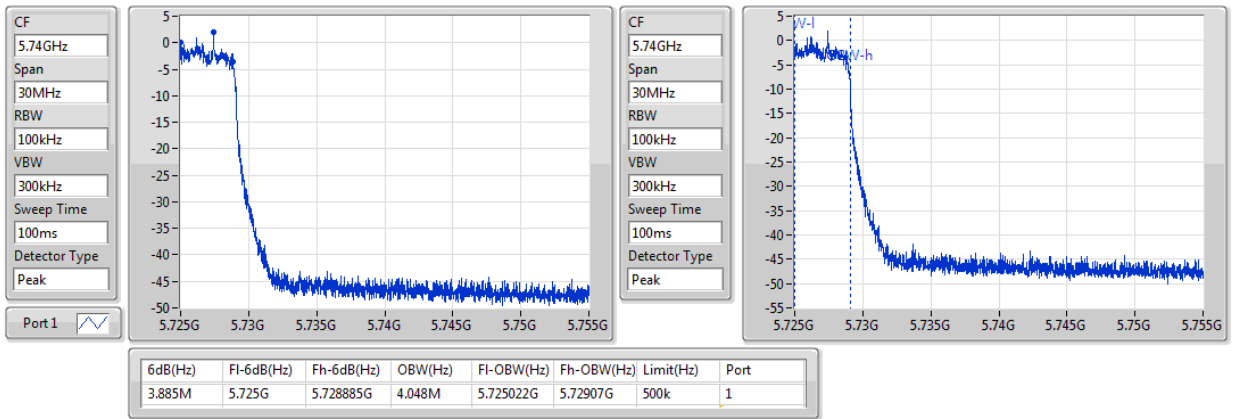

**6dB Bandwidth and 99% Occupied Bandwidth Plot on Configuration IEEE 802.11ax 40MHz / Nss 1
MCS 0 / 1S4T TXBF / Ant. 4 / CH142 / 5710 MHz (EBW3 & OBW3)**

802.11ax HEW40-BF_Nss1,(MCS0)_4TX

EBW

5710MHz Straddle 5.725-5.85GHz

11/07/2020

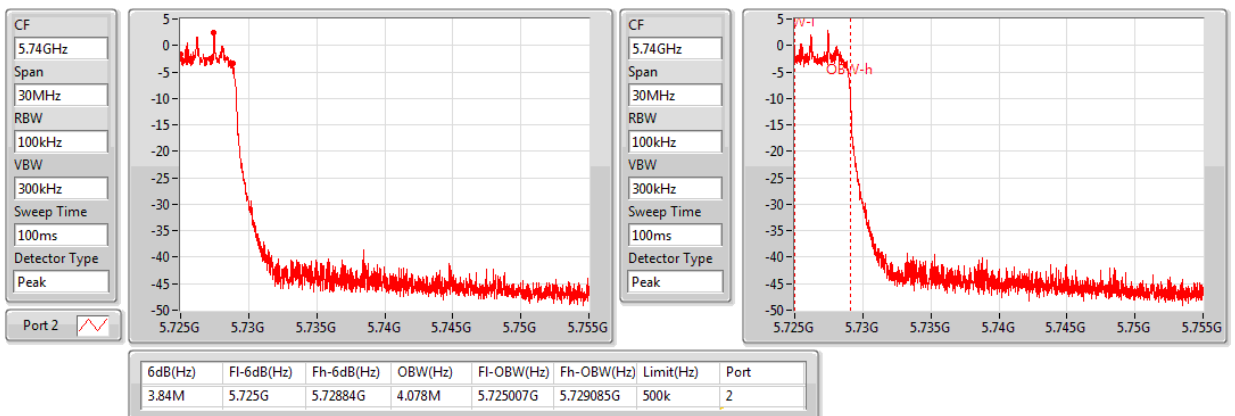



6dB Bandwidth and 99% Occupied Bandwidth Plot on Configuration IEEE 802.11ax 40MHz / Nss 1 MCS 0 / 1S4T TXBF / Ant. 5 / CH142 / 5710 MHz (EBW3 & OBW3)

802.11ax HEW40-BF_Nss1,(MCS0)_4TX

EBW

5710MHz Straddle 5.725-5.85GHz

11/07/2020

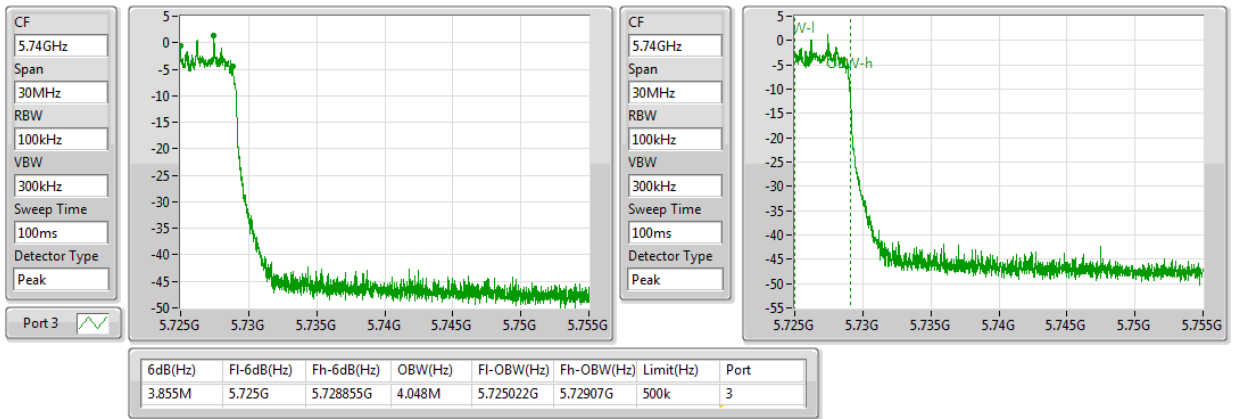

6dB Bandwidth and 99% Occupied Bandwidth Plot on Configuration IEEE 802.11ax 40MHz / Nss 1 MCS 0 / 1S4T TXBF / Ant. 6 / CH142 / 5710 MHz (EBW3 & OBW3)

802.11ax HEW40-BF_Nss1,(MCS0)_4TX

EBW

5710MHz Straddle 5.725-5.85GHz

11/07/2020

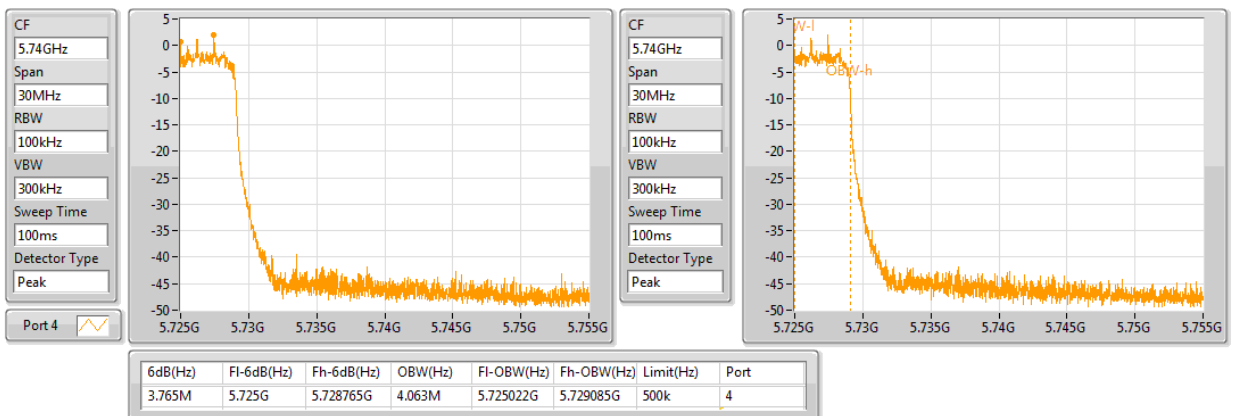



26dB Bandwidth and 99% Occupied Bandwidth Plot on Configuration IEEE 802.11ax 40MHz / Nss 2 MCS 0 / 2S4T TXBF / Ant. 3 / CH142 / 5710 MHz (EBW2c & OBW2c)

802.11ax HEW40-BF_Nss2,(MCS0)_4TX

EBW

5710MHz Straddle 5.47-5.725GHz

11/07/2020

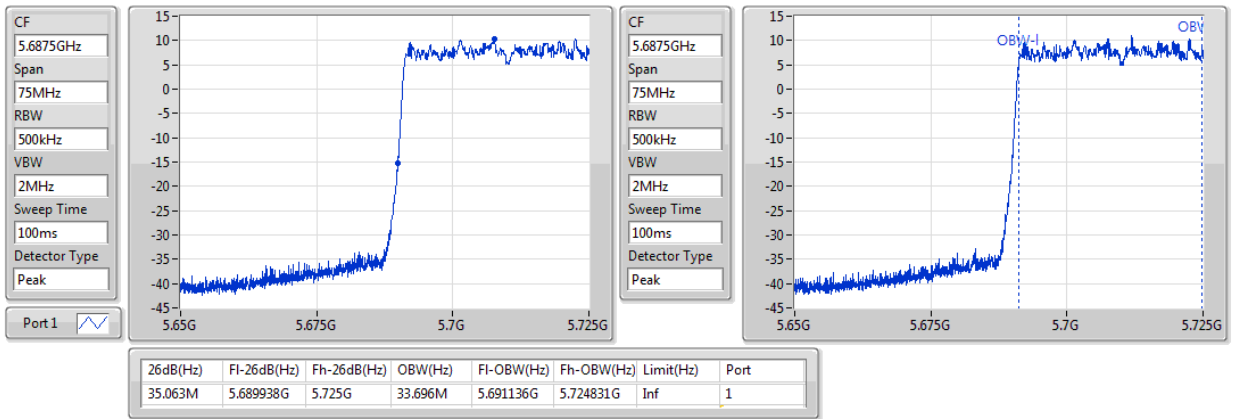

26dB Bandwidth and 99% Occupied Bandwidth Plot on Configuration IEEE 802.11ax 40MHz / Nss 2 MCS 0 / 2S4T TXBF / Ant. 4 / CH142 / 5710 MHz (EBW2c & OBW2c)

802.11ax HEW40-BF_Nss2,(MCS0)_4TX

EBW

5710MHz Straddle 5.47-5.725GHz

11/07/2020

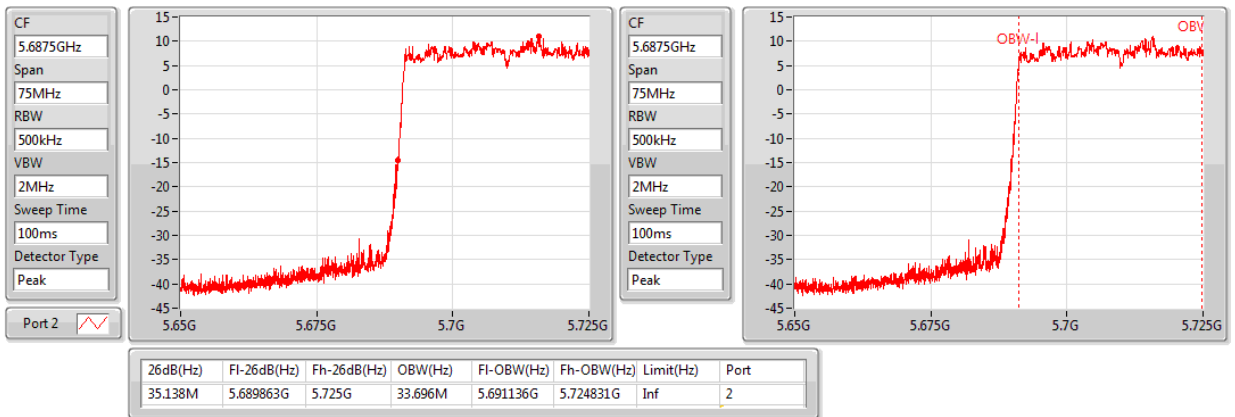



26dB Bandwidth and 99% Occupied Bandwidth Plot on Configuration IEEE 802.11ax 40MHz / Nss 2 MCS 0 / 2S4T TXBF / Ant. 5 / CH142 / 5710 MHz (EBW2c & OBW2c)

802.11ax HEW40-BF_Nss2,(MCS0)_4TX

EBW

5710MHz Straddle 5.47-5.725GHz

11/07/2020

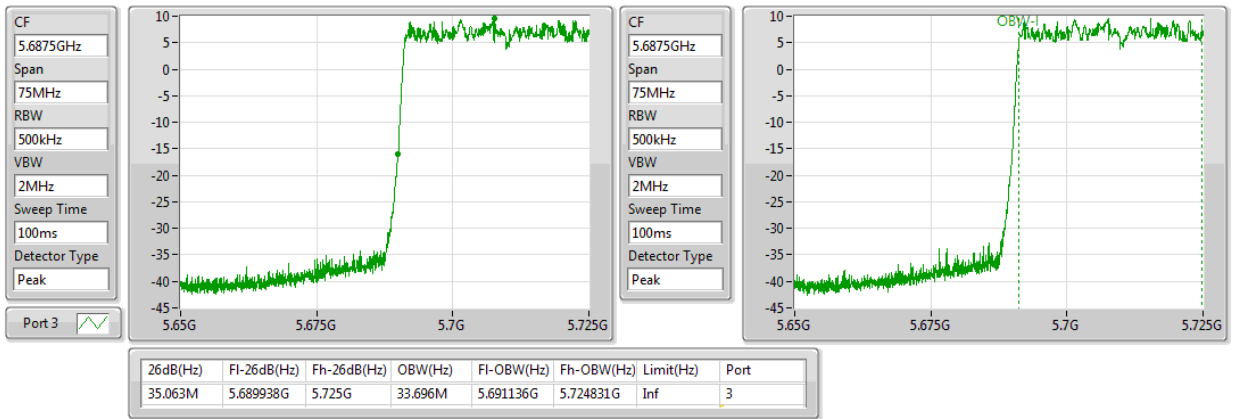

26dB Bandwidth and 99% Occupied Bandwidth Plot on Configuration IEEE 802.11ax 40MHz / Nss 2 MCS 0 / 2S4T TXBF / Ant. 6 / CH142 / 5710 MHz (EBW2c & OBW2c)

802.11ax HEW40-BF_Nss2,(MCS0)_4TX

EBW

5710MHz Straddle 5.47-5.725GHz

11/07/2020

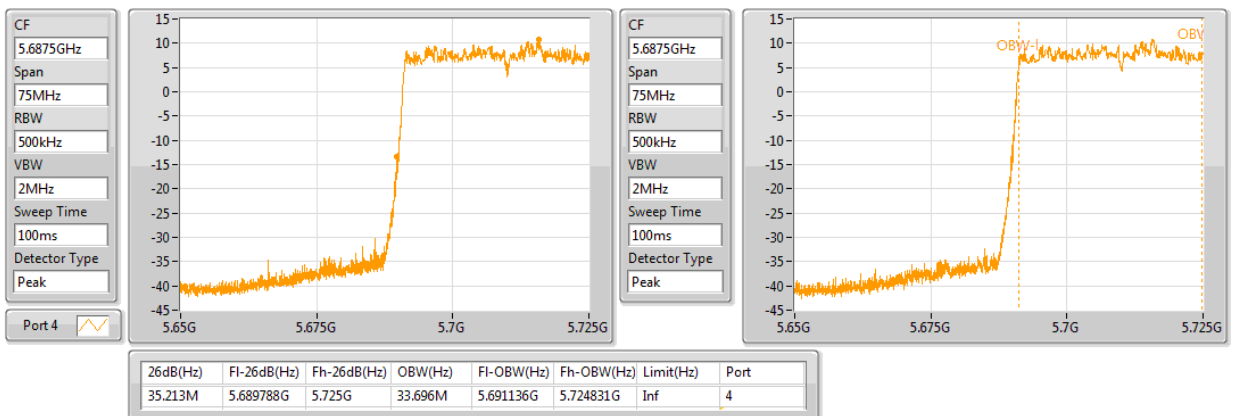



6dB Bandwidth and 99% Occupied Bandwidth Plot on Configuration IEEE 802.11ax 40MHz / Nss 2 MCS 0 / 2S4T TXBF / Ant. 3 / CH142 / 5710 MHz (EBW3 & OBW3)

802.11ax HEW40-BF_Nss2,(MCS0)_4TX

EBW

5710MHz Straddle 5.725-5.85GHz

11/07/2020

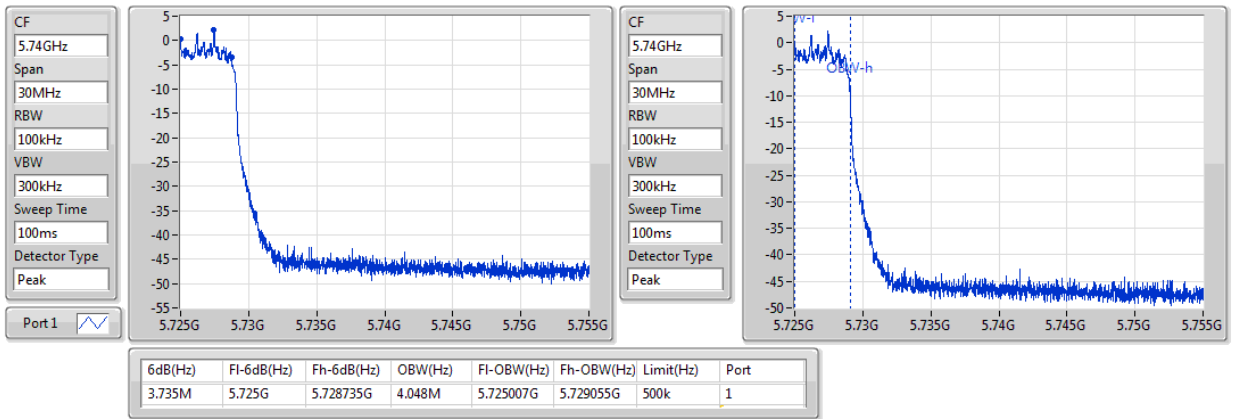

6dB Bandwidth and 99% Occupied Bandwidth Plot on Configuration IEEE 802.11ax 40MHz / Nss 2 MCS 0 / 2S4T TXBF / Ant. 4 / CH142 / 5710 MHz (EBW3 & OBW3)

802.11ax HEW40-BF_Nss2,(MCS0)_4TX

EBW

5710MHz Straddle 5.725-5.85GHz

11/07/2020

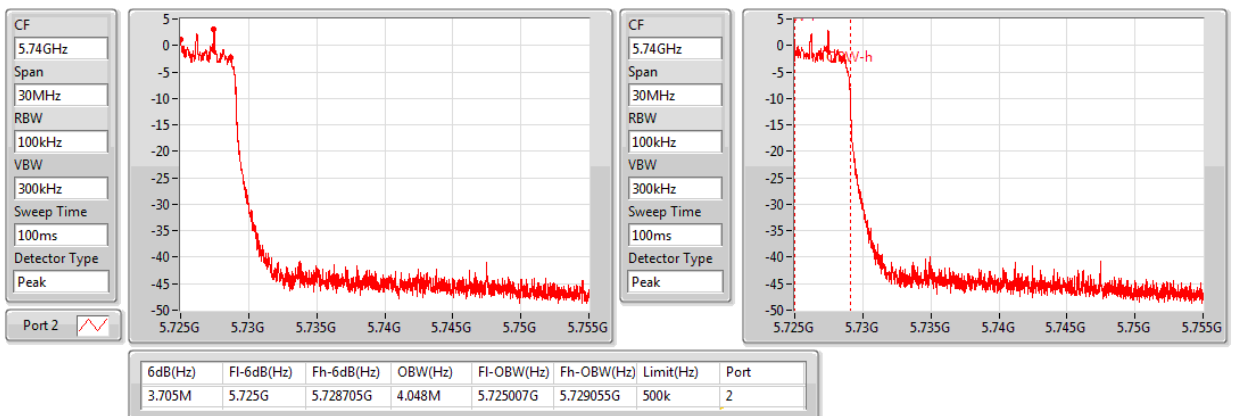



6dB Bandwidth and 99% Occupied Bandwidth Plot on Configuration IEEE 802.11ax 40MHz / Nss 2 MCS 0 / 2S4T TXBF / Ant. 5 / CH142 / 5710 MHz (EBW3 & OBW3)

802.11ax HEW40-BF_Nss2,(MCS0)_4TX

EBW

5710MHz Straddle 5.725-5.85GHz

11/07/2020

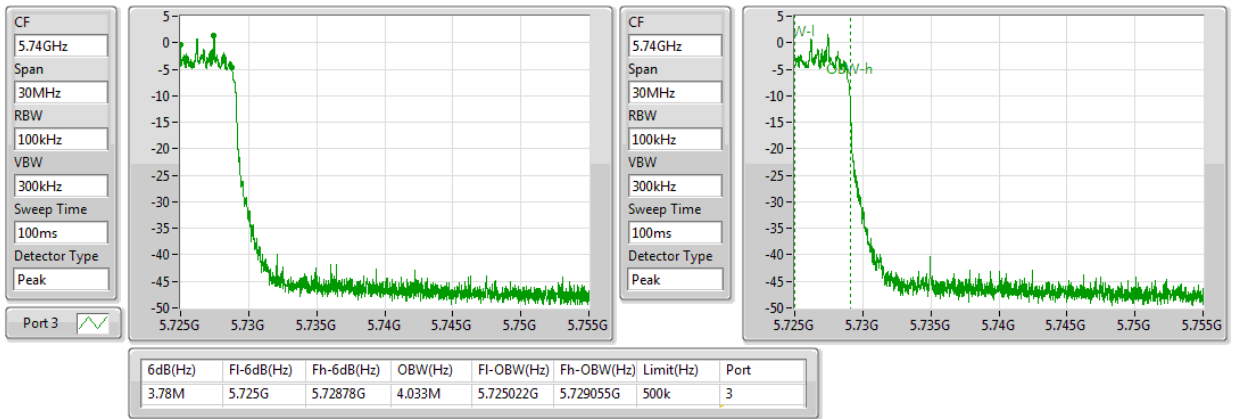

6dB Bandwidth and 99% Occupied Bandwidth Plot on Configuration IEEE 802.11ax 40MHz / Nss 2 MCS 0 / 2S4T TXBF / Ant. 6 / CH142 / 5710 MHz (EBW3 & OBW3)

802.11ax HEW40-BF_Nss2,(MCS0)_4TX

EBW

5710MHz Straddle 5.725-5.85GHz

11/07/2020

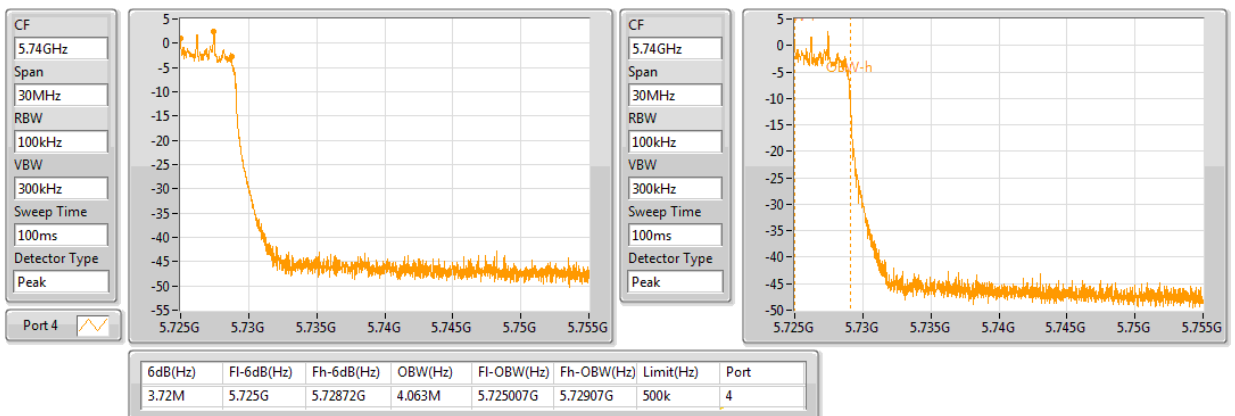



26dB Bandwidth and 99% Occupied Bandwidth Plot on Configuration IEEE 802.11ax 40MHz / Nss 3 MCS 0 / 3S4T TXBF / Ant. 3 / CH142 / 5710 MHz (EBW2c & OBW2c)

802.11ax HEW40-BF_Nss3,(MCS0)_4TX

EBW

5710MHz Straddle 5.47-5.725GHz

11/07/2020

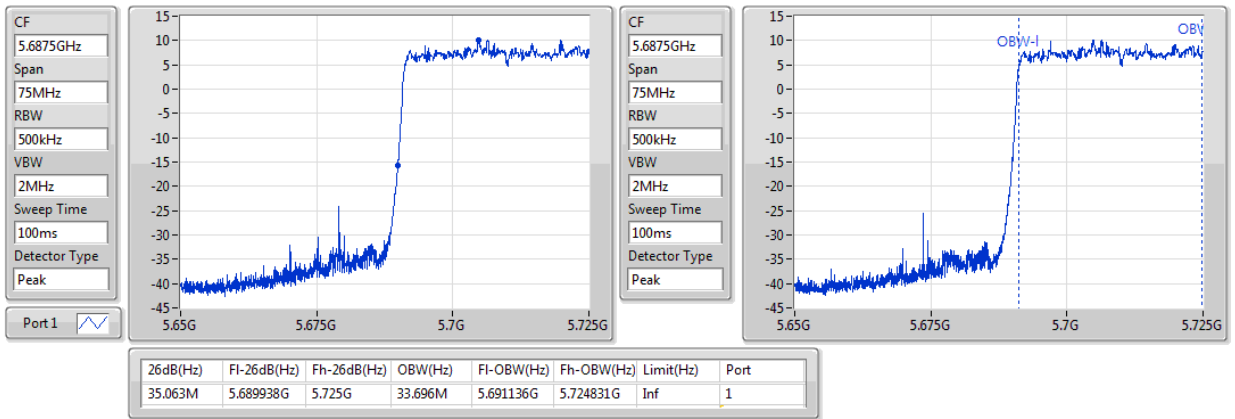

26dB Bandwidth and 99% Occupied Bandwidth Plot on Configuration IEEE 802.11ax 40MHz / N Nss 3 MCS 0 / 3S4T TXBF / Ant. 4 / CH142 / 5710 MHz (EBW2c & OBW2c)

802.11ax HEW40-BF_Nss3,(MCS0)_4TX

EBW

5710MHz Straddle 5.47-5.725GHz

11/07/2020

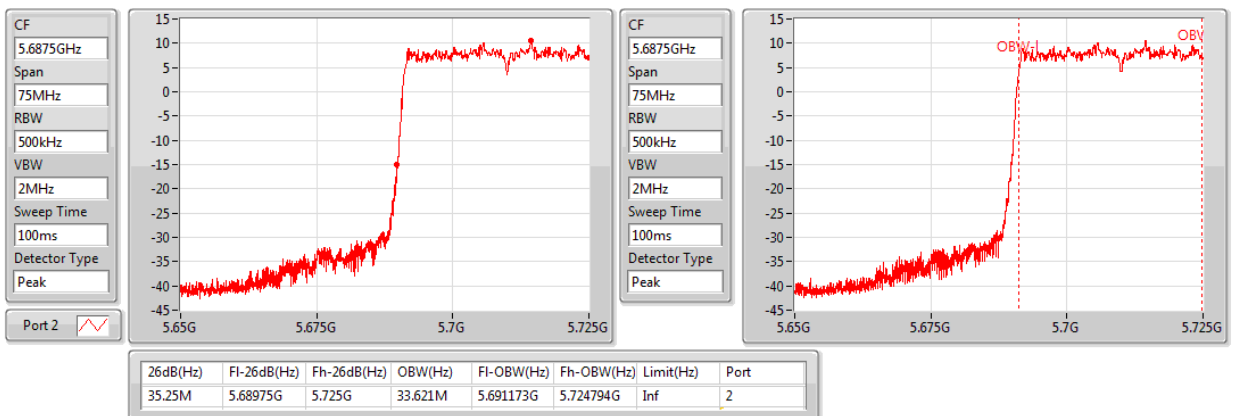



26dB Bandwidth and 99% Occupied Bandwidth Plot on Configuration IEEE 802.11ax 40MHz / Nss 3 MCS 0 / 3S4T TXBF / Ant. 5 / CH142 / 5710 MHz (EBW2c & OBW2c)

802.11ax HEW40-BF_Nss3,(MCS0)_4TX

EBW

5710MHz Straddle 5.47-5.725GHz

11/07/2020

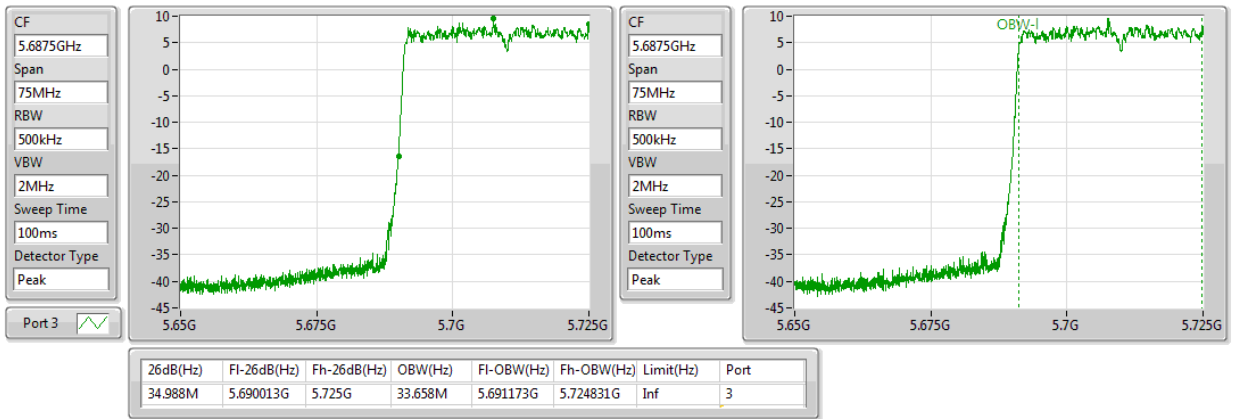

26dB Bandwidth and 99% Occupied Bandwidth Plot on Configuration IEEE 802.11ax 40MHz / Nss 3 MCS 0 / 3S4T TXBF / Ant. 6 / CH142 / 5710 MHz (EBW2c & OBW2c)

802.11ax HEW40-BF_Nss3,(MCS0)_4TX

EBW

5710MHz Straddle 5.47-5.725GHz

11/07/2020

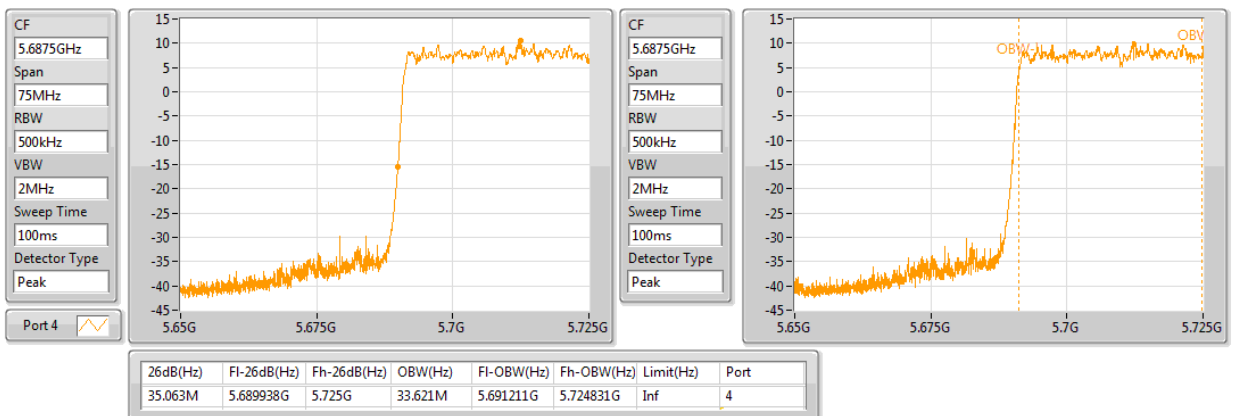



6dB Bandwidth and 99% Occupied Bandwidth Plot on Configuration IEEE 802.11ax 40MHz / Nss 3 MCS 0 / 3S4T TXBF / Ant. 3 / CH142 / 5710 MHz (EBW3 & OBW3)

802.11ax HEW40-BF_Nss3,(MCS0)_4TX

EBW

5710MHz Straddle 5.725-5.85GHz

11/07/2020

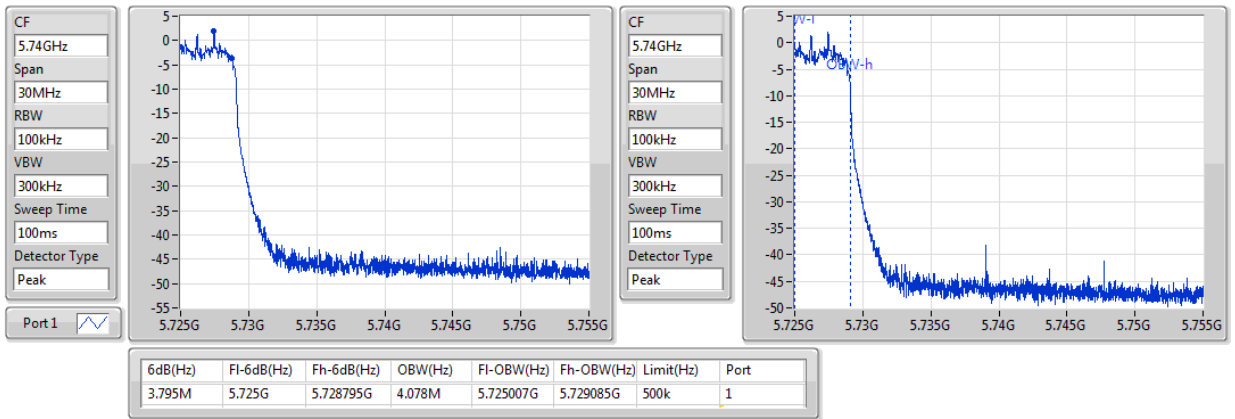

6dB Bandwidth and 99% Occupied Bandwidth Plot on Configuration IEEE 802.11ax 40MHz / Nss 3 MCS 0 / 3S4T TXBF / Ant. 4 / CH142 / 5710 MHz (EBW3 & OBW3)

802.11ax HEW40-BF_Nss3,(MCS0)_4TX

EBW

5710MHz Straddle 5.725-5.85GHz

11/07/2020

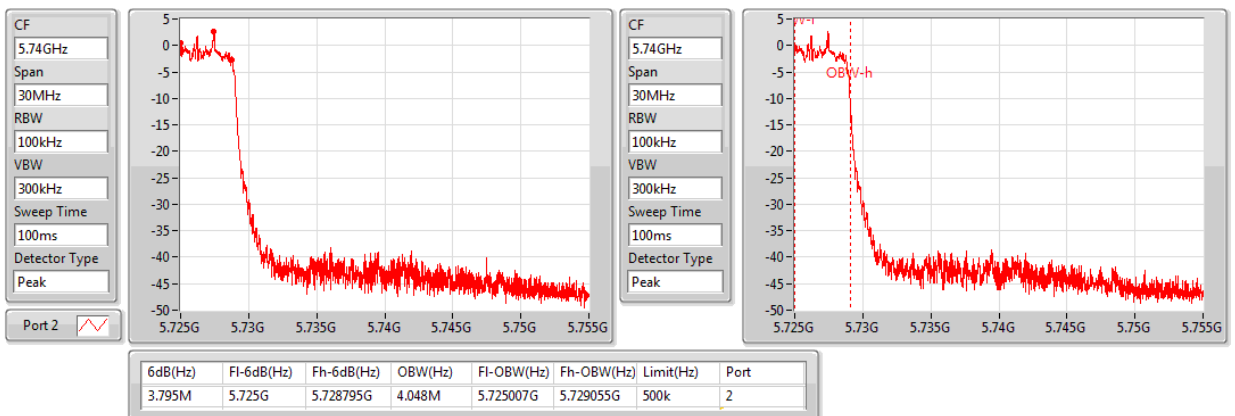



6dB Bandwidth and 99% Occupied Bandwidth Plot on Configuration IEEE 802.11ax 40MHz / Nss 3 MCS 0 / 3S4T TXBF / Ant. 5 / CH142 / 5710 MHz (EBW3 & OBW3)

802.11ax HEW40-BF_Nss3,(MCS0)_4TX

EBW

5710MHz Straddle 5.725-5.85GHz

11/07/2020

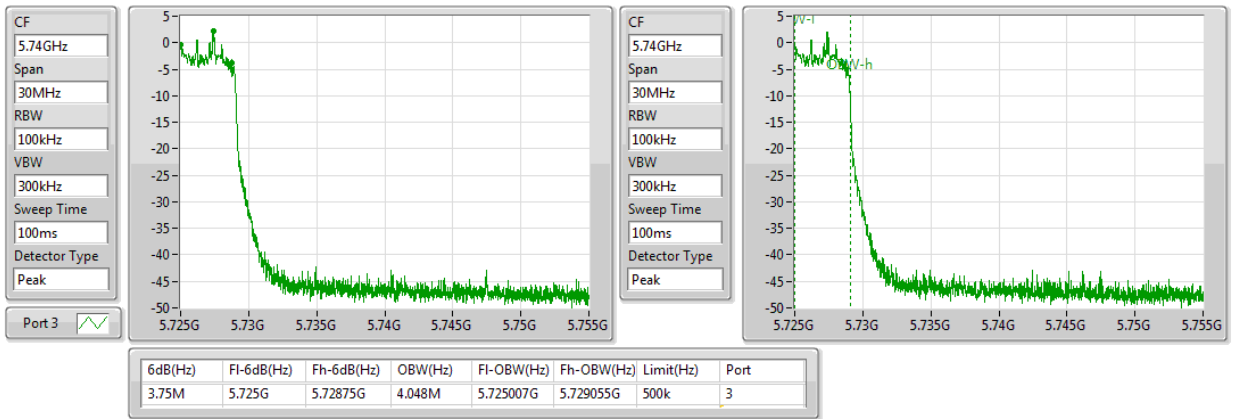

6dB Bandwidth and 99% Occupied Bandwidth Plot on Configuration IEEE 802.11ax 40MHz / Nss 3 MCS 0 / 3S4T TXBF / Ant. 6 / CH142 / 5710 MHz (EBW3 & OBW3)

802.11ax HEW40-BF_Nss3,(MCS0)_4TX

EBW

5710MHz Straddle 5.725-5.85GHz

11/07/2020

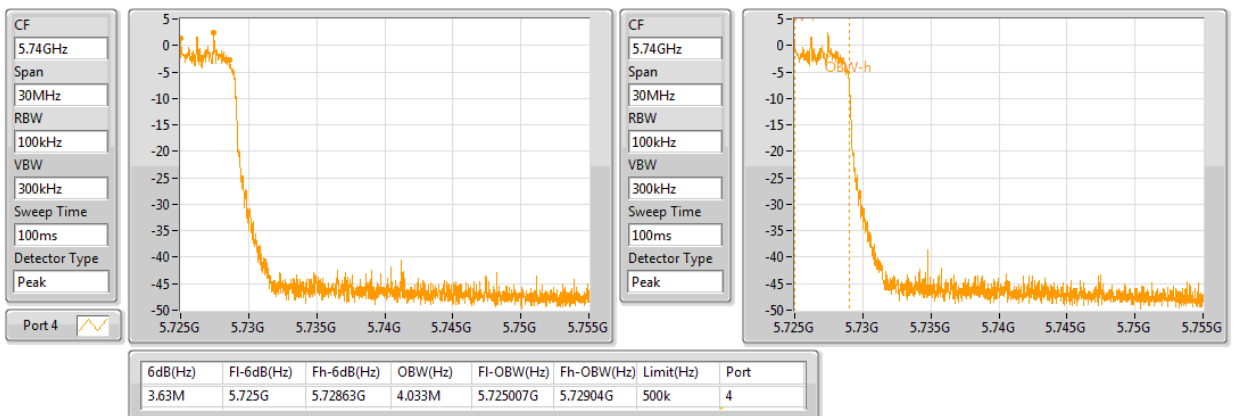



Configuration IEEE 802.11ax 80MHz

Emission Bandwidth (MHz)										
Mode	Number of Transmit Chains (NTX)	Frequency	EBW2c for 26dB Emission Bandwidth (MHz), EBW3 for 6dB Emission Bandwidth (MHz)							
			Ant. 3		Ant. 4		Ant. 5		Ant. 6	
			EBW2c	EBW3	EBW2c	EBW3	EBW2c	EBW3	EBW2c	EBW3
802.11ax 80MHz (CDD)	1 stream 4TX	5690 MHz	75.950	3.810	75.795	3.825	75.873	3.795	75.795	3.825
802.11ax 80MHz (TXBF)	1 stream 4TX	5690 MHz	75.873	3.795	75.718	3.840	75.873	3.705	75.873	3.840
802.11ax 80MHz (TXBF)	2 stream 4TX	5690 MHz	75.640	3.555	75.640	3.780	75.873	3.975	75.950	3.765
802.11ax 80MHz (TXBF)	3 stream 4TX	5690 MHz	75.718	3.750	75.718	3.705	75.718	3.510	75.640	3.825

99% Occupied Bandwidth (MHz)										
Mode	Number of Transmit Chains (NTX)	Frequency	99% Occupied Bandwidth (MHz)							
			Ant. 3		Ant. 4		Ant. 5		Ant. 6	
			OBW2c	OBW3	OBW2c	OBW3	OBW2c	OBW3	OBW2c	OBW3
802.11ax 80MHz (CDD)	1 stream 4TX	5690 MHz	72.969	4.123	72.969	4.093	72.969	4.093	73.046	4.123
802.11ax 80MHz (TXBF)	1 stream 4TX	5690 MHz	72.969	4.123	72.969	4.093	72.891	4.123	72.969	4.123
802.11ax 80MHz (TXBF)	2 stream 4TX	5690 MHz	73.123	4.108	73.278	4.093	72.969	4.108	73.278	4.093
802.11ax 80MHz (TXBF)	3 stream 4TX	5690 MHz	73.046	4.108	72.969	4.108	73.046	4.078	73.046	4.093



26dB Bandwidth and 99% Occupied Bandwidth Plot on Configuration IEEE 802.11ax 80MHz / Nss 1 MCS 0 / 1S4T CDD / Ant. 3 / CH138 / 5690 MHz (EBW2c & OBW2c)

802.11ax HEW80_Nss1,(MCS0)_4TX

EBW

5690MHz Straddle 5.47-5.725GHz

11/07/2020

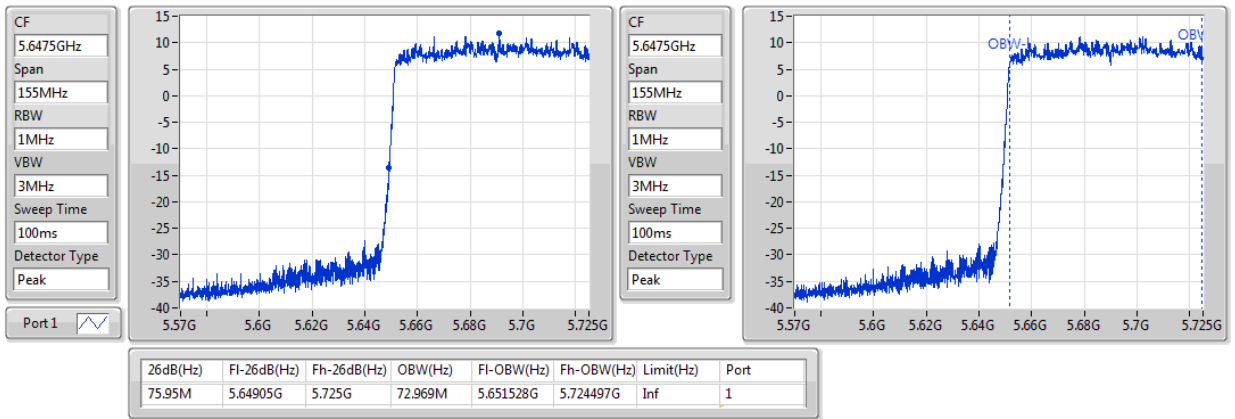

26dB Bandwidth and 99% Occupied Bandwidth Plot on Configuration IEEE 802.11ax 80MHz / Nss 1 MCS 0 / 1S4T CDD / Ant. 4 / CH138 / 5690 MHz (EBW2c & OBW2c)

802.11ax HEW80_Nss1,(MCS0)_4TX

EBW

5690MHz Straddle 5.47-5.725GHz

11/07/2020

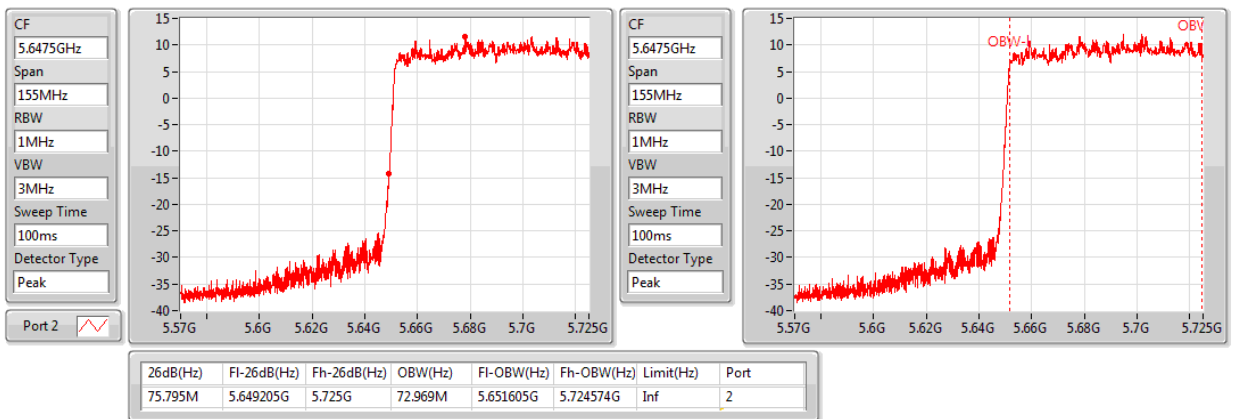



26dB Bandwidth and 99% Occupied Bandwidth Plot on Configuration IEEE 802.11ax 80MHz / Nss 1 MCS 0 / 1S4T CDD / Ant. 5 / CH138 / 5690 MHz (EBW2c & OBW2c)

802.11ax HEW80_Nss1,(MCS0)_4TX

EBW

5690MHz Straddle 5.47-5.725GHz

11/07/2020

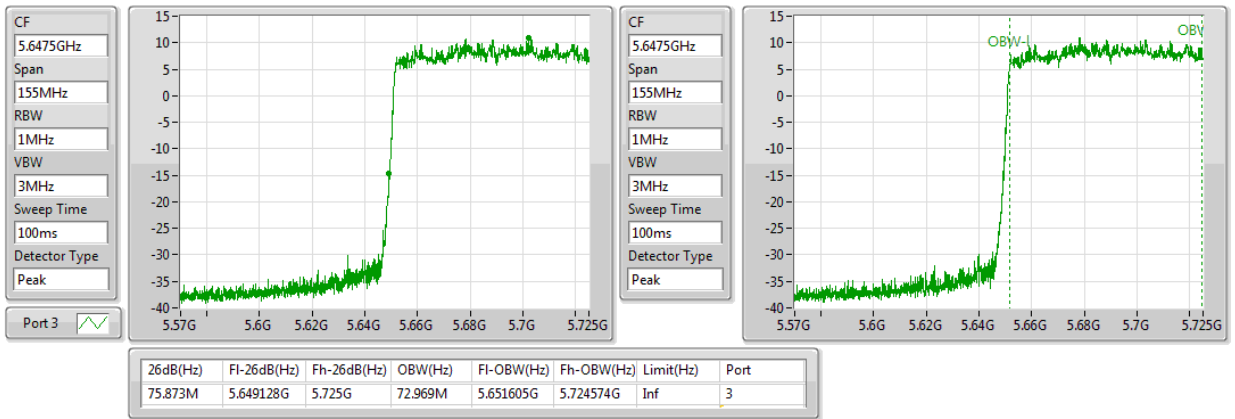

26dB Bandwidth and 99% Occupied Bandwidth Plot on Configuration IEEE 802.11ax 80MHz / Nss 1 MCS 0 / 1S4T CDD / Ant. 6 / CH138 / 5690 MHz (EBW2c & OBW2c)

802.11ax HEW80_Nss1,(MCS0)_4TX

EBW

5690MHz Straddle 5.47-5.725GHz

11/07/2020

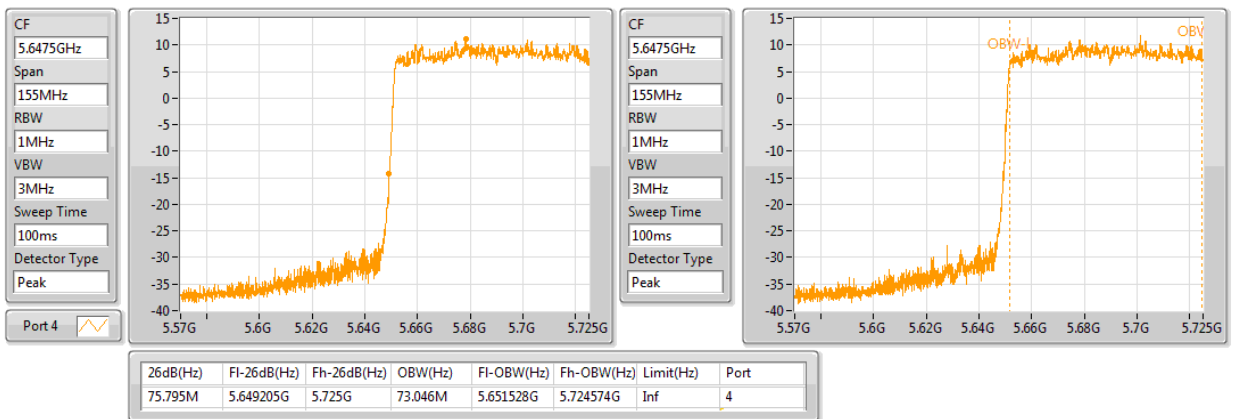



**6dB Bandwidth and 99% Occupied Bandwidth Plot on Configuration IEEE 802.11ax 80MHz / Nss 1
MCS 0 / 1S4T CDD / Ant. 3 / CH138 / 5690 MHz (EBW3 & OBW3)**

802.11ax HEW80_Nss1,(MCS0)_4TX

EBW

5690MHz Straddle 5.725-5.85GHz

11/07/2020

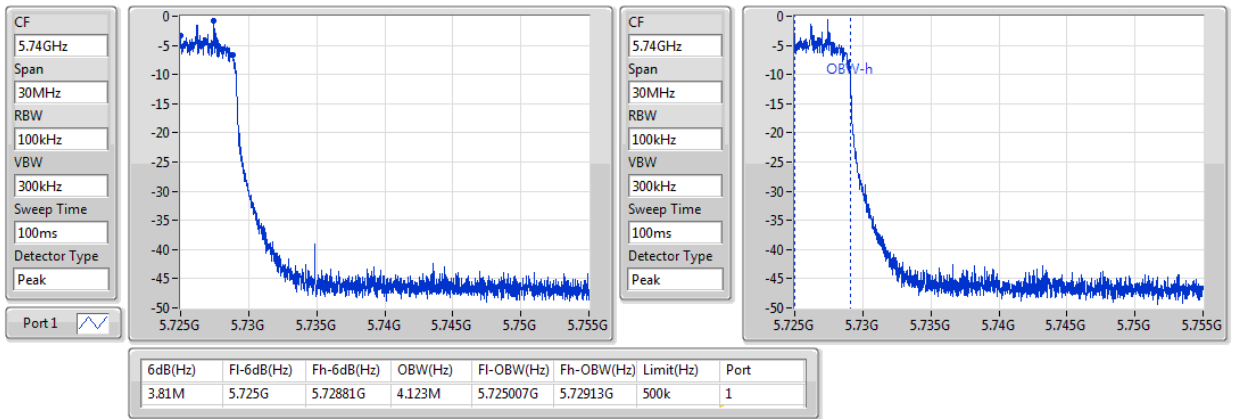

**6dB Bandwidth and 99% Occupied Bandwidth Plot on Configuration IEEE 802.11ax 80MHz / Nss 1
MCS 0 / 1S4T CDD / Ant. 4 / CH138 / 5690 MHz (EBW3 & OBW3)**

802.11ax HEW80_Nss1,(MCS0)_4TX

EBW

5690MHz Straddle 5.725-5.85GHz

11/07/2020

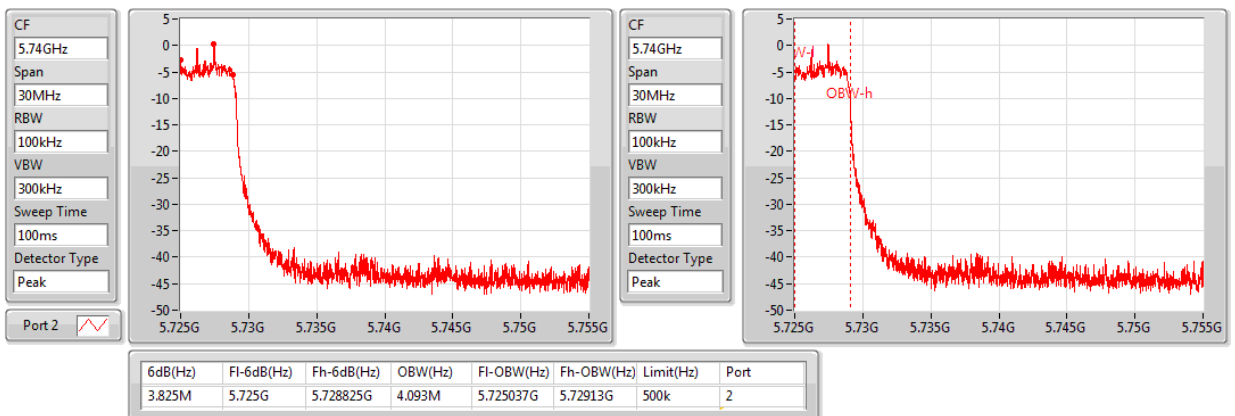



6dB Bandwidth and 99% Occupied Bandwidth Plot on Configuration IEEE 802.11ax 80MHz / Nss 1 MCS 0 / 1S4T CDD / Ant. 5 / CH138 / 5690 MHz (EBW3 & OBW3)

802.11ax HEW80_Nss1,(MCS0)_4TX

EBW

5690MHz Straddle 5.725-5.85GHz

11/07/2020

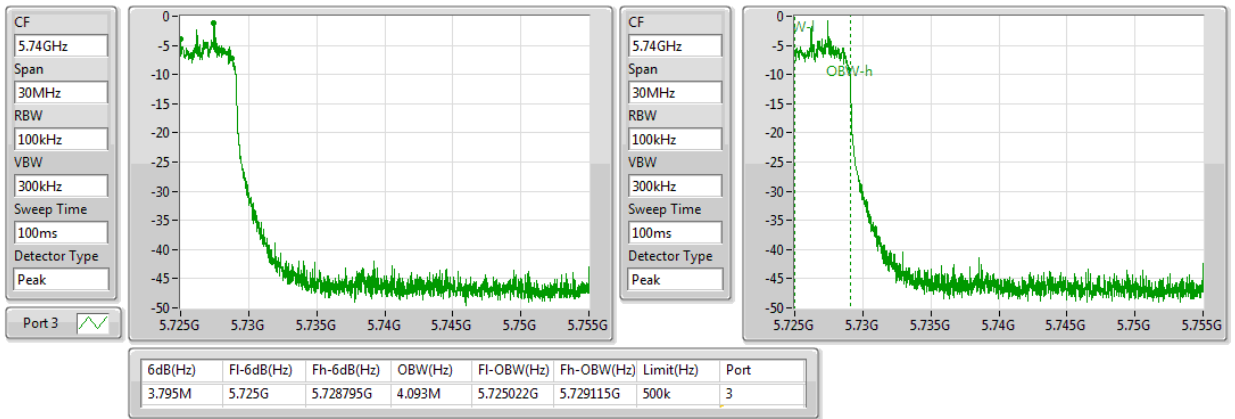

6dB Bandwidth and 99% Occupied Bandwidth Plot on Configuration IEEE 802.11ax 80MHz / Nss 1 MCS 0 / 1S4T CDD / Ant. 6 / CH138 / 5690 MHz (EBW3 & OBW3)

802.11ax HEW80_Nss1,(MCS0)_4TX

EBW

5690MHz Straddle 5.725-5.85GHz

11/07/2020

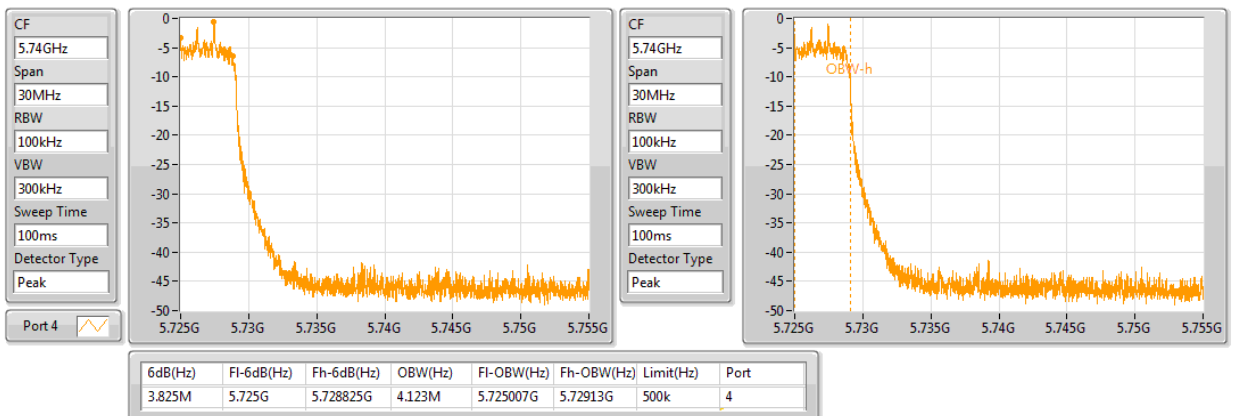



**26dB Bandwidth and 99% Occupied Bandwidth Plot on Configuration IEEE 802.11ax 80MHz / Nss 1
MCS 0 / 1S4T TXBF / Ant. 3 / CH138 / 5690 MHz (EBW2c & OBW2c)**

802.11ax HEW80-BF_Nss1,(MCS0)_4TX

EBW

5690MHz Straddle 5.47-5.725GHz

11/07/2020

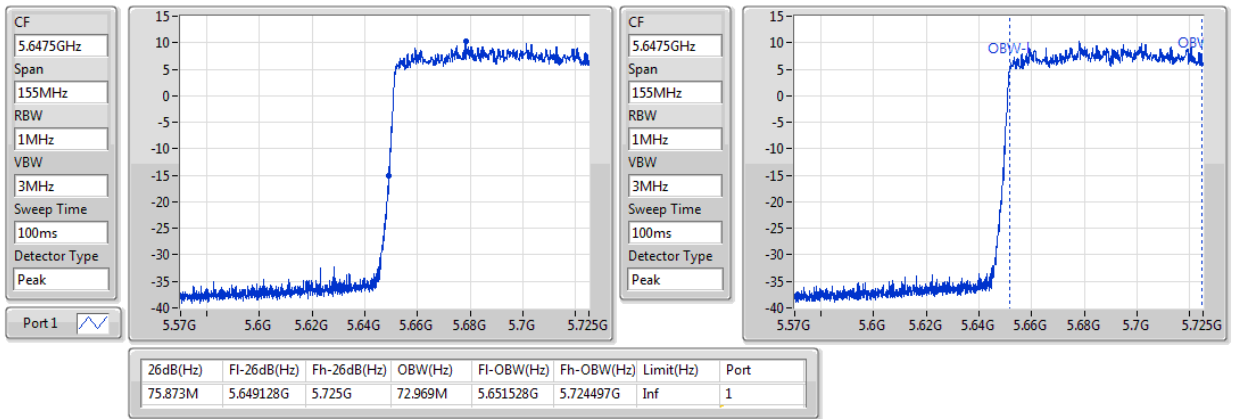

**26dB Bandwidth and 99% Occupied Bandwidth Plot on Configuration IEEE 802.11ax 80MHz / Nss 1
MCS 0 / 1S4T TXBF / Ant. 4 / CH138 / 5690 MHz (EBW2c & OBW2c)**

802.11ax HEW80-BF_Nss1,(MCS0)_4TX

EBW

5690MHz Straddle 5.47-5.725GHz

11/07/2020

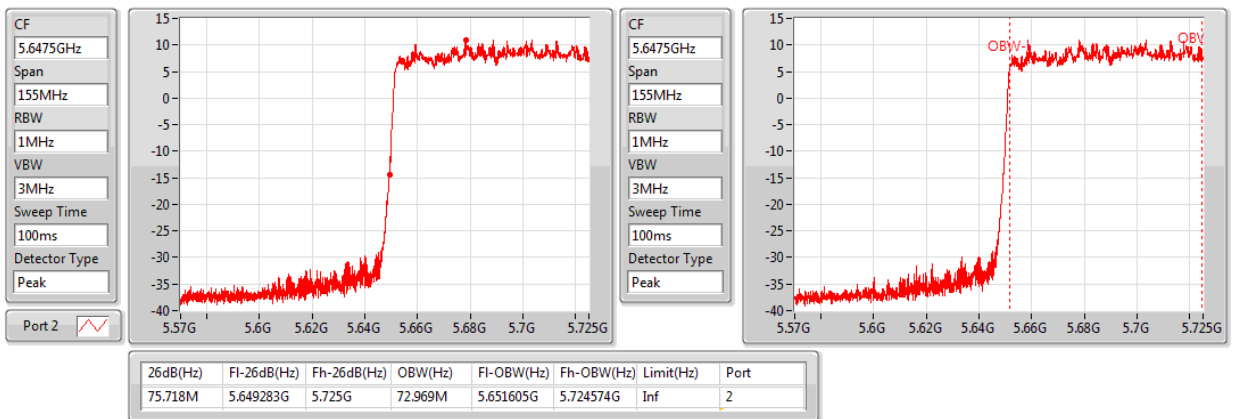



26dB Bandwidth and 99% Occupied Bandwidth Plot on Configuration IEEE 802.11ax 80MHz / Nss 1 MCS 0 / 1S4T TXBF / Ant. 5 / CH138 / 5690 MHz (EBW2c & OBW2c)

802.11ax HEW80-BF_Nss1,(MCS0)_4TX

EBW

5690MHz Straddle 5.47-5.725GHz

11/07/2020

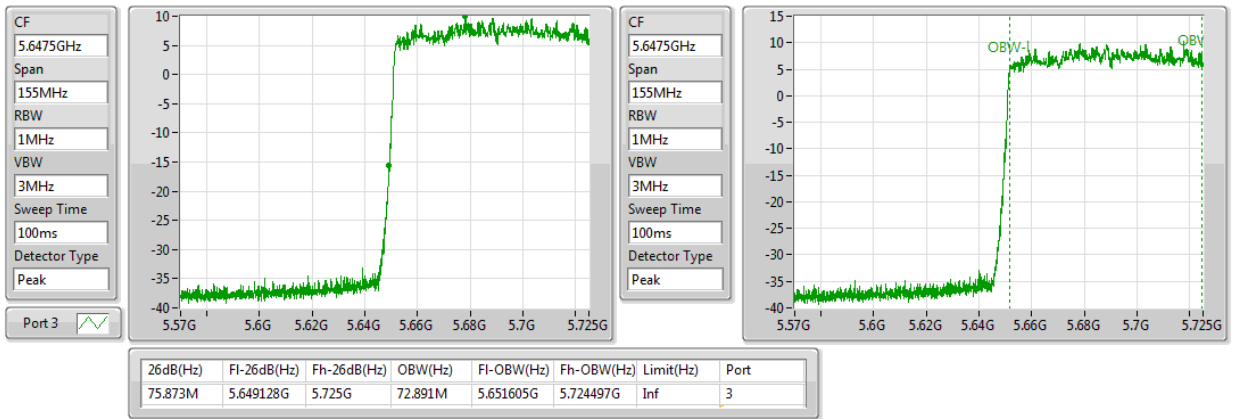

26dB Bandwidth and 99% Occupied Bandwidth Plot on Configuration IEEE 802.11ax 80MHz / Nss 1 MCS 0 / 1S4T TXBF / Ant. 6 / CH138 / 5690 MHz (EBW2c & OBW2c)

802.11ax HEW80-BF_Nss1,(MCS0)_4TX

EBW

5690MHz Straddle 5.47-5.725GHz

11/07/2020

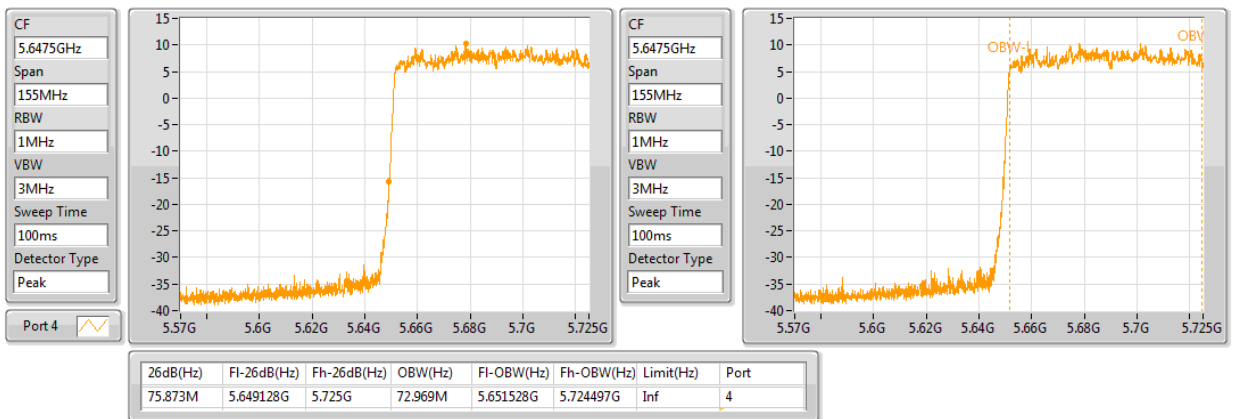



6dB Bandwidth and 99% Occupied Bandwidth Plot on Configuration IEEE 802.11ax 80MHz / Nss 1 MCS 0 / 1S4T TXBF / Ant. 3 / CH138 / 5690 MHz (EBW3 & OBW3)

802.11ax HEW80-BF_Nss1,(MCS0)_4TX

EBW

5690MHz Straddle 5.725-5.85GHz

11/07/2020

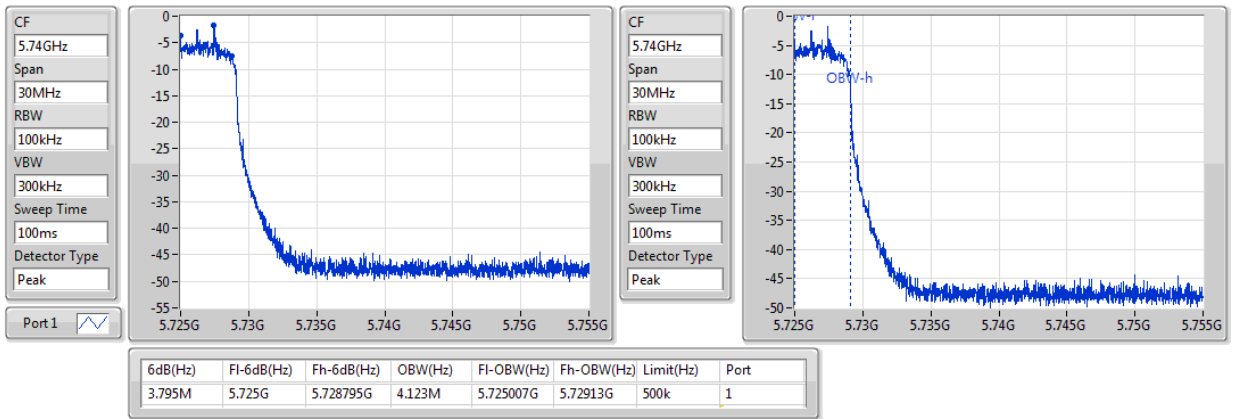

6dB Bandwidth and 99% Occupied Bandwidth Plot on Configuration IEEE 802.11ax 80MHz / Nss 1 MCS 0 / 1S4T TXBF / Ant. 4 / CH138 / 5690 MHz (EBW3 & OBW3)

802.11ax HEW80-BF_Nss1,(MCS0)_4TX

EBW

5690MHz Straddle 5.725-5.85GHz

11/07/2020

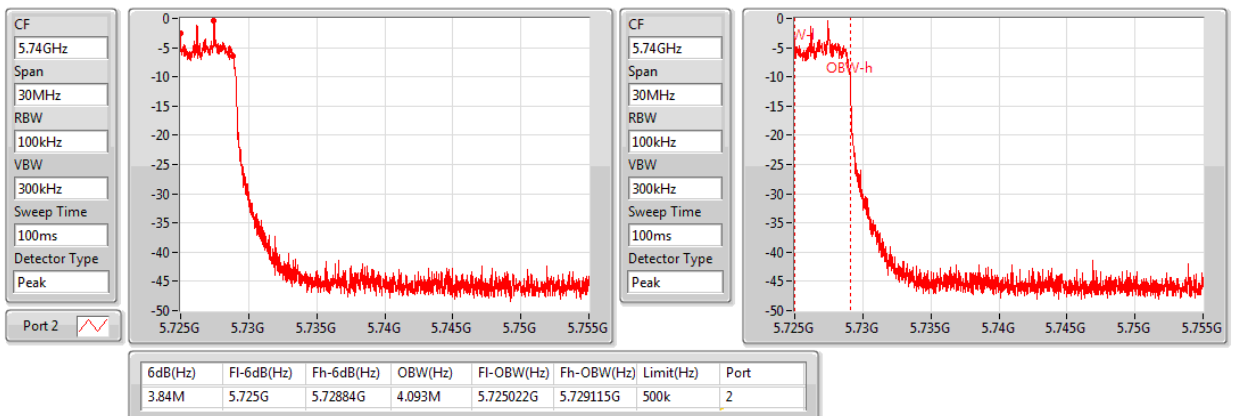



6dB Bandwidth and 99% Occupied Bandwidth Plot on Configuration IEEE 802.11ax 80MHz / Nss 1 MCS 0 / 1S4T TXBF / Ant. 5 / CH138 / 5690 MHz (EBW3 & OBW3)

802.11ax HEW80-BF_Nss1,(MCS0)_4TX

EBW

5690MHz Straddle 5.725-5.85GHz

11/07/2020

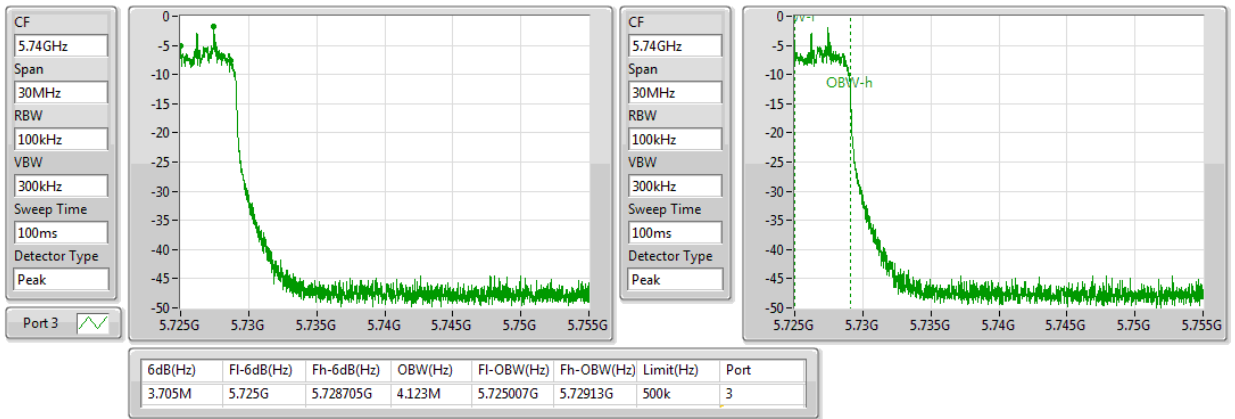

6dB Bandwidth and 99% Occupied Bandwidth Plot on Configuration IEEE 802.11ax 80MHz / Nss 1 MCS 0 / 1S4T TXBF / Ant. 6 / CH138 / 5690 MHz (EBW3 & OBW3)

802.11ax HEW80-BF_Nss1,(MCS0)_4TX

EBW

5690MHz Straddle 5.725-5.85GHz

11/07/2020

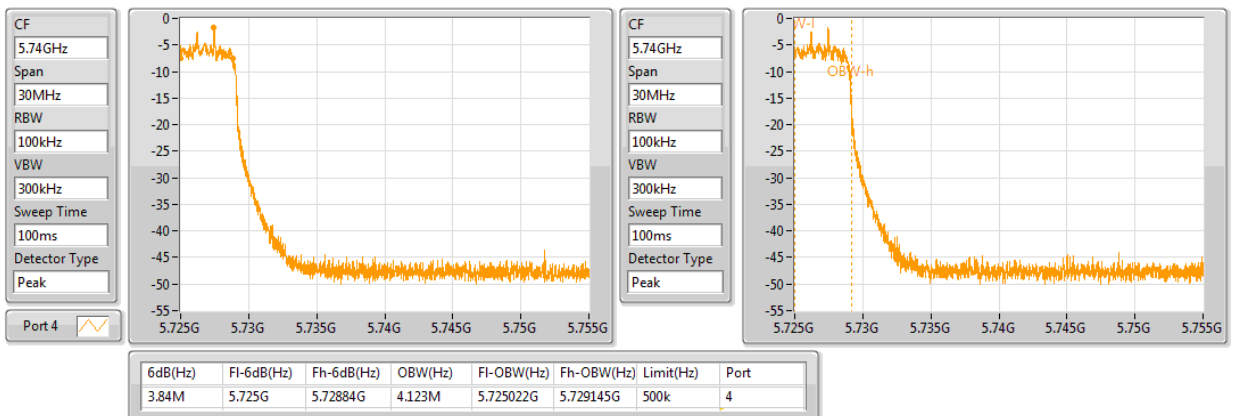



**26dB Bandwidth and 99% Occupied Bandwidth Plot on Configuration IEEE 802.11ax 80MHz / Nss 2
MCS 0 / 2S4T TXBF / Ant. 3 / CH138 / 5690 MHz (EBW2c & OBW2c)**

802.11ax HEW80-BF_Nss2,(MCS0)_4TX

EBW

5690MHz Straddle 5.47-5.725GHz

11/07/2020

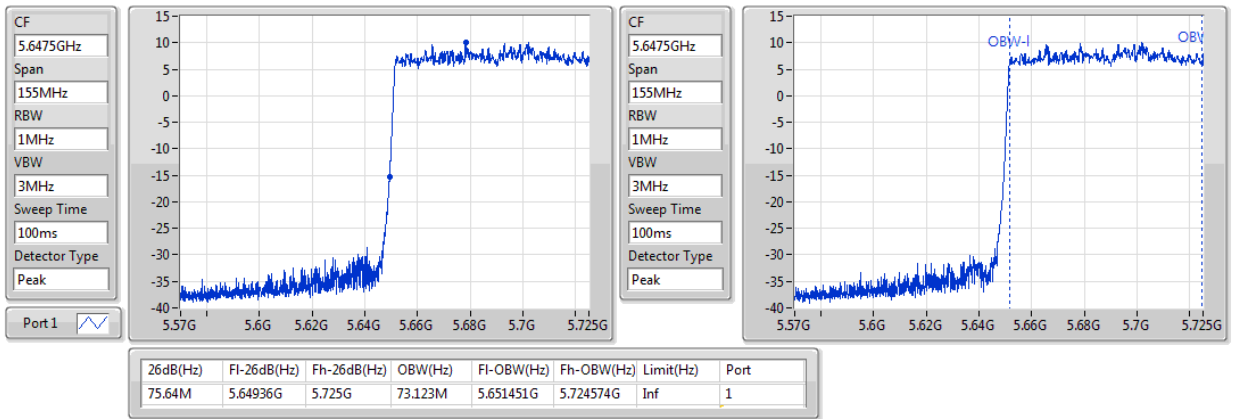

**26dB Bandwidth and 99% Occupied Bandwidth Plot on Configuration IEEE 802.11ax 80MHz / Nss 2
MCS 0 / 2S4T TXBF / Ant. 4 / CH138 / 5690 MHz (EBW2c & OBW2c)**

802.11ax HEW80-BF_Nss2,(MCS0)_4TX

EBW

5690MHz Straddle 5.47-5.725GHz

11/07/2020

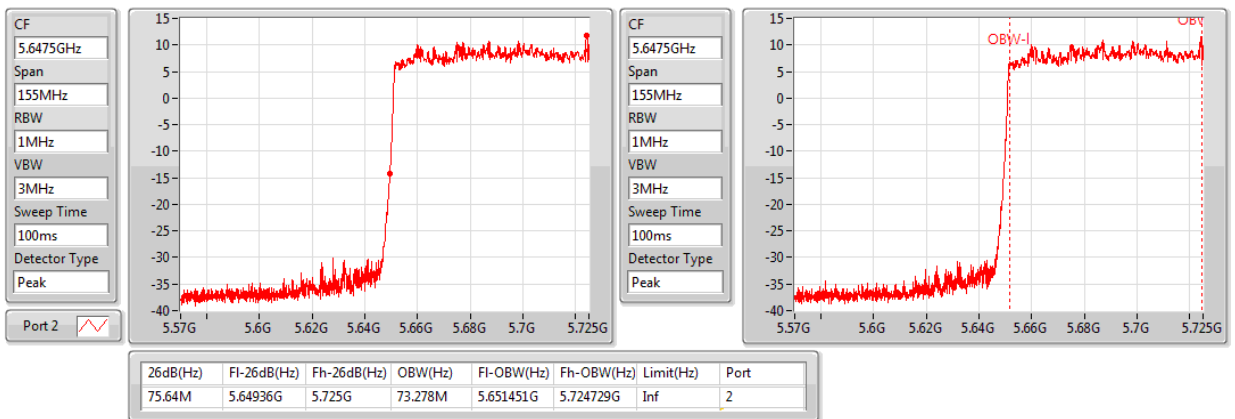



26dB Bandwidth and 99% Occupied Bandwidth Plot on Configuration IEEE 802.11ax 80MHz / Nss 2 MCS 0 / 2S4T TXBF / Ant. 5 / CH138 / 5690 MHz (EBW2c & OBW2c)

802.11ax HEW80-BF_Nss2,(MCS0)_4TX

EBW

5690MHz Straddle 5.47-5.725GHz

11/07/2020

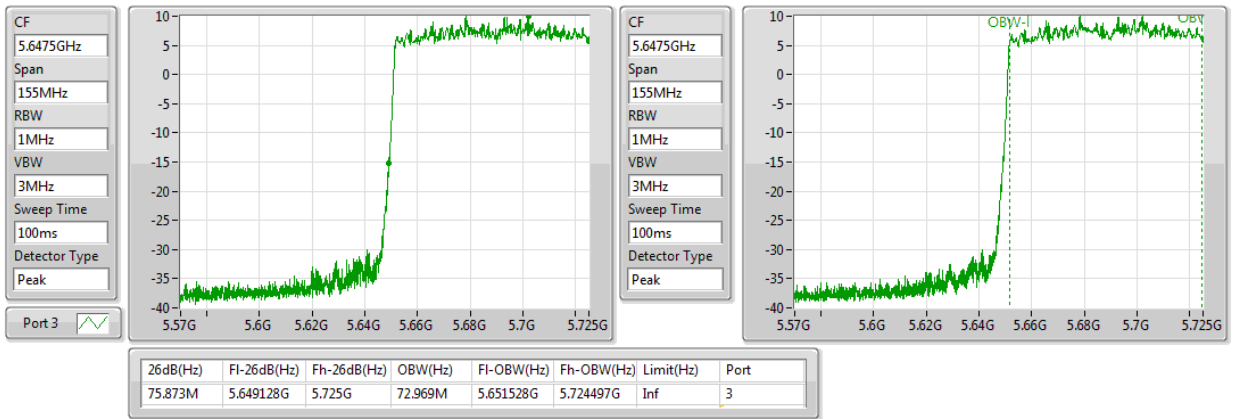

26dB Bandwidth and 99% Occupied Bandwidth Plot on Configuration IEEE 802.11ax 80MHz / Nss 2 MCS 0 / 2S4T TXBF / Ant. 6 / CH138 / 5690 MHz (EBW2c & OBW2c)

802.11ax HEW80-BF_Nss2,(MCS0)_4TX

EBW

5690MHz Straddle 5.47-5.725GHz

11/07/2020

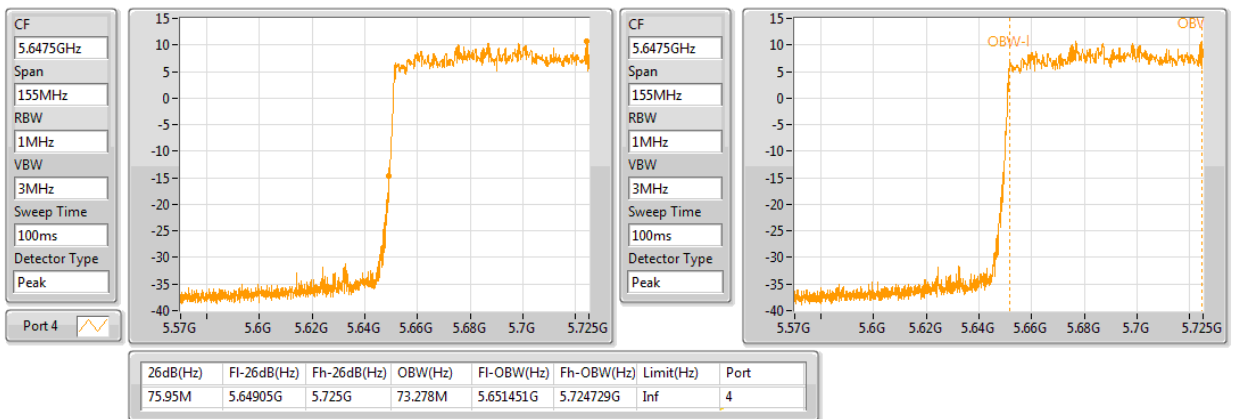



**6dB Bandwidth and 99% Occupied Bandwidth Plot on Configuration IEEE 802.11ax 80MHz / Nss 2
MCS 0 / 2S4T TXBF / Ant. 3 / CH138 / 5690 MHz (EBW3 & OBW3)**

802.11ax HEW80-BF_Nss2,(MCS0)_4TX

EBW

5690MHz Straddle 5.725-5.85GHz

11/07/2020

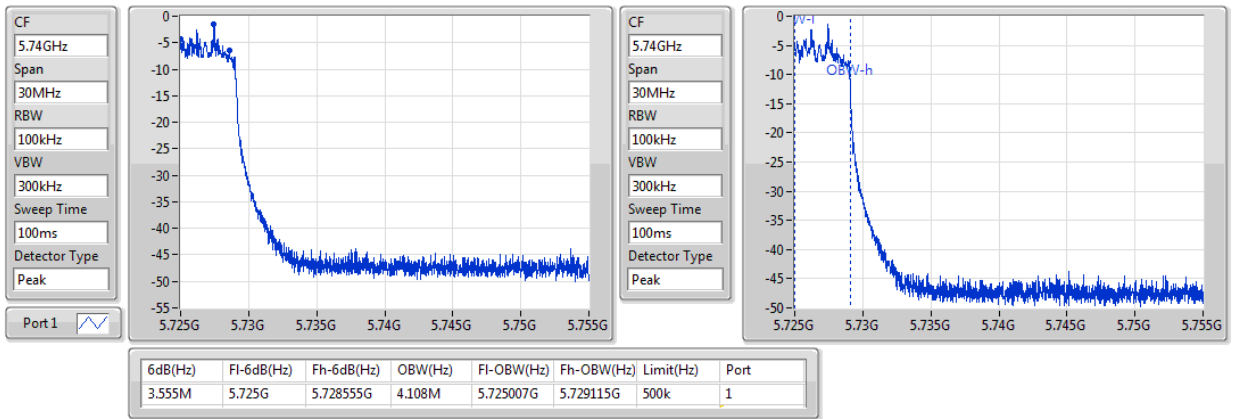

**6dB Bandwidth and 99% Occupied Bandwidth Plot on Configuration IEEE 802.11ax 80MHz / Nss 2
MCS 0 / 2S4T TXBF / Ant. 4 / CH138 / 5690 MHz (EBW3 & OBW3)**

802.11ax HEW80-BF_Nss2,(MCS0)_4TX

EBW

5690MHz Straddle 5.725-5.85GHz

11/07/2020

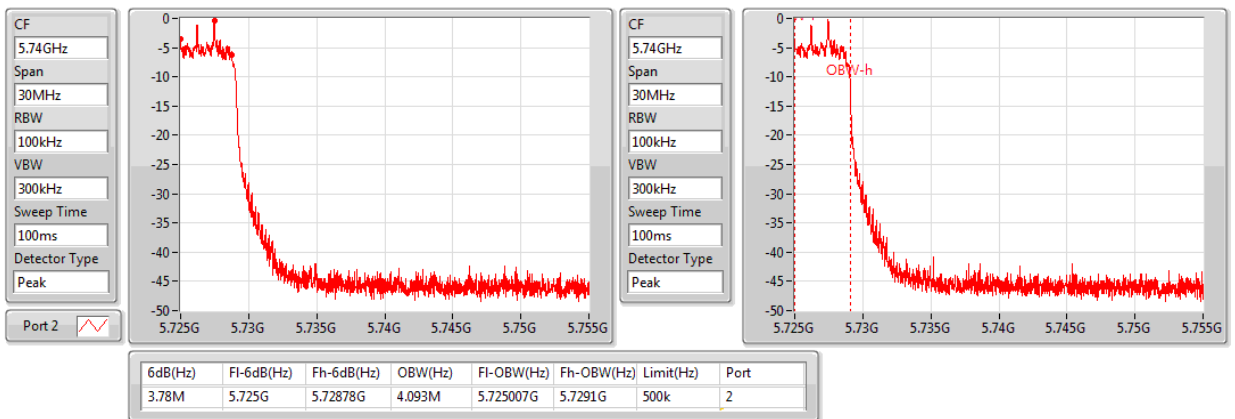



**6dB Bandwidth and 99% Occupied Bandwidth Plot on Configuration IEEE 802.11ax 80MHz / Nss 2
MCS 0 / 2S4T TXBF / Ant. 5 / CH138 / 5690 MHz (EBW3 & OBW3)**

802.11ax HEW80-BF_Nss2,(MCS0)_4TX

EBW

5690MHz Straddle 5.725-5.85GHz

11/07/2020

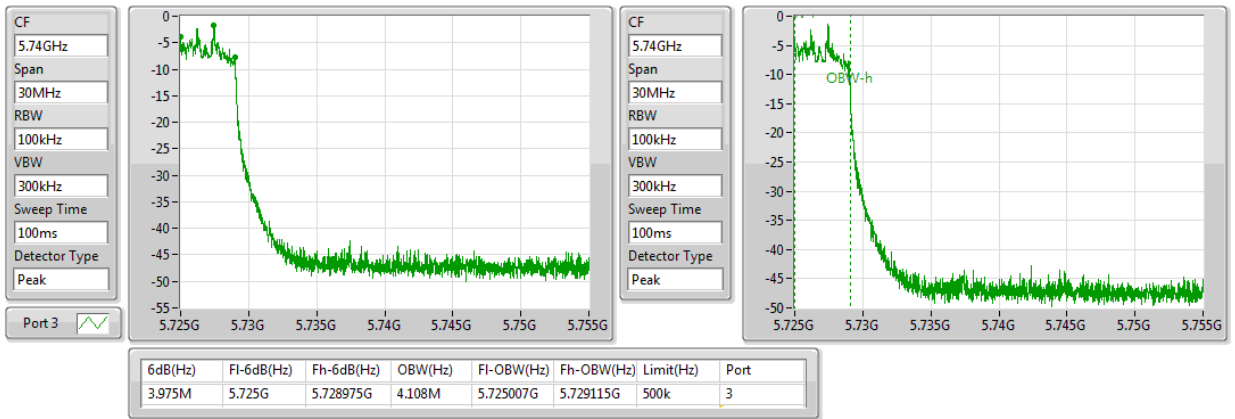

**6dB Bandwidth and 99% Occupied Bandwidth Plot on Configuration IEEE 802.11ax 80MHz / Nss 2
MCS 0 / 2S4T TXBF / Ant. 6 / CH138 / 5690 MHz (EBW3 & OBW3)**

802.11ax HEW80-BF_Nss2,(MCS0)_4TX

EBW

5690MHz Straddle 5.725-5.85GHz

11/07/2020

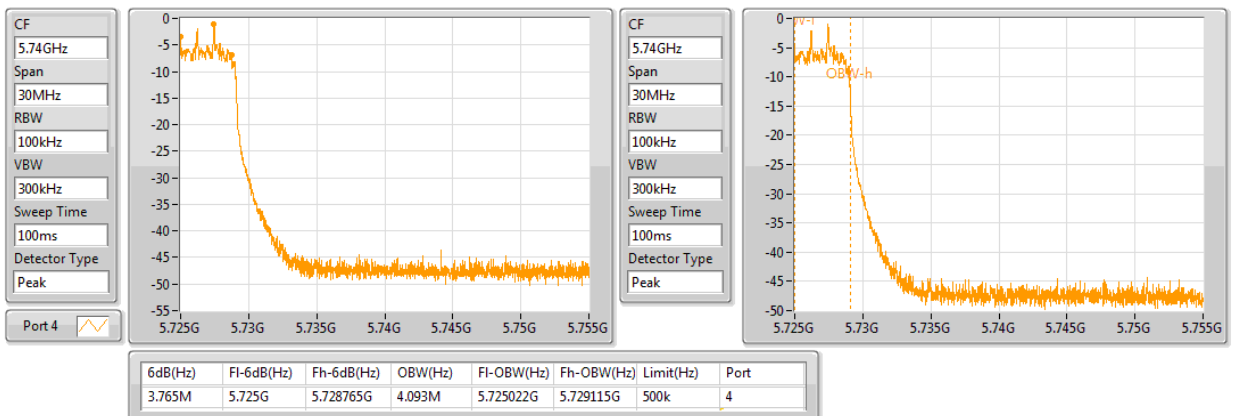



26dB Bandwidth and 99% Occupied Bandwidth Plot on Configuration IEEE 802.11ax 80MHz / Nss 3 MCS 0 / 3S4T TXBF / Ant. 3 / CH138 / 5690 MHz (EBW2c & OBW2c)

802.11ax HEW80-BF_Nss3,(MCS0)_4TX

EBW

5690MHz Straddle 5.47-5.725GHz

11/07/2020

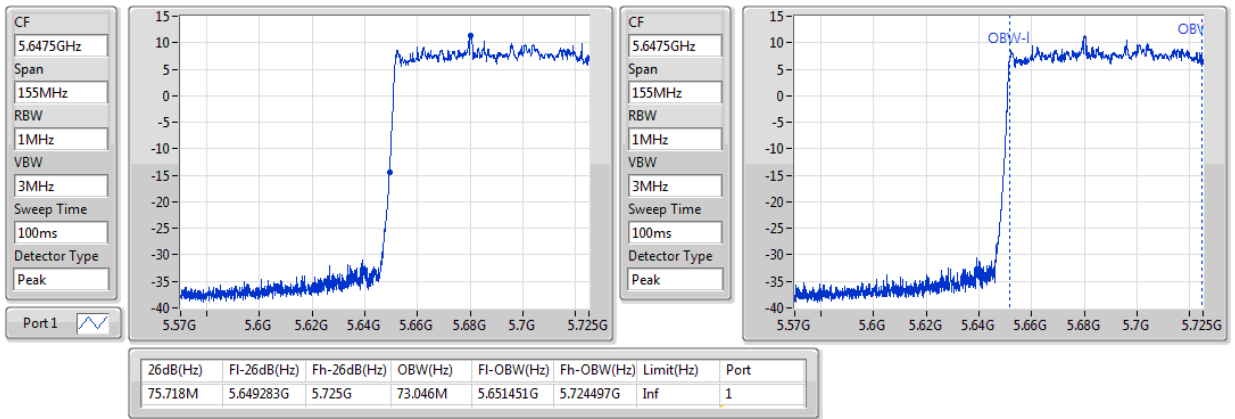

26dB Bandwidth and 99% Occupied Bandwidth Plot on Configuration IEEE 802.11ax 80MHz / Nss 3 MCS 0 / 3S4T TXBF / Ant. 4 / CH138 / 5690 MHz (EBW2c & OBW2c)

802.11ax HEW80-BF_Nss3,(MCS0)_4TX

EBW

5690MHz Straddle 5.47-5.725GHz

11/07/2020

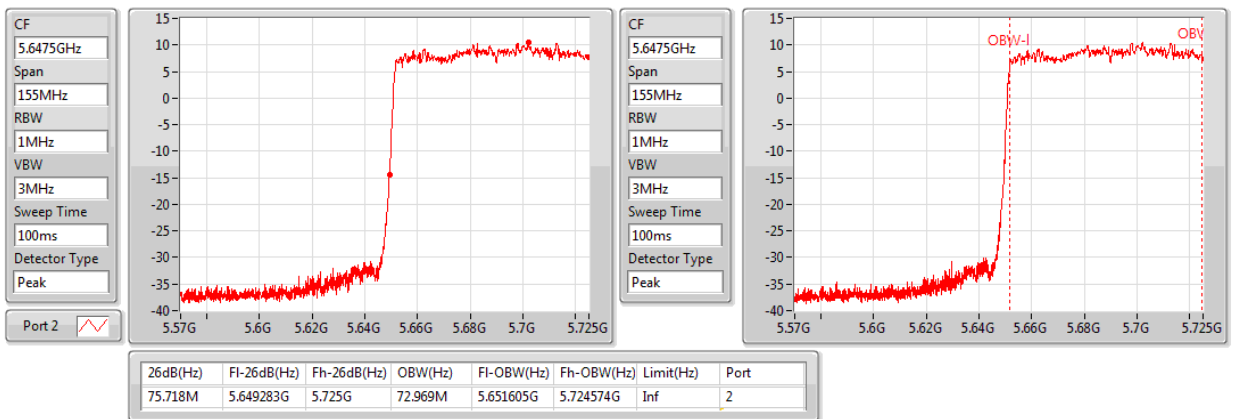



**26dB Bandwidth and 99% Occupied Bandwidth Plot on Configuration IEEE 802.11ax 80MHz / Nss 3
MCS 0 / 3S4T TXBF / Ant. 5 / CH138 / 5690 MHz (EBW2c & OBW2c)**

802.11ax HEW80-BF_Nss3,(MCS0)_4TX

EBW

5690MHz Straddle 5.47-5.725GHz

11/07/2020

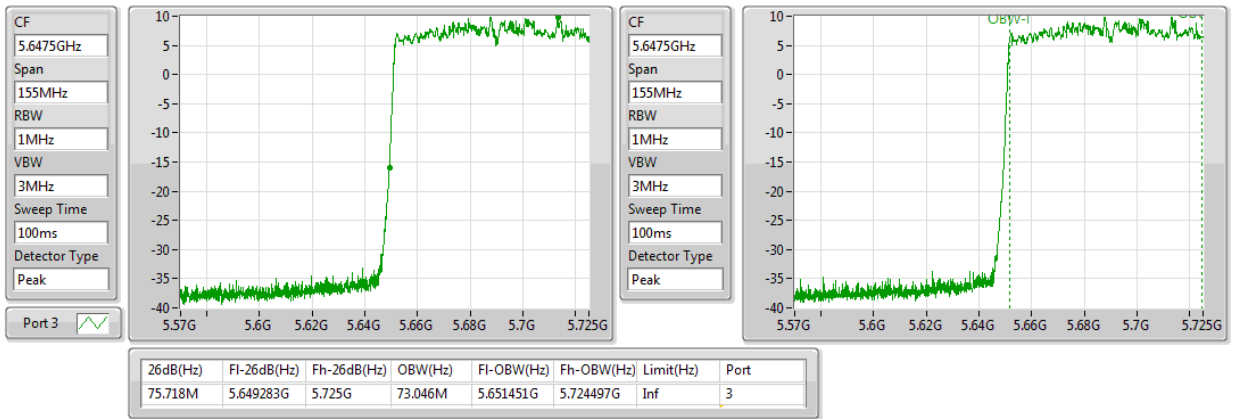

**26dB Bandwidth and 99% Occupied Bandwidth Plot on Configuration IEEE 802.11ax 80MHz / Nss 3
MCS 0 / 3S4T TXBF / Ant. 6 / CH138 / 5690 MHz (EBW2c & OBW2c)**

802.11ax HEW80-BF_Nss3,(MCS0)_4TX

EBW

5690MHz Straddle 5.47-5.725GHz

11/07/2020

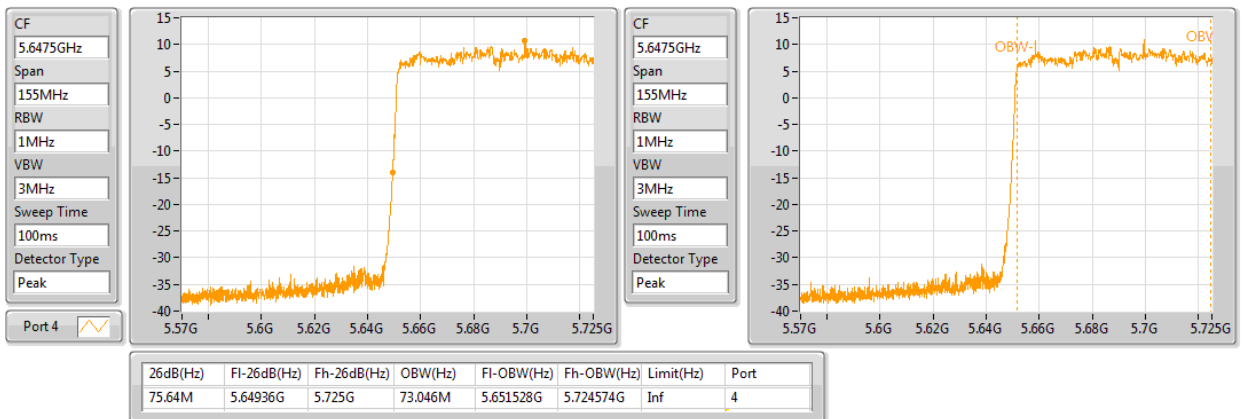



**6dB Bandwidth and 99% Occupied Bandwidth Plot on Configuration IEEE 802.11ax 80MHz / Nss 3
MCS 0 / 3S4T TXBF / Ant. 3 / CH138 / 5690 MHz (EBW3 & OBW3)**

802.11ax HEW80-BF_Nss3,(MCS0)_4TX

EBW

5690MHz Straddle 5.725-5.85GHz

11/07/2020

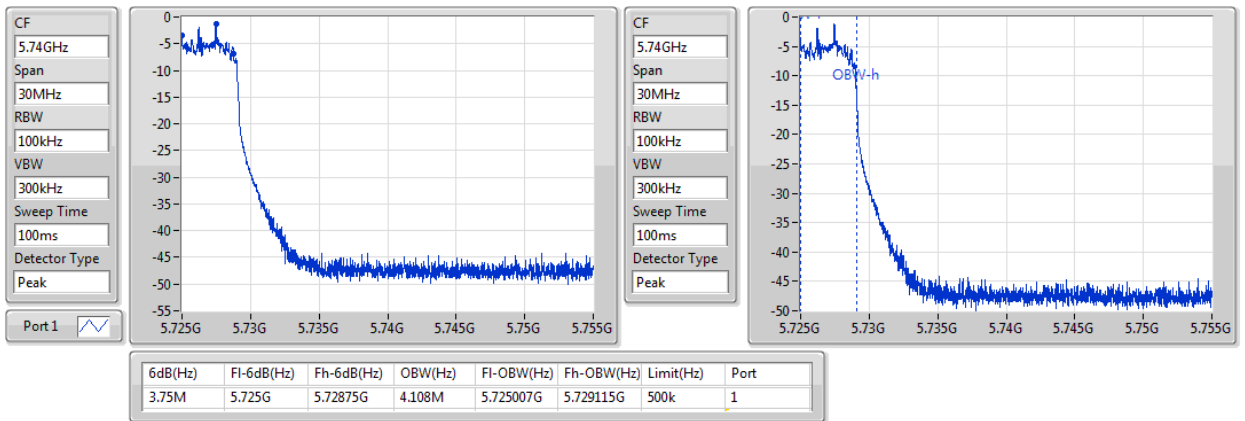

**6dB Bandwidth and 99% Occupied Bandwidth Plot on Configuration IEEE 802.11ax 80MHz / Nss 3
MCS 0 / 3S4T TXBF / Ant. 4 / CH138 / 5690 MHz (EBW3 & OBW3)**

802.11ax HEW80-BF_Nss3,(MCS0)_4TX

EBW

5690MHz Straddle 5.725-5.85GHz

11/07/2020

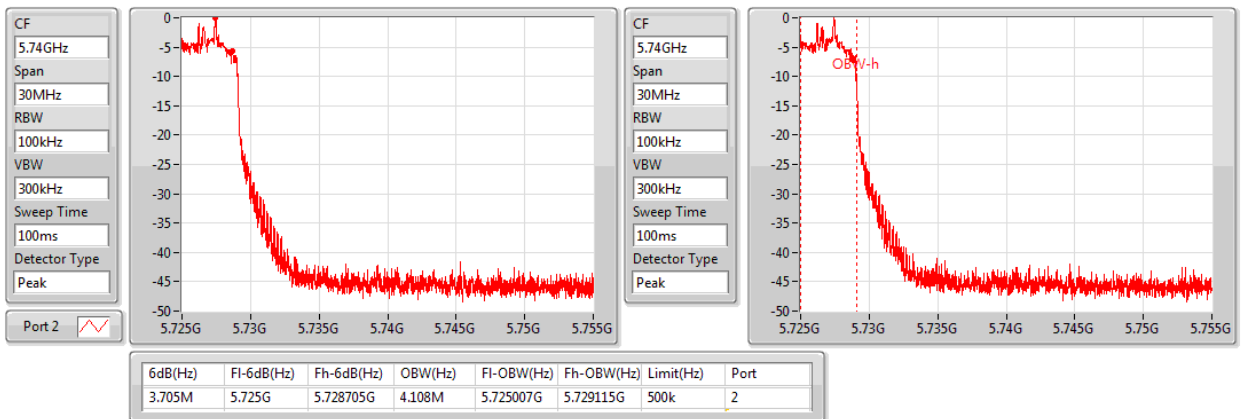



**6dB Bandwidth and 99% Occupied Bandwidth Plot on Configuration IEEE 802.11ax 80MHz / Nss 3
MCS 0 / 3S4T TXBF / Ant. 5 / CH138 / 5690 MHz (EBW3 & OBW3)**

802.11ax HEW80-BF_Nss3,(MCS0)_4TX

EBW

5690MHz Straddle 5.725-5.85GHz

11/07/2020

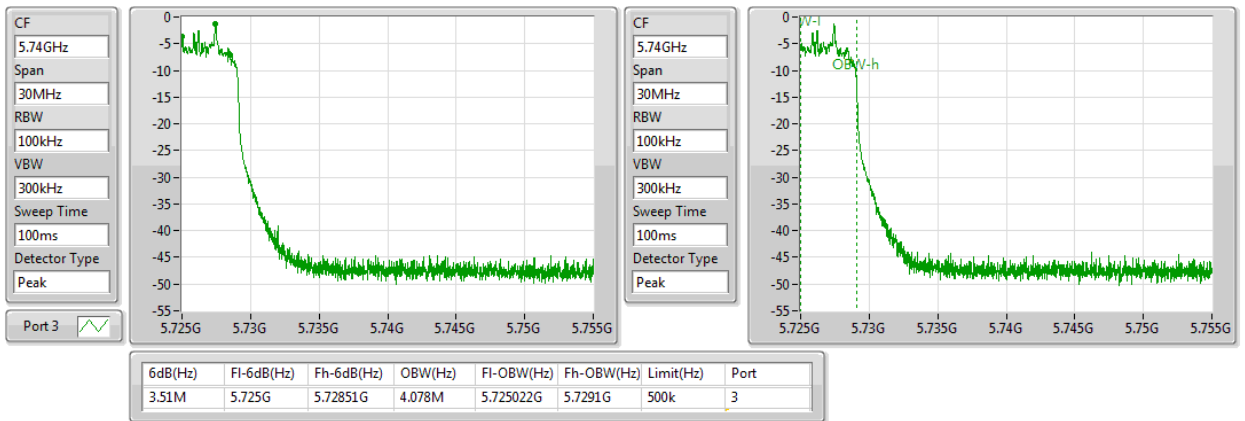

**6dB Bandwidth and 99% Occupied Bandwidth Plot on Configuration IEEE 802.11ax 80MHz / Nss 3
MCS 0 / 3S4T TXBF / Ant. 6 / CH138 / 5690 MHz (EBW3 & OBW3)**

802.11ax HEW80-BF_Nss3,(MCS0)_4TX

EBW

5690MHz Straddle 5.725-5.85GHz

11/07/2020

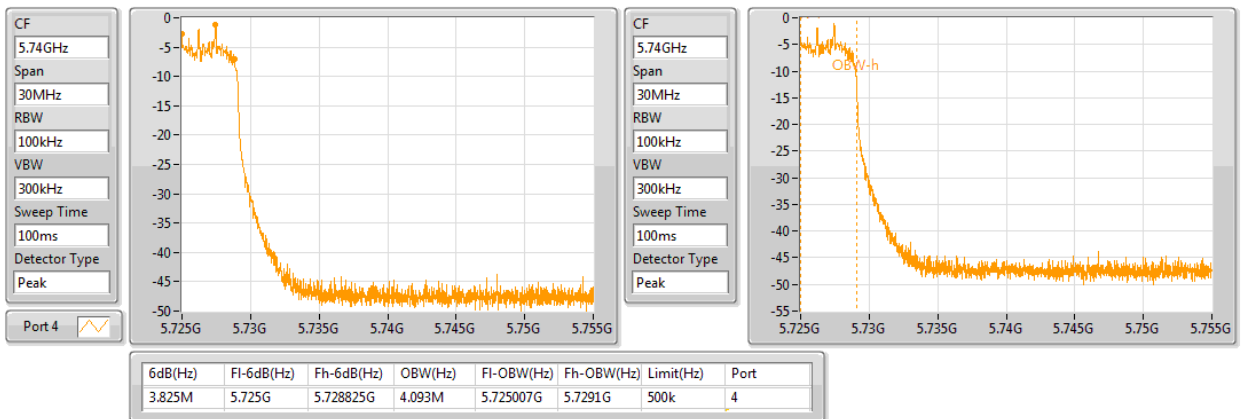

2.4.2. Maximum Conducted Output Power Measurement for Band-Crossing Channel

2.4.2.1 Limit

Operation Band	EUT Category		Limit
U-NII-2C	<input checked="" type="checkbox"/>	---	250mW (23.98 dBm) or 11 dBm+10 log B*
U-NII-3	<input checked="" type="checkbox"/>	---	1 Watt (30 dBm)

Note:*B is the 99% occupied bandwidth in megahertz.

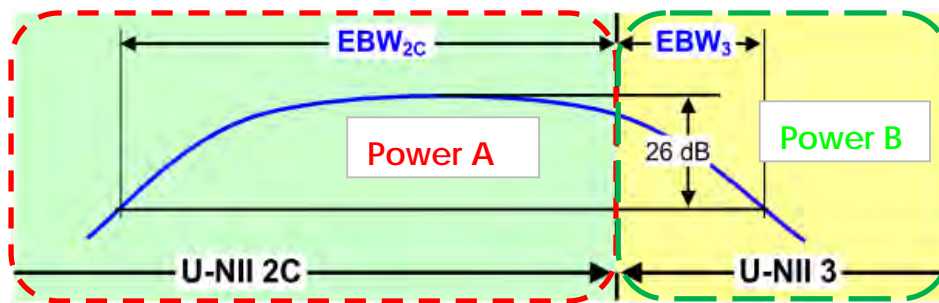

Emission Bandwidth (EBW) within a Band for Band-Crossing Signals

1. Limit was performed in accordance with KDB 789033 D02 General UNII Test Procedures New Rules v02r01, in section “In-band emission limits (A)(3)”, 14/12/2017
2. Power A: Limit based on $EBW_{2c} = 11 + 10 \log(EBW_{2c})$ when $< 20\text{MHz}$ or 24dBm when $> 20\text{MHz}$ (UNII-2C)
3. Power B: Limit based on $EBW_3 = 17 + 10 \log(EBW_3)$ when $< 20\text{MHz}$ or 30dBm when $> 20\text{MHz}$ (UNII-3)

2.4.2.2 Measuring Instruments and Setting

Please refer to section 3 of equipments list in this report. The following table is the setting of the spectrum analyzer.

Spectrum Parameter	Setting
Attenuation	Auto
Span Frequency	Encompass the entire emissions bandwidth (EBW) of the signal
RBW	1000 kHz
VBW	3000 kHz
Detector	RMS
Trace	Average Sweep count 100
Sweep Time	Auto

2.4.2.3 Test Procedures

Maximum Conducted Output Power

1. The transmitter output (antenna port) was connected RF switch to the spectrum analyzer.
2. Measure the power of each spectrum segment by integrating across the EBW of that segment following the procedures of 789033 D02 General UNII Test Procedures New Rules v02r01, in section “Maximum conducted output power Method SA-2 (E)(2)(d)”, 14/12/2017.
3. Test was performed in accordance with KDB 789033 D02 General UNII Test Procedures New Rules v02r01, in section “In-band emission limits (A)(3)”, 14/12/2017
4. If an EBW extends across the boundary between two adjacent bands, the boundary frequency between the bands serves as one edge of the frequency range to be integrated. Integration across an entire U-NII band without regard to 26-dB points is also acceptable for determining conducted output power within that band.
5. Integrate over the band or integrate over a span including the 26-dB EBWs of transmission segments within the band or integrate over 26-dB EBW of each transmission segment in the band and sum.

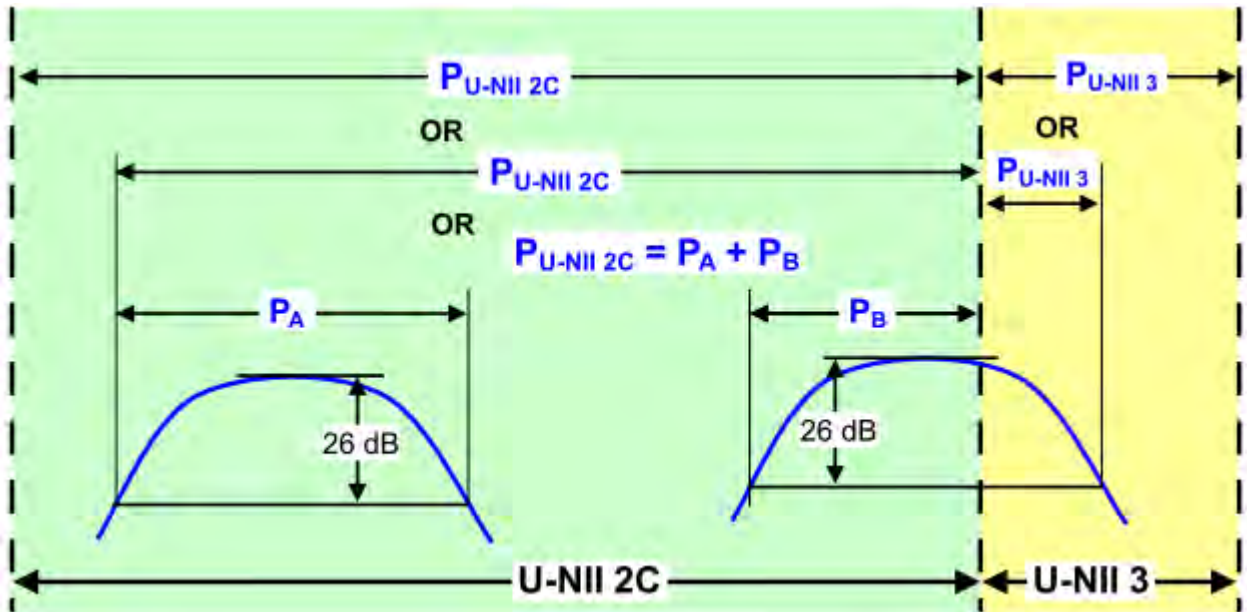

6. When measuring maximum conducted output power with multiple antenna systems, add every result of the values by mathematic formula.
7. Adjust the measurement in dBm by adding $10 \log(1/x)$ where x is the duty cycle. Record the average power level.

Transmit Power Control (TPC)

1. Measure the power of each spectrum segment by integrating across the EBW of that segment following the procedures of 789033 D02 General UNII Test Procedures New Rules v02r01, in section “Maximum conducted output power Method SA-2 (E)(2)(d)”, 14/12/2017.
2. Test was performed in accordance with KDB 789033 D02 General UNII Test Procedures New Rules v02r01, in section “In-band emission limits (A)(3)”, 14/12/2017
3. Configure the CH, BW and SSID according to test plan at band 2 and band 3.
4. Make STA associate with AP.
5. Generate downlink data traffic with traffic generating tools (Iperf)
6. Use telnet via Ethernet port or console via Uart interface to control AP.
7. Use the TPC lowest power level command to measurement the TPC lowest power level.
8. Follow Max conducted Output power step 4~7 record the power value within UNII2C

2.4.2.4 Test Setup Layout

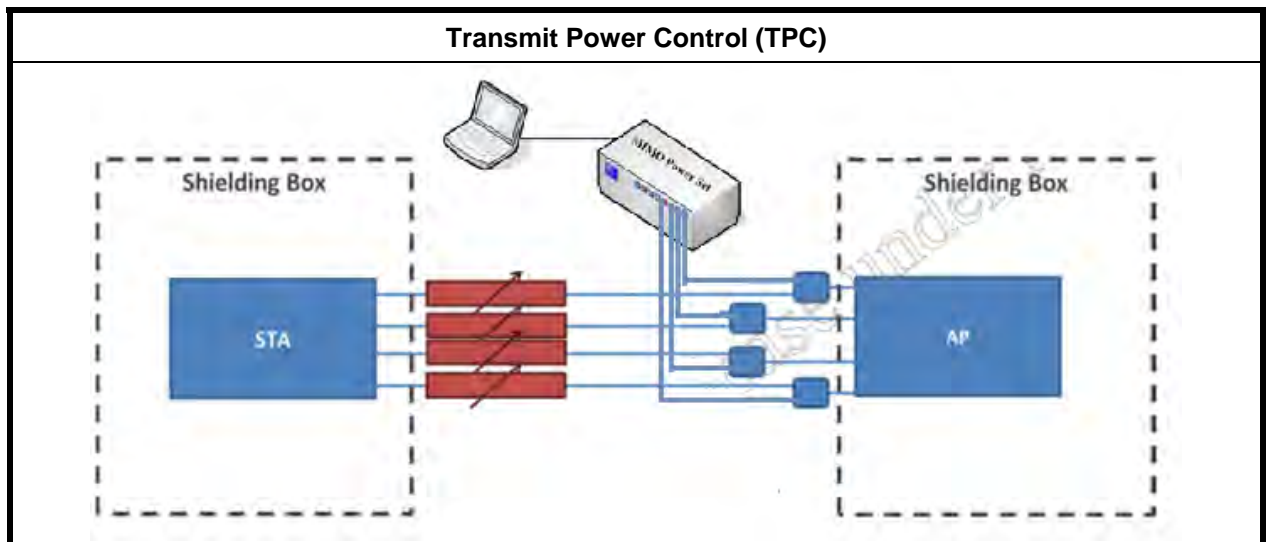
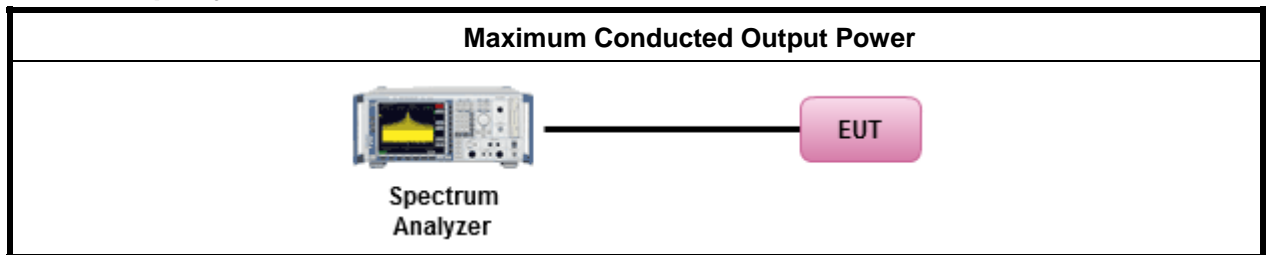

2.4.2.5 Test Deviation

There are no deviation with the original standard.

2.4.2.6 EUT Operation during Test

The EUT was programmed to be in continuously transmitting mode.



2.4.2.7 Test Result for Maximum Conducted Output Power

Configuration IEEE 802.11a

<U-NII-2C, Power A, EBW2c, OFDM, 1S4T, CDD>

Channel	Frequency	Conducted Power (dBm)					Max. Limit (dBm)	Max. Gain (dBi)	Highest EIRP (dBm)	Highest EIRP Limit (dBm)	Result
		Ant. 3	Ant. 4	Ant. 5	Ant. 6	Total					
144	5720 MHz (UNII 2C)	16.21	16.63	15.21	16.53	22.20	22.93	4.74	26.94	30.00	PASS
Channel	Frequency	Conducted Power (dBm)					Max. Gain (dBi)	Lowest EIRP (dBm)	Lowest EIRP Limit (dBm)	Result	
		Ant. 3	Ant. 4	Ant. 5	Ant. 6	Total					
144	5720 MHz (UNII 2C)	9.81	10.21	9.02	10.42	15.92	4.74	20.66	24.00	PASS	

Note1: 5720 MHz (UNII 2C)= Max. Limit: 11+10*log(B) or 23.98dBm; 11+10*log(UNII 2C)=11+10*log(15.575)= 22.93dBm<23.98dBm, so limit=22.93dBm.

<U-NII-3, Power B, EBW3, OFDM, 1S4T, CDD>

Channel	Frequency	Conducted Power (dBm)					Max. Gain (dBi)	Max. Limit (dBm)	Result
		Ant. 3	Ant. 4	Ant. 5	Ant. 6	Total			
144	5720 MHz (UNII 3)	10.25	11.00	9.56	10.22	16.31	4.74	30.00	PASS

Note1: 5720 MHz (UNII 3)= Max. Gain= 4.74dBi <6dBi, so the limit doesn't reduce.



Maximum Conducted Output Power Plot on Configuration IEEE 802.11a / OFDM / 1S4T CDD / Ant. 3 + Ant. 4 + Ant. 5 + Ant. 6 / CH144 / 5720 MHz (UNII 2C)

802.11a_Nss1,(6Mbps)_4TX

AV Power

5720MHz Straddle 5.47-5.725GHz

13/07/2020

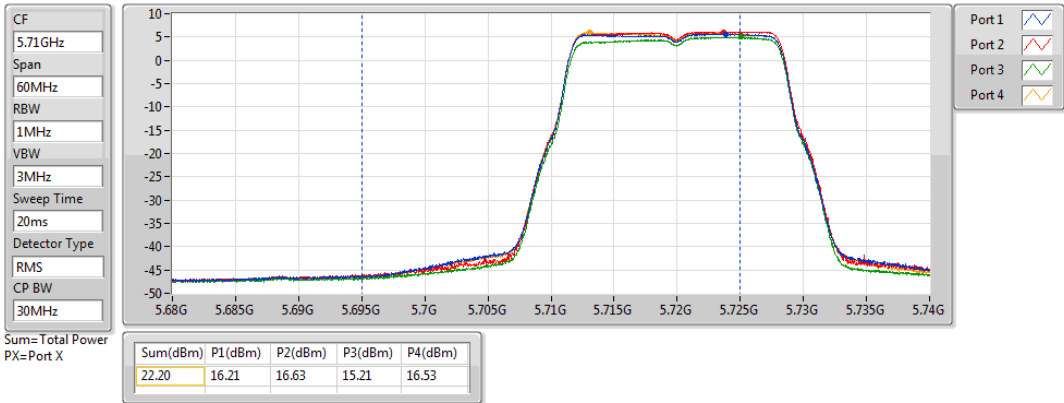

Maximum Conducted Output Power Plot on Configuration IEEE 802.11a / OFDM / 1S4T CDD / Ant. 3 + Ant. 4 + Ant. 5 + Ant. 6 / CH144 / 5720 MHz (UNII 3)

802.11a_Nss1,(6Mbps)_4TX

AV Power

5720MHz Straddle 5.725-5.85GHz

13/07/2020

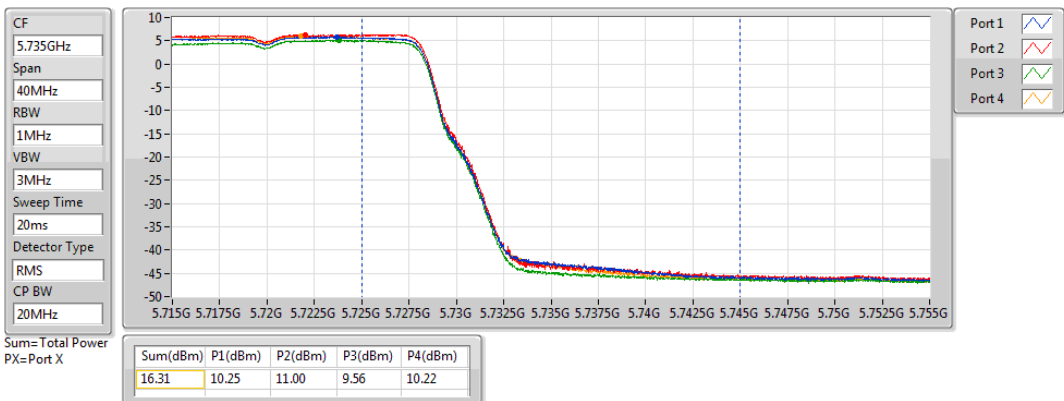



Configuration IEEE 802.11ax 20MHz

<U-NII-2C, Power A, EBW2c, Nss 1 MCS0, 1S4T, CDD>

Channel	Frequency	Conducted Power (dBm)					Max. Limit (dBm)	Max. Gain (dBi)	Highest EIRP (dBm)	Highest EIRP Limit (dBm)	Result
		Ant. 3	Ant. 4	Ant. 5	Ant. 6	Total					
144	5720 MHz (UNII 2C)	16.92	16.96	15.41	16.55	22.52	22.94	4.74	27.26	30.00	PASS
Channel	Frequency	Conducted Power (dBm)					Max. Gain (dBi)	Lowest EIRP (dBm)	Lowest EIRP Limit (dBm)	Result	
		Ant. 3	Ant. 4	Ant. 5	Ant. 6	Total					
144	5720 MHz (UNII 2C)	10.11	10.42	9.23	10.52	16.12	4.74	20.86	24.00	PASS	

Note1: 5720 MHz (UNII 2C)= Max. Limit: 11+10*log(B) or 23.98dBm; 11+10*log(UNII 2C)=11+10*log(15.645) =22.94dBm<23.98dBm, so limit=22.94dBm.

<U-NII-3, Power B, EBW3, Nss 1 MCS0, 1S4T, CDD>

Channel	Frequency	Conducted Power (dBm)					Max. Gain (dBi)	Max. Limit (dBm)	Result
		Ant. 3	Ant. 4	Ant. 5	Ant. 6	Total			
144	5720 MHz (UNII 3)	11.66	11.86	10.35	11.43	17.38	4.74	30.00	PASS

Note1: 5720 MHz (UNII 3)= Max. Gain= 4.74dBi <6dBi, so the limit doesn't reduce.



<U-NII-2C, Power A, EBW2c, Nss 1 MCS0, 1S4T, TXBF>

Channel	Frequency	Conducted Power (dBm)					Max. Limit (dBm)	Directional Gain (dBi)	Highest EIRP (dBm)	Highest EIRP Limit (dBm)	Result
		Ant. 3	Ant. 4	Ant. 5	Ant. 6	Total					
144	5720 MHz (UNII 2C)	16.47	16.41	14.97	16.02	22.03	22.08	6.85	28.88	30.00	PASS
Channel	Frequency	Conducted Power (dBm)					Directional Gain (dBi)	Lowest EIRP (dBm)	Lowest EIRP Limit (dBm)	Result	
		Ant. 3	Ant. 4	Ant. 5	Ant. 6	Total					
144	5720 MHz (UNII 2C)	9.74	9.91	9.04	10.16	15.75	6.85	22.60	24.00	PASS	

Note1: 5720 MHz (UNII 2C)= Max. Limit: 11+10*log(B) or 23.98dBm; $Directional\ Gain = 10 \cdot \log \left[\frac{\sum_{j=1}^{N_{SS}} \left\{ \sum_{k=1}^{N_{ANT}} g_{j,k} \right\}^2}{N_{ANT}} \right] =$

6.85dBi>6dBi, so the power limit shall be reduced to 11+10*log(UNII 2C)=11+10*log(15.593)-(6.85-6)
 =22.08dBm<23.98dBm, so limit=22.08dBm.

<U-NII-3, Power B, EBW3, Nss 1 MCS0, 1S4T, TXBF>

Channel	Frequency	Conducted Power (dBm)					Directional Gain (dBi)	Max. Limit (dBm)	Result
		Ant. 3	Ant. 4	Ant. 5	Ant. 6	Total			
144	5720 MHz (UNII 3)	11.23	11.34	9.99	10.98	16.94	6.85	29.15	PASS

Note1: 5720 MHz (UNII 3) = $Directional\ Gain = 10 \cdot \log \left[\frac{\sum_{j=1}^{N_{SS}} \left\{ \sum_{k=1}^{N_{ANT}} g_{j,k} \right\}^2}{N_{ANT}} \right] = 6.85dBi > 6dBi$, so the power limit shall be

reduced to 30-(6.85-6)=29.15dBm.



<U-NII-2C, Power A, EBW2c, Nss 2 MCS0, 2S4T, TXBF>

Channel	Frequency	Conducted Power (dBm)					Max. Limit (dBm)	Directional Gain (dBi)	Highest EIRP (dBm)	Highest EIRP Limit (dBm)	Result
		Ant. 3	Ant. 4	Ant. 5	Ant. 6	Total					
144	5720 MHz (UNII 2C)	17.05	17.46	15.53	17.13	22.87	22.92	5.17	28.04	30.00	PASS
Channel	Frequency	Conducted Power (dBm)					Directional Gain (dBi)	Lowest EIRP (dBm)	Lowest EIRP Limit (dBm)	Result	
		Ant. 3	Ant. 4	Ant. 5	Ant. 6	Total					
144	5720 MHz (UNII 2C)	10.05	10.39	9.14	10.31	16.02	5.17	21.19	24.00	PASS	

Note1: 5720 MHz (UNII 2C)= $Directional\ Gain = 10 \cdot \log \left[\frac{\sum_{j=1}^{N_{SS}} \left\{ \sum_{k=1}^{N_{ANT}} g_{j,k} \right\}^2}{N_{ANT}} \right] = 5.17\text{dBi} < 6\text{dBi}$, so the limit doesn't reduce.

<U-NII-3, Power B, EBW3, Nss 2 MCS0, 2S4T, TXBF>

Channel	Frequency	Conducted Power (dBm)					Directional Gain (dBi)	Max. Limit (dBm)	Result
		Ant. 3	Ant. 4	Ant. 5	Ant. 6	Total			
144	5720 MHz (UNII 3)	11.85	12.20	10.59	12.02	17.73	5.17	30.00	PASS

Note1: 5720 MHz (UNII 3)= $Directional\ Gain = 10 \cdot \log \left[\frac{\sum_{j=1}^{N_{SS}} \left\{ \sum_{k=1}^{N_{ANT}} g_{j,k} \right\}^2}{N_{ANT}} \right] = 5.17\text{dBi} < 6\text{dBi}$, so the limit doesn't reduce.



<U-NII-2C, Power A, EBW2c, Nss 3 MCS0, 3S4T, TXBF>

Channel	Frequency	Conducted Power (dBm)					Max. Limit (dBm)	Directional Gain (dBi)	Highest EIRP (dBm)	Highest EIRP Limit (dBm)	Result
		Ant. 3	Ant. 4	Ant. 5	Ant. 6	Total					
144	5720 MHz (UNII 2C)	16.99	17.32	15.73	17.01	22.82	22.93	3.33	26.15	30.00	PASS
Channel	Frequency	Conducted Power (dBm)					Directional Gain (dBi)	Lowest EIRP (dBm)	Lowest EIRP Limit (dBm)	Result	
		Ant. 3	Ant. 4	Ant. 5	Ant. 6	Total					
144	5720 MHz (UNII 2C)	9.59	10.13	9.15	9.97	15.75	3.33	19.08	24.00	PASS	

Note1: 5720 MHz (UNII 2C)= $Directional\ Gain = 10 \cdot \log \left[\frac{\sum_{j=1}^{N_{SS}} \left\{ \sum_{k=1}^{N_{ANT}} g_{j,k} \right\}^2}{N_{ANT}} \right] = 3.33\text{dBi} < 6\text{dBi}$, so the limit doesn't reduce.

<U-NII-3, Power B, EBW3, Nss 3 MCS0, 3S4T, TXBF>

Channel	Frequency	Conducted Power (dBm)					Directional Gain (dBi)	Max. Limit (dBm)	Result
		Ant. 3	Ant. 4	Ant. 5	Ant. 6	Total			
144	5720 MHz (UNII 3)	11.76	12.04	10.55	11.78	17.59	3.33	30.00	PASS

Note1: 5720 MHz (UNII 3)= $Directional\ Gain = 10 \cdot \log \left[\frac{\sum_{j=1}^{N_{SS}} \left\{ \sum_{k=1}^{N_{ANT}} g_{j,k} \right\}^2}{N_{ANT}} \right] = 3.33\text{dBi} < 6\text{dBi}$, so the limit doesn't reduce.



Maximum Conducted Output Power Plot on Configuration IEEE 802.11ax 20MHz / Nss 1 MCS 0 / 1S4T CDD / Ant. 3 + Ant. 4 + Ant. 5 + Ant. 6 / CH144 / 5720 MHz (UNII 2C)

**802.11ax HEW20_Nss1,(MCS0)_4TX
5720MHz Straddle 5.47-5.725GHz**

AV Power

02/07/2020

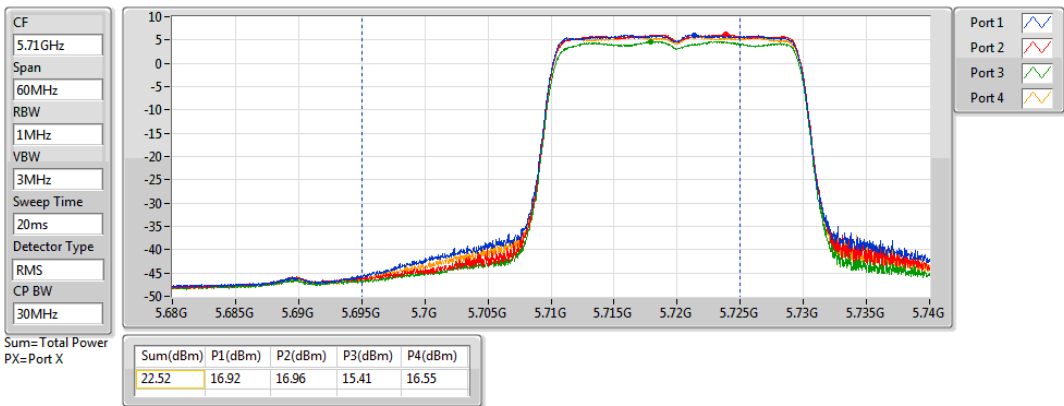

Maximum Conducted Output Power Plot on Configuration IEEE 802.11ax 20MHz / Nss 1 MCS 0 / 1S4T CDD / Ant. 3 + Ant. 4 + Ant. 5 + Ant. 6 / CH144 / 5720 MHz (UNII 3)

**802.11ax HEW20_Nss1,(MCS0)_4TX
5720MHz Straddle 5.725-5.85GHz**

AV Power

02/07/2020

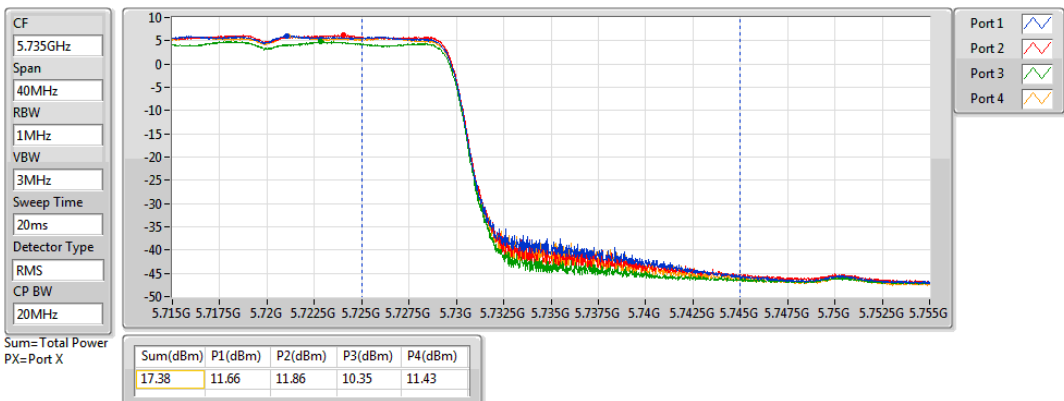



Maximum Conducted Output Power Plot on Configuration IEEE 802.11ax 20MHz / Nss 1 MCS 0 / 1S4T TXBF / Ant. 3 + Ant. 4 + Ant. 5 + Ant. 6 / CH144 / 5720 MHz (UNII 2C)

802.11ax HEW20-BF_Nss1,(MCS0)_4TX

AV Power

5720MHz Straddle 5.47-5.725GHz

02/07/2020

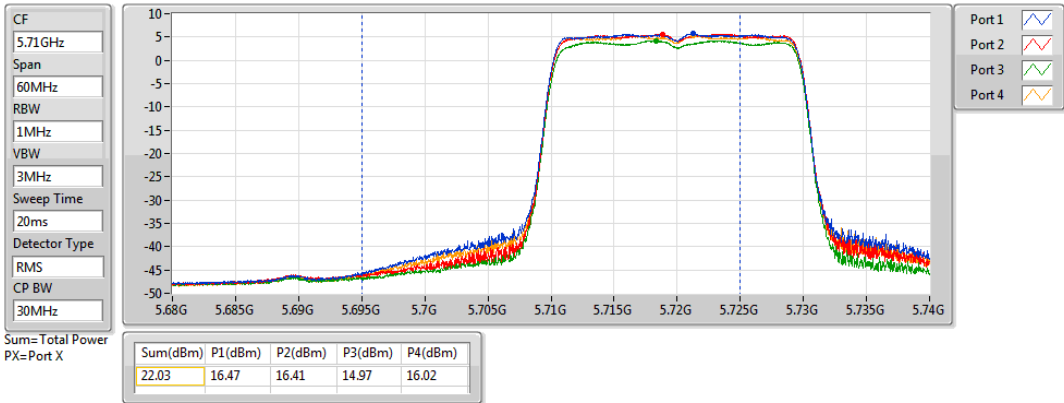

Maximum Conducted Output Power Plot on Configuration IEEE 802.11ax 20MHz / Nss 1 MCS 0 / 1S4T TXBF / Ant. 3 + Ant. 4 + Ant. 5 + Ant. 6 / CH144 / 5720 MHz (UNII 3)

802.11ax HEW20-BF_Nss1,(MCS0)_4TX

AV Power

5720MHz Straddle 5.725-5.85GHz

02/07/2020

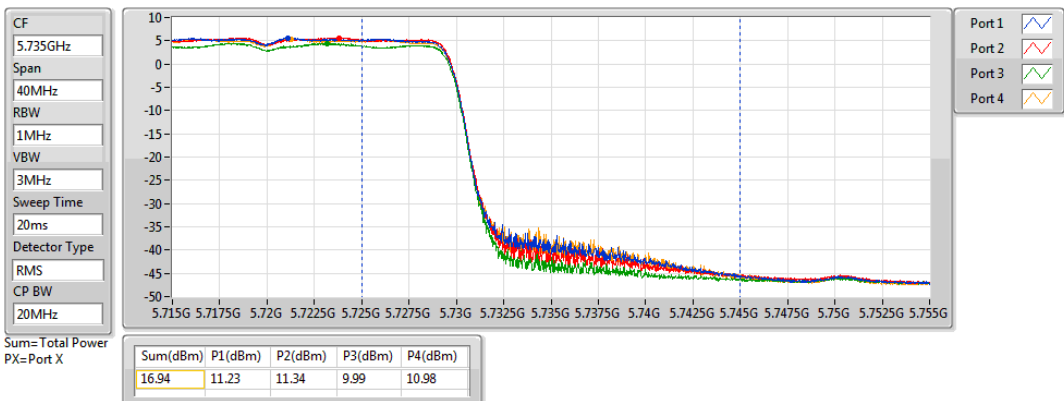



Maximum Conducted Output Power Plot on Configuration IEEE 802.11ax 20MHz / Nss 2 MCS 0 / 2S4T TXBF / Ant. 3 + Ant. 4 + Ant. 5 + Ant. 6 / CH144 / 5720 MHz (UNII 2C)

802.11ax HEW20-BF_Nss2,(MCS0)_4TX
5720MHz Straddle 5.47-5.725GHz

AV Power

02/07/2020

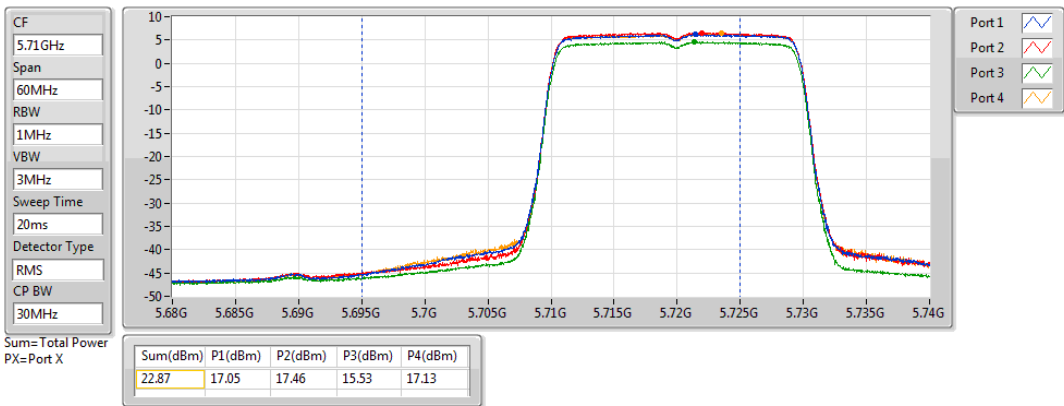

Maximum Conducted Output Power Plot on Configuration IEEE 802.11ax 20MHz / Nss 2 MCS 0 / 2S4T TXBF / Ant. 3 + Ant. 4 + Ant. 5 + Ant. 6 / CH144 / 5720 MHz (UNII 3)

802.11ax HEW20-BF_Nss2,(MCS0)_4TX
5720MHz Straddle 5.725-5.85GHz

AV Power

02/07/2020

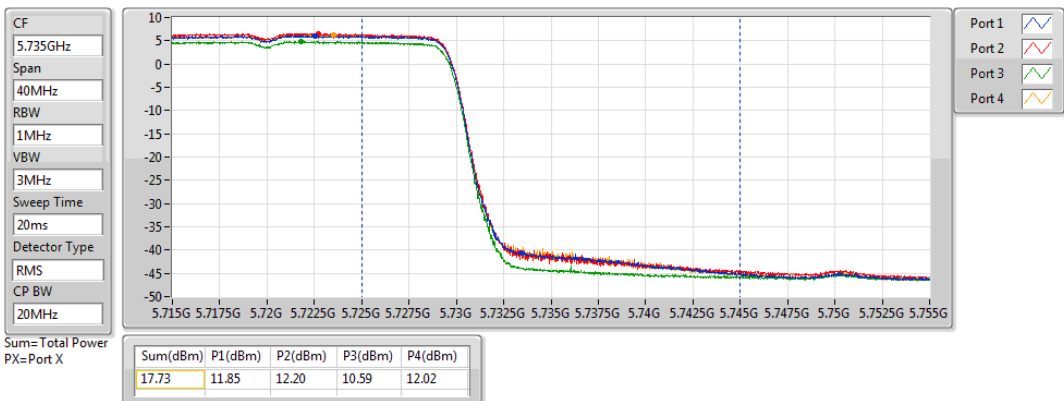



Maximum Conducted Output Power Plot on Configuration IEEE 802.11ax 20MHz / Nss 3 MCS 0 / 3S4T TXBF / Ant. 3 + Ant. 4 + Ant. 5 + Ant. 6 / CH144 / 5720 MHz (UNII 2C)

802.11ax HEW20-BF_Nss3,(MCS0)_4TX

AV Power

5720MHz Straddle 5.47-5.725GHz

03/07/2020

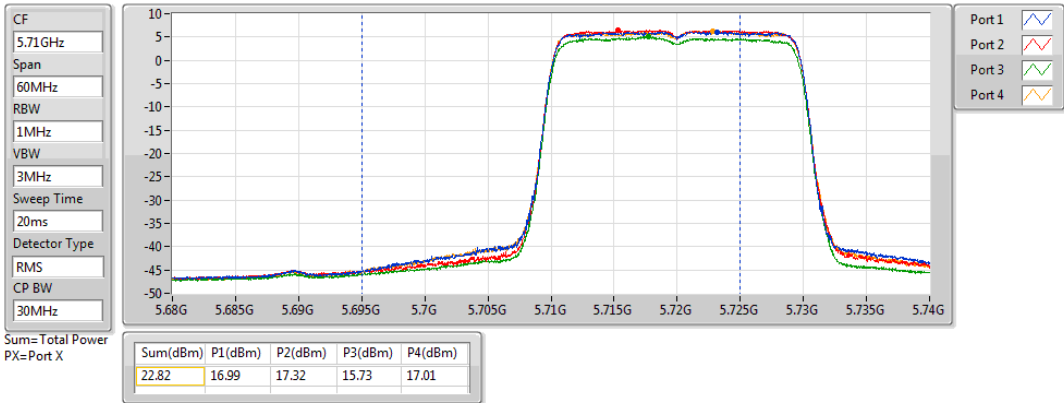

Maximum Conducted Output Power Plot on Configuration IEEE 802.11ax 20MHz / Nss 3 MCS 0 / 3S4T TXBF / Ant. 3 + Ant. 4 + Ant. 5 + Ant. 6 / CH144 / 5720 MHz (UNII 3)

802.11ax HEW20-BF_Nss3,(MCS0)_4TX

AV Power

5720MHz Straddle 5.725-5.85GHz

03/07/2020

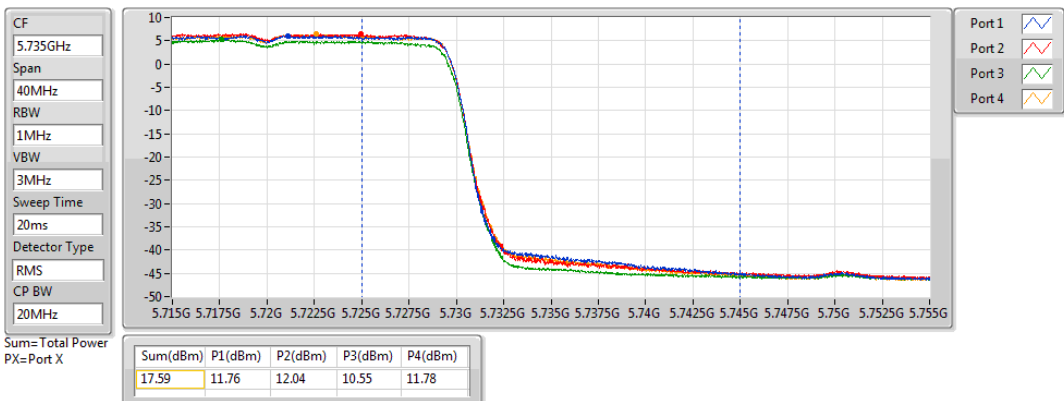



Configuration IEEE 802.11ax 40MHz

<U-NII-2C, Power A, EBW2c, Nss 1 MCS0, 1S4T, CDD>

Channel	Frequency	Conducted Power (dBm)					Max. Limit (dBm)	Max. Gain (dBi)	Highest EIRP (dBm)	Highest EIRP Limit (dBm)	Result
		Ant. 3	Ant. 4	Ant. 5	Ant. 6	Total					
142	5710 MHz (UNII 2C)	18.36	17.93	16.84	18.03	23.85	23.98	4.58	28.43	30.00	PASS
Channel	Frequency	Conducted Power (dBm)					Max. Gain (dBi)	Lowest EIRP (dBm)	Lowest EIRP Limit (dBm)	Result	
		Ant. 3	Ant. 4	Ant. 5	Ant. 6	Total					
142	5710 MHz (UNII 2C)	11.11	11.13	10.29	11.75	17.12	4.58	21.70	24.00	PASS	

Note1: 5710 MHz (UNII 2C)= Max. Limit= 4.58dBi <6dBi, so the limit doesn't reduce.

<U-NII-3, Power B, EBW3, Nss 1 MCS0, 1S4T, CDD>

Channel	Frequency	Conducted Power (dBm)					Max. Gain (dBi)	Max. Limit (dBm)	Result
		Ant. 3	Ant. 4	Ant. 5	Ant. 6	Total			
142	5710 MHz (UNII 3)	8.67	8.37	7.41	8.31	14.24	4.58	30.00	PASS

Note1: 5720 MHz (UNII 3)= Max. Limit= 4.58dBi <6dBi, so the limit doesn't reduce.



<U-NII-2C, Power A, EBW2c, Nss 1 MCS0, 1S4T, TXBF>

Channel	Frequency	Conducted Power (dBm)					Max. Limit (dBm)	Directional Gain (dBi)	Highest EIRP (dBm)	Highest EIRP Limit (dBm)	Result
		Ant. 3	Ant. 4	Ant. 5	Ant. 6	Total					
142	5710 MHz (UNII 2C)	17.63	17.19	16.32	16.91	23.06	23.18	6.80	29.86	30.00	PASS
Channel	Frequency	Conducted Power (dBm)					Directional Gain (dBi)	Lowest EIRP (dBm)	Lowest EIRP Limit (dBm)	Result	
		Ant. 3	Ant. 4	Ant. 5	Ant. 6	Total					
142	5710 MHz (UNII 2C)	10.61	10.59	9.89	11.23	16.63	6.80	23.43	24.00	PASS	

Note1: 5710 MHz (UNII 2C) = Directional Gain = $10 \cdot \log \left[\frac{\sum_{j=1}^{N_{SS}} \left\{ \sum_{k=1}^{N_{ANT}} g_{j,k} \right\}^2}{N_{ANT}} \right] = 6.80\text{dBi} > 6\text{dBi}$, so the power limit shall be

reduced to 23.98-(6.80-6)=23.18dBm.

<U-NII-3, Power B, EBW3, Nss 1 MCS0, 1S4T, TXBF>

Channel	Frequency	Conducted Power (dBm)					Directional Gain (dBi)	Max. Limit (dBm)	Result
		Ant. 3	Ant. 4	Ant. 5	Ant. 6	Total			
142	5710 MHz (UNII 3)	7.77	7.57	6.74	7.19	13.36	6.80	29.20	PASS

Note1: 5710 MHz (UNII 3) = Directional Gain = $10 \cdot \log \left[\frac{\sum_{j=1}^{N_{SS}} \left\{ \sum_{k=1}^{N_{ANT}} g_{j,k} \right\}^2}{N_{ANT}} \right] = 6.80\text{dBi} > 6\text{dBi}$, so the power limit shall be

reduced to 30-(6.80-6)=29.20dBm.



<U-NII-2C, Power A, EBW2c, Nss 2 MCS0, 2S4T, TXBF>

Channel	Frequency	Conducted Power (dBm)					Max. Limit (dBm)	Directional Gain (dBi)	Highest EIRP (dBm)	Highest EIRP Limit (dBm)	Result
		Ant. 3	Ant. 4	Ant. 5	Ant. 6	Total					
142	5710 MHz (UNII 2C)	17.90	17.98	16.93	18.09	23.77	23.98	5.08	28.85	30.00	PASS
Channel	Frequency	Conducted Power (dBm)					Directional Gain (dBi)	Lowest EIRP (dBm)	Lowest EIRP Limit (dBm)	Result	
		Ant. 3	Ant. 4	Ant. 5	Ant. 6	Total					
142	5710 MHz (UNII 2C)	10.72	10.64	10.17	11.39	16.77	5.08	21.85	24.00	PASS	

Note1: 5710 MHz (UNII 2C)= $Directional\ Gain = 10 \cdot \log \left[\frac{\sum_{j=1}^{N_{SS}} \left\{ \sum_{k=1}^{N_{ANT}} g_{j,k} \right\}^2}{N_{ANT}} \right] = 5.08\text{dBi} < 6\text{dBi}$, so the limit doesn't reduce.

<U-NII-3, Power B, EBW3, Nss 2 MCS0, 2S4T, TXBF>

Channel	Frequency	Conducted Power (dBm)					Directional Gain (dBi)	Max. Limit (dBm)	Result
		Ant. 3	Ant. 4	Ant. 5	Ant. 6	Total			
142	5710 MHz (UNII 3)	8.04	8.44	7.45	8.21	14.07	5.08	30.00	PASS

Note1: 5710 MHz (UNII 3)= $Directional\ Gain = 10 \cdot \log \left[\frac{\sum_{j=1}^{N_{SS}} \left\{ \sum_{k=1}^{N_{ANT}} g_{j,k} \right\}^2}{N_{ANT}} \right] = 5.08\text{dBi} < 6\text{dBi}$, so the limit doesn't reduce.



<U-NII-2C, Power A, EBW2c, Nss 3 MCS0, 3S4T, TXBF>

Channel	Frequency	Conducted Power (dBm)					Max. Limit (dBm)	Directional Gain (dBi)	Highest EIRP (dBm)	Highest EIRP Limit (dBm)	Result
		Ant. 3	Ant. 4	Ant. 5	Ant. 6	Total					
142	5710 MHz (UNII 2C)	18.03	18.10	16.87	18.16	23.84	23.98	3.20	27.04	30.00	PASS
Channel	Frequency	Conducted Power (dBm)					Directional Gain (dBi)	Lowest EIRP (dBm)	Lowest EIRP Limit (dBm)	Result	
		Ant. 3	Ant. 4	Ant. 5	Ant. 6	Total					
142	5710 MHz (UNII 2C)	10.26	10.36	9.73	10.97	16.37	3.20	19.57	24.00	PASS	

Note1: 5710 MHz (UNII 2C)= $Directional\ Gain = 10 \cdot \log \left[\frac{\sum_{j=1}^{N_{SS}} \left\{ \sum_{k=1}^{N_{ANT}} g_{j,k} \right\}^2}{N_{ANT}} \right] = 3.20\text{dBi} < 6\text{dBi}$, so the limit doesn't reduce.

<U-NII-3, Power B, EBW3, Nss 3 MCS0, 3S4T, TXBF>

Channel	Frequency	Conducted Power (dBm)					Directional Gain (dBi)	Max. Limit (dBm)	Result
		Ant. 3	Ant. 4	Ant. 5	Ant. 6	Total			
142	5710 MHz (UNII 3)	8.08	8.48	7.51	8.31	14.13	3.20	30.00	PASS

Note1: 5710 MHz (UNII 3)= $Directional\ Gain = 10 \cdot \log \left[\frac{\sum_{j=1}^{N_{SS}} \left\{ \sum_{k=1}^{N_{ANT}} g_{j,k} \right\}^2}{N_{ANT}} \right] = 3.20\text{dBi} < 6\text{dBi}$, so the limit doesn't reduce.



Maximum Conducted Output Power Plot on Configuration IEEE 802.11ax 40MHz / Nss 1 MCS 0 / 1S4T CDD / Ant. 3 + Ant. 4 + Ant. 5 + Ant. 6 / CH142 / 5710 MHz (UNII 2C)

802.11ax HEW40_Nss1,(MCS0)_4TX

AV Power

5710MHz Straddle 5.47-5.725GHz

02/07/2020

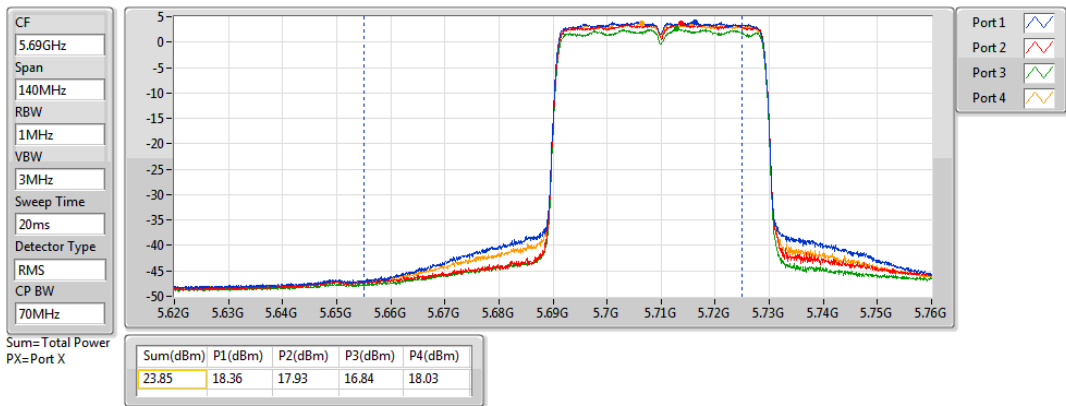

Maximum Conducted Output Power Plot on Configuration IEEE 802.11ax 40MHz / Nss 1 MCS 0 / 1S4T CDD / Ant. 3 + Ant. 4 + Ant. 5 + Ant. 6 / CH142 / 5710 MHz (UNII 3)

802.11ax HEW40_Nss1,(MCS0)_4TX

AV Power

5710MHz Straddle 5.725-5.85GHz

02/07/2020

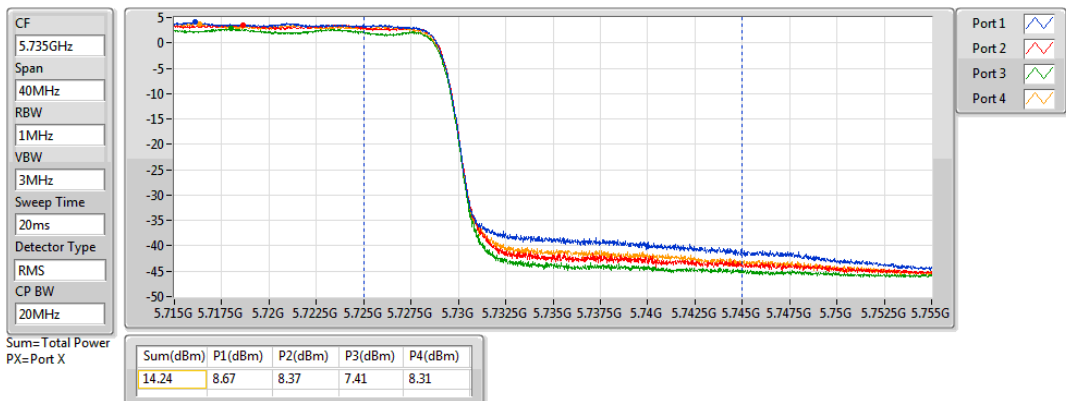



Maximum Conducted Output Power Plot on Configuration IEEE 802.11ax 40MHz / Nss 1 MCS 0 / 1S4T TXBF / Ant. 3 + Ant. 4 + Ant. 5 + Ant. 6 / CH142 / 5710 MHz (UNII 2C)

802.11ax HEW40-BF_Nss1,(MCS0)_4TX

AV Power

5710MHz Straddle 5.47-5.725GHz

02/07/2020

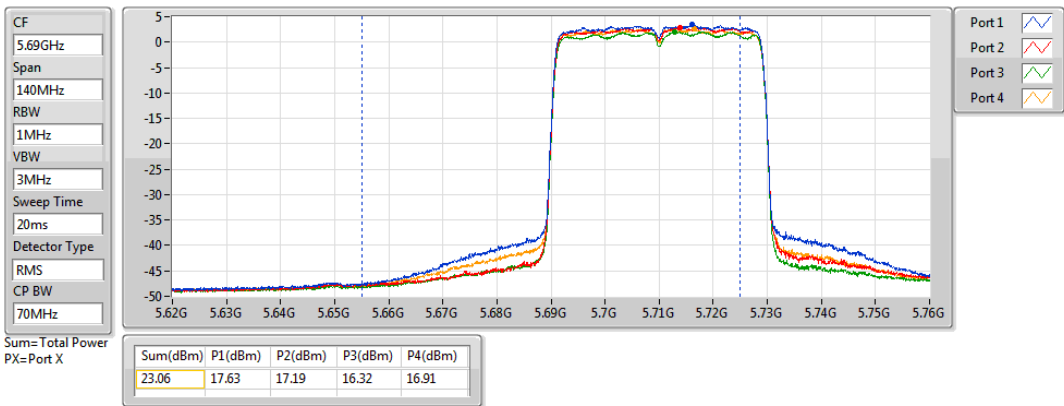

Maximum Conducted Output Power Plot on Configuration IEEE 802.11ax 40MHz / Nss 1 MCS 0 / 1S4T TXBF / Ant. 3 + Ant. 4 + Ant. 5 + Ant. 6 / CH142 / 5710 MHz (UNII 3)

802.11ax HEW40-BF_Nss1,(MCS0)_4TX

AV Power

5710MHz Straddle 5.725-5.85GHz

02/07/2020

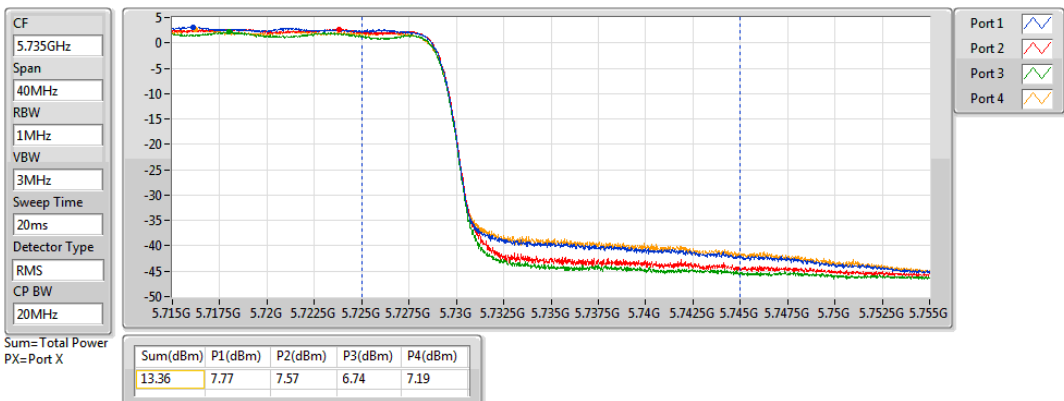



Maximum Conducted Output Power Plot on Configuration IEEE 802.11ax 40MHz / Nss 2 MCS 0 / 2S4T TXBF / Ant. 3 + Ant. 4 + Ant. 5 + Ant. 6 / CH142 / 5710 MHz (UNII 2C)

802.11ax HEW40-BF_Nss2,(MCS0)_4TX

AV Power

5710MHz Straddle 5.47-5.725GHz

02/07/2020

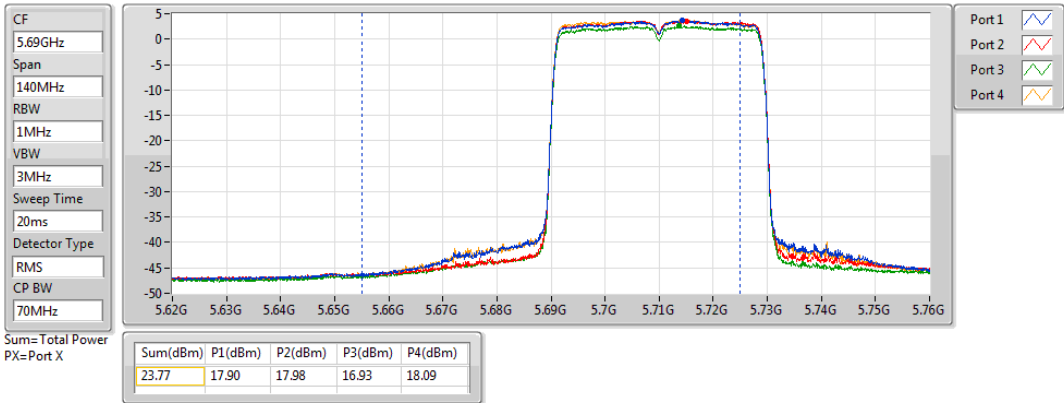

Maximum Conducted Output Power Plot on Configuration IEEE 802.11ax 40MHz / Nss 2 MCS 0 / 2S4T TXBF / Ant. 3 + Ant. 4 + Ant. 5 + Ant. 6 / CH142 / 5710 MHz (UNII 3)

802.11ax HEW40-BF_Nss2,(MCS0)_4TX

AV Power

5710MHz Straddle 5.725-5.85GHz

02/07/2020

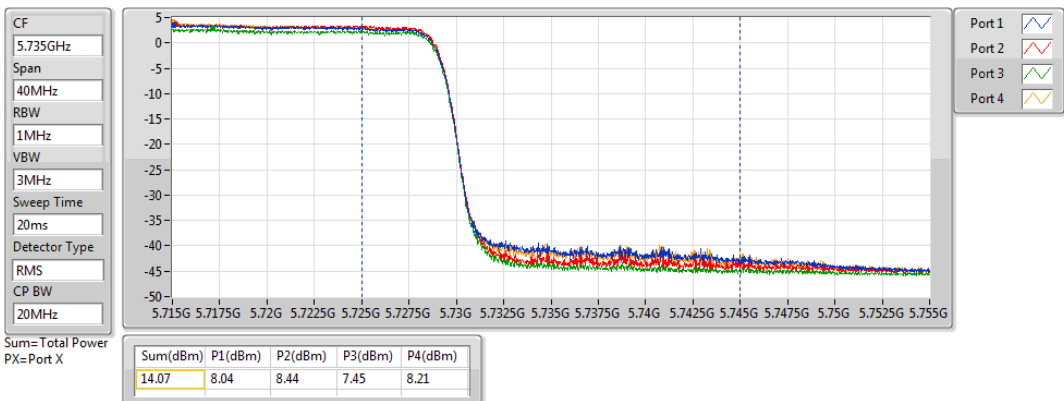



Maximum Conducted Output Power Plot on Configuration IEEE 802.11ax 40MHz / Nss 3 MCS 0 / 3S4T TXBF / Ant. 3 + Ant. 4 + Ant. 5 + Ant. 6 / CH142 / 5710 MHz (UNII 2C)

802.11ax HEW40-BF_Nss3,(MCS0)_4TX

AV Power

5710MHz Straddle 5.47-5.725GHz

03/07/2020

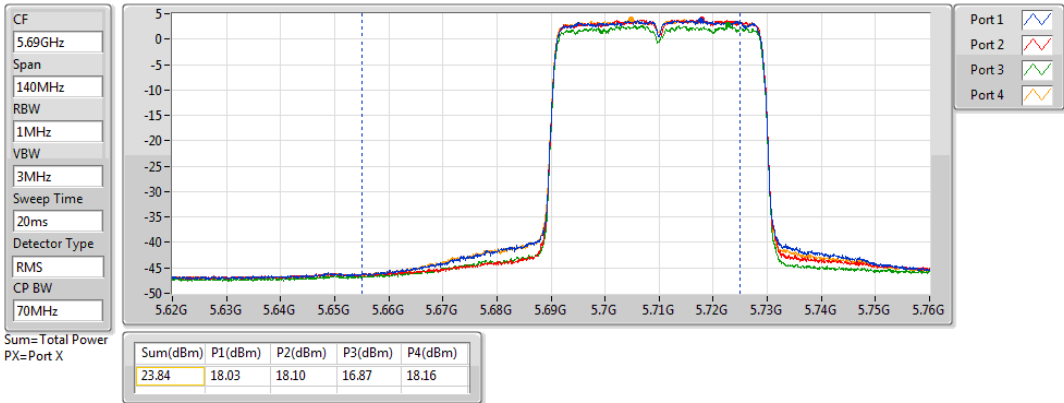

Maximum Conducted Output Power Plot on Configuration IEEE 802.11ax 40MHz / Nss 3 MCS 0 / 3S4T TXBF / Ant. 3 + Ant. 4 + Ant. 5 + Ant. 6 / CH142 / 5710 MHz (UNII 3)

802.11ax HEW40-BF_Nss3,(MCS0)_4TX

AV Power

5710MHz Straddle 5.725-5.85GHz

03/07/2020

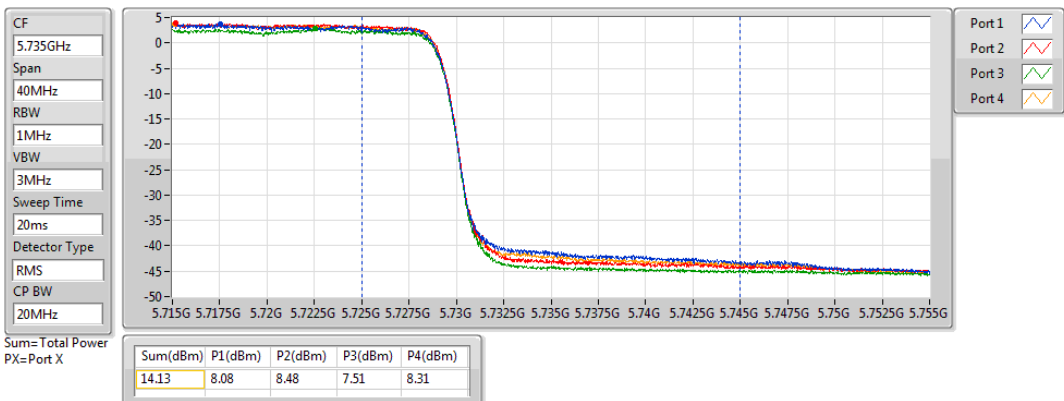



Configuration IEEE 802.11ax 80MHz

<U-NII-2C, Power A, EBW2c, Nss 1 MCS0, 1S4T, CDD>

Channel	Frequency	Conducted Power (dBm)					Max. Limit (dBm)	Max. Gain (dBi)	Highest EIRP (dBm)	Highest EIRP Limit (dBm)	Result
		Ant. 3	Ant. 4	Ant. 5	Ant. 6	Total					
138	5690 MHz (UNII 2C)	18.06	18.11	17.48	17.79	23.89	23.98	4.23	28.12	30.00	PASS
Channel	Frequency	Conducted Power (dBm)					Max. Gain (dBi)	Lowest EIRP (dBm)	Lowest EIRP Limit (dBm)	Result	
		Ant. 3	Ant. 4	Ant. 5	Ant. 6	Total					
138	5690 MHz (UNII 2C)	11.44	11.51	10.66	11.51	17.31	4.23	21.54	24.00	PASS	

Note1: 5690 MHz (UNII 2C)= Max. Limit= 4.23dBi <6dBi, so the limit doesn't reduce.

<U-NII-3, Power B, EBW3, Nss 1 MCS0, 1S4T, CDD>

Channel	Frequency	Conducted Power (dBm)					Max. Gain (dBi)	Max. Limit (dBm)	Result
		Ant. 3	Ant. 4	Ant. 5	Ant. 6	Total			
138	5690 MHz (UNII 3)	4.83	5.11	4.68	4.50	10.81	4.23	30.00	PASS

Note1: 5690 MHz (UNII 3)= Max. Limit= 4.23dBi <6dBi, so the limit doesn't reduce.



<U-NII-2C, Power A, EBW2c, MCS0, 1S4T, TXBF>

Channel	Frequency	Conducted Power (dBm)					Max. Limit (dBm)	Directional Gain (dBi)	Highest EIRP (dBm)	Highest EIRP Limit (dBm)	Result
		Ant. 3	Ant. 4	Ant. 5	Ant. 6	Total					
138	5690 MHz (UNII 2C)	17.36	17.34	16.63	17.08	23.13	23.31	6.67	29.80	30.00	PASS
Channel	Frequency	Conducted Power (dBm)					Directional Gain (dBi)	Lowest EIRP (dBm)	Lowest EIRP Limit (dBm)	Result	
		Ant. 3	Ant. 4	Ant. 5	Ant. 6	Total					
138	5690 MHz (UNII 2C)	10.14	10.59	9.69	10.61	16.29	6.67	22.96	24.00	PASS	

Note1: 5690 MHz (UNII 2C) = Directional Gain = $10 \cdot \log \left[\frac{\sum_{j=1}^{N_{SE}} \left\{ \sum_{k=1}^{N_{ANT}} g_{j,k} \right\}^2}{N_{ANT}} \right]$ = 6.67dBi > 6dBi, so the power limit shall be

reduced to 23.98-(6.67-6)=23.31dBm.

<U-NII-3, Power B, EBW3, MCS0, 1S4T, TXBF>

Channel	Frequency	Conducted Power (dBm)					Directional Gain (dBi)	Max. Limit (dBm)	Result
		Ant. 3	Ant. 4	Ant. 5	Ant. 6	Total			
138	5690 MHz (UNII 3)	4.11	4.24	3.76	3.78	10.00	6.67	29.33	PASS

Note1: 5690 MHz (UNII 3) = Directional Gain = $10 \cdot \log \left[\frac{\sum_{j=1}^{N_{SE}} \left\{ \sum_{k=1}^{N_{ANT}} g_{j,k} \right\}^2}{N_{ANT}} \right]$ = 6.67dBi > 6dBi, so the power limit shall be

reduced to 30-(6.67-6)=29.33dBm.



<U-NII-2C, Power A, EBW2c, Nss 2 MCS0, 2S4T, TXBF>

Channel	Frequency	Conducted Power (dBm)					Max. Limit (dBm)	Directional Gain (dBi)	Highest EIRP (dBm)	Highest EIRP Limit (dBm)	Result
		Ant. 3	Ant. 4	Ant. 5	Ant. 6	Total					
138	5690 MHz (UNII 2C)	17.97	18.06	17.18	17.88	23.81	23.98	4.96	28.77	30.00	PASS
Channel	Frequency	Conducted Power (dBm)					Directional Gain (dBi)	Lowest EIRP (dBm)	Lowest EIRP Limit (dBm)	Result	
		Ant. 3	Ant. 4	Ant. 5	Ant. 6	Total					
138	5690 MHz (UNII 2C)	10.41	10.65	9.72	10.64	16.39	4.96	21.35	24.00	PASS	

Note1: 5690 MHz (UNII 2C)= $Directional\ Gain = 10 \cdot \log \left[\frac{\sum_{j=1}^{N_{SS}} \left\{ \sum_{k=1}^{N_{ANT}} g_{j,k} \right\}^2}{N_{ANT}} \right] = 4.96\text{dBi} < 6\text{dBi}$, so the limit doesn't reduce.

<U-NII-3, Power B, EBW3, Nss 2 MCS0, 2S4T, TXBF>

Channel	Frequency	Conducted Power (dBm)					Directional Gain (dBi)	Max. Limit (dBm)	Result
		Ant. 3	Ant. 4	Ant. 5	Ant. 6	Total			
138	5690 MHz (UNII 3)	4.63	5.23	4.34	4.39	10.68	4.96	30.00	PASS

Note1: 5690 MHz (UNII 3)= $Directional\ Gain = 10 \cdot \log \left[\frac{\sum_{j=1}^{N_{SS}} \left\{ \sum_{k=1}^{N_{ANT}} g_{j,k} \right\}^2}{N_{ANT}} \right] = 4.96\text{dBi} < 6\text{dBi}$, so the limit doesn't reduce.



<U-NII-2C, Power A, EBW2c, Nss 3 MCS0, 3S4T, TXBF>

Channel	Frequency	Conducted Power (dBm)					Max. Limit (dBm)	Directional Gain (dBi)	Highest EIRP (dBm)	Highest EIRP Limit (dBm)	Result
		Ant. 3	Ant. 4	Ant. 5	Ant. 6	Total					
138	5690 MHz (UNII 2C)	18.00	18.25	17.46	17.95	23.94	23.98	3.06	27.00	30.00	PASS
Channel	Frequency	Conducted Power (dBm)					Directional Gain (dBi)	Lowest EIRP (dBm)	Lowest EIRP Limit (dBm)	Result	
		Ant. 3	Ant. 4	Ant. 5	Ant. 6	Total					
138	5690 MHz (UNII 2C)	10.49	10.82	9.83	10.69	16.49	3.06	19.55	24.00	PASS	

Note1: 5690 MHz (UNII 2C)= $Directional\ Gain = 10 \cdot \log \left[\frac{\sum_{j=1}^{N_{SS}} \left\{ \sum_{k=1}^{N_{ANT}} g_{j,k} \right\}^2}{N_{ANT}} \right] = 3.06\text{dBi} < 6\text{dBi}$, so the limit doesn't reduce.

<U-NII-3, Power B, EBW3, Nss 3 MCS0, 3S4T, TXBF>

Channel	Frequency	Conducted Power (dBm)					Directional Gain (dBi)	Max. Limit (dBm)	Result
		Ant. 3	Ant. 4	Ant. 5	Ant. 6	Total			
138	5690 MHz (UNII 3)	4.69	5.28	4.65	4.65	10.85	3.06	30.00	PASS

Note1: 5690 MHz (UNII 3)= $Directional\ Gain = 10 \cdot \log \left[\frac{\sum_{j=1}^{N_{SS}} \left\{ \sum_{k=1}^{N_{ANT}} g_{j,k} \right\}^2}{N_{ANT}} \right] = 3.06\text{dBi} < 6\text{dBi}$, so the limit doesn't reduce.



Maximum Conducted Output Power Plot on Configuration IEEE 802.11ax 80MHz / Nss 1 MCS 0 / 1S4T CDD / Ant. 3 + Ant. 4 + Ant. 5 + Ant. 6 / CH138 / 5690 MHz (UNII 2C)

**802.11ax HEW80_Nss1,(MCS0)_4TX
5690MHz Straddle 5.47-5.725GHz**

AV Power

02/07/2020

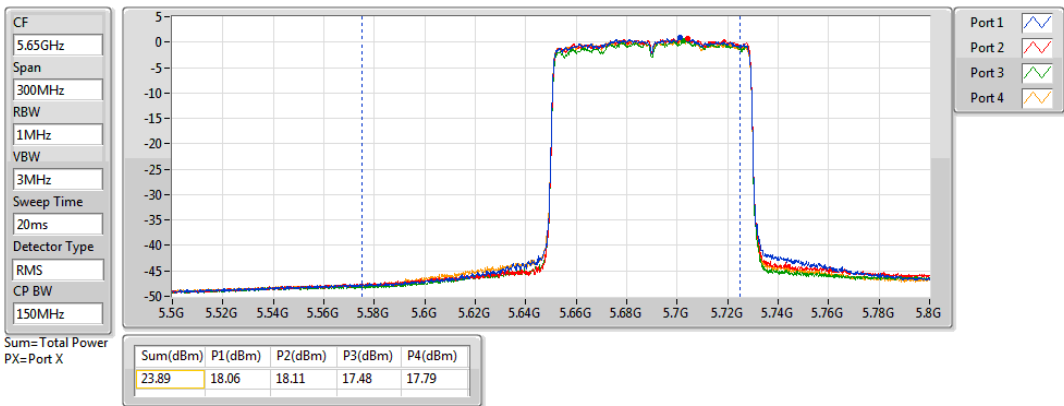

Maximum Conducted Output Power Plot on Configuration IEEE 802.11ax 80MHz / Nss 1 MCS 0 / 1S4T CDD / Ant. 3 + Ant. 4 + Ant. 5 + Ant. 6 / CH138 / 5690 MHz (UNII 3)

**802.11ax HEW80_Nss1,(MCS0)_4TX
5690MHz Straddle 5.725-5.85GHz**

AV Power

02/07/2020

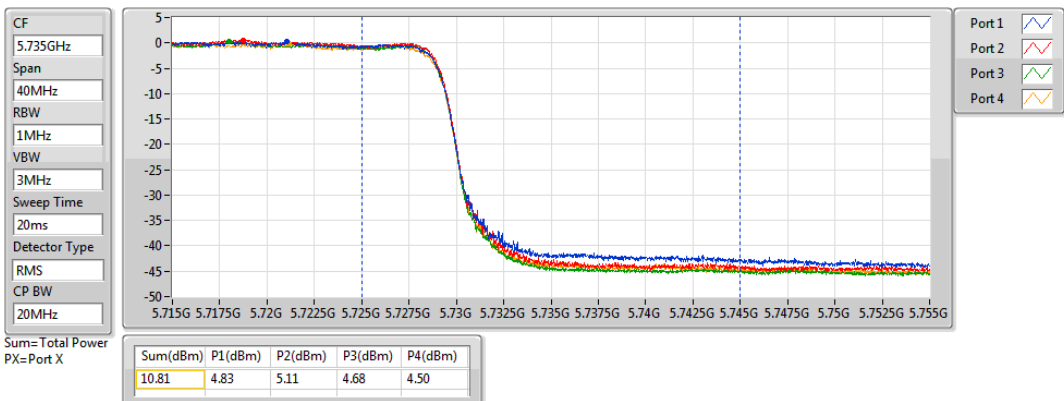



Maximum Conducted Output Power Plot on Configuration IEEE 802.11ax 80MHz / Nss 1 MCS 0 / 1S4T TXBF / Ant. 3 + Ant. 4 + Ant. 5 + Ant. 6 / CH138 / 5690 MHz (UNII 2C)

802.11ax HEW80-BF_Nss1,(MCS0)_4TX

AV Power

5690MHz Straddle 5.47-5.725GHz

02/07/2020

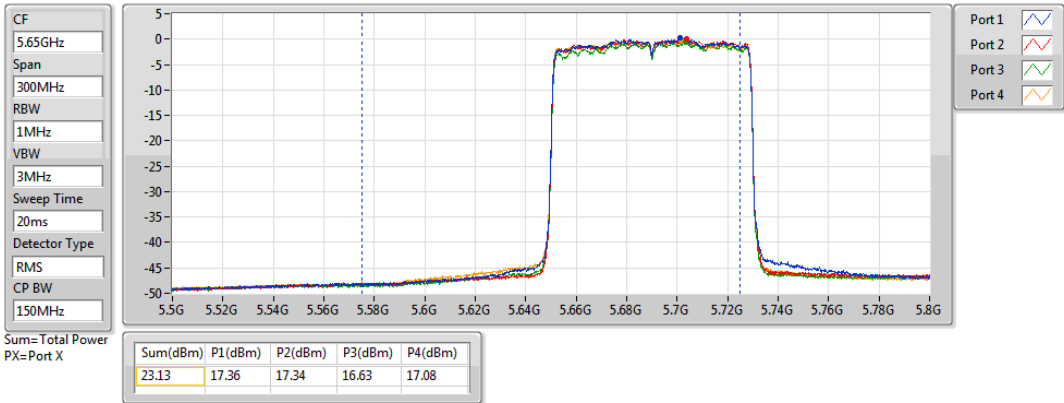

Maximum Conducted Output Power Plot on Configuration IEEE 802.11ax 80MHz / Nss 1 MCS 0 / 1S4T TXBF / Ant. 3 + Ant. 4 + Ant. 5 + Ant. 6 / CH138 / 5690 MHz (UNII 3)

802.11ax HEW80-BF_Nss1,(MCS0)_4TX

AV Power

5690MHz Straddle 5.725-5.85GHz

02/07/2020

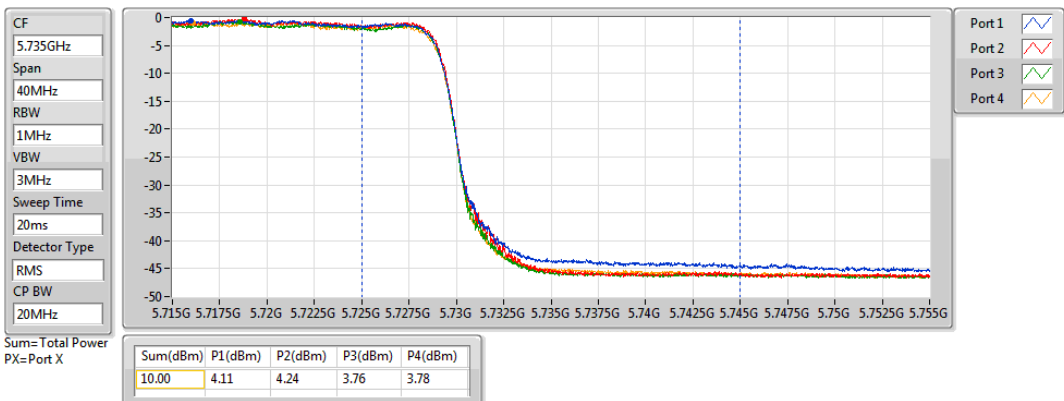



Maximum Conducted Output Power Plot on Configuration IEEE 802.11ax 80MHz / Nss 2 MCS 0 / 2S4T TXBF / Ant. 3 + Ant. 4 + Ant. 5 + Ant. 6 / CH138 / 5690 MHz (UNII 2C)

802.11ax HEW80-BF_Nss2,(MCS0)_4TX

AV Power

5690MHz Straddle 5.47-5.725GHz

02/07/2020

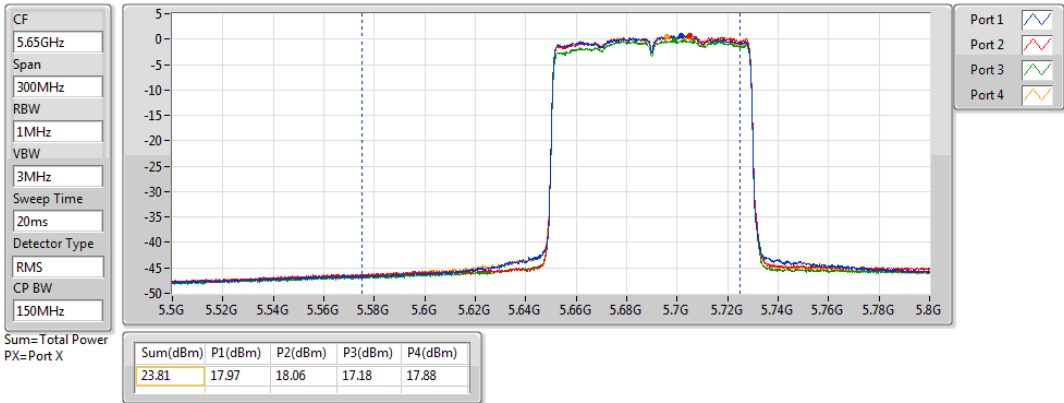

Maximum Conducted Output Power Plot on Configuration IEEE 802.11ax 80MHz / Nss 2 MCS 0 / 2S4T TXBF / Ant. 3 + Ant. 4 + Ant. 5 + Ant. 6 / CH138 / 5690 MHz (UNII 3)

802.11ax HEW80-BF_Nss2,(MCS0)_4TX

AV Power

5690MHz Straddle 5.725-5.85GHz

02/07/2020

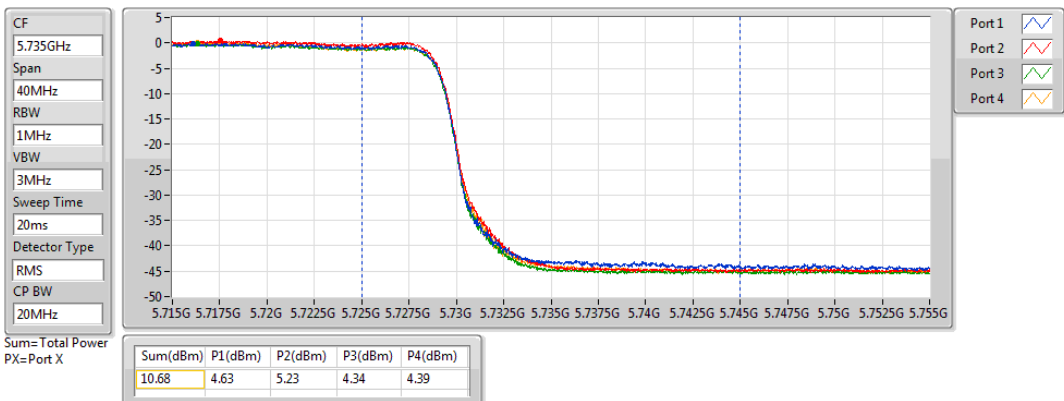



Maximum Conducted Output Power Plot on Configuration IEEE 802.11ax 80MHz / Nss 3 MCS 0 / 3S4T TXBF / Ant. 3 + Ant. 4 + Ant. 5 + Ant. 6 / CH138 / 5690 MHz (UNII 2C)

802.11ax HEW80-BF_Nss3,(MCS0)_4TX

AV Power

5690MHz Straddle 5.47-5.725GHz

03/07/2020

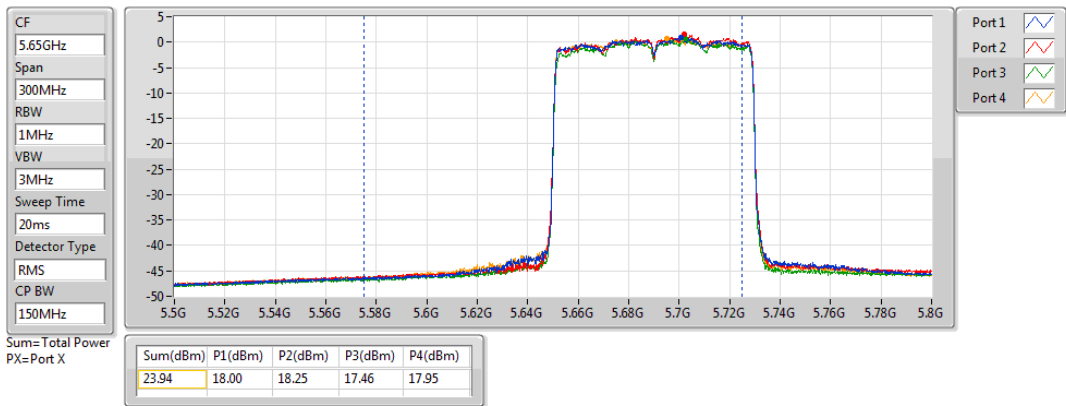

Maximum Conducted Output Power Plot on Configuration IEEE 802.11ax 80MHz / Nss 3 MCS 0 / 3S4T TXBF / Ant. 3 + Ant. 4 + Ant. 5 + Ant. 6 / CH138 / 5690 MHz (UNII 3)

802.11ax HEW80-BF_Nss3,(MCS0)_4TX

AV Power

5690MHz Straddle 5.725-5.85GHz

03/07/2020

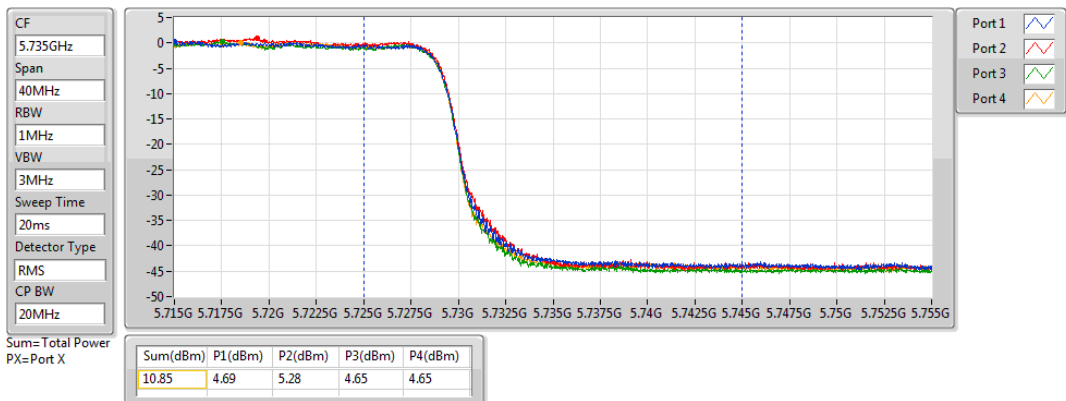

2.4.3. Power Spectral Density Measurement for Band-Crossing Channel

2.4.3.1 Limit

Operation Band	EUT Category		Limit
U-NII-2C	<input checked="" type="checkbox"/>	---	11dBm/ MHz
U-NII-3	<input checked="" type="checkbox"/>	---	30 dBm/500kHz

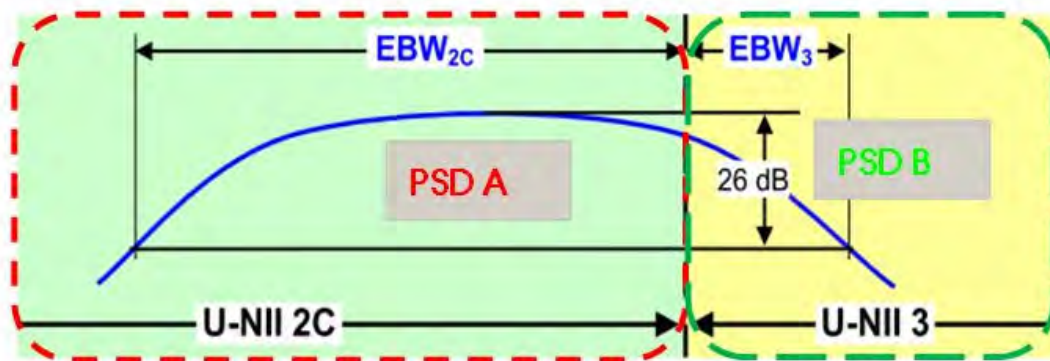

Emission Bandwidth (EBW) within a Band for Band-Crossing Signals

1. Limit was performed in accordance with KDB 789033 D02 General UNII Test Procedures New Rules v02r01, in section “In-band emission limits (A)(2)”, 14/12/2017
2. PSD A: Limit based on EBW2c = 11dBm/ MHz
3. PSD B: Limit based on EBW3 = 30dBm/500kHz

2.4.3.2 Measuring Instruments and Setting

Please refer to section 3 of equipments list in this report. The following table is the setting of the spectrum analyzer.

For U-NII-2C band:

Spectrum Parameter	Setting
Attenuation	Auto
Span Frequency	Encompass the entire emissions bandwidth (EBW) of the signal
RBW	1 MHz
VBW	≥ 3 MHz
Detector	RMS
Trace	Average
Sweep Time	Auto, trigger set to “free run”
Trace average	100 times



For U-NII-3 band:

Spectrum Parameter Setting	Setting
Attenuation	Auto
Span Frequency	Encompass the entire emissions bandwidth (EBW) of the signal
RBW	500kHz
VBW	≥ 3 RBW
Detector	RMS
Trace	Average
Sweep Time	Auto, set to "free run"
Trace average	100 times

2.4.3.3 Test Procedure

1. The transmitter output (antenna port) was connected RF switch to the spectrum analyzer.
2. For U-NII-1, U-NII-2A & U-NII-2C Bands, PSD Measure was performed in accordance with 789033 D02 General UNII Test Procedures New Rules v02r01, in section "Maximum conducted output power(E)(2)(d) Method SA-2", 14/12/2017.
3. For U-NII-3 Band, PSD Measure was performed in accordance with 789033 D02 General UNII Test Procedures New Rules v02r01, in section "Maximum Power Spectral Density (F)(5)", 14/12/2017.
4. Multiple antenna systems was performed in accordance 662911 D01 Multiple Transmitter Output v02r01 in-Band Power Spectral Density (PSD) Measurements (b) Measure and sum spectral maximum across the outputs.
5. With this technique, spectra are measured at each output of the device at the required resolution bandwidth. The maximum value(peak) of each spectrum is determined
6. These maximum values are then summed mathematically in linear power units across the outputs

2.4.3.4 Test Setup Layout

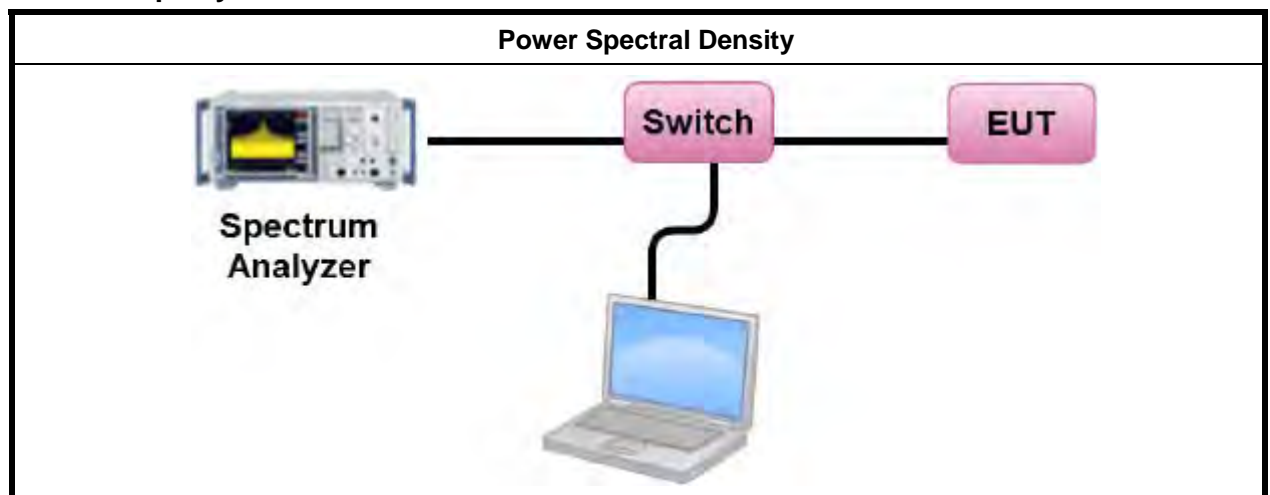



2.4.3.5 Test Deviation

There are no deviation with the original standard.

2.4.3.6 EUT Operation during Test

The EUT was programmed to be in continuously transmitting mode.



2.4.3.7 Test Result of Power Spectral Density

Configuration IEEE 802.11a

<U-NII-2C, PSD A, EBW2c, OFDM / 1S4T CDD / Ant. 3 + Ant. 4 + Ant. 5 + Ant. 6>

Channel	Frequency	Power Density (dBm/MHz)	Directional Gain (dBi)	Max. Limit (dBm/MHz)	Result
144	5720 MHz (UNII 2C)	10.14	6.85	10.15	PASS

<U-NII-3, PSD B, EBW3, OFDM / 1S4T CDD / Ant. 3 + Ant. 4 + Ant. 5 + Ant. 6>

Channel	Frequency	Power Density (dBm/500kHz)	Directional Gain (dBi)	Power Density Limit (dBm/500kHz)	Result
144	5720 MHz (UNII 3)	8.64	6.85	29.15	PASS

Note1: Method 1 of powr density measurement of KDB 789033 is using for calculation totol power density. Total power density is summing entire spectra across corresponding frequency bins on the various outputs by computer.

Note2: Refer to section 1.15 for duty cycle spectrum plot.

Note3: 5720 MHz (UNII 2C)= $Directional\ Gain = 10 \cdot \log \left[\frac{\sum_{j=1}^{N_{ch}} \left\{ \sum_{k=1}^{N_{ANT}} g_{j,k} \right\}^2}{N_{ANT}} \right] = 6.85dBi > 6dBi$, so the power limit shall be reduced to 11.00-(6.85-6)=10.15dBm/MHz.

Note4: 5720 MHz (UNII 3)= $Directional\ Gain = 10 \cdot \log \left[\frac{\sum_{j=1}^{N_{ch}} \left\{ \sum_{k=1}^{N_{ANT}} g_{j,k} \right\}^2}{N_{ANT}} \right] = 6.85dBi > 6dBi$, so the power limit shall be reduced to 30.00-(6.85-6)=29.15dBm/500kHz.



Power Density Plot on Configuration IEEE 802.11a / OFDM / 1S4T CDD / Ant. 3 + Ant. 4 + Ant. 5 + Ant. 6 / CH144 / 5720 MHz (UNII 2C)

802.11a_Nss1,(6Mbps)_4TX

PSD

5720MHz Straddle 5.47-5.725GHz

13/07/2020

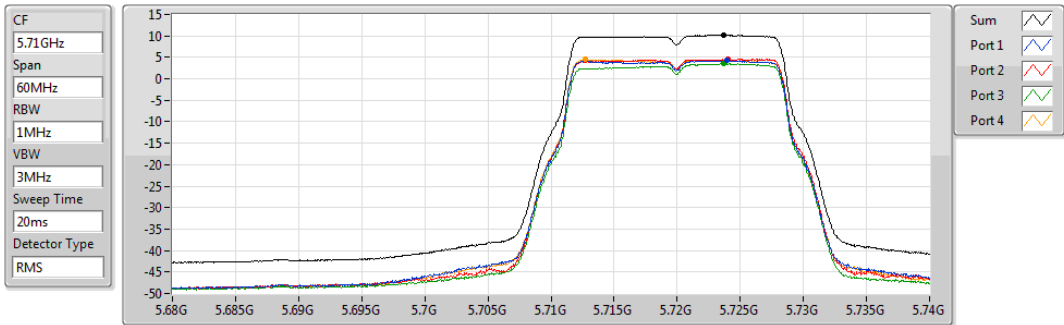

Sum	PD	Port 1	Port 2	Port 3	Port 4
(dBm/RBW)	(dBm/RBW)	(dBm/RBW)	(dBm/RBW)	(dBm/RBW)	(dBm/RBW)
10.14	10.14	4.26	4.51	3.53	4.48

Power Density Plot on Configuration IEEE 802.11a / OFDM / 1S4T CDD / Ant. 3 + Ant. 4 + Ant. 5 + Ant. 6 / CH144 / 5720 MHz (UNII 3)

802.11a_Nss1,(6Mbps)_4TX

PSD

5720MHz Straddle 5.725-5.85GHz

13/07/2020

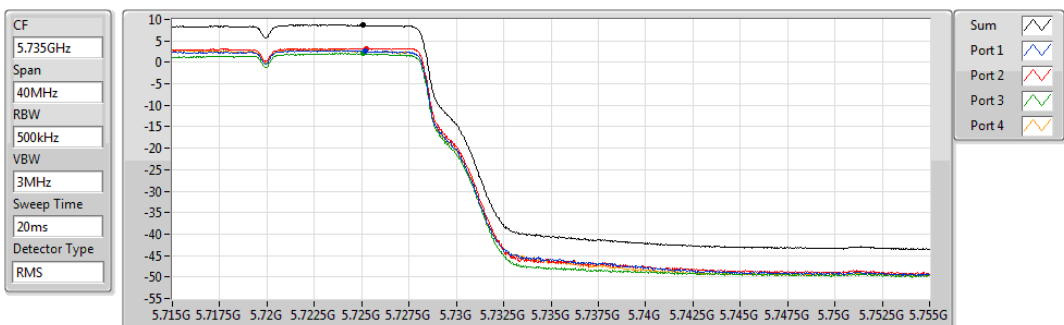

Sum	PD	Port 1	Port 2	Port 3	Port 4
(dBm/RBW)	(dBm/RBW)	(dBm/RBW)	(dBm/RBW)	(dBm/RBW)	(dBm/RBW)
8.64	8.64	2.64	3.23	2.09	2.67



Configuration IEEE 802.11ax 20MHz

<U-NII-2C, PSD A, EBW2c, Nss 1 MCS 0 / 1S4T CDD / Ant. 3 + Ant. 4 + Ant. 5 + Ant. 6>

Channel	Frequency	Power Density (dBm/MHz)	Directional Gain (dBi)	Max. Limit (dBm/MHz)	Result
144	5720 MHz (UNII 2C)	10.00	6.85	10.15	PASS

< U-NII-3, PSD B, EBW3, Nss 1 MCS 0 / 1S4T CDD / Ant. 3 + Ant. 4 + Ant. 5 + Ant. 6>

Channel	Frequency	Power Density (dBm/500kHz)	Directional Gain (dBi)	Power Density Limit (dBm/500kHz)	Result
144	5720 MHz (UNII 3)	8.32	6.85	29.15	PASS

Note1: Method 1 of powr density measurement of KDB 789033 is using for calculation total power density. Total power density is summing entire spectra across corresponding frequency bins on the various outputs by computer.

Note2: Refer to section 1.15 for duty cycle spectrum plot.

Note3: 5720 MHz (UNII 2C)= $Directional\ Gain = 10 \cdot \log \left[\frac{\sum_{j=1}^{N_{ch}} \left\{ \sum_{k=1}^{N_{ANT}} g_{j,k} \right\}^2}{N_{ANT}} \right] = 6.85dBi > 6dBi$, so the power limit shall be reduced to 11.00-(6.85-6)=10.15dBm/MHz.

Note4: 5720 MHz (UNII 3)= $Directional\ Gain = 10 \cdot \log \left[\frac{\sum_{j=1}^{N_{ch}} \left\{ \sum_{k=1}^{N_{ANT}} g_{j,k} \right\}^2}{N_{ANT}} \right] = 6.85dBi > 6dBi$, so the power limit shall be reduced to 30.00-(6.85-6)= 29.15dBm/500kHz.



<U-NII-2C, PSD A, EBW2c, Nss 1 MCS 0 / 1S4T TXBF / Ant. 3 + Ant. 4 + Ant. 5 + Ant. 6>

Channel	Frequency	Power Density (dBm/MHz)	Directional Gain (dBi)	Max. Limit (dBm/MHz)	Result
144	5720 MHz (UNII 2C)	9.66	6.85	10.15	PASS

<U-NII-3, PSD B, EBW3, Nss 1 MCS 0 / 1S4T TXBF / Ant. 3 + Ant. 4 + Ant. 5 + Ant. 6>

Channel	Frequency	Power Density (dBm/500kHz)	Directional Gain (dBi)	Power Density Limit (dBm/500kHz)	Result
144	5720 MHz (UNII 3)	7.88	6.85	29.15	PASS

Note1: Method 1 of powr density measurement of KDB 789033 is using for calculation totol power density. Total power density is summing entire spectra across corresponding frequency bins on the various outputs by computer.

Note2: Refer to section 1.15 for duty cycle spectrum plot.

Note3: 5720 MHz (UNII 2C)= $Directional\ Gain = 10 \cdot \log \left[\frac{\sum_{j=1}^{N_{ch}} \left\{ \sum_{k=1}^{N_{ANT}} g_{j,k} \right\}^2}{N_{ANT}} \right] = 6.85dBi > 6dBi$, so the power limit shall be

reduced to 11.00-(6.85-6)=10.15dBm/MHz.

Note4: 5720 MHz (UNII 3)= $Directional\ Gain = 10 \cdot \log \left[\frac{\sum_{j=1}^{N_{ch}} \left\{ \sum_{k=1}^{N_{ANT}} g_{j,k} \right\}^2}{N_{ANT}} \right] = 6.85dBi > 6dBi$, so the power limit shall be

reduced to 30.00-(6.85-6)=29.15dBm/500kHz.



<U-NII-2C, PSD A, EBW2c, Nss 2 MCS 0 / 2S4T TXBF / Ant. 3 + Ant. 4 + Ant. 5 + Ant. 6>

Channel	Frequency	Power Density (dBm/MHz)	Directional Gain (dBi)	Max. Limit (dBm/MHz)	Result
144	5720 MHz (UNII 2C)	10.43	5.17	11.00	PASS

<U-NII-3, PSD B, EBW3, Nss 2 MCS 0 / 2S4T TXBF / Ant. 3 + Ant. 4 + Ant. 5 + Ant. 6>

Channel	Frequency	Power Density (dBm/500kHz)	Directional Gain (dBi)	Power Density Limit (dBm/500kHz)	Result
144	5720 MHz (UNII 3)	8.84	5.17	30	PASS

Note1: Method 1 of power density measurement of KDB 789033 is used for calculation of total power density. Total power density is the sum of the entire spectra across corresponding frequency bins on the various outputs by computer.

Note2: Refer to section 1.15 for duty cycle spectrum plot.

Note3: 5720 MHz (UNII 2C) = Directional Gain = $10 \cdot \log \left[\frac{\sum_{j=1}^{N_{SS}} \left\{ \sum_{k=1}^{N_{ANT}} g_{j,k} \right\}^2}{N_{ANT}} \right] = 5.17 \text{dBi} < 6 \text{dBi}$, so the limit doesn't reduce.

Note4: 5720 MHz (UNII 3) = Directional Gain = $10 \cdot \log \left[\frac{\sum_{j=1}^{N_{SS}} \left\{ \sum_{k=1}^{N_{ANT}} g_{j,k} \right\}^2}{N_{ANT}} \right] = 5.17 \text{dBi} < 6 \text{dBi}$, so the limit doesn't reduce.



<U-NII-2C, PSD A, EBW2c, Nss 3 MCS 0 / 3S4T TXBF / Ant. 3 + Ant. 4 + Ant. 5 + Ant. 6>

Channel	Frequency	Power Density (dBm/MHz)	Directional Gain (dBi)	Max. Limit (dBm/MHz)	Result
144	5720 MHz (UNII 2C)	10.37	3.33	11.00	PASS

<U-NII-3, PSD B, EBW3, Nss 3 MCS 0 / 3S4T TXBF / Ant. 3 + Ant. 4 + Ant. 5 + Ant. 6>

Channel	Frequency	Power Density (dBm/500kHz)	Directional Gain (dBi)	Power Density Limit (dBm/500kHz)	Result
144	5720 MHz (UNII 3)	8.75	3.33	30.00	PASS

Note1: Method 1 of power density measurement of KDB 789033 is used for calculation of total power density. Total power density is the sum of the entire spectra across corresponding frequency bins on the various outputs by computer.

Note2: Refer to section 1.15 for duty cycle spectrum plot.

Note3: 5720 MHz (UNII 2C) = Directional Gain = $10 \cdot \log \left[\frac{\sum_{j=1}^{N_{SS}} \left\{ \sum_{k=1}^{N_{ANT}} g_{j,k} \right\}^2}{N_{ANT}} \right] = 3.33\text{dBi} < 6\text{dBi}$, so the limit doesn't reduce.

Note4: 5720 MHz (UNII 3) = Directional Gain = $10 \cdot \log \left[\frac{\sum_{j=1}^{N_{SS}} \left\{ \sum_{k=1}^{N_{ANT}} g_{j,k} \right\}^2}{N_{ANT}} \right] = 3.33\text{dBi} < 6\text{dBi}$, so the limit doesn't reduce.



Power Density Plot on Configuration IEEE 802.11ax 20MHz / Nss 1 MCS 0 / 1S4T CDD / Ant. 3 + Ant. 4 + Ant. 5 + Ant. 6 / CH144 / 5720 MHz (UNII 2C)

**802.11ax HEW20_Nss1,(MCS0)_4TX
5720MHz Straddle 5.47-5.725GHz**

PSD

02/07/2020

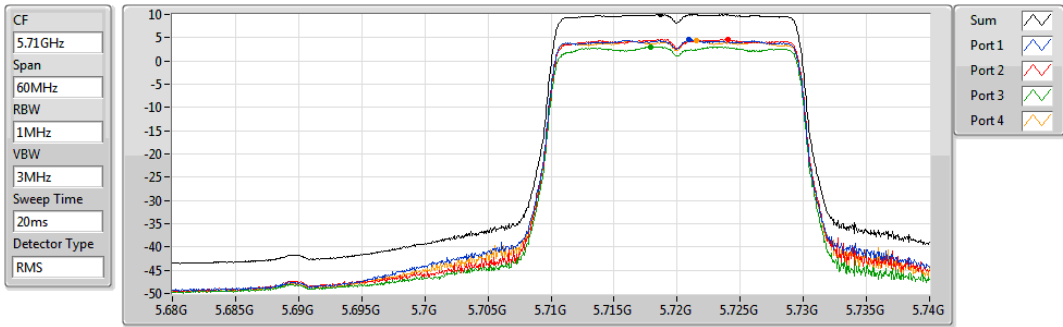

Sum	PD	Port 1	Port 2	Port 3	Port 4
(dBm/RBW)	(dBm/RBW)	(dBm/RBW)	(dBm/RBW)	(dBm/RBW)	(dBm/RBW)
10.00	10.00	4.55	4.65	3.06	4.33

Power Density Plot on Configuration IEEE 802.11ax 20MHz / Nss 1 MCS 0 / 1S4T CDD / Ant. 3 + Ant. 4 + Ant. 5 + Ant. 6 / CH144 / 5720 MHz (UNII 3)

**802.11ax HEW20_Nss1,(MCS0)_4TX
5720MHz Straddle 5.725-5.85GHz**

PSD

02/07/2020

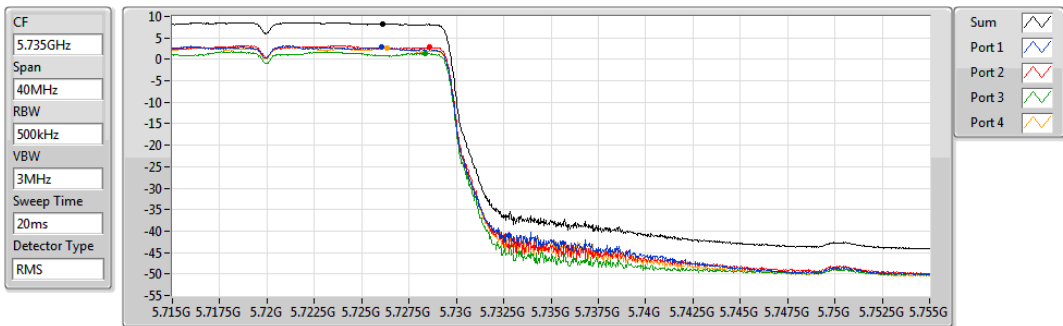

Sum	PD	Port 1	Port 2	Port 3	Port 4
(dBm/RBW)	(dBm/RBW)	(dBm/RBW)	(dBm/RBW)	(dBm/RBW)	(dBm/RBW)
8.32	8.32	2.85	2.81	1.37	2.64



Power Density Plot on Configuration IEEE 802.11ax 20MHz / Nss 1 MCS 0 / 1S4T TXBF / Ant. 3 + Ant. 4 + Ant. 5 + Ant. 6 / CH144 / 5720 MHz (UNII 2C)

**802.11ax HEW20-BF_Nss1,(MCS0)_4TX
5720MHz Straddle 5.47-5.725GHz**

PSD

02/07/2020

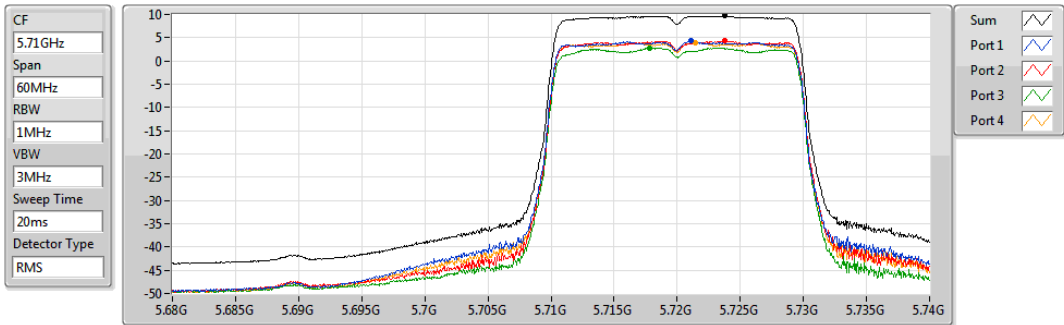

Sum	PD	Port 1	Port 2	Port 3	Port 4
(dBm/RBW)	(dBm/RBW)	(dBm/RBW)	(dBm/RBW)	(dBm/RBW)	(dBm/RBW)
9.66	9.66	4.30	4.31	2.79	3.99

Power Density Plot on Configuration IEEE 802.11ax 20MHz / Nss 1 MCS 0 / 1S4T TXBF / Ant. 3 + Ant. 4 + Ant. 5 + Ant. 6 / CH144 / 5720 MHz (UNII 3)

**802.11ax HEW20-BF_Nss1,(MCS0)_4TX
5720MHz Straddle 5.725-5.85GHz**

PSD

02/07/2020

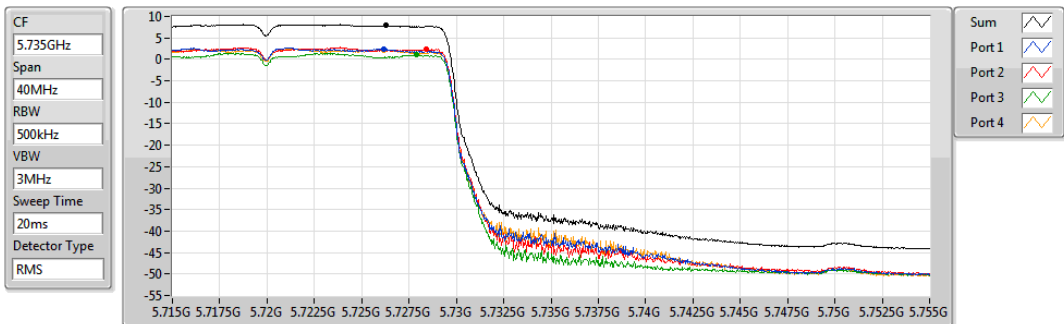

Sum	PD	Port 1	Port 2	Port 3	Port 4
(dBm/RBW)	(dBm/RBW)	(dBm/RBW)	(dBm/RBW)	(dBm/RBW)	(dBm/RBW)
7.88	7.88	2.41	2.33	1.01	2.25



Power Density Plot on Configuration IEEE 802.11ax 20MHz / Nss 2 MCS 0 / 2S4T TXBF / Ant. 3 + Ant. 4 + Ant. 5 + Ant. 6 / CH144 / 5720 MHz (UNII 2C)

**802.11ax HEW20-BF_Nss2,(MCS0)_4TX
5720MHz Straddle 5.47-5.725GHz**

PSD

02/07/2020

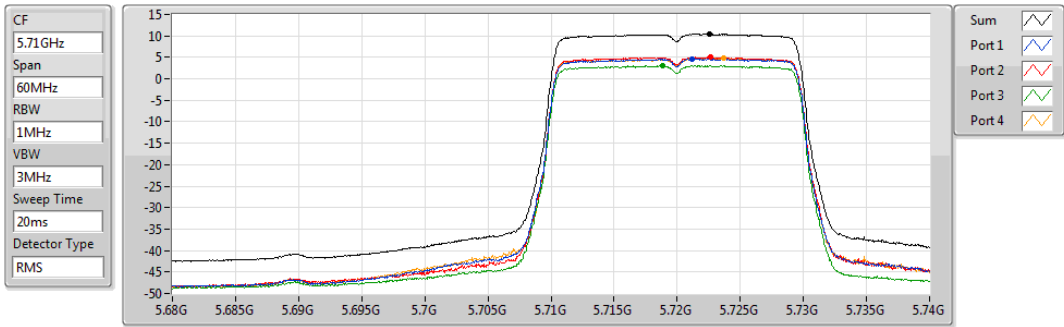

Sum	PD	Port 1	Port 2	Port 3	Port 4
(dBm/RBW)	(dBm/RBW)	(dBm/RBW)	(dBm/RBW)	(dBm/RBW)	(dBm/RBW)
10.43	10.43	4.64	5.03	3.09	4.83

Power Density Plot on Configuration IEEE 802.11ax 20MHz / Nss 2 MCS 0 / 2S4T TXBF / Ant. 3 + Ant. 4 + Ant. 5 + Ant. 6 / CH144 / 5720 MHz (UNII 3)

**802.11ax HEW20-BF_Nss2,(MCS0)_4TX
5720MHz Straddle 5.725-5.85GHz**

PSD

02/07/2020

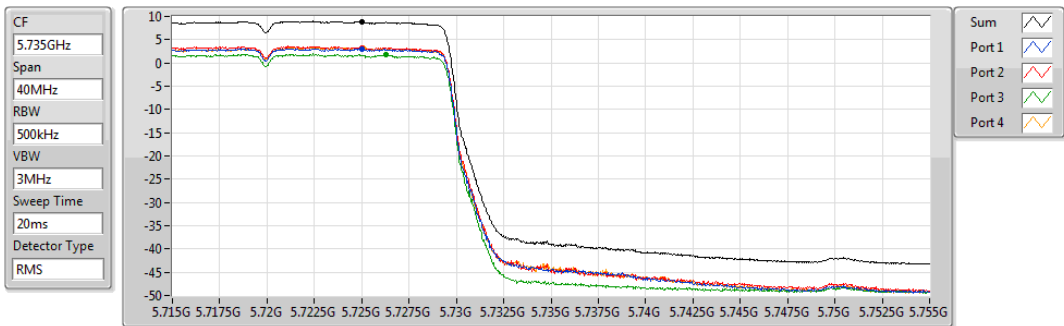

Sum	PD	Port 1	Port 2	Port 3	Port 4
(dBm/RBW)	(dBm/RBW)	(dBm/RBW)	(dBm/RBW)	(dBm/RBW)	(dBm/RBW)
8.84	8.84	2.91	3.28	1.71	3.30



Power Density Plot on Configuration IEEE 802.11ax 20MHz / Nss 3 MCS 0 / 3S4T TXBF / Ant. 3 + Ant. 4 + Ant. 5 + Ant. 6 / CH144 / 5720 MHz (UNII 2C)

**802.11ax HEW20-BF_Nss3,(MCS0)_4TX
5720MHz Straddle 5.47-5.725GHz**

PSD

03/07/2020

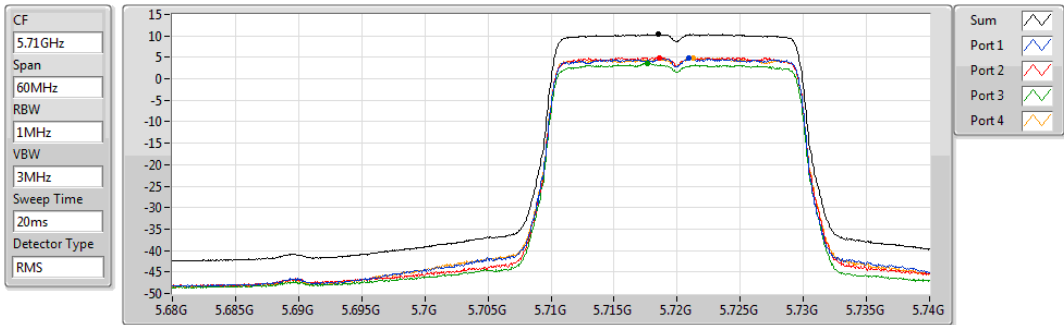

Sum	PD	Port 1	Port 2	Port 3	Port 4
(dBm/RBW)	(dBm/RBW)	(dBm/RBW)	(dBm/RBW)	(dBm/RBW)	(dBm/RBW)
10.37	10.37	4.75	4.93	3.68	4.85

Power Density Plot on Configuration IEEE 802.11ax 20MHz / Nss 3 MCS 0 / 3S4T TXBF / Ant. 3 + Ant. 4 + Ant. 5 + Ant. 6 / CH144 / 5720 MHz (UNII 3)

**802.11ax HEW20-BF_Nss3,(MCS0)_4TX
5720MHz Straddle 5.725-5.85GHz**

PSD

03/07/2020

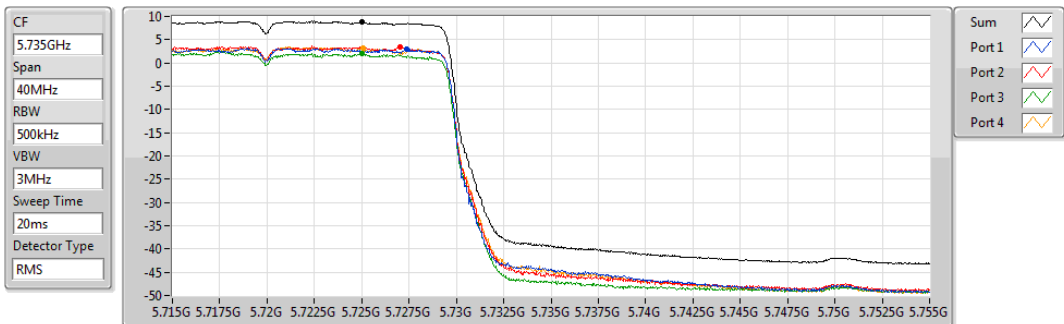

Sum	PD	Port 1	Port 2	Port 3	Port 4
(dBm/RBW)	(dBm/RBW)	(dBm/RBW)	(dBm/RBW)	(dBm/RBW)	(dBm/RBW)
8.75	8.75	2.90	3.34	2.02	3.10



Configuration IEEE 802.11ax 40MHz

<U-NII-2C, PSD A, EBW2c, Nss 1 MCS 0 / 1S4T CDD / Ant. 3 + Ant. 4 + Ant. 5 + Ant. 6>

Channel	Frequency	Power Density (dBm/MHz)	Directional Gain (dBi)	Max. Limit (dBm/MHz)	Result
142	5710 MHz (UNII 2C)	7.79	6.80	10.20	PASS

<U-NII-3, PSD B, EBW3, Nss 1 MCS 0 / 1S4T CDD / Ant. 3 + Ant. 4 + Ant. 5 + Ant. 6>

Channel	Frequency	Power Density (dBm/500kHz)	Directional Gain (dBi)	Power Density Limit (dBm/500kHz)	Result
142	5710 MHz (UNII 3)	5.88	6.80	29.20	PASS

Note1: Method 1 of powr density measurement of KDB 789033 is using for calculation total power density. Total power density is summing entire spectra across corresponding frequency bins on the various outputs by computer.

Note2: Refer to section 1.15 for duty cycle spectrum plot.

Note3: 5710 MHz (UNII 2C)= $Directional\ Gain = 10 \cdot \log \left[\frac{\sum_{j=1}^{N_{SS}} \left\{ \sum_{k=1}^{N_{ANT}} g_{j,k} \right\}^2}{N_{ANT}} \right] = 6.80dBi > 6dBi$, so the power limit shall be reduced to 11.00-(6.80-6)=10.20dBm/MHz.

Note4: 5710 MHz (UNII 3) = $Directional\ Gain = 10 \cdot \log \left[\frac{\sum_{j=1}^{N_{SS}} \left\{ \sum_{k=1}^{N_{ANT}} g_{j,k} \right\}^2}{N_{ANT}} \right] = 6.80dBi > 6dBi$, so the power limit shall be reduced to 30-(6.80-6)=29.20dBm/500kHz.



<U-NII-2C, PSD A, EBW2c, Nss 1 MCS 0 / 1S4T TXBF / Ant. 3 + Ant. 4 + Ant. 5 + Ant. 6>

Channel	Frequency	Power Density (dBm/MHz)	Directional Gain (dBi)	Max. Limit (dBm/MHz)	Result
142	5710 MHz (UNII 2C)	6.93	6.80	10.20	PASS

<U-NII-3, PSD B, EBW3, Nss 1 MCS 0 / 1S4T TXBF / Ant. 3 + Ant. 4 + Ant. 5 + Ant. 6>

Channel	Frequency	Power Density (dBm/500kHz)	Directional Gain (dBi)	Power Density Limit (dBm/500kHz)	Result
142	5710 MHz (UNII 3)	4.91	6.80	29.20	PASS

Note1: Method 1 of powr density measurement of KDB 789033 is using for calculation totol power density. Total power density is summing entire spectra across corresponding frequency bins on the various outputs by computer.

Note2: Refer to section 1.15 for duty cycle spectrum plot.

Note3: 5710 MHz (UNII 2C) = $Directional\ Gain = 10 \cdot \log \left[\frac{\sum_{j=1}^{N_{SS}} \left\{ \sum_{k=1}^{N_{ANT}} g_{j,k} \right\}^2}{N_{ANT}} \right] = 6.80dBi > 6dBi$, so the power limit shall be

reduced to 11.00-(6.80-6)=10.20dBm/MHz.

Note4: 5710 MHz (UNII 3) = $Directional\ Gain = 10 \cdot \log \left[\frac{\sum_{j=1}^{N_{SS}} \left\{ \sum_{k=1}^{N_{ANT}} g_{j,k} \right\}^2}{N_{ANT}} \right] = 6.80dBi > 6dBi$, so the power limit shall be

reduced to 30-(6.80-6)=29.20dBm/500kHz.



<U-NII-2C, PSD A, EBW2c, Nss 2 MCS 0 / 2S4T TXBF / Ant. 3 + Ant. 4 + Ant. 5 + Ant. 6>

Channel	Frequency	Power Density (dBm/MHz)	Directional Gain (dBi)	Max. Limit (dBm/MHz)	Result
142	5710 MHz (UNII 2C)	7.86	5.08	11.00	PASS

<U-NII-3, PSD B, EBW3, Nss 2 MCS 0 / 2S4T TXBF / Ant. 3 + Ant. 4 + Ant. 5 + Ant. 6>

Channel	Frequency	Power Density (dBm/500kHz)	Directional Gain (dBi)	Power Density Limit (dBm/500kHz)	Result
142	5710 MHz (UNII 3)	5.90	5.08	30.00	PASS

Note1: Method 1 of power density measurement of KDB 789033 is used for calculation of total power density. Total power density is the sum of the entire spectra across corresponding frequency bins on the various outputs by computer.

Note2: Refer to section 1.15 for duty cycle spectrum plot.

Note3: 5710 MHz (UNII 2C) = Directional Gain = $10 \cdot \log \left[\frac{\sum_{j=1}^{N_{SS}} \left\{ \sum_{k=1}^{N_{ANT}} g_{j,k} \right\}^2}{N_{ANT}} \right] = 5.08 \text{dBi} < 6 \text{dBi}$, so the limit doesn't reduce.

Note4: 5710 MHz (UNII 3) = Directional Gain = $10 \cdot \log \left[\frac{\sum_{j=1}^{N_{SS}} \left\{ \sum_{k=1}^{N_{ANT}} g_{j,k} \right\}^2}{N_{ANT}} \right] = 5.08 \text{dBi} < 6 \text{dBi}$, so the limit doesn't reduce.



<U-NII-2C, PSD A, EBW2c, Nss 3 MCS 0 / 3S4T TXBF / Ant. 3 + Ant. 4 + Ant. 5 + Ant. 6>

Channel	Frequency	Power Density (dBm/MHz)	Directional Gain (dBi)	Max. Limit (dBm/MHz)	Result
142	5710 MHz (UNII 2C)	7.91	3.20	11.00	PASS

<U-NII-3, PSD B, EBW3, Nss 3 MCS 0 / 3S4T TXBF / Ant. 3 + Ant. 4 + Ant. 5 + Ant. 6>

Channel	Frequency	Power Density (dBm/500kHz)	Directional Gain (dBi)	Power Density Limit (dBm/500kHz)	Result
142	5710 MHz (UNII 3)	6.05	3.20	30.00	PASS

Note1: Method 1 of power density measurement of KDB 789033 is used for calculation of total power density. Total power density is the sum of the entire spectra across corresponding frequency bins on the various outputs by computer.

Note2: Refer to section 1.15 for duty cycle spectrum plot.

Note3: 5710 MHz (UNII 2C) = $Directional\ Gain = 10 \cdot \log \left[\frac{\sum_{j=1}^{N_{SS}} \left\{ \sum_{k=1}^{N_{ANT}} g_{j,k} \right\}^2}{N_{ANT}} \right] = 3.20\text{dBi} < 6\text{dBi}$, so the limit doesn't reduce.

Note4: 5710 MHz (UNII 3) = $Directional\ Gain = 10 \cdot \log \left[\frac{\sum_{j=1}^{N_{SS}} \left\{ \sum_{k=1}^{N_{ANT}} g_{j,k} \right\}^2}{N_{ANT}} \right] = 3.20\text{dBi} < 6\text{dBi}$, so the limit doesn't reduce.



Power Density Plot on Configuration IEEE 802.11ax 40MHz / Nss 1 MCS 0 / 1S4T CDD / Ant. 3 + Ant. 4 + Ant. 5 + Ant. 6 / CH142 / 5710 MHz (UNII 2C)

**802.11ax HEW40_Nss1,(MCS0)_4TX
5710MHz Straddle 5.47-5.725GHz**

PSD

02/07/2020

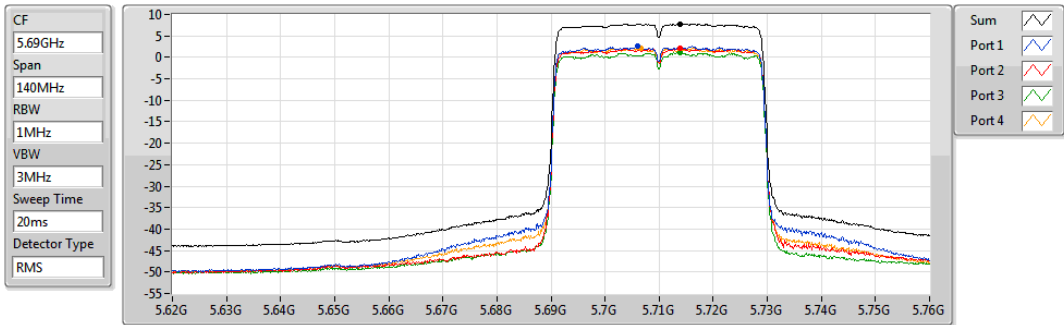

Sum	PD	Port 1	Port 2	Port 3	Port 4
(dBm/RBW)	(dBm/RBW)	(dBm/RBW)	(dBm/RBW)	(dBm/RBW)	(dBm/RBW)
7.79	7.79	2.56	2.12	1.06	2.19

Power Density Plot on Configuration IEEE 802.11ax 40MHz / Nss 1 MCS 0 / 1S4T CDD / Ant. 3 + Ant. 4 + Ant. 5 + Ant. 6 / CH142 / 5710 MHz (UNII 3)

**802.11ax HEW40_Nss1,(MCS0)_4TX
5710MHz Straddle 5.725-5.85GHz**

PSD

02/07/2020

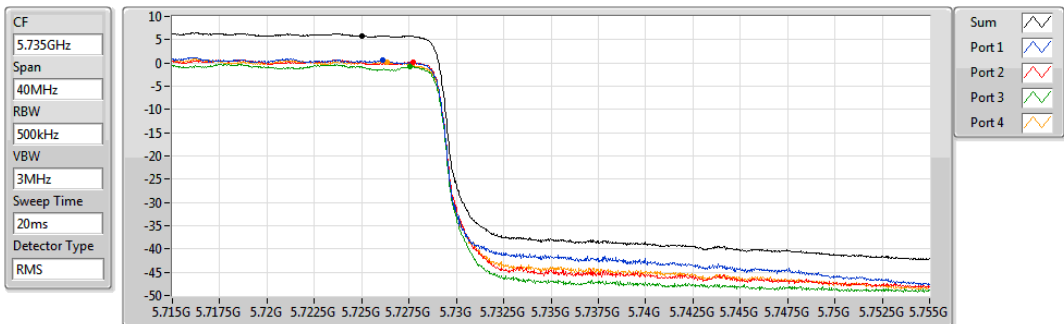

Sum	PD	Port 1	Port 2	Port 3	Port 4
(dBm/RBW)	(dBm/RBW)	(dBm/RBW)	(dBm/RBW)	(dBm/RBW)	(dBm/RBW)
5.88	5.88	0.52	0.08	-0.80	0.20



Power Density Plot on Configuration IEEE 802.11ax 40MHz / Nss 1 MCS 0 / 1S4T TXBF / Ant. 3 + Ant. 4 + Ant. 5 + Ant. 6 / CH142 / 5710 MHz (UNII 2C)

**802.11ax HEW40-BF_Nss1,(MCS0)_4TX
5710MHz Straddle 5.47-5.725GHz**

PSD

02/07/2020

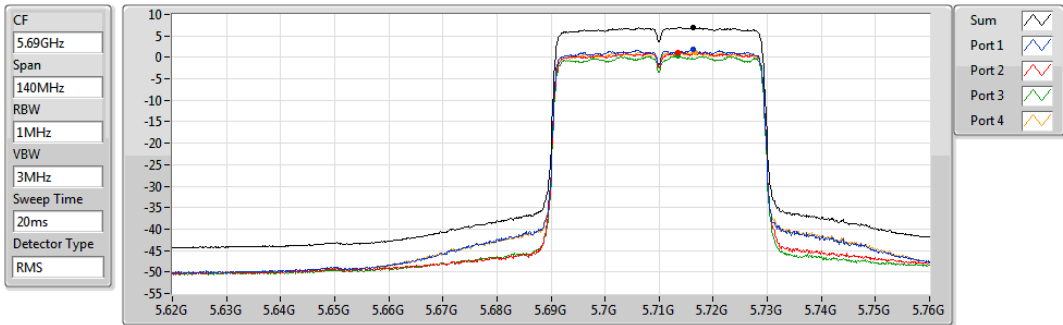

Sum	PD	Port 1	Port 2	Port 3	Port 4
(dBm/RBW)	(dBm/RBW)	(dBm/RBW)	(dBm/RBW)	(dBm/RBW)	(dBm/RBW)
6.93	6.93	1.85	1.22	0.34	1.22

Power Density Plot on Configuration IEEE 802.11ax 40MHz / Nss 1 MCS 0 / 1S4T TXBF / Ant. 3 + Ant. 4 + Ant. 5 + Ant. 6 / CH142 / 5710 MHz (UNII 3)

**802.11ax HEW40-BF_Nss1,(MCS0)_4TX
5710MHz Straddle 5.725-5.85GHz**

PSD

02/07/2020

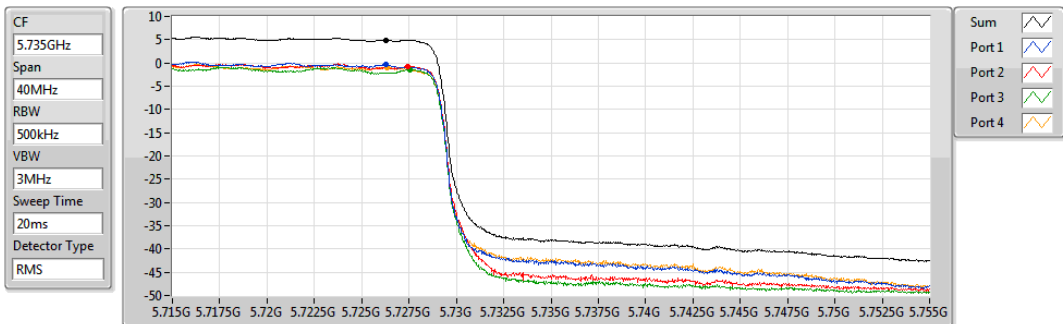

Sum	PD	Port 1	Port 2	Port 3	Port 4
(dBm/RBW)	(dBm/RBW)	(dBm/RBW)	(dBm/RBW)	(dBm/RBW)	(dBm/RBW)
4.91	4.91	-0.37	-0.76	-1.37	-0.95



Power Density Plot on Configuration IEEE 802.11ax 40MHz / Nss 2 MCS 0 / 2S4T TXBF / Ant. 3 + Ant. 4 + Ant. 5 + Ant. 6 / CH142 / 5710 MHz (UNII 2C)

**802.11ax HEW40-BF_Nss2,(MCS0)_4TX
5710MHz Straddle 5.47-5.725GHz**

PSD

02/07/2020

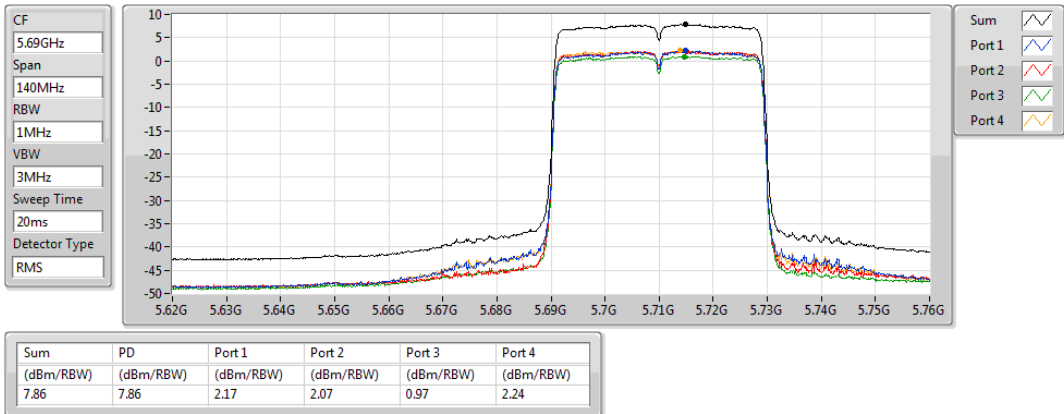

Power Density Plot on Configuration IEEE 802.11ax 40MHz / Nss 2 MCS 0 / 2S4T TXBF / Ant. 3 + Ant. 4 + Ant. 5 + Ant. 6 / CH142 / 5710 MHz (UNII 3)

**802.11ax HEW40-BF_Nss2,(MCS0)_4TX
5710MHz Straddle 5.725-5.85GHz**

PSD

02/07/2020

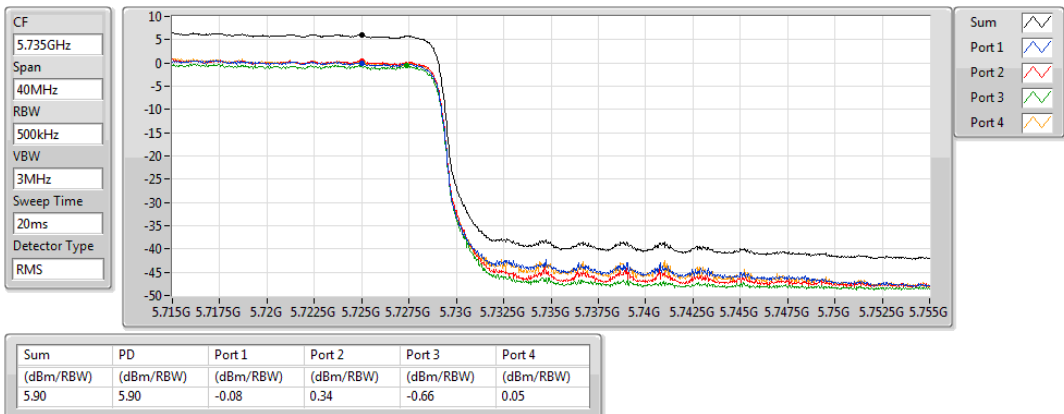



Power Density Plot on Configuration IEEE 802.11ax 40MHz / Nss 3 MCS 0 / 3S4T TXBF / Ant. 3 + Ant. 4 + Ant. 5 + Ant. 6 / CH142 / 5710 MHz (UNII 2C)

**802.11ax HEW40-BF_Nss3,(MCS0)_4TX
5710MHz Straddle 5.47-5.725GHz**

PSD

03/07/2020

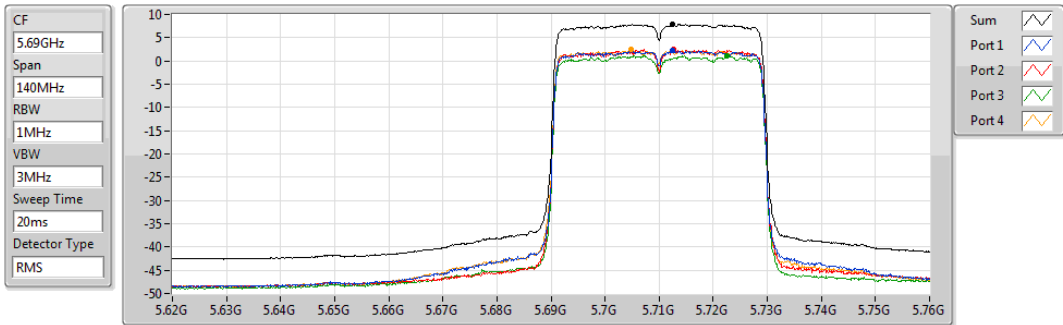

Sum	PD	Port 1	Port 2	Port 3	Port 4
(dBm/RBW)	(dBm/RBW)	(dBm/RBW)	(dBm/RBW)	(dBm/RBW)	(dBm/RBW)
7.91	7.91	2.23	2.55	1.14	2.53

Power Density Plot on Configuration IEEE 802.11ax 40MHz / Nss 3 MCS 0 / 3S4T TXBF / Ant. 3 + Ant. 4 + Ant. 5 + Ant. 6 / CH142 / 5710 MHz (UNII 3)

**802.11ax HEW40-BF_Nss3,(MCS0)_4TX
5710MHz Straddle 5.725-5.85GHz**

PSD

03/07/2020

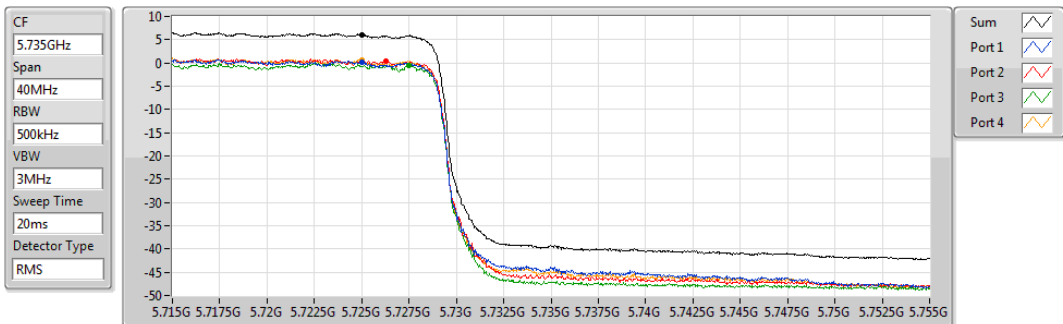

Sum	PD	Port 1	Port 2	Port 3	Port 4
(dBm/RBW)	(dBm/RBW)	(dBm/RBW)	(dBm/RBW)	(dBm/RBW)	(dBm/RBW)
6.05	6.05	0.11	0.46	-0.59	0.51



Configuration IEEE 802.11ax 80MHz

<U-NII-2C, PSD A, EBW2c, Nss 1 MCS 0 / 1S4T CDD / Ant. 3 + Ant. 4 + Ant. 5 + Ant. 6>

Channel	Frequency	Power Density (dBm/MHz)	Directional Gain (dBi)	Max. Limit (dBm/MHz)	Result
138	5690 MHz (UNII 2C)	4.95	6.67	10.33	PASS

<U-NII-3, PSD B, EBW3, Nss 1 MCS 0 / 1S4T CDD / Ant. 3 + Ant. 4 + Ant. 5 + Ant. 6>

Channel	Frequency	Power Density (dBm/500kHz)	Directional Gain (dBi)	Power Density Limit (dBm/500kHz)	Result
138	5690 MHz (UNII 3)	2.66	6.67	29.33	PASS

Note1: Method 1 of powr density measurement of KDB 789033 is using for calculation total power density. Total power density is summing entire spectra across corresponding frequency bins on the various outputs by computer.

Note2: Refer to section 1.15 for duty cycle spectrum plot.

Note3: 5690 MHz (UNII 2C)= $Directional\ Gain = 10 \cdot \log \left[\frac{\sum_{j=1}^{N_{SS}} \left\{ \sum_{k=1}^{N_{ANT}} g_{j,k} \right\}^2}{N_{ANT}} \right] = 6.67\text{dBi} > 6\text{dBi}$, so the power limit shall be reduced to 11.00-(6.67-6)=10.33dBm/MHz.

Note4: 5690 MHz (UNII 3) = $Directional\ Gain = 10 \cdot \log \left[\frac{\sum_{j=1}^{N_{SS}} \left\{ \sum_{k=1}^{N_{ANT}} g_{j,k} \right\}^2}{N_{ANT}} \right] = 6.67\text{dBi} > 6\text{dBi}$, so the power limit shall be reduced to 30-(6.67-6)=29.33dBm/500kHz.



<U-NII-2C, PSD A, EBW2c, Nss 1 MCS 0 / 1S4T TXBF / Ant. 3 + Ant. 4 + Ant. 5 + Ant. 6>

Channel	Frequency	Power Density (dBm/MHz)	Directional Gain (dBi)	Max. Limit (dBm/MHz)	Result
138	5690 MHz (UNII 2C)	4.22	6.67	10.33	PASS

<U-NII-3, PSD B, EBW3, Nss 1 MCS 0 / 1S4T TXBF / Ant. 3 + Ant. 4 + Ant. 5 + Ant. 6>

Channel	Frequency	Power Density (dBm/500kHz)	Directional Gain (dBi)	Power Density Limit (dBm/500kHz)	Result
138	5690 MHz (UNII 3)	1.84	6.67	29.33	PASS

Note1: Method 1 of powr density measurement of KDB 789033 is using for calculation totol power density. Total power density is summing entire spectra across corresponding frequency bins on the various outputs by computer.

Note2: Refer to section 1.15 for duty cycle spectrum plot.

Note3: $5690 \text{ MHz (UNII 2C)} = \text{Directional Gain} = 10 \cdot \log \left[\frac{\sum_{j=1}^{N_{SS}} \left\{ \sum_{k=1}^{N_{ANT}} g_{j,k} \right\}^2}{N_{ANT}} \right] = 6.67\text{dBi} > 6\text{dBi}$, so the power limit shall be

reduced to $11.00 - (6.67 - 6) = 10.33\text{dBm/MHz}$.

Note4: $5690 \text{ MHz (UNII 3)} = \text{Directional Gain} = 10 \cdot \log \left[\frac{\sum_{j=1}^{N_{SS}} \left\{ \sum_{k=1}^{N_{ANT}} g_{j,k} \right\}^2}{N_{ANT}} \right] = 6.67\text{dBi} > 6\text{dBi}$, so the power limit shall be

reduced to $30 - (6.67 - 6) = 29.33\text{dBm/500kHz}$.



<U-NII-2C, PSD A, EBW2c, Nss 2 MCS 0 / 2S4T TXBF / Ant. 3 + Ant. 4 + Ant. 5 + Ant. 6>

Channel	Frequency	Power Density (dBm/MHz)	Directional Gain (dBi)	Max. Limit (dBm/MHz)	Result
138	5690 MHz (UNII 2C)	4.92	4.96	11.00	PASS

<U-NII-3, PSD B, EBW3, Nss 2 MCS 0 / 2S4T TXBF / Ant. 3 + Ant. 4 + Ant. 5 + Ant. 6>

Channel	Frequency	Power Density (dBm/500kHz)	Directional Gain (dBi)	Power Density Limit (dBm/500kHz)	Result
138	5690 MHz (UNII 3)	2.64	4.96	30.00	PASS

Note1: Method 1 of power density measurement of KDB 789033 is using for calculation total power density. Total power density is summing entire spectra across corresponding frequency bins on the various outputs by computer.

Note2: Refer to section 1.15 for duty cycle spectrum plot.

Note3: 5690 MHz (UNII 2C) = Directional Gain = $10 \cdot \log \left[\frac{\sum_{j=1}^{N_{SS}} \left\{ \sum_{k=1}^{N_{ANT}} g_{j,k} \right\}^2}{N_{ANT}} \right] = 4.96\text{dBi} < 6\text{dBi}$, so the limit doesn't reduce.

Note4: 5690 MHz (UNII 3) = Directional Gain = $10 \cdot \log \left[\frac{\sum_{j=1}^{N_{SS}} \left\{ \sum_{k=1}^{N_{ANT}} g_{j,k} \right\}^2}{N_{ANT}} \right] = 4.96\text{dBi} < 6\text{dBi}$, so the limit doesn't reduce.



<U-NII-2C, PSD A, EBW2c, Nss 3 MCS 0 / 3S4T TXBF / Ant. 3 + Ant. 4 + Ant. 5 + Ant. 6>

Channel	Frequency	Power Density (dBm/MHz)	Directional Gain (dBi)	Max. Limit (dBm/MHz)	Result
138	5690 MHz (UNII 2C)	5.29	3.06	11.00	PASS

<U-NII-3, PSD B, EBW3, Nss 3 MCS 0 / 3S4T TXBF / Ant. 3 + Ant. 4 + Ant. 5 + Ant. 6>

Channel	Frequency	Power Density (dBm/500kHz)	Directional Gain (dBi)	Power Density Limit (dBm/500kHz)	Result
138	5690 MHz (UNII 3)	2.92	3.06	30.00	PASS

Note1: Method 1 of power density measurement of KDB 789033 is using for calculation total power density. Total power density is summing entire spectra across corresponding frequency bins on the various outputs by computer.

Note2: Refer to section 1.15 for duty cycle spectrum plot.

Note3: 5690 MHz (UNII 2C) = Directional Gain = $10 \cdot \log \left[\frac{\sum_{j=1}^{N_{SS}} \left\{ \sum_{k=1}^{N_{ANT}} g_{j,k} \right\}^2}{N_{ANT}} \right] = 3.06\text{dBi} < 6\text{dBi}$, so the limit doesn't reduce.

Note4: 5690 MHz (UNII 3) = Directional Gain = $10 \cdot \log \left[\frac{\sum_{j=1}^{N_{SS}} \left\{ \sum_{k=1}^{N_{ANT}} g_{j,k} \right\}^2}{N_{ANT}} \right] = 3.06\text{dBi} < 6\text{dBi}$, so the limit doesn't reduce.



Power Density Plot on Configuration IEEE 802.11ax 80MHz / Nss 1 MCS 0 / 1S4T CDD / Ant. 3 + Ant. 4 + Ant. 5 + Ant. 6 / CH138 / 5690 MHz (UNII 2C)

802.11ax HEW80_Nss1,(MCS0)_4TX
5690MHz Straddle 5.47-5.725GHz

PSD

02/07/2020

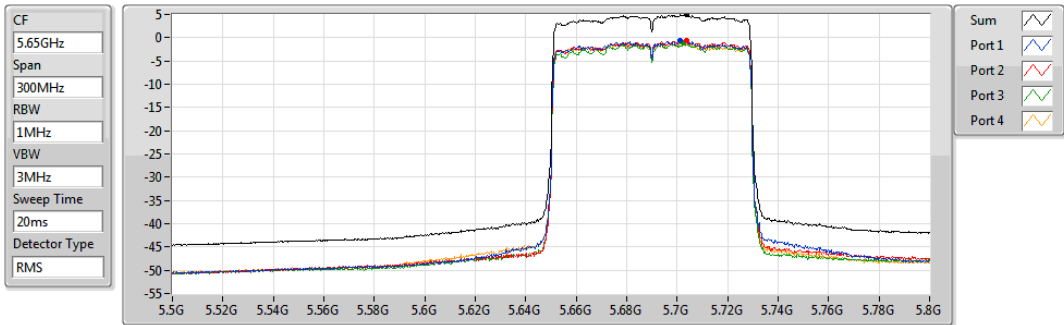

Sum	PD	Port 1	Port 2	Port 3	Port 4
(dBm/RBW)	(dBm/RBW)	(dBm/RBW)	(dBm/RBW)	(dBm/RBW)	(dBm/RBW)
4.95	4.95	-0.58	-0.59	-1.12	-0.92

Power Density Plot on Configuration IEEE 802.11ax 80MHz / Nss 1 MCS 0 / 1S4T CDD / Ant. 3 + Ant. 4 + Ant. 5 + Ant. 6 / CH138 / 5690 MHz (UNII 3)

802.11ax HEW80_Nss1,(MCS0)_4TX
5690MHz Straddle 5.725-5.85GHz

PSD

02/07/2020

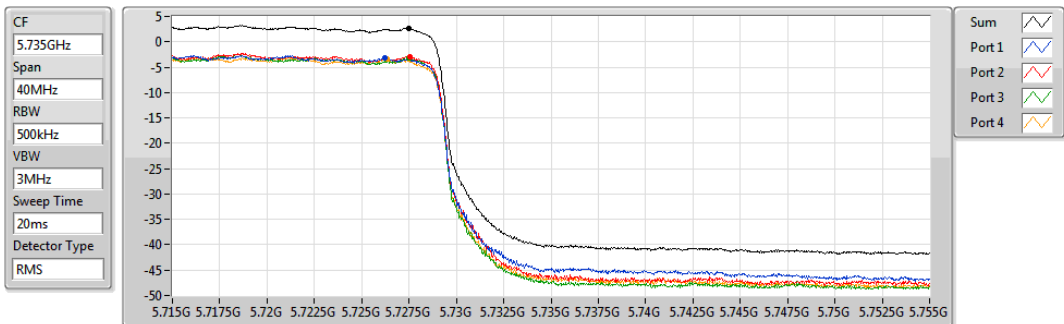

Sum	PD	Port 1	Port 2	Port 3	Port 4
(dBm/RBW)	(dBm/RBW)	(dBm/RBW)	(dBm/RBW)	(dBm/RBW)	(dBm/RBW)
2.66	2.66	-3.26	-2.98	-3.26	-3.36



Power Density Plot on Configuration IEEE 802.11ax 80MHz / Nss 1 MCS 0 / 1S4T TXBF / Ant. 3 + Ant. 4 + Ant. 5 + Ant. 6 / CH138 / 5690 MHz (UNII 2C)

**802.11ax HEW80-BF_Nss1,(MCS0)_4TX
5690MHz Straddle 5.47-5.725GHz**

PSD

02/07/2020

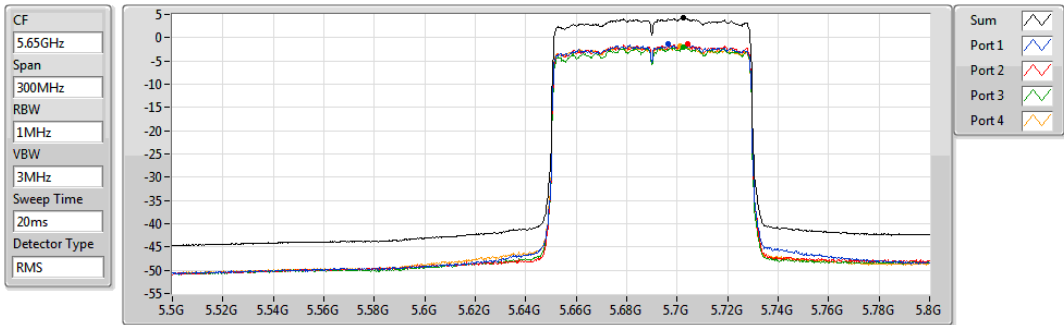

Sum	PD	Port 1	Port 2	Port 3	Port 4
(dBm/RBW)	(dBm/RBW)	(dBm/RBW)	(dBm/RBW)	(dBm/RBW)	(dBm/RBW)
4.22	4.22	-1.38	-1.31	-1.93	-1.74

Power Density Plot on Configuration IEEE 802.11ax 80MHz / Nss 1 MCS 0 / 1S4T TXBF / Ant. 3 + Ant. 4 + Ant. 5 + Ant. 6 / CH138 / 5690 MHz (UNII 3)

**802.11ax HEW80-BF_Nss1,(MCS0)_4TX
5690MHz Straddle 5.725-5.85GHz**

PSD

02/07/2020

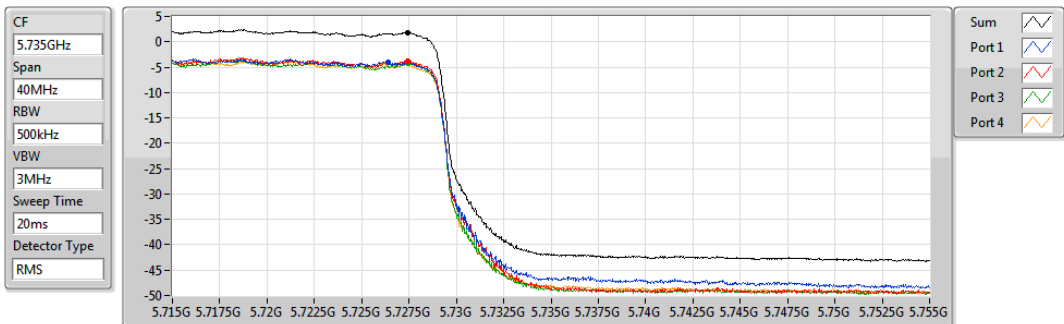

Sum	PD	Port 1	Port 2	Port 3	Port 4
(dBm/RBW)	(dBm/RBW)	(dBm/RBW)	(dBm/RBW)	(dBm/RBW)	(dBm/RBW)
1.84	1.84	-3.95	-3.83	-4.14	-4.14



Power Density Plot on Configuration IEEE 802.11ax 80MHz / Nss 2 MCS 0 / 2S4T TXBF / Ant. 3 + Ant. 4 + Ant. 5 + Ant. 6 / CH138 / 5690 MHz (UNII 2C)

**802.11ax HEW80-BF_Nss2,(MCS0)_4TX
5690MHz Straddle 5.47-5.725GHz**

PSD

02/07/2020

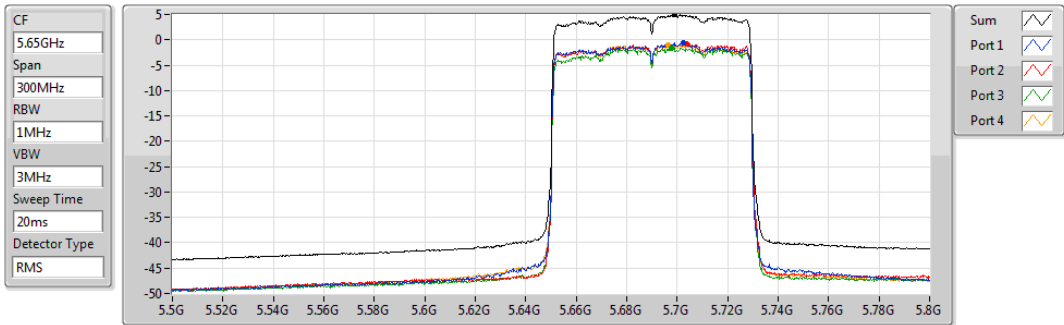

Sum	PD	Port 1	Port 2	Port 3	Port 4
(dBm/RBW)	(dBm/RBW)	(dBm/RBW)	(dBm/RBW)	(dBm/RBW)	(dBm/RBW)
4.92	4.92	-0.65	-0.74	-1.65	-1.05

Power Density Plot on Configuration IEEE 802.11ax 80MHz / Nss 2 MCS 0 / 2S4T TXBF / Ant. 3 + Ant. 4 + Ant. 5 + Ant. 6 / CH138 / 5690 MHz (UNII 3)

**802.11ax HEW80-BF_Nss2,(MCS0)_4TX
5690MHz Straddle 5.725-5.85GHz**

PSD

02/07/2020

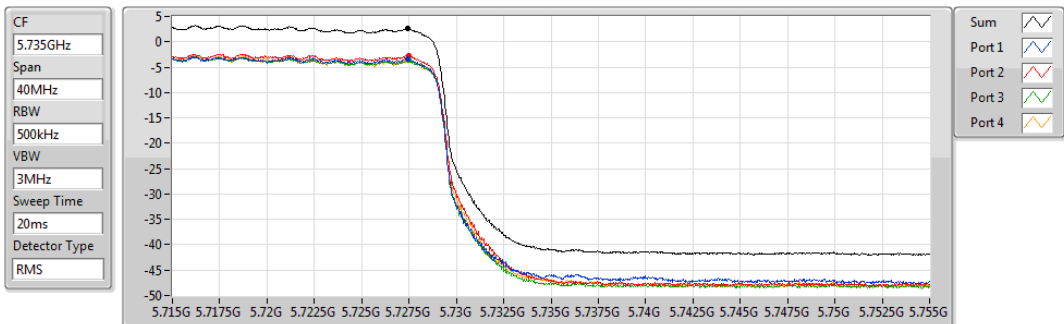

Sum	PD	Port 1	Port 2	Port 3	Port 4
(dBm/RBW)	(dBm/RBW)	(dBm/RBW)	(dBm/RBW)	(dBm/RBW)	(dBm/RBW)
2.64	2.64	-3.33	-2.65	-3.70	-3.62



Power Density Plot on Configuration IEEE 802.11ax 80MHz / Nss 3 MCS 0 / 3S4T TXBF / Ant. 3 + Ant. 4 + Ant. 5 + Ant. 6 / CH138 / 5690 MHz (UNII 2C)

**802.11ax HEW80-BF_Nss3,(MCS0)_4TX
5690MHz Straddle 5.47-5.725GHz**

PSD

03/07/2020

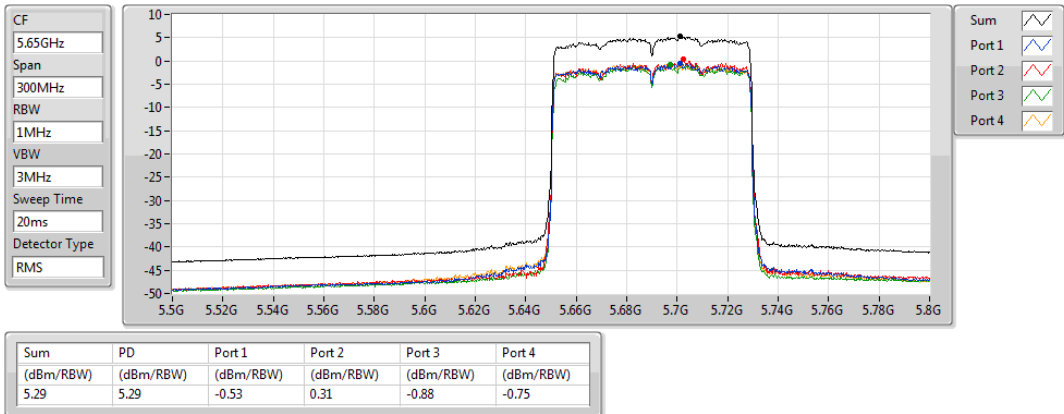

Power Density Plot on Configuration IEEE 802.11ax 80MHz / Nss 3 MCS 0 / 3S4T TXBF / Ant. 3 + Ant. 4 + Ant. 5 + Ant. 6 / CH138 / 5690 MHz (UNII 3)

**802.11ax HEW80-BF_Nss3,(MCS0)_4TX
5690MHz Straddle 5.725-5.85GHz**

PSD

03/07/2020

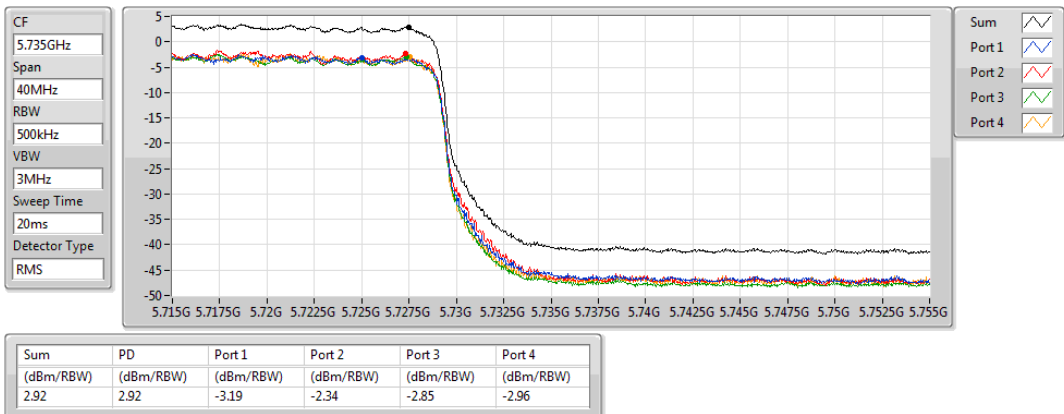



2.5. Radiated Emissions Measurement

2.5.1. Limit

Radiated emissions which fall within the restricted band specified on 15.205(a) must comply with the radiated emission limits specified as below table:

Frequencies (MHz)	Field Strength (micorvolts/meter)	Measurement Distance (meters)
0.009~0.490	2400/F(kHz)	300
0.490~1.705	24000/F(kHz)	30
1.705~30.0	30	30
30~88	100	3
88~216	150	3
216~960	200	3
Above 960	500	3

Note:

1. The lower limit shall apply at the transition frequencies.
2. Emission level (dB μ V/m) = 20 log Emission level (μ V/m).
3. For frequencies above 1000MHz, the field strength limits are based on average detector, however, the peak field strength of any emission shall not exceed the maximum permitted average limits, specified above by more than 20dB under any condition of modulation.



2.5.2. Limits of Unwanted Emission out of the restricted bands

APPLICABLE TO	EIRP LIMIT (dBm)	EQUIVALENT FIELD STRENGTH AT 3m (dBμV/m)	
U-NII-2A 5250~5350MHz	PK: -27 (dBm/MHz)	PK: 68.2 (dBμV/m)	-27dBm/MHz can be substituted by PK: 74 (dBμV/m) AV: 54 (dBμV/m)
U-NII-2C 5470~5725MHz	PK: -27 (dBm/MHz)	PK: 68.2 (dBμV/m)	-27dBm/MHz can be substituted by PK: 74 (dBμV/m) AV: 54 (dBμV/m)
U-NII-3 5725~5850MHz	(Note)		

NOTE: 15.407(b)(4) For transmitters operating in the 5.725-5.85 GHz band:

(i) All emissions shall be limited to a level of -27 dBm/MHz at 75 MHz or more above or below the band edge increasing linearly to 10 dBm/MHz at 25 MHz above or below the band edge, and from 25 MHz above or below the band edge increasing linearly to a level of 15.6 dBm/MHz at 5 MHz above or below the band edge, and from 5 MHz above or below the band edge increasing linearly to a level of 27 dBm/MHz at the band edge.

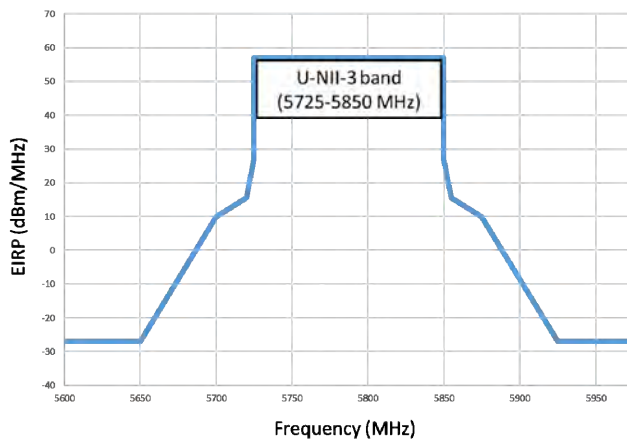

15.407 new rule(FCC16-24)	
Frequency	Limit(dBm/MHz)
5460	-27
5650	-27
5700	10
5720	15.6
5725	27
5725	N/A
5850	27
5855	15.6
5875	10
5925	-27
7250	-27

The following formula is used to convert the equipment isotropic radiated power (eirp) to field strength:

$$E = \frac{100000\sqrt{30P}}{3} \mu\text{V/m, where P is the eirp (Watts).$$



2.5.3. Measuring Instruments and Setting

Please refer to section 3 of equipments list in this report. The following table is the setting of spectrum analyzer and receiver.

Spectrum Parameter	Setting
Attenuation	Auto
Start Frequency	1 GHz
Stop Frequency	10th carrier harmonic
RBW / VBW (Emission in restricted band)	1MHz / 3MHz for Peak, Duty cycle \geq 98% 1MHz / 10Hz for Average Duty cycle < 98% 1MHz / (1/T) for Average, where T is pulse time.
RBW / VBW (Emission in non-restricted band)	1MHz / 3MHz for peak
Detector	Peak
Trace mode	max hold.

Note : According to KDB 789033 D02 v02 r01 G. 6. d) **Method VB.**

As an alternative, the analyzer may be set to linear detector mode. Ensure that video filtering is applied in linear voltage domain (rather than in a log or dB domain). Some analyzers require linear display mode in order to accomplish this. Others have a setting for Average-VBW Type, which can be set to "Voltage" regardless of the display mode.

Receiver Parameter	Setting
Attenuation	Auto
Start ~ Stop Frequency	9kHz~150kHz / RBW 200Hz for QP
Start ~ Stop Frequency	150kHz~30MHz / RBW 9kHz for QP
Start ~ Stop Frequency	30MHz~1000MHz / RBW 120kHz for QP

**2.5.4. Test Procedures**

1. Configure the EUT according to ANSI C63.10. The EUT was placed on the top of the turntable 0.8 meter above ground for below 1G and 1.5 meter above ground for above 1G. The phase center of the receiving antenna mounted on the top of a height-variable antenna tower was placed 3 meters far away from the turntable.
2. Power on the EUT and all the supporting units. The turntable was rotated by 360 degrees to determine the position of the highest radiation.
3. The height of the broadband receiving antenna was varied between one meter and four meters above ground to find the maximum emissions field strength of both horizontal and vertical polarization.
4. For each suspected emissions, the antenna tower was scan (from 1 m to 4 m) and then the turntable was rotated (from 0 degree to 360 degrees) to find the maximum reading.
5. Set the test-receiver system to Peak or CISPR quasi-peak Detect Function with specified bandwidth under Maximum Hold Mode.
6. For emissions above 1GHz, use 1MHz VBW and 3MHz RBW for peak reading. Then 1MHz RBW and 1/T Hz VBW for average reading in spectrum analyzer.
7. When the radiated emissions limits are expressed in terms of the average value of the emissions, and pulsed operation is employed, the measurement field strength shall be determined by averaging over one complete pulse train, including blanking intervals, as long as the pulse train does not exceed 0.1 seconds. As an alternative (provided the transmitter operates for longer than 0.1 seconds) or in cases where the pulse train exceeds 0.1 seconds, the measured field strength shall be determined from the average absolute voltage during a 0.1 second interval during which the field strength is at its maximum value.
8. If the emissions level of the EUT in peak mode was 3 dB lower than the average limit specified, then testing will be stopped and peak values of EUT will be reported, otherwise, the emissions which do not have 3 dB margin will be repeated one by one using the quasi-peak method for below 1GHz.
9. For testing above 1GHz, the emissions level of the EUT in peak mode was lower than average limit (that means the emissions level in peak mode also complies with the limit in average mode), then testing will be stopped and peak values of EUT will be reported, otherwise, the emissions will be measured in average mode again and reported.
10. In case the emission is lower than 30MHz, loop antenna has to be used for measurement and the recorded data should be QP measured by receiver. High – Low scan is not required in this case.

2.5.5. Test Setup Layout

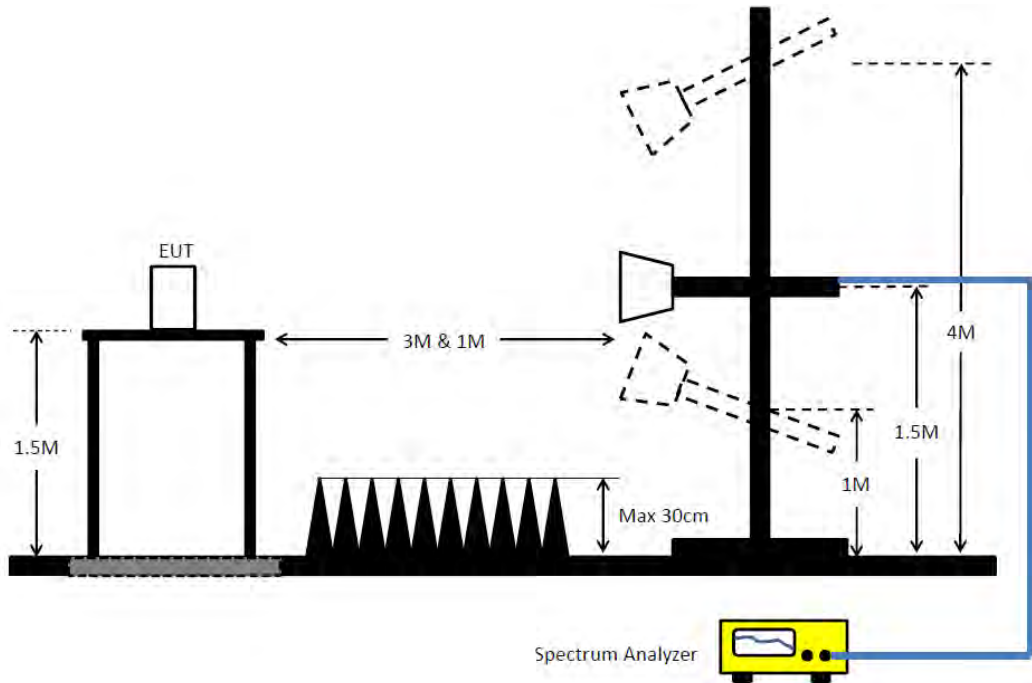

2.5.6. Test Deviation

There is no deviation with the original standard.

2.5.7. EUT Operation during Test

For CDD mode:

The EUT was programmed to be in continuously transmitting mode.

For TXBF mode:

The EUT was programmed to be in beamforming transmitting mode.

2.5.8. Measurement Results Calculation

The measured Level is calculated using:

Corrected Reading: Antenna factor (AF) + Cable loss (CL) + Read level (Raw) - Preamp factor (PA)(if applicable) = Level .



2.5.9. Results for Radiated Emissions (1GHz~40GHz)

Following channel(s) was (were) selected for the final test as listed below.

MODE	TX Chain	TESTED CHANNEL	MODULATION TECHNOLOGY	MODULATION TYPE	DATA RATE (Mbps)
802.11ax 20MHz	(1S2T, CDD)	52, 60, 64	OFDMA	BPSK	Nss1 MCS0 (8.6)
802.11ax 20MHz	(1S4T, CDD)	100, 116, 140, 144	OFDMA	BPSK	Nss1 MCS0 (26)
802.11ax 20MHz	(1S2T, TXBF)	52, 60, 64	OFDMA	BPSK	Nss1 MCS0 (8.6)
802.11ax 20MHz	(1S4T, TXBF)	100, 116, 140, 144	OFDMA	BPSK	Nss1 MCS0 (8.6)
802.11ax 20MHz	(2S4T, TXBF)	100, 116, 140, 144	OFDMA	BPSK	Nss2 MCS0 (17.2)
802.11ax 20MHz	(3S4T, TXBF)	100, 116, 140, 144	OFDMA	BPSK	Nss3 MCS0 (25.8)
802.11ax 40MHz	(1S2T, CDD)	54, 62	OFDMA	BPSK	Nss1 MCS0 (17.2)
802.11ax 40MHz	(1S4T, CDD)	102, 110, 134, 142	OFDMA	BPSK	Nss1 MCS0 (17.2)
802.11ax 40MHz	(1S2T, TXBF)	54, 62	OFDMA	BPSK	Nss1 MCS0 (17.2)
802.11ax 40MHz	(1S4T, TXBF)	102, 110, 134, 142	OFDMA	BPSK	Nss1 MCS0 (17.2)
802.11ax 40MHz	(2S4T, TXBF)	102, 110, 134, 142	OFDMA	BPSK	Nss2 MCS0 (34.4)
802.11ax 40MHz	(3S4T, TXBF)	102, 110, 134, 142	OFDMA	BPSK	Nss3 MCS0 (51.6)
802.11ax 80MHz	(1S2T, CDD)	58	OFDMA	BPSK	Nss1 MCS0 (36)
802.11ax 80MHz	(1S4T, CDD)	106, 122, 138	OFDMA	BPSK	Nss1 MCS0 (36)
802.11ax 80MHz	(1S2T, TXBF)	58	OFDMA	BPSK	Nss1 MCS0 (36)
802.11ax 80MHz	(1S4T, TXBF)	106, 122, 138	OFDMA	BPSK	Nss1 MCS0 (36)
802.11ax 80MHz	(2S4T, TXBF)	106, 122, 138	OFDMA	BPSK	Nss2 MCS0 (72.1)
802.11ax 80MHz	(3S4T, TXBF)	106, 122, 138	OFDMA	BPSK	Nss3 MCS0 (108.1)
802.11ax 160MHz	(1S4T, CDD)	114	OFDMA	BPSK	Nss1 MCS0 (72.1)
802.11ax 160MHz	(1S4T, TXBF)	114	OFDMA	BPSK	Nss1 MCS0 (72.1)
802.11ax 160MHz	(2S4T, TXBF)	114	OFDMA	BPSK	Nss2 MCS0 (144.2)
802.11ax 160MHz	(3S4T, TXBF)	114	OFDMA	BPSK	Nss3 MCS0 (216.2)



Transmitter Radiated Emissions (1GHz~10th Harmonic)			
Operating Mode	802.11ax 20MHz / Nss 1 MCS 0 / 1S2T CDD / Ant. 1 + Ant. 2 / CH52	Polarization	V

802.11ax HEW20_Nss1,(MCS0)_2TX
5260MHz_TX

08/06/2020

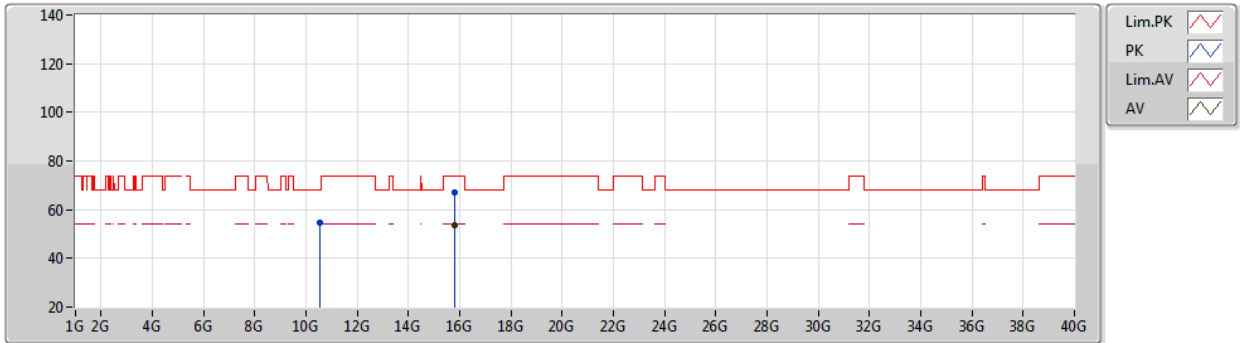

EUT Y_2TX
 Setting 100
 04-E-P-2

Type	Freq (Hz)	Level (dBuV/m)	Limit (dBuV/m)	Margin (dB)	Raw (dBuV)	Dist (m)	Condition	Azimuth (°)	Height (m)	Comment	AF (dB)	CL (dB)	PA (dB)
PK	10.52658G	54.75	68.20	-13.45	42.50	3	Vertical	309	1.60	-	39.02	7.63	34.40
PK	15.78588G	67.14	74.00	-6.86	54.31	3	Vertical	309	1.80	-	38.84	9.39	35.40
AV	15.78084G	53.57	54.00	-0.43	40.74	3	Vertical	309	1.80	-	38.84	9.39	35.40

Note 1: The amplitude of spurious emissions which are attenuated by more than 20 dB below the permissible value has no need to be reported.

Note 2: Measurement receive antenna polarization: H (Horizontal), V (Vertical)



Transmitter Radiated Emissions (1GHz~10th Harmonic)			
Operating Mode	802.11ax 20MHz / Nss 1 MCS 0 / 1S2T CDD / Ant. 1 + Ant. 2 / CH52	Polarization	H

802.11ax HEW20_Nss1,(MCS0)_2TX
5260MHz_TX

08/06/2020

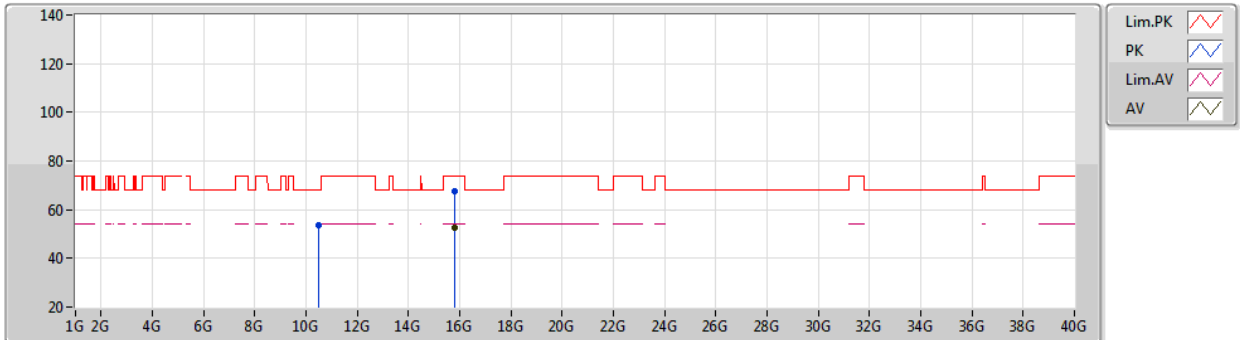

EUT Y_2TX
 Setting 100
 04-E-P-2

Type	Freq (Hz)	Level (dBuV/m)	Limit (dBuV/m)	Margin (dB)	Raw (dBuV)	Dist (m)	Condition	Azimuth (°)	Height (m)	Comment	AF (dB)	CL (dB)	PA (dB)
PK	10.48766G	53.79	68.20	-14.41	41.56	3	Horizontal	300	1.65	-	38.99	7.61	34.37
PK	15.78728G	67.74	74.00	-6.26	54.92	3	Horizontal	269	2.37	-	38.83	9.39	35.40
AV	15.78238G	52.82	54.00	-1.18	39.99	3	Horizontal	269	2.37	-	38.84	9.39	35.40

Note 1: The amplitude of spurious emissions which are attenuated by more than 20 dB below the permissible value has no need to be reported.

Note 2: Measurement receive antenna polarization: H (Horizontal), V (Vertical)



Transmitter Radiated Emissions (1GHz~10th Harmonic)			
Operating Mode	802.11ax 20MHz / Nss 1 MCS 0 / 1S2T CDD / Ant. 1 + Ant. 2 / CH60	Polarization	V

802.11ax HEW20_Nss1,(MCS0)_2TX
5300MHz_TX

08/06/2020

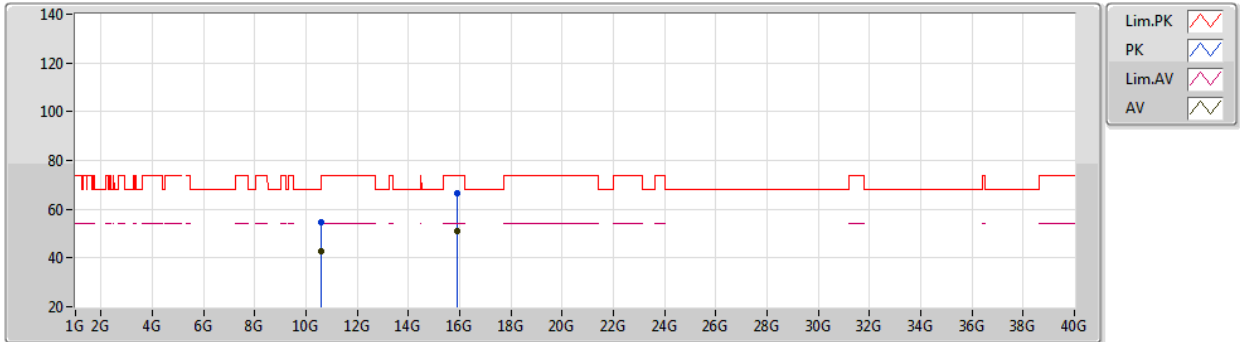

EUT Y_2TX
 Setting 100
 04-E-P-2

Type	Freq (Hz)	Level (dBuV/m)	Limit (dBuV/m)	Margin (dB)	Raw (dBuV)	Dist (m)	Condition	Azimuth (°)	Height (m)	Comment	AF (dB)	CL (dB)	PA (dB)
PK	10.6028G	54.53	74.00	-19.47	42.26	3	Vertical	307	2.85	-	39.08	7.67	34.48
AV	10.60042G	42.69	54.00	-11.31	30.41	3	Vertical	307	2.85	-	39.08	7.67	34.47
PK	15.89104G	66.32	74.00	-7.68	53.63	3	Vertical	310	1.80	-	38.72	9.40	35.43
AV	15.9007G	51.23	54.00	-2.77	38.55	3	Vertical	310	1.80	-	38.71	9.40	35.43

Note 1: The amplitude of spurious emissions which are attenuated by more than 20 dB below the permissible value has no need to be reported.

Note 2: Measurement receive antenna polarization: H (Horizontal), V (Vertical)



Transmitter Radiated Emissions (1GHz~10th Harmonic)

Operating Mode | 802.11ax 20MHz / Nss 1 MCS 0 / 1S2T CDD / Ant. 1 + Ant. 2 / CH60 | **Polarization** | H

802.11ax HEW20_Nss1,(MCS0)_2TX
5300MHz_TX

08/06/2020

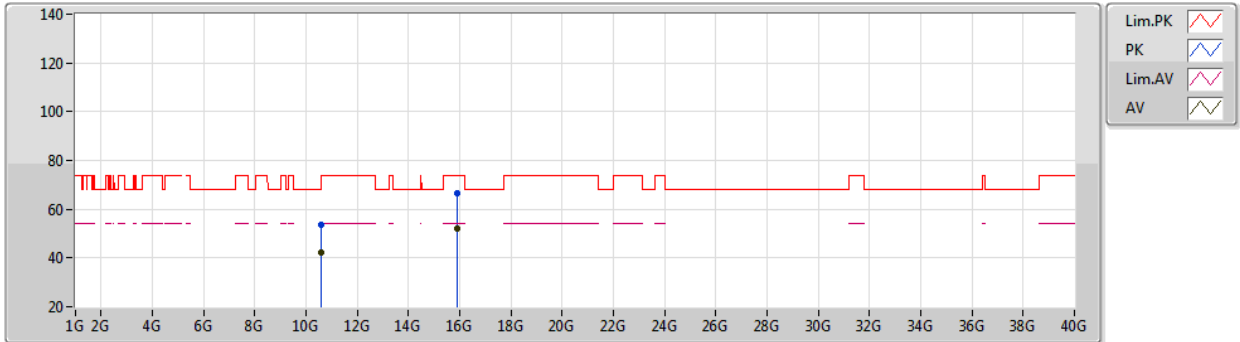

EUT Y_2TX
 Setting 100
 04-E-P-2

Type	Freq (Hz)	Level (dBuV/m)	Limit (dBuV/m)	Margin (dB)	Raw (dBuV)	Dist (m)	Condition	Azimuth (°)	Height (m)	Comment	AF (dB)	CL (dB)	PA (dB)
PK	10.61456G	53.84	74.00	-20.16	41.57	3	Horizontal	302	1.58	-	39.09	7.67	34.49
AV	10.60168G	42.45	54.00	-11.55	30.18	3	Horizontal	302	1.58	-	39.08	7.67	34.48
PK	15.89706G	66.81	74.00	-7.19	54.13	3	Horizontal	266	1.95	-	38.71	9.40	35.43
AV	15.89958G	51.92	54.00	-2.08	39.24	3	Horizontal	266	1.95	-	38.71	9.40	35.43

Note 1: The amplitude of spurious emissions which are attenuated by more than 20 dB below the permissible value has no need to be reported.

Note 2: Measurement receive antenna polarization: H (Horizontal), V (Vertical)



Transmitter Radiated Emissions (1GHz~10th Harmonic)			
Operating Mode	802.11ax 20MHz / Nss 1 MCS 0 / 1S2T CDD / Ant. 1 + Ant. 2 / CH64	Polarization	V

**802.11ax HEW20_Nss1,(MCS0)_2TX
5320MHz_TX**

08/06/2020

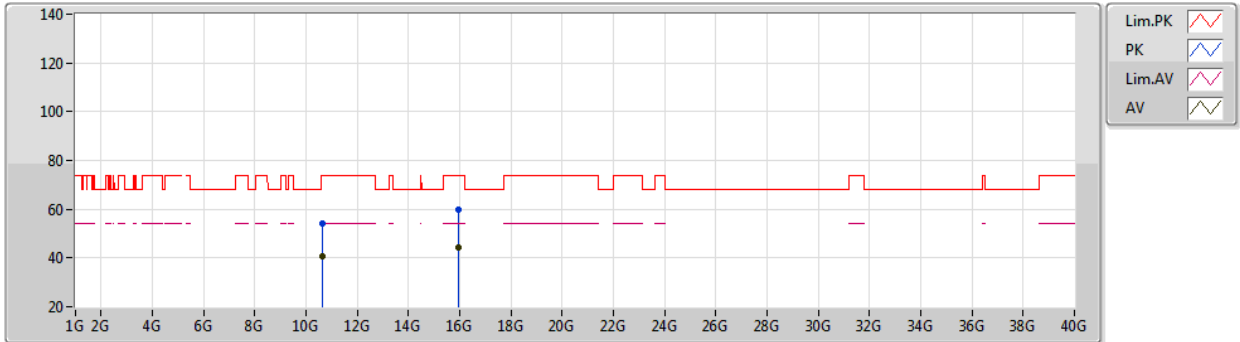

EUT Y_2TX
Setting 87
04-E-P-2

Type	Freq (Hz)	Level (dBuV/m)	Limit (dBuV/m)	Margin (dB)	Raw (dBuV)	Dist (m)	Condition	Azimuth (°)	Height (m)	Comment	AF (dB)	CL (dB)	PA (dB)
PK	10.6436G	54.08	74.00	-19.92	41.79	3	Vertical	167	1.56	-	39.11	7.69	34.51
AV	10.6408G	40.86	54.00	-13.14	28.57	3	Vertical	167	1.56	-	39.11	7.69	34.51
PK	15.95552G	59.76	74.00	-14.24	47.14	3	Vertical	314	1.76	-	38.65	9.41	35.44
AV	15.9635G	44.08	54.00	-9.92	31.47	3	Vertical	314	1.76	-	38.64	9.41	35.44

Note 1: The amplitude of spurious emissions which are attenuated by more than 20 dB below the permissible value has no need to be reported.

Note 2: Measurement receive antenna polarization: H (Horizontal), V (Vertical)



Transmitter Radiated Emissions (1GHz~10th Harmonic)

Operating Mode | 802.11ax 20MHz / Nss 1 MCS 0 / 1S2T CDD / Ant. 1 + Ant. 2 / CH64 | **Polarization** | H

802.11ax HEW20_Nss1,(MCS0)_2TX
5320MHz_TX

08/06/2020

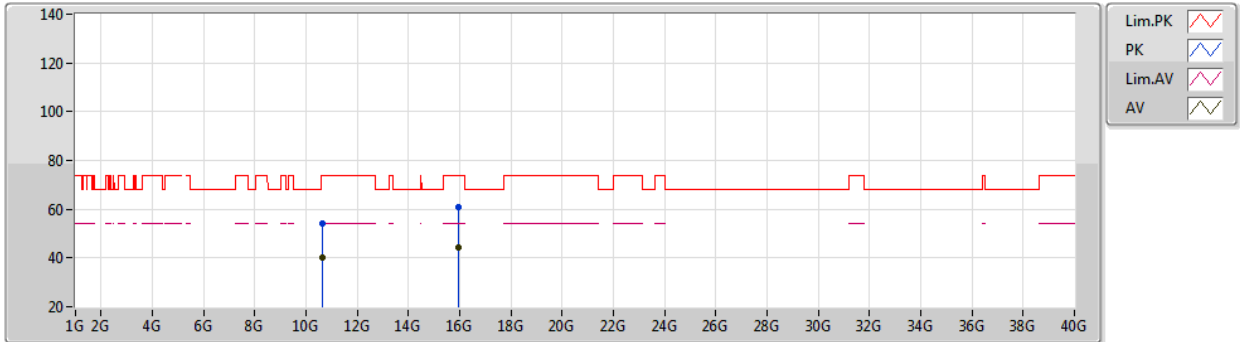

EUT Y_2TX
 Setting 87
 04-E-P-2

Type	Freq (Hz)	Level (dBuV/m)	Limit (dBuV/m)	Margin (dB)	Raw (dBuV)	Dist (m)	Condition	Azimuth (°)	Height (m)	Comment	AF (dB)	CL (dB)	PA (dB)
PK	10.64236G	53.89	74.00	-20.11	41.60	3	Horizontal	203	2.01	-	39.11	7.69	34.51
AV	10.63922G	40.27	54.00	-13.73	27.98	3	Horizontal	203	2.01	-	39.11	7.69	34.51
PK	15.95706G	60.93	74.00	-13.07	48.31	3	Horizontal	263	1.87	-	38.65	9.41	35.44
AV	15.95958G	44.55	54.00	-9.45	31.94	3	Horizontal	263	1.87	-	38.64	9.41	35.44

Note 1: The amplitude of spurious emissions which are attenuated by more than 20 dB below the permissible value has no need to be reported.
 Note 2: Measurement receive antenna polarization: H (Horizontal), V (Vertical)



Transmitter Radiated Emissions (1GHz~10th Harmonic)			
Operating Mode	802.11ax 20MHz / Nss 1 MCS 0 / 1S4T CDD / Ant. 3 + Ant. 4 + Ant. 5 + Ant. 6 / CH100	Polarization	V

802.11ax HEW20_Nss1,(MCS0)_4TX

08/06/2020

5500MHz_TX

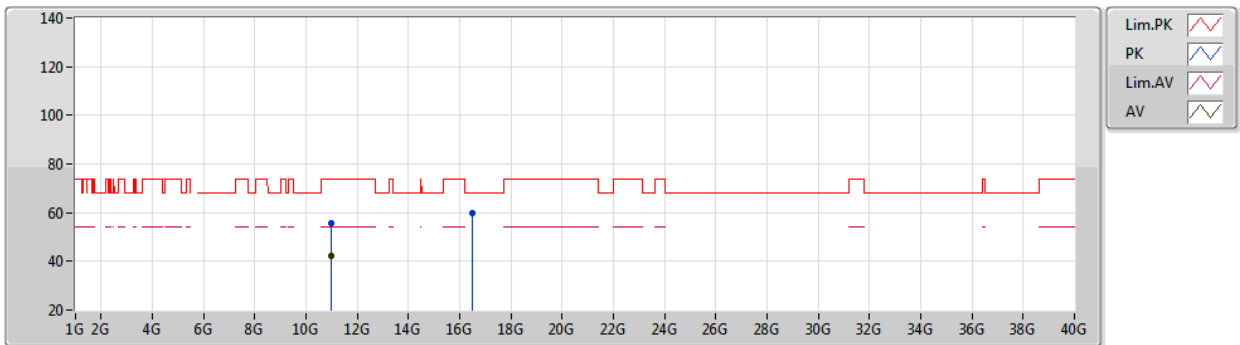

EUT Y_4TX
Setting 79
04-K-P-2

Type	Freq (Hz)	Level (dBuV/m)	Limit (dBuV/m)	Margin (dB)	Raw (dBuV)	Dist (m)	Condition	Azimuth (°)	Height (m)	Comment	AF (dB)	CL (dB)	PA (dB)
PK	10.99712G	55.86	74.00	-18.14	43.45	3	Vertical	246	1.99	-	39.40	7.86	34.85
AV	11.00196G	42.01	54.00	-11.99	29.60	3	Vertical	246	1.99	-	39.40	7.86	34.85
PK	16.50474G	59.79	68.20	-8.41	45.77	3	Vertical	276	1.13	-	39.71	9.80	35.49

Note 1: The amplitude of spurious emissions which are attenuated by more than 20 dB below the permissible value has no need to be reported.

Note 2: Measurement receive antenna polarization: H (Horizontal), V (Vertical)



Transmitter Radiated Emissions (1GHz~10th Harmonic)			
Operating Mode	802.11ax 20MHz / Nss 1 MCS 0 / 1S4T CDD / Ant. 3 + Ant. 4 + Ant. 5 + Ant. 6 / CH100	Polarization	H

802.11ax HEW20_Nss1,(MCS0)_4TX

08/06/2020

5500MHz_TX

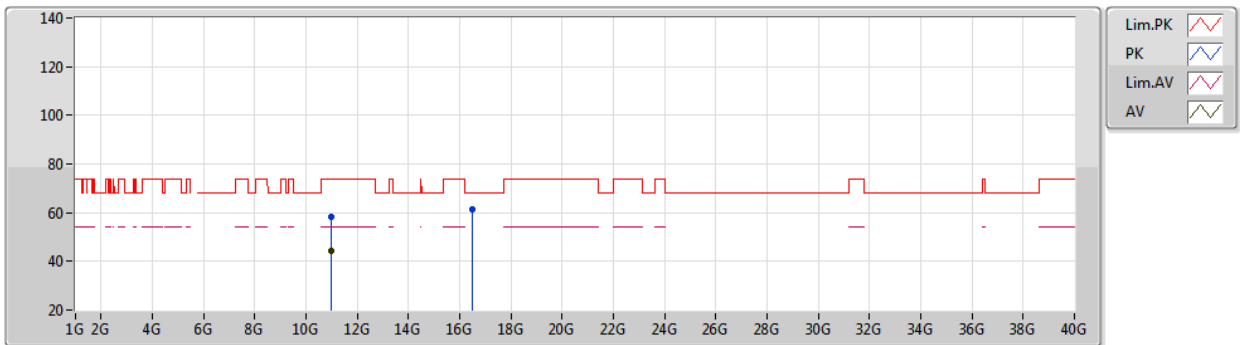

EUT Y_4TX
Setting 79
04-K-P-2

Type	Freq (Hz)	Level (dBuV/m)	Limit (dBuV/m)	Margin (dB)	Raw (dBuV)	Dist (m)	Condition	Azimuth (°)	Height (m)	Comment	AF (dB)	CL (dB)	PA (dB)
PK	11.005G	58.09	74.00	-15.91	45.68	3	Horizontal	5	2.18	-	39.40	7.86	34.85
AV	10.9998G	44.53	54.00	-9.47	32.12	3	Horizontal	5	2.18	-	39.40	7.86	34.85
PK	16.50498G	61.40	68.20	-6.80	47.38	3	Horizontal	310	2.52	-	39.71	9.80	35.49

Note 1: The amplitude of spurious emissions which are attenuated by more than 20 dB below the permissible value has no need to be reported.

Note 2: Measurement receive antenna polarization: H (Horizontal), V (Vertical)



Transmitter Radiated Emissions (1GHz~10th Harmonic)			
Operating Mode	802.11ax 20MHz / Nss 1 MCS 0 / 1S4T CDD / Ant. 3 + Ant. 4 + Ant. 5 + Ant. 6 / CH116	Polarization	V

802.11ax HEW20_Nss1,(MCS0)_4TX

08/06/2020

5580MHz_TX

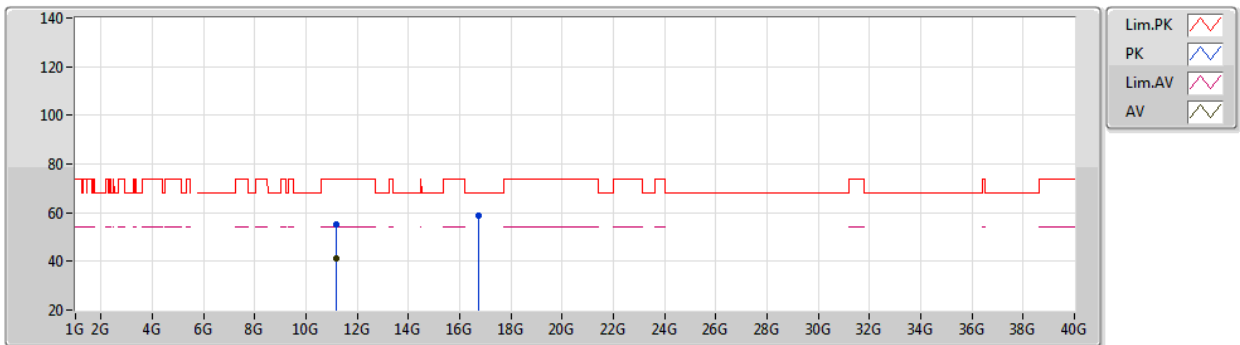

EUT Y_4TX
Setting 80
04-K-P-2

Type	Freq (Hz)	Level (dBuV/m)	Limit (dBuV/m)	Margin (dB)	Raw (dBuV)	Dist (m)	Condition	Azimuth (°)	Height (m)	Comment	AF (dB)	CL (dB)	PA (dB)
PK	11.1607G	55.05	74.00	-18.95	42.67	3	Vertical	331	1.09	-	39.32	7.96	34.90
AV	11.1609G	41.31	54.00	-12.69	28.93	3	Vertical	331	1.09	-	39.32	7.96	34.90
PK	16.7316G	58.63	68.20	-9.57	43.94	3	Vertical	336	1.80	-	40.21	9.98	35.50

Note 1: The amplitude of spurious emissions which are attenuated by more than 20 dB below the permissible value has no need to be reported.

Note 2: Measurement receive antenna polarization: H (Horizontal), V (Vertical)



Transmitter Radiated Emissions (1GHz~10th Harmonic)			
Operating Mode	802.11ax 20MHz / Nss 1 MCS 0 / 1S4T CDD / Ant. 3 + Ant. 4 + Ant. 5 + Ant. 6 / CH116	Polarization	H

802.11ax HEW20_Nss1,(MCS0)_4TX

08/06/2020

5580MHz_TX

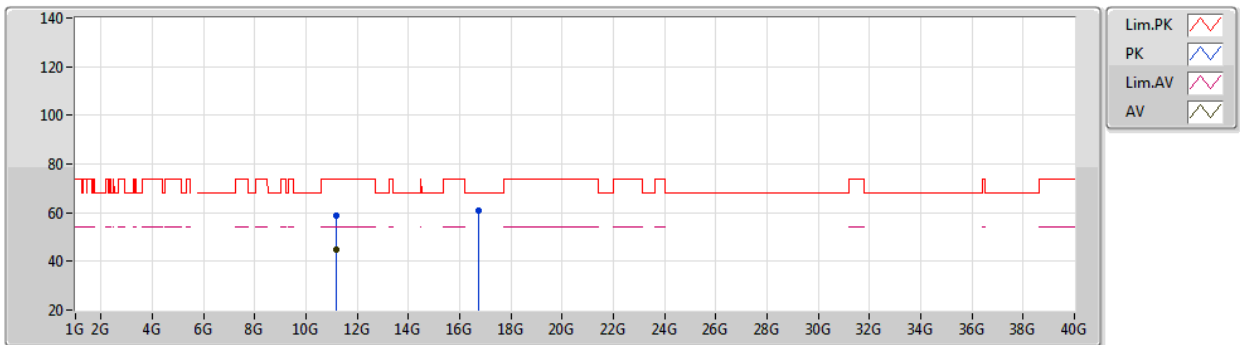

EUT Y_4TX
Setting 80
04-K-P-2

Type	Freq (Hz)	Level (dBuV/m)	Limit (dBuV/m)	Margin (dB)	Raw (dBuV)	Dist (m)	Condition	Azimuth (°)	Height (m)	Comment	AF (dB)	CL (dB)	PA (dB)
PK	11.1601G	58.62	74.00	-15.38	46.24	3	Horizontal	309	1.66	-	39.32	7.96	34.90
AV	11.16G	44.98	54.00	-9.02	32.60	3	Horizontal	309	1.66	-	39.32	7.96	34.90
PK	16.7434G	60.65	68.20	-7.55	45.92	3	Horizontal	316	1.80	-	40.24	9.99	35.50

Note 1: The amplitude of spurious emissions which are attenuated by more than 20 dB below the permissible value has no need to be reported.

Note 2: Measurement receive antenna polarization: H (Horizontal), V (Vertical)



Transmitter Radiated Emissions (1GHz~10th Harmonic)			
Operating Mode	802.11ax 20MHz / Nss 1 MCS 0 / 1S4T CDD / Ant. 3 + Ant. 4 + Ant. 5 + Ant. 6 / CH140	Polarization	V

802.11ax HEW20_Nss1,(MCS0)_4TX
5700MHz_TX

08/06/2020

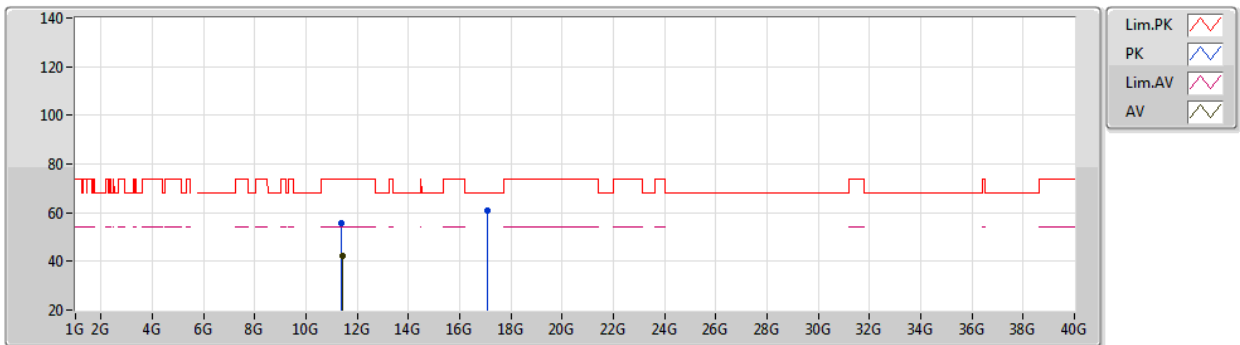

EUT Y_4TX
Setting 81
04-K-P-2

Type	Freq (Hz)	Level (dBuV/m)	Limit (dBuV/m)	Margin (dB)	Raw (dBuV)	Dist (m)	Condition	Azimuth (°)	Height (m)	Comment	AF (dB)	CL (dB)	PA (dB)
PK	11.3982G	55.67	74.00	-18.33	43.32	3	Vertical	307	1.80	-	39.20	8.12	34.97
AV	11.4029G	42.33	54.00	-11.67	29.98	3	Vertical	307	1.80	-	39.20	8.12	34.97
PK	17.1064G	60.99	68.20	-7.21	45.42	3	Vertical	290	2.53	-	40.90	10.16	35.49

Note 1: The amplitude of spurious emissions which are attenuated by more than 20 dB below the permissible value has no need to be reported.

Note 2: Measurement receive antenna polarization: H (Horizontal), V (Vertical)



Transmitter Radiated Emissions (1GHz~10th Harmonic)			
Operating Mode	802.11ax 20MHz / Nss 1 MCS 0 / 1S4T CDD / Ant. 3 + Ant. 4 + Ant. 5 + Ant. 6 / CH140	Polarization	H

802.11ax HEW20_Nss1,(MCS0)_4TX

08/06/2020

5700MHz_TX

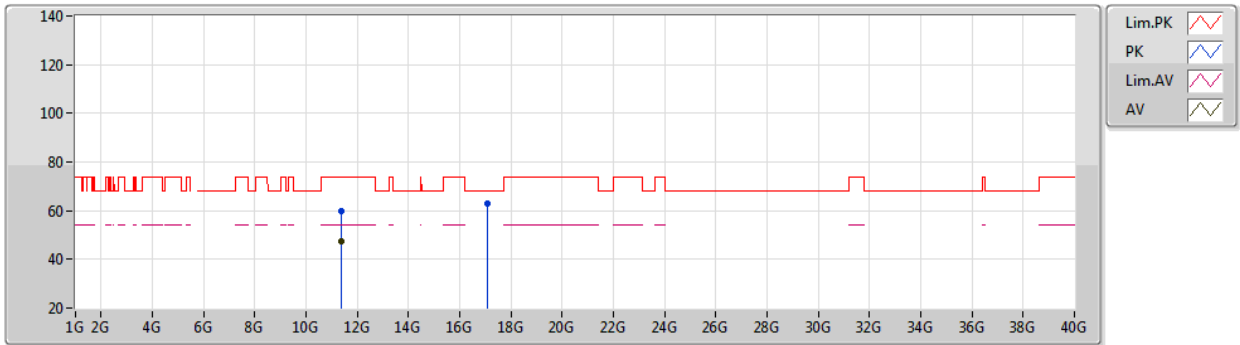

EUT_Y_4TX
Setting 81
04-K-P-2

Type	Freq (Hz)	Level (dBuV/m)	Limit (dBuV/m)	Margin (dB)	Raw (dBuV)	Dist (m)	Condition	Azimuth (°)	Height (m)	Comment	AF (dB)	CL (dB)	PA (dB)
PK	11.4G	59.99	74.00	-14.01	47.64	3	Horizontal	312	1.67	-	39.20	8.12	34.97
AV	11.3998G	47.37	54.00	-6.63	35.02	3	Horizontal	312	1.67	-	39.20	8.12	34.97
PK	17.101G	62.81	68.20	-5.39	47.24	3	Horizontal	326	1.51	-	40.89	10.17	35.49

Note 1: The amplitude of spurious emissions which are attenuated by more than 20 dB below the permissible value has no need to be reported.

Note 2: Measurement receive antenna polarization: H (Horizontal), V (Vertical)



Transmitter Radiated Emissions (1GHz~10th Harmonic)			
Operating Mode	802.11ax 20MHz / Nss 1 MCS 0 / 1S4T CDD / Ant. 3 + Ant. 4 + Ant. 5 + Ant. 6 / CH144	Polarization	V

802.11ax HEW20_Nss1,(MCS0)_4TX
5720MHz Straddle 5.47-5.725GHz_TX

08/06/2020

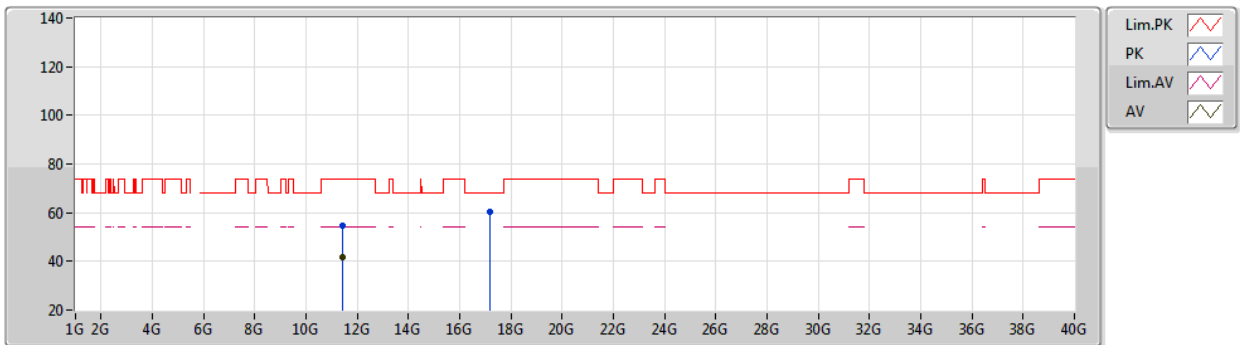

EUT Y_4TX
 Setting 80
 04-E-P-2

Type	Freq (Hz)	Level (dBuV/m)	Limit (dBuV/m)	Margin (dB)	Raw (dBuV)	Dist (m)	Condition	Azimuth (°)	Height (m)	Comment	AF (dB)	CL (dB)	PA (dB)
PK	11.4384G	54.87	74.00	-19.13	42.53	3	Vertical	284	2.95	-	39.18	8.14	34.98
AV	11.4384G	41.97	54.00	-12.03	29.63	3	Vertical	284	2.95	-	39.18	8.14	34.98
PK	17.16248G	60.17	68.20	-8.03	44.54	3	Vertical	206	1.58	-	40.95	10.15	35.47

Note 1: The amplitude of spurious emissions which are attenuated by more than 20 dB below the permissible value has no need to be reported.

Note 2: Measurement receive antenna polarization: H (Horizontal), V (Vertical)



Transmitter Radiated Emissions (1GHz~10th Harmonic)			
Operating Mode	802.11ax 20MHz / Nss 1 MCS 0 / 1S4T CDD / Ant. 3 + Ant. 4 + Ant. 5 + Ant. 6 / CH144	Polarization	H

802.11ax HEW20_Nss1,(MCS0)_4TX
5720MHz Straddle 5.47-5.725GHz_TX

08/06/2020

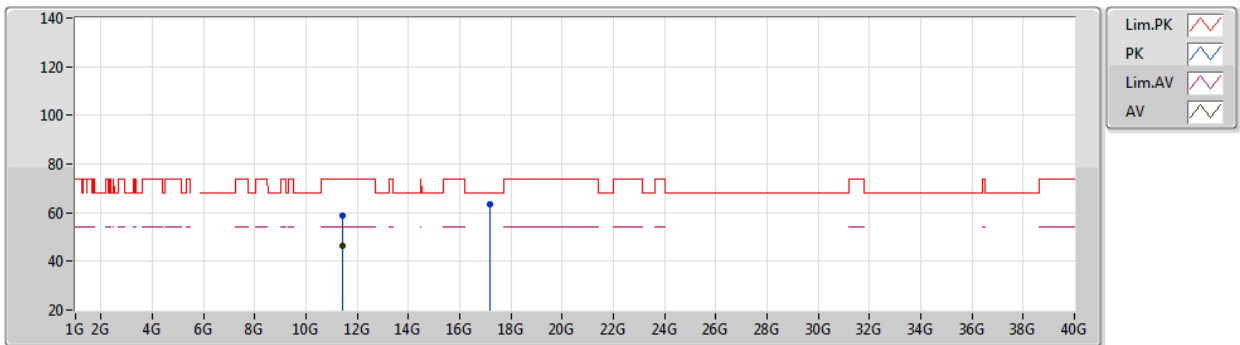

EUT Y_4TX
 Setting 80
 04-E-P-2

Type	Freq (Hz)	Level (dBuV/m)	Limit (dBuV/m)	Margin (dB)	Raw (dBuV)	Dist (m)	Condition	Azimuth (°)	Height (m)	Comment	AF (dB)	CL (dB)	PA (dB)
PK	11.4416G	59.02	74.00	-14.98	46.67	3	Horizontal	274	2.03	-	39.18	8.15	34.98
AV	11.4386G	46.41	54.00	-7.59	34.06	3	Horizontal	274	2.03	-	39.18	8.15	34.98
PK	17.1622G	63.45	68.20	-4.75	47.82	3	Horizontal	270	1.60	-	40.95	10.15	35.47

Note 1: The amplitude of spurious emissions which are attenuated by more than 20 dB below the permissible value has no need to be reported.

Note 2: Measurement receive antenna polarization: H (Horizontal), V (Vertical)



Transmitter Radiated Emissions (1GHz~10th Harmonic)			
Operating Mode	802.11ax 20MHz / Nss 1 MCS 0 / TXBF 1S2T / Ant. 1 + Ant. 2 / CH52	Polarization	V

802.11ax HEW20-BF_Nss1,(MCS0)_2TX
5260MHz_TX

08/06/2020

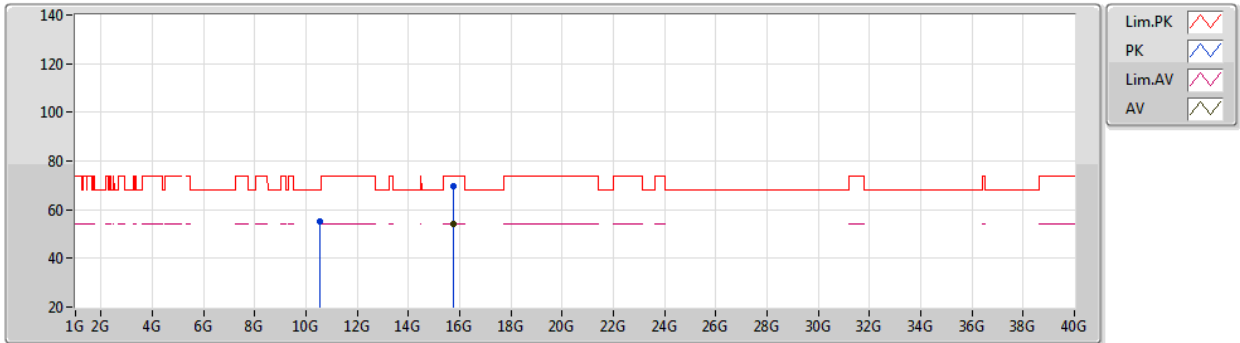

EUT Y_2TX
 Setting 92
 04-E-P-2

Type	Freq (Hz)	Level (dBuV/m)	Limit (dBuV/m)	Margin (dB)	Raw (dBuV)	Dist (m)	Condition	Azimuth (°)	Height (m)	Comment	AF (dB)	CL (dB)	PA (dB)
PK	10.5243G	55.21	68.20	-12.99	42.96	3	Vertical	235	1.80	-	39.02	7.63	34.40
PK	15.7644G	69.77	74.00	-4.23	56.92	3	Vertical	309	1.79	-	38.86	9.39	35.40
AV	15.7676G	53.97	54.00	-0.03	41.12	3	Vertical	309	1.79	-	38.86	9.39	35.40

Note 1: The amplitude of spurious emissions which are attenuated by more than 20 dB below the permissible value has no need to be reported.

Note 2: Measurement receive antenna polarization: H (Horizontal), V (Vertical)



Transmitter Radiated Emissions (1GHz~10th Harmonic)			
Operating Mode	802.11ax 20MHz / Nss 1 MCS 0 / TXBF 1S2T / Ant. 1 + Ant. 2 / CH52	Polarization	H

802.11ax HEW20-BF_Nss1,(MCS0)_2TX
5260MHz_TX

08/06/2020

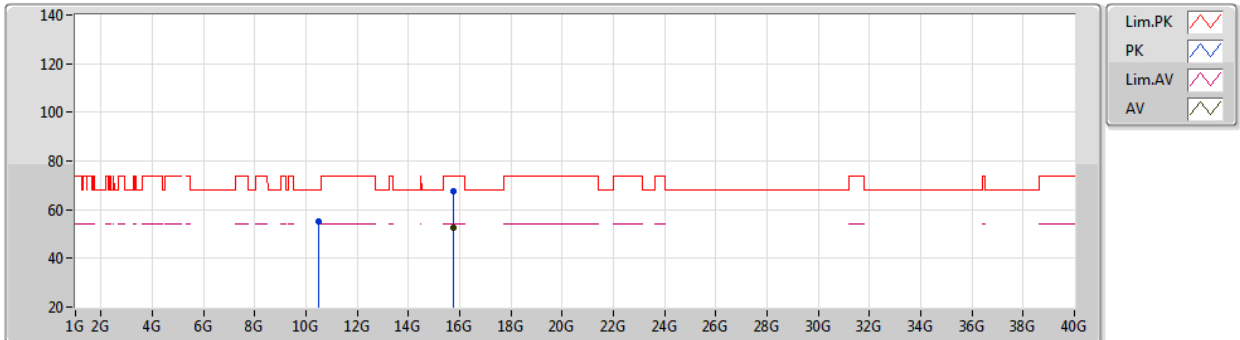

EUT Y_2TX
 Setting 92
 04-E-P-2

Type	Freq (Hz)	Level (dBuV/m)	Limit (dBuV/m)	Margin (dB)	Raw (dBuV)	Dist (m)	Condition	Azimuth (°)	Height (m)	Comment	AF (dB)	CL (dB)	PA (dB)
PK	10.51412G	55.01	68.20	-13.19	42.76	3	Horizontal	316	2.09	-	39.01	7.63	34.39
PK	15.7774G	67.34	74.00	-6.66	54.51	3	Horizontal	344	1.86	-	38.84	9.39	35.40
AV	15.7766G	52.82	54.00	-1.18	39.98	3	Horizontal	344	1.86	-	38.85	9.39	35.40

Note 1: The amplitude of spurious emissions which are attenuated by more than 20 dB below the permissible value has no need to be reported.

Note 2: Measurement receive antenna polarization: H (Horizontal), V (Vertical)



Transmitter Radiated Emissions (1GHz~10th Harmonic)			
Operating Mode	802.11ax 20MHz / Nss 1 MCS 0 / TXBF 1S2T / Ant. 1 + Ant. 2 / CH60	Polarization	V

**802.11ax HEW20-BF_Nss1,(MCS0)_2TX
5300MHz_TX**

08/06/2020

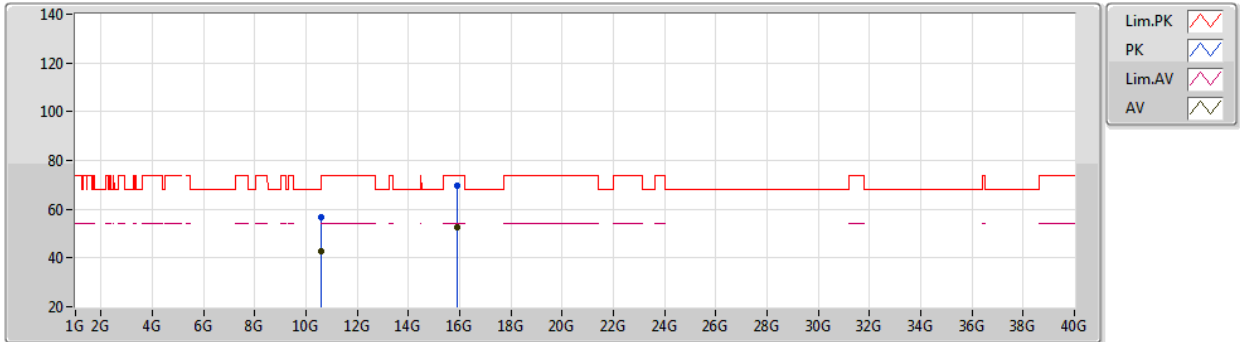

EUT Y_2TX
Setting 95
04-E-P-2

Type	Freq (Hz)	Level (dBuV/m)	Limit (dBuV/m)	Margin (dB)	Raw (dBuV)	Dist (m)	Condition	Azimuth (°)	Height (m)	Comment	AF (dB)	CL (dB)	PA (dB)
PK	10.6117G	56.72	74.00	-17.28	44.44	3	Vertical	306	2.88	-	39.09	7.67	34.48
AV	10.6141G	42.72	54.00	-11.28	30.45	3	Vertical	306	2.88	-	39.09	7.67	34.49
PK	15.9156G	69.58	74.00	-4.42	56.92	3	Vertical	309	1.80	-	38.69	9.40	35.43
AV	15.9098G	52.50	54.00	-1.50	39.83	3	Vertical	309	1.80	-	38.70	9.40	35.43

Note 1: The amplitude of spurious emissions which are attenuated by more than 20 dB below the permissible value has no need to be reported.

Note 2: Measurement receive antenna polarization: H (Horizontal), V (Vertical)



Transmitter Radiated Emissions (1GHz~10th Harmonic)			
Operating Mode	802.11ax 20MHz / Nss 1 MCS 0 / TXBF 1S2T / Ant. 1 + Ant. 2 / CH64	Polarization	H

**802.11ax HEW20-BF_Nss1,(MCS0)_2TX
5300MHz_TX**

08/06/2020

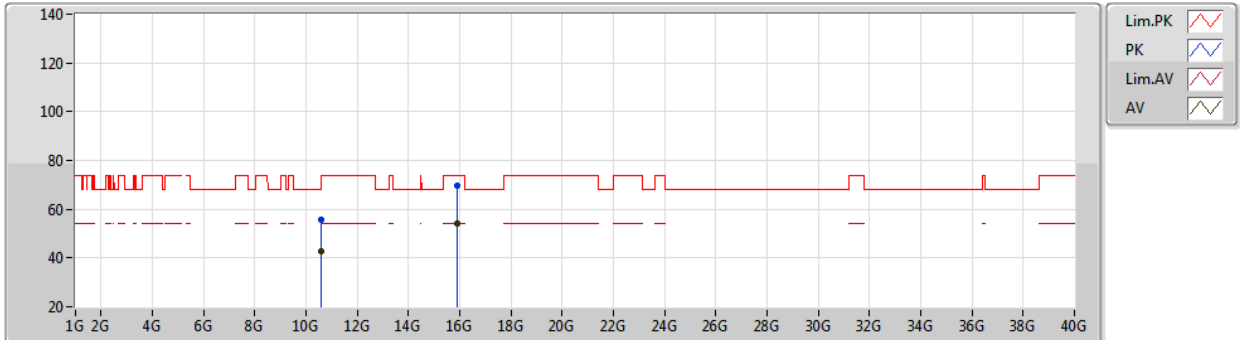

EUT Y_2TX
Setting 95
04-E-P-2

Type	Freq (Hz)	Level (dBuV/m)	Limit (dBuV/m)	Margin (dB)	Raw (dBuV)	Dist (m)	Condition	Azimuth (°)	Height (m)	Comment	AF (dB)	CL (dB)	PA (dB)
PK	10.6009G	55.88	74.00	-18.12	43.60	3	Horizontal	36	2.95	-	39.08	7.67	34.47
AV	10.603G	42.59	54.00	-11.41	30.32	3	Horizontal	36	2.95	-	39.08	7.67	34.48
PK	15.9062G	69.87	74.00	-4.13	57.20	3	Horizontal	261	1.86	-	38.70	9.40	35.43
AV	15.9026G	53.97	54.00	-0.03	41.29	3	Horizontal	261	1.86	-	38.71	9.40	35.43

Note 1: The amplitude of spurious emissions which are attenuated by more than 20 dB below the permissible value has no need to be reported.

Note 2: Measurement receive antenna polarization: H (Horizontal), V (Vertical)



Transmitter Radiated Emissions (1GHz~10th Harmonic)			
Operating Mode	802.11ax 20MHz / Nss 1 MCS 0 / TXBF 1S2T / Ant. 1 + Ant. 2 / CH64	Polarization	V

**802.11ax HEW20-BF_Nss1,(MCS0)_2TX
5320MHz_TX**

08/06/2020

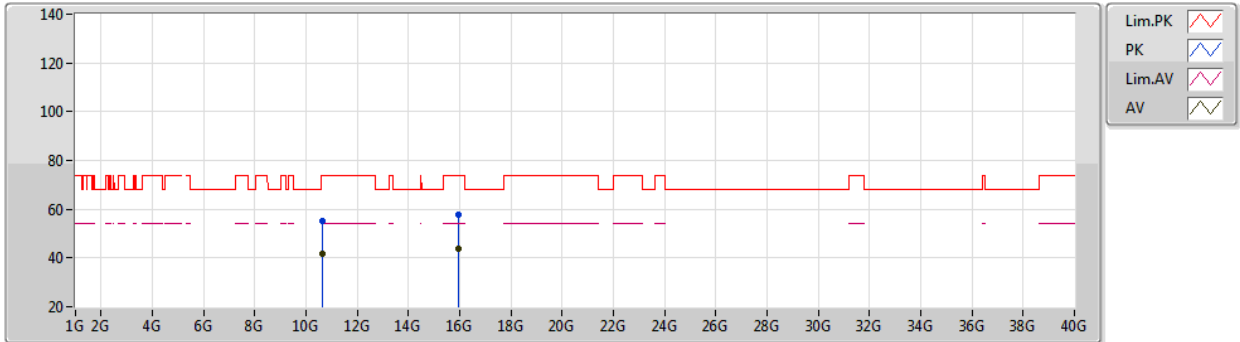

EUT_Y_2TX
Setting 81
04-E-L-2

Type	Freq (Hz)	Level (dBuV/m)	Limit (dBuV/m)	Margin (dB)	Raw (dBuV)	Dist (m)	Condition	Azimuth (°)	Height (m)	Comment	AF (dB)	CL (dB)	PA (dB)
PK	10.63596G	55.36	74.00	-18.64	43.07	3	Vertical	247	1.38	-	39.11	7.69	34.51
AV	10.63696G	41.70	54.00	-12.30	29.41	3	Vertical	247	1.38	-	39.11	7.69	34.51
PK	15.96784G	57.80	74.00	-16.20	45.19	3	Vertical	309	1.80	-	38.64	9.41	35.44
AV	15.96284G	43.92	54.00	-10.08	31.31	3	Vertical	309	1.80	-	38.64	9.41	35.44

Note 1: The amplitude of spurious emissions which are attenuated by more than 20 dB below the permissible value has no need to be reported.

Note 2: Measurement receive antenna polarization: H (Horizontal), V (Vertical)



Transmitter Radiated Emissions (1GHz~10th Harmonic)			
Operating Mode	802.11ax 20MHz / Nss 1 MCS 0 / TXBF 1S2T / Ant. 1 + Ant. 2 / CH64	Polarization	H

**802.11ax HEW20-BF_Nss1,(MCS0)_2TX
5320MHz_TX**

08/06/2020

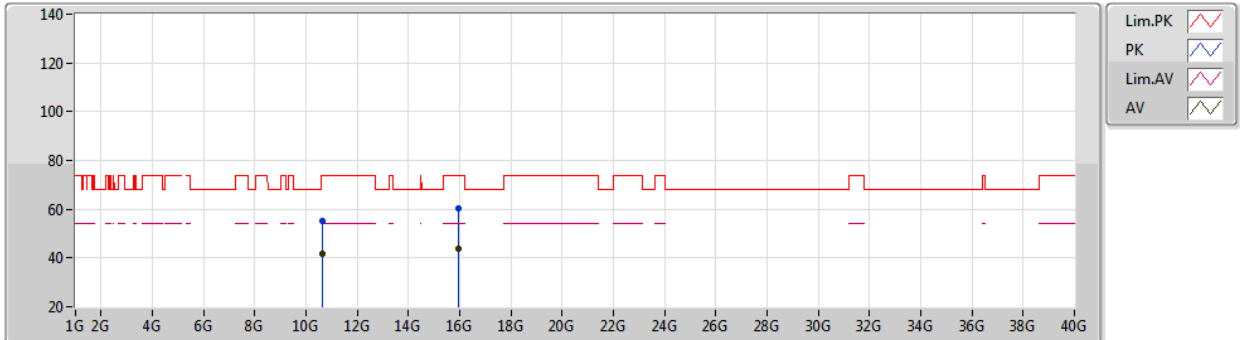

EUT Y_2TX
Setting 81
04-E-L-2

Type	Freq (Hz)	Level (dBuV/m)	Limit (dBuV/m)	Margin (dB)	Raw (dBuV)	Dist (m)	Condition	Azimuth (°)	Height (m)	Comment	AF (dB)	CL (dB)	PA (dB)
PK	10.6432G	55.21	74.00	-18.79	42.92	3	Horizontal	34	2.94	-	39.11	7.69	34.51
AV	10.64344G	41.93	54.00	-12.07	29.64	3	Horizontal	34	2.94	-	39.11	7.69	34.51
PK	15.96804G	60.11	74.00	-13.89	47.50	3	Horizontal	315	1.80	-	38.64	9.41	35.44
AV	15.96016G	43.87	54.00	-10.13	31.26	3	Horizontal	315	1.80	-	38.64	9.41	35.44

Note 1: The amplitude of spurious emissions which are attenuated by more than 20 dB below the permissible value has no need to be reported.

Note 2: Measurement receive antenna polarization: H (Horizontal), V (Vertical)



Transmitter Radiated Emissions (1GHz~10th Harmonic)			
Operating Mode	802.11ax 20MHz / Nss 1 MCS 0 / 1S4T TXBF / Ant. 3 + Ant. 4 + Ant. 5 + Ant. 6 / CH100	Polarization	V

**802.11ax HEW20-BF_Nss1,(MCS0)_4TX
5500MHz_TX**

08/06/2020

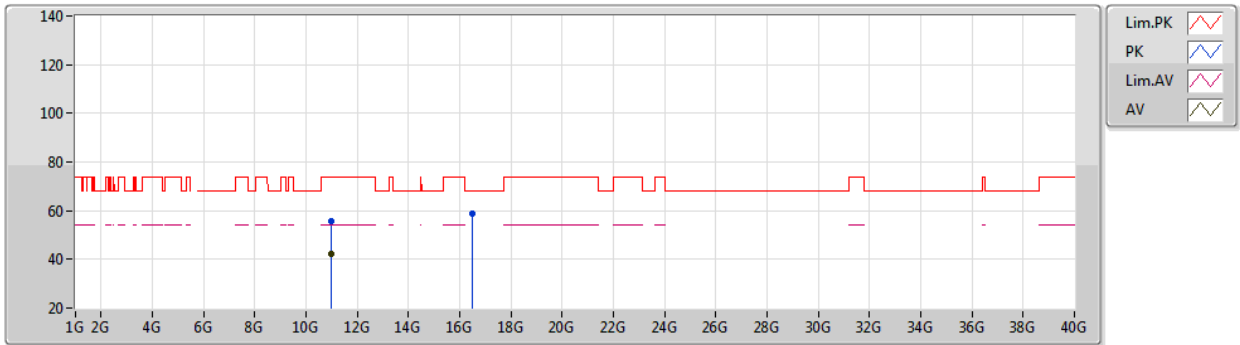

EUT Y_4TX
Setting 80
04-E-P-2

Type	Freq (Hz)	Level (dBuV/m)	Limit (dBuV/m)	Margin (dB)	Raw (dBuV)	Dist (m)	Condition	Azimuth (°)	Height (m)	Comment	AF (dB)	CL (dB)	PA (dB)
PK	10.99502G	55.92	74.00	-18.08	43.51	3	Vertical	314	1.76	-	39.40	7.86	34.85
AV	10.99856G	42.07	54.00	-11.93	29.66	3	Vertical	314	1.76	-	39.40	7.86	34.85
PK	16.5034G	59.04	68.20	-9.16	45.02	3	Vertical	308	1.80	-	39.71	9.80	35.49

Note 1: The amplitude of spurious emissions which are attenuated by more than 20 dB below the permissible value has no need to be reported.

Note 2: Measurement receive antenna polarization: H (Horizontal), V (Vertical)



Transmitter Radiated Emissions (1GHz~10th Harmonic)			
Operating Mode	802.11ax 20MHz / Nss 1 MCS 0 / 1S4T TXBF / Ant. 3 + Ant. 4 + Ant. 5 + Ant. 6 / CH100	Polarization	H

**802.11ax HEW20-BF_Nss1,(MCS0)_4TX
5500MHz_TX**

08/06/2020

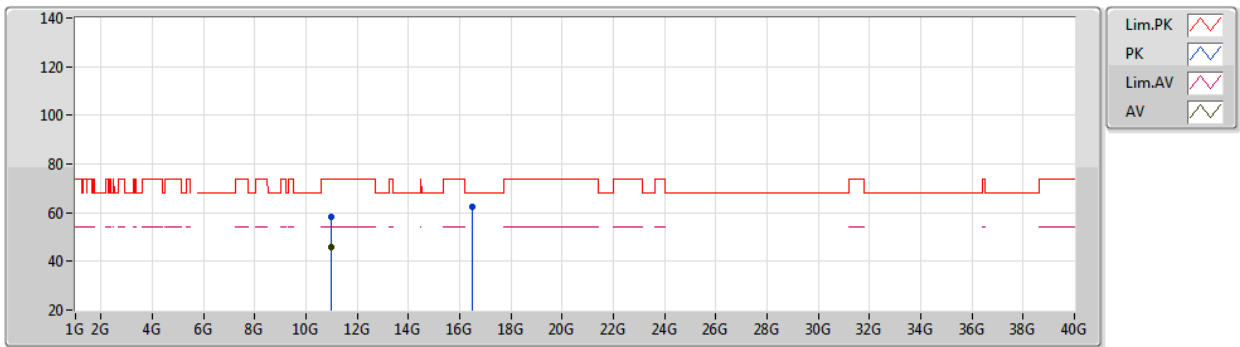

EUT_Y_4TX
Setting 80
04-E-P-2

Type	Freq (Hz)	Level (dBuV/m)	Limit (dBuV/m)	Margin (dB)	Raw (dBuV)	Dist (m)	Condition	Azimuth (°)	Height (m)	Comment	AF (dB)	CL (dB)	PA (dB)
PK	10.9874G	58.52	74.00	-15.48	46.12	3	Horizontal	353	2.22	-	39.39	7.85	34.84
AV	10.9949G	45.77	54.00	-8.23	33.36	3	Horizontal	353	2.22	-	39.40	7.86	34.85
PK	16.4964G	62.41	68.20	-5.79	48.40	3	Horizontal	269	1.97	-	39.69	9.80	35.48

Note 1: The amplitude of spurious emissions which are attenuated by more than 20 dB below the permissible value has no need to be reported.

Note 2: Measurement receive antenna polarization: H (Horizontal), V (Vertical)



Transmitter Radiated Emissions (1GHz~10th Harmonic)			
Operating Mode	802.11ax 20MHz / Nss 1 MCS 0 / 1S4T TXBF / Ant. 3 + Ant. 4 + Ant. 5 + Ant. 6 / CH116	Polarization	V

802.11ax HEW20-BF_Nss1,(MCS0)_4TX
5580MHz_TX

08/06/2020

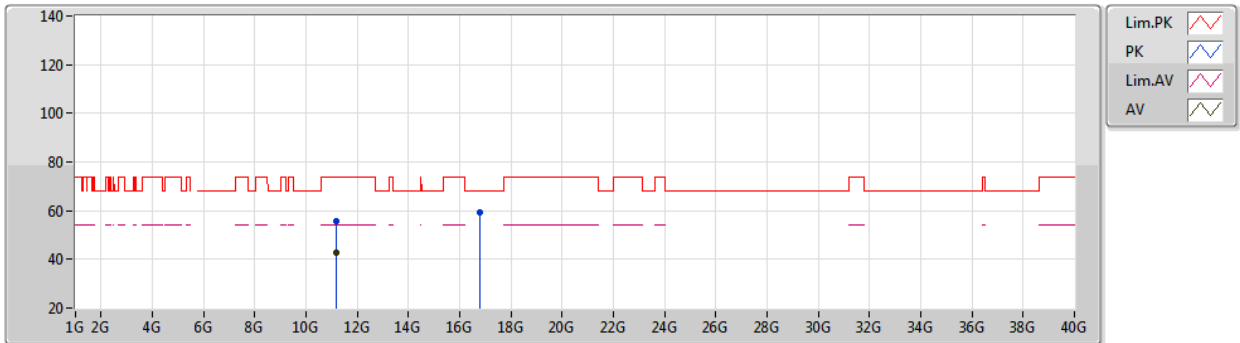

EUT Y_4TX
 Setting 80
 04-E-P-2

Type	Freq (Hz)	Level (dBuV/m)	Limit (dBuV/m)	Margin (dB)	Raw (dBuV)	Dist (m)	Condition	Azimuth (°)	Height (m)	Comment	AF (dB)	CL (dB)	PA (dB)
PK	11.166G	55.69	74.00	-18.31	43.30	3	Vertical	309	1.00	-	39.32	7.97	34.90
AV	11.1596G	42.86	54.00	-11.14	30.48	3	Vertical	309	1.00	-	39.32	7.96	34.90
PK	16.7625G	59.25	68.20	-8.95	44.47	3	Vertical	269	1.08	-	40.28	10.00	35.50

Note 1: The amplitude of spurious emissions which are attenuated by more than 20 dB below the permissible value has no need to be reported.

Note 2: Measurement receive antenna polarization: H (Horizontal), V (Vertical)



Transmitter Radiated Emissions (1GHz~10th Harmonic)			
Operating Mode	802.11ax 20MHz / Nss 1 MCS 0 / 1S4T TXBF / Ant. 3 + Ant. 4 + Ant. 5 + Ant. 6 / CH116	Polarization	H

802.11ax HEW20-BF_Nss1,(MCS0)_4TX
5580MHz_TX

08/06/2020

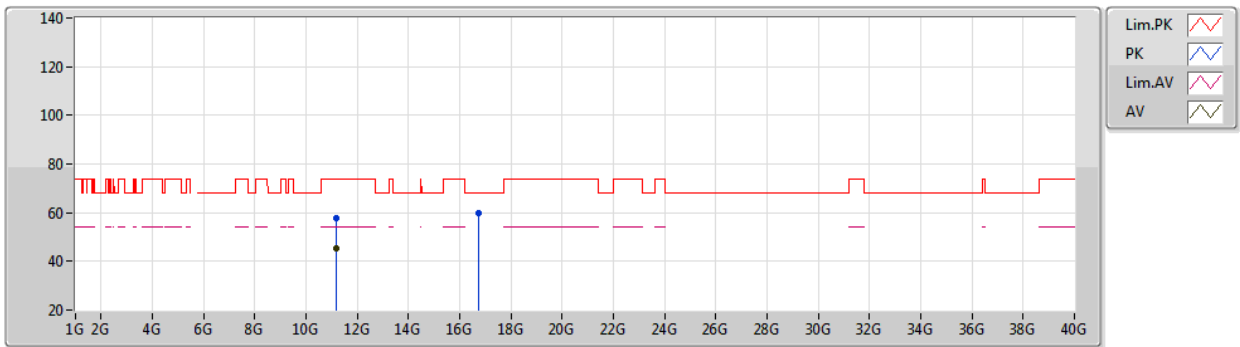

EUT Y_4TX
Setting 80
04-E-P-2

Type	Freq (Hz)	Level (dBuV/m)	Limit (dBuV/m)	Margin (dB)	Raw (dBuV)	Dist (m)	Condition	Azimuth (°)	Height (m)	Comment	AF (dB)	CL (dB)	PA (dB)
PK	11.1656G	57.99	74.00	-16.01	45.60	3	Horizontal	326	1.80	-	39.32	7.97	34.90
AV	11.1602G	45.19	54.00	-8.81	32.81	3	Horizontal	326	1.80	-	39.32	7.96	34.90
PK	16.73204G	59.80	68.20	-8.40	45.11	3	Horizontal	315	1.14	-	40.21	9.98	35.50

Note 1: The amplitude of spurious emissions which are attenuated by more than 20 dB below the permissible value has no need to be reported.

Note 2: Measurement receive antenna polarization: H (Horizontal), V (Vertical)



Transmitter Radiated Emissions (1GHz~10th Harmonic)			
Operating Mode	802.11ax 20MHz / Nss 1 MCS 0 / 1S4T TXBF / Ant. 3 + Ant. 4 + Ant. 5 + Ant. 6 / CH140	Polarization	V

802.11ax HEW20-BF_Nss1,(MCS0)_4TX
5700MHz_TX

08/06/2020

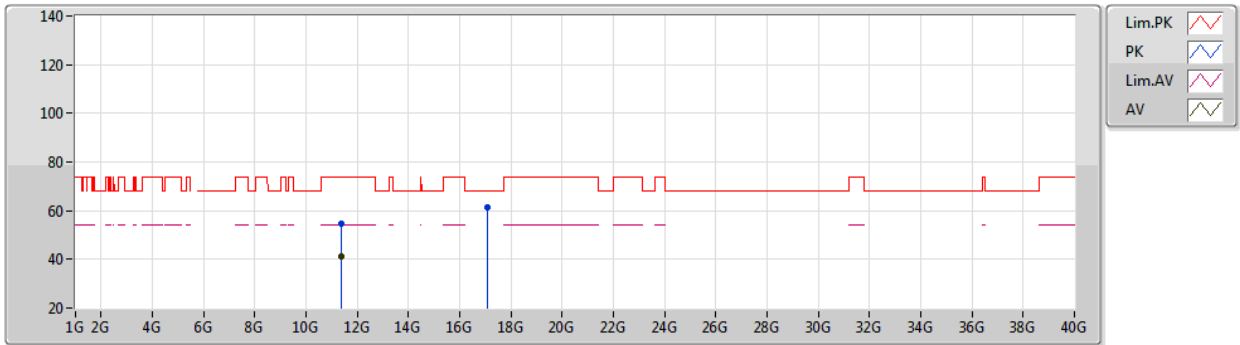

EUT Y_4TX
Setting 72
04-E-P-2

Type	Freq (Hz)	Level (dBuV/m)	Limit (dBuV/m)	Margin (dB)	Raw (dBuV)	Dist (m)	Condition	Azimuth (°)	Height (m)	Comment	AF (dB)	CL (dB)	PA (dB)
PK	11.382G	54.81	74.00	-19.19	42.45	3	Vertical	332	1.69	-	39.21	8.11	34.96
AV	11.3835G	41.43	54.00	-12.57	29.07	3	Vertical	332	1.69	-	39.21	8.11	34.96
PK	17.10536G	61.31	68.20	-6.89	45.75	3	Vertical	201	2.12	-	40.89	10.16	35.49

Note 1: The amplitude of spurious emissions which are attenuated by more than 20 dB below the permissible value has no need to be reported.

Note 2: Measurement receive antenna polarization: H (Horizontal), V (Vertical)



Transmitter Radiated Emissions (1GHz~10th Harmonic)			
Operating Mode	802.11ax 20MHz / Nss 1 MCS 0 / 1S4T TXBF / Ant. 3 + Ant. 4 + Ant. 5 + Ant. 6 / CH140	Polarization	H

802.11ax HEW20-BF_Nss1,(MCS0)_4TX
5700MHz_TX

08/06/2020

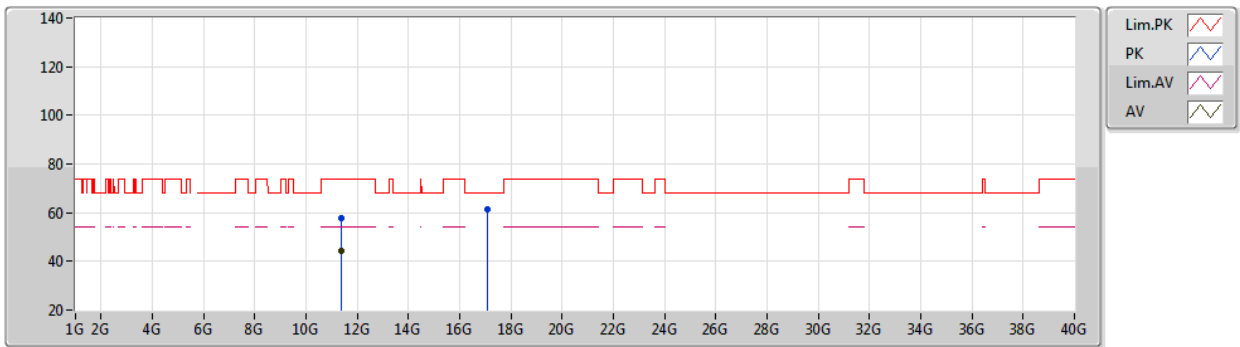

EUT Y_4TX
Setting 72
04-E-P-2

Type	Freq (Hz)	Level (dBuV/m)	Limit (dBuV/m)	Margin (dB)	Raw (dBuV)	Dist (m)	Condition	Azimuth (°)	Height (m)	Comment	AF (dB)	CL (dB)	PA (dB)
PK	11.4002G	57.90	74.00	-16.10	45.55	3	Horizontal	301	2.41	-	39.20	8.12	34.97
AV	11.39984G	44.44	54.00	-9.56	32.09	3	Horizontal	301	2.41	-	39.20	8.12	34.97
PK	17.09728G	61.30	68.20	-6.90	45.73	3	Horizontal	167	1.35	-	40.89	10.17	35.49

Note 1: The amplitude of spurious emissions which are attenuated by more than 20 dB below the permissible value has no need to be reported.

Note 2: Measurement receive antenna polarization: H (Horizontal), V (Vertical)



Transmitter Radiated Emissions (1GHz~10th Harmonic)			
Operating Mode	802.11ax 20MHz / Nss 1 MCS 0 / 1S4T TXBF / Ant. 3 + Ant. 4 + Ant. 5 + Ant. 6 / CH144	Polarization	V

802.11ax HEW20-BF_Nss1,(MCS0)_4TX
5720MHz Straddle 5.47-5.725GHz_TX

08/06/2020

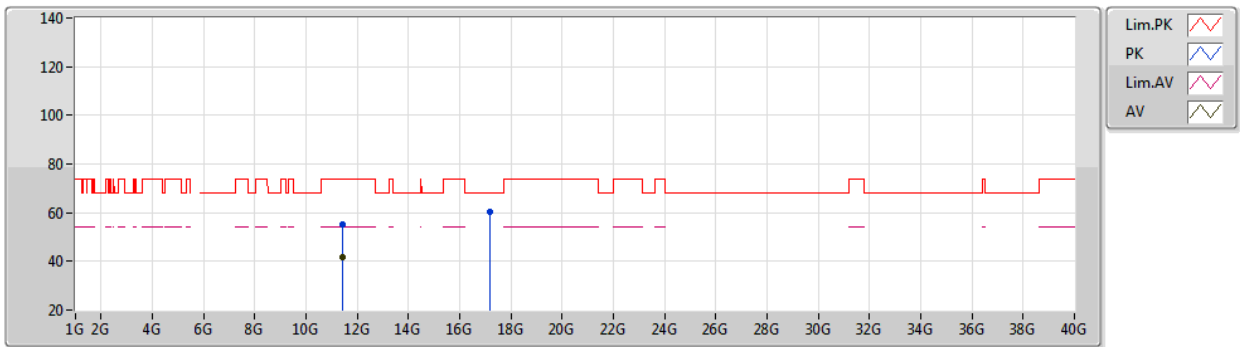

EUT Y_4TX
 Setting 80
 04-K-P-2

Type	Freq (Hz)	Level (dBuV/m)	Limit (dBuV/m)	Margin (dB)	Raw (dBuV)	Dist (m)	Condition	Azimuth (°)	Height (m)	Comment	AF (dB)	CL (dB)	PA (dB)
PK	11.4381G	55.07	74.00	-18.93	42.73	3	Vertical	189	1.51	-	39.18	8.14	34.98
AV	11.4416G	41.56	54.00	-12.44	29.21	3	Vertical	189	1.51	-	39.18	8.15	34.98
PK	17.15626G	60.29	68.20	-7.91	44.67	3	Vertical	19	2.27	-	40.94	10.15	35.47

Note 1: The amplitude of spurious emissions which are attenuated by more than 20 dB below the permissible value has no need to be reported.

Note 2: Measurement receive antenna polarization: H (Horizontal), V (Vertical)



Transmitter Radiated Emissions (1GHz~10th Harmonic)			
Operating Mode	802.11ax 20MHz / Nss 1 MCS 0 / 1S4T TXBF / Ant. 3 + Ant. 4 + Ant. 5 + Ant. 6 / CH144	Polarization	H

802.11ax HEW20-BF_Nss1,(MCS0)_4TX
5720MHz Straddle 5.47-5.725GHz_TX

08/06/2020

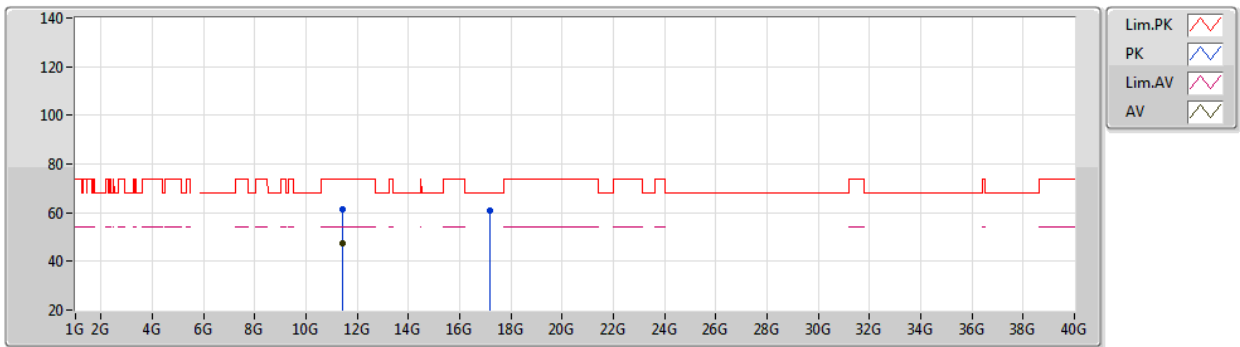

EUT Y_4TX
 Setting 80
 04-K-P-2

Type	Freq (Hz)	Level (dBuV/m)	Limit (dBuV/m)	Margin (dB)	Raw (dBuV)	Dist (m)	Condition	Azimuth (°)	Height (m)	Comment	AF (dB)	CL (dB)	PA (dB)
PK	11.4228G	61.38	74.00	-12.62	49.03	3	Horizontal	35	2.19	-	39.19	8.13	34.97
AV	11.4263G	47.20	54.00	-6.80	34.84	3	Horizontal	35	2.19	-	39.19	8.14	34.97
PK	17.15622G	60.65	68.20	-7.55	45.03	3	Horizontal	288	1.57	-	40.94	10.15	35.47

Note 1: The amplitude of spurious emissions which are attenuated by more than 20 dB below the permissible value has no need to be reported.

Note 2: Measurement receive antenna polarization: H (Horizontal), V (Vertical)



Transmitter Radiated Emissions (1GHz~10th Harmonic)			
Operating Mode	802.11ax 20MHz / Nss 2 MCS 0 / 2S4T TXBF / Ant. 3 + Ant. 4 + Ant. 5 + Ant. 6 / CH100	Polarization	V

**802.11ax HEW20-BF_Nss2,(MCS0)_4TX
5500MHz_TX**

08/06/2020

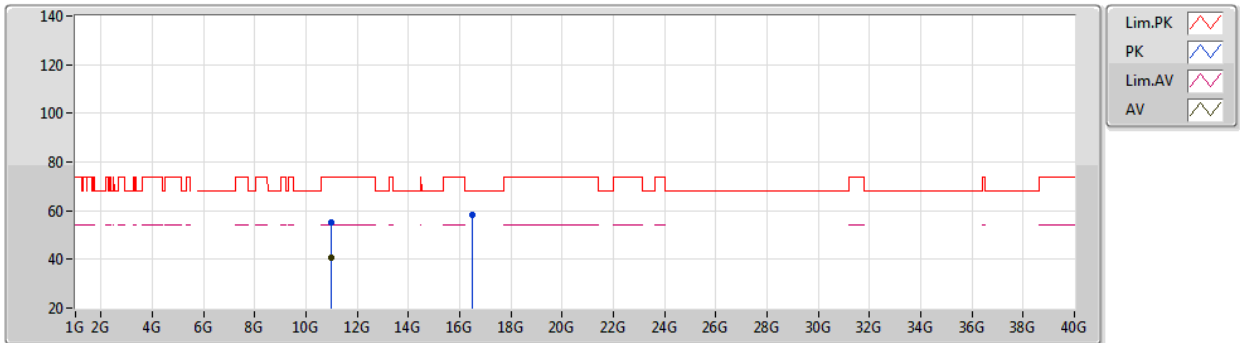

EUT Y_4TX
Setting 80
04-E-P-2

Type	Freq (Hz)	Level (dBuV/m)	Limit (dBuV/m)	Margin (dB)	Raw (dBuV)	Dist (m)	Condition	Azimuth (°)	Height (m)	Comment	AF (dB)	CL (dB)	PA (dB)
PK	10.99844G	55.08	74.00	-18.92	42.67	3	Vertical	272	1.00	-	39.40	7.86	34.85
AV	11.00144G	40.81	54.00	-13.19	28.40	3	Vertical	272	1.00	-	39.40	7.86	34.85
PK	16.49442G	58.42	68.20	-9.78	44.41	3	Vertical	295	1.01	-	39.69	9.80	35.48

Note 1: The amplitude of spurious emissions which are attenuated by more than 20 dB below the permissible value has no need to be reported.

Note 2: Measurement receive antenna polarization: H (Horizontal), V (Vertical)



Transmitter Radiated Emissions (1GHz~10th Harmonic)			
Operating Mode	802.11ax 20MHz / Nss 2 MCS 0 / 2S4T TXBF / Ant. 3 + Ant. 4 + Ant. 5 + Ant. 6 / CH100	Polarization	H

802.11ax HEW20-BF_Nss2,(MCS0)_4TX
5500MHz_TX

08/06/2020

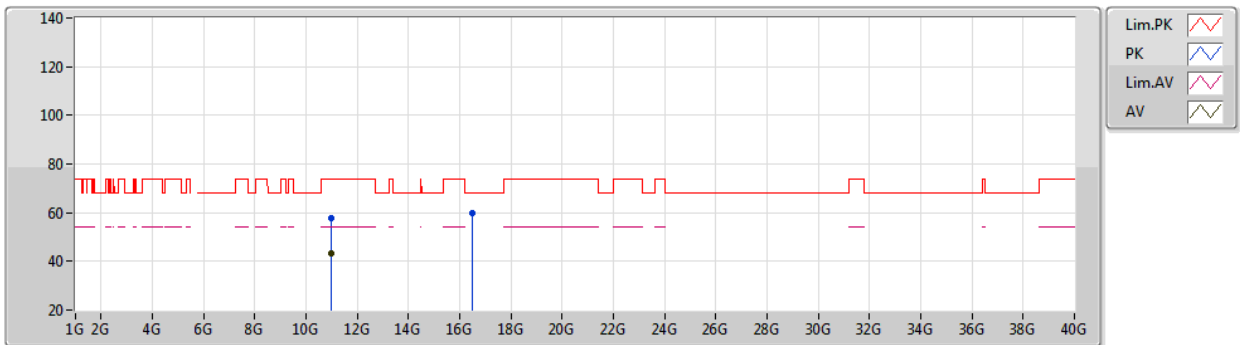

EUT_Y_4TX
Setting 80
04-E-P-2

Type	Freq (Hz)	Level (dBuV/m)	Limit (dBuV/m)	Margin (dB)	Raw (dBuV)	Dist (m)	Condition	Azimuth (°)	Height (m)	Comment	AF (dB)	CL (dB)	PA (dB)
PK	11.0024G	57.73	74.00	-16.27	45.32	3	Horizontal	226	2.18	-	39.40	7.86	34.85
AV	11.0001G	43.27	54.00	-10.73	30.86	3	Horizontal	226	2.18	-	39.40	7.86	34.85
PK	16.5034G	59.86	68.20	-8.34	45.84	3	Horizontal	340	1.80	-	39.71	9.80	35.49

Note 1: The amplitude of spurious emissions which are attenuated by more than 20 dB below the permissible value has no need to be reported.

Note 2: Measurement receive antenna polarization: H (Horizontal), V (Vertical)



Transmitter Radiated Emissions (1GHz~10th Harmonic)			
Operating Mode	802.11ax 20MHz / Nss 2 MCS 0 / 2S4T TXBF / Ant. 3 + Ant. 4 + Ant. 5 + Ant. 6 / CH116	Polarization	V

802.11ax HEW20-BF_Nss2,(MCS0)_4TX
5580MHz_TX

08/06/2020

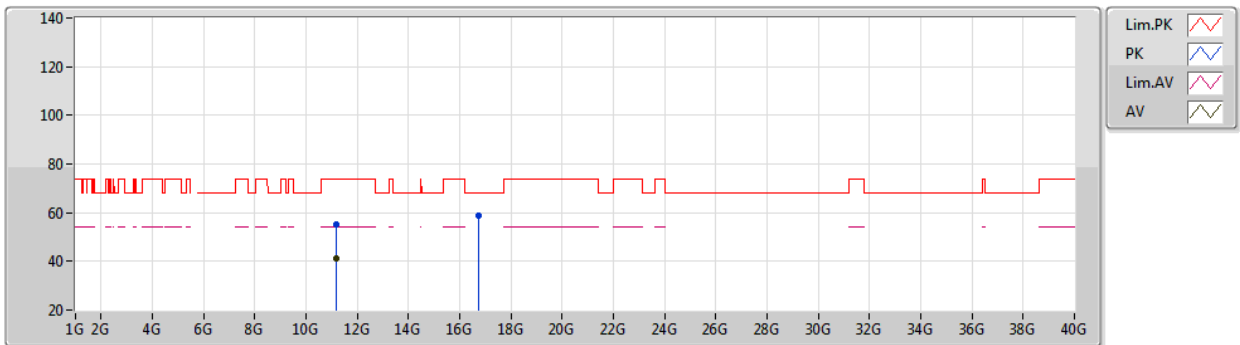

EUT Y_4TX
Setting 80
04-E-P-2

Type	Freq (Hz)	Level (dBuV/m)	Limit (dBuV/m)	Margin (dB)	Raw (dBuV)	Dist (m)	Condition	Azimuth (°)	Height (m)	Comment	AF (dB)	CL (dB)	PA (dB)
PK	11.1588G	54.94	74.00	-19.06	42.56	3	Vertical	311	2.13	-	39.32	7.96	34.90
AV	11.1596G	41.33	54.00	-12.67	28.95	3	Vertical	311	2.13	-	39.32	7.96	34.90
PK	16.74276G	58.82	68.20	-9.38	44.10	3	Vertical	315	1.80	-	40.23	9.99	35.50

Note 1: The amplitude of spurious emissions which are attenuated by more than 20 dB below the permissible value has no need to be reported.

Note 2: Measurement receive antenna polarization: H (Horizontal), V (Vertical)



Transmitter Radiated Emissions (1GHz~10th Harmonic)			
Operating Mode	802.11ax 20MHz / Nss 2 MCS 0 / 2S4T TXBF / Ant. 3 + Ant. 4 + Ant. 5 + Ant. 6 / CH116	Polarization	H

802.11ax HEW20-BF_Nss2,(MCS0)_4TX
5580MHz_TX

08/06/2020

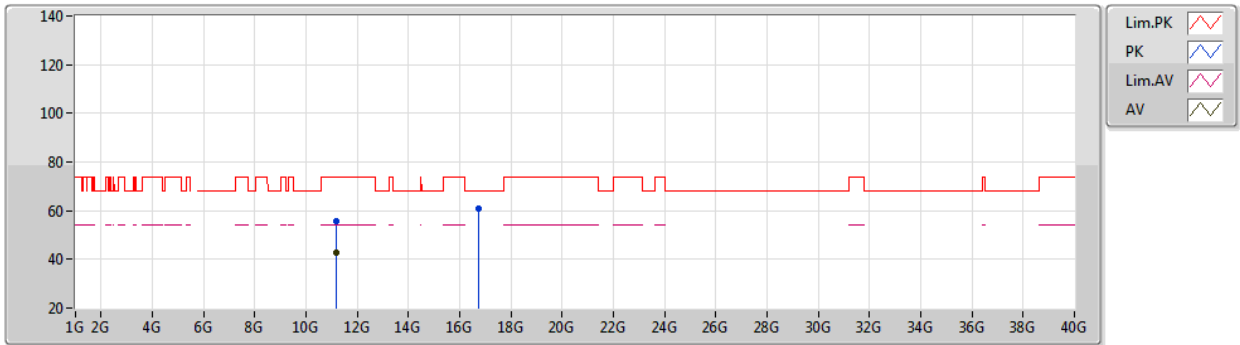

EUT_Y_4TX
Setting 80
04-E-P-2

Type	Freq (Hz)	Level (dBuV/m)	Limit (dBuV/m)	Margin (dB)	Raw (dBuV)	Dist (m)	Condition	Azimuth (°)	Height (m)	Comment	AF (dB)	CL (dB)	PA (dB)
PK	11.1612G	55.81	74.00	-18.19	43.43	3	Horizontal	289	1.79	-	39.32	7.96	34.90
AV	11.1602G	43.01	54.00	-10.99	30.63	3	Horizontal	289	1.79	-	39.32	7.96	34.90
PK	16.74414G	60.76	68.20	-7.44	46.03	3	Horizontal	321	1.80	-	40.24	9.99	35.50

Note 1: The amplitude of spurious emissions which are attenuated by more than 20 dB below the permissible value has no need to be reported.

Note 2: Measurement receive antenna polarization: H (Horizontal), V (Vertical)



Transmitter Radiated Emissions (1GHz~10th Harmonic)			
Operating Mode	802.11ax 20MHz / Nss 2 MCS 0 / 2S4T TXBF / Ant. 3 + Ant. 4 + Ant. 5 + Ant. 6 / CH140	Polarization	V

802.11ax HEW20-BF_Nss2,(MCS0)_4TX
5700MHz_TX

08/06/2020

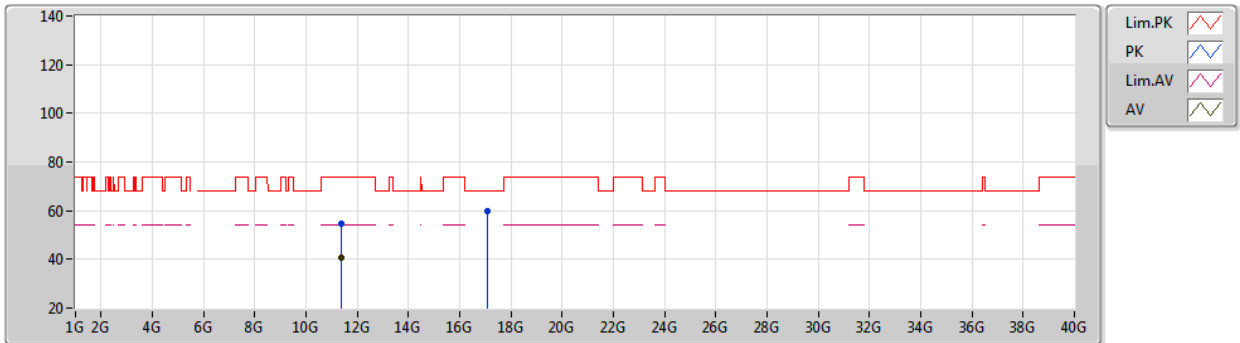

EUT Y_4TX
Setting 74
04-E-P-2

Type	Freq (Hz)	Level (dBuV/m)	Limit (dBuV/m)	Margin (dB)	Raw (dBuV)	Dist (m)	Condition	Azimuth (°)	Height (m)	Comment	AF (dB)	CL (dB)	PA (dB)
PK	11.39644G	54.56	74.00	-19.44	42.20	3	Vertical	315	1.56	-	39.20	8.12	34.96
AV	11.3999G	40.79	54.00	-13.21	28.44	3	Vertical	315	1.56	-	39.20	8.12	34.97
PK	17.09658G	59.84	68.20	-8.36	44.27	3	Vertical	247	1.80	-	40.89	10.17	35.49

Note 1: The amplitude of spurious emissions which are attenuated by more than 20 dB below the permissible value has no need to be reported.

Note 2: Measurement receive antenna polarization: H (Horizontal), V (Vertical)



Transmitter Radiated Emissions (1GHz~10th Harmonic)			
Operating Mode	802.11ax 20MHz / Nss 2 MCS 0 / 2S4T TXBF / Ant. 3 + Ant. 4 + Ant. 5 + Ant. 6 / CH140	Polarization	H

802.11ax HEW20-BF_Nss2,(MCS0)_4TX
5700MHz_TX

08/06/2020

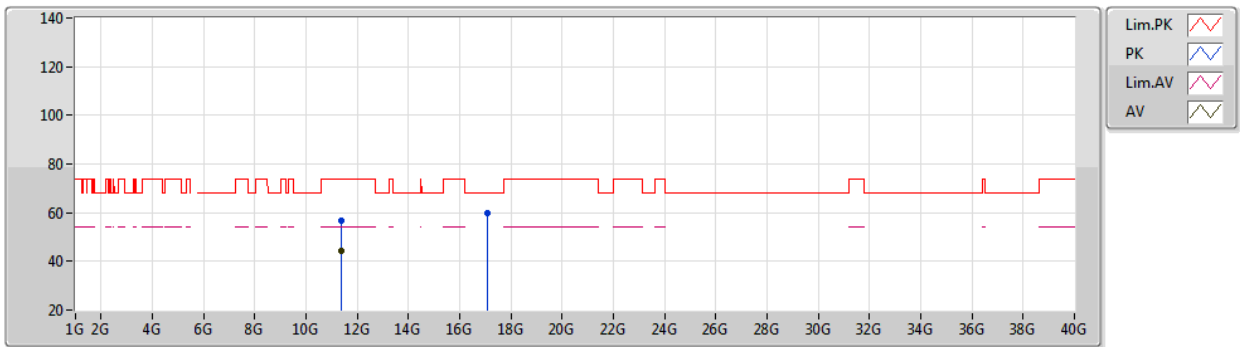

EUT Y_4TX
Setting 74
04-E-P-2

Type	Freq (Hz)	Level (dBuV/m)	Limit (dBuV/m)	Margin (dB)	Raw (dBuV)	Dist (m)	Condition	Azimuth (°)	Height (m)	Comment	AF (dB)	CL (dB)	PA (dB)
PK	11.3994G	56.85	74.00	-17.15	44.50	3	Horizontal	315	1.65	-	39.20	8.12	34.97
AV	11.3999G	44.40	54.00	-9.60	32.05	3	Horizontal	315	1.65	-	39.20	8.12	34.97
PK	17.10274G	59.70	68.20	-8.50	44.13	3	Horizontal	360	1.80	-	40.89	10.17	35.49

Note 1: The amplitude of spurious emissions which are attenuated by more than 20 dB below the permissible value has no need to be reported.

Note 2: Measurement receive antenna polarization: H (Horizontal), V (Vertical)



Transmitter Radiated Emissions (1GHz~10th Harmonic)			
Operating Mode	802.11ax 20MHz / Nss 2 MCS 0 / 2S4T TXBF / Ant. 3 + Ant. 4 + Ant. 5 + Ant. 6 / CH144	Polarization	V

802.11ax HEW20-BF_Nss2,(MCS0)_4TX
5720MHz Straddle 5.47-5.725GHz_TX

08/06/2020

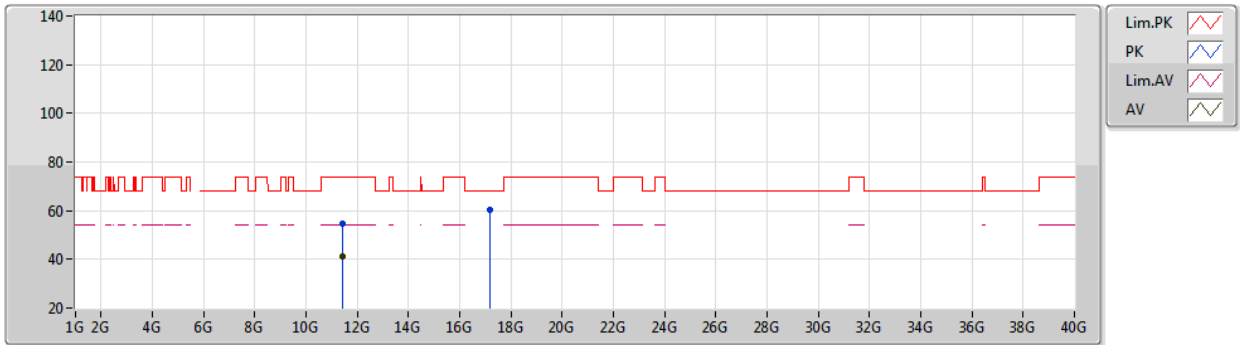

EUT Y_4TX
 Setting 80
 04-E-P-2

Type	Freq (Hz)	Level (dBuV/m)	Limit (dBuV/m)	Margin (dB)	Raw (dBuV)	Dist (m)	Condition	Azimuth (°)	Height (m)	Comment	AF (dB)	CL (dB)	PA (dB)
PK	11.4504G	54.57	74.00	-19.43	42.23	3	Vertical	319	1.43	-	39.17	8.15	34.98
AV	11.4396G	41.17	54.00	-12.83	28.82	3	Vertical	319	1.43	-	39.18	8.15	34.98
PK	17.15958G	60.42	68.20	-7.78	44.80	3	Vertical	360	1.43	-	40.94	10.15	35.47

Note 1: The amplitude of spurious emissions which are attenuated by more than 20 dB below the permissible value has no need to be reported.

Note 2: Measurement receive antenna polarization: H (Horizontal), V (Vertical)



Transmitter Radiated Emissions (1GHz~10th Harmonic)			
Operating Mode	802.11ax 20MHz / Nss 2 MCS 0 / 2S4T TXBF / Ant. 3 + Ant. 4 + Ant. 5 + Ant. 6 / CH144	Polarization	H

802.11ax HEW20-BF_Nss2,(MCS0)_4TX
5720MHz Straddle 5.47-5.725GHz_TX

08/06/2020

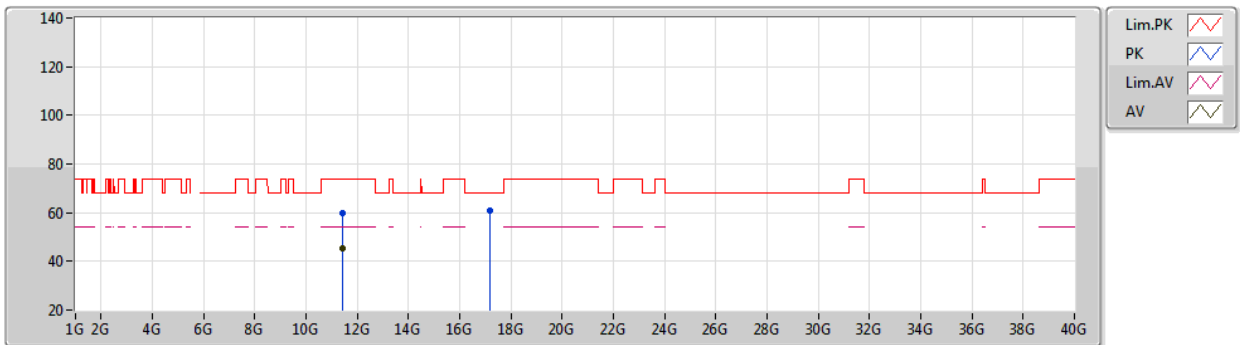

EUT Y_4TX
 Setting 80
 04-E-P-2

Type	Freq (Hz)	Level (dBuV/m)	Limit (dBuV/m)	Margin (dB)	Raw (dBuV)	Dist (m)	Condition	Azimuth (°)	Height (m)	Comment	AF (dB)	CL (dB)	PA (dB)
PK	11.44G	59.84	74.00	-14.16	47.49	3	Horizontal	315	1.64	-	39.18	8.15	34.98
AV	11.44G	45.42	54.00	-8.58	33.07	3	Horizontal	315	1.64	-	39.18	8.15	34.98
PK	17.1619G	60.92	68.20	-7.28	45.29	3	Horizontal	359	1.80	-	40.95	10.15	35.47

Note 1: The amplitude of spurious emissions which are attenuated by more than 20 dB below the permissible value has no need to be reported.

Note 2: Measurement receive antenna polarization: H (Horizontal), V (Vertical)



Transmitter Radiated Emissions (1GHz~10th Harmonic)			
Operating Mode	802.11ax 20MHz / Nss 3 MCS 0 / 3S4T TXBF / Ant. 3 + Ant. 4 + Ant. 5 + Ant. 6 / CH100	Polarization	V

**802.11ax HEW20-BF_Nss3,(MCS0)_4TX
5500MHz_TX**

08/06/2020

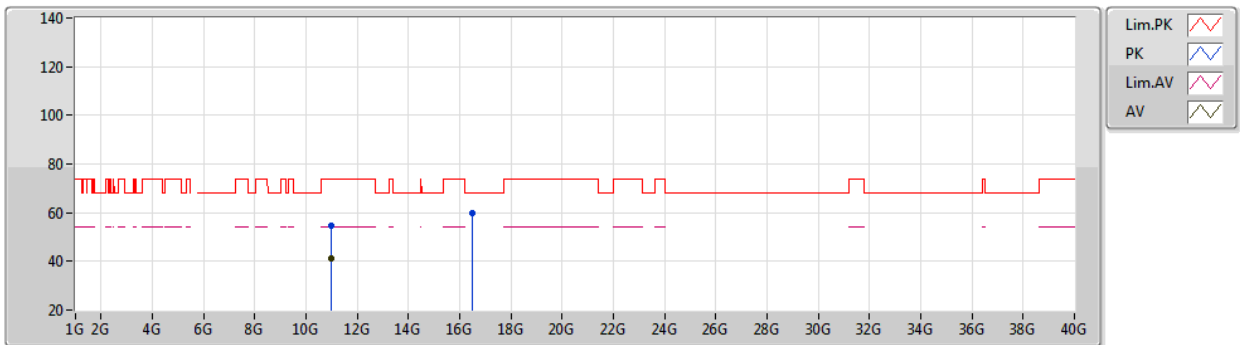

EUT Y_4TX
Setting 80
04-E-P-2

Type	Freq (Hz)	Level (dBuV/m)	Limit (dBuV/m)	Margin (dB)	Raw (dBuV)	Dist (m)	Condition	Azimuth (°)	Height (m)	Comment	AF (dB)	CL (dB)	PA (dB)
PK	11.0022G	54.55	74.00	-19.45	42.14	3	Vertical	290	1.75	-	39.40	7.86	34.85
AV	11G	41.04	54.00	-12.96	28.63	3	Vertical	290	1.75	-	39.40	7.86	34.85
PK	16.49834G	59.67	68.20	-8.53	45.65	3	Vertical	28	1.80	-	39.70	9.80	35.48

Note 1: The amplitude of spurious emissions which are attenuated by more than 20 dB below the permissible value has no need to be reported.

Note 2: Measurement receive antenna polarization: H (Horizontal), V (Vertical)



Transmitter Radiated Emissions (1GHz~10th Harmonic)			
Operating Mode	802.11ax 20MHz / Nss 3 MCS 0 / 3S4T TXBF / Ant. 3 + Ant. 4 + Ant. 5 + Ant. 6 / CH100	Polarization	H

802.11ax HEW20-BF_Nss3,(MCS0)_4TX
5500MHz_TX

08/06/2020

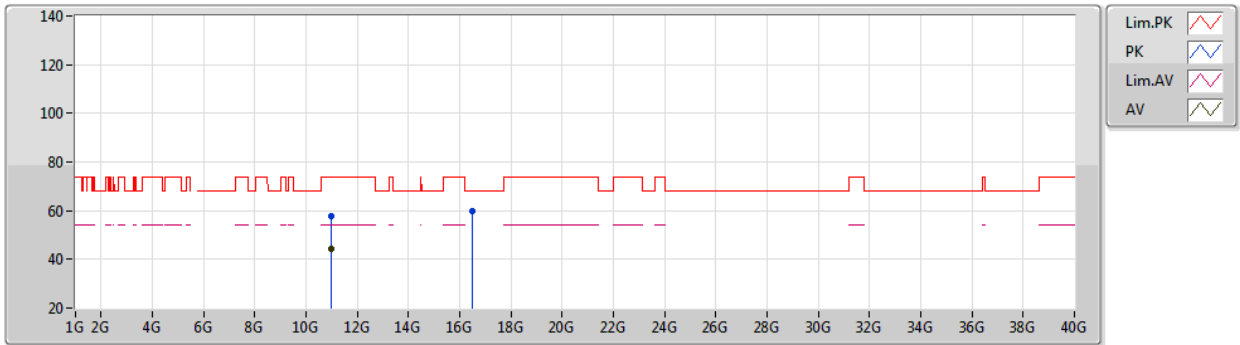

EUT_Y_4TX
Setting 80
04-E-P-2

Type	Freq (Hz)	Level (dBuV/m)	Limit (dBuV/m)	Margin (dB)	Raw (dBuV)	Dist (m)	Condition	Azimuth (°)	Height (m)	Comment	AF (dB)	CL (dB)	PA (dB)
PK	10.9988G	57.66	74.00	-16.34	45.25	3	Horizontal	0	2.17	-	39.40	7.86	34.85
AV	10.9994G	44.50	54.00	-9.50	32.09	3	Horizontal	0	2.17	-	39.40	7.86	34.85
PK	16.49942G	59.78	68.20	-8.42	45.76	3	Horizontal	163	1.80	-	39.70	9.80	35.48

Note 1: The amplitude of spurious emissions which are attenuated by more than 20 dB below the permissible value has no need to be reported.

Note 2: Measurement receive antenna polarization: H (Horizontal), V (Vertical)



Transmitter Radiated Emissions (1GHz~10th Harmonic)			
Operating Mode	802.11ax 20MHz / Nss 3 MCS 0 / 3S4T TXBF / Ant. 3 + Ant. 4 + Ant. 5 + Ant. 6 / CH116	Polarization	V

802.11ax HEW20-BF_Nss3,(MCS0)_4TX
5580MHz_TX

08/06/2020

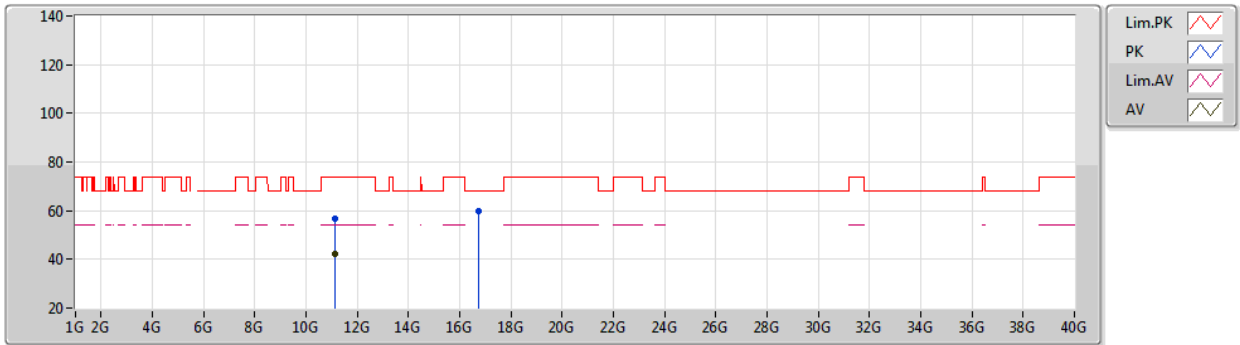

EUT Y_4TX
Setting 80
04-E-P-2

Type	Freq (Hz)	Level (dBuV/m)	Limit (dBuV/m)	Margin (dB)	Raw (dBuV)	Dist (m)	Condition	Azimuth (°)	Height (m)	Comment	AF (dB)	CL (dB)	PA (dB)
PK	11.155G	56.65	74.00	-17.35	44.26	3	Vertical	248	2.03	-	39.32	7.96	34.89
AV	11.15566G	42.13	54.00	-11.87	29.75	3	Vertical	248	2.03	-	39.32	7.96	34.90
PK	16.74008G	60.02	68.20	-8.18	45.30	3	Vertical	347	1.80	-	40.23	9.99	35.50

Note 1: The amplitude of spurious emissions which are attenuated by more than 20 dB below the permissible value has no need to be reported.

Note 2: Measurement receive antenna polarization: H (Horizontal), V (Vertical)



Transmitter Radiated Emissions (1GHz~10th Harmonic)			
Operating Mode	802.11ax 20MHz / Nss 3 MCS 0 / 3S4T TXBF / Ant. 3 + Ant. 4 + Ant. 5 + Ant. 6 / CH116	Polarization	H

802.11ax HEW20-BF_Nss3,(MCS0)_4TX
5580MHz_TX

08/06/2020

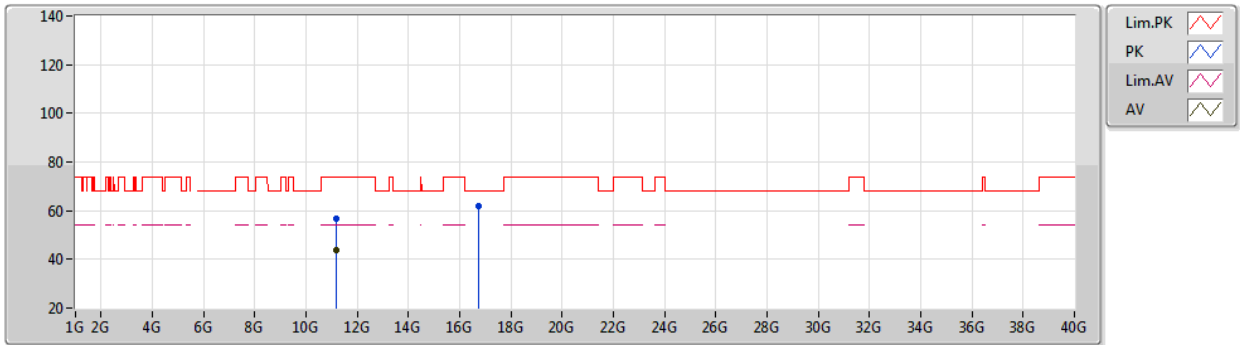

EUT Y_4TX
Setting 80
04-E-P-2

Type	Freq (Hz)	Level (dBuV/m)	Limit (dBuV/m)	Margin (dB)	Raw (dBuV)	Dist (m)	Condition	Azimuth (°)	Height (m)	Comment	AF (dB)	CL (dB)	PA (dB)
PK	11.1592G	56.96	74.00	-17.04	44.58	3	Horizontal	326	1.65	-	39.32	7.96	34.90
AV	11.1599G	44.01	54.00	-9.99	31.63	3	Horizontal	326	1.65	-	39.32	7.96	34.90
PK	16.7393G	61.77	68.20	-6.43	47.05	3	Horizontal	317	1.80	-	40.23	9.99	35.50

Note 1: The amplitude of spurious emissions which are attenuated by more than 20 dB below the permissible value has no need to be reported.

Note 2: Measurement receive antenna polarization: H (Horizontal), V (Vertical)



Transmitter Radiated Emissions (1GHz~10th Harmonic)			
Operating Mode	802.11ax 20MHz / Nss 3 MCS 0 / 3S4T TXBF / Ant. 3 + Ant. 4 + Ant. 5 + Ant. 6 / CH140	Polarization	V

802.11ax HEW20-BF_Nss3,(MCS0)_4TX
5700MHz_TX

08/06/2020

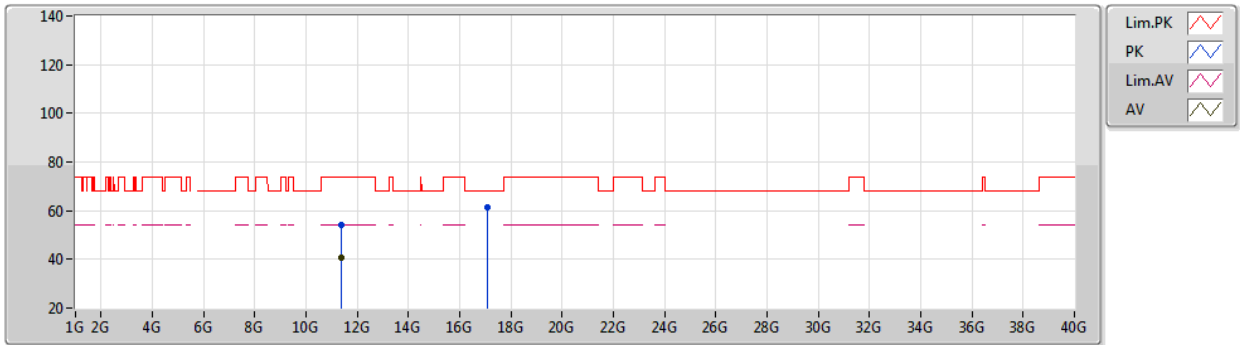

EUT Y_4TX
Setting 76
04-E-P-2

Type	Freq (Hz)	Level (dBuV/m)	Limit (dBuV/m)	Margin (dB)	Raw (dBuV)	Dist (m)	Condition	Azimuth (°)	Height (m)	Comment	AF (dB)	CL (dB)	PA (dB)
PK	11.39894G	54.32	74.00	-19.68	41.97	3	Vertical	54	1.88	-	39.20	8.12	34.97
AV	11.3962G	40.61	54.00	-13.39	28.25	3	Vertical	54	1.88	-	39.20	8.12	34.96
PK	17.09604G	61.23	68.20	-6.97	45.66	3	Vertical	2	2.40	-	40.89	10.17	35.49

Note 1: The amplitude of spurious emissions which are attenuated by more than 20 dB below the permissible value has no need to be reported.

Note 2: Measurement receive antenna polarization: H (Horizontal), V (Vertical)



Transmitter Radiated Emissions (1GHz~10th Harmonic)			
Operating Mode	802.11ax 20MHz / Nss 3 MCS 0 / 3S4T TXBF / Ant. 3 + Ant. 4 + Ant. 5 + Ant. 6 / CH140	Polarization	H

802.11ax HEW20-BF_Nss3,(MCS0)_4TX
5700MHz_TX

08/06/2020

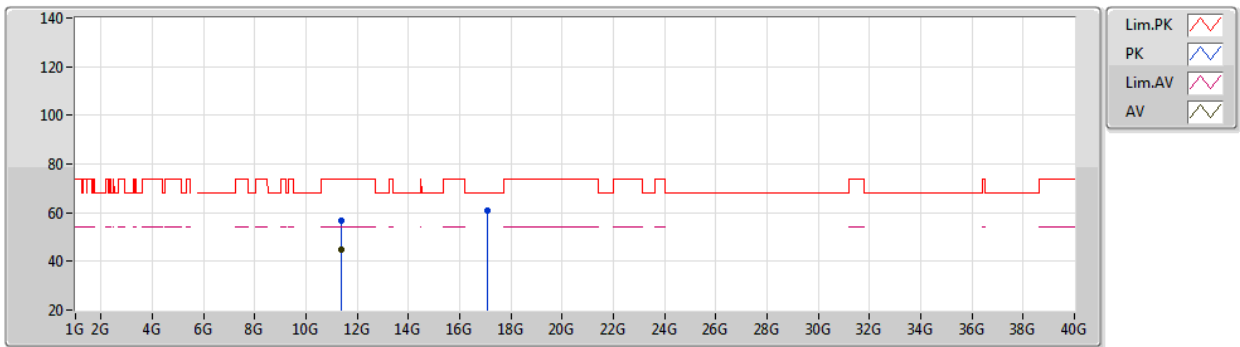

EUT Y_4TX
Setting 76
04-E-P-2

Type	Freq (Hz)	Level (dBuV/m)	Limit (dBuV/m)	Margin (dB)	Raw (dBuV)	Dist (m)	Condition	Azimuth (°)	Height (m)	Comment	AF (dB)	CL (dB)	PA (dB)
PK	11.39832G	56.95	74.00	-17.05	44.60	3	Horizontal	313	1.61	-	39.20	8.12	34.97
AV	11.39998G	44.88	54.00	-9.12	32.53	3	Horizontal	313	1.61	-	39.20	8.12	34.97
PK	17.1012G	61.03	68.20	-7.17	45.46	3	Horizontal	181	1.80	-	40.89	10.17	35.49

Note 1: The amplitude of spurious emissions which are attenuated by more than 20 dB below the permissible value has no need to be reported.

Note 2: Measurement receive antenna polarization: H (Horizontal), V (Vertical)



Transmitter Radiated Emissions (1GHz~10th Harmonic)			
Operating Mode	802.11ax 20MHz / Nss 3 MCS 0 / 3S4T TXBF / Ant. 3 + Ant. 4 + Ant. 5 + Ant. 6 / CH144	Polarization	V

802.11ax HEW20-BF_Nss3,(MCS0)_4TX
5720MHz Straddle 5.47-5.725GHz_TX

08/06/2020

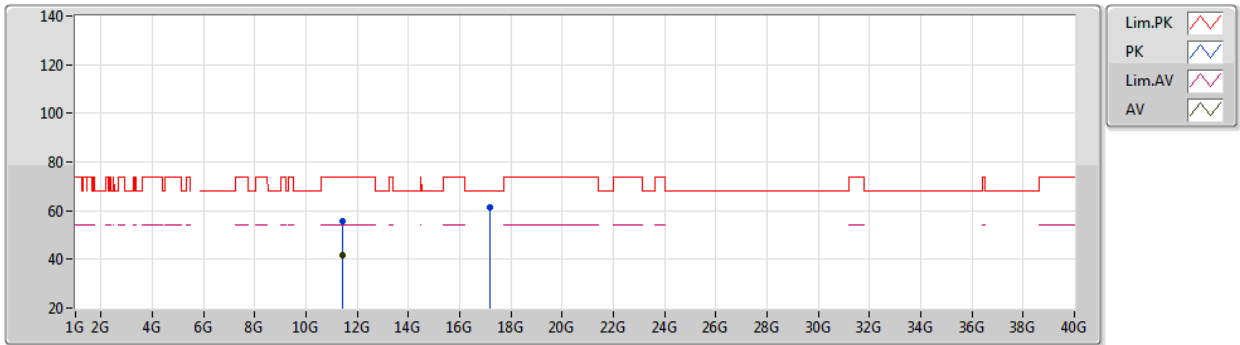

EUT Y_4TX
 Setting 80
 04-E-P-2

Type	Freq (Hz)	Level (dBuV/m)	Limit (dBuV/m)	Margin (dB)	Raw (dBuV)	Dist (m)	Condition	Azimuth (°)	Height (m)	Comment	AF (dB)	CL (dB)	PA (dB)
PK	11.4446G	55.53	74.00	-18.47	43.18	3	Vertical	285	2.94	-	39.18	8.15	34.98
AV	11.43998G	41.55	54.00	-12.45	29.20	3	Vertical	285	2.94	-	39.18	8.15	34.98
PK	17.15928G	61.59	68.20	-6.61	45.97	3	Vertical	268	2.60	-	40.94	10.15	35.47

Note 1: The amplitude of spurious emissions which are attenuated by more than 20 dB below the permissible value has no need to be reported.

Note 2: Measurement receive antenna polarization: H (Horizontal), V (Vertical)



Transmitter Radiated Emissions (1GHz~10th Harmonic)			
Operating Mode	802.11ax 20MHz / Nss 3 MCS 0 / 3S4T TXBF / Ant. 3 + Ant. 4 + Ant. 5 + Ant. 6 / CH144	Polarization	H

802.11ax HEW20-BF_Nss3,(MCS0)_4TX
5720MHz Straddle 5.47-5.725GHz_TX

08/06/2020

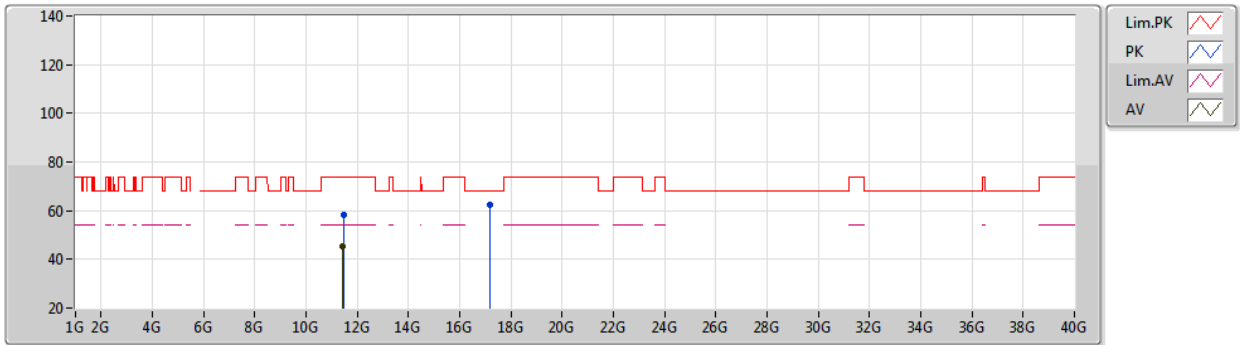

EUT Y_4TX
 Setting 80
 04-E-P-2

Type	Freq (Hz)	Level (dBuV/m)	Limit (dBuV/m)	Margin (dB)	Raw (dBuV)	Dist (m)	Condition	Azimuth (°)	Height (m)	Comment	AF (dB)	CL (dB)	PA (dB)
PK	11.453G	58.22	74.00	-15.78	45.88	3	Horizontal	312	1.64	-	39.17	8.15	34.98
AV	11.44G	45.13	54.00	-8.87	32.78	3	Horizontal	312	1.64	-	39.18	8.15	34.98
PK	17.16308G	62.37	68.20	-5.83	46.74	3	Horizontal	345	1.50	-	40.95	10.15	35.47

Note 1: The amplitude of spurious emissions which are attenuated by more than 20 dB below the permissible value has no need to be reported.

Note 2: Measurement receive antenna polarization: H (Horizontal), V (Vertical)



Transmitter Radiated Emissions (1GHz~10th Harmonic)			
Operating Mode	802.11ax 40MHz / Nss 1 MCS 0 / 1S2T CDD / Ant. 1 + Ant. 2 / CH54	Polarization	V

802.11ax HEW40_Nss1,(MCS0)_2TX
5270MHz_TX

08/06/2020

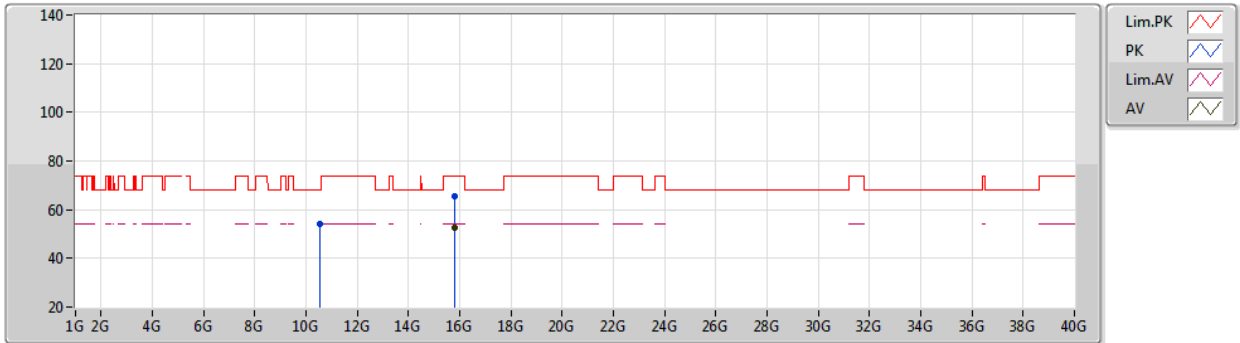

EUT Y_2TX
 Setting 96
 04-E-P-2

Type	Freq (Hz)	Level (dBuV/m)	Limit (dBuV/m)	Margin (dB)	Raw (dBuV)	Dist (m)	Condition	Azimuth (°)	Height (m)	Comment	AF (dB)	CL (dB)	PA (dB)
PK	10.5402G	54.01	68.20	-14.19	41.76	3	Vertical	254	1.80	-	39.03	7.64	34.42
PK	15.8014G	65.43	74.00	-8.57	52.63	3	Vertical	309	1.80	-	38.82	9.39	35.41
AV	15.8082G	52.53	54.00	-1.47	39.74	3	Vertical	309	1.80	-	38.81	9.39	35.41

Note 1: The amplitude of spurious emissions which are attenuated by more than 20 dB below the permissible value has no need to be reported.

Note 2: Measurement receive antenna polarization: H (Horizontal), V (Vertical)



Transmitter Radiated Emissions (1GHz~10th Harmonic)			
Operating Mode	802.11ax 40MHz / Nss 1 MCS 0 / 1S2T CDD / Ant. 1 + Ant. 2 / CH54	Polarization	H

802.11ax HEW40_Nss1,(MCS0)_2TX
5270MHz_TX

08/06/2020

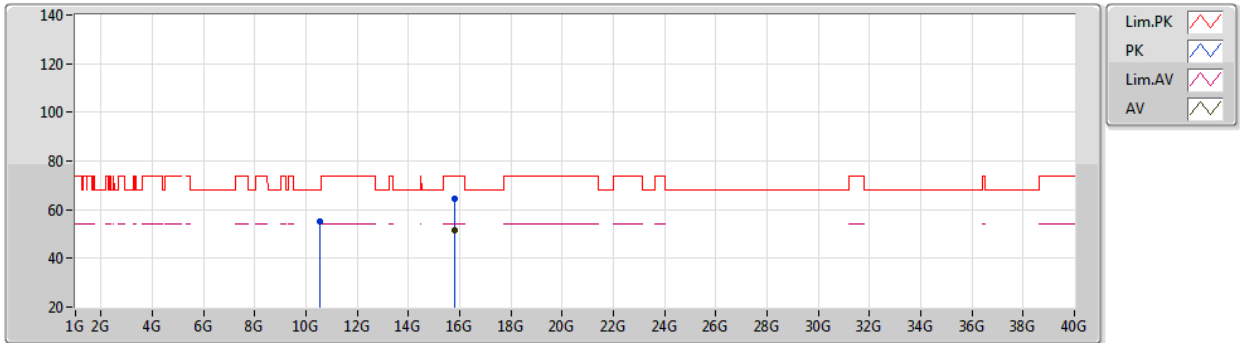

EUT Y_2TX
 Setting 96
 04-E-P-2

Type	Freq (Hz)	Level (dBuV/m)	Limit (dBuV/m)	Margin (dB)	Raw (dBuV)	Dist (m)	Condition	Azimuth (°)	Height (m)	Comment	AF (dB)	CL (dB)	PA (dB)
PK	10.54404G	55.02	68.20	-13.18	42.76	3	Horizontal	310	1.60	-	39.04	7.64	34.42
PK	15.7998G	64.51	74.00	-9.49	51.71	3	Horizontal	267	1.94	-	38.82	9.39	35.41
AV	15.7998G	51.65	54.00	-2.35	38.85	3	Horizontal	267	1.94	-	38.82	9.39	35.41

Note 1: The amplitude of spurious emissions which are attenuated by more than 20 dB below the permissible value has no need to be reported.

Note 2: Measurement receive antenna polarization: H (Horizontal), V (Vertical)



Transmitter Radiated Emissions (1GHz~10th Harmonic)

Operating Mode | 802.11ax 40MHz / Nss 1 MCS 0 / 1S2T CDD / Ant. 1 + Ant. 2 / CH62 | **Polarization** | V

802.11ax HEW40_Nss1,(MCS0)_2TX
5310MHz_TX

08/06/2020

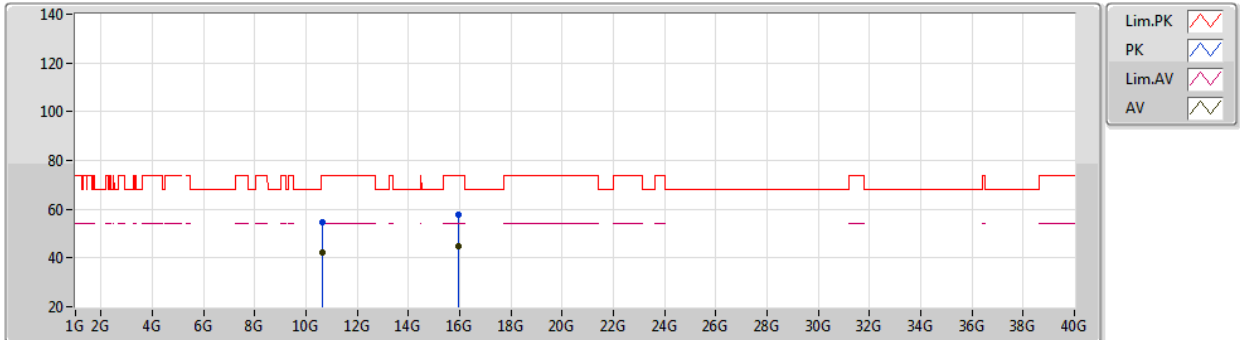

EUT Y_2TX
 Setting 77
 04-E-P-2

Type	Freq (Hz)	Level (dBuV/m)	Limit (dBuV/m)	Margin (dB)	Raw (dBuV)	Dist (m)	Condition	Azimuth (°)	Height (m)	Comment	AF (dB)	CL (dB)	PA (dB)
PK	10.62454G	54.66	74.00	-19.34	42.38	3	Vertical	211	1.42	-	39.10	7.68	34.50
AV	10.62272G	41.99	54.00	-12.01	29.71	3	Vertical	211	1.42	-	39.10	7.68	34.50
PK	15.92666G	57.76	74.00	-16.24	45.11	3	Vertical	345	1.80	-	38.68	9.40	35.43
AV	15.93258G	44.82	54.00	-9.18	32.19	3	Vertical	345	1.80	-	38.67	9.40	35.44

Note 1: The amplitude of spurious emissions which are attenuated by more than 20 dB below the permissible value has no need to be reported.

Note 2: Measurement receive antenna polarization: H (Horizontal), V (Vertical)



Transmitter Radiated Emissions (1GHz~10th Harmonic)			
Operating Mode	802.11ax 40MHz / Nss 1 MCS 0 / 1S2T CDD / Ant. 1 + Ant. 2 / CH62	Polarization	H

**802.11ax HEW40_Nss1,(MCS0)_2TX
5310MHz_TX**

08/06/2020

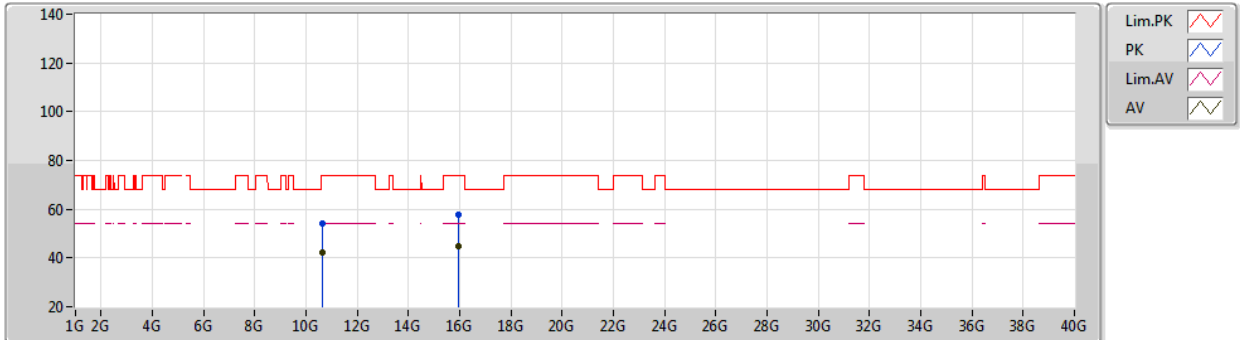

EUT Y_2TX
Setting 77
04-E-P-2

Type	Freq (Hz)	Level (dBuV/m)	Limit (dBuV/m)	Margin (dB)	Raw (dBuV)	Dist (m)	Condition	Azimuth (°)	Height (m)	Comment	AF (dB)	CL (dB)	PA (dB)
PK	10.6237G	54.38	74.00	-19.62	42.10	3	Horizontal	304	1.13	-	39.10	7.68	34.50
AV	10.61844G	42.22	54.00	-11.78	29.94	3	Horizontal	304	1.13	-	39.09	7.68	34.49
PK	15.93138G	57.84	74.00	-16.16	45.19	3	Horizontal	339	1.80	-	38.68	9.40	35.43
AV	15.9345G	45.01	54.00	-8.99	32.38	3	Horizontal	339	1.80	-	38.67	9.40	35.44

Note 1: The amplitude of spurious emissions which are attenuated by more than 20 dB below the permissible value has no need to be reported.

Note 2: Measurement receive antenna polarization: H (Horizontal), V (Vertical)



Transmitter Radiated Emissions (1GHz~10th Harmonic)			
Operating Mode	802.11ax 40MHz / Nss 1 MCS 0 / 1S4T CDD / Ant. 3 + Ant. 4 + Ant. 5 + Ant. 6 / CH102	Polarization	V

802.11ax HEW40_Nss1,(MCS0)_4TX
5510MHz_TX

08/06/2020

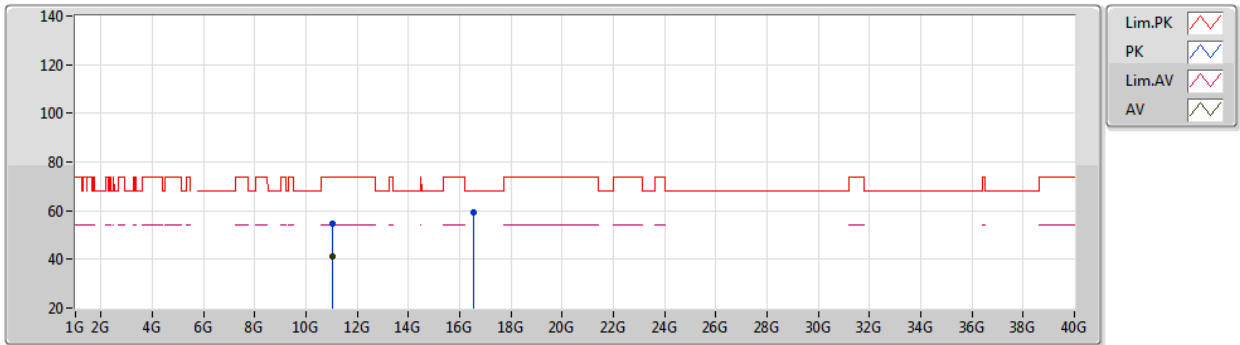

EUT Y_4TX
Setting 76
04-E-P-2

Type	Freq (Hz)	Level (dBuV/m)	Limit (dBuV/m)	Margin (dB)	Raw (dBuV)	Dist (m)	Condition	Azimuth (°)	Height (m)	Comment	AF (dB)	CL (dB)	PA (dB)
PK	11.0415G	54.89	74.00	-19.11	42.48	3	Vertical	302	1.00	-	39.38	7.89	34.86
AV	11.0257G	41.36	54.00	-12.64	28.95	3	Vertical	302	1.00	-	39.39	7.88	34.86
PK	16.5305G	59.19	68.20	-9.01	45.09	3	Vertical	255	1.80	-	39.77	9.82	35.49

Note 1: The amplitude of spurious emissions which are attenuated by more than 20 dB below the permissible value has no need to be reported.

Note 2: Measurement receive antenna polarization: H (Horizontal), V (Vertical)



Transmitter Radiated Emissions (1GHz~10th Harmonic)			
Operating Mode	802.11ax 40MHz / Nss 1 MCS 0 / 1S4T CDD / Ant. 3 + Ant. 4 + Ant. 5 + Ant. 6 / CH102	Polarization	H

802.11ax HEW40_Nss1,(MCS0)_4TX
5510MHz_TX

08/06/2020

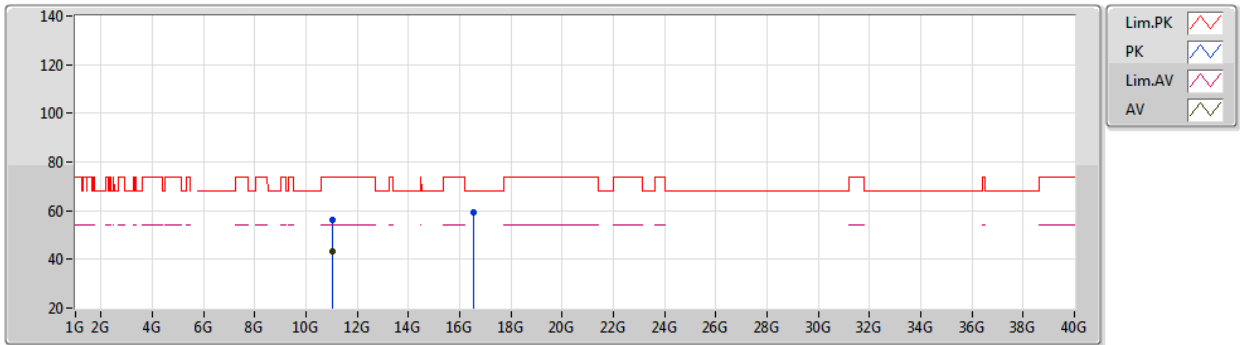

EUT_Y_4TX
Setting 76
04-E-P-2

Type	Freq (Hz)	Level (dBuV/m)	Limit (dBuV/m)	Margin (dB)	Raw (dBuV)	Dist (m)	Condition	Azimuth (°)	Height (m)	Comment	AF (dB)	CL (dB)	PA (dB)
PK	11.02558G	56.18	74.00	-17.82	43.77	3	Horizontal	304	1.65	-	39.39	7.88	34.86
AV	11.01994G	43.16	54.00	-10.84	30.76	3	Horizontal	304	1.65	-	39.39	7.87	34.86
PK	16.53266G	59.44	68.20	-8.76	45.33	3	Horizontal	100	1.30	-	39.77	9.83	35.49

Note 1: The amplitude of spurious emissions which are attenuated by more than 20 dB below the permissible value has no need to be reported.

Note 2: Measurement receive antenna polarization: H (Horizontal), V (Vertical)



Transmitter Radiated Emissions (1GHz~10th Harmonic)			
Operating Mode	802.11ax 40MHz / Nss 1 MCS 0 / 1S4T CDD / Ant. 3 + Ant. 4 + Ant. 5 + Ant. 6 / CH110	Polarization	V

802.11ax HEW40_Nss1,(MCS0)_4TX

08/06/2020

5550MHz_TX

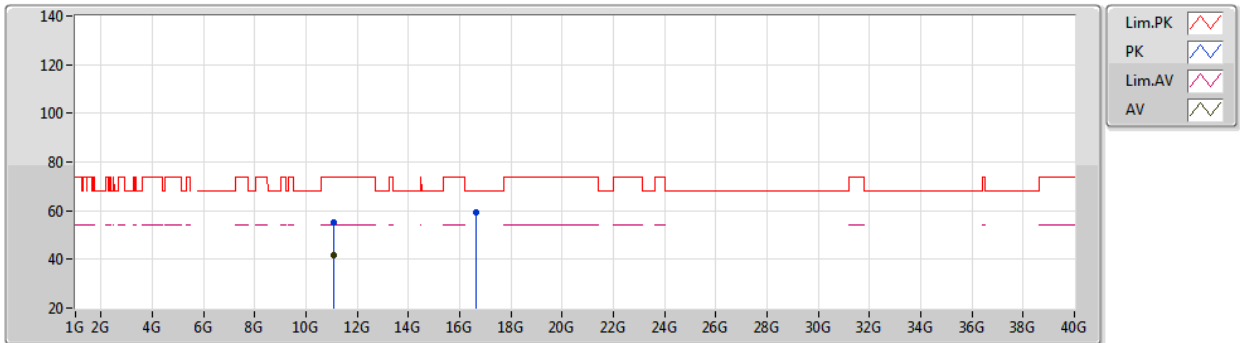

EUT Y_4TX
Setting 80
04-E-P-2

Type	Freq (Hz)	Level (dBuV/m)	Limit (dBuV/m)	Margin (dB)	Raw (dBuV)	Dist (m)	Condition	Azimuth (°)	Height (m)	Comment	AF (dB)	CL (dB)	PA (dB)
PK	11.0859G	54.94	74.00	-19.06	42.53	3	Vertical	300	1.00	-	39.36	7.92	34.87
AV	11.1009G	41.96	54.00	-12.04	29.56	3	Vertical	300	1.00	-	39.35	7.93	34.88
PK	16.65282G	59.50	68.20	-8.70	45.04	3	Vertical	154	2.69	-	40.04	9.92	35.50

Note 1: The amplitude of spurious emissions which are attenuated by more than 20 dB below the permissible value has no need to be reported.

Note 2: Measurement receive antenna polarization: H (Horizontal), V (Vertical)



Transmitter Radiated Emissions (1GHz~10th Harmonic)			
Operating Mode	802.11ax 40MHz / Nss 1 MCS 0 / 1S4T CDD / Ant. 3 + Ant. 4 + Ant. 5 + Ant. 6 / CH110	Polarization	H

802.11ax HEW40_Nss1,(MCS0)_4TX
5550MHz_TX

08/06/2020

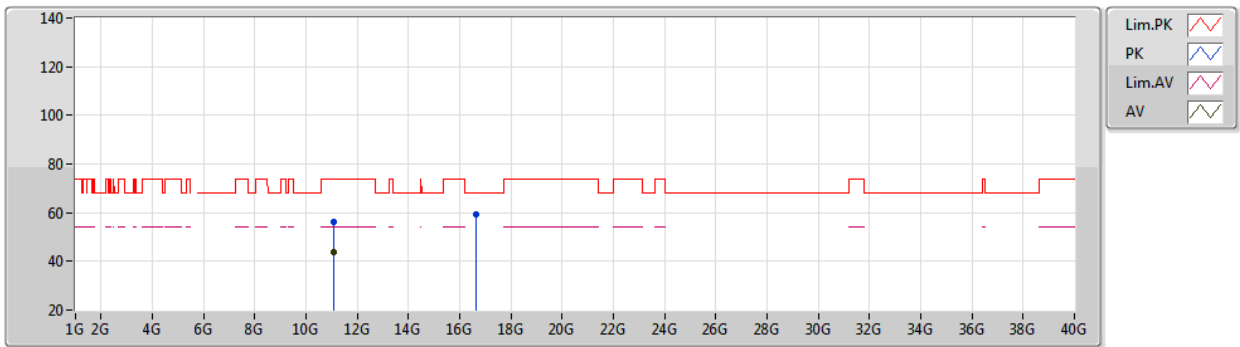

EUT_Y_4TX
Setting 80
04-E-P-2

Type	Freq (Hz)	Level (dBuV/m)	Limit (dBuV/m)	Margin (dB)	Raw (dBuV)	Dist (m)	Condition	Azimuth (°)	Height (m)	Comment	AF (dB)	CL (dB)	PA (dB)
PK	11.0996G	56.42	74.00	-17.58	44.03	3	Horizontal	326	1.80	-	39.35	7.92	34.88
AV	11.0999G	43.60	54.00	-10.40	31.21	3	Horizontal	326	1.80	-	39.35	7.92	34.88
PK	16.64528G	59.46	68.20	-8.74	45.03	3	Horizontal	355	1.80	-	40.02	9.91	35.50

Note 1: The amplitude of spurious emissions which are attenuated by more than 20 dB below the permissible value has no need to be reported.

Note 2: Measurement receive antenna polarization: H (Horizontal), V (Vertical)



Transmitter Radiated Emissions (1GHz~10th Harmonic)			
Operating Mode	802.11ax 40MHz / Nss 1 MCS 0 / 1S4T CDD / Ant. 3 + Ant. 4 + Ant. 5 + Ant. 6 / CH134	Polarization	V

802.11ax HEW40_Nss1,(MCS0)_4TX
5670MHz_TX

08/06/2020

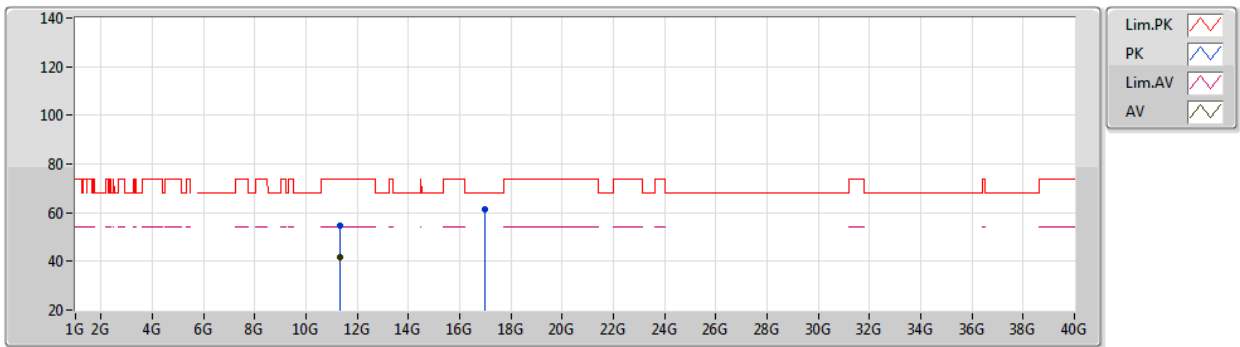

EUT Y_4TX
Setting 80
04-E-P-2

Type	Freq (Hz)	Level (dBuV/m)	Limit (dBuV/m)	Margin (dB)	Raw (dBuV)	Dist (m)	Condition	Azimuth (°)	Height (m)	Comment	AF (dB)	CL (dB)	PA (dB)
PK	11.3283G	54.85	74.00	-19.15	42.49	3	Vertical	305	1.80	-	39.24	8.07	34.95
AV	11.3332G	41.62	54.00	-12.38	29.26	3	Vertical	305	1.80	-	39.23	8.08	34.95
PK	17.00052G	61.20	68.20	-7.00	45.73	3	Vertical	194	1.80	-	40.80	10.19	35.52

Note 1: The amplitude of spurious emissions which are attenuated by more than 20 dB below the permissible value has no need to be reported.

Note 2: Measurement receive antenna polarization: H (Horizontal), V (Vertical)



Transmitter Radiated Emissions (1GHz~10th Harmonic)			
Operating Mode	802.11ax 40MHz / Nss 1 MCS 0 / 1S4T CDD / Ant. 3 + Ant. 4 + Ant. 5 + Ant. 6 / CH134	Polarization	H

802.11ax HEW40_Nss1,(MCS0)_4TX
5670MHz_TX

08/06/2020

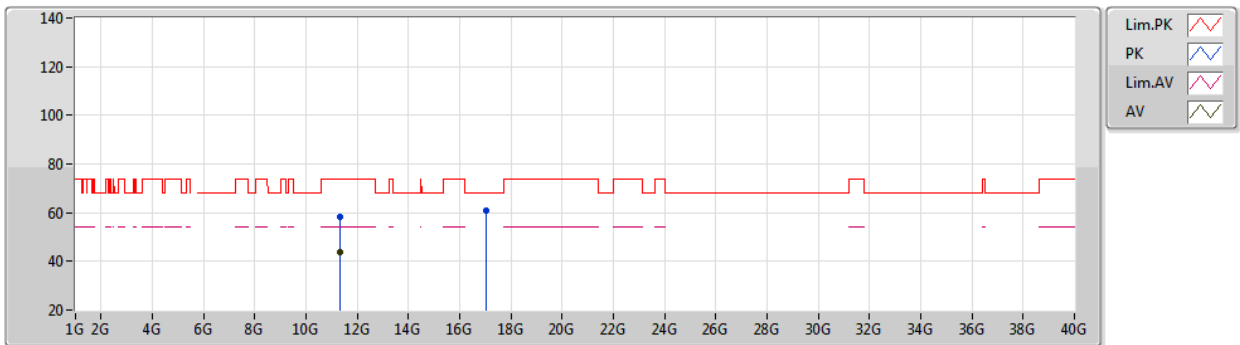

EUT Y_4TX
Setting 80
04-E-P-2

Type	Freq (Hz)	Level (dBuV/m)	Limit (dBuV/m)	Margin (dB)	Raw (dBuV)	Dist (m)	Condition	Azimuth (°)	Height (m)	Comment	AF (dB)	CL (dB)	PA (dB)
PK	11.3436G	58.15	74.00	-15.85	45.79	3	Horizontal	273	2.15	-	39.23	8.08	34.95
AV	11.34564G	43.91	54.00	-10.09	31.55	3	Horizontal	273	2.15	-	39.23	8.08	34.95
PK	17.01282G	60.75	68.20	-7.45	45.27	3	Horizontal	360	1.80	-	40.81	10.19	35.52

Note 1: The amplitude of spurious emissions which are attenuated by more than 20 dB below the permissible value has no need to be reported.

Note 2: Measurement receive antenna polarization: H (Horizontal), V (Vertical)



Transmitter Radiated Emissions (1GHz~10th Harmonic)			
Operating Mode	802.11ax 40MHz / Nss 1 MCS 0 / 1S4T CDD / Ant. 3 + Ant. 4 + Ant. 5 + Ant. 6 / CH142	Polarization	V

802.11ax HEW40_Nss1,(MCS0)_4TX
5710MHz Straddle 5.47-5.725GHz_TX

08/06/2020

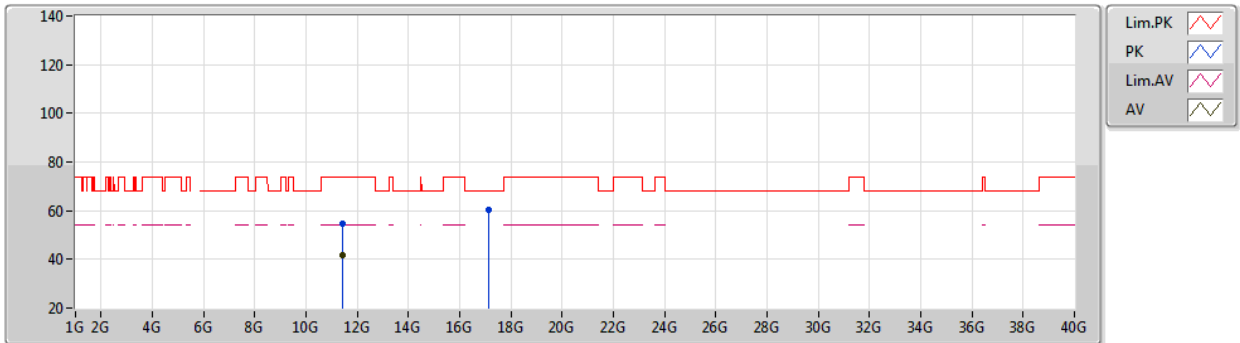

EUT Y_4TX
 Setting 80
 04-E-P-2

Type	Freq (Hz)	Level (dBuV/m)	Limit (dBuV/m)	Margin (dB)	Raw (dBuV)	Dist (m)	Condition	Azimuth (°)	Height (m)	Comment	AF (dB)	CL (dB)	PA (dB)
PK	11.42054G	54.88	74.00	-19.12	42.53	3	Vertical	321	1.99	-	39.19	8.13	34.97
AV	11.42036G	41.65	54.00	-12.35	29.30	3	Vertical	321	1.99	-	39.19	8.13	34.97
PK	17.13004G	60.33	68.20	-7.87	44.73	3	Vertical	73	2.98	-	40.92	10.16	35.48

Note 1: The amplitude of spurious emissions which are attenuated by more than 20 dB below the permissible value has no need to be reported.

Note 2: Measurement receive antenna polarization: H (Horizontal), V (Vertical)



Transmitter Radiated Emissions (1GHz~10th Harmonic)			
Operating Mode	802.11ax 40MHz / Nss 1 MCS 0 / 1S4T CDD / Ant. 3 + Ant. 4 + Ant. 5 + Ant. 6 / CH142	Polarization	H

802.11ax HEW40_Nss1,(MCS0)_4TX
5710MHz Straddle 5.47-5.725GHz_TX

08/06/2020

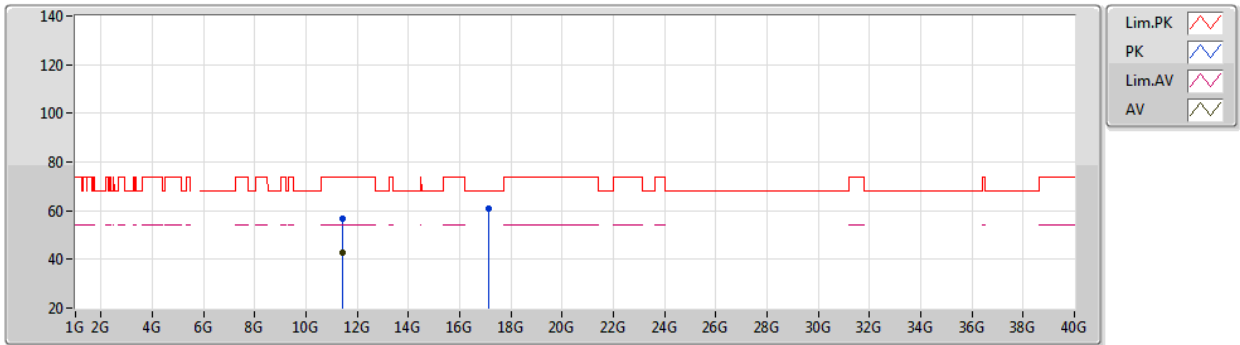

EUT Y_4TX
 Setting 80
 04-E-P-2

Type	Freq (Hz)	Level (dBuV/m)	Limit (dBuV/m)	Margin (dB)	Raw (dBuV)	Dist (m)	Condition	Azimuth (°)	Height (m)	Comment	AF (dB)	CL (dB)	PA (dB)
PK	11.42354G	56.76	74.00	-17.24	44.40	3	Horizontal	256	1.55	-	39.19	8.14	34.97
AV	11.42294G	42.77	54.00	-11.23	30.42	3	Horizontal	256	1.55	-	39.19	8.13	34.97
PK	17.11986G	60.91	68.20	-7.29	45.32	3	Horizontal	313	1.62	-	40.91	10.16	35.48

Note 1: The amplitude of spurious emissions which are attenuated by more than 20 dB below the permissible value has no need to be reported.

Note 2: Measurement receive antenna polarization: H (Horizontal), V (Vertical)



Transmitter Radiated Emissions (1GHz~10th Harmonic)			
Operating Mode	802.11ax 40MHz / Nss 1 MCS 0 / TXBF 1S2T / Ant. 1 + Ant. 2 / CH54	Polarization	V

**802.11ax HEW40-BF_Nss1,(MCS0)_2TX
5270MHz_TX**

08/06/2020

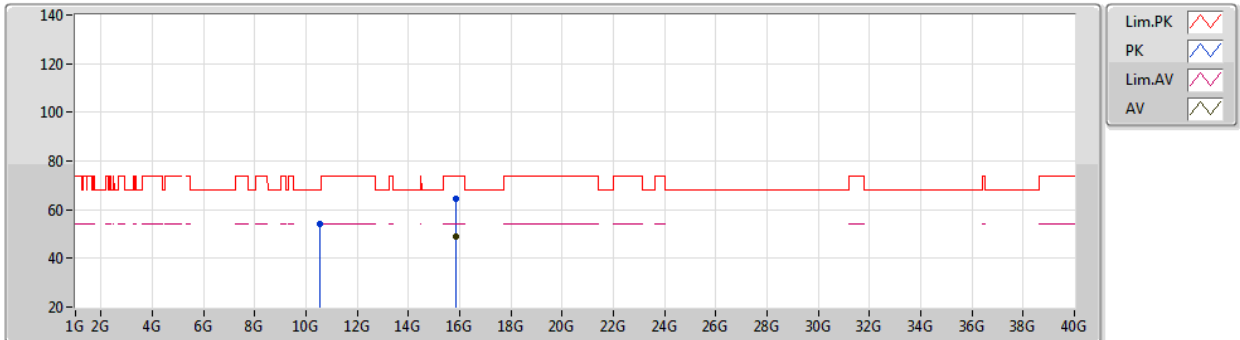

EUT Y_2TX
Setting 96
04-E-L-2

Type	Freq (Hz)	Level (dBuV/m)	Limit (dBuV/m)	Margin (dB)	Raw (dBuV)	Dist (m)	Condition	Azimuth (°)	Height (m)	Comment	AF (dB)	CL (dB)	PA (dB)
PK	10.5392G	54.32	68.20	-13.88	42.07	3	Vertical	303	2.97	-	39.03	7.64	34.42
PK	15.8328G	64.39	74.00	-9.61	51.62	3	Vertical	308	1.80	-	38.78	9.40	35.41
AV	15.8478G	49.00	54.00	-5.00	36.25	3	Vertical	308	1.80	-	38.77	9.40	35.42

Note 1: The amplitude of spurious emissions which are attenuated by more than 20 dB below the permissible value has no need to be reported.

Note 2: Measurement receive antenna polarization: H (Horizontal), V (Vertical)



Transmitter Radiated Emissions (1GHz~10th Harmonic)			
Operating Mode	802.11ax 40MHz / Nss 1 MCS 0 / TXBF 1S2T / Ant. 1 + Ant. 2 / CH54	Polarization	H

**802.11ax HEW40-BF_Nss1,(MCS0)_2TX
5270MHz_TX**

08/06/2020

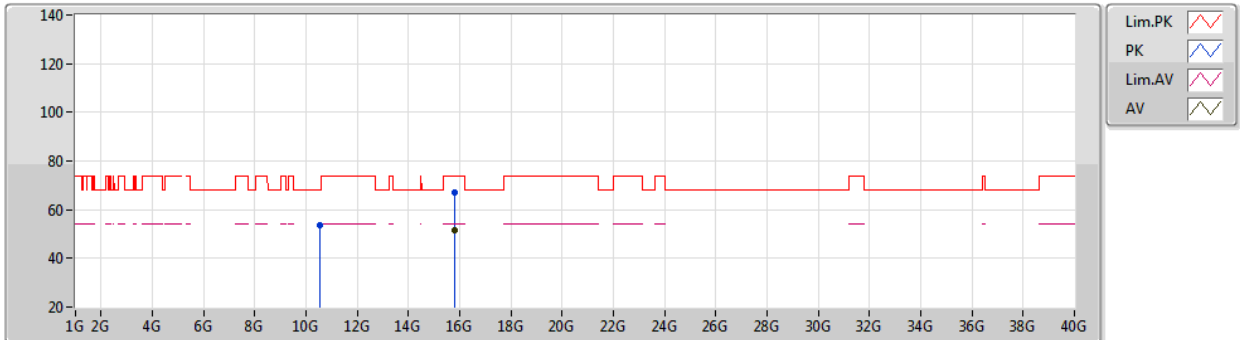

EUT Y_2TX
Setting 96
04-E-L-2

Type	Freq (Hz)	Level (dBuV/m)	Limit (dBuV/m)	Margin (dB)	Raw (dBuV)	Dist (m)	Condition	Azimuth (°)	Height (m)	Comment	AF (dB)	CL (dB)	PA (dB)
PK	10.54728G	53.83	68.20	-14.37	41.57	3	Horizontal	147	1.80	-	39.04	7.64	34.42
PK	15.7942G	67.22	74.00	-6.78	54.40	3	Horizontal	290	2.62	-	38.83	9.39	35.40
AV	15.8218G	51.75	54.00	-2.25	38.96	3	Horizontal	290	2.62	-	38.80	9.40	35.41

Note 1: The amplitude of spurious emissions which are attenuated by more than 20 dB below the permissible value has no need to be reported.

Note 2: Measurement receive antenna polarization: H (Horizontal), V (Vertical)



Transmitter Radiated Emissions (1GHz~10th Harmonic)			
Operating Mode	8802.11ax 40MHz / Nss 1 MCS 0 / TXBF 1S2T / Ant. 1 + Ant. 2 / CH62	Polarization	V

**802.11ax HEW40-BF_Nss1,(MCS0)_2TX
5310MHz_TX**

08/06/2020

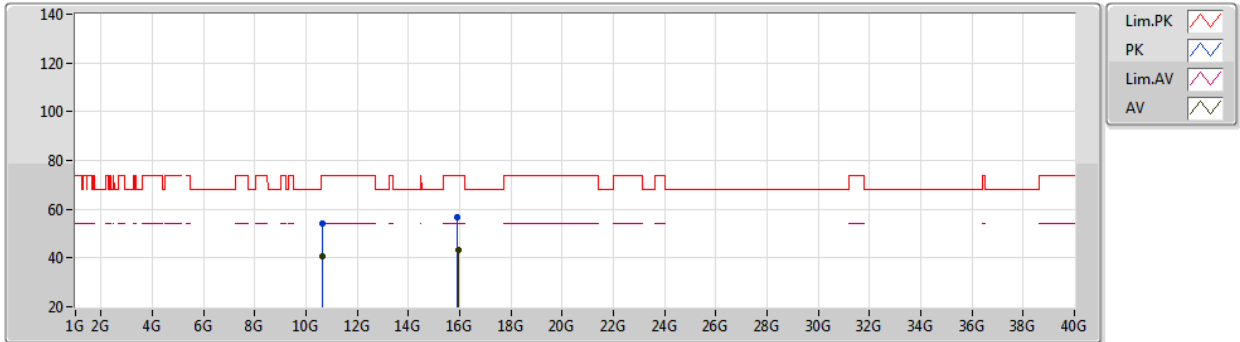

EUT Y_2TX
Setting 78
04-E-L-2

Type	Freq (Hz)	Level (dBuV/m)	Limit (dBuV/m)	Margin (dB)	Raw (dBuV)	Dist (m)	Condition	Azimuth (°)	Height (m)	Comment	AF (dB)	CL (dB)	PA (dB)
PK	10.62524G	54.36	74.00	-19.64	42.08	3	Vertical	251	1.27	-	39.10	7.68	34.50
AV	10.62156G	40.56	54.00	-13.44	28.27	3	Vertical	251	1.27	-	39.10	7.68	34.49
PK	15.9234G	56.95	74.00	-17.05	44.30	3	Vertical	52	1.80	-	38.68	9.40	35.43
AV	15.9512G	43.26	54.00	-10.74	30.64	3	Vertical	52	1.80	-	38.65	9.41	35.44

Note 1: The amplitude of spurious emissions which are attenuated by more than 20 dB below the permissible value has no need to be reported.

Note 2: Measurement receive antenna polarization: H (Horizontal), V (Vertical)



Transmitter Radiated Emissions (1GHz~10th Harmonic)			
Operating Mode	802.11ax 40MHz / Nss 1 MCS 0 / TXBF 1S2T / Ant. 1 + Ant. 2 / CH62	Polarization	H

**802.11ax HEW40-BF_Nss1,(MCS0)_2TX
5310MHz_TX**

08/06/2020

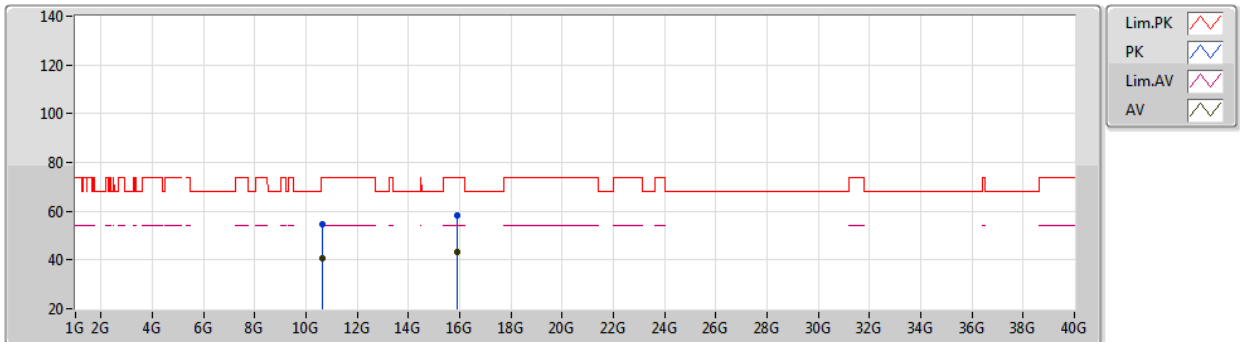

EUT Y_2TX
Setting 78
04-E-L-2

Type	Freq (Hz)	Level (dBuV/m)	Limit (dBuV/m)	Margin (dB)	Raw (dBuV)	Dist (m)	Condition	Azimuth (°)	Height (m)	Comment	AF (dB)	CL (dB)	PA (dB)
PK	10.61596G	54.46	74.00	-19.54	42.18	3	Horizontal	304	1.79	-	39.09	7.68	34.49
AV	10.6222G	40.48	54.00	-13.52	28.19	3	Horizontal	304	1.79	-	39.10	7.68	34.49
PK	15.8916G	58.25	74.00	-15.75	45.56	3	Horizontal	134	1.50	-	38.72	9.40	35.43
AV	15.8848G	43.34	54.00	-10.66	30.63	3	Horizontal	134	1.50	-	38.73	9.40	35.42

Note 1: The amplitude of spurious emissions which are attenuated by more than 20 dB below the permissible value has no need to be reported.
 Note 2: Measurement receive antenna polarization: H (Horizontal), V (Vertical)



Transmitter Radiated Emissions (1GHz~10th Harmonic)			
Operating Mode	802.11ax 40MHz / Nss 1 MCS 0 / 1S4T TXBF / Ant. 3 + Ant. 4 + Ant. 5 + Ant. 6 / CH102	Polarization	V

**802.11ax HEW40-BF_Nss1,(MCS0)_4TX
5510MHz_TX**

08/06/2020

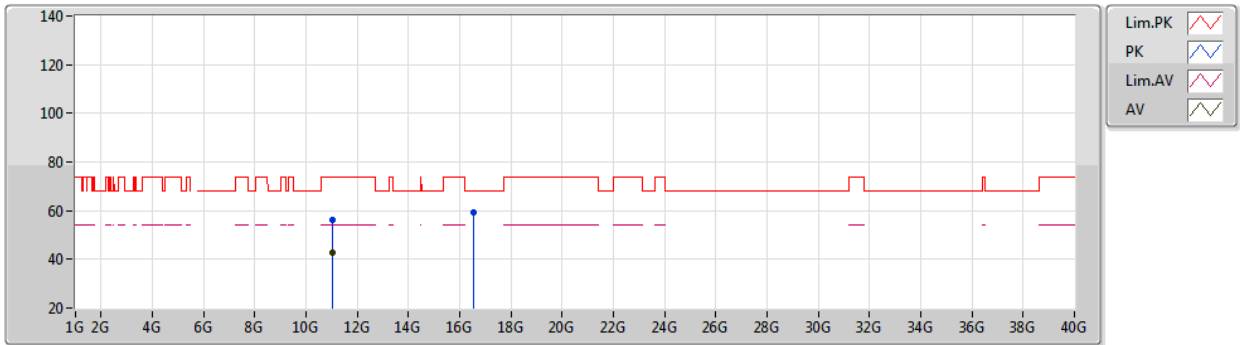

EUT Y_4TX
Setting 75
04-E-P-2

Type	Freq (Hz)	Level (dBuV/m)	Limit (dBuV/m)	Margin (dB)	Raw (dBuV)	Dist (m)	Condition	Azimuth (°)	Height (m)	Comment	AF (dB)	CL (dB)	PA (dB)
PK	11.02184G	56.30	74.00	-17.70	43.90	3	Vertical	326	2.48	-	39.39	7.87	34.86
AV	11.01578G	42.64	54.00	-11.36	30.23	3	Vertical	326	2.48	-	39.39	7.87	34.85
PK	16.52688G	59.52	68.20	-8.68	45.43	3	Vertical	226	1.48	-	39.76	9.82	35.49

Note 1: The amplitude of spurious emissions which are attenuated by more than 20 dB below the permissible value has no need to be reported.

Note 2: Measurement receive antenna polarization: H (Horizontal), V (Vertical)



Transmitter Radiated Emissions (1GHz~10th Harmonic)			
Operating Mode	802.11ax 40MHz / Nss 1 MCS 0 / 1S4T TXBF / Ant. 3 + Ant. 4 + Ant. 5 + Ant. 6 / CH102	Polarization	H

802.11ax HEW40-BF_Nss1,(MCS0)_4TX
5510MHz_TX

08/06/2020

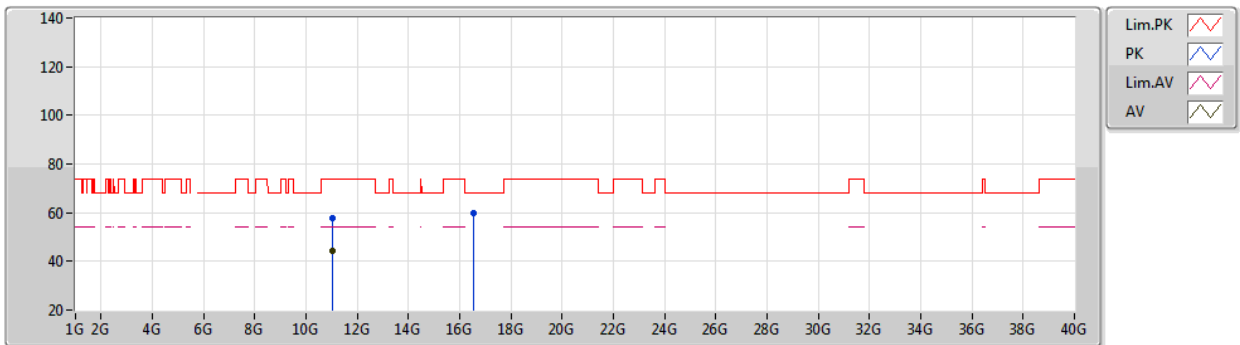

EUT Y_4TX
Setting 75
04-E-P-2

Type	Freq (Hz)	Level (dBuV/m)	Limit (dBuV/m)	Margin (dB)	Raw (dBuV)	Dist (m)	Condition	Azimuth (°)	Height (m)	Comment	AF (dB)	CL (dB)	PA (dB)
PK	11.025G	57.92	74.00	-16.08	45.51	3	Horizontal	317	2.78	-	39.39	7.88	34.86
AV	11.03G	44.42	54.00	-9.58	32.02	3	Horizontal	317	2.78	-	39.38	7.88	34.86
PK	16.5323G	59.59	68.20	-8.61	45.48	3	Horizontal	295	1.43	-	39.77	9.83	35.49

Note 1: The amplitude of spurious emissions which are attenuated by more than 20 dB below the permissible value has no need to be reported.

Note 2: Measurement receive antenna polarization: H (Horizontal), V (Vertical)



Transmitter Radiated Emissions (1GHz~10th Harmonic)			
Operating Mode	802.11ax 40MHz / Nss 1 MCS 0 / 1S4T TXBF / Ant. 3 + Ant. 4 + Ant. 5 + Ant. 6 / CH110	Polarization	V

**802.11ax HEW40-BF_Nss1,(MCS0)_4TX
5550MHz_TX**

08/06/2020

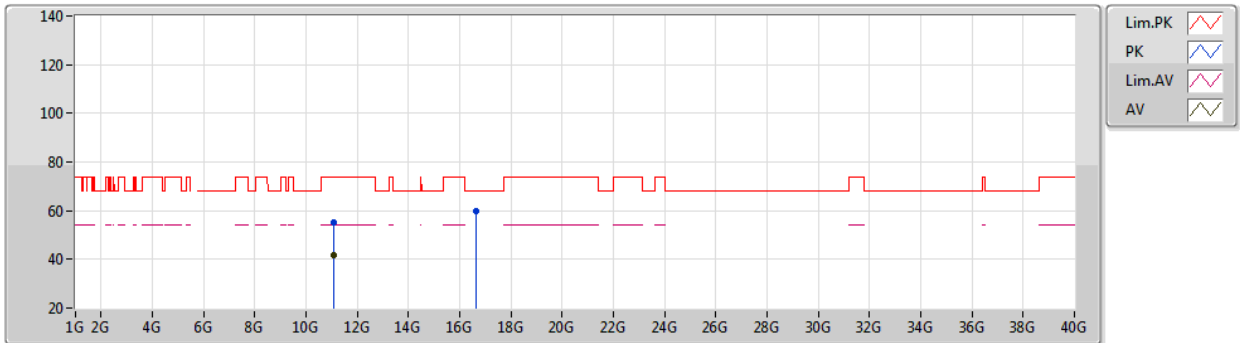

EUT Y_4TX
Setting 80
04-K-P-2

Type	Freq (Hz)	Level (dBuV/m)	Limit (dBuV/m)	Margin (dB)	Raw (dBuV)	Dist (m)	Condition	Azimuth (°)	Height (m)	Comment	AF (dB)	CL (dB)	PA (dB)
PK	11.09662G	55.38	74.00	-18.62	42.99	3	Vertical	275	2.26	-	39.35	7.92	34.88
AV	11.09976G	41.59	54.00	-12.41	29.20	3	Vertical	275	2.26	-	39.35	7.92	34.88
PK	16.65122G	59.71	68.20	-8.49	45.26	3	Vertical	205	1.43	-	40.03	9.92	35.50

Note 1: The amplitude of spurious emissions which are attenuated by more than 20 dB below the permissible value has no need to be reported.

Note 2: Measurement receive antenna polarization: H (Horizontal), V (Vertical)



Transmitter Radiated Emissions (1GHz~10th Harmonic)			
Operating Mode	802.11ax 40MHz / Nss 1 MCS 0 / 1S4T TXBF / Ant. 3 + Ant. 4 + Ant. 5 + Ant. 6 / CH110	Polarization	H

**802.11ax HEW40-BF_Nss1,(MCS0)_4TX
5550MHz_TX**

08/06/2020

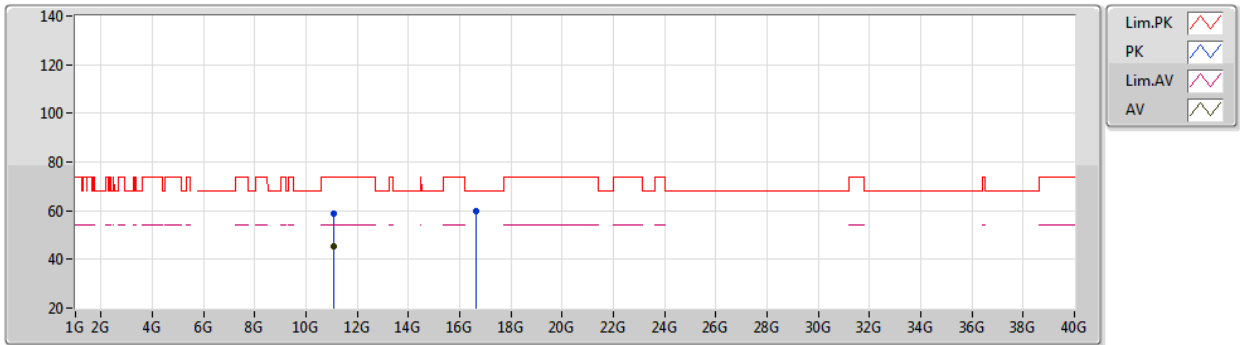

EUT_Y_4TX
Setting 80
04-K-P-2

Type	Freq (Hz)	Level (dBuV/m)	Limit (dBuV/m)	Margin (dB)	Raw (dBuV)	Dist (m)	Condition	Azimuth (°)	Height (m)	Comment	AF (dB)	CL (dB)	PA (dB)
PK	11.0956G	58.85	74.00	-15.15	46.46	3	Horizontal	0	2.27	-	39.35	7.92	34.88
AV	11.1004G	45.27	54.00	-8.73	32.87	3	Horizontal	0	2.27	-	39.35	7.93	34.88
PK	16.6396G	59.69	68.20	-8.51	45.26	3	Horizontal	102	1.82	-	40.01	9.91	35.49

Note 1: The amplitude of spurious emissions which are attenuated by more than 20 dB below the permissible value has no need to be reported.

Note 2: Measurement receive antenna polarization: H (Horizontal), V (Vertical)



Transmitter Radiated Emissions (1GHz~10th Harmonic)			
Operating Mode	802.11ax 40MHz / Nss 1 MCS 0 / 1S4T TXBF / Ant. 3 + Ant. 4 + Ant. 5 + Ant. 6 / CH134	Polarization	V

**802.11ax HEW40-BF_Nss1,(MCS0)_4TX
5670MHz_TX**

08/06/2020

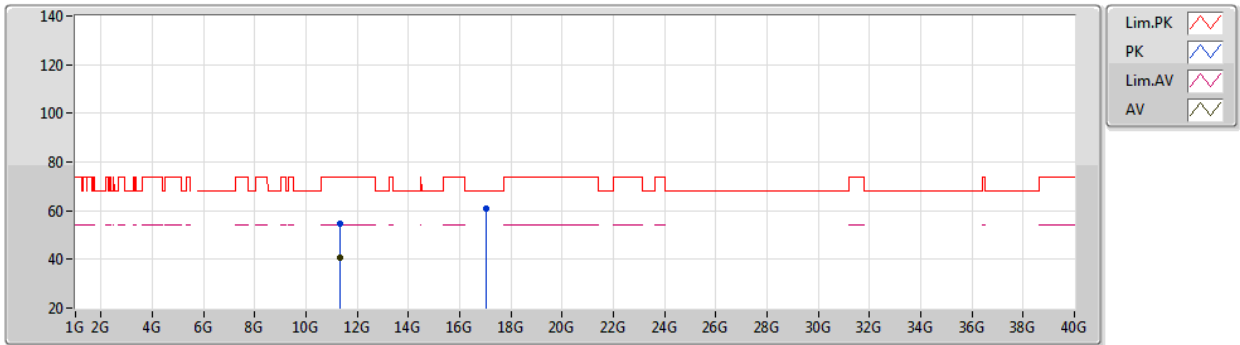

EUT Y_4TX
Setting 80
04-E-P-2

Type	Freq (Hz)	Level (dBuV/m)	Limit (dBuV/m)	Margin (dB)	Raw (dBuV)	Dist (m)	Condition	Azimuth (°)	Height (m)	Comment	AF (dB)	CL (dB)	PA (dB)
PK	11.33526G	54.50	74.00	-19.50	42.14	3	Vertical	34	1.38	-	39.23	8.08	34.95
AV	11.33646G	40.94	54.00	-13.06	28.58	3	Vertical	34	1.38	-	39.23	8.08	34.95
PK	17.00944G	60.87	68.20	-7.33	45.39	3	Vertical	52	1.96	-	40.81	10.19	35.52

Note 1: The amplitude of spurious emissions which are attenuated by more than 20 dB below the permissible value has no need to be reported.

Note 2: Measurement receive antenna polarization: H (Horizontal), V (Vertical)



Transmitter Radiated Emissions (1GHz~10th Harmonic)			
Operating Mode	802.11ax 40MHz / Nss 1 MCS 0 / 1S4T TXBF / Ant. 3 + Ant. 4 + Ant. 5 + Ant. 6 / CH134	Polarization	H

**802.11ax HEW40-BF_Nss1,(MCS0)_4TX
5670MHz_TX**

08/06/2020

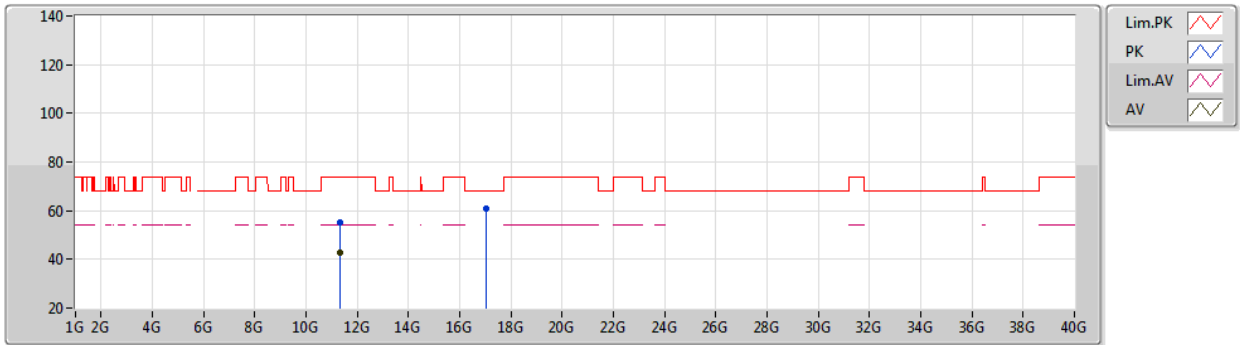

EUT_Y_4TX
Setting 80
04-E-P-2

Type	Freq (Hz)	Level (dBuV/m)	Limit (dBuV/m)	Margin (dB)	Raw (dBuV)	Dist (m)	Condition	Azimuth (°)	Height (m)	Comment	AF (dB)	CL (dB)	PA (dB)
PK	11.3272G	55.03	74.00	-18.97	42.66	3	Horizontal	281	2.46	-	39.24	8.07	34.94
AV	11.3254G	42.66	54.00	-11.34	30.29	3	Horizontal	281	2.46	-	39.24	8.07	34.94
PK	17.01176G	60.78	68.20	-7.42	45.30	3	Horizontal	198	1.87	-	40.81	10.19	35.52

Note 1: The amplitude of spurious emissions which are attenuated by more than 20 dB below the permissible value has no need to be reported.

Note 2: Measurement receive antenna polarization: H (Horizontal), V (Vertical)



Transmitter Radiated Emissions (1GHz~10th Harmonic)			
Operating Mode	802.11ax 40MHz / Nss 1 MCS 0 / 1S4T TXBF / Ant. 3 + Ant. 4 + Ant. 5 + Ant. 6 / CH142	Polarization	V

802.11ax HEW40-BF_Nss1,(MCS0)_4TX
5710MHz Straddle 5.47-5.725GHz_TX

08/06/2020

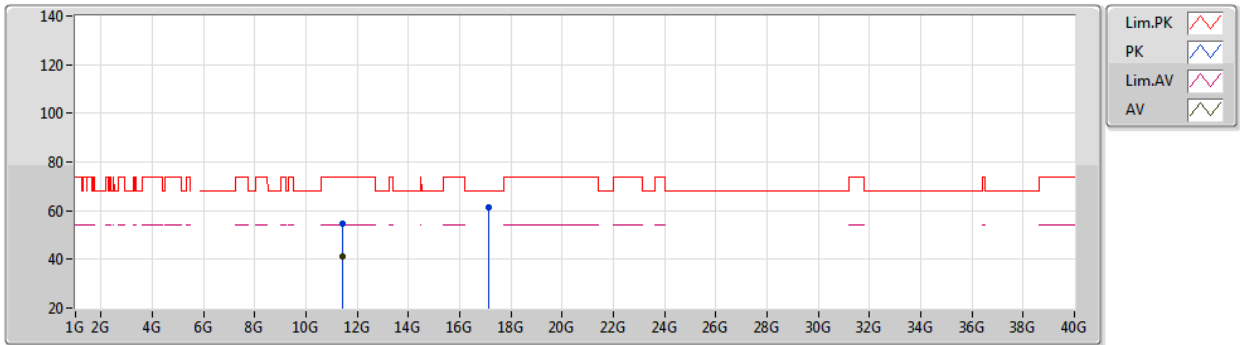

EUT Y_4TX
 Setting 80
 04-E-P-2

Type	Freq (Hz)	Level (dBuV/m)	Limit (dBuV/m)	Margin (dB)	Raw (dBuV)	Dist (m)	Condition	Azimuth (°)	Height (m)	Comment	AF (dB)	CL (dB)	PA (dB)
PK	11.42088G	54.69	74.00	-19.31	42.34	3	Vertical	241	1.68	-	39.19	8.13	34.97
AV	11.41986G	41.30	54.00	-12.70	28.95	3	Vertical	241	1.68	-	39.19	8.13	34.97
PK	17.12762G	61.57	68.20	-6.63	45.98	3	Vertical	125	2.02	-	40.91	10.16	35.48

Note 1: The amplitude of spurious emissions which are attenuated by more than 20 dB below the permissible value has no need to be reported.

Note 2: Measurement receive antenna polarization: H (Horizontal), V (Vertical)



Transmitter Radiated Emissions (1GHz~10th Harmonic)			
Operating Mode	802.11ax 40MHz / Nss 1 MCS 0 / 1S4T TXBF / Ant. 3 + Ant. 4 + Ant. 5 + Ant. 6 / CH142	Polarization	H

802.11ax HEW40-BF_Nss1,(MCS0)_4TX
5710MHz Straddle 5.47-5.725GHz_TX

08/06/2020

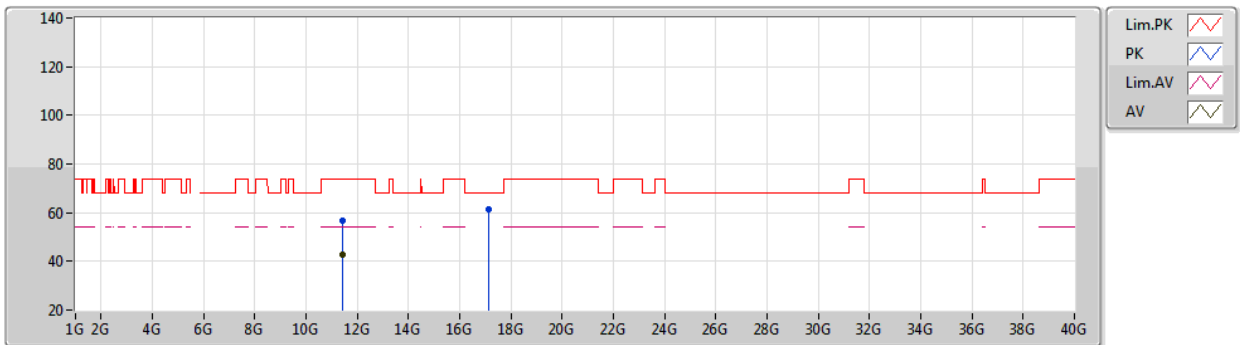

EUT Y_4TX
 Setting 80
 04-E-P-2

Type	Freq (Hz)	Level (dBuV/m)	Limit (dBuV/m)	Margin (dB)	Raw (dBuV)	Dist (m)	Condition	Azimuth (°)	Height (m)	Comment	AF (dB)	CL (dB)	PA (dB)
PK	11.4151G	56.80	74.00	-17.20	44.45	3	Horizontal	24	1.35	-	39.19	8.13	34.97
AV	11.42026G	42.74	54.00	-11.26	30.39	3	Horizontal	24	1.35	-	39.19	8.13	34.97
PK	17.1324G	61.26	68.20	-6.94	45.66	3	Horizontal	31	1.92	-	40.92	10.16	35.48

Note 1: The amplitude of spurious emissions which are attenuated by more than 20 dB below the permissible value has no need to be reported.

Note 2: Measurement receive antenna polarization: H (Horizontal), V (Vertical)



Transmitter Radiated Emissions (1GHz~10th Harmonic)			
Operating Mode	802.11ax 40MHz / Nss 2 MCS 0 / 2S4T TXBF / Ant. 3 + Ant. 4 + Ant. 5 + Ant. 6 / CH102	Polarization	V

**802.11ax HEW40-BF_Nss2,(MCS0)_4TX
5510MHz_TX**

08/06/2020

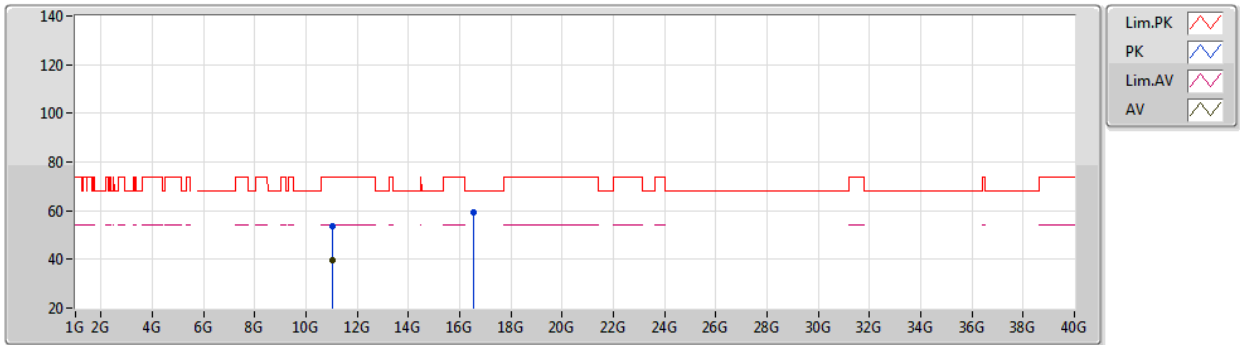

EUT Y_4TX
Setting 79
04-E-P-2

Type	Freq (Hz)	Level (dBuV/m)	Limit (dBuV/m)	Margin (dB)	Raw (dBuV)	Dist (m)	Condition	Azimuth (°)	Height (m)	Comment	AF (dB)	CL (dB)	PA (dB)
PK	11.02346G	53.57	74.00	-20.43	41.16	3	Vertical	289	1.70	-	39.39	7.88	34.86
AV	11.02458G	39.85	54.00	-14.15	27.44	3	Vertical	289	1.70	-	39.39	7.88	34.86
PK	16.52742G	59.12	68.20	-9.08	45.03	3	Vertical	343	1.80	-	39.76	9.82	35.49

Note 1: The amplitude of spurious emissions which are attenuated by more than 20 dB below the permissible value has no need to be reported.

Note 2: Measurement receive antenna polarization: H (Horizontal), V (Vertical)



Transmitter Radiated Emissions (1GHz~10th Harmonic)			
Operating Mode	802.11ax 40MHz / Nss 2 MCS 0 / 2S4T TXBF / Ant. 3 + Ant. 4 + Ant. 5 + Ant. 6 / CH102	Polarization	H

802.11ax HEW40-BF_Nss2,(MCS0)_4TX
5510MHz_TX

08/06/2020

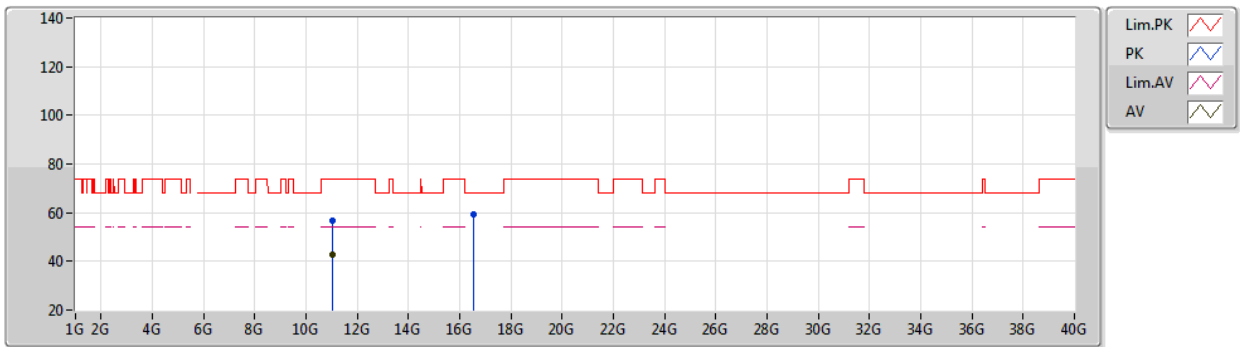

EUT Y_4TX
Setting 79
04-E-P-2

Type	Freq (Hz)	Level (dBuV/m)	Limit (dBuV/m)	Margin (dB)	Raw (dBuV)	Dist (m)	Condition	Azimuth (°)	Height (m)	Comment	AF (dB)	CL (dB)	PA (dB)
PK	11.02832G	56.92	74.00	-17.08	44.51	3	Horizontal	360	2.14	-	39.39	7.88	34.86
AV	11.02416G	42.61	54.00	-11.39	30.20	3	Horizontal	360	2.14	-	39.39	7.88	34.86
PK	16.52502G	59.35	68.20	-8.85	45.26	3	Horizontal	344	1.80	-	39.76	9.82	35.49

Note 1: The amplitude of spurious emissions which are attenuated by more than 20 dB below the permissible value has no need to be reported.

Note 2: Measurement receive antenna polarization: H (Horizontal), V (Vertical)



Transmitter Radiated Emissions (1GHz~10th Harmonic)			
Operating Mode	802.11ax 40MHz / Nss 2 MCS 0 / 2S4T TXBF / Ant. 3 + Ant. 4 + Ant. 5 + Ant. 6 / CH110	Polarization	V

**802.11ax HEW40-BF_Nss2,(MCS0)_4TX
5550MHz_TX**

08/06/2020

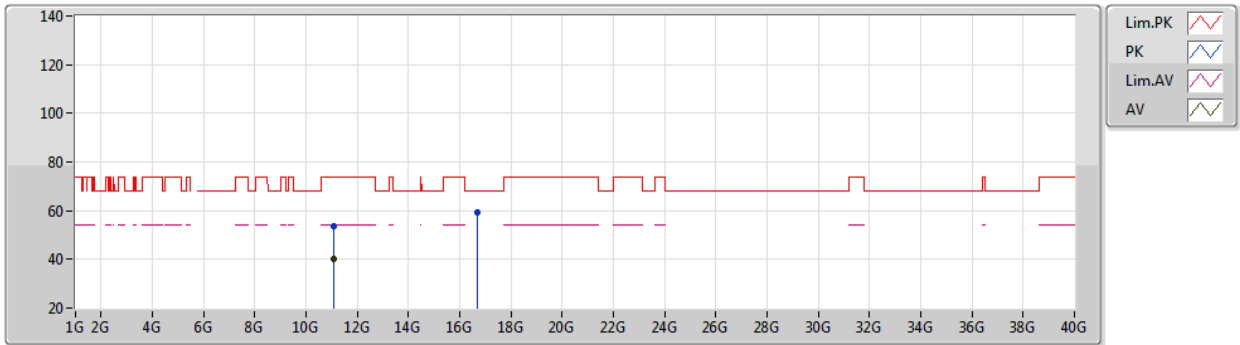

EUT Y_4TX
Setting 80
04-E-P-2

Type	Freq (Hz)	Level (dBuV/m)	Limit (dBuV/m)	Margin (dB)	Raw (dBuV)	Dist (m)	Condition	Azimuth (°)	Height (m)	Comment	AF (dB)	CL (dB)	PA (dB)
PK	11.09184G	53.57	74.00	-20.43	41.18	3	Vertical	258	1.63	-	39.35	7.92	34.88
AV	11.08976G	39.93	54.00	-14.07	27.53	3	Vertical	258	1.63	-	39.36	7.92	34.88
PK	16.66488G	59.15	68.20	-9.05	44.66	3	Vertical	139	1.54	-	40.06	9.93	35.50

Note 1: The amplitude of spurious emissions which are attenuated by more than 20 dB below the permissible value has no need to be reported.

Note 2: Measurement receive antenna polarization: H (Horizontal), V (Vertical)



Transmitter Radiated Emissions (1GHz~10th Harmonic)			
Operating Mode	802.11ax 40MHz / Nss 2 MCS 0 / 2S4T TXBF / Ant. 3 + Ant. 4 + Ant. 5 + Ant. 6 / CH110	Polarization	H

802.11ax HEW40-BF_Nss2,(MCS0)_4TX
5550MHz_TX

08/06/2020

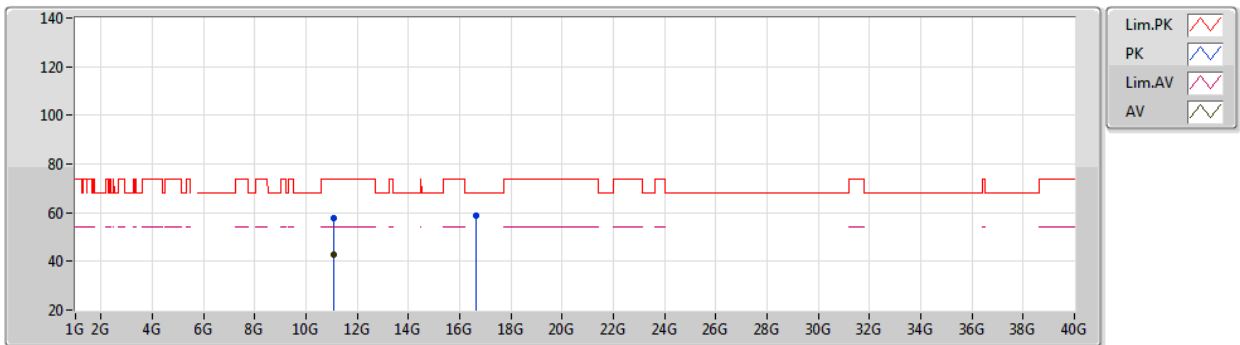

EUT Y_4TX
Setting 80
04-E-P-2

Type	Freq (Hz)	Level (dBuV/m)	Limit (dBuV/m)	Margin (dB)	Raw (dBuV)	Dist (m)	Condition	Azimuth (°)	Height (m)	Comment	AF (dB)	CL (dB)	PA (dB)
PK	11.09984G	58.00	74.00	-16.00	45.61	3	Horizontal	341	1.66	-	39.35	7.92	34.88
AV	11.10032G	42.83	54.00	-11.17	30.43	3	Horizontal	341	1.66	-	39.35	7.93	34.88
PK	16.64264G	58.88	68.20	-9.32	44.45	3	Horizontal	73	1.05	-	40.01	9.91	35.49

Note 1: The amplitude of spurious emissions which are attenuated by more than 20 dB below the permissible value has no need to be reported.

Note 2: Measurement receive antenna polarization: H (Horizontal), V (Vertical)



Transmitter Radiated Emissions (1GHz~10th Harmonic)			
Operating Mode	802.11ax 40MHz / Nss 2 MCS 0 / 2S4T TXBF / Ant. 3 + Ant. 4 + Ant. 5 + Ant. 6 / CH134	Polarization	V

802.11ax HEW40-BF_Nss2,(MCS0)_4TX
5670MHz_TX

08/06/2020

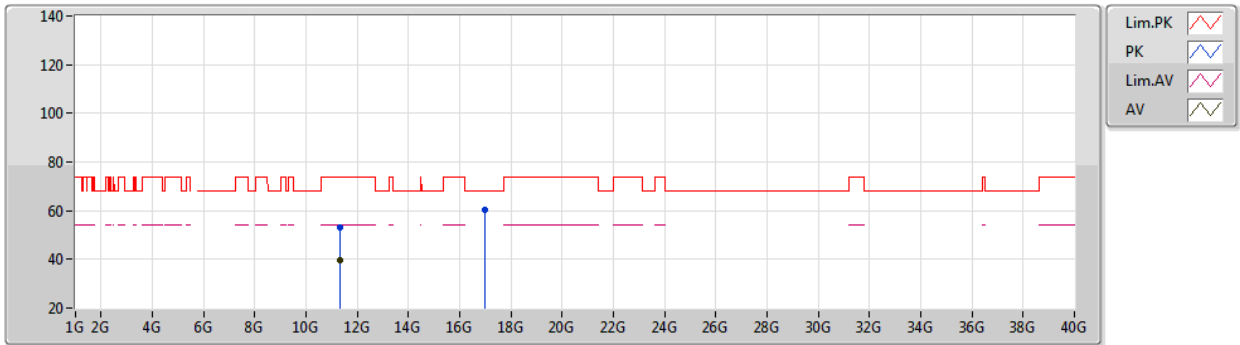

EUT Y_4TX
Setting 80
04-E-P-2

Type	Freq (Hz)	Level (dBuV/m)	Limit (dBuV/m)	Margin (dB)	Raw (dBuV)	Dist (m)	Condition	Azimuth (°)	Height (m)	Comment	AF (dB)	CL (dB)	PA (dB)
PK	11.31264G	52.99	74.00	-21.01	40.63	3	Vertical	317	1.59	-	39.24	8.06	34.94
AV	11.3424G	39.70	54.00	-14.30	27.34	3	Vertical	317	1.59	-	39.23	8.08	34.95
PK	16.99528G	60.19	68.20	-8.01	44.73	3	Vertical	322	1.01	-	40.79	10.19	35.52

Note 1: The amplitude of spurious emissions which are attenuated by more than 20 dB below the permissible value has no need to be reported.

Note 2: Measurement receive antenna polarization: H (Horizontal), V (Vertical)



Transmitter Radiated Emissions (1GHz~10th Harmonic)			
Operating Mode	802.11ax 40MHz / Nss 2 MCS 0 / 2S4T TXBF / Ant. 3 + Ant. 4 + Ant. 5 + Ant. 6 / CH134	Polarization	H

**802.11ax HEW40-BF_Nss2,(MCS0)_4TX
5670MHz_TX**

08/06/2020

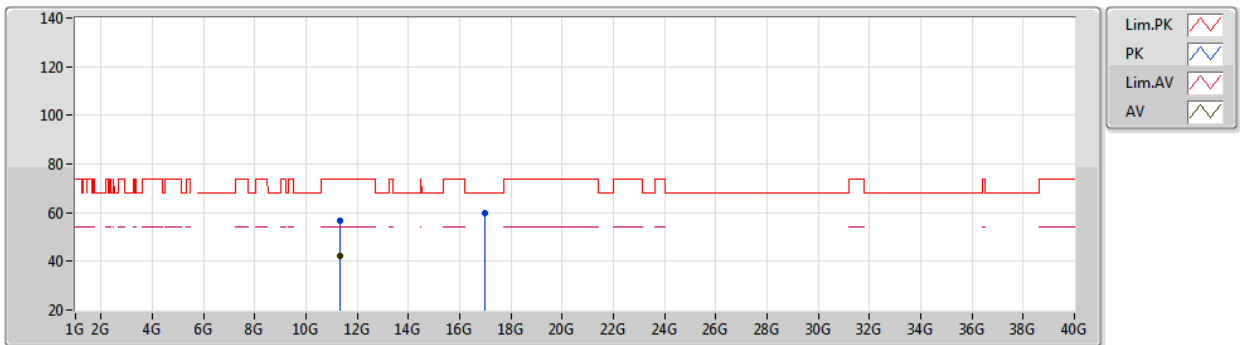

EUT Y_4TX
Setting 80
04-E-P-2

Type	Freq (Hz)	Level (dBuV/m)	Limit (dBuV/m)	Margin (dB)	Raw (dBuV)	Dist (m)	Condition	Azimuth (°)	Height (m)	Comment	AF (dB)	CL (dB)	PA (dB)
PK	11.34G	56.48	74.00	-17.52	44.12	3	Horizontal	310	1.67	-	39.23	8.08	34.95
AV	11.34G	42.38	54.00	-11.62	30.02	3	Horizontal	310	1.67	-	39.23	8.08	34.95
PK	16.98088G	59.73	68.20	-8.47	44.31	3	Horizontal	280	2.28	-	40.76	10.18	35.52

Note 1: The amplitude of spurious emissions which are attenuated by more than 20 dB below the permissible value has no need to be reported.

Note 2: Measurement receive antenna polarization: H (Horizontal), V (Vertical)



Transmitter Radiated Emissions (1GHz~10th Harmonic)			
Operating Mode	802.11ax 40MHz / Nss 2 MCS 0 / 2S4T TXBF / Ant. 3 + Ant. 4 + Ant. 5 + Ant. 6 / CH142	Polarization	V

802.11ax HEW40-BF_Nss2,(MCS0)_4TX
5710MHz Straddle 5.47-5.725GHz_TX

08/06/2020

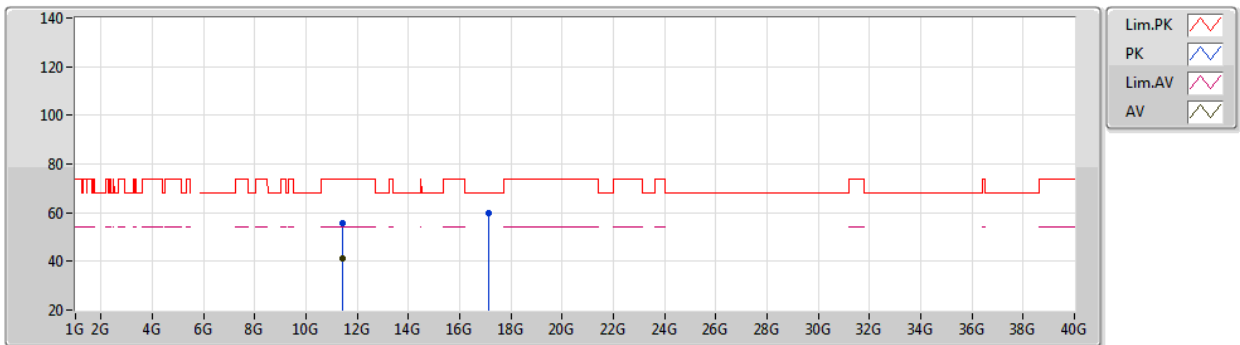

EUT Y_4TX
 Setting 80
 04-E-P-2

Type	Freq (Hz)	Level (dBuV/m)	Limit (dBuV/m)	Margin (dB)	Raw (dBuV)	Dist (m)	Condition	Azimuth (°)	Height (m)	Comment	AF (dB)	CL (dB)	PA (dB)
PK	11.41998G	55.45	74.00	-18.55	43.10	3	Vertical	152	1.23	-	39.19	8.13	34.97
AV	11.41998G	41.07	54.00	-12.93	28.72	3	Vertical	152	1.23	-	39.19	8.13	34.97
PK	17.13298G	59.64	68.20	-8.56	44.04	3	Vertical	111	1.36	-	40.92	10.16	35.48

Note 1: The amplitude of spurious emissions which are attenuated by more than 20 dB below the permissible value has no need to be reported.

Note 2: Measurement receive antenna polarization: H (Horizontal), V (Vertical)



Transmitter Radiated Emissions (1GHz~10th Harmonic)			
Operating Mode	802.11ax 40MHz / Nss 2 MCS 0 / 2S4T TXBF / Ant. 3 + Ant. 4 + Ant. 5 + Ant. 6 / CH142	Polarization	H

802.11ax HEW40-BF_Nss2,(MCS0)_4TX
5710MHz Straddle 5.47-5.725GHz_TX

08/06/2020

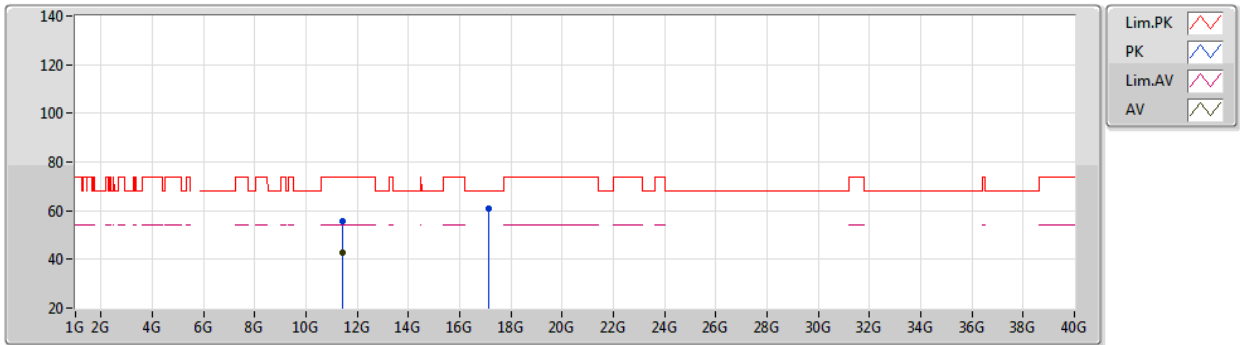

EUT Y_4TX
 Setting 80
 04-E-P-2

Type	Freq (Hz)	Level (dBuV/m)	Limit (dBuV/m)	Margin (dB)	Raw (dBuV)	Dist (m)	Condition	Azimuth (°)	Height (m)	Comment	AF (dB)	CL (dB)	PA (dB)
PK	11.41972G	55.80	74.00	-18.20	43.45	3	Horizontal	268	1.80	-	39.19	8.13	34.97
AV	11.4199G	42.93	54.00	-11.07	30.58	3	Horizontal	268	1.80	-	39.19	8.13	34.97
PK	17.1296G	60.74	68.20	-7.46	45.14	3	Horizontal	287	1.80	-	40.92	10.16	35.48

Note 1: The amplitude of spurious emissions which are attenuated by more than 20 dB below the permissible value has no need to be reported.

Note 2: Measurement receive antenna polarization: H (Horizontal), V (Vertical)



Transmitter Radiated Emissions (1GHz~10th Harmonic)			
Operating Mode	802.11ax 40MHz / Nss 3 MCS 0 / 3S4T TXBF / Ant. 3 + Ant. 4 + Ant. 5 + Ant. 6 / CH102	Polarization	V

**802.11ax HEW40-BF_Nss3,(MCS0)_4TX
5510MHz_TX**

08/06/2020

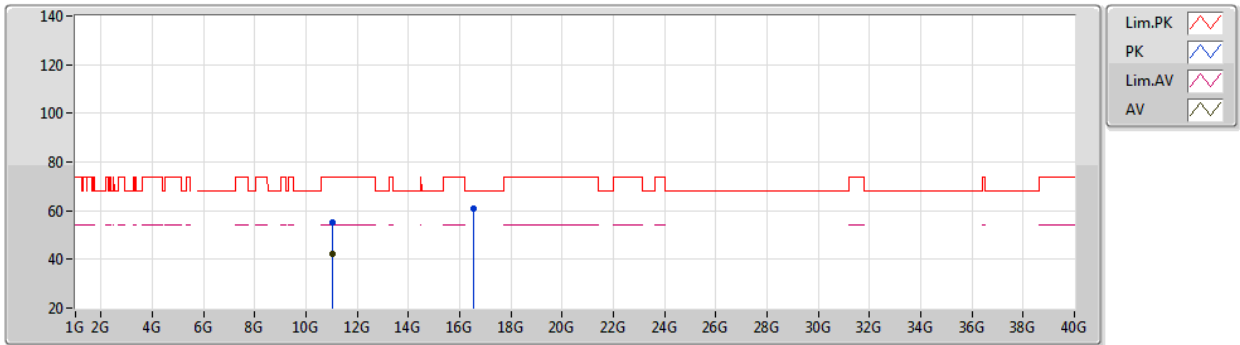

EUT Y_4TX
Setting 77
04-E-P-2

Type	Freq (Hz)	Level (dBuV/m)	Limit (dBuV/m)	Margin (dB)	Raw (dBuV)	Dist (m)	Condition	Azimuth (°)	Height (m)	Comment	AF (dB)	CL (dB)	PA (dB)
PK	11.0408G	55.13	74.00	-18.87	42.72	3	Vertical	239	2.04	-	39.38	7.89	34.86
AV	11.0311G	42.08	54.00	-11.92	29.68	3	Vertical	239	2.04	-	39.38	7.88	34.86
PK	16.53348G	60.63	68.20	-7.57	46.52	3	Vertical	181	1.56	-	39.77	9.83	35.49

Note 1: The amplitude of spurious emissions which are attenuated by more than 20 dB below the permissible value has no need to be reported.

Note 2: Measurement receive antenna polarization: H (Horizontal), V (Vertical)



Transmitter Radiated Emissions (1GHz~10th Harmonic)			
Operating Mode	802.11ax 40MHz / Nss 3 MCS 0 / 3S4T TXBF / Ant. 3 + Ant. 4 + Ant. 5 + Ant. 6 / CH102	Polarization	H

802.11ax HEW40-BF_Nss3,(MCS0)_4TX
5510MHz_TX

08/06/2020

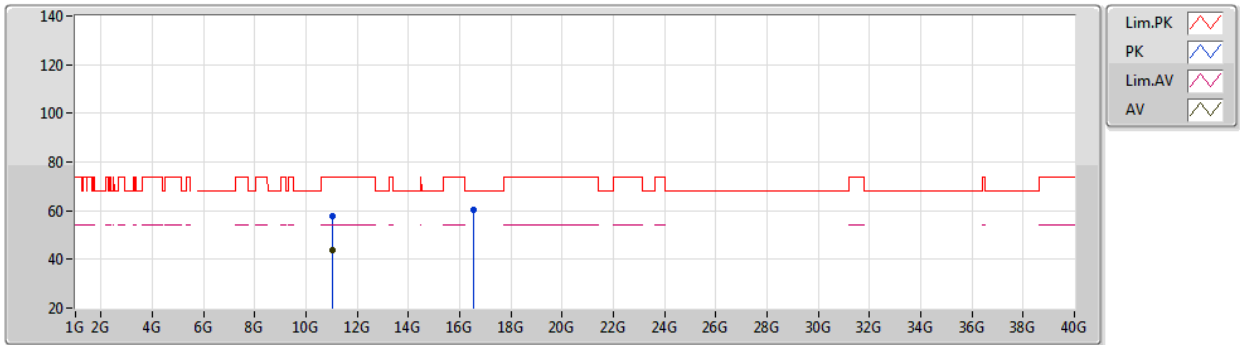

EUT Y_4TX
Setting 77
04-E-P-2

Type	Freq (Hz)	Level (dBuV/m)	Limit (dBuV/m)	Margin (dB)	Raw (dBuV)	Dist (m)	Condition	Azimuth (°)	Height (m)	Comment	AF (dB)	CL (dB)	PA (dB)
PK	11.02G	57.98	74.00	-16.02	45.58	3	Horizontal	332	1.62	-	39.39	7.87	34.86
AV	11.0198G	43.87	54.00	-10.13	31.47	3	Horizontal	332	1.62	-	39.39	7.87	34.86
PK	16.53466G	60.09	68.20	-8.11	45.97	3	Horizontal	110	1.80	-	39.78	9.83	35.49

Note 1: The amplitude of spurious emissions which are attenuated by more than 20 dB below the permissible value has no need to be reported.

Note 2: Measurement receive antenna polarization: H (Horizontal), V (Vertical)



Transmitter Radiated Emissions (1GHz~10th Harmonic)			
Operating Mode	802.11ax 40MHz / Nss 3 MCS 0 / 3S4T TXBF / Ant. 3 + Ant. 4 + Ant. 5 + Ant. 6 / CH110	Polarization	V

**802.11ax HEW40-BF_Nss3,(MCS0)_4TX
5550MHz_TX**

08/06/2020

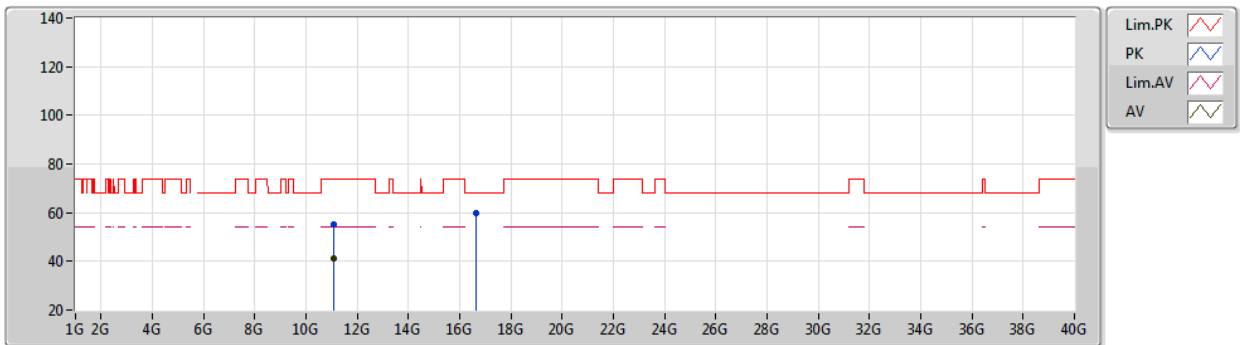

EUT Y_4TX
Setting 80
04-E-P-2

Type	Freq (Hz)	Level (dBuV/m)	Limit (dBuV/m)	Margin (dB)	Raw (dBuV)	Dist (m)	Condition	Azimuth (°)	Height (m)	Comment	AF (dB)	CL (dB)	PA (dB)
PK	11.0908G	55.27	74.00	-18.73	42.88	3	Vertical	320	1.80	-	39.35	7.92	34.88
AV	11.0894G	41.00	54.00	-13.00	28.60	3	Vertical	320	1.80	-	39.36	7.92	34.88
PK	16.6535G	59.88	68.20	-8.32	45.42	3	Vertical	304	1.80	-	40.04	9.92	35.50

Note 1: The amplitude of spurious emissions which are attenuated by more than 20 dB below the permissible value has no need to be reported.

Note 2: Measurement receive antenna polarization: H (Horizontal), V (Vertical)



Transmitter Radiated Emissions (1GHz~10th Harmonic)			
Operating Mode	802.11ax 40MHz / Nss 3 MCS 0 / 3S4T TXBF / Ant. 3 + Ant. 4 + Ant. 5 + Ant. 6 / CH110	Polarization	H

802.11ax HEW40-BF_Nss3,(MCS0)_4TX
5550MHz_TX

08/06/2020

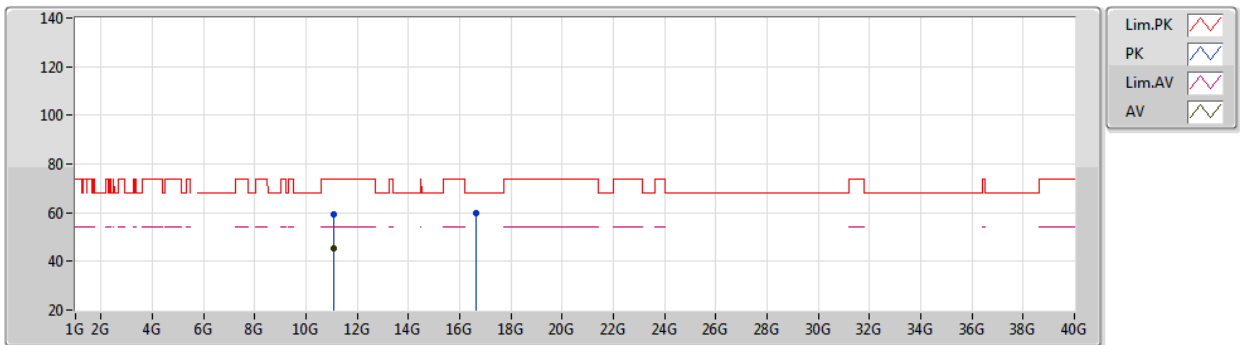

EUT_Y_4TX
Setting 80
04-E-P-2

Type	Freq (Hz)	Level (dBuV/m)	Limit (dBuV/m)	Margin (dB)	Raw (dBuV)	Dist (m)	Condition	Azimuth (°)	Height (m)	Comment	AF (dB)	CL (dB)	PA (dB)
PK	11.096G	59.36	74.00	-14.64	46.97	3	Horizontal	350	1.62	-	39.35	7.92	34.88
AV	11.09518G	45.55	54.00	-8.45	33.16	3	Horizontal	350	1.62	-	39.35	7.92	34.88
PK	16.6318G	59.59	68.20	-8.61	45.19	3	Horizontal	275	1.73	-	39.99	9.90	35.49

Note 1: The amplitude of spurious emissions which are attenuated by more than 20 dB below the permissible value has no need to be reported.

Note 2: Measurement receive antenna polarization: H (Horizontal), V (Vertical)



Transmitter Radiated Emissions (1GHz~10th Harmonic)			
Operating Mode	802.11ax 40MHz / Nss 3 MCS 0 / 3S4T TXBF / Ant. 3 + Ant. 4 + Ant. 5 + Ant. 6 / CH134	Polarization	V

**802.11ax HEW40-BF_Nss3,(MCS0)_4TX
5670MHz_TX**

08/06/2020

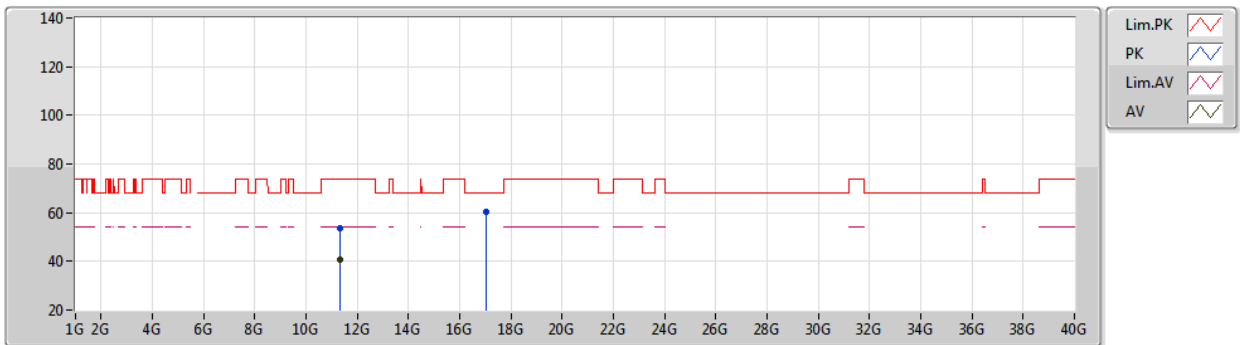

EUT Y_4TX
Setting 80
04-E-P-2

Type	Freq (Hz)	Level (dBuV/m)	Limit (dBuV/m)	Margin (dB)	Raw (dBuV)	Dist (m)	Condition	Azimuth (°)	Height (m)	Comment	AF (dB)	CL (dB)	PA (dB)
PK	11.3442G	53.37	74.00	-20.63	41.01	3	Vertical	311	1.00	-	39.23	8.08	34.95
AV	11.34G	40.52	54.00	-13.48	28.16	3	Vertical	311	1.00	-	39.23	8.08	34.95
PK	17.01164G	60.44	68.20	-7.76	44.96	3	Vertical	360	1.49	-	40.81	10.19	35.52

Note 1: The amplitude of spurious emissions which are attenuated by more than 20 dB below the permissible value has no need to be reported.

Note 2: Measurement receive antenna polarization: H (Horizontal), V (Vertical)



Transmitter Radiated Emissions (1GHz~10th Harmonic)			
Operating Mode	802.11ax 40MHz / Nss 3 MCS 0 / 3S4T TXBF / Ant. 3 + Ant. 4 + Ant. 5 + Ant. 6 / CH134	Polarization	H

**802.11ax HEW40-BF_Nss3,(MCS0)_4TX
5670MHz_TX**

08/06/2020

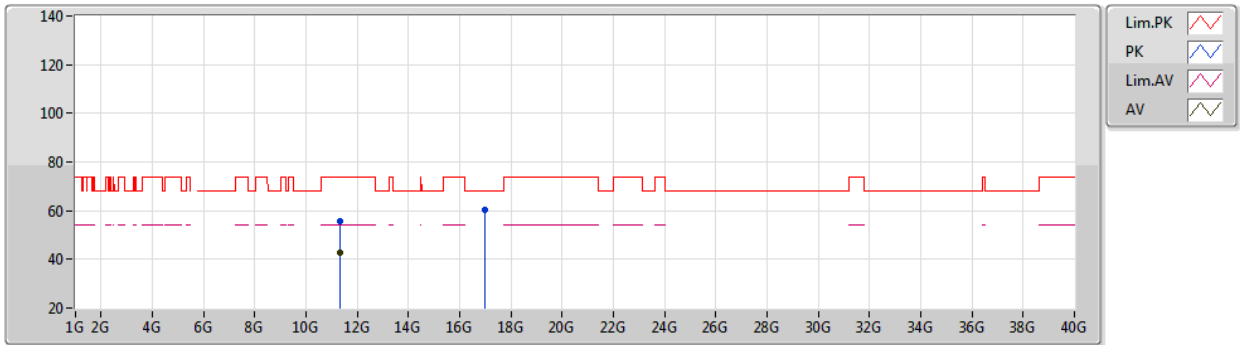

EUT Y_4TX
Setting 80
04-E-P-2

Type	Freq (Hz)	Level (dBuV/m)	Limit (dBuV/m)	Margin (dB)	Raw (dBuV)	Dist (m)	Condition	Azimuth (°)	Height (m)	Comment	AF (dB)	CL (dB)	PA (dB)
PK	11.3216G	55.54	74.00	-18.46	43.17	3	Horizontal	317	1.67	-	39.24	8.07	34.94
AV	11.3398G	42.98	54.00	-11.02	30.62	3	Horizontal	317	1.67	-	39.23	8.08	34.95
PK	17.00756G	60.19	68.20	-8.01	44.71	3	Horizontal	242	1.76	-	40.81	10.19	35.52

Note 1: The amplitude of spurious emissions which are attenuated by more than 20 dB below the permissible value has no need to be reported.

Note 2: Measurement receive antenna polarization: H (Horizontal), V (Vertical)



Transmitter Radiated Emissions (1GHz~10th Harmonic)			
Operating Mode	802.11ax 40MHz / Nss 3 MCS 0 / 3S4T TXBF / Ant. 3 + Ant. 4 + Ant. 5 + Ant. 6 / CH142	Polarization	V

802.11ax HEW40-BF_Nss3,(MCS0)_4TX
5710MHz Straddle 5.47-5.725GHz_TX

08/06/2020

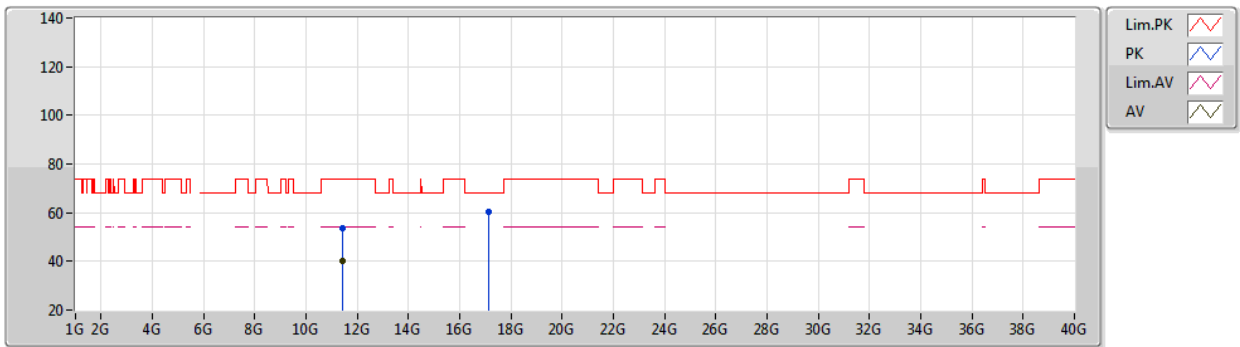

EUT Y_4TX
 Setting 80
 04-E-P-2

Type	Freq (Hz)	Level (dBuV/m)	Limit (dBuV/m)	Margin (dB)	Raw (dBuV)	Dist (m)	Condition	Azimuth (°)	Height (m)	Comment	AF (dB)	CL (dB)	PA (dB)
PK	11.41884G	53.51	74.00	-20.49	41.16	3	Vertical	301	1.80	-	39.19	8.13	34.97
AV	11.4238G	40.39	54.00	-13.61	28.03	3	Vertical	301	1.80	-	39.19	8.14	34.97
PK	17.13468G	60.24	68.20	-7.96	44.64	3	Vertical	41	1.80	-	40.92	10.16	35.48

Note 1: The amplitude of spurious emissions which are attenuated by more than 20 dB below the permissible value has no need to be reported.

Note 2: Measurement receive antenna polarization: H (Horizontal), V (Vertical)



Transmitter Radiated Emissions (1GHz~10th Harmonic)			
Operating Mode	802.11ax 40MHz / Nss 3 MCS 0 / 3S4T TXBF / Ant. 3 + Ant. 4 + Ant. 5 + Ant. 6 / CH142	Polarization	H

802.11ax HEW40-BF_Nss3,(MCS0)_4TX
5710MHz Straddle 5.47-5.725GHz_TX

08/06/2020

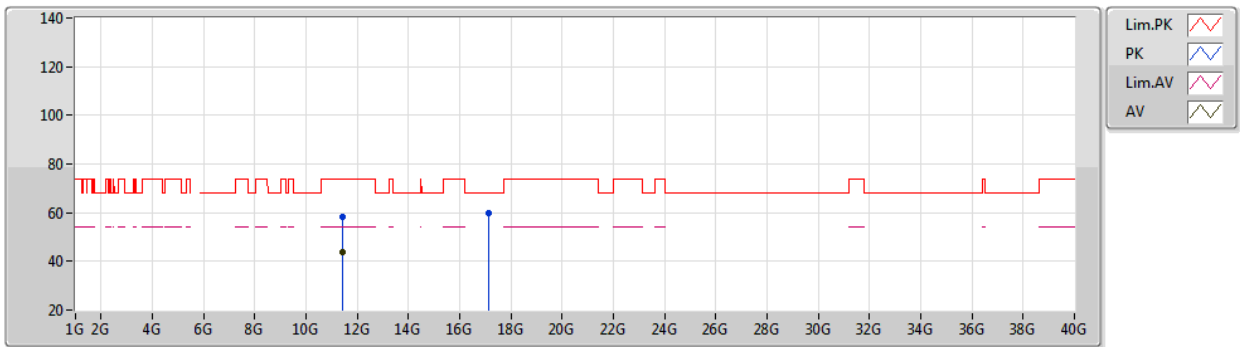

EUT Y_4TX
 Setting 80
 04-E-P-2

Type	Freq (Hz)	Level (dBuV/m)	Limit (dBuV/m)	Margin (dB)	Raw (dBuV)	Dist (m)	Condition	Azimuth (°)	Height (m)	Comment	AF (dB)	CL (dB)	PA (dB)
PK	11.42G	58.04	74.00	-15.96	45.69	3	Horizontal	313	1.65	-	39.19	8.13	34.97
AV	11.42G	43.78	54.00	-10.22	31.43	3	Horizontal	313	1.65	-	39.19	8.13	34.97
PK	17.13104G	60.06	68.20	-8.14	44.46	3	Horizontal	283	1.80	-	40.92	10.16	35.48

Note 1: The amplitude of spurious emissions which are attenuated by more than 20 dB below the permissible value has no need to be reported.

Note 2: Measurement receive antenna polarization: H (Horizontal), V (Vertical)

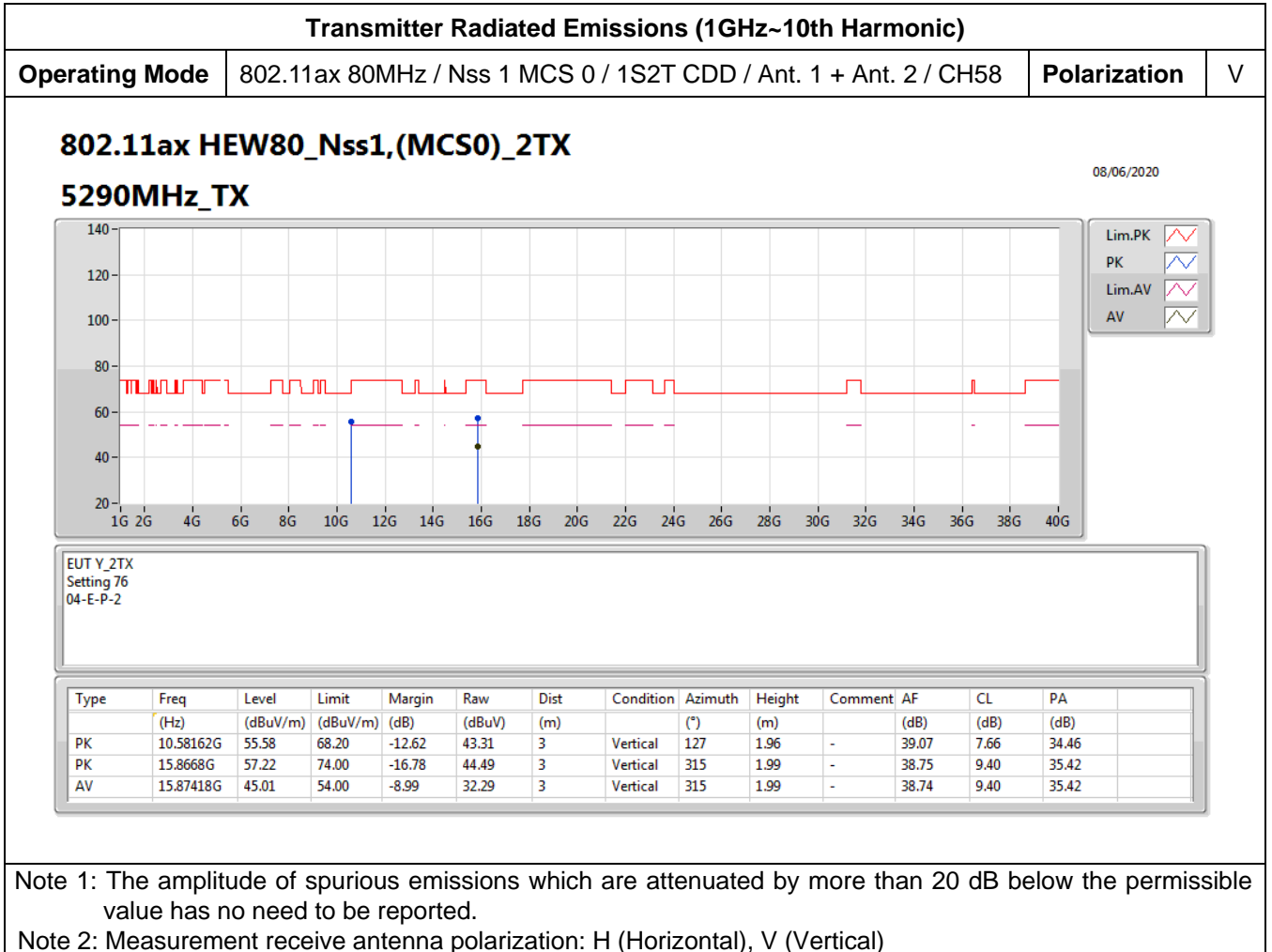



Transmitter Radiated Emissions (1GHz~10th Harmonic)			
Operating Mode	802.11ax 80MHz / Nss 1 MCS 0 / 1S2T CDD / Ant. 1 + Ant. 2 / CH58	Polarization	H

802.11ax HEW80_Nss1,(MCS0)_2TX
5290MHz_TX

08/06/2020

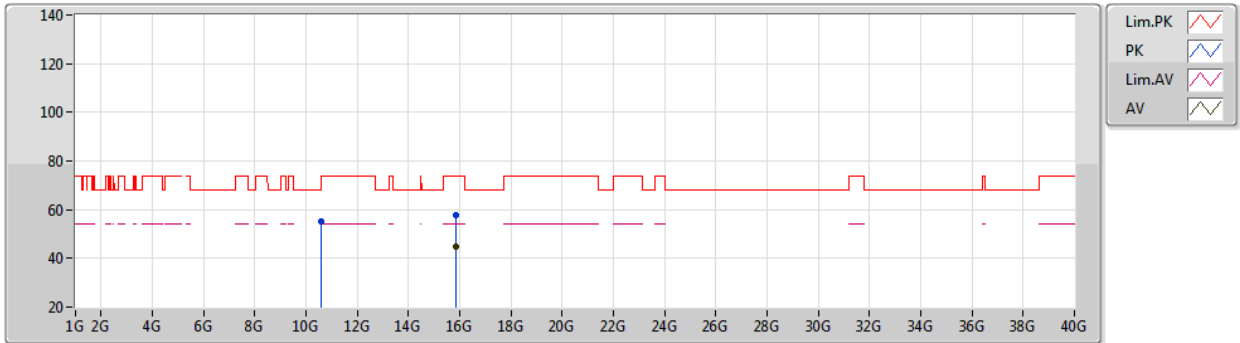

EUT Y_2TX
 Setting 76
 04-E-P-2

Type	Freq (Hz)	Level (dBuV/m)	Limit (dBuV/m)	Margin (dB)	Raw (dBuV)	Dist (m)	Condition	Azimuth (°)	Height (m)	Comment	AF (dB)	CL (dB)	PA (dB)
PK	10.58204G	55.00	68.20	-13.20	42.73	3	Horizontal	356	1.57	-	39.07	7.66	34.46
PK	15.86762G	57.95	74.00	-16.05	45.22	3	Horizontal	65	1.02	-	38.75	9.40	35.42
AV	15.86854G	44.84	54.00	-9.16	32.12	3	Horizontal	65	1.02	-	38.74	9.40	35.42

Note 1: The amplitude of spurious emissions which are attenuated by more than 20 dB below the permissible value has no need to be reported.

Note 2: Measurement receive antenna polarization: H (Horizontal), V (Vertical)



Transmitter Radiated Emissions (1GHz~10th Harmonic)			
Operating Mode	802.11ax 80MHz / Nss 1 MCS 0 / 1S4T CDD / Ant. 3 + Ant. 4 + Ant. 5 + Ant. 6 / CH106	Polarization	V

**802.11ax HEW80_Nss1,(MCS0)_4TX
5530MHz_TX**

08/06/2020

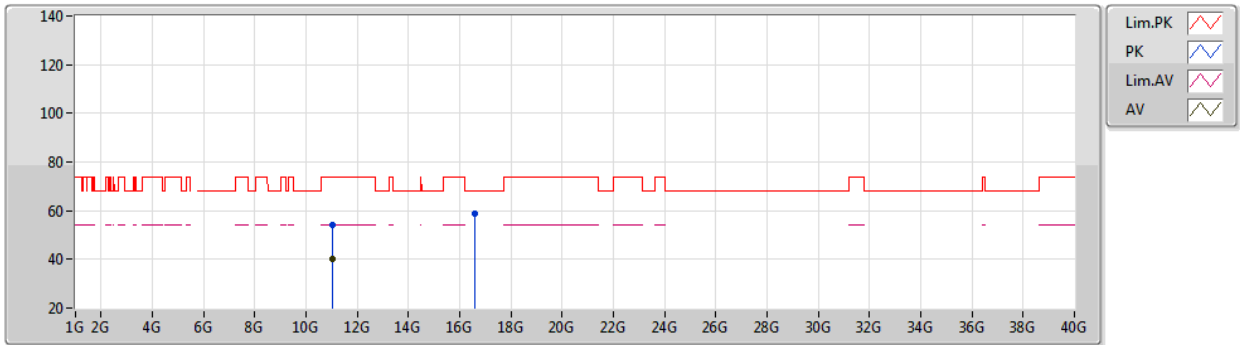

EUT Y_4TX
Setting 76
04-E-P-2

Type	Freq (Hz)	Level (dBuV/m)	Limit (dBuV/m)	Margin (dB)	Raw (dBuV)	Dist (m)	Condition	Azimuth (°)	Height (m)	Comment	AF (dB)	CL (dB)	PA (dB)
PK	11.0554G	54.38	74.00	-19.62	41.98	3	Vertical	336	1.80	-	39.37	7.90	34.87
AV	11.0441G	40.28	54.00	-13.72	27.87	3	Vertical	336	1.80	-	39.38	7.89	34.86
PK	16.59452G	58.78	68.20	-9.42	44.49	3	Vertical	235	1.80	-	39.91	9.87	35.49

Note 1: The amplitude of spurious emissions which are attenuated by more than 20 dB below the permissible value has no need to be reported.

Note 2: Measurement receive antenna polarization: H (Horizontal), V (Vertical)



Transmitter Radiated Emissions (1GHz~10th Harmonic)			
Operating Mode	802.11ax 80MHz / Nss 1 MCS 0 / 1S4T CDD / Ant. 3 + Ant. 4 + Ant. 5 + Ant. 6 / CH106	Polarization	H

802.11ax HEW80_Nss1,(MCS0)_4TX

08/06/2020

5530MHz_TX

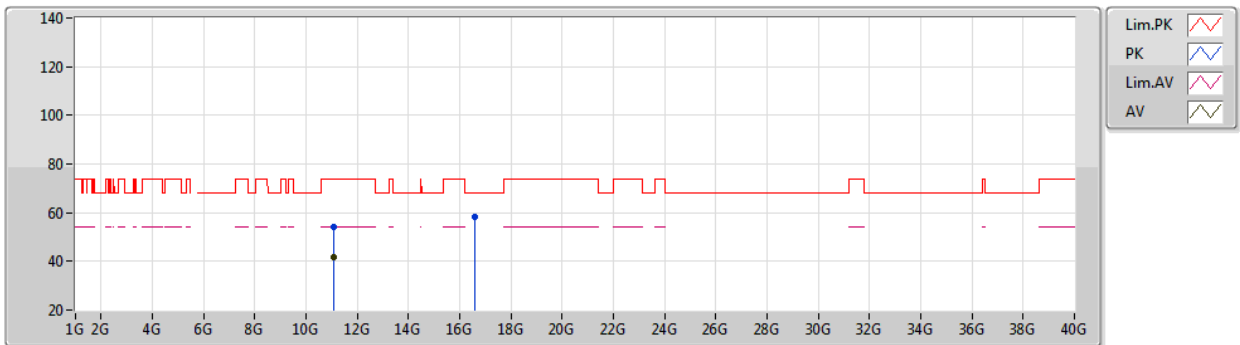

EUT Y_4TX
Setting 76
04-E-P-2

Type	Freq (Hz)	Level (dBuV/m)	Limit (dBuV/m)	Margin (dB)	Raw (dBuV)	Dist (m)	Condition	Azimuth (°)	Height (m)	Comment	AF (dB)	CL (dB)	PA (dB)
PK	11.0724G	54.37	74.00	-19.63	41.97	3	Horizontal	31	2.23	-	39.36	7.91	34.87
AV	11.0668G	41.48	54.00	-12.52	29.08	3	Horizontal	31	2.23	-	39.37	7.90	34.87
PK	16.58526G	58.53	68.20	-9.67	44.26	3	Horizontal	359	1.80	-	39.89	9.87	35.49

Note 1: The amplitude of spurious emissions which are attenuated by more than 20 dB below the permissible value has no need to be reported.

Note 2: Measurement receive antenna polarization: H (Horizontal), V (Vertical)



Transmitter Radiated Emissions (1GHz~10th Harmonic)			
Operating Mode	802.11ax 80MHz / Nss 1 MCS 0 / 1S4T CDD / Ant. 3 + Ant. 4 + Ant. 5 + Ant. 6 / CH122	Polarization	V

802.11ax HEW80_Nss1,(MCS0)_4TX
5610MHz_TX

08/06/2020

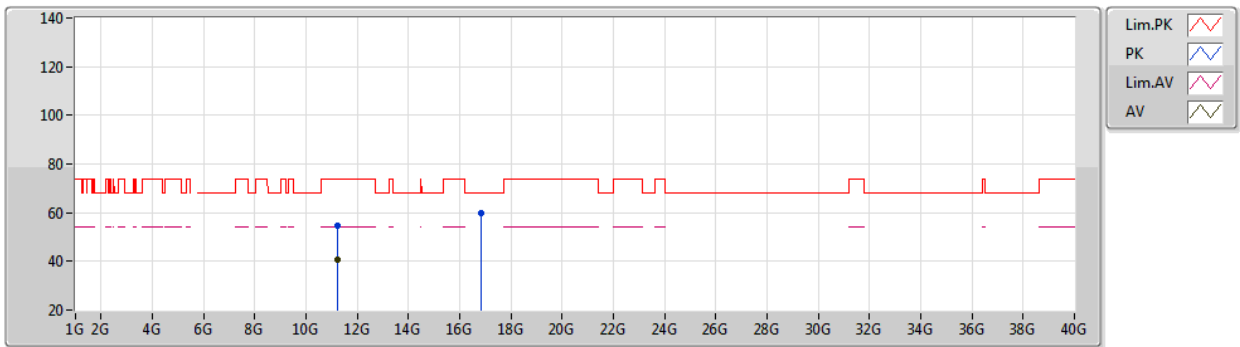

EUT Y_4TX
Setting 80
04-E-P-2

Type	Freq (Hz)	Level (dBuV/m)	Limit (dBuV/m)	Margin (dB)	Raw (dBuV)	Dist (m)	Condition	Azimuth (°)	Height (m)	Comment	AF (dB)	CL (dB)	PA (dB)
PK	11.21538G	54.67	74.00	-19.33	42.29	3	Vertical	306	1.00	-	39.29	8.00	34.91
AV	11.21996G	40.76	54.00	-13.24	28.38	3	Vertical	306	1.00	-	39.29	8.00	34.91
PK	16.8259G	59.65	68.20	-8.55	44.69	3	Vertical	102	1.80	-	40.42	10.05	35.51

Note 1: The amplitude of spurious emissions which are attenuated by more than 20 dB below the permissible value has no need to be reported.

Note 2: Measurement receive antenna polarization: H (Horizontal), V (Vertical)



Transmitter Radiated Emissions (1GHz~10th Harmonic)			
Operating Mode	802.11ax 80MHz / Nss 1 MCS 0 / 1S4T CDD / Ant. 3 + Ant. 4 + Ant. 5 + Ant. 6 / CH122	Polarization	H

802.11ax HEW80_Nss1,(MCS0)_4TX
5610MHz_TX

08/06/2020

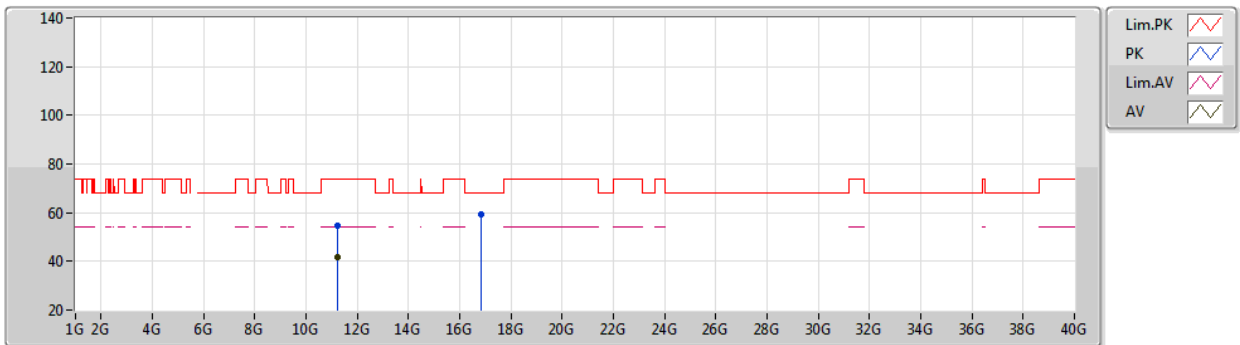

EUT Y_4TX
Setting 80
04-E-P-2

Type	Freq (Hz)	Level (dBuV/m)	Limit (dBuV/m)	Margin (dB)	Raw (dBuV)	Dist (m)	Condition	Azimuth (°)	Height (m)	Comment	AF (dB)	CL (dB)	PA (dB)
PK	11.22013G	54.67	74.00	-19.33	42.29	3	Horizontal	314	1.70	-	39.29	8.00	34.91
AV	11.21991G	41.94	54.00	-12.06	29.56	3	Horizontal	314	1.70	-	39.29	8.00	34.91
PK	16.82616G	59.23	68.20	-8.97	44.27	3	Horizontal	239	1.80	-	40.42	10.05	35.51

Note 1: The amplitude of spurious emissions which are attenuated by more than 20 dB below the permissible value has no need to be reported.

Note 2: Measurement receive antenna polarization: H (Horizontal), V (Vertical)



Transmitter Radiated Emissions (1GHz~10th Harmonic)			
Operating Mode	802.11ax 80MHz / Nss 1 MCS 0 / 1S4T CDD / Ant. 3 + Ant. 4 + Ant. 5 + Ant. 6 / CH138	Polarization	V

802.11ax HEW80_Nss1,(MCS0)_4TX
5690MHz Straddle 5.47-5.725GHz_TX

08/06/2020

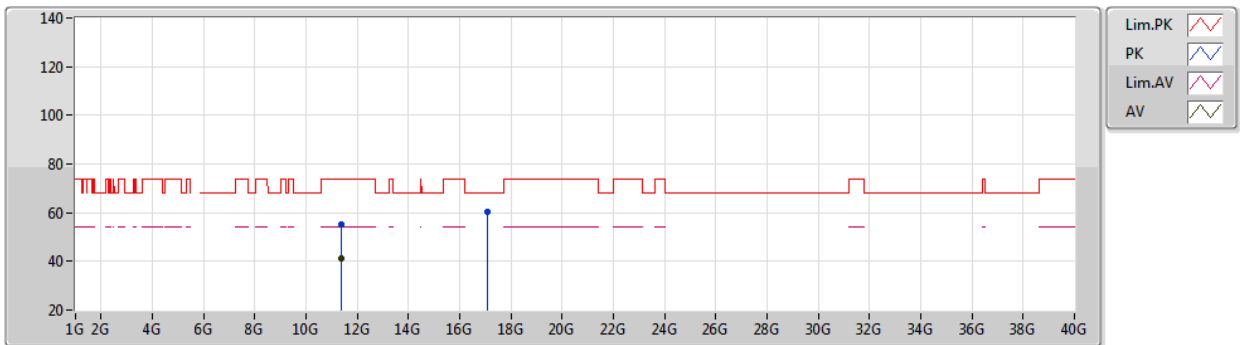

EUT Y_4TX
 Setting 80
 04-E-P-2

Type	Freq (Hz)	Level (dBuV/m)	Limit (dBuV/m)	Margin (dB)	Raw (dBuV)	Dist (m)	Condition	Azimuth (°)	Height (m)	Comment	AF (dB)	CL (dB)	PA (dB)
PK	11.38876G	55.04	74.00	-18.96	42.68	3	Vertical	276	3.00	-	39.21	8.11	34.96
AV	11.37988G	41.17	54.00	-12.83	28.81	3	Vertical	276	3.00	-	39.21	8.11	34.96
PK	17.07736G	60.54	68.20	-7.66	45.00	3	Vertical	47	2.38	-	40.87	10.17	35.50

Note 1: The amplitude of spurious emissions which are attenuated by more than 20 dB below the permissible value has no need to be reported.

Note 2: Measurement receive antenna polarization: H (Horizontal), V (Vertical)



Transmitter Radiated Emissions (1GHz~10th Harmonic)			
Operating Mode	802.11ax 80MHz / Nss 1 MCS 0 / 1S4T CDD / Ant. 3 + Ant. 4 + Ant. 5 + Ant. 6 / CH138	Polarization	H

802.11ax HEW80_Nss1,(MCS0)_4TX
5690MHz Straddle 5.47-5.725GHz_TX

08/06/2020

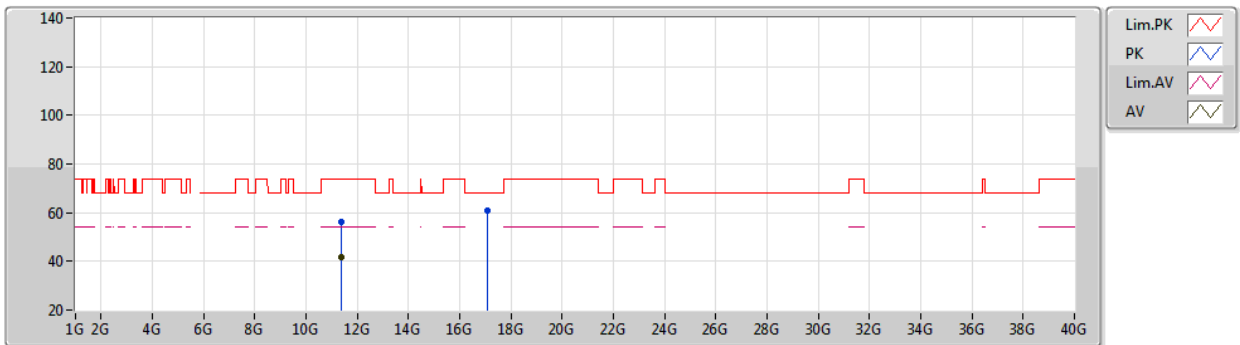

EUT Y_4TX
 Setting 80
 04-E-P-2

Type	Freq (Hz)	Level (dBuV/m)	Limit (dBuV/m)	Margin (dB)	Raw (dBuV)	Dist (m)	Condition	Azimuth (°)	Height (m)	Comment	AF (dB)	CL (dB)	PA (dB)
PK	11.38348G	56.41	74.00	-17.59	44.05	3	Horizontal	234	1.70	-	39.21	8.11	34.96
AV	11.38368G	41.79	54.00	-12.21	29.43	3	Horizontal	234	1.70	-	39.21	8.11	34.96
PK	17.0722G	60.84	68.20	-7.36	45.31	3	Horizontal	299	1.50	-	40.86	10.17	35.50

Note 1: The amplitude of spurious emissions which are attenuated by more than 20 dB below the permissible value has no need to be reported.

Note 2: Measurement receive antenna polarization: H (Horizontal), V (Vertical)



Transmitter Radiated Emissions (1GHz~10th Harmonic)			
Operating Mode	802.11ax 80MHz / Nss 1 MCS 0 / TXBF 1S2T / Ant. 1 + Ant. 2 / CH58	Polarization	V

802.11ax HEW80-BF_Nss1,(MCS0)_2TX
5290MHz_TX

08/06/2020

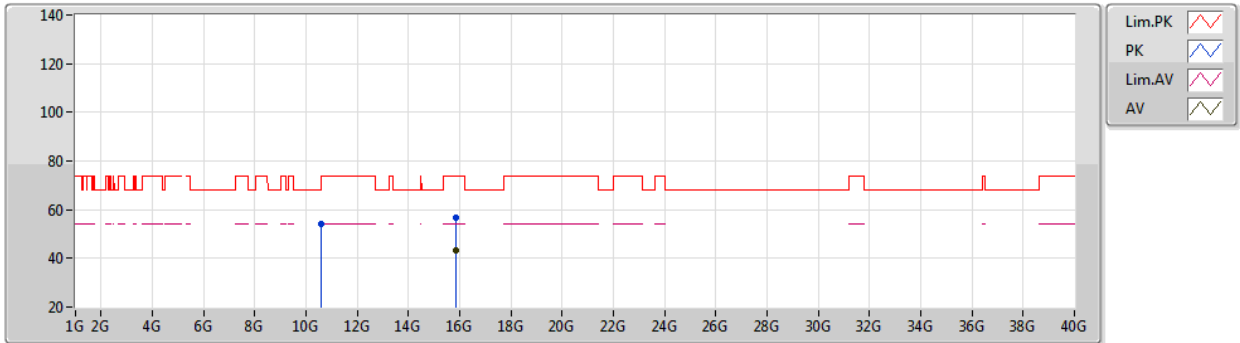

EUT Y_2TX
 Setting 77
 04-E-L-2

Type	Freq (Hz)	Level (dBuV/m)	Limit (dBuV/m)	Margin (dB)	Raw (dBuV)	Dist (m)	Condition	Azimuth (°)	Height (m)	Comment	AF (dB)	CL (dB)	PA (dB)
PK	10.5822G	54.17	68.20	-14.03	41.90	3	Vertical	162	2.97	-	39.07	7.66	34.46
PK	15.86518G	56.69	74.00	-17.31	43.96	3	Vertical	203	1.40	-	38.75	9.40	35.42
AV	15.8705G	43.13	54.00	-10.87	30.41	3	Vertical	203	1.40	-	38.74	9.40	35.42

Note 1: The amplitude of spurious emissions which are attenuated by more than 20 dB below the permissible value has no need to be reported.

Note 2: Measurement receive antenna polarization: H (Horizontal), V (Vertical)



Transmitter Radiated Emissions (1GHz~10th Harmonic)			
Operating Mode	802.11ax 80MHz / Nss 1 MCS 0 / TXBF 1S2T / Ant. 1 + Ant. 2 / CH58	Polarization	H

802.11ax HEW80-BF_Nss1,(MCS0)_2TX
5290MHz_TX

08/06/2020

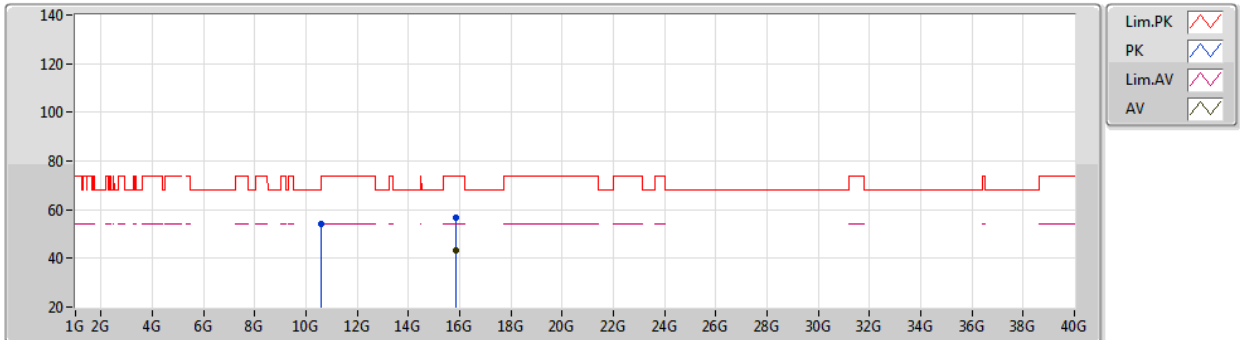

EUT Y_2TX
 Setting 77
 04-E-L-2

Type	Freq (Hz)	Level (dBuV/m)	Limit (dBuV/m)	Margin (dB)	Raw (dBuV)	Dist (m)	Condition	Azimuth (°)	Height (m)	Comment	AF (dB)	CL (dB)	PA (dB)
PK	10.58004G	53.95	68.20	-14.25	41.69	3	Horizontal	232	2.62	-	39.06	7.66	34.46
PK	15.87354G	56.59	74.00	-17.41	43.87	3	Horizontal	248	1.22	-	38.74	9.40	35.42
AV	15.86762G	43.14	54.00	-10.86	30.41	3	Horizontal	248	1.22	-	38.75	9.40	35.42

Note 1: The amplitude of spurious emissions which are attenuated by more than 20 dB below the permissible value has no need to be reported.

Note 2: Measurement receive antenna polarization: H (Horizontal), V (Vertical)



Transmitter Radiated Emissions (1GHz~10th Harmonic)			
Operating Mode	802.11ax 80MHz / Nss 1 MCS 0 / 1S4T TXBF / Ant. 3 + Ant. 4 + Ant. 5 + Ant. 6 / CH106	Polarization	V

**802.11ax HEW80-BF_Nss1,(MCS0)_4TX
5530MHz_TX**

08/06/2020

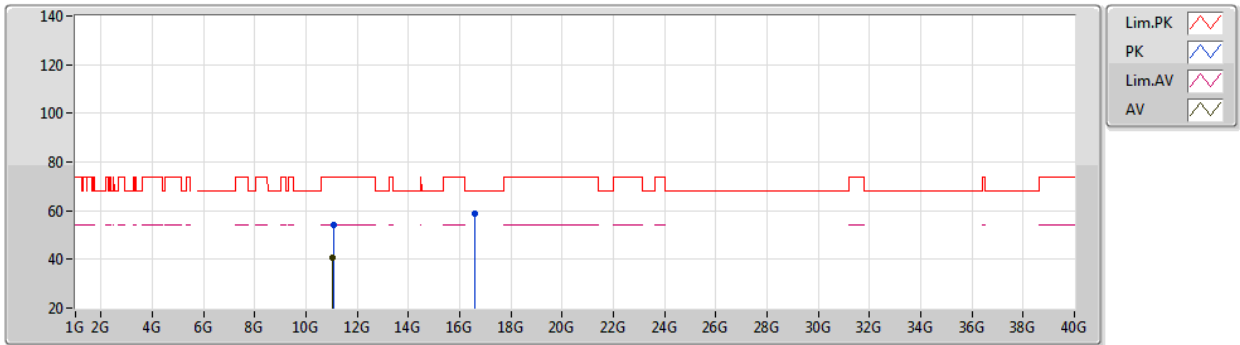

EUT Y_4TX
Setting 79
04-E-P-2

Type	Freq (Hz)	Level (dBuV/m)	Limit (dBuV/m)	Margin (dB)	Raw (dBuV)	Dist (m)	Condition	Azimuth (°)	Height (m)	Comment	AF (dB)	CL (dB)	PA (dB)
PK	11.05816G	54.30	74.00	-19.70	41.90	3	Vertical	61	2.27	-	39.37	7.90	34.87
AV	11.05696G	40.70	54.00	-13.30	28.30	3	Vertical	61	2.27	-	39.37	7.90	34.87
PK	16.59184G	58.74	68.20	-9.46	44.46	3	Vertical	190	1.47	-	39.90	9.87	35.49

Note 1: The amplitude of spurious emissions which are attenuated by more than 20 dB below the permissible value has no need to be reported.

Note 2: Measurement receive antenna polarization: H (Horizontal), V (Vertical)



Transmitter Radiated Emissions (1GHz~10th Harmonic)			
Operating Mode	802.11ax 80MHz / Nss 1 MCS 0 / 1S4T TXBF / Ant. 3 + Ant. 4 + Ant. 5 + Ant. 6 / CH106	Polarization	H

802.11ax HEW80-BF_Nss1,(MCS0)_4TX
5530MHz_TX

08/06/2020

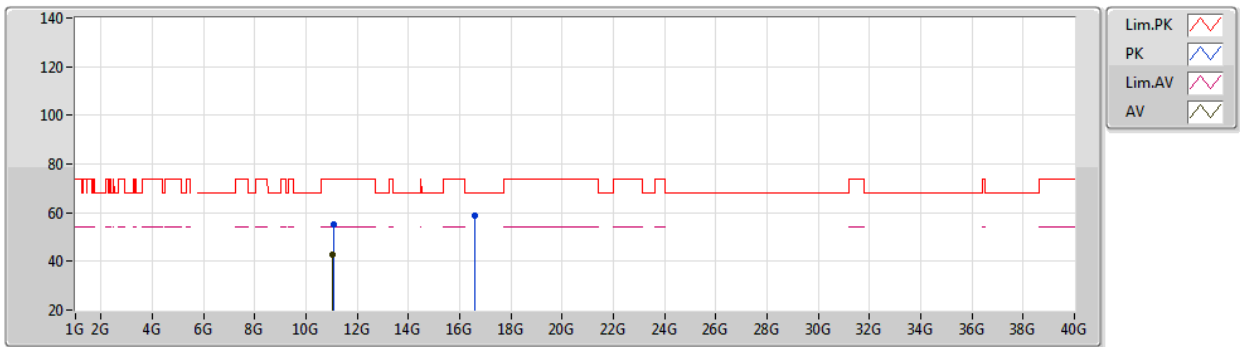

EUT Y_4TX
Setting 79
04-E-P-2

Type	Freq (Hz)	Level (dBuV/m)	Limit (dBuV/m)	Margin (dB)	Raw (dBuV)	Dist (m)	Condition	Azimuth (°)	Height (m)	Comment	AF (dB)	CL (dB)	PA (dB)
PK	11.0796G	55.24	74.00	-18.76	42.84	3	Horizontal	323	2.95	-	39.36	7.91	34.87
AV	11.01G	42.51	54.00	-11.49	30.10	3	Horizontal	323	2.95	-	39.39	7.87	34.85
PK	16.586G	58.87	68.20	-9.33	44.60	3	Horizontal	236	1.97	-	39.89	9.87	35.49

Note 1: The amplitude of spurious emissions which are attenuated by more than 20 dB below the permissible value has no need to be reported.

Note 2: Measurement receive antenna polarization: H (Horizontal), V (Vertical)



Transmitter Radiated Emissions (1GHz~10th Harmonic)			
Operating Mode	802.11ax 80MHz / Nss 1 MCS 0 / 1S4T TXBF / Ant. 3 + Ant. 4 + Ant. 5 + Ant. 6 / CH122	Polarization	V

**802.11ax HEW80-BF_Nss1,(MCS0)_4TX
5610MHz_TX**

08/06/2020

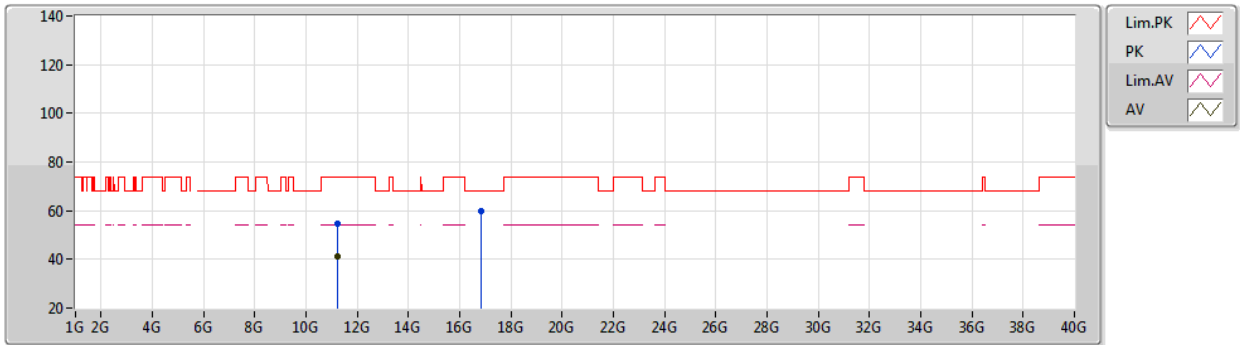

EUT Y_4TX
Setting 80
04-E-P-2

Type	Freq (Hz)	Level (dBuV/m)	Limit (dBuV/m)	Margin (dB)	Raw (dBuV)	Dist (m)	Condition	Azimuth (°)	Height (m)	Comment	AF (dB)	CL (dB)	PA (dB)
PK	11.22238G	54.76	74.00	-19.24	42.38	3	Vertical	136	1.07	-	39.29	8.00	34.91
AV	11.2205G	41.15	54.00	-12.85	28.77	3	Vertical	136	1.07	-	39.29	8.00	34.91
PK	16.8304G	59.99	68.20	-8.21	45.01	3	Vertical	115	2.47	-	40.43	10.06	35.51

Note 1: The amplitude of spurious emissions which are attenuated by more than 20 dB below the permissible value has no need to be reported.

Note 2: Measurement receive antenna polarization: H (Horizontal), V (Vertical)



Transmitter Radiated Emissions (1GHz~10th Harmonic)			
Operating Mode	802.11ax 80MHz / Nss 1 MCS 0 / 1S4T TXBF / Ant. 3 + Ant. 4 + Ant. 5 + Ant. 6 / CH122	Polarization	H

802.11ax HEW80-BF_Nss1,(MCS0)_4TX
5610MHz_TX

08/06/2020

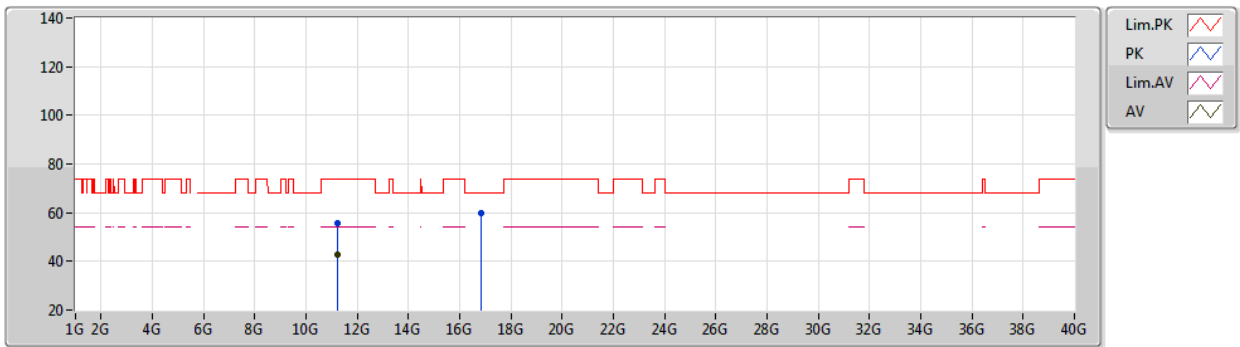

EUT Y_4TX
Setting 80
04-E-P-2

Type	Freq (Hz)	Level (dBuV/m)	Limit (dBuV/m)	Margin (dB)	Raw (dBuV)	Dist (m)	Condition	Azimuth (°)	Height (m)	Comment	AF (dB)	CL (dB)	PA (dB)
PK	11.2106G	55.86	74.00	-18.14	43.48	3	Horizontal	282	1.80	-	39.29	8.00	34.91
AV	11.2198G	42.62	54.00	-11.38	30.24	3	Horizontal	282	1.80	-	39.29	8.00	34.91
PK	16.82892G	59.92	68.20	-8.28	44.95	3	Horizontal	86	1.85	-	40.42	10.06	35.51

Note 1: The amplitude of spurious emissions which are attenuated by more than 20 dB below the permissible value has no need to be reported.

Note 2: Measurement receive antenna polarization: H (Horizontal), V (Vertical)



Transmitter Radiated Emissions (1GHz~10th Harmonic)			
Operating Mode	802.11ax 80MHz / Nss 1 MCS 0 / 1S4T TXBF / Ant. 3 + Ant. 4 + Ant. 5 + Ant. 6 / CH138	Polarization	V

802.11ax HEW80-BF_Nss1,(MCS0)_4TX
5690MHz Straddle 5.47-5.725GHz_TX

08/06/2020

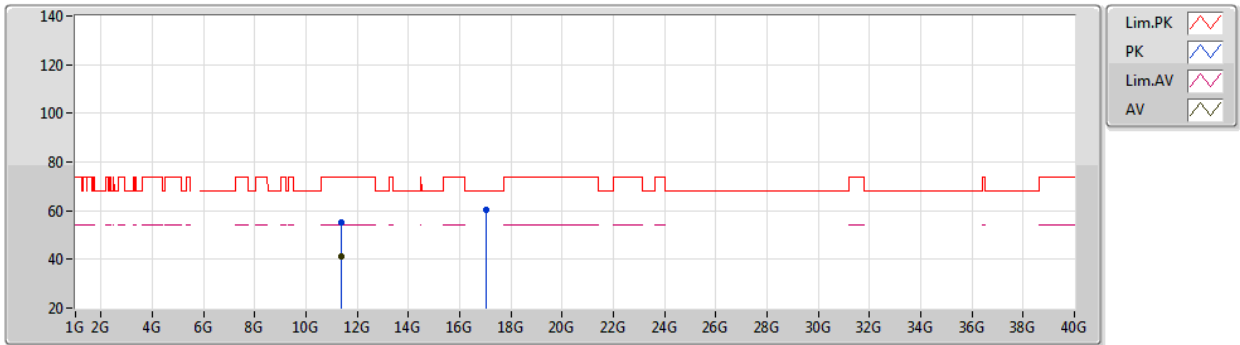

EUT Y_4TX
 Setting 80
 04-E-P-2

Type	Freq (Hz)	Level (dBuV/m)	Limit (dBuV/m)	Margin (dB)	Raw (dBuV)	Dist (m)	Condition	Azimuth (°)	Height (m)	Comment	AF (dB)	CL (dB)	PA (dB)
PK	11.38254G	54.93	74.00	-19.07	42.57	3	Vertical	69	2.91	-	39.21	8.11	34.96
AV	11.38428G	41.43	54.00	-12.57	29.07	3	Vertical	69	2.91	-	39.21	8.11	34.96
PK	17.0477G	60.57	68.20	-7.63	45.06	3	Vertical	22	2.46	-	40.84	10.18	35.51

Note 1: The amplitude of spurious emissions which are attenuated by more than 20 dB below the permissible value has no need to be reported.

Note 2: Measurement receive antenna polarization: H (Horizontal), V (Vertical)



Transmitter Radiated Emissions (1GHz~10th Harmonic)			
Operating Mode	802.11ax 80MHz / Nss 1 MCS 0 / 1S4T TXBF / Ant. 3 + Ant. 4 + Ant. 5 + Ant. 6 / CH138	Polarization	H

802.11ax HEW80-BF_Nss1,(MCS0)_4TX
5690MHz Straddle 5.47-5.725GHz_TX

08/06/2020

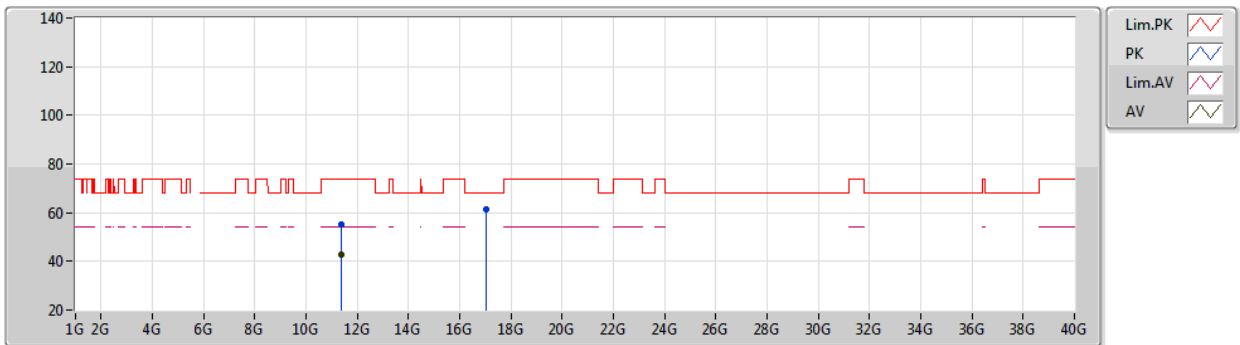

EUT Y_4TX
 Setting 80
 04-E-P-2

Type	Freq (Hz)	Level (dBuV/m)	Limit (dBuV/m)	Margin (dB)	Raw (dBuV)	Dist (m)	Condition	Azimuth (°)	Height (m)	Comment	AF (dB)	CL (dB)	PA (dB)
PK	11.37998G	54.96	74.00	-19.04	42.60	3	Horizontal	322	1.75	-	39.21	8.11	34.96
AV	11.37998G	42.55	54.00	-11.45	30.19	3	Horizontal	322	1.75	-	39.21	8.11	34.96
PK	17.0471G	61.53	68.20	-6.67	46.02	3	Horizontal	356	2.19	-	40.84	10.18	35.51

Note 1: The amplitude of spurious emissions which are attenuated by more than 20 dB below the permissible value has no need to be reported.

Note 2: Measurement receive antenna polarization: H (Horizontal), V (Vertical)



Transmitter Radiated Emissions (1GHz~10th Harmonic)			
Operating Mode	802.11ax 80MHz / Nss 2 MCS 0 / 2S4T TXBF / Ant. 3 + Ant. 4 + Ant. 5 + Ant. 6 / CH106	Polarization	V

802.11ax HEW80-BF_Nss2,(MCS0)_4TX
5530MHz_TX

08/06/2020

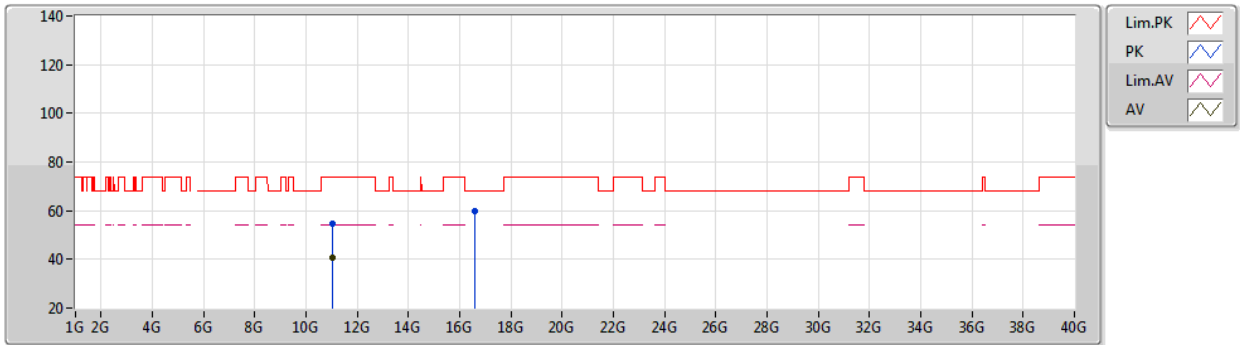

EUT Y_4TX
Setting 80
04-E-P-2

Type	Freq (Hz)	Level (dBuV/m)	Limit (dBuV/m)	Margin (dB)	Raw (dBuV)	Dist (m)	Condition	Azimuth (°)	Height (m)	Comment	AF (dB)	CL (dB)	PA (dB)
PK	11.0551G	54.73	74.00	-19.27	42.33	3	Vertical	261	2.02	-	39.37	7.90	34.87
AV	11.05532G	40.75	54.00	-13.25	28.35	3	Vertical	261	2.02	-	39.37	7.90	34.87
PK	16.59256G	60.03	68.20	-8.17	45.75	3	Vertical	297	1.27	-	39.90	9.87	35.49

Note 1: The amplitude of spurious emissions which are attenuated by more than 20 dB below the permissible value has no need to be reported.

Note 2: Measurement receive antenna polarization: H (Horizontal), V (Vertical)



Transmitter Radiated Emissions (1GHz~10th Harmonic)			
Operating Mode	802.11ax 80MHz / Nss 2 MCS 0 / 2S4T TXBF / Ant. 3 + Ant. 4 + Ant. 5 + Ant. 6 / CH106	Polarization	H

**802.11ax HEW80-BF_Nss2,(MCS0)_4TX
5530MHz_TX**

08/06/2020

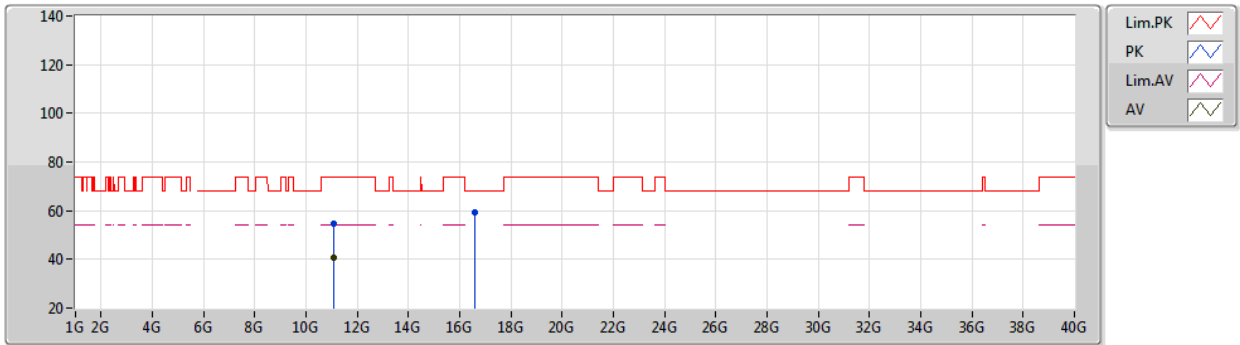

EUT Y_4TX
Setting 80
04-E-P-2

Type	Freq (Hz)	Level (dBuV/m)	Limit (dBuV/m)	Margin (dB)	Raw (dBuV)	Dist (m)	Condition	Azimuth (°)	Height (m)	Comment	AF (dB)	CL (dB)	PA (dB)
PK	11.05758G	54.72	74.00	-19.28	42.32	3	Horizontal	45	2.12	-	39.37	7.90	34.87
AV	11.06088G	40.65	54.00	-13.35	28.25	3	Horizontal	45	2.12	-	39.37	7.90	34.87
PK	16.58742G	59.35	68.20	-8.85	45.08	3	Horizontal	147	2.17	-	39.89	9.87	35.49

Note 1: The amplitude of spurious emissions which are attenuated by more than 20 dB below the permissible value has no need to be reported.

Note 2: Measurement receive antenna polarization: H (Horizontal), V (Vertical)



Transmitter Radiated Emissions (1GHz~10th Harmonic)			
Operating Mode	802.11ax 80MHz / Nss 2 MCS 0 / 2S4T TXBF / Ant. 3 + Ant. 4 + Ant. 5 + Ant. 6 / CH122	Polarization	V

802.11ax HEW80-BF_Nss2,(MCS0)_4TX
5610MHz_TX

08/06/2020

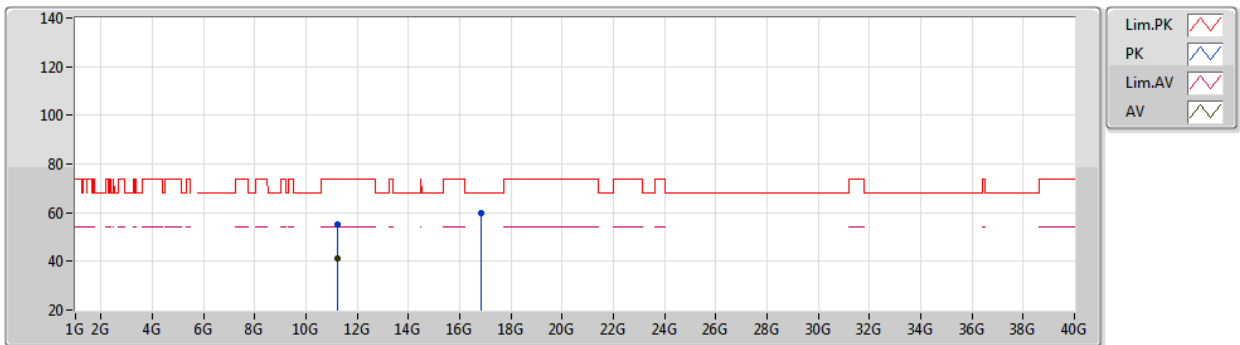

EUT Y_4TX
Setting 80
04-E-P-2

Type	Freq (Hz)	Level (dBuV/m)	Limit (dBuV/m)	Margin (dB)	Raw (dBuV)	Dist (m)	Condition	Azimuth (°)	Height (m)	Comment	AF (dB)	CL (dB)	PA (dB)
PK	11.21592G	55.18	74.00	-18.82	42.80	3	Vertical	83	1.89	-	39.29	8.00	34.91
AV	11.21982G	41.42	54.00	-12.58	29.04	3	Vertical	83	1.89	-	39.29	8.00	34.91
PK	16.83294G	59.64	68.20	-8.56	44.66	3	Vertical	29	1.43	-	40.43	10.06	35.51

Note 1: The amplitude of spurious emissions which are attenuated by more than 20 dB below the permissible value has no need to be reported.

Note 2: Measurement receive antenna polarization: H (Horizontal), V (Vertical)



Transmitter Radiated Emissions (1GHz~10th Harmonic)			
Operating Mode	802.11ax 80MHz / Nss 2 MCS 0 / 2S4T TXBF / Ant. 3 + Ant. 4 + Ant. 5 + Ant. 6 / CH122	Polarization	H

802.11ax HEW80-BF_Nss2,(MCS0)_4TX
5610MHz_TX

08/06/2020

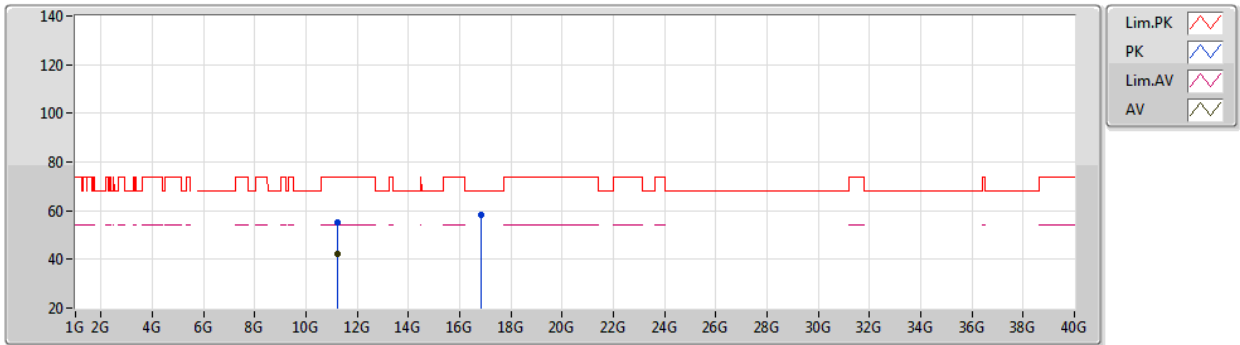

EUT Y_4TX
Setting 80
04-E-P-2

Type	Freq (Hz)	Level (dBuV/m)	Limit (dBuV/m)	Margin (dB)	Raw (dBuV)	Dist (m)	Condition	Azimuth (°)	Height (m)	Comment	AF (dB)	CL (dB)	PA (dB)
PK	11.22002G	55.36	74.00	-18.64	42.98	3	Horizontal	315	1.80	-	39.29	8.00	34.91
AV	11.2198G	42.38	54.00	-11.62	30.00	3	Horizontal	315	1.80	-	39.29	8.00	34.91
PK	16.83328G	58.52	68.20	-9.68	43.54	3	Horizontal	186	1.17	-	40.43	10.06	35.51

Note 1: The amplitude of spurious emissions which are attenuated by more than 20 dB below the permissible value has no need to be reported.

Note 2: Measurement receive antenna polarization: H (Horizontal), V (Vertical)



Transmitter Radiated Emissions (1GHz~10th Harmonic)			
Operating Mode	802.11ax 80MHz / Nss 2 MCS 0 / 2S4T TXBF / Ant. 3 + Ant. 4 + Ant. 5 + Ant. 6 / CH138	Polarization	V

802.11ax HEW80-BF_Nss2,(MCS0)_4TX
5690MHz Straddle 5.47-5.725GHz_TX

08/06/2020

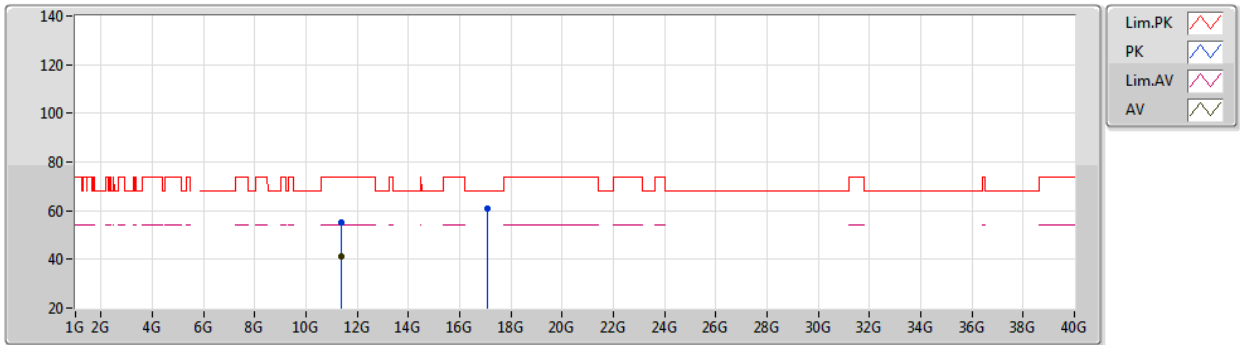

EUT Y_4TX
 Setting 80
 04-E-P-2

Type	Freq (Hz)	Level (dBuV/m)	Limit (dBuV/m)	Margin (dB)	Raw (dBuV)	Dist (m)	Condition	Azimuth (°)	Height (m)	Comment	AF (dB)	CL (dB)	PA (dB)
PK	11.38278G	55.29	74.00	-18.71	42.93	3	Vertical	47	1.15	-	39.21	8.11	34.96
AV	11.38406G	41.21	54.00	-12.79	28.85	3	Vertical	47	1.15	-	39.21	8.11	34.96
PK	17.06628G	61.00	68.20	-7.20	45.47	3	Vertical	272	1.37	-	40.86	10.17	35.50

Note 1: The amplitude of spurious emissions which are attenuated by more than 20 dB below the permissible value has no need to be reported.

Note 2: Measurement receive antenna polarization: H (Horizontal), V (Vertical)



Transmitter Radiated Emissions (1GHz~10th Harmonic)			
Operating Mode	802.11ax 80MHz / Nss 2 MCS 0 / 2S4T TXBF / Ant. 3 + Ant. 4 + Ant. 5 + Ant. 6 / CH138	Polarization	H

802.11ax HEW80-BF_Nss2,(MCS0)_4TX
5690MHz Straddle 5.47-5.725GHz_TX

08/06/2020

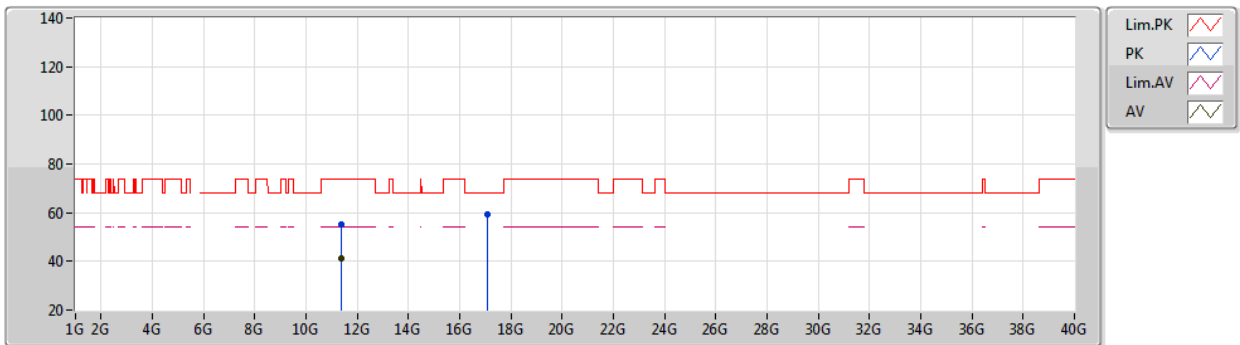

EUT Y_4TX
 Setting 80
 04-E-P-2

Type	Freq (Hz)	Level (dBuV/m)	Limit (dBuV/m)	Margin (dB)	Raw (dBuV)	Dist (m)	Condition	Azimuth (°)	Height (m)	Comment	AF (dB)	CL (dB)	PA (dB)
PK	11.3811G	55.24	74.00	-18.76	42.88	3	Horizontal	95	2.48	-	39.21	8.11	34.96
AV	11.37658G	41.01	54.00	-12.99	28.66	3	Horizontal	95	2.48	-	39.21	8.10	34.96
PK	17.07118G	59.42	68.20	-8.78	43.89	3	Horizontal	210	1.53	-	40.86	10.17	35.50

Note 1: The amplitude of spurious emissions which are attenuated by more than 20 dB below the permissible value has no need to be reported.

Note 2: Measurement receive antenna polarization: H (Horizontal), V (Vertical)



Transmitter Radiated Emissions (1GHz~10th Harmonic)			
Operating Mode	802.11ax 80MHz / Nss 3 MCS 0 / 3S4T TXBF / Ant. 3 + Ant. 4 + Ant. 5 + Ant. 6 / CH106	Polarization	V

**802.11ax HEW80-BF_Nss3,(MCS0)_4TX
5530MHz_TX**

08/06/2020

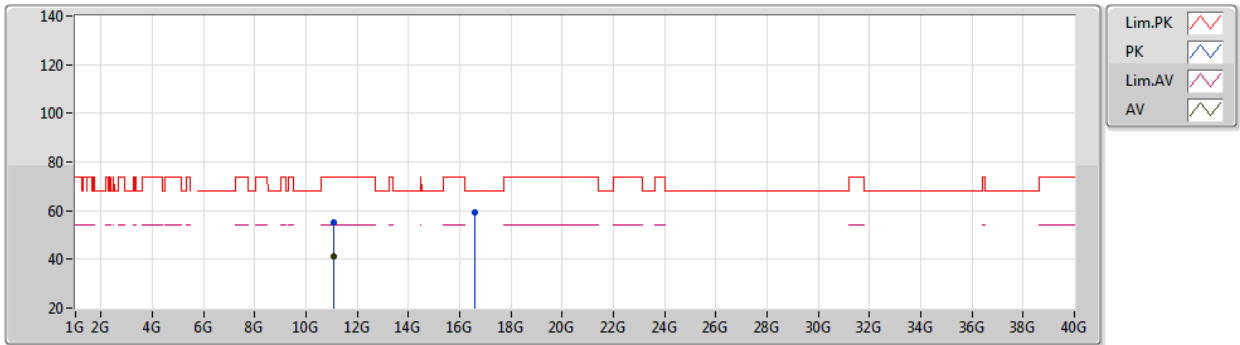

EUT Y_4TX
Setting 76
04-E-P-2

Type	Freq (Hz)	Level (dBuV/m)	Limit (dBuV/m)	Margin (dB)	Raw (dBuV)	Dist (m)	Condition	Azimuth (°)	Height (m)	Comment	AF (dB)	CL (dB)	PA (dB)
PK	11.05828G	55.22	74.00	-18.78	42.82	3	Vertical	252	2.01	-	39.37	7.90	34.87
AV	11.06152G	41.29	54.00	-12.71	28.89	3	Vertical	252	2.01	-	39.37	7.90	34.87
PK	16.58558G	59.40	68.20	-8.80	45.13	3	Vertical	213	1.80	-	39.89	9.87	35.49

Note 1: The amplitude of spurious emissions which are attenuated by more than 20 dB below the permissible value has no need to be reported.

Note 2: Measurement receive antenna polarization: H (Horizontal), V (Vertical)



Transmitter Radiated Emissions (1GHz~10th Harmonic)			
Operating Mode	802.11ax 80MHz / Nss 3 MCS 0 / 3S4T TXBF / Ant. 3 + Ant. 4 + Ant. 5 + Ant. 6 / CH106	Polarization	H

802.11ax HEW80-BF_Nss3,(MCS0)_4TX
5530MHz_TX

08/06/2020

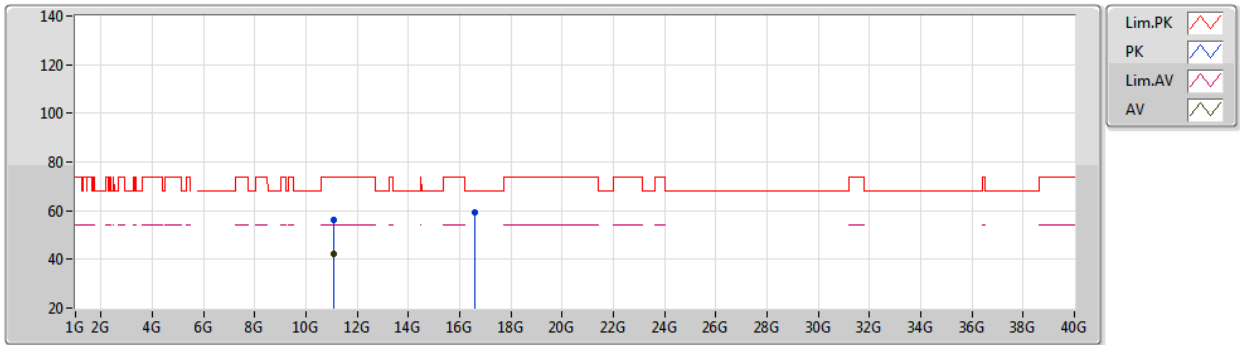

EUT Y_4TX
Setting 76
04-E-P-2

Type	Freq (Hz)	Level (dBuV/m)	Limit (dBuV/m)	Margin (dB)	Raw (dBuV)	Dist (m)	Condition	Azimuth (°)	Height (m)	Comment	AF (dB)	CL (dB)	PA (dB)
PK	11.0894G	56.06	74.00	-17.94	43.66	3	Horizontal	348	1.59	-	39.36	7.92	34.88
AV	11.0598G	42.38	54.00	-11.62	29.98	3	Horizontal	348	1.59	-	39.37	7.90	34.87
PK	16.5886G	59.42	68.20	-8.78	45.15	3	Horizontal	117	1.80	-	39.89	9.87	35.49

Note 1: The amplitude of spurious emissions which are attenuated by more than 20 dB below the permissible value has no need to be reported.

Note 2: Measurement receive antenna polarization: H (Horizontal), V (Vertical)



Transmitter Radiated Emissions (1GHz~10th Harmonic)			
Operating Mode	802.11ax 80MHz / Nss 3 MCS 0 / 3S4T TXBF / Ant. 3 + Ant. 4 + Ant. 5 + Ant. 6 / CH122	Polarization	V

802.11ax HEW80-BF_Nss3,(MCS0)_4TX
5610MHz_TX

08/06/2020

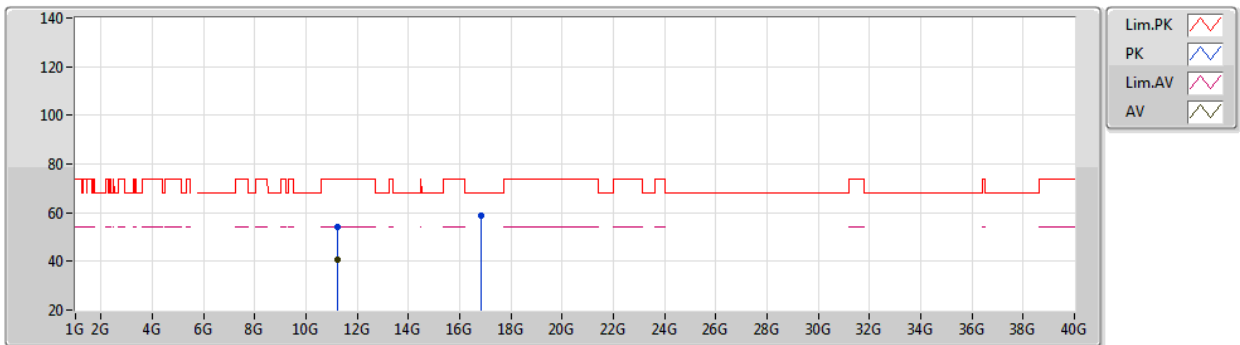

EUT Y_4TX
Setting 80
04-E-P-2

Type	Freq (Hz)	Level (dBuV/m)	Limit (dBuV/m)	Margin (dB)	Raw (dBuV)	Dist (m)	Condition	Azimuth (°)	Height (m)	Comment	AF (dB)	CL (dB)	PA (dB)
PK	11.21804G	54.36	74.00	-19.64	41.98	3	Vertical	256	2.87	-	39.29	8.00	34.91
AV	11.21994G	40.58	54.00	-13.42	28.20	3	Vertical	256	2.87	-	39.29	8.00	34.91
PK	16.83266G	58.74	68.20	-9.46	43.76	3	Vertical	333	1.80	-	40.43	10.06	35.51

Note 1: The amplitude of spurious emissions which are attenuated by more than 20 dB below the permissible value has no need to be reported.

Note 2: Measurement receive antenna polarization: H (Horizontal), V (Vertical)



Transmitter Radiated Emissions (1GHz~10th Harmonic)			
Operating Mode	802.11ax 80MHz / Nss 3 MCS 0 / 3S4T TXBF / Ant. 3 + Ant. 4 + Ant. 5 + Ant. 6 / CH122	Polarization	H

802.11ax HEW80-BF_Nss3,(MCS0)_4TX
5610MHz_TX

08/06/2020

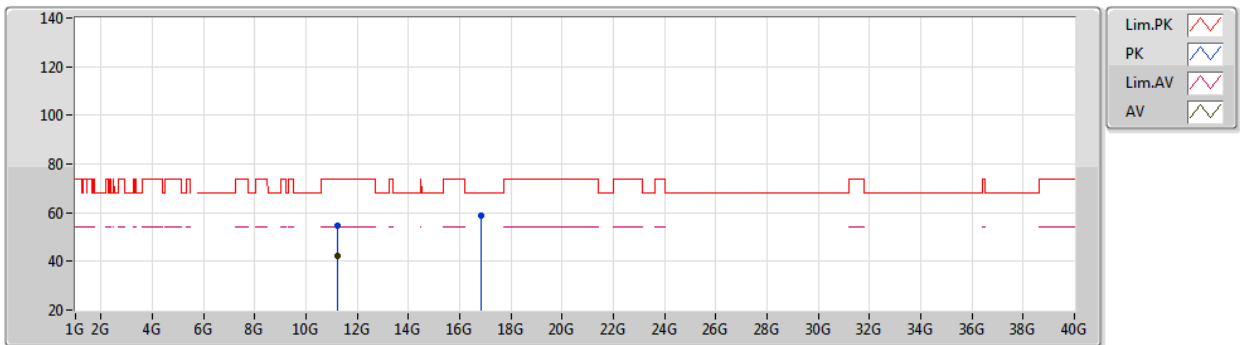

EUT Y_4TX
Setting 80
04-E-P-2

Type	Freq (Hz)	Level (dBuV/m)	Limit (dBuV/m)	Margin (dB)	Raw (dBuV)	Dist (m)	Condition	Azimuth (°)	Height (m)	Comment	AF (dB)	CL (dB)	PA (dB)
PK	11.21626G	54.45	74.00	-19.55	42.07	3	Horizontal	321	1.80	-	39.29	8.00	34.91
AV	11.2199G	42.42	54.00	-11.58	30.04	3	Horizontal	321	1.80	-	39.29	8.00	34.91
PK	16.82742G	58.73	68.20	-9.47	43.76	3	Horizontal	335	1.80	-	40.42	10.06	35.51

Note 1: The amplitude of spurious emissions which are attenuated by more than 20 dB below the permissible value has no need to be reported.

Note 2: Measurement receive antenna polarization: H (Horizontal), V (Vertical)



Transmitter Radiated Emissions (1GHz~10th Harmonic)			
Operating Mode	802.11ax 80MHz / Nss 3 MCS 0 / 3S4T TXBF / Ant. 3 + Ant. 4 + Ant. 5 + Ant. 6 / CH138	Polarization	V

802.11ax HEW80-BF_Nss3,(MCS0)_4TX
5690MHz Straddle 5.47-5.725GHz_TX

08/06/2020

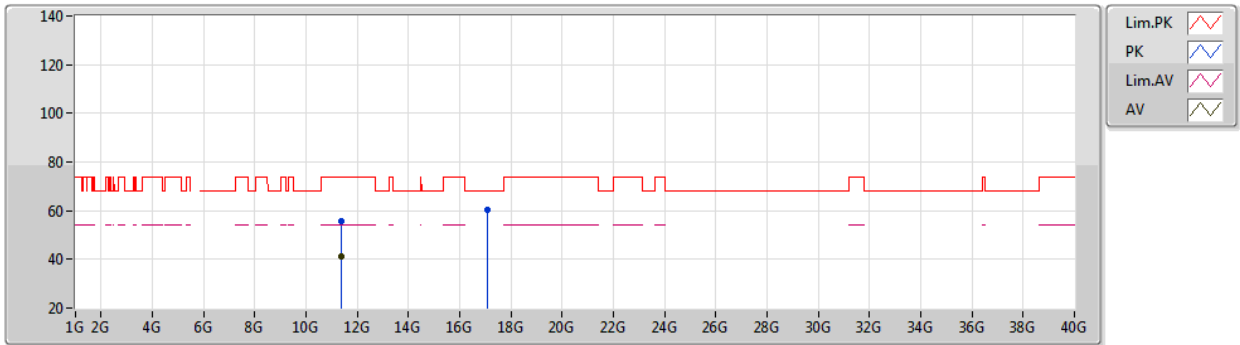

EUT Y_4TX
 Setting 80
 04-E-P-2

Type	Freq (Hz)	Level (dBuV/m)	Limit (dBuV/m)	Margin (dB)	Raw (dBuV)	Dist (m)	Condition	Azimuth (°)	Height (m)	Comment	AF (dB)	CL (dB)	PA (dB)
PK	11.4008G	55.48	74.00	-18.52	43.13	3	Vertical	314	1.74	-	39.20	8.12	34.97
AV	11.3945G	41.07	54.00	-12.93	28.71	3	Vertical	314	1.74	-	39.20	8.12	34.96
PK	17.07298G	60.53	68.20	-7.67	44.99	3	Vertical	360	2.99	-	40.87	10.17	35.50

Note 1: The amplitude of spurious emissions which are attenuated by more than 20 dB below the permissible value has no need to be reported.

Note 2: Measurement receive antenna polarization: H (Horizontal), V (Vertical)



Transmitter Radiated Emissions (1GHz~10th Harmonic)			
Operating Mode	802.11ax 80MHz / Nss 3 MCS 0 / 3S4T TXBF / Ant. 3 + Ant. 4 + Ant. 5 + Ant. 6 / CH138	Polarization	H

802.11ax HEW80-BF_Nss3,(MCS0)_4TX
5690MHz Straddle 5.47-5.725GHz_TX

08/06/2020

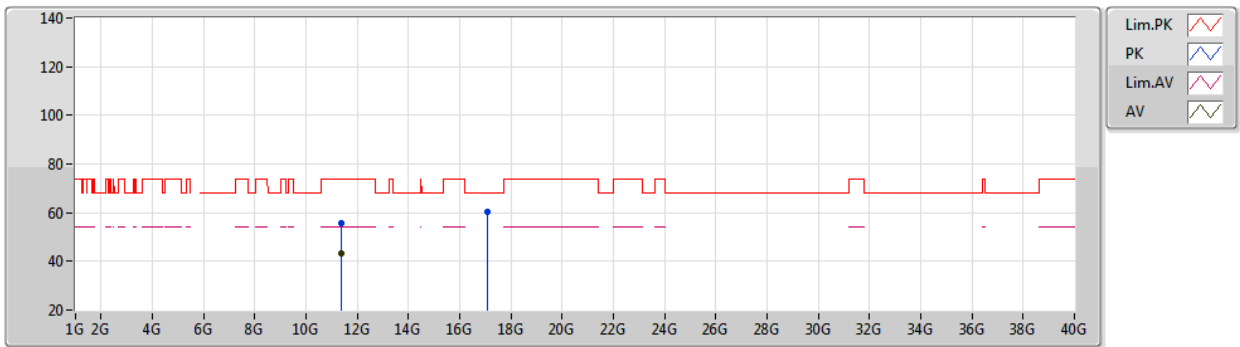

EUT Y_4TX
 Setting 80
 04-E-P-2

Type	Freq (Hz)	Level (dBuV/m)	Limit (dBuV/m)	Margin (dB)	Raw (dBuV)	Dist (m)	Condition	Azimuth (°)	Height (m)	Comment	AF (dB)	CL (dB)	PA (dB)
PK	11.3798G	55.50	74.00	-18.50	43.14	3	Horizontal	317	1.66	-	39.21	8.11	34.96
AV	11.3798G	43.30	54.00	-10.70	30.94	3	Horizontal	317	1.66	-	39.21	8.11	34.96
PK	17.06556G	60.45	68.20	-7.75	44.92	3	Horizontal	338	1.80	-	40.86	10.17	35.50

Note 1: The amplitude of spurious emissions which are attenuated by more than 20 dB below the permissible value has no need to be reported.

Note 2: Measurement receive antenna polarization: H (Horizontal), V (Vertical)



Transmitter Radiated Emissions (1GHz~10th Harmonic)			
Operating Mode	802.11ax 160MHz / Nss 1 MCS 0 / 1S4T CDD / Ant. 3 + Ant. 4 + Ant. 5 + Ant. 6 / CH114	Polarization	V

**802.11ax HEW160_Nss1,(MCS0)_4TX
5570MHz_TX**

08/06/2020

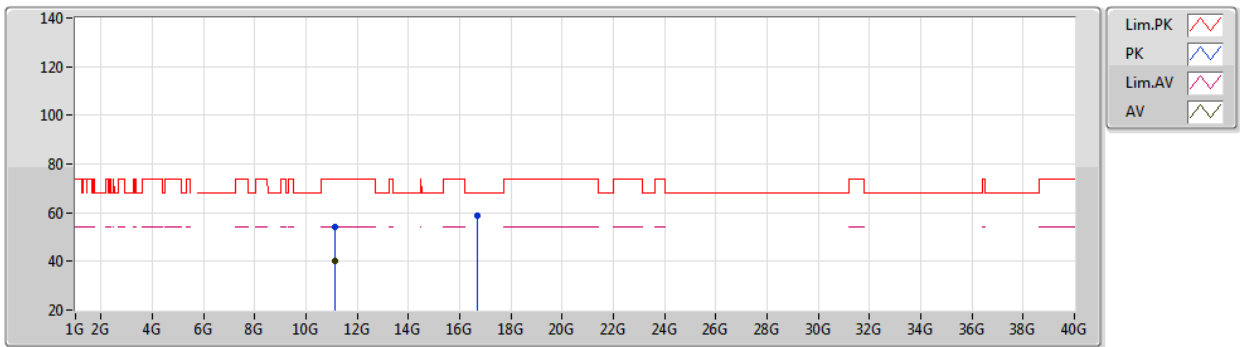

EUT Y_4TX
Setting 76
04-K-P-2

Type	Freq (Hz)	Level (dBuV/m)	Limit (dBuV/m)	Margin (dB)	Raw (dBuV)	Dist (m)	Condition	Azimuth (°)	Height (m)	Comment	AF (dB)	CL (dB)	PA (dB)
PK	11.14452G	54.26	74.00	-19.74	41.87	3	Vertical	53	1.80	-	39.33	7.95	34.89
AV	11.1438G	40.41	54.00	-13.59	28.02	3	Vertical	53	1.80	-	39.33	7.95	34.89
PK	16.71168G	58.64	68.20	-9.56	44.00	3	Vertical	227	1.80	-	40.17	9.97	35.50

Note 1: The amplitude of spurious emissions which are attenuated by more than 20 dB below the permissible value has no need to be reported.

Note 2: Measurement receive antenna polarization: H (Horizontal), V (Vertical)



Transmitter Radiated Emissions (1GHz~10th Harmonic)			
Operating Mode	802.11ax 160MHz / Nss 1 MCS 0 / 1S4T CDD / Ant. 3 + Ant. 4 + Ant. 5 + Ant. 6 / CH114	Polarization	H

**802.11ax HEW160_Nss1,(MCS0)_4TX
5570MHz_TX**

08/06/2020

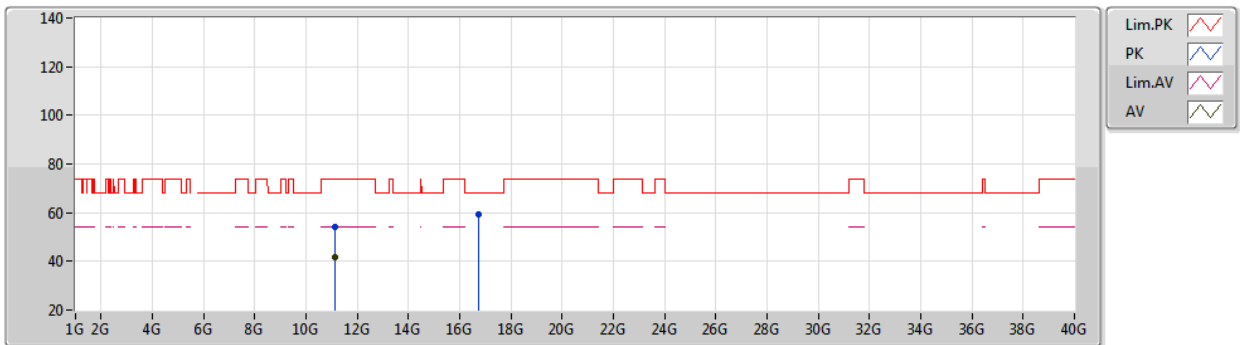

EUT Y_4TX
Setting 76
04-K-P-2

Type	Freq (Hz)	Level (dBuV/m)	Limit (dBuV/m)	Margin (dB)	Raw (dBuV)	Dist (m)	Condition	Azimuth (°)	Height (m)	Comment	AF (dB)	CL (dB)	PA (dB)
PK	11.13492G	54.09	74.00	-19.91	41.70	3	Horizontal	317	1.71	-	39.33	7.95	34.89
AV	11.13992G	41.50	54.00	-12.50	29.11	3	Horizontal	317	1.71	-	39.33	7.95	34.89
PK	16.7198G	59.22	68.20	-8.98	44.57	3	Horizontal	25	2.02	-	40.18	9.97	35.50

Note 1: The amplitude of spurious emissions which are attenuated by more than 20 dB below the permissible value has no need to be reported.

Note 2: Measurement receive antenna polarization: H (Horizontal), V (Vertical)



Transmitter Radiated Emissions (1GHz~10th Harmonic)			
Operating Mode	802.11ax 160MHz / Nss 1 MCS 0 / 1S4T TXBF / Ant. 3 + Ant. 4 + Ant. 5 + Ant. 6 / CH114	Polarization	V

802.11ax HEW160-BF_Nss1,(MCS0)_4TX
5570MHz_TX

08/06/2020

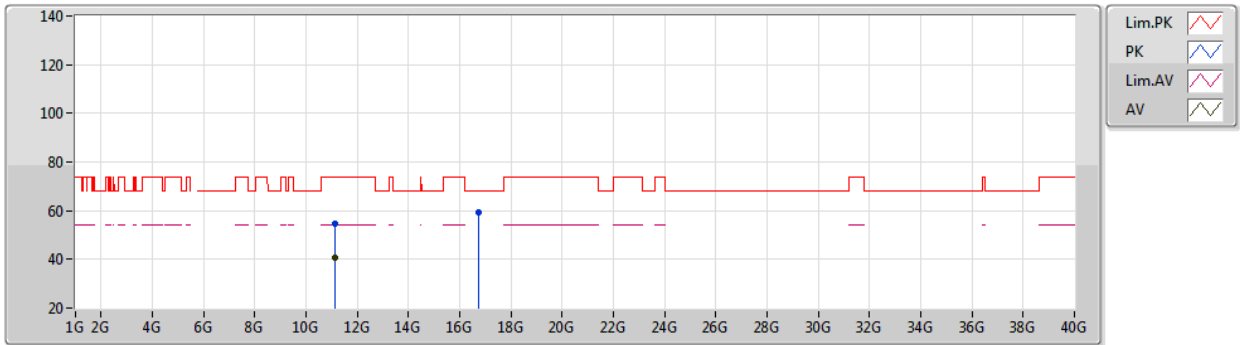

EUT Y_4TX
 Setting 77
 04-E-P-2

Type	Freq (Hz)	Level (dBuV/m)	Limit (dBuV/m)	Margin (dB)	Raw (dBuV)	Dist (m)	Condition	Azimuth (°)	Height (m)	Comment	AF (dB)	CL (dB)	PA (dB)
PK	11.14046G	54.66	74.00	-19.34	42.27	3	Vertical	319	2.27	-	39.33	7.95	34.89
AV	11.13902G	40.94	54.00	-13.06	28.55	3	Vertical	319	2.27	-	39.33	7.95	34.89
PK	16.71338G	59.14	68.20	-9.06	44.50	3	Vertical	302	1.68	-	40.17	9.97	35.50

Note 1: The amplitude of spurious emissions which are attenuated by more than 20 dB below the permissible value has no need to be reported.

Note 2: Measurement receive antenna polarization: H (Horizontal), V (Vertical)



Transmitter Radiated Emissions (1GHz~10th Harmonic)			
Operating Mode	802.11ax 160MHz / Nss 1 MCS 0 / 1S4T TXBF / Ant. 3 + Ant. 4 + Ant. 5 + Ant. 6 / CH114	Polarization	H

**802.11ax HEW160-BF_Nss1,(MCS0)_4TX
5570MHz_TX**

08/06/2020

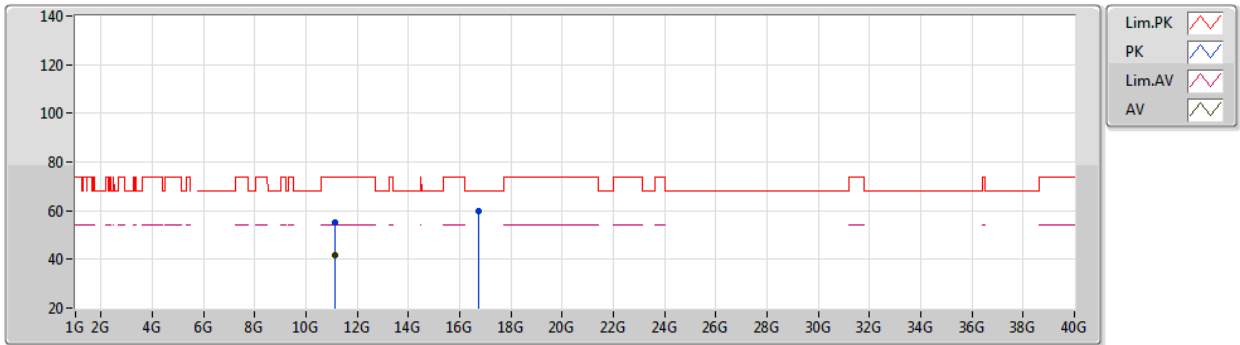

EUT Y_4TX
Setting 77
04-E-P-2

Type	Freq (Hz)	Level (dBuV/m)	Limit (dBuV/m)	Margin (dB)	Raw (dBuV)	Dist (m)	Condition	Azimuth (°)	Height (m)	Comment	AF (dB)	CL (dB)	PA (dB)
PK	11.13676G	55.07	74.00	-18.93	42.68	3	Horizontal	282	1.79	-	39.33	7.95	34.89
AV	11.13774G	41.92	54.00	-12.08	29.53	3	Horizontal	282	1.79	-	39.33	7.95	34.89
PK	16.71366G	59.83	68.20	-8.37	45.19	3	Horizontal	115	1.80	-	40.17	9.97	35.50

Note 1: The amplitude of spurious emissions which are attenuated by more than 20 dB below the permissible value has no need to be reported.

Note 2: Measurement receive antenna polarization: H (Horizontal), V (Vertical)



Transmitter Radiated Emissions (1GHz~10th Harmonic)			
Operating Mode	802.11ax 160MHz / Nss 2 MCS 0 / 2S4T TXBF / Ant. 3 + Ant. 4 + Ant. 5 + Ant. 6 / CH114	Polarization	V

**802.11ax HEW160-BF_Nss2,(MCS0)_4TX
5570MHz_TX**

08/06/2020

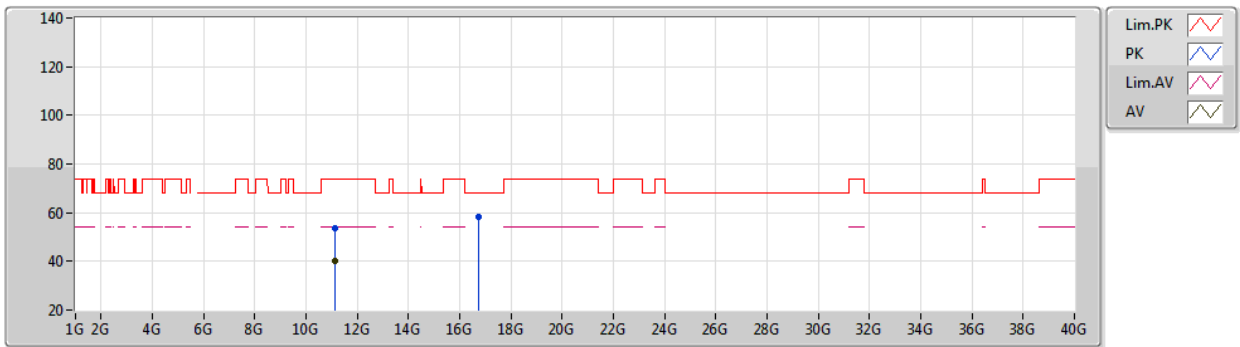

EUT Y_4TX
Setting
04-E-P-2

Type	Freq (Hz)	Level (dBuV/m)	Limit (dBuV/m)	Margin (dB)	Raw (dBuV)	Dist (m)	Condition	Azimuth (°)	Height (m)	Comment	AF (dB)	CL (dB)	PA (dB)
PK	11.14468G	53.41	74.00	-20.59	41.02	3	Vertical	178	1.51	-	39.33	7.95	34.89
AV	11.13636G	40.12	54.00	-13.88	27.73	3	Vertical	178	1.51	-	39.33	7.95	34.89
PK	16.72392G	58.31	68.20	-9.89	43.65	3	Vertical	5	1.80	-	40.19	9.97	35.50

Note 1: The amplitude of spurious emissions which are attenuated by more than 20 dB below the permissible value has no need to be reported.

Note 2: Measurement receive antenna polarization: H (Horizontal), V (Vertical)



Transmitter Radiated Emissions (1GHz~10th Harmonic)			
Operating Mode	802.11ax 160MHz / Nss 2 MCS 0 / 2S4T TXBF / Ant. 3 + Ant. 4 + Ant. 5 + Ant. 6 / CH114	Polarization	H

802.11ax HEW160-BF_Nss2,(MCS0)_4TX
5570MHz_TX

08/06/2020

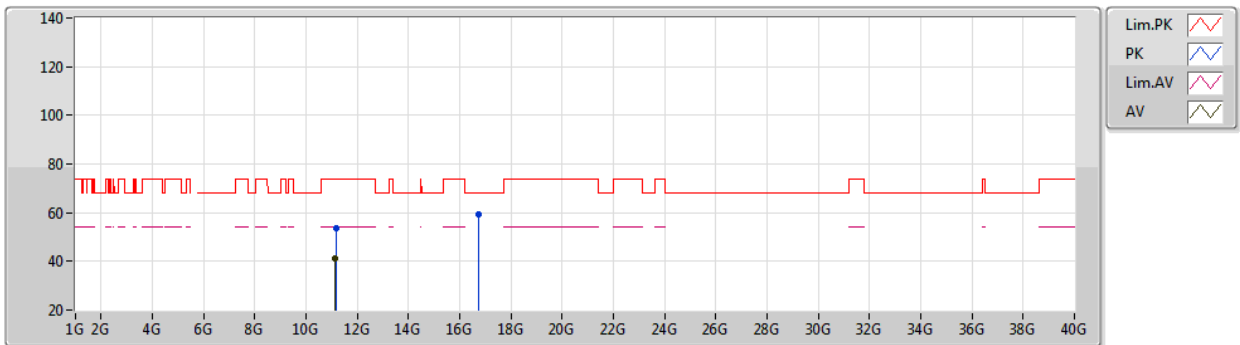

EUT Y_4TX
 Setting
 04-E-P-2

Type	Freq (Hz)	Level (dBuV/m)	Limit (dBuV/m)	Margin (dB)	Raw (dBuV)	Dist (m)	Condition	Azimuth (°)	Height (m)	Comment	AF (dB)	CL (dB)	PA (dB)
PK	11.1567G	53.87	74.00	-20.13	41.49	3	Horizontal	295	1.78	-	39.32	7.96	34.90
AV	11.1401G	41.13	54.00	-12.87	28.74	3	Horizontal	295	1.78	-	39.33	7.95	34.89
PK	16.71922G	59.11	68.20	-9.09	44.46	3	Horizontal	242	1.76	-	40.18	9.97	35.50

Note 1: The amplitude of spurious emissions which are attenuated by more than 20 dB below the permissible value has no need to be reported.

Note 2: Measurement receive antenna polarization: H (Horizontal), V (Vertical)



Transmitter Radiated Emissions (1GHz~10th Harmonic)			
Operating Mode	802.11ax 160MHz / Nss 3 MCS 0 / 3S4T TXBF / Ant. 3 + Ant. 4 + Ant. 5 + Ant. 6 / CH114	Polarization	V

802.11ax HEW160-BF_Nss3,(MCS0)_4TX
5570MHz_TX

08/06/2020

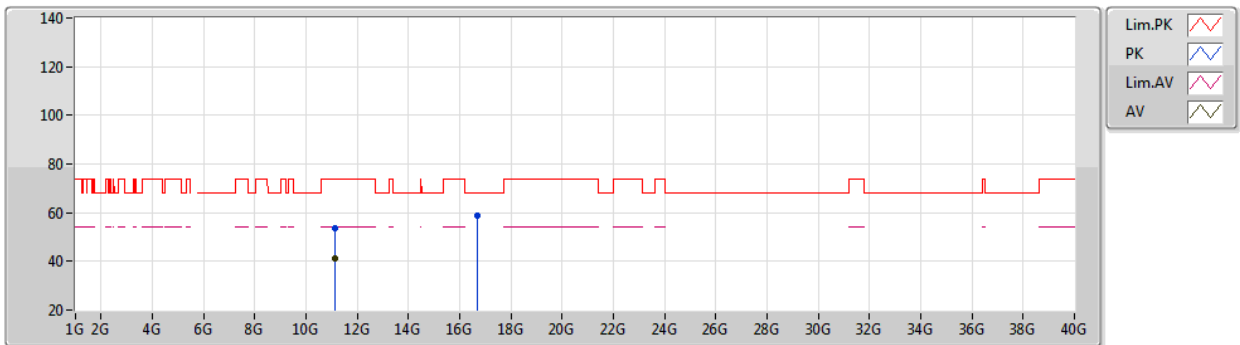

EUT Y_4TX
 Setting 68
 04-E-P-2

Type	Freq (Hz)	Level (dBuV/m)	Limit (dBuV/m)	Margin (dB)	Raw (dBuV)	Dist (m)	Condition	Azimuth (°)	Height (m)	Comment	AF (dB)	CL (dB)	PA (dB)
PK	11.13608G	53.64	74.00	-20.36	41.25	3	Vertical	40	1.80	-	39.33	7.95	34.89
AV	11.1416G	41.03	54.00	-12.97	28.64	3	Vertical	40	1.80	-	39.33	7.95	34.89
PK	16.7067G	58.75	68.20	-9.45	44.14	3	Vertical	357	1.80	-	40.15	9.96	35.50

Note 1: The amplitude of spurious emissions which are attenuated by more than 20 dB below the permissible value has no need to be reported.

Note 2: Measurement receive antenna polarization: H (Horizontal), V (Vertical)



Transmitter Radiated Emissions (1GHz~10th Harmonic)			
Operating Mode	802.11ax 160MHz / Nss 3 MCS 0 / 3S4T TXBF / Ant. 3 + Ant. 4 + Ant. 5 + Ant. 6 / CH114	Polarization	H

802.11ax HEW160-BF_Nss3,(MCS0)_4TX
5570MHz_TX

08/06/2020

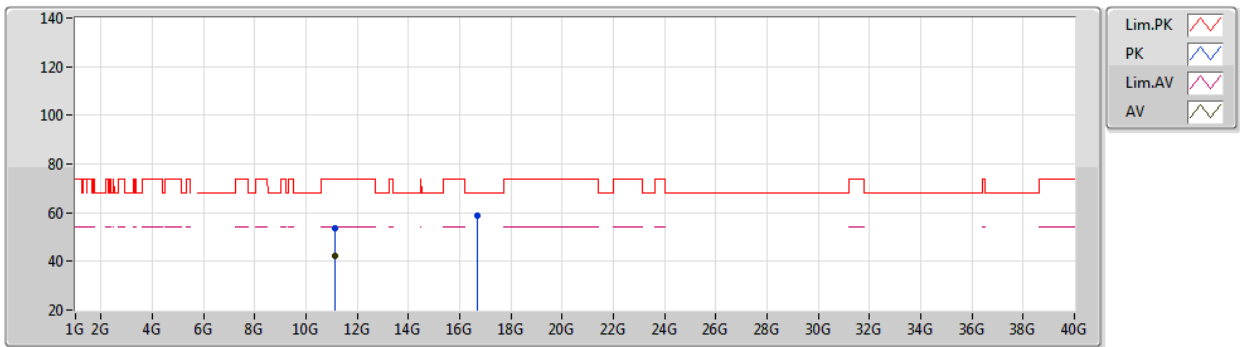

EUT Y_4TX
 Setting 68
 04-E-P-2

Type	Freq (Hz)	Level (dBuV/m)	Limit (dBuV/m)	Margin (dB)	Raw (dBuV)	Dist (m)	Condition	Azimuth (°)	Height (m)	Comment	AF (dB)	CL (dB)	PA (dB)
PK	11.1404G	53.45	74.00	-20.55	41.06	3	Horizontal	319	1.93	-	39.33	7.95	34.89
AV	11.14G	41.99	54.00	-12.01	29.60	3	Horizontal	319	1.93	-	39.33	7.95	34.89
PK	16.7084G	58.71	68.20	-9.49	44.09	3	Horizontal	225	1.80	-	40.16	9.96	35.50

Note 1: The amplitude of spurious emissions which are attenuated by more than 20 dB below the permissible value has no need to be reported.

Note 2: Measurement receive antenna polarization: H (Horizontal), V (Vertical)

**2.5.10. Test Result of Band Edge and Fundamental Emissions**

Following channel(s) was (were) selected for the final test as listed below.

MODE	TX Chain	TESTED CHANNEL	MODULATION TECHNOLOGY	MODULATION TYPE	DATA RATE (Mbps)
802.11ax 20MHz	(1S2T, CDD)	52, 60, 64	OFDMA	BPSK	Nss1 MCS0 (8.6)
802.11ax 20MHz	(1S4T, CDD)	100, 116, 140, 144	OFDMA	BPSK	Nss1 MCS0 (26)
802.11ax 20MHz	(1S2T, TXBF)	52, 60, 64	OFDMA	BPSK	Nss1 MCS0 (8.6)
802.11ax 20MHz	(1S4T, TXBF)	100, 116, 140, 144	OFDMA	BPSK	Nss1 MCS0 (8.6)
802.11ax 20MHz	(2S4T, TXBF)	100, 116, 140, 144	OFDMA	BPSK	Nss2 MCS0 (17.2)
802.11ax 20MHz	(3S4T, TXBF)	100, 116, 140, 144	OFDMA	BPSK	Nss3 MCS0 (25.8)
802.11ax 40MHz	(1S2T, CDD)	54, 62	OFDMA	BPSK	Nss1 MCS0 (17.2)
802.11ax 40MHz	(1S4T, CDD)	102, 110, 134, 142	OFDMA	BPSK	Nss1 MCS0 (17.2)
802.11ax 40MHz	(1S2T, TXBF)	54, 62	OFDMA	BPSK	Nss1 MCS0 (17.2)
802.11ax 40MHz	(1S4T, TXBF)	102, 110, 134, 142	OFDMA	BPSK	Nss1 MCS0 (17.2)
802.11ax 40MHz	(2S4T, TXBF)	102, 110, 134, 142	OFDMA	BPSK	Nss2 MCS0 (34.4)
802.11ax 40MHz	(3S4T, TXBF)	102, 110, 134, 142	OFDMA	BPSK	Nss3 MCS0 (51.6)
802.11ax 80MHz	(1S2T, CDD)	58	OFDMA	BPSK	Nss1 MCS0 (36)
802.11ax 80MHz	(1S4T, CDD)	106, 122, 138	OFDMA	BPSK	Nss1 MCS0 (36)
802.11ax 80MHz	(1S2T, TXBF)	58	OFDMA	BPSK	Nss1 MCS0 (36)
802.11ax 80MHz	(1S4T, TXBF)	106, 122, 138	OFDMA	BPSK	Nss1 MCS0 (36)
802.11ax 80MHz	(2S4T, TXBF)	106, 122, 138	OFDMA	BPSK	Nss2 MCS0 (72.1)
802.11ax 80MHz	(3S4T, TXBF)	106, 122, 138	OFDMA	BPSK	Nss3 MCS0 (108.1)
802.11ax 160MHz	(1S4T, CDD)	114	OFDMA	BPSK	Nss1 MCS0 (72.1)
802.11ax 160MHz	(1S4T, TXBF)	114	OFDMA	BPSK	Nss1 MCS0 (72.1)
802.11ax 160MHz	(2S4T, TXBF)	114	OFDMA	BPSK	Nss2 MCS0 (144.2)
802.11ax 160MHz	(3S4T, TXBF)	114	OFDMA	BPSK	Nss3 MCS0 (216.2)



Band Edge and Fundamental Emissions

Operating Mode 802.11ax 20MHz / Nss 1 MCS 0 / 1S2T CDD / Ant. 1 + Ant. 2 / CH52 **Polarization** V

**802.11ax HEW20_Nss1,(MCS0)_2TX
5260MHz_TX**

08/06/2020

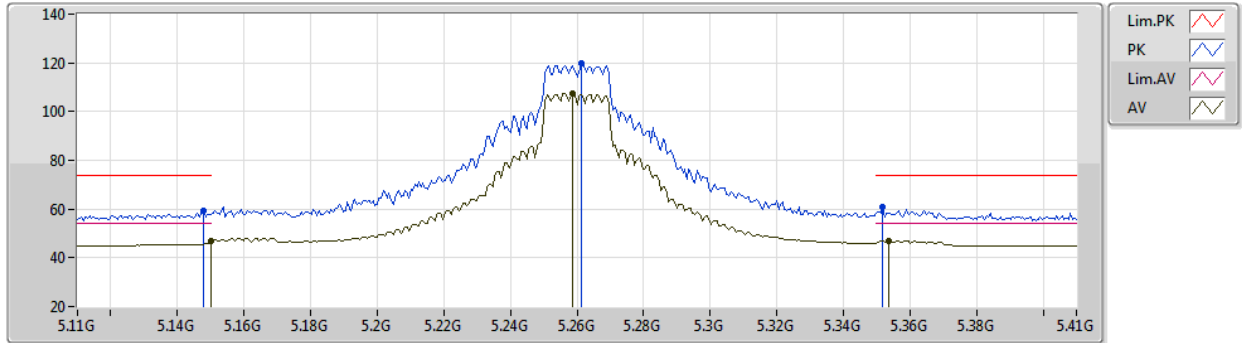

EUT Y_2TX
Setting 100
04-E-P-2-10

Type	Freq (Hz)	Level (dBuV/m)	Limit (dBuV/m)	Margin (dB)	Raw (dBuV)	Dist (m)	Condition	Azimuth (°)	Height (m)	Comment	AF (dB)	CL (dB)	PA (dB)
PK	5.1478G	59.25	74.00	-14.75	54.47	3	Vertical	177	2.60	-	33.05	5.10	33.37
AV	5.15G	46.76	54.00	-7.24	41.98	3	Vertical	177	2.60	-	33.05	5.10	33.37
PK	5.2612G	119.91	Inf	-Inf	114.97	3	Vertical	177	2.60	-	33.16	5.16	33.38
AV	5.2588G	107.26	Inf	-Inf	102.32	3	Vertical	177	2.60	-	33.16	5.16	33.38
PK	5.3518G	60.78	74.00	-13.22	55.60	3	Vertical	177	2.60	-	33.36	5.21	33.39
AV	5.3536G	47.13	54.00	-6.87	41.95	3	Vertical	177	2.60	-	33.36	5.21	33.39

Note 1: Frequencies within 5250~5350 are the fundamental frequencies at 5260MHz
 Note 2: Measurement receive antenna polarization: H (Horizontal), V (Vertical)



Band Edge and Fundamental Emissions

Operating Mode | 802.11ax 20MHz / Nss 1 MCS 0 / 1S2T CDD / Ant. 1 + Ant. 2 / CH52 | **Polarization** | H

**802.11ax HEW20_Nss1,(MCS0)_2TX
5260MHz_TX**

08/06/2020

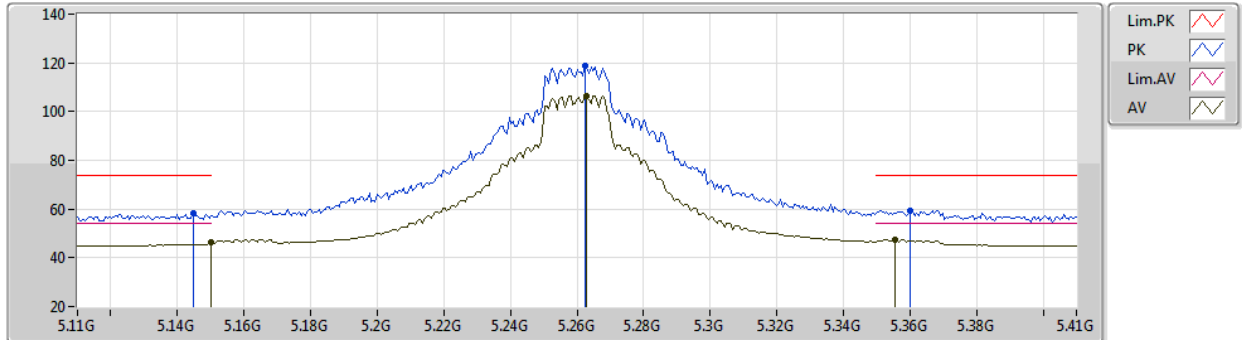

EUT_Y_2TX
Setting 100
04-E-P-2-10

Type	Freq (Hz)	Level (dBuV/m)	Limit (dBuV/m)	Margin (dB)	Raw (dBuV)	Dist (m)	Condition	Azimuth (°)	Height (m)	Comment	AF (dB)	CL (dB)	PA (dB)
PK	5.1448G	58.05	74.00	-15.95	53.28	3	Horizontal	242	1.75	-	33.04	5.10	33.37
AV	5.15G	46.60	54.00	-7.40	41.82	3	Horizontal	242	1.75	-	33.05	5.10	33.37
PK	5.2624G	118.72	Inf	-Inf	113.78	3	Horizontal	242	1.75	-	33.16	5.16	33.38
AV	5.263G	106.60	Inf	-Inf	101.66	3	Horizontal	242	1.75	-	33.16	5.16	33.38
PK	5.3602G	59.47	74.00	-14.53	54.27	3	Horizontal	242	1.75	-	33.38	5.21	33.39
AV	5.3554G	47.33	54.00	-6.67	42.14	3	Horizontal	242	1.75	-	33.37	5.21	33.39

Note 1: Frequencies within 5250~5350 are the fundamental frequencies at 5260MHz
 Note 2: Measurement receive antenna polarization: H (Horizontal), V (Vertical)



Band Edge and Fundamental Emissions

Operating Mode | 802.11ax 20MHz / Nss 1 MCS 0 / 1S2T CDD / Ant. 1 + Ant. 2 / CH60 | **Polarization** | V

**802.11ax HEW20_Nss1,(MCS0)_2TX
5300MHz_TX**

08/06/2020

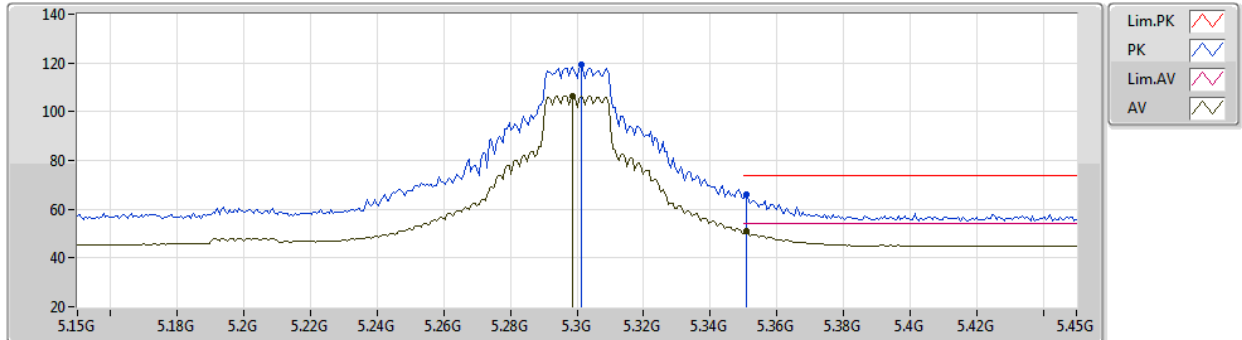

EUT Y_2TX
Setting 100
04-E-P-2-10

Type	Freq (Hz)	Level (dBuV/m)	Limit (dBuV/m)	Margin (dB)	Raw (dBuV)	Dist (m)	Condition	Azimuth (°)	Height (m)	Comment	AF (dB)	CL (dB)	PA (dB)
PK	5.3012G	119.30	Inf	-Inf	114.30	3	Vertical	181	2.77	-	33.20	5.18	33.38
AV	5.2988G	106.49	Inf	-Inf	101.49	3	Vertical	181	2.77	-	33.20	5.18	33.38
PK	5.351G	66.00	74.00	-8.00	60.83	3	Vertical	181	2.77	-	33.35	5.21	33.39
AV	5.351G	50.78	54.00	-3.22	45.61	3	Vertical	181	2.77	-	33.35	5.21	33.39

Note 1: Frequencies within 5250~5350 are the fundamental frequencies at 5300MHz
 Note 2: Measurement receive antenna polarization: H (Horizontal), V (Vertical)



Band Edge and Fundamental Emissions

Operating Mode | 802.11ax 20MHz / Nss 1 MCS 0 / 1S2T CDD / Ant. 1 + Ant. 2 / CH60 | **Polarization** | H

**802.11ax HEW20_Nss1,(MCS0)_2TX
5300MHz_TX**

08/06/2020

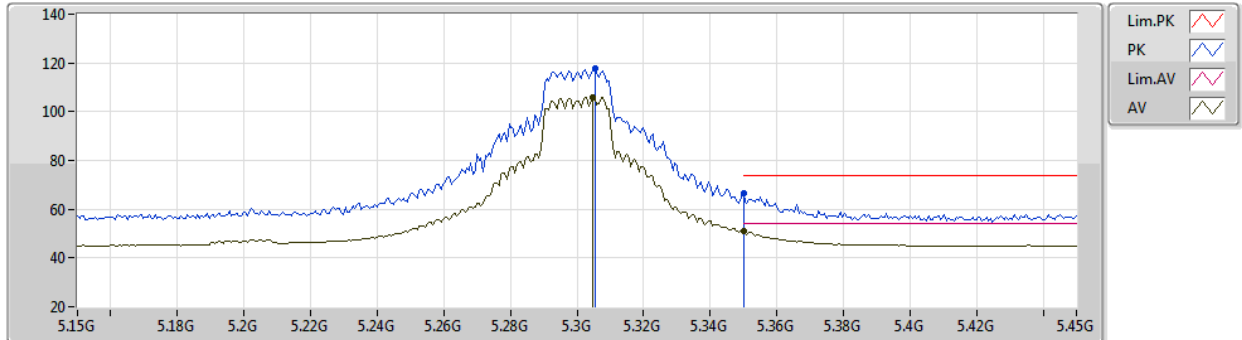

EUT Y_2TX
Setting 100
04-E-P-2-10

Type	Freq (Hz)	Level (dBuV/m)	Limit (dBuV/m)	Margin (dB)	Raw (dBuV)	Dist (m)	Condition	Azimuth (°)	Height (m)	Comment	AF (dB)	CL (dB)	PA (dB)
PK	5.3054G	117.97	Inf	-Inf	112.95	3	Horizontal	240	1.82	-	33.22	5.18	33.38
AV	5.3048G	106.00	Inf	-Inf	100.99	3	Horizontal	240	1.82	-	33.21	5.18	33.38
PK	5.35G	66.42	74.00	-7.58	61.25	3	Horizontal	240	1.82	-	33.35	5.21	33.39
AV	5.35G	51.27	54.00	-2.73	46.10	3	Horizontal	240	1.82	-	33.35	5.21	33.39

Note 1: Frequencies within 5250~5350 are the fundamental frequencies at 5300MHz

Note 2: Measurement receive antenna polarization: H (Horizontal), V (Vertical)



Band Edge and Fundamental Emissions

Operating Mode | 802.11ax 20MHz / Nss 1 MCS 0 / 1S2T CDD / Ant. 1 + Ant. 2 / CH64 | **Polarization** | V

**802.11ax HEW20_Nss1,(MCS0)_2TX
5320MHz_TX**

08/06/2020

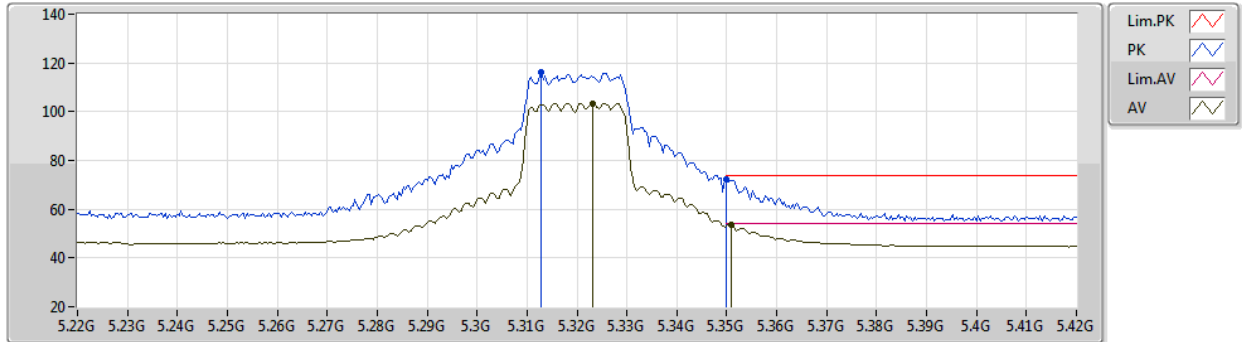

EUT Y_2TX
Setting 87
04-E-P-2-10

Type	Freq (Hz)	Level (dBuV/m)	Limit (dBuV/m)	Margin (dB)	Raw (dBuV)	Dist (m)	Condition	Azimuth (°)	Height (m)	Comment	AF (dB)	CL (dB)	PA (dB)
PK	5.3128G	116.10	Inf	-Inf	111.05	3	Vertical	211	2.49	-	33.24	5.19	33.38
AV	5.3232G	103.47	Inf	-Inf	98.39	3	Vertical	211	2.49	-	33.27	5.19	33.38
PK	5.35G	72.09	74.00	-1.91	66.92	3	Vertical	211	2.49	-	33.35	5.21	33.39
AV	5.3508G	53.79	54.00	-0.21	48.62	3	Vertical	211	2.49	-	33.35	5.21	33.39

Note 1: Frequencies within 5250~5350 are the fundamental frequencies at 5320MHz
 Note 2: Measurement receive antenna polarization: H (Horizontal), V (Vertical)



Band Edge and Fundamental Emissions

Operating Mode | 802.11ax 20MHz / Nss 1 MCS 0 / 1S2T CDD / Ant. 1 + Ant. 2 / CH64 | **Polarization** | H

**802.11ax HEW20_Nss1,(MCS0)_2TX
5320MHz_TX**

08/06/2020

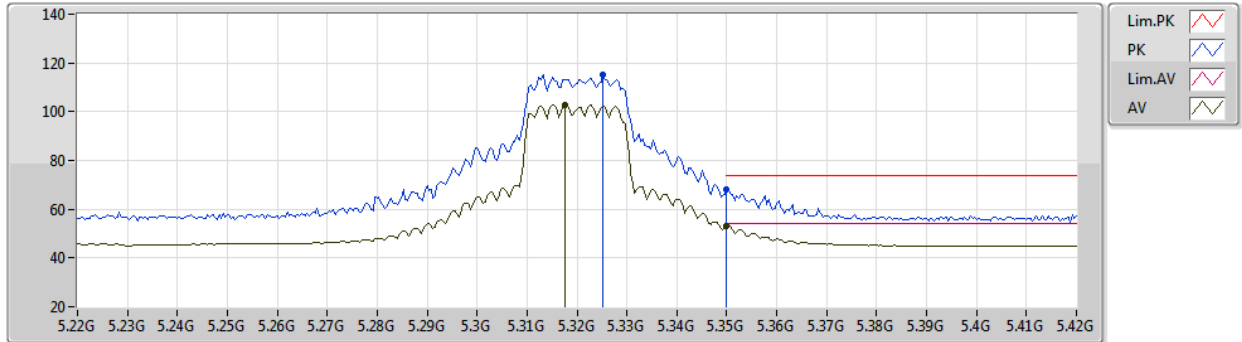

EUT Y_2TX
Setting 87
04-E-P-2-10

Type	Freq (Hz)	Level (dBuV/m)	Limit (dBuV/m)	Margin (dB)	Raw (dBuV)	Dist (m)	Condition	Azimuth (°)	Height (m)	Comment	AF (dB)	CL (dB)	PA (dB)
PK	5.3252G	115.20	Inf	-Inf	110.11	3	Horizontal	246	1.86	-	33.28	5.19	33.38
AV	5.3176G	102.63	Inf	-Inf	97.57	3	Horizontal	246	1.86	-	33.25	5.19	33.38
PK	5.35G	68.30	74.00	-5.70	63.13	3	Horizontal	246	1.86	-	33.35	5.21	33.39
AV	5.35G	53.05	54.00	-0.95	47.88	3	Horizontal	246	1.86	-	33.35	5.21	33.39

Note 1: Frequencies within 5250~5350 are the fundamental frequencies at 5320MHz
 Note 2: Measurement receive antenna polarization: H (Horizontal), V (Vertical)



Band Edge and Fundamental Emissions

Operating Mode	802.11ax 20MHz / Nss 1 MCS 0 / 1S4T CDD / Ant. 3 + Ant. 4 + Ant. 5 + Ant. 6 / CH100	Polarization	V
-----------------------	---	---------------------	---

**802.11ax HEW20_Nss1,(MCS0)_4TX
5500MHz_TX**

08/06/2020

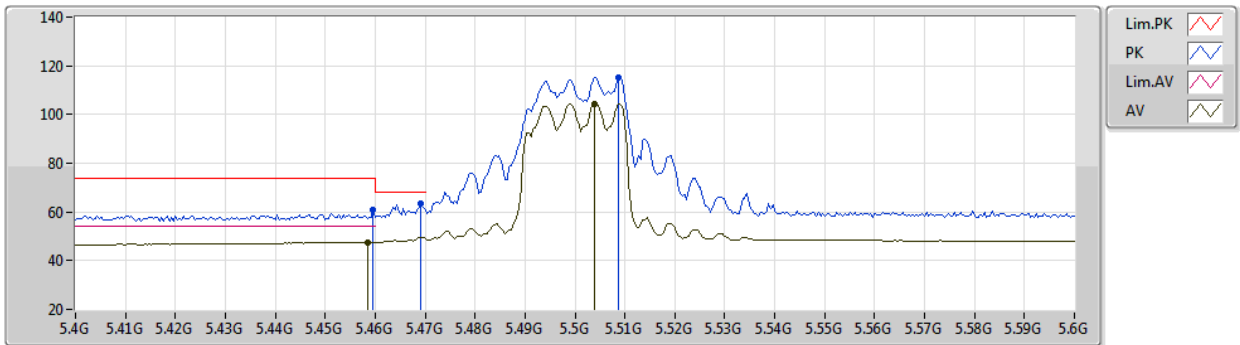

EUT_Y_4TX
Setting 79
04-K-P-2-10

Type	Freq (Hz)	Level (dBuV/m)	Limit (dBuV/m)	Margin (dB)	Raw (dBuV)	Dist (m)	Condition	Azimuth (°)	Height (m)	Comment	AF (dB)	CL (dB)	PA (dB)
PK	5.4596G	60.65	74.00	-13.35	55.09	3	Vertical	124	2.43	-	33.68	5.27	33.39
AV	5.4584G	47.66	54.00	-6.34	42.10	3	Vertical	124	2.43	-	33.68	5.27	33.39
PK	5.4692G	63.19	68.20	-5.01	57.60	3	Vertical	124	2.43	-	33.71	5.27	33.39
PK	5.5088G	115.26	Inf	-Inf	109.53	3	Vertical	124	2.43	-	33.82	5.30	33.39
AV	5.504G	104.37	Inf	-Inf	98.66	3	Vertical	124	2.43	-	33.81	5.29	33.39

Note 1: Frequencies within 5470~5725 are the fundamental frequencies at 5500MHz
 Note 2: Measurement receive antenna polarization: H (Horizontal), V (Vertical)



Band Edge and Fundamental Emissions

Operating Mode	802.11ax 20MHz / Nss 1 MCS 0 / 1S4T CDD / Ant. 3 + Ant. 4 + Ant. 5 + Ant. 6 / CH100	Polarization	H
-----------------------	---	---------------------	---

**802.11ax HEW20_Nss1,(MCS0)_4TX
5500MHz_TX**

08/06/2020

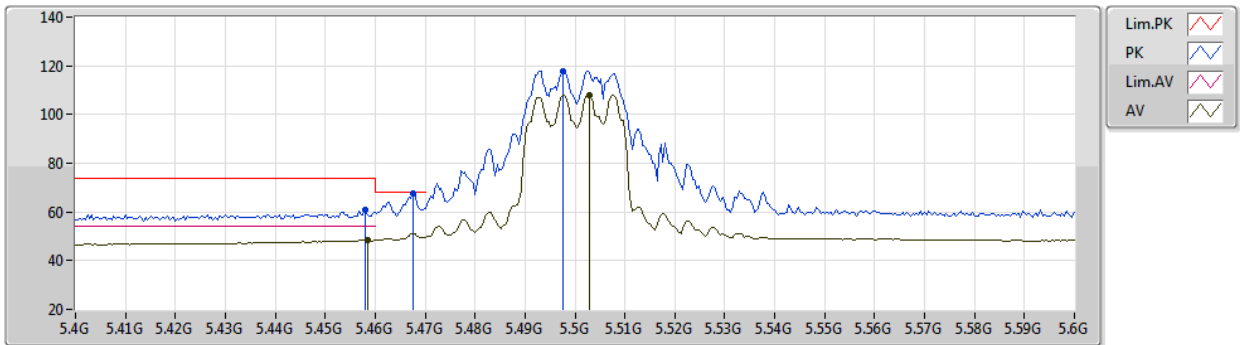

EUT_Y_4TX
Setting 79
04-K-P-2-10

Type	Freq (Hz)	Level (dBuV/m)	Limit (dBuV/m)	Margin (dB)	Raw (dBuV)	Dist (m)	Condition	Azimuth (°)	Height (m)	Comment	AF (dB)	CL (dB)	PA (dB)
PK	5.458G	60.71	74.00	-13.29	55.17	3	Horizontal	312	2.36	-	33.67	5.26	33.39
AV	5.4584G	48.21	54.00	-5.79	42.65	3	Horizontal	312	2.36	-	33.68	5.27	33.39
PK	5.4676G	67.52	68.20	-0.68	61.94	3	Horizontal	312	2.36	-	33.70	5.27	33.39
PK	5.4976G	117.98	Inf	-Inf	112.29	3	Horizontal	312	2.36	-	33.79	5.29	33.39
AV	5.5028G	108.12	Inf	-Inf	102.41	3	Horizontal	312	2.36	-	33.81	5.29	33.39

Note 1: Frequencies within 5470~5725 are the fundamental frequencies at 5500MHz
 Note 2: Measurement receive antenna polarization: H (Horizontal), V (Vertical)



Band Edge and Fundamental Emissions

Operating Mode	802.11ax 20MHz / Nss 1 MCS 0 / 1S4T CDD / Ant. 3 + Ant. 4 + Ant. 5 + Ant. 6 / CH116	Polarization	V
-----------------------	---	---------------------	---

**802.11ax HEW20_Nss1,(MCS0)_4TX
5580MHz_TX**

08/06/2020

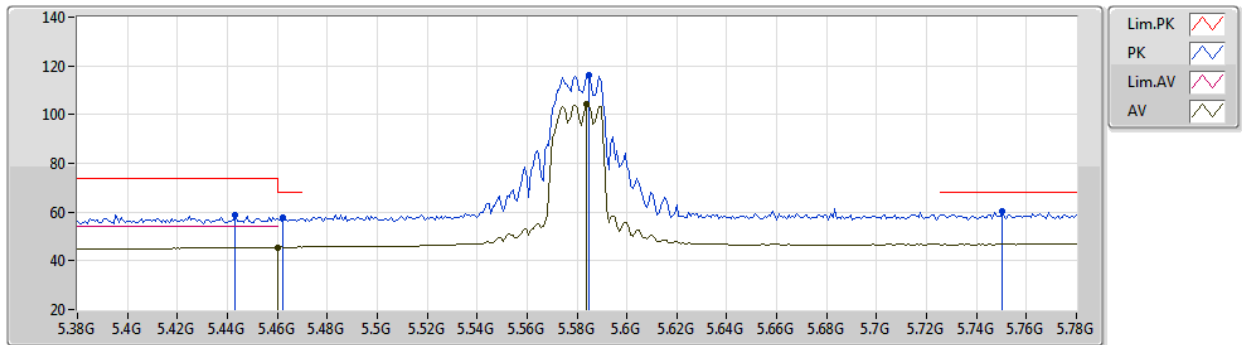

EUT_Y_4TX
Setting 80
04-K-P-2-10

Type	Freq (Hz)	Level (dBuV/m)	Limit (dBuV/m)	Margin (dB)	Raw (dBuV)	Dist (m)	Condition	Azimuth (°)	Height (m)	Comment	AF (dB)	CL (dB)	PA (dB)
PK	5.4432G	58.77	74.00	-15.23	53.27	3	Vertical	122	2.27	-	33.63	5.26	33.39
PK	5.4624G	57.54	68.20	-10.66	51.97	3	Vertical	122	2.27	-	33.69	5.27	33.39
AV	5.46G	45.56	54.00	-8.44	40.00	3	Vertical	122	2.27	-	33.68	5.27	33.39
PK	5.5848G	116.38	Inf	-Inf	110.43	3	Vertical	122	2.27	-	33.97	5.35	33.37
AV	5.584G	104.11	Inf	-Inf	98.16	3	Vertical	122	2.27	-	33.97	5.35	33.37
PK	5.7504G	60.13	68.20	-8.07	53.80	3	Vertical	122	2.27	-	34.20	5.48	33.35

Note 1: Frequencies within 5470~5725 are the fundamental frequencies at 5580MHz
 Note 2: Measurement receive antenna polarization: H (Horizontal), V (Vertical)



Band Edge and Fundamental Emissions

Operating Mode	802.11ax 20MHz / Nss 1 MCS 0 / 1S4T CDD / Ant. 3 + Ant. 4 + Ant. 5 + Ant. 6 / CH116	Polarization	H
-----------------------	--	---------------------	---

**802.11ax HEW20_Nss1,(MCS0)_4TX
5580MHz_TX**

08/06/2020

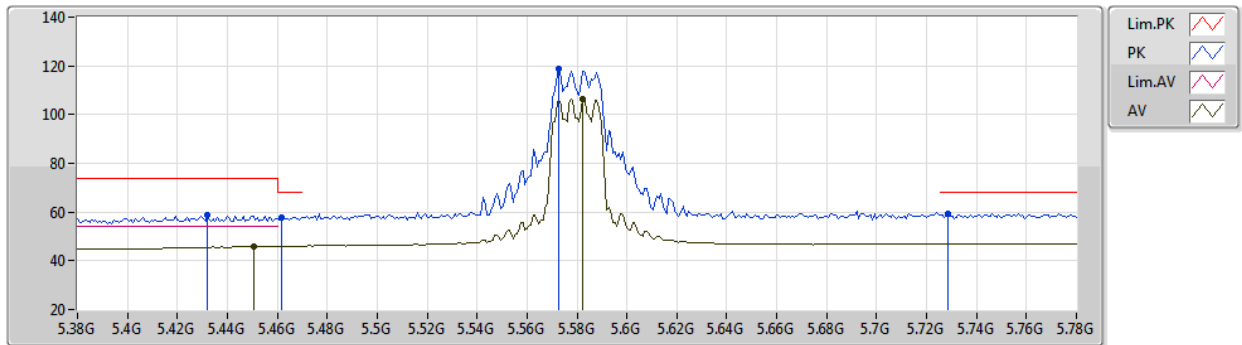

EUT_Y_4TX
Setting 80
04-K-P-2-10

Type	Freq (Hz)	Level (dBuV/m)	Limit (dBuV/m)	Margin (dB)	Raw (dBuV)	Dist (m)	Condition	Azimuth (°)	Height (m)	Comment	AF (dB)	CL (dB)	PA (dB)
PK	5.432G	58.90	74.00	-15.10	53.44	3	Horizontal	315	1.79	-	33.60	5.25	33.39
PK	5.4616G	57.75	68.20	-10.45	52.19	3	Horizontal	315	1.79	-	33.68	5.27	33.39
AV	5.4504G	45.91	54.00	-8.09	40.39	3	Horizontal	315	1.79	-	33.65	5.26	33.39
PK	5.5728G	118.76	Inf	-Inf	112.85	3	Horizontal	315	1.79	-	33.95	5.34	33.38
AV	5.5824G	106.54	Inf	-Inf	100.60	3	Horizontal	315	1.79	-	33.96	5.35	33.37
PK	5.7288G	59.43	68.20	-8.77	53.16	3	Horizontal	315	1.79	-	34.16	5.46	33.35

Note 1: Frequencies within 5470~5725 are the fundamental frequencies at 5580MHz
 Note 2: Measurement receive antenna polarization: H (Horizontal), V (Vertical)

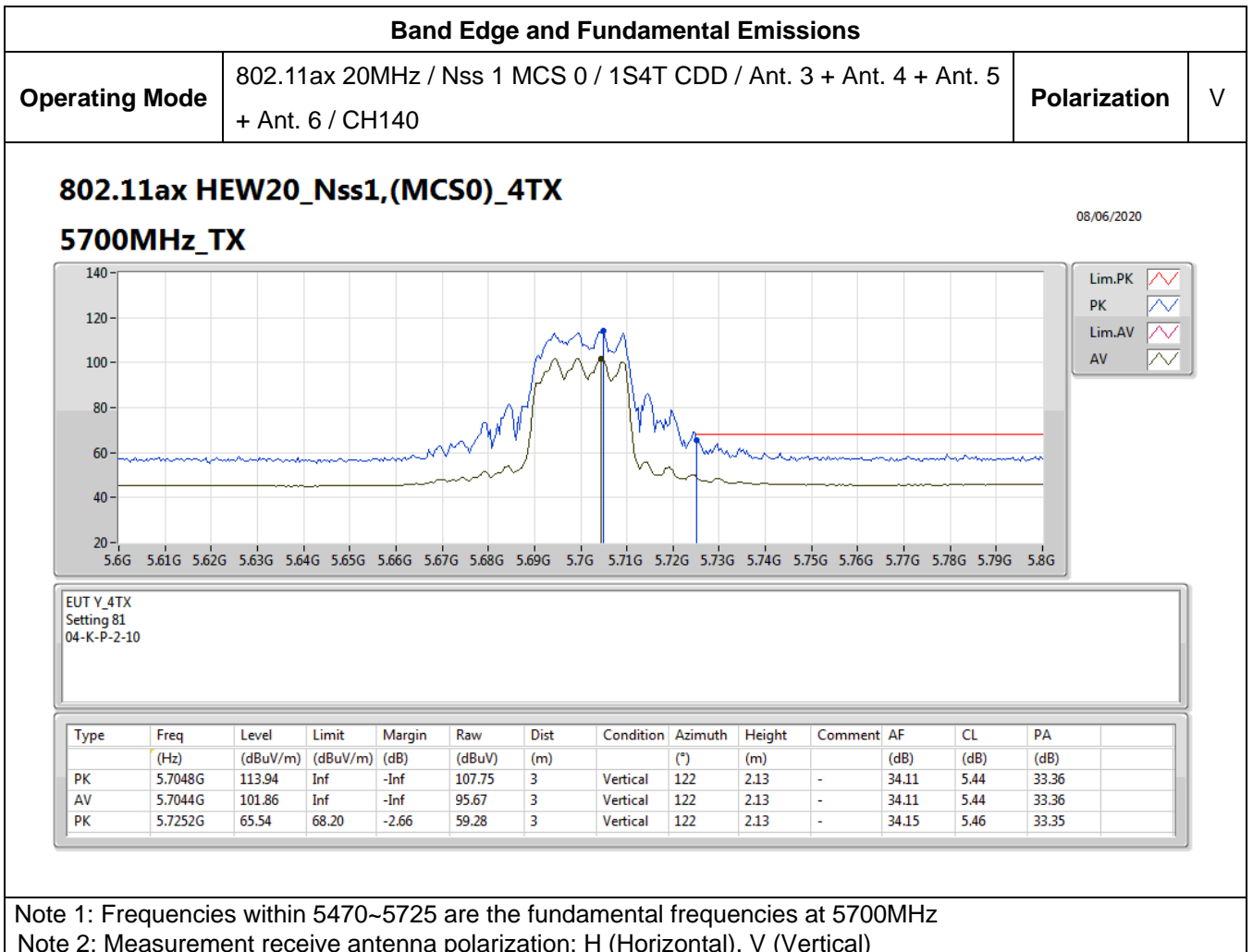

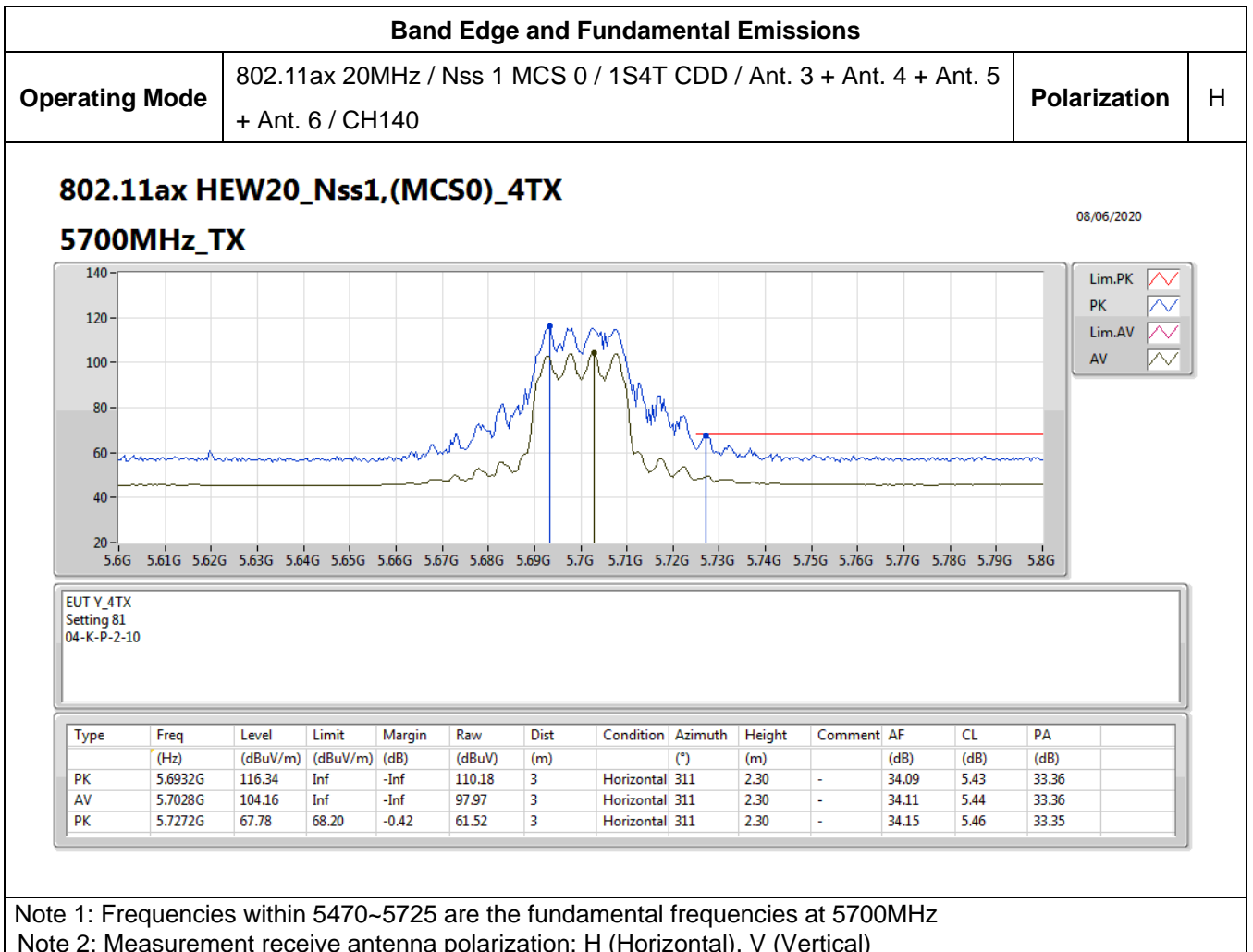



Band Edge and Fundamental Emissions			
Operating Mode	802.11ax 20MHz / Nss 1 MCS 0 / 1S4T CDD / Ant. 3 + Ant. 4 + Ant. 5 + Ant. 6 / CH144	Polarization	V

802.11ax HEW20_Nss1,(MCS0)_4TX
5720MHz Straddle 5.47-5.725GHz_TX

08/06/2020

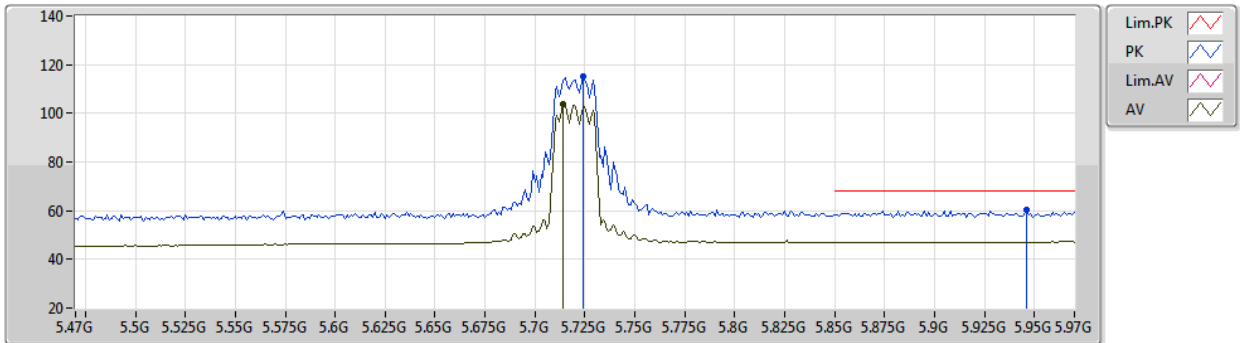

EUT Y_4TX
 Setting 80
 04-K-P-2-10

Type	Freq (Hz)	Level (dBuV/m)	Limit (dBuV/m)	Margin (dB)	Raw (dBuV)	Dist (m)	Condition	Azimuth (°)	Height (m)	Comment	AF (dB)	CL (dB)	PA (dB)
PK	5.724G	115.07	Inf	-Inf	108.82	3	Vertical	124	1.85	-	34.15	5.46	33.36
AV	5.714G	103.55	Inf	-Inf	97.33	3	Vertical	124	1.85	-	34.13	5.45	33.36
PK	5.946G	60.54	68.20	-7.66	53.16	3	Vertical	124	1.85	-	35.08	5.62	33.32

Note 1: Frequencies within 5470~5725 are the fundamental frequencies at 5720MHz
 Note 2: Measurement receive antenna polarization: H (Horizontal), V (Vertical)



Band Edge and Fundamental Emissions

Operating Mode	802.11ax 20MHz / Nss 1 MCS 0 / 1S4T CDD / Ant. 3 + Ant. 4 + Ant. 5 + Ant. 6 / CH144	Polarization	H
-----------------------	--	---------------------	---

802.11ax HEW20_Nss1,(MCS0)_4TX
5720MHz Straddle 5.47-5.725GHz_TX

08/06/2020

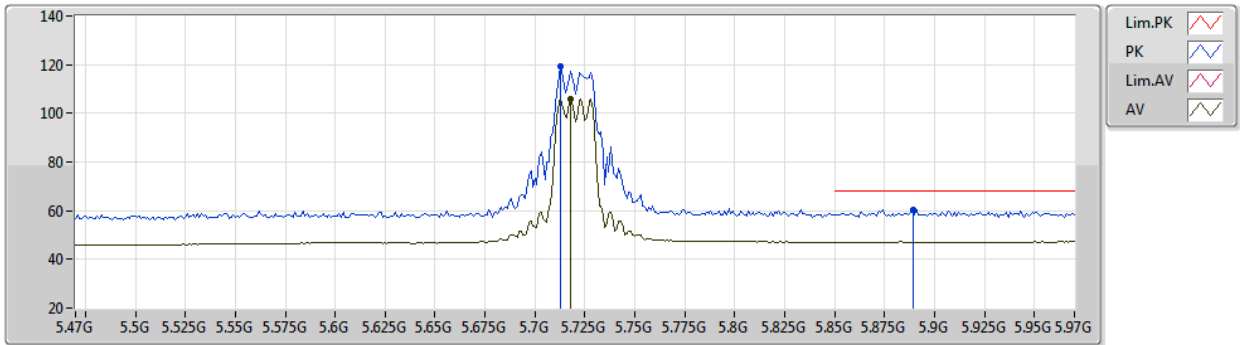

EUT Y_4TX
Setting 80
04-K-P-2-10

Type	Freq (Hz)	Level (dBuV/m)	Limit (dBuV/m)	Margin (dB)	Raw (dBuV)	Dist (m)	Condition	Azimuth (°)	Height (m)	Comment	AF (dB)	CL (dB)	PA (dB)
PK	5.713G	119.54	Inf	-Inf	113.32	3	Horizontal	312	1.80	-	34.13	5.45	33.36
AV	5.718G	105.99	Inf	-Inf	99.76	3	Horizontal	312	1.80	-	34.14	5.45	33.36
PK	5.889G	60.35	68.20	-7.85	53.26	3	Horizontal	312	1.80	-	34.83	5.58	33.32

Note 1: Frequencies within 5470~5725 are the fundamental frequencies at 5720MHz
 Note 2: Measurement receive antenna polarization: H (Horizontal), V (Vertical)



Band Edge and Fundamental Emissions

Operating Mode 802.11ax 20MHz / Nss 1 MCS 0 / TXBF 1S2T / Ant. 1 + Ant. 2 / CH52 **Polarization** V

**802.11ax HEW20-BF_Nss1,(MCS0)_2TX
5260MHz_TX**

08/06/2020

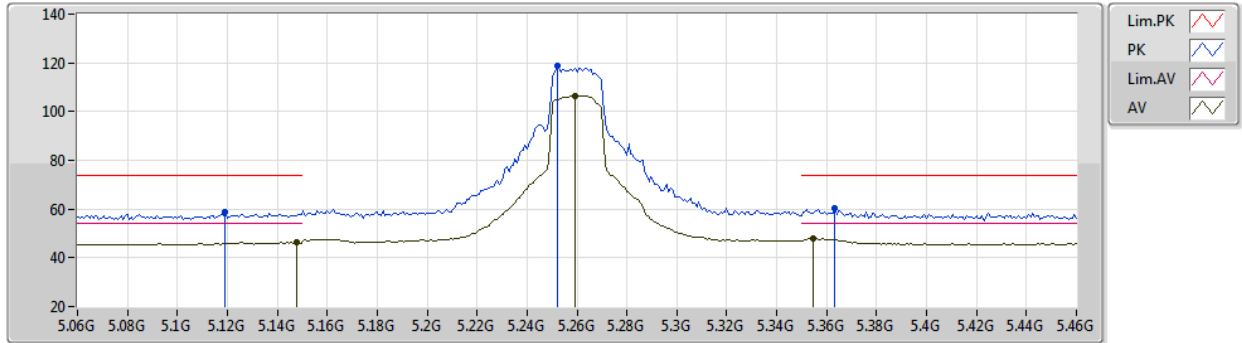

EUT Y_2TX
Setting 92
04-E-P-2-10

Type	Freq (Hz)	Level (dBuV/m)	Limit (dBuV/m)	Margin (dB)	Raw (dBuV)	Dist (m)	Condition	Azimuth (°)	Height (m)	Comment	AF (dB)	CL (dB)	PA (dB)
PK	5.1192G	59.04	74.00	-14.96	54.30	3	Vertical	234	1.73	-	33.02	5.09	33.37
AV	5.148G	46.18	54.00	-7.82	41.40	3	Vertical	234	1.73	-	33.05	5.10	33.37
PK	5.252G	118.72	Inf	-Inf	113.79	3	Vertical	234	1.73	-	33.15	5.16	33.38
AV	5.2592G	106.55	Inf	-Inf	101.61	3	Vertical	234	1.73	-	33.16	5.16	33.38
PK	5.3632G	60.15	74.00	-13.85	54.94	3	Vertical	234	1.73	-	33.39	5.21	33.39
AV	5.3544G	47.87	54.00	-6.13	42.69	3	Vertical	234	1.73	-	33.36	5.21	33.39

Note 1: Frequencies within 5250~5350 are the fundamental frequencies at 5260MHz
 Note 2: Measurement receive antenna polarization: H (Horizontal), V (Vertical)



Band Edge and Fundamental Emissions

Operating Mode 802.11ax 20MHz / Nss 1 MCS 0 / TXBF 1S2T / Ant. 1 + Ant. 2 / CH52 **Polarization** H

**802.11ax HEW20-BF_Nss1,(MCS0)_2TX
5260MHz_TX**

08/06/2020

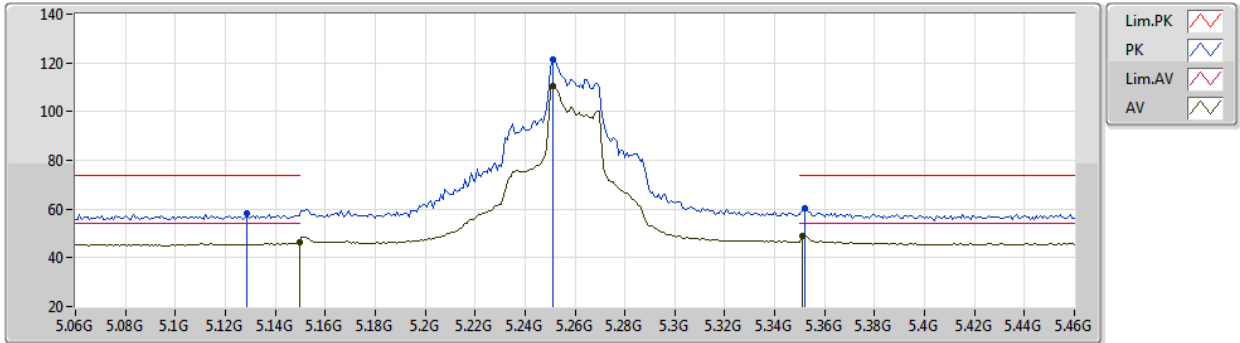

EUT Y_2TX
Setting 92
04-E-P-2-10

Type	Freq (Hz)	Level (dBuV/m)	Limit (dBuV/m)	Margin (dB)	Raw (dBuV)	Dist (m)	Condition	Azimuth (°)	Height (m)	Comment	AF (dB)	CL (dB)	PA (dB)
PK	5.1288G	58.07	74.00	-15.93	53.32	3	Horizontal	29	1.42	-	33.03	5.09	33.37
AV	5.1496G	46.52	54.00	-7.48	41.74	3	Horizontal	29	1.42	-	33.05	5.10	33.37
PK	5.2512G	121.55	Inf	-Inf	116.62	3	Horizontal	29	1.42	-	33.15	5.16	33.38
AV	5.2512G	110.27	Inf	-Inf	105.34	3	Horizontal	29	1.42	-	33.15	5.16	33.38
PK	5.352G	60.09	74.00	-13.91	54.91	3	Horizontal	29	1.42	-	33.36	5.21	33.39
AV	5.3512G	48.84	54.00	-5.16	43.67	3	Horizontal	29	1.42	-	33.35	5.21	33.39

Note 1: Frequencies within 5250~5350 are the fundamental frequencies at 5260MHz
 Note 2: Measurement receive antenna polarization: H (Horizontal), V (Vertical)



Band Edge and Fundamental Emissions

Operating Mode 802.11ax 20MHz / Nss 1 MCS 0 / TXBF 1S2T / Ant. 1 + Ant. 2 / CH60 **Polarization** V

**802.11ax HEW20-BF_Nss1,(MCS0)_2TX
5300MHz_TX**

08/06/2020

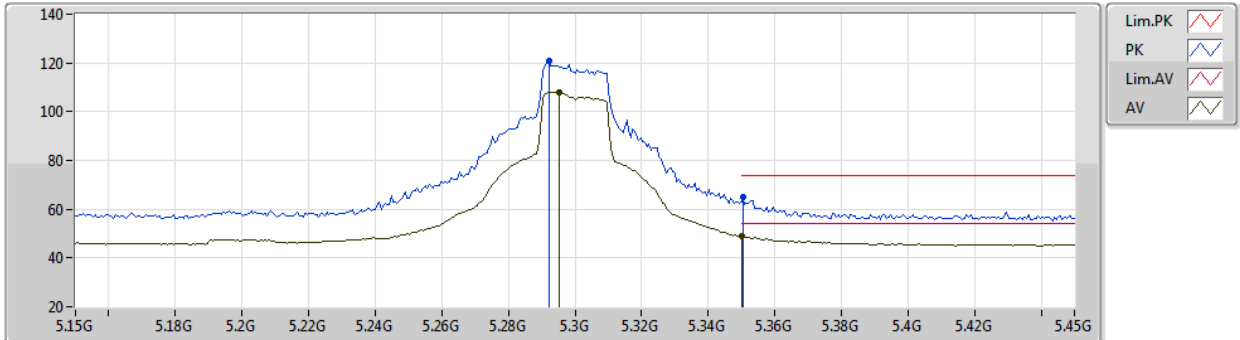

EUT Y_2TX
Setting 95
04-E-P-2-10

Type	Freq (Hz)	Level (dBuV/m)	Limit (dBuV/m)	Margin (dB)	Raw (dBuV)	Dist (m)	Condition	Azimuth (°)	Height (m)	Comment	AF (dB)	CL (dB)	PA (dB)
PK	5.2922G	121.09	Inf	-Inf	116.10	3	Vertical	209	2.93	-	33.19	5.18	33.38
AV	5.2952G	108.13	Inf	-Inf	103.13	3	Vertical	209	2.93	-	33.20	5.18	33.38
PK	5.3504G	65.14	74.00	-8.86	59.97	3	Vertical	209	2.93	-	33.35	5.21	33.39
AV	5.35G	48.89	54.00	-5.11	43.72	3	Vertical	209	2.93	-	33.35	5.21	33.39

Note 1: Frequencies within 5250~5350 are the fundamental frequencies at 5300MHz
 Note 2: Measurement receive antenna polarization: H (Horizontal), V (Vertical)



Band Edge and Fundamental Emissions

Operating Mode | 802.11ax 20MHz / Nss 1 MCS 0 / TXBF 1S2T / Ant. 1 + Ant. 2 / CH60 | **Polarization** | H

**802.11ax HEW20-BF_Nss1,(MCS0)_2TX
5300MHz_TX**

08/06/2020

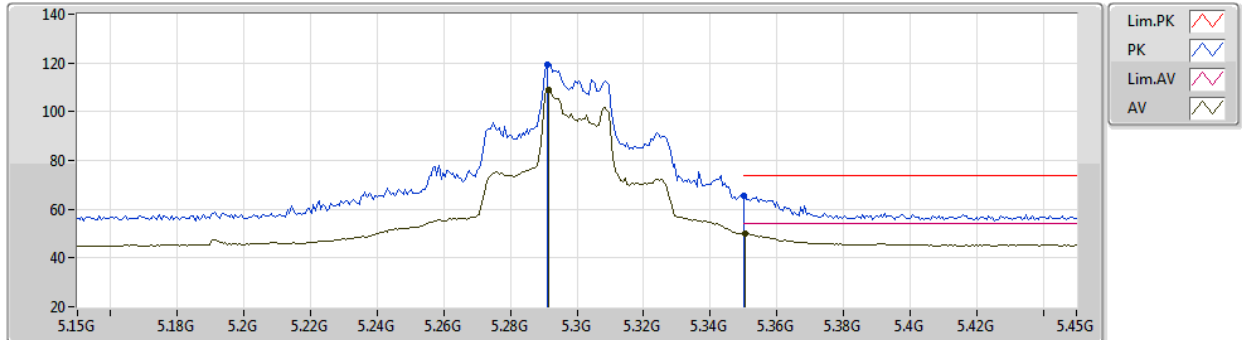

EUT Y_2TX
Setting 95
04-E-P-2-10

Type	Freq (Hz)	Level (dBuV/m)	Limit (dBuV/m)	Margin (dB)	Raw (dBuV)	Dist (m)	Condition	Azimuth (°)	Height (m)	Comment	AF (dB)	CL (dB)	PA (dB)
PK	5.291G	119.47	Inf	-Inf	114.48	3	Horizontal	233	1.79	-	33.19	5.18	33.38
AV	5.2916G	108.76	Inf	-Inf	103.77	3	Horizontal	233	1.79	-	33.19	5.18	33.38
PK	5.35G	65.34	74.00	-8.66	60.17	3	Horizontal	233	1.79	-	33.35	5.21	33.39
AV	5.3504G	49.90	54.00	-4.10	44.73	3	Horizontal	233	1.79	-	33.35	5.21	33.39

Note 1: Frequencies within 5250~5350 are the fundamental frequencies at 5300MHz

Note 2: Measurement receive antenna polarization: H (Horizontal), V (Vertical)



Band Edge and Fundamental Emissions

Operating Mode | 802.11ax 20MHz / Nss 1 MCS 0 / TXBF 1S2T / Ant. 1 + Ant. 2 / CH64 | **Polarization** | V

**802.11ax HEW20-BF_Nss1,(MCS0)_2TX
5320MHz_TX**

08/06/2020

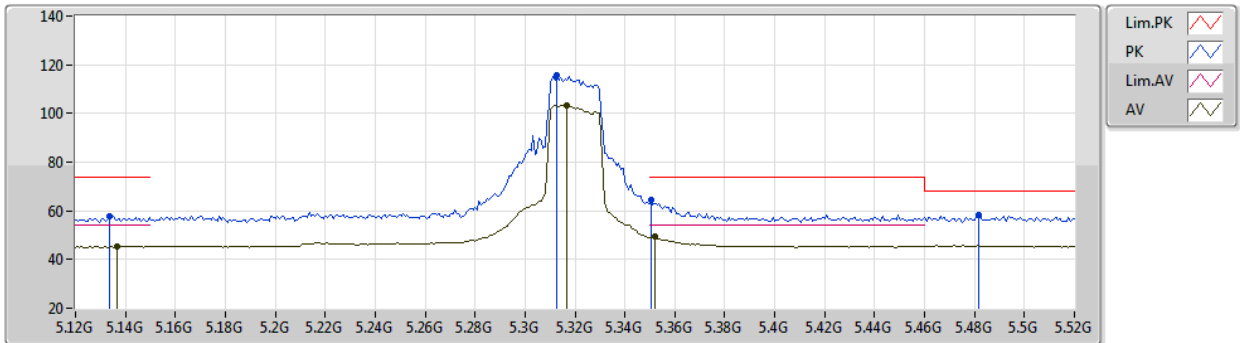

EUT Y_2TX
Setting 81
04-E-P-2-10

Type	Freq (Hz)	Level (dBuV/m)	Limit (dBuV/m)	Margin (dB)	Raw (dBuV)	Dist (m)	Condition	Azimuth (°)	Height (m)	Comment	AF (dB)	CL (dB)	PA (dB)
PK	5.1336G	57.65	74.00	-16.35	52.89	3	Vertical	184	2.92	-	33.03	5.10	33.37
AV	5.1368G	45.43	54.00	-8.57	40.66	3	Vertical	184	2.92	-	33.04	5.10	33.37
PK	5.3128G	115.77	Inf	-Inf	110.72	3	Vertical	184	2.92	-	33.24	5.19	33.38
AV	5.3168G	103.33	Inf	-Inf	98.27	3	Vertical	184	2.92	-	33.25	5.19	33.38
PK	5.3504G	64.53	74.00	-9.47	59.36	3	Vertical	184	2.92	-	33.35	5.21	33.39
AV	5.352G	49.26	54.00	-4.74	44.08	3	Vertical	184	2.92	-	33.36	5.21	33.39
PK	5.4816G	58.28	68.20	-9.92	52.65	3	Vertical	184	2.92	-	33.74	5.28	33.39

Note 1: Frequencies within 5250~5350 are the fundamental frequencies at 5320MHz

Note 2: Measurement receive antenna polarization: H (Horizontal), V (Vertical)