

SIEMENS



SINAMICS S150

NEMA Enclosed Drives

SINAMICS Drives

Catalog
D 21.7

Part 2
2016

Related Catalogs

SINAMICS S120CM D21.7.1 • 2013
Cabinet Modules (North America Edition)
DRCA-D2171-0313



SINAMICS S120 D21.3 • 2014
Chassis Units and Cabinet Modules (IEC)
SINAMICS S150
Drive Converter Cabinet Units (IEC)
E86060-K5521-A131-A4-7600
DRCA-21300-1214



SIMOTION, SINAMICS S120 and Motors for Production Machines
Catalog PM 21 • 2013
E86060-K4921-A101-A3-7600
DRCA-K4921-0713



SINAMICS G150 NEMA D11.7 • 2013
Enclosed Drives
LDPC-0D117-0313



SINAMICS G130 D11 • 2015
Drive Converter Chassis Units
SINAMICS G150
Drive Converter Cabinet Units (IEC)
E86050-K5511-A101-A6-7600
DRCA-D1100-0715



SINAMICS and Motors for Single-Axis Drives D31 • 2015
E86050-K5531-A101-A1-7600
DRCA-D31XX-0115



Low Voltage AC Motors D81.2 • 2014
Selection and Pricing Guide, USA Edition
NMPC-00600-0414

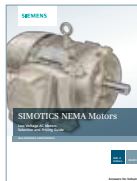

SIMOTICS FD (IEC) D81.8 • 2015
Flexible Duty Motors
Optimized for SINAMICS drives
E86060-K5581-A181-A3-7600



The Engineering Manual

SINAMICS Low Voltage Engineering Manual

Engineering Manual for

- SINAMICS G130 Drive Converter Chassis Units,
- SINAMICS G150 Drive Converter Cabinet Units,
- SINAMICS S120 Chassis Format Units,
- SINAMICS S120 Cabinet Modules,
- SINAMICS S150 Converter Cabinet Units



This manual offers users comprehensive support with the configuring of drives and associated system components.

The first three chapters are devoted primarily to the fundamental physical principles of variable-speed electric drives and include EMC Installation Guidelines as well as general system descriptions and planning information which relate to all products in the SINAMICS range.

The other chapters then discuss in detail questions relating to the dimensioning of drives with converters of specific types as well as the selection of suitable motors.

Note:

The engineering manual is not available as a printed hard copy, but only as an electronic file in PDF format.

SINAMICS Drives

SINAMICS S150 NEMA enclosed drives

Catalog D21.7 (Part 2) – 2016



Quality

The products and systems described in this catalog are produced/distributed in accordance with the requirements of a quality management system which has been certified to ISO 9001:2008.

Introduction

1

SINAMICS S150 NEMA
Enclosed drives

2

Engineering information

3

Training
Service and support

4

SINAMICS S150 NEMA

Introduction

1

The SINAMICS drives family

One Family, One Source, All Applications

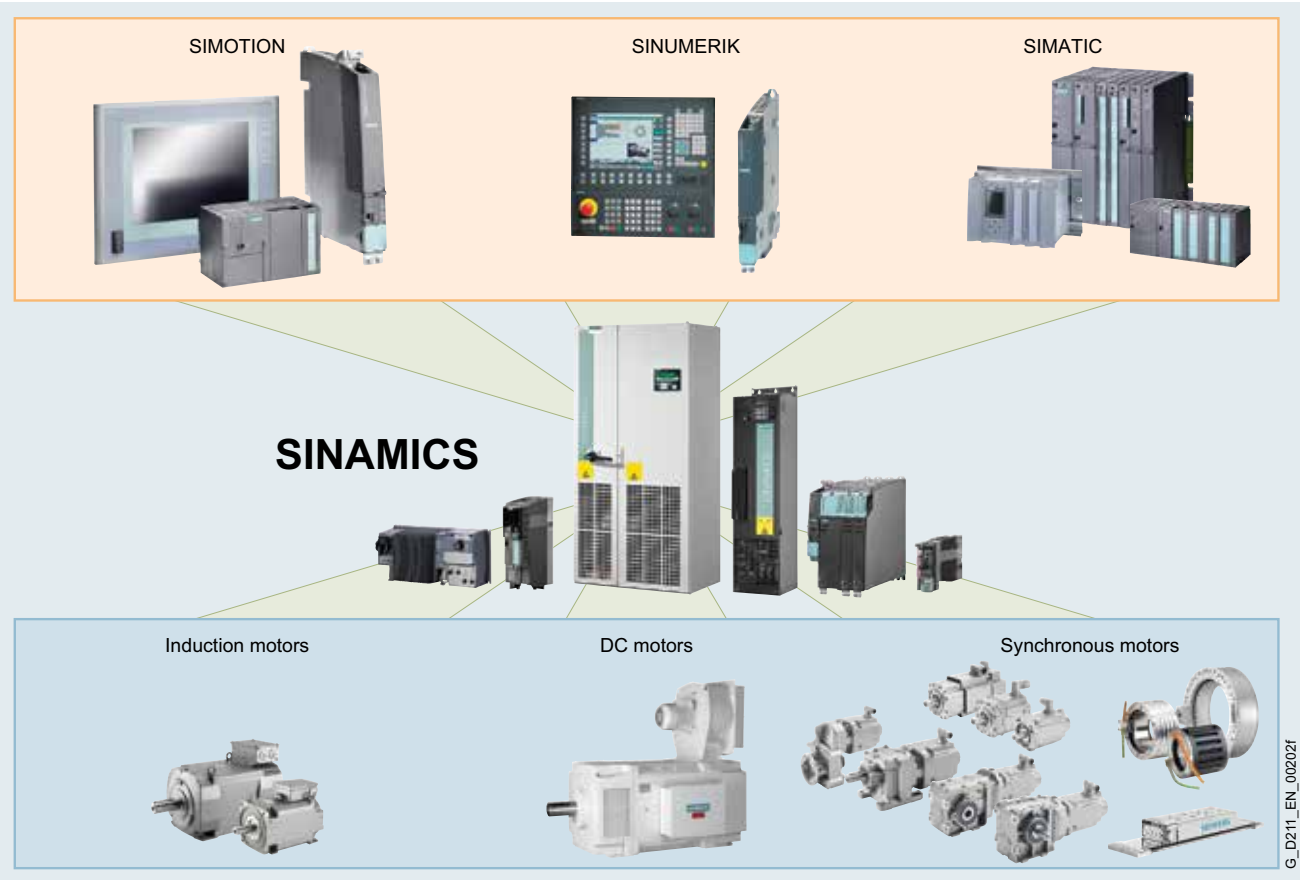

Application

SINAMICS is the family of drives from Siemens designed for industrial applications that offers solutions for all drive tasks:

- Basic pump and fan applications in the process industry
- Complex single-motor drives in centrifuges, presses, extruders, elevators, as well as conveyor and transport systems
- Coordinated drive line-ups for textile, plastic film, and paper machines, as well as for rolling mills
- High precision servo drives for machining
- Highly dynamic servo drives for machine tools, as well as packaging and printing machines

Product variants

The SINAMICS range offers the ideal variant for all drive tasks:

- SINAMICS G is designed for standard applications, mostly with induction motors, that have less stringent requirements on the dynamic performance.
- SINAMICS S handles complex drive tasks with synchronous or induction motors and fulfills the most stringent requirements regarding.
 - the dynamic performance and control accuracy
 - integration of extensive technological functions in the drive control system.
- SINAMICS DCM is the DC drive in the SINAMICS family. It can be configured to address both basic as well as demanding drive applications.

Platform concept and Totally Integrated Automation

All SINAMICS versions are based on a platform concept. Common hardware and software components, as well as standardized tools for design, configuration, and commissioning tasks ensure high-level integration across all components. SINAMICS covers the full range of drive applications. The different SINAMICS versions can be easily combined with each other.

SINAMICS is part of the Siemens "Totally Integrated Automation" concept. Integrated SINAMICS systems covering engineering, data management and communication at the automation level, result in extremely cost effective solutions based on SIMOTION (motion control), SINUMERIK (machine tool) and SIMATIC (PLC and DCS) control systems.

Quality management to ISO 9001

SINAMICS meets the highest quality requirements. Comprehensive quality assurance measures in all development, engineering and production processes ensure a consistently high level of quality.

Of course, our quality management systems are certified by independent authorities in accordance with ISO 9001.

SINAMICS S150 NEMA Introduction



1/2

The members of the SINAMICS drives family
SINAMICS low voltage drives
SINAMICS DC drives
SINAMICS medium voltage drives
SINAMICS S150

SINAMICS S150 NEMA

Introduction

1

The SINAMICS drives family

SINAMICS low voltage drives

SINAMICS G110



The versatile single motor drive for low power ratings

SINAMICS G120



The modular single motor drive for low up to medium power ratings

SINAMICS G110D



The distributed single motor drive for basic solutions

SINAMICS G120D



The distributed single motor drive for high performance

Typical ratings

230 V 1 ph. AC in / 3 ph. out
0.15 to 4 HP
(0.12 to 3 kW)

380 to 690 V 3 ph. AC
0.15 to 400 HP
(0.37 to 250 kW)

380 to 480 V 3 ph. AC
1 to 10 HP
(0.75 to 7.5 kW)

380 to 480 V 3 ph. AC
1 to 10 HP
(0.75 to 7.5 kW)

Main applications

Machine and plants for industrial and commercial applications

Machine and plants for industrial and commercial applications

Horizontal conveyor applications main focus on distribution and logistics in airports; suitable for basic conveyor-related tasks with local control or connected to a bus via ASInterface

Conveyor applications in industrial environments, main focus on the automotive industry; also suitable for high-performance applications e.g. at airports and in the food, beverage and tobacco industry

Application examples

- Simple pumps and fans
- Auxiliary drives
- Conveyor systems
- Billboards
- Door/gate operating mechanisms

- Pumps
- Fans
- Compressors

- Conveyor systems
- Airports
- Distribution logistics

- Conveyor systems
- Electric monorail system in distribution Logistics

Highlights

- Compact
- Can be flexibly adapted to different applications
- Simple and fast commissioning
- Clear terminal layout
- Optimum interaction with SIMATIC and LOGO!

- Modular
- Can be flexibly expanded
- Safety Integrated
- Simple and fast commissioning
- Regenerative feedback
- Innovative cooling concept
- Optimum interaction with SIMOTION and SIMATIC

- Low profile design with standard footprint, IP65
- Easy, fast commissioning
- Optional key-operated disconnect switch
- AS-Interface with bus parameterization
- Quick stop function
- Integrated brake control
- Optimum interaction with SIMATIC and LOGO!

- Low profile design with standard footprint, IP65
- Modular
- Can be flexibly expanded
- Easy, fast commissioning
- Regenerative feedback
- Optimum interaction with SIMOTION and SIMATIC
- SINAMICS Safety Integrated

Catalog D31

Catalog D31

Catalog D31

Catalog D31

SINAMICS S150 NEMA

Introduction

The SINAMICS drives family

SINAMICS low voltage drives

SINAMICS G120E



The versatile enclosed drive for low to medium power ratings

SINAMICS G130



The modular single motor drive solution for drives with a high power rating

SINAMICS G150 (IEC)



The universal enclosed drive solution for drives with a high power rating

SINAMICS G150 NEMA



The universal high power enclosed drive solution per North American standards

Typical ratings

380 to 480 V 3 ph. AC
1 to 200 HP
(0.75 to 132 kW)

380 to 690 V 3 ph. AC
100 to 800 HP
(75 to 560 kW)

380 to 690 V 3 ph. AC
100 to 1,250 HP
(75 to 2,700 kW)

380 to 600 V 3 ph. AC
150 to 800 HP
(110 to 560 kW)

Main applications

Standard and regenerative industrial applications in water, chemicals, oil and gas, packaging, paper, metals, minerals and others

Applications in the process and production industry, including power stations, oil and gas, petrochemicals, paper, cement, stone, metals

Applications in the process and production industry, including power stations, oil and gas, petrochemicals, paper, cement, stone, metals

Applications in the process and production industry, including power stations, oil and gas, petrochemicals, paper, cement, stone, metals

Application examples

- Pumps and fans
- Compressors
- Conveyors
- Mixers
- Kilns

- Pumps and fans
- Compressors
- Extruders and mixers
- Crushers
- Grinding mills
- Kilns
- Test stands

- Pumps and fans
- Compressors
- Extruders and mixers
- Crushers
- Grinding mills
- Marine propulsion
- Test stands

- Pumps and fans
- Compressors
- Extruders and mixers
- Crushers
- Grinding mills
- Kilns
- Test stands

Highlights

- Ready to connect and run
- Flexibility based on G120 modular components
- Optional power regeneration
- UL508C listed
- Safety Integrated
- Optimum interaction with SIMOTION and SIMATIC

- Modular components
- Space-saving
- Low noise
- Easy, quick commissioning
- Optimum interaction with SIMATIC
- Safety Integrated

- Ready to connect and run enclosed drive per IEC standards
- Broad power range
- Space-saving
- Low noise
- Easy, quick commissioning
- Optimum interaction with SIMATIC
- Safety Integrated

- Ready to connect and run enclosed drive per NEMA/ANSI standards
- Optional listing to UL508A
- Low noise
- Easy, quick commissioning
- Safety Integrated

SINAMICS G120E Data Sheet

Catalog D11

Catalog D11

D11.7.1

SINAMICS S150 NEMA

Introduction

1

The SINAMICS drives family

SINAMICS low voltage drives		SINAMICS DC drives	SINAMICS medium voltage drives
SINAMICS S120	SINAMICS S150	SINAMICS DCM	SINAMICS GM150 / SM150 SINAMICS GL150 / SL150
			
<i>The flexible, modular applied drive system for demanding drive tasks</i>	<i>The drive solution for demanding high power single motor drives</i>	<i>The scalable drive system for basic and demanding applications</i>	<i>Drive solutions for single motor and multi motor medium voltage drives</i>
Typical ratings			
380 to 690 V 3 ph. AC 0.15 to 5,000 HP (0.12 to 4,500 kW)	380 to 690 V 3 ph. AC 100 to 1,250 HP (75 to 1,200 kW)	85 to 950 V 3 ph. AC 5 to 24,000 HP (4 kW to 18 MW)	2.3 to 12 kV 3 ph. AC 1,250 to 100,000 HP (1 to 75 MW)
Main applications			
High performance applications in all industries, including coordinated multi-motor drive systems and very high power single drives, motion control (positioning, synchronization).	High performance, fully regenerative standalone drive applications requiring clean power (low harmonics, controllable power factor)	Industrial applications in metals, plastics, printing, paper, cranes, mining, oil and gas, for new installations and retrofits.	General and high performance, very high speed and very low speed applications mainly in the process industries.
Application examples			
<ul style="list-style-type: none"> • Machine tools • Production machines: • Presses • Converting applications • Handling equipment • Paper machines • Rolling mills • Marine applications 	<ul style="list-style-type: none"> • Test bays • Centrifuges • Elevators and cranes • Cross cutters and shears • Downhill conveyor belts • Presses • Cable winches 	<ul style="list-style-type: none"> • Rolling mills • Cross cutters and shears • Wire-drawing machines • Extruders and kneaders • Presses • Elevators and cranes • Cableways and lifts • Mine hoists 	<ul style="list-style-type: none"> • Compressors • Pumps and fans • Extruders and mixers • Hot and cold rolling stands • Mine hoists • Conveyor belts • Grinding mills • Test stand drives
Highlights			
<ul style="list-style-type: none"> • Flexible and modular • Choice of rectifier types • Fully scalable - ratings, functionality, number of axes, performance • Auto-configuration • Wide range of motors • Optimum interaction with SIMOTION, SIMATIC and SINUMERIK • Safety Integrated • Air or liquid cooled 	<ul style="list-style-type: none"> • Ready to connect and run • High control accuracy and dynamic response • Low harmonics, exceeding IEEE 519 requirements • Tolerant of line voltage fluctuations • Reactive power compensation option • Safety Integrated 	<ul style="list-style-type: none"> • Choice of Control Units • Integrated field power supply • Free function blocks and Drive Control Chart • Expandable functionality using SINAMICS components • Single-phase connection possible 	<ul style="list-style-type: none"> • Compact design and high power density • Ready to connect and run enclosed drive • Simple operator control and monitoring • Extremely rugged, reliable in operation and almost maintenance free • Air and liquid cooled versions
Catalogs D21.3, D21.7.1, PM21	This catalog and D21.3	Catalog D23.1	Catalog D12

Application of SINAMICS S150

SINAMICS S150 is an enclosed variable speed drive for high performance stand-alone applications that may require high dynamic performance also on weak or fluctuating power supplies, clean power (low harmonics always meeting the harmonic limits of IEEE 519), frequent braking at high power levels or full regeneration of power back into the supply (4 quadrant operation). Examples of typical applications include centrifuges, test stands, cranes and hoists, overland or downhill conveyors, presses, cross cutters and shears.

Functionality

SINAMICS S150 includes state-of-the-art IGBT PWM inverters on both the line side and motor side, which enables it to transmit power in both directions, from the line to the load or from the load back to the line, whilst operating at unity, or leading or lagging power factor. The drive is characterized by the following capabilities:

- Power regeneration continuously at full rated current for braking. Dynamic braking using a braking chopper and resistor is also optionally available, for example to enable electrical braking of an overhauling load even in the event of a power failure
- An innovative line side clean power filter which provides a clean sinusoidal waveform with current and voltage harmonics well below the most stringent limits of IEEE 519-1992
- Operation on weak power supplies, and tolerance to fluctuations in the line voltage or frequency without affecting or degrading highly dynamic control of the motor.
- Operation at unity power factor (default setting), or reactive power control (capacitive or inductive) to help improve the facility power factor, by operating at a leading or lagging input powerfactor
- Voltage boost operation, for example operate a motor at 460 V, 60 Hz off a 400 V, 50 Hz supply without the need for a step-up transformer

The control can be operated in either Volts/Hertz or sensorless vector control modes, or closed loop vector control with encoder with the addition of optional speed and position encoder interface boards. Siemens vector control also allows operation down to zero speed with high torque accuracy, without an encoder. Other control functions include, for example:

- Critical speed avoidance (4 bands)
- Auto-restart with variable restart delay and number of restarts
- Restart on the fly to catch a spinning motor
- Kinetic buffering where the drive draws power from the motor while it is coasting down during a supply dip or failure

The user friendly AOP30 operator panel with graphical LCD and plain-text display provides easy commissioning and parameterization using interactive menus, and alarm and fault logs.

Benefits

- Clean power drive designed for high efficiency operation at unity (or controllable) power factor
- Motoring or regenerating at full rated current
- All components are easily accessible, making the drive extremely service friendly
- Increase in plant availability since individual modules and power components can be replaced quickly and easily
- Easy commissioning and parameterization using interactive menus on the user friendly AOP30 operator panel with graphical LCD and plain text display
- Type tested, robust design provides guaranteed performance in industrial environments
- A broad range of standard options to optimally configure the drive for the required environment and application



SINAMICS S150 NEMA

Introduction

1

SINAMICS S150 – A Global Product

SINAMICS S150 is a global product. However, regional differences in regulations, standards, specifications and voltage levels for power and control require modifications to the packaging (enclosure) and auxiliary components. SINAMICS 150 enclosed drives are therefore offered in versions designed to IEC (European) as well as to NEMA (North American) standards.

SINAMICS S150 designs to NEMA vs. to IEC standards

All models of SINAMICS S150 (designed to NEMA or IEC standards) use the identical basic drive and electronics components – power module of a particular power and voltage rating, CU320-2 control unit, CompactFlash card

with firmware, AOP30 operator panel as well as interface modules (digital and analog input/output modules such as TM31, SMC30 encoder interface, VSM10 voltage sensing module, CBE20 Ethernet communications module, etc.).

Differences between the NEMA and IEC versions are found in the configuration of the base units, i.e. the enclosure type and the scope of auxiliary equipment/options included, as well as the offered range of standard and custom options.

Below is an overview of some of the more significant differences between NEMA and IEC versions (note this is not a complete list!).

	SINAMICS S150 NEMA Enclosed drive	SINAMICS S150 IEC Cabinet unit
Base unit enclosure and configuration	<p>NEMA 1 (equivalent to IP21 with top hat/roof – air discharge front and back)</p> <p>Included in base for all ratings:</p> <ul style="list-style-type: none"> • Circuit breaker disconnect per NEC/UL for motor branch circuit protection. • Molded case circuit breaker (type VL) plus main contactor, or motorized insulated case (type WL) circuit breaker • Fixed mounted fuses to meet SCCR • SCCR per UL508A: standard 65kA for 480V, 25kA to 65kA for 600V units, large ratings optionally up to 100 kA • Input clean power filter • Touch safe covers • EMC filter Category C3 for 2nd environment (industrial) per IEC 61800-3. 	<p>IP20 (no roof – air discharge upwards)</p> <p>Included in base:</p> <ul style="list-style-type: none"> • Only for ratings >800 A, motorized (type WL) circuit breaker. Note this is not compliant with NEC/UL requirements for motor branch circuit protection. • Input clean power filter • EMC filter Category C3 for 2nd environment (industrial) per IEC 61800-3 <p>EXCLUDED from base (requires option code):</p> <ul style="list-style-type: none"> • Fused disconnect (for <800A). Note this option is not compliant with NEC/UL requirements for motor branch circuit protection • Touch safe covers for smaller ratings (e.g. <400 kW, IP20 or IP21 cabinet)
Enclosure options	<ul style="list-style-type: none"> • NEMA 1 filtered with louvers and dust filters (equivalent to IP23) • IP43 as for IEC unit • NEMA 12 (ventilated) – louvers and fine air filters (equivalent to IP54) 	<ul style="list-style-type: none"> • IP21 (with raised roof) • IP23 (with top hat, louvers & dust filters) • IP43 (like IP23, plus 1 mm mesh screen) • IP54 (like IP23, plus fine air filters)
Exclusive standard options	<p>Only for NEMA version:</p> <ul style="list-style-type: none"> • UL/cUL listing per UL508A 	<p>Only for IEC version:</p> <ul style="list-style-type: none"> • Marine version, and individual marine certification by ABS, DNV and others • EMC filter Category C2 for 1st environment (residential) per IEC 61800-3

SINAMICS S150 NEMA Enclosed drive



2/2	Product design
2/3	Selection and ordering data HP and current ratings
2/4	Technical data Noise level Heat loss Weights Dimensions
2/5	Outline dimension sketch
2/6	Options Table of standard option codes
2/7	Options combination matrix Valid and invalid combinations of options
2/8	Description of options Detailed description of each standard option
2/14	Custom options

SINAMICS S150 NEMA

Enclosed drive

Product design

SINAMICS S150 NEMA enclosed drive is ready to install and run, complete with all necessary accessories. It is offered with a large variety of standard and custom input and output options, such as different enclosure types, output reactor and a range of control and safety integrated options.

SINAMICS S150 NEMA is delivered with the following standard features:

- Basic NEMA 1 enclosure (with top hat, without air filters)
- Circuit breaker disconnect (per NEC requirements for motor branch circuit protection), mechanically interlocked with the enclosure door
- Fuses for short circuit current rating (SCCR)
- Active Interface Module with clean power filter and pre-charge circuit
- Controller CU320-2 DP with integral PROFIBUS DP port
- Input/output module TM31, with digital and analog I/O wired to a customer terminal strip

- Advanced Operator Panel AOP30 for easy start-up and operation
- Windows-based start-up STARTER software – common to all models of the SINAMICS drives family
- CE mark
- Optional UL listing per UL508A

The picture below shows the following cabinets (from left to right):

- Line connection module (door closed) with circuit breaker disconnect and fuses
- Active Interface Module (door open)
- Active Line Module (door closed) – this is the line side IGBT PWM inverter
- Motor Module (door open) – this is the motor side IGBT PWM inverter



SINAMICS S150 enclosed drive 700HP
with NEMA 1 filtered enclosure with transportation beams
(top hats are supplied loose but not shown), 4" base (plinth)

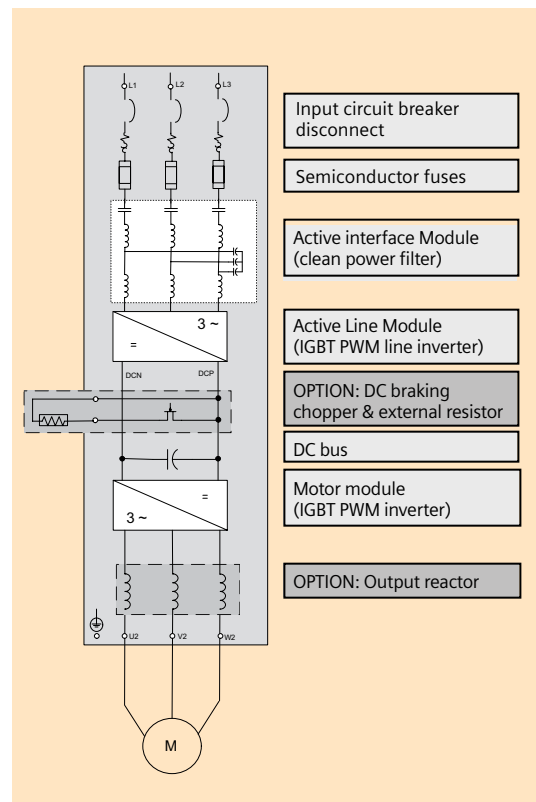

Typical power circuit of SINAMICS S150 enclosed drive

SINAMICS S150 NEMA

Enclosed drive

Selection and ordering data

Note: HP ratings are provided as a guide only, for standard 2, 4 or 6 pole motors. Actual motor currents may be higher, especially for motors with 8 or more poles.

Select a drive based on motor FLA (full load amps) and overloads. Refer also to engineering information.

Low overload			High overload			Rated output current I_N ¹⁾⁴⁾	Input current ⁵⁾	SINAMICS S150 NEMA Enclosed drive	
Output (at 460 V or 575 V, 60 Hz)	Base load current I_L ²⁾⁴⁾	Base load current I_H ³⁾⁴⁾	Output (at 460 V or 575 V, 60 Hz)	Base load current I_L ²⁾⁴⁾	Base load current I_H ³⁾⁴⁾				A
HP	at 400 V or 500 V, 50 Hz	kW	A	HP	at 400 V or 500 V, 50 Hz	kW	A	A	Order No.
Supply voltage 380 V to 480 V 3 ph. AC									
150	110	205	205	150	90	178	210	197	6SL3710-7LE32-1AU3
200	132	250	250	150	110	233	260	242	6SL3710-7LE32-6AU3
250	160	302	302	200	132	277	310	286	6SL3710-7LE33-1AU3
300	200	370	370	250	160	340	380	349	6SL3710-7LE33-8AU3
400	250	477	477	350	200	438	490	447	6SL3710-7LE35-0AU3
500	315	590	590	400	250	460	605	549	6SL3710-7LE36-1AU3
600	400	725	725	500	315	570	745	674	6SL3710-7LE37-5AU3
700	450	820	820	600	400	700	840	759	6SL3710-7LE38-4AU3
800	560	960	960	700	450	860	985	888	6SL3710-7LE41-0AU3
1000	710	1230	1230	900	560	1127	1260	1133	6SL3710-7LE41-2AU3
1150	800	1370	1370	1000	710	1257	1405	1262	6SL3710-7LE41-4AU3
Supply voltage 500 V to 600 V 3 ph. A									
75	75	80	80	75	55	76	85	86	6SL3710-7LG28-5AU3
100	90	95	95	75	75	89	100	99	6SL3710-7LG31-0AU3
100	110	115	115	100	90	107	120	117	6SL3710-7LG31-2AU3
125	132	142	142	125	110	134	150	144	6SL3710-7LG31-5AU3
150	160	170	170	150	132	157	175	166	6SL3710-7LG31-8AU3
200	200	208	208	200	160	192	215	202	6SL3710-7LG32-2AU3
250	250	250	250	250	200	233	260	242	6SL3710-7LG32-6AU3
300	315	320	320	300	250	280	330	304	6SL3710-7LG33-3AU3
400	400	400	400	350	315	367	410	375	6SL3710-7LG34-1AU3
450	450	452	452	450	400	416	465	424	6SL3710-7LG34-7AU3
600	560	560	560	500	450	514	575	522	6SL3710-7LG35-8AU3
700	710	710	710	600	630	657	735	665	6SL3710-7LG37-4AU3
800	800	790	790	700	710	724	810	732	6SL3710-7LG38-1AU3
900	900	880	880	800	800	814	910	821	6SL3710-7LG38-8AU3
1000	1000	1000	1000	900	900	917	1025	923	6SL3710-7LG41-0AU3
1250	1200	1230	1230	1100	1000	1136	1270	1142	6SL3710-7LG41-3AU3

- 1) The rated output current I_N is the maximum continuous output current, without any overload.
- 2) The base load current I_L for light overload duty is based on a duty cycle of duration 300 s with overload of 110% for 60 s or 150% for 10 s.
- 3) The base load current I_H for high overload duty is based on a duty cycle of duration 300 s with overload of 150% for 60 s.
- 4) For a NEMA 12 (ventilated) enclosure (option M54), current values reduced per the derating factor provided on page 3/3.
- 5) The input current is based on the rated output current and includes 10 A to power auxiliary circuits required by the drive.

When ordering a drive with options, add -Z to the order no. followed by option codes separated by a "+" sign.

Example:
6SL3710-7LE32-1AU3-Z M06+M90+...

Note:

- S150 is a standard product, defined by its order no. and option codes.
- "Y" options (+Y...) require additional text to describe the option

For example: +Y09 Special enclosure color **RAL 1018 (traffic yellow)**

SINAMICS S150 NEMA

Enclosed drive

Technical data

SINAMICS S150 NEMA enclosed drive	Output (light overload) at 460 V or 575 V, 60 Hz	Noise level L _{pA} (1m) 50/60 Hz	Cooling air flow demand	Heat loss at 50 Hz (690V)/ 60 Hz (575V)	Short circuit current rating (SCCR)		Nominal Width Drive enclosure W _N		Weight approx. (std enclosure w/o options)		Nominal Width Options Cabinet (dV/dt filter L10) W _O	
					Std.	+L70	inch	mm	lb	kg	inch	mm
Model No.	HP	dB(A)	cfm	kW	kA	kA	inch	mm	lb	kg	inch	mm
Supply voltage 380 V to 480 V 3 ph. AC												
6SL3710-7LE32-1AU3	150	71 / 73	1229	6.31 / 6.49	65	–	55.1	1400	1561	708	N/A*	N/A*
6SL3710-7LE32-6AU3	200	71 / 73	1483	7.55 / 7.85	65	–	55.1	1400	1561	708	N/A*	N/A*
6SL3710-7LE33-1AU3	250	72 / 74	2521	10.01 / 10.45	65	–	63.0	1600	1967	892	N/A*	N/A*
6SL3710-7LE33-8AU3	300	72 / 74	2521	10.72 / 11.15	65	–	70.9	1800	2161	980	N/A*	N/A*
6SL3710-7LE35-0AU3	400	72 / 74	2521	13.13 / 13.65	65	–	70.9	1800	2161	980	N/A*	N/A*
6SL3710-7LE36-1AU3	500	77 / 79	4153	17.69 / 18.55	65	–	86.6	2200	3783	1716	15.7	400
6SL3710-7LE37-5AU3	600	77 / 79	4153	20.63 / 21.75	65	–	86.6	2200	3816	1731	15.7	400
6SL3710-7LE38-4AU3	700	77 / 79	4153	21.10 / 22.25	65	84	86.6	2200	3920	1778	15.7	400
6SL3710-7LE41-0AU3	800	77 / 79	5509	27.25 / 28.65	65	84	110.2	2800	5309	2408	23.6	600
6SL3710-7LE41-2AU3	1000	78 / 80	5509	33.05 / 34.85	65	100	110.2	2800	5309	2408	23.6	600
6SL3710-7LE41-4AU3	1150	78 / 80	5509	33.95 / 35.85	65	100	110.2	2800	5309	2408	23.6	600
Supply voltage 500 V to 600 V 3 ph. AC												
6SL3710-7LG28-5AU3	75	71 / 73	1229	5.12 / 4.45	25	–	55.1	1400	1561	708	N/A*	N/A*
6SL3710-7LG31-0AU3	100	71 / 73	1229	5.38 / 4.65	25	–	55.1	1400	1561	708	N/A*	N/A*
6SL3710-7LG31-2AU3	100	71 / 73	1229	5.84 / 5.12	25	–	55.1	1400	1561	708	N/A*	N/A*
6SL3710-7LG31-5AU3	125	71 / 73	1229	5.75 / 4.97	25	–	55.1	1400	1561	708	N/A*	N/A*
6SL3710-7LG31-8AU3	150	75 / 77	2521	11.02 / 11.15	25	–	63.0	1600	1967	892	N/A*	N/A*
6SL3710-7LG32-2AU3	200	75 / 77	2521	11.44 / 11.56	25	–	63.0	1600	1967	892	N/A*	N/A*
6SL3710-7LG32-6AU3	250	75 / 77	2521	11.97 / 12.03	35	–	63.0	1600	1967	892	N/A*	N/A*
6SL3710-7LG33-3AU3	300	75 / 77	2521	12.69 / 12.63	35	–	63.0	1600	1967	892	N/A*	N/A*
6SL3710-7LG34-1AU3	400	77 / 79	4153	19.98 / 18.86	35	–	86.6	2200	4783	1716	15.7	400
6SL3710-7LG34-7AU3	450	77 / 79	4153	20.55 / 19.47	35	–	86.6	2200	3783	1716	15.7	400
6SL3710-7LG35-8AU3	600	77 / 79	4153	24.05 / 22.85	35	–	86.6	2200	3783	1716	15.7	400
6SL3710-7LG37-4AU3	700	77 / 79	5509	30.25 / 28.75	65	84	110.2	2800	5071	2300	23.6	600
6SL3710-7LG38-1AU3	800	77 / 79	5509	34.45 / 32.75	65	84	110.2	2800	5309	2408	23.6	600
6SL3710-7LG38-8AU3	900	77 / 79	5509	34.65 / 32.85	65	100	110.2	2800	5309	2408	23.6	600
6SL3710-7LG41-0AU3	1000	77 / 79	5509	36.15 / 34.25	65	100	110.2	2800	5309	2408	23.6	600
6SL3710-7LG41-3AU3	1250	77 / 79	5509	42.25 / 39.25	65	100	110.2	2800	5309	2408	23.6	600

N/A* = option L10 dV/dt filter can be accommodated in the base enclosure, and does not require an options cabinet

SINAMICS S150 NEMA

Enclosed drive

Outline dimension sketch

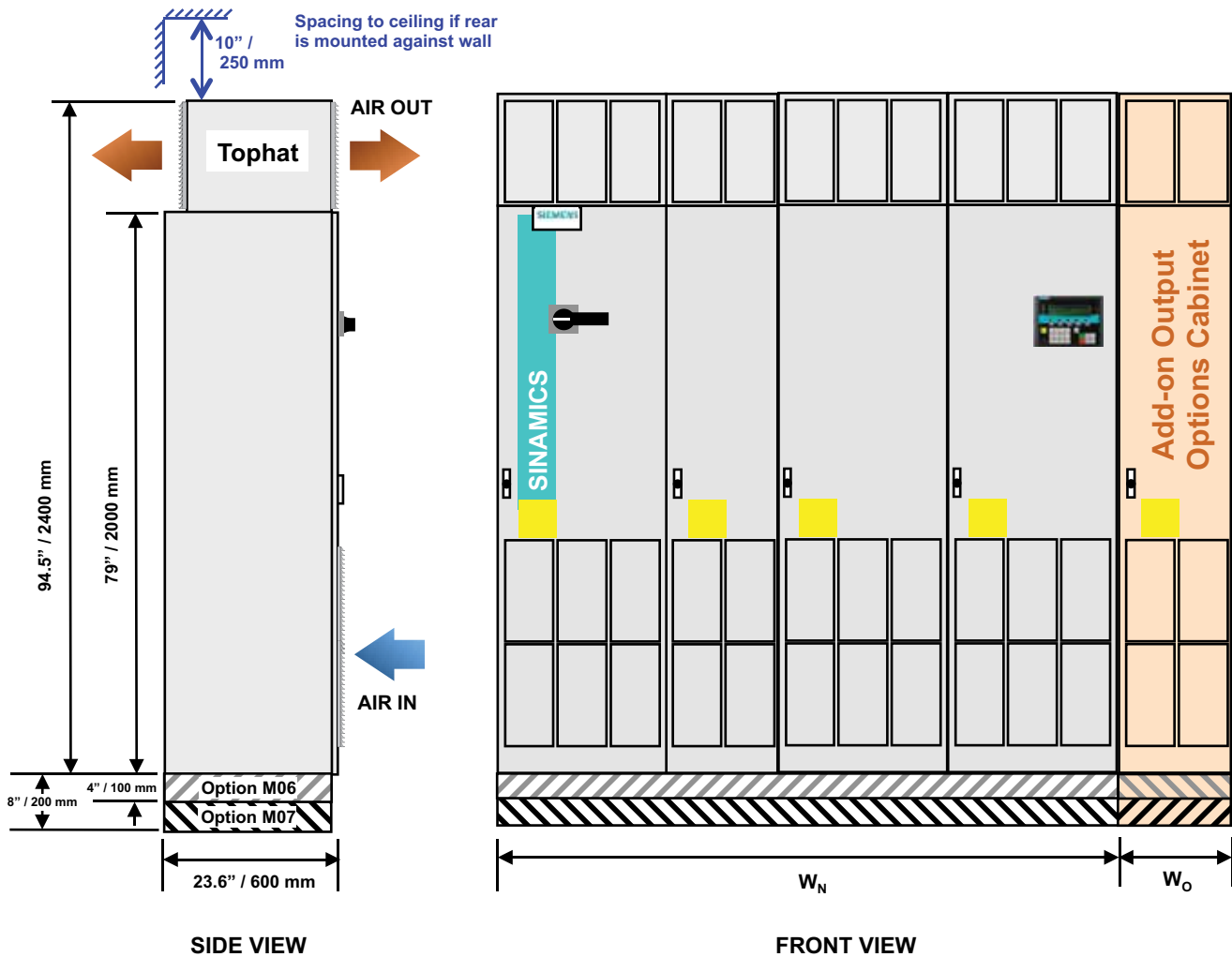

2

Note:

- The drawing shows the SINAMICS S150 enclosed drive with louvers (option M23, M43 or M54).
- For transport reasons, the tophats are delivered separately and must be fitted on site.
- To assure proper air circulation through the drive, please allow a minimum space of 10" (250 mm) between drive tophat and ceiling when mounted against a wall.
- All dimensions are nominal for sheet steel enclosure, tolerance 0.5" (12 mm), excluding protruding components. Please refer to order drawings for exact details.

SINAMICS S150 NEMA

Enclosed drive

Options

Option code	Description	Comment
Enclosure Options		
M06	Base (plinth) 4" (100 mm)	
M07	Base (plinth) 8" (200 mm)	
M13	Line side top cable entry	Only for input current rating >800 A @ 460 V, >600 A @ 575 V
M23	Enclosure NEMA 1 filtered	
M43	Enclosure IP43	
M54	Enclosure NEMA 12 (ventilated)	Requires current derate (refer to page 3/3)
M78	Motor side top cable exit	
M90	Lifting beam/eye bolts	Recommended: Required to lift the drive off pallet
Y09	Special enclosure paint color (specify color)	Please specify required color in text
Power Options		
L04	Infeed module one size smaller	
L08	Motor reactor	
L10	Output dV/dt filter with VPL (voltage peak limiter)	May require add-on options cabinet
L40	Filter (AIM) monitoring	
L61	Braking unit 25/125 kW, 480 V (for 150 HP to 200 HP)	
L62	Braking unit 50/250 kW, 480 V (for 250 HP to 1,150 HP)	
L64	Braking unit 25/125 kW, 600 V (for 75 HP to 125 HP)	
L65	Braking unit 50/250 kW, 600 V (for 150 HP to 1,250 HP)	
L70	High SCCR (short circuit current rating) 84 or 100 kA	
L87	Insulation Monitor for ungrounded supplies	
L96	Input surge protective device Type 1 per UL1449	
Miscellaneous Options		
L17	Feeder for external auxiliaries (line volts) 3ph. AC, max. 10 A	
L50	Enclosure light with power outlet 120 V, 1 ph AC, 5 A	
L55	Enclosure space heater	
U90	UL listing per UL508A	Requires options M23 or M43 or M54
U91	cUL listing for Canada per UL508A	Requires options M23 or M43 or M54, and T58
Control Options		
G20	CBC10 communication board CANopen	
G22	MODBUS RTU (to PROFIBUS) communication converter	
G33	CBE20 Communication Board Ethernet, SINAMICS link or PROFINET or Ethernet/IP	
G51	TM150 Terminal Module for temperature (RTD) monitoring	
G52	Qty. 2 of TM150 Terminal Module for temperature (RTD) monitoring	
G61	Additional TM31 terminal module for digital and analog I/O	
G65	TM31 I/O wired to customer terminal strip	
G66	Additional TM31 (opt. G61) I/O wired to customer terminal strip	
K01	SAFETY Safety license (for 1 axis)	
K46	SMC10 sensor module for speed/position feedback	
K48	SAFETY SMC20 sensor module for speed/position feedback	
K50	SAFETY SMC30 sensor module for speed feedback	
K51	VSM10 voltage sensing module	
K52	SAFETY Additional SMC30 sensor module	
K82	SAFETY Terminal interface for Safety Integrated functions STO and SS1	
K87	SAFETY TM54F Terminal Module (requires option K01)	
K88 ¹⁾	SAFETY Safe Brake Adapter SBA, 230 V AC	
K95	Control unit CU320-2 PN (PROFINET)	
N55	ALL STOP (mushroom pushbutton), coast to stop	
N57	EMERGENCY OFF category 0, 120 V or 24 V, coast to stop	
N59	EMERGENCY STOP category 1, 120 V, controlled ramp down	
N60	EMERGENCY STOP category 1, 24 V, controlled ramp down	
N70	Control power supply 120 V 1 ph AC, 5 A	
Documentation and Languages		
D02	Customer drawings in dxf format	Standard: In pdf format only
D04	Customer documentation in paper format, one set	Standard: In electronic format only
D14	Advance copy of customer documentation (pdf)	Standard: Documents ship with drive
D58	Documentation English/French	Standard: Documentation English/Spanish
T58	Nameplate English/French	For additional languages, please consult factory
Testing		
F03	Visual inspection by customer	
F71	Witnessed function test without motor	
F75	Witnessed function test with test-bay motor, no load	
F77	Witnessed test incl. high-voltage and insulation test (only additional to option F71 or F75)	
F97	Witnessed customer specific test (on request)	

¹⁾ This option is not yet UL listed and cannot be included in a UL listed drive.

Options combination matrix

The following tables provide an overview of possible and impermissible combinations of standard options. Please refer to the descriptions of options for more information. Custom configurations may be possible to provide combinations not available as standard – please contact the factory.

Mechanical and miscellaneous options

	L08	L10	M06	M07	M23	M43	M54	M78	U90	U91
L08		-	✓	✓	✓	✓	✓	-	✓	✓
L10	-		✓	✓	✓	✓	✓	-	✓	✓
M06	✓	✓		-	✓	✓	✓	✓	✓	✓
M07	✓	✓	-		✓	✓	✓	✓	✓	✓
M23	✓	✓	✓	✓		-	-	✓	✓	✓
M43	✓	✓	✓	✓	-		-	✓	✓	✓
M54	✓	✓	✓	✓	-	-		✓	✓	✓
M78	-	-	✓	✓	✓	✓	✓		✓	✓
U90	✓	✓	✓	✓	✓	✓	✓	✓		-
U91	✓	✓	✓	✓	✓	✓	✓	✓	-	

✓	Possible combination
-	Combination not available as standard

Communication and control options

	G20	G22	G33	G51	G52	G61	G65	K95
G20		-	-	✓	✓	✓	✓	✓
G22	-		-	✓	✓	✓	✓	-
G33	-	-		✓	✓	✓	✓	✓
G51	✓	✓	✓		-	✓	✓	✓
G52	✓	✓	✓	-		✓	✓	✓
G61	✓	✓	✓	✓	✓		✓	✓
G65	✓	✓	✓	✓	✓	✓		✓
K95	✓	-	✓	✓	✓	✓	✓	

Braking unit options

	L61	L62	L64	L65
L61		-	-	-
L62	-		-	-
L64	-	-		-
L65	-	-	-	

Sensor module (encoder) options

	K46	K48	K50	K51	K52
K46		-	-	-	-
K48	-		-	-	-
K50	-	-		-	-
K51	-	-	-		-
K52	-	-	-	-	

Safety and stop options

	K82	N55	N57	N59	N60
K82		✓	✓	✓	✓
N55	✓		-	-	-
N57	✓	-		-	-
N59	✓	-	-		-
N60	✓	-	-	-	

Description of options

Standard documentation

Customer drawings supplied with the new SINAMICS S150 NEMA are always job specific (showing the configuration actually supplied, options not provided are not shown).

All customer documentation is provided in electronic format on a CD, which ships inside the drive. All documents are in pdf format (Adobe Acrobat) and are supplied in English and a copy in Spanish. In addition, a paper copy of the Safety and Transportation Guidelines and the Installation Check List are included too.

D02

Customer drawings in dxf format

Schematics, outline dimension and layout drawings will be provided in AutoCAD (dxf) on the CD (or as specified by other option codes).

D04

Customer documentation in paper format, one set

A paper copy of customer drawings, spare parts list and test certificate is shipped with the drive. For multiple copies, add option code to order no. multiple times (once for each set).

D14

Advance copy of customer documentation (pdf)

To receive a copy of customer drawings earlier than with drive shipment, i.e. after order placement (typically within 2 weeks). If option codes D02 and/or D04 are specified, the advance copy of the drawings will be supplied in dxf format and/or paper too.

D58

Documentation English/French

Two copies of the documentation (drawings and manuals) will be provided on the CD (or as specified by other option codes), one in English and the other in French.

F03, F71, F75, F77, F97

Witnessed (or observed) testing

Order code	Description	
F03	Visual inspection by customer	<p>The scope of the inspection comprises:</p> <ul style="list-style-type: none"> • Checking the enclosure type • Checking the equipment (components) • Checking the equipment identifiers • Checking the clearance and creepage distances • Checking the wires • Checking the customer documentation • Submitting the acceptance report <p>The checks are carried out with the drive deenergized.</p>
F71	Witnessed or observed function test of drive without motor	<p>The scope of the witnessed test comprises:</p> <ul style="list-style-type: none"> • Visual inspection as per option F03 • Check of power supply • Check of protective and monitoring devices (simulation) • Check of fans • Precharging test • Functional test without connected motor • Submitting the acceptance report <p>After the visual inspection with the drive switched off, the drive is connected to rated voltage. No current flows at the drive output.</p>
F75	Witnessed or observed function test with test-bay motor, no load supply	<p>The scope of the witnessed test comprises:</p> <ul style="list-style-type: none"> • Visual inspection as per option F03 • Check of power supply • Check of protective and monitoring devices (simulation) • Check of fans • Precharging test • Functional test with test bay motor (no load) • Submitting the acceptance report <p>After the visual inspection with the drive switched off, the drive is connected to rated voltage.</p> <p>A small current flows at the drive output to power the test bay motor (no load).</p>
F77	Witnessed or observed test incl. high-voltage and insulation test	<p>The scope of the acceptance comprises:</p> <ul style="list-style-type: none"> • High-voltage test • Measurement of insulation resistance
F97	Witnessed or observed customer specific drive acceptance inspections/tests (on request)	<p>If additional witnessed testing is desired over and above options F03 to F71, please provide a specification/test plan for the factory to submit a quotation.</p>

Description of options

G20

CBC10 Communication Board CANopen

The CBC10 Communication Board is used to interface the CU320-2 Control Unit of the SINAMICS S150 to the CAN (Controller Area Network) protocol. The board's driver software fulfills the standards of the following CANopen specification of the CiA organization (CAN in Automation):

- Communication profiles in accordance with DS 301
- Drive profile in accordance with DSP 402 (in this case Profile Velocity Mode)
- EDS (Electronic Data Sheet) in accordance with DSP 306
- Operating status signaling in accordance with DSP 305

The CBC10 Communication Board plugs into the option slot on the CU320-2 Control Unit. The CAN interface on the CBC10 has 2 SUB-D connections for input and output.

G22

MODBUS RTU communication

A MicroBridge converter connects the PROFIBUS port on the CU320-2 DP control unit to a MODBUS RTU or ASCII network. The male DB9 network port will operate at any standard baud rate from 1,200 to 115,200 baud.

A pre-defined set of MODBUS holding registers is provided to allow access to the most common drive parameters, monitor values, setpoint values, and control points for the drive.

G33

CBE20 Communication Board Ethernet

The CBE20 Communication Board connects the CU320-2 DP or CU320-2 PN Control Unit to an additional communications bus. The CBE20 can be parameterized to connect to either:

- **SINAMICS Link** high speed peer-to-peer communications with other CBE20 modules plugged into the CU320-2 control units of other SINAMICS drives, up to 64 nodes.
- **PROFINET** I/O network, 100 Mbit/s full-duplex, supports real-time classes RT (Real-Time) and IRT (Isochronous Real-Time). (Only one communication interface can be used in isochronous operation when operating the CBE20 in a CU320-2 DP or PN Control Unit).
- **EtherNet/IP** (EtherNet Industrial Protocol) is an open standard predominantly used in the automation industry. EtherNet/IP is supported by the Open DeviceNet Vendor Association (ODVA).

In addition, the CBE20 allows on a PROFINET or EtherNet/IP network:

- Standard **Ethernet TCP/IP** communication for engineering processes using the STARTER commissioning tool

The CBE20 Communication Board plugs into the option slot on the CU320-2 Control Unit. It has 4x RJ45 Ethernet ports.

Description of the CBE20 Communication Board Ethernet
→ Chapter 4.

G51/G52

TM150 Terminal Module (RTD Monitoring)

Up to two TM150 may be mounted in a SINAMICS S150:
G51 = 1x TM150, G52 = 2x TM150.

The TM150 RTD module is suitable for monitoring temperature sensors type Pt100 or Pt1000 (Platinum RTD 100 ohm or 1,000 ohm), KTY84, PTC thermistor or a temperature switch contact (NC). Up to 12 sensors in 2-wire connection or up to 6 sensors in 3- or 4-wire connection can be connected to one TM150.

Temperature values from the TM150 are available for further processing, for transmission to the process control system via bus communications and can be displayed on the AOP30.

Note: TM150 inputs are not electrically isolated. Only temperature sensors isolated per IEC 61800-5-1 may be connected to terminals "+Temp" and "-Temp." Failure to observe these instructions can result in electric shock!

G61

Additional TM31 terminal module

In the standard version, the drive already includes an input/output module (TM31 terminal module). With a second module, the number of available digital and analog inputs/outputs within the drive is doubled. Refer to engineering information for details.

G65/66

TM31 I/O wired to customer terminal strip

The terminals of a TM31 module (for #16/#14 AWG wire) are wired to a customer terminal strip for connecting #14/#12 AWG wires.

K01

Safety License

Safety Integrated Basic Functions (STO, SS1, SBA) do not require a license. A license is, however, required for using Safety Integrated Extended Functions. It is irrelevant which safety functions are used and how many.

The safety licenses can be optionally ordered retrospectively and loaded to the CompactFlash card. A license key can be generated via the WEB License Manager at: www.siemens.com/automation/license

K46 SMC10 Sensor Module Cabinet-Mounted

The SMC10 Sensor Module Cabinet-Mounted connects to a resolver to simultaneously sense the speed and the rotor position angle of a motor, and make this information available to the regulator via the DRIVE-CLiQ interface. The following encoder signals can be evaluated:

- 2-pole resolver
- Multi-pole resolver

The motor temperature can also be detected using KTY84-130 or PTC thermistors.

Description of the SMC10 Sensor Module Cabinet-Mounted – Chapter 3.

Description of options

K48

SMC20 Sensor Module Cabinet-Mounted

The SMC20 Sensor Module Cabinet-Mounted connects to an incremental encoder to simultaneously sense the speed and the rotor position angle of a motor, and make this information available to the regulator via the DRIVE-CLiQ interface.

The following encoder signals can be evaluated:

- Incremental encoder sin/cos 1 VPP
- EnDat absolute encoder
- SSI encoder with incremental signals sin/cos 1 VPP (firmware version 2.4 and later)

The motor temperature can also be detected using KTY84-130 or PTC thermistors.

[Description of the SMC20 Sensor Module Cabinet-Mounted – Chapter 3.](#)

K50

SMC30 sensor module for speed feedback

The SMC30 encoder module is used to connect a speed feedback encoder to the drive. Rotary pulse encoder signals are converted for evaluation via the DRIVE-CLiQ interface of the controller.

The following encoders are supported by the SMC30:

- TTL encoders
- HTL encoders

The motor temperature can also be detected using a KTY84-130 sensor or PTC thermistors. [Description of the SMC30 Sensor Module Cabinet-Mounted – Chapter 3.](#)

K51

VSM10 voltage sensing module

The VSM10 Voltage Sensing Module reads the voltage waveform at the drive output to allow implementation of the following functions:

- Flying restart of a permanent-magnet synchronous motor without encoder.
- Quick flying restart of large induction motors: The voltage sensing function eliminates the delay incurred by demagnetization of the motor.

[Description of the VSM10 voltage sensing module – Chapter 3.](#)

K52

Additional SMC30 Sensor Module

This option code is to add a second SMC30 sensor module (in addition to one specified by option K50). Two SMC30 with associated encoders may be required for Safety Extended functions.

K82

Terminal interface for controlling the “Safe Torque Off” and “Safe Stop 1” safety functions

This terminal interface offers a wide voltage range (24 V to 240 V DC or AC) for easy integration of the following basic Safety Integrated functions into the plant controls:

- Safe Torque Off (STO)
- Safe Stop 1 (SS1) (time-controlled)

The components inside the drive (Control Unit and Power Module, from the terminals on these devices) are certified in combination with firmware versions to satisfy the requirements of the following standards. With option K82 the enclosed drive unit also meets the requirements of:

- Machinery Directive 98/37/EC
- IEC 60204-1
- ISO 13849-1 Category 3, for Performance Level (PL) d
- IEC 61508 SIL 2

These Safety Integrated functions of SINAMICS S150 are generally certified by independent institutes. An up-to-date list of certificates is available on request from your local Siemens office.

K87

TM54F Terminal Module

The TM54F Terminal Module provides fail safe digital inputs and outputs for hardwired control of the Safety Integrated extended functions (as opposed to control via bus communications with PROFIsafe).

Safety Integrated extended functions require a safety license (option **K01**).

The TM54F must be connected directly to the Control Unit via DRIVE-CLiQ.

Note: It is not permissible to connect Motor Modules and Line Modules to a TM54F. The TM54F has 4 fail safe digital outputs and 10 fail safe digital inputs. A fail-safe digital output consists of one 24 V DC switching output, an output switching to ground and one digital input to check the switching state. A fail-safe digital input consists of two digital inputs.

K88

Safe Brake Adapter SBA, 230 V AC

Safe Brake Control (SBC) is a basic safety function that is used in safety-relevant applications, for example in presses or rolling mills. In the no-current state, the brake is applied to the drive motor shaft using spring force. The brake is released when current flows in it (low active).

The Safe Brake Adapter 230 V AC is factory installed in the drive. A source of power is connected to terminal -X12 on the Safe Brake Adapter. For control, a connection is established between the Safe Brake Adapter and the Control Interface Module in the factory using a wire harness. On the plant side, to control the brake, a connection must be made between terminal -X14 on the Safe Brake Adapter and the brake.

Note: The safe brake adapter is not yet UL listed. Option K88 cannot be included in a UL listed drive.

Description of options

K95

CU320-2 PN Control Unit

Replace the standard CU320-2 DP with PROFIBUS port by the CU320-2 PN with PROFINET port

L04

Infeed module one size smaller

With this option, the infeed (Active Line Module/Active Interface Module) is rated one power level lower than the Motor Module (inverter).

This option is suitable for the following applications, for example:

- When the Motor Module is operated at pulse frequencies greater than the rated pulse frequency, which means that the output power is reduced (current derating as a function of the pulse frequency).
- If the rated power is required in regenerative mode and the system losses are covered by the Motor Module.
- With motors that have a higher efficiency and/or a lower power factor compared to typical standard induction motors.
- The application requires high current of the Motor Module only at lower speeds (maximum power demand than the maximum power rating of the unit), e.g. drives with a high breakaway torque.

When using option **L04**, the following restrictions apply:

- The rated output current of the Motor Module is only available as long as the infeed (Active Line Module) is not loaded with the rated power.
- In the event of line undervoltage, the output power is reduced in proportion to the line voltage.
- The unit should be operated at unity line power factor (this corresponds to the factory default setting) to provide only active power. (no reactive power compensation).

Option **L04** is available only for the following units:

SINAMICS S150 Enclosed drive	Output at 460 V (Light Overload)	Permissible currents		
		Rated output current	Standard input current rating	Input current rating Option L04
6SL3710-...	HP	A	A	A
Supply voltage 380 V to 480 V 3 ph. AC				
7LE33-1AU3	250	310	310	260
7LE35-0AU3	400	490	490	380
7LE36-1AU3	500	605	605	490
7LE37-5AU3	600	745	745	605
7LE41-0AU3	800	985	985	840

L08

Motor reactor

Motor reactors reduce the voltage load on the motor windings by reducing the voltage gradients (dV/dt) generated by the drive at the motor terminals. (Note that a motor reactor does not increase the maximum motor cable length for SINAMICS S150 – refer to engineering information).

L10

Output dV/dt-Filter with VPL (Voltage Peak Limiter)

The dV/dt filter plus VPL allows the connection of non-inverter duty motors to the SINAMICS S150 drive.

For motors insulated per NEMA MG1, part 30 (voltage peaks <1,000 V and dV/dt <500 V/μs) the maximum allowable motor cable length is as follows. Note that longer cable lengths of up to 450 m are possible, but voltage peaks may exceed 1,000 V. Please refer to engineering information for additional details.

Rated voltage	Maximum motor cable length for motors insulated per NEMA MG1, part 30	
	Unshielded cable	Shielded cable
380 – 480 V	980' (300 m)	980' (300 m)
500 – 600 V	490' (150 m)	490' (150 m)

The dV/dt filter plus VPL consists of two components: the dV/dt reactor and the VPL (Voltage Peak Limiter), which limits voltage peaks and returns the energy to the DC link. It is housed in an add-on options cabinet. Option L10 cannot be combined with option M78 (Motor side top cable exit).

L17

Feeder for external auxiliaries (line volts) 3ph. AC

An outgoing circuit fused at max. 10 A for external auxiliary equipment (for example, a motor blower). The voltage is tapped at the converter input and, therefore, has the same level as the supply voltage. The circuit includes a motor circuit protector (MCP) and a contactor (120 V coil) that can be controlled internally by the drive or externally.

L40

Filter (AIM) monitoring

The very low line harmonics of the Active Infeed can only be guaranteed if the clean power filter functions correctly. Option **L40** is recommended especially for weak and sensitive line supplies where the harmonic quality must be guaranteed, and where a reduction of filter performance is not acceptable. This option monitors the filter characteristics and reliably identifies any changes. The following characteristics are monitored:

- Filter capacitance: The capacitance of the filter is calculated using the current and voltage. The calculated value is compared with the installed capacitance. An alarm is issued if a capacitor fails.
- Short-circuit: A short-circuit in the filter is identified by monitoring the current and voltage. The current is monitored against a maximum value and the voltage against a minimum value. An OFF 2 trip command (coast to stop) is issued to the main circuit breaker if a limit value is exceeded.

L50

Enclosure light with power outlet 120 V, 1 ph AC, 5 A

One universal light with an integrated service socket (3 pin US style) is installed in the line connection cabinet of the drive as well as in the add-on options cabinet (if applicable). The light is switched manually. This option requires an external power source.

Description of options

L55

Enclosure space heater

Space heaters are recommended at low ambient temperatures and high levels of humidity to prevent condensation. One 90 W heater is provided for each cabinet >32" (800 mm) width. For cabinets exceeding this width, two heaters will be installed. This option requires an external power source.

L61, L62, L64, L65

Braking units

Braking units may be required for drives in which motors might operate in generator mode and the excess energy cannot be absorbed by other loads or regenerated back into the supply system, or braking is required if the supply system fails.

The braking unit comprises two components:

- A Braking Module that can be installed in the air discharge of chassis format power units
- A braking resistor to be mounted externally (IP20 degree of protection).

The braking unit functions as an autonomous unit, and does not require an external power supply. During the braking process, the kinetic energy is converted into heat in the externally mounted braking resistor.

A cable length of max. 328 ft. (100 m) is permissible between the Braking Module and the braking resistor. This allows the braking resistor to be mounted externally so that heat losses can be dissipated outside the drive enclosure. The braking resistor is directly connected to the Braking Module.

For SINAMICS S150, the following braking modules are available, depending on the frame size:

Option	For frame size	Braking Module		
		Rated power P_{DB} kW	Rated power P_{DB} kW	Rated power P_{DB} kW
380 ... 480 V 3ph. AC (& 660... 690 V 3ph. AC)				
L61	FX	25	100	125
L62	GX, HX, JX	50	200	250
500 ... 600 V 3ph. AC				
L64	FX	25	100	125
L65	GX, HX, JX	50	200	250

P_{DB} : Rated power (continuous braking power)

P_{20} : 20 s power referred to a braking interval of 90 s

P_{15} : 15 s power referred to a braking interval of 90 s

For additional information, please refer to the description of Braking Modules in Section 3.

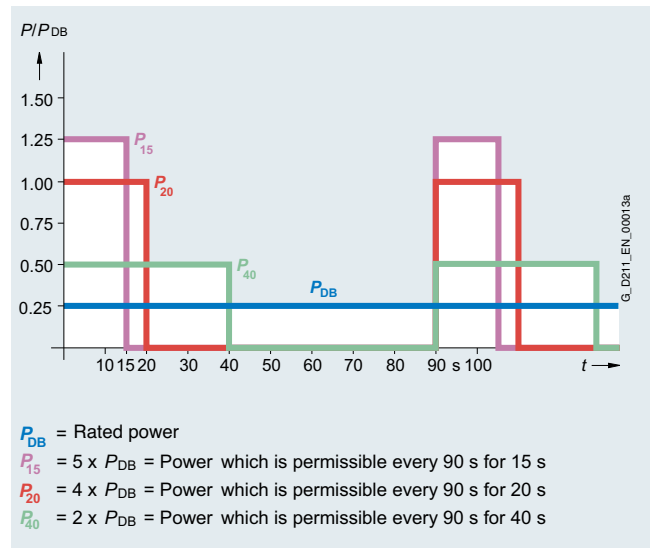

Load diagram for Braking Modules and braking resistors

Additional notes about possible duty cycles of the braking resistors and other engineering notes are included in the SINAMICS Low Voltage Engineering Manual.

L70

High SCCR rating

Line Connection Modules have a short circuit current rating (SCCR) per UL508A supplement SB. The standard SCCR as well as the high SCCR (84 or 100 kA) available for large ratings available with option L70 are shown in the technical data on page 2/4.

L87

Insulation Monitor for ungrounded supplies

An insulation monitor must be used if the drive is operated on an ungrounded power supply. This device monitors the complete electrically connected circuit for insulation (ground) faults. Two threshold values of resistance to ground (between 1 k Ω and 10 M Ω) can be set (for alarm and fault).

Since the response philosophy to a ground fault may differ, output relay contacts are not wired in the drive but available for wiring to drive terminals or integration into a plant control system. Additional terminals on the device are provided for an output to an external display, and inputs for external reset and test buttons.

Note: Only one insulation monitor can be used in an electrically connected network.

L96

Input surge protective device

Type 1 Surge Protective Device per UL 1449 Third Edition, wired to load side of incoming circuit breaker.

M06

Base (plinth) 4" (100mm) high

The 4" enclosure base allows larger bending radii for cables (cable entry from below) and routing them within the base.

Description of options

It is delivered already mounted to the enclosure. The height of the operator panel changes accordingly. The base is always colored RAL 7022 (umbra grey). A special color is not possible.



Enclosure with option M06

M07

Base (plinth) 8" (200mm) high

The 8" enclosure base provides more space for bending and routing cables. The base is delivered already mounted to the enclosure. The height of the operator panel changes accordingly.

The base color is the same as the enclosure, RAL 7035 (light grey). If the enclosure is ordered in a special color (option Y09), the 8" base is also painted the same color.

M13

Line side top cable entry

This option provides copper stabs and a ground connection in the tophat (only for drives with input current rating >800 A @ 460 V, >600 A @ 575 V. For smaller ratings cables can enter from top or bottom).

M23

Enclosure NEMA 1 filtered

Louvers and foam air filters are added to air inlet and outlet openings (IP23). A NEMA 1 filtered enclosure is required to meet the requirements for listing the enclosed drive per UL508A.

M43

Enclosure IP43

Similar to NEMA 1 filtered (M23), but additionally a 1 mm wire mesh is provided behind the air filters.

M54

Enclosure NEMA 12 (ventilated)

Louvers and fine paper air filters are added to air inlet and outlet openings (IP54), to prevent even fine dust particles from entering the enclosure in very dusty environments. These fine dust filters are a patented design for high volume airflow with small derating. The drive current must be derated with a NEMA 12 filtered enclosure – refer to derating values on page 3/3.

M78

Motor side top cable exit

This option provides copper stabs and a ground connection in the tophat above the power module, for connecting motor cables entering the enclosure from above.

If option L61 or L62 is selected together with option M78, the braking resistor should also be connected from above. Note that the combination of standard options M78 with L08 (motor reactor) or L10 (dV/dt filter) is not possible. Please consult factory if this combination is required.

M90

Lifting beams

Note: Option M90 is strongly recommended, to enable lifting the drives off their pallet safely.

Once the drives are in position, the lifting hardware needs to be removed to mount the tophats. For multiple drives with identical enclosure sizes, option M90 can be ordered once and the hardware re-used for other units.



SINAMICS drive on pallet with transportation beams

N55

ALL STOP, coast to stop

A mushroom style, latching, twist-to-release, padlockable push button is mounted on the door wired to OFF2. The motor coasts to stop.

This function is a basic single channel stop circuit. With an input contactor (options L13, L29 or L30), the drive can also be isolated from the supply.

N57

EMERGENCY OFF category 0, coast to stop, 120 V AC or 24 V DC

EMERGENCY OFF Category 0 for uncontrolled stop in accordance with IEC 60204-1

The function bypasses the microprocessor controller by means of a safety relay combination in accordance with IEC 60204-1, and disconnects the drive from the line by opening the input contactor. The motor coasts to stop.

A mushroom style, latching, twist-to-release, padlockable push button is mounted on the door. When delivered, the button circuit is preset to 120 V AC. Jumpers must be set when using 24 V DC.

N59

EMERGENCY STOP category 1, controlled ramp down, 120 V AC

EMERGENCY STOP Category 1 for controlled stop in accordance with IEC 60204-1, 120 V AC circuit.

The function includes a fast ramp down of the drive (to be parameterized by the user). This is followed by disconnecting the drive from the supply as described for the EMERGENCY OFF category 0.

A mushroom style, latching, twist-to-release, padlockable push button is mounted on the door.

A braking unit may be necessary to achieve the required shutdown times also in the event of a power failure.

SINAMICS S150 NEMA

Enclosed drive

Description of options

Attention: Option N59 always assumes that the drive can be electrically isolated from the supply; i.e. either option L13, L29 or L30 must be selected too.

N60

EMERGENCY STOP category 1, controlled ramp down, 24 V DC

EMERGENCY STOP Category 1 for controlled stop in accordance with IEC 60204-1, 24 V DC circuit.

The function includes a fast ramp down of the drive (to be parameterized by the user). This is followed by disconnecting the drive from the supply as described for the EMERGENCY OFF category 0.

A mushroom style, latching, twist-to-release, padlockable push button is mounted on the door.

A braking unit may be necessary to achieve the required shutdown times also in the event of a power failure.

N70

Control power supply 120 V, 6 A

A 120 V 1ph. AC control power supply fused for 6A, protected by an MCP, is provided for customer use, for example to supply power to external interlocking circuits.

T58

Nameplate English/French

The standard nameplate text is in both English and Spanish. This option provides for a nameplate with both English and French text.

U90

UL listing per UL508A

The drive is provided with the UL listing mark per UL508A (UL file number E83449).

The basis for UL listing is the maximum continuous output current rating of the drive. For a specific duty cycle rating (light overload/VT or high overload/CT) the respective base load current may not in all instances be in line with the current rating per NEC table 430-150.



UL listing mark

Note UL listing requires air filters (options M23 or M43 or M54).

U91

cUL listing for Canada per UL508A

The drive is provided with the cUL listing mark for Canada per UL508A (UL file number E83449).

Note cUL listing requires air filters (options M23 or M43 or M54), and English/French nameplate (T58).

Y09

Special enclosure paint color (specify color)

The standard color of the drive enclosures is RAL 7035 (light grey). The special color must be specified in plain text when ordering.

In general, colors available as powder coating can be ordered. Please consult factory to confirm. The enclosure, tophats and, if specified, 8" high plinths (option M07) will be supplied in the specified special color.

Note:

1. The molded plastic parts (e.g. louvers) are colored RAL 7035 and cannot be painted.
2. 4" plinths are always colored RAL 7022 (umber grey).
3. Cabinet frames and interiors are always colored RAL 7035.

Custom options

In addition to the standard options described above, SINAMICS S150 NEMA enclosed drive can be supplied with a broad range of custom engineered options for specific environmental or application conditions.

Examples of custom options include:

- Flange mounted vertical disconnect handle
- Additional control components: Pushbuttons, control switches and indicator lights
- 120 V digital inputs/outputs
- Isolated analog inputs/outputs
- Output sinusoidal filter
- Output contactor, including multiple contactors for pump staging schemes
- Automatic bypass, to automatically transfer the motor to bypass operation for example in the event of a drive fault, or alternatively speed dependent for energy savings.
- Synchronized bypass, for bumpless transfer of motor(s) from the drive to the fixed frequency supply, and back.
- NEMA 12 enclosure suitable for ducting air in and out.

Please consult factory for custom engineered options.



SINAMICS S150 NEMA with flange mount vertical disconnect handle.



3/2	Technical data Electrical and mechanical data Compliance with standards Ambient conditions Mechanical stability
3/3	Derating data Current derating due to altitude and temperature Voltage derating due to altitude Current derating due to pulse frequency
3/5	Motor and drive sizing, overloads Dimensioning of drives Motor and drive sizing Overload capability
3/6	Input and output reactors and filters, harmonics, motor design Input line reactor Harmonic feedback Motor cable lengths Motor design Output reactor and dV/dt filter
3/7	Operator panel
3/8	Control interfaces, Firmware functions
3/9	Control unit and accessories Bus communications
3/10	CBE20 Communication Board EtherNet
3/11	Digital/analog inputs and outputs
3/12	RTD monitor
3/13	Sensor Modules
3/17	Safety integrated functions
3/27	Overview of Safety Integrated Functions
3/28	TM54F Terminal Module
3/30	Safe Brake Adapter
3/31	Braking Units

SINAMICS S150 NEMA

Engineering Information

Technical data

Electrical data			
Supply voltages and output ranges	380 V to 480 V 3 ph AC, ±10% (-15% < 1 min) 150 to 1,150 HP 500 V to 600 V 3 ph AC, ±10% (-15% < 1 min) 75 to 1,250 HP		
Supply systems	Grounded (TN/TT) supplies or ungrounded (IT) supplies		
Line frequency	47 Hz to 63 Hz		
Output frequency	0 Hz to 550 Hz (higher output frequencies possible - consult factory)		
Power factor fundamental / total	Preset to 1.0; adjustable		
Converter efficiency	> 96%		
Control method	Vector control (sensorless and closed loop) or V/Hz control		
Fixed speeds	15 fixed speeds plus 1 minimum speed, programmable (in the default setting 3 fixed setpoints plus 1 minimum speed can be selected via digital inputs or bus communications)		
Skipped frequency ranges	4, programmable		
Setpoint resolution	0.001 rpm digital (14 bits + sign); 12 bit analog		
Braking operation	Fully regenerative as standard; optional braking unit and resistor for braking if power fails		
Mechanical data			
Type of enclosure	NEMA1 (optionally NEMA 1 filtered or NEMA 12 ventilated)		
Enclosure details	Rittal TS8, doors with double bit lock and 3-point latch, three section base plates for cable entry		
Enclosure color	RAL 7035 light grey, indoor installation		
Type of cooling	Forced air ventilation		
Noise level LpA (1 m)	< 80 dB at 60 Hz line frequency		
Environmental protection	Nickel plated busbars, varnish coated electronic boards		
Compliance with standards			
Standards	NEMA ICS 7, NEMA ICS 7.1, NEMA 250, NFPA79, UL508C for power module, ISO 13849-1, IEC 60146-1-1, IEC 60204-1, IEC 60529, IEC 60508-1, IEC 61800-2, IEC 61800-3, IEC61800-5-1, IEC 61800-5-2		
UL listing	Optional listing per UL508A		
CE marking	In accordance with EMC directive No. 2004/108/EC and low-voltage directive No.2006/95/EC and Machinery Directive No. 2006/42/EC for functional safety)		
EMC conformance	EMC conformance is compliant with the EMC product standard for variable-speed drives IEC 61800-3 for the "Second environment", category C3 (industrial supply systems). The equipment is not designed for connection to the "First environment" (public/ residential supply systems) and may cause electromagnetic interference on a public system.		
Ambient conditions	Operation	Storage	Transport
Ambient temperature	32°F to 104°F (0 °C to +40 °C) Up to +122°F (+50°C) with derating	-13°F (-25 °C) to 131°F (+55 °C)	-13°F (-25 °C) to 158°F (+70 °C) Above -40°F (-40 °C) for 24 hours
Relative humidity (non-condensing)	5% to 95% Class 3K3 to IEC 60721-3-3	5% to 95% Class 1K4 to IEC 60721-3-1	5% to 95% at 40 °C Class 2K3 to IEC 60721-3-2
Environmental class/harmful chemical substances	Class 3C2 to IEC 60721-3-3	Class 1C2 to IEC 60721-3-1	Class 2C2 to IEC 60721-3-2
Organic/biological influences	Class 3B1 to IEC 60721-3-3	Class 1B1 to IEC 60721-3-1	Class 2B1 to IEC 60721-3-2
Installation altitude	Up to 6,600 ft (2000 m) above sea level without reduction in performance, > 6,600 ft see derating data		
Mechanical stability	Operation	Storage	Transport
Vibratory load			
- Deflection	0.075 mm at 10 Hz to 58 Hz	1.5 mm at 5 Hz to 9 Hz	3.1 mm at 5 Hz to 9 Hz
- Acceleration	10 m/s ² at > 58 Hz to 200 Hz –	5 m/s ² at > <u>9 Hz</u> to 200 Hz Class 1M2 to IEC 60721-3-1	<u>10 m/s²</u> at > <u>9 Hz</u> to 200 Hz Class 2M2 to IEC 60721-3-2
Shock load			
- Acceleration	100 m/s ² at 11 ms Class 3M4 to IEC 60721-3-3	40 m/s ² at 22 ms Class 1M2 to IEC 60721-3-1	100 m/s ² at 11 ms Class 2M2 to IEC 60721-3-2

Deviations from the defined classes are identified by underlining.

Derating data

Current derating as a function of the installation altitude and ambient temperature

SINAMICS S150 drives and the associated system components are rated for an ambient temperature of 104 °F (40 °C) and installation altitudes up to 6,600 ft (2,000 m) above sea level.

For ambient temperatures > 104 °F (40 °C) the output current must be reduced. Ambient temperatures above 122 °F (50 °C) are not permissible.

At installation altitudes > 6,600 ft (>2,000 m) above sea level, it must be taken into consideration that with increasing altitude, the air pressure decreases and therefore the air density. As a consequence, the cooling efficiency and the insulation capacity of the air also decrease.

Due to the reduced cooling efficiency, it is necessary, on one hand, to reduce the ambient temperature and on the other hand, to lower heat loss in the drive by reducing the output current, whereby ambient temperatures lower than 104 °F (40 °C) may be offset to compensate.

The following table specifies the permissible output current as a function of the installation altitude and ambient temperature for the various enclosure types.

The values apply under the precondition that it is guaranteed that the cooling air flow is as specified in the technical data.

Installation altitude above sea level m	Current derating factor (as a % of the rated current) for an ambient/air intake temperature of						
	68 °F (20 °C)	77 °F (25 °C)	86 °F (30 °C)	95 °F (35 °C)	104 °F (40 °C)	113 °F (45 °C)	122 °F (50 °C)
For NEMA 1 and NEMA 1 filtered (IP20 to IP43) enclosures							
0 to 6,600 ft (0 to 2,000 m)	100%	100%	100%	100%	100%	93.3%	86.7%
up to 8,200 ft (up to 2,500 m)	100%	100%	100%	100%	96.3%		
up to 9,800 ft (up to 3,000 m)	100%	100%	100%	98.7%			
up to 11,500 ft (up to 3,500 m)	100%	100%	100%				
up to 13,100 ft (up to 4,000 m)	100%	100%	96.3%				
up to 14,800 ft (up to 4,500 m)	100%	97.5%					
up to 16,400 ft (up to 5,000 m)	98.2%						
For NEMA 12 ventilated (IP54) enclosures							
0 to 6,600 ft (0 to 2,000 m)	100%	100%	100%	100%	93.3%	86.7%	80.0%
up to 8,200 ft (up to 2,500 m)	100%	100%	100%	96.3%	89.8%		
up to 9,800 ft (up to 3,000 m)	100%	100%	98.7%	92.5%			
up to 11,500 ft (up to 3,500 m)	100%	100%	94.7%				
up to 13,100 ft (up to 4,000 m)	100%	96.3%	90.7%				
up to 14,800 ft (up to 4,500 m)	97.5%	92.1%					
up to 16,400 ft (up to 5,000 m)	93.0%						

Current-derating factors for SINAMICS S150 as a function of the ambient/air intake temperature, the installation altitude and the enclosure type

Voltage derating:

For installation altitudes from 6,600 ft (2,000 m) up to 16,400 ft (5,000 m), voltage derating is additionally required. Alternatively, voltage derating may be avoided by inserting an

isolating transformer upstream and in close proximity to the drive, to reduce transient overvoltages to levels permitted by EN 60664-1. [For additional information, please refer to the SINAMICS Low Voltage Engineering Manual.](#)

SINAMICS S150 NEMA

Engineering Information

Characteristic curves

Current derating for SINAMICS S150 drives as a function of the pulse frequency

For control performance reasons or to increase output frequency, the pulse frequency can be increased relative to the factory setting. When the pulse frequency is increased, the output current needs to be derated. This derating factor must be applied to the currents specified in the technical data.

An increased pulse frequency may also be used to reduce motor noise. Note that SINAMICS S150 firmware also includes functionality that allows an increased pulse frequency without derating, when conditions permit (load, ambient temperature, and input voltage). The pulse frequency is automatically reduced if the drive approaches its thermal limits.

For additional information, please refer to the [SINAMICS Low Voltage Engineering Manual](#).

Order No.	Rated power at 460 (400) V kW	Rated power at 460 V HP	Rated output current I_N A	Derating factor at pulse frequency				
				2.5 kHz	4 kHz	5 kHz	7.5 kHz	8 kHz
Line voltage 380 ... 480 V 3ph. AC								
6SL3710-7LE32-1AU3	125 (110)	150	210	95%	82%	74%	54%	50%
6SL3710-7LE32-6AU3	160 (132)	200	260	95%	83%	74%	54%	50%
6SL3710-7LE33-1AU3	200 (160)	250	310	97%	88%	78%	54%	50%
6SL3710-7LE33-8AU3	250 (200)	300	380	96%	87%	77%	54%	50%
6SL3710-7LE35-0AU3	300 (250)	400	490	94%	78%	71%	53%	50%

Derating factor of the output current as a function of the pulse frequency for units with a rated pulse frequency of 2 kHz

Order No.	Rated power at 460 (400) V or 575 (690) V kW	Rated power at 460 V or 575V HP	Rated output current I_N A	Derating factor at pulse frequency				
				2 kHz	2.5 kHz	4 kHz	5 kHz	7.5 kHz
Line voltage 380 ... 480 V 3ph. AC								
6SL3710-7LE36-1AU3	355 (315)	500	605	83%	72%	64%	60%	40%
6SL3710-7LE37-5AU3	450 (400)	600	745	83%	72%	64%	60%	40%
6SL3710-7LE38-4AU3	500 (450)	700	840	87%	79%	64%	55%	40%
6SL3710-7LE41-0AU3	650 (560)	800	985	92%	87%	70%	60%	50%
6SL3710-7LE41-2AU3	800 (710)	1,000	1,260	92%	87%	70%	60%	50%
6SL3710-7LE41-4AU3	900 (800)	1,150	1,405	97%	95%	74%	60%	50%
Line voltage 500 ... 600 V 3ph. AC								
6SL3710-7LG28-5AU3	60 (75)	75	85	93%	89%	71%	60%	40%
6SL3710-7LG31-0AU3	75 (90)	100	100	92%	88%	71%	60%	40%
6SL3710-7LG31-2AU3	90 (110)	125	120	92%	88%	71%	60%	40%
6SL3710-7LG31-5AU3	110 (132)	150	150	90%	84%	66%	55%	35%
6SL3710-7LG31-8AU3	132 (160)	150	175	92%	87%	70%	60%	40%
6SL3710-7LG32-2AU3	160 (200)	200	215	92%	87%	70%	60%	40%
6SL3710-7LG32-6AU3	200 (250)	250	260	92%	88%	71%	60%	40%
6SL3710-7LG33-3AU3	250 (315)	300	330	89%	82%	65%	55%	40%
6SL3710-7LG34-1AU3	300 (400)	400	410	89%	82%	65%	55%	35%
6SL3710-7LG34-7AU3	350 (450)	450	465	92%	87%	67%	55%	35%
6SL3710-7LG35-8AU3	450 (560)	600	575	91%	85%	64%	50%	35%
6SL3710-7LG37-4AU3	560 (710)	700	735	87%	79%	64%	55%	25%
6SL3710-7LG38-1AU3	630 (800)	800	810	97%	95%	71%	55%	35%
6SL3710-7LG38-8AU3	750 (900)	900	910	92%	87%	67%	55%	33%
6SL3710-7LG41-0AU3	800 (1,000)	1,000	1,025	91%	86%	64%	50%	30%
6SL3710-7LG41-3AU3	1,000 (1,200)	1,250	1,270	87%	79%	55%	40%	25%

Derating factor of the output current as a function of the pulse frequency for units with a rated pulse frequency of 1.25 kHz

The following table lists the approx. maximum output frequency as a function of pulse frequency, at default 250 μ s current controller clock cycle. Higher output frequencies are possible at higher pulse frequencies and current controller clock cycles as low as 125 μ s:

Pulse frequency	Max. output frequency
1.25 kHz	100 Hz
2.00 kHz	160 Hz
2.50 kHz	200 Hz
≥ 4.00 kHz	300 Hz

Motor and drive sizing, overloads

Dimensioning of drives

The SINAMICS S150 drive may be operated with both variable torque and constant torque loads at either low or high overload duties.

For variable torque (VT) loads (torque is proportional to the square of the speed) such as fans/blowers, centrifugal pumps and compressors, the rated continuous output current of the drive should be at least equal to the motor current at full torque at the required load point.

It is recommended that the rated continuous output current of the drive be equal to or larger than the motor FLA (full load amps) when fully utilized (SF = 1.0).

For constant torque (CT) loads, the drive base load current (for either low or high overload duty, as required by the application) should be at least equal to the motor current at full torque at the required load point.

Motor and drive sizing

Service Factor must be considered for motors operating at Service Factors beyond 1.0. Please consult factory for assistance sizing the drive.

Motor rated current greater than drive rated current:
If the rated current (FLA) of the selected motor is larger than the rated drive output current, the motor can only be operated at partial load. The following limit must be observed:

The maximum drive output current (overload current) should be greater than or equal to the rated current (FLA) of the motor. If this dimensioning instruction is not observed, current peaks can occur as a result of the low leakage inductance of larger motors, which can either lead to nuisance tripping or can cause a continuous reduction in output by the drive's internal protection circuit.

Rated motor current much smaller than drive rated current:

In sensorless vector control, the rated motor current (FLA) must be at least 1/4 of the rated drive output current.

With lower motor currents, operation is possible in Volts/Hz control mode only.



Overload capability

SINAMICS S150 drives may be operated at either low or high overload duties. The drives have an overload reserve to deal with breakaway torques, for example. If larger surge loads occur, this must be taken into account when configuring. In drives with overload requirements, the appropriate base load current must therefore be used as a basis for the required load.

The criterion for overload is that the drive is operated with its base load current before and after the overload occurs, and a duty cycle duration of 300 s is assumed.

The base load current I_L for a low overload is based on a duty cycle of 110% for 60 s or 150% for 10 s.

The base load current I_H for a high overload is based on a duty cycle of 150% for 60 s or 160% for 10 s.

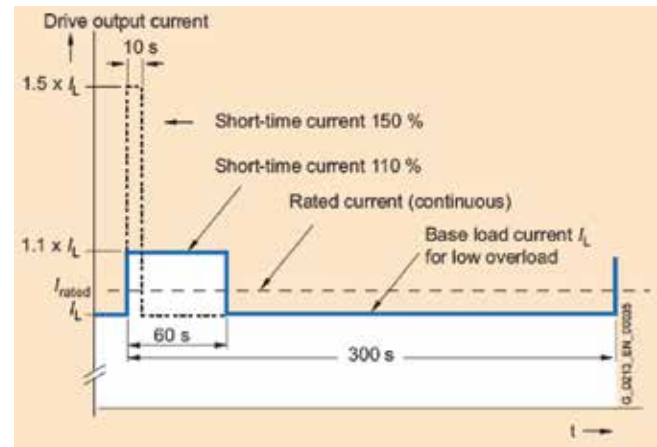

Low overload

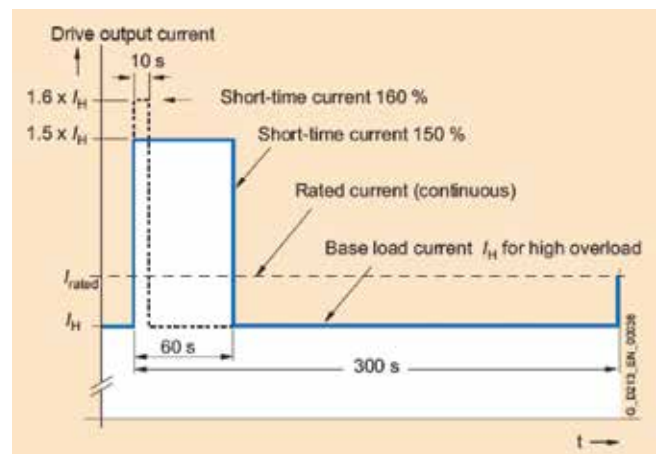

High overload

Input and output reactors and filters, harmonics, motor design

Harmonic feedback to the supply system

The Active Infeed with clean power filter ensure that SINAMICS S150 drives always meet the harmonic distortion limits of IEEE 519-1992.

Input power factor

The Active Infeed allows the control of reactive power absorbed by the drive.

In the factory default setting the drive operates at unity power factor.

It is however also possible to control the reactive power for an input power factor in the range of approx. 0.80 leading to 0.80 lagging.

Motor cable lengths

The cable capacitance of long motor cables causes high charging currents, and the drives' ability to cope with these charging currents may require limits on cable length, and in some cases the use of an output reactor. SINAMICS S150 technology allows much longer motor cable lengths without output reactor than older generation products.

Maximum motor cable lengths for SINAMICS S150 without or with output reactor (option L08) or dV/dt filter (option L10) are:

Unshielded cable: 1,480 ft (450 m)

Shielded cable: 980 ft (300 m)

If longer cable lengths are required, please consult factory.

Motor design

The switching of IGBTs results in high rates of rise of voltage (dV/dt) and voltage spikes of up to twice the DC bus voltage at the motor terminals due to reflections in the cable. Note that the critical cable length at which voltage doubling occurs reduces with motor size; for high ratings (150 HP and up) the critical cable length can be well below 50 ft. For higher HP drives like SINAMICS S150, the motor cable length is therefore not a significant factor when considering the stresses applied to the motor due to voltage rate of rise and peaks.

Inverter duty motors

Inverter duty motors have an insulation system per NEMA MG1, part 31 (peaks of 3.1 times the rated voltage with rise times of 0.1 or more microsecond). They are designed for the dV/dt and voltage spikes expected with operation on PWM drives, and generally do not require the drive to be fitted with an output reactor or filter.

Non-inverter duty motors

Motors designed for across the line operation may have an insulation system per NEMA MG1, part 30 (voltage peaks of up to 1,000 V with rise times of 2 or more microseconds). Operating such a motor on a VFD requires the use of an output filter, to ensure long term reliable operation and avoid premature insulation failure.

Motor (output) reactor (option L08)

An output reactor limits the rate of rise of voltage (dV/dt) and helps to avoid damaging bearing currents. An output reactor does not reduce the magnitude of voltage peaks, irrespective of cable length. A motor reactor is therefore generally not adequate for operating non-inverter duty motors on drives.

dV/dt filter with VPL (option L10)

The dV/dt filter plus VPL (Voltage Peak Limiter) allows the connection of non-inverter duty motors to the SINAMICS S150 drive, by limiting the voltage rate of rise dV/dt to <500 V/μs and voltage peaks as follows:

Rated voltage	Approx. peak voltage for motor cable length of		
	490' (150 m)	980' (300 m)	1480' (450 m)
380 – 480 V	<1,000 V	<1,000 V	<1,200 V
500 – 600 V	<1,000 V	<1,200 V	1,300 V

Max. pulse and output frequencies (options L08 & L10)

The maximum pulse frequency and output frequency for SINAMICS S150 with output reactor (option L08) or dV/dt filter (option L10) are:

Rated output	Max. pulse frequency	Max. output frequency
150 – 400 HP @ 380 – 480 V	4 kHz	150 Hz
All other ratings	2.5 kHz	150 Hz

Recommended practice

For maximum reliability and equipment life when operating a motor on a VFD, use:

- An inverter duty motor per NEMA MG1, part 31 with insulated non-drive end bearing or shaft grounding brush
- A dV/dt filter for a non-inverter duty motor
- Motor cables with a symmetrical design, screened to minimize EMC issues (PE = ground wire)

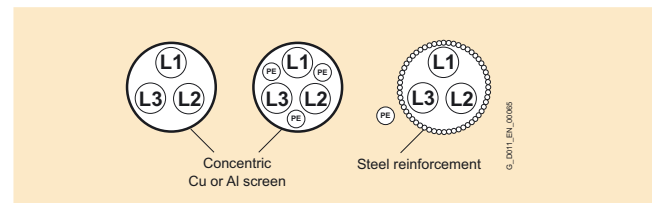

- Grounding wires with low impedance across a large frequency range (DC to 70 MHz) such as braided copper, terminated with the largest possible surface area
- Separate ground wires connected directly between motor and drive, and between motor and driven machine

Operator panel

AOP30 advanced operator panel



The advanced operator panel is mounted in the enclosure door of the drive for operation, monitoring and commissioning tasks. The AOP30 features a graphical LCD with backlighting for plain text and bar graph display of process variables.

The AOP30's two-stage safety concept prevents unintentional or unauthorized changes to settings. Operation of the drive from the operator panel can be disabled by a password ensuring that only parameter values and process variables can be displayed on the panel. The OFF key is factory-set to active but can also be deactivated by the customer. Another password can be used to prevent the unauthorized modification of drive parameters.

During the first start-up of the drive, the user will automatically be guided through the initial start-up procedure that allows a very simple and quick commissioning process. Only 6 motor parameters (from the motor nameplate) have to be entered when the drive is started up for the first time. The control is then optimized automatically to fine-tune the drive to the motor.

English, Spanish, French, German, Italian and Chinese are stored on the CU320-2 Control Unit's CompactFlash card as operator panel languages. The desired language must be downloaded to the AOP30 prior to commissioning. Polish, Portuguese, Russian and Czech are available in addition to these standard panel languages. These can be downloaded free of charge from the Internet under the following link: <http://support.industry.siemens.com/>

The following pictures show screen shots of the display in various operating phases, beginning with first start-up.



Only 6 motor parameters need to be entered: Output power, speed, current, power factor, voltage and frequency of the motor.

This information can be found on the motor nameplate, and is entered into the screens on the display by following a short, menu-driven procedure. The type of motor cooling must be entered in addition.

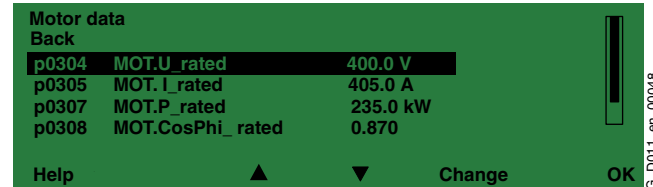

The next screen contains the parameter values that are used to automatically optimize the control.

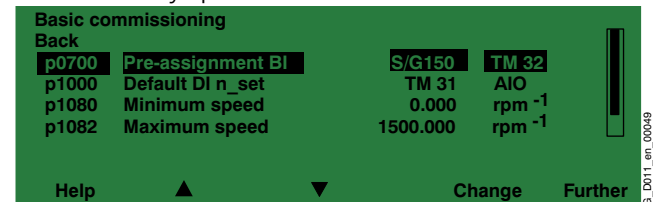

During operation, current data such as setpoint and actual values is indicated on the display as absolute values in either US or international units, or in percent. Up to three process variables can be viewed as a quasi-analog bar graph.

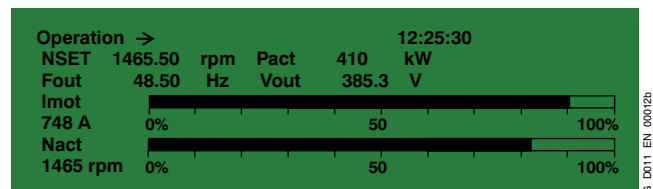
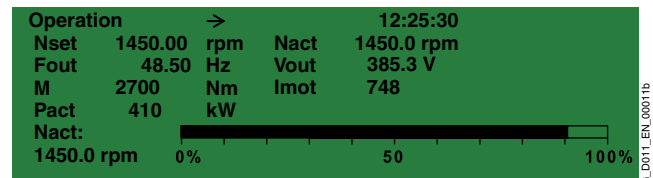

Any **alarms** which occur are indicated by flashing of the yellow "ALARM" LED, while **faults** are signaled by a lit red "FAULT" LED. There is also an indication of the cause displayed in plain text on the display's status line.

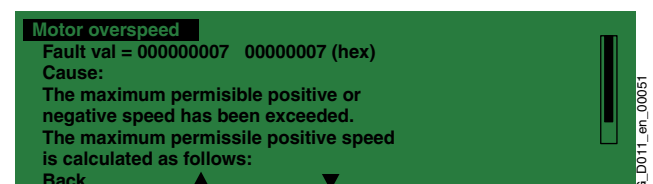
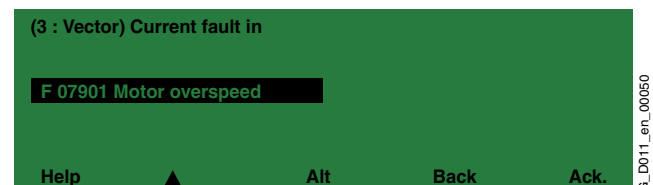

Alarms and faults are displayed and stored with a time stamp.

Control interfaces, Firmware functions

Control interfaces

Both a PROFIBUS interface on the CU320-2 DP control unit and a terminal module are provided as standard for use as the control interface.

The terminal module permits connection to the higher level control using analog and digital signals. Optionally the analog and digital inputs and outputs can be expanded by a second terminal module. Additional digital I/O on the CU320-2 control unit may be utilized too.

To simplify configuration and commissioning of the drive, the inputs and outputs are preset to factory default settings.

Open loop control and regulator functions

The drive regulator contains a high-quality sensorless vector control with speed and current control as well as motor and drive protection.

Software and protection functions

A selection of standard software functions is described below:

Firmware functions	
Setpoint input	The setpoint can be defined internally or externally, internally as a fixed, motorized potentiometer or jog setpoint, externally via the PROFIBUS interface or an analog input of the terminal module. The internal fixed setpoints and the motorized potentiometer setpoint can be switched over or adjusted using control commands via all interfaces.
Motor identification	Automatic motor identification permits fast and simple commissioning and optimization of the drive control.
Ramp function generator	A user friendly ramp function generator with separately adjustable ramp up and ramp down times, together with variable smoothing times in the lower and upper speed ranges, improve the control response and therefore prevent mechanical overloading of the drive train. The ramp down characteristics for emergency stop can be parameterized separately.
Vdc max controller	The Vdc max (DC bus) controller automatically prevents overvoltages in the DC link if, for example, the ramp-down time is set too short. This is achieved by automatically extending the ramp-down time.
Kinetic buffering	During line supply failure, this functions draws power from the motor to keep the drive powered up, to the extent permitted by the kinetic energy of the drive train. The speed drops depending on the moment of inertia and torque of the load. The drive maintains control of the motor and reaccelerates it to the current speed setpoint when the power supply returns.
Automatic restart ¹⁾	The automatic restart function switches the drive on again when the power is restored after a power failure, and ramps the motor back up to the speed setpoint.
Flying restart¹⁾	The flying restart function provides bumpless connection of the drive on to a rotating motor.
Technology controller	A PID controller is provided for technology control functions such as level, pressure or flow control. The P, I, and D components can be set separately. An "extended pump functions" macro offers pump specific functions including Energy Saving (hibernate), Enhanced Energy Saving, Maintenance Cleaning and Wall Deposits Prevention.
Free function blocks	The freely programmable function blocks make it easy to implement logic and arithmetic functions for controlling the drive. The blocks can be programmed using either the operator panel or the STARTER commissioning tool.
Drive Control Chart (DCC)	Drive Control Chart (DCC) is an additional tool for the easy configuration of sophisticated process-oriented functions. The block library contains a large selection of control, arithmetic and logic blocks as well as extensive open-loop and closed-loop control functions. The user-friendly DCC editor enables easy graphical configuration and a clear representation of control loop structures. DCC is an add-on to the STARTER commissioning tool.
Write protection	Write protection to prevent accidental changes to setting parameters (without password function).
Know-how protection	Know-how protection for encrypting stored data, e.g. to protect expert configuring knowledge, and to protect against modification and duplication (with password function).
Web server	The integrated web server provides information about the drive unit via its web pages. The web server is accessed using an Internet browser via unsecured (http) or secured transmission (https).
Motor protection	
I²t detection for motor protection	The motor temperature is calculated in a motor model in the drive software, taking into account the current speed and load. More exact sensing of the temperature, also taking into account the influence of the ambient temperature, is possible by means of direct temperature monitoring using KTY84 sensors in the motor winding.
Evaluation of motor temperature	Motor protection by evaluating a KTY84 or PTC temperature sensor. When a KTY84 sensor is connected, the limit values can be set for temperature alarm or trip. With a PTC thermistor, the reaction following triggering (alarm or trip) can be defined.
Motor stall protection	A stalled motor (locked rotor) is recognized and the motor is protected against thermal overloading by shutting down.
Power section protection	
Ground fault monitoring on the output side	In grounded neutral systems a ground fault on the output side is detected by summation of phase currents, and results in shutdown.
Electronic short-circuit protection on the output side	A short-circuit between motor and drive (on the drive output terminals, in the motor cable, in the motor terminal box) is detected and interrupted.
Thermal overload protection	The temperature of the power section is monitored via a thermal model calculation that includes monitoring of heat sink temperature. An alarm is given when the first overtemperature threshold is reached. If the temperature rises further, either a trip is initiated or the pulse frequency or output current are automatically adjusted to reduce the thermal load until the problem is eliminated (for example, replacing blocked filter mats).

¹⁾ Factory setting: not activated (can be programmed).

CU320-2 Control Unit



The communication, open-loop and closed-loop control functions for the SINAMICS S150 drive are executed in the CU320-2 Control Unit.

Two versions of the CU320-2 Control Unit are available, with different bus communication protocols:

- CU320-2 DP with one PROFIBUS interface with PROFIdrive profile
- CU320-2 PN (**option K95**) with a PROFINET interface with PROFIdrive profile

Additional bus communication protocols are available by inserting a communications module in the option slot.

Design

The CU320-2 Control Unit has the following interfaces as standard (Note: Some of the inputs and outputs may be utilized for internal signals or options).

- 12 parameterizable digital inputs 24 V DC (isolated)
- 8 parameterizable bidirectional digital inputs/digital outputs 24 V DC (non-floating)
- 1 serial RS232 interface (connection for the AOP30 Advanced Operator Panel)
- 1 slot for the CompactFlash card on which firmware and parameters are stored
- 1 slot for mounting an option module (e.g. TB30 Terminal Board or CBE20 Communications Board Ethernet)
- 2 rotary coding switches for manually setting the PROFIBUS address
- 1 Ethernet interface for commissioning and diagnostics
- 3 test sockets and one reference ground for commissioning support

A shield connection for the signal cable shield on the option module is located on the CU320-2 Control Unit.

The status of the CU320-2 Control Unit is indicated via multi-color LEDs.

As the firmware and parameter settings are stored on a plug-in CompactFlash card, the Control Unit can be changed without the need for software tools.



The CompactFlash card contains the firmware and parameter settings. The CompactFlash card is plugged into the appropriate slot on the CU320-2 Control Unit.

CBE20 Communication Board Ethernet (option G33)



The CBE20 Communication Board (**option G33**) is required, if

- a CU320-2 DP (PROFIBUS) Control Unit, is to be connected to a PROFINET-IO network
- a CU320-2 DP (PROFIBUS) or CU320-2 PN (PROFINET) Control Unit is to be connected to an EtherNet/IP network
- SINAMICS Link is to be used to directly exchange data between several CU320-2 DP (PROFIBUS) or CU320-2 PN (PROFINET) Control Units without using a higher-level control system.

The CBE20 is parameterized to operate in one of these modes. In addition, the CBE20 allows Standard Ethernet TCP/IP communication for engineering processes using the STARTER commissioning tool on a PROFINET or EtherNet/IP network.

PROFINET

With the CBE20 Communication Board, SINAMICS S150 is a PROFINET IO device in the sense of PROFINET and can perform the following functions:

- PROFINET IO device
- 100 Mbit/s full duplex
- Supports real-time classes of PROFINET IO:
 - RT (Real-Time)
 - IRT (Isochronous Real-Time), minimum send cycle 500 μ s
- Connects to controls as PROFINET IO devices according to the PROFIdrive profile
- Integrated 4-port switch with four RJ45 sockets based on the PROFINET ASIC ERTEC400. The optimum topology (line, star, tree) can therefore be configured without additional external switches.

EtherNet/IP

EtherNet/IP (EtherNet Industrial Protocol) is an open standard predominantly used in the automation industry. EtherNet/IP is supported by the Open DeviceNet Vendor Association (ODVA).

SINAMICS Link

SINAMICS Link can be used to directly exchange data between several CU320-2 DP (PROFIBUS) or CU320-2 PN (PROFINET) Control Units without using a higher-level control system. Possible applications for the SINAMICS Link include:

- Torque sharing for several drives
- Setpoint cascading for several drives
- Load distribution for drives coupled through a material web
- Coordination between SINAMICS G or SINAMICS S with the CU320-2 Control Unit and SINAMICS DC Master with CUD Control Units.

Only CU320-2 Control Units or CUD Control Units of the SINAMICS DC Master can be integrated into this communication network.

SINAMICS Link is activated by appropriately parameterizing the Control Units of the participants.

Integration

The CBE20 Communication Board plugs into the option slot on the CU320-2 Control Unit.

Digital and analog inputs and outputs

TM31 Terminal Module



The TM31 Terminal Module contains:

- 8 digital inputs
- 4 bidirectional inputs/outputs
- 2 analog inputs (differential)
- 2 analog outputs
- 2 relay outputs (changeover)
- Input for KTY84 temperature sensor or PTC thermistor
- $\pm 10\text{V}$ auxiliary voltage output for analog setpoint input
- $\pm 24\text{V}$ auxiliary voltage output for digital inputs

TM31 specifications

Digital inputs

• Voltage	-3 V + 30 V
• Low level (an open digital input is interpreted as "low")	-3 V to +5 V
• High level	15 V to 30 V
• Current consumption (at 24 V DC)	Typ. 10 mA
• Signal propagation delays for digital inputs	L to H: approx. 50 μs H to L: approx. 100 μs
• Max. wire size	#16 AWG (1.5 mm ²)

Digital outputs (continuously short-circuit-proof)

• Voltage	24 V DC
• Max. load current per digital output	100 mA
• Max total current of digital outputs	400 mA
• Max. wire size	#16 AWG (1.5 mm ²)

Analog inputs

(a switch is used to toggle between voltage and current input)

• As voltage input	
- Voltage range	-10 V to +10 V
- Internal resistance R_i	100 k Ω
• As current input	
- Current range	4 mA to 20 mA / -20 mA to +20 mA / 0 mA to 20 mA
- Internal resistance R_i	250 Ω
- Resolution	11 bit + sign
• Max. wire size	#16 AWG (1.5 mm ²)

Analog outputs (continuously short-circuit-proof)

• Voltage range	-10 V to +10 V
• Max. load current	-3 mA to +3 mA
• Current range	4 mA to 20 mA, -20 mA to +20 mA, 0 mA to 20 mA
• Max. load resistance	500 Ω for outputs in the range -20 mA to +20 mA
• Resolution	11 bit + sign
• Max. wire size	#16 AWG (1.5 mm ²)

Relay outputs (form C change-over contacts)

• Max. load current	8 A
• Max. switching voltage	250 V AC, 30 V DC
• Max. switching power (@ 250 V AC)	2000 VA ($\cos \varphi = 1$) 750 VA ($\cos \varphi = 0.4$)
• Max. switching power (at 30 V DC)	240 W (ohmic load)
• Required minimum current	100 mA
• Max. wire size	#14 AWG (2.5 mm ²)

RTD monitor

TM150 Terminal Module (options G51 and G52)



The TM150 RTD module is suitable for monitoring a variety of temperature sensors, over the temperature range -146°F (-99°C) to +480°F (+250°C):

- Pt100 – Platinum RTD 100 ohm
- Pt1000 – Platinum RTD 1,000 ohm
- KTY84 – temperature sensor
- PTC – Positive temperature coefficient thermistor
- Temperature switch (NC) contact (for example Thermoclick or bimetallic switch)

Up to 12 sensors in 2-wire connection or up to 6 sensors in 3- or 4-wire connection can be connected to one TM150. The TM150 detects wire breakage or a short circuit in the RTD leads for Pt100, Pt1000 and KTY84 sensors, and short circuit for PTC thermistors.

Temperature values from the TM150 are available for further processing. Motor winding temperatures can be used for the thermal motor model in the closed loop control. Temperature values can be displayed on the AOP30, and transmitted to the process control system via bus communications.

Note: TM150 inputs are not galvanically isolated. Only temperature sensors isolated per IEC 61800-5-1 may be connected to terminals "+Temp" and "-Temp". Failure to observe these instructions can result in electric shock!

Technical data

TM150 Terminal Module

Temperature sensor inputs

The inputs can be parameterized individually for the evaluation of sensors

- Conductor cross section, max. #16 AWG (1.5 mm²)
- Measuring current per sensor, approx. 0.8 mA

PE connection M4 screw

Conformity CE

Approvals, according to cULus

SMC10 Sensor Module (option K46)



The SMC10 Sensor Module Cabinet-Mounted (option K46) is required to evaluate the encoder signals of motors without a DRIVE-CLiQ interface. External encoders can also be connected via the SMC10.

The following encoder signals can be evaluated:

- 2-pole resolver
- Multipole resolver

Design

The SMC10 Sensor Module Cabinet-Mounted features the following interfaces as standard:

- 1 encoder connection including motor temperature detection (KTY84-130 or PTC) via SUB-D connector

The status of the SMC10 Sensor Module Cabinet-Mounted is indicated via a multi-color LED.

The signal cable shield can be connected via the encoder system and can also be connected to the SMC10 Sensor Module via shield connection terminal, e.g. Phoenix Contact type SK8 or Weidmüller type KLBÜ CO 1.

Technical data

SMC10 Sensor Module Cabinet-Mounted

Encoders which can be evaluated	<ul style="list-style-type: none"> • 2-pole resolver • Multipole resolver
• Excitation voltage, rms	4.1 V
• Excitation frequency	5 ... 10 kHz depending on the current controller clock cycle of the Motor Module or Power Module
• Transformation ratio	0.5
• Encoder frequency, max.	2 kHz (120,000 rpm) depending on the pole pair number of the resolver and the current controller clock cycle of the Motor Module or Power Module
• Signal subdivision (interpolation), max.	16,384 times (14 bit)
• Cable length to encoder, max.	426 ft (130 m)
Conformity	CE
Approvals, according to	cULus

SMC20 Sensor Module (option K48)



The SMC20 Sensor Module Cabinet-Mounted (**option K48**) is required to evaluate the encoder signals of motors without a DRIVE-CLiQ interface. External encoders can also be connected via the SMC20.

The following encoder signals can be evaluated:

- Incremental encoder sin/cos 1 V_{pp}
- EnDat absolute encoder
- SSI encoder with TTL/HTL incremental signals sin/cos 1 V_{pp} (firmware version 2.4 and later)
- SSI encoder without incremental signals

The motor temperature can also be detected with KTY84-130 or PTC thermistors.

Design

The SMC20 Sensor Module Cabinet-Mounted features the following interfaces as standard:

- 1 encoder connection including motor temperature detection (KTY84-130 or PTC) via SUB-D connector or terminals

The status of the SMC20 Sensor Module Cabinet-Mounted is indicated via a multi-color LED.

The signal cable shield can be connected via the encoder system and can also be connected to the SMC20 Sensor Module Cabinet-Module via shield connection terminal, e.g. Phoenix Contact type SK8 or Weidmüller type KLBÜ CO 1.

Technical data

SMC20 Sensor Module Cabinet-Mounted

Encoders which can be evaluated	<ul style="list-style-type: none"> • Incremental encoder sin/cos 1 V_{pp} • EnDat absolute encoder • SSI encoder with incremental mental signals sin/cos 1 V_{pp} (firmware version 2.4 and later)
• Encoder supply	5 V DC/0.35 A
• Encoder frequency incremental signals, max	500 kHz
• Signal subdivision (interpolation), max.	16,384 times (14 bit)
• SSI baud rate	100kBaud
• Cable length to encoder, max.	426 ft (130 m)
PE connection	M4 screw
Conformity	CE
Approvals, according to	cULus

SMC30 Sensor Module (options K50 and K52)



The SMC30 Sensor Module Cabinet-Mounted (options K50 and K52) is required to evaluate the encoder signals of motors without a DRIVE-CLiQ interface. External encoders can also be connected via the SMC30.

The following encoder signals can be evaluated:

- Incremental encoders TTL/HTL with/without open-circuit detection (open-circuit detection is only available with bipolar signals)
- SSI encoder with TTL/HTL incremental signals
- SSI encoder without incremental signals

The motor temperature can also be detected with KTY84-130 or PTC thermistors.

Design

The SMC30 Sensor Module Cabinet-Mounted features the following interfaces as standard:

- 1 encoder connection including motor temperature detection (KTY84-130 or PTC) via SUB-D connector or terminals

The status of the SMC30 Sensor Module Cabinet-Mounted is indicated via a multi-color LED.

The maximum encoder cable length between SMC30 modules and encoders is 330 ft (100 m). For HTL encoders, this length can be increased to 990 ft (300 m) if the A*, A and B*, B signals are evaluated and the power supply cable has a minimum cross-section of #20 AWG (0.5 mm²).

The signal cable shield can be connected to the SMC30 Sensor Module Cabinet-Mounted via a shield connection terminal, e.g. Phoenix Contact type SK8 or Weidmüller type KLBÜ CO 1.

Technical data

SMC30 Sensor Module Cabinet-Mounted

Power loss max.	10 W
Encoders which can be evaluated	<ul style="list-style-type: none"> • Incremental encoder TTL/HTL • SSI encoder with TTL/HTL incremental signals • SSI encoder without incremental signals
<ul style="list-style-type: none"> • Input impedance 	
- TTL	570 Ω
- HTL, max.	16 mA
• Encoder supply	24 V DC/0.35 A or 5 V DC/0.35 A
• Encoder frequency max.	300 kHz
• SSI baud rate	100 ... 250 kBaud
• Limiting frequency, max.	300 kHz
• Resolution absolute position SSI	30 bit
• Cable length, max.	
- TTL encoder	330 ft (100 m) (only bipolar signals permitted) ¹⁾
- HTL encoder	330 ft (100 m) for unipolar signals 990 ft (300 m) for bipolar signals ¹⁾
- SSI encoder	330 ft (100 m)
Conformity	CE
Approvals, according to	cULus

¹⁾ Signal cables twisted in pairs and shielded.

When is a speed feedback encoder recommended?

SINAMICS S150 is capable of accurately controlling torque at and near zero speed without a speed feedback encoder. A speed feedback encoder is therefore required only rarely. A speed feedback encoder should be considered if one or more of the following applies to the (usually constant torque) application:

- Maximum speed accuracy
- Very high dynamic performance requirements
- Accurate control of torque below 5% speed (especially with overhauling loads)
- High starting torque or high overloads at low speeds (especially with overhauling loads)

VSM10 Voltage Sensing Module (option K51)



The VSM10 Voltage Sensing Module (option **K51**) allows the line supply or motor voltage characteristic to be precisely sensed.

The VSM10 is used, for example, to switch to a rotating synchronous motor (flying restart function).

Design

The VSM10 Voltage Sensing Module has the following interfaces:

- 1 connection for direct voltage sensing up to 690 V
- 1 connection for voltage sensing using voltage transformers, max. 100 V 3 ph.
- 2 analog inputs (reserved for resonance monitoring in Active Interface Modules)
- 1 temperature sensor input (KTY84-130 or PTC)

The status of the VSM10 Voltage Sensing Module is indicated by a two-color LED.

Technical data

VSM10 Voltage Sensing Module

Line voltage detection

- | | |
|--|----------------|
| • Insulation resistance neutral point – ground when the jumper is not inserted | > 10 MΩ |
| • Input resistance | |
| - Terminal X521 | > 362 kΩ/phase |
| - Terminal X522 | > 2.5 MΩ/phase |

Conformity	CE
Approvals, according to	cULus

Safety Integrated – Overview

This section provides an overview of Safety Integrated functions of SINAMICS S150. For further details please refer to www.siemens.com/safety-drives as well as the current version of manuals published on the Siemens Technical Support website: "SINAMICS G130, G150, S120 Chassis, S120 Cabinet Modules, S150 Safety Integrated Function Manual" <https://support.industry.siemens.com/cs/us/en/view/106254588> and the "SINAMICS S120 Safety Integrated Function Manual" <https://support.industry.siemens.com/cs/us/en/view/99668646>

Safety functions integral to the SINAMICS drives

SINAMICS drives are characterized by a large number of integrated safety functions. In combination with the sensors and safety control required for the safety functionality, they ensure that highly-effective protection for persons and machines is implemented in a practice-oriented manner.

They fulfill the following equipment requirements:

- SIL 2 according to IEC 61508
- PL d and Category 3 according to EN ISO 13849-1

The Safety Integrated functions of SINAMICS drives are certified by independent institutions. You can obtain the corresponding test certificates and manufacturer's declarations from your Siemens contacts.

The integrated safety functions that are currently available in the SINAMICS drive system are described below. The functional safety of all of the functions satisfies the requirements defined in the international standard IEC 61800-5-2 for variable-speed drive systems.

The safety functions integrated into the SINAMICS drive system can be roughly divided into four categories:

- **Functions for safely stopping a drive**
 - Safe Torque Off (STO)
 - Safe Stop 1 (SS1)
 - Safe Stop 2 (SS2)
 - Safe Operating Stop (SOS)
- **Functions for safe brake management**
 - Safe Brake Control (SBC)
 - Safe Brake Test (SBT) (this function exceeds the scope of IEC 61800-5-2)
- **Functions for safely monitoring the motion of a drive**
 - Safely-Limited Speed (SLS)
 - Safe Speed Monitor (SSM)
 - Safe Direction (SDI)
- **Functions for safely monitoring the position of a drive**
 - Safely-Limited Position (SLP)
 - Safe Position (SP) (this function exceeds the scope of IEC 61800-5-2)

Basic Functions and Extended Functions

The Safety Integrated functions of the SINAMICS drive system are grouped into Basic Functions and Extended Functions. The Basic Functions are included in the standard scope of delivery of the drive. The user can activate these functions at any time. An encoder is not required for their use.

- **Basic Functions**
 - Safe Torque Off (STO)
 - Safe Brake Control (SBC)
 - Safe Stop 1 (SS1)
- **Extended Functions**
 - Safe Stop 1 (SS1) with SBR or SAM
 - Safe Stop 2 (SS2) with SAM
 - Safe Operating Stop (SOS)
 - Safely-Limited Speed (SLS)
 - Safe Speed Monitor (SSM)
 - Safe Direction (SDI)
 - Safely-Limited Position (SLP)
 - Safe Position (SP)
 - Safe Brake Test (SBT)

For the Extended Functions Safe Stop 1 (SS1) and Safe Stop 2 (SS2) with SAM, safe acceleration monitoring (SAM) is performed during braking to identify any faults during the braking phase.

If Safe Stop 1 is used as an encoderless function, a Safe Brake Ramp (SBR) can be configured as an alternative.

Safety Integrated – Overview (continued)

Activation of safety functions

The Safety Integrated functions are fully integrated in the drive system. They can be activated as follows:

- Via safety-related inputs on the Control Unit and the power unit (Basic Functions) or using Option K82 “Terminal interface for Safety Integrated functions STO and SS1” which provides a convenient customer interface for enclosed drives

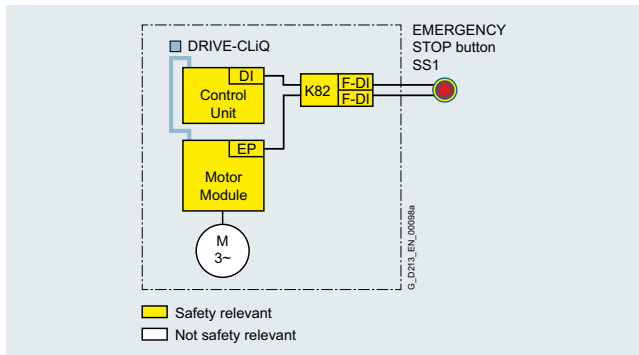

STO integrated safety technology using fail-safe inputs

- Via safety-related inputs on the TM54F Terminal Module (option K87) (Extended Functions)

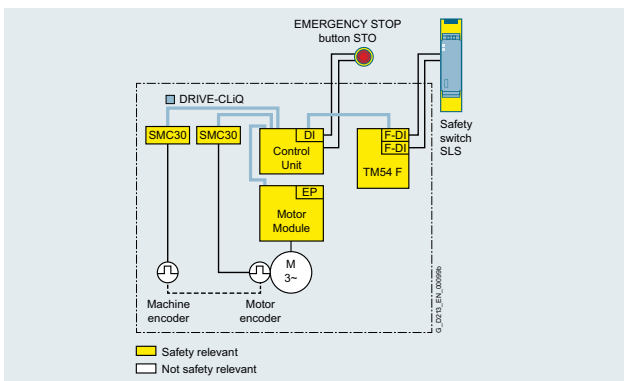

SLS integrated safety technology using fail-safe inputs

- Via PROFIBUS or PROFINET with the PROFIsafe profile (Basic and Extended Functions)

The TM54F Terminal Module is not required when functions are selected via PROFIsafe.

As an alternative to controlling via terminals and/or PROFIsafe, there is also the option to parameterize some safety functions without selection. In this mode, after parameterization and a POWER ON, these functions are permanently selected.

Example:

“SLS without selection” can be used, for example, to monitor the maximum speed to prevent the drive from exceeding a mechanical speed limit. For this purpose, using the “without selection” function, an F-DI does not have to be used.

PROFIsafe

SINAMICS drives support the PROFIsafe profile based on PROFIBUS as well as on PROFINET. PROFIsafe is an open communication standard that facilitates standard and safety-relevant communication along one communication path (hardwired or wireless). A second, separate bus system is therefore not required. The telegrams that are sent are continually monitored to ensure reliable communication.

Potential errors such as lost or repeated telegrams, or telegrams received in the wrong sequence, are prevented by the consecutive numbering of safety-related telegrams, by monitoring of telegrams to ensure that they are received within a defined time period, and by transmission of an identifier for the telegram sender/receiver. A CRC (cyclic redundancy check) data security mechanism is also used.

Licensing

The Safety Integrated Basic Functions do not require a license. The Safety Integrated Extended Functions require a license (option K01). It is irrelevant which safety functions are used and how many.

Safety Integrated – Overview (continued)

Option K82 Terminal interface for STO and SS1

Option K82 "Terminal interface for Safety Integrated functions STO and SS1" provides a convenient customer interface for enclosed drives (terminal strip X41) that offers:

- 3rd party certification of compliance with the relevant safety standards
- A wide voltage range for input signals 24 VDC - 230 VAC
- Contact for checkback signal

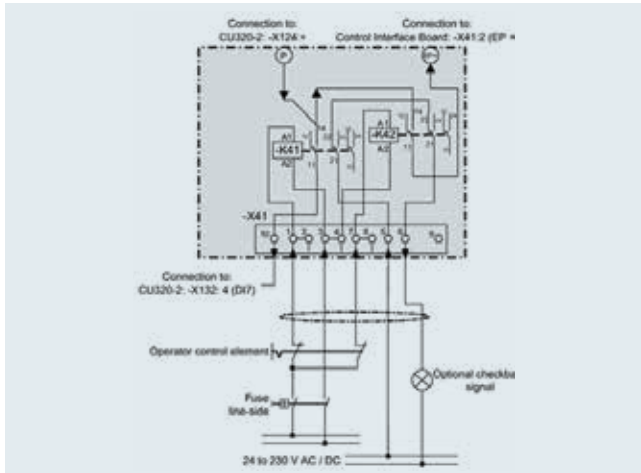

The operator control element must be a safety switch in accordance with the relevant standards, or a certified safety controller.

The circuit can be parameterized for either STO or SS1 functions:

- STO (immediate blocking of inverter, coast to stop), or
- SS1 (fast ramp down; STO will be activated after a (parameterized) time delay).

Note that if SS1 is activated when the motor is stationary, the STO signal making the drive safe will only be activated after the ramp down delay time. The checkback signal confirms when STO is effective.

The following information related to external control circuit wiring is provided as a guideline only. Please refer to the relevant manuals for current specifications to be used for circuit design:

Control power 24 VDC to 230 VAC (-15%, +10%); Max. wire size 2,5 mm²; fuse max. 4 A

Max. wire length (applies to the sum of the outgoing and return lines):

- AC control voltage, 60 Hz (cable capacitance max. 300 pF/m [91.4 pF/ft]):
 - 24 V: 4,000 m [13,100 ft]
 - 110 V: 640 m [2,100 ft]
 - 230 V: 1600 m [525 ft]
- DC control voltage 24 V (min. cross-section 0.75 mm²/# xx AWG): 1,500 m [4,900 ft]

Note that exceeding the maximum wire length and capacitance will cause malfunction of the safety circuit.

Emergency Stop compared to Safety Integrated functions

What is the difference between options K82 STO/SS1 and N57 Emergency OFF category 0 respectively N59/N60 Emergency STOP category 1?

STO and Emergency OFF cat. 0 both result in a coast to stop, and SS1 and Emergency STOP cat. 1 both result in a fast ramp down with subsequent removal of power. All these designs incorporate safety relays.

Differences between these options are the standards and specifications that are being met. Safety Integrated functions include strict requirements related to design, wiring, testing and start-up, and associated certification by qualified personnel at various stages. There are requirements for redundancy in certain circuits and components. These requirements apply to components and circuitry both inside the drive enclosure as well as outside in the plant.

The requirements met with Emergency OFF/Emergency STOP are not as extensive.

Safety Integrated – Description of functions

Safe Torque Off (STO)

The STO function is the most common and basic drive-integrated safety function. It ensures that no torque-generating energy can continue to affect a motor and prevents unintentional startup.

Effect

This function is a mechanism that prevents the drive from restarting unexpectedly, in accordance with EN 60204-1, Section 5.4. Safe Torque Off suppresses the drive pulses (corresponds to Stop Category 0 of EN 60204-1). The drive is reliably torquefree. This state is monitored internally in the drive.

Application

STO has the immediate effect that the drive cannot supply any torque-generating energy. STO can be used wherever the drive will naturally reach a standstill due to load torque or friction in a sufficiently short time or when “coasting down” of the drive will not have any relevance for safety.

Customer benefits

The benefit to the customer of using the Safety Integrated function STO as opposed to a conventional safety system based on electromechanical switchgear is that no separate components are needed and the costs incurred for the wiring and maintenance of separate components can therefore be saved. Owing to the fast electronic switching times, the function provides a shorter reaction time than the conventional solution comprising electromechanical components.

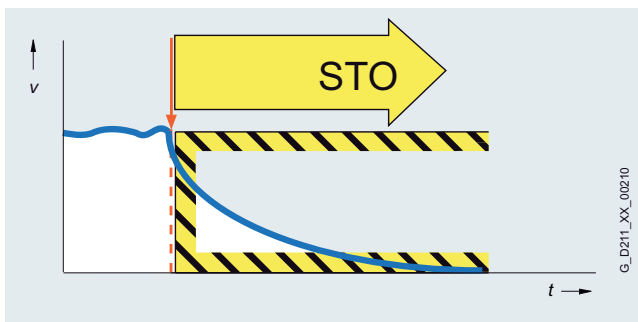

Safe Torque Off (STO)

Safe Stop 1 (SS1)

The SS1 function causes a motor to stop rapidly and safely and switches the motor to a torque-free state after it reaches a standstill, i.e. by activating STO.

Effect

The SS1 function can safely stop the drive in accordance with EN 60204-1, Stop Category 1. When the SS1 function is selected, the drive brakes autonomously along a quick-stop ramp and automatically activates the Safe Torque Off and Safe Brake Control functions (if configured) when the parameterized safety delay time expires.

In firmware version V4.5 and higher, an additional variant of SS1 is available (SS1E). In this case, selection of SS1 does not initiate autonomous braking of the drive, but starts the safe delay timer instead. The higher-level controller remains in control of the setpoint which must bring the drive to a standstill within this time.

Application

The SS1 function is used when, in the event of a safety-relevant incident, the drive must stop as quickly as possible followed by transition into the STO state (e.g. EMERGENCY STOP). It is thus used to bring large centrifugal masses to a stop as quickly as possible for the safety of the operating personnel, or to brake motors at high speeds as quickly as possible. Typical applications include saws, grinding machine spindles, centrifuges, winders, and storage and retrieval systems.

Customer benefits

The targeted stopping of a drive by means of SS1 reduces the risk of danger, increases the productivity of a machine, and allows the safety clearances in a machine to be reduced. The principle is to bring the drive actively to a standstill as opposed to using the STO function on its own. Complex mechanical brakes that are susceptible to wear are not normally required to brake the motor.

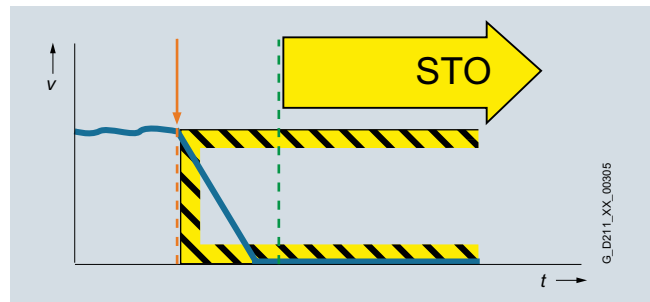

Safe Stop 1 (SS1)

Safety Integrated – Description of functions (continued)

Safe Stop 2 (SS2)

The SS2 function brings the motor to a standstill quickly and safely and then activates the standstill position once the motor has stopped.

Effect

The Safe Stop 2 function can safely stop the drive in accordance with EN 60204-1, Stop Category 2. When the SS2 function is selected, the drive brakes autonomously along a quick-stop ramp. In contrast to SS1, the drive control remains operational afterwards, i.e. the motor can supply the full torque required to maintain zero speed. The standstill is safely monitored by the Safe Operating Stop (SOS) function.

Application

As with SS1, the SS2 function ensures the quickest possible deceleration of the motor. However, the motor power is not switched off. Instead, a control system prevents it from leaving the standstill position – even if it is affected by external forces.

Customer benefits

The SS2 function ensures a rapid axis stop. Since the control remains active, productive operation can immediately continue without referencing after the safety function is deselected. This ensures short setup and standstill times and high productivity.

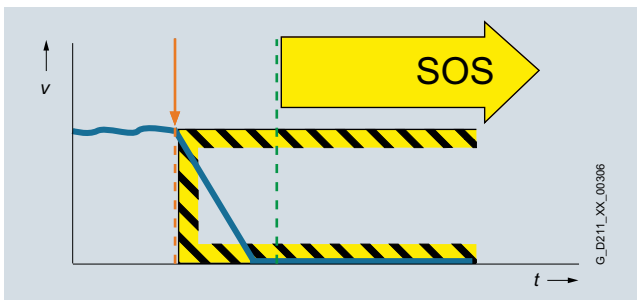

Safe Stop 2 (SS2)

Safe Operating Stop (SOS)

With the SOS function, the stopped motor is held in position and monitored by drive control.

Effect

The SOS function constitutes safe standstill monitoring. The drive control remains in operation. The motor can therefore deliver the full torque to hold the current position. The actual position is reliably monitored. In contrast to safety functions SS1 and SS2, the speed setpoint is not influenced autonomously by the drive.

Application

SOS is the ideal function for all those applications for which the machine or parts of the machine must be at a safe standstill for certain machining steps, but where the drive must also supply a holding torque. It is ensured that despite counter torque the drive remains in its current position. When SOS is selected, the drive does not influence the speed setpoint autonomously (in contrast to SS1 and SS2). Instead, the drive expects the higher level control system to initiate coordinated power-down of the axes as a group within an adjustable wait time. This can be used to prevent any damage to the machine or product. Typical applications for SOS include winders, converting and packaging machines and machine tools.

Customer benefits

No mechanical components are necessary to keep the axis in position despite any counterforce that may occur. Due to the short switching times and the fact that the drive control always remains active, setup and downtimes are reduced. Re-referencing of the axis after exit from the SOS function is not necessary. The axis can traverse again immediately after deactivation of the SOS function.

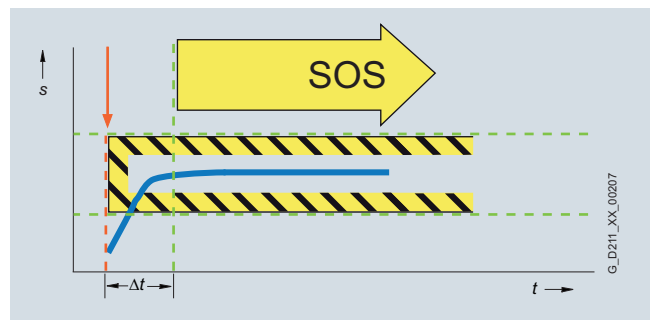

Safe Operating Stop (SOS)

Safety Integrated – Description of functions (continued)

Safe Brake Control (SBC)

The SBC function permits the safe control of a holding brake. SBC (when enabled) is always activated in parallel with STO.

Effect

A holding brake which is active in a de-energized state is controlled and monitored using safe two-channel technology. Due to the two-channel control, the brake may still be activated in the event of an insulation fault in the control cable. Test pulses are used to ensure early detection of such faults.

Notes

The safe brake control does not detect mechanical faults in the brake, for example worn brake pads.

The motor brake terminals are integrated with Motor Modules in booksize format. An additional Safe Brake Adapter is required for power units in chassis format.

Application

The SBC function is used in conjunction with the functions STO or SS1 to prevent the movement of an axis in the torque-free state, e.g. due to gravity.

Customer benefits

Again, the function saves the use of external hardware and the associated wiring.

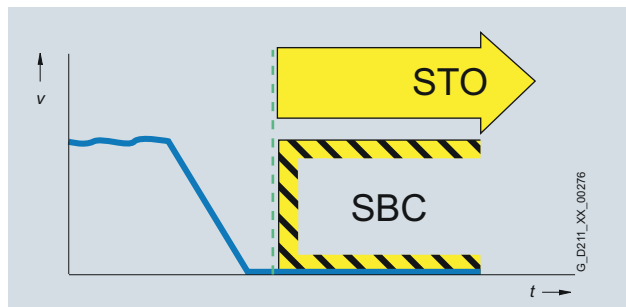

SBC – Safe Brake Control

Safe Brake Test (SBT)

The SBT function carries out a brake function test at regular intervals.

Effect

The proper functioning of brakes that have become worn is checked by application of a torque to the closed brake. Drive systems that have two brakes, e.g. motor brake and external brake, can be tested with different torque values.

Application

The SBT function is suitable for implementing a safe brake in combination with the SBC function.

Customer benefits

The function detects faults or wear in the mechanical components of the brake. Automatic brake function tests reduce maintenance overheads and increase the safety and reliability of the machine/plant.

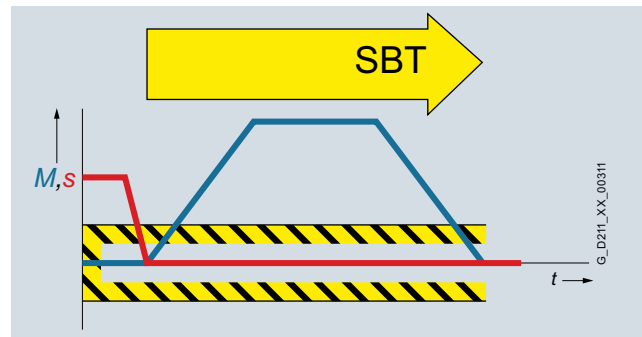

Safe Brake Test (SBT)

Safe Brake Adapter

Safe Brake Adapter

The Safe Brake Control (SBC) function requires a Safe Brake Adapter (option **K88** for SINAMICS S150).

The Safe Brake Adapter allows safe control of electro-mechanical motor brakes.

The Safe Brake Adapter controls 230 V AC brakes. The SBC function monitors the control of the brake, but not the mechanical components of the brake.

The drive controls the connected brake using the motor holding brake function.

External overvoltage limiters are not required.

With the Safe Brake Adapter function, the brake is controlled in accordance with IEC 61508 SIL 2 and EN ISO 13849-1 PL d and Category 3.

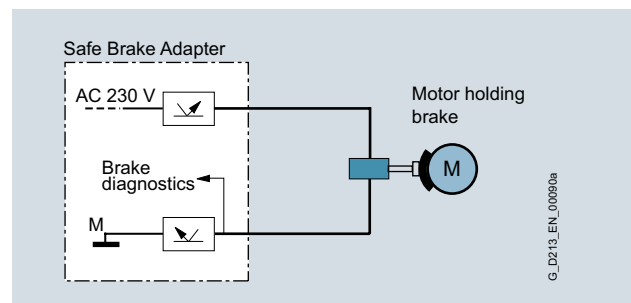

Safe Brake Control (SBC)

Safety Integrated – Description of functions (continued)

Safely-Limited Speed (SLS)

The SLS function monitors the drive to ensure that it does not exceed a preset speed limit.

Effect

The SLS function monitors the drive against a parameterized speed limit. Four different limit values can be selected. As with SOS, the speed setpoint is not independently influenced. After SLS has been selected, the higher-level control must decelerate the drive until its speed drops below the selected speed limit within a parameterizable time. If the speed limit is exceeded, a customizable drive-integrated fault reaction occurs.

The SLS limit stage 1 can be multiplied by a factor that is transferred in 16-bit resolution via PROFIsafe. This allows an almost unlimited number of limits to be specified.

Application

The SLS function is used if people are in the danger zone of a machine and their safety can only be guaranteed only if the machine speed is reduced. Typical application cases include those in which an operator must enter the danger zone of the machine for the purposes of maintenance or setting up, such as a winder in which the material is manually threaded by the operator. To prevent injury to the operator, the roller may only spin at a safely reduced speed. SLS is often also used as part of a two-stage safety concept. While a person is in a less critical zone, the SLS function is activated, and the drives are only safely stopped when the operator enters a more critical area closer to the machine with higher potential risk. SLS can be used not only for operator protection, but also for tool protection, e.g. if a maximum speed must not be exceeded.

Customer benefits

The SLS function can contribute to a significant reduction in downtime, or greatly simplify or even accelerate setup. The overall effect achieved is a higher availability of the plant. Moreover, external components such as speed monitors can be omitted.

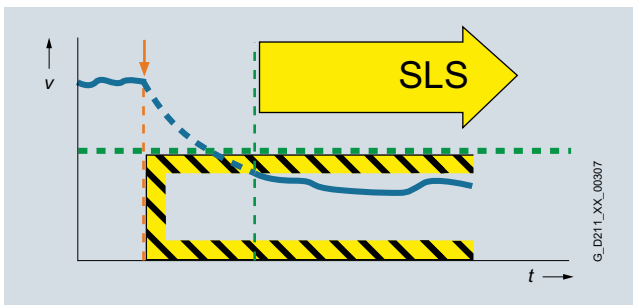

Safely-Limited Speed (SLS)

Safe Speed Monitor (SSM)

The SBT function carries out a brake function test at regular intervals.

Effect

The proper functioning of brakes that have become worn is checked by application of a torque to the closed brake. Drive systems that have two brakes, e.g. motor brake and external brake, can be tested with different torque values.

Application

The SBT function is suitable for implementing a safe brake in combination with the SBC function.

Customer benefits

The function detects faults or wear in the mechanical components of the brake. Automatic brake function tests reduce maintenance overheads and increase the safety and reliability of the machine/plant.

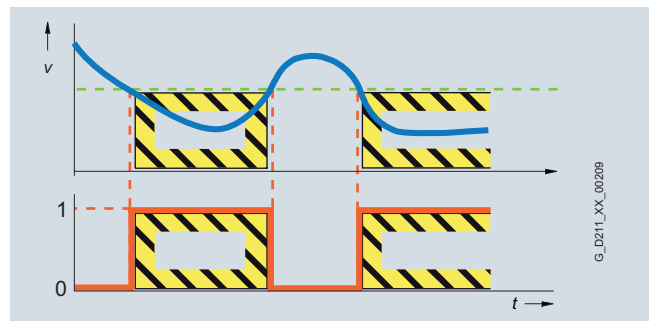

Safe Speed Motor (SSM)

Safety Integrated – Description of functions (continued)

Safe Direction (SDI)

The SDI function ensures that the drive can only move in the selected direction.

Effect

Deviation from the direction of motion currently being monitored is detected reliably and the configured drive-integrated fault reaction is initiated. It is possible to select which direction of rotation is to be monitored.

Application

The SDI function is used when the drive may only move in one direction. A typical application is to permit the operator access to a danger zone, as long as the machine is rotating in the safe direction, i.e. away from the operator. In this state, the operator can feed material into the work zone / remove material from the work zone without danger.

Customer benefits

The function does away with the use of external components such as speed monitors and the associated wiring expense. The release of a danger zone, i.e. while the direction of machine rotation is away from the operator, increases productivity. Without the SDI function, the machine would need to be safely stopped during material loading and removal.

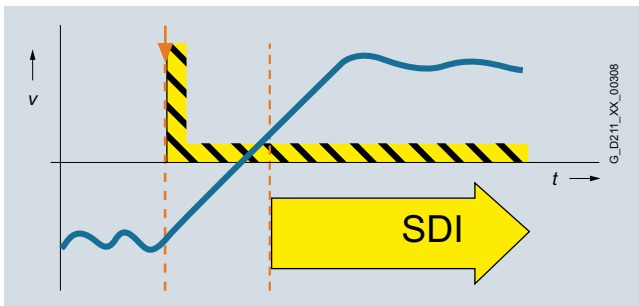

Safe Direction (SDI)

Safely-Limited Position (SLP)

The SLP function monitors the axis to ensure that it remains within the permissible traversing range.

Effect

When SLP is activated, the traversing range limited by the configured software limit switches is safely monitored. If the axis exits the permitted traversing range, a customizable fault reaction is initiated. It is possible to toggle between two traversing ranges, even when the machine is in operation.

Application

SLP is used for any application which requires a machine operator to enter a protection zone, e.g. in order to load or remove material. Safe monitoring of the axis position ensures that the axis cannot move into the protection zone released for operators and so place them in danger, for example, on storage and retrieval machines, gantry cranes or machining centers.

Customer benefits

SLP can be used to implement highly-effective protection zone monitoring. The function does away with the use of external components such as hardware limit switches and the associated wiring expense. Thanks to the fast response to limit-value violations, safety clearances can be reduced.

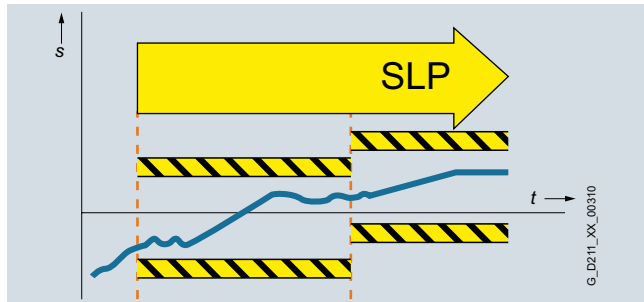

Safely-Limited Position (SLP)

Safety Integrated – Description of functions (continued)

Safe Position (SP)

The SP function transfers the actual position values determined safely in the drive over safe PROFIsafe communication to a safety control.

Effect

In contrast to the SLP function that monitors the current actual position value against a limit and, in the case of an overshoot, activates a drive-integrated fault reaction, SP transfers the current actual position values to the safety control. Position monitoring is implemented in the safety program of the control. Extended PROFIsafe telegrams are available for transferring the position values. The position values can be transferred either in 16-bit- or 32-bit resolution. A time stamp is also transferred with the position values.

Application

The SP function can be used to create tailored safety concepts. It is ideal for use on machines that require flexible safety functions. It is extremely versatile and can be used, for example, to implement safe, axis-specific range detection by means of the Safe (SCA) function. The SP function is also suitable for developing cross-axis safety concepts, multi-dimensional protection zones and zoning concepts.

Customer benefits

Position monitoring or speed monitoring is implemented in the safety program of the control, so the user has the flexibility to develop tailor-made safety functions. The reaction to a limit overshoot must also be specified in the safety program. While this requires more initial programming work, it also makes it possible to initiate a variety of different, situation-specific fault responses

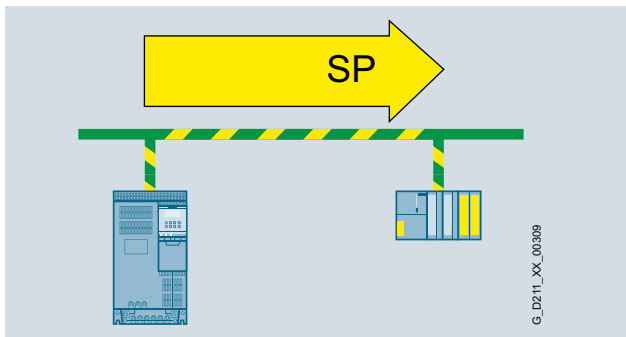

Safe Position (SP)

The principle of operation of Safety Integrated

Two independent switch-off signal paths

Two mutually independent switch-off signal paths are provided. All switch-off signal paths are low active. This therefore ensures that when a component fails or there is a wire break, the system always transitions to the safe state. When a fault is detected in the switch-off signal paths, the “Safe Torque Off” or “Safe Stop 1” function (depending on the parameterization, also refer to the table at the end of this chapter) is activated and a restart is prevented.

Two-channel monitoring structure

All of the hardware and software functions important for Safety Integrated are implemented in two mutually independent monitoring channels (e.g. switch-off signal paths, data management, data comparison). A cyclic data cross-check is carried out on the safety-relevant data in the two monitoring channels.

The monitoring functions in each monitoring channel are based on the principle that before a particular action, there must be a defined state, and after the action there must be a specific feedback.

If this expectation is not fulfilled in a monitoring channel, then the drive is shut down in both channels and an appropriate message output.

Forced checking procedure using a test stop

In order to fulfill the requirements of EN ISO 13849-1 and IEC 61508 with respect to early fault detection, the functions and the switch-off signal paths must be tested within a specific time period at least once to ensure that they are operating correctly. This must be realized either cyclically and manually or the test stop must be automatically initiated as part of the process. The test stop cycle is monitored and an alarm is issued if a test stop is not initiated within the required time period. A test stop does not require a power on. The process is acknowledged by deselection of the test stop request.

Examples of execution of forced checking procedure

- When the drives are stationary after power-up of the system
- Before the protective door is opened
- In a specified rhythm (e.g. in an 8-hour cycle)
- In automatic mode, time-driven and event-driven

Safety Integrated – Using encoders

Safe speed/position sensing with encoder

Incremental encoders or absolute encoders with photoelectric sampling are permitted for safe sensing of the position values on a drive. HTL/TTL incremental encoders can also be used.

Safe actual value sensing relies on redundant evaluation of the incremental tracks A/B that supply sin/cos signals of 1 Vpp. Only encoders of the type whose A/B track signals are created and processed using purely analog techniques can be used. The encoder signals are input via the SMC20 Sensor Module Cabinet- Mounted (cabinet option **K48**).

When HTL/TTL incremental encoders are used, safe actual value sensing is achieved by the use of two independent encoders or special dual HTL/TTL encoders. In this case, the minimum possible speed resolution must be taken into account. The encoder signals are input via the SMC30 Sensor Module Cabinet- Mounted (cabinet options **K50**, **K52**).

When motors with a DRIVE-CLiQ interface are used, the speed/ position actual values are generated directly in the motor as safe values and transferred to the Control Unit over a safe DRIVE-CLiQ communication link. When motors without a DRIVE-CLiQ connection are used, a Sensor Module (SMC20/30, SME20/25/120/125) must be provided. A separate DRIVE-CLiQ connection is required for each measuring system.

The following can be used for safe speed/position sensing:

- Single-encoder systems or
- Dual-encoder systems

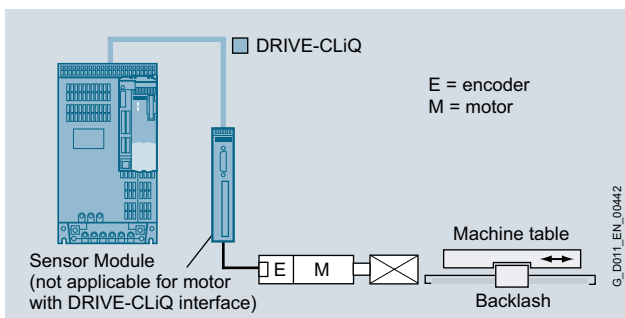

Example: Single-encoder system

In a single-encoder system, the motor encoder is used exclusively for safe actual value sensing. In this case, the motor encoder must be an incremental or absolute encoder with photoelectric sampling.

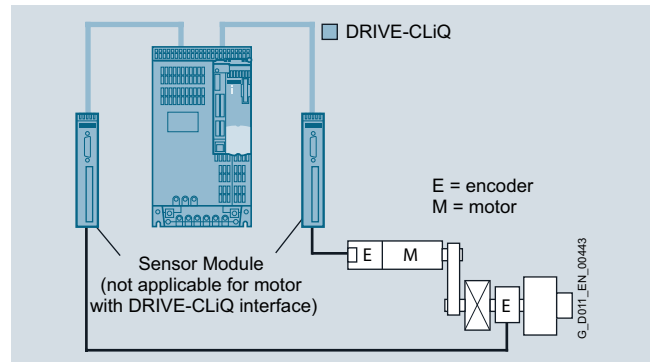

Example: Dual-encoder system

With a dual-encoder system, the safe actual values for a drive are provided by two separate encoders.

For this configuration, either two HTL/TTL encoders, one dual HTL/TTL encoder or one HTL/TTL encoder and one sine-cosine encoder can be used.

The encoder must be mechanically attached in such a manner that the encoder shaft is unable to unplug or slide off.

For further information, refer to IEC 61800-5-2: 2007, Table D.16.

A list of Siemens motors that fulfill the electrical and mechanical requirements is available at: <http://support.automation.siemens.com/WW/view/en/33512621>

Safe actual value sensing without encoder

For applications with encoderless mode or with encoders that have no safety capability, the safety functions can also be implemented without an encoder. It is not possible to use all safety functions in this case.

In operation without encoder the speed actual values are calculated from the measured electrical actual values. It is thus possible to implement speed monitoring in operation without an encoder.

An encoder that is used for the purposes of motor control has no significance for the safety function here.

Safety Integrated Extended Functions “without encoder” must not be used if the motor, after it has been switched off, can still be accelerated by the mechanical elements of the connected machine component.

In the hoisting gear of a crane, for example, the suspended load can accelerate the motor as soon as the motor is switched off. In this case, the safety functions “without encoder” are not permitted.

By contrast, a horizontal conveyor is always braked to a standstill due to friction as soon as the motor is switched off. In this case, the safety functions “without encoder” may be used.

Safety Integrated – Summary

Overview of Safety Integrated functions

Note: Please refer to page 3/17 and following pages for function names.

Function	Control	Underlying function	Reaction to limit overshoot	External setpoint active	Encoder required ¹⁾	License required
Safety Basic Functions						
STO	<ul style="list-style-type: none"> Terminal module, option K82 PROFIsafe 	SBC (if activated)	–	No	No	No
SS1	<ul style="list-style-type: none"> Terminal module (option K82) PROFIsafe 	STO, following expiry of the parameterized delay time, SBC (if activated)	STO	Can be parameterized	No	No
SBC	<ul style="list-style-type: none"> With STO (immediately or following expiry of the delay time with SS1) Via Safe Brake Adapter 	–	–	–	No	No
Extended Functions						
STO	<ul style="list-style-type: none"> F-DI on TM54F PROFIsafe 	SBC (if activated)	–	No	Yes ²⁾	Yes ³⁾
SS1 with SBR/SAM	<ul style="list-style-type: none"> F-DI on TM54F PROFIsafe 	Safe Acceleration Monitor (SAM) or Safe Brake Ramp (SBR) during braking. STO and SBC (if activated) following expiry of the parameterized delay time or if the speed falls below the minimum speed limit	STO	Can be parameterized	No	Yes
SS2	<ul style="list-style-type: none"> F-DI on TM54F PROFIsafe 	Safe Acceleration Monitor (SAM) during braking. SOS following expiry of the parameterized delay time	SS1 → STO	No	Yes	Yes
SLS encorderless	<ul style="list-style-type: none"> F-DI on TM54F PROFIsafe Continuously activated 	–	STO, SS1 (can be parameterized)	Yes	No	Yes
SLS	<ul style="list-style-type: none"> F-DI on TM54F PROFIsafe Continuously activated 	–	STO, SS1, SS2 or SOS (can be parameterized)	Yes	Yes	Yes
SOS	<ul style="list-style-type: none"> F-DI on TM54F PROFIsafe 	–	SS1 → STO	Yes	Yes	Yes
SSM	<ul style="list-style-type: none"> Always active, if configured 	–	Signals that the speed has fallen below a specified value	Yes	No	Yes
SDI	<ul style="list-style-type: none"> F-DI on TM54F PROFIsafe Continuously activated 	–	STO, SS1, SS2 or SOS (can be parameterized)	Yes	No	Yes
SLP	<ul style="list-style-type: none"> F-DI on TM54F PROFIsafe 	–	STO, SS1, SS2 or SOS (can be parameterized)	Yes	Yes	Yes
SP	<ul style="list-style-type: none"> Always active, if configured 	–	–	Yes	Yes	Yes
SBT	<ul style="list-style-type: none"> F-DI on TM54F PROFIsafe 	–	Signals test result. Alarm if test fails	Yes	Yes	Yes

¹⁾ Safety Integrated Extended Functions without encoder can be implemented subject to certain restrictions.

For further details, please refer to the current version of the "SINAMICS G130, G150, S120 Chassis, S120 Cabinet Modules, S150 Safety Integrated Function Manual" which is published on the Siemens Technical Support website <https://support.industry.siemens.com/cs/us/en/view/106254588>

²⁾ Activation using terminals on the TM54F requires an encoder.

³⁾ Activation using terminals on the TM54F requires a license (option **K01**).

Fail-safe inputs and outputs

TM54F Terminal Module (option K87)



The TM54F Terminal Module (option K87) is a dual-processor I/O interface with 4 fail-safe digital outputs and 10 fail-safe digital inputs for using Safety Integrated functions of the SINAMICS S150 drive via external actuators and sensors.

All of the available safety functions integrated in the drive can be controlled via the fail-safe digital inputs of the TM54F Terminal Module.

The fail-safe digital outputs and inputs have two channels with an internal crosswise data comparison via the two processors. A fail-safe digital output consists of one P-switching and one M-switching output as well as one digital input to read back the switching state. A fail-safe digital input consists of two digital inputs.

Safety sensors can be connected over two switchable 24 V sensor supplies and evaluated via the fail-safe digital inputs. The switchable 24 V sensor supply ensures that the fail-safe digital inputs can be dynamized to detect dormant errors (this dynamization is used to check the shutdown paths). A non-switchable 24 V sensor supply is additionally provided by the TM54F Terminal Module for connecting safety sensors that cannot be dynamized.

The TM54F Terminal Module is connected directly to a Control Unit via DRIVE-CLiQ. Each Control Unit can only be assigned to one TM54F Terminal Module.

Additional DRIVE-CLiQ nodes such as Sensor Modules and Terminal Modules (however no additional TM54F Terminal Module) can be operated on the TM54F Terminal Module.

The following are located on the TM54F Terminal Module:

- 4 fail-safe digital outputs
- 10 fail-safe digital inputs
- 4 LEDs, single color for indicating the status of the read back channel of the fail-safe digital outputs
- 4 LEDs, dual-color for indicating the status of the fail-safe digital outputs
- 20 LEDs, dual-color for indicating the status of the fail-safe digital inputs
- 3 LEDs, single color for indicating the status of the 24 V sensor supplies
- 2 connections for 24 V sensor supply, switchable
- 1 connection for 24 V sensor supply, non-switchable

The signal cable shield can be connected to the TM54F Terminal Module via a shield connection terminal, e.g. Phoenix Contact type SK8 or Weidmüller type KLBÜ CO 1. The shield connection terminal must not be used for strain relief.

The status of the TM54F Terminal Module is indicated via a multicolor LED.

Pins for connector coding are included in the TM54F Terminal Module scope of delivery.

Technical data

TM54F Terminal Module	
Current demand (X524 at 24 V DC) without DRIVE-CLiQ supply	0.2 A
Max. current demand ext. 24 V or supplying the digital outputs and 24 V sensor supply (X514 at 24 V DC)	4 A
I/O devices	
• Number of fail-safe digital inputs	10
• Number of fail-safe digital outputs	4
• 24 V sensor supply	3, of which 2 can be internally shut down to dynamize fail-safe digital inputs, current carrying capacity of input is 0.5 A
• Connection system	Plug-in screw-type terminals
• Wire size, max.	#14 AWG (1.5 mm ²)
Digital inputs According to IEC 61131-2 Type 1, with electrical isolation	
• Voltage	-3 ... +30 V
• Low level (an open digital input is interpreted as "low")	-3 ... +5 V
• High level	15 ... 30 V
• Current consumption at 24V DC, typ.	>2 mA
• Delay time of digital inputs, approx ¹⁾	
- L → H, typ.	30 μs
- H → L, typ.	60 μs
• Safe state	Low level (for inputs that can be inverted: without inversion)
Digital outputs Continuously short-circuit proof	
• Voltage	24 V DC
• Load current per fail-safe digital output max. ²⁾	0.5 A
• Delay times (resistive load) ¹⁾	
- L → H, typ.	300 μs
- H → L, typ.	350 μs
• Safe state	Output switched off

TM54F Terminal Module	
Scanning cycle t_{SI} for fail-safe digital inputs or fail-safe digital outputs	4 ... 25 ms (adjustable)
Conformity	CE
Approvals, according to	cULus
Safety Integrated	Safety Integrity Level 2 (SIL2) acc. to IEC 61508, Performance Level d (PLd) acc. to ISO 13849-1 and Control Category 3 acc. to ISO 13849-1

1) The specified delay times refer to the hardware. The actual reaction time depends on the time slot in which the digital input/output is processed.

2) The total current of all fail-safe digital outputs must not exceed 5.33 A.

Safe Brake Adapter (option K88)



A Safe Brake Adapter SBA is required to safely control a motor holding brake via the Safe Brake Control (SBC) safety function according to IEC 61800-5-2.

The Safe Brake Adapter is available for 230 V AC brake control voltages.

It is available as option **K88** for SINAMICS S150.

Note: The SBA approval is currently only valid for IEC regions. The SBA is not yet UL listed and may not be included in a UL listed SINAMICS S150 drive.

Safe Brake Adapter	Option K88
Supply voltage of the motor holding brake	230 V AC
Max. permissible current consumption of the	
• Motor holding brake	2 A
• Fast de-energization	2 A
Max, permissable cable lengths	
• to the brake	990 ft (300 m)
Max. wire size	#12 AWG (2.5 mm ²)
Safety Integrated	Safety Integrity Level 2 (SIL2) acc. to IEC 61508, Performance Level d (PLd) acc. to ISO 13849-1 and Control Category 3 acc. to ISO 13849-1

Integration

The SBC function is controlled and monitored by the SINAMICS Drives firmware. The control and feedback signal regarding the switching state of the SBA relay is realized via terminals of the Control Interface Module (CIM). The excitation coil of the holding brake is connected directly at the SBA.

Braking units

Braking units

Braking units are used when the drive needs to absorb regenerative energy occasionally and briefly, for example when stopping it quickly (emergency stop). The braking units comprise a braking module and a braking resistor, which is installed externally.

Two sizes of braking units are available for the SINAMICS S150 enclosed drive with braking powers of 100 kW (for 150 HP & 200 HP, 460V) and 200 kW (for larger 460 V and 575V units). For higher braking powers, braking units may be connected in parallel for larger drives (on request, not for all ratings).

A thermal contact, which can be integrated into the drive's alarm and shutdown sequence, is installed in the braking resistor for monitoring.

Determining the required braking units and braking resistors

- For periodic duty cycles with a load duration of ≤ 90 s, the mean braking power value within this duty cycle must be determined. The relevant period should be used as the time base.
- For periodic duty cycles with a load duration of ≥ 90 s or for sporadic braking operations, a 90 s time segment in which the greatest mean value occurs should be selected. A 90 s period should be set as the time base.

When determining the required braking unit rating (braking module and braking resistor), consider both the mean braking power value and the required peak braking power.

Basic Data

Supply voltage	380 V to 480 V	380 V to 480 V	500 V to 600 V	500 V to 600 V
Enclosed drive SINAMICS S150	150 HP to 200 HP	250 HP to 1,150 HP	75 HP to 125 HP	150 HP to 1,250 HP
Braking module Continuous power P_{DB}	25 kW	50 kW	25kW	50 kW
Braking module Power P_{40}	50 kW	100 kW	50kW	100 kW
Braking module Rated power P_{20}	100 kW	200 kW	100kW	200 kW
Braking module Peak power P_{15}	125 kW	250 kW	125kW	250 kW
Braking resistor R_B	4.4 Ω $\pm 7.5\%$	2.2 Ω $\pm 7.5\%$	6.8 Ω $\pm 7.5\%$	3.4 Ω $\pm 7.5\%$
Max. current	189 A	378 A	153A	306 A
Option code	L61	L62	L64	L65

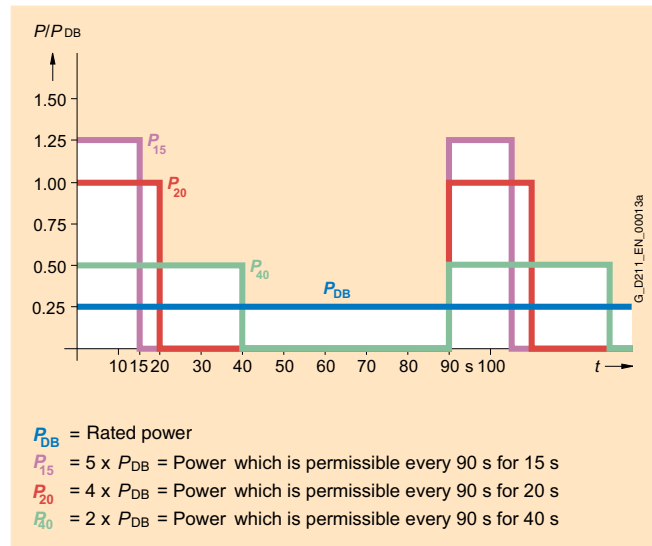

Load diagram

Calculating the P20 power

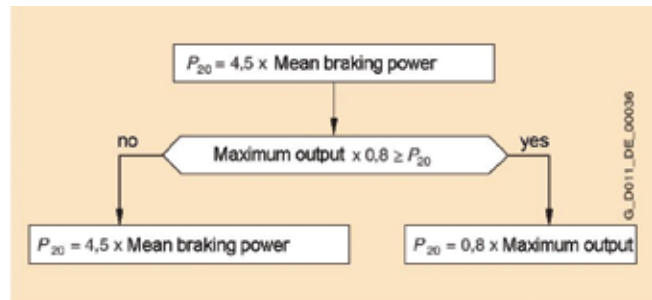

To reduce the voltage stress on the motor and drive, the response threshold at which the braking unit is activated and the DC bus voltage generated can be reduced. For example, the DC bus voltage for the drives in the voltage range from 380 V to 480 V can be reduced from 774 V to 673 V. This also reduces the possible peak power. A factor of 1.06, rather than a factor of 0.8 should be used.

The ON/OFF states of the braking module are controlled by a 2-point controller. The respective response thresholds are shown in the following table:

Drive voltage range	Braking unit response threshold
380 V to 480 V	774 V (673 V)
500 V to 600 V	967 V (841 V)

Braking units, maintenance accessory

Example

The design of the braking unit is to be calculated for a 200HP (132 kW) drive.

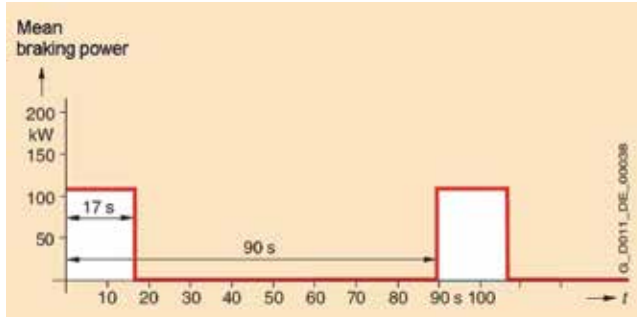

The Mean braking power = $90 \text{ kW} \times 17 \text{ s} / 90 \text{ s} = 17.0 \text{ kW}$

$$P_{20} = 4.5 \times 17.0 \text{ kW} = 76.5 \text{ kW}$$

$$\text{Peak power} = 0.8 \times 90 \text{ kW} = 72.0 \text{ kW}$$

Result:

The mean braking power is the determining factor in the configuration of the braking module and braking resistor, i.e. a braking unit $\geq 76.5 \text{ kW}$ should be provided.

The 100 kW braking unit is suitable.

When the response threshold is reduced, the required braking power P_{20} is calculated as follows:

$$\text{Mean braking power} = 90 \text{ kW} \times 17 \text{ s} / 90 \text{ s} = 17.0 \text{ kW}$$

$$P_{20} = 4.5 \times 17.0 \text{ kW} = 76.5 \text{ kW}$$

$$\text{Peak power} = 1.06 \times 90 \text{ kW} = 95.4 \text{ kW}$$

Result:

The peak power to be generated is the determining factor in the configuration of the braking module and braking resistor, i.e. a braking unit $\geq 95.4 \text{ kW}$ should be provided.

The 100 kW braking unit is suitable.

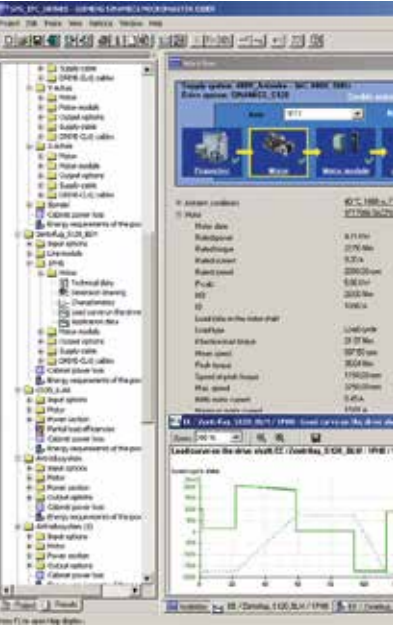

4/2

Engineering software

SIZER for Siemens drives
STARTER commissioning tool
Integration
Drive Control Chart

4/6

Service & Support

Service tool for exchanging power blocks
Spare parts
Complete lifecycle services
Service & Support contacts

SIZER for Siemens Drives engineering tool

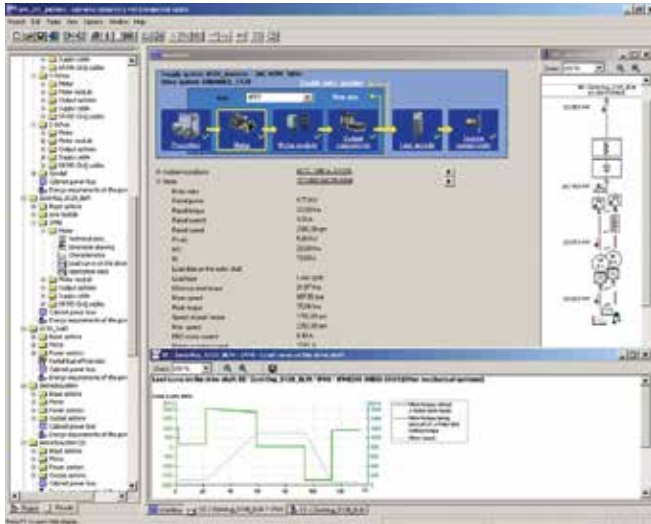

The following drives and controls can be engineered in a user-friendly way using the SIZER for Siemens Drives engineering tool:

- SINAMICS Low Voltage, MICROMASTER 4, DYNAVERT T, SIMATIC ET 200S FC and SIMATIC ET 200pro FC drive systems
- Motor starters
- SINUMERIK CNC control
- SIMOTION Motion Control System
- SIMATIC Technology

It provides support when setting up the technologies involved in the hardware and firmware components required for a drive task. SIZER for Siemens Drives covers the full range of operations required to configure a complete drive system, from simple single drives to complex multi-axis applications.

SIZER for Siemens Drives supports all of the configuring steps in a workflow:

- Configuring the power supply
- Selecting the motor and gearbox, including calculation of mechanical transmission elements
- Configuring the drive components
- Compiling the required accessories
- Selecting the line-side and motor-side power options, e.g., cables, filters, and reactors

When SIZER for Siemens Drives was being designed, particular importance was placed on a high degree of usability and a universal, function-based approach to the drive application. The extensive user guidance makes using the tool easy. Status information keeps you continually informed about the progress of the configuration process.

The SIZER for Siemens Drives user interface is available in German, English, French and Italian.

The drive configuration is saved in a project. In the project, the components and functions used are displayed in a hierarchical tree structure.

The project view permits the configuration of drive systems and the copying/inserting/modifying of drives already configured.

The configuration process produces the following results:

- A parts list of the required components (export to Excel, use of the Excel data sheet for import to SAP)
- Technical specifications of the system
- Characteristic curves
- Comments on system reactions
- Mounting arrangement of drive and control components and dimension drawings of motors
- Energy requirements of the configured application

These results are displayed in a results tree and can be reused for documentation purposes.

Technological online help is available:

- Detailed technical specifications
- Information about the drive systems and their components
- Decision-making criteria for the selection of components
- Online help in German, English, French, Italian, Chinese and Japanese

System requirements

- PG or PC with Pentium III min. 800 MHz (recommended > 1 GHz)
- 512 MB RAM (1 GB RAM recommended)
- At least 4.1 GB of free hard disk space
- An additional 100 MB of free hard disk space on the Windows system drive
- Screen resolution 1024 × 768 pixels (recommended 1280 × 1024 pixels)
- Operating system
 - Windows 7 Professional (32/64 bit)
 - Windows 7 Enterprise (32/64 bit)
 - Windows 7 Ultimate (32/64 bit)
 - Windows 7 Home (32/64 bit)
 - Windows Vista Business
 - Windows XP Professional SP3 (32/64 bit)
 - Windows XP Home Edition SP3
- Microsoft Internet Explorer 5.5 SP2

Selection and ordering data

	Order No.
SIZER for Siemens Drives engineering tool DVD-ROM German, English, French, Italian	6SL3070-0AA00-0AG0

More information

The SIZER for Siemens Drives engineering tool is available free on the Internet at:

www.siemens.com/sizer

STARTER commissioning tool

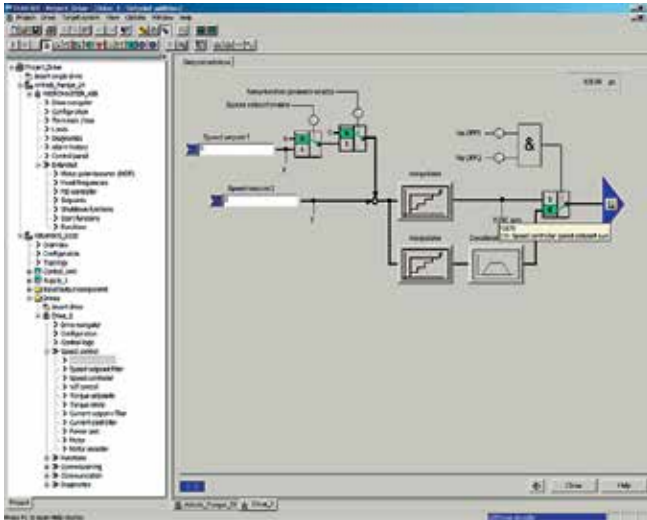

The user-friendly STARTER commissioning tool can be used for

- Commissioning
- Optimization
- Diagnostics

This software can be operated either as a standalone PC application, integrated in SIMATIC STEP 7 with TIA compatibility via Drive ES Basic, or it can be integrated into the SCOUT engineering system (for SIMOTION). The basic functions and handling are the same in both cases.

Configuring can be realized both offline as well as online. If several drives are connected to the selected communication bus, then an online connection can be established to several drives simultaneously.

The project wizards can be used to create the drives within the structure of the project tree.

Beginners are supported by solution-based dialog guidance, whereby a standard graphics-based display maximizes clarity when setting the drive parameters.

First commissioning is guided by a wizard which makes all the basic settings in the drive. Therefore, getting a motor up and running is merely a question of setting a few of the drive parameters as part of the drive configuration process.

The travel commands can be simply entered via the control panel from the PC.

The individual settings can be made using the graphic parameterizing screen forms, which precisely visualize the drive mode of operation.

Examples of individual settings that can be made include:

- How terminals are used
- Bus interface
- Setpoint channel (e.g., fixed setpoints)
- Closed-loop speed control (e.g., ramp-function generator, limits)
- BICO interconnections
- Diagnostics

For experts, the expert list can be used to specifically and quickly access individual parameters at any time. An individual compilation of frequently used parameters can be saved in dedicated user lists and watch tables.

In addition, the following functions are available for optimization purposes:

- Self-optimization of the controller settings (depending on the drive unit)
- Setup and evaluation of trace recordings
Tool function for recording 2 × 8 signals with
 - Measuring cursor function
 - Extensive trigger functions
 - Several Y scales
 - Sampling times in the current controller cycle clock
- Numerous measuring functions such as step functions and frequency response analysis

Diagnostics functions provide information about:

- Control/status words
- Parameter status
- Conditions of use
- Communication states

Performance features

- User-friendly: Only a small number of settings need to be made for successful first commissioning: The motor starts to rotate
- Solution-oriented dialog-based user guidance simplifies commissioning
- Self-optimization functions reduce manual optimization work.

System requirements V4.2 and higher

- PG or PC Pentium III min. 1 GHz (recommended > 1 GHz)
- 1 GB RAM (recommended 2 GB RAM)
- Screen resolution 1024 × 768 pixels, 16 bit color depth
- Free hard disk memory min. 3 GB
- Software
 - Microsoft Internet Explorer V6.0 or higher
 - 32 bit operating systems:
 - Microsoft Windows Server 2003 SP2
 - Microsoft Windows Server 2008
 - Microsoft Windows XP Professional SP3
 - Microsoft Windows 7 Professional incl. SP1
 - Microsoft Windows 7 Ultimate incl. SP1
 - Microsoft Windows 7 Enterprise incl. SP1 (Standard Installation)
 - 64 bit operating systems:
 - Microsoft Windows 7 Professional SP1
 - Microsoft Windows 7 Ultimate SP1
 - Microsoft Windows 7 Enterprise SP1 (Standard Installation)
 - Microsoft Windows Server 2008 R2 SP1

SINAMICS S150 NEMA

Engineering Tools, Service & Support

Integration

The fieldbus communication between the Control Units of SINAMICS S120, SINAMICS S150, SINAMICS G130 and SINAMICS G150 can, depending on the CU version (DP or PN), be realized via PROFIBUS or PROFINET/Ethernet, alternatively, also via the serial RS232 interface.

Further, there is the option of coupling SINAMICS S120, SINAMICS S150, SINAMICS G130, SINAMICS G150 and SINAMICS DC MASTER via SINAMICS Link, e.g. to establish a setpoint cascade.

For commissioning and service, a PG/PC can be connected to the CU320-2 Control Unit via PROFIBUS. A PROFIBUS connection must be available with a connecting cable at the PG/PC.

Further, communication between a CU320-2 Control Unit and PG/PC can also be established via Ethernet, either via an (optional) CBE20 Communication Board or the Ethernet interface -X127 on the CU320-2 Control Unit.

Note on -X127:

This Ethernet port is only intended for communication with a PG/PC for service and commissioning.

Selection and ordering data

	Order No.
STARTER commissioning tool For SINAMICS and MICROMASTER on DVD-ROM German, English, French, Italian, Spanish	6SL3072-0AA00-0AGO
Accessories	
PROFINET/Ethernet Standard-CAT5 Ethernet cable or PROFINET cable	

More information

The STARTER commissioning tool is also available for update purposes on the Internet at www.siemens.com/starter

Drive Control Chart (DCC)

Drive Control Chart (DCC) expands the scope of device functions by means of freely available closed-loop control, calculation and logic modules and offers a means by which technological functions can be graphically configured in the SINAMICS S120 drive system. DCC is installed as an additional application to the STARTER commissioning tool.

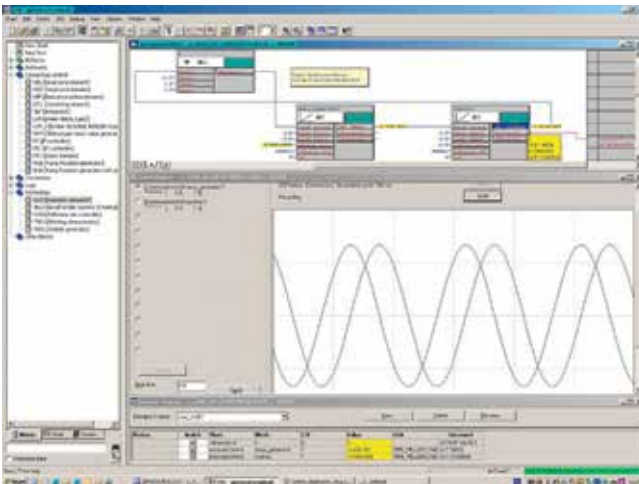
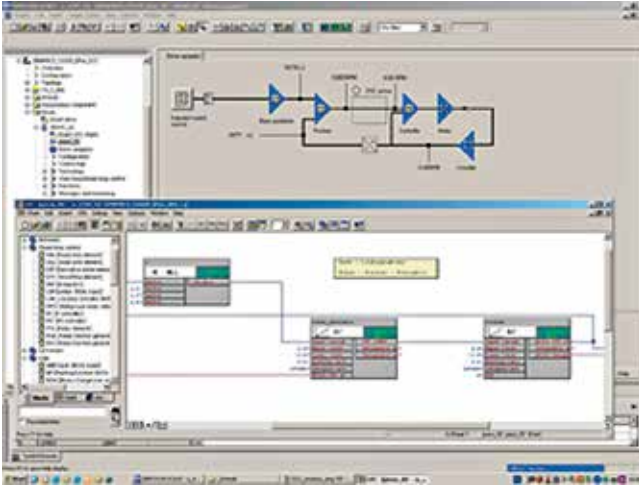

Drive Control Chart expands the possibility for very simply configuring technological functions, both for the SIMOTION motion control system as well as for the SINAMICS S120 drive system. For users, this opens up a new dimension regarding the adaptability of the systems mentioned to the specific functions of their machines.

DCC has no restrictions with regard to the number of usable functions; this is only limited by the performance capability of the target platform.

The user-friendly DCC Editor enables easy graphics-based configuration, allows control loop structures to be clearly represented and provides a high degree of reusability of diagrams that have already been created.

The open-loop and closed-loop control functions are defined by using multi-instance-capable blocks (Drive Control Blocks (DCBs)) from a pre-defined library (DCB library) that are selected and graphically linked with one another by dragging and dropping. Test and diagnostic functions allow the program behavior to be verified and, in the case of a fault, the cause identified.

The block library encompasses a large selection of closed-loop, arithmetic and logic blocks, as well as comprehensive open loop and closed-loop control functions.

For logically combining, evaluating and acquiring binary signals, all commonly used logic functions are available for selection (AND, XOR, on/off delay, RS flipflop, counter, etc.). A wide range of arithmetic functions, such as absolute value generation blocks, dividers and minimum/maximum evaluation are available to monitor and evaluate numerical quantities. In addition to the closed-loop drive control, axial winder functions, closed-loop PI controllers, ramp-function generators or wobble generators can be configured simply and easily.

Drive Control Chart for SINAMICS S120 also provides a convenient basis for resolving drive-level open-loop and closed-loop control tasks directly in the converter. This further extends the possibility of adapting SINAMICS to the particular application. Local data processing in the drive supports the implementation of modular machine concepts and results in an increase in the overall machine performance.

Minimum hardware and software requirements

See the STARTER engineering software, since DCC is installed in addition to this.

Selection and ordering data (options)

DCC comprises the graphic configuring tool (DCC Editor) and the block library (DCB library).

DCC is installed in addition to the SCOUT or STARTER engineering software.

The engineering license required for each PC (floating) for DCC is purchased at the same time the order is placed; additional runtime licenses are not required.

DCC can be ordered in two versions: as version for SIMOTION and SINAMICS applications, or as version for SINAMICS applications only.

Existing licenses for DCC V2.1 can also be used for DCC V2.2 SP1.

An upgrade variant for the engineering license can be selected for existing DCC V2.0 versions.

Description	Order No.
DCC V2.3 for STARTER V4.4 Graphic configuring with Drive Control Chart DCC Editor + DCB standard library for use on SINAMICS S120/S150	
<ul style="list-style-type: none"> • Single Engineering License, with data carrier • Upgrade Engineering License, with data carrier: 	6AU1810-1HA23-0XA0 6AU1810-1HA23-0XE0
The DCB Extension blocks are also configured by means of the graphic configuring tool (DCC Editor). The use of these blocks requires a runtime license.	
SINAMICS DCB Extension License Runtime license for relicensing with firmware V4.6 and higher	6SL3077-0AA00-0AB0

Service tool

Mounting device for power blocks



Power block mounting device for installing and removing the power blocks for Basic Line Modules, Smart Line Modules, Active Line modules and Motor Modules in chassis format.

The mounting device is a mounting aid. It is placed in the front of the module and attached to the module. The telescopic rails allow the device to be adjusted to the installation height of the power blocks.

Once the mechanical and electrical connections have been released, the power block can be removed from the module.

The power block is guided and supported by the guide rails on the handling device.

Selection and ordering data

Description	Order No.
Mounting device for installing and removing power blocks	6SL3766-1FA00-0AA0

Spare Parts

SparesOnWeb – Online spare parts catalog



SparesOnWeb is a web-based tool for determining the spare parts available for a SINAMICS drive. After you have registered and entered the serial number and order number, the spare parts available for the relevant unit are displayed.

www.siemens.com/sow

Complete life cycle service

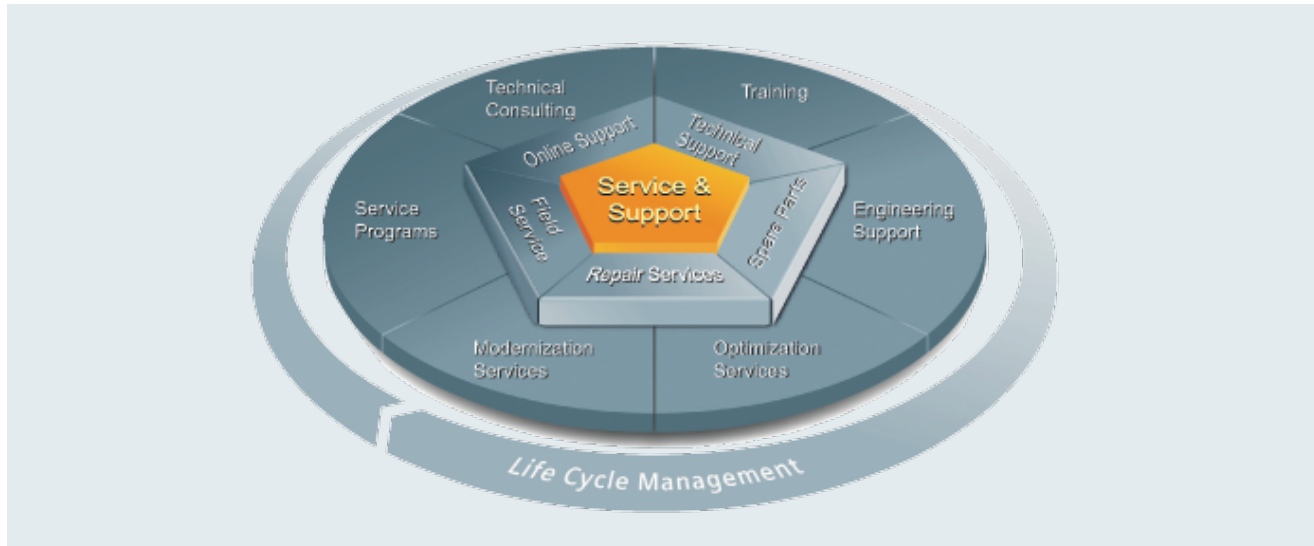

For machine constructors, solution providers and plant operators: The service offering from Siemens industry, Automation and Drive Technologies includes comprehensive services for a wide range of different users in all sectors of the manufacturing and process industry.

To accompany our products and systems, we offer integrated and structured services that provide valuable support in every phase of the life cycle of your machine or plant – from planning and implementation through commissioning as far as maintenance and modernization.

Our Service & Support accompanies you worldwide in all matters concerning automation and drives from Siemens. We provide direct on-site support in more than 100 countries through all phases of the life cycle of your machines and plants.

You have an experienced team of specialists at your side to provide active support and bundled know-how. Regular training courses and intensive contact among our employees – even across continents – ensure reliable service in the most diverse areas.

Training

Start-up and maintenance training

Siemens Industry offers the following course for SINAMICS S120:

Course name: SINAMICS S Setup & Maintenance
 Course code: SCT-DVSNAM1A
 Duration: 4½ Days

This course provides training on Siemens' SINAMICS S drive systems family. Student will gain experience necessary to setup and maintain the operation of the SINAMICS S. The course includes an analysis of required hardware, steps for a quick startup, as well as additional application dependent steps for configuration, tuning and troubleshooting. A working knowledge of the drive communications capabilities will also be presented. The course also covers the extensive diagnostic capabilities of the drive.

Please see the Siemens Industry SITRAIN Internet site for dates and costs of scheduled classes at: <http://www.usa.siemens.com/training>

Service & Support Contacts

Pre-sales Support, Order Entry

Please contact your local sales office.

GA400 facility, Alpharetta, GA

Phone: (770) 740-3000

e-mail: drives-marketing.industry@siemens.com

Technical Support

Inside USA, toll free: 1-800-333-7421

Outside USA: +1(423)262-5710

Online request: www.siemens.com/automation/support-request

Customer Service, Field Services, Spare Parts & Repair

Inside USA, toll free: 1-800-241-4453

Outside USA: +1(423)262-5711

e-mail: helpline.sii@siemens.com

Published by
Siemens Industry, Inc. 2016.

Siemens Industry, Inc.
100 Technology Drive
Alpharetta, GA 30005

For more information, please contact
our Customer Support Center.

Phone: +1 (800) 241-4453

E-mail: info.us@siemens.com

www.usa.siemens.com/drives

Order No: DRCA-D2172-0216

Printed in U.S.A.

© 2016 Siemens Industry, Inc.

Subject to changes and errors. The information given in this document only contains general descriptions and/or performance features which may not always specifically reflect those described, or which may undergo modification in the course of further development of the products. The requested performance features are binding only when they are expressly agreed upon in the concluded contract.