

# USER MANUAL

## 64-xx Label Printer



# Using the Documentation

Copyright.....	2	Text appearance .....	10
Documentation structure.....	3	Title page .....	11
Datapool, documentation object.....	3	Abbreviations .....	12
Documentation concept.....	3	Printer names.....	12
Documentation format .....	6	Parameters .....	12
Printing the documentation .....	7	Index.....	13
Navigation aids .....	8		
Symbols and note signs.....	9		
Warning notes .....	9		
Symbols .....	10		



## CAUTION!

Read the user manual before operating the device for the first time.  
The user manual is an essential part of the device it belongs to.  
The user manual is to be stored at the machine operating location and made accessible to the operator.

## Copyright

© 2015 by Novexx Solutions GmbH. All rights reserved.

Reprinting and reproduction of these documents, including extracts, is only allowed with the express permission of the manufacturer. More detailed information is available from your supplier.

### Copyright

The documentation is subject to copyright. The copyright claims include all forms and types of material and information which may be protected by current copyright laws. No part of the documentation may be copied, reproduced in any other manner, processed or translated into another language, irrespective of the manner and fashion or with which means this takes place.

### Copy

Electronically stored device information (CD ROM, Internet) supplied by the manufacturer may be printed out by the user, provided that the print medium serves the use or servicing of the described product.

### Protected rights

Names are generally given without any mention of existing patents, registered designs or trademarks. The absence of a corresponding remark does not give any implication that the name can be used at will. All trademarks are recognised.

### Alterations

No liability is assumed for the accuracy of the contents of this documentation. The manufacturer reserves the right to alter technical or other specifications with no prior notice. Deviations in the documentation from prevailing conditions do not represent an obligation to redeliver.

### Guarantee

The manufacturer does not guarantee the existence or non-existence of properties with the description of subject contents. Nor does the manufacturer give any express or tacit guarantee declarations whatsoever.

## Documentation structure

### Datapool, documentation object

The overall documentation is a part of the datapool, which is provided for the printer user and the service personnel on CD or other electronic media.

#### Datapool

This datapool includes:

- this printer documentation,
- the printer drivers

#### Printer doc

Here the overall documentation (abbr.: documentation) is to be understood as the printer documentation.

The printer documentation contains all the information which is required for using the product. Using the product means preparing it for use, putting it into operation, setting it up, the operation, servicing and maintenance, fault searching and the service for optional extensions, settings and repairs.

#### Doc object

The documentation object includes

- various printer families (printer series), consisting of different printer models (devices),
- standard and optional additions for the printer (options) and
- the printer language Easy Plug.

### Documentation concept

The wide range of products which must be documented and the demand for documentation distribution and use, both in electronic form (CD/Internet, PC) as well as in paper form, have resulted in the following documentation concept:

#### Structure

The documentation consists of

- topic sections (generally comparable to chapters),
- manuals (handbooks, instructions),
- link pages and the
- start page (start page of the CD documentation).



**Subject section**

Thematically-related subject contents are described in each topic section. A topic section is the smallest unit of information with its own

- page numbering,
- header bar,
- list of contents,
- index,
- device classification and
- its own revision status.

Subject sections form the basis of the manual. A topic section can be simultaneously assigned to several manuals. Subject sections are in one, in some cases two, languages.

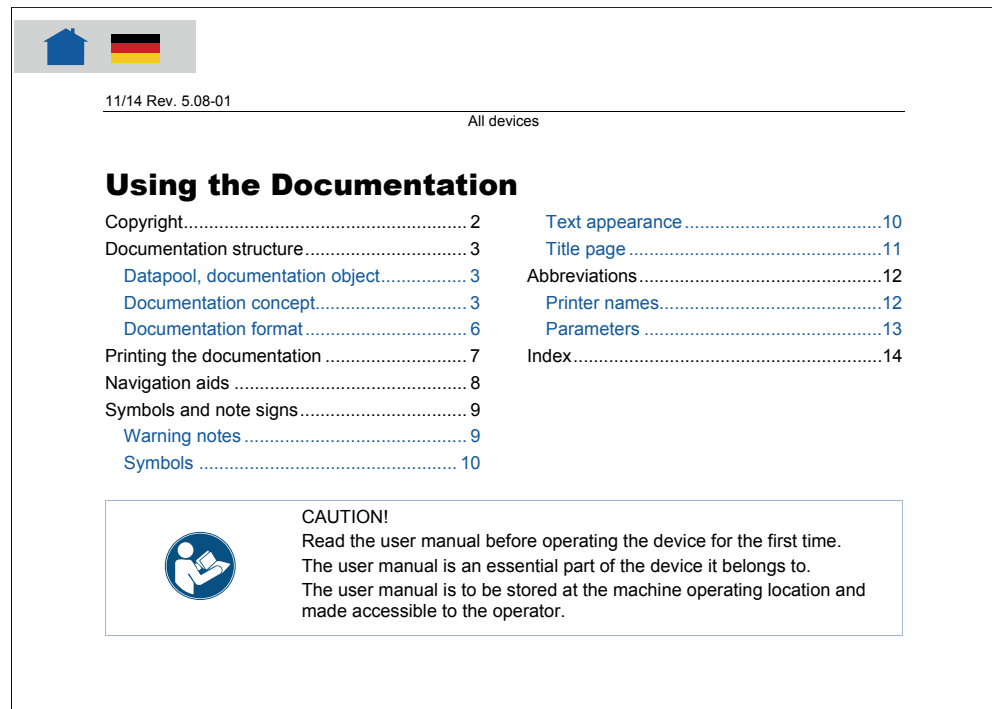

Fig. 1 Example: First page of topic section "Using the Documentation"

**Manual**

A manual is composed of different topic sections. The following features characterize a manual:

- Title page with a list of contents, device classification and revision status (see Fig. 1).
- The list of contents contains the designations of the topic sections and also serves as a link distributor to these topic sections.
- The contents of a manual refer to a certain device, a device family or an option (documentation object).
- A manual is assigned to a certain language and only contains topic sections in this language.
- A manual is assigned to a certain user group. There are *Service Manuals* (mainly for the Service), *User Manuals* (mainly for the user) and just *Manuals* (for Service and user).



Fig. 1 Each Manual title page provides a list of topic section in its right half.

To a certain extent manuals are only virtual, as the same topic section can be simultaneously assigned to different manuals (the topic section physically only exists once).

Subject sections which are only assigned to a single manual are colour-coded on the title page of the manual (in the same colour as the title of the manual, see "Symbols and note signs").

## Link page

A link page is only an organisational component of the datapool available on electronic media. The following features characterize a link page:

- Assignment to a single language
- Function as a link distributor to the individual manuals (access to the overall documentation of the corresponding language)
- Function as a link distributor to other components of the datapool provided on the electronic medium (e. g. printer drivers and print and design software in the corresponding language)

**Start page**

The start page is also only an organisational component and is displayed when the CD starts, or on the Internet on the link to the printer datapool. The following features characterize a start page:

- Assignment is irrespective of the language or multilingual
- Function for the language selection made by the user
- Function as a link distributor to the link page with the selected language.

This gives the following documentation hierarchy:

**Hierarchy**

1. Start page (selection of the language)
2. Link page (selection of the manual)
3. Manual title page (selection of the topic section)
4. Subject section contents page (selection of the subtheme)

In most cases, the subtheme selected in step 4 equates to the information being searched for. For instance, the selection of the status number in the list of contents of the topic section leads straight to the description of this status number.

**Documentation format**

All elements of the printer overall documentation are in Adobe PDF (Portable Document Format). This has the following practical advantages:

**Printing**

- The documents can be printed in the required quality irrespective of the printer type and the fonts which are used.

**Memory**

- Less memory is required for saving the document due to differentiated data compression (faster loading, faster printing).

**Internet**

- Internet compatibility due to the relatively small amount of data.

**License**

- Simple distribution without the need to purchase licenses (Adobe Reader licenses are provided free of charge by Adobe worldwide and in many languages).

**Platform**

- Can run on different platforms (Windows/Macintosh/Linux)

**Links**

- Links within and between Acrobat documents, as well as links to documents in other formats and executable files.
- Other Acrobat Reader functions such as page returns, bookmarks, thumbnails, document-overlapping search function with an automated index, etc.
- More detailed information about the Acrobat Reader is contained in the Acrobat online help.

## Printing the documentation

In order to make the documentation readable without a PC, the documents can be printed in A4 as well as in Letter format. For printing, the Acrobat Reader uses the print capabilities of the platform it is run on. The layout of the printed documents equals the appearance on the monitor screen.

Mind the following hints before you start to print:

When printing several manuals, it is not necessary to print out all topic sections starting with the title page.

- Only print out the topic sections marked in black once. These topic sections are referenced from different Manuals. Physically, they consist of the same data.
- Always print out all subjects marked in purple. Reference is only made once in the respective manual to each purple topic section.

When printing all of only one manual, it is necessary to print out all topic sections in this manual starting from the title page.

### Example

- In order to print a *user manual*, proceed as follows:
  1. Print the title page.
  2. Click the topic sections on the right half of the title page one after the other. Print each topic section completely.
- In order to print the *service manual* additionally, switch to the title page of the service manual and only click the topic sections written in purple. Print those topic sections. The remaining black topic sections are already printed with the user manual.

### Text integration

It is also possible to integrate documentation text (and images) in other documents using the Windows clipboard. As a result, e. g. order information (spare part designations and part numbers) can be used simply and with no additional effort.

- ▶ Pay attention to copyright restrictions. Information on this subject can be found under "Copyright".



## Navigation aids



### Info search

The following options are available for quickly searching for information in the paper documentation:

- The title page of each manual with a list of contents of the topic section
- The detailed list of contents with page numbers on the first page of each topic section
- The own page numbering of each topic section
- The index at the end of each topic section.

### Links

In the top left corner of each title page and on the first page of each topic section, you find small graphics, which ease the change back to higher levels of the documentation (see Tab. 1).

Symbol	Meaning
	<i>Triangle</i> : Link to the last opened page.
	<i>Triangle</i> : Link to the last opened page. <i>House</i> : Link to the menu page. <i>Flag</i> : Link to the german page of identical content. On the corresponding german page, a british flag symbolizes the cross-reference to the british page.
	<i>Houses with flags</i> : Links to the menu pages in different languages. Is used in bilingual topic sections (e.g. spare parts lists).

Tab. 1 Navigation aids can be found on the first pages of the PDF-documents.

## Symbols and note signs

### Warning notes

Warning notes warn of a possibly dangerous situation. Personal injury, material damage or data loss are possible, if care is not taken.

Depending on the dimension of possible damages, the warning notes look different:







- Warning note, which warns of a danger that can lead to injuries, if the dangerous situation is not avoided. Appearance: Exclamation mark in a triangle, signal word "WARNING", blue frame, blue shaded text field (see below).

	<p><b>WARNING!</b> Description of the <i>danger source</i>. Description of <i>possible personal injury</i>. → <i>Measure to avoid personal injury</i>. → Further measure to avoid personal injury. → ...</p>
---	--



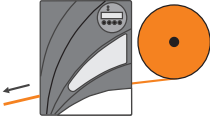
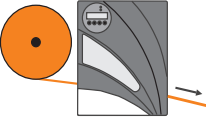



- Warning note, which warns of a danger that can lead to material damage or data loss, if the dangerous situation is not avoided. Appearance: Exclamation mark in a triangle, signal word "CAUTION", blue frame (see below)..

	<p><b>CAUTION!</b> Description of the <i>danger source</i>. Description of <i>possible material damage</i>. → Measure to avoid material damage. → ...</p>
---	---

## Symbols

	Warning of the risk of injury due to moving or rapidly rotating parts! Long hair, loose jewellery, long sleeves, etc. are not admissible when operating the machine. Wear sufficient personal protection gear.
	Tools required for the described service action.
	Marks additional information, which has not necessarily to be read to operate the machine, but which improves the understanding for the described function.
	Lefthand version (LH version): Symbol marking a text section which refers to the LH version of a device. (Only important for DPM, PEM and ALX 92x)
	Righthand version (RH version): Symbol marking a text section which refers to the RH version of a device. (Only important for DPM, PEM and ALX 92x)
	CE label: Documents the EC conformity of the device.
	Recycling: Notes about disposal. Pay attention to environmental protection!
	Arrow at the right bottom corner: paragraph is continued on the following page. 

## Text appearance

	1. (Numbered) Action instructions, introductory text: 2. follow the sequence!
	Focus arrow: action instructions, sequence not stipulated.
	Note arrow: special note. Pay attention!
	Focus point: feature, extra paragraph.
	Focus circle: Reference to another text position or info source.
	Exists. Completed. Yes. Applies.
<a href="#">Blue text with link symbol</a> 	Link to other positions in the documentation (click). Exception: In lists of contents, the black text is also linked.

## Title page

**Link**

Black text in the blue frame:  
link to topic sections which occur several times in different manuals (click).

**Link**

Purple text in the blue frame:  
link to a topic section which only occurs once and belongs specifically to the manual (click).

**Link**

Blue text in the blue frame:  
A click on the text starts an executable program, e.g. the printer driver unpacking program starting from the "Manual printer driver" title page.

## Abbreviations

### Printer names

If there is not enough space to call all printers by their full names, the abbreviated spellings listed in Tab. 2 are used.

Spelling	Meaning	Example, note
64-04/05	64-04, 64-05	
64bit series	Printer/Print-Dispenser with 64bit electronics	64-xx, DPM, PEM, ALX 92x
64-xx	Tabletop printer with 64bit electronics	64-04, 64-05, 64-06, 64-08
ALX 92x	Print-Dispenser of the ALX 92x series	ALX 924, ALX 925, ALX 926

Tab. 2 Abbreviated spelling of printers.

### Parameters

The notation of parameters is done as follows:

MENU > Parameter name

Example:

INTERF. PARAM. > Interface

(Parameter "Interface" in the menu "INTERF. PARAM.")

# Index

## A

Abbreviations ..... 12  
Alterations, technical ..... 2

## C

Copy ..... 2  
Copyright ..... 2

## D

Datapool ..... 3  
Documentation  
  concept ..... 3  
  format ..... 6  
  object ..... 3  
  structure ..... 3

## H

Hierarchy ..... 6

## L

Link page ..... 5

## P

Paper documentation ..... 7  
Patents ..... 2  
Pinch Point ..... 10

## R

Redelivery, documentation ..... 2  
Registered designs ..... 2  
Reservation ..... 2

## S

Safety notes ..... 9  
Start page ..... 6  
Subject section ..... 4

## T

Trademarks ..... 2



## Safety Notes

Note about printer names .....	2
Information and qualifications .....	3
Follow the instructions .....	3
Information must be made available .....	3
Ensure necessary qualifications .....	3
Machine operating safety .....	4
Conditions for safe use .....	4
Protect against injuries that can result from electrical current .....	4
Protect against injuries that can result from mechanical actions .....	4

## Note about printer names

The protective measures described in the following count for all printers (e. g. 64-xx), print-and-apply machines (e. g. ALX 92x) and print-and-apply modules (DPM) distributed by Novexx Solutions.

▣ In this document, all above mentioned printer types are referred to as „machine“.



## Information and qualifications



### Follow the instructions

Safe and efficient operation of the printer can only be guaranteed if you observe all necessary information.

Product liability and warranty can only be claimed, if the printer was operated according to the notes and instructions in the user manual.

→ Before operating the device, read the operating instructions and all other notes carefully.

→ Observe the additional safety and warning notes on the device.

### Information must be made available

This operating manual...

→ is to be stored at the printer operating location and made accessible to the operator.

→ is to be maintained in legible condition.

→ If the machine is sold, it must be made available to the new owner

→ Safety and warning notices attached to the machine must be kept clean and legible. Missing or damaged warning labels and plates are to be replaced.

### Ensure necessary qualifications

#### Operation

→ Only allow the printer to be operated, adjusted and serviced by instructed and authorised personnel.

Instruction of the operating personnel must ensure

- that operating personnel can use the machine independently and without posing a danger.
- that operating personnel can remedy minor operational malfunctions themselves.

→ Train at least 2 persons to operate the machine.

→ Make label materials for test purposes available in sufficient quantities.

→ Moreover, personnel are to be regularly instructed about work safety and environmental protection issues.

→ The responsibilities for operation, adjustment and servicing of the machine must be clearly defined and consistently maintained.

→ Only make adjustments to the machine in accordance with this manual and with all due care.

#### Service

Special servicing, fault searching and fault correction are to be carried out by the manufacturer, his appointees or other authorised service agents. This also includes the optional installation and refitting of components.

## Machine operating safety



### Conditions for safe use

- Only use the machine in enclosed areas with environmental conditions matching the values given in the technical specifications.
- Only operate the machine on a plane, solid support.
- Only trained and authorized personnel should operate the printer!
- During operation, the printhead can become hot! Care should be taken when touching the printhead!
- Do not make any modifications or any additional casing for the machine!
- Do not allow any liquids to enter into the machine!
- Repairs to the machine may only be performed by authorized specialists who are aware of the risks involved!
- Make sure that the power supply socket for the machine is readily accessible!
- Lay the power supply cable, data cables and compressed air hoses (if applicable) in a way that nobody can stumble over it.
- In case of emergency, switch off the machine and pull off the power supply cable!
- Only use original accessories!



### Protect against injuries that can result from electrical current

- Only put the machine into operation when installed in a correctly installed housing.
- Only operate the machine using the system voltage indicated on the nameplate!
- Only connect the machine to a grounded power socket fitted to authorized standards!
- Only connect devices to the interfaces at the machine that fulfil SELV (safety extra-low voltage) circuit requirements according to EN 60950!



### Protect against injuries that can result from mechanical actions

- Only operate the printer when the cover is closed!
- Don't wear loose long hair (if necessary, wear a hairnet).
- Keep loose jewellery, long sleeves, etc. away from rotating parts or the printer.
- Wear sufficient personal protective equipment.

### Applicator operation

The following printers can be operated with an applicator:

- 64-xx
- ALX 92x
- DPM

Operation with an applicator causes additional hazards, which must be safeguarded by the following additional protective measure:

- Only operate the printer, if it is equipped with an appropriate safeguarding device<sup>1</sup>. This device must stop the printer, if it is opened.

1) Movable interlocking guard according to EN ISO 12100-1, 3.25.4



# Commissioning & Operation

Mounting the printer .....	2	Configuring the data interface .....	13
Unpacking the 64-xx .....	2	Offline operation .....	14
Carrying the 64-xx .....	4	Online operation .....	15
Mounting the 64-xx .....	5	Creating a print job .....	16
Device description .....	6	Transferring a print job .....	16
Printer connections .....	6	Applying memory cards .....	18
Operator panel .....	8	Setting the realtime clock .....	19
Operating modes .....	9	Outputting the realtime clock value using Easy Plug .....	19
Basic Operating Procedures .....	11	Starting to print .....	20
Connecting the printer .....	11	Settings for the material type .....	20
Switching on the printer .....	13	Printing the status report .....	20

## Mounting the printer

### Unpacking the 64-xx

1. Lift off the lid of the shipping box [1].
2. Take out the plastic bag containing the accessories [1B].
3. Lift off the styrofoam support [1A].

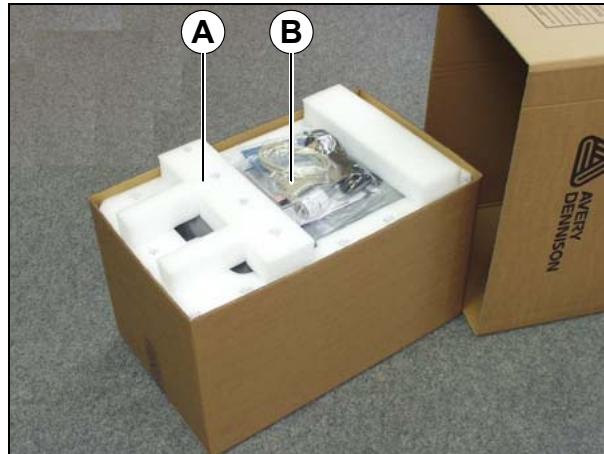

[1] Shipping box without lid:

- A Styrofoam support
- B Accessories

4. Part the plastic cover [2].



[2] Open the plastic bag...



**WARNING!**

Printers with mounted cutter: The cutter may cause cut injuries.

- Do not grasp the cutter [3A] as a handle.
- Use the cutter motor [3B] as a handle.



[3] Don't use the cutter as a handle!

5. Grab the printer from underneath and lift it out. The material feed slot in the back wall of the printer [3A] can be used as a handle.
  - ▮ Printers with mounted cutter: The motor [4B], but *not* the cutter [4A] may be used as a handle!

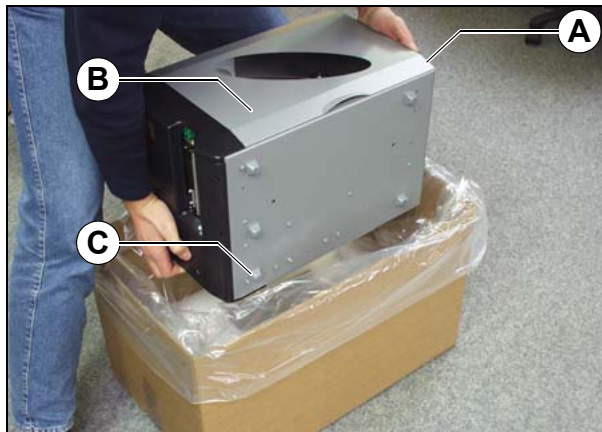

[4] Lift the printer out of the box.  
 A Back wall of printer (not visible)  
 B Front cover (do not use for lifting)  
 C Rubber feet



**CAUTION!** - Do not lift the printer by the front cover [4B]. The front cover is a movable part not designed for handling stress.

6. Place the printer on a level surface in its usual operating position (rubber feet [4C] at the bottom).
  - ▮ The *original packaging* should always be used for transporting the printer!

## Carrying the 64-xx



### WARNING!

The 64-xx is a heavy printer. The weight depends on the printer type and equipment and can vary from 20 kg (64-04/05) up to 29.5 kg (64-08 Dispenser).

A bad carrying technique can cause back injury.

- Try to lift the printer in a safe way, for example by
- carrying it close to your body, and by
  - bending your knees, not your back.

→ To carry the printer, put one hand under the base plate and the other into the feed slot at the back of the printer.



CAUTION! - Do not lift the printer by the front cover (window side), as this can damage it!

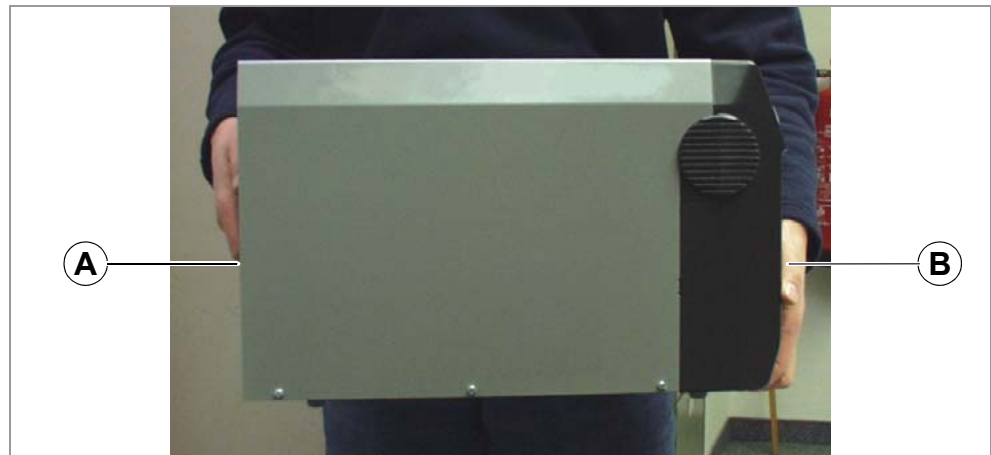

[5] Carrying the 64-xx safely (A: back – grab by the feed slot, B: front – grab by the base plate).

## Mounting the 64-xx

The 64-xx has been designed as a desktop printer, which means that it is normally mounted in an upright position on a table [2]. Other sufficiently large, level and sturdy surfaces can also be used as a base.



### WARNING!

When choosing a base for the printer, observe the following guidelines to avoid dangerous operating conditions:

- The base needs to be at least as deep and wide as the printer itself.
- The surface needs to be level, solid and dry.
- The printer's fan and ventilation slits must not be obstructed, as the device may overheat otherwise.
- The printer must not be mounted in the immediate vicinity of other heat sources.
- The environmental conditions specified (temperature, air humidity, etc.) need to be complied with.
- The power cable should be run to the printer so that
  - nobody will trip on it, and that
  - the power plug can easily be pulled out if necessary.



[6] The correct orientation of the 64-04.

# Device description

## Printer connections



### CAUTION!

Add-on devices of an inferior quality may damage the printer!

→ Connect the printer only to devices that fulfil SELV (safety extra-low voltage) circuit requirements acc. to EN 60950!

→ Only connect OEM devices.

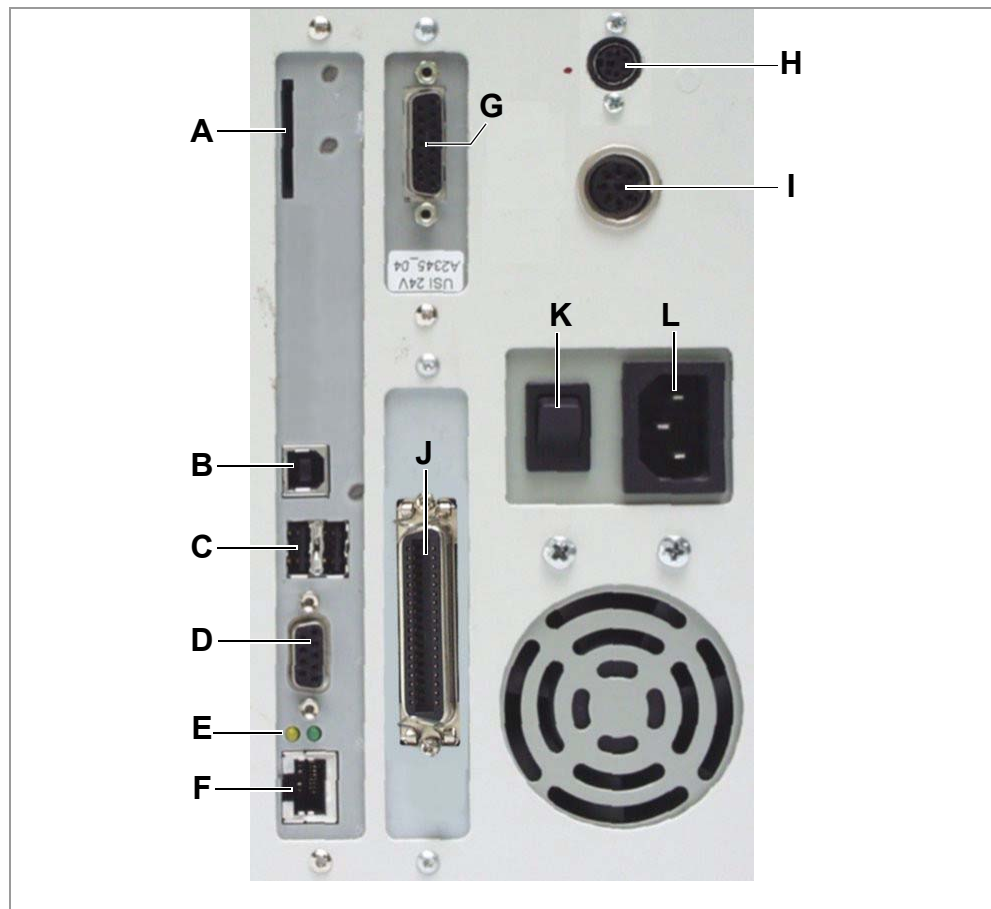

[7] Back of the 64-xx with the following options installed: USI board (H), connector for remote operator panel (I) and start/stop signal input (J).

- A** *Card slot*  
For SD/MMC cards; is not yet supported
- B** *USB interface type B (device)*  
For transfer of print data
- C** *2x USB interface type A (host)*  
To connect devices (e.g. keyboard, scanner)
- D** *RS232 interface*  
For serial transfer of print data
- E** *Status-LED/Ethernet*



64-xx

**F** *Ethernet interface*

To connect to an „Ethernet 10/100 Base T“ network

**G** *Optional: Signal interface USI*

- 4 inputs / 8 outputs
- Standard at „64-xx Dispenser A“

**H** *Optional: Mini-DIN connector*

To connect a remote operator panel

**I** *Optional: start/stop signal input*

- Standard at 64-xx Dispenser
- To connect a foot switch (signal starts printer) or a stacker (signal stops printer)

**J** *Centronics interface*

For parallel transfer of print data (cable is inclusive)

**K** *Power switch*

Turns the printer on/off

**L** *Mains power supply connector*

Connection to a mains socket using the provided power cable

**M** *Connector for peripheral devices*

Admissible peripheral devices are:

- Cutter („Cutter 2000“)
- Rewinder („Rewinder 2000“)
- Applicator LTSI (with „64-xx Dispenser A“ only)
- Photoelectric switch at the dispensing edge (with „64-xx Dispenser M“ only)



[8] Connector (M) for peripheral devices.

### Operator panel



[9] Operator panel of the 64-xx.

#### Display

With 32 digits and two lines, the display shows the operating conditions (modes) for parameters, values, status and errors. You can select the language you want to use for the display. Backlighting ensures good legibility.

#### Button functions

The buttons offer a multitude of operating functions. A logical menu structure is used for operation. The meaning of each button varies according to the operating mode and the menu item. Additionally, special functions have been programmed for certain button combinations.

Depending on the modes and menu levels, the following functions apply for each button:

#### Online button

- For switching between online and offline mode.
- For confirming entries, menu items and messages.
- For selecting print jobs and for entering values in standalone mode.

#### Cut button

Triggers a cut. Requirements:

- Cutter fitted and activated.
- Printer offline.
- Also for accessing deeper levels within the menu structure and selecting menu items.
- For decrementing values.

#### Feed button

- For feeding in material when the device is offline.
- For starting the printing process once the feed has been stopped (in online mode).
- Also for accessing deeper levels within the menu structure and selecting menu items.
- Increments values.

#### Prog button

- For accessing the parameter menu when offline.
- For stepping back through the parameter menu and/or exiting it.

For more detailed descriptions of the button functions, please see

- Chapter [Offline operation](#) on page 14 and Chapter [Online operation](#) on page 15
- In topic section [Info-Printouts and Parameter](#)

**Remote operator panel** 64-0x Gen. 3 (or higher) machines can be equipped with a remote operator panel. For this, the printer must provide the appropriate - optional - connector, see chapter [Printer connections](#) on page 6. The connection can be retrofitted (see service manual).

The button functions are the same as those on the standard operator panel. Exception: The on/off switch is not available at the remote control panel.

With the remote control panel connected, both panels are active and show the same information.



**CAUTION!**

Manipulating both operator panels simultaneously can cause malfunctions.

→ Always use only one operator panel at a time to operate the printer. (Using both operator panels alternately is admissible).



**CAUTION!**

If the connection cable is longer than 2.5 m, EMC-caused disturbances can occur.

- Only use the factory-installed cable.
- Don't extend the cable.



[10] Remote operator panel (article number A8293)

### Operating modes

#### Offline mode

Printer settings can be made when the device is *offline*. The offline mode is normally active when the printer is switched on. Print jobs are received via the selected interface but not processed.

**OFFLINE 0 JOBS** No jobs are waiting to be processed.

To configure the printer so that it goes directly into online mode when switched on, set the parameter `SYSTEM PARAMETER > Active Mode` to "Online".

**Online mode**

In *online* mode, print jobs are received and processed immediately. Possible messages:

ONLINE 0 JOBS No jobs are waiting to be processed.

ONLINE 0: JOBS The current data transfer to the printer is shown on the display. This is indicated by the dot on the bottom right next to the number of loaded jobs.

Another point on half line height above the first shows the interpreter status:

- *No point*: No data to interpret.
- *Solid point*: The interpreter is busy (still data left in the spooler).
- *Flashing point*: The interpreter is waiting for data required to complete a command (no data in the spooler).

ONLINE 13 JOBS  
Restcount: 25 During printing, the display also shows the number of received print jobs (13) and the remaining number of labels (25) to be printed in the current job.

ONLINE 13 JOBS  
Restcount: endless If a print job recognises an endless number of labels to be printed, then the remaining number for this job is also shown as endless.

▣► To stop printing, press the online button.

**Message mode**

The printer uses status reports to signal an error or a particular operating status. This message mode indicates that the printer is waiting to quit or for fault clearance. When quitting, the printer switches from message mode to offline mode (depending on the error and the progress of the last active process).

Status 5001  
No gap found Messages are made up of the status number and a brief descriptive text.

The status message 5001 (shown above) occurs when for example the printer is set for punched label material, but continuous form material without punches has been inserted. In this case, the printer will continue to feed the material for a few seconds before it generates an error message.

*Status Reports*: see topic section [Status Reports](#) .

**Standalone mode**

In standalone mode, print jobs are not transferred but saved on a plugin card. They are started directly from the printer's operator panel or via a connected keyboard.

*Standalone mode*: see topic section [Advanced Applications](#) .

## Basic Operating Procedures

### Connecting the printer

**WARNING!**

The printer operates using mains voltage! Touching electrically live parts can cause exposure to hazardous electrical currents and may lead to burns.

- Make sure that the printer is switched off before connecting the power cable.
- Only operate the printer using the system voltage indicated on the nameplate.
- Only connect the printer to a grounded power socket fitted to authorised standards.
- The power cable should be run to the printer so that
  - nobody will trip on it, and that
  - the power plug can easily be pulled out if necessary.

1. Ensure that the printer is switched off (mains switch [11A] at “0” position).
2. Connect the mains cable [11B] that came with the printer to the mains connector at the printer.
3. Connect the supplied mains cable [11B] to the mains connector at the printer [11C] and to a mains socket.

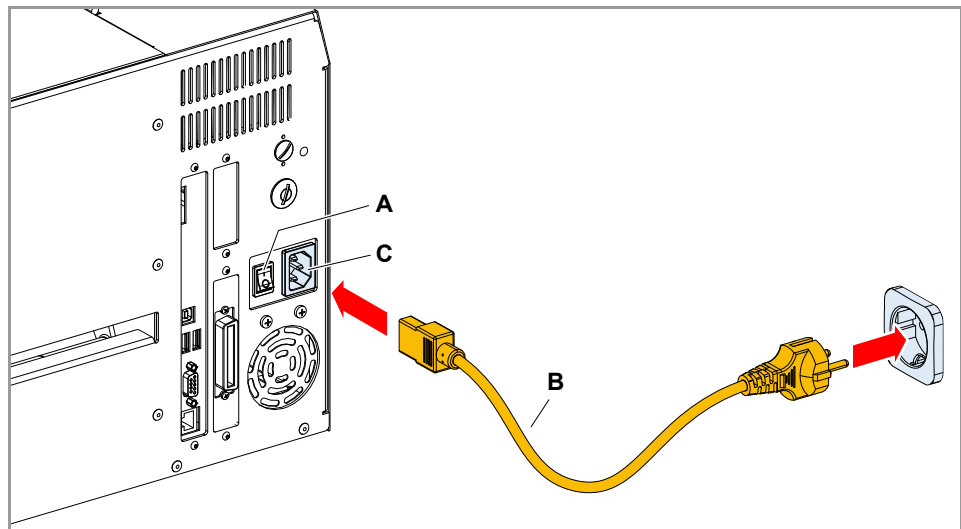

[11] Connecting the power cable (B).

4. Connect a standard USB data cable [12A] to the USB connector at the printer [12B] and to the appropriate connector at the data host <sup>1</sup>.

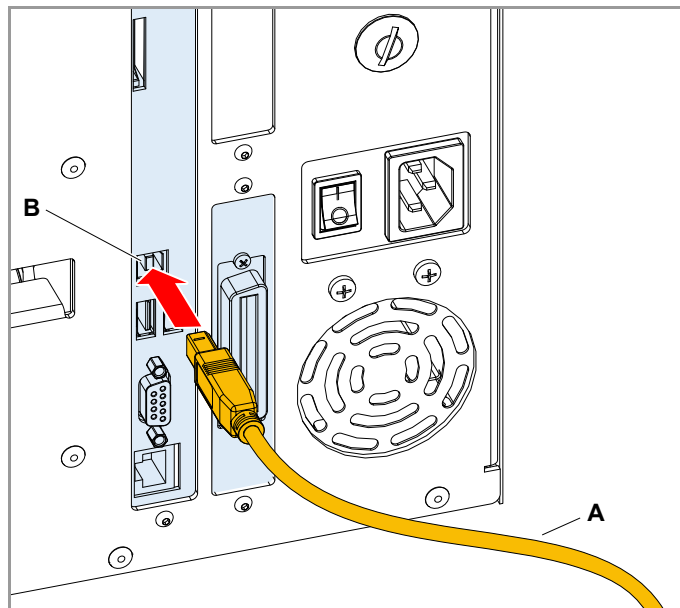

[12] Connecting a (USB) data cable (A).

▮ Print data can also be transferred via the RS232, Centronics (Option) or Ethernet interface (set the data interface with `INTERFACE PARA > EASYPLUGINTERPR > Interface`).

**Cables**: Ordering numbers for suitable power or data cables can be found in topic section „Accessories“.

---

1) e. g. computer or network

## Switching on the printer

→ Turn on the printer using the power switch (set to position “1”). The following sequence of messages is displayed:

System start...	The boot loader is starting.
System start... Start user prog	Valid firmware recognised, program is starting.
64-05 V 6.52	Printer type Version number of the printer firmware
Memory: 64 MB Flashcard: 32 MB	Internal RAM (here: 64 MB) Optional RAM on the memory medium (here: 32 MB) – only displayed if a memory medium (memory card or USB stick) is connected.
OFFLINE 0 JOBS Initialisation	Offline mode
ONLINE 0 JOBS	Online mode. The unit is ready for printing.

If the parameter `SYSTEM PARAMETER > Turn-on mode` is set to “Offline”, the printer switches directly to offline mode when turned on.

⚠ CAUTION! - Wait at least 10 seconds between switching the device off and on again, otherwise any modified parameter settings are not saved.

## Configuring the data interface

By factory default, the 64-xx is set for data transfer via the USB interface. Print data can also be transferred via the RS232, RS422/485<sup>1</sup>, USB, Centronics<sup>2</sup> or Ethernet interface.

→ Choosing the port: `INTERFACE PARA > EASYPLUGINTERPR > Interface`

→ Configuring the port:

- RS232: `INTERFACE PARA > COM1 PORT > ...`
- RS232/422/485 (optional): `INTERFACE PARA > COM3 PORT > ...`
- Ethernet: `INTERFACE PARA > NETWORK PARAM. > ...`

⚠ We recommend that your network administrator configures the network settings.

USB: no configuration required

*Setting parameters:* see topic section [Info-Printouts and Parameters](#) □, chapter “Using the Parameter Menu”.

*Ethernet interface:* Information about using it can be found in topic section [Advanced Applications](#) □.

1) Only with installed I/O interface board (option)

2) Only with installed Centronics interface board (option)

## Offline operation

- Changing from offline to online mode:



- Switching into online mode when print job is stopped



- Slow material and ribbon feed:

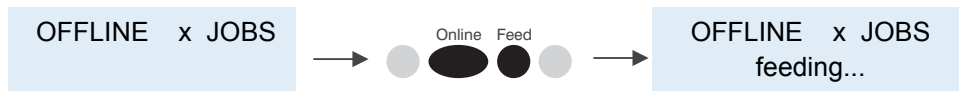

- Material is reversing below the printhead:



- Reset

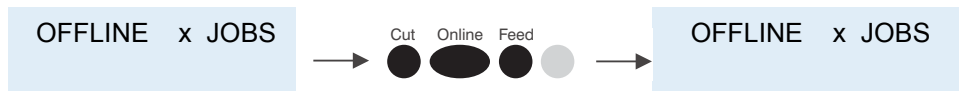

- Opening the parameter menu



- Feeding material to next punch or while button is pressed:



For more information, see topic section “Setup”, chapter [Setting the label length automatically](#).



## Online operation

- Switching to offline mode:



- Adjusting the print contrast: press Feed button to increase, press Cut button to decrease the print contrast



- Stopping a print job: The label currently being printed will be completed before the printer stops.



a) The message "Stopped xxx" alternates with "Press Feed".

- Switching to offline mode when print job is stopped



- Continuing a print job

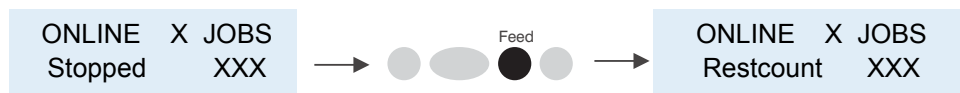

- Standalone mode: select a print job stored on an SD card (example: *Testdat.FOR*)



For more information, see topic section "Advanced Applications", chapter [Standalone Operation](#) on page 8.

## Creating a print job

There are basically two ways of generating a print job: You can use a label layout program together with a Windows printer driver or create a simple text file containing printer commands.

**Windows printer driver** There are different printer drivers available for the various versions of Windows. Using the printer drivers, you can print from nearly any Windows application. The functionality depends heavily on the layout software you use. We recommend using a special label layout program such as offered by NiceLabel.

Printer drivers can be found here:

- [www.novexx.com](http://www.novexx.com) 
- Documentation CD (also contains this operating manual)

Installing the printer driver using the documentation CD:

1. Insert the documentation CD

The language selection menu [13] opens:

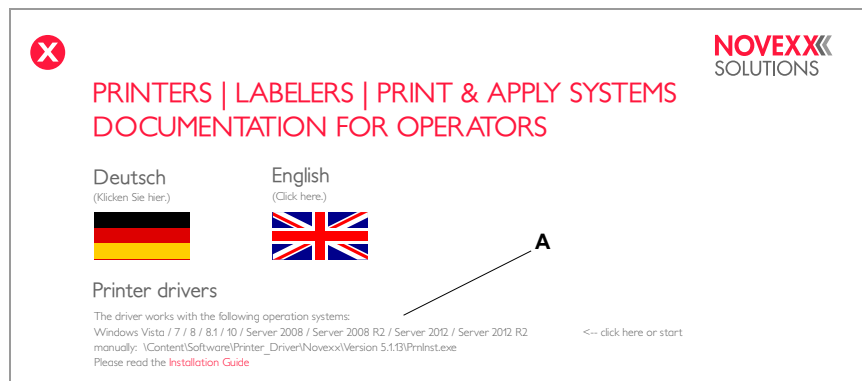

[13] The language selection menu appears after you insert the Documentation CD.

2. Click on the text below the header „Printer drivers“ [13A].
3. Follow the instructions given by the Installation Wizard.

## Command file

Enter a sequence of printer commands into a text file and send this file to the printer. To do this, you require a simple text editor and the copy command in MS-DOS. Easy-Plug is a special command language for formulating print jobs. However, writing a print job in text file format does require some programming knowledge. Furthermore, you will not be able to preview the resulting printout on screen. Instead, you will have to create a test printout in order to view the final results of your print job.

For a practical example of a print job together with instructions for testing purposes, see *Easy-Plug Manual*, topic section “General Notes, Definitions and Command Overview”, section [Programming Example](#) .

## Transferring a print job

The printer cannot process the print job until it has been loaded into RAM. This can be accomplished in two ways:

- Using a *data cable* to the data host (computer or network)
- Using an external *memory medium* (memory card or USB thumb drive)

**Data cable and layout program**

If you are using a label layout program, the appropriate print command has to be triggered. The data port is set when you install the printer driver.

**Data cable and Easy-Plug file**

Requirements:

- Data cable has been connected between printer and data host
- Command file was created (here: "testjob.txt") and stored on the data host respectively on the memory medium
- The command line (DOS prompt) has been started in Windows

Enter the following command:

- Serial port (COM1): `copy testjob.txt com1`
- USB port: `copy testjob.txt \\computer name\share name`, with
  - *Computer name* = name of computer. In Windows XP for instance, this can be found under START > SETTINGS > CONTROL PANEL > SYSTEM > COMPUTER NAME
  - In Windows XP, the *share name* can be found under START > SETTINGS > PRINTERS AND FAXES after right-clicking PROPERTIES > SHARE. The share name is a printer connected to a specific port, such as the USB port for USB transfer or the TCP/IP port for Ethernet transfer.
- Ethernet port: as described above for the USB port. For more information on transmitting data via Ethernet, see topic section "Advanced Applications", chapter [Data Transmission with Ethernet](#) on page 17.

Tips on transferring data via USB or Ethernet:

- The procedure described here does not apply to Windows 98, Windows ME or Windows NT 4.0.
- The share name must comply with MS-DOS conventions (max. 8 characters long, no special characters or spaces)

**Memory medium and Easy-Plug file**

Printing starts immediately after switching on

1. Save the print job file in the root directory on the memory medium and name it *autostrt.for*.
2. Connect the memory medium to the printer (see next section).
3. Switch on the rprinter.

The printer processes the print job as soon as it is in online mode.

Alternatively, the print job can be started in standalone mode; for more details, see topic section "Advanced Applications", [Standalone Operation](#) on page 8.

## Applying memory cards

The printers belonging to the 64-xx series support the following external memory media:

- SD/SDHC card [14] <sup>1</sup>
- USB thumb drive



**CAUTION!** - Observe the following guidelines to avoid damaging the printer or the memory medium.

- Only use memory media approved by NOVEXX Solutions.
- Always wait at least 5 seconds after switching off the printer before connecting or disconnecting any memory medium.
- When connecting or disconnecting memory media, never use force.

Flawless functioning of memory media is only guaranteed for the types distributed by NOVEXX Solutions:



[14] Left: SD card (article no. A101465, 2 GB nominal);  
right: USB thumb drive (article no. A105325, 2 GB nominal).

**Applying SD cards** □: see „Manual plugin-cards/data carrier“, topic section „Application“, chapter „CF/SD cards“.

### Inserting a SD card

1. Switch off the printer. Wait for 5 seconds.
2. Insert the SD card [15A] with the labelled side facing to the right and the contacts facing ahead into the card slot until it clicks into place.

### Removing a SD card

1. Switch off the printer. Wait for 5 seconds.
2. Press onto the SD card, until it unlocks. Remove the SD card from the card slot.

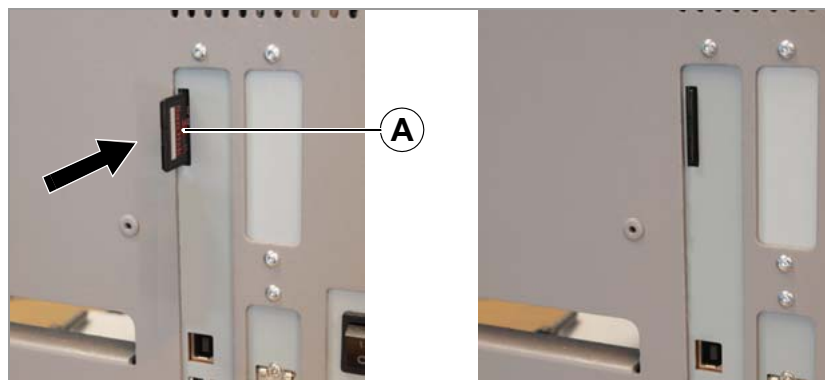

[15] Inserting a SD card (A). If the memory card has been inserted correctly, it will sit flush with the printer's rear wall (right).

1) SD and SDHC cards are supported with firmware version 6.35 or above.

## Setting the realtime clock

The realtime clock in the 64-xx printers can be used, for example, to calculate and print the expiry date of a perishable product.

This is how you set the realtime clock:

1. Navigate to the `SYSTEM PARAMETER > Realtime Clock`.

Realtime clock  
dd.mm.yyyy hh:mm

dd = day, mm = month, yyyy = year, hh = hour, mm =  
minute

2. To enter the date and time, use the Cut button to shift the cursor, the Feed button to change the parameter, and the Online button to save it.

*Setting parameters:* see topic section [Info-Printouts and Parameters](#), chapter “Using the Parameter Menu”.

## Outputting the realtime clock value using Easy Plug

Use the following Easy Plug commands to output the current realtime clock value:

- #YC realtime as text
- #YS realtime as barcode
- #DM download month names

See [Easy Plug manual](#)

## Starting to print

### Settings for the material type

The parameter settings described below provide the printer with the necessary information about the label material used. When printing from a layout program, these settings are usually provided automatically by the printer driver. For your first test prints, you need to configure them manually.

#### Material type

The label material is “endless”, which means that it contains *no* punches/perforations, breaks or reflex marks that could be recognised by the punch sensor:

→ Set the PRINT PARAMETER > Material Type to “endless”.

The label material contains punches/perforations, breaks or reflex marks that can be recognised by the punch sensor (so-called “punched” material):

→ Set the PRINT PARAMETER > Material Type to “Punched”.

#### Material length

→ Set the PRINT PARAMETER > Material Length to the length of the material (in mm).

#### Material width

→ Set the PRINT PARAMETER > Material Width to the width of the material (in mm).

Only for punched/perforated material:

#### Type of punch

Label material with breaks or punches:

→ Set the SYSTEM PARAMETER > Sensor Type to “Punched”.

Label material with reflex marks:

→ Set the SYSTEM PARAMETER > Sensor Type to “Reflex”.

*Setting parameters:* see topic section [Info-Printouts and Parameters](#) , chapter “Using the Parameter Menu”.

### Printing the status report

A status report printout is a perfectly adequate printer test. The width of the status printout can be set to 100 mm or 50 mm. This should match the width of the label material used. The length of the printout is 200 mm.

#### 100 mm width

→ Navigate to INFO PRINTOUT > Printer Status.

The printout that is triggered spans a label length of 2x 200 mm, listing all of the printer’s current parameter settings.

#### 50 mm width

→ Set the SYSTEM PARAMETER > Print Info Mode to “Compact right”.

→ Navigate to INFO PRINTOUT > Printer Status.

The printout that is triggered contains the same information as the wider printout, compressed to a width of 50 mm.

#### Density

If the printout is not as black as you would like it to be, increase the print density as follows:

1. Press the Esc button while in online mode. Display:

Print contrast  
60%

2. By pressing the Cut/Feed buttons, you can increase or decrease the heat energy of the printhead (in %).

The heat energy should be kept as low as possible while retaining an acceptable printing result. A high level of heat energy reduces the lifespan of the printhead.



# Setting up

Winding diagrams .....	2	Material / Ribbon end .....	11
64-xx .....	2	Material end .....	11
Designation of parts .....	2	Ribbon end .....	11
64-xx dispenser .....	3	Rewinder full .....	11
Designation of parts .....	3	Settings for all printers .....	12
Selecting ribbon/material .....	4	Ribbon tension .....	12
Label material .....	4	Material light barrier .....	13
Thermotransfer ribbon .....	4	Print head contact pressure .....	14
Inserting material .....	5	Adjusting the position of the print head ....	15
Inserting fan-folded material .....	8	Material parameters .....	16
Changing material .....	9	Settings at 64-xx dispensers .....	17
64-xx .....	9	Dispenser types .....	17
64-xx dispenser .....	9	Basic settings .....	17
Inserting ribbon .....	10	Parameter settings for	
		„64-xx dispenser M“ .....	18
		Parameters settings for	
		„64-xx dispenser A“ .....	18
		Index .....	19



## Winding diagrams

The winding diagrams show the winding direction of material and ribbon through the 64-xx or through the 64-xx dispenser printer. You must follow this basic schema when inserting/changing material and ribbon.

▣▣▣▣▶ Ribbon and material should only be inserted/changed by specially trained personnel.

### 64-xx

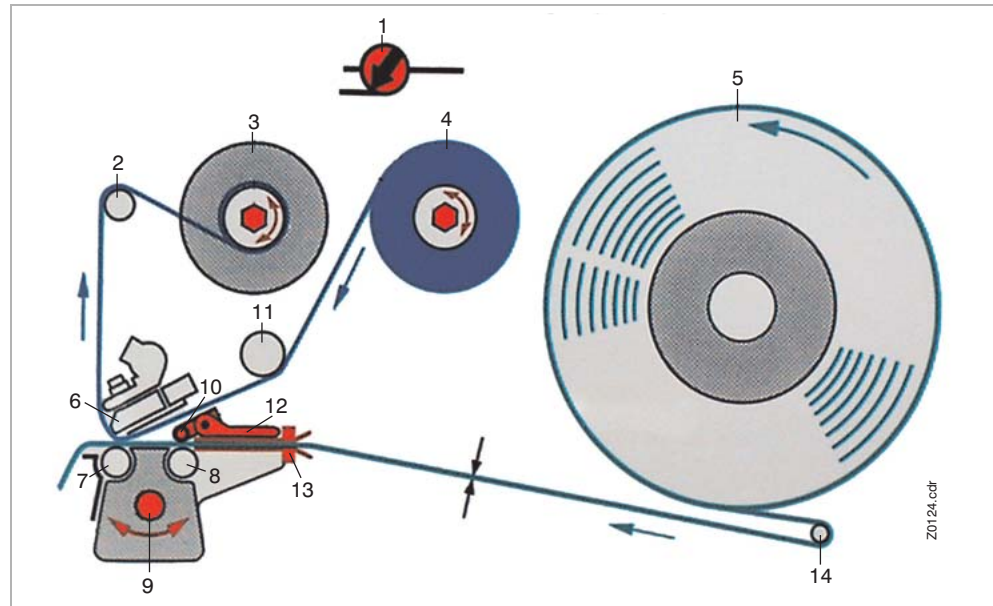

[1] This is how to insert material and ribbon correctly in the 64-xx or Chess x.

### Designation of parts

No.	Designation	No.	Designation
1	Adjusting knob for print head contact pressure	8	Feed roller
2	Ribbon roller	9	Adjusting knob for punch sensor
3	Ribbon rewind mandrel	10	Pad rollers
4	Ribbon unwind mandrel	11	Ribbon deflector
5	Material unwinder	12	Opener
6	Print head	13	Material guide
7	Print roller	14	Dancer arm

[Tab. 1] Designation of parts on the 64-xx.

64-xx – 64-xx dispenser

**64-xx dispenser**

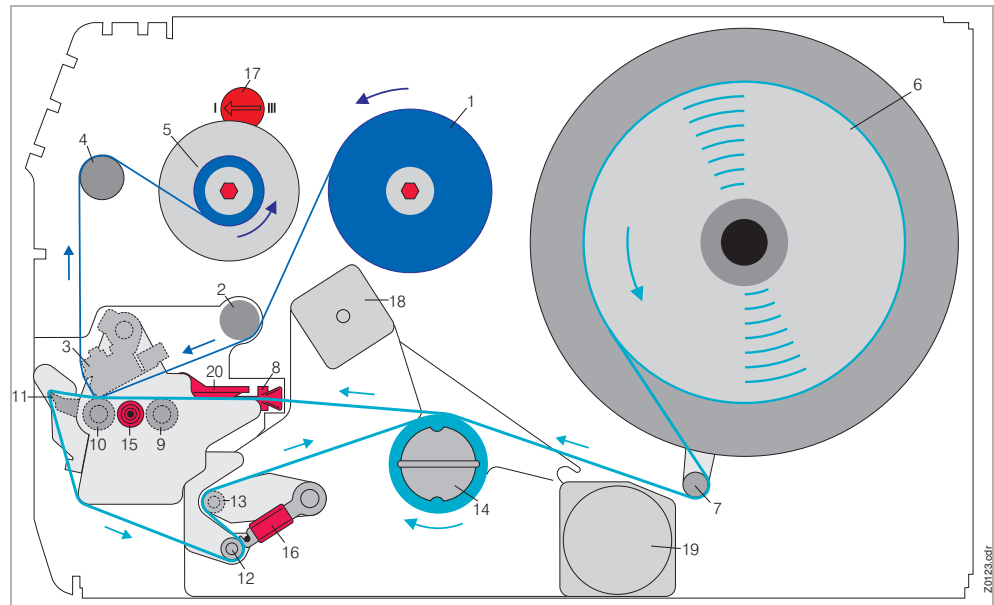

[15] This is how to insert material and ribbon correctly in the 64-xx dispenser (each of type M).

**Designation of parts**

No.	Designation	No.	Designation
1	Ribbon unwind mandrel	11	Dispensing edge
2	Ribbon deflector	12	Feed roller
3	Print head	13	Deflection roller
4	Ribbon roller	14	Rewinder
5	Ribbon rewind mandrel	15	Adjusting knob for punch sensor
6	Material unwinder	16	Locking lever
7	Dancer arm	17	Adjusting knob for print head contact pressure
8	Material guide	18	Clutch release motor
9	Feed roller	19	Rewinder motor
10	Print roller	20	Opener

[Tab. 2] Designation of parts on the 64-xx dispenser.

## Selecting ribbon/material

### Label material

When selecting the material, you must take 3 factors into account:

- the abrasive behavior of the surface structure of the material;
- the properties with regard to the chemical reaction when printing ink is transferred;
- the temperature required to transfer the ink.

### Abrasive behavior

If the material is very abrasive, the print head becomes “worn down” quicker than would normally be the case. This criterion is of particular importance in thermoprinting. It is not so critical in the case of thermotransfer printing, as the ribbon can be chosen to be somewhat wider than the material, ensuring that the print head is protected across the entire width of the material.

### Head temperature

The same applies if the temperature of the print head is high. Material and ribbon need longer to cool down, the print quality is more critical and the print head will wear down sooner.

For papers with grammages greater than 240 g, it may be necessary to make adjustments with regard to the contact pressure and the position of the print head.

### Thermotransfer ribbon

For ribbon, we recommend the following:

- the reverse side of the ribbon must have an antistatic, friction-reducing coating (backcoating);
- ribbons must be specified for “near edge type print heads”;
- ribbons should be suitable for print speeds of up to 12 inch/sec. (300 mm/s).



!!!► Ribbon without these properties can reduce the performance of the printer and/or the print quality as well as damage the print head!

## Inserting material



### CAUTION!

Rotating axles! These can pull in and tear off hair, clothing and jewelry.

- *Do not operate the machine with the hood open!*
- *Keep long hair, loose clothing, jewelry etc. well away from the machine!*

- 64-xx: Steps 1 to 8
- 64-xx dispenser: Steps 1 to 18

1. Open the hood of the unit.
2. Pull off the outer guide disk (1) of the unwinder (2).
3. Creel material on the unwinder with the corresponding adapter rings. The roll of material should turn anti-clockwise when unwinding.
4. Refit the outer guide disk of the unwinder.
5. Lay material around the dancer arm.
6. Set the material guide to the width of the label material. To do this, loosen the knurled screw on the underside of the front material guide (3). Push the material guide sideways. Tighten the knurled screw again (Fig. 2).
7. Press the red opener (4) of the intake in order to raise the pad rollers. With the opener depressed, push the start of the material through the material guide until it is below the print head (Fig. 3).
8. Align the material so that it is taken in straight. With the loading lever depressed, position the pad rollers of the printing unit in such a way that both rollers (5) sit symmetrically on the material. (The print head has been removed in Fig. 4 to allow a better view).

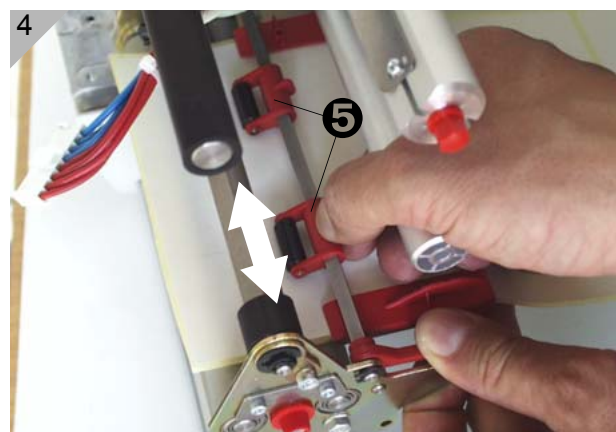
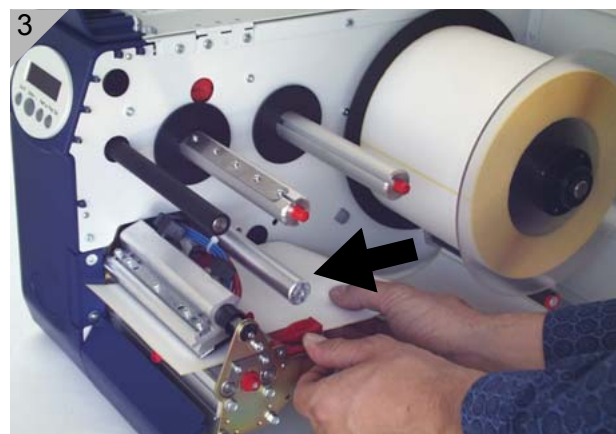
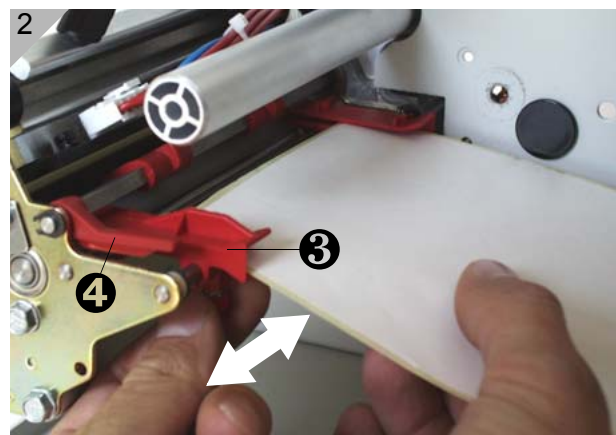

## 64-xx – 64-xx dispenser

**Only 64-xx dispenser:**

9. Guide material through under the dispenser roller (1).
10. Pull labels off the backing paper over a length of about 50 cm (Fig. 1).
11. Open the locking lever (press downwards, Fig. 2) and swivel it half a revolution to the rear.
12. Pull the drawing module (2) all the way out (Fig. 3).
13. Guide the backing paper under the print module to the rear (Fig. 4).

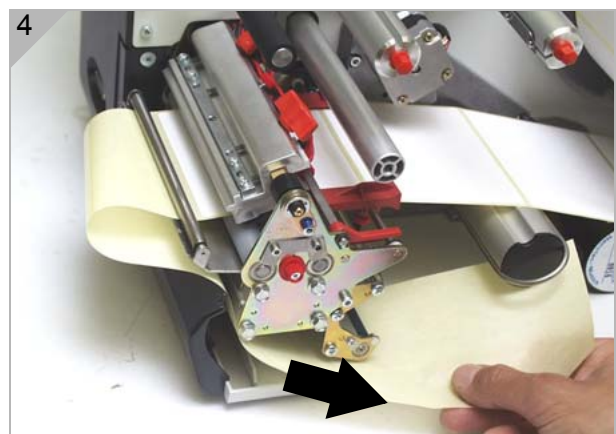
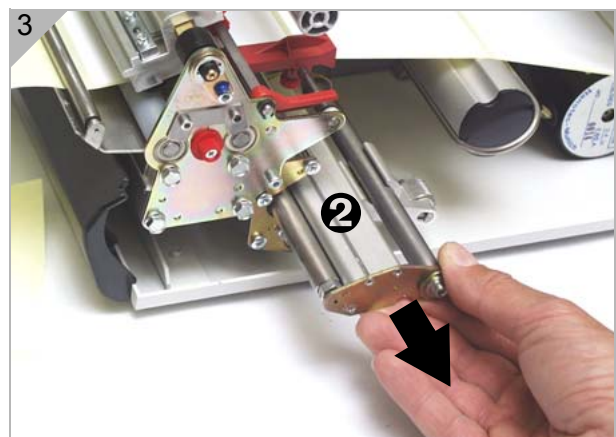
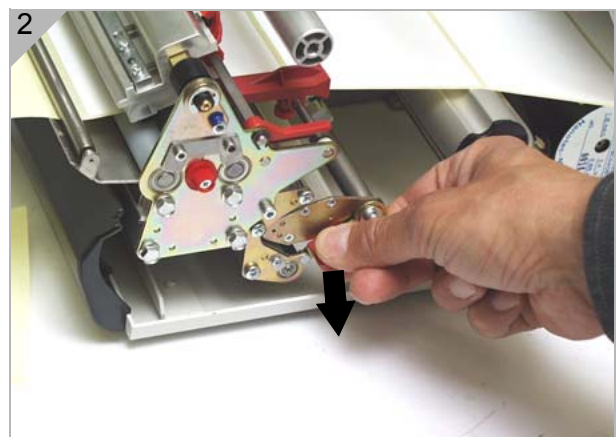
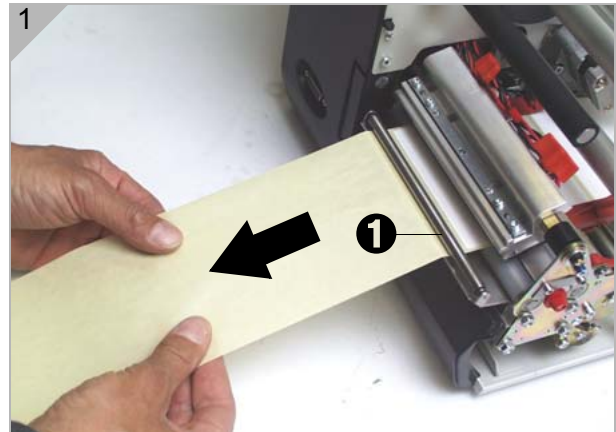

○ Continued on next page.

14. Guide the backing paper around the feed roller (1) and guide pins (2) of the drawing module to form an S shape (Fig. 1).

15. Put the drawing module back in again (Fig. 2).

⚡ On insertion, it is essential that the locking lever points to the right (= half a revolution open). Do not lock it until the drawing module has been pushed in all the way to the limit stop!



16. Wind the end of the backing paper clockwise around the rewinder (3) and fix with the clip (4) (Figs. 3 and 4).

17. Position the block bearing the pressure roller (5) in the middle of the backing paper.

⚡ This is important for proper transport of the backing paper around the dispensing edge!

18. Lock the locking lever (Fig. 4).

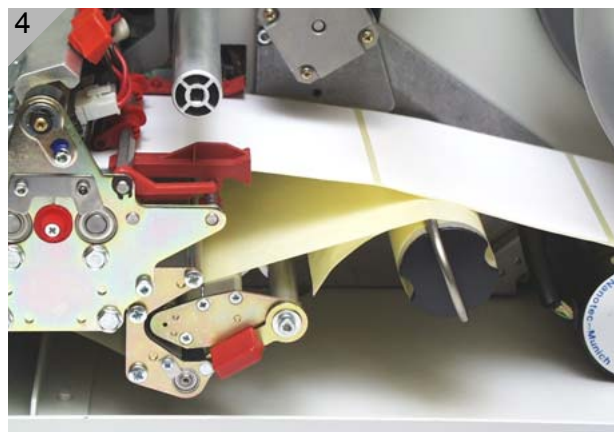
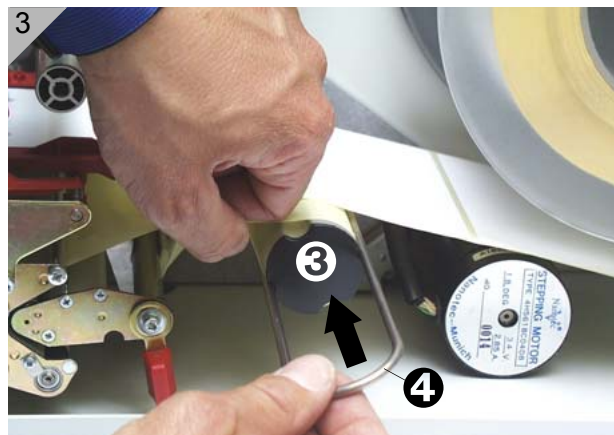
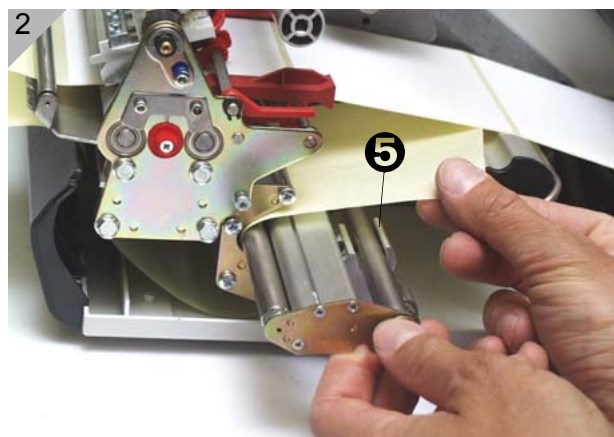
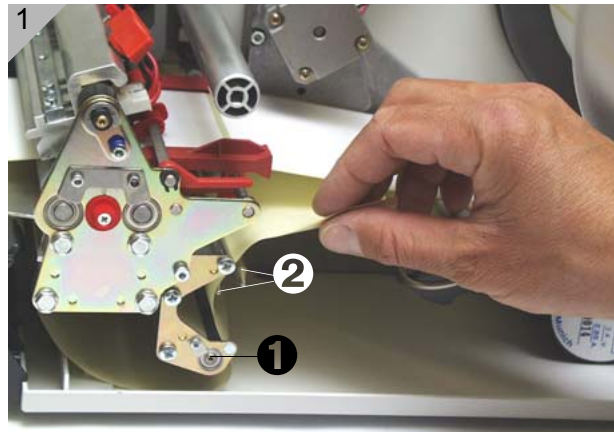

## Inserting fan-folded material

1. Set the outer disc of the material unwinder to the width of the material.
2. Pull the material through the inlet opening (1) to the material guide with the side to be printed showing upwards.
3. Then proceed as described in section [Inserting material](#) on page 5.

[1] *Pull the fan-folded material through the inlet opening in the rear side and proceed then as described under „Inserting material“.*

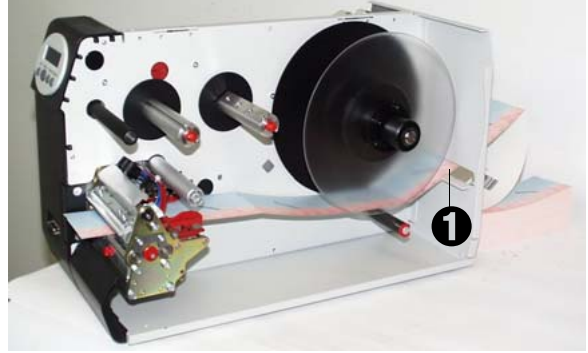

## Changing material

Proceed as described in the following to replace an inserted material roll before it comes to an end.

▮▮▮▮ The printer must be switched on; otherwise, the printhead presses on the material.

### 64-xx

1. Switch the printer to offline mode and open the front hood.
2. To remove the material, press the opener while at the same time pulling the material away to the rear (Fig. 2).

### 64-xx dispenser

1. Switch the printer to offline mode and open the front hood.
2. Tear the backing paper off (2), pull out the clip (Fig. 3) and remove the wound up backing paper (Fig. 4).
3. Open the shutter (3) and pull out the remaining backing paper towards the dispensing edge.
4. To remove the material, press the opener while at the same time pulling the material away to the rear (Fig. 2).

▮▮▮▮ It is also possible to convey the material backwards out of the print module by pressing the Online+Cut keys in offline mode.

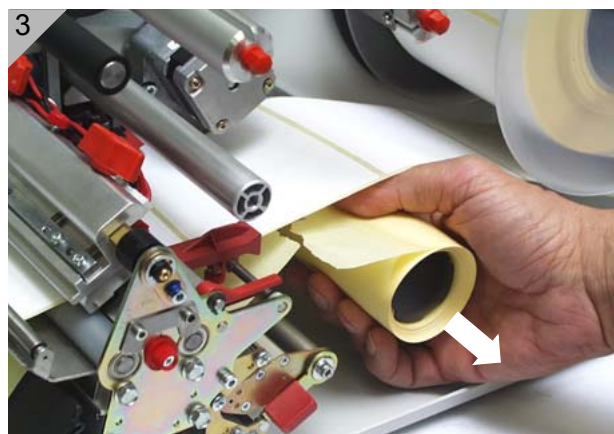
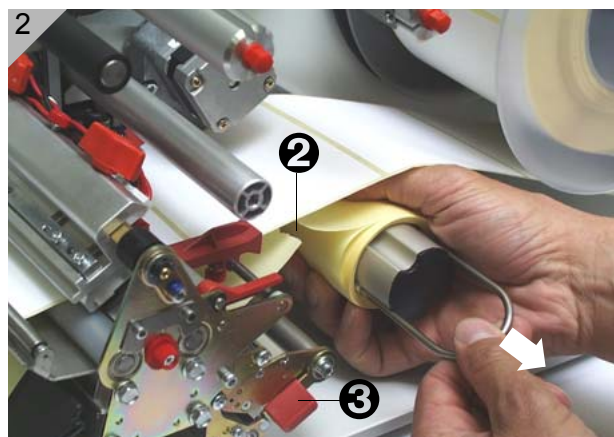



## Inserting ribbon

1. Switch the printer on.
2. Open the hood of the printer.
3. Place the roll of ribbon on the right ribbon mandrel (1) so that it can unwind anti-clockwise.
4. Place the empty ribbon core on the left mandrel (2).
5. Lead the end of the protective ribbon (yellow here) under the ribbon deflector (3) and print head (4).
6. Then pull the (protective) ribbon upwards and lay it over the ribbon roller (5).
7. Lead the (protective) ribbon under the rewriter mandrel (2) and secure it on the empty ribbon core using the self-adhesive strip (6) (Fig. 3).

⚠ In many types of ribbon, the protective ribbon (shown in yellow in the illustration) is followed by a strip of cleaning ribbon (7) which serves to remove contamination from the print head. It is essential that the material is inserted as described so that the cleaning effect is guaranteed!



8. Check that the ribbon is free of folds and is running true. Tension the ribbon by hand if necessary.

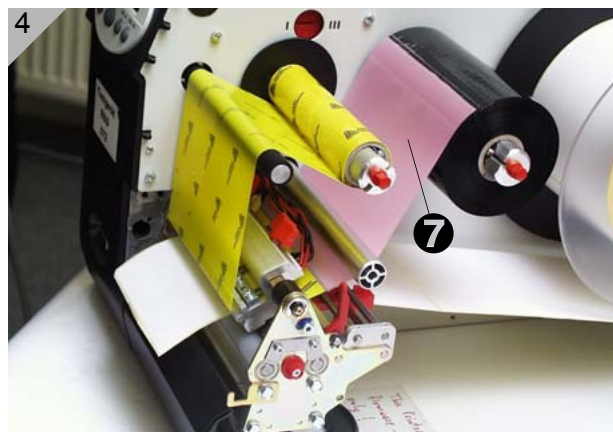
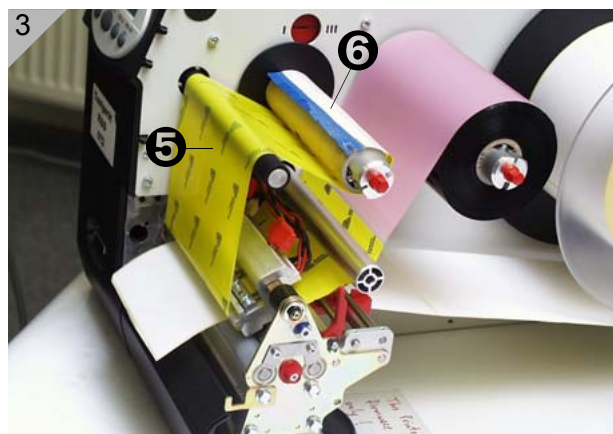
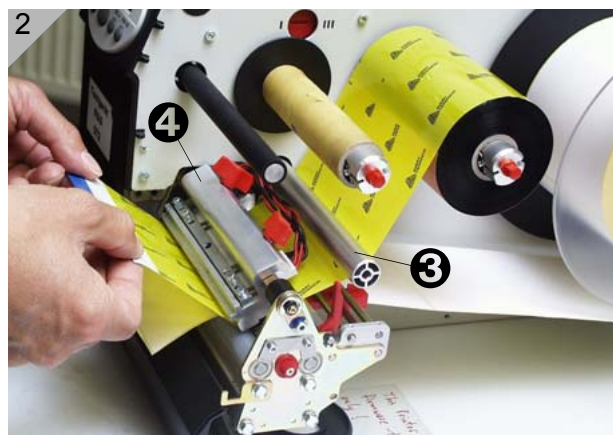
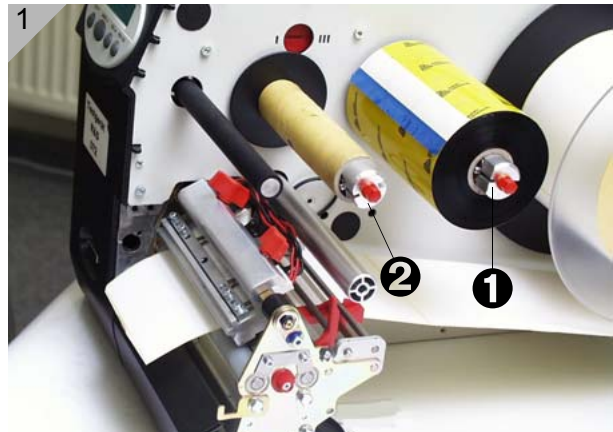

## Material / Ribbon end

### Material end

If the material end has passed the material guiding, the following status message appears:

Status	5002
Material end	

1. Press the opener and pull the remaining material from the front side (display side) out of the print unit.
  2. Only dispenser version:  
Open the shutter and pull the remaining backing paper in direction rewriter out of the print unit.
  3. Take the clip off the rewriter and remove the wound up backing paper.
- For additional information read section [Changing material](#) on page 9.

### Ribbon end

If the ribbon roll is emptied, that is the ribbon unwinding mandrel stopped turning, the following status message appears:

Status	5008
Ribbon end	

- Proceed as described in section [Inserting ribbon](#) on page 10.
- The ribbon end detection can be switched off, e.g. for thermal printing.
- To do so, set the parameter SYSTEM PARAMETERS > Ribbon autoecon. to „thermal printing“.

### Rewriter full

▣→ Only for dispenser versions!

The dispenser rewriter can wind up the backing paper of a roll with 210 mm outer diameter and 4“ (102 mm) core inner diameter. If the maximum capacity of the rewriter is reached, the following status message appears:

Status	5064
Rewriter full	

- Proceed as described in section [Changing material](#) on page 9.
- ▣→ Best clear the rewriter after every printed material roll!

## Settings for all printers

### Ribbon tension

The torques of the ribbon unwind mandrel (1) and ribbon rewind mandrel (2) can be set using the red plastic hexagons on the ribbon mandrels. If these are turned clockwise, the torque increases (Fig. 1: dispenser version).

### Factory settings

The factory setting covers a wide range of different ribbon widths, but very narrow or very wide ribbons may necessitate readjustment.

### Setting

During feeding, the ribbon must run evenly and free of folds for the entire length between the mandrels. The following guidelines will facilitate setting:

The ribbon is loose or creased or is wound on the rewind mandrel too loosely.

- ➔ Increase the unwind/rewind torque (Turn the red hex nut clockwise).  
The ribbon visibly stretches or tears during printing. The ribbon is inadequately transported.
- ➔ Decrease the unwind/rewind torque (Turn the red hex nut counter clockwise).
- More details about setting the ribbon tension can be found under “Adjusting the ribbon brake” in the “Service print module” section of the 64-xx service manual.

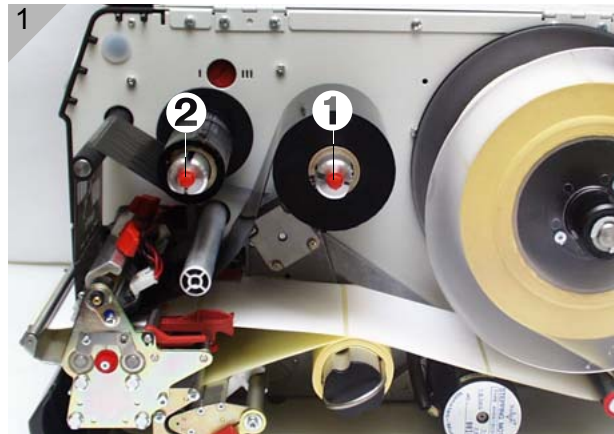

## Material light barrier

The series 64-xx printers are fitted with transmitted-light light barriers.

Reflector light barriers are also available as an option.

### To set

Setting is performed by means of the red rotary knob (1) on the outside of the print module. The light barrier can be adjusted in a range of 15 mm transverse to the material by turning the rotary knob. A dial (2) shows the setting value from 0 to 15.

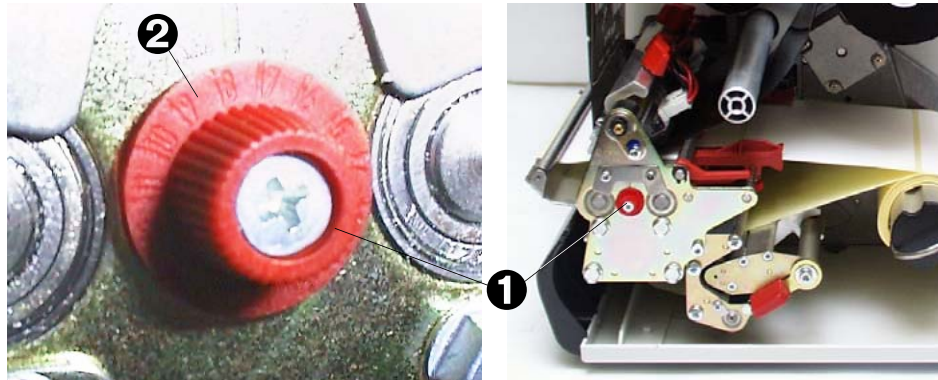

[1] The red adjusting knob (1) is used to adjust the lateral position of the punch light barrier (figure: dispenser version).

### Setting value

Light barrier	Setting value =
Transmitted light	Punch position - 2 mm
Reflector	Punch position - 13 mm

[Tab. 1] How to determine the setting value for the punch light barrier. (Punch position = distance of punch center from (inner) edge of material (3); setting value = dial value to be set by turning the red wheel)



[2] Punch position = distance of punch center from (inner) edge of material (3).

→ To set, turn the rotary knob (1) until the desired setting value is opposite the marking.

### Example

(for transmitted-light light barriers) center of punch from left edge = 11 mm, from which 2 mm deducted, giving a setting value of 9 mm.

▮ For round labels, it is possible to perform a preliminary setting of the punch offset manually on the printer (parameter `PRINT PARAMETERS > X - print offset`) or by activation in order to capture the start of the labels correctly.

## Print head contact pressure

Different material widths and/or material thicknesses have an effect on the contact pressure of the thermal strip on the feed roller.

The contact pressure can be set in 3 steps:

- I Position for 64-04/05 or for thin/narrow material up to the maximum print width of the 64-05 (1)
- II Position for 64-06 or for average material up to the maximum print width of the 64-06 (2)
- III Position for 64-08 or for thick/wide material up to the maximum print width of the 64-08 (3)

### To set:

The red adjusting screw (4) sits above the ribbon roller and can be turned by means of a coin.

- For medium head contact pressure, turn the arrow to position II until it engages.
- For greater head contact pressure, turn the arrow to position III until it engages.

Always choose the lightest contact pressure that will produce an acceptable printing result. This will help to protect the print head and the entire unit.

Excess contact pressure can lead to premature wear on the print head.



### Factory setting:

Position 1, thin/narrow material

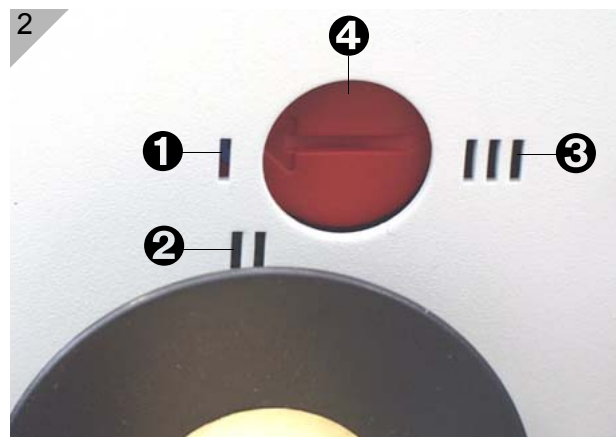
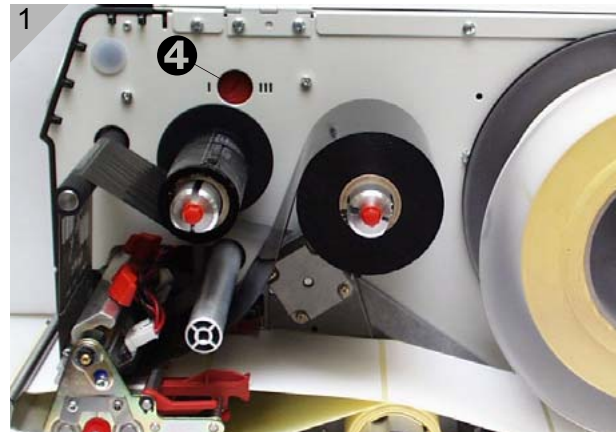

### Adjusting the position of the print head

☛ Only for the standard version of 64-05/06/08!

The print head 0 line can be adjusted variably from 2 mm (from the left edge of the label) to 13 mm:

1. Loosen both thumb screws (1) and push the print head to the desired position.  
☛ The print head does not have to be taken off!
2. Tighten the screws again.
3. Loosen the stud screws at the black plastic disks (2) using a 2 mm allen key (one screw per disk).
4. Adjust the plastic disks to the same position as the inside of the print head.
5. Tighten the stud screws again.

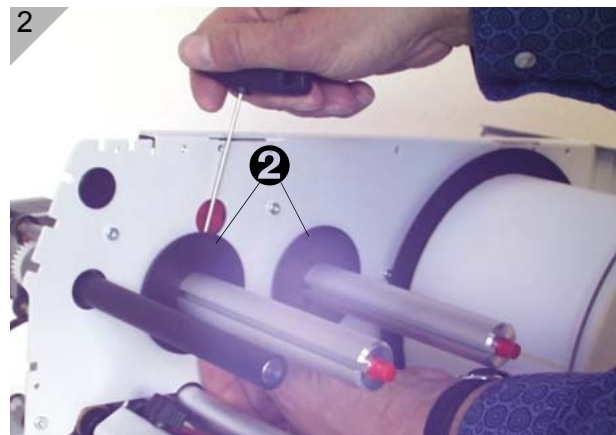
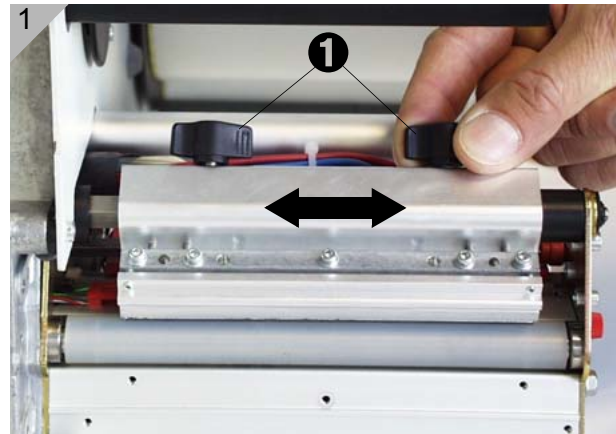

## Material parameters

The following three parameters are used to tell the printer the properties of the label material with which you would like to work:

Parameter	Function
PRINT PARAMETER > material type	Sets the type of material (punched or continuous)
PRINT PARAMETER > material length	Sets the length of material
PRINT PARAMETER > material width	Sets the width of the material
SYSTEM PARAMETER > light sens. type	Sets the type of light barrier (reflector or transmitted light) suitable for the material (marks or punches)

[Tab. 1] Important parameters for setting material properties

- Advice on setting parameters can be found under “Operating the parameter menu” in the topic section “Info printouts and parameters”.

## Settings at 64-xx dispensers

### Dispenser types

The 64-xx is available as „Dispenser M“ or „Dispenser A“ (see tab. 2).

Type	Property	Operating mode
64-xx Dispenser M	<ul style="list-style-type: none"> <li>Short dispensing edge with label sensor</li> <li>Connector for start/stop signal (e. g. for footswitch)</li> </ul>	Printing/dispensing is triggered manually (single start), e. g. by a footswitch. The dispensed labels are taken off by hand. <i>Alternatively:</i> Printing/dispensing is triggered by the label sensor, if a dispensed label is taken off.
64-xx Dispenser A	<ul style="list-style-type: none"> <li>Long dispensing edge without label sensor</li> <li>Connector for start/stop signal (e. g. for footswitch)</li> </ul>	Printing/dispensing is triggered manually (single start), e. g. by a footswitch. The dispensed labels are taken off by hand. <i>Alternatively:</i> The dispensed label is taken over by an applicator.

[Tab. 2] Different configuration of „Dispenser M“ and „Dispenser A“.

### Basic settings

The following table shows a basic setting for those parameters which are most important for dispenser operation (see tab. 3). The setting can be applied to both, type M and type A, with the purpose of using a *footswitch*.

Submenu	Parameter	Setting
SYSTEM PARAMETERS	Periph. device	Dispenser
	External signal	Singlestart
	Start print mode	Pulse rising
DISPENSER PARA	Dispense Mode	Real 1:1 Mode
	Dispensposition	0 mm
	Dispensing mode	fast
	Application mode	Immediate Mode
	Start source	Foot switch
	Dispensing edge	short
	Transport mode	Dispenser motor

[Tab. 3] Basic setting of the parameters most important for dispenser operation - valid for both dispenser versions.

☛ It is *not* possible to connect two foot switches to the printer (USI and Single Start) and use them simultaneously.

- Advice on setting parameters can be found in topic section [Info printouts and parameters](#).
- Information about operation with start signal can be found in topic section [Advanced Applications](#), chapter „Printing with start signal“.



### Parameter settings for „64-xx dispenser M“

The printing/dispensing process can be triggered by foot switch or by light barrier:

#### Foot switch

The values preset by the manufacturer (see tab. 3) are valid for manual triggering of the printing/dispensing via the Single-Start connector, e.g. using a foot switch. After pressing the foot switch, one label is printed and dispensed.

→ Set DISPENSER PARA > Start source to „Foot switch“.

#### Light barrier

The dispensed label triggers a light barrier. This stops the printing/dispensing until the user takes the label off. Then, the printer moves the material back under the print head (only if „Real 1:1 Mode“ is selected, see parameter DISPENSER PARA > Dispense Mode) and prints and dispenses the next label.

Change the basic parameter setting as follows to use the light barrier for triggering:

→ Set DISPENSER PARA > Start source to „Light barrier“.

### Parameters settings for „64-xx dispenser A“

„64-xx dispenser A“ is equipped with a longer dispensing edge which leaves enough space for closing the hood if an applicator is mounted. This long dispensing edge has no light barrier.

#### Applicator

The „64-xx dispenser A“ is designed to be used with the LTSI applicator.

- Advice on printer operation with the LTSI applicator, see [Service manual LTSI](#).
- Advice on setting parameters can be found in topic section [Info printouts and parameters](#).
- Information about operation with start signal can be found in topic section [Advanced Applications](#), chapter „Printing with start signal“.

## Index

### C

Changing material [9](#)

### D

Designation of parts

- 64-xx [2](#)

- 64-xx dispenser [3](#)

Dispenser

- parameters for version A [18](#)

- parameters for version M [18](#)

Drawing module [7](#)

### F

Fan-folded material [8](#)

Foot switch, use two switches simultaneously  
[17](#)

### I

Inserting Material [5](#)

Inserting ribbon [10](#)

### L

Label material [4](#)

### M

Material end [11](#)

### R

Rewinder full [11](#)

Ribbon end [11](#)

### S

Setting label material parameters [16](#)

Setting the material light barrier [13](#)

Setting the position of the print head [15](#)

Setting the print head contact pressure [14](#)

Setting the ribbon tension [12](#)

### T

Thermoprinting ribbon [4](#)

### W

Winding schema

- Dispenser version [3](#)

- Standard version [2](#)



# Advanced Applications

Printing with temperature compensation .....	2	Access via Web/FTP server .....	21
Requirements .....	2	Web server .....	21
Function description .....	2	FTP server .....	26
Printing with start signal .....	4	Data transmission with WLAN .....	29
Application notes .....	4	Requirements .....	29
Available interfaces .....	4	Notes .....	29
Connecting the signal source .....	5	Printer setup .....	30
Settings in the parameter menu .....	7	Connecting .....	30
Standalone Operation .....	8	PC setup .....	31
Requirements .....	8	Testing the connection .....	32
Functional Description .....	9	Sending a printjob .....	32
Selecting files from memory card .....	9	Storing and transferring parameter settings	33
Executing printjobs .....	12	Recommendations .....	33
Executing firmware files .....	12	Application cases .....	33
Automatic file execution .....	13	Storing settings on memory card .....	34
Additionally usable keys on a keyboard ..	13	Loading settings from memory card .....	35
Insert Input Field in Printjob .....	13	Automatic setup loading .....	35
Example Application .....	14	Verifying Bar Codes with OLV .....	36
Data input by interface .....	15	System Requirements .....	36
Data Transmission with Ethernet .....	17	Functional Description .....	36
System Requirements .....	17	Setup .....	37
Integration of Ethernet Interface .....	18	Appendix .....	39
Setting the IP Parameters .....	19	Setup file for AP 5.4 (Gen. 1) .....	39
Transmission with Raw Socket Interface	19	Setup file for AP 5.4 (Gen. 2) .....	45
Transmission with LPD Server .....	20	Setup file for 64-05 (Gen. 2) .....	51
Troubleshooting .....	20	Setup file for 64-06 (Gen. 3) .....	55
		Setup file for ALX 926 (Gen. 3) .....	63

## Printing with temperature compensation

### Requirements

- Suitable printers: All devices listed in the headline of this document
- Firmware: All versions

### Function description

The print contrast is heavily dependent on the temperature of the printhead. This can be set using the parameter `SYSTEM PARAMETERS > Print contrast` or in the online mode after pressing the Esc button.

When the printer is being used for a big print job, the temperature of the printhead and the print contrast increase during printing. This increase is greater, the larger the print-job and the larger the amount of black to be printed.

In extreme cases, this rise in temperature can lead to smearing in fine structures when printed, e.g. barcodes arranged crosswise to the printing direction. To avoid this, the firmware constantly checks and corrects the printhead temperature. The precondition for this is that the parameter `SYSTEM PARAMETERS > Temp. reduction` is set to a value > 0 (Default: 20%).

► The temperature compensation is the greater, the higher the setting of the parameter `SYSTEM PARAMETERS > Temp. reduction` is [1].

Parameter	Function
<code>SYSTEM PARAMETERS &gt; Print contrast</code>	Sets the print contrast, i.e. indirectly, the printhead temperature (actually adjusts the driving power of the printhead).
<code>SYSTEM PARAMETERS &gt; Temp. reduction</code>	Sets the correction factor for the temperature compensation. The higher the selected setting, the greater the reduction of the driving power when the printhead temperature rises.

[Tab. 1] Parameters for setting the temperature compensation.

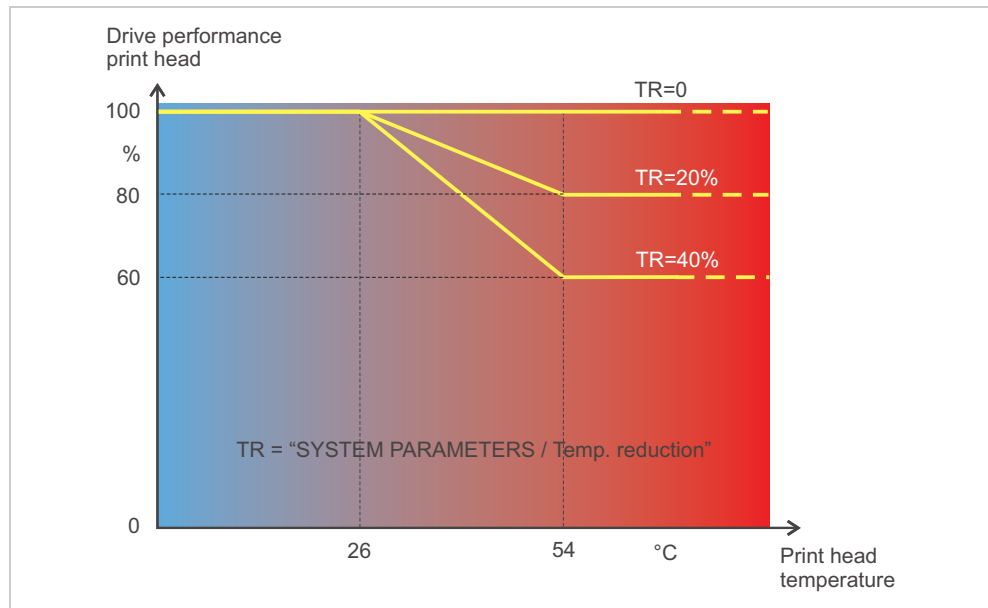

[1] With the parameter SYSTEM PARAMETERS > Temp. reduction activated, the driving power of the printhead – and therefore indirectly the print contrast – are reduced. Reduction starts at a temperature of 26°C. The maximum value is maintained at 54°C and above.

**Readout example**

The driving power of the printhead is 100% (setable in online mode after pressing the Prog button).

The printing layout contains a lot of black areas. For this reason, the temperature reduction is activated with 40%.

→ SYSTEM PARAMETERS > Temp. reduction = 40%.

Now, if the printhead temperature rises above 26°C, the driving power will be reduced automatically.

Reading out the diagram results in: With a given printhead temperature of approx. 40°C, the driving power is reduced to approx. 80%; with a supposed printhead temperature of 54°C or above, it is reduced to 60%.

## Printing with start signal

### Application notes

Print-and-Apply systems are normally triggered by an external start signal, which typically comes from a product sensor placed at the conveyor. In most cases, after a start signal arrived, a label is printed, dispensed and applied on the product.

This chapter describes...

- different ways of connecting a start signal source
- required settings in the printer parameter menu

### Available interfaces

Depending on the printer type and configuration, different interfaces for start signal input are available (Tab. 2).

Printer	Singlestart <sup>a</sup>	USI <sup>b</sup>	AI <sup>c</sup>	E/A <sup>d</sup>
64-xx Dispenser	S	O	--	--
64-xx	O	O	--	--
AP 5.4 Dispenser	S	--	--	O
AP 4.4	O	--	--	--
AP 5.4	O	--	--	O
AP 5.4 Gen. 2	S	--	--	O
AP 5.6	S	--	--	O
AP 7.t	O	--	--	O
ALX 92x	O	O	O	--

[Tab. 2] Interfaces for start signal input for the different printer types  
(S = Standard; O = Optional; -- = No option)

- Singlestart connector on the devices rear side
- USI board with signal interface
- Applicator Interface with signal interface
- I/O board with signal interface

## Connecting the signal source

### Product sensor

The 3 accessory boards USI, AI and I/O provide each a signal interface shaped as a D-Sub connector [2B] [3A]. To those connectors, a start signal source can be connected. As signal source serves usually a product sensor (photoelectric switch).

For detailed information on connecting a signal source see (Tab. 3):

Printer	Board	Article no. product sensor
ALX 92x, DPM, PEM	USI <sup>a</sup>	A2682
ALX 92x	AI	A7112 (Light sensor) N100136 (Connection cable)
AP 5.4, AP 5.4 Gen. 2, AP 5.6	I/O	No pre-assembled product sensor available.

[Tab. 3] Article numbers for product sensors.

a) USI in the 24 V version

► For details about the connector pinout, refer to the Service Manual of the relevant printer, topic section „Electronics“.

### Footswitch

Footswitches are available as accessory for both, 64-xx and AP 5.4/5.6 printers and are shipped ready configured (see topic section [Accessories](#) ).

Printer	Article no. foot switch
AP 5.4, AP 5.4 Gen. 2, AP 5.6	A4053
64-xx Dispenser with LTSI	A4053 + A7268 <sup>a</sup>
64-xx Dispenser	97685

[Tab. 4] Article numbers for foot switches.

a) Adapter cable for connection to a USI.

→ Connect the footswitch to the singlestart connector [2A].

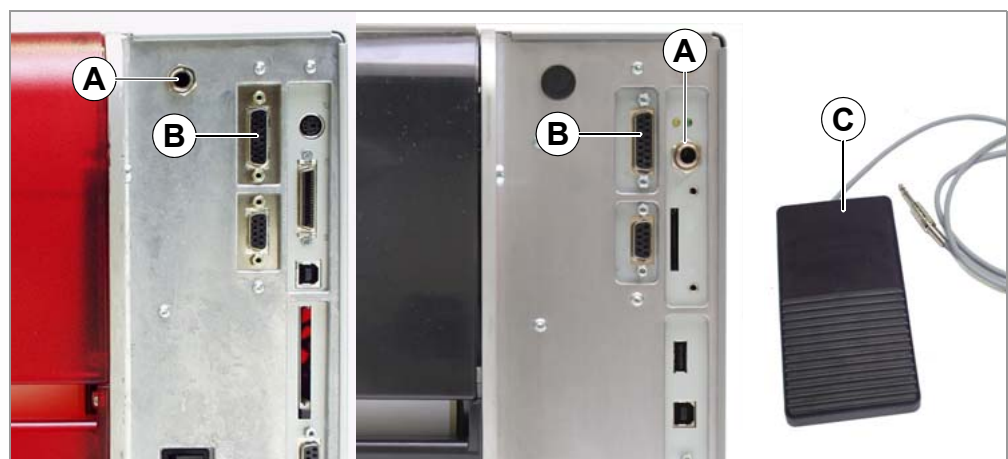

[2] Single-start connector (A) and I/O board signal connector (B) at AP 5.4 (left) and at AP 5.4 Gen. 2 or AP 5.6 (right) respectively. Matching footswitch (C) with 3-point plug.

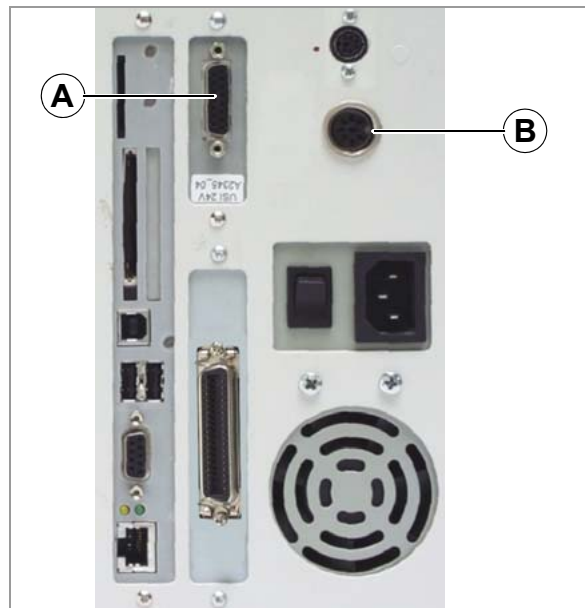

[3] USI signal connector (A) and singlestart connector (B) at a 64-xx.  
If the printer is operated with a LTSI applicator, the footswitch has to be connected to the USI!

### Light barrier

(64-xx Dispenser type M and AP 5.4/5.6 Dispenser only) This printer type is shipped with a short dispensing edge [4B] with a light barrier, which serves as signal source. After printing and dispensing, the label blocks the light barrier and stops the printer until the label is taken off. As soon as the light barrier is clear again, the next label is printed.

→ Connect the light barrier to the D-Sub connector at the printer front side [4A].

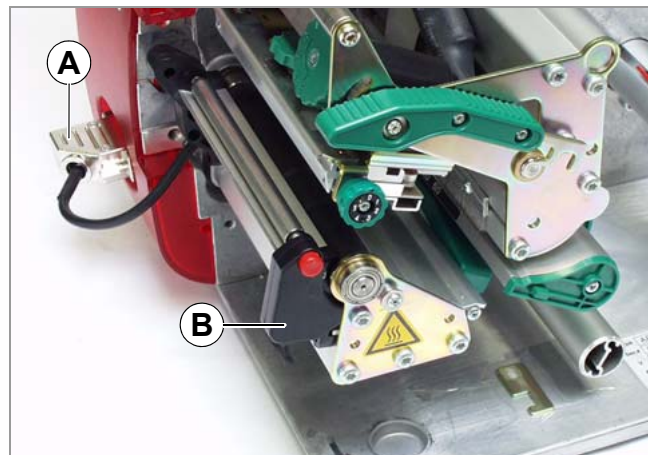

[4] AP 5.4 Dispenser.



## Settings in the parameter menu

Setting	Interface	Printer	Parameter	Value
Accept start signals	--	All	SYSTEM PARAMETER > External signal	Singlestart
Signal source	Singlestart input	64-xx	-- <sup>a</sup>	--
		64-xx Dispenser, AP 5.4 Dispenser, AP 5.6 Dispenser	DISPENSER PARA > Start source	Foot switch
		AP 5.4, AP 5.6, AP 7.t	--	--
	Disp. edge light barrier	64-xx Dispenser, AP 5.4 Dispenser, AP 5.6 Dispenser	DISPENSER PARA > Start source	Light barrier
		USI	DISPENSER PARA > Start source	USI interface
	I/O	64-xx, ALX 92x, ALX 73x	--	--
		AP 5.4, AP 5.6, AP 7.t	--	--
AI	ALX 92x, ALX 73x	--	--	
Signal flange	Singlestart input	64-xx, AP 5.4, AP 7.t, AP 5.4 Gen II, AP 5.6	SYSTEM PARAMETER > Start print mode	„Pulse rising“
	USI	64-xx, ALX 92x	DP INTERFACE > Start print mode	„Pulse rising“
	I/O	AP 5.4, AP 5.6, AP 7.t	I/O BOARD > Start print mode	„Pulse rising“
	AI	ALX 92x, ALX 73x	APPLICATOR PARA > Start print mode	„Pulse rising“
Start delay	Singlestart input	AP 5.4 Gen II Dispenser, AP 5.6 Dispenser	DISPENSER PARA > Start offset	Enter distance between start sensor and dispensing edge
	USI	64-xx, ALX 92x, ALX 73x	DP INTERFACE > Start delay	
	I/O	AP 5.4 Gen II Dispenser, AP 5.6 Dispenser	DISPENSER PARA > Start offset	
	AI	ALX 92x, ALX 73x	APPLICATOR PARA > Start delay	

[Tab. 5] Overview on the most important settings for start signal application (Firmware versions 3.52/6.52/7.52).

a) „--“ = No setting required.

► Further settings for 64-xx Dispenser see user manual 64-xx, topic section „Setup“, chapter [Settings at 64-xx dispensers](#) on page 17.

► Settings for application of ALX 92x with applicator see service manual ALX 92x, topic section „Applicator Interface“, chapter [Selecting an applicator type](#) on page 5.

## Standalone Operation

### Requirements

#### Printer

Suitable printers: all devices listed in the headline of this document, except for AP 4.4 (which has no card slot)

#### Firmware

Printer	Feature	Firmware version
64-xx, DPM, PEM, ALX 92x	Gen. 2 <sup>a</sup>	3.0
64-xx, DPM, PEM, ALX 92x	Gen. 3 <sup>b</sup>	5.02
ALX 73x	--	6.36
AP 5.4, AP 7.t	--	1.10
AP 5.4 Gen II, AP 5.6	MLK	3.34

[Tab. 6] Minimum firmware requirement for standalone operation.

- a) Characteristic feature: No USB interfaces, but Centronics as standard.  
 b) Characteristic feature: USB interfaces, Centronics optional.

#### CPU board

Printer	Feature	CPU board number
64-xx, DPM, PEM, ALX 92x	Gen. 2	A2292/A2293
64-xx, DPM, PEM, ALX 92x	Gen. 3	A6621
PM 3000	--	A6621
AP 5.4, AP 7.t	--	A3927
AP 5.4 Gen II, AP 5.6	MLK	A100150

[Tab. 7] Minimum CPU board requirement for standalone operation.

#### Options board

Is required for the printer types listed below to be able to connect a keyboard. The order number for the options board can be found in topic section [Accessories](#) .

- 64-xx Gen. 2
- DPM Gen. 2
- PEM Gen. 2
- ALX 92x Gen. 2

#### Memory card

For order number, see the Plugin Card Manual, topic [Available Cards](#) .

#### Card reader

PC or laptop with card reader

#### Keyboard

On request, a keyboard can be connected to the printer. This considerably simplifies entry of variable data, especially when dealing with text.

▣ 64-xx, DPM, PEM and ALX 92x of Generation 2 require an additional board for connecting the keyboard, see chapter [Options board](#)  on page 8. The Options board provides a PS/2 connector; an USB-to-PS/2 adapter comes with the offered keyboards.

Keyboard type	Order #
USB-keyboard <sup>a</sup> without numeric keypad, German layout	A8407
USB-keyboard <sup>a</sup> without numeric keypad, US layout	A8406

[Tab. 8] Keyboards available as accessory.

- a) Comes with USB-to-PS/2 adapter (required for „AP 5.4 red“ and for „64-xx Gen. 2“)

AP 4.4 – AP 5.4 – AP 5.6 – AP 7.t – 64-xx – DPM – PEM – ALX 92x

The matching keyboard layout is set with parameter `SYSTEM PARAMETER > keyboard`.

➡ Before first use, check if the intended keyboard really works with the printer.

## Functional Description

Standalone operation means the printer can be operated without it needing to be connected to a host computer. For this purpose, a PC is used to store the print job on a CompactFlash card (memory card). After this card is plugged into the card slot at the printer, the operator can start the print jobs on demand. For this, he uses the printer control panel or a keyboard connected to the printer. Variable data can also be entered via the control panel or the external keyboard.

The standalone mode can always be accessed from the „normal“ printer operation (with online/offline mode and message mode). To do so, press the Online and Esc buttons simultaneously.

It is helpful to imagine two consoles, between which can be switched by pressing Online + Esc.

Console „Normal operation“		Console „Standalone operation“
Online mode	Online + Esc	Selecting print jobs
Offline mode		Inserting field contents
Message mode		Inserting print amounts
Parameter menu	Ctrl + Ins	Starting print jobs
	(Keyboard)	Error messages are faded in

[Tab. 9] Functions and display texts in normal and in standalone operation mode.

## Features

Standalone operation in brief:

- Printing without computer connection
- Data entry via control panel or keyboard
- Reading print job from the memory card
- Entry or selection of field content
- Updating Firmware from memory card

## Selecting files from memory card

## Requirements

The card slot which is used for standalone operation must provide the drive letter C. 64-xx, DPM, PEM, ALX 92x <sup>1</sup>:

➔ Set `INTERF.PARAM. > DRIVEASSIGNMENT > Drive C` to „Compact flash“ or „Compact flash 2“ („Compact flash 2“ appears only with the optional 2<sup>nd</sup> card slot).

AP 5.4 Gen. 2, AP 5.6:

➔ Set `INTERF.PARAM. > DRIVEASSIGNMENT > Drive C` to „SD/MMC card“ (= factory setting).

Other printers: No setting required

1) With firmware version 5.32 or higher (each Gen. 3)

Selectable are files with the following extentions:

- „\*.FOR“ (printjob)
- „\*.S3B“ (firmware)

▣▣▣▣ The files must be stored on memory card in folder \FORMATS.

▣▣▣▣ If no file with one of the above listed endings is found in folder \FORMATS, or if no memory card is inserted, the following message appears:

```
Standalone
No files!
```

▣▣▣▣ If a huge amount of printjob files is stored in folder \FORMATS, this can lead to the following status message:

```
Status num: 8857
Wrong mem config
```

To remedy the cause of this message, take one (or both) of the following measures:

- Reduce the number of files in the \FORMATS folder
- Increase the amount of assigned memory in SYSTEM PARAMETER > Free store size

## Selecting a file

1. Press the *Online* + *Esc* buttons to get into the standalone mode. The following is displayed:

```
Choose a file
Novexx.for
```

„Novexx.for“ stands for any printjob file, which is stored in the \FORMATS folder.

Assumption: More than one file is stored in the \FORMATS folder: In this case the first file in alphabetical order is displayed.

2. Press the *Cut* or *Feed button* to step to the next file.

▣▣▣▣ Press the *Esc button* to jump back to the first entry of the list.

3. Press the *Online button* to start proceeding the file

In case of a printjob file, the printjob is started, in case of a firmware file, the firmware upload starts.

If the interpretation of the selected print job takes longer than 300 ms, the following message appears after selecting a printjob:

```
Novexx.for
Executing .
```

„Novexx.for“ = printjob file

The point after „Executing“ moves as long as the interpreter works.

Afterwards, input data are requested. If no input fields are provided, only the print amount is queried:

```
Enter quantity
1
```

The initial print amount is set in the printjob.

4. Change the print
5. Press the *buttons Online+Esc* to get back to the Online mode.

**Key/button functions**

Operation	Printer button	Keyboard key
Go to previous file	Feed	Cursor Up
Go to next file	Cut (or Apply)	Cursor Down
Confirm the selection	Online	Enter
More than one file: jump back to the first file in the list	Esc	Esc

[Tab. 10] Keys for file selection

**Quick selection**

▣▣▣▣ If an external keyboard is connected, the file can be selected by typing in the first letter of the file name.

Example:

After changing to the standalone mode, the following is displayed:

```
Choose a file
Novexx.for
```

„Novexx.for“ stands for any printjob file, which is stored in the \FORMATS folder.

1. Press the key for the first letter of the wanted file name , e. g. „D“. Display:

```
D
Default.for
```

D stands for the typed-in character.

„Default.for“ is in alphabetical order the first file with a „D“ as first letter.

2. Press the enter key to select the file, or  
Press the esc key to undo the input.

## Executing printjobs

All input fields are polled, which are defined as such in the print job (see [Example Application](#) on page 14). Next, the print quantity is requested. As soon as the print quantity is confirmed (online button), the print job is executed. From now on, all information about the job is displayed in the "Print control" console. While the print job is processed, it is started newly in the „Standalone“ console. The input fields are polled again, with the previous entries as default. Alternating with the first input field, the text „Start next job“ is displayed.

- ▣▣▣▣ Each printjob file may contain *only one* printjob. If any printjob file contains more than one printjobs, only the first printjob is executed.
- ▣▣▣▣ The new start of the print job can be avoided by setting the parameter SYSTEM PARAMETER > Single job mode to „deactivated“.
- ▣▣▣▣ Press the Esc button to go back to the file selection.

Operation	Printer button	Keyboard key
Increase by 1	Feed	Cursor Up
Decrease by 1 (the predecessor of 0 is 9)	Cut (or Apply)	Cursor Down
Enter	Online	Enter
Delete/Cancel	Esc	Esc

[Tab. 11] Keys for entering variable data

- ▣▣▣▣ It's also possible to enter a single „\*“ for the print quantity. This makes the print quantity „endless“.

## Executing firmware files

Files with the extension `.S3B` are firmware files. Selecting a firmware file means starting a firmware download. As this is a fundamental intervention to the system, firmware files are not executed immediately. The query "Firmwaredownload ? No/Yes" demands explicit confirmation of the operator.

- ▣▣▣▣ The same firmware file renamed to the extension `.FOR` is executed without querying.

Operation	Printer button	Keyboard key
Switch between Yes/No	Feed	Cursor Up
Switch between Yes/No	Cut (or Apply)	Cursor Down
Confirm the selection	Online	Enter
More than one file: jump back to the first file in the list	Esc	Esc

[Tab. 12] Keys for loading firmware files

## Automatic file execution

If the file `DEFAULT.FOR` (All letters lower case or all upper case; „Default.for“ doesn't work) exists on memory card in the folder `\FORMATS`, this file is executed automatically at system start. Display during power up, until the file is executed:

Standalone  
Initializing

► If a file `\AUTOSTRT.FOR` is also existing (in the root directory, not case-sensitive), it will be executed first. But be aware that standalone-printjobs are only executed properly, if the relevant file is stored in `\FORMATS`, as described above.

## Additionally usable keys on a keyboard

With an external keyboard connected, the printer can be operated without touching the buttons of the operation panel. The function keys F5-F8 can be used alternatively to the operation panel buttons:

Operation	Keyboard key
Delete the current print job (works in both consoles)	Ctrl+Del
Jump to the start (e.g. start of a file selection list)	Ctrl+Home
Jump to the end (e.g. end of a file selection list)	Ctrl+End
Change between Standalone and standard console	Ctrl+Ins
Delete backwards	Backspace
Same function as <i>cut/apply</i> printer button	F5
Same function as <i>online</i> printer button	F6
Same function as <i>feed</i> printer button	F7
Same function as <i>prog/esc</i> printer button	F8

[Tab. 13] Additional keys for operating the printer with an external keyboard.

## Insert Input Field in Printjob

Input fields can be defined in the following Easy Plug field types:

- Text field
- Counting field
- Barcode field

These field types can be defined through the following Easy Plug commands: YT, YN, YB, IDM, PDF, MXC, CBF, YC, YS, YG.

Using a special syntax it is made clear in these commands that the text dealt with here is not a fixed text, but text requested at the time of implementation.

Further information on the input field syntax can be found in the description of the respective command in the Easy Plug Manual, topic section [Description of commands](#) □

## Example Application

1. Generate two text files with the content shown in the tables below.

▮▮▮▮ Tip: Cut out the content using the Acrobat Reader text selection tool and copy it to a text file.

Example
#!A1#IMN100/60#ER
#J40#T5#YT107/0///Simple test for
#J30#T5#YN100/0/60///STANDALONE Mode
#Q3/

[Tab. 14] File „TEST1.FOR“

Example
#J10#T5#YT107/0///Fixtext#G
#J40#T5#YN100/0/60///\$<Color:>,Lightred
#J40#T5#YN100/0/60///\$<Color:>,Lightred
#J20#T5#YT107/0///\$<Article number:>,
#!A1#IMN100/60#ER
#Q3/

[Tab. 15] File „NOVEXX.FOR“

2. Create a directory on the memory card called \FORMATS.
3. Store the two text files as TEST1.FOR and NOVEXX.FOR on the memory card in the directory \FORMATS.

▮▮▮▮ The file ending must be \*.FOR!

▮▮▮▮ There is no difference made between uppercase and lowercase letters!

4. Switch off printer.
5. Insert memory card into the printer's card slot.
6. Turn on printer and switch to online mode.
7. Simultaneously press the Online and ESC keys.

The first file on the memory card is displayed:

Choose a file  
NOVEXX.FOR

8. Call up the file TEST1.FOR by pressing the Cut or Feed keys.

▮▮▮▮ On DPM or ALX 92x, please press the Apply instead of the Cut key!

9. Confirm selection by pressing the Online button.

Now you are asked for the quantity of labels to be printed:

Enter quantity  
3

Quantity 3 appears as default, as this was already preset in the printjob. To increase the quantity to 10, for instance, please perform the following procedure:

10. Press the ESC key. This erases the 3.
11. Press the Feed button in order to incrementally increase (up to a max. of 9) the quantity of labels to be printed.



▣▣▣▣▶ Quantity 0 = infinite printing!

12. Press the Online button to move forward by one position. Should you wish to enter a number with two or more digits, simply increase the second digit using the Feed button. Should the number only have one digit, press the Online button again.

The printer will now print the stipulated number of labels.

## NOVEXX.FOR

In case of the NOVEXX.FOR file, this works somewhat differently. Once the file is called up, the following is displayed:

```
ONLINE      1 JOBS
Color: Lightred
```

In the second line the printer will ask for the content for the first data field. "Color" is a prompt and therefore not printed. The preset content of the printjob is called "Lightred".

- *Without keyboard* you can enter the desired text in characters. Entering letters works in the same way as digit entry (see example TEST1.FOR). Using the Cut or Feed buttons, you can scroll through the available set of characters until the required character appears. Use the Online button to move forward by one position. After entering the last character, press the Online button twice.
- *With a keyboard* you can, after the input prompt "Color:", simply enter a different content.

▣▣▣▣▶ The entry may only have a length that ensures the printout does not extend over the label edge! - otherwise a printer error message is displayed!

The next input field is displayed and then the next etc., until all input fields have been processed.

At the end you may change the quantity of labels to be printed if required.

## Data input by interface

Available with firmware x.33 or a later version.

Apart from putting in data by operation panel or by external keyboard, the data can be sent via interface.

Application example: Reading in data from a RS232 barcode scanner via serial interface.

**Selecting the interface** → INTERF.PARAM. > OPTIONS > StandAlone Input

▣▣▣▣▶ Listed are only interfaces, which are available in the printer and are not already occupied by another function.

## Application notes

The following characters or character sequences are replaced by *respectively one* „Enter“ action, if received.

- <CR> <sup>1</sup>
- <CR><LF>
- <LF> <sup>2</sup>
- <LF><CR>

▣▣▣▣▶ Data received at the interface are processed *only then*, if the printer is switched to standalone operation.

1) <cr> = 0x0D

2) <lf> = 0x0A

**Example**

Example of a standalone printjob on the memory card:

```
#!A1#DC
#IMSR100.08/100.08
#HV50
#PR8/8/
#RX0
#ERN/1//0
#R0/0
#VTS/Var1//10///Test Var1#G
#VTS/Var2//10///Test Var2#G
#T34.16 #J90.75 #FD/0/L #SS100/BVUN/42X42/0 #VW/L/Var1#G
#T34.08 #J79.58 #FD/0/L #SS100/BVUN/42X42/0 #VW/L/Var2#G
#Q1#G
#!P1
```

The following data is received via the data interface:

```
Content1<cr><lf>
Content2<cr><lf>
3<cr><lf>
```

The first two lines assign the content „Content1“ to the variable „Var1“ and the content „Content2“ to the variable „Var2“. The third line assigns the print quantity „3“.

## Data Transmission with Ethernet

### System Requirements



CAUTION! - Unqualified manipulations of a data network can disturb or stop its proper functioning.

Connecting a device to a network requires network administrator knowledge.

→ Consult your network administrator for assistance, if you don't have knowledge on this level!

#### Hardware

- Printer

Printer	Feature	Ethernet connection by
AP 4.4	–	Ethernet connection <i>not possible!</i>
AP 5.4	–	Integrated Ethernet interface
AP 5.6	–	
AP 7.t	–	
64-xx		
DPM	Gen. 2	CPU board A2292 with integrated Ethernet interface (optional)
PEM		
ALX 92x		
64-xx		
DPM	Gen. 3	Integrated Ethernet interface
PEM		
ALX 92x		
ALX 73x		

[Tab. 16] Equipment of the different printer types with Ethernet interfaces.

- Ethernet cable: must have quality „Cat. 5E“ and be shielded.

#### Software

- Firmware:

Printer	Feature	Firmware version
64-xx, DPM, PEM, ALX 92x	Gen. 2	3.0
64-xx, DPM, PEM, ALX 92x	Gen. 3	5.02
ALX 73x	--	6.36 <sup>a</sup>
AP 5.4, AP 5.6, AP 7.t	--	alle Versionen

[Tab. 17] Minimum firmware requirement if it is to apply the Ethernet function.

a) Printer firmware

- Network protocol: TCP/IP

## Integration of Ethernet Interface

The Ethernet interface of the printers is laid out as 10/100 Base T. The transmission speed is set by autonegotiation. LEDs are located above the RJ 45 plug, showing the network situation [5][6][7].

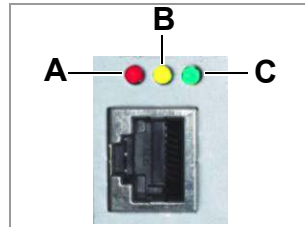

[5] Position of the signal LEDs at 64-xx, DPM, PEM, ALX 92x (each Gen. 2).

- A LED red lights = Printer is connected to network
- B LED yellow flashes = Network traffic
- C LED green lights = High transmission rate (100 Mbit/s)

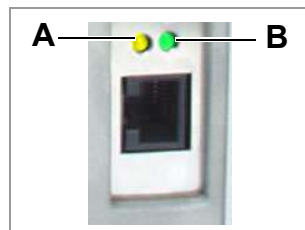

[6] Position of the signal LEDs at AP 5.4, AP 7.t, ALX 73x and 64-xx, DPM, PEM, ALX 92x (each Gen. 3)

- A LED yellow lights = Printer is connected to network; LED flashes = Network traffic
- B LED green lights = High transmission rate (100 Mbit/s)

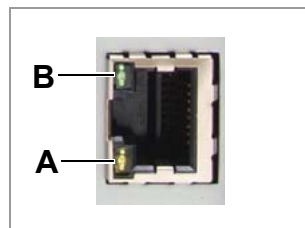

[7] Position of the signal LEDs at AP 5.4 Gen. II and AP 5.6.

- A LED yellow lights = Printer is connected to network; LED flashes = Network traffic
- B LED green lights = High transmission rate (100 Mbit/s)

### MAC Address

An internationally unique MAC (Media Access Control) address is required for Ethernet operation. It consists of 6 bytes and is usually separated by colons or hyphens (hexadecimal, e.g. 00:0a:44:02:00:49 or 00-0a-44-02-00-49). The first 3 bytes are constant 00:0A:44 (Novexx code), the last 3 bytes vary for each device. The product manufacturer is responsible for the allocation of the MAC addresses.

### IP Address

In the printer software a TCP/IP protocol stack is implemented, i.e. for network purposes the device requires an IP address along with the MAC address. IP-addresses are always displayed as 4 bytes separated by dots (e.g. 192.168.1.99). IP addresses are assigned by the network operator, as a rule the network administrator.

▣▣▣▣► MAC and IP addresses originate from different protocol layers and are generally independent of each other.

Further information about TCP/IP can be found in the abundance of literature on the subject.

## Setting the IP Parameters

The IP-parameter settings can either be set fix, or they can be requested from a DHCP server with every start of the printer. To assist the system administrator, the DHCP server is provided a device name on request, which consists of a combination of printer type + 3 digits from the MAC address. (e.g. AP\_5.4\_\_\_300dpi\_020049). The following values have been preset:

- IP address: 192.168.1.99
- Net mask: 255.255.255.0
- Default gateway: 0.0.0.0

▣▣▣▣ Connection to a name server is not required.

Menu	Parameter	Description
INTERF. PARAM. > NETWORK PARAM	IP addressassign	Here, please set "fixed IP address" or "DHCP".
	IP address	IP parameter input fields, in case "fixed IP address" was set for the address assign type.
	Net mask	
	Gateway address	

[Tab. 18] Setting the IP parameters in the printer menu

▣▣▣▣ **WARNING:** The address allocation for each device must be clear and unambiguous. Ask your network administrator for assistance!

## Transmission with Raw Socket Interface

Printing data can be transmitted using a parameterisable socket interface (TCP server socket on port number > 1024).

This protocol is supported by

- all Unix derivatives; a connection similar to that of terminal servers can be established.
- Windows 2000, Windows XP

A software package from external providers is required for Windows 95, Windows 98 and Windows NT (e.g. Serial/IP by Tactical Software, <http://www.tacticalsoftware.com>).

In this way you can set the Port address in the printer's parameter menu:

Parameter	Description
INTERF. PARAM. > NETWORK PARAM. > Port address	Here you can select the port number of the service in section 1024-65535
INTERF. PARAM. > EASYPLUGINTERPR > Interface	Here a TCP/IP socket must be set in order to receive printing data at the set port number.

[Tab. 19] Setting the port address in the printer's parameter menu

## Transmission with LPD Server

Printing data can be transmitted to the printer using the LPR/LPD (Line Printer Daemon) protocol (“BSD Spooler”).

This protocol is supported by

- all Unix derivatives
- Windows NT, Windows 2000 und Windows XP
  - ▮ The print queue of the host must be named „lp“!

### Example

1. Set parameter INTERF.PARAM. > EASYPLUGINTERPR > Interface to „LPD server“.
2. Send the printjob file (here: „test.txt“) as illustrated using the „lpr“ command [8].

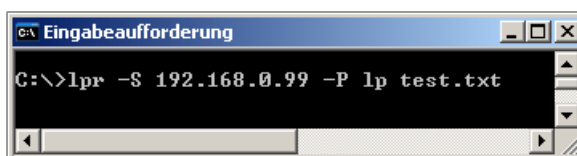

[8] Sending a printjob with the „lpr“ command.

- ▮ Enter „lpr ?“ to get a list of the admissible command options.
- ▮ For the use of LPD server under Windows NT or Windows 2000, please refer to the following link:

<http://support.microsoft.com/default.aspx?scid=kb;EN-US;179156> 

- ▮ For the use of LPD server under Windows 95 and Windows 98, a software package from external providers is required (e.g. Windows LPR Spooler, see the following link).

<http://home.arcor.de/Heil-Consulting/> 

## Troubleshooting

The following should be checked if a problem occurs:

- Ethernet connection: The yellow LED belonging to the printer network socket must be illuminated. If this is not the case, possible sources of error are:
  - that the network is not connected to the outlet.
  - ISDN outlet: Erroneous, the network cable was connected to an ISDN instead of a network outlet. Both outlet types do not differ mechanically.
  - an incorrect cable (ISDN cable?) is used to connect the printer to the network outlet.
  - a defective hub/switch.
  - a defective printer board.
- IP parameter: The defined parameters or parameters set via DHCP are displayed in the “Printer Status” printout. A “ping” to the set IP address must return an echo. This also works if a different interface is set in the Easy Plug Interpreter parameter. Possible source of error: Incorrect configuration of a network participant.
- On the printer, either “TCP/IP socket” or “LPD server” must be set in the Easy Plug Interpreter parameter.

## Access via Web/FTP server

### Web server

#### Applications

The web server makes it possible

- to set or read the values of parameters from the parameter menu via a web browser
- to control the operator panel of the labeller resp. the printer via a web browser.
- ▣▣▣▣ The web server is *not* multi-session compatible, i.e. only one user can be logged in at any time.
- ▣▣▣▣ The web server is a setup utility, not an operational one. The web server should not be heavily used during a high performance application of the dispenser, otherwise this could result in losses in machine performance.

#### Prerequisites

- Suitable printers: All printers listed in the headline, apart from the AP 4.4
- Required firmware:

Printer	Feature	Min. firmware vers.
64-xx, DPM, PEM, ALX 92x	Gen. 2	3.40
64-xx, DPM, PEM, ALX 92x	Gen. 3	5.02
AP 5.4, AP 7.t	--	3.0
AP 5.4 Gen II, AP 5.6	MLK	3.34

- The printer is connected to a network
- A valid IP address is assigned to the printer (by the network administrator or by a DHCP server)
- INTERFACE PARA >NETWORK PARAM. > WEB server must be set to "On".

#### Starting the web server

1. Note down the IP address of the printer.
  - ▣▣▣▣ This is shown under INTERFACE PARA >NETWORK PARAM. > IP address
2. Start the internet browser.
3. Enter the following in the address bar:
 

http://[IP address without initial zeroes]

Example: IP address = 144.093.029.031

Enter: http://144.93.29.31

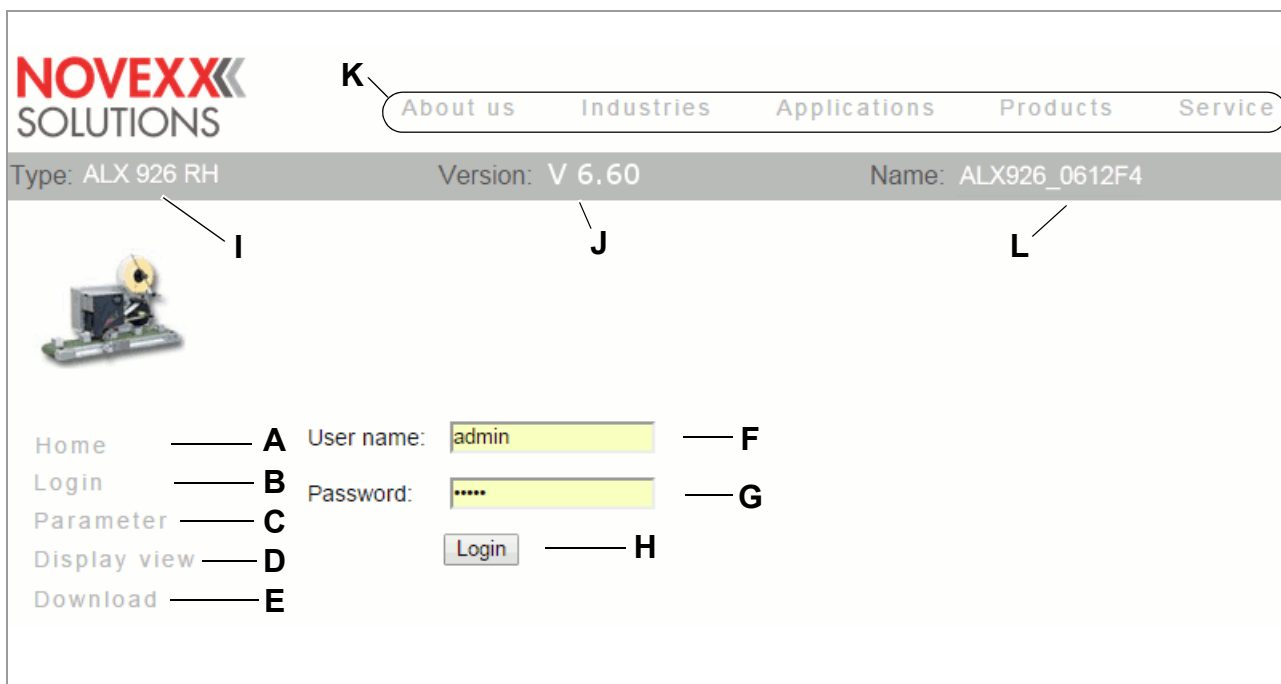

[9] Login dialogue of the web server

- A** Link to the web server home
- B** Opens input fields for user name and password [9]
- C** Calls the parameter menu  
Enables settings in the labeller parameter menu to be changed.
- D** Calls the operator panel display  
Gives access to all the parameters of the real operator panel
- E** Starts the FTP server in a new browser window  
See chapter [FTP server](#) on page 26.
- F** Input field for user name  
Preset: "admin"
- G** Input field for password  
Preset: "admin"  
The password can be changed under `INTERFACE PARA >NETWORK PARAM. > WEB server`
- H** Click on this button after entering user name and password
- I** Displays the machine model
- J** Displays the firmware version
- K** Links to the Avery Dennison Machinery website
- L** DHCP host name (see `INTERFACE PARA >NETWORK PARAM. > DHCP host name`)

### Logging in to the web server

1. Click on the "Login" link [9B]
2. Enter user name and password [9F, G]  
Preset in both cases: admin
3. Click on the "Login" button [9H]



### Changing a setting in the parameter menu

Click on the names of submenus and parameters to open them so that you can change the settings they contain.

Example

Making a change to PRINT PARAMETERS > Materiallength:

1. Click on “Parameter” link [9C].
2. Click on “PRINT PARAMETERS” link.
3. Click on “Materiallength” link.
4. A dialog box opens: [10].
5. Enter the required value in the entry field.
6. Click on the “Save” button.

The value is now transferred to the labeller.

**Change parameter value**

<p><b>Materiallength</b> (min: 5.0 mm max: 7900.0 mm step: 0.1 mm)</p>	<input style="width: 100%;" type="text" value="100.0"/>
<input type="button" value="Save"/> <input type="button" value="Cancel"/>	

[10] Example: Dialog box for entering value for the parameter PRINT PARAMETERS > Materiallength

**i** Some parameters trigger a reset of the labeller, if they have been changed on the labeller via the operator panel. However, if any of these parameters is changed via the web server, the reset does not occur automatically. The changes only come into effect after the next time the labeller is reset. In these cases, the “Reset” button [11A] appears after the setting has been changed.

The screenshot shows the NOVEXX SOLUTIONS web interface. At the top left is the logo. Navigation links include 'About us', 'Industries', 'Applications', and 'Pr'. A grey header bar contains 'Type: ALX 926', 'Version: V6.60-SR1', and 'Name: ALX92'. Below this is a notification box with a red border and text: 'Some parameters were changed'. To the right of the notification is a 'Reset' button. On the left side, there is a small image of a device and two menu items: 'Home' and 'Logout'. The main content area is divided into two columns. The left column is titled 'PRINT PARAMETERS' and contains a sub-section 'INTERFACE PARA' with a list of options: '>EASYPLUGINTERPR', '>COM1 PORT', '>COM3 PORT', '>COM4 PORT', '>CENTRONICS', '>NETWORK PARAM.', '>OPTIONS', and '>DRIVEASSIGNMENT'. Below this is the start of another section 'SYSTEM PARAMETER'. The right column is also titled 'PRINT PARAMETERS' and lists several settings: 'Print speed: 12.0 Inch/s', 'Feed speed: 16.0 Inch/s', 'Materialtype: Punched', 'Materiallength: 160.0 mm', 'Materialwidth: 100.0 mm', and 'Print direction: Foot first'.

[11] Information (A): Changes made to the parameter setting do not come into effect until after a reset.

The virtual operator panel

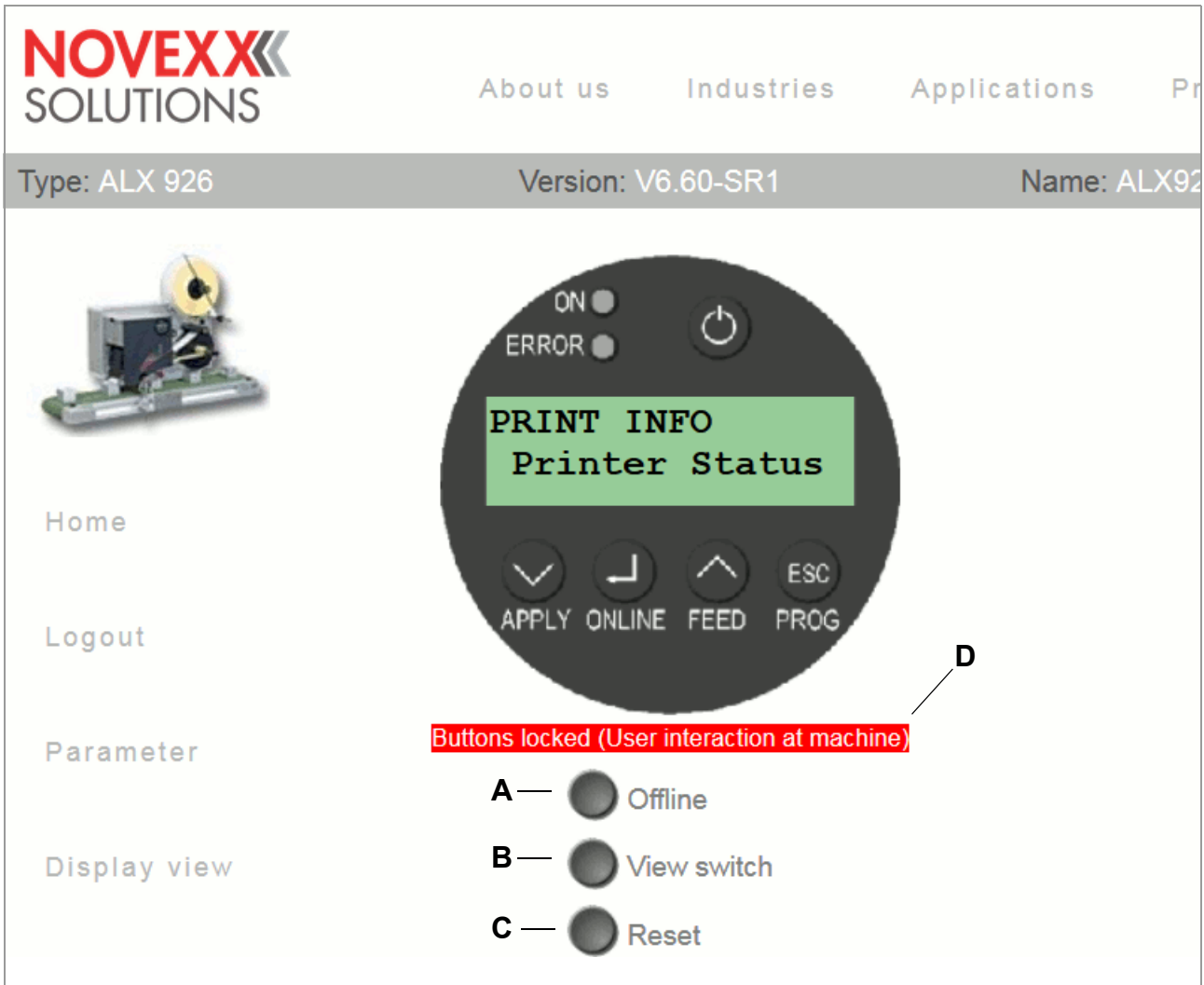

[12] The virtual operator panel

After the “Display view” link is clicked, an image of the operator panel (= virtual operator panel) appears on the screen [12]. All of the buttons on the real operator panel can also be operated by mouse-click on the virtual operator panel.

The buttons [12A-C] underneath the virtual operator panel are equivalent to key combinations on the real operator panel

- A** “Offline” button
  - Sets the machine offline during dispensing mode
  - Equals pressing the ONLINE button
- B** “View switch” button
  - Switches into standalone mode
  - Equivalent to pressing the buttons ONLINE + ESC
- C** “Reset” button
  - Triggers a reset
  - Equivalent to pressing the buttons APPLY + ONLINE + FEED

**D** Status line [13E]

In order to avoid putting an operating person at the machine at risk by sudden starting up of the machine, the virtual operator panel is locked as soon as a button at the machine operator panel is pressed. The status line indicates the current status:

Message	Meaning
No	A user is logged in at the virtual operator panel. The virtual operator panel is unlocked.
„Buttons locked (not logged in)“	No user is logged in at the virtual operator panel. The virtual operator panel is locked.
„Buttons locked (User interaction at machine)“	A user is logged in at the virtual operator panel. The virtual operator panel is blocked, because an operator at the machine operator panel has pressed a button Reactivate the virtual operator panel: → Switch from „Offline“ to „Online“ at the machine operator panel.

**FTP server****Applications**

The file transfer protocol (FTP) server (RFC959) enables access to the internal RAM disk and to the memory card in the card slot of the LMA/PMA (as long as there is a memory card in the slot).

In this way, files (configuration or firmware files) can be saved to the memory card or the internal RAM disk, or existing files renamed or deleted.

- ▣▣▣▣ The FTP server is multi-session compatible.
- ▣▣▣▣ The FTP server should not be heavily used during a high performance application of the labeller.

**Prerequisites**

- The printer is connected to a network
- A valid IP address is assigned to the printer (by the network administrator or by a DHCP server)
- INTERFACE PARA >NETWORK PARAM. > FTP server is set to “On”.
- A FTP client <sup>1</sup> is installed on the host computer.
- The FTP connection is *not* blocked by a firewall

**Establishing a FTP connection**

1. Note down the IP address of the printer.
  - ▣▣▣▣ The IP address is shown under INTERFACE PARA >NETWORK PARAM. > IP address
2. Start the FTP client.
3. Enter the following in the address bar:
 

```
ftp://[IP address without initial zeroes]
```

 Example: IP address = 144.093.029.047  
 Enter: ftp://144.93.29.47  
 An input field for the user name and password appears.

1) e. g. WS-FTP, Internet Explorer, Midnight Commander, Firefox

4. Enter user name and password.

A user name can be chosen at will; preset password = "avery"

Change the password under INTERFACE PARA >NETWORK PARAM. > FTP Password

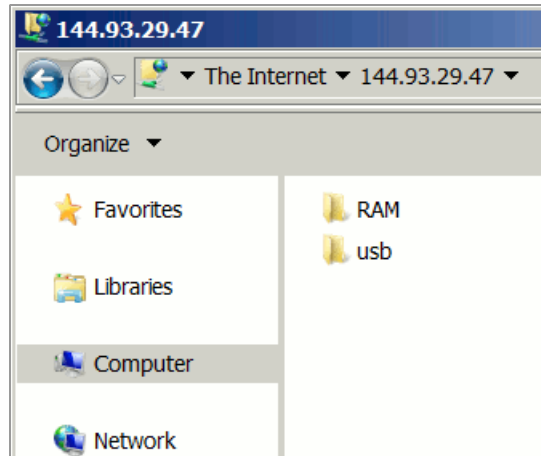

[13] User interface of the FTP server in the Windows Explorer.  
RAM = internal machine memory; usb = connected USB stick.

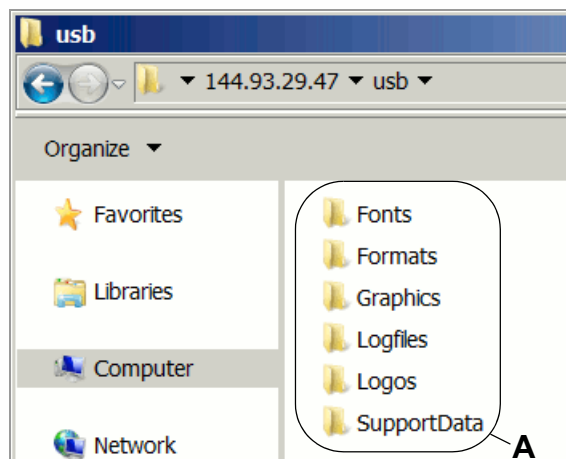

[14] Folders on the USB stick (A).

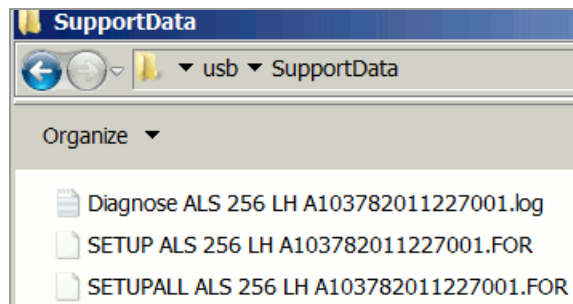

[15] Files in folder „SupportData“.

If the login was successful, separate folders appear in the FTP client, one for the internal RAM disk and one for each connected memory medium [13]:

- RAM:

The content of the RAM disk is without matter for the user.

- USB:

If one of the functions for storing setup or diagnosis data on a memory medium was already processed, the following subfolders can be found here <sup>1)</sup>:

Subfolder	Comment
Formats	<ul style="list-style-type: none"> <li>• Location for setup files (see MASCHINEN SETUP &gt; Param. speichern)</li> <li>• Location for firmware files to be uploaded in standalone mode</li> </ul>
Logfiles	Location for diagnosis files (see SERVICE/DIAGNOS. > Diagnose speich.)
SupportData	Location for setup and diagnosis files (see SERVICE/DIAGNOS. > Gen.SupportDaten) [15]
Fonts	
Graphics	Without function
Logos	

1) Depending on the applied memory medium appears SD, CF or USB.

## Data transmission with WLAN

According to standard IEEE 802.11b

### Requirements

#### Suitable printers

Printer	Firmware
AP 5.4, AP 7.t	3.00
64-xx, DPM, PEM, ALX 92x (each Gen. 3)	5.31
ALX 73x	6.36

[Tab. 20] Minimum firmware versions for use of WLAN.

#### Revision number CPU board

- AP 5.4, AP 7.t: at least 3 (A3927-03)
  - 64-xx, DPM, PEM, ALX 92x, ALX 73x: at least 4 (A6621-04)
- Displaying the revision number: SERVICE DATA > CPU BOARD DATA > CPU identifier

#### WLAN CF cards

- D-Link „DCF-660W“ (article number A7456)
- Linksys „WCF12“ (no longer available)
- Pretec „OC-WLBXX-A“ (no longer available) [16A]

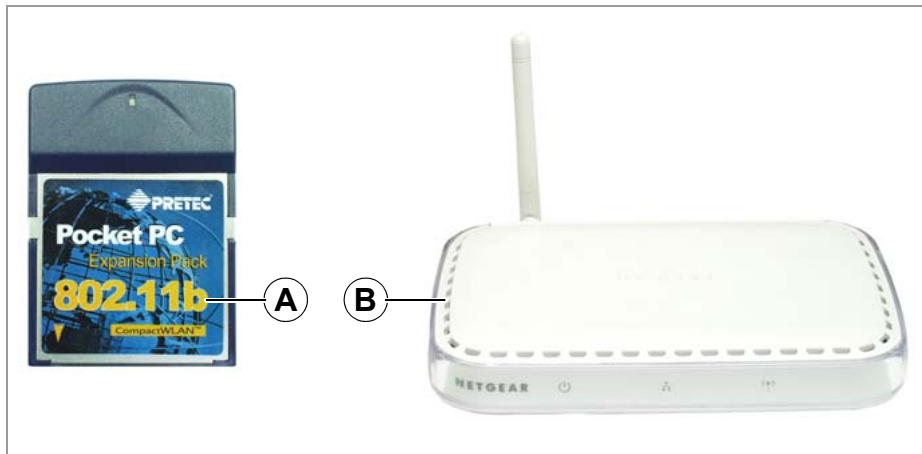

[16] WLAN CF card (A) ; Wireless Access Point (B)

#### Further requirements

- Access point according to standard IEEE 802.11b station mode „infrastructure“ (e. g. „Netgear Wireless Access Point WG602“ [16B])
- Ethernet crossed link cable (1:1 cable), to connect the access point to the host computer
- PC with operating system Windows XP

### Notes

WLAN = Wireless Local Area Network

This section describes a simple setup, with which data transmission from a host computer (e. g. PC) via an access point to a label printer can be tested. This setup doesn't suit for real network operation.

## Printer setup



CAUTION! - Network manipulations can disturb or avoid proper network operation.

→ Before connecting any device to a network, always ensure the approval of the network administrator.

1. Insert the WLAN CF card into the printers card slot. Switch the printer on.  
In the printer menu `INTERF. PARAM. > NETWORK PARAM.`, additional parameters for WLAN operation show up.

The LED at the card is flashing as long as the card is not logged in at the access point.

2. Make the following settings in the `INTERF. PARAM. > NETWORK PARAM.` menu:

Parameter	Setting	Note
IP addressassign	Fixed IP address	
IP address	e. g. 192.168.000.999	ask the network administrator for it; the initial three bytes must equal the PC address
Net mask	255.255.255.000	= default setting
WLAN SSID	idt	use lower case letters
WLAN WEP	disabled	
WLAN default key	0	or any other setting
FTP server		arbitrary setting
WEB Server		arbitrary setting

[Tab. 21] Required parameter settings in the printer menu.

3. Set parameter `INTERF. PARAM. > EASYPLUGINTERPR > Interface` to „LPD Server“.
4. Restart printer to activate the settings.

## Connecting

1. Connect the access point to the PC using a crossed link cable. Connect the access point to the mains supply and switch it on.
2. Check, if the LED at the WLAN CF card lights up permanent. If it does not, check the following points:
  - Is the card plugged firmly into the card slot?
  - Does the card match one of the supported card types?
  - Is the parameter `INTERF. PARAM. > NETWORK PARAM. > WLAN SSID` set to „idt“ (small letters!)?



## PC setup

1. In Windows XP call: *Start > Settings > System > Network*.
2. Click on *Configuration*, click the right mouse button and select *Properties*.  
Window [17] shows up.

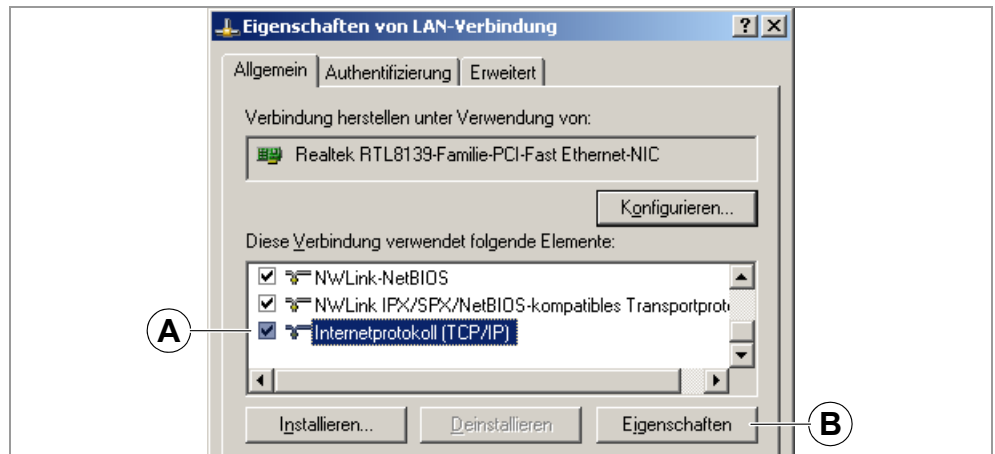

[17] „Properties of LAN connection“ window.

3. Select the item „Internet protocol (TCP/IP)“ [17A] and click on the „Properties“ button [17B].

Window [18] appears.

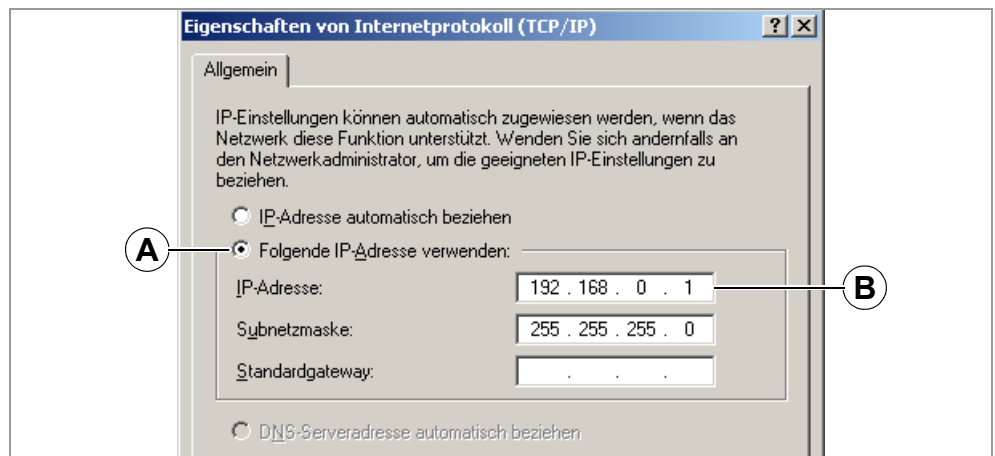

[18] „Properties of internet protocol (TCP/IP)“ window.

4. Activate the input field for fixed IP addresses [18A].
5. Ask the network administrator for suitable IP addresses. Type the IP address into field [18B] (e. g. 192.168.0.1).
6. Restart the PC to activate the settings.

## Testing the connection

1. Call the input window: *Start > Programs > Accessories > Input prompt*.
2. Enter the command „ping“ with the printers IP address, e.g. „ping 192.168.0.99“.
3. If the connection works properly, four answer lines appear in the input prompt window [19].

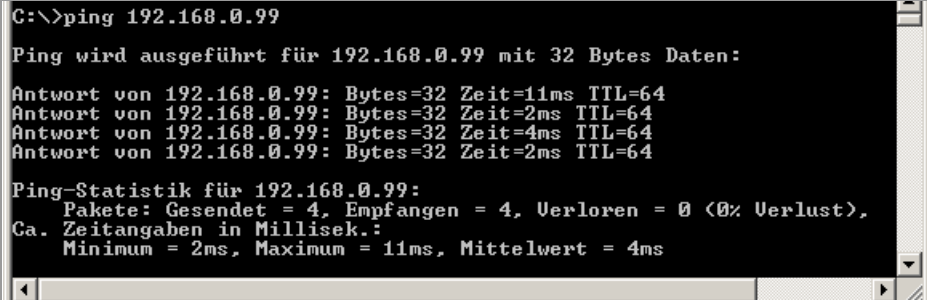

```

C:\>ping 192.168.0.99

Ping wird ausgeführt für 192.168.0.99 mit 32 Bytes Daten:

Antwort von 192.168.0.99: Bytes=32 Zeit=11ms TTL=64
Antwort von 192.168.0.99: Bytes=32 Zeit=2ms TTL=64
Antwort von 192.168.0.99: Bytes=32 Zeit=4ms TTL=64
Antwort von 192.168.0.99: Bytes=32 Zeit=2ms TTL=64

Ping-Statistik für 192.168.0.99:
    Pakete: Gesendet = 4, Empfangen = 4, Verloren = 0 (0% Verlust),
    Ca. Zeitangaben in Millisek.:
        Minimum = 2ms, Maximum = 11ms, Mittelwert = 4ms
  
```

[19] Input prompt window after proceeding ping with the printers IP address.

➡ As an additional test, „ping“ can also be called with the IP address of the access point. The default IP address of the Netgear WG602 is 192.168.0.227

If the printer doesn't send back an answer, the connection doesn't work properly. Measures in this case are:

- ➔ Check all the above mentioned settings.
- ➔ Contact the network administrator for advice.

## Sending a printjob

1. Have an Easy-Plug printjob ready (in this example: „test.txt“).
2. Send the printjob using the command „lpr“ [20].

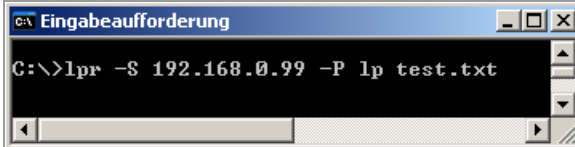

```

C:\>lpr -S 192.168.0.99 -P lp test.txt
  
```

[20] Sending a printjob using the lpr command

After some seconds, the printer should start printing.

➡ During data transmission, the LED at the WLAN CF card flashes.

## Storing and transferring parameter settings

### Recommendations

- Suitable printers: All printers listed in the headline, apart from the AP 4.4 (which has no card slot)
- Firmware:

Printer	Feature	Firmware version
64-xx, DPM, PEM, ALX 92x	Gen. 2	3.40
64-xx, DPM, PEM, ALX 92x	Gen. 3	5.02
ALX 73x	--	6.36
AP 5.4, AP 7.t	--	3.00
AP 5.4 Gen II, AP 5.6	MLK	7.34

[Tab. 22] Minimum firmware requirement if it is to store or transfer parameter settings.

### Application cases

Sometimes, it will be necessary to reinstall all parameter settings of a printer at a time or to transfer the settings to another printer. In those cases, the operator can save time, money and nerves by loading all the parameter settings completely. The following cases are possible:

- After a printer is being serviced, it is supposed to get the same settings as before.
- The parameter settings of one printer are supposed to be transferred to another printer of the same type.
- Several printers of the same type should be provided with the same settings.

It is advisable to read out and to store the parameter settings completely, to be able to restore them later. To do so, there are two ways:

#### Easy-Plug

Reading out via the interface by means of appropriate Easy-Plug commands. This requires sound knowledge of the command language Easy-Plug and is not further discussed here.

Further information: refer to the Easy-Plug manual, topic section [Description of commands](#) □, commands #!PG and #PC.

#### Memory card

Storing the parameter settings on a memory card in a text file („setup file“) (see description below).

## Storing settings on memory card

1. Call parameter `SPECIAL FUNCTION > Store parameters` <sup>1</sup>.
  - ▮ This parameter is only visible, if a memory card is plugged into the printer card slot.
2. Select a storing option: „With adjust para“ or „Without adj. par“.
  - „With adjust para“  
(Default setting) Parameters, which carry device specific settings, are also saved. Examples for this type of settings are the printhead resistance and the sensor settings.  
  
The relevant parameter names are marked with a „\*“ in the setup file. This option is recommended, if the settings are supposed to be reinstalled on the same printer.
  - „Without adj. par“  
Parameters, which carry device specific settings, are not saved.  
  
This option is recommended, if settings are supposed to be transferred to another printer of the same type.
3. After having chosen the storing option, the default file name is displayed (storing location: directory \FORMATS on memory card):
  - `SETUPALL.FOR` for storing option „With adjust para“
  - `SETUP.FOR` for storing option „Without adj. par“
  - ▮ File names and directory can be modified with the printer operation buttons or with a connected keyboard.
  - ▮ If a file with the given name already exists, it will be overwritten without further inquiry.

Command ID	Parameter name	Setting
#G Printer System Menu		
#PC2001/24.50	#G Head disp dist.	: 24.5 mm
#PC2002/0	#G Speed unit	: Inch/s
#PC2003/36.40	#G Foil end warning	: 36.4 mm
#PC2004/0	#G Display mode	: Job rest quant.
#PC2005/0	#G *Dispense counter	: 0
#PC2006/0	#G w/wo magazine	: with
#PC2007/0	#G Autom. dot check	: Off
#PC2008/10	#G Earliest dottest	: after 10 label
#PC2009/0	#G Latest dotcheck	: after 0 label
#PC2010/0	#G Dottestarea from	: 0 mm
#PC2011/104	#G Dottestarea to	: 104 mm
#PC2012/0	#G Print emulation	: Easyplug
#PC2013/9	#G Character Sets	: IBM

[Tab. 23] Detail of a setup file.

Some complete listings of a setup files can be found in the [Appendix D](#) on page 39 .

1) Older printers: call `SPECIAL FUNCTION > Parameter to CF`

## Loading settings from memory card

All files with parameter settings, which are stored in the \FORMATS directory, can be read out using the standalone mode.

▣▣▣▣► The file extension must be „.FOR“, see [Selecting files from memory card](#) □ on page 9.

## Automatic setup loading

→ Save the setup file as \AUTOSTRT.FOR (in the root directory on memory card).

Loading the settings:

1. Switch the printer off.
2. Insert the memory card.
3. Switch the printer on. The setup loading starts automatically. Display text when the settings are loaded:

Switch off.  
Remove card

## Verifying Bar Codes with OLV

### System Requirements

#### Printer

- Suitable printers: 64-xx / DPM / PEM / ALX 92x.
- Printer firmware: at least version 3.30
  - ▣ With firmware v. 3.30, the OLV can only be connected to Com2, that is, the option board A2294 must be installed in the printer.

#### OLV

- SV100 with power supply, interface cable and mounting plate.

Part	Order # (RJS)
Scanner/OLV	002-7973
Installation kit with PC software and power supply	002-8107
Mounting plate with scanner bracket	002-4608

[Tab. 24] Ordering numbers of the manufacturer for the SV 100.

- Firmware version: X302
- Manufacturer: RJS [www.RJS1.com](http://www.RJS1.com) 
- Serial data cable (1:1) to connect printer and OLV.
- For use outside of the USA, a country specific power cable is required.

Cable	Order # (Novexx)
Serial cable	A1207
Power cable euro norm	90600
Power cable UK	A0635
Power cable switzerland	A0842
Power cable denmark	A3598

[Tab. 25] Accessories for the SV 100 available at Novexx Solutions

### Functional Description

An OLV is a bar code scanner, which is able to rate the scanned bar code in quality (according to ANSI grades). The OLV is placed in front of the printer, so that it can read the bar codes directly after printing [21].

- ▣ Only the OLV „SV100“ by RJS can be used.
- ▣ Only bar codes can be verified, which are printed with a rotation of 0° or 180°.

## Setup

1. Place the printer on the OLV mounting plate as illustrated.
  - ▣▣▣▣ Operating the OLV at a DPM / PEM / ALX 92x requires a support stand matching the respective installation situation
2. Connect the OLV to the serial interface of the printer.
  - ▣▣▣▣ After the printer has been switched on, initialization commands are sent to the OLV. Therefore, the OLV has first to be switched on. These initialization commands switch on the laser beam (among other things).
  - ▣▣▣▣ The sending of the initialization commands can be repeated at any time by pressing the Feed and Esc buttons (at the printer) simultaneously. This may be necessary, if the OLV was switched off.
3. Switch on the OLV.
4. Switch on the printer.
5. Set the printer parameter `INTERF. PARAM. > OPTIONS > OLV` option to „Serial Com1“ or „Serial Com2“, depending on the port on which the OLV is connected.
  - ▣▣▣▣ (Firmware 3.30: Set the printer parameter `INTERF. PARAM. > COM2 PORT > Function Option` to „Barcode OLV“.)

The data transfer parameters of the interface are automatically set to the default values required by the SV100 (115 200 baud, 8 data bits, no parity, 2 stop bits, hardware handshake).
6. Position the OLV so, that the distance between laser beam (on the label) and print-head is as short as possible.
  - ▣▣▣▣ For detailed information on setting the OLV please refer to the SV100 manual.
7. Set the parameters in the `OLV PARAMETERS` menu (at the printer).

Information about the parameters can be found in topic section [Info-Printouts and Parameters](#) .

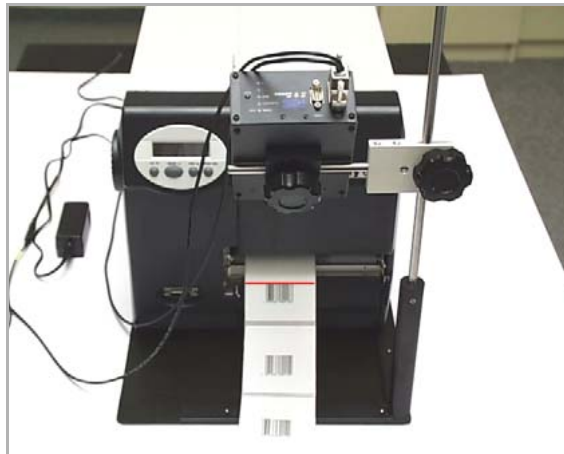

[21] 64-05 with OLV mounted (front view).

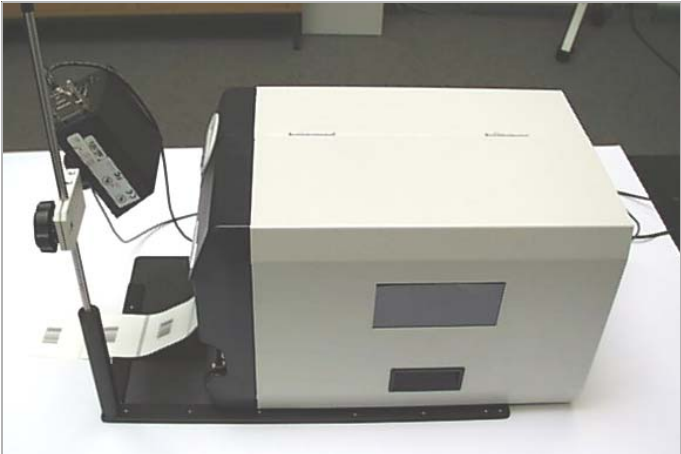

[22] 64-05 with OLV mounted (side view).



## Appendix

### Setup file for AP 5.4 (Gen. 1)

```

#!A1
#G Machine Setup for AP 5.4 300 Dpi Version: V3.10
#G Serial number : A424904304797
#G MAC Address : 000a.44.02.13.8c
#G Creation date : 05.05.2006 16:01

#G-----
#G Printer Parameter Menu
#G-----
#PC1001/1 #G Infeed no. : Nr. 1
#PC1002/8 #G Inf. change spd. : 8 Inch/s
#PC1003/4.0 #G Print speed : 4 Inch/s
#PC1004/4.0 #G Feed speed : 4 Inch/s
#PC1005/1 #G Materialtype : Punched
#PC1006/200.0 #G Materiallength : 200.0 mm
#PC1007/48.0 #G Materialwidth : 48.0 mm
#PC1027/0 #G Print direction : Foot first
#PC1008/0.0 #G Punch offset : 0.0 mm
#PC1009/1 #G Bar code multip. : * 1
#PC1010/0 #G UPC plain-copy : In line
#PC1011/0 #G EAN Readline : Standard
#PC1012/0 #G EAN sep. lines : With readl. only
#PC1013/0 #G Rotated barcodes : Normal
#PC1014/0 #G Cut mode : Real 1:1 mode
#PC1015/3 #G Cut speed : 3 Inch/s
#PC1016/105 #G Cut width : 105 mm
#PC1017/0.0 #G Cut position : 0.0 mm
#PC1018/0.0 #G Double cut : 0.0 mm
#PC1019/1 #G Rewind direction : Printing outside
#PC1020/0.0 #G *X - Printadjust : 0.0 mm
#PC1021/0.0 #G *Y - Printadjust : 0.0 mm
#PC1022/0 #G Punchmode : Automatic
#PC1023/128 #G Punchlevel : 128
#PC1024/30 #G Matend : 30
#G-----
#G Easyplug Interpreter
#G-----
#PC1101/2 #G Interface : TCP/IP SOCKET
#PC1102/0 #G Spooler mode : Mult. print jobs
#PC1103/1 #G *Printer ID no. : 1
#PC1104/64 #G Spooler size : 64 KBytes
#G-----
#G COM1 Port Parameter
#G-----
#PC1201/5 #G Baud rate : 9600 Baud
#PC1202/8 #G No. of data bits : 8
#PC1203/2 #G Parity : None
#PC1204/1 #G Stop bits : 1 Bit
#PC1205/0 #G Data synch. : RTS/CTS
#PC1206/0 #G Serial port mode : RS232
#PC1207/1 #G Frame error : Display

```

AP 4.4 – AP 5.4 – AP 5.6 – AP 7.t – 64-xx – DPM – PEM – ALX 92x

```

#G-----
#G COM2 Port Parameter
#G-----
#PC1302/5          #G Baud rate       : 9600 Baud
#PC1303/8          #G No. of data bits : 8
#PC1304/2          #G Parity           : None
#PC1305/1          #G Stop bits        : 1 Bit
#PC1306/0          #G Data synch.      : RTS/CTS
#PC1307/0          #G Serial port mode : RS232
#PC1308/1          #G Frame error      : Display
#G-----
#G COM3 Port Parameter
#G-----
#PC1351/2          #G Baud rate       : 9600 Baud
#PC1354/1          #G Parity           : None
#PC1356/0          #G Data synch.      : RTS/CTS
#PC1358/1          #G Frame error      : Display
#G-----
#G COM4 Port Parameter
#G-----
#PC1361/2          #G Baud rate       : 9600 Baud
#PC1364/1          #G Parity           : None
#PC1366/0          #G Data synch.      : RTS/CTS
#PC1368/1          #G Frame error      : Display
#G-----
#G Centronics Port Parameter
#G-----
#PC1401/1          #G PnP function     : On
#G-----
#G Ethernet Parameter
#G-----
#PC1501/0          #G IP Addressassign : DHCP
#PC1502/-1872945967 #G *IP address      : 144.093.028.209
#PC1503/-65536     #G *Net mask         : 255.255.000.000
#PC1504/0          #G *Gateway address  : 000.000.000.000
#PC1505/9100       #G Port address      : 9100
#PC1506/0          #G Ethernet speed    : Auto negotiation
#PC1521/1          #G SNMP Agent        : Enabled
#PC1522/public#G   #G SNMP password     : public
#PC1507/1          #G FTP server        : Enabled
#PC1508/novexx#G   #G FTP Password      : novexx
#PC1509/1          #G WEB server        : Enabled
#PC1510/5          #G WEB display refr  : 5 s
#PC1511/admin#G    #G WEB admin passw.  : admin
#PC1512/supervisor#G #G WEB supervisor p.: supervisor
#PC1513/AP5.4_300dpi_02138C#G#G DHCP host name : AP5.4_300dpi_02138C
#PC1514/idt#G      #G WLAN SSID         : idt
#PC1515/0          #G WLAN WEP          : Disabled
#PC1516/1          #G WLAN default key  : 1
#PC1517/123456789aBCd123456789AbcD#G#G WLAN key 1 : 123456789aB-
Cd123456789AbcD
#PC1518/123456789aBCd123456789AbcD#G#G WLAN key 2 : 123456789aB-
Cd123456789AbcD
#PC1519/123456789aBCd123456789AbcD#G#G WLAN key 3 : 123456789aB-
Cd123456789AbcD
#PC1520/123456789aBCd123456789AbcD#G#G WLAN key 4 : 123456789aB-
Cd123456789AbcD

```

## AP 4.4 – AP 5.4 – AP 5.6 – AP 7.t – 64-xx – DPM – PEM – ALX 92x

```

#G-----
#G Options Parameter
#G-----
#PC5300/0          #G Remote Display   : Disabled
#G-----
#G Printer System Menu
#G-----
#PC2001/24.5      #G Head disp dist.  : 24.5 mm
#PC2002/0         #G Speed unit       : Inch/s
#PC2003/36.4     #G Foil end warning : 36.4 mm
#PC2060/0        #G Foil warn stop   : Disabled
#PC2004/0        #G Display mode     : Job rest quant.
#PC2005/372      #G *Dispense counter : 372
#PC2006/0        #G w/wo magazine   : with
#PC2012/0        #G Print emulation  : Easyplug
#PC2013/3        #G Character sets   : Germany
#PC2014/0        #G Character filter  : Chars >= 20Hex
#PC2015/0        #G Light sens. type : Punched
#PC2016/0        #G Head-sensor dist : 0 mm
#PC2017/50       #G Sens. punch-LS   : 50 %
#PC2018/0        #G Foil mode        : Thermo transfer
#PC2019/9.9     #G Ribb. eco. limit : 9.9 mm
#PC2058/0        #G Feed mode        : Head up
#PC2020/1        #G Turn-on mode     : Online
#PC2021/0        #G Interface delay  : 0 ms
#PC2022/1        #G Error reprint    : Enabled
#PC2023/0        #G Single-job mode  : Disabled
#PC2025/1106    #G *Head resistance : 1106 Ohm / 12 Dot
#PC2026/20      #G Temp. reduction  : 20 %
#PC2066/1        #G Thin line emphas  : On
#PC2027/0        #G Voltage offset   : 0 %
#PC2028/1        #G Logo expansion   : Yes
#PC2029/0        #G Miss. label tol. : 0
#PC2031/1        #G Periph. device   : Cutter
#PC2032/2        #G Infeed module    : 2 infeeds
#PC2033/1        #G Singlestartquant : 1
#PC2035/0        #G Application mode  : Save mode
#PC2036/0        #G Appl. waitpos.   : 0 mm
#PC2037/10      #G Applicator speed : 10 Inch/s
#PC2038/0        #G Start mode       : Edge
#PC2039/0        #G Start source     : Light barrier
#PC2057/0        #G Calibration mode : Automatic
#PC2042/0        #G External signal  : Disabled
#PC2043/0        #G Signal edge      : Falling edge
#PC2044/1        #G Apply key        : Enabled
#PC2045/99      #G Print contrast   : 99 %
#PC2046/512     #G Ram disk size    : 512 KBytes
#PC2047/256     #G Font downl. area : 256 KBytes
#PC2048/1024    #G Free store size  : 1024 KBytes
#PC2049/2       #G Print info mode  : Compact right
#PC2050/0       #G Reprint function : Disabled
#PC2051/1       #G Language         : English
#PC2063/1       #G Keyboard         : English
#PC2053/0       #G Access authoriz. : Deactivated
#PC2059/80      #G Max InitFeedback : 80 mm
#PC1026/0       #G Material feed    : for- / backwards

```

## AP 4.4 – AP 5.4 – AP 5.6 – AP 7.t – 64-xx – DPM – PEM – ALX 92x

```

#G-----
#G Peripheral Parameter Menu
#G-----
#PC2512/1          #G Rewinder Motor   : Generation 2
#PC2501/0          #G Current mode     : Table values
#PC2502/100       #G Min rew. current : 100
#PC2503/250       #G Max rew. current : 250
#PC2504/170       #G Min rew. current : 170 %
#PC2505/170       #G Max rew. current : 170 %
#PC2506/0          #G Start rew. curr. : 0 %
#PC2507/30        #G Start cur. len.  : 30 mm
#PC2508/95        #G Pullback current : 95
#PC2509/50        #G Back diameter    : 50 mm
#PC2510/0          #G Break current    : 0
#PC2511/120       #G Break diameter   : 120 mm
#G-----
#G Dispenser Interface
#G-----
#PC3001/0          #G Interface type   : USI interface
#PC3002/0.0        #G Start delay      : 0.0 mm
#PC3003/0          #G Start print mode : Pulse falling
#PC3004/0          #G End print mode   : Mode 0
#PC3005/0          #G Reprint signal   : Disabled
#PC3006/1          #G Ribbon signal    : Enabled
#PC3007/0          #G Material signal  : Disabled
#PC3013/60.0       #G Diam. mat. end   : 60.0 mm
#PC3008/0          #G Feed input       : Standard
#PC3012/0          #G Pause input      : Standard
#PC3009/0          #G Start error stop : Off
#PC3010/1          #G Internal inputs  : Enabled
#PC3011/0          #G Apply mode       : After start sig.
#G-----
#G Textile Parameter Menu
#G-----
#PC3301/1          #G Changelabel Mode : Always at jobend
#PC3302/1          #G Changelab Print  : With print
#PC3303/10         #G Changelab Length : + 10 mm
#PC3304/1          #G Label Eject Mode : Yes, at job end
#PC3305/0          #G Head lift autom. : after 0 labels
#G-----
#G Applicator Parameter Menu
#G-----
#PC3101/0          #G Applicator type  : LTP - LTPV
#PC3102/0          #G Apply mode       : After start sig.
#PC3110/2          #G Start print mode : Pulse rising
#PC3103/0          #G Start error stop : Off
#PC3104/0          #G APSF sensor res. : 0 pulses/m
#PC3105/0.0        #G Start delay      : 0.0 mm
#PC3106/1          #G Dwell time       : 1 ms
#PC3107/1          #G Blow on time     : 1 ms
#PC3108/0          #G Restart delay    : 0 ms
#PC3109/2000       #G Position timeout : 2000 ms
#PC3212/0          #G Start error stop : Off
#G-----
#G I/O Board Parameter Menu
#G-----
#PC3201/0.0        #G Start delay      : 0.0 mm
#PC3202/0          #G APSF sensor res. : 0 pulses/m
#PC3203/0          #G Start print mode : Pulse falling
#PC3204/0          #G Reprint signal   : Disabled
#PC3205/0          #G Feed input       : Disabled
#PC3206/0          #G Pause input      : Disabled
#PC3207/0          #G Error output      : Printer error
#PC3208/0          #G Error polarity   : Level low active
#PC3209/1          #G Status output    : Low ribbon warn.
#PC3210/0          #G Status polarity  : Level low active
#PC3211/0          #G End print mode   : Mode0 inactive
#G-----

```

## AP 4.4 – AP 5.4 – AP 5.6 – AP 7.t – 64-xx – DPM – PEM – ALX 92x

## #G MLI Parameter Menu

```
#G-----
#PC4002/15          #G Darkness           : 15
#PC4003/126        #G Control Prefix    : 7EH
#PC4004/94         #G Format Prefix     : 5EH
#PC4005/44         #G Delimiter Char    : 2CH
#PC4006/0          #G Label Top         : 0 Dots
#PC4007/0          #G Left Position     : 0 Dots
#PC4009/0          #G Resolution        : 300 DPI
#PC4010/0          #G Error Indication  : OFF
#PC4011/0          #G Error Checking    : YES
#PC4012/0          #G 305 DPI Scaling  : YES
#PC4013/0          #G Image Save Path   : Internal RAM
#PC4014/1          #G Command ^PR      : Enable
#PC4015/1          #G Command ^MT      : Enable
#PC4017/0          #G Label Invert     : Disable
#PC4016/1          #G Command ^JM      : Enable
```

## #G Printer Special Menue

```
#G-----
#PC5001/1          #G *Printer type     : AP 5
#PC5002/1          #G *Printhead type   : KPA 300 DPI
#PC5004/0          #G Command sequence  : ,#G`
#PC5005/0          #G EasyPl. file log  : Disabled
```

## #G Printer Service Menu

```
#G-----
#PC5111/0          #G Spec parameter 1  : 0
#PC5112/0          #G Spec parameter 2  : 0
#PC5113/0          #G EasyPlug Monitor  : Disabled
#PC5125/0          #G EP Monitor Mode   : Interpreter data
#PC5116/127        #G *Punch adjust     : 127
#PC5117/128        #G *Reflex adjust    : 128
#PC5119/234        #G *Foil adjust      : 234
#PC5120/170        #G *Head sens adjust : 170
#PC5121/0          #G *Optn.1           : 0
#PC5122/0          #G *Optn.2 adjust    : 0
#PC5101/35         #G Matend tolerance  : 35 mm
#PC5102/0.0        #G Feed adjust       : 0.0 %
#PC5103/0.0        #G Foil feed adjust  : 0.0 %
#PC5104/0.0        #G *Punch y calibr.  : 0.0 mm
#PC5123/31775      #G *Rewinder adjust  : 31775
#PC5127/1          #G Debug interface   : Serial Com1
#PC5124/0          #G Debug mask        : 0
#PC5128/-1872945986 #G Debug IP address  : 144.093.028.190
```

## #G Module Firmware Versions

```
#G-----
#G readonly ID=30004 #G System version    : V3.10
#G readonly ID=30052 #G Peripheraldriver  : V 3 - T 3
#G readonly ID=30057 #G Intern. rewinder  : V 4 - T 36
```

AP 4.4 – AP 5.4 – AP 5.6 – AP 7.t – 64-xx – DPM – PEM – ALX 92x

```

#G-----
#G Operational Data
#G-----
#G readonly ID=30014 #G Serv. operations : 0
#G readonly ID=30015 #G Head number : 0
#G readonly ID=30016 #G Roll number : 0
#G readonly ID=30017 #G Cutter number : 0
#G readonly ID=30018 #G Head run length : 441 m
#G readonly ID=30019 #G Roll run length : 401 m
#G readonly ID=30020 #G Cuts on knife : 881
#G readonly ID=30021 #G Tot. mat. length : 401 m
#G readonly ID=30022 #G Tot. foil length : 358 m
#G readonly ID=30023 #G Total cuts : 881
#G readonly ID=30025 #G Head strobes : 3978688
#G readonly ID=30026 #G Foil diameter : 67.8 mm
#G readonly ID=30028 #G Operation time : 209 hours 46 min
#G-----
#G Power supply data
#G-----
#G readonly ID=30029 #G Type : Blue Mountain
#G-----
#G CPU board data
#G-----
#G readonly ID=30034 #G CPU identifier : 25-0
#G readonly ID=30036 #G PCB Revision : REV03
#G readonly ID=30037 #G FPGA version : 5817
#G readonly ID=30039 #G MAC Address : 000a.44.02.13.8c
#G readonly ID=30040 #G Serial number : A424904304797
#G readonly ID=30041 #G Production date : 03.08.2004
#G readonly ID=30042 #G PCB part number : A3407-03
#G readonly ID=30043 #G Board part numb. : A4249-01
#G readonly ID=30044 #G Manufacturer : Multitech Sys
#G readonly ID=30045 #G Work place : FCT Test Station
#G readonly ID=30046 #G Company name : Novexx Solutions
#G-----
#G CF card slot status
#G-----
#G readonly ID=30047 #G Card in slot : Yes
#G readonly ID=30048 #G Card typ : 3.3 Volt
#G-----
#G Internal Memory Configuration
#G-----
#G readonly ID=30010 #G Space for Jobs : 7.8 MB
#G readonly ID=30007 #G Ram memory size : 16 MB
#G readonly ID=30008 #G Flash mem size : 4 MB FUJ
#G readonly ID=30009 #G Compact flash : 32 MB
#G readonly ID=30010 #G Space for Jobs : 7.8 MB
#G readonly ID=30011 #G Max. Labellength : 1984 mm
#G readonly ID=30013 #G Default values : User defined
#G-----
#G Printer Debug Menu
#G-----
#PC5403/0 #G Pctrl communica. : Disabled
#PC5402/0 #G Variables : Disabled
#PC5400/0 #G Label generation : Disabled
#PC5401/0 #G Print handling : Disabled
#G-----
#G Execute system restart ( 217 parameters )
#G-----
#PC999999/-1#G

```

AP 4.4 – AP 5.4 – AP 5.6 – AP 7.t – 64-xx – DPM – PEM – ALX 92x

**Setup file for AP 5.4 (Gen. 2)**

```

#!A1
#G Machine Setup for AP 5.4 300 Dpi Version: V7.T10568M
#G Serial number : A100149091300006
#G MAC Address : 000A.44.07.00.05
#G Creation date : 24.02.2017 11:10

#G-----
#G Printer Parameter Menu
#G-----
#PC1001/1 #G Infeed no. : Nr. 1
#PC1002/8 #G Inf. change spd. : 8 Inch/s
#PC1003/4.0 #G Print speed : 4 Inch/s
#PC1004/4.0 #G Feed speed : 4 Inch/s
#PC1005/0 #G Material type : Endless
#PC1006/27.0 #G Material length : 27.0 mm
#PC1007/105.0 #G Material width : 105.0 mm
#PC1027/0 #G Print direction : Foot first
#PC1008/0.0 #G Punch offset : 0.0 mm
#PC1009/1 #G Bar code multip. : * 1
#PC1029/0 #G Tradit. Imaging : No
#PC1010/0 #G UPC plain-copy : In line
#PC1011/0 #G EAN Readline : Standard
#PC1012/0 #G EAN sep. lines : With readl. only
#PC1013/1 #G Rotated barcodes : Optimized
#PC1014/0 #G Dispense Mode : Real 1:1 mode
#PC1015/3 #G Cut speed : 3
#PC1016/105 #G Cut width : 105
#PC1017/0.0 #G Dispenseposition : 0.0 mm
#PC1018/0.0 #G Double cut : 0.0 mm
#PC1019/1 #G Rewind direction : Printing outside
*PC1020/0.0 #G *X - Printadjust : 0.0 mm
*PC1021/0.0 #G *Y - Printadjust : 0.0 mm
#PC1022/0 #G Punch mode : Automatic
#PC1023/128 #G Punch level : 128
#PC1024/30 #G Matend : 30
#G-----
#G Easyplug Interpreter
#G-----
#PC1101/7 #G Print interface : Automatic
#PC1102/0 #G Spooler mode : Mult. print jobs
*PC1103/1 #G *Printer ID no. : 1
#PC1104/64 #G Spooler size : 64 KBytes
#PC2072/0 #G Offline mode : Interf. disabled
#PC2021/0 #G Interface delay : 0 ms
#G-----
#G COM1 Port Parameter
#G-----
#PC1201/8 #G Baud rate : 115200 Baud
#PC1202/8 #G No. of data bits : 8
#PC1203/2 #G Parity : None
#PC1204/1 #G Stop bits : 1 Bit
#PC1205/0 #G Data synch. : RTS/CTS
#PC1206/0 #G Serial port mode : RS232
#PC1207/1 #G Frame error : Display
#G-----
#G COM2 Port Parameter
#G-----
#PC1302/8 #G Baud rate : 115200 Baud
#PC1303/8 #G No. of data bits : 8
#PC1304/2 #G Parity : None
#PC1305/1 #G Stop bits : 1 Bit
#PC1306/0 #G Data synch. : RTS/CTS
#PC1307/0 #G Serial port mode : RS232
#PC1308/1 #G Frame error : Display
#G-----
#G COM3 Port Parameter

```

## AP 4.4 – AP 5.4 – AP 5.6 – AP 7.t – 64-xx – DPM – PEM – ALX 92x

```

#G-----
#PC1351/2          #G  Baud rate       : 9600 Baud
#PC1353/8          #G  No. of data bits : 8
#PC1354/1          #G  Parity          : None
#PC1355/2          #G  Stop bits       : Automatic
#PC1356/0          #G  Data synch.     : RTS/CTS
#PC1357/0          #G  Serial port mode : RS232
#PC1358/1          #G  Frame error     : Display
#G-----
#G COM4 Port Parameter
#G-----
#PC1361/2          #G  Baud rate       : 9600 Baud
#PC1363/8          #G  No. of data bits : 8
#PC1364/1          #G  Parity          : None
#PC1365/2          #G  Stop bits       : 2 Bit
#PC1366/0          #G  Data synch.     : RTS/CTS
#PC1368/1          #G  Frame error     : Display
#G-----
#G COM5 Port Parameter
#G-----
#PC1371/2          #G  Baud rate       : 9600 Baud
#PC1373/8          #G  No. of data bits : 8
#PC1374/1          #G  Parity          : None
#PC1375/2          #G  Stop bits       : 2 Bit
#PC1376/0          #G  Data synch.     : RTS/CTS
#PC1378/1          #G  Frame error     : Display
#G-----
#G USB Port Parameter
#G-----
#PC1451/0          #G  USB select      : External Device
#G-----
#G Ethernet Parameter
#G-----
#PC1501/0          #G  IP Addressassign : DHCP
*PC1502/010.220.000.225 #G *IP address      : 010.220.000.225
*PC1503/255.255.254.000 #G *Net mask        : 255.255.254.000
*PC1504/010.220.000.001 #G *Gateway address : 010.220.000.001
#PC1505/9100       #G  Port address     : 9100
#PC1506/0          #G  Ethernet speed   : Auto negotiation
#PC1513/AP5.4_300dpi_070005#G#G DHCP host name   : AP5.4_300dpi_070005
#PC1521/0          #G  SNMP Agent       : Off
#PC1522/public#G   #G  SNMP password    : public
#PC1507/1          #G  FTP server       : On
#PC1508/novexx#G   #G  FTP Password     : novexx
#PC1509/1          #G  WEB server       : On
#PC1510/5          #G  WEB display refr : 5 s
#PC1511/admin#G    #G  WEB admin passw. : admin
#PC1512/supervisor#G #G  WEB supervisor p.: supervisor
#PC1532/operator#G #G  WEB operator p. : operator
#PC1529/0          #G  Time client      : Off
#PC1530/-2105212662 #G  Time server IP   : 130.133.001.010
#PC1531/3600       #G  Sync. interval   : 3600 s
#PC1533/0.0        #G  Time zone        : +0:00
#G-----
#G Options Parameter
#G-----
#PC5207/0          #G  RFID Option      : Off
#PC1550/0          #G  StandAlone Input : None
#PC5310/0          #G  #VW/I Interface  : Easyplug
#G-----
#G Drive Assignment
#G-----
#PC1600/3          #G  Drive C          : SD card
#PC1601/4          #G  Drive D          : USB thumb drive
#G-----
#G Printer System Menu
#G-----
#PC2001/24.5       #G  Head disp dist.  : 24.5 mm

```



## AP 4.4 – AP 5.4 – AP 5.6 – AP 7.t – 64-xx – DPM – PEM – ALX 92x

```

#PC2002/0      #G Speed unit      : Inch/s
#PC2069/1      #G Cover open error : Immediately
#PC2003/36.4  #G Foil end warning : 36.4 mm
#PC2060/0      #G Foil warn stop   : Off
#PC2004/0      #G Display mode     : Job rest quant.
*PC2005/86     #G *Dispense counter : 86
#PC2006/0      #G w/wo magazine    : with
#PC2012/0      #G Print Interpret.  : Easyplug
#PC2013/9      #G Character sets    : IBM
#PC2014/0      #G Character filter   : Chars >= 20Hex
#PC2015/0      #G Label sens. type  : Punched
#PC2016/0      #G Head-sensor dist  : 0 mm
#PC2017/50     #G Sens. punch-LS   : 50 %
#PC2018/0      #G Foil mode         : Thermo transfer
#PC2019/10.0  #G Ribb. eco. limit  : 10.0 mm
#PC2077/0.0    #G Head down lead    : 0.0 mm
#PC2058/0      #G Feed mode         : Head up
#PC2020/1      #G Turn-on mode      : Online
#PC2022/1      #G Error reprint     : On
#PC2071/0      #G EasyPlug errors   : Tolerant handl.
#PC2023/0      #G Single-job mode   : Off
*PC2025/1146  #G *Head resistance  : 1146 Ohm / 12 Dot
#PC2026/20     #G Temp. reduction   : 20 %
#PC2066/0      #G Thin line emphas   : Off
#PC2027/0      #G Voltage offset    : 0 %
#PC2028/1      #G Logo expansion    : Yes
#PC2029/2      #G Miss. label tol.  : 2
#PC2067/1      #G Gap detect. mode  : Autom. forward
#PC2068/5      #G Foil stretching   : Feedback: 5 mm
#PC3306/0      #G Head lift autom.  : Off
#PC2031/3      #G Periph. device    : Tear-off edge
#PC2032/2      #G Infeed module     : 2 infeeds
#PC2033/1      #G Singlestartquant  : 1
#PC2035/0      #G Application mode   : Safe mode
#PC2036/0      #G Appl. waitpos.    : 0 mm
#PC2037/10     #G Applicator speed   : 10 Inch/s
#PC2039/0      #G Start source      : Light barrier
#PC2057/0      #G Calibration mode  : Automatic
#PC2042/0      #G External signal    : Off
#PC2043/0      #G Start print mode   : Pulse falling
#PC2044/1      #G Apply key         : On
#PC2045/80     #G Print contrast    : 80 %
#PC2046/512    #G Ram disk size     : 512 KBytes
#PC2047/256    #G Font downl. area  : 256 KBytes
#PC2048/4096   #G Free store size    : 4096 KBytes
#PC2049/0      #G Print info mode   : Par.values right
#PC2050/0      #G Reprint function  : Off
#PC2051/1      #G Language          : English
#PC2063/1      #G Keyboard          : English
#PC2053/0      #G Access authoriz.  : Off
#PC1026/0      #G Material feed     : for- / backwards
#G-----
#G Peripheral Parameter Menu
#G-----
#PC2059/80     #G Max InitFeedback  : 80 mm
#PC1031/100    #G Forw feed rat.    : 100 %
#PC1032/100    #G Backw feed rat.   : 100 %
#PC6004/15.0   #G Start offset      : 15.0 mm
#PC6014/0      #G Start error stop  : Off
#PC6017/0.0    #G Product length    : 0.0 mm
#PC6005/0      #G Speed Adaption    : Off
#PC6006/1      #G Encoder Type      : 2 Phases normal
#PC6008/500    #G Encoder Resol.    : 500 pulses/turn
#PC6009/64.0   #G Encoder Diameter  : 64.0mm 0.0var
#PC6035/0      #G Multi label mode  : Off
#PC6036/25.0   #G Label 2 offset    : 25.0 mm
#PC6037/25.0   #G Label 3 offset    : 25.0 mm
#PC2501/0      #G Current mode      : Table values

```

## AP 4.4 – AP 5.4 – AP 5.6 – AP 7.t – 64-xx – DPM – PEM – ALX 92x

```

#PC2502/100          #G  Min rew. current : 100
#PC2503/250          #G  Max rew. current : 250
#PC2504/110          #G  Min rew. current : 110 %
#PC2505/110          #G  Max rew. current : 110 %
#PC2506/0            #G  Start rew. curr.  : 0 %
#PC2507/30           #G  Start cur. len.   : 30 mm
#PC2508/94           #G  Pullback current : 94
#PC2509/50           #G  Back diameter    : 50 mm
#PC2510/0            #G  Break current     : 0
#PC2511/120          #G  Break diameter   : 120 mm
#G-----
#G Dispenser Interface
#G-----
#PC3001/0            #G  Interface type    : USI interface
#PC3003/0            #G  Start print mode  : Pulse falling
#PC3004/0            #G  End print mode    : Mode 0
#PC3005/0            #G  Reprint signal    : Off
#PC3006/1            #G  Ribbon signal     : On
#PC3007/0            #G  Material signal   : Off
#PC3013/60.0         #G  Diam. mat. end    : 60.0 mm
#PC3008/0            #G  Feed input        : Standard
#PC3012/0            #G  Pause input       : Standard
#PC3009/0            #G  Start error stop  : Off
#PC3010/1            #G  Internal inputs   : On
#PC3011/0            #G  Apply mode        : After start sig.
#PC3014/0            #G  USI profile       : Default
#PC3015/1            #G  Warning signal    : Level high activ
#G-----
#G Textile Parameter Menu
#G-----
#PC3301/0            #G  Changelabel Mode  : Easyplug select
#PC3302/1            #G  Changelab Print   : With print
#PC3303/10           #G  Changelab Length  : + 10 mm
#PC3304/0            #G  Label Eject Mode  : No
#PC3305/0            #G  Head lift autom.  : after 0 labels
#G-----
#G Applicator Parameter Menu (AI Board)
#G-----
#PC3101/6            #G  Applicator type    : Direct Dispense
#PC3102/0            #G  Apply mode         : After start sig.
#PC3110/2            #G  Start print mode  : Pulse rising
#PC3118/0            #G  TouchDown Sensor  : Pulse falling
#PC3116/0            #G  Lab release time   : 0 ms
#PC3106/1            #G  Dwell time        : 1 ms
#PC3107/1            #G  Blow on time       : 1 ms
#PC3108/0            #G  Restart delay     : 0 ms
#PC3115/80           #G  Stop lag time      : 80 ms
#PC3109/2000         #G  Position timeout   : 2000 ms
#PC3117/99           #G  TouchDownTimeout  : Off
#PC3111/0            #G  Apply comp. time   : 0 ms
#G-----
#G I/O Board Parameter Menu
#G-----
#PC3203/0            #G  Start print mode  : Pulse falling
#PC3204/0            #G  Reprint signal    : Off
#PC3205/0            #G  Feed input        : Off
#PC3206/0            #G  Pause input       : Off
#PC3207/0            #G  Error output       : Printer error
#PC3208/0            #G  Error polarity    : Level low active
#PC3209/1            #G  Status output     : Low ribbon warn.
#PC3210/0            #G  Status polarity   : Level low active
#PC3211/0            #G  End print mode    : Mode0 inactive
#G-----
#G LTSI Applicator Parameter Menu
#G-----
#PC3152/0            #G  Apply mode         : After start sig.
#PC3153/190          #G  Stroke length     : 190 mm
#PC3154/0            #G  Appl. waitpos.    : 0 mm

```

## AP 4.4 – AP 5.4 – AP 5.6 – AP 7.t – 64-xx – DPM – PEM – ALX 92x

```

#PC3155/350.0      #G  Applicator speed : 350 mm/s
#PC3158/0         #G  Restart delay   :    0 ms
#G-----
#G ZPL Parameter Menu
#G-----
#PC4002/15       #G  Darkness        : 15
#PC4003/126     #G  Control Prefix  : 7EH
#PC4004/94       #G  Format Prefix   : 5EH
#PC4005/44       #G  Delimiter Char  : 2CH
#PC4006/0        #G  Label Top       : 0 Dots
#PC4007/0        #G  Left Position   : 0 Dots
#PC4009/0        #G  Resolution      : 300 DPI
#PC4010/0        #G  Error Indication : OFF
#PC4011/0        #G  Error Checking  : YES
#PC4013/0        #G  Image Save Path : Internal RAM
#PC4014/1        #G  Command ^PR    : Enable
#PC4015/1        #G  Command ^MT    : Enable
#PC4017/0        #G  Label Invert   : Disable
#PC4016/1        #G  Command ^JM    : Enable
#PC4018/1        #G  Command ^MD/~SD : Enable
#G-----
#G RFID Parameter Menu
#G-----
#PC5208/10       #G  Power level     : [10]
#PC5201/10       #G  Try Times       : 10
#PC2055/3        #G  Max Tags to stop : 3
#PC2056/1        #G  Nr CMD retries  : 1
#PC5204/0        #G  Chip Protection : Off
#PC5206/6.0      #G  Chip Size       : 6.0 mm
#PC5205/20.0     #G  Chip Offset     : 20.0 mm
#G-----
#G Printer Special Menu
#G-----
*PC5001/1        #G *Printer type    : AP 5
*PC5002/1        #G *Printhead type  : KPA 300 DPI
#PC5004/0        #G  Command sequence : '##'
#PC5005/0        #G  EasyPl. file log : Off
#PC5129/0        #G  Flash Res. Area  : 0 KBytes
#G-----
#G Printer Service Menu
#G-----
#PC5111/0        #G  Spec parameter 1 : 0
#PC5112/0        #G  Spec parameter 2 : 0
#PC5113/0        #G  EasyPlug Monitor : Off
#PC5125/0        #G  EP Monitor Mode  : Interpreter data
*PC5116/140     #G *Punch adjust    : 140
*PC5117/112     #G *Reflex adjust   : 112
*PC5119/128     #G *Foil adjust     : 128
*PC5120/128     #G *Head sens adjust : 128
*PC5121/128     #G *Optn.1         : 128
*PC5122/128     #G *Optn.2 adjust   : 128
#PC5101/35      #G  Matend tolerance : 35 mm
#PC5102/0.0     #G  Feed adjust     : 0.0 % [ribbon]
#PC5105/0.0     #G  Feed adjust     : 0.0 % [direct]
#PC5103/0.0     #G  Foil feed adjust : 0.0 %
*PC5104/0.0     #G *Punch y calibr. : 0.0 mm
#PC5132/0       #G  Rew.Sens.Connect : At stepperdriver
*PC5123/32832   #G *Rewinder adjust : 32832
#G-----
#G DHCP Addresses
#G-----
#G readonly ID=30001 #G  IP address      : 000.000.000.000
#G readonly ID=30002 #G  Net mask        : 000.000.000.000
#G readonly ID=30003 #G  Gateway address : 000.000.000.000
#G-----
#G Module Firmware Versions
#G-----
#G readonly ID=30004 #G  System version  : V7.T10568M

```

AP 4.4 – AP 5.4 – AP 5.6 – AP 7.t – 64-xx – DPM – PEM – ALX 92x

```

#G readonly ID=30067 #G System revision : 10568M
#G readonly ID=30070 #G System date : Sep 27 2016
#G readonly ID=30061 #G Bootloader : V3.90
#G readonly ID=30062 #G uMon : V2.1 26Sep2016
#G readonly ID=30076 #G Model ID : AP 5.4 300 Dpi Gen-2
#G readonly ID=30086 #G PnP Hardware ID : NovexxAP5.4_300dpi1EC5
#G readonly ID=30077 #G Printer-Model : AP 5.
#G readonly ID=30078 #G Printhead : 4
#G readonly ID=30079 #G Printhead dpi : 300
#G readonly ID=30080 #G Printhead Dot/mm : 11.811000
#G readonly ID=30081 #G Storage media : RAM,SD
#G readonly ID=30052 #G Peripheraldriver : V 3 - T 3

```

```

#G-----
#G Operational Data
#G-----

```

```

#G readonly ID=30014 #G Serv. operations : 0
#G readonly ID=30015 #G Head number : 1
#G readonly ID=30016 #G Roll number : 1
#G readonly ID=30018 #G Head run length : 104 m
#G readonly ID=30019 #G Roll run length : 112 m
#G readonly ID=30021 #G Tot. mat. length : 112 m
#G readonly ID=30022 #G Tot. foil length : 74 m
#G readonly ID=30025 #G Head strobes : 1219950
#G readonly ID=30071 #G Head temperature : 20 °C
#G readonly ID=30026 #G Foil diameter : 80.4 mm
#G readonly ID=30028 #G Operation time : 0 hours 1 min
#G readonly ID=30082 #G Total Operation : 76 hours 10 min

```

```

#G-----
#G Power supply data
#G-----

```

```

#G readonly ID=30029 #G PS type : Blue Mountain
#G readonly ID=30072 #G PS Temperature : 24 °C

```

```

#G-----
#G CPU board data
#G-----

```

```

#G readonly ID=30034 #G CPU identifier : 2-4
#G readonly ID=30036 #G PCB Revision : REV00
#G readonly ID=30037 #G FPGA version : 6A04
#G readonly ID=30039 #G MAC Address : 000A.44.07.00.05
#G readonly ID=30040 #G Serial number : A100149091300006
#G readonly ID=30041 #G Production date : 02.04.2009
#G readonly ID=30042 #G PCB part number : A100148
#G readonly ID=30043 #G Board part numb. : A100150
#G readonly ID=30044 #G Manufacturer : Multitech Sys
#G readonly ID=30045 #G Work place : FCT Dolphin
#G readonly ID=30046 #G Company name : Avery Dennison

```

```

#G-----
#G Display board data
#G-----

```

```

#G readonly ID=30059 #G Display Version : V3.10
#G readonly ID=30068 #G Display serialNr : A714900S08100457

```

```

#G-----
#G Internal Memory Configuration
#G-----

```

```

#G readonly ID=30007 #G RAM memory size : 64 MB
#G readonly ID=30008 #G Flash mem size : 4 MB AMD
#G readonly ID=30064 #G SD card : 7.50GB/8GB (c:)
#G readonly ID=30010 #G Space for Jobs : 46.4 MB
#G readonly ID=30011 #G Max. Labellength : 11612 mm
#G readonly ID=30013 #G Custom defaults : No

```

```

#G-----
#G Statistics
#G-----

```

```

#G readonly ID=30100 #G Nr of Tags :
#G readonly ID=30101 #G Nr. invalid tags :
#G readonly ID=30110 #G Scrap rate : 100.0 %
#G readonly ID=30102 #G Total Nr. SELECT :
#G readonly ID=30103 #G Invalid SELECT :

```

## AP 4.4 – AP 5.4 – AP 5.6 – AP 7.t – 64-xx – DPM – PEM – ALX 92x

```

#G readonly ID=30104 #G Total Nr. READ :
#G readonly ID=30105 #G Invalid READ :
#G readonly ID=30106 #G Total Nr. WRITES :
#G readonly ID=30107 #G Invalid WRITE :
#G readonly ID=30108 #G Rate READ :
#G readonly ID=30109 #G Rate WRITE :
#G-----
#G Printer Debug Menu
#G-----
#PC5127/0 #G Debug interface : Off
#PC5124/0 #G Debug mask : 0
#PC5128/-1872945986 #G Debug IP address : 144.093.028.190
#PC5404/0 #G Fields : Off
#PC5400/0 #G Label generation : Off
#PC5401/0 #G Print handling : Off
#PC5402/0 #G Variables : Off
#PC5408/0 #G OLV data : Off
#PC5403/0 #G Pctrl communica. : Off
#PC5406/0 #G RFID-Reader : Off
#PC5407/0 #G RFID-Task : Off
#PC5131/1 #G BitimageFileDump : Easyplug select
#PC5405/0 #G Debug Shell : Off
#PC5409/0 #G Text Seg.Observ. : Off
#G-----
#G Execute system restart ( 270 parameters )
#G-----
#PC999999/-1#G

```

**Setup file for 64-05 (Gen. 2)**

```

#!A1
#G Machine Setup for 64-05 Version: V3.40
#G Serial number :
#G MAC Address :
#G Creation date : 24.02.2017 07:14
#G-----
#G Printer Parameter Menu
#G-----
#PC1001/1 #G Infeed no. : Nr. 1
#PC1002/8 #G Inf. change spd. : 8 Inch/s
#PC1003/7.00 #G Print speed : 7 Inch/s
#PC1004/7.00 #G Feed speed : 7 Inch/s
#PC1005/1 #G Materialtype : Punched
#PC1006/24.92 #G Materiallength : 24.9 mm
#PC1007/49.83 #G Materialwidth : 49.8 mm
#PC1008/0.00 #G Punch offset : 0.0 mm
#PC1009/1 #G Bar code multip. : * 1
#PC1010/0 #G UPC plain-copy : In line
#PC1011/0 #G EAN Readline : Standard
#PC1012/0 #G EAN sep. lines : With readl. only
#PC1013/1 #G Rotated barcodes : Optimized
#PC1014/0 #G Dispense Mode : Real 1:1 mode
#PC1015/3 #G Cut speed : 3 Inch/s
#PC1016/128 #G Cut width : 128 mm
#PC1017/0.00 #G Cut position : 0.0 mm
#PC1018/0.00 #G Double cut : 0.0 mm
#PC1019/1 #G Rewind direction : Printing outside
*PC1020/0.00 #G *X - Printadjust : 0.0 mm
*PC1021/0.00 #G *Y - Printadjust : 0.0 mm
#PC1022/0 #G Punchmode : Automatic
#PC1023/128 #G Punchlevel : 128
#G-----
#G Printer System Menu
#G-----
#PC2001/24.50 #G Head disp dist. : 24.5 mm
#PC2002/0 #G Speed unit : Inch/s
#PC2003/36.40 #G Foil end warning : 36.4 mm

```

AP 4.4 – AP 5.4 – AP 5.6 – AP 7.t – 64-xx – DPM – PEM – ALX 92x

```

#PC2004/0          #G Display mode      : Job rest quant.
*PC2005/0          #G *Dispense counter : 0
#PC2006/0          #G w/wo magazine    : with
#PC2007/0          #G Autom. dot check  : Off
#PC2008/10         #G Earliest dottest  : after 10 label
#PC2009/0          #G Latest dotcheck   : after 0 label
#PC2010/0          #G Dottestarea from  : 0 mm
#PC2011/128        #G Dottestarea to    : 128 mm
#PC2012/0          #G Print emulation   : Easyplug
#PC2013/9          #G Character sets    : IBM
#PC2014/0          #G Character filter   : Chars >= 20Hex
#PC2015/0          #G Light sens. type  : Punched
#PC2016/0          #G Head-sensor dist  : 0 mm
#PC2017/50         #G Sens. punch-LS    : 50 %
#PC2018/0          #G Ribbon autoecon.  : Disabled
#PC2019/10.00     #G Ribb. eco. limit  : 10.0 mm
#PC2058/0          #G Feed mode         : Head up
#PC2020/1          #G Turn-on mode      : Online
#PC2021/0          #G Interface delay   : 0 ms
#PC2022/1          #G Error reprint     : Enabled
#PC2023/0          #G Single-job mode   : Disabled
*PC2024/1276      #G *Head resistance  : 1276 Ohm
#PC2026/20         #G Temp. reduction   : 20 %
#PC2027/0          #G Voltage offset    : 0 %
#PC2028/1          #G Logo expansion    : Yes
#PC2029/2          #G Miss. label tol.  : 2
#PC2030/1          #G Mat. end detect.  : Transparent
#PC2031/0          #G Periph. device    : None
#PC2032/2          #G Infeed module     : 2 infeeds
#PC2033/1          #G Singlestartquant  : 1
#PC2034/0          #G Dispensing mode   : fast
#PC2035/0          #G Application mode   : Save mode
#PC2036/0          #G Appl. waitpos.    : 0 mm
#PC2037/10         #G Applicator speed  : 10 Inch/s
#PC2038/0          #G Start mode        : Edge
#PC2039/0          #G Start source      : Light barrier
#PC2040/0          #G Dispensing edge   : short
#PC2041/0          #G Transport mode    : Dispenser motor
#PC2042/0          #G External signal   : Disabled
#PC2043/0          #G Signal edge       : Falling edge
#PC2044/1          #G Apply key         : Enabled
#PC2045/70         #G Print contrast    : 70 %
#PC2046/512        #G Ram disk size     : 512 KBytes
#PC2047/256        #G Font downl. area  : 256 KBytes
#PC2048/512        #G Free store size   : 512 KBytes
#PC2049/0          #G Print info mode   : Par.values right
#PC2050/0          #G Reprint function  : Disabled
#PC2051/1          #G Language          : English
#PC2052/1          #G Signal / buzzer   : On
#PC2053/0          #G Access authoriz.  : Deactivated
#G-----
#G Easyplug Interpreter
#G-----
#PC1101/1          #G Interface         : Centronics
#PC1102/0          #G Spooler mode      : Mult. print jobs
*PC1103/1          #G *Printer ID no.   : 1
#PC1104/64         #G Spooler size      : 64 KBytes
#G-----
#G COM1 Port Parameter
#G-----
#PC1201/5          #G Baud rate         : 9600 Baud
#PC1202/8          #G No. of data bits  : 8
#PC1203/2          #G Parity            : None
#PC1204/1          #G Stop bits         : 1 Bit
#PC1205/0          #G Data synch.       : RTS/CTS
#PC1206/0          #G Serial port mode  : RS232
#PC1207/1          #G Frame error       : Display
#G-----

```

AP 4.4 – AP 5.4 – AP 5.6 – AP 7.t – 64-xx – DPM – PEM – ALX 92x

```

#G COM2 Port Parameter
#G-----
#PC1301/0          #G Function Option   : None
#PC1302/5          #G Baud rate         : 9600 Baud
#PC1303/8          #G No. of data bits  : 8
#PC1304/2          #G Parity             : None
#PC1305/1          #G Stop bits         : 1 Bit
#PC1306/0          #G Data synch.       : RTS/CTS
#PC1307/0          #G Serial port mode  : RS232
#PC1308/1          #G Frame error       : Display
#G-----
#G Centronics Port Parameter
#G-----
#PC1401/1          #G PnP function      : On
#PC1402/0          #G Select signal     : Always online
#PC1403/0          #G SelectIn signal   : Supported
#G-----
#G Ethernet Parameter
#G-----
#PC1501/1          #G IP Addressassign  : Fixed IP address
*PC1502/872611845 #G *IP address       : 052.003.000.005
*PC1503/-256       #G *Net mask         : 255.255.255.000
*PC1504/872611840 #G *Gateway address  : 052.003.000.000
#PC1505/4000       #G Port address      : 4000
#PC1506/0          #G Ethernet speed    : Auto negotiation
#PC1507/0          #G FTP server        : Disabled
#PC1508/avery#G    #G FTP Password     : avery
#G-----
#G Printer Special Menue
#G-----
*PC5001/0          #G *Printer type     : 64-0x
*PC5002/1          #G *Printhead type   : KCE 5Inch
#PC5003/1          #G Disp. Head Offs.  : Yes
#PC5004/0          #G Command sequence  : '#G'
#G-----
#G Printer Service Menu
#G-----
*PC5101/0          #G *Head step tune   : 0 step(s)
#PC5111/0          #G Spec parameter 1  : 0
#PC5112/0          #G Spec parameter 2  : 0
#PC5113/0          #G EasyPlug monitor  : Disabled
#PC5114/0.00       #G Paper jam level   : 0.0 %
*PC5115/128        #G *Matend adjust    : 128
*PC5116/128        #G *Punch adjust     : 128
*PC5117/128        #G *Reflex adjust    : 128
*PC5118/128        #G *Fullsize adjust  : 128
*PC5123/0          #G *Rewinder adjust  : 0
#PC5124/0          #G Debug             : 0
#G-----
#G Dispenser Interface
#G-----
#PC3001/0          #G Interface type    : USI interface
#PC3002/0.00       #G Start delay       : 0.0 mm
#PC3003/0          #G Start print mode  : Pulse falling
#PC3004/0          #G End print mode    : Mode 0
#PC3005/0          #G Reprint signal    : Disabled
#PC3006/1          #G Ribbon signal     : Enabled
#PC3007/0          #G Material signal   : Disabled
#PC3008/0          #G Feed input        : Standard
#PC3008/0          #G Pause input       : Standard
#PC3009/0          #G Start error stop  : Off
#PC3010/1          #G Internal inputs   : Enabled
#PC3011/0          #G Appliccate mode   : After start sig.
#G-----
#G Not visible
#G-----
#PC4008/12000      #G Max Media Length  : 12000 Dots
#G-----

```

AP 4.4 – AP 5.4 – AP 5.6 – AP 7.t – 64-xx – DPM – PEM – ALX 92x

```

#G OLV Parameter Menu
#G-----
#PC3501/0          #G Verify mode      : All barcodes
#PC3502/0          #G Cancel. printing : Disabled
#PC3503/0          #G Reprint quantity : 0
#PC3504/1          #G OLV mode         : fast
#PC3505/0          #G Ref Decode       : No test
#PC3506/-1         #G Decodability     : -1
#PC3507/-1         #G Modulation       : -1
#PC3508/-1         #G Defects          : -1
#PC3509/-1         #G Edge Contrast    : -1
#PC3510/-1         #G Rmin/Rmax        : -1
#PC3511/-1         #G Symbol Contrast  : -1
#PC3512/-1         #G PCS              : -1
#PC3513/-1         #G R (white)        : -1
#PC3514/-1         #G R (black)        : -1
#PC3515/-1         #G Ratio            : -1
#PC3516/-1         #G ANSI Symb. Grade : -1
#PC3517/10         #G Dist. head-beam  : 10 mm
#G-----
#G ZPLII Parameter Menu
#G-----
#PC4001/0          #G Emulator Version : v1.25
#PC4002/15         #G Darkness          : 15
#PC4003/126        #G Control Prefix    : 7EH
#PC4004/94         #G Format Prefix     : 5EH
#PC4005/44         #G Delimiter Char    : 2CH
#PC4006/0          #G Label Top         : 0 Dots
#PC4007/0          #G Left Position     : 0 Dots
#PC4009/0          #G Resolution        : 300 DPI
#PC4010/0          #G Error Indication  : OFF
#PC4011/0          #G Error Checking    : YES
#PC4012/0          #G 305 DPI Scaling   : YES
#PC4013/0          #G Image Save Path   : Internal RAM
#PC4014/1          #G Commad ^PR        : Enabled
#PC4015/1          #G Commad ^MT        : Enabled
#G-----
#G Applicator Parameter Menu
#G-----
#PC3101/0          #G Applicator type   : LTP - LTPV
#PC3102/0          #G Apply mode        : After start sig.
#PC3103/0          #G Start error stop  : Off
#PC3104/0          #G APSF sensor res.  : 0 pulses/m
#PC3105/0.00       #G Start delay       : 0.0 ms
#PC3106/1          #G Dwell time        : 1 ms
#PC3107/1          #G Blow on time      : 1 ms
#PC3108/0          #G Restart delay     : 0 ms
#PC3109/2000       #G Position timeout  : 2000 ms
#G-----
#G Operational Data
#G-----
#G Serv. operations : 0
#G Head number      : 1
#G Roll number      : 1
#G Head run length  : 242 m
#G Roll run length  : 345 m
#G Tot. mat. length : 345 m
#G Tot. foil length : 240 m
#G Total head moves : 1966
#G Head strobes     : 1978416
#G Foil diameter    : 37.4 mm
#G Operation time   : 164 hours 10 min
#G-----
#G Power supply data
#G-----
#G Type              : CME PSupply
#G-----
#G CPU board data

```



## AP 4.4 – AP 5.4 – AP 5.6 – AP 7.t – 64-xx – DPM – PEM – ALX 92x

```

#G-----
#G CPU identifier : 34-16
#G Syst. controller : GT-64111
#G PCB Revision : REV-04 A1159
#G Manufactur. data : not valid
#G-----
#G Peripheraldriver
#G-----
#G Feed driver : V 3 - T 3
#G Foil driver : V 3 - T 3
#G Head driver : V 3 - T 3
#G Peripheraldriver : V 3 - T 3
#G-----
#G Internal Memory Configuration
#G-----
#G Ram memory size : 8 MB
#G Flash mem size : 2 MB AMD
#G Compact flash : 123 MB
#G Space for Jobs : 2.7 MB
#G Max. Labellength : 529 mm
#G Default values : Standard
#G-----
#G Execute system restart ( 174 parameters )
#G-----
#PC999999/-1#G

```

**Setup file for 64-06 (Gen. 3)**

```

#!A1
#G Machine Setup for 64-06 Version: V6.60
#G Serial number : A662106142213663
#G MAC Address : 000A.44.06.35.5F
#G Creation date : 23.02.2017 17:16
#G-----
#G Printer Parameter Menu
#G-----
#PC1001/1 #G Infeed no. : Nr. 1
#PC1002/8 #G Inf. change spd. : 8 Inch/s
#PC1003/14.0 #G Print speed : 14 Inch/s
#PC1004/14.0 #G Feed speed : 14 Inch/s
#PC1005/0 #G Materialtype : Endless
#PC1006/25.0 #G Materiallength : 25.0 mm
#PC1007/100.0 #G Materialwidth : 100.0 mm
#PC1027/0 #G Print direction : Foot first
#PC1008/0.0 #G Punch offset : 0.0 mm
#PC1009/1 #G Bar code multip. : * 1
#PC1029/0 #G Tradit. Imaging : No
#PC1010/0 #G UPC plain-copy : In line
#PC1011/0 #G EAN Readline : Standard
#PC1012/0 #G EAN sep. lines : With readl. only
#PC1013/1 #G Rotated barcodes : Optimized
#PC1014/0 #G Dispense Mode : Real 1:1 mode
#PC1015/3 #G Cut speed : 3
#PC1016/160 #G Cut width : 160
#PC1017/0.0 #G Cut position : 0.0 mm
#PC1018/0.0 #G Double cut : 0.0 mm
#PC1019/1 #G Rewind direction : Printing outside
#PC1020/0.0 #G *X - Printadjust : 0.0 mm
#PC1021/0.0 #G *Y - Printadjust : 0.0 mm
#PC1022/0 #G Punchmode : Automatic
#PC1023/128 #G Punchlevel : 128
#PC1024/30 #G Matend : 30
#G-----
#G Easyplug Interpreter
#G-----
#PC1101/7 #G Interface : Automatic

```

## AP 4.4 – AP 5.4 – AP 5.6 – AP 7.t – 64-xx – DPM – PEM – ALX 92x

```

#PC1102/0          #G Spooler mode      : Mult. print jobs
#PC1103/1          #G *Printer ID no.   : 1
#PC1104/64         #G Spooler size      : 64 KBytes
#PC2072/0          #G Offline mode     : Interf. disabled
#PC2021/0          #G Interface delay   : 0 ms
#G-----
#G COM1 Port Parameter
#G-----
#PC1201/8          #G Baud rate        : 115200 Baud
#PC1202/8          #G No. of data bits : 8
#PC1203/2          #G Parity            : None
#PC1204/1          #G Stop bits         : 1 Bit
#PC1205/0          #G Data synch.      : RTS/CTS
#PC1206/0          #G Serial port mode  : RS232
#PC1207/1          #G Frame error       : Display
#G-----
#G COM2 Port Parameter
#G-----
#PC1302/8          #G Baud rate        : 115200 Baud
#PC1303/8          #G No. of data bits : 8
#PC1304/2          #G Parity            : None
#PC1305/1          #G Stop bits         : 1 Bit
#PC1306/0          #G Data synch.      : RTS/CTS
#PC1307/0          #G Serial port mode  : RS232
#PC1308/1          #G Frame error       : Display
#G-----
#G COM3 Port Parameter
#G-----
#PC1351/2          #G Baud rate        : 9600 Baud
#PC1353/8          #G No. of data bits : 8
#PC1354/1          #G Parity            : None
#PC1355/2          #G Stop bits         : Automatic
#PC1356/0          #G Data synch.      : RTS/CTS
#PC1357/0          #G Serial port mode  : RS232
#PC1358/1          #G Frame error       : Display
#G-----
#G COM4 Port Parameter
#G-----
#PC1361/2          #G Baud rate        : 9600 Baud
#PC1363/8          #G No. of data bits : 8
#PC1364/1          #G Parity            : None
#PC1365/2          #G Stop bits         : 2 Bit
#PC1366/0          #G Data synch.      : RTS/CTS
#PC1368/1          #G Frame error       : Display
#G-----
#G COM5 Port Parameter
#G-----
#PC1371/2          #G Baud rate        : 9600 Baud
#PC1373/8          #G No. of data bits : 8
#PC1374/1          #G Parity            : None
#PC1375/2          #G Stop bits         : 2 Bit
#PC1376/0          #G Data synch.      : RTS/CTS
#PC1378/1          #G Frame error       : Display
#G-----
#G Centronics Port Parameter
#G-----
#PC1401/1          #G PnP function      : On
#G-----
#G Ethernet Parameter
#G-----
#PC1501/1          #G IP Addressassign  : Fixed IP address
#PC1502/192.168.001.099 #G *IP address      : 192.168.001.099
#PC1503/255.255.255.000 #G *Net mask         : 255.255.255.000
#PC1504/000.000.000.000 #G *Gateway address  : 000.000.000.000
#PC1505/9100       #G Port address      : 9100
#PC1506/0          #G Ethernet speed    : Auto negotiation
#PC1513/6404_06355F#G #G DHCP host name   : 6404_06355F
#PC1514/novexx#G   #G WLAN SSID         : novexx

```

AP 4.4 – AP 5.4 – AP 5.6 – AP 7.t – 64-xx – DPM – PEM – ALX 92x

```

#PC1515/0           #G WLAN WEP           : Off
#PC1516/1           #G WLAN default key  : 1
#PC1523/123456789a#G #G WLAN 64Bit Key 1  : 123456789a
#PC1524/123456789a#G #G WLAN 64Bit Key 2  : 123456789a
#PC1525/123456789a#G #G WLAN 64Bit Key 3  : 123456789a
#PC1526/123456789a#G #G WLAN 64Bit Key 4  : 123456789a
#PC1517/123456789ABCD123456789ABCD#G#G WLAN 128BitKey 1 : 123456789AB-
CD123456789ABCD
#PC1518/123456789ABCD123456789ABCD#G#G WLAN 128BitKey 2 : 123456789AB-
CD123456789ABCD
#PC1519/123456789ABCD123456789ABCD#G#G WLAN 128BitKey 3 : 123456789AB-
CD123456789ABCD
#PC1520/123456789ABCD123456789ABCD#G#G WLAN 128BitKey 4 : 123456789AB-
CD123456789ABCD
#PC1521/0           #G SNMP Agent         : Off
#PC1522/public#G    #G SNMP password     : public
#PC1507/1           #G FTP server         : On
#PC1508/novexx#G    #G FTP Password      : novexx
#PC1509/1           #G WEB server         : On
#PC1510/5           #G WEB display refr  : 5 s
#PC1511/admin#G     #G WEB admin passw.  : admin
#PC1512/supervisor#G #G WEB supervisor p. : supervisor
#PC1532/operator#G  #G WEB operator p.   : operator
#PC1529/0           #G Time client        : Off
#PC1530/-2105212662 #G Time server IP    : 130.133.001.010
#PC1531/3600        #G Sync. interval    : 3600 s
#PC1533/0.0         #G Time zone          : +0:00
#G-----
#G Options Parameter
#G-----
#PC3518/0           #G OLV Option         : Off
#PC5207/0           #G RFID Option        : Off
#PC1550/0           #G StandAlone Input   : None
#PC5310/0           #G #GVW/I Interface   : Easyplug
#G-----
#G Drive Assignment
#G-----
#PC1600/1           #G Drive C            : CompactFlash
#PC1602/3           #G Drive E            : SD card
#PC1603/4           #G Drive F            : USB stick
#G-----
#G Printer System Menu
#G-----
#PC2002/0           #G Speed unit         : Inch/s
#PC2069/0           #G Cover open error   : If material feed
#PC2003/36.4        #G Foil end warning   : 36.4 mm
#PC2060/0           #G Foil warn stop     : Off
#PC2004/0           #G Display mode       : Job rest quant.
#PC2005/32          #G *Dispense counter  : 32
#PC2006/0           #G w/wo magazine     : with
#PC2007/0           #G Autom. dot check   : Off
#PC2008/10          #G Earliest dottest   : after 10 label
#PC2009/0           #G Latest dotcheck    : after 0 label
#PC2010/0           #G Dottestarea from   : 0 mm
#PC2011/107         #G Dottestarea to     : 107 mm
#PC2012/0           #G Print Interpret.   : Easyplug
#PC2013/9           #G Character sets     : IBM
#PC2014/0           #G Character filter    : Chars >= 20Hex
#PC2015/0           #G Label sens. type   : Punched
#PC2016/0           #G Head-sensor dist   : 0 mm
#PC2017/50          #G Sens. punch-LS     : 50 %
#PC2018/0           #G Ribbon autoecon.   : Off
#PC2019/10.0        #G Ribb. eco. limit   : 10.0 mm
#PC2077/0.0         #G Head down lead     : 0.0 mm
#PC2058/0           #G Feed mode          : Head up
#PC2020/1           #G Turn-on mode       : Online
#PC2022/1           #G Error reprint      : On
#PC2071/0           #G EasyPlug errors    : Tolerant handl.

```

## AP 4.4 – AP 5.4 – AP 5.6 – AP 7.t – 64-xx – DPM – PEM – ALX 92x

```

#PC2023/0          #G Single-job mode : Off
#PC2024/1325      #G *Head resistance : 1325 Ohm
#PC2026/20        #G Temp. reduction : 20 %
#PC2027/0         #G Voltage offset   : 0 %
#PC2028/1         #G Logo expansion  : Yes
#PC2029/2         #G Miss. label tol. : 2
#PC2067/1         #G Gap detect. mode : Autom. forward
#PC2068/5         #G Foil stretching : Feedback: 5 mm
#PC3306/0         #G Head lift autom. : Off
#PC2030/1         #G Mat. end detect. : Transparent
#PC2031/0         #G Periph. device   : None
#PC2032/2         #G Infeed module    : 2 infeeds
#PC2033/1         #G Singlestartquant : 1
#PC2034/0         #G Dispensing mode   : fast
#PC2035/0         #G Application mode  : Safe mode
#PC2036/0         #G Appl. waitpos.   : 0 mm
#PC2037/10        #G Applicator speed  : 10 Inch/s
#PC2039/0         #G Start source      : Light barrier
#PC2040/0         #G Dispensing edge   : short
#PC2001/24.5      #G Head disp dist.  : 24.5 mm
#PC2042/0         #G External signal   : Off
#PC2043/0         #G Start print mode  : Pulse falling
#PC2044/1         #G Apply key         : On
#PC2045/110       #G Print contrast    : 110 %
#PC2046/512       #G Ram disk size     : 512 KBytes
#PC2047/256       #G Font downl. area  : 256 KBytes
#PC2048/4096      #G Free store size   : 4096 KBytes
#PC2049/0         #G Print info mode   : Par.values right
#PC2050/0         #G Reprint function  : Off
#PC2051/1         #G Language          : English
#PC2063/1         #G Keyboard          : English
#PC2052/0         #G Signal / buzzer   : Off
#PC2053/0         #G Access authoriz.  : Off
#PC1026/0         #G Material feed     : for- / backwards
#G-----
#G Peripheral Parameter Menu
#G-----
#PC2059/80        #G Max InitFeedback : 80 mm
#PC2041/0         #G Transport mode    : Dispenser motor
#PC1031/100       #G Forw feed rat.    : 100 %
#PC1032/100       #G Backw feed rat.   : 100 %
#PC6004/15.0      #G Start offset      : 15.0 mm
#PC6014/0         #G Start error stop  : Off
#PC6017/0.0       #G Product length    : 0.0 mm
#PC6005/0         #G Speed Adaption    : Off
#PC6006/1         #G Encoder Type      : 2 Phases normal
#PC6008/500       #G Encoder Resol.    : 500 pulses/turn
#PC6009/64.0      #G Encoder Diameter  : 64.0mm 0.0var
#PC6035/0         #G Multi label mode  : Off
#PC6036/25.0      #G Label 2 offset    : 25.0 mm
#PC6037/25.0      #G Label 3 offset    : 25.0 mm
#G-----
#G Dispenser Interface
#G-----
#PC3001/0         #G Interface type    : USI interface
#PC3003/0         #G Start print mode  : Pulse falling
#PC3004/0         #G End print mode    : Mode 0
#PC3005/0         #G Reprint signal    : Off
#PC3006/1         #G Ribbon signal     : On
#PC3007/0         #G Material signal   : Off
#PC2061/0         #G Mat. signal stop  : Off
#PC3013/60.0      #G Diam. mat. end    : 60.0 mm
#PC3008/0         #G Feed input        : Standard
#PC3012/0         #G Pause input       : Standard
#PC3009/0         #G Start error stop  : Off
#PC3010/1         #G Internal inputs   : On
#PC3011/0         #G Apply mode        : After start sig.
#PC3014/0         #G USI profile       : Default

```

AP 4.4 – AP 5.4 – AP 5.6 – AP 7.t – 64-xx – DPM – PEM – ALX 92x

#PC3015/1 #G Warning signal : Level high activ

#G-----

#G Applicator Parameter Menu (AI Board)

#G-----

#PC3101/6 #G Applicator type : Direct Dispense
#PC3102/0 #G Apply mode : After start sig.
#PC3110/2 #G Start print mode : Pulse rising
#PC3118/0 #G TouchDown Sensor : Pulse falling
#PC3114/0 #G Label verify : Off
#PC3116/0 #G Lab release time : 0 ms
#PC3106/1 #G Dwell time : 1 ms
#PC3107/1 #G Blow on time : 1 ms
#PC3108/0 #G Restart delay : 0 ms
#PC3115/80 #G Stop lag time : 80 ms
#PC3109/2000 #G Position timeout : 2000 ms
#PC3117/99 #G TouchDownTimeout : Off
#PC3111/0 #G Apply comp. time : 0 ms

#G-----

#G I/O Board Parameter Menu

#G-----

#PC3203/0 #G Start print mode : Pulse falling
#PC3204/0 #G Reprint signal : Off
#PC3205/0 #G Feed input : Off
#PC3206/0 #G Pause input : Off
#PC3207/0 #G Error output : Printer error
#PC3208/0 #G Error polarity : Level low active
#PC3209/1 #G Status output : Low ribbon warn.
#PC3210/0 #G Status polarity : Level low active
#PC3211/0 #G End print mode : Mode0 inactive

#G-----

#G OLV Parameter Menu

#G-----

#PC3501/0 #G Verify mode : All barcodes
#PC3502/0 #G Cancel. printing : Off
#PC3503/0 #G Reprint quantity : 0
#PC3504/1 #G OLV mode : fast
#PC3505/0 #G Ref Decode : No test
#PC3506/-1 #G Decodability : -1
#PC3507/-1 #G Modulation : -1
#PC3508/-1 #G Defects : -1
#PC3509/-1 #G Edge Contrast : -1
#PC3510/-1 #G Rmin/Rmax : -1
#PC3511/-1 #G Symbol Contrast : -1
#PC3512/-1 #G PCS : -1
#PC3513/-1 #G R (white) : -1
#PC3514/-1 #G R (black) : -1
#PC3515/-1 #G Ratio : -1
#PC3516/-1 #G ANSI Symb. Grade : -1
#PC3517/10 #G Dist. head-beam : 10 mm

#G-----

#G LTSI Applicator Parameter Menu

#G-----

#PC3152/0 #G Apply mode : After start sig.
#PC3153/190 #G Stroke length : 190 mm
#PC3154/0 #G Appl. waitpos. : 0 mm
#PC3155/350.0 #G Applicator speed : 350 mm/s
#PC3158/0 #G Restart delay : 0 ms

#G-----

#G ZPL Parameter Menu

#G-----

#PC4002/15 #G Darkness : 15
#PC4003/126 #G Control Prefix : 7EH
#PC4004/94 #G Format Prefix : 5EH
#PC4005/44 #G Delimiter Char : 2CH
#PC4006/0 #G Label Top : 0 Dots
#PC4007/0 #G Left Position : 0 Dots
#PC4009/0 #G Resolution : 300 DPI
#PC4010/0 #G Error Indication : OFF

## AP 4.4 – AP 5.4 – AP 5.6 – AP 7.t – 64-xx – DPM – PEM – ALX 92x

```

#PC4011/0          #G Error Checking      : YES
#PC4012/0          #G 305 DPI Scaling    : YES
#PC4013/0          #G Image Save Path    : Internal RAM
#PC4014/1          #G Command ^PR        : Enable
#PC4015/1          #G Command ^MT        : Enable
#PC4017/0          #G Label Invert       : Disable
#PC4016/1          #G Command ^JM        : Enable
#PC4018/1          #G Command ^MD/~SD    : Enable
#G-----
#G RFID Parameter Menu
#G-----
#PC5208/10         #G Power level        : [10]
#PC5201/10         #G Try Times          : 10
#PC2055/3          #G Max Tags to stop   : 3
#PC2056/1          #G Nr CMD retries     : 1
#PC5204/0          #G Chip Protection    : Off
#PC5206/6.0        #G Chip Size          : 6.0 mm
#PC5205/20.0       #G Chip Offset        : 20.0 mm
#G-----
#G Printer Special Menue
#G-----
#PC5001/0          #G *Printer type      : 64-0x
#PC5002/2          #G *Printhead type    : KCE 6Inch
#PC5003/0          #G Disp. Head Offs.   : No
#PC5004/0          #G Command sequence   : '#G'
#PC5006/0          #G *Sensor type       : Standard
#PC5005/0          #G EasyPl. file log   : Off
#PC5129/0          #G Flash Res. Area    : 0 KBytes
#G-----
#G Printer Service Menu
#G-----
#PC5110/-1         #G *Head step tune    : -1 step(s)
#PC5111/0          #G Spec parameter 1   : 0
#PC5112/0          #G Spec parameter 2   : 0
#PC5113/0          #G EasyPlug Monitor   : Off
#PC5125/0          #G EP Monitor Mode    : Interpreter data
#PC5115/95         #G *Matend adjust     : 95
#PC5116/75         #G *Punch adjust      : 75
#PC5117/200        #G *Reflex adjust     : 200
#PC5118/155        #G *Fullsize adjust   : 155
#PC5130/255        #G *Aux adjust        : 255
#PC5101/35         #G Matend tolerance   : 35 mm
#PC5102/0.0        #G Feed adjust        : 0.0% [ribbon]
#PC5105/0.0        #G Feed adjust        : 0.0% [direct]
#PC5103/0.0        #G Foil feed adjust   : 0.0 %
#PC5104/0.0        #G *Punch y calibr.   : 0.0 mm
#PC5132/0          #G Rew.Sens.Connect   : At stepperdriver
#PC5123/44629     #G *Rewinder adjust   : 44629
#G-----
#G DHCP Addresses
#G-----
#G readonly ID=30001 #G IP address         :
#G readonly ID=30002 #G Net mask           :
#G readonly ID=30003 #G Gateway address    :
#G-----
#G Module Firmware Versions
#G-----
#G readonly ID=30004 #G System version     : V6.60
#G readonly ID=30067 #G System revision    : 9456
#G readonly ID=30070 #G System date        : Jan 19 2016
#G readonly ID=30061 #G Bootloader         : V3.83
#G readonly ID=30062 #G uMon               : V3.7 30Jun2015
#G readonly ID=30076 #G Model-ID           : 64-06
#G readonly ID=30077 #G Printer-Model      : 64-0x
#G readonly ID=30078 #G Printhead          : 6
#G readonly ID=30079 #G Printhead dpi      : 305
#G readonly ID=30080 #G Printhead Dot/mm   : 12.000000
#G readonly ID=30081 #G storage medias     : RAM,SD

```

AP 4.4 – AP 5.4 – AP 5.6 – AP 7.t – 64-xx – DPM – PEM – ALX 92x

```

#G readonly ID=30049 #G Feed driver : V 3 - T 3
#G readonly ID=30050 #G Foil driver : V 3 - T 3
#G readonly ID=30051 #G Head driver : V 3 - T 3
#G readonly ID=30052 #G Peripheraldriver : V 3 - T 3
#G readonly ID=30055 #G USI interface : V 14 - T 36
#G-----
#G Operational Data
#G-----
#G readonly ID=30014 #G Serv. operations : 0
#G readonly ID=30015 #G Head number : 0
#G readonly ID=30016 #G Roll number : 0
#G readonly ID=30018 #G Head run length : 7 m
#G readonly ID=30019 #G Roll run length : 7 m
#G readonly ID=30021 #G Tot. mat. length : 7 m
#G readonly ID=30022 #G Tot. foil length : 357928 m
#G readonly ID=30025 #G Head strobes : 88274
#G readonly ID=30071 #G Head temperature : 27 °C
#G readonly ID=30026 #G Foil diameter : 81.0 mm
#G readonly ID=30028 #G Operation time : 0 hours 0 min
#G readonly ID=30082 #G Total Operation : 2 hours 58 min
#G-----
#G Power supply data
#G-----
#G readonly ID=30029 #G Type : ME500PowerSupply
#G readonly ID=30030 #G Version : H9.03 F2.00
#G readonly ID=30031 #G Serial number : 14153060
#G readonly ID=30072 #G PS Temperature : 25 °C
#G readonly ID=30032 #G Standby+On time : 30 hours 46 min
#G readonly ID=30033 #G On time : 30 hours 46 min
#G readonly ID=30200 #G PS Reg. 0x000 : 90 00 00 19 00 FF 2F FF 40 5B
C0 B2 C0 52 30 27
#G readonly ID=30201 #G PS Reg. 0x010 : 00 00 30 46 00 00 30 46 00 00
1B 28 C0 FF 00 CC
#G readonly ID=30202 #G PS Reg. 0x020 : 2F 00 00 00 00 00 00 00 00 00
00 00 00 00 00 00
#G readonly ID=30203 #G PS Reg. 0x030 : 01 FF 64 00 19 00 60 80 00 00
00 00 00 00 00 00
#G readonly ID=30204 #G PS Reg. 0x040 : 10 00 00 09 03 14 15 30 60 00
01 00 1E 00 00 00
#G readonly ID=30205 #G PS Reg. 0x050 : 91 4B 50 25 32 05 20 F0 DA 73
FF 37 AA 64 00 00
#G readonly ID=30206 #G PS Reg. 0x060 : 0A 46 32 32 00 6E 00 00 4B 00
19 19 00 00 32 0F
#G readonly ID=30207 #G PS Reg. 0x070 : 00 00 30 46 00 00 30 46 00 00
30 46 00 00 30 46
#G readonly ID=30208 #G PS Reg. 0x080 : 4D 45 35 30 30 50 6F 77 65 72
53 75 70 70 6C 79
#G readonly ID=30209 #G PS Reg. 0x090 : 02 00 00 00 00 00 00 00 50 5A
2D 3C 03 00 00 00
#G readonly ID=30210 #G PS Reg. 0x0A0 : C0 00 00 00 00 00 00 00 00 00
00 00 00 00 00 00
#G readonly ID=30211 #G PS Reg. 0x0B0 : 00 00 00 00 00 00 00 00 00 00
00 00 00 00 00 00
#G readonly ID=30212 #G PS Reg. 0x0C0 : 10 00 00 00 00 00 00 00 00 00
00 00 00 00 00 00
#G readonly ID=30213 #G PS Reg. 0x0D0 : 80 4B 50 25 32 05 20 F0 DA 73
FF 37 AA 64 00 00
#G readonly ID=30214 #G PS Reg. 0x0E0 : 0A 46 32 32 00 6E 00 00 4B 00
19 19 00 00 32 00
#G readonly ID=30215 #G PS Reg. 0x0F0 : 00 00 00 00 00 00 00 00 00 00
00 00 00 00 00 00
#G readonly ID=30216 #G PS Reg. 0x100 : 77 02 75 03 63 C6 40 4A 80 68
80 59 C0 B2 00 00
#G readonly ID=30217 #G PS Reg. 0x110 : 00 00 00 01 00 00 2A 00 00 3D
00 00 95 05 00 D8
#G readonly ID=30218 #G PS Reg. 0x120 : 00 00 2C 00 00 32 00 00 03 00
00 00 00 00 00 00

```

AP 4.4 – AP 5.4 – AP 5.6 – AP 7.t – 64-xx – DPM – PEM – ALX 92x

```

#G readonly ID=30219 #G PS Reg. 0x130 : 00 00 00 00 00 00 00 00 00 00 00
00 00 00 00 00 00
#G readonly ID=30220 #G PS Reg. 0x140 : 33 00 00 00 00 00 00 00 00 00 00
00 00 00 00 00 00
#G readonly ID=30221 #G PS Reg. 0x150 : 00 00 00 00 00 00 00 00 00 00 00
00 00 00 00 00 00
#G readonly ID=30222 #G PS Reg. 0x160 : 00 00 00 00 00 00 00 00 00 00 00
00 00 00 00 00 00
#G readonly ID=30223 #G PS Reg. 0x170 : 00 00 00 00 00 00 00 00 00 00 00
00 00 00 00 00 00
#G-----
#G CPU board data
#G-----
#G readonly ID=30034 #G CPU identifier : 2-4
#G readonly ID=30036 #G PCB Revision : REV04
#G readonly ID=30037 #G FPGA version : C403
#G readonly ID=30039 #G MAC Address : 000A.44.06.35.5F
#G readonly ID=30040 #G Serial number : A662106142213663
#G readonly ID=30041 #G Production date : 26.05.2014
#G readonly ID=30042 #G PCB part number : A6619-04
#G readonly ID=30043 #G Board part numb. : A6621-06
#G readonly ID=30044 #G Manufacturer : Katek HU KFT
#G readonly ID=30045 #G Work place : FE1
#G readonly ID=30046 #G Company name : Katek HU KFT
#G-----
#G Display board data
#G-----
#G readonly ID=30059 #G Display Version : V3.10
#G readonly ID=30068 #G Display serialNr : A714901S14010288
#G-----
#G Internal Memory Configuration
#G-----
#G readonly ID=30007 #G RAM memory size : 64 MB
#G readonly ID=30008 #G Flash mem size : 4 MB AMD
#G readonly ID=30064 #G SD card : 7.50GB/8GB (e:)
#G readonly ID=30010 #G Space for Jobs : 47.7 MB
#G readonly ID=30011 #G Max. Labellength : 7602 mm
#G readonly ID=30013 #G Custom defaults : No
#G-----
#G Statistics
#G-----
#G readonly ID=30100 #G Nr of Tags :
#G readonly ID=30101 #G Nr. invalid tags :
#G readonly ID=30110 #G Scrap rate : 0.0 %
#G readonly ID=30102 #G Total Nr. SELECT :
#G readonly ID=30103 #G Invalid SELECT :
#G readonly ID=30104 #G Total Nr. READ :
#G readonly ID=30105 #G Invalid READ :
#G readonly ID=30106 #G Total Nr. WRITES :
#G readonly ID=30107 #G Invalid WRITE :
#G readonly ID=30108 #G Rate READ :
#G readonly ID=30109 #G Rate WRITE :
#G-----
#G Printer Debug Menu
#G-----
#PC5127/0 #G Debug interface : Off
#PC5124/0 #G Debug mask : 0
#PC5128/-1872945986 #G Debug IP address : 144.093.028.190
#PC5404/0 #G Fields : Off
#PC5400/0 #G Label generation : Off
#PC5401/0 #G Print handling : Off
#PC5402/0 #G Variables : Off
#PC5408/0 #G OLV data : Off
#PC5403/0 #G Pctrl communica. : Off
#PC5406/0 #G RFID-Reader : Off
#PC5407/0 #G RFID-Task : Off
#PC5131/1 #G BitimageFileDump : Easyplug select
#PC5405/0 #G Debug Shell : Off

```



## AP 4.4 – AP 5.4 – AP 5.6 – AP 7.t – 64-xx – DPM – PEM – ALX 92x

```
#PC5409/0          #G Text Seg.Observ. : Off
#G-----
#G Execute system restart ( 297 parameters )
#G-----
#PC999999/-1#G
```

**Setup file for ALX 926 (Gen. 3)**

```
#!A1
#G Machine Setup for ALX 926   Version: V6.T9130
#G Serial number       : A662003063000738
#G MAC Address         : 000A.44.05.01.BB
#G Creation date      : 01.01.2000 00:00

#G-----
#G Printer Parameter Menu
#G-----
#PC1001/1          #G Infeed no.       : Nr. 1
#PC1002/8          #G Inf. change spd. : 8 Inch/s
#PC1003/2.0        #G Print speed      : 2.0 Inch/s
#PC1004/2.0        #G Feed speed       : 2.0 Inch/s
#PC1005/0          #G Materialtype     : Endless
#PC1006/200.8      #G Materiallength   : 200.8 mm
#PC1007/100.8     #G Materialwidth    : 100.8 mm
#PC1027/0          #G Print direction  : Foot first
#PC1008/0.0        #G Punch offset     : 0.0 mm
#PC1009/1          #G Bar code multip. : * 1
#PC1029/0          #G Tradit. Imaging  : No
#PC1010/0          #G UPC plain-copy   : In line
#PC1011/0          #G EAN Readline     : Standard
#PC1012/0          #G EAN sep. lines   : With readl. only
#PC1013/1          #G Rotated barcodes : Optimized
#PC1015/3          #G Cut speed         : 3
#PC1016/160        #G Cut width         : 160
#PC1018/0.0        #G Double cut        : 0.0 mm
#PC1020/0.0        #G *X - Printadjust : 0.0 mm
#PC1021/0.0        #G *Y - Printadjust : 0.0 mm
#PC1022/0          #G Punchmode        : Automatic
#PC1023/128        #G Punchlevel       : 128
#PC1024/30         #G Matend            : 30

#G-----
#G Easyplug Interpreter
#G-----
#PC1101/0          #G Interface         : Serial Com1
#PC1102/0          #G Spooler mode      : Mult. print jobs
#PC1103/1          #G *Printer ID no.   : 1
#PC1104/64         #G Spooler size      : 64 KBytes
#PC2072/0          #G Offline mode      : Interf. disabled
#PC2021/0          #G Interface delay   : 0 ms

#G-----
#G COM1 Port Parameter
#G-----
#PC1201/8          #G Baud rate         : 115200 Baud
#PC1202/8          #G No. of data bits  : 8
#PC1203/2          #G Parity            : None
#PC1204/1          #G Stop bits         : 1 Bit
#PC1205/0          #G Data synch.       : RTS/CTS
#PC1206/0          #G Serial port mode  : RS232
#PC1207/1          #G Frame error       : Display

#G-----
#G COM2 Port Parameter
#G-----
#PC1302/8          #G Baud rate         : 115200 Baud
#PC1303/8          #G No. of data bits  : 8
#PC1304/2          #G Parity            : None
#PC1305/1          #G Stop bits         : 1 Bit
#PC1306/0          #G Data synch.       : RTS/CTS
```

AP 4.4 – AP 5.4 – AP 5.6 – AP 7.t – 64-xx – DPM – PEM – ALX 92x

```

#PC1307/0          #G  Serial port mode : RS232
#PC1308/1          #G  Frame error      : Display
#G-----
#G COM3 Port Parameter
#G-----
#PC1351/2          #G  Baud rate          : 9600 Baud
#PC1353/8          #G  No. of data bits  : 8
#PC1354/1          #G  Parity             : None
#PC1355/2          #G  Stop bits         : Automatic
#PC1356/0          #G  Data synch.       : RTS/CTS
#PC1357/0          #G  Serial port mode  : RS232
#PC1358/1          #G  Frame error      : Display
#G-----
#G COM4 Port Parameter
#G-----
#PC1361/2          #G  Baud rate          : 9600 Baud
#PC1363/8          #G  No. of data bits  : 8
#PC1364/1          #G  Parity             : None
#PC1365/2          #G  Stop bits         : 2 Bit
#PC1366/0          #G  Data synch.       : RTS/CTS
#PC1368/1          #G  Frame error      : Display
#G-----
#G COM5 Port Parameter
#G-----
#PC1371/2          #G  Baud rate          : 9600 Baud
#PC1373/8          #G  No. of data bits  : 8
#PC1374/1          #G  Parity             : None
#PC1375/2          #G  Stop bits         : 2 Bit
#PC1376/0          #G  Data synch.       : RTS/CTS
#PC1378/1          #G  Frame error      : Display
#G-----
#G Centronics Port Parameter
#G-----
#PC1401/1          #G  PnP function       : On
#G-----
#G Ethernet Parameter
#G-----
#PC1501/0          #G  IP Addressassign  : DHCP
#PC1502/192.168.001.099 #G *IP address       : 192.168.001.099
#PC1503/255.255.255.000 #G *Net mask         : 255.255.255.000
#PC1504/000.000.000.000 #G *Gateway address  : 000.000.000.000
#PC1505/9100       #G  Port address      : 9100
#PC1506/0          #G  Ethernet speed    : Auto negotiation
#PC1513/ALX926_062B9F#G #G DHCP host name    : ALX926_062B9F
#PC1514/avery#G    #G  WLAN SSID        : avery
#PC1515/0          #G  WLAN WEP         : Off
#PC1516/1          #G  WLAN default key  : 1
#PC1523/123456789a#G #G WLAN 64Bit Key 1  : 123456789a
#PC1524/123456789a#G #G WLAN 64Bit Key 2  : 123456789a
#PC1525/123456789a#G #G WLAN 64Bit Key 3  : 123456789a
#PC1526/123456789a#G #G WLAN 64Bit Key 4  : 123456789a
#PC1517/123456789ABCD123456789ABCD#G#G WLAN 128BitKey 1 : 123456789AB-
CD123456789ABCD
#PC1518/123456789ABCD123456789ABCD#G#G WLAN 128BitKey 2 : 123456789AB-
CD123456789ABCD
#PC1519/123456789ABCD123456789ABCD#G#G WLAN 128BitKey 3 : 123456789AB-
CD123456789ABCD
#PC1520/123456789ABCD123456789ABCD#G#G WLAN 128BitKey 4 : 123456789AB-
CD123456789ABCD
#PC1521/0          #G  SNMP Agent        : Off
#PC1522/public#G   #G  SNMP password     : public
#PC1507/1          #G  FTP server        : On
#PC1508/avery#G    #G  FTP Password      : avery
#PC1509/1          #G  WEB server        : On
#PC1510/5          #G  WEB display refr  : 5 s
#PC1511/admin#G    #G  WEB admin passw.  : admin
#PC1512/supervisor#G #G WEB supervisor p. : supervisor
#PC1532/operator#G #G  WEB operator p.   : operator

```

## AP 4.4 – AP 5.4 – AP 5.6 – AP 7.t – 64-xx – DPM – PEM – ALX 92x

```

#PC1529/0          #G Time client      : Off
#PC1530/-2105212662 #G Time server IP   : 130.133.001.010
#PC1531/3600       #G Sync. interval   : 3600 s
#PC1533/0.0        #G Time zone        : +0:00
#G-----
#G Options Parameter
#G-----
#PC3518/0          #G OLV Option       : Off
#PC5207/0          #G RFID Option      : Off
#PC1550/0          #G StandAlone Input : None
#PC5310/0          #G #GVW/I Interface : Easyplug
#G-----
#G Drive Assignment
#G-----
#PC1600/1          #G Drive C          : CompactFlash
#PC1601/2          #G Drive D          : CompactFlash 2
#PC1602/3          #G Drive E          : SD card
#PC1603/4          #G Drive F          : USB stick
#G-----
#G Printer System Menu
#G-----
#PC2002/0          #G Speed unit       : Inch/s
#PC2069/1          #G Cover open error : Immediately
#PC2003/36.4       #G Foil end warning : 36.4 mm
#PC2060/0          #G Foil warn stop   : Off
#PC2006/0          #G w/wo magazine    : with
#PC2007/0          #G Autom. dot check  : Off
#PC2008/10         #G Earliest dottest : after 10 label
#PC2009/0          #G Latest dotcheck   : after 0 label
#PC2010/0          #G Dottestarea from : 0 mm
#PC2011/160        #G Dottestarea to   : 160 mm
#PC2012/0          #G Print Interpret.  : Easyplug
#PC2013/9          #G Character sets    : IBM
#PC2014/0          #G Character filter   : Chars >= 20Hex
#PC2015/0          #G Label sens. type  : Punched
#PC2016/0          #G Head-sensor dist  : 0 mm
#PC2017/50         #G Sens. punch-LS    : 50 %
#PC2018/0          #G Ribbon autoecon.  : Off
#PC2019/10.0       #G Ribb. eco. limit  : 10.0 mm
#PC2077/0.0        #G Head down lead    : 0.0 mm
#PC2058/0          #G Feed mode         : Head up
#PC2020/1          #G Turn-on mode      : Online
#PC2022/1          #G Error reprint     : On
#PC2071/0          #G EasyPlug errors   : Tolerant handl.
#PC2023/0          #G Single-job mode   : Off
#PC2024/1257       #G *Head resistance  : 1257 Ohm
#PC2026/20         #G Temp. reduction   : 20 %
#PC2027/0          #G Voltage offset    : 0 %
#PC2028/1          #G Logo expansion    : Yes
#PC2029/2          #G Miss. label tol.  : 2
#PC2067/2          #G Gap detect. mode  : Autom. feed back
#PC2068/0          #G Foil stretching   : Feedback: 0 mm
#PC3306/0          #G Head lift autom.  : Off
#PC2030/1          #G Mat. end detect.  : Transparent
#PC2031/4          #G Periph. device    : Dispenser
#PC2032/2          #G Infeed module     : 2 infeeds
#PC2033/1          #G Singlestartquant  : 1
#PC2042/0          #G External signal    : Off
#PC2043/0          #G Start print mode  : Pulse falling
#PC2044/1          #G Apply key         : On
#PC2045/96         #G Print contrast    : 96 %
#PC2046/512        #G Ram disk size     : 512 KBytes
#PC2047/256        #G Font downl. area  : 256 KBytes
#PC2048/4096       #G Free store size   : 4096 KBytes
#PC2049/0          #G Print info mode   : Par.values right
#PC2050/0          #G Reprint function  : Off
#PC2051/1          #G Language          : English
#PC2063/1          #G Keyboard          : English

```

## AP 4.4 – AP 5.4 – AP 5.6 – AP 7.t – 64-xx – DPM – PEM – ALX 92x

```
#PC2052/0          #G Signal / buzzer : Off
#PC2053/0          #G Access authoriz. : Off
#PC1026/0          #G Material feed : for- / backwards
```

```
#G-----
#G Dispenser Parameter Menu
```

```
#G-----
#PC2001/10.0      #G Head disp dist. : 10.0 mm
#PC1014/0         #G Dispense Mode : Real 1:1 mode
#PC1017/0.0       #G Dispenseposition : 0.0 mm
#PC1019/1         #G Rewind direction : Printing outside
#PC2004/0         #G Display mode : Job rest quant.
#PC2005/143       #G *Dispense counter : 143
#PC2034/0         #G Dispensing mode : fast
#PC2035/1         #G Application mode : Immediate mode
#PC2036/0         #G Appl. waitpos. : 0 mm
#PC2037/10        #G Applicator speed : 10 Inch/s
#PC2039/0         #G Start source : Light barrier
#PC2040/0         #G Dispensing edge : short
#PC2059/80        #G Max InitFeedback : 80 mm
#PC2041/0         #G Transport mode : Dispenser motor
#PC1031/100       #G Forw feed rat. : 100 %
#PC1032/100       #G Backw feed rat. : 100 %
#PC6004/15.0      #G Start offset : 15.0 mm
#PC6014/0         #G Start error stop : Off
#PC6017/0.0       #G Product length : 0.0 mm
#PC6005/0         #G Speed Adaption : Off
#PC6006/0         #G Encoder Type : Single Phase
#PC6008/500       #G Encoder Resol. : 500 pulses/turn
#PC6009/64.0      #G Encoder Diameter : 64.0mm 0.0var
#PC6035/0         #G Multi label mode : Off
#PC6036/20.0      #G Label 2 offset : 20.0 mm
#PC6037/20.0      #G Label 3 offset : 20.0 mm
```

```
#G-----
#G Dispenser Interface
```

```
#G-----
#PC3001/0         #G Interface type : USI interface
#PC3003/0         #G Start print mode : Pulse falling
#PC3004/0         #G End print mode : Mode 0
#PC3005/0         #G Reprint signal : Off
#PC3006/1         #G Ribbon signal : On
#PC3007/0         #G Material signal : Off
#PC2061/0         #G Mat. signal stop : Off
#PC3013/60.0     #G Diam. mat. end : 60.0 mm
#PC3008/0         #G Feed input : Standard
#PC3012/0         #G Pause input : Standard
#PC3009/0         #G Start error stop : Off
#PC3010/1         #G Internal inputs : On
#PC3011/0         #G Apply mode : After start sig.
#PC3014/0         #G USI profile : Default
#PC3015/1         #G Warning signal : Level high activ
```

```
#G-----
#G Applicator Parameter Menu (AI Board)
```

```
#G-----
#PC3101/4         #G Applicator type : ASA
#PC3102/1         #G Apply mode : After print
#PC3110/2         #G Start print mode : Pulse rising
#PC3118/0         #G TouchDown Sensor : Pulse falling
#PC3114/0         #G Label verify : Off
#PC3116/1         #G Lab release time : 1 ms
#PC3106/500       #G Dwell time : 500 ms
#PC3107/196       #G Blow on time : 196 ms
#PC3108/0         #G Restart delay : 0 ms
#PC3115/80        #G Stop lag time : 80 ms
#PC3109/750       #G Position timeout : 750 ms
#PC3117/99        #G TouchDownTimeout : Off
#PC3111/0         #G Apply comp. time : 0 ms
```

```
#G-----
#G I/O Board Parameter Menu
```

## AP 4.4 – AP 5.4 – AP 5.6 – AP 7.t – 64-xx – DPM – PEM – ALX 92x

```

#G-----
#PC3203/0          #G Start print mode : Pulse falling
#PC3204/0          #G Reprint signal   : Off
#PC3205/0          #G Feed input      : Off
#PC3206/0          #G Pause input     : Off
#PC3207/0          #G Error output    : Printer error
#PC3208/0          #G Error polarity  : Level low active
#PC3209/1          #G Status output   : Low ribbon warn.
#PC3210/0          #G Status polarity : Level low active
#PC3211/0          #G End print mode  : Mode0 inactive
#G-----
#G OLV Parameter Menu
#G-----
#PC3501/0          #G Verify mode     : All barcodes
#PC3502/0          #G Cancel. printing : Off
#PC3503/0          #G Reprint quantity : 0
#PC3504/1          #G OLV mode        : fast
#PC3505/0          #G Ref Decode      : No test
#PC3506/-1         #G Decodability    : -1
#PC3507/-1         #G Modulation      : -1
#PC3508/-1         #G Defects         : -1
#PC3509/-1         #G Edge Contrast   : -1
#PC3510/-1         #G Rmin/Rmax       : -1
#PC3511/-1         #G Symbol Contrast : -1
#PC3512/-1         #G PCS             : -1
#PC3513/-1         #G R (white)       : -1
#PC3514/-1         #G R (black)       : -1
#PC3515/-1         #G Ratio           : -1
#PC3516/-1         #G ANSI Symb. Grade : -1
#PC3517/10         #G Dist. head-beam : 10 mm
#G-----
#G LTSI Applicator Parameter Menu
#G-----
#PC3152/0          #G Apply mode      : After start sig.
#PC3153/190        #G Stroke length   : 190 mm
#PC3154/0          #G Appl. waitpos. : 0 mm
#PC3155/350.0      #G Applicator speed : 350 mm/s
#PC3158/0          #G Restart delay   : 0 ms
#G-----
#G ZPL Parameter Menu
#G-----
#PC4002/15         #G Darkness        : 15
#PC4003/126        #G Control Prefix  : 7EH
#PC4004/94         #G Format Prefix    : 5EH
#PC4005/44         #G Delimiter Char  : 2CH
#PC4006/0          #G Label Top       : 0 Dots
#PC4007/0          #G Left Position   : 0 Dots
#PC4009/0          #G Resolution      : 300 DPI
#PC4010/0          #G Error Indication : OFF
#PC4011/0          #G Error Checking  : YES
#PC4012/0          #G 305 DPI Scaling : YES
#PC4013/0          #G Image Save Path : Internal RAM
#PC4014/1          #G Command ^PR     : Enable
#PC4015/1          #G Command ^MT     : Enable
#PC4017/0          #G Label Invert    : Disable
#PC4016/1          #G Command ^JM     : Enable
#PC4018/1          #G Command ^MD/~SD : Enable
#G-----
#G RFID Parameter Menu
#G-----
#PC5208/10         #G Power level     : [10]
#PC5201/10         #G Try Times       : 10
#PC2055/3          #G Max Tags to stop : 3
#PC2056/1          #G Nr CMD retries  : 1
#PC5204/0          #G Chip Protection : Off
#PC5206/6.0        #G Chip Size       : 6.0 mm
#PC5205/20.0       #G Chip Offset     : 20.0 mm
#G-----

```

## AP 4.4 – AP 5.4 – AP 5.6 – AP 7.t – 64-xx – DPM – PEM – ALX 92x

```

#G Printer Special Menue
#G-----
#PC5001/3          #G *Printer type      : ALX 92x LH
#PC5002/2          #G *Printhead type   : KCE 6Inch
#PC5003/0          #G  Disp. Head Offs. : No
#PC5004/0          #G  Command sequence : '#G'
#PC5006/0          #G *Sensor type      : Standard
#PC5005/0          #G  EasyPl. file log : Off
#PC5129/0          #G  Flash Res. Area  : 0 KBytes
#G-----
#G Printer Service Menu
#G-----
#PC5110/0          #G *Head step tune   : 0 step(s)
#PC5111/0          #G  Spec parameter 1 : 0
#PC5112/0          #G  Spec parameter 2 : 0
#PC5113/0          #G  EasyPlug Monitor : Off
#PC5125/0          #G  EP Monitor Mode  : Interpreter data
#PC5115/18         #G *Matend adjust    : 18
#PC5116/67         #G *Punch adjust     : 67
#PC5117/95         #G *Reflex adjust    : 95
#PC5118/155        #G *Fullsize adjust  : 155
#PC5130/255        #G *Aux adjust       : 255
#PC5101/35         #G  Matend tolerance : 35 mm
#PC5102/0.0        #G  Feed adjust      : 0.0% [ribbon]
#PC5105/0.0        #G  Feed adjust      : 0.0% [direct]
#PC5103/0.0        #G  Foil feed adjust : 0.0 %
#PC5104/0.0        #G *Punch y calibr.  : 0.0 mm
#PC5132/0          #G  Rew.Sens.Connect : At stepperdriver
#PC5123/31791     #G *Rewinder adjust  : 31791
#G-----
#G DHCP Addresses
#G-----
#G readonly ID=30001 #G  IP address       : 000.000.000.000
#G readonly ID=30002 #G  Net mask         : 000.000.000.000
#G readonly ID=30003 #G  Gateway address  : 000.000.000.000
#G-----
#G Module Firmware Versions
#G-----
#G readonly ID=30004 #G  System version   : V6.T9130
#G readonly ID=30067 #G  System revision  : 9130
#G readonly ID=30070 #G  System date      : Sep 10 2015
#G readonly ID=30061 #G  Bootloader       : V3.78
#G readonly ID=30062 #G  uMon             : V2.6 31Aug2006
#G readonly ID=30076 #G  Model-ID         : ALX 926
#G readonly ID=30077 #G  Printer-Model    : ALX 92x
#G readonly ID=30078 #G  Printhead        : 6
#G readonly ID=30079 #G  Printhead dpi    : 305
#G readonly ID=30080 #G  Printhead Dot/mm : 12.000000
#G readonly ID=30081 #G  storage medias   : RAM,SD
#G readonly ID=30049 #G  Feed driver      : V 3 - T 3
#G readonly ID=30050 #G  Foil driver       : V 3 - T 3
#G readonly ID=30051 #G  Head driver       : V 3 - T 3
#G readonly ID=30056 #G  Rewinder driver  : V 4 - T 36
#G-----
#G Operational Data
#G-----
#G readonly ID=30014 #G  Serv. operations : 0
#G readonly ID=30015 #G  Head number      : 1
#G readonly ID=30016 #G  Roll number      : 1
#G readonly ID=30018 #G  Head run length  : 115613 m
#G readonly ID=30019 #G  Roll run length  : 282973 m
#G readonly ID=30021 #G  Tot. mat. length : 282973 m
#G readonly ID=30022 #G  Tot. foil length : 37633 m
#G readonly ID=30025 #G  Head strobes     : 3162058982
#G readonly ID=30071 #G  Head temperature : 22 °C
#G readonly ID=30026 #G  Foil diameter    : 81.3 mm
#G readonly ID=30027 #G  Dispensing cycl. : 1764387
#G readonly ID=30028 #G  Operation time   : 0 hours 1 min

```

AP 4.4 – AP 5.4 – AP 5.6 – AP 7.t – 64-xx – DPM – PEM – ALX 92x

```

#G readonly ID=30082 #G Total Operation : 0 hours 39 min
#G-----
#G Power supply data
#G-----
#G readonly ID=30029 #G Type : HME PSupply 450
#G readonly ID=30030 #G Version : H1.07 Fl.33
#G readonly ID=30031 #G Serial number : 06300019
#G readonly ID=30072 #G PS Temperature : 23 °C
#G readonly ID=30032 #G Standby+On time : 575 hours 0 min
#G readonly ID=30033 #G On time : 566 hours 30 min
#G readonly ID=30200 #G PS Reg. 0x000 : 82 00 00 17 00 FF 0F FF 00 05
75 00 00 05 75 00
#G readonly ID=30201 #G PS Reg. 0x010 : 00 05 66 30 00 05 75 00 70 74
00 04 04 04 00 00
#G readonly ID=30202 #G PS Reg. 0x020 : 3F 00 00 00 00 00 00 00 00 00
00 00 00 00 00 00
#G readonly ID=30203 #G PS Reg. 0x030 : 00 00 00 00 00 00 00 00 00 00
00 00 00 00 00 0B
#G readonly ID=30204 #G PS Reg. 0x040 : 10 CC 20 01 07 06 30 00 19 00
00 00 00 00 00 00
#G readonly ID=30205 #G PS Reg. 0x050 : 7D 78 8C 23 50 0A 14 4B DA 73
00 00 00 00 00 00
#G readonly ID=30206 #G PS Reg. 0x060 : 0A 46 32 32 64 6E 00 00 4B 64
19 19 FA 00 00 00
#G readonly ID=30207 #G PS Reg. 0x070 : 00 05 66 30 00 05 75 00 00 05
66 30 00 05 75 00
#G readonly ID=30208 #G PS Reg. 0x080 : 48 4D 45 20 50 53 75 70 70 6C
79 20 34 35 30 20
#G readonly ID=30209 #G PS Reg. 0x090 : 01 33 00 00 00 00 00 00 8C A0
50 64 03 00 00 00
#G readonly ID=30210 #G PS Reg. 0x0A0 : C0 00 00 00 00 00 00 00 00 00
00 00 00 00 00 00
#G readonly ID=30211 #G PS Reg. 0x0B0 : 00 00 00 00 00 00 00 00 00 00
00 00 00 00 00 00
#G readonly ID=30212 #G PS Reg. 0x0C0 : 10 00 00 01 01 00 00 00 01 00
00 00 00 00 00 00
#G readonly ID=30213 #G PS Reg. 0x0D0 : 80 78 8C 23 50 0A 14 4B DA 73
00 00 00 00 00 00
#G readonly ID=30214 #G PS Reg. 0x0E0 : 0A 46 32 32 64 6E 00 00 4B 64
19 19 FA 00 00 00
#G readonly ID=30215 #G PS Reg. 0x0F0 : 00 00 00 00 00 00 00 00 00 00
00 00 00 00 00 00
#G readonly ID=30216 #G PS Reg. 0x100 : 02 00 00 17 00 FF 0F FF 00 05
75 00 00 05 75 00
#G readonly ID=30217 #G PS Reg. 0x110 : 00 05 66 30 00 05 75 00 70 74
00 04 04 04 00 00
#G readonly ID=30218 #G PS Reg. 0x120 : 3F D1 00 00 00 00 00 00 00 00
00 00 00 00 00 00
#G readonly ID=30219 #G PS Reg. 0x130 : 00 00 00 00 00 00 00 00 00 00
00 00 00 00 00 16
#G readonly ID=30220 #G PS Reg. 0x140 : 10 CC 20 01 07 06 30 00 19 00
00 00 00 00 00 00
#G readonly ID=30221 #G PS Reg. 0x150 : 7D 78 8C 23 50 0A 14 4B DA 73
00 00 00 00 00 00
#G readonly ID=30222 #G PS Reg. 0x160 : 0A 46 32 32 64 6E 00 00 4B 64
19 19 FA 00 00 00
#G readonly ID=30223 #G PS Reg. 0x170 : 00 05 66 30 00 05 75 00 00 05
66 30 00 05 75 00
#G-----
#G CPU board data
#G-----
#G readonly ID=30034 #G CPU identifier : 2-4
#G readonly ID=30036 #G PCB Revision : REV02
#G readonly ID=30037 #G FPGA version : C403
#G readonly ID=30039 #G MAC Address : 000A.44.05.01.BB
#G readonly ID=30040 #G Serial number : A662003063000738
#G readonly ID=30041 #G Production date : 01.08.2006
#G readonly ID=30042 #G PCB part number : A6619-02

```

AP 4.4 – AP 5.4 – AP 5.6 – AP 7.t – 64-xx – DPM – PEM – ALX 92x

```

#G readonly ID=30043 #G Board part numb. : A6621-01
#G readonly ID=30044 #G Manufacturer : Multitech Sys
#G readonly ID=30045 #G Work place : FCT Dolphin
#G readonly ID=30046 #G Company name : Multitech Sys
#G-----
#G Display board data
#G-----
#G readonly ID=30059 #G Display Version : V3.10
#G readonly ID=30068 #G Display serialNr : A662603S10040015
#G-----
#G Internal Memory Configuration
#G-----
#G readonly ID=30007 #G RAM memory size : 64 MB
#G readonly ID=30008 #G Flash mem size : 4 MB AMD
#G readonly ID=30064 #G SD card : 7.50GB/8GB (e:)
#G readonly ID=30010 #G Space for Jobs : 47.8 MB
#G readonly ID=30011 #G Max. Labellength : 7619 mm
#G readonly ID=30013 #G Custom defaults : No
#G-----
#G Statistics
#G-----
#G readonly ID=30100 #G Nr of Tags :
#G readonly ID=30101 #G Nr. invalid tags :
#G readonly ID=30110 #G Scrap rate : 100.0 %
#G readonly ID=30102 #G Total Nr. SELECT :
#G readonly ID=30103 #G Invalid SELECT :
#G readonly ID=30104 #G Total Nr. READ :
#G readonly ID=30105 #G Invalid READ :
#G readonly ID=30106 #G Total Nr. WRITES :
#G readonly ID=30107 #G Invalid WRITE :
#G readonly ID=30108 #G Rate READ :
#G readonly ID=30109 #G Rate WRITE :
#G-----
#G Printer Debug Menu
#G-----
#PC5127/0 #G Debug interface : Off
#PC5124/0 #G Debug mask : 0
#PC5128/-1872945986 #G Debug IP address : 144.093.028.190
#PC5404/0 #G Fields : Off
#PC5400/0 #G Label generation : Off
#PC5401/0 #G Print handling : Off
#PC5402/0 #G Variables : Off
#PC5408/0 #G OLV data : Off
#PC5403/0 #G Pctrl communica. : Off
#PC5406/0 #G RFID-Reader : Off
#PC5407/0 #G RFID-Task : Off
#PC5131/1 #G BitimageFileDump : Easyplug select
#PC5405/0 #G Debug Shell : Off
#PC5409/0 #G Text Seg.Observ. : Off
#G-----
#G Execute system restart ( 298 parameters )
#G-----
#PC999999/-1#G

```





## Servicing and Maintenance

General Notes.....	2	Rubber rollers .....	9
Servicing by trained personnel.....	2	Cleaning the print roller.....	9
Safety .....	2	Cleaning the feed roller.....	10
Fault correction .....	2	Cleaning the dispenser-feed-roller.....	11
Ordering spare parts .....	3	Photoelectric switches .....	12
Servicing and cleaning.....	4	Cleaning the gap photoelectric switch .....	12
Notes for cleaning .....	4	Cleaning the material end photoelectric	
Cleaning agents .....	4	switch.....	12
Printhead.....	5	Cleaning the cutter .....	13
Cleaning the print head .....	5	Cleaning/exchanging the dust filter liner.....	14
Changing the print head.....	6	Important notes .....	14
Checking the print head .....	7	Exchanging the filter liner.....	14
		Index.....	15

## General Notes

### Servicing by trained personnel

Regular and proper servicing is necessary in order to ensure that the device is permanently ready for operation.

#### Qualification

Servicing and repair work may only be carried out by appropriately qualified personnel. The safety, reliability and long service life of the device depend on such work being carried out correctly.

- ▣▣▣▣➔ Damage which is caused by improper servicing, repairs or care is the responsibility of the person causing it.

**Manufacturer service** For reliable servicing, maintenance, diagnosis and fault correction please contact your supplier, the nearest customer service centre or any other service centres authorised by the manufacturer.

### Safety



#### WARNING!

Dangerous situations can arise during servicing and repair work. Accidents can be caused by mechanical or electrical influences if the appropriate safety instructions are not heeded!

- ➔ Switch off the device during servicing, repair and care work!
- ➔ Take the utmost care when cleaning the cutter!
- ➔ Repairs to the printer may only be performed by authorized specialists who are aware of the risks being involved!

### Fault correction

#### Status

In the event of faults occurring on the device, evaluate the status reports of the device before doing anything. Read the corresponding chapter in this documentation.

#### Call servicing

If you are not authorised to carry out diagnosis and fault correction work, call your technician or the authorised service. The appropriate documentation and spare parts are available to the service personnel in order to carry out repair work of a sufficient quality.

### **Ordering spare parts**

- ▶ Only use original spare parts from the manufacturer. The use of parts which do not satisfy the high demands set by the printer manufacturer can cause unnecessary problems.

The following information is necessary when ordering:

#### **Order information**

- Type of device
- Serial number of the device
- Optional fittings for the device
- Designation and part number of the spare part
- Number of parts required

## Servicing and cleaning

### Notes for cleaning

#### Intervals

Regular servicing and cleaning work is necessary for safe operation and high running performance. The servicing intervals are dependent on the operation and ambient conditions, daily operating times and the print medium.

- ▣▣▣▣➤ Regularly clean the print head and feed roller of paper, adhesive and ink residues.

### Cleaning agents

Part to be cleaned	Cleaning agent	Ordering no.
Printhead	Printhead cleaning pen	95327
	Cleaning paper	5030
	Ethyl or Isopropyl alcohol	
Rubber rollers (e.g. print roller, feed roller, brake roller)	Cleaning agent for rubber rollers	98925
Deflection axles or tubes made of metal	Methylated spirit	A103198
	Label remover	
Outer surfaces	Comercially available neutral cleaning agents	

Tab. 1 Recommended cleaning agents.



- ▣▣▣▣➤ CAUTION! - Do not use any cleaning agents which could damage or destroy the coating surfaces, labelling, display, type plates, electrical components etc.
- ▣▣▣▣➤ CAUTION! - Under no circumstances should you use scouring or synthetic solvent cleaning agents. Avoid acidic and alkaline solutions.

## Printhead

### Cleaning the print head

1. Switch off the device.
2. Pull out the mains plug.
3. Remove material and ribbon.
4. Unscrew the two thumb screws on the print head mounting until the entire printhead mounting can be rotated upwards on the contact shaft.



- ⚠ CAUTION! - The printhead is a sensitive electronic component and can be damaged by electrostatic charges. Therefore, discharge any bodily static electricity before coming into contact with the print head by touching the base plate of the printer. The printhead does not need to be removed. Mark the position of the printhead on the axle, if it is not flushed against the inner or outer plastic ring.

5. Clean the print head using a dust-free cloth and cleaning fuel.

*Fig. 1 Cleaning of the printhead – the printhead needs not to be unplugged (Fig: Dispenser version).*



- ⚠ CAUTION! - Do not use any objects with sharp edges. Metal objects may never be allowed to come into contact with the print head surface!
6. After cleaning, return the print head mounting to its old position and retighten the thumb screws.
  - ⚠ Press the thumb screw on the tapered edge of the square axle and ensure the exact positioning of the print head mounting on the axle. Also pay attention to the position of the print head in relation to the edge of the label.

Basic factory settings: Flush against the inner black plastic plug.

7. Before switching on the device, check whether the print head cable is still properly connected. If this is not the case, plug in the cable correctly.

## Changing the print head

The print head is adjusted to the print head mounting during manufacture. As a result the print head can only be replaced in conjunction with the print head mounting.

1. Switch off the device.
2. Pull out the mains plug.
3. Remove material and ribbon.
4. Pull out both plugs in a horizontal direction from the print head.
- ⚡➡ Wait at least 3 minutes after switching off the device before removing the print head cable from the print head. Mark the position of an axially adjusted print head.
6. Unscrew the two thumb screws on the print head mounting until the entire print head mounting can be removed from the contact shaft (Fig. 2).

*Fig. 2 Take care not to touch the connector contacts (1) or the thermal edge (2) when removing the printhead!*

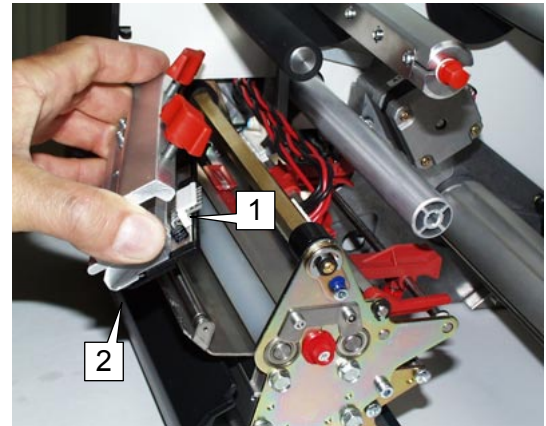

- ⚡➡ **CAUTION!** - The print head is a sensitive electronic component and can be damaged by electrostatic charges. Therefore, discharge any bodily static electricity before coming into contact with the print head by touching the base plate of the printer. The print head may not be touched on the print bar or on the plug-in contacts.
8. To install, move the new print head mounting to the old position and tighten the thumb screws.
  - ⚡➡ Before doing this make a note of the resistance value of the print head (read off from the print head). When placing the print head on the print head mounting, ensure that the print head is lying flat.
  - ⚡➡ Press the thumb screw on the tapered edge of the square axle and ensure the exact positioning of the print head mounting on the axle. Also pay attention to the position of the print head in relation to the edge of the label.

Basic factory settings: Flush against the inner black plastic plug.

9. Plug the print head cable back into the print head.
10. The resistance value of the print head must be entered after putting the printer into operation using the parameter `SYSTEM PARAMETERS > Head resistance`.



- |||➔ Entering a false value can damage the print head!
- Please also read the Service Manual, topic section "Service print module", paragraph "Exchanging the printhead".
- |||➔ If the printout is worse than before, after a new printhead was installed, the printhead position has possibly to be adjusted. This setting should be done by a service technician.
- For details refer to the Service Manual, topic section "Mechanics", chapter "Printhead adjustment" / "Adjusting the printhead position".

### Checking the print head

The printers of the 64-xx series are provided with a test function, which tests the functionality of every single dot (dot check).

There are two different modes of operation with three different possibilities to start a dot check:

Dot check modes	Call by
Automatic dot check	Automatic execution after powering on or in printing pauses. To activate the automatic, refer to parameter SYSTEM PARAMETERS > Autom. dot check
	Easy Plug: Add an optional D to the obligatory #ER command (-> #ERD) to trigger a dot check at the end of the print job.
Dot check on demand	Dot check with subsequent status report that informs about the number and the location of the defective dots. Parameter SERVICE FUNCTIONS > Head dot test
	Dot check with subsequent printing of a pattern which visualizes the test result. Parameter "PRINT INFO/ Dottest endless/punched".
	In Off-line mode by pressing the Apply+Feed buttons. Equals the call by parameter „Head dot test“, but without the status report. Defective dots are displayed by status messages.

Tab. 2 The five ways to start a dot check.

#### Display message

Die Displayanzeige für einen defekten Dot ist bei allen Dottestvarianten:

```
Status:          5103
Dot defective
```

If all dots are faultless, no display message appears.

#### Duration

All five ways of dot checking test the entire printhead width. Therefore, the test procedure may take from 10 s up to several minutes time (the wider the printhead is and the more dots are defective, the longer).

- ➡ 64-08 printers need up to 40 min time to perform a dot check. For this reason, it is not recommended to use the "Automatic dot check" mode with this type of printer.



- ➡ **CAUTION!** - Never change the setting of a dot check parameter, during a dot check is running! Disregard may cause the printer firmware to crash.

**Abortion**

- ➡ If really considered necessary, please cancel the dot check by a reset (press Feed+Cut+Online button)!



- ➡ Never cancel a dot test by switching off the printer! This can destroy some dots of the print head.



## Rubber rollers

### Cleaning the print roller

1. Switch off the device.
2. Pull out the mains plug.
3. Remove material and ribbon.
4. Only dispenser version: Remove the dispensing edge to gain easier access to the print roller. To do so, unscrew both holding screws (1) ( ).

*Fig. 3 When using a 64-xx dispenser or Chess x dispenser, remove the dispensing edge to gain easier access to the print roller.*

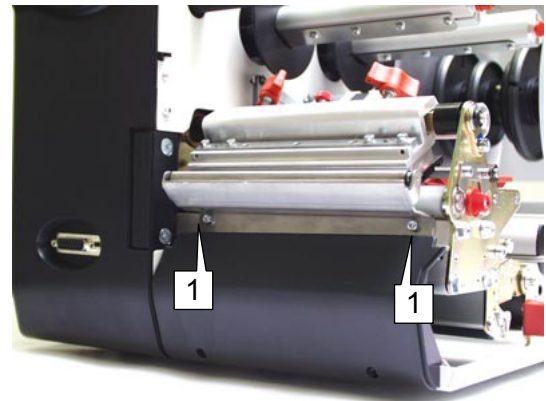

5. Unscrew the two thumb screws on the print head mounting until the entire print head mounting can be rotated upwards on the contact shaft.
- See paragraph "[Cleaning the print head](#)" on page 5.
- ➡ The print head may or does not need to be removed. Mark the position of the printhead on the axle, if it is not flushed against the inner or outer plastic ring.
6. Now the print roller can be easily accessed from ahead. The rollers should be turned gradually in order to clean them properly.

*Fig. 4 Rotate the printhead upwards before cleaning it.*





- ▣ CAUTION! - Only clean the print roller with a dust-free cloth and roller cleaner. Never use knives or sharp-edged objects to clean the rollers!

Keeping impurities and dirt of any description away from the printing area generally increases the running performance of the printer, and especially that of the print head. The print image is also adversely affected by dirt and other impurities.

7. After cleaning, return the print head mounting to its old position and retighten the thumb screws.
- ▣ Press the thumb screw on the tapered edge of the square axle and ensure the exact positioning of the print head mounting on the axle. Also pay attention to the position of the print head in relation to the edge of the label.

Basic factory settings: Flush against the inner black plastic plug.

8. Before switching on the device, check whether the print head cable is still properly connected. If this is not the case, plug in the cable correctly.

### **Cleaning the feed roller**

Every now and then, the feed roller and the contact pressure rollers should be cleaned.

1. Switch off the device.
2. Pull out the mains plug.
3. Remove material and ribbon.
4. Remove the printhead.
- For detailed information refer to chapter "[Changing the print head](#)" on page 6.
5. Turn the feed roller stepwise while cleaning it using a cloth (Fig. 5) and rubber cleaner until the entire roller is free of residue.
- ▣ Shift the front material guiding (1) and the contact pressure rollers (2) for better access to the roller.

*Fig. 5 In order to clean the feed roller remove the printhead and shift material guiding (1) and contact pressure rollers (2) aside.*

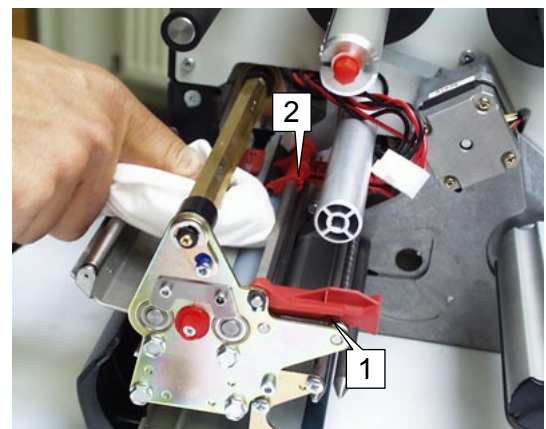

7. After cleaning, return the print head mounting to its old position and retighten the thumb screws.
- ▣▣▣▣➔ Press the thumb screw on the tapered edge of the square axle and ensure the exact positioning of the print head mounting on the axle. Also pay attention to the position of the print head in relation to the edge of the label.

Basic factory settings: Flush against the inner black plastic plug.

8. Before switching on the device, check whether the print head cable is still properly connected. If this is not the case, plug in the cable correctly.

### **Cleaning the dispenser-feed-roller**

- ▣▣▣▣➔ Only for 64-xx dispenser!
  1. Switch off the device.
  2. Pull out the mains plug.
  3. Remove material and ribbon.
  4. Pull out the pull-out module (, left side).
- Read in any case paragraph "Inserting material" in topic section "Setup"!



*Fig. 6 Left side: pulling out the pull-out module; right side: cleaning the dispenser-feed-roller using roller cleaner.*

5. Turn the feed roller stepwise while cleaning it using a cloth (Fig. 6, right side) and rubber cleaner until the entire roller is free of residue.
6. Remount the pull-out module.

## Photoelectric switches

### Cleaning the gap photoelectric switch

1. Switch off the device.
2. Pull out the mains plug.
3. Remove material and ribbon.
4. Unscrew the two thumb screws on the print head mounting the entire print head mounting can be rotated upwards on the contact shaft.
- See paragraph "[Cleaning the print head](#)" on page 5.
- ▣ The print head does not need to be removed. Mark the position of the printhead on the axle, if it is not flushed against the inner or outer plastic ring.  
The gap photoelectric switch can now be easily accessed from above.
5. Clean the gap photoelectric switch with compressed air (compressed air can be ordered in a can as an accessory).
- ▣ Additionally clean it using cleaning fuel and a dust-free cloth if it is particularly dirty.
6. After cleaning, return the print head mounting to its old position and retighten the thumb screws.
- ▣ Press the thumb screw on the tapered edge of the square axle and ensure the exact positioning of the print head mounting on the axle. Also pay attention to the position of the print head in relation to the edge of the label.  
Basic factory settings: Flush against the inner black plastic plug.
7. Before switching on the device, check whether the print head cable is still properly connected. If this is not the case, plug in the cable correctly.

### Cleaning the material end photoelectric switch

The material end photoelectric switch is located on the inner red material feed on the print module. It is necessary to regularly clean the photoelectric switch of material and dust particles. The cleaning intervals are dependent on the materials being used.

- Clean the material end photoelectric switch with compressed air (compressed air can be ordered in a can as an accessory).
- ▣ Additionally clean it using cleaning fuel and a dust-free cloth if it is particularly dirty.

## Cleaning the cutter

▣▣▣▣➔ Only with cutter option!



### WARNING!

Sharp blades may cause cut injuries at hands and fingers!

- ➔ Take the utmost caution when cleaning the cutters!
- ➔ Do not touch the cutters with bare hands!

When self-adhesive material is being used, removal of glue residue is necessary at regular intervals to ensure that material continues to be cut and transported correctly. Paper scraps and adhesive can cause malfunctions.



▣▣▣▣➔ CAUTION! - Use non-fluff cloths and cleaning fuel for cleaning. Never work on the cutter blades with hard metal objects! Even the slightest, non-visible damage to the blade can considerably reduce the cutting ability of the blade.

1. Switch off the device and pull out the mains plug.
2. Remove material and ribbon.
3. Remove glue residue from the top and bottom cutters. It may be necessary to slightly swivel the cutter in order to access the entire cutting edge.

## Cleaning/exchanging the dust filter liner

### Important notes

The dust filter is an option (article number A9344). The filter is mounted in front of the fan opening at the printer rear side.

- ▶ Installation must be done by a qualified service technician.
- Installation instruction see service manual, topic section „Service Mechanics“, chapter „Assembling accessories“, “Dustfilter”.



#### CAUTION!

An exhausted filter liner can cause the power supply to overheat and the device to break down.

→ Replace the filter liner regularly, at least in monthly intervals.

- ▶ The replacement interval of the filter liner has to be defined individually according to...
  - dust occurrence
  - operating times
- ▶ The filter liner can be cleaned by blowing it out with compressed air or by washing it out.

### Exchanging the filter liner



Fig. 7 64-08 with mounted dust filter (A).

1. Turn the screw (B) at the filter holder  $\frac{1}{4}$  rotation.
2. Remove the filter holder. Take the filter liner (A) out of the filter holder.
3. Insert a new filter liner (article no. A2581).  
*Alternativ:* Clean the filter liner by blowing it out with compressed air or wash it out and dry it and insert it afterwards.
4. Press the filter holder against the rear side and turn the screw (B)  $\frac{1}{4}$  rotation.

## Index

<b>C</b>		<b>M</b>	
Changing the print head .....	6	Material end photoelectric switch.....	12
Charges, electrostatic .....	5, 6	Material feed .....	12
Cleaning .....	4	<b>N</b>	
- knife.....	13	Neutral cleaning agents .....	4
- material end photoelectric switch .....	12	<b>O</b>	
- notes .....	4	Ordering spare parts.....	3
- print head .....	5	<b>P</b>	
- print roller .....	9	Putting into operation .....	6
Cleaning fuel .....	4	<b>R</b>	
<b>D</b>		Resistance value thermal bar .....	6
Dot check .....	7	<b>S</b>	
Dust filter liner, exchanging, cleaning .....	14	Servicing .....	4
<b>F</b>		Servicing, general notes .....	2
Fault correction .....	2	<b>T</b>	
<b>G</b>		Testing the printhead .....	7
Glue residue.....	13	Trained personnel.....	2
<b>I</b>			
Ink residues.....	4		



# Info Printouts & Parameters

- General Information ..... 6
  - Important setting instructions ..... 6
  - Area of application ..... 6
- Operating the parameter menu ..... 8
  - Example ..... 8
  - Parameter Menu 64-xx ..... 9
  - Parameter Menu DPM/PEM/ALX ..... 10
- Overview Parameter Menus ..... 11
  - Understanding the Parameter Overviews 11
  - 64-xx all parameters ..... 12
  - 64-xx operator parameters ..... 15
  - DPM/PEM/ALX 92x all parameters ..... 17
  - DPM / PEM / ALX 92x operator parameters ..... 20
  - ALX 73x (PMA) all parameters ..... 22
  - ALX 73x (PMA) operator parameters ..... 25
- Alphabetical Parameter List ..... 27

- EAN sep. lines ..... 45
- Dispense Mode..... 45
- Dispenseposition ..... 47
- Cut mode .....48
- Cut speed ..... 50
- Cut position..... 50
- Double cut..... 50
- Rest position .....51
- Cut width..... 51
- Rewind direction ..... 51
- Rotated Barcodes ..... 52
- X - Printadjust ..... 53
- Y – Printadjust ..... 53
- Punch mode..... 53
- Punch level ..... 54

## PRINT INFO

- Printer status ..... 30
- Memory status..... 31
- Font status ..... 32
- Flashdata status..... 35
- Service Status ..... 36
- Dottest endless ..... 37
- Dottest punched ..... 37
- Reference label ..... 38
- RFID Status..... 39

## PRINT PARAMETERS

- Print speed ..... 40
- Feed speed ..... 40
- Material type ..... 41
- Material length..... 41
- Material width ..... 41
- Print direction ..... 42
- Punch offset ..... 42
- Bar code multip. .... 43
- Tradit. Imaging ..... 43
- UPC plain-copy ..... 44
- EAN Readline..... 45

## INTERFACE PARA

### > EASYPLUGINTERPR

- Print interface..... 55
- Spooler mode ..... 55
- Printer ID No. .... 56
- Spooler size ..... 56
- Offline mode ..... 56
- Interface delay ..... 56

### > COM1 PORT

- Baud rate ..... 57
- No. of data bits..... 57
- Parity..... 57
- Stop bits..... 57
- Data synch..... 58
- Frame error..... 58

### > COM3 PORT

- Baud rate ..... 58
- No. of data bits..... 58
- Parity..... 58
- Stop bits..... 59
- Data synch..... 59
- Frame error..... 59
- Serial Port Mode ..... 59



## &gt; COM4 PORT

Baud rate.....	60
No. of data bits.....	60
Parity.....	60
Stop bits.....	60
Data synch.....	60
Frame error.....	60

## &gt; CENTRONICS

PnP function.....	61
-------------------	----

## &gt; NETWORK PARAM.

IP addressassign.....	61
IP address.....	61
Net mask.....	61
Gateway address.....	62
Port address.....	62
Ethernet speed.....	62
MAC address.....	62
FTP server.....	63
FTP password.....	63
WEB server.....	63
WEB display refr.....	64
WEB admin passw.....	65
WEB supervisor p.....	65
WEB operator p.....	66
Time client.....	66
Time server IP.....	67
Sync. interval.....	67
Time zone.....	67
DHCP host name.....	67
WLAN SSID.....	68
WLAN WEP.....	68
WLAN default key.....	68
WLAN 64Bit key 1.....	69
WLAN 64Bit key 2.....	69
WLAN 64Bit key 3.....	69
WLAN 64Bit key 4.....	69
WLAN 128Bit key 1.....	69
WLAN 128Bit key 2.....	70
WLAN 128Bit key 3.....	70
WLAN 128Bit key 4.....	70
WLAN com quality.....	70
WLAN signal lev.....	70

## &gt; OPTIONS

OLV Option.....	71
RFID Option.....	71
StandAlone Input.....	71
#V/W/I Interface.....	72

## &gt; DRIVEASSIGNMENT

Drive C.....	72
Drive E.....	72
Drive F.....	73

## SYSTEM PARAMETER

Speed unit.....	74
Cover open error.....	74
Foil end warning.....	74
Foil warn stop.....	74
Autom. dot check.....	75
Early dottest.....	75
Latest dottest.....	76
Dottestarea from.....	76
Dottestarea to.....	77
Print Interpret.....	77
Character sets.....	78
Character filter.....	79
Light sens. type.....	79
Head-sensor dist.....	79
Ribbon autoecon.....	79
Ribbon economy limit.....	80
Head down lead.....	80
Feed mode.....	80
Turn-on mode.....	81
Error reprint.....	81
EasyPlug error.....	81
Single job mode.....	81
Head resistance.....	82
Temp. reduction.....	83
Voltage offset.....	83
Expand Logo.....	83
Miss. label tol.....	83
Gap detect mode.....	84
Foil stretching.....	84
Head lift autom.....	84
Mat.end detect.....	85
Periph. device.....	85

Singlestartquant .....	86
Head disp dist .....	86
External signal.....	86
Start print mode.....	86
Apply key.....	87
Print contrast.....	87
Ram disk size.....	87
Font downl. area .....	88
Free store size .....	88
Print info mode .....	90
Reprint function .....	90
Language .....	90
Keyboard .....	91
Signal / buzzer .....	91
Access authoriz.....	91
Realtime clock.....	92
Material feed .....	93

## DISPENSER PARA

Head disp dist. ....	94
Dispense Mode .....	94
Dispenseposition.....	96
Display mode .....	97
Dispense counter .....	97
Dispensing mode .....	97
Application mode.....	97
Start source.....	98
Dispensing edge .....	98
Max InitFeedback.....	98
Transport mode.....	99
Start offset.....	99
Start error stop .....	99
Product length .....	100
Speed Adaption .....	101
Encoder Type.....	101
Encoder Resol.....	101
Encoder Diameter .....	101
Forw. feed rat. ....	102
Backw feed rat. ....	102
Multi label mode .....	103
Label 2 offset.....	103
Label 3 offset.....	103

## APPLICATOR PARA

Applicator type.....	104
Application mode .....	105
Start print mode .....	105
Dwell time .....	106
Blow on time .....	106
Restart delay.....	106
Apply comp. time .....	106
Position timeout .....	107
Lab release time .....	107
Touch down sens.....	107
TouchDownTimeout.....	107

## I/O BOARD

Start print mode .....	109
Reprint Signal .....	109
Feed input.....	110
Pause input.....	110
Error output.....	110
Error Polarity.....	111
Status output .....	111
Status polarity.....	111
End print mode .....	112

## OLV PARAMETERS

Verify mode.....	113
Cancel. printing.....	113
Reprint quantity.....	113
OLV mode.....	113
Ref Decode.....	114
Decodability .....	114
Modulation .....	114
Defects.....	114
Edge contrast.....	114
Rmin/Rmax.....	115
Symbol contrast.....	115
PCS .....	115
R (white) .....	115
R (black) .....	115
Ratio .....	116
ANSI symbol grade.....	116
Dist. head-beam .....	116

**DP INTERFACE**

Interface type .....	117
Start print mode.....	117
End print mode.....	118
Reprint signal .....	118
Ribbon signal .....	118
Material signal .....	119
Mat. signal stop .....	119
Feed input .....	119
Pause input .....	120
Start error stop .....	120
Internal inputs.....	120
Apply mode .....	121
USI profile .....	121
Warning signal .....	121

**ZPL PARAMETERS**

Darkness .....	122
Control Prefix .....	122
Format Prefix.....	122
Delimiter Char .....	122
Label Top .....	123
Left Position .....	123
Manual Calibrate .....	123
Resolution .....	123
Error Indication .....	124
Error Checking .....	124
305 DPI Scaling .....	124
Image Save Path.....	124
Command ^PR.....	124
Command ^MT.....	125
Label Invert .....	125
Command ^JM .....	125
Command ^MD/~SD.....	126

**SPECIAL FUNCTION**

Printer type.....	127
Printhead type .....	127
Sensor type .....	128
Disp. Head Offs.....	128
Default Values.....	128
Command sequence .....	128
Delete job .....	128

Delete spooler.....	129
Factory settings .....	129
Custom defaults.....	129
Store Parameters.....	129
Store Diagnosis .....	130
Gen.Support Data.....	130
EasyPI. file log .....	130
Log files delete.....	131
Data blocks del. ....	131
RFID stat. del. ....	133

**SERVICE FUNCTION**

Service.....	134
Head exchange.....	134
Roller exchange.....	134
Cutter exchange .....	134
Serv. data reset .....	135
Head dot test .....	135
Head step tune .....	136
EasyPlug monitor.....	136
EP Monitor Mode .....	136
Head adjust.....	136
Sensor adjust.....	136
Sensor test .....	137
Cutter test .....	137
Matend tolerance .....	137
Feedadjust label .....	137
Feed adjust.....	137
Punch y calibr. ....	138
Foil feed adjust .....	138
Punch y calibr .....	138
PS registers .....	138
Scanner test.....	139
Memory card test.....	139
Send test .....	140
Receive test.....	141
Com2 comun. test.....	142
Com2 port test .....	142
Headvo. adj. 20 V .....	143
Headvo. adj. 28 V .....	143
Printtest.....	143
Rewinder adjust.....	143
Rewinder values .....	144

## SERVICE DATA

### > MODULE FW VERS.

System version.....	145
System revision.....	145
System date.....	145
Bootloader.....	145
uMon.....	145
Feed driver.....	145
Foil driver.....	145
Head driver.....	146
Peripheraldriver.....	146
Rewinder.....	146
USI interface.....	146
Applicator int.....	146
Dispenser lift.....	146
Dispenser feed.....	147

### > OPERATION DATA

Serv. operations.....	147
Headnumber.....	147
Roll number.....	147
Cutter number.....	147
Head run length.....	147
Roll run length.....	148
Cuts on knife.....	148
Tot. mat. length.....	148
Tot. foil length.....	148
Total cuts.....	148
Total head moves.....	148
Head strobes.....	149
Head temperature.....	149
Foil diameter.....	149
Dispensing cycl.....	149
Operation time.....	149

### > POWERSUPPLYDATA

Type.....	150
PS temperature.....	150
Version.....	150
Serial number.....	150
Standby+On time.....	150
On time.....	151

### > CPU BOARD DATA

CPU identifier.....	151
PCB revision.....	151
FPGA version.....	151
MAC address.....	151
Serial number.....	151
Production date.....	151
PCB part number.....	152
Board part numb.....	152
Manufacturer.....	152
Work place.....	152
Company name.....	152

### > DISPLAY DATA

Display version.....	152
Display SerialNr.....	152
Remote disp. vers.....	153
Remote disp. #.....	153

### > MEMORY DATA

Ram memory size.....	153
Flash mem size.....	153
CompactFlash.....	153
SD card.....	154
USB.....	154
Space for Jobs.....	154
Max. Labellength.....	154
Default values.....	154

## General Information

### Important setting instructions

Starting in offline mode, you get to the parameter menu by pressing the prog button. There you can set/alter the different parameters of the printer and activate/deactivate options.

Many Parameters provide a range within the setting can be changed with a standard step width. By this step width, the setting is changed, if the Cut-(Apply-) or Feed button is pressed once.

▣▣▣▣➔ The step width can be increased ten times, if the Online button is pressed simultaneously (Cut+Online or Feed+Online).

▣▣▣▣➔ Wait at least 10 seconds between switching the device off and on again, otherwise any modified parameter settings are not saved.

▣▣▣▣➔ With some parameters, false settings can result in the device being damaged (e. g. if the print head temperature is too high). Data and/or print orders are also deleted during formatting and with other settings.

▣▣▣▣➔ Pay attention to the corresponding notes in the following description to ensure that no damage occurs!



### Area of application

The description counts for all devices listed in the headline of this document. All status printouts and parameters are described in the same order as they *may appear* in the parameter menu of the respective printer.

▣▣▣▣➔ Not all of the parameters appear in each of the listed printers!

At the beginning of each parameter description can be found information about the availability of the parameter:

64-xx	ALX 92x	DPM
▣▣▣▣➔ ALX 92x/DPM: Only with installed USI board.		

Fig. 1: At the beginning of each parameter description, the availability of the parameter is specified: Between the two lines is a list of the concerned printer types; the remark below (arrow) quotes further conditions.

If a parameter appears in the menu of a certain printer type or not, depends on the following, which can be read from this bar:

- The *printer type*:  
Printers, which have the parameter available in the parameter menu, are listed between the lines. Example (see fig. 1): 64-xx, ALX 92x, ALX 73x (PMA), DPM.
- The configuration with *options* and/or certain *parameter settings*:  
Example (see fig. 1): The parameter only appears in the menu of an ALX 92x or DPM, if the device is equipped with an USI board. If the remark is not assigned to a special printer type, it is valid for all listed printers.

**Firmware**

This description applies to all printers which are equipped with the following firmware version:

6.60

- The paragraph „Overview Parameter Menues“ in this topic section contains an overview of all available parameters of the respective printer.

## Operating the parameter menu

The illustrations on the following pages clarify the operating principle of the parameter menu. The return path shown on the left of the screen, called up using the Prog. button, also applies for parameters in the middle of the screen.

### Setting values

The setting of a parameter always follows this scheme:

1. Select the parameter.
2. Press the Online button.
3. Set the parameter to the intended value by pressing the Cut or Feed button.
4. Confirm by pressing the Online button.

### Example

Setting the parameter `PRINT PARAMETERS > Material type` to punched material.

1. Press prog button.

OFFLINE 0 JOBS	Initial state: off-line mode
----------------	------------------------------

2. Press prog button.

PRINT INFO
------------

3. Press cut button.

PRINT PARAMETERS
------------------

4. Press online button.

PRINT PARAMETERS Print speed	First parameter in the <code>PRINT PARAMETERS</code> menu.
---------------------------------	--

5. Press cut button repeatedly, until the following is displayed:

Material type Endless
--------------------------

6. Press feed button.

Material type Punched	Setting the parameter to the intended value by pressing the Cut or Feed button.
--------------------------	---

7. Press online button.

PRINT PARAMETERS Material type	Confirm with Online button.
-----------------------------------	-----------------------------

8. Press prog button 2x.

OFFLINE 0 JOBS	"Way back" by pressing the Prog button.
----------------	---

### Parameter Menu 64-xx

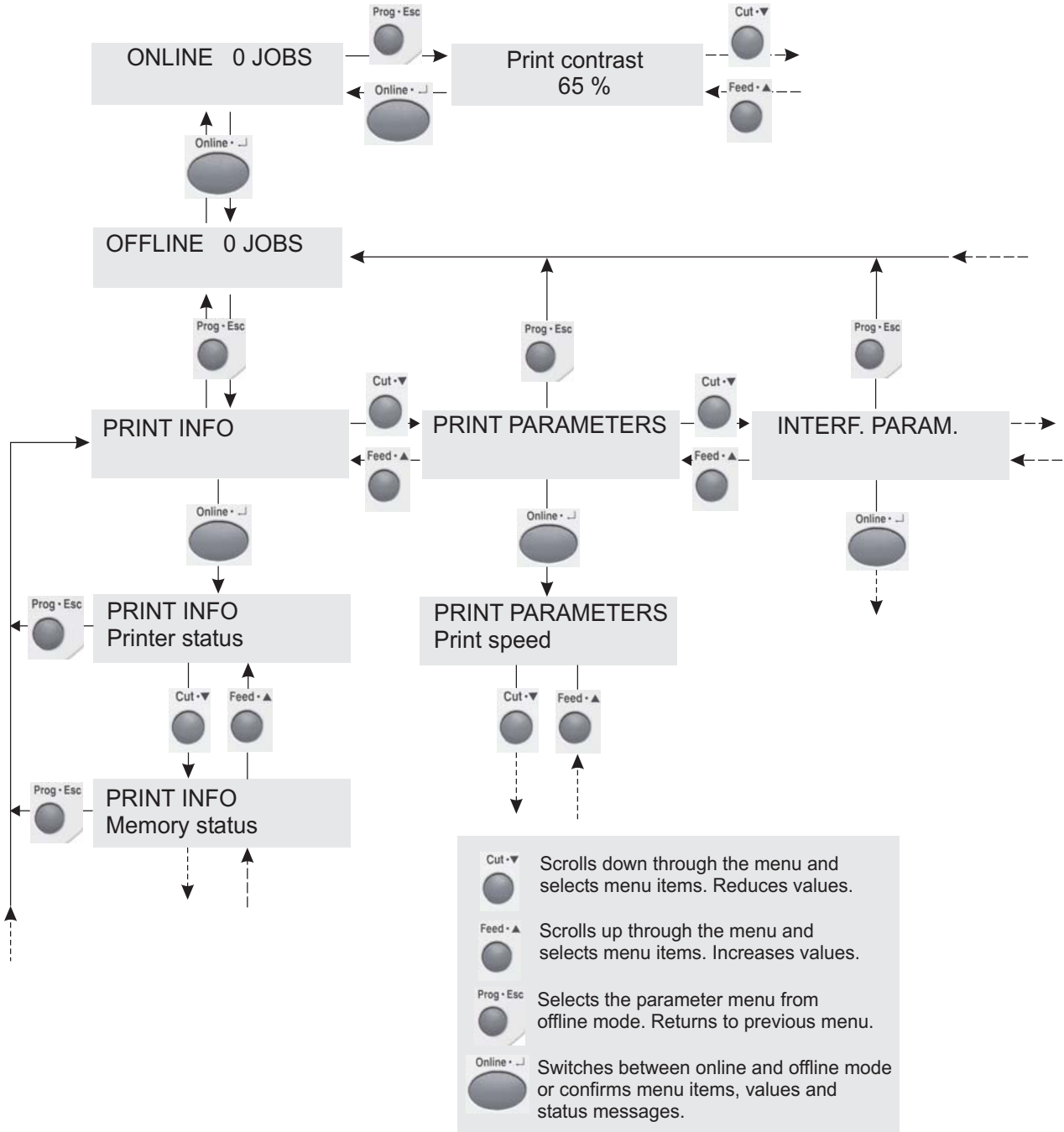

Fig. 1: Guideline through the parameter menu. Start into it by pressing the Prog button in off-line mode.



## Parameter Menu DPM/PEM/ALX

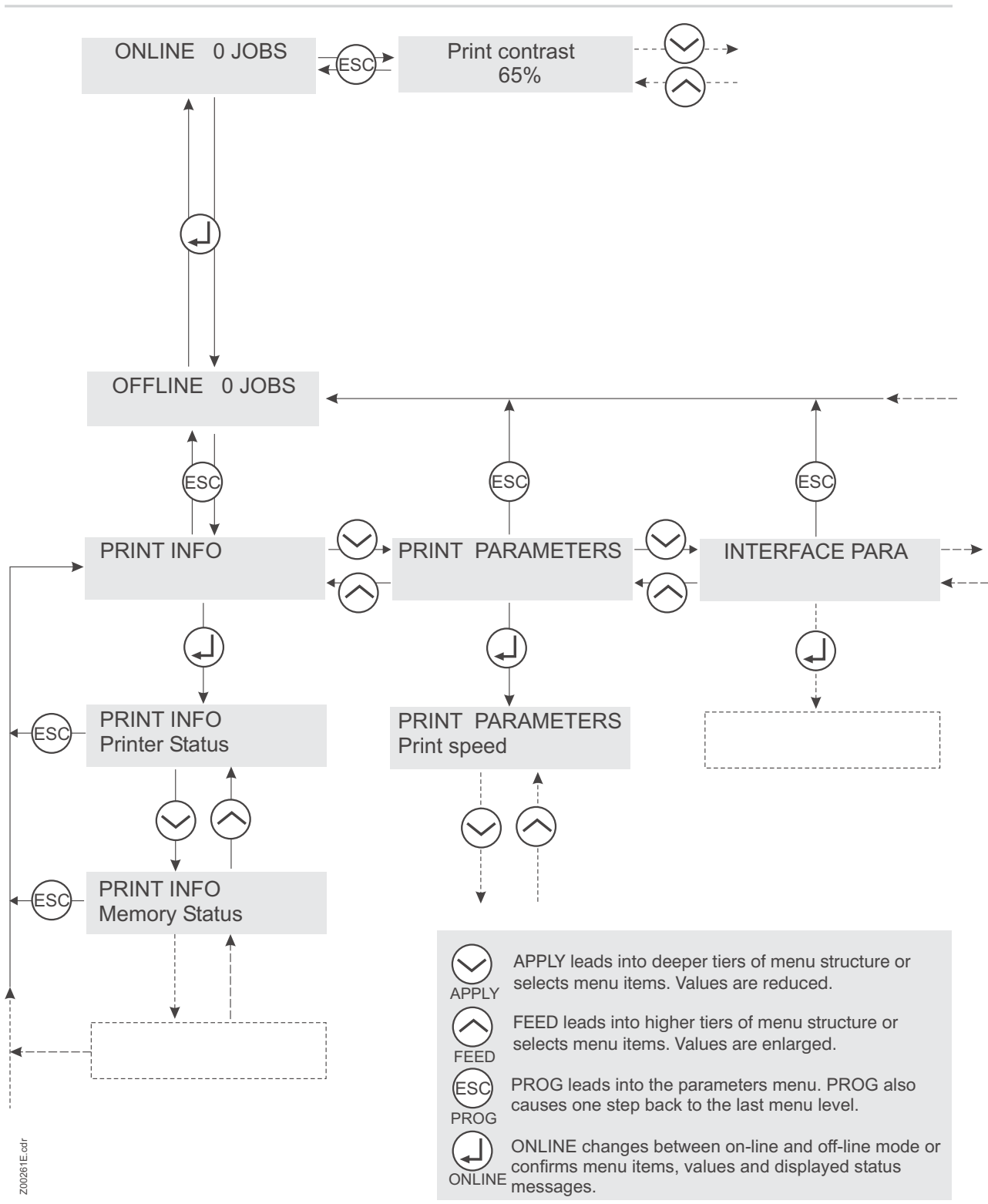

Fig. 2: Functional diagram of the DPM/PEM/ALX parameter menu. You get into the menu by pressing the Prog key in Offline-Mode.

## Overview Parameter Menus

### Understanding the Parameter Overviews

The charts in the following show all of the parameters implemented in the printer firmware. Some parameters are only visible in the parameter menu under specific preconditions. These parameters are provided with a gray background and a digit at the right column edge. The digit refers to a footnote describing the precondition under which the parameter is visible.

PRINT INFO	PRINT PARAMETERS	INTERFACE PARA	(Interf. Para. continued)	(Interf. Para. continued)	SYSTEM PARAMETER
Printer status	Print speed	> EASYPLUGINTERPR	Parity	WLAN SSID 31	Foil end warning
Memory status	Feed speed	Print interface	Stop bits	WLAN WEP 31	Cover open error
Font status	Material type	Spooler mode	Data synch.	WLAN default key 31	Foil warn stop
Flashdata status 9	Material length	Printer ID No.	Frame error	WLAN 64Bit key 1 31	Autom. dot check
Service status	Material width	Spooler size		WLAN 64Bit key 2 31	Early dottest 15
Dottest endless	Print direction	Offline mode	> CENTRONICS	WLAN 64Bit key 3 31	Latest dottest 15
Dottest punched	Punch offset	Interface delay	PnP function	WLAN 64Bit key 4 31	Dottestarea from 15
Reference label	Bar code Multip.			WLAN 128Bit key 1 31	Dottestarea to 15
RFID status 22	Tradit. imaging 13	> COM1 PORT	> NETWORK PARAM.	WLAN 128Bit key 2 31	Print Interpret.
	UPC plain-copy	Baud rate	IP Addressassign	WLAN 128Bit key 3 31	Character sets
	EAN Readline	No. of data bits	IP Address	WLAN 128Bit key 4 31	Character filter
	EAN sep. lines	Parity	Net mask	WLAN com quality 31	Light sens. type
	Rotated Barcodes	Stop bits	Gateway address	WLAN signal lev. 31	Head-sensor dist 13
	Dispensposition 14	Data synch.	Ethernet speed		Ribbon autoecon.
	Cut mode 6	Frame error	Port address	> OPTIONS	Ribb. eco. limit 2
	Cut speed 6		MAC address	OLV option	Head down lead 13/2
	Cut position 6	> COM2 PORT 11	FTP server	RFID option	Feed mode
	Double cut 6	Baud rate 11	FTP password 13	StandAlone Input	Turn-on mode
	Rest position 6	No. of data bits 11	WEB server	#VW/I Interface	Error reprint
	Cut width 6	Parity 11	WEB display refr. 28		EasyPlug errors
	Rewind direction 5	Stop bits 11	WEB admin passw. 13	> DRIVEASSIGNMENT	Single job mode
	X – print offset	Data synch. 11	WEB supervisor p. 13	Drive C	Head resistance 13
	Y – print offset	Serial Port Mode 11	WEB operator p. 13	Drive D	Temp. reduction
	Punch mode	Frame error 11	Time client	Drive E 40	Voltage offset
	Punch level 12		Time server IP 32	Drive F	Expand Logo 3
		> COM4 PORT	Sync. interval 32		Miss. label tol.
		Baud rate	Time zone 32		Gap detect. mode
		No. of data bits	DHCP host name		Foil stretching 21

1. Only 64-xx dispenser with 4" printhead 2. Only if SYSTEM PARAMETER > Ribbon autoecon. = „On“, „On Turbo“ or „Thermal/headlift“ 3. Only with 8-Dot-Emulation 4. Only with 64-08 5. Only with rewinder option 6. Only with cutter 7. Only with USI interface 8. Only if SYSTEM PARAMETER > Gap detect. mode = Autom. feed back 9. Only with at least one data block stored in the flash memory 10. Only if SYSTEM PARAMETER > Print Interpret. = „ZPL Emulation“ 11. Only with I/O board 12. Only if PRINT PARAMETERS > Punch mode = Manual 13. Only in production mode 14. Only with 64-xx dispenser 15. Only if SYSTEM PARAMETER > Autom. dot check = Continuous 16. For details read parameter description 17. Only with 64-04/05/06 18. Only with installed RFID option 19. Only if DP INTERFACE > Interface type = USI Applicator 20. Only with SYSTEM PARAMETER > Dispensing edge = „User defined“ 21. Not with 64-xx dispenser 22. Only with an activated RFID option 24. With connected remote display only 25. With Applicator Interface only 26. Only OLV option activated 27. Depends on the applicator type 28. Only if INTERFACE PARA > NETWORK PARAM. > WEB server = „On“ 29. Availability depends on device conf. 30. Only with a CF card inserted 31. Only with a WLAN CF card inserted 32. Only if INTERFACE PARA > NETWORK PARAM. > Time client = „On“ 33. Only if SYSTEM PARAMETER > Periph. device = „Tear-off edge“ 34. Only if SYSTEM PARAMETER > Periph. device = „Dispenser“ 35. Only if DISPENSER PARA > Transport mode = „Dual motors“ 36. Only if DISPENSER PARA > Speed Adaption = „On“ 37. Only if DISPENSER PARA > Multi label mode = „x labels/start“ 38. Only if DISPENSER PARA > Multi label mode = „3 labels/start“ 39. Only if CPU board index is -06 or lower

64-xx – DPM – PEM – ALX 92x – ALX 73x (PMA)

(System Param. continued)

		<b>DISPENSER PARA 14</b>	<b>I/O BOARD PARA 11</b>	<b>OLV PARAMETERS 26</b>	<b>DP INTERFACE 7</b>	<b>ZPL PARAMETERS 10</b>
Mat. end detect.		Dispense mode 14	Start delay 11	Verify mode 26	Interface type 7	Version 10
Periph. device		Dispenseposition 14	Reprint Signal 11	Cancel. printing 26	Start print mode 7	Darkness 10
Singlestartquant		Display mode 14	Feed input 11	Reprint quantity 26	End print mode 7	Control Prefix 10
Head disp dist 20		Dispense counter 14	Pause input 11	OLV mode 26	Reprint signal 7	Format Prefix 10
External signal		Dispensing mode 14	Error output 11	Ref Decode 26	Ribbon signal 7	Delimiter Char 10
Start print mode		Application mode 14	Error polarity 11	Decodability 26	Material signal 7	Label Top 10
Apply key 13		Start source 14	Status output 11	Modulation 26	Feed input 7	Left Position 10
Print contrast		Dispensing edge 14	Status polarity 11	Defects 26	Pause input 7	Manual Calibrate 10
Ram disk size		Max InitFeedback 14	End print mode 11	Edge Contrast 26	Start error stop 7	Resolution 10
Font downl. area		Transport mode 14		Rmin/Rmax 26	Internal inputs 7	Error Indication 10
Free store size		Start offset 14		Symbol Contrast 26	Apply mode 7/19	Error Checking 10
Print Info Mode		Start error stop 14		PCS 26	USI profile 7	305 DPI Scaling 10
Reprint function		Product length 14		R (white) 26	Warning signal 7	Image Save Path 10
Language		Forw feed rat. 14/35		R (black) 26		Command ^PR 10
Keyboard		Backw feed rat. 14/35		Ratio 26		Command ^MT 10
Signal / buzzer				ANSI Symbolgrade 26		Label Invert 10
Access authoriz.				Dist. head-beam 26		Command ^JM 10
Realtime clock						

1. Only 64-xx dispenser with 4" printhead 2. Only if SYSTEM PARAMETER > Ribbon autoecon. = „On“, „On Turbo“ or „Thermal/headlift“ 3. Only with 8-Dot-Emulation 4. Only with 64-08 5. Only with rewriter option 6. Only with cutter 7. Only with USI interface 8. Only if SYSTEM PARAMETER > Gap detect. mode = Autom. feed back 9. Only with at least one data block stored in the flash memory 10. Only if SYSTEM PARAMETER > Print Interpret. = „ZPL Emulation“ 11. Only with I/O board 12. Only if PRINT PARAMETERS > Punch mode = Manual 13. Only in production mode 14. Only with 64-xx dispenser 15. Only if SYSTEM PARAMETER > Autom. dot check = Continuous 16. For details read parameter description 17. Only with 64-04/05/06 18. Only with installed RFID option 19. Only if DP INTERFACE > Interface type = USI Applicator 20. Only with SYSTEM PARAMETER > Dispensing edge = „User defined“ 21. Not with 64-xx dispenser 22. Only with an activated RFID option 24. With connected remote display only 25. With Applicator Interface only 26. Only OLV option activated 27. Depends on the applicator type 28. Only if INTERFACE PARA > NETWORK PARAM. > WEB server = „On“ 29. Availability depends on device conf. 30. Only with a CF card inserted 31. Only with a WLAN CF card inserted 32. Only if INTERFACE PARA > NETWORK PARAM. > Time client = „On“ 33. Only if SYSTEM PARAMETER > Periph. device = „Tear-off edge“ 34. Only if SYSTEM PARAMETER > Periph. device = „Dispenser“ 35. Only if DISPENSER PARA > Transport mode = „Dual motors“ 36. Only if DISPENSER PARA > Speed Adaption = „On“ 37. Only if DISPENSER PARA > Multi label mode = „x labels/start“ 38. Only if DISPENSER PARA > Multi label mode = „3 labels/start“ 39. Only if PEM 39. Only if CPU board index is -06 or lower

64-xx – DPM – PEM – ALX 92x – ALX 73x (PMA)

64-xx Parameters

FW 6.75

SPECIAL FUNCTION	
Printertype	13
Printhead type	13
Disp. Head Offs.	1/13
Command Sequence	13
Delete job	
Delete spooler	
Factory settings	
Custom defaults	13
Store Parameters	
Store Diagnosis	
Gen.Support Data	
EasyPI. file log	30
Log files delete	30
Data blocks del.	9
RFID stat. del.	22

SERVICE FUNCTION	
Service	13
Head exchange	13
Roller exchange	13
Cutter exchange	13/6
Serv. data reset	13
Head dot test	
Head step tune	13
EasyPlug monitor	13
EP Monitor Mode	13
Head adjust	
Sensor adjust	13
Sensor test	
Cutter test	
Matend tolerance	
Feedadjust label	
Feed adjust	
Foil feed adjust	13
Punch Y calibr.	13
PS registers	4/13
Scanner test	
Memory card test	
Send test	
Receive test	
Com2 comun. test	11
Com2 port test	11
Headvo. adj. 20 V	13/17
Headvo. adj. 28 V	13/17
Print test	

(Service Funct. continued)

Rewinder setup	5
Rewinder values	5

SERVICE DATA	
> MODULE FW VERS.	
System version	
System revision	
System date	
Bootloader	
uMon	
Feed driver	
Foil driver	
Head driver	
Peripheraldriver	29
Rewinder	29
USI interface	29
Dispenser lift	29
Dispenser feed	29
> OPERATION DATA	
Serv. operations	
Headnumber	
Roll number	
Cutter number	6
Head run length	
Roll run length	
Cuts on knife	6
Tot. mat. length	
Tot. foil length	
Total cuts	6
Total head moves	
Head strobes	

(Service Data cont.)

Head temperature	
Foil diameter	
Dispensing cycl.	
Operation time	

> POWERSUPPLYDATA

Type	
PS temperature	
Version	29
Serial number	29
Operation time	29
Total on time	29

> CPU BOARD DATA

CPU identifier	
PCB revision	
FPGA version	
MAC address	
Serial number	
Production date	
PCB part number	
Board part numb.	
Manufacturer	13
Work place	13
Company name	13

(Service Data cont.)

> DISPLAY DATA

Display version	
Display SerialNr	
Remote disp. vers.	24
Remote disp. #	24

> MEMORY DATA

Ram memory size	
Flash mem size	
CompactFlash	30
SD card	30
USB	30
Space for Jobs	
Max. Labellength	
Default values	

1. Only 64-xx dispenser with 4" printhead 2. Only if SYSTEM PARAMETER > Ribbon autoecon. = „On“, „On Turbo“ or „Thermal/headlift“ 3. Only with 8-Dot-Emulation 4. Only with 64-08 5. Only with rewriter option 6. Only with cutter 7. Only with USI interface 8. Only if SYSTEM PARAMETER > Gap detect. mode = Autom. feed back 9. Only with at least one data block stored in the flash memory 10. Only if SYSTEM PARAMETER > Print Interpret. = „ZPL Emulation“ 11. Only with I/O board 12. Only if PRINT PARAMETERS > Punch mode = Manual 13. Only in production mode 14. Only with 64-xx dispenser 15. Only if SYSTEM PARAMETER > Autom. dot check = Continuous 16. For details read parameter description 17. Only with 64-04/05/06 18. Only with installed RFID option 19. Only if DP INTERFACE > Interface type = USI Applicator 20. Only with SYSTEM PARAMETER > Dispensing edge = „User defined“ 21. Not with 64-xx dispenser 22. Only with an activated RFID option 24. With connected remote display only 25. With Applicator Interface only 26. Only OLV option activated 27. Depends on the applicator type 28. Only if INTERFACE PARA > NETWORK PARAM. > WEB server = „On“ 29. Availability depends on device conf. 30. Only with a CF card inserted 31. Only with a WLAN CF card inserted 32. Only if INTERFACE PARA > NETWORK PARAM. > Time client = „On“ 33. Only if SYSTEM PARAMETER > Periph. device = „Tear-off edge“ 34. Only if SYSTEM PARAMETER > Periph. device = „Dispenser“ 35. Only if DISPENSER PARA > Transport mode = „Dual motors“ 36. Only if DISPENSER PARA > Speed Adaption = „On“ 37. Only if DISPENSER PARA > Multi label mode = „x labels/start“ 38. Only if DISPENSER PARA > Multi label mode = „3 labels/start“ 39. Only if PEM 39. Only if CPU board index is -06 or lower

PRINT PARAMETERS	
Print speed	
Feed speed	
Material type	
Material length	
Material width	
Print direction	
Cut speed	6
Cut position	6
Double cut	6
Rewind direction	5
X – print offset	
Y – print offset	

SYSTEM PARAMETER	
Light sens. type	
Ribbon autoecon.	
Ribbon eco. limit	
Print contrast	

DISPENSER PARA 14	
Dispenseposition	14
Start offset	14

SPECIAL FUNCTION	
Delete job	
Delete spooler	
Store Parameters	
Store Diagnosis	

SERVICE FUNCTION	
Head dot test	
Matend tolerance	

SERVICE DATA	
> MODULE FW VERS.	
System version	
System revision	
System date	
Bootloader	
uMon	
Feed driver	
Foil driver	
Head driver	
Peripheraldriver	29
Rewinder	29
USI interface	29
Dispenser lift	29
Dispenser feed	29

> OPERATION DATA	
Serv. operations	
Headnumber	
Roll number	
Cutter number	6
Head run length	
Roll run length	
Cuts on knife	6
Tot. mat. length	
Tot. foil length	
Total cuts	6
Total head moves	
Head strobes	

1. Only 64-xx dispenser with 4" printhead 2. Only if SYSTEM PARAMETER > Ribbon autoecon. = „On“, „On Turbo“ or „Thermal/headlift“ 3. Only with 8-Dot-Emulation 4. Only with 64-08 5. Only with rewinder option 6. Only with cutter 7. Only with USI interface 8. Only if SYSTEM PARAMETER > Gap detect. mode = Autom. feed back 9. Only with at least one data block stored in the flash memory 10. Only if SYSTEM PARAMETER > Print Interpret. = „ZPL Emulation“ 11. Only with I/O board 12. Only if PRINT PARAMETERS > Punch mode = Manual 13. Only in production mode 14. Only with 64-xx dispenser 15. Only if SYSTEM PARAMETER > Autom. dot check = Continuous 16. For details read parameter description 17. Only with 64-04/05/06 18. Only with installed RFID option 19. Only if DP INTERFACE > Interface type = USI Applicator 20. Only with SYSTEM PARAMETER > Dispensing edge = „User defined“ 21. Not with 64-xx dispenser 22. Only with an activated RFID option 24. With connected remote display only 25. With Applicator Interface only 26. Only OLV option activated 27. Depends on the applicator type 28. Only if INTERFACE PARA > NETWORK PARAM. > WEB server = „On“ 29. Availability depends on device conf. 30. Only with a CF card inserted 31. Only with a WLAN CF card inserted 32. Only if INTERFACE PARA > NETWORK PARAM. > Time client = „On“ 33. Only if SYSTEM PARAMETER > Periph. device = „Tear-off edge“ 34. Only if SYSTEM PARAMETER > Periph. device = „Dispenser“ 35. Only if DISPENSER PARA > Transport mode = „Dual motors“ 36. Only if DISPENSER PARA > Speed Adaption = „On“ 37. Only if DISPENSER PARA > Multi label mode = „x labels/start“ 38. Only if DISPENSER PARA > Multi label mode = „3 labels/start“ 39. Only PEM 39. Only if CPU board index is -06 or lower

(Service Data cont.)

Head temperature
Foil diameter
Dispensing cycl.
Operation time

> POWERSUPPLYDATA	
Type	
PS temperature	
Version	29
Serial number	29
Operation time	29
Total on time	29

> CPU BOARD DATA	
CPU identifier	
PCB revision	
FPGA version	
MAC address	
Serial number	
Production date	
PCB part number	
Board part numb.	
Manufacturer	13
Work place	13
Company name	13

(Service Data cont.)

> DISPLAY DATA	
Display version	
Display SerialNr	
Remote disp. vers.	24
Remote disp. #	24

> MEMORY DATA	
Ram memory size	
Flash mem size	
CompactFlash	30
SD card	30
USB	30
Space for Jobs	
Max. Labellength	
Default values	

1. Only 64-xx dispenser with 4" printhead 2. Only if SYSTEM PARAMETER > Ribbon autoecon. = „On“, „On Turbo“ or „Thermal/headlift“ 3. Only with 8-Dot-Emulation 4. Only with 64-08 5. Only with rewinder option 6. Only with cutter 7. Only with USI interface 8. Only if SYSTEM PARAMETER > Gap detect. mode = Autom. feed back 9. Only with at least one data block stored in the flash memory 10. Only if SYSTEM PARAMETER > Print Interpret. = „ZPL Emulation“ 11. Only with I/O board 12. Only if PRINT PARAMETERS > Punch mode = Manual 13. Only in production mode 14. Only with 64-xx dispenser 15. Only if SYSTEM PARAMETER > Autom. dot check = Continuous 16. For details read parameter description 17. Only with 64-04/05/06 18. Only with installed RFID option 19. Only if DP INTERFACE > Interface type = USI Applicator 20. Only with SYSTEM PARAMETER > Dispensing edge = „User defined“ 21. Not with 64-xx dispenser 22. Only with an activated RFID option 24. With connected remote display only 25. With Applicator Interface only 26. Only OLV option activated 27. Depends on the applicator type 28. Only if INTERFACE PARA > NETWORK PARAM. > WEB server = „On“ 29. Availability depends on device conf. 30. Only with a CF card inserted 31. Only with a WLAN CF card inserted 32. Only if INTERFACE PARA > NETWORK PARAM. > Time client = „On“ 33. Only if SYSTEM PARAMETER > Periph. device = „Tear-off edge“ 34. Only if SYSTEM PARAMETER > Periph. device = „Dispenser“ 35. Only if DISPENSER PARA > Transport mode = „Dual motors“ 36. Only if DISPENSER PARA > Speed Adaption = „On“ 37. Only if DISPENSER PARA > Multi label mode = „x labels/start“ 38. Only if DISPENSER PARA > Multi label mode = „3 labels/start“ 39. Only if CPU board index is -06 or lower

PRINT INFO	
Printer status	
Memory status	
Font status	
Flashdata status	9
Service status	
Dottest endless	
Dottest punched	
Reference label	
RFID status	22

PRINT PARAMETERS	
Print speed	
Feed speed	
Material type	
Material length	
Material width	
Print direction	
Punch offset	
Bar code Multip.	
Tradit. imaging	13
UPC plain-copy	
EAN Readline	
EAN sep. lines	
Rotated Barcodes	
Dispense Mode	33
Dispensposition	33
X – print offset	
Y – print offset	
Punch mode	
Punch level	12

INTERFACE PARA	
> EASYPLUGINTERPR	
Print interface	
Spooler mode	
Printer ID No.	
Spooler size	
Offline mode	
Interface delay	

> COM1 PORT	
Baud rate	
No. of data bits	
Parity	
Stop bits	
Data synchron.	
Frame error	

> COM2 PORT	
Baud rate	11
No. of data bits	11
Parity	11
Stop bits	11
Data synchron.	11
Serial Port Mode	11
Frame error	11

> COM4 PORT	
Baud rate	
No. of data bits	

(INTERFACE PARA cont.)	
Parity	
Data synchron.	
Stop bits	
Frame error	
> CENTRONICS	
PnP function	

> NETWORK PARAM.	
IP Address assign	
IP Address	
Net mask	
Gateway address	
Port address	
Ethernet speed	
MAC address	
FTP server	
FTP password	13
WEB server	
WEB admin passw.	13
WEB supervisor p.	13
WEB operator p.	13
Time client	
Time server IP	32
Sync. interval	32
Time zone	32
DHCP host name	
WLAN SSID	31

(INTERFACE PARA cont.)	
WLAN WEP	31
WLAN default key	31
WLAN 64Bit key 1	31
WLAN 64Bit key 2	31
WLAN 64Bit key 3	31
WLAN 64Bit key 4	31
WLAN 128Bit key 1	31
WLAN 128Bit key 2	31
WLAN 128Bit key 3	31
WLAN 128Bit key 4	31
WLAN com quality	31
WLAN signal lev.	31

> OPTIONEN	
OLV option	
RFID option	18
StandAlone Input	
#VW/I Interface	

> DRIVEASSIGNMENT	
Drive C	
Drive D	
Drive E	40
Drive F	

SYSTEM PARAMETER	
Speed unit	
Cover open error	
Foil end warning	
Foil warn stop	
Autom. dot check	
Early dottest	15
Latest dottest	15
Dottestarea from	15
Dottestarea to	15
Print Interpret.	
Character sets	
Character filter	
Light sens. type	
Head-sensor dist.	13
Ribbon autoecon.	
Ribb. eco. limit	2
Head down lead	13/2
Feed mode	
Turn-on mode	
Error reprint	
EasyPlug errors	
Single job mode	
Head resistance	13
Temp. reduction	
Voltage offset	
Expand Logo	3
Miss. label tol.	
Gap detect. mode	

1. Only 64-xx dispenser with 4" printhead 2. Only if SYSTEM PARAMETER > Ribbon autoecon. = „On“, „On Turbo“ or „Thermal/headlift“ 3. Only with 8-Dot-Emulation 4. Only with 64-08 5. Only with rewinder option 6. Only with cutter 7. Only with USI interface 8. Only if SYSTEM PARAMETER > Gap detect. mode = Autom. feed back 9. Only with at least one data block stored in the flash memory 10. Only if SYSTEM PARAMETER > Print Interpret. = „ZPL Emulation“ 11. Only with I/O board 12. Only if PRINT PARAMETERS > Punch mode = Manual 13. Only in production mode 14. Only with 64-xx dispenser 15. Only if SYSTEM PARAMETER > Autom. dot check = Continuous 16. For details read parameter description 17. Only with 64-04/05/06 18. Only with installed RFID option 19. Only if DP INTERFACE > Interface type = USI Applicator 20. Only with SYSTEM PARAMETER > Dispensing edge = „User defined“ 21. Not with 64-xx dispenser 22. Only with an activated RFID option 24. With connected remote display only 25. With Applicator Interface only 26. Only OLV option activated 27. Depends on the applicator type 28. Only if INTERFACE PARA > NETWORK PARAM. > WEB server = „On“ 29. Availability depends on device conf. 30. Only with a CF card inserted 31. Only with a WLAN CF card inserted 32. Only if INTERFACE PARA > NETWORK PARAM. > Time client = „On“ 33. Only if SYSTEM PARAMETER > Periph. device = „Tear-off edge“ 34. Only if SYSTEM PARAMETER > Periph. device = „Dispenser“ 35. Only if DISPENSER PARA > Transport mode = „Dual motors“ 36. Only if DISPENSER PARA > Speed Adaption = „On“ 37. Only if DISPENSER PARA > Multi label mode = „x labels/start“ 38. Only if DISPENSER PARA > Multi label mode = „3 labels/start“ 39. Only if PEM 39. Only if CPU board index is -06 or lower



64-xx – DPM – PEM – ALX 92x – ALX 73x (PMA)

(System Param. cont.)

Foil stretching	13
Head lift autom.	39
Mat. end detect.	
Periph. device	13*
Singlestartquant	
Dispensing Mode	33
Application mode	33
External signal	
Start print mode	
Apply key	13
Print contrast	
Ram disk size	
Font downl. area	
Free store size	
Print info mode	
Reprint function	
Language	
Keyboard	
Signal / buzzer	
Access authoriz.	
Realtime clock	
Material feed	

<b>DISPENSER PARA</b>	<b>34</b>
Head disp dist.	34
Dispense mode	34
Dispenseposition	34
Display mode	34
Dispense counter	34
Dispensing mode	34
Application mode	34
Max InitFeedback	34
Start offset	34
Start error stop	34
Product length	34
Speed Adaption	34
Encoder Type	34/36
Encoder Resol.	34/36
Encoder Diameter	34/36
Multi label mode	
Label 2 offset	34/37
Label 3 offset	34/38

<b>APPLICATOR PARA</b>	<b>25</b>
Applicator type	25
Application mode	25
Start print mode	25
Dwell time	25/27
Blow on time	25/28
Restart delay	25
Apply comp. time	25/27
Position timeout	25/33
Lab release time	25/27
Touch down sens.	25/27
TouchDownTimeout	25/27

<b>OLV PARAMETERS</b>	<b>26</b>
Verify mode	26
Cancel. printing	26
Reprint quantity	26
OLV mode	26
Ref Decode	26
Decodability	26
Modulation	26
Defects	26
Edge Contrast	26
Rmin/Rmax	26
Symbol Contrast	26
PCS	26
R (white)	26
R (black)	26
Ratio	26
ANSI Symbolgrade	26
Dist. head-beam	26

<b>DP INTERFACE</b>	<b>7</b>
Interface type	7
Start print mode	7
End print mode	7
Reprint signal	7
Ribbon signal	7
Material signal	7
Feed input	7
Pause input	7
Start error stop	7
Internal inputs	7
Apply mode	19
USI profile	26
Warning signal	7

<b>ZPL PARAMETERS</b>	<b>10</b>
Version	10
Darkness	10
Control Prefix	10
Format Prefix	10
Delimiter Char	10
Label Top	10
Left Position	10
Manual Calibrate	10
Resolution	10
Error Indication	10
Error Checking	10
305 DPI Scaling	10
Image Save Path	10
Command ^PR	10
Command ^MT	10
Label Invert	10
Command ^JM	10

\*) Counts only for ALX 92x/DPM

1. Only 64-xx dispenser with 4" printhead 2. Only if SYSTEM PARAMETER > Ribbon autoecon. = „On“, „On Turbo“ or „Thermal/headlift“ 3. Only with 8-Dot-Emulation 4. Only with 64-08 5. Only with rewinder option 6. Only with cutter 7. Only with USI interface 8. Only if SYSTEM PARAMETER > Gap detect. mode = Autom. feed back 9. Only with at least one data block stored in the flash memory 10. Only if SYSTEM PARAMETER > Print Interpret. = „ZPL Emulation“ 11. Only with I/O board 12. Only if PRINT PARAMETERS > Punch mode = Manual 13. Only in production mode 14. Only with 64-xx dispenser 15. Only if SYSTEM PARAMETER > Autom. dot check = Continuous 16. For details read parameter description 17. Only with 64-04/05/06 18. Only with installed RFID option 19. Only if DP INTERFACE > Interface type = USI Applicator 20. Only with SYSTEM PARAMETER > Dispensing edge = „User defined“ 21. Not with 64-xx dispenser 22. Only with an activated RFID option 24. With connected remote display only 25. With Applicator Interface only 26. Only OLV option activated 27. Depends on the applicator type 28. Only if INTERFACE PARA > NETWORK PARAM. > WEB server = „On“ 29. Availability depends on device conf. 30. Only with a CF card inserted 31. Only with a WLAN CF card inserted 32. Only if INTERFACE PARA > NETWORK PARAM. > Time client = „On“ 33. Only if SYSTEM PARAMETER > Periph. device = „Tear-off edge“ 34. Only if SYSTEM PARAMETER > Periph. device = „Dispenser“ 35. Only if DISPENSER PARA > Transport mode = „Dual motors“ 36. Only if DISPENSER PARA > Speed Adaption = „On“ 37. Only if DISPENSER PARA > Multi label mode = „x labels/start“ 38. Only if DISPENSER PARA > Multi label mode = „3 labels/start“ 39. Only PEM 39. Only if CPU board index is -06 or lower

64-xx – DPM – PEM – ALX 92x – ALX 73x (PMA)

I/O BOARD PARA	11
Start print mode	11
Reprint Signal	11
Feed	11
Pause input	11
Error output	11
Error polarity	11
Status output	11
Status polarity	11
End print mode	11

SPECIAL FUNCTION	
Printer type	13
Printhead type	13
Command Sequence	13
Delete job	
Delete spooler	
Factory settings	
Custom defaults	13
Store Parameters	
Store Diagnosis	
Gen.Support Data	
EasyPl. file log	30
Log files delete	30
Data blocks del.	9
RFID stat. del.	22

SERVICE FUNCTION	
Service	13
Head exchange	13
Roller exchange	13
Serv. data reset	13
Head dot test	
Head step tune	13
EasyPlug monitor	13
EP Monitor Mode	13
Head adjust	
Sensor adjust	13
Sensor test	
Cutter test	
Matend tolerance	
Feedadjust label	
Feed adjust	
Foil feed adjust	13
Punch Y calibr.	13
PS register	13
Scanner test	
Memory card test	
Send test	
Receive test	
Com2 comun. test	13
Com2 port test	13
Rewinder setup	
Rewinder values	
Print test	

SERVICE DATA	
> MODULE FW VERS.	
System version	
System revision	
System date	
Bootloader	
uMon	
Feed driver	
Foil driver	
Head driver	
Rewinder	29
USI interface	29
Applicator int.	29
> OPERATION DATA	
Serv. operations	
Headnumber	
Roll number	
Head run length	
Roll run length	
Tot. mat. length	
Tot. foil length	
Total head moves	
Head strobes	
Head temperature	
Foil diameter	
Dispensing cycl.	
Operation time	

(Service Data cont.)

> POWERSUPPLYDATA	
Type	
Version	29
Serial number	29
PS temperature	
Operation time	29
Total on time	29
> CPU BOARD DATA	
CPU identifier	
PCB revision	
FPGA version	
MAC address	
Serial number	
Production date	
PCB part number	
Board part numb.	
Manufacturer	13
Work place	13
Company name	13

> DISPLAY DATA	
Display version	
Display serialnr	
Remote disp. vers.	24
Remote disp. #	24

(Service Data cont.)

> MEMORY DATA	
Ram memory size	
Flash mem size	
CompactFlash	30
SD card	30
USB	30
Space for Jobs	
Max. Labellength	
Default values	

1. Only 64-xx dispenser with 4" printhead 2. Only if SYSTEM PARAMETER > Ribbon autoecon. = „On“, „On Turbo“ or „Thermal/headlift“ 3. Only with 8-Dot-Emulation 4. Only with 64-08 5. Only with rewinder option 6. Only with cutter 7. Only with USI interface 8. Only if SYSTEM PARAMETER > Gap detect. mode = Autom. feed back 9. Only with at least one data block stored in the flash memory 10. Only if SYSTEM PARAMETER > Print Interpret. = „ZPL Emulation“ 11. Only with I/O board 12. Only if PRINT PARAMETERS > Punch mode = Manual 13. Only in production mode 14. Only with 64-xx dispenser 15. Only if SYSTEM PARAMETER > Autom. dot check = Continuous 16. For details read parameter description 17. Only with 64-04/05/06 18. Only with installed RFID option 19. Only if DP INTERFACE > Interface type = USI Applicator 20. Only with SYSTEM PARAMETER > Dispensing edge = „User defined“ 21. Not with 64-xx dispenser 22. Only with an activated RFID option 24. With connected remote display only 25. With Applicator Interface only 26. Only OLV option activated 27. Depends on the applicator type 28. Only if INTERFACE PARA > NETWORK PARAM. > WEB server = „On“ 29. Availability depends on device conf. 30. Only with a CF card inserted 31. Only with a WLAN CF card inserted 32. Only if INTERFACE PARA > NETWORK PARAM. > Time client = „On“ 33. Only if SYSTEM PARAMETER > Periph. device = „Tear-off edge“ 34. Only if SYSTEM PARAMETER > Periph. device = „Dispenser“ 35. Only if DISPENSER PARA > Transport mode = „Dual motors“ 36. Only if DISPENSER PARA > Speed Adaption = „On“ 37. Only if DISPENSER PARA > Multi label mode = „x labels/start“ 38. Only if DISPENSER PARA > Multi label mode = „3 labels/start“ 39. Only if CPU board index is -06 or lower

64-xx – DPM – PEM – ALX 92x – ALX 73x (PMA)

PRINT PARAMETERS	SYSTEM PARAMETER	DISPENSER PARA 34	APPLICATOR PARA 25	SPECIAL FUNCTION	SERVICE FUNCTION
Print speed	Light sens. type	Dispenseposition 34	Dwell time 25/27	Delete job	Head dot test
Feed speed	Ribbon autoecon.	Start offset 34	Blow on time 25/27	Delete spooler	Matend tolerance
Material type	Ribbon eco. limit		Restart delay 25	Store Parameters	
Material length	Print contrast		Position timeout 25/27	Store Diagnosis	
Material width					
Print direction					
X – print offset					
Y – print offset					

1. Only 64-xx dispenser with 4" printhead 2. Only if SYSTEM PARAMETER > Ribbon autoecon. = „On“, „On Turbo“ or „Thermal/headlift“ 3. Only with 8-Dot-Emulation 4. Only with 64-08 5. Only with rewinder option 6. Only with cutter 7. Only with USI interface 8. Only if SYSTEM PARAMETER > Gap detect. mode = Autom. feed back 9. Only with at least one data block stored in the flash memory 10. Only if SYSTEM PARAMETER > Print Interpret. = „ZPL Emulation“ 11. Only with I/O board 12. Only if PRINT PARAMETERS > Punch mode = Manual 13. Only in production mode 14. Only with 64-xx dispenser 15. Only if SYSTEM PARAMETER > Autom. dot check = Continuous 16. For details read parameter description 17. Only with 64-04/05/06 18. Only with installed RFID option 19. Only if DP INTERFACE > Interface type = USI Applicator 20. Only with SYSTEM PARAMETER > Dispensing edge = „User defined“ 21. Not with 64-xx dispenser 22. Only with an activated RFID option 24. With connected remote display only 25. With Applicator Interface only 26. Only OLV option activated 27. Depends on the applicator type 28. Only if INTERFACE PARA > NETWORK PARAM. > WEB server = „On“ 29. Availability depends on device conf. 30. Only with a CF card inserted 31. Only with a WLAN CF card inserted 32. Only if INTERFACE PARA > NETWORK PARAM. > Time client = „On“ 33. Only if SYSTEM PARAMETER > Periph. device = „Tear-off edge“ 34. Only if SYSTEM PARAMETER > Periph. device = „Dispenser“ 35. Only if DISPENSER PARA > Transport mode = „Dual motors“ 36. Only if DISPENSER PARA > Speed Adaption = „On“ 37. Only if DISPENSER PARA > Multi label mode = „x labels/start“ 38. Only if DISPENSER PARA > Multi label mode = „3 labels/start“ 39. Only PEM 39. Only if CPU board index is -06 or lower

**SERVICE DATA**

(Service Data cont.)

(Service Data cont.)

> MODULE FW VERS.	
System version	
System revision	
System date	
Bootloader	
uMon	
Feed driver	
Foil driver	
Head driver	
Rewinder	29
USI interface	29
Applicator int.	29
> OPERATION DATA	
Serv. operations	
Headnumber	
Roll number	
Head run length	
Roll run length	
Tot. mat. length	
Tot. foil length	
Total head moves	
Head strobes	
Head temperature	
Foil diameter	
Dispensing cycl.	
Operation time	

> POWERSUPPLYDATA	
Type	
Version	29
Serial number	29
PS temperature	
Operation time	29
Total on time	29

> CPU BOARD DATA	
CPU identifier	
Syst. controller	
PCB revision	
MAC address	
Serial number	
Production date	
PCB part number	
Board part numb.	
Manufacturer	13
Work place	13
Company name	13

> DISPLAY DATA	
Display version	
Display serialnr	
Remote disp. vers.	24
Remote disp. #	24

> MEMORY DATA	
Ram memory size	
Flash mem size	
CompactFlash	30
SD card	30
USB	30
Space for Jobs	
Max. Labellength	
Default values	

1. Only 64-xx dispenser with 4" printhead 2. Only if SYSTEM PARAMETER > Ribbon autoecon. = „On“, „On Turbo“ or „Thermal/headlift“ 3. Only with 8-Dot-Emulation 4. Only with 64-08 5. Only with rewinder option 6. Only with cutter 7. Only with USI interface 8. Only if SYSTEM PARAMETER > Gap detect. mode = Autom. feed back 9. Only with at least one data block stored in the flash memory 10. Only if SYSTEM PARAMETER > Print Interpret. = „ZPL Emulation“ 11. Only with I/O board 12. Only if PRINT PARAMETERS > Punch mode = Manual 13. Only in production mode 14. Only with 64-xx dispenser 15. Only if SYSTEM PARAMETER > Autom. dot check = Continuous 16. For details read parameter description 17. Only with 64-04/05/06 18. Only with installed RFID option 19. Only if DP INTERFACE > Interface type = USI Applicator 20. Only with SYSTEM PARAMETER > Dispensing edge = „User defined“ 21. Not with 64-xx dispenser 22. Only with an activated RFID option 24. With connected remote display only 25. With Applicator Interface only 26. Only OLV option activated 27. Depends on the applicator type 28. Only if INTERFACE PARA > NETWORK PARAM. > WEB server = „On“ 29. Availability depends on device conf. 30. Only with a CF card inserted 31. Only with a WLAN CF card inserted 32. Only if INTERFACE PARA > NETWORK PARAM. > Time client = „On“ 33. Only if SYSTEM PARAMETER > Periph. device = „Tear-off edge“ 34. Only if SYSTEM PARAMETER > Periph. device = „Dispenser“ 35. Only if DISPENSER PARA > Transport mode = „Dual motors“ 36. Only if DISPENSER PARA > Speed Adaption = „On“ 37. Only if DISPENSER PARA > Multi label mode = „x labels/start“ 38. Only if DISPENSER PARA > Multi label mode = „3 labels/start“ 39. Only PEM 39. Only if CPU board index is -06 or lower

PRINT INFO	PRINT PARAMETERS	INTERFACE PARA	(INTERFACE PARA cont.)	(INTERFACE PARA cont.)	SYSTEM PARAMETER
Printer status	Print speed	> EASYPLUGINTERPR	Parity	WLAN default key 31	Cover open error
Memory status	Feed speed	Print interface	Data synchron.	WLAN 64Bit key 1 31	Foil end warning
Font status	Material type	Spooler mode	Stop bits	WLAN 64Bit key 2 31	Foil warn stop
Flashdata status 9	Material length	Printer ID No.	Frame error	WLAN 64Bit key 3 31	Autom. dot check
Service status	Material width	Spooler size		WLAN 64Bit key 4 31	Early dottest 15
Dottest endless	Print direction	Offline mode	> CENTRONICS	WLAN 128Bit key 1 31	Latest dottest 15
Dottest punched	Punch offset	Interface delay	PnP function	WLAN 128Bit key 2 31	Dottestarea from 15
Reference label	Bar code Multip.			WLAN 128Bit key 3 31	Dottestarea to 15
	Tradit. imaging 13	> COM1 PORT	> NETWORK PARAM.	WLAN 128Bit key 4 31	Print Interpret.
	UPC plain-copy	Baud rate	IP Addressassign	WLAN com quality 31	Character sets
	EAN Readline	No. of data bits	IP Address	WLAN signal lev. 31	Character filter
	EAN sep. lines	Parity	Net mask		Light sens. type
	Rotated Barcodes	Stop bits	Gateway address	> OPTIONEN	Head-sensor dist. 13
	X – print offset	Data synchron.	Port address	OLV option	Ribbon autoecon.
	Y – print offset	Frame error	Ethernet speed	RFID option 18	Ribbon eco. limit
	Punch mode		MAC address	StandAlone Input	Feed mode
	Punch level 12	> COM3 PORT 11	FTP server	#VW/I Interface	Turn-on mode
		Baud rate 11	FTP password 13		Error reprint
		No. of data bits 11	WEB server	> DRIVEASSIGNMENT	EasyPlug errors
		Parity 11	WEB admin passw. 13	Drive C	Single job mode
		Stop bits 11	WEB supervisor p. 13	Drive D	Head resistance 13
		Data synchron. 11	WEB operator p. 13	Drive E 40	Temp. reduction
		Serial Port Mode 11	Time client	Drive F	Voltage offset
		Frame error 11	Time server IP 32		Expand Logo 3
			Sync interval 32		Miss. label tol.
		> COM4 PORT	DHCP host name		Gap detect. mode
		Baud rate	WLAN SSID 31		Foil stretching 13
		No. of data bits	WLAN WEP 31		Head lift autom.

1. Only 64-xx dispenser with 4" printhead 2. Only if SYSTEM PARAMETER > Ribbon autoecon. = „On“, „On Turbo“ or „Thermal/headlift“ 3. Only with 8-Dot-Emulation 4. Only with 64-08 5. Only with rewriter option 6. Only with cutter 7. Only with USI interface 8. Only if SYSTEM PARAMETER > Gap detect. mode = Autom. feed back 9. Only with at least one data block stored in the flash memory 10. Only if SYSTEM PARAMETER > Print Interpret. = „ZPL Emulation“ 11. Only with I/O board 12. Only if PRINT PARAMETERS > Punch mode = Manual 13. Only in production mode 14. Only with 64-xx dispenser 15. Only if SYSTEM PARAMETER > Autom. dot check = Continuous 16. For details read parameter description 17. Only with 64-04/05/06 18. Only with installed RFID option 19. Only if DP INTERFACE > Interface type = USI Applicator 20. Only with SYSTEM PARAMETER > Dispensing edge = „User defined“ 21. Not with 64-xx dispenser 22. Only with an activated RFID option 24. With connected remote display only 25. With Applicator Interface only 26. Only OLV option activated 27. Depends on the applicator type 28. Only if INTERFACE PARA > NETWORK PARAM. > WEB server = „On“ 29. Availability depends on device conf. 30. Only with a CF card inserted 31. Only with a WLAN CF card inserted 32. Only if INTERFACE PARA > NETWORK PARAM. > Time client = „On“ 33. Only if SYSTEM PARAMETER > Periph. device = „Tear-off edge“ 34. Only if SYSTEM PARAMETER > Periph. device = „Dispenser“ 35. Only if DISPENSER PARA > Transport mode = „Dual motors“ 36. Only if DISPENSER PARA > Speed Adaption = „On“ 37. Only if DISPENSER PARA > Multi label mode = „x labels/start“ 38. Only if DISPENSER PARA > Multi label mode = „3 labels/start“ 39. Only if CPU board index is -06 or lower

64-xx – DPM – PEM – ALX 92x – ALX 73x (PMA)

(System Param. cont.)

	DP INTERFACE 7	ZPL PARAMETERS 10	I/O BOARD PARA 11	SPECIAL FUNCTION	SERVICE FUNCTION
Mat. end detect.	Interface type 7	Version 10	Start print mode 11	Printer type 13	Service 13
Periph. device 13/16	Start print mode 7	Darkness 10	Reprint Signal 11	Printhead type 13	Head exchange 13
Print contrast	End print mode 7	Control Prefix 10	Feed 11	Sensor type 13	Roller exchange 13
Ram disk size	Reprint signal 7	Format Prefix 10	Pause input 11	Command Sequence 13	Serv. data reset 13
Font downl. area	Ribbon signal 7	Delimiter Char 10	Error output 11	Delete job	Head dot test
Free store size	Material signal 7	Label Top 10	Error polarity 11	Delete spooler	Head step tune 13
Print info mode	Feed input 7	Left Position 10	Status output 11	Factory settings	EasyPlug monitor 13
Language	Pause input 7	Manual Calibrate 10	Status polarity 11	Custom defaults 13	EP Monitor Mode 13
Keyboard	Start error stop 7	Resolution 10	End print mode 11	Store Parameters	Head adjust
Signal / buzzer	Internal inputs 7	Error Indication 10		Store Diagnosis	Sensor adjust 13
Access authoriz.	Apply mode 19	Error Checking 10		Gen.Support Data	Sensor test
Realtime clock	USI profile 26	305 DPI Scaling 10		EasyPl. file log 30	Cutter test
	Warning signal 7	Image Save Path 10		Log files delete 30	Matend tolerance
		Command ^PR 10		Data blocks del. 9	Feedadjust label
		Command ^MT 10			Feed adjust
		Label Invert 10			Foil feed adjust 13
		Command ^JM 10			Punch Y calibr. 13
					PS register 13
					Scanner test
					Memory card test
					Send test
					Receive test
					Print test

1. Only 64-xx dispenser with 4" printhead 2. Only if SYSTEM PARAMETER > Ribbon autoecon. = „On“, „On Turbo“ or „Thermal/headlift“ 3. Only with 8-Dot-Emulation 4. Only with 64-08 5. Only with rewinder option 6. Only with cutter 7. Only with USI interface 8. Only if SYSTEM PARAMETER > Gap detect. mode = Autom. feed back 9. Only with at least one data block stored in the flash memory 10. Only if SYSTEM PARAMETER > Print Interpret. = „ZPL Emulation“ 11. Only with I/O board 12. Only if PRINT PARAMETERS > Punch mode = Manual 13. Only in production mode 14. Only with 64-xx dispenser 15. Only if SYSTEM PARAMETER > Autom. dot check = Continuous 16. For details read parameter description 17. Only with 64-04/05/06 18. Only with installed RFID option 19. Only if DP INTERFACE > Interface type = USI Applicator 20. Only with SYSTEM PARAMETER > Dispensing edge = „User defined“ 21. Not with 64-xx dispenser 22. Only with an activated RFID option 24. With connected remote display only 25. With Applicator Interface only 26. Only OLV option activated 27. Depends on the applicator type 28. Only if INTERFACE PARA > NETWORK PARAM. > WEB server = „On“ 29. Availability depends on device conf. 30. Only with a CF card inserted 31. Only with a WLAN CF card inserted 32. Only if INTERFACE PARA > NETWORK PARAM. > Time client = „On“ 33. Only if SYSTEM PARAMETER > Periph. device = „Tear-off edge“ 34. Only if SYSTEM PARAMETER > Periph. device = „Dispenser“ 35. Only if DISPENSER PARA > Transport mode = „Dual motors“ 36. Only if DISPENSER PARA > Speed Adaption = „On“ 37. Only if DISPENSER PARA > Multi label mode = „x labels/start“ 38. Only if DISPENSER PARA > Multi label mode = „3 labels/start“ 39. Only PEM 39. Only if CPU board index is -06 or lower

SERVICE DATA	
> MODULE FW VERS.	
System version	
System revision	
System date	
Bootloader	
uMon	
Feed driver	
Foil driver	
Head driver	
Rewinder	29
USI interface	29
Applicator int.	29
> OPERATION DATA	
Serv. operations	
Headnumber	
Roll number	
Head run length	
Roll run length	
Tot. mat. length	
Tot. foil length	
Total head moves	
Head strobes	
Head temperature	
Foil diameter	
Operation time	

(Service Data cont.)

> POWERSUPPLYDATA	
Type	
Version	29
Serial number	29
PS temperature	
Operation time	29
Total on time	29
> CPU BOARD DATA	
CPU identifier	
PCB revision	
FPGA version	
MAC address	
Serial number	
Production date	
PCB part number	
Board part numb.	
Manufacturer	13
Work place	13
Company name	13
> DISPLAY DATA	
Display version	
Display serialnr	
Remote disp. vers.	24
Remote disp. #	24

(Service Data cont.)

> MEMORY DATA	
Ram memory size	
Flash mem size	
CompactFlash	30
Space for Jobs	
Max. Labellength	
Default values	

1. Only 64-xx dispenser with 4" printhead 2. Only if SYSTEM PARAMETER > Ribbon autoecon. = „On“, „On Turbo“ or „Thermal/headlift“ 3. Only with 8-Dot-Emulation 4. Only with 64-08 5. Only with rewinder option 6. Only with cutter 7. Only with USI interface 8. Only if SYSTEM PARAMETER > Gap detect. mode = Autom. feed back 9. Only with at least one data block stored in the flash memory 10. Only if SYSTEM PARAMETER > Print Interpret. = „ZPL Emulation“ 11. Only with I/O board 12. Only if PRINT PARAMETERS > Punch mode = Manual 13. Only in production mode 14. Only with 64-xx dispenser 15. Only if SYSTEM PARAMETER > Autom. dot check = Continuous 16. For details read parameter description 17. Only with 64-04/05/06 18. Only with installed RFID option 19. Only if DP INTERFACE > Interface type = USI Applicator 20. Only with SYSTEM PARAMETER > Dispensing edge = „User defined“ 21. Not with 64-xx dispenser 22. Only with an activated RFID option 24. With connected remote display only 25. With Applicator Interface only 26. Only OLV option activated 27. Depends on the applicator type 28. Only if INTERFACE PARA > NETWORK PARAM. > WEB server = „On“ 29. Availability depends on device conf. 30. Only with a CF card inserted 31. Only with a WLAN CF card inserted 32. Only if INTERFACE PARA > NETWORK PARAM. > Time client = „On“ 33. Only if SYSTEM PARAMETER > Periph. device = „Tear-off edge“ 34. Only if SYSTEM PARAMETER > Periph. device = „Dispenser“ 35. Only if DISPENSER PARA > Transport mode = „Dual motors“ 36. Only if DISPENSER PARA > Speed Adaption = „On“ 37. Only if DISPENSER PARA > Multi label mode = „x labels/start“ 38. Only if DISPENSER PARA > Multi label mode = „3 labels/start“ 39. Only if CPU board index is -06 or lower

64-xx – DPM – PEM – ALX 92x – ALX 73x (PMA)

ALX 73x (PMA) op. Parameters

FW 6.60

PRINT INFO	PRINT PARAMETERS	SYSTEM PARAMETER	APPLICATOR PARA 25	SPECIAL FUNCTION	SERVICE FUNCTION
Printer status	Print speed	Light sens. type	Dwell time 25/27	Delete job	Head dot test
Memory status	Feed speed	Ribbon autoecon.	Blow on time 25/27	Delete spooler	Print test
Font status	Material type	Ribbon eco. limit	Restart delay 25	Store Parameters	
Flashdata status 9	Material length	Print contrast	Position timeout 25/27	Store Diagnosis	
Service status	Material width				
Dottest endless	Print direction				
Dottest punched	X – print offset				
Reference label	Y – print offset				

1. Only 64-xx dispenser with 4" printhead 2. Only if SYSTEM PARAMETER > Ribbon autoecon. = „On“, „On Turbo“ or „Thermal/headlift“ 3. Only with 8-Dot-Emulation 4. Only with 64-08 5. Only with rewinder option 6. Only with cutter 7. Only with USI interface 8. Only if SYSTEM PARAMETER > Gap detect. mode = Autom. feed back 9. Only with at least one data block stored in the flash memory 10. Only if SYSTEM PARAMETER > Print Interpret. = „ZPL Emulation“ 11. Only with I/O board 12. Only if PRINT PARAMETERS > Punch mode = Manual 13. Only in production mode 14. Only with 64-xx dispenser 15. Only if SYSTEM PARAMETER > Autom. dot check = Continuous 16. For details read parameter description 17. Only with 64-04/05/06 18. Only with installed RFID option 19. Only if DP INTERFACE > Interface type = USI Applicator 20. Only with SYSTEM PARAMETER > Dispensing edge = „User defined“ 21. Not with 64-xx dispenser 22. Only with an activated RFID option 24. With connected remote display only 25. With Applicator Interface only 26. Only OLV option activated 27. Depends on the applicator type 28. Only if INTERFACE PARA > NETWORK PARAM. > WEB server = „On“ 29. Availability depends on device conf. 30. Only with a CF card inserted 31. Only with a WLAN CF card inserted 32. Only if INTERFACE PARA > NETWORK PARAM. > Time client = „On“ 33. Only if SYSTEM PARAMETER > Periph. device = „Tear-off edge“ 34. Only if SYSTEM PARAMETER > Periph. device = „Dispenser“ 35. Only if DISPENSER PARA > Transport mode = „Dual motors“ 36. Only if DISPENSER PARA > Speed Adaption = „On“ 37. Only if DISPENSER PARA > Multi label mode = „x labels/start“ 38. Only if DISPENSER PARA > Multi label mode = „3 labels/start“ 39. Only PEM 39. Only if CPU board index is -06 or lower



<b>SERVICE DATA</b>	
> MODULE FW VERS.	
System version	
System revision	
System date	
Bootloader	
uMon	
Feed driver	
Foil driver	
Head driver	
Rewinder	29
USI interface	29
Applicator int.	29
> OPERATION DATA	
Serv. operations	
Headnumber	
Roll number	
Head run length	
Roll run length	
Tot. mat. length	
Tot. foil length	
Total head moves	
Head strobes	
Head temperature	
Foil diameter	
Dispensing cycl.	
Operation time	

(Service Data cont.)

> POWERSUPPLYDATA	
Type	
Version	29
Serial number	29
PS temperature	
Operation time	29
Total on time	29
> CPU BOARD DATA	
CPU identifier	
Syst. controller	
PCB revision	
MAC address	
Serial number	
Production date	
PCB part number	
Board part numb.	
Manufacturer	13
Work place	13
Company name	13
> DISPLAY DATA	
Display version	
Display serialnr	
Remote disp. vers.	24
Remote disp. #	24

(Service Data cont.)

> MEMORY DATA	
Ram memory size	
Flash mem size	
CompactFlash	30
Space for Jobs	
Max. Labellength	
Default values	

1. Only 64-xx dispenser with 4" printhead 2. Only if SYSTEM PARAMETER > Ribbon autoecon. = „On“, „On Turbo“ or „Thermal/headlift“ 3. Only with 8-Dot-Emulation 4. Only with 64-08 5. Only with rewinder option 6. Only with cutter 7. Only with USI interface 8. Only if SYSTEM PARAMETER > Gap detect. mode = Autom. feed back 9. Only with at least one data block stored in the flash memory 10. Only if SYSTEM PARAMETER > Print Interpret. = „ZPL Emulation“ 11. Only with I/O board 12. Only if PRINT PARAMETERS > Punch mode = Manual 13. Only in production mode 14. Only with 64-xx dispenser 15. Only if SYSTEM PARAMETER > Autom. dot check = Continuous 16. For details read parameter description 17. Only with 64-04/05/06 18. Only with installed RFID option 19. Only if DP INTERFACE > Interface type = USI Applicator 20. Only with SYSTEM PARAMETER > Dispensing edge = „User defined“ 21. Not with 64-xx dispenser 22. Only with an activated RFID option 24. With connected remote display only 25. With Applicator Interface only 26. Only OLV option activated 27. Depends on the applicator type 28. Only if INTERFACE PARA > NETWORK PARAM. > WEB server = „On“ 29. Availability depends on device conf. 30. Only with a CF card inserted 31. Only with a WLAN CF card inserted 32. Only if INTERFACE PARA > NETWORK PARAM. > Time client = „On“ 33. Only if SYSTEM PARAMETER > Periph. device = „Tear-off edge“ 34. Only if SYSTEM PARAMETER > Periph. device = „Dispenser“ 35. Only if DISPENSER PARA > Transport mode = „Dual motors“ 36. Only if DISPENSER PARA > Speed Adaption = „On“ 37. Only if DISPENSER PARA > Multi label mode = „x labels/start“ 38. Only if DISPENSER PARA > Multi label mode = „3 labels/start“ 39. Only if CPU board index is -06 or lower

## Alphabetical Parameter List

#VW/I Interface . . . . .	<a href="#">72</a>	Cut width . . . . .	<a href="#">51</a>	Drive E . . . . .	<a href="#">72</a>
305 DPI Scaling . . . . .	<a href="#">124</a>	Cuts on knife . . . . .	<a href="#">148</a>	Drive F . . . . .	<a href="#">73</a>
Access authoriz. . . . .	<a href="#">91</a>	Cutter exchange . . . . .	<a href="#">134</a>	Dwell time . . . . .	<a href="#">106</a>
ANSI symbol grade . . . . .	<a href="#">116</a>	Cutter number . . . . .	<a href="#">147</a>	EAN Readline . . . . .	<a href="#">45</a>
Application mode . . . . .	<a href="#">105</a>	Cutter test . . . . .	<a href="#">137</a>	EAN sep. lines . . . . .	<a href="#">45</a>
Application mode . . . . .	<a href="#">97</a>	Darkness . . . . .	<a href="#">122</a>	Early dottest . . . . .	<a href="#">75</a>
Applicator int. . . . .	<a href="#">146</a>	Data blocks del. . . . .	<a href="#">131</a>	EasyPl. file log . . . . .	<a href="#">130</a>
Applicator type . . . . .	<a href="#">104</a>	Data synch. . . . .	<a href="#">58</a>	EasyPlug error . . . . .	<a href="#">81</a>
Apply comp. time . . . . .	<a href="#">106</a>	Data synch. . . . .	<a href="#">59</a>	EasyPlug monitor . . . . .	<a href="#">136</a>
Apply key . . . . .	<a href="#">87</a>	Data synch. . . . .	<a href="#">60</a>	Edge contrast . . . . .	<a href="#">114</a>
Apply mode . . . . .	<a href="#">121</a>	Decodability . . . . .	<a href="#">114</a>	Encoder Diameter . . . . .	<a href="#">101</a>
Autom. dot check . . . . .	<a href="#">75</a>	Default Values . . . . .	<a href="#">128</a>	Encoder Resol. . . . .	<a href="#">101</a>
Backw feed rat. . . . .	<a href="#">102</a>	Default values . . . . .	<a href="#">154</a>	Encoder Type . . . . .	<a href="#">101</a>
Bar code multip. . . . .	<a href="#">43</a>	Defects . . . . .	<a href="#">114</a>	End print mode . . . . .	<a href="#">112</a>
Baud rate . . . . .	<a href="#">57</a>	Delete job . . . . .	<a href="#">128</a>	End print mode . . . . .	<a href="#">118</a>
Baud rate . . . . .	<a href="#">58</a>	Delete spooler . . . . .	<a href="#">129</a>	EP Monitor Mode . . . . .	<a href="#">136</a>
Baud rate . . . . .	<a href="#">60</a>	Delimiter Char . . . . .	<a href="#">122</a>	Error Checking . . . . .	<a href="#">124</a>
Blow on time . . . . .	<a href="#">106</a>	DHCP host name . . . . .	<a href="#">67</a>	Error Indication . . . . .	<a href="#">124</a>
Board part numb. . . . .	<a href="#">152</a>	Disp. Head Offs. . . . .	<a href="#">128</a>	Error output . . . . .	<a href="#">110</a>
Bootloader . . . . .	<a href="#">145</a>	Dispense counter . . . . .	<a href="#">97</a>	Error Polarity . . . . .	<a href="#">111</a>
Cancel. printing . . . . .	<a href="#">113</a>	Dispense Mode . . . . .	<a href="#">45</a>	Error reprint . . . . .	<a href="#">81</a>
Character filter . . . . .	<a href="#">79</a>	Dispense Mode . . . . .	<a href="#">94</a>	Ethernet speed . . . . .	<a href="#">62</a>
Character sets . . . . .	<a href="#">78</a>	Dispenseposition . . . . .	<a href="#">47</a>	Expand Logo . . . . .	<a href="#">83</a>
Com2 commun. test . . . . .	<a href="#">142</a>	Dispenseposition . . . . .	<a href="#">96</a>	External signal . . . . .	<a href="#">86</a>
Com2 port test . . . . .	<a href="#">142</a>	Dispenser feed . . . . .	<a href="#">147</a>	Factory settings . . . . .	<a href="#">129</a>
Command ^JM. . . . .	<a href="#">125</a>	Dispenser lift . . . . .	<a href="#">146</a>	Feed adjust . . . . .	<a href="#">137</a>
Command ^MT . . . . .	<a href="#">125</a>	Dispensing cycl. . . . .	<a href="#">149</a>	Feed driver . . . . .	<a href="#">145</a>
Command ^PR . . . . .	<a href="#">124</a>	Dispensing edge . . . . .	<a href="#">98</a>	Feed input . . . . .	<a href="#">110</a>
Command ^MD/~SD . . . . .	<a href="#">126</a>	Dispensing mode . . . . .	<a href="#">97</a>	Feed input . . . . .	<a href="#">119</a>
Command sequence . . . . .	<a href="#">128</a>	Display mode . . . . .	<a href="#">97</a>	Feed mode . . . . .	<a href="#">80</a>
CompactFlash . . . . .	<a href="#">153</a>	Display SerialNr . . . . .	<a href="#">152</a>	Feed speed . . . . .	<a href="#">40</a>
Company name . . . . .	<a href="#">152</a>	Display version . . . . .	<a href="#">152</a>	Feedadjust label . . . . .	<a href="#">137</a>
Control Prefix . . . . .	<a href="#">122</a>	Dist. head-beam . . . . .	<a href="#">116</a>	Flash mem size . . . . .	<a href="#">153</a>
Cover open error . . . . .	<a href="#">74</a>	Dottest endless . . . . .	<a href="#">37</a>	Flashdata status . . . . .	<a href="#">35</a>
CPU identifier . . . . .	<a href="#">151</a>	Dottest punched . . . . .	<a href="#">37</a>	Foil diameter . . . . .	<a href="#">149</a>
Custom defaults . . . . .	<a href="#">129</a>	Dottestarea from . . . . .	<a href="#">76</a>	Foil driver . . . . .	<a href="#">145</a>
Cut mode . . . . .	<a href="#">48</a>	Dottestarea to . . . . .	<a href="#">77</a>	Foil end warning . . . . .	<a href="#">74</a>
Cut position . . . . .	<a href="#">50</a>	Double cut . . . . .	<a href="#">50</a>	Foil feed adjust . . . . .	<a href="#">138</a>
Cut speed . . . . .	<a href="#">50</a>	Drive C . . . . .	<a href="#">72</a>	Foil stretching . . . . .	<a href="#">84</a>

64-xx – DPM – PEM – ALX 92x – ALX 73x (PMA)

Foil warn stop . . . . .	<a href="#">74</a>	Label 2 offset . . . . .	<a href="#">103</a>	Pause input . . . . .	<a href="#">110</a>
Font downl. area . . . . .	<a href="#">88</a>	Label 3 offset . . . . .	<a href="#">103</a>	Pause input . . . . .	<a href="#">120</a>
Font status . . . . .	<a href="#">32</a>	Label Invert. . . . .	<a href="#">125</a>	PCB part number . . . . .	<a href="#">152</a>
Format Prefix . . . . .	<a href="#">122</a>	Label Top . . . . .	<a href="#">123</a>	PCB revision . . . . .	<a href="#">151</a>
Forw. feed rat. . . . .	<a href="#">102</a>	Language . . . . .	<a href="#">90</a>	PCS . . . . .	<a href="#">115</a>
FPGA version . . . . .	<a href="#">151</a>	Latest dottest . . . . .	<a href="#">76</a>	Periph. device . . . . .	<a href="#">85</a>
Frame error . . . . .	<a href="#">58</a>	Left Position . . . . .	<a href="#">123</a>	Peripheraldriver . . . . .	<a href="#">146</a>
Frame error . . . . .	<a href="#">59</a>	Light sens. type . . . . .	<a href="#">79</a>	PnP function . . . . .	<a href="#">61</a>
Frame error . . . . .	<a href="#">60</a>	Log files delete . . . . .	<a href="#">131</a>	Port address . . . . .	<a href="#">62</a>
Free store size . . . . .	<a href="#">88</a>	MAC address . . . . .	<a href="#">151</a>	Position timeout . . . . .	<a href="#">107</a>
FTP password . . . . .	<a href="#">63</a>	MAC address . . . . .	<a href="#">62</a>	Print contrast . . . . .	<a href="#">87</a>
FTP server . . . . .	<a href="#">63</a>	Manual Calibrate . . . . .	<a href="#">123</a>	Print direction . . . . .	<a href="#">42</a>
Gap detect mode . . . . .	<a href="#">84</a>	Manufacturer . . . . .	<a href="#">152</a>	Print info mode . . . . .	<a href="#">90</a>
Gateway address . . . . .	<a href="#">62</a>	Mat. signal stop . . . . .	<a href="#">119</a>	Print interface . . . . .	<a href="#">55</a>
Gen.Support Data . . . . .	<a href="#">130</a>	Mat.end detect. . . . .	<a href="#">85</a>	Print Interpret. . . . .	<a href="#">77</a>
Head adjust. . . . .	<a href="#">136</a>	Matend tolerance . . . . .	<a href="#">137</a>	Print speed . . . . .	<a href="#">40</a>
Head disp dist. . . . .	<a href="#">86</a>	Material feed . . . . .	<a href="#">93</a>	Printer ID No. . . . .	<a href="#">56</a>
Head disp dist. . . . .	<a href="#">94</a>	Material length . . . . .	<a href="#">41</a>	Printer status . . . . .	<a href="#">30</a>
Head dot test . . . . .	<a href="#">135</a>	Material signal . . . . .	<a href="#">119</a>	Printer type . . . . .	<a href="#">127</a>
Head down lead . . . . .	<a href="#">80</a>	Material type . . . . .	<a href="#">41</a>	Printhead type . . . . .	<a href="#">127</a>
Head driver . . . . .	<a href="#">146</a>	Material width . . . . .	<a href="#">41</a>	Printtest . . . . .	<a href="#">143</a>
Head exchange . . . . .	<a href="#">134</a>	Max InitFeedback . . . . .	<a href="#">98</a>	Product length . . . . .	<a href="#">100</a>
Head lift autom. . . . .	<a href="#">84</a>	Max. Labellength . . . . .	<a href="#">154</a>	Production date . . . . .	<a href="#">151</a>
Head resistance . . . . .	<a href="#">82</a>	Memory card test . . . . .	<a href="#">139</a>	PS registers . . . . .	<a href="#">138</a>
Head run length . . . . .	<a href="#">147</a>	Memory status . . . . .	<a href="#">31</a>	PS temperature . . . . .	<a href="#">150</a>
Head step tune . . . . .	<a href="#">136</a>	Miss. label tol. . . . .	<a href="#">83</a>	Punch level . . . . .	<a href="#">54</a>
Head strobes . . . . .	<a href="#">149</a>	Modulation . . . . .	<a href="#">114</a>	Punch mode . . . . .	<a href="#">53</a>
Head temperature . . . . .	<a href="#">149</a>	Multi label mode . . . . .	<a href="#">103</a>	Punch offset . . . . .	<a href="#">42</a>
Headnumber . . . . .	<a href="#">147</a>	Net mask . . . . .	<a href="#">61</a>	Punch y calibr . . . . .	<a href="#">138</a>
Head-sensor dist. . . . .	<a href="#">79</a>	No. of data bits . . . . .	<a href="#">57</a>	Punch y calibr. . . . .	<a href="#">138</a>
Headvo. adj. 20 V . . . . .	<a href="#">143</a>	No. of data bits . . . . .	<a href="#">58</a>	R (black) . . . . .	<a href="#">115</a>
Headvo. adj. 28 V . . . . .	<a href="#">143</a>	No. of data bits . . . . .	<a href="#">60</a>	R (white) . . . . .	<a href="#">115</a>
Image Save Path . . . . .	<a href="#">124</a>	Offline mode . . . . .	<a href="#">56</a>	Ram disk size . . . . .	<a href="#">87</a>
Interface delay . . . . .	<a href="#">56</a>	OLV mode . . . . .	<a href="#">113</a>	Ram memory size . . . . .	<a href="#">153</a>
Interface type . . . . .	<a href="#">117</a>	OLV Option. . . . .	<a href="#">71</a>	Ratio . . . . .	<a href="#">116</a>
Internal inputs . . . . .	<a href="#">120</a>	On time . . . . .	<a href="#">151</a>	Realtime clock . . . . .	<a href="#">92</a>
IP address . . . . .	<a href="#">61</a>	Operation time . . . . .	<a href="#">149</a>	Receive test . . . . .	<a href="#">141</a>
IP addressassign . . . . .	<a href="#">61</a>	Parity . . . . .	<a href="#">57</a>	Ref Decode . . . . .	<a href="#">114</a>
Keyboard . . . . .	<a href="#">91</a>	Parity . . . . .	<a href="#">58</a>	Reference label . . . . .	<a href="#">38</a>
Lab release time . . . . .	<a href="#">107</a>	Parity . . . . .	<a href="#">60</a>	Remote disp. #. . . . .	<a href="#">153</a>

64-xx – DPM – PEM – ALX 92x – ALX 73x (PMA)

Remote disp. vers. . . . .	<a href="#">153</a>	Speed Adaption . . . . .	<a href="#">101</a>	uMon . . . . .	<a href="#">145</a>
Reprint function. . . . .	<a href="#">90</a>	Speed unit . . . . .	<a href="#">74</a>	UPC plain-copy . . . . .	<a href="#">44</a>
Reprint quantity. . . . .	<a href="#">113</a>	Spooler mode . . . . .	<a href="#">55</a>	USB . . . . .	<a href="#">154</a>
Reprint Signal . . . . .	<a href="#">109</a>	Spooler size . . . . .	<a href="#">56</a>	USI interface . . . . .	<a href="#">146</a>
Reprint signal . . . . .	<a href="#">118</a>	StandAlone Input . . . . .	<a href="#">71</a>	USI profile . . . . .	<a href="#">121</a>
Resolution. . . . .	<a href="#">123</a>	Standby+On time . . . . .	<a href="#">150</a>	Verify mode . . . . .	<a href="#">113</a>
Rest position. . . . .	<a href="#">51</a>	Start error stop . . . . .	<a href="#">120</a>	Version. . . . .	<a href="#">150</a>
Restart delay. . . . .	<a href="#">106</a>	Start error stop . . . . .	<a href="#">99</a>	Voltage offset. . . . .	<a href="#">83</a>
Rewind direction . . . . .	<a href="#">51</a>	Start offset . . . . .	<a href="#">99</a>	Warning signal. . . . .	<a href="#">121</a>
Rewinder adjust . . . . .	<a href="#">143</a>	Start print mode . . . . .	<a href="#">105</a>	WEB admin passw. . . . .	<a href="#">65</a>
Rewinder values . . . . .	<a href="#">144</a>	Start print mode . . . . .	<a href="#">109</a>	WEB display refr . . . . .	<a href="#">64</a>
Rewinder. . . . .	<a href="#">146</a>	Start print mode . . . . .	<a href="#">117</a>	WEB operator p. . . . .	<a href="#">66</a>
RFID Option . . . . .	<a href="#">71</a>	Start print mode . . . . .	<a href="#">86</a>	WEB server . . . . .	<a href="#">63</a>
RFID stat. del. . . . .	<a href="#">133</a>	Start source . . . . .	<a href="#">98</a>	WEB supervisor p. . . . .	<a href="#">65</a>
RFID Status . . . . .	<a href="#">39</a>	Status output . . . . .	<a href="#">111</a>	WLAN 128Bit key 1 . . . . .	<a href="#">69</a>
Ribbon autoecon. . . . .	<a href="#">79</a>	Status polarity. . . . .	<a href="#">111</a>	WLAN 128Bit key 2 . . . . .	<a href="#">70</a>
Ribbon economy limit . . . . .	<a href="#">80</a>	Stop bits . . . . .	<a href="#">57</a>	WLAN 128Bit key 3 . . . . .	<a href="#">70</a>
Ribbon signal . . . . .	<a href="#">118</a>	Stop bits . . . . .	<a href="#">59</a>	WLAN 128Bit key 4 . . . . .	<a href="#">70</a>
Rmin/Rmax. . . . .	<a href="#">115</a>	Stop bits . . . . .	<a href="#">60</a>	WLAN 64Bit key 1 . . . . .	<a href="#">69</a>
Roll number . . . . .	<a href="#">147</a>	Store Diagnosis . . . . .	<a href="#">130</a>	WLAN 64Bit key 2 . . . . .	<a href="#">69</a>
Roll run length. . . . .	<a href="#">148</a>	Store Parameters . . . . .	<a href="#">129</a>	WLAN 64Bit key 3 . . . . .	<a href="#">69</a>
Roller exchange . . . . .	<a href="#">134</a>	Symbol contrast . . . . .	<a href="#">115</a>	WLAN 64Bit key 4 . . . . .	<a href="#">69</a>
Rotated Barcodes. . . . .	<a href="#">52</a>	Sync. interval . . . . .	<a href="#">67</a>	WLAN com quality . . . . .	<a href="#">70</a>
Scanner test . . . . .	<a href="#">139</a>	System date . . . . .	<a href="#">145</a>	WLAN default key . . . . .	<a href="#">68</a>
SD card. . . . .	<a href="#">154</a>	System revision . . . . .	<a href="#">145</a>	WLAN signal lev. . . . .	<a href="#">70</a>
Send test. . . . .	<a href="#">140</a>	System version. . . . .	<a href="#">145</a>	WLAN SSID. . . . .	<a href="#">68</a>
Sensor adjust . . . . .	<a href="#">136</a>	Temp. reduction . . . . .	<a href="#">83</a>	WLAN WEP . . . . .	<a href="#">68</a>
Sensor test . . . . .	<a href="#">137</a>	Time client . . . . .	<a href="#">66</a>	Work place. . . . .	<a href="#">152</a>
Sensor type. . . . .	<a href="#">128</a>	Time server IP . . . . .	<a href="#">67</a>	X - Printadjust . . . . .	<a href="#">53</a>
Serial number . . . . .	<a href="#">150</a>	Time zone. . . . .	<a href="#">67</a>	Y – Printadjust . . . . .	<a href="#">53</a>
Serial number . . . . .	<a href="#">151</a>	Tot. foil length. . . . .	<a href="#">148</a>		
Serial Port Mode. . . . .	<a href="#">59</a>	Tot. mat. length . . . . .	<a href="#">148</a>		
Serv. data reset . . . . .	<a href="#">135</a>	Total cuts . . . . .	<a href="#">148</a>		
Serv. operations . . . . .	<a href="#">147</a>	Total head moves. . . . .	<a href="#">148</a>		
Service Status. . . . .	<a href="#">36</a>	Touch down sens. . . . .	<a href="#">107</a>		
Service . . . . .	<a href="#">134</a>	TouchDownTimeout. . . . .	<a href="#">107</a>		
Signal / buzzer . . . . .	<a href="#">91</a>	Tradit. Imaging . . . . .	<a href="#">43</a>		
Single job mode . . . . .	<a href="#">81</a>	Transport mode . . . . .	<a href="#">99</a>		
Singlestartquant . . . . .	<a href="#">86</a>	Turn-on mode. . . . .	<a href="#">81</a>		
Space for Jobs . . . . .	<a href="#">154</a>	Type . . . . .	<a href="#">150</a>		

## PRINT INFO

A material width of 100 mm is necessary to print the reports. The status print-out is approx. 200 mm long.

### Printer status

64-xx ALX 92x DPM PEM ALX 73x (PMA)

A protocol can be printed to get an overview of customer-specific parameter settings, see [1].

▣▣▣▣▣ Which parameters are listed, depends on the printer type.

Printer Status	Printer Status	Printer Status	Printer Status
<b>Printer type</b> : ALX 926 RH <b>Printhead type</b> : KCE 6Inch <b>System version</b> : V6.35 May 4 2010 <hr/> <b>Printer Parameter Menu</b> <hr/> <b>Print speed</b> : 8.0 Inch/s <b>Feed speed</b> : 8.0 Inch/s <b>Materialtype</b> : Endless <b>Materiallength</b> : 25.0 mm <b>Materialwidth</b> : 100.0 mm <b>Print direction</b> : Foot first <b>Punch offset</b> : 0.0 mm <b>Bar code multip.</b> : * 1 <b>UPC plain-copy</b> : In line <b>EAN Readline</b> : Standard <b>EAN sep. lines</b> : With readl. only <b>Rotated barcodes</b> : Optimized <b>Dispense Mode</b> : Real 1:1 mode <b>Dispenseposition</b> : 0.0 mm <b>X - Printadjust</b> : 0.0 mm <b>Y - Printadjust</b> : 0.0 mm <b>Punchmode</b> : Automatic <b>Punchlevel</b> : 128 <hr/> <b>Printer Interface Menu</b> <hr/> <b>Easyplug Interpreter</b> <hr/> <b>Interface</b> : TCP/IP SOCKET <b>Spooler mode</b> : Mult. print jobs <b>Printer ID no.</b> : 1 <b>Spooler size</b> : 64 KBytes <b>Offline mode</b> : Interf. disabled <b>Interface delay</b> : 0 ms <hr/> <b>COM1 Port Parameter</b> <hr/> <b>Baud rate</b> : 115200 Baud <b>No. of data bits</b> : 8 <b>Parity</b> : None <b>Stop bits</b> : 1 Bit	<b>Data synch.</b> : RTS/CTS <b>Frame error</b> : Display <hr/> <b>COM2 Port Parameter</b> <hr/> <b>Baud rate</b> : 115200 Baud <b>No. of data bits</b> : 8 <b>Parity</b> : None <b>Stop bits</b> : 1 Bit <b>Data synch.</b> : RTS/CTS <b>Frame error</b> : Display <hr/> <b>Centronics Port Parameter</b> <hr/> <b>PnP function</b> : On <hr/> <b>Ethernet Parameter</b> <hr/> <b>IP Addressassign</b> : DHCP <b>IP address</b> : 144.093.029.062 <b>Net mask</b> : 255.255.254.000 <b>Gateway address</b> : 144.093.028.001 <b>Port address</b> : 9100 <b>Ethernet speed</b> : Auto negotiation <b>SNMP Agent</b> : Disabled <b>FTP server</b> : Enabled <b>WEB server</b> : Enabled <b>WEB display refr</b> : 5 s <b>Time client</b> : Disabled <b>DHCP host name</b> : PEM06_050131 <b>MAC Address</b> : 00.0a.44.05.01.31 <hr/> <b>Options Parameter</b> <hr/> <b>OLV Option</b> : Disabled <b>RFID Option</b> : Disabled <b>StandAlone Input</b> : None <hr/> <b>Printer System Menu</b> <hr/> <b>Head disp dist.</b> : 24.5 mm <b>Speed unit</b> : Inch/s <b>Cover open error</b> : Immediately <b>Foil end warning</b> : 36.4 mm	<b>Foil warn stop</b> : Disabled <b>Display mode</b> : Job rest quant. <b>Dispense counter</b> : 0 <b>Autom. dot check</b> : Off <b>Print Interpret.</b> : Easyplug <b>Character sets</b> : IBM <b>Character filter</b> : Chars > = 20Hex <b>Light sens. type</b> : Punched <b>Ribbon autoecon.</b> : Disabled <b>Ribb. eco. limit</b> : 10.0 mm <b>Feed mode</b> : Head up <b>Turn-on mode</b> : Online <b>Error reprint</b> : Enabled <b>EasyPlug errors</b> : Tolerant handl. <b>Single-job mode</b> : Disabled <b>Head resistance</b> : 1000 Ohm <b>Temp. reduction</b> : 20 % <b>Voltage offset</b> : 0 % <b>Miss. label tol.</b> : 2 <b>Gap detect. mode</b> : Autom. forward <b>Mat. end detect.</b> : Transparent <b>Periph. device</b> : Tear-off edge <b>Singlestartquant</b> : 1 <b>Dispensing mode</b> : fast <b>Application mode</b> : Save mode <b>External signal</b> : Singlestart <b>Start print mode</b> : Pulse falling <b>Print contrast</b> : 60 % <b>Ram disk size</b> : 512 KBytes <b>Font downl. area</b> : 256 KBytes <b>Free store size</b> : 3072 KBytes <b>Print info mode</b> : Par.values right <b>Reprint function</b> : Disabled <b>Language</b> : English <b>Keyboard</b> : English <b>Signal / buzzer</b> : Off <b>Access authoriz.</b> : Deactivated <b>Realtime Clock</b> : 16.09.2010 09:54 <b>Material feed</b> : for- / backwards	<hr/> <b>Applicator Parameter Menu (AI B</b> <hr/> <b>Applicator type</b> : <b>Start print mode</b> : <b>Restart delay</b> : <hr/> <b>Internal Options</b> <hr/> <b>Default values</b> : <b>Com2 Option</b> :

[1] Example of printout „Printer status“.

#### Listed items:

- System version:
  - Shows the installed firmware version as well as the release date of this version.
  - Firmware version: R = firmware RISC processor, H = firmware H8 processor.
- Printer type:
  - Shows the printer type, which has been set using parameter `SERVICE FUNCTIONS > printer type` (e.g. 64-04)
  - "USA" displayed after the printer type indicates that the USA font is loaded.
  - "8DOT" displayed after the printer type indicates that the 8-Dot emulation is loaded.

- **Printer Parameter Menu**  
Shows the setting of the parameters in the `PRINT PARAMETERS` menu.
- **Printer Interface Menu**  
Shows the setting of the parameters in the `INTERFACE PARA` menu.
- **Printer system menu**  
Shows the setting of the parameters in the `SYSTEM PARAMETER` menu.
- **Dispenser Interface**  
Shows the setting of the parameters in the `DP INTERFACE` menu.
- **Internal Options**
  - **Default values:** Shows the values which are used in case of a factory reset (Standard or Default). See parameter `SPECIAL FUNCTION > Default Values`.
  - **Realtime Clock:** Shows the set time and date, if a realtime clock is installed. In case of a too low battery, the line "Battery empty" is added.
  - **2. com port:** Shows if an additional serial Interface is installed (not supported).

## Memory status

---

64-xx    ALX 92x    DPM    PEM    ALX 73x (PMA)

---

A memory protocol can be printed to provide an overview of the distribution of the available memory capacity (one page).

▣▣▣▣➔ The entries differ depending on printer type and configuration.

MEMORY STATUS	
<u>Internal Memory Configuration</u>	
Ram memory size	: 64 MB
Flash mem size	: 4 MB AMD
CompactFlash	: 117 MB / 128 MB
Space for Jobs	: 51.2 MB
Max. Labellength	: 8167 mm
Default values	: Standard
Space for spooler	: 64 KB
Space for RAM disc	: 512 KB
Font downl. area	: 256 KB
Free store size	: 3072 KB
<u>Logos on RAM disc</u>	
<u>Graphics on RAM disc</u>	
<u>Easyplug formats on Memory Card (C:)</u>	
Testjob.for	407 Bytes
<u>Logos on Memory Card (C:)</u>	
<u>Graphics on Memory Card (C:)</u>	

[2] Example of a „Memory status“ printout.

### Listed items:

- Internal Memory Configuration
- See paragraph > [MEMORY DATA](#) □ on page 152.

- Logos on RAM disc
  - Graphics on RAM disc
  - Fonts on RAM disc
- See „Plugin card manual“, topic section „Application“, chapter [CF/SD cards](#)

### Font status

64-xx	ALX 92x	DPM	PEM	ALX 73x (PMA)
-------	---------	-----	-----	---------------

Print samples of all installed characters, bar codes and line samples (several pages).

Page „Font Library“ shows a list of the internal fonts and line styles.

### Internal Fonts

- ➔ Use the Easy-Plug commands listed in the first column of the report (e.g. #YT100), to print using the appropriate font.
- Easy Plug commands: Refer to the Easy Plug Manual, topic section [Description of Commands](#) .
- For a list of all characters contained in the internal fonts, refer to the User Manual, topic section [Internal Fonts](#) .

FONT LIBRARY		
Number of Fonts : 20 (internal)		
EP. Cmd	Height	Font Sample
Y1100	0.83	0123456789ABCDEF0123456789ABCDEF0123456789ABCDEF
Y1101	1.33	0123456789ABCDEF0123456789ABCDEF0123456789ABCDEF
Y1102	1.50	0123456789ABCDEF0123456789ABCDEF0123456789ABCDEF
Y1103	2.00	0123456789ABCDEF0123456789ABCDEF0123456789ABCDEF
Y1104	2.82	0123456789ABCDEF
Y1105	1.50	0123456789ABCDEF0123456789ABCDEF0123456789ABCDEF
Y1106	2.00	0123456789ABCDEF0123456789ABCDEF0123456789ABCDEF
Y1107	2.82	0123456789ABCDE
Y1108	3.25	0123456789ABCDEF
Y1109	5.16	0123456789
Y1110	2.75	0123456789ABCDEF
Y1111	1.41	0123456789ABCDEF0123456789ABCDEF0123456789ABCDEF
Y1112	1.82	0123456789ABCDEF0123456789ABCDEF0123456789ABCDEF
Y1113	1.82	0123456789ABCDEF0123456789ABCDEF0123456789ABCDEF
Y1114	2.33	0123456789ABCDEF0123456789ABCDEF0123456789ABCDEF
Y1115	2.33	0123456789ABCDEF0123456789ABCDEF0123456789ABCDEF
Y1116	2.38	0123456789ABCDEF
Y1100	40 P	0123456789ABCDEF
Y1101	40 P	0123456789ABCDEF
Y1102	40 P	0123456789ABCDEF
Line Style	Line Sample	
Typ 0	—————	
Typ 1	- - - - -	
Typ 2	- - - - -	
Typ 3	.....	
Typ 4	- - - - -	
Typ 5	- - - - -	
Typ 6	- - - - -	
Typ 7	- - - - -	
Typ 8	- - - - -	
Typ 9	- - - - -	
Typ 10	.....	
Typ 11	.....	
Typ 12	.....	

[3] Print sample „Font Status“, section „Font Library“.

**Internal Line Styles**

➔ Use the line style number (first column) with one of the Easy Plug commands #YL or #YR to print lines in the matching style.

○ Easy Plug commands: Refer to the Easy Plug Manual, topic section [Description of Commands](#) .





























➔ Additionally, the following line styles are available:

- 13: Checked pattern with 3 dot edge length
- 14: Checked pattern with 1 mm edge length
- 15: Checked pattern with 5 mm edge length

➔ The line width has to be defined as a multiple of the edge length of the checked pattern!

**Internal bar codes**

The pages titled „Barcode Library“ show print samples of the internal bar codes (see [4], [5]).

BARCODE LIBRARY			BARCODE LIBRARY			BARCODE LIBRARY		
EasyPlug Nr.	Barcode Sample		EasyPlug Nr.	Barcode Sample		EasyPlug Nr.	Barcode Sample	
0	 12345670	EAN 8	14	 1 2 3 4 5 6 7 8 9 0	HSI	27	 00000000000000	CODE 128 Pharmacy
1	 1 234567 890128	EAN 13	15	 1234567890	EAN 128			
2	 1 2345678901 2	UPICA	16	 * 1 2 3 4 5 6 7 8 9 0 *	CODE 39 (2:1)			
3	 * 1 2 3 4 5 6 7 8 9 0 *	CODE 93	17	 Frachtpostkontrollnum 99 21348.075.016.40 1	POSTCODE (flatcode)			
4	 1234567890	CODE 2/5 Interleaved	18	 Deutsche Post AG Frachtpost 56.310.243.031 3	POSTCODE (flatcode)			
5	 1 2 3 4 5 6 7 8 9 0	CODE 2/5 Matrix	19	 1Z 321 652 10 0134 0098	CODE 128 (UPSI)			
6	 1 2 3 4 5 6 7 8 9 0	CODE 2/5 5 Sturche	20	 * 1 2 3 4 5 6 7 8 9 0 *	CODE 39 (2.5:1)			
7	 * 1 2 3 4 5 6 7 8 9 0 *	CODE 39	21	 1 2 3 4 5 6 7 8 9 0	CODE 2/5 Interleaved Ratio (1:3)			
8	 a 1 2 3 4 5 a	CODE 93	22	 1 2 3 4 5 6 7 8 9 0	CODE 2/5 Matrix Ratio (1:2.5)			
9	 1 234567 0	UPICE	23	 * 1 2 3 4 5 6 7 8 9 0 *	CODE 2/5 Matrix Ratio (1:3)			
10	 1 2	ADD DN 2	24	 1234567890	CODE 39 Extended			
11	 1 2 3 4 5	ADD DN 5	25	 1234567890	CODE 128 A			
12	 1 2 3 4 5 6 7 8 9 0	ITF	26	 1234567890	CODE 128 B			
13	 1234567890	CODE 128			CODE 128 C			

[4] Print sample „Font Status“, section „Barcode Library“.

- *Onedimensional bar codes* are printed with the Easy-Plug command #YB, see manual Easy-Plug, topic section [Description of Commands](#) .
- *Two-dimensional bar codes* are printed by means of special Easy-Plug commands:



Easy-Plug command	Bar code
#IDM	Data Matrix Code
#MXC	Maxi Code
#PDF	PDF 417
#CBF	Codabar F
#CFN	Code 49
#SQR	QR Matrix Code

[1] Internal, two-dimensional bar codes.

- **GS1 DataBar (formerly RSS) and Composite Component (CC) bar codes** are printed by means of the Easy-Plug command #RSS. The bar code is determined by the number in the first column of the subsequent table. This number is added to the command as a parameter.

**BARCODE LIBRARY**

EasyPlug Nr.	Barcode Sample	
#RSS1		GS1 Databar Omnidr.
#RSS2		GS1 Databar Truncated
#RSS3		GS1 Databar Stacked
#RSS4		GS1 Databar Stacked Omnidirectional
#RSS5		GS1 Databar Limited
#RSS6		GS1 Databar Expanded
#RSS7		UFC-A + CC-A/CC-B
#RSS8		UFC-E + CC-A/CC-B
#RSS9		EAN-13 + CC-A/CC-B
#RSS10		EAN-8 + CC-A/CC-B
#RSS11		UCC/EAN-128 + CC-A/CC-B
#RSS12		UCC/EAN-128 + CC-C

**BARCODE LIBRARY**

EasyPlug Nr.	Barcode Sample	
		Data Matrix Code
		Maxi Code
		PDF 417
		Codablock F
		Code 49
		QR Code

[5] Print sample „Font Status“, section „Font Library“: Listing of RSS-Codes and 2-dim. bar codes.

### Flashdata status

64-xx    ALX 92x    DPM    PEM    ALX 73x (PMA)

Prints a list of all fonts stored in the flash memory. This can be e. g. customized fonts or diagnose data.

- For details see topic section [Internal Fonts](#) , paragraph „Customized fonts“.
- For detailed information about diagnosis data refer to the service manual, topic section „Fault location“, „Reading out diagnosis data“.

FLASH DATA BLOCKS	
Total flash for data blocks	: 1872 KByte
Flash data block partition size	: 16 KByte
Number of flash data blocks	: 2
Remaining flash for data blocks	: 1104 KByte
<hr/>	
Block 0    Diagnostics information	128 KByte
<hr/>	
Block 1    MPCL Block	128 KByte
<hr/>	

[6] Example printout „Flashdata status“.

## Service Status

64-xx    ALX 92x    DPM    PEM    ALX 73x (PMA)

Print the Service status report to read about operation time, no. of services, no. of exchanged parts and other matters of service interest (one page).

Use the parameter `SERVICE FUNCTION > Serv. data reset`, to set all the counters to zero, which are listed on the printout.

Service Status	
<b>Operational Data</b>	
Service operations	: 4294967295
Head number	: 0
Roll number	: 0
Knife number	: 0
Head run length	: 0 m
Roll run length	: 0 m
Cuts on knife	: 9
Total material length	: 358429 m
Total foil length	: 358150 m
Total cuts	: 2187
Total head moves	: 2414
Head strokes	: 1922179
Foil diameter	: 44.5 mm
Operation time	: 20 hours 16 min
<b>Power supply data</b>	
Type:	: CME PSupply
<b>CPU board data</b>	
CPU identifier	: 34-16
System controller	: GT-64111
Board Revision	: REV04
<b>Peripheraldriver</b>	
Feed driver	: V3 - T3
Foil driver	: V3 - T3
Head driver	: V3 - T3
Peripheraldriver	: V3 - T3
USI interface	: V2 - T1

[7] Example of a „Service Status“ printout.

- For information on the operational data on the service status printout refer to paragraph > [OPERATION DATA](#) on page 146.
- For information on the power supply data on the service status printout refer to paragraph > [POWERSUPPLYDATA](#) on page 149.
- For information on the CPU board data on the service status printout refer to paragraph > [CPU BOARD DATA](#) on page 150.
- For information on the peripheral driver data on the service status printout refer to paragraph > [MODULE FW VERS.](#) on page 144.

## Dottest endless

64-xx	ALX 92x	DPM	PEM	ALX 73x (PMA)
-------	---------	-----	-----	---------------

Dottest for application with endless label stock.

This function prints a pattern which enables trained personnel to check the adjustment as well as the function of the printhead.

### Only in supervisor mode:

If no dot check has been proceeded (by calling the parameter `SERVICE FUNCTION > Head dot test`) since powering on the printer, a test is started before printing the status report. Depending on the result, one of the following messages is printed on the bottom margin of the label:

- "All print dots o.k."
- "x print dots defective"

➡ 64-08 printers don't proceed this dot check automatically, because this would be very time consuming. The printout shows the message:

- "Head Dot Test not yet executed"

If a dot test has already been performed since powering on the printer, the above showed messages are also displayed at 64-08 printers after proceeding a "Dottest endless" or „Dottest punched“.

- For information about the supervisor mode, see paragraph [Access authoriz.](#) on page 90

### Test pattern

The „Dottest endless“ or „Dottest punched“ prints a pattern consisting of 33 rows filled with vertical lines on the upper label area. All lines have a constant distance of 4 dot. With every new row, the line pattern is shifted one dot. The resulting line-pattern repeats every four rows.

The test pattern shows missing dots clearly as white vertical lines running through the pattern.

The lower label area is filled with testpatterns, which are kept close to those used by Kyocera. The patterns are useful for printout comparison.

The bars underneath the test pattern allow the adjustment of the different zero lines.

## Dottest punched

64-xx	ALX 92x	DPM	PEM	ALX 73x (PMA)
-------	---------	-----	-----	---------------

Dottest for application with punched material.

- See parameter [Dottest endless](#) on page 37.

### Reference label

64-xx	ALX 92x	DPM	PEM	ALX 73x (PMA)
-------	---------	-----	-----	---------------

Prints a label with some examples of barcodes, fonts, logos... just try out!

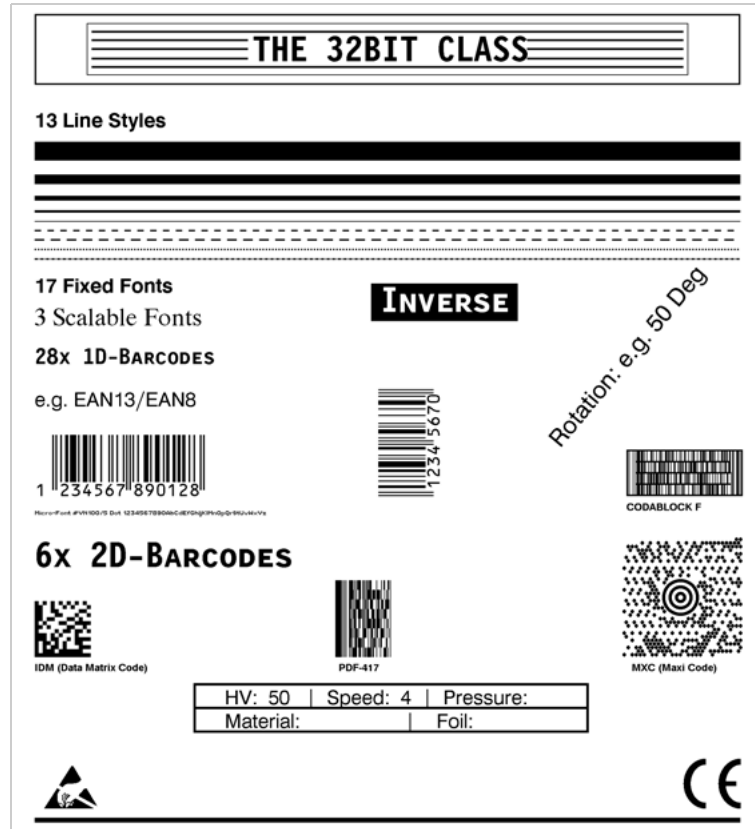

[8] Example of a Reference label printout (INFO AUSDRUCKEN > Reference label).

### RFID Status

▶ Only with activated RFID option.

64-xx    ALX 92x    DPM

Prints a status printout with RFID specific data:

RFID Status	
System version	: V4.00 Jun 23 2005 [R4.00 PE2.50 H4.00Q]
Printer type	: 64-05
Nr CMD retries	: 3
Nr invalid tags	: 3
<hr/>	
Statistics	
<hr/>	
Nr of Tags	: 7043
Nr. invalid tags	: 2788
Total Nr. SELECT	: 7803
Invalid SELECT	: 16%
Total Nr. READ	: 1189
Invalid READ	: 29%
Total Nr. WRITES	: 5483
Invalid WRITE	: 37%
Rate READ	: 45
Rate WRITE	: 46

[2] Example of a RFID status printout ( INFO AUSTRUCKEN > RFID Status).

## PRINT PARAMETERS

### Print speed

64-xx	ALX 92x	DPM	PEM	ALX 73x (PMA)
-------	---------	-----	-----	---------------

The print speed (material feed) can be adjusted according to the ribbon and material combination being used in order to optimise the contrast depth and the density of the print image.

x inch/s (mm/s)

Setting range: see table (tab. 3); Unit interval: 1 inch/s (5 mm/s)

Default setting: 8 inch/s

▣▣▣▣► DPM / PEM / ALX 92x / ALX 73x (PMA): Print speed can be set optionally in Inch/s or mm/s. The unit is selected with **SYSTEM PARAMETER > Speed unit**.

Printer	Print speed / feed speed	
	(mm/s)	(Inch/s)
64-04/05		2-16
6406		2-14
64-08		2-9
ALX 924/5, DPM 4/5", PEM 4/5", ALX 734/5 (PMA)	50-400	2-16
ALX 926, DPM 6", PEM 6", ALX 736 (PMA)	50-300	2-12

[3] The setting range of the print/feed speed depends on the printer type.

### Feed speed

64-xx	ALX 92x	DPM	PEM	ALX 73x (PMA)
-------	---------	-----	-----	---------------

Setting:

The value for the feed speed should not be set too high for print applications with long calculating units (e. g. consecutive numbering). This can help to avoid alternating between abrupt braking to 0 (zero) and acceleration to print speed.

▣▣▣▣► When altering the print speed, the feed speed is equal to the print speed. If a different feed speed is required, this must be set again.

x inch/s (mm/s)

Setting range: see table (tab. 3); Unit interval: 1 inch/s (5 mm/s)

Default setting: 8 inch/s

▣▣▣▣► DPM / PEM / ALX 92x / ALX 73x (PMA): Print speed can be set optionally in Inch/s or mm/s. The unit is selected with **SYSTEM PARAMETER > Speed unit**.

## Material type

64-xx	ALX 92x	DPM	PEM	ALX 73x (PMA)
-------	---------	-----	-----	---------------

Definition of the materials used. A distinction is made between reel material and gapped material (hole gaps, self-adhesive material with register gaps). The detected gap position corresponds to the start of the label.

▣▣▣▣➔ The value is overwritten by the appropriate Easy Plug command when sending label formats.

**Endless**

If material is to be used without gaps.

**Punched**

If material is to be used with gaps (default setting).

## Material length

64-xx	ALX 92x	DPM	PEM	ALX 73x (PMA)
-------	---------	-----	-----	---------------

The material length (label length) is the distance between the gaps, measured from the front edge (beginning) of a label to the front edge of the next label.

▣▣▣▣➔ The value is overwritten by the appropriate Easy Plug command when sending label formats.

**xxx mm**

Setting range: 5 mm to "max. length entry"; Unit interval: 0.1 mm

Default setting: 100 mm

Maximum length entry: dependent on the print head width and memory configuration.

## Material width

64-xx	ALX 92x	DPM	PEM	ALX 73x (PMA)
-------	---------	-----	-----	---------------

Zero position of the left border. If the printer is working in line-printer mode, alterations can be made in millimetre units.

**xxx mm**

Setting range: "min. width" to "max. width"; Unit interval: 0.1 mm

Default setting: 100 mm

- Min. width: dependent on the printer type
  - Max. width: dependent on print head width and memory configuration.
- For detailed material width information, refer to topic section „Specifications“.



## Print direction

64-xx	ALX 92x	DPM	PEM	ALX 73x (PMA)
-------	---------	-----	-----	---------------

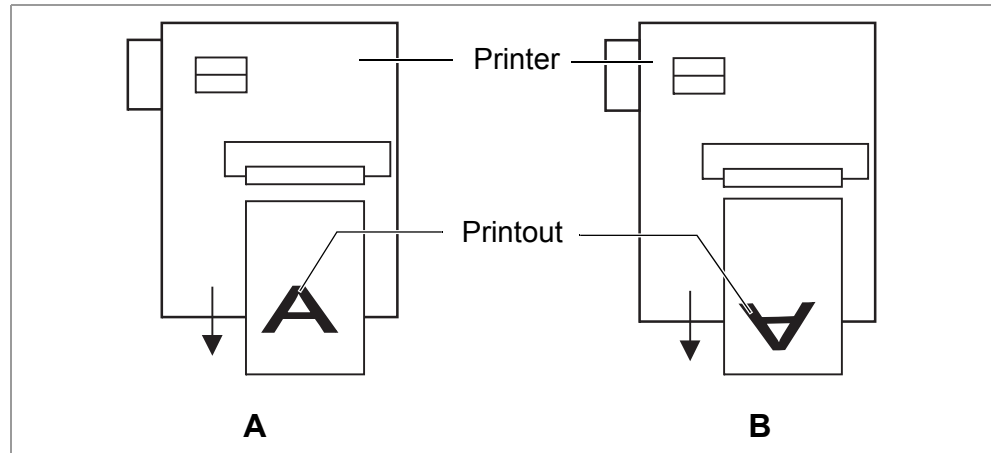

[9] Orientation of the printout „Foot first“ (A) or „Head first“ (B).

### Foot first

(Default) Orientation of the printout according to [9A].

### Head first

Orientation of the printout according to [9B]. Mind the following:

▣ Define the „true“ label length (without gap length) in parameter `PRINT PARAMETERS > Material length`. If the label gap is wider than 5 mm, the parameter `SYSTEM PARAMETER > Miss. label tol.` must be set to a value more than zero.

▣ The distance between material base line and the first printable dot is 1 mm. To keep this distance while printing „head first“, the material width must be calculated as follows::

$$b_{Mat} = b_{Bp} - 2mm, \text{ with}$$

$b_{Mat}$ : Material width

$b_{Bp}$ : Backing paper width

## Punch offset

64-xx	ALX 92x	DPM	PEM	ALX 73x (PMA)
-------	---------	-----	-----	---------------

The zero position can be determined offset in millimetre units from the detected gap position.

▣ The value is overwritten by the appropriate Easy Plug command when sending label formats.

Setting range: -8 to +max. label length; Unit interval: 0,1 mm

Default setting: 0 mm

Maximum offset in feed direction: -8 mm

Minimum offset against feed direction: +max. label length

xxx mm

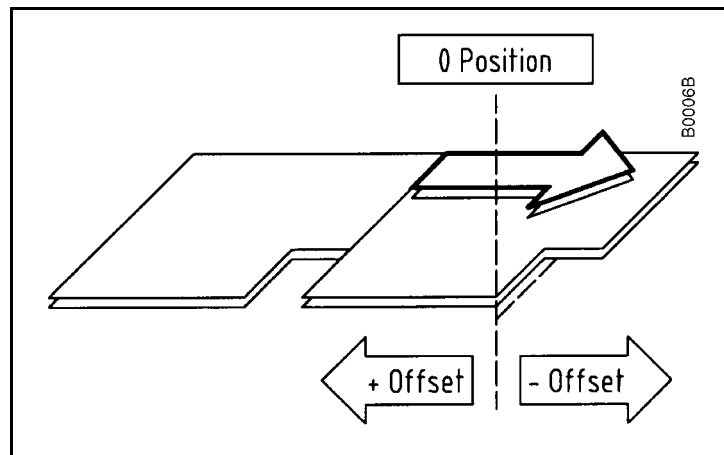

[10] Positive and negative offset in relation to the feed direction (arrow).

### Bar code multip.

64-xx	ALX 92x	DPM	PEM	ALX 73x (PMA)
-------	---------	-----	-----	---------------

Bar code height scaling factor

Increases the bar code height defined in the label layout (Easy-Plug) by multiplication by a factor of 1 to 10.

x

Setting range: 1 to 10; Unit interval: 1; Default setting: 1

The printed bar code height calculates starting with the value defined in the label layout multiplied by the scaling factor x.

### Tradit. Imaging

64-xx	ALX 92x	DPM	PEM	ALX 73x (PMA)
-------	---------	-----	-----	---------------

▣ In production mode only.

Up to firmware version x.31, the barcode height was calculated with the formula:

$$\text{Barcodeheight}_{Print} = (\text{Barcodeheight}_{Layout} + 1) \cdot x$$

with x = PRINT PARAMETERS > Barcode Multi.

By doing so, the printed barcode height in millimeters was by 1 higher than the value defined in the layout (1 --> 2 mm, 2 --> 3 mm, etc.)<sup>1)</sup>.

From firmware version x.31 on, the printed barcode is exactly as high in millimeters, as the value in the layout is (1 --> 1 mm, 2 --> 2 mm, etc.)<sup>1)</sup>.

No

New height calculation (1 --> 1 mm, 2 --> 2 mm, etc.) is applied (default setting).

The plain copy line is printed with OCR-B font.

Yes

Setting for customers with print layouts based on the *old* height calculation scheme.

1) Assumed that PRINT PARAMETERS > Barcode Multi. = „1“.

## 64-xx – DPM – PEM – ALX 92x – ALX 73x (PMA)

The plain copy line of the barcodes EAN8, EAN13, UPC-A and UPC-E is printed with the same fonts, which older printer types like TTK or TTX x50 have used.

**UPC plain-copy**

64-xx	ALX 92x	DPM	PEM	ALX 73x (PMA)
-------	---------	-----	-----	---------------

The position of the first and last digit in the plain-copy line - underneath the bar code - can be adjusted as required.

**Raised**

First and last digit of the UPCA or first digit with the UPCE are raised (default setting).

**In line**

All digits in the decoded line are in line under the code.

**EAN Readline**

64-xx	ALX 92x	DPM	PEM	ALX 73x (PMA)
-------	---------	-----	-----	---------------

**<> Signs**

Readline enclosed in "<>" signs or terminated by a ">"-Sign (EAN 13).

**Standard**

Readline without "<>" or ">" signs (default).

**EAN sep. lines**

64-xx	ALX 92x	DPM	PEM	ALX 73x (PMA)
-------	---------	-----	-----	---------------

EAN separation lines. Parameter for controlling of EAN or UPC barcodes if they are printed without readline.

**With readl. only**

(Default) The separation bars at the beginning, middle, and the end of the barcode are only long, if the barcode is printed with a readline.

**Always long**

The separation bars at the beginning, middle, and the end of the barcode are always long, regardless if the barcode is printed with or without readline. The position of the barcode is the same as with the readline option switched on.

**Dispense Mode**

64-xx	ALX 92x	DPM
-------	---------	-----

Governs the run of the print-dispense procedure.

▣ Only if `SYSTEM PARAMETER > Periph. device = „Tear-off edge“`.

▣ The ribbon autoeconomy function can only be used in "Real 1:1 Mode"!

**Dispense only**

With this setting, the printer can be used as a mere dispenser without processing print jobs. Set the material length before you use this function.

See parameter `PRINT PARAMETERS > Material length`.

After calling "Dispense only", the printer restarts; afterwards, the following is displayed:

Dispense only Labels	0
-------------------------	---

0 = Number of dispensed labels.

The parameters menu can be activated as usual after having switched to the offline mode by pressing the Online button two times.

### Normal 1:1 Mode

- The printer cannot print on the whole label surface. A stripe at the label beginning stays unprinted.
- The label is being dispensed while printing.
- The output volume is at its maximum level.

▣ The width of the unprintable stripe is calculated as follows:

*Distance print line to dispensing edge + Dispense position* (see [4])

Printer	Distance print line - dispensing edge
64-xx	39.8 mm (long dispensing edge) 24.2 mm (short dispensing edge)
AP 5.4	25.0 mm

[4] Distances between print line and dispensing edge for some printers.

- Also refer to parameter PRINT PARAMETERS > Dispense position.
- A graphic can be found under PRINT PARAMETERS > Cut mode > Normal 1:1 mode.

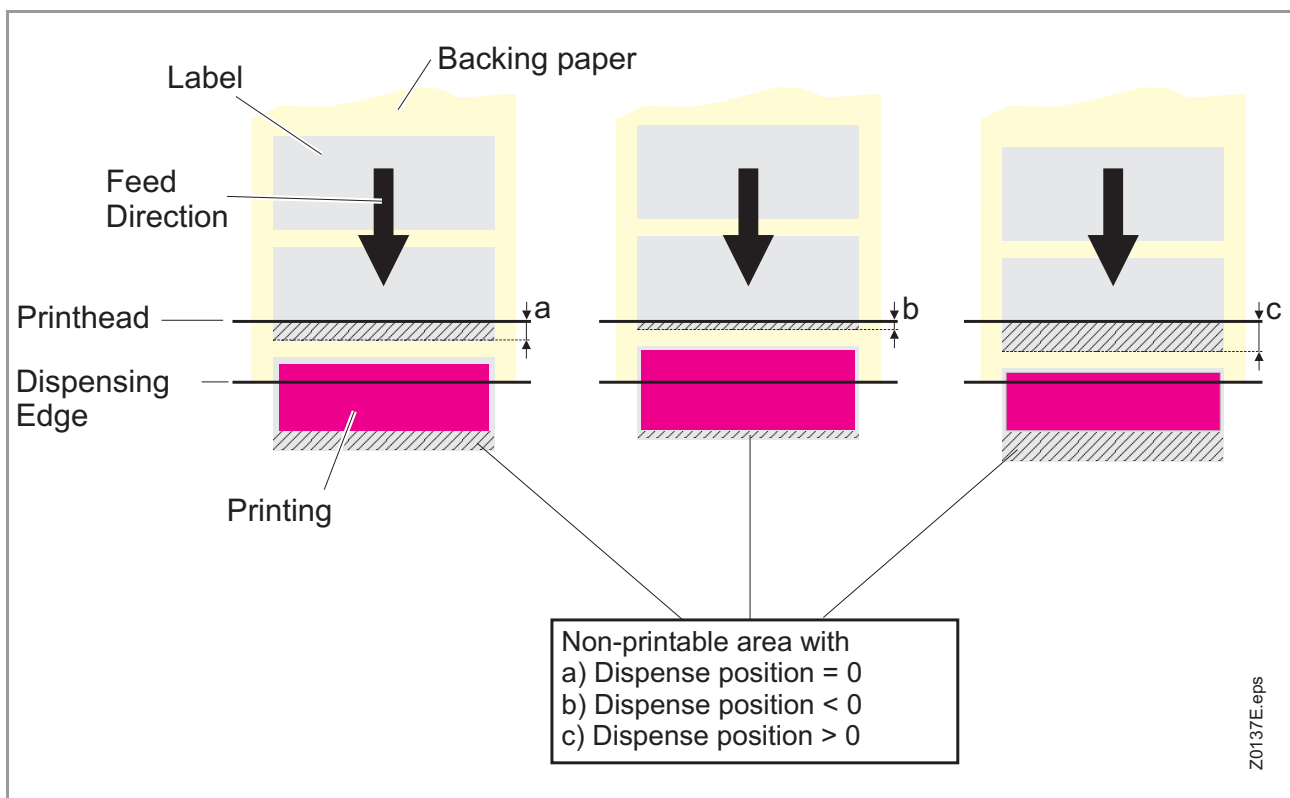

[11] The size of the not imprintable area in Normal 1:1 depends of the setting of parameter SYSTEM PARAMETER > Dispense Position.

**Batch Mode**

- The printer can print the whole label surface.
- Dispensing of the label takes place during printing. Printing of the next label is interrupted until the label is completely dispensed.
- The output volume is at its maximum level.

▣▣▣▣ The *Batch mode* is optimised for printing and dispensing at high speeds. Due to this, it is not possible to use all features available in modes *Normal 1:1* or *Real 1:1*. Also consider, that printing data must be available on time and in sufficient quantity.

▣▣▣▣ The following Job/Parameter-combinations must not be used:

- Jobs with counter fields
- Jobs with variable fields
- SYSTEM PARAMETER > Dispensing mode must be set to "fast".
- The USI reprint function is not supported. DP INTERFACE > Reprint signal must be set to "deactivated".
- Foil save

○ A graphic can be found under PRINT PARAMETERS > Cut mode > Batch mode.

**Real 1:1 Mode**

(Default setting)

- The printer can print the whole label surface.
- After dispensing a label, the beginning of the next label is drawn back under the print head.
- The output volume is lower than in *Batch Mode* or *Normal 1:1 Mode*.

○ A graphic can be found under PRINT PARAMETERS > Cut mode > Real 1:1 mode.

**Dispenseposition**

64-xx ALX 92x DPM

▣▣▣▣ Only with SYSTEM PARAMETER > Periph. device = „Tear-off edge“.

Dispense position

Adjusts the dispense position in or against the feed direction. Depending on the set dispense position, the dispensed label sticks to the backing paper with a more or less wide strip [12]. The required width of this strip depends on the further processing.

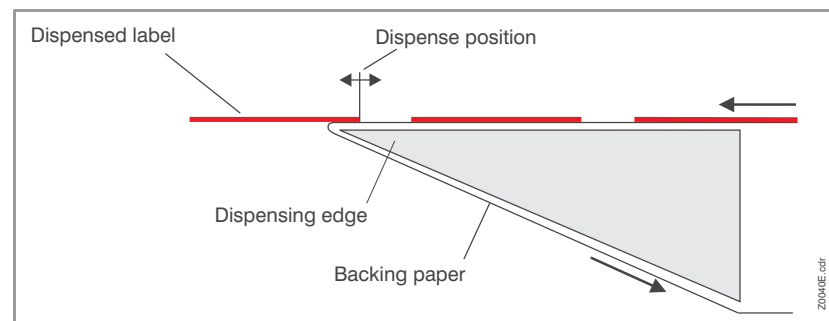

[12] Dispense position (= stop position) of the dispensed label.

x.x mm

Setting range: -30.0 to +20.0 mm; Unit interval: 0.1 mm; Default setting: -6.0 mm

## Cut mode

64-xx

► Only with mounted and activated cutter (SYSTEM PARAMETER > Periph. device = „Cutter“).

This is where the procedure for the label output and cut is defined.

### Real 1:1 mode

The whole surface of the label is printable. The label is pushed forward to the cutter for cutting. After the cut, the beginning of the next label is drawn back under the print head. This reduces the output volume (in relation to a certain time).

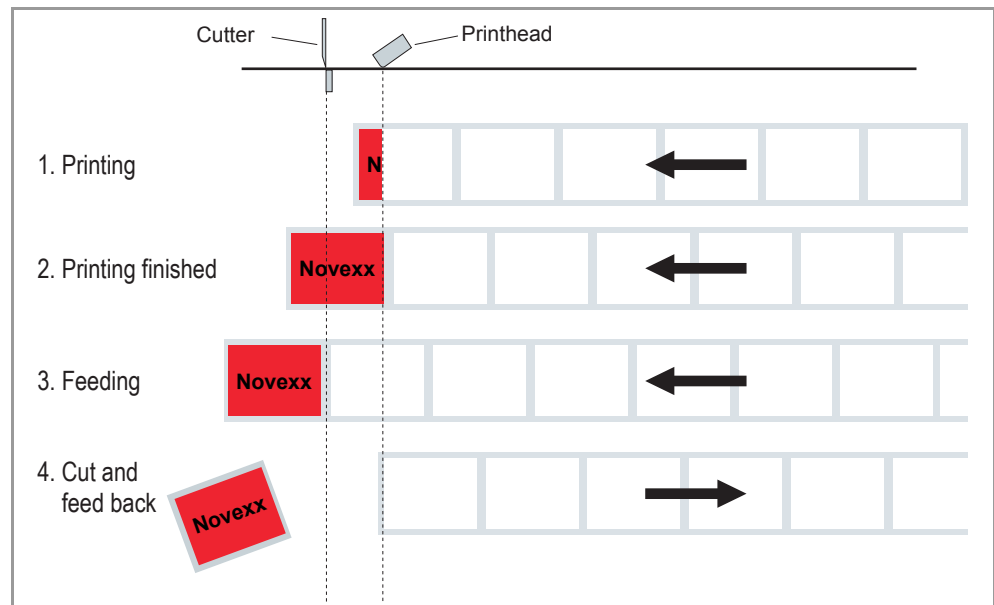

[13] Printing process (schematic) in „Real 1:1 Mode“.

**Batch mode**

The whole surface of the label is printable. Cutting takes place during printing. This can result in brief interruptions within the print zone of the following label. The output volume is at its maximum level.

Requirements for the batch mode are:

- Ribbon economy is not active (parameter `SYSTEM PARAMETER > Ribbon autoecon. = "Off"`)
- Material length >18 mm (>14 mm on the TTX 350)
- Number of cuts for a print job - at least 2 or more

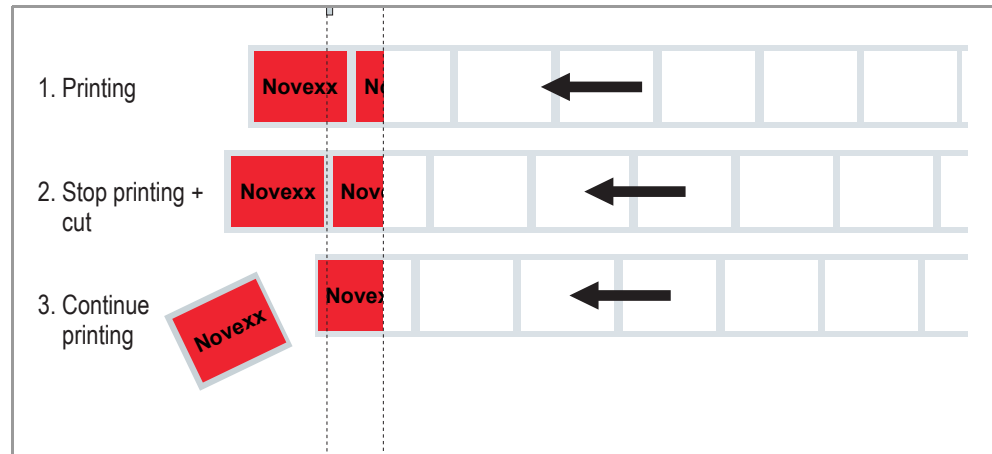

[14] Printing process in Batch mode (schematic).

**Normal 1:1 mode**

In N1:1 mode, cutting takes place during printing. The zero-line of the printing is shifted 18 mm in y-direction. This offset equals the distance cutter-print-head. Caused by this shifting, the first 18 mm of the label are not printable. These measurement corresponds to the distance between print head and cutter. The output volume is at its maximum level.

(The offset of the zero-line is caused historically and serves the compatibility of older printer models).

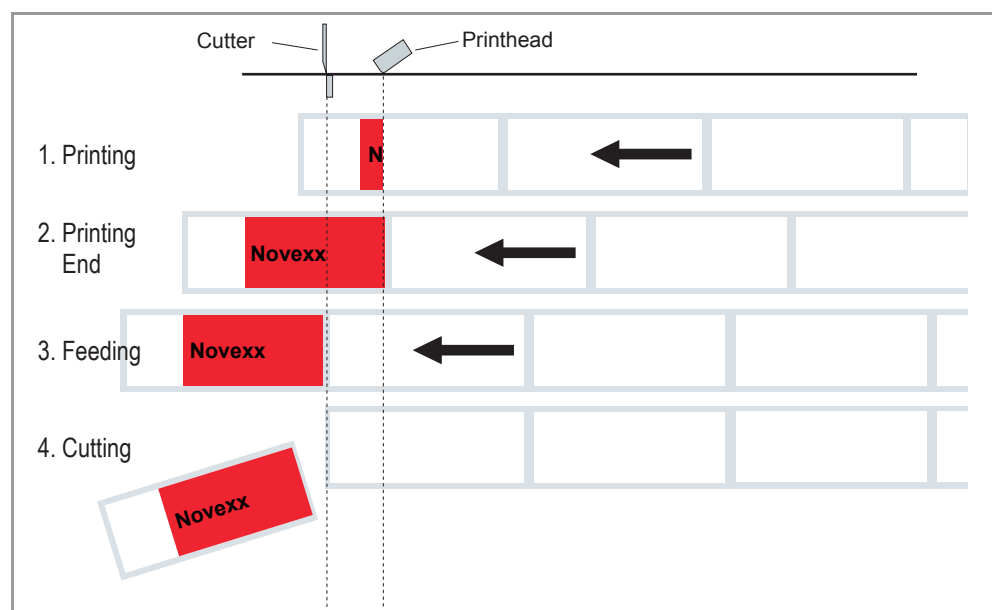

[15] Printing process in Normal 1:1 mode (schematic).

## Cut speed

---

64-xx

---

▣▣▣▣► Only with mounted and activated cutter (SYSTEM PARAMETER > Periph. device = „Cutter“).

The cut speed is to be adjusted to the material thickness and strength.

x

Setting range: 2 to 5; Unit interval: 1

- 2: extremely slow; for thick and strong material
- 5: extremely fast; for thin material

## Cut position

---

64-xx

---

▣▣▣▣► Only with mounted and activated cutter (SYSTEM PARAMETER > Periph. device = „Cutter“).

The cut position is identical to the detected gap position, i. e. with the start of the label. Fine settings to meet specific customer requirements can be programmed using the parameter PRINT PARAMETER > Cut position.

x inch/s

Setting range: -2.0 to +2.0 mm; Unit interval: 0.1mm

- Maximum offset in feed direction: -2.0 mm
- No offset: 0 mm
- Minimum offset against feed direction: -2.0 mm

## Double cut

---

64-xx

---

▣▣▣▣► Only with mounted and activated cutter (SYSTEM PARAMETER > Periph. device = „Cutter“).

Joining grids or the gap area between the labels can be removed using a double cut, thereby improving the outline.

The first cut is offset by the distance set from the recognized gap position away in the feed direction, the second cut is made at the gap position.

A possible correction of the cut position ("Cut position" function) is calculated for both cuts and must be taken into consideration.

x inch/s

Setting range: 0.0 to 5.0 mm; Unit interval: 0.1mm

Normal simple cut: 0.0 mm

▣▣▣▣► The smallest possible double cut distance of 1.0 mm must be adhered to!



## Rest position

---

 64-xx
 

---

▣▣▣▣► Only with mounted and activated cutter (SYSTEM PARAMETER > Periph. device = Cutter).

To avoid that the label material is wrapped around the print roller after a long idle time, the material rest position can be changed to „at cutter“.

at head

The material rest position in idle times is at the print head

at cutter

The material rest position in idle times is at the cutter to avoid material being wrapped around the print roller

## Cut width

---

 64-xx
 

---

▣▣▣▣► Only with mounted and activated cutter (SYSTEM PARAMETER > Periph. device = „Cutter“).

xxx

Setting range: 0 to MAX\_CUT\_WIDTH;

Default setting: MAX\_CUT\_WIDTH

The values for MAX\_CUT\_WIDTH depend on printer type and printhead:

Printer	MAX_CUT_WIDTH
64-04	106
64-05	128
64-06	160
64-08	213
AP 5.4 with 203 dpi	104
AP 5.4 with 300 dpi	105
AP 5.6 with 203 dpi	168
AP 5.6 with 300 dpi	167

▣▣▣▣► The values for MAX\_CUT\_WIDTH don't equate to the real cut width (no linear relation between value and cut width). The proper setting value has to be determined by trying.

## Rewind direction

---

 64-xx
 

---

▣▣▣▣► Only with mounted and activated (external) rewinder (SYSTEM PARAMETERS > Periph. device = „Rewinder“). Determines the sense of rotation of the optional Rewinder.

Printing outside

Rewind direction: The printed label is facing *outside*.

Printing inside

Rewind direction: The printed label is facing *inside*.

### Rotated Barcodes

---

64-xx	ALX 92x	DPM	PEM	ALX 73x (PMA)
-------	---------	-----	-----	---------------

---

Improves readability of rotated (90° and 270°) bar codes.

**Normal**

„Normal“ printing without special processing of rotated bar codes.

**Optimized**

(Default setting) The line and gap widths of rotated bar codes are modified to improve readability.

## X - Printadjust

64-xx	ALX 92x	DPM	PEM	ALX 73x (PMA)
-------	---------	-----	-----	---------------

The zero point of the mask is moved in relation to the edge of the label on the X- axis, i. e. lengthways to the material.

▣▣▣▣ If the setting is changed, while the print job is stopped, the printer recalculates the format using the changed values.

▣▣▣▣ Caution with graphics, which are generated via one of the Easy Plug commands #YI, #YIR or #YIB! If the graphics is shifted beyond the label border as a consequence of changing the parameter "X-Printadjust", the part of the graphics which "juts out" will get lost.

x.x mm

Setting range: -15.0 to +15.0 mm; Unit interval: 0.1mm

Default setting: 0.0 mm

- Maximum offset away from the edge of the label: +15.0 mm
- No offset: 0.0mm
- Maximum offset towards the edge of the label: -15.0 mm

## Y – Printadjust

64-xx	ALX 92x	DPM	PEM	ALX 73x (PMA)
-------	---------	-----	-----	---------------

The zero point of the mask is moved in relation to the gap position on the Y-axis, i. e. in the feed direction.

▣▣▣▣ If the setting is changed, while the print job is stopped, the printer recalculates the format using the changed values.

▣▣▣▣ Caution with graphics, which are generated via one of the Easy Plug commands #YI, #YIR or #YIB! If the graphics is shifted beyond the label border as a consequence of changing the parameter "Y-Printadjust", the part of the graphics which "juts out" will get lost.

x.x mm

Setting range: -15.0 to +15.0 mm; Unit interval: 0.1mm

Default setting: 0.0 mm

- Maximum offset in feed direction: +15.0 mm
- No offset: 0.0mm
- Minimum offset against feed direction: -15.0 mm

## Punch mode

64-xx	ALX 92x	DPM	PEM	ALX 73x (PMA)
-------	---------	-----	-----	---------------

Automatic

Automatic mode, for material with a contrast zone = gap in the label.

"Automatic" is the default setting, suitable for all materials with which there is a difference in the transparency between the label and gap of more than 2 values (see Description, sensor check).

Manual

Manual setting, for material with several varying contrast zones. Settings are made using the parameter `PRINT PARAMETERS > Punch level`.

The range of the value automatically measured by the gap detection can be defined specifically for the label material. This allows materials with high-contrast proof points within the label to be processed, which would otherwise be measured as 'false' gaps by the system. The corresponding setting value is then equal to, or smaller than, the value measured at the actual gap.

### Punch level

64-xx	ALX 92x	DPM	PEM	ALX 73x (PMA)
-------	---------	-----	-----	---------------

▣▣▣▣➔ Only if PRINT PARAMETERS > Punch mode = „Manual“.

xxx

Setting range: 0 to 255; Unit interval: 1

The value xxx stands for the current contrast within the photoelectric switch of the material which has just been inserted. This serves to determine a threshold value for the inserted material.

```
Punch level
Punch xxx Val yyy
```

xxx = current measurement at the punch sensor

yyy = set threshold value

### Example

Self-adhesive material with black bars lengthways across the label

- Reading:
  - Masking paper: 30
  - Masking paper + label: 60
  - Masking paper + label + black bars: 190
- Setting value: 60
 

A setting value of 60 means that all readings over 60 are ignored, therefore also the reading 190 at the black bar.

## INTERFACE PARA

Interface parameter

### > EASYPLUGINTERPR

#### Print interface

64-xx	ALX 92x	DPM	PEM	ALX 73x (PMA)
-------	---------	-----	-----	---------------

This parameter sets the interface, by which the printer will receive data.

**Serial Com1**

Serial interface Com1.

**Centronics**

Parallel interface

▣▣▣▣ Only with installed Centronics adapter board.

**Only for Ethernet interface (10/100 Base T):**

**TCP/IP Socket**

Print data can be sent to the printer via a TCP/IP socket

**LPD Server**

Print data can be sent to the printer via the LPR/LPD-protocol

**USB**

USB interface

**Serial Com3**

Serial interface Com3.

▣▣▣▣ Only with optional I/O board mounted.

▣▣▣▣ Selection of the type of serial interface is done with parameter `INTERFACE PARA > >COM PORT > Serial Port Mode`

**Automatic**

(Default setting) All interfaces are enabled to receive data, but *not simultaneously*.

▣▣▣▣ Don't send data to more than one interface at a time.

▣▣▣▣ Except are interfaces, which are being used by an option (e.g. OLV).

#### Spooler mode

64-xx	ALX 92x	DPM	PEM	ALX 73x (PMA)
-------	---------	-----	-----	---------------

The operating mode of the spooler determines whether print series are processed individually, or whether the spooler can receive print data when printing several series.

**Single print job**

Single print series mode (the interface can only receive data after printing the required number of labels of a single series)

**Mult. print jobs**

Multiple print series mode (the interface can receive data while the series is being printed)

**Printer ID No.**

64-xx	ALX 92x	DPM	PEM	ALX 73x (PMA)
-------	---------	-----	-----	---------------

Printer identification number

Determines the identification number of the printer. In such a way, the printer can be addressed by the Easy Plug command #!An (n=printer ID).

The use of ID numbers is in particular reasonable for data transfer by RS422/485 interface, if several printers are connected by one data line. Each of the connected printers then only incorporates the data mapped to him by #!An command.

**xx** Setting range: 0 to 31; Unit interval: 1

**Spooler size**

64-xx	ALX 92x	DPM	PEM	ALX 73x (PMA)
-------	---------	-----	-----	---------------

The memory capacity of the printer buffer can be set according to the requirements of each customer.

**xxx Kbyte** Unit interval: 16-2048 kBytes; step width: 16 kBytes; default setting: 64 kBytes

**Offline mode**

64-xx	ALX 92x	DPM	PEM	ALX 73x (PMA)
-------	---------	-----	-----	---------------

**Interf. disabled** Easy-Plug commands are *not* accepted, while the machine is in offline mode (default setting).

**Interf. enabled** Easy-Plug commands *are* accepted in offline mode.

**Interface delay**

64-xx	ALX 92x	DPM	PEM	ALX 73x (PMA)
-------	---------	-----	-----	---------------

☛ Only visible, if INTERFACE PARA >EASYPLUGINTERPR > Offline mode = „Interf. enabled“

After switching from online to offline mode, the printer interface is deactivated. This parameter offers a settable delay time before deactivating the interface.

**xxxx ms** Setting range: 0-1000; Unit interval: 100; Default setting: 0

**> COM1 PORT****Baud rate**

64-xx	ALX 92x	DPM	PEM	ALX 73x (PMA)
-------	---------	-----	-----	---------------

**Data transfer speed**

Speed of data transfer using the serial interface.

**xxxxxx Baud**

Setting range: 300 to 115200 Baud; Unit interval: 300/600/1200/2400/4800/9600/19200/38400/115200 (default)

**No. of data bits**

64-xx	ALX 92x	DPM	PEM	ALX 73x (PMA)
-------	---------	-----	-----	---------------

This parameter can be defined in connection with both the serial and the parallel interface.

**7**

7 Data bits

**8**

8 Data bits

**Parity**

64-xx	ALX 92x	DPM	PEM	ALX 73x (PMA)
-------	---------	-----	-----	---------------

Defines the parity check of serial transmitted data.

The parity bit is for checking data transmission. If the check shows an error, a corresponding message is displayed. The setting must be identical at the sender and the receiver. Normally transmission is set without a parity bit.

**Odd**

Odd parity.

A parity bit is added so that there is an odd number of 1 Bits.

**Even**

Even parity.

A parity bit is added so that there is an even number of 1 Bits.

**None**

No check bit. Sending and receiving without check bit.

**Always zero**

Check bit is always 0 (zero). Sending and receiving without parity check.

**Stop bits**

64-xx	ALX 92x	DPM	PEM	ALX 73x (PMA)
-------	---------	-----	-----	---------------

**Number of stop bits****1 Bit**

1 stop bit

**2 Bit**

2 stop bits

**Data synch.**

64-xx	ALX 92x	DPM	PEM	ALX 73x (PMA)
-------	---------	-----	-----	---------------

Data synchronisation at the serial interface.

**RTS/CTS**

Data synchronisation through hardware

**XON/XOFF**

Data synchronisation through software

**None**

Handshake signals are ignored

**Frame error**

64-xx	ALX 92x	DPM	PEM	ALX 73x (PMA)
-------	---------	-----	-----	---------------

**Display**

(Default) An error message is displayed, if a framing error is detected while the printer is receiving serial data.

**Ignore**

Framing errors will be ignored, no error messages are displayed.

**> COM3 PORT**

▣▣▣▣ This menu only appears, if the optional I/O board is installed.

**Baud rate**

64-xx	ALX 92x	DPM	PEM	ALX 73x (PMA)
-------	---------	-----	-----	---------------

▣▣▣▣ With mounted and connected I/O board only.  
Speed of data transfer using the serial interface.

**xxxxxx Baud**

Setting range: 2400 to 115200 Baud; Unit interval: 2400/4800/9600/19200/38400/115200 (default)

**No. of data bits**

64-xx	ALX 92x	DPM	PEM	ALX 73x (PMA)
-------	---------	-----	-----	---------------

▣▣▣▣ With mounted and connected I/O board only.  
The number of data bits is always 8.

**Parity**

64-xx	ALX 92x	DPM	PEM	ALX 73x (PMA)
-------	---------	-----	-----	---------------

▣▣▣▣ With mounted and connected I/O board only.  
Defines the parity check of serial transmitted data.

The parity bit is for checking data transmission. If the check shows an error, a corresponding message is displayed. The setting must be identical at the sender and the receiver. Normally transmission is set without a parity bit.



<b>Even</b>	Even parity. A parity bit is added so that there is an even number of 1 Bits.
<b>None</b>	No check bit. Sending and receiving without check bit.

### Stop bits

64-xx	ALX 92x	DPM	PEM	ALX 73x (PMA)
<p>▣▣▣▣ With mounted and connected I/O board only. The number of stop bits is 2 and cannot be changed.</p>				

### Data synch.

64-xx	ALX 92x	DPM	PEM	ALX 73x (PMA)
<p>▣▣▣▣ With mounted and connected I/O board only. ○ See parameter <a href="#">Data synch.</a> on page 57.</p>				

### Frame error

64-xx	ALX 92x	DPM	PEM	ALX 73x (PMA)
<p>▣▣▣▣ With mounted and connected I/O board only. ○ See parameter <a href="#">Frame error</a> on page 57.</p>				

### Serial Port Mode

64-xx	ALX 92x	DPM	PEM	ALX 73x (PMA)
<p>▣▣▣▣ With mounted and connected I/O board only. Setting of the serial interface type.</p>				

<b>RS232</b>	Sets Com2 to RS 232. Data synchronisation may be done by hardware (RTS/CTS) or by software (XON/XOFF). Maximum cable length is 15 m.
<b>RS422</b>	Sets Com2 to RS 422. RS 422 is a 4 wire point to point connection, suitable for only one device. Receiver and driver of the printer are always enabled. Data synchronization is only possible by software (XON/XOFF). Maximum cable length is 1 km with twisted telecommunication cable.
<b>RS485</b>	Sets Com2 to RS 485. RS 485 is a 2 or 4 wire bus system for up to 30 devices. The printer's receiver is always enabled, the printer's driver is only enabled, if the printer sends data to the host. Data synchronization is only possible by software (XON/XOFF). Maximum cable length is 1 km with twisted telecommunication cable.

**> COM4 PORT**

Internal interface, to which the optional RFID read/write unit can be connected.

**Baud rate**

64-xx	ALX 92x	DPM	PEM	ALX 73x (PMA)
-------	---------	-----	-----	---------------

- See parameter [Baud rate](#)  on page 56.

**No. of data bits**

64-xx	ALX 92x	DPM	PEM	ALX 73x (PMA)
-------	---------	-----	-----	---------------

Fixed setting of 8 Bits.

**Parity**

64-xx	ALX 92x	DPM	PEM	ALX 73x (PMA)
-------	---------	-----	-----	---------------

- See parameter [Parity](#)  on page 56.

**Stop bits**

64-xx	ALX 92x	DPM	PEM	ALX 73x (PMA)
-------	---------	-----	-----	---------------

Fixed setting of 2 Bits.

**Data synch.**

64-xx	ALX 92x	DPM	PEM	ALX 73x (PMA)
-------	---------	-----	-----	---------------

- See parameter [Data synch.](#)  on page 57.

**Frame error**

64-xx	ALX 92x	DPM	PEM	ALX 73x (PMA)
-------	---------	-----	-----	---------------

- See parameter [Frame error](#)  on page 57.

## &gt; CENTRONICS

**PnP function**

64-xx	ALX 92x	DPM	PEM	ALX 73x (PMA)
-------	---------	-----	-----	---------------

**Off**

The printer doesn't send any identification signals to the Centronics port.

**On**

The printer sends identification signals via the Centronics port (if any is connected) to the host computers Windows operating system. Windows will search for an appropriate driver. (Default setting).

## &gt; NETWORK PARAM.

**IP address assign**

64-xx	ALX 92x	DPM	PEM	ALX 73x (PMA)
-------	---------	-----	-----	---------------

▣▣▣▣➔ A change of this parameter setting forces a printer restart.

**Fixed IP address**

This setting activates the parameters "Net mask" and "Gateway address" (see below).

**DHCP**

IP address is assigned automatically. The assigned IP address is displayed for a moment on the printer display, while the printer is starting.

**IP address**

64-xx	ALX 92x	DPM	PEM	ALX 73x (PMA)
-------	---------	-----	-----	---------------

**xxx.xxx.xxx.xxx**

Setting range per xxx value: 0 to 255

Change between the digits by pressing the Cut or Feed button; Acknowledge the setting by pressing the Online button. After a change of the IP address, the printer will reset automatically.

**Net mask**

64-xx	ALX 92x	DPM	PEM	ALX 73x (PMA)
-------	---------	-----	-----	---------------

**xxx.xxx.xxx.xxx**

Setting range per xxx value: 0 to 255

Depending on the set IP address appears a default value.

▣▣▣▣➔ We recommend to use the default value!

## Gateway address

64-xx	ALX 92x	DPM	PEM	ALX 73x (PMA)
-------	---------	-----	-----	---------------

xxx.xxx.xxx.xxx

Setting range per xxx value: 0 to 255

000.000.000.000 = no gateway is used

## Port address

64-xx	ALX 92x	DPM	PEM	ALX 73x (PMA)
-------	---------	-----	-----	---------------

Setting range: 1024 to 65535. Default: 9100.

## Ethernet speed

64-xx	ALX 92x	DPM	PEM	ALX 73x (PMA)
-------	---------	-----	-----	---------------

Auto negotioation

The communication speed is selected automatically.

10M half duplex

The communication speed is set to 10 MBit/s *half duplex*.

10M full duplex

The communication speed is set to 10 MBit/s *full duplex*.

100M half duplex

The communication speed is set to 100 MBit/s *half duplex*.

100M full duplex

The communication speed is set to 100 MBit/s *full duplex*.

## MAC address

64-xx	ALX 92x	DPM	PEM	ALX 73x (PMA)
-------	---------	-----	-----	---------------

Displays the MAC address of the CPU board. This address can not be changed in the parameter menu.

## FTP server

64-xx	ALX 92x	DPM	PEM	ALX 73x (PMA)
-------	---------	-----	-----	---------------

The File Transfer Protocol (FTP) server (RFC959) allows access to the internal RAM disk of the printer and, if available, to the memory card. The FTP server is capable of multisesion mode, without evaluating the user name when logging in. The password must match the set password (see below).

- For further information read the user manual, topic section „Advanced Applications“, chapter „Data transmission with FTP“.

**On** Switches the FTP server *on*.

**Off** Switches the FTP server *off*.

## FTP password

64-xx	ALX 92x	DPM	PEM	ALX 73x (PMA)
-------	---------	-----	-----	---------------

▣▣▣▣▶ Parameter only appears in production mode.

Input of the FTP server password by means of a connected keyboard or the printers operation panel. Default setting: „novexx“.

Changing the password:

1. Press the Esc button. The cursor jumps to the first character.
2. Press the Cut- or Feed button until the wanted character appears. Acknowledge by pressing the Online button.
3. Put in the next character.
4. Acknowledge the new password by pressing the Online button.

## WEB server

64-xx	ALX 92x	DPM	PEM	ALX 73x (PMA)
-------	---------	-----	-----	---------------

The web server may be used to

- read out or change parameter settings of the printer with a web browser
- operate the printer via a web browser.

▣▣▣▣▶ The WEB server is not multi-session capable, what means that only one user at a time can be logged in.

### Requirements for use of the web server function:

- Printer is connected to network
- A valid IP address is assigned to the printer (by the network administrator or by a DHCP server)
- INTERFACE PARA > NETWORK PARAM. > WEB server must be set to „On“.

### Starting the web server:

1. Write down the printers IP address (INTERFACE PARA > NETWORK PARAM. > IP address).
2. Start the web browser.

3. Insert into the address field:

http://[IP address without leading zeros]

Example: IP address = 144.093.029.031

Input: http://144.93.29.31

4. Click „Login“.

5. Type in user name (admin) and password (admin).

If the login was successful, you will find the following menu items at the left window margin:

Menu item	Function
Home	Jump to the home page
Logout	Interrupt the connection to the printer
Parameter	<p>Opens the parameter menu. By clicking on submenus and parameters, those can be opened and the parameter settings be changed.</p> <p>▣▣▣▣► Some parameters force the printer to reset, if their setting is modified by means of the operation panel. If the parameters are changed via the web server, this doesn't happen automatically. Therefore, the modifications only become effective after the next printer restart. A restart can be triggered remote in the „Display view“.</p>
Display view	Opens the display operation panel. Enables remote operation of the printer.
Download	<p>Opens another browser window with the URL of the FTP server. For more information read the description of <code>INTERFACE PARA &gt; NETWORK PARAM. &gt; FTP server</code>.</p>
Help	Help texts

[5] Functions of the web server.

- On** Switches the web server *on*.
- Off** Switches the web server *off*.

## WEB display refr

(WEB display refresh)

64-xx	ALX 92x	DPM	PEM	ALX 73x (PMA)
-------	---------	-----	-----	---------------

▣▣▣▣► Only appears, if `INTERF.PARAM > NETWORK PARAM. > Time client = „On“`.

Automatic updating of the web browser display. The setting determines the time in seconds between two updates.

▣▣▣▣► Setting 0 = „no automatic updating“.

- xx s** Setting range: 0 to 20; Default setting: 5

**WEB admin passw.**

(WEB administrator password)

64-xx	ALX 92x	DPM	PEM	ALX 73x (PMA)
-------	---------	-----	-----	---------------

■ Only in production mode.

Modifying the password for web server access as admin.

Default setting: „admin“

■ The user name is also „admin“.

■ If the user logs in as admin to the web server, he/she has access to all parameters, which are *not* marked with the footmark „only in production mode“.

Changing the password at the operating panel:

1. Press the Esc button. The cursor jumps to the first character.
2. Press the Cut- or Feed button until the wanted character appears. Acknowledge by pressing the Online button.
3. Type in the next character.
4. Acknowledge the new password by pressing the Online button.

■ Alternatively, the password can be typed in using a keyboard, or via the web server.

**WEB supervisor p.**

(WEB supervisor password)

64-xx	ALX 92x	DPM	PEM	ALX 73x (PMA)
-------	---------	-----	-----	---------------

■ Only in production mode.

Modifying the password for web server access as supervisor.

Default setting: „supervisor“

■ The user name is also „supervisor“.

■ If the user logs in as supervisor to the web server, he/she has access to *all* parameters.

Changing the password at the operating panel:

1. Press the Esc button. The cursor jumps to the first character.
2. Press the Cut- or Feed button until the wanted character appears. Acknowledge by pressing the Online button.
3. Type in the next character.
4. Acknowledge the new password by pressing the Online button.

■ Alternatively, the password can be typed in using a keyboard, or via the web server.

**WEB operator p.**

(WEB operator password)

64-xx	ALX 92x	DPM	PEM	ALX 73x (PMA)
-------	---------	-----	-----	---------------

▣▣▣▣➔ Only in production mode.

Modifying the password for web server access as supervisor.

Default setting: „operator“

▣▣▣▣➔ The user name is also „operator“.

▣▣▣▣➔ If the user logs in as operator to the web server, he/she has access to a selection of parameters, which are necessary for settings during labelling operation.

- For details see paragraph [64-xx operator parameters](#)  on page 15 or paragraph [DPM / PEM / ALX 92x operator parameters](#)  on page 20.

Changing the password at the operating panel:

1. Press the Esc button. The cursor jumps to the first character.
2. Press the Cut- or Feed button until the wanted character appears. Acknowledge by pressing the Online button.
3. Type in the next character.
4. Acknowledge the new password by pressing the Online button.

▣▣▣▣➔ Alternatively, the password can be typed in using a keyboard, or via the web server.

**Time client**

64-xx	ALX 92x	DPM	PEM	ALX 73x (PMA)
-------	---------	-----	-----	---------------

Loads the current time from a time server.

**Off**

The time client is switched off.

**On**

The time client is switched on. The time is loaded with the frequency set under *Sync. interval* from a time server with the IP address *Time server IP*.

If there is no valid time server response within 2 s after system start, an error message appears:

Status num:	9040
No Time Server	



With the time client service, the current date and time can be obtained from a time server using RFC868 time protocol on UDP port 37. For this purpose, a time server IP address needs to be given. Date and time are initially requested at start up an optional in a setable update interval during operation time. It is also stored in the internal real time clock. There is no time offset or daylight saving hour, so the server time must exactly match the local time of the printer.



## Time server IP

64-xx	ALX 92x	DPM	PEM	ALX 73x (PMA)
-------	---------	-----	-----	---------------

IP address of the time server.

▣▣▣▣ Only appears if INTERFACE PARA > NETWORK PARAM. > Time client = „On“.

xxx.xxx.xxx.xxx

Enter the IP address following the xxx.xxx.xxx.xxx schema.  
Setting range for each xxx value: [0...255].

## Sync. interval

64-xx	ALX 92x	DPM	PEM	ALX 73x (PMA)
-------	---------	-----	-----	---------------

Determines the frequency for time requests.

▣▣▣▣ Only appears if INTERFACE PARA > NETWORK PARAM. > Time client = „On“.

xxxx

Setting range: [0...9999] s; Default setting: 3600 s.

## Time zone

64-xx	ALX 92x	DPM	PEM
-------	---------	-----	-----

Correction of the time received by the time server by a value expressed in hours (hh) and minutes (mm).

▣▣▣▣ Only appears if INTERFACE PARA > NETWORK PARAM. > Time client = „On“.

+/- hh:mm

Setting range: [-12:00...+12:00]; Default setting: 00:00; Step width: 00:30

## DHCP host name

64-xx	ALX 92x	DPM	PEM	ALX 73x (PMA)
-------	---------	-----	-----	---------------

Host name of the printer. Default setting: „Device name“ + the last 3 figures of the MAC adress.

Typing in the host name at the operating panel:

1. Press the Esc button. The cursor jumps to the first character.
2. Press the Cut- or Feed button until the wanted character appears.  
Acknowledge by pressing the Online button.

▣▣▣▣ Valid characters: A-Z, a-z, 0-9, -

3. Type in the next character.
4. Acknowledge the new password by pressing the Online button.  
▣▣▣▣ Alternatively, the password can be typed in using a keyboard, or via the web server.

## WLAN SSID

64-xx	ALX 92x	DPM	PEM	ALX 73x (PMA)
-------	---------	-----	-----	---------------

Only with plugged-in WLAN CF-card

A Service Set Identifier (SSID) is the identification of a radio frequency network, which is based on IEEE 802.11.

Each WLAN owns a configurable SSID, by which the network is identified. The SSID is the name of the network.

The SSID character string is configured in the base station (Access Point) of the WLAN. It must be also configured on all clients, which are supposed to access the access point. The SSID is attached uncoded to all packets to identify them as part of that network.

xxxxxxxxxxx...

The SSID consists of a maximum of 32 alphanumeric characters. Default setting: „novexx“

- Detailed information about using the WLAN feature: read the user manual, topic section [Advanced Applications](#) .

## WLAN WEP

64-xx	ALX 92x	DPM	PEM	ALX 73x (PMA)
-------	---------	-----	-----	---------------

Only with plugged-in WLAN CF-card

WEP („Wired Equivalent Privacy“) is an encryption scheme for WLAN.

Off

(Default setting) Communication with the host is *not* encoded.

64Bit key

Communication with the host is encoded using 64 Bit WEP encoding.

128Bit key

Communication with the host is encoded using 128 Bit WEP encoding.

- Detailed information about using the WLAN feature: read the user manual, topic section [Advanced Applications](#) .

## WLAN default key

64-xx	ALX 92x	DPM	PEM	ALX 73x (PMA)
-------	---------	-----	-----	---------------

Only with plugged-in WLAN CF-card

Selection of the encryption key, which is used for packet transmission.

x

Setting range: 1-4; Default setting: 1

- Detailed information about using the WLAN feature: read the user manual, topic section [Advanced Applications](#) .

**WLAN 64Bit key 1**

64-xx	ALX 92x	DPM	PEM	ALX 73x (PMA)
-------	---------	-----	-----	---------------

▣ Only with plugged-in WLAN CF-card

Definition of an encryption key for packet transmission. The key will be used, if it is enabled under `INTERFACE PARA > NETWORK PARAM. > WLAN default key`.

xxxxxxxxxxx...

Character string of 26 hexadecimal characters. Default setting:  
„123456789abcd123456789abcd“

▣ Admissible characters: A-F, a-f, 0-9

- Detailed information about using the WLAN feature: read the user manual, topic section [Advanced Applications](#) .

**WLAN 64Bit key 2**

64-xx	ALX 92x	DPM	PEM	ALX 73x (PMA)
-------	---------	-----	-----	---------------

▣ Only with plugged-in WLAN CF-card

- See parameter [WLAN 64Bit key 1](#)  on page 68.

**WLAN 64Bit key 3**

64-xx	ALX 92x	DPM	PEM	ALX 73x (PMA)
-------	---------	-----	-----	---------------

▣ Only with plugged-in WLAN CF-card

- See parameter [WLAN 64Bit key 1](#)  on page 68.

**WLAN 64Bit key 4**

64-xx	ALX 92x	DPM	PEM	ALX 73x (PMA)
-------	---------	-----	-----	---------------

▣ Only with plugged-in WLAN CF-card

- See parameter [WLAN 64Bit key 1](#)  on page 68.

**WLAN 128Bit key 1**

64-xx	ALX 92x	DPM	PEM	ALX 73x (PMA)
-------	---------	-----	-----	---------------

▣ Only with plugged-in WLAN CF-card

Definition of an encryption key for packet transmission. The key will be used, if it is enabled under `INTERFACE PARA > NETWORK PARAM. > WLAN default key`.

xxxxxxxxxxx...

Character string of 26 hexadecimal characters. Default setting:  
„123456789abcd123456789abcd“

▣ Admissible characters: A-Z, a-z, 0-9

- Detailed information about using the WLAN feature: read the user manual, topic section [Advanced Applications](#) .

64-xx – DPM – PEM – ALX 92x – ALX 73x (PMA)

**WLAN 128Bit key 2**

64-xx	ALX 92x	DPM	PEM	ALX 73x (PMA)
-------	---------	-----	-----	---------------

- ▣ Only with plugged-in WLAN CF-card
- See parameter [WLAN 128Bit key 1](#) on page 68.

**WLAN 128Bit key 3**

64-xx	ALX 92x	DPM	PEM	ALX 73x (PMA)
-------	---------	-----	-----	---------------

- ▣ Only with plugged-in WLAN CF-card
- See parameter [WLAN 128Bit key 1](#) on page 68.

**WLAN 128Bit key 4**

64-xx	ALX 92x	DPM	PEM	ALX 73x (PMA)
-------	---------	-----	-----	---------------

- ▣ Only with plugged-in WLAN CF-card
- See parameter [WLAN 128Bit key 1](#) on page 68.

**WLAN com quality**

64-xx	ALX 92x	DPM	PEM	ALX 73x (PMA)
-------	---------	-----	-----	---------------

- ▣ Only with plugged-in WLAN CF-card
- This value represents the signal-to-noise ratio (SNR) of the connection. The value is shown in % and is a measure for the connection quality.

x%

WLAN communication quality in %

- Detailed information about using the WLAN feature: read the user manual, topic section [Advanced Applications](#).

**WLAN signal lev.**

64-xx	ALX 92x	DPM	PEM	ALX 73x (PMA)
-------	---------	-----	-----	---------------

- ▣ Only with plugged-in WLAN CF-card
- Shows the WLAN average signal level in percent. This value suits for optimizing the location of the printer or access point to get the best network connection.

x%

Signal level in %

- Detailed information about using the WLAN feature: read the user manual, topic section [Advanced Applications](#).

## &gt; OPTIONS

**OLV Option**

64-xx	ALX 92x	DPM	PEM
-------	---------	-----	-----

**Off**OLV-Option is *not* activated (OLV = Online Verifier).**Serial Com1**

Com1 is activated for OLV application.

▣▣▣▣ This setting option is only visible, if Com1 is not activated for any other option.

**Serial Com2**

Com2 is activated for OLV application.

▣▣▣▣ This setting option is only visible, if Com2 is not activated for any other option.

**RFID Option**

64-xx	ALX 92x	DPM
-------	---------	-----

**Off**RFID-Option is *not* activated (RFID = Radio Frequency Identification).**Serial Com1**

This setting option is not relevant for application of the RFID option.

▣▣▣▣ This setting option is only visible, if Com1 is not activated for any other option.

**Serial Com4**

Com4 is activated for application of the RFID option (Setting for 64-xx Gen 3, DPM Gen 3, ALX 92x Gen 3).

▣▣▣▣ This setting option is only visible, if Com4 is not activated for any other option.

**StandAlone Input**

64-xx	ALX 92x	DPM	PEM	ALX 73x (PMA)
-------	---------	-----	-----	---------------

Defines an interface for data input in standalone mode.

▣▣▣▣ Interfaces are only selectable, if installed and not used by another function (e. g. as data interface). If `INTERFACE PARA >EASYPLUGINTERPR > Print interface = „Automatic“`, all interfaces besides Com3 are blanked out.

**None**

No data input via interface.

**Serial Com1**

Com1 is activated for data input in standalone mode.

**Serial Com2**

Com2 is activated for data input in standalone mode.

**Serial Com3**

Com3 is activated for data input in standalone mode.

**TCP/IP SOCKET**

Ethernet interface is activated for data input in standalone mode.

**#VW/I Interface**

64-xx	ALX 92x	DPM	PEM	ALX 73x (PMA)
-------	---------	-----	-----	---------------

Defines the output interface belonging to the Easy-Plug command #VW/I.

**Easyplug**

(Default) Interface that is defined in `INTERFACE PARA >EASYPLUGINTERPR > Print interface` as input interface for print data.

**Serial Com1**

Serial interface Com 1.

☛ Only available for selection, if the interface is not occupied by another function.

**USB**

USB interface

☛ Only available for selection, if the interface is not occupied by another function.

**TCP/IP SOCKET**

Ethernet interface

☛ Only available for selection, if the interface is not occupied by another function.

**Serial Com3**

Serial interface Com 3.

☛ Only available for selection, if the optional I/O board is installed and if the interface is not occupied by another function.

**> DRIVEASSIGNMENT**

- For detailed information read the Easy-Plug manual, topic section [General Notes, Definitions and Command Overview](#) □, chapter „Drive names“.

**Drive C**

64-xx	ALX 92x	DPM	PEM	ALX 73x (PMA)
-------	---------	-----	-----	---------------

Assigns drive letter C: to one of the card slots.

**None**

C: is not assigned

**CompactFlash**

(Default for CPU boards *up to* index A6621-06) C: is assigned to the standard CF card slot (left slot at the 64-xx)

**SD card**

(Default for CPU boards with index A6621-07 *or higher*) Assigns drive letter C: to the SD card slot

**USB-stick**

C: is assigned to the USB host port.

**Drive E**

64-xx	ALX 92x	DPM	PEM	ALX 73x (PMA)
-------	---------	-----	-----	---------------

☛ Only with CPU boards *up to* index A6621-06

Assigns drive letter E: to one of the card slots or USB ports.

**None**

E: is not assigned

**CompactFlash**

E: is assigned to the standard CF card slot (left slot at the 64-xx)

**SD card** (Default) Assigns drive letter E: to the SD card slot  
**USB stick** E: is assigned to the first detected USB host connector

**Drive F**

---

64-xx	ALX 92x	DPM	PEM	ALX 73x (PMA)
-------	---------	-----	-----	---------------

---

Assigns drive letter F: to one of the card slots or USB ports.

**None** F: is not assigned  
**CompactFlash** F: is assigned to the standard CF card slot (left slot at the 64-xx)  
**SD card** Assigns drive letter F: to the SD card slot  
**USB stick** (Default) F: is assigned to the first detected USB host connector

## SYSTEM PARAMETER

### Speed unit

	ALX 92x	DPM	PEM
--	---------	-----	-----

The print or feed speed can optional be set in mm/s or in inch/s.

mm/s

Set speeds in mm/s

Inch/s

Set speeds in inch/s (default)

### Cover open error

64-xx	ALX 92x	DPM	PEM
-------	---------	-----	-----

Defines, when the status message „Cover open“ appears:

5003

Immediately

(Default) Status message appears immediately after opening the hood.

If material feed

(Default for 64-xx) Statusmessage appears if the hood is open and material feed is supposed to start.

### Foil end warning

64-xx	ALX 92x	DPM	PEM	ALX 73x (PMA)
-------	---------	-----	-----	---------------

Setting of a limit diameter for the ribbon roll. If the ribbon roll diameter falls below the set value, the displayed message changes from...

ONLINE X JOBS ...to...

FOLIE X JOBS ...while the display is blinking.

64-xx, DPM / PEM, ALX 92x:

Additionally to the display message, a signal is set at the (optional) USI.

- For details refer to the parameters [DP INTERFACE > Ribbon signal](#) and [SERVICE DATA > OPERATION DATA > Foil diameter](#)

x.xx mm

Setting range: 25.4 to 50.0 mm; Unit interval: 0.1 mm;  
Default setting: 25.4 mm

### Foil warn stop

64-xx	ALX 92x	DPM	PEM	ALX 73x (PMA)
-------	---------	-----	-----	---------------

Off

(Default setting) Printer does *not* stop in case of a „Foil end warning“.

On

If a „Foil end warning“ occurs, the printer stops after the current label and shows the status message:



PrintStatus: 5110  
Foil low

➔ Press the online button to acknowledge the message, then the feed button to continue printing.

### Autom. dot check

64-xx	ALX 92x	DPM	PEM
-------	---------	-----	-----

Automatic dot check

Checks the print head for defective dots. The dot check can be carried out either after powering on the printer or in print pauses between print jobs.

Continuous

The dot check is carried out in pauses between print jobs. If a new print job arrives before the dot check is done, the print job will be preferred. The printer then interrupts the dot check and proceeds later with the next "opportunity" at the last tested dot.

The parameters *Early dottest*, *Latest dottest*, *Dottestarea from*, *Dottestarea to* determine the conditions under which the dot check is executed.

- ▣➔ Those parameters show up only,
  - if "continuous" has been selected
  - after the following automatic restart of the printer!

Power on only

The dot check is proceeded immediately after powering on the printer. During testing appears the – blinking – display message:

OFFLINE 0 JOBS  
Head dot test

Off

The automatic dot check is switched off.

### Early dottest

64-xx	ALX 92x	DPM	PEM
-------	---------	-----	-----

▣➔ Only if SYSTEM PARAMETER > Autom. dot check = „Continuous“.

Earliest dot check

Determines the number of printed labels, after which the dot check should at the earliest start.

Example:

The setting 3 means that the dot check starts in the first printing pause after three printed labels. After a successfully executed dot check starts the next dot check again in the first pause after three printed labels.

after x label

Setting range: 1 to 9999; Unit interval: 1; default setting: 10

## Latest dottest

64-xx	ALX 92x	DPM	PEM
-------	---------	-----	-----

Only if SYSTEM PARAMETER > Autom. dot check = „Continuous“.

Determines the number of printed labels, after which the dot check must be finished.

Example:

The setting 5 means that the dot check has to be finished at the latest after the fifth printed label. If necessary, printing is interrupted after the fifth label. After a successfully proceeded dot check has the next dot check again to be finished after five labels.

after x label

Setting range: 1 to 9999; Unit interval: 1; default setting: 0

The setting "after 0 label" means, that the dot check will possibly be never finished! – given a high utilization of the printer (A printing pause will never be forced).

The value for "Latest dottest" must be set higher than the value for "Early dottest"! (exception: value 0).

## Dottestarea from

64-xx	ALX 92x	DPM	PEM
-------	---------	-----	-----

Only if SYSTEM PARAMETER > Autom. dot check = „Continuous“.

Limitates the area of a print head, in which the dots are checked. The parameter sets the lower border of the dot check area. The value equals the distance to the left print head end in mm, looked at the print head from above (see Fig. 13).

x mm

Setting range: refer to Tab. 3; Unit interval: 1; default setting: 0 mm

Printer type	Setting range in mm	No. of dotss
64-04 / Chess 4	0-107	1280
64-05 / Chess 5	0-128	1536
64-06 / Chess 6	0-160	1920
64-08 / Chess 8	0-214	2560

[6] Setting range for the dot check, depending on the print head width. Right column: Total number of dots of the print head.

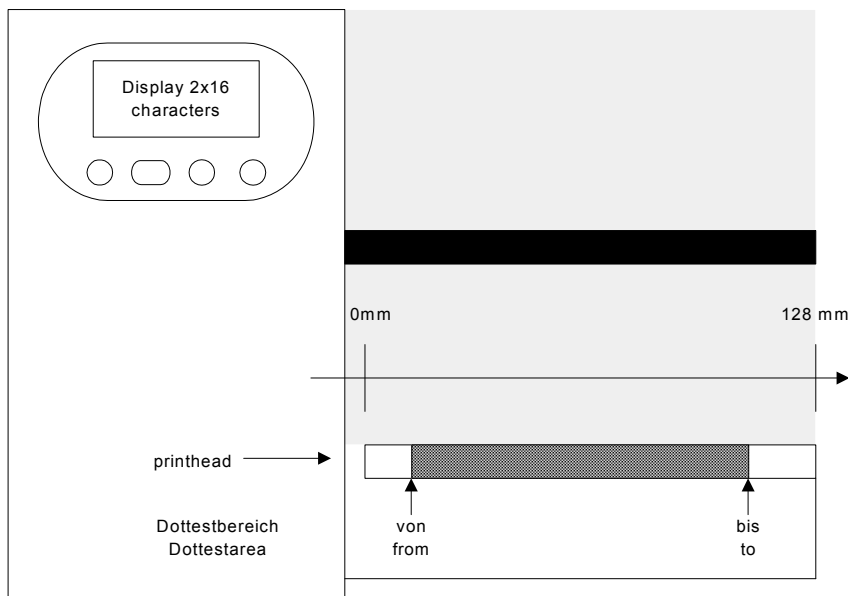

[16] Dot check area (=Dottestarea) of the printer (schematic).

**Dottestarea to**

64-xx	ALX 92x	DPM	PEM
-------	---------	-----	-----

Only if SYSTEM PARAMETER > Autom. dot check = „Continuous“.

Upper border of the dot check area. The value sets the distance in mm to the left print head end, looked at on the print head from above.

x mm

Setting range: refer to Tab. 3; Unit interval: 1; Default setting: 0 mm

**Print Interpret.**

64-xx	ALX 92x	DPM	PEM	ALX 73x (PMA)
-------	---------	-----	-----	---------------

**Easyplug**

Printjobs written in the Easy-Plug command language can be interpreted.

**Lineprinter**

Lineprinter (or similar to Lineprinter), print-out of the print command.

**Hex Dump**

Print-out in hexadecimal format.

In Lineprinter and Hex Dump, commands are printed out in the form of a list with the character set 12.

When setting Lineprinter or Hex Dump, Easy Plug commands which have not yet been processed are deleted!

**ZPL Emulation**

Printjobs written in the ZPL II<sup>®1)</sup> command language („ZPL“) can be interpreted.

Firmware loading requires changing into EasyPlug first.

**EasyPlug/ZPL Emu**

Printjobs in EasyPlug and ZPL can be interpreted.

1) ZPL II is a registered trademark of ZIH Corp.

Use this setting only for simple printjobs. Complications are more likely with this setting.

## Character sets

64-xx	ALX 92x	DPM	PEM	ALX 73x (PMA)
-------	---------	-----	-----	---------------

Setting the character set:

- **16bit:** UTF-8 coding.
- **8bit:** Choose between IBM and ANSI character set.
- **7Bit:** Additionally to the IBM and ANSI character sets, some country specific character sets are provided, which have some characters allocated differently (see table below)

The country specific character sets are only suitable for older 7bit applications!

Decimal	35	36	64	91	92	93	94	96	123	124	125	126	>127
ASCII	#	\$	@	[	\	]	^	'	{		}	~	
UTF-8	#	\$	@	[	\	]	^	'	{		}	~	print
ISO 8859-2	#	\$	@	[	\	]	^	'	{		}	~	print
ANSI (CP 1250)	#	\$	@	[	\	]	^	'	{		}	~	print
ANSI (CP 1252) <sup>a</sup>	#	\$	@	[	\	]	^	'	{		}	~	print
IBM	#	\$	@	[	\	]	^	'	{		}	~	print
Special	f	¢	blank	blank	¼	½	blank	blank	«	•	»	±	blank
Norway	#	\$	@	Æ	¥	Å	^	'	æ	¢	å	~	blank
Spain	#	\$	@	i	Ñ	Ç	^	'	¿	ñ	ç	~	blank
Sweden	#	•	É	Ä	Ö	Å	Ü	é	ä	ö	å	ü	blank
Italy	Š	\$	§	°	ç	é	^	'	à	ò	è	~	blank
Germany	#	\$	§	Ä	Ö	Ü	^	'	ä	ö	ü	ß	blank
France	£	\$	à	°	ç	§	^	'	é	ù	è	~	blank
United Kingdom	£	\$	@	[	\	]	^	'	{		}	½	blank
USA	#	\$	@	[	\	]	^	'	{		}	~	blank
blank = space, print = printable													

[7] Country settings for applications, which base on 7bit ASCII code.

a) Covering ISO 8859-1.

- For complete tables of all fixfonts characters available with setting "IBM" refer to the User Manual, topic section "Internal Fonts". You also find there a comparison of the IBM and ANSI character sets.

### Character filter

64-xx	ALX 92x	DPM	PEM	ALX 73x (PMA)
-------	---------	-----	-----	---------------

#### Character >= 20Hex

Filter function is activated. Characters smaller than 20H are filtered out of the data flow.

#### All character

Filter function is deactivated. Characters smaller than 20H are treated as normal characters.

### Light sens. type

64-xx	ALX 92x	DPM	PEM	ALX 73x (PMA)
-------	---------	-----	-----	---------------

#### Light sensor type

The optional reflex photoelectric switch for labels with reflecting length markings, or the normal factory-fitted photoelectric switch for labels with transparent or register gaps (self-adhesive labels), must be defined according to the application.

#### Full Size

Full Size photoelectric switch (Adjustment range is the material width).

#### Reflex

Reflex photoelectric switch (for reflecting markings)

#### Punched

Transparent photoelectric switch (for gaps)

### Head-sensor dist.

(Distance between printline and label sensor)

64-xx	ALX 92x	DPM	PEM	ALX 73x (PMA)
-------	---------	-----	-----	---------------

Parameter appears only in production mode or if a value > 0 is set.  
Printhead-sensor distance

Special function for setting non-standard punch sensors. Such sensors can be applied in special application devices ("Nistan"). The value x is the distance between thermal edge and punch sensor in millimeters.

#### x mm

Setting range: 0 to 400 mm

A „non standard sensor“ must be installed and connected instead of the regular punch sensor.

0 = disabled (the regular punch sensor is used).

### Ribbon autoecon.

64-xx	DPM	PEM	ALX 92x
-------	-----	-----	---------

#### Ribbon automatic economy mode („ribbon saving“)

Generally can be chosen between thermal transfer printing and thermal direct printing. It is necessary to select the type of printing in order to be able to switch over the ribbon end detection.

Switching on the Ribbon automatic economy mode in *thermal transfer* mode interrupts the ribbon feed between print periods. This saves ribbon, particularly with long labels with a minimum print area. The additional feature in turbo mode is that a higher feed speed is used between the print periods. The feed speed is set in `PRINT PARAMETERS > Feed speed`.

With the setting „Thermal/headlift“ activated in *thermal direct* mode, the printhead is lifted between print periods. This reduces printhead abrasion.

▣▣▣▣ The settings „On“, „Thermal/headlift“ and „On Turbo“ should only be activated with unprinted areas from at least approx. 10 mm in length.

Thermal/headlift	Thermal direct printing with printhead lifting
Thermal printing	Thermal direct printing (Ribbon-end-LS switched off)
On	Thermal transfer printing with ribbon automatic economy mode on
Off	Thermal transfer printing with ribbon automatic economy mode off
On Turbo	Thermal transfer printing with turbo ribbon automatic economy mode on

### Ribbon economy limit

64-xx	DPM	PEM	ALX 92x
-------	-----	-----	---------

The ribbon economy limit determines the length of the printing free area on the label from that on the ribbon economy automatic should be activated.

▣▣▣▣ Only with `SYSTEM PARAMETER > Ribbon autoecon.` = „On“.

x,xx mm	Setting range: xx up to 100,0 mm; Unit interval: 0,1 mm (the initial value depends on the feed speed) Default-value: 5.0 mm
---------	--

### Head down lead

64-xx	DPM	PEM	ALX 92x
-------	-----	-----	---------

Defines the distance the printhead has to touch down *before* the first printed dotline. The function improves the print quality when entering a printed area with activated ribbon autoeconomy function.

▣▣▣▣ Only with `SYSTEM PARAMETER > Ribbon autoecon.` = „On“.

▣▣▣▣ Only in production mode or with a setting of  $x > 0$ .

x.x mm	Setting range: [0.0...10.0] mm; Default setting: 0.0 mm; Step width: 0.1 mm
--------	---

### Feed mode

64-xx	DPM	PEM	ALX 92x
-------	-----	-----	---------

Head up	(Default) The printhead is <i>lifted</i> during label material initialization and label feeding.
---------	--

Head down	The printhead is <i>down</i> during label material initialization and label feeding. For certain critical label materials, this setting can result in a better impression accuracy on the first label compared to the following labels.
-----------	---

### Turn-on mode

64-xx	ALX 92x	DPM	PEM	ALX 73x (PMA)
-------	---------	-----	-----	---------------

Operating mode of the printer after it has been switched on.

<b>Online</b>	Printer starts in on-line mode.
<b>Offline</b>	Printer starts in off-line mode.
<b>Standalone</b>	Printer starts in standalone mode.

### Error reprint

64-xx	ALX 92x	DPM	PEM	ALX 73x (PMA)
-------	---------	-----	-----	---------------

If an error occurs while a label is printed, the last printed label is reprinted. For label layouts containing variable data (for example, count fields), disable the reprint function.

<b>On</b>	Reprint in error cases (default setting)
<b>Off</b>	No reprint in error cases.

### EasyPlug error

64-xx	ALX 92x	DPM	PEM	ALX 73x (PMA)
-------	---------	-----	-----	---------------

Handling of errors caused by faulty Easy-Plug commands.

<b>Tolerant handl.</b>	The label is printed, after the Easy-Plug/Bitimage error was acknowledged (default setting).
<b>Strict handling</b>	<p>The Easy-Plug command, which caused the error, is displayed after approx. 2 seconds in the lower display line. The displayed text is up to 30 characters long and is scrolled automatically.</p> <p>If a single character caused the error, this character is marked with „&gt;&gt; &lt;&lt;„ in the display text, to facilitate the detection.</p> <p>By pressing the cut button, the display can be toggled between error message and Easy-Plug command text.</p> <p>After acknowledging the first occurred Easy-Plug error, the printjob and the spooler are deleted (as by #!CA). This prevents the printing of labels with format errors.</p>

### Single job mode

64-xx	ALX 92x	DPM	PEM	ALX 73x (PMA)
-------	---------	-----	-----	---------------

In single job mode (also stop mode) the printer stops after every job and waits until the operator restarts the print process.

<b>Off</b>	Single job mode is switched off (default setting).
------------	--

**On** Single job mode is switched on. The printer always displays "Start next job", before starting a new print job. This requests the user to acknowledge by pressing the Online button.

### Head resistance

64-xx	ALX 92x	DPM	PEM	ALX 73x (PMA)
-------	---------	-----	-----	---------------

For optimum print quality, the individual print head resistance of the thermo head employed in the device must be set once with this parameter.

When replacing the print head, the resistance value of the print head (to be read off from the print head) must be entered again.



#### CAUTION!

Entering a false value can damage the print head.

→ Read off the correct value from the print head and set it accordingly.

▣▣▣▣ The value set here remains when the factory settings are carried out.  
Setting range: 1000 to 1500 Ohm; Unit interval: 1 Ohm

xxxx Ohm

Setting the print head resistance:

#### Setting:

1. From the print head, read off the resistance value to be set and make a note of it (1000 to 1500).
2. In off-line mode press the Prog. button, display: *PRINT INFO*.
3. Press the Cut button until *SYSTEM PARAMETER* is displayed.
4. Press the Online button, display:

```
SYSTEM PARAMETER
Foil end warning
```

5. Press the Cut button until the following is displayed:

```
SYSTEM PARAMETER
Head resistance
```

6. Press the Online button, set value is displayed.
7. Set the previously noted resistance value of the print head using the Feed and Cut buttons.
8. Press the Online button to confirm the set value.
9. Press the Prog. button to return to the display *OFFLINE 0 JOBS*.



## Temp. reduction

64-xx	ALX 92x	DPM	PEM	ALX 73x (PMA)
-------	---------	-----	-----	---------------

Reduction in the print head temperature

The parameter `SYSTEM PARAMETER > Temperature reduct.` allows the power supply to be reduced in the event of an increase in the print head temperature, thereby ensuring an evenly good print image.

xxx%

Setting range: 0 to 100%; Unit interval: 5%

The following setting alternatives are available:

- 0%: No temperature reduction.
  - xx%: Up to xx% temperature reduction with a hot print head.
  - Default setting: 20%.
- For further information refer to the user manual, topic section „Advanced Application“, chapter „Printing with Temperature Compensation“

## Voltage offset

64-xx	ALX 92x	DPM	PEM	ALX 73x (PMA)
-------	---------	-----	-----	---------------

The voltage offset increases the head voltage and therefore the head temperature which e.g. was set by Easy Plug command (HV).

xx%

Setting range: 0 to 20%; Unit interval: 1%; Default setting: 0%

## Expand Logo

64-xx	ALX 92x	DPM	PEM
-------	---------	-----	-----

▣► Only with 8-Dot emulation.

Off

Logos are printed in normal size.

On

Logos are printed enlarged.

## Miss. label tol.

64-xx	ALX 92x	DPM	PEM	ALX 73x (PMA)
-------	---------	-----	-----	---------------

Missing label tolerance

The maximum search path for gaps which cannot be found can be varied. In cases of difficult gap detection (i. e. minimum variation in the light transparency, gap to label), shortening the search path is to be recommended. Label loss resulting from gaps not being detected can be reduced in this way. Printing does not take place during the search process.

xx

Setting range: 0 to 50; Unit interval: 1

- Example 0 (Zero label length):  
A gap must be found after a printed label otherwise an error message is given. This setting is for detecting every missing label.
- Example 5 (Five label lengths):

A gap must be found after a maximum of 5 label lengths otherwise an error message is given.

### Gap detect mode

64-xx	ALX 92x	DPM	PEM	ALX 73x (PMA)
-------	---------	-----	-----	---------------

After one of the following events, the printer must always search for the punch, that is initialize the label material:

- After switching the printer on
- After changing the label material

#### Manual

The operator has to initialize the material the first time always manually by pressing the feed key several times.

#### Autom. Forward

(Default for printers) The material initialization is always done automatically, if necessary. There is no backward movement of the material during the initialization.

#### Autom. feed back

▣▣▣▣ Only 64-xx Dispenser, ALX 92x, DPM/PEM

(Default for those devices) The material initialization is always done automatically, if necessary. The label material is moved forward and backward during the initialization. The stretch of backward movement can be set with parameter SYSTEM PARAMETER > Max InitFeedback (see below).

### Foil stretching

64-xx	ALX 92x	DPM	PEM	ALX 73x (PMA)
-------	---------	-----	-----	---------------

▣▣▣▣ 64-xx: Only standard printers (without dispenser).

After stopping and restarting the print process, the print quality can fall off for a short stretch in the area printed first after the restart. The reason for this behaviour is the foil tension, which relaxes slightly due to the stopping.

The foil stretching function feeds the label material backwards for the defined stretch before restarting the print process. Afterwards, feeding starts before the printing. This stretches the foil before printing starts.

- Advantage: High print quality from the beginning
- Disadvantage: Higher foil consumption; lower label rate

#### Feedback = xx mm

Setting range: 0 to 20 mm; Step width: 1 mm; Default setting: 5 mm

### Head lift autom.

PEM	ALX 73x (PMA)
-----	---------------

Some applications with high print speed and/or small labels have shown that the imprint accuracy differs, depending on if there is a print stop between two labels or not. The function „Head lift automatic“ lifts the printhead between all labels for a short time and thus provides a more regular imprint accuracy.

▣▣▣▣ The function reduces the label throughput, because each head lift needs about 80 ms time.

<b>Off</b>	Head lift automatic is switched off.
<b>On</b>	Head lift automatic is switched on. The printhead is lifted automatically after each printed label.

### Mat.end detect.

64-xx	ALX 92x	DPM	PEM	ALX 73x (PMA)
-------	---------	-----	-----	---------------

Material end detection.

The material end detection can be deactivated for processing labels with gaps longer than 15 mm, or if using material with a high fluctuation in light transparency (Status message „5002 material end“ is displayed even though material is present).



#### CAUTION!

Soiling or damaging the print roller.

- Endless (= not converted) material should not be processed when the material end detection is deactivated (otherwise, printing is continued on the print roller after material end).

<b>Reflex</b>	Material end detection by means of a reflex sensor.
<b>Transparent</b>	Material end detection by means of a transmission sensor.
<b>Off</b>	No material end detection.

### Periph. device

64-xx	ALX 92x	DPM	PEM	ALX 73x (PMA)
-------	---------	-----	-----	---------------

After installation, options must be selected under "Peripheral device" in order to be assured of the corresponding sensor queries and printer reactions.



#### CAUTION!

Selecting an incorrect option can lead to malfunctions or damage.

<b>None</b>	No peripheral device is installed.
<b>Cutter</b>	Sets the printer firmware to the cutter option. Selection permits access to the cut parameters.
<b>Rewinder</b>	Sets the printer firmware to the rewinder option. Selection permits access to the rewinder setting parameters.
<b>Tear-off edge</b>	(Default setting) Sets the printer firmware to the tear-off edge option. The punch is fed forward to the tear-off edge.
<b>Dispenser</b>	Setting for 64-xx dispenser version.

▣ (ALX 92x/DPM) Parameter is displayed in production mode only.

▣ (64-04/05) After selecting this value, the parameter SPECIAL FUNCTION > Disp. Head Offs. appears automatically, if the parameter SPECIAL FUNCTION > Printhead type is set to „KCE 4 Inch“.

- See parameter [Disp. Head Offs.](#) on page 127.

- See parameter [Printhead type](#) on page 126.

**Disp. with LTSI**

Setting for operation of a LTSI applicator, see [Technical Manual LTSI](#)

**Singlestartquant**

64-xx	ALX 92x	DPM	PEM
-------	---------	-----	-----

Determines the label quantity, which will be printed after a start signal.

**xx**

Setting range: 1 to 10; Unit interval: 1; Default setting: 1

**Head disp dist**

(Distance printhead - dispensing edge)

64-xx	ALX 92x	DPM
-------	---------	-----

▣▣▣▣▶ 64-xx: 64-xx dispenser only and only with SYSTEM PARAMETER >  
Dispensing edge = „User defined“

For setting the distance between printhead and dispensing edge.

**xxx.x mm**

Setting range: 10.0 to 100.0 mm; Unit interval: 0.1 mm; Default setting: 20 mm

**External signal**

64-xx	ALX 92x	DPM	PEM
-------	---------	-----	-----

The parameter determines, if and how an incoming signal at the - optional - single start connector will be interpreted.

**Off**

Signal interpretation disabled.

**Singlestart**

The signal triggers the printing of a single label. This setting may be used e.g. for printing single labels by means of a foot switch.

**Stacker full**

The signal triggers the display of a status report and stops the printer. This setting may be used when using a stacker (= stacker full signal).

- Detailed information about using start signals can be found in the user manual, topic section „Advanced Applications“, chapter „Printing with start signal“, [Settings in the parameter menu](#)

**Start print mode**

64-xx	ALX 92x	DPM	PEM
-------	---------	-----	-----

Selecting a print mode. Depending on the selected mode, a start signal at the single-start input will be interpreted differently.

- Information about using the start signal: see user manual, topic section „Special applications“, chapter „Printing with start signal“.

<b>Pulse fall/ris</b>	The printing of a label is triggered by a low-high-change as well as by a high-low-change of the start signal. The printing occurs only after the set delay time.
<b>Level high activ</b>	Labels are being printed as long as the start signal is held high.
<b>Pulse rising</b>	The printing of a label is triggered by a low-high-change of the start signal. The printing occurs only after the set delay time.
<b>Level low active</b>	Labels are being printed as long as the start signal is held low.
<b>Pulse falling</b>	(Default setting) The printing of a label is triggered by a high-low-change of the start signal. The printing occurs only after the set delay time.

### Apply key

64-xx	ALX 92x	DPM	PEM
-------	---------	-----	-----

▣▣▣▣ 64-xx: Only if `SYSTEM PARAMETER > Periph. device` is set to „Dispenser“.

▣▣▣▣ Parameter is displayed in production mode only.

▣▣▣▣ Only if `SYSTEM PARAMETER > External signal` is set to „Singlestart“

**On** (Default) The application can be triggered by pressing the cut respectively apply key.

**Off** Triggering the application by pressing the cut/apply key is *not* possible.

### Print contrast

64-xx	ALX 92x	DPM	PEM	ALX 73x (PMA)
-------	---------	-----	-----	---------------

**xxx%** Setting range: 1 to 110%; Unit interval: 1; Default setting: 60



#### CAUTION!

The parameter `Print contrast` affects directly the life durance of the printhead. It counts: „The higher the setting of `Print contrast` is, the lower is the life durance of the printhead“. This counts even more for settings above 100%.

Therefore mind:

→ Always choose the lowest possible setting necessary to produce an acceptable print result.

### Ram disk size

64-xx	ALX 92x	DPM	PEM	ALX 73x (PMA)
-------	---------	-----	-----	---------------

A part of the printer memory can be identified as a RAM disk. The RAM disk can be used in the same way as the Compact Flash Card, e.g. for storage of logos or fonts.

With the parameter Ram disk size, the customer can set the size of the RAM disk to his needs. Be aware, that RAM disk memory is not available for print picture buildup. Use of much RAM disk memory reduces the picture buildup rate of the printer.

**xxxx KBytes**

▣▣▣▣ Switching the printer off extinguishes the memory content! Fonts, logos etc., which were loaded on the RAM disk, must be loaded again after switching the printer off.

Setting range: 128 KBytes to the maximum size, which depends on the memory configuration and allocation of the printer; Unit interval: 128 KBytes; Default setting: 512 KBytes.

- See also parameter `PRINT INFO > Memory status`.

### Font downl. area



64-xx	ALX 92x	DPM	PEM	ALX 73x (PMA)
-------	---------	-----	-----	---------------

If speedo-fonts are supposed to be used, they have first to be copied to a reserved RAM disk area. Use parameter „Font downl. area“ to reserve the RAM disk area in the required size.

The size of the required RAM disk area depends on the size of the font files to be loaded.

▣▣▣▣ Mind to reserve a big enough RAM disk area!

There are two ways to copy the font files to the RAM disk:

- Copy from CompactFlashcard:  
The font files must be placed in a folder named \fonts on the CompactFlashcard during system startup. The files must be named fontxxx.spd (xxx = No. from 200 up to 999).
- For details refer to the „Plugin-card manual“, topic section „Application“, paragraph [CF/SD-cards](#) .
- Copy via Easy Plug command #DF (download file).
- More information about the #DF command: See manual „Easy Plug“, topic section [Description of Commands](#) .

**xxx KBytes**

Setting range: 128 KBytes to the maximum size, which depends on the memory configuration and allocation of the printer; Unit interval: 128 KBytes; Default setting: 256 KBytes

▣▣▣▣ Switching the printer off extinguishes the memory content! Fonts, logos etc., which were loaded on the RAM disk, must be loaded again after switching the printer off.

### Free store size



64-xx	ALX 92x	DPM	PEM	ALX 73x (PMA)
-------	---------	-----	-----	---------------

By setting this parameter, a part of the memory is reserved, which the printer firmware can use if necessary (dynamic memory allocation). If this memory area is dimensioned too small, the printer firmware can not work and the error message „8856 Free store size“ shows up.

▣▣▣▣ The more memory is allocated using this parameter, the less memory is available for print jobs.

**xxx KBytes**

Setting range: 4 MB to the maximum size, which depends on the memory configuration and allocation of the printer; Unit interval: 128 KBytes; Default setting: 4 MB.

- ➔ A good advice is to increase the set value step by step, starting with the minimum of 4 MB, until the status message 8856 ("Free store size", what means the memory area is low) does no longer appear during data conversion.
- Use with the Easy Plug command #YG, see manual [Easy Plug](#) .
- See parameter [Memory status](#)  on page 31.

## Print info mode

64-xx	ALX 92x	DPM	PEM	ALX 73x (PMA)
-------	---------	-----	-----	---------------

Structure option for info printouts.

### Par. values right

Setting for 100 mm material width. The parameter values are printed on the right side of the parameter names:

*Parameter name: Value*

### Par. values left

Setting for 100 mm material width. The parameter values are printed on the left side of the parameter names:

*Value: Parameter name*

### Compact right

Setting for 50 mm material width. The parameter values are printed on the right side of the parameter names:

*Parameter name: Value*

### Compact left

Setting for 50 mm material width. The parameter values are printed on the left side of the parameter names:

*Value: Parameter name*

## Reprint function

64-xx	ALX 92x	DPM	PEM
-------	---------	-----	-----

### Off

(Default setting) Reprinting is not possible.

### On

The last printed label can be reprinted by pressing the feed button in online mode, if the printer is not printing at that moment.

## Language

64-xx	ALX 92x	DPM	PEM	ALX 73x (PMA)
-------	---------	-----	-----	---------------

Setting the display language.

### Japanese

### Chinese

⚠ Not all chinese display texts are translated. Not translated texts are displayed in english.

### Czech

### Russian

### Turkish

### Polish

### Italian

### Danish

### Dutch

### Spanish

### French

### English

### German



## Keyboard

64-xx	ALX 92x	DPM	PEM	ALX 73x (PMA)
-------	---------	-----	-----	---------------

Setting the keyboard layout country version for standalone operation.

Polish  
Swedish  
Finish  
Danish  
Spanish  
French  
English  
German

## Signal / buzzer

64-xx	ALX 92x	DPM	PEM	ALX 73x (PMA)
-------	---------	-----	-----	---------------

On

Tone signal activated

Off

Tone signal deactivated

## Access authoriz.

64-xx	ALX 92x	DPM	PEM	ALX 73x (PMA)
-------	---------	-----	-----	---------------

Access authorization

Limits the access either to all printer functions (Power-up code) or only to the parameter menu (user or supervisor mode). Changed settings become active after the next switch-on.

### Key codes

Regardless when the code is prompted, can three different key codes be typed in tab. 8.

Enter code

Entering a key code: Type the corresponding buttons of the control panel in succession. A valid key code switches the printer into the appropriate mode.

Mode	Key code	Impact
User	2x Cut <sup>a</sup> , Feed, Online	Access only to the submenus PRINT INFO and SERVICE DATA
Operator	Cut, Online, Feed, Prog	Access to reduced parameter menu
Supervisor	2x Online, Feed, Cut, 2x Online	Access to all parameters except production parameters
Production	Cut, Online, Feed, Cut, 3x Online	Access to all parameters

[8] Permissible key codes.

a) With DPM, PEM, ALX 92x press Apply-key instead.

**CAUTION!**

Production mode: Input errors to certain parameters can make the printer inoperable or can damage it.

→ The production code may only be applied by *trained service technicians*.

Especially service technicians may use the direct access into production mode, even if the parameter *Access authoriz.* is set to „Off“, what means that no password will be queried at all. To do so, proceed as follows:

1. Switch printer off.
2. Switch printer on, simultaneously press the Feed+Prog-key until the printer type is displayed.

After the printer was powered up, the key code will be queried:

3. Enter the production code.

**Possible Settings****Off**

Password interrogation switched off (default)

**Power-up code**

Activates the password interrogation directly after switching the printer on.

After the input of a valid key code, the printer switches into offline mode. Depending on the entered key code, the printer starts in user, supervisor or production mode.

**User**

Activates the password interrogation when accessing the parameter menu.

- The printer is in the offline mode after switch-on
- Change to the online mode is possible without restriction
- To reach the parameters-menu, enter a valid key code
- Valid key codes: all

**Operator**

Access to reduced parameter menu; contains only parameters which are necessary for daily use of the printer.

- For details see paragraph [64-xx operator parameters](#) on page 15 or paragraph [DPM / PEM / ALX 92x operator parameters](#) on page 20.

**Supervisor**

As setting „User“, with different valid key codes:

- Valid key codes: Supervisor, Production

**User auto start**

Printer starts without password interrogation. Only the menus *PRINT INFO* and *SERVICE DATA* are accessible.

**Realtime clock**

64-xx	ALX 92x	DPM	PEM	ALX 73x (PMA)
-------	---------	-----	-----	---------------

The realtime clock provides actual date and time. Those data can be processed using the Easy-Plug *#YC*, *#YS* or *#DM* commands.

Realtime Clock dd.mm.yyyy hh:mm
------------------------------------

dd=Day, mm=Month, yyyy=Year, hh=Hour,  
mm=Minute (Example: 19.02.2001 14:41)

Setting date / time:

1. Press the CUT(Apply) button repeatedly, until the digit blinks which you want

to alter.

2. Set the intended value to the digit by pressing the FEED button (repeatedly).
  3. Repeat steps 1 and 2 until date / time is set correctly.
  4. Press the ONLINE button.
- ▣▣▣▣▶ Press the ESC button to leave the parameter without altering the setting.

## Material feed

ALX 92x	DPM

Suppresses backwards material feeding.

### For-/backwards

Standard setting; material is fed forwards and backwards.

### Only forwards

The label material is only fed forwards. Printjobs, which contain commands for using R 1:1 or N 1:1 mode, are automatically printed in batch mode. The batch mode is modified in a way, that the label following after a printjob is not drawn back under the printhead, but is ejected in forward direction. The effect is, that one label stays unprinted between two succeeding printjobs.

Print mode	Feed direction following label	
	„for-/backwards“	„Only forwards“
Batch	<-->	-->
R 1:1	<-->	Batch <sup>a</sup>
N 1:1	<-->	Batch <sup>a</sup>

[9] *Suppression of the backward movement with the setting „Only forwards“.*  
 <--> = Material feeding in both direction; --> = Material feeding only forwards.

a) *The backwards movement is suppressed during initialization.*

## DISPENSER PARA

▣▣▣▣ This menu appears only, if **SYSTEM PARAMETER > Periph. device** is set to „Dispenser“.

### Head disp dist.

(Distance printhead - dispensing edge)

ALX 92x	DPM
---------	-----

xxx,x mm

Setting range: 10.0 to 200.0 mm; Step width: 0.1 mm; Default setting: 20 mm

### Dispense Mode

64-xx	ALX 92x	DPM
-------	---------	-----

Governs the run of the print-dispense procedure.

▣▣▣▣ Only if **SYSTEM PARAMETER > Periph. device** = „Dispenser“.

▣▣▣▣ The ribbon autoeconomy function can only be used in "Real 1:1 Mode"! With this setting, the printer can be used as a mere dispenser without processing print jobs. Set the material length before you use this function.

Dispense only

- See parameter **PRINT PARAMETERS > Material length**.

After calling "Dispense only", the printer restarts; afterwards, the following is displayed:

Dispense only Labels	0	0 = Number of dispensed labels.
-------------------------	---	---------------------------------

The parameters menu can be activated as usual after having switched to the offline mode by pressing the Online button two times.

Normal 1:1 Mode

- The printer cannot print on the whole label surface. A stripe at the label beginning stays unprinted.
- The label is being dispensed while printing.
- The output volume is at its maximum level.

▣▣▣▣ The width of the unprintable stripe is calculated as follows:

*Distance print line to dispensing edge (25 mm) + Dispense position (tab. 10)*

Printer	Distance print line - dispensing edge
64-xx	39.8 mm (long dispensing edge) 24.2 mm (short dispensing edge)
AP 5.4	25.0 mm

[10] Distances between print line and dispensing edge for some printers.

- Also refer to parameter **PRINT PARAMETERS > Dispense position**.
- A graphic can be found under **PRINT PARAMETERS > Cut mode > Normal 1:1 mode**.

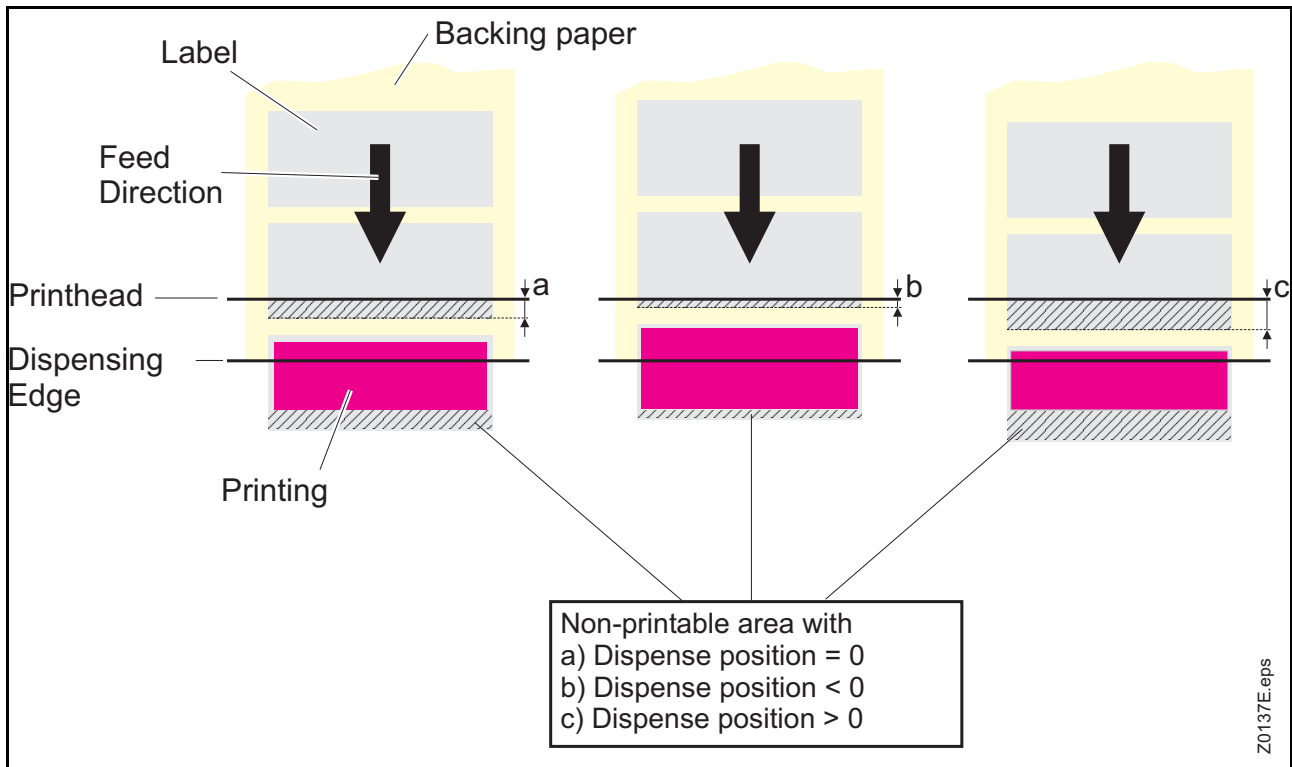

[17] The size of the not imprintable area in Normal 1:1 depends of the setting of parameter DISPENSE PARAMETERS > Dispense Position.

### Batch Mode

- The printer can print the whole label surface.
- Dispensing of the label takes place during printing. Printing of the next label is interrupted until the label is completely dispensed.
- The output volume is at its maximum level.

▣▣▣▣ The *Batch mode* is optimised for printing and dispensing at high speeds. Due to this, it is not possible to use all features available in modes *Normal 1:1* or *Real 1:1*. Also consider, that printing data must be available on time and in sufficient quantity.

▣▣▣▣ The following must be considered in batch mode:

- Printjobs must not contain counter fields or variable fields
  - DISPENSE PARAMETER > Dispensing mode must be set to "fast".
  - The USI reprint function is not supported. DP INTERFACE > Reprint signal must be set to "deactivated".
  - Foil save must not be activated
- A graphic can be found under PRINT PARAMETERS > Cut mode > Batch mode.

### Real 1:1 Mode

(Default setting)

- The printer can print the whole label surface.
  - After dispensing a label, the beginning of the next label is drawn back under the print head.
  - The output volume is lower than in *Batch Mode* or *Normal 1:1 Mode*.
- A graphic can be found under PRINT PARAMETERS > Cut mode > Real 1:1 mode.

## Dispenseposition

64-xx ALX 92x DPM

Only if `SYSTEM PARAMETER > Periph. device = „Dispenser“`.

Adjusts the dispense position in or against the feed direction. Depending on the set dispense position, the dispensed label sticks to the backing paper with a more or less wide strip [18]. The required width of this strip depends on the further processing.

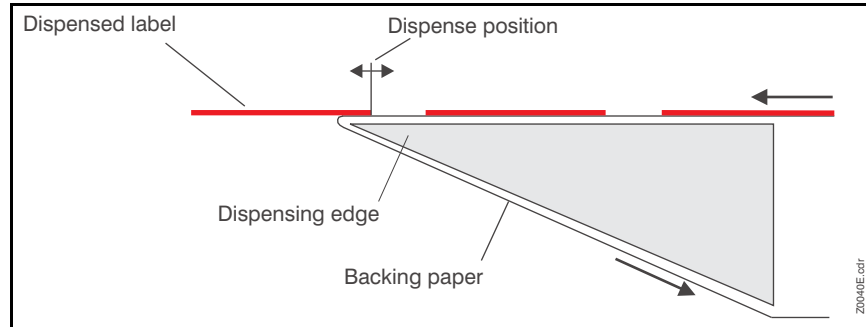

[18] Dispense position of the dispensed label.

x.x mm

Setting range: -30.0 to +20.0 mm; Unit interval: 0.1 mm; Default setting: -6.0 mm

## Display mode

---

64-xx	ALX 92x	DPM
-------	---------	-----

---

▣▣▣▣ Only if SYSTEM PARAMETER > Periph. device = „Dispenser“.

Makes the *already* printed labels appear in the display instead of the *not yet* printed ones.

**Job rest quant.**

Display of the *not yet* printed labels of a print job.

▣▣▣▣ The counter keeps it's value even after switching the printer off.

**Dispense counter**

Counting of start pulses. Activate the counter by selecting "Dispense counter". The counted number appears on the display after the parameter *Dispense counter* (see below) has been selected.

## Dispense counter

---

64-xx	ALX 92x	DPM
-------	---------	-----

---

▣▣▣▣ Only if SYSTEM PARAMETER > Periph. device = „Dispenser“.

Dispense counter xxxxxx	xxxxxx = Number of dispensed labels.
----------------------------	--------------------------------------

▣▣▣▣ The displayed value can be varied by pressing the Cut or Feed button. There are two ways of setting back the counter:

- Set the parameter *Display mode* (see above) to "Job rest quant." , then back to "Dispense counter" and confirm by pressing the Online button.
- Reduce the displayed number by pressing the Cut button.

## Dispensing mode

---

64-xx	ALX 92x	DPM	PEM
-------	---------	-----	-----

---

▣▣▣▣ Only if SYSTEM PARAMETER > Periph. device = „Dispenser“.

▣▣▣▣ Only effective in real 1:1 mode!

Real 1:1 mode normally bears the disadvantage of a slightly lower impression accuracy, caused by the additional slippage at the rollers while feeding back.

The parameter "Dispensing mode" enables optimal positioned printouts even in real 1:1 mode. This accuracy is reached by feeding back the next label to be printed behind the gap sensor instead of "only" as far as under the print head. The additional distance of backwards feeding reduces the output rate slightly.

**exact**

Printout with a maximum impression accuracy

**fast**

(Default) Printout with a lower impression accuracy but higher output rate.

## Application mode

---

64-xx	ALX 92x	DPM
-------	---------	-----

---

▣▣▣▣ Only if SYSTEM PARAMETER > Periph. device = „Dispenser“.

<b>Save Mode</b>	A start signal is required to draw the next label back under the print head. This setting bears advantages for label material with a strong adhesive, which would not stay attached to the applicator when the backing paper is fed backwards.
<b>Immediate Mode</b>	After the just printed label has reached the dispense position, the following label is drawn back under the print head. The dispensed label stays attached to the applicator (default setting).
<b>Synchronous mode</b>	Drawing back of the next label to be printed is triggered by the <i>not</i> active edge of the start signal. The active edge is defined with <i>Start print mode</i> . <i>Not</i> active is the opposite signal edge.  Requirements: <ul style="list-style-type: none"> <li>• USI: <ul style="list-style-type: none"> <li>– USI firmware version: 7 or higher</li> <li>– DP INTERFACE &gt; Start print mode = „Pulse rising“ or „Pulse falling“</li> </ul> </li> <li>• AI: APPLICATOR PARA &gt; Start print mode = „Pulse rising“ or „Pulse falling“</li> </ul>

### Start source

---

64-xx

---

▣▣▣▣ Only if SYSTEM PARAMETER > Periph. device = „Dispenser“.  
Choose a signal source for the start signal:

<b>Foot switch</b>	Optional foot switch is used to generate the start signal.
<b>Light barrier</b>	(Default setting) Photoelectric switch at the dispensing edge which detects the taking off of the dispensed label.  ▣▣▣▣ The setting "Light barrier" is unsuitable for product sensors! Product sensors must be connected to the I/O board!

### Dispensing edge

---

64-xx

---

▣▣▣▣ Only if SYSTEM PARAMETER > Periph. device = „Dispenser“.  
Adapts the feeding to the length of the dispensing edge.

<b>long</b>	Long dispensing edge
<b>short</b>	Short dispensing edge (Default setting)
<b>User defined</b>	The distance between print line and dispensing edge can be set by SYSTEM PARAMETER > Head disp dist (see below). This is helpful if none of the standard dispensing edges are applied.

### Max InitFeedback

---

64-xx	ALX 92x	DPM
-------	---------	-----

---

▣▣▣▣ 64-xx: Only with dispenser version.  
▣▣▣▣ Only if SYSTEM PARAMETER > Gap detect mode = „Autom. feed back“.



During initialization, the label material is fed back until the next punch/reflex mark is reached. This parameter defines the maximum admissible backwards feeding length.

xx mm

Setting range: 0 to 200 mm; Step width: 1 mm; Default setting: 80 mm

## Transport mode

64-xx

► Only if `SYSTEM PARAMETER > Periph. device = „Dispenser“`.

In normal operation mode, the rewinder motor (Dispenser Motor) feeds the material, while the feed motor runs idle. When applying very slim material, it can be advisable to add the power of the feed motor in order to prevent material rupture (Dual Motors). To run the printer like a usual non-dispenser, the rewinder motor can be switched off (Printer Motor).

► Absolutely use the "Dual Motors" mode, if the following three conditions are the case:

- Printer is used as dispenser
- Ribbon autoeconomy mode switched on
- Print speed higher than 203 mm/s (8 inch/s)

Printer Motor

Rewinder motor switched off. The printer behaves like a model without dispenser option.

Dual Motors

Both motors (feed and rewinder) are activated.

Dispenser Motor

The feed motor is switched off. The rewinder motor feeds the material (Default setting).

## Start offset

64-xx ALX 92x DPM

Function for operation with product sensor.

Use this parameter to set the distance between product sensor (light barrier) and dispensing edge. The recommended delay time is calculated of the "Start delay" distance and the conveyor speed (= print speed in cases of direct application).

xxx.x mm

Setting range: 15.0 bis 2999.9 mm; Unit interval: 0.1 mm;  
Default setting: 15.0 mm

## Start error stop

64-xx ALX 92x DPM

Function for operation with product sensor.

Determines the reaction of the machine on a product start error. A product start error occurs in the following cases:

- If a further start signal arrives, before the current label is completely printed.

- *With mounted I/O board or USI board only:* If a reprint is requested, before the first label after powering on is printed.
- If a start signal arrives and no printjob is loaded.

If a product start error occurs, the machine stops and displays the appropriate status message. If an I/O board or an USI is installed, the following output signals are activated (set low):

- ERROR\
- MACHINE STATUS\

**On** (Default) Start errors are worked up (the machine stops!)

**Off** Start errors are being ignored.

**Product length**

---

64-xx	ALX 92x	DPM
-------	---------	-----

---

Function for operation with product sensor.

If this function is activated, the printer ignores all start signals until the product has passed the dispensing edge.

**0.0 mm** Setting range: [0.0...1999.9] mm; Default setting.: 0.0

## Speed Adaption

ALX 92x	DPM
---------	-----

Aktivieren der Geschwindigkeits-Adaption (APSF)

**On**

The dispensing speed adapts automatically to match the speed of the conveyor belt.

Prerequisites:

- APSF kit installed
- Rotary encoder installed
- The following parameters must be set to match the applied rotary encoder:
  - DISPENSER PARA > Encoder Type
  - DISPENSER PARA > Encoder Resol.
  - DISPENSER PARA > Encoder Diameter

**Off**

(Default setting) The dispensing speed remains constant, at the value that was set using parameter PRINT PARAMETERS > Print speed.

## Encoder Type

ALX 92x	DPM
---------	-----

Type of rotary encoder used.

☛ Only if DISPENSER PARA > Speed Adaption = „On“

**Single Phase**

(Default setting) Setting for single phase rotary encoder

**2 Phases normal**

Setting for normal 2 phase rotary encoder

**2 Phases invert.**

Setting for inverted 2 phase rotary encoder

## Encoder Resol.

ALX 92x	DPM
---------	-----

Resolution of the rotary encoder used.

☛ Only if DISPENSER PARA > Speed Adaption = „On“

**xxxx**

Setting range: 0,0 bis 9999 pulses/turn; Default setting: 500

## Encoder Diameter

ALX 92x	DPM
---------	-----

Diameter of the measuring wheel at the rotary encoder used.

☛ Only if DISPENSER PARA > Speed Adaption = „On“

**xxx,x**

Setting range: 0,0 bis 200,0 mm; Default setting: 64,0

200.0 mm	20.6 var
----------	----------

The diameter of the measuring wheel is shown on the left. The current product speed as calculated by the machine appears on the right. If this speed is not equal to the actual speed, the setting for the measuring wheel diameter can be changed to align the actual and measured values for the conveyor speed.

Example shown on display: The speed of the conveyor belt is calculated at 20.6 m/min for a measuring wheel of diameter 200 mm at the current rate of rotation.

### Forw. feed rat.

---

64-xx

---

▣▣▣▣ 64-xx dispenser only

▣▣▣▣ Only if DISPENSER PARA > Transport mode = „Dual motors“

Forward feed ratio

Setting the forward feed ratio (in dispensing direction)

$$\frac{\text{Dispensing motor feed speed}}{\text{Feed motor feed speed}} \cdot 100\% = \text{Setting value\%}$$

xxx%

Setting range: 90 - 100%; Step width: 1; Default setting: 100%

### Backw feed rat.

---

64-xx

---

▣▣▣▣ 64-xx dispenser only

▣▣▣▣ Only if DISPENSER PARA > Transport mode = „Dual motors“

Backward feed ratio

Setting the backward feed ratio (contrary to the dispensing direction)

$$\frac{\text{Dispensing motor feed speed}}{\text{Feed motor feed speed}} \cdot 100\% = \text{Setting value\%}$$

xxx%

Setting range: 90 - 100%; Step width: 1; Default setting: 100%

## Multi label mode

---

ALX 92x    DPM

---

☛ Only works if a singlestart connector or an USI is used as signal input - it doesn't work, if an AI is applied as signal input.

Off

Each start signal causes printing of one label.

x labels/start

Each start signal causes printing of x labels; x = [2...20];

x > 3: The distance of all following labels after the 2nd label matches the value set in `DISPENSER PARA > Label 2 offset`.

## Label 2 offset

---

ALX 92x    DPM

---

☛ Only if `DISPENSER PARA > Multi label mode = „x labels/start“`

Defines the distance of the 2nd label and of all following labels, if x > 3 (see `DISPENSER PARA > Multi label mode`). The distance is measured from the front label edge of the preceding label.

x mm

Setting range: x...9999.9 mm; Default: x, with x = `DISPENSER PARA > Label pitch`.

## Label 3 offset

---

ALX 92x    DPM

---

☛ Only if `DISPENSER PARA > Multi label mode = „3 labels/start“`

Defines the distance of the 3rd label for the `DISPENSER PARA > Multi label mode` parameter (see above). The distance is measured from the front label edge of the preceding label.

x mm

Setting range: x...9999.9 mm; Default: x, with x = `DISPENSER PARA > Label pitch`.

## APPLICATOR PARA

▣▣▣▣➔ This menu only appears in printers of the types DPM, PEM and ALX 92x, and only, if the optional Applicator Interface (AI) is connected.

### Applicator type

ALX 92x	DPM
---------	-----

▣▣▣▣➔ Only with an AI installed.  
Selection, which applicator type will be applied:

#### LTP-LTPV

LTP = Light Touch Pneumatic

LTPV = Light Touch Pneumatic Vacuum

Applicator with „Light Touch“ function. „Light Touch“ means, that the movement of the (compressed air) cylinder is limited by sensors, which react to a light touch onto the product. The LTPV additionally sucks the labels on with a vacuum nozzle.

Advantages:

- Application on products with different heights possible
  - Only light pressure onto the product (important with sensitive products)
- Refer to [Technical Manual LTP/LTPV](#) .

#### PEP

The cylinder movement is limited by a setable length of time. After the run out of this application time, the cylinder moves back into home position.

#### PEP Blow on

PEP-type applicator with blow on function: After run out of the application time, the blow on function is activated. After run out of the blow on time, the applicator moves back into home position.

#### PEP II Sensor

The cylinder movement is limited by a (touch down) sensor, which signals the contact to the product and triggers the backwards-movement.

#### ASA

ASA = Air stream applicator. This applicator type has no moving parts, but blows the label onto the product (also called „blow box“). After the start signal, the blow on valve is opened for a setable time length.

#### Reverse PEP

This applicator is partly time related. Working procedure:

The applicator moves to its end position and “waits“ for the start signal. The start signal triggers the blow on valve which is active for the defined blow on time. After the run out or the blown on time, the applicator moves to home position, gets the next label and moves to the wait position.

#### Direct Dispense

Dispensing with dispensing edge (without applicator).

#### BTS

BTS = Bad tag separator. This device does the opposite of an applicator: it removes labels from the dispensing edge of a labeller. The BTS is used for sorting out RFID labels, which could not be read/written properly.

#### O-ring applicat.

Setting for an O-ring applicator.



#### LA-BO

**Label Applicator Blow On.**

- For details refer to the [User Manual LA-BO](#) .

#### LA-CE

**Label Applicator Corner Edge**, applies the label around a corner edge.

- LA-SO**                      **Label Applicator Swing On**, applies the label with a rotation movement.
- For details refer to the [User Manual LA-SO](#) 
- LA-TO Timed**              **Label Applicator Tamp On**, time controlled
- LA-TO Sensor**            LA-TO, sensor controlled
- LA-TO BO Timed**        **Label Applicator Tamp On** with **Blow On** function, time controlled
- LA-TO BO Sensor**      **Label Applicator Tamp On** with **Blow On** function, sensor controlled
- For details about LA-TO and LA-TO BO refer to the [User Manual LA-TO](#) 

## Application mode

ALX 92x	DPM
---------	-----

▣▣▣▣➔ Only with an AI installed.

Defines, if the application process starts with applying („After start signal“) or with printing the label. Precondition: A printjob is loaded and the printer is in online mode.

- After print**                      The start signal triggers the immediate printing, dispensing and applying of a label.
- After start sig.**                The start signal triggers the application of an already printed and dispensed label. After applying the label, the next one is immediately printed and dispensed.
- A flow chart illustrating the application process can be found in the [User Manual LTP/LTPV](#) , topic section "Installation / Setup", paragraph „Product description“ > "Function diagram LTSI / LTP / LTPV".

## Start print mode

ALX 92x	DPM
---------	-----

▣▣▣▣➔ Only with an AI installed.

Selecting a print mode. Depending on the selected mode, the start signal will be interpreted differently by the AI.

Requirements:

- SYSTEM PARAMETER > External signal = „Singlestart“
- A printjob was transferred (DATA READY)
- Printer is switched „Online“
- No error messages

▣▣▣▣➔ Start Print Mode replaces the Parameter SYSTEM PARAMETER > Signal edge, which can be found in older firmware versions.

- Further information about using a start signal: Read the user manual, topic section „Advanced Applications“, chapter [Printing with start signal](#) 

▣▣▣▣➔ 64-xx: This parameter has priority over SYSTEM PARAMETER > Signal edge, which is relevant for setting the triggering of the single start connector.

- Pulse fall/ris**                      The printing of a label is triggered by a low-high-change as well as by a high-low change of the start signal. The printing occurs only after the set delay time.

<b>Level high active</b>	Labels will be printed as long as the start signal is held high.
<b>Pulse rising</b>	The printing of a label is triggered by a low-high change of the start signal. The printing occurs only after the set delay time.
<b>Level low active</b>	Labels will be printed as long as the start signal is held low.
<b>Pulse falling</b>	(Default setting) The printing of a label is triggered by a high-to-low change of the start signal. The printing occurs only after the set delay time.

### Dwell time

ALX 92x	DPM
---------	-----

■ Only with an AI installed.

■ Only if **APPLICATOR PARA > Applicator type** = „PEP“, „PEP Blow on“, „Reverse PEP“, „BTS“, „LA-SO“, „LA-TO zeitgest.“.

Defines the dwell time for the apply cylinder. The dwell time is the time during which the cylinder valve is turned on.

xxxxx ms      Setting range: 1 to 99999 ms; Unit interval: 1 ms; Default setting: 1 ms

### Blow on time

ALX 92x	DPM
---------	-----

■ Only with an AI installed.

■ Only if **APPLICATOR PARA > Applicator type** = „PEP Blow on“, „PEP II Sensor“, „ASA“, „Reverse PEP“, „BTS“, „O-Ring Applikator“, „LTP - LTPV“ or „LA-BO“.

 Standard applicators of the LTP/LTPV types don't need the „Blow on time“ signal, therefore this parameter is not relevant for them. The parameter is intended for special variants of the LTP/LTPV applicator, which provide an additional blow-on function using this signal.

xxxxx ms      Setting range: 0 to 99999 ms; Unit interval: 1 ms; Default setting: 1 ms

### Restart delay

ALX 92x	DPM
---------	-----

■ Only with an AI installed.

Sets the delay time after the application, during which no start signals are accepted.

xxxxx ms      Setting range: 0 to 99999 ms; Unit interval: 1 ms; Default setting: 0 ms

### Apply comp. time

ALX 92x	DPM
---------	-----

■ Only with an AI installed.

■ Only if **APPLICATOR PARA > Applicator type** is not „Direct Dispense“



Compensation time for the applicator stroke time; required for operation with variable conveyor speed.

xxxxx ms

Setting range: 0 to 99999 ms; Unit interval: 1 ms; Default setting: 0 ms

- For details refer to the service manual ALX 92x, topic section „Installation/ Deinstallation“, chapter „Installing APSF“ > „Compensation time with applicator operation“.

### Position timeout

ALX 92x	DPM
---------	-----

▣ Only with an AI installed.

▣ Not with `APPLICATOR PARA > Applicator type` = „ASA“, „Direct Dispense“, „LA-BO“.

Sets the delay time, after which a position error of the applicator is displayed as an error. A position error occurs, if the applicator doesn't reach any of its end positions within the required time frame.

xxxxx ms

Setting range: 200 to 99999 ms; Unit interval: 1 ms;  
Default setting: 2000 ms

Off

Set  $x < 200$  to disable the function.

### Lab release time

ALX 92x	DPM
---------	-----

▣ Only with an AI installed.

▣ Not with `APPLICATOR PARA > Applicator type` = „ASA“.

▣ Required setting: `APPLICATOR PARA > Application mode` = „After printing“

Defines a delay between the dispensing and the start of application of the label.

xxxx ms

Setting range: 1-99999 ms; Unit interval: 1 ms; Default setting: 0 ms

### Touch down sens.

ALX 92x	DPM
---------	-----

Switching behaviour of the touchdown sensor.

▣ Only with an AI installed.

▣ Only visible with certain applicator types.

Pulse falling

The *falling* signal edge at the sensor triggers the touchdown trigger event

Pulse rising

The *rising* signal edge at the sensor triggers the touchdown trigger event

### TouchDownTimeout

ALX 92x	DPM
---------	-----

Timeout at the touchdown sensor.

- ▣▣▣▣ Only with an AI installed.
- ▣▣▣▣ Only visible with certain applicator types.

This time specifies the maximal wait time for the touchdown trigger event. If the specified time is exceeded without the touchdown event, the applicator continues operation in the same manner as the touchdown event would have taken place. *No error message will appear in this case.*

xxxxx

Setting range: 100 to 99999 ms

Off

(Default setting)

## I/O BOARD

▣▣▣▣ This menu appears only if the optional I/O Board is mounted.

### Start print mode

64-xx	ALX 92x	DPM	PEM	ALX 73x (PMA)
-------	---------	-----	-----	---------------

▣▣▣▣ Only with an I/O board mounted.

Selecting a print mode. Depending on the selected mode, the input signal START\_PRINT will be interpreted differently by the I/O Board signal interface. The parameter is also used for the device connected to the foot switch jack.

- Make sure to select SYSTEM PARAMETER > External Signal = „Single Start“.
- See parameter [External signal](#) on page 85.
- Note: The parameter Start Print Mode replaces the parameter Signal Edge in the SYSTEM PARAMETER menu.
- Preconditions: Print job is available (DATA READY), printer is in “Online” mode, no error messages.

#### Pulse falling

(Default setting) The printing of a label is triggered by a high-to-low change of the signal at the input START PRINT. The printing occurs only after the set delay time.

#### Pulse rising

The printing of a label is triggered by a low-high change of the signal at the input START PRINT. The printing occurs only after the set delay time.

#### Pulse fall/ris

The printing of a label is triggered by a low-high-change as well as by a high-low change of the signal at the input START PRINT. The printing occurs only after the set delay time.

#### Level low active

Labels will be printed as long as the signal at input START PRINT is held low.

#### Level high activ

Labels will be printed as long as the signal at input START PRINT is held high.

### Reprint Signal

64-xx	ALX 92x	DPM	PEM	ALX 73x (PMA)
-------	---------	-----	-----	---------------

▣▣▣▣ Only with an I/O board mounted.

#### Off

The input signal is disabled

#### On

The last printed label will be reprinted on the falling edge of the REPRINT signal.

Preconditions:

- The label to be reprinted, should be printed and dispensed.
- Printer is in online mode.

▣▣▣▣ If a REPRINT is triggered while the printer is in “I/O-Board Pause” mode, the reprint will proceed as soon as the printer is switched back in online mode.  
Precondition: in level mode START PRINT must be inactive.

## Feed input

64-xx	ALX 92x	DPM	PEM	ALX 73x (PMA)
-------	---------	-----	-----	---------------

☐☐☐☐➔ Only with an I/O board mounted.

Concerns the input signal FEED at the signal interface.

**On**

(Default setting) Feeding of one label on the falling signal edge. The display shows „I/O board feed“ during feeding. Requirements are:

- Offline mode, „stopped mode“ or „pause mode“
- Online mode and no print job loaded.

**Off**

Signals at the FEED input are ignored.

## Pause input

64-xx	ALX 92x	DPM	PEM	ALX 73x (PMA)
-------	---------	-----	-----	---------------

☐☐☐☐➔ Only with an I/O board mounted.

Concerns the input signal PAUSE at the signal interface.

**Off**

Signals at the PAUSE input are ignored.

**Pause**

A high-to-low transition switches the printer into the „I/O-Board Pause“ mode. The next high-low-transition switches the printer back into the online mode. If parameter *I/O-Board > Start print mode* is set to „Level high active“ or „Level low active“, any activating of the PAUSE signal stops the printing after the current label.

Features:

- Printer display shows „I/O-Board pause“
- ERROR is active (only if *I/O Board > Error output* is set to „Printer err+Off“)
- If a print job is available: DATA READY becomes inactive (if *I/O Board > Status output* is set to „Print job ready“)
- START PRINT signals are suppressed
- REPRINT requests are processed after switching into online mode.

A "low" signal for 20 ms switches the printer into the pause mode. The pause mode is the same as the "Online stopped" mode and can be switched to the "Online" mode by pressing the feed button.

## Error output

64-xx	ALX 92x	DPM	PEM	ALX 73x (PMA)
-------	---------	-----	-----	---------------

☐☐☐☐➔ Only with an I/O board mounted.

This parameter defines different events, which activate the output signal ERROR.

**Printer error**

ERROR will be activated in all of the following cases:

- Material end
- Ribbon end (only if *SYSTEM PARAMETER > Foil mode* = „Thermo transfer“)
- No punch recognized (only if *PRINT PARAMETERS > Material type* = „punched“)
- Printhead pressure lever was opened during the printing of a label.

- Start print error
  - Other errors, which keep the printer from printing
- ▣▣▣▣ During the initialization (powering up) of the printer, the ERROR-signal is instable!

**Printererr + Offl**

In addition to the above mentioned cases activate the following events the ERROR-signal:

- The printer is in offline mode
- The printhead pressure lever is open
- „I/O board pause“ mode
- Stopped mode (the printing was stopped)

**Error Polarity**

64-xx	ALX 92x	DPM	PEM	ALX 73x (PMA)
-------	---------	-----	-----	---------------

▣▣▣▣ Only with an I/O board mounted.  
Switches the polarity of the ERROR signal.

**Level high activ**

The output is high when it is active, otherwise low.

**Level low active**

The output is low when it is active, otherwise high. (Default)

**Status output**

64-xx	ALX 92x	DPM	PEM	ALX 73x (PMA)
-------	---------	-----	-----	---------------

▣▣▣▣ Only with an I/O board mounted.  
This parameter defines different events, which activate the output signal MACHINE STATUS.

**Low ribbon warn**

The signal is activated, if the ribbon roll diameter is less than the limit.

- See parameter [Foil end warning](#) on page 73.

**Print job ready**

(Default setting) The signal is activated, if the printer has finished image processing and is ready to start printing.

The signal is *not activated*, if:

- the print job is done,
- the print job was stopped,
- the printer was switched to offline mode,
- the printer is in pause mode.

**Status polarity**

64-xx	ALX 92x	DPM	PEM	ALX 73x (PMA)
-------	---------	-----	-----	---------------

▣▣▣▣ Only with an I/O board mounted.  
Switches the polarity of the MACHINE STATUS signal.

**Level high activ**

The output is high when it is active, otherwise low.

**Level low active**

(Default setting)The output is low when it is active, otherwise high.

## End print mode

64-xx	ALX 92x	DPM	PEM	ALX 73x (PMA)
-------	---------	-----	-----	---------------

▣► Only with an I/O board mounted.

Concerns the output signal PRINT\_END at the I/O board signal interface. Determines the signal response after printing of a label.

### Mode0 inactive

No print end signal.

### Mode1 low level

Low, if the print module is just printing a label, otherwise high. The output is also deactivated (= low) as long as labels are fed with "Feed Button" or "Feed Signal".

### Mode2 high level

High, if the print module is just printing a label, otherwise low. The output is also deactivated (= high) as long as labels are fed with "Feed Button" or "Feed Signal".

### Mode3 low pulse

(Default setting) Low for 20 ms after printing and dispensing a label. The output is also activated (= low) after a label is fed with "Feed Button" or "Feed Signal".

### Mode4 high pulse

High for 20 ms after printing and dispensing a label. The output is also activated (= high) after a label is fed with "Feed Button" or "Feed Signal".

## OLV PARAMETERS

▣▣▣▣ This menu only appears, if an online verifier (OLV) is connected to the printer. For this, the parameter `INTERFACE PARA > COM2 PORT > Function Option` must be set to „Barcode OLV“.

### Verify mode

64-xx	ALX 92x	DPM	PEM
-------	---------	-----	-----

All bar codes

▣▣▣▣ Only if `OLV PARAMETER > Cancel. printing = „On“`.

All bar codes are being checked according to the limits set at the printer.

Easyplug select.

▣▣▣▣ Easy-Plug print jobs don't have to be modified when using this setting. Only those bar codes are being verified, which have the „V“ set in the command option.

- For details refer to the Easy-Plug manual, command #YB.

### Cancel. printing

64-xx	ALX 92x	DPM	PEM
-------	---------	-----	-----

▣▣▣▣ 64-xx: Parameter is not supported for dispenser version.

Cancellation printing

Off

No cancellation printing.

On

If no validation data for the printed bar code was sent, or if the bar code exceeds the set limits, the faulty printed label is cancelled. Afterwards, the same label is reprinted. The amount of reprints can be set with the parameter „Reprint quantity“. If the error still occurs after the so defined quantity of labels was reprinted, the printing stops and an adequate error message appears.

### Reprint quantity

64-xx	ALX 92x	DPM	PEM
-------	---------	-----	-----

▣▣▣▣ Only, if `OLV PARAMETER > Cancel. printing = „On“`.

Defines the maximum amount of reprint attempts after a bar code read error.

xxx

- Setting range: 0 to 10, Unit interval: 1; Default setting: 0

### OLV mode

64-xx	ALX 92x	DPM	PEM
-------	---------	-----	-----

Fast legacy

No additional material feed is made, if the bar code is near the end of a label. An additional material feed is only made if the last label of a job is printed and the printer has to stop. This is the behaviour of a Gen. 1 printer with firmware 3.40.

Limitations:

- `OLV PARAMETERS > Cancel. printing` is not available

## 64-xx – DPM – PEM – ALX 92x – ALX 73x (PMA)

- It is not recommended to use the setting „Fast legacy“ as a standard, as some unexpected behavior, depending on the label format, may occur. Each label format has to be tested explicitly.

**fast**

Standard verification mode.

**slow**

Each print job is proceeded as if it contained counting fields. Additionally, each labels is moved forward underneath the laser beam and backwards again. This procedure slows down the label throughput, but on the other hand it ensures that the correct counting field content is printed after an error ocured.

**Ref Decode**

64-xx	ALX 92x	DPM	PEM
-------	---------	-----	-----

☛ Only if OLV PARAMETER > Cancel. printing = „On“.

**No Test**

The bar code doesn't have to be decodable.

**Pass**

The bar code must be decodable.

**Decodability**

64-xx	ALX 92x	DPM	PEM
-------	---------	-----	-----

☛ Only if OLV PARAMETER > Cancel. printing = „On“.

☛ Condition: Value >= Limit.

**xxx**

Setting range: -1 to 100; Unit interval: 1; -1 = No checking.

**Modulation**

64-xx	ALX 92x	DPM	PEM
-------	---------	-----	-----

☛ Only if OLV PARAMETER > Cancel. printing = „On“.

☛ Condition: Value >= Limit.

**xxx**

Setting range: -1 to 100; Unit interval: 1; -1 = No checking.

**Defects**

64-xx	ALX 92x	DPM	PEM
-------	---------	-----	-----

☛ Only if OLV PARAMETER > Cancel. printing = „On“.

☛ Condition: Value <= Limit.

**xxx**

Setting range: -1 to 100; Unit interval: 1; -1 = No checking.

**Edge contrast**

64-xx	ALX 92x	DPM	PEM
-------	---------	-----	-----

☛ Only if OLV PARAMETER > Cancel. printing = „On“.

☛ Condition: Value >= Limit.

**xxx**

Setting range: -1 to 100; Unit interval: 1; -1 = No checking.



**Rmin/Rmax**

64-xx	ALX 92x	DPM	PEM
-------	---------	-----	-----

Minimaler/maximaler Reflexionsgrad.

☛ Only if OLV PARAMETER > Cancel. printing = „On“.

☛ Condition: Value <= Limit.

xxx

Setting range: -1 to 100; Unit interval: 1; -1 = No checking.

**Symbol contrast**

64-xx	ALX 92x	DPM	PEM
-------	---------	-----	-----

☛ Only if OLV PARAMETER > Cancel. printing = „On“.

☛ Condition: Value >= Limit.

xxx

Setting range: -1 to 100; Unit interval: 1; -1 = No checking.

**PCS**

64-xx	ALX 92x	DPM	PEM
-------	---------	-----	-----

Print Contrast Signal.

☛ Only if OLV PARAMETER > Cancel. printing = „On“.

☛ Condition: Value >= Limit.

xxx

Setting range: -1 to 100; Unit interval: 1; -1 = No checking.

**R (white)**

64-xx	ALX 92x	DPM	PEM
-------	---------	-----	-----

Reflectance.

☛ Only if OLV PARAMETER > Cancel. printing = „On“.

☛ Condition: Value >= Limit.

xxx

Setting range: -1 to 100; Unit interval: 1; -1 = No checking.

**R (black)**

64-xx	ALX 92x	DPM	PEM
-------	---------	-----	-----

Reflectance.

☛ Only if OLV PARAMETER > Cancel. printing = „On“.

☛ Condition: Value <= Limit.

xxx

Setting range: -1 to 100; Unit interval: 1; -1 = No checking.

**Ratio**

---

64-xx	ALX 92x	DPM	PEM
-------	---------	-----	-----

---

▶ Only if OLV PARAMETER > Cancel. printing = „On“.

▶ Condition: Value >= Limit.

xxx

Setting range: -1 to 99; Unit interval: 1; -1 = No checking.

**ANSI symbol grade**

---

64-xx	ALX 92x	DPM	PEM
-------	---------	-----	-----

---

▶ Only if OLV PARAMETER > Cancel. printing = „On“.

▶ Condition: Value >= Limit.

For most applications, it is sufficient to set only this parameter. The previously listed parameters are checked automatically according to ANSI grade.

xxx

Setting range: -1 to 40; Unit interval: 1; -1 = No checking.

Value	ANSI Grade
0-5	F
5-15	D
15-25	C
25-35	B
35-40	A

[11] ANSI symbol grades

**Dist. head-beam**

---

64-xx	ALX 92x	DPM	PEM
-------	---------	-----	-----

---

For most applications, it is sufficient to set only this parameter. The previously listed parameters are checked automatically according to ANSI grade.

Setting of the distance between reading position of the laser beam and print head.

xx mm

Setting range: 6 to 18; Unit interval: 1

## DP INTERFACE

- ▣▣▣▣▶ The parameters described in this section only appear in the parameter menu after a USI board is mounted.
- For information on signals and pin assignment of the USI, refer to the Service Manual, topic section "Electronics", chapter "USI board".

### Interface type

64-xx	ALX 92x	DPM	PEM	ALX 73x (PMA)
-------	---------	-----	-----	---------------

- ▣▣▣▣▶ Only with USI board.  
Sets the machine to the used application procedure.

#### USI interface

Setting for direct dispensing.

#### USI applicator

Setting for operation of an applicator with additional PLC.

### Start print mode

64-xx	ALX 92x	DPM	PEM	ALX 73x (PMA)
-------	---------	-----	-----	---------------

- ▣▣▣▣▶ Only with USI board.  
Selecting a print mode. Depending on the selected mode, the input signal START\_PRINT will be interpreted differently by the USI interface.

Requirements:

- SYSTEM PARAMETER > External signal = „Singlestart“
- A printjob was transferred (DATA READY)
- Printer is switched „Online“
- No error messages

- ▣▣▣▣▶ Start Print Mode replaces the Parameter SYSTEM PARAMETER > Signal edge, which can be found in older firmware versions.

- ▣▣▣▣▶ 64-xx: This parameter has priority over SYSTEM PARAMETER > Signal edge, which is relevant for setting the triggering of the single start connector.

- Further information about using a start signal: Read the user manual, topic section „Advanced Applications“, chapter [Printing with start signal](#) .

#### Pulse fall/ris

The printing of a label is triggered by a low-high-change as well as by a high-low-change of the signal at the input START PRINT. The printing occurs only after the set delay time.

#### Level high activ

Labels are being printed as long as the signal at input START PRINT is held high.

#### Pulse rising

The printing of a label is triggered by a low-high-change of the signal at the input START PRINT. The printing occurs only after the set delay time.

#### Level low active

Labels are being printed as long as the signal at input START PRINT is held low.

#### Pulse falling

(Default setting) The printing of a label is triggered by a high-low-change of the signal at the input START PRINT. The printing occurs only after the set delay time.

## End print mode

64-xx	ALX 92x	DPM	PEM	ALX 73x (PMA)
-------	---------	-----	-----	---------------

☛ Only with USI board.

Concerns the output signal PRINT\_END at the USI interface. Determines the signal response after printing of a label.

### Mode 0

No print end signals.

### Mode 1

Low, if the print module is printing a label, otherwise high.

### Mode 2

High, if the print module is printing a label, otherwise low.

### Mode 3

(Default setting) Low for 20 ms after printing and dispensing a label. The signal is also low, if the label material is *only* fed - triggered by pressing the feed button or by a feed signal.

### Mode 4

High for 20 ms after printing and dispensing a label. The signal is also high, if the label material is *only* fed - triggered by pressing the feed button or by a feed signal.

### Mode 5

The PRINT\_END signal is *low* as long as the material is fed forwards (even for gap initialization).

### Mode 6

The PRINT\_END signal is *high* as long as the material is fed forwards (even for gap initialization).

## Reprint signal

64-xx	ALX 92x	DPM	PEM	ALX 73x (PMA)
-------	---------	-----	-----	---------------

☛ Only with USI board.

Determines the reaction on an incoming signal at pin REPRINT\ at the USI.

### Off

(Default setting) Incoming signal is ignored.

### On

On a high-low toggle of the signal: The last printout is repeated.

## Ribbon signal

64-xx	ALX 92x	DPM	PEM	ALX 73x (PMA)
-------	---------	-----	-----	---------------

☛ Only with USI board.

Concerns the output signal WARNING at the USI, which signalizes the close shortness of ribbon or material.

### On

(Default setting) High, if the ribbon stack is less than the threshold value.

- The threshold setting is done with the parameter `SYSTEM PARAMETER > Foil end warning.`

### Off

Ribbon signal deactivated.

## Material signal

64-xx	ALX 92x	DPM	PEM	ALX 73x (PMA)
-------	---------	-----	-----	---------------

▣ Only with USI board.

Concerns the output signal WARNING at the USI, which indicates the close shortness of ribbon or material.

**On**

High, if the diameter of the material roll falls below a certain value. The limit diameter is set by positioning the outer diameter (OD) sensor.

**Off**

▣ Requirement: "OD sensor material" is installed.  
No material end warning.

## Mat. signal stop

64-xx	ALX 92x	DPM	PEM	ALX 73x (PMA)
-------	---------	-----	-----	---------------

▣ Only with USI board.

Defines the reaction of the printer on a material low signal coming from the OD-sensor.

○ See [DP INTERFACE > Material signal](#)

**Off**

(Default) The output signal WARNING at the USI is activated (precondition: [DP INTERFACE > Material signal](#) is set to „enabled“). The printing will be continued.

**On**

After a material low warning occurred, the printer finishes printing the current label and stops afterwards. The display shows:

```
Print Status: 5123
USI Material low
```

After acknowledging the message, the printing can be continued.

## Feed input

64-xx	ALX 92x	DPM	PEM	ALX 73x (PMA)
-------	---------	-----	-----	---------------

▣ Only with USI board.

Concerns the output signal FEED at the USI.

**Standard**

(Default setting) Feed of blank labels as long as signal is "low".  
Precondition: Off-line mode or printing stopped in on-line mode.

**JP5**

A signal different from the standard FEED can be used. Precondition: an appropriate firmware change (NISTAN).

## Pause input

64-xx	ALX 92x	DPM	PEM	ALX 73x (PMA)
-------	---------	-----	-----	---------------

▣▣▣▣▶ Only with USI board.

Concerns the output signal PAUSE\ of the USI.

### Standard

(Default setting) A "low" signal for 20 ms switches the DPM / PEM to the pause status. The pause status equals the status "on-line stopped" and can be closed by pressing the feed button.

### JP6

A signal different from the standard PAUSE\ can be used. Precondition: an appropriate firmware change (NISTAN).

## Start error stop

64-xx	ALX 92x	DPM	PEM	ALX 73x (PMA)
-------	---------	-----	-----	---------------

▣▣▣▣▶ Only with USI board.

Determines the reaction of the machine on a product start error. A product start error occurs in the following cases:

- If a further start signal arrives, before the current label is completely printed.
- If a reprint is requested, before the first label after powering on is printed.
- If a start signal arrives and no printjob is loaded.

If a product start error occurs, the machine stops and displays the appropriate status report. At the same time, the following output signals are activated (set low):

- ERROR
- MACHINE STATUS

### On

Start errors are worked up (the machine stops!) (default setting)

### Off

Start errors are being ignored.

## Internal inputs

64-xx	ALX 92x	DPM	PEM	ALX 73x (PMA)
-------	---------	-----	-----	---------------

▣▣▣▣▶ Only with USI board.

Defines, if the internal inputs (CN300) on the USI board will be used or not.

- To find the location of the inputs, refer to the service manual, topic section "Circuit/Component Diagrams", chapter "USI board".

### On

The internal inputs will be enabled.

### Off

The internal inputs will be disabled.

## Apply mode

64-xx	ALX 92x	DPM	PEM	ALX 73x (PMA)
-------	---------	-----	-----	---------------

▣ Only with USI board.

▣ Only, if `DP INTERFACE > Interface type = „USI Applicator“`.

Defines, if the application process starts with applying („After start signal“) or with printing („After print“). Requirements: Printjob transferred, printer is switched „Online“.

### After print

The start signal triggers the immediate printing, dispensing and applying of a label. Precondition: A printjob is loaded and the printer is in online mode.

### After start sig.

The start signal triggers the application of an already printed and dispensed label. After applying the label, the next one is immediately printed and dispensed. Precondition: A printjob is loaded and the printer is in online mode.

- For detailed information about the applicator mode refer to the Technical Manual LTSI, topic section "Specifications", paragraph "Function diagram LTSI / LTP / LTPV".

## USI profile

64-xx	ALX 92x	DPM	PEM	ALX 73x (PMA)
-------	---------	-----	-----	---------------

▣ Only with USI board (minimum required USI firmware version: 9).

### Standard

Standard setting without forwarding the BTS (Bad Tag Signal).

### Bad Tag

Forwards the BTS to the „Warning“ output of the USI (pin 9). The BTS is generated, if a read/write operation on a RFID-Tag failed.

## Warning signal

64-xx	DPM	PEM	ALX 92x
-------	-----	-----	---------

▣ Only with USI board (minimum required USI firmware version: 9).

### Level low active

The warning signal will be activated with *low* level.

### Level high activ

(Default setting) The warning signal will be activated with *high* level.

## ZPL PARAMETERS

This section lists the ZPL II® commands that the printer can interpret with any special notes, if applicable.

▣▣▣▣ This menu appears only with SYSTEM PARAMETER > Print Interpret. set to „ZPL Emulation“ or „EasyPlug/ZPL Emu“.

▣▣▣▣ ZPL is not supported in Standalone Mode.

▣▣▣▣ Recommended settings:

SYSTEM PARAMETER > RAM disk size at least 2048 Kbytes

SYSTEM PARAMETER > Free store size at least 4 MB

### Darkness

64-xx	ALX 92x	DPM	PEM	ALX 73x (PMA)
-------	---------	-----	-----	---------------

Print contrast for ZPL printjobs. This setting is modified by printjobs which contain print contrast information. The print contrast set by SYSTEM PARAMETERS > Print contrast is not influenced by this setting.

xx

Setting range: 0-30; Step width: 1; Default setting: the Easy-Plug setting is overtaken.

### Control Prefix

64-xx	ALX 92x	DPM	PEM	ALX 73x (PMA)
-------	---------	-----	-----	---------------

Indicates the start of a ZPL control instruction.

xxH

Default: xx = 7E (0x7E = „Tilde“)

### Format Prefix

64-xx	ALX 92x	DPM	PEM	ALX 73x (PMA)
-------	---------	-----	-----	---------------

Indicates the start of a ZPL format instruction.

xxH

Default: xx = 5E (0x5E = „Caret“)

### Delimiter Char

64-xx	ALX 92x	DPM	PEM	ALX 73x (PMA)
-------	---------	-----	-----	---------------

Used as a parameter place marker in ZPL format instructions.

xxH

Default: xx = 2C (0x2C = „Comma“)



64-xx – DPM – PEM – ALX 92x – ALX 73x (PMA)

**Label Top**

64-xx	ALX 92x	DPM	PEM	ALX 73x (PMA)
-------	---------	-----	-----	---------------

Label top offset (y-offet) in dots. Equals the parameter `PRINT PARAMETERS > Y-Printadjust`, which will be ignored, when ZPL printjobs are printed.

**xxx Dots**

Setting range: -240 - +240; Default: 0; Step width: 1

**Left Position**

64-xx	ALX 92x	DPM	PEM	ALX 73x (PMA)
-------	---------	-----	-----	---------------

Left position offset (x-offset) in dots. Equals the parameter `PRINT PARAMETERS > X-Printadjust`, which will be ignored, when ZPL printjobs are printed.

**xxx Dots**

Setting range: -9999 - +9999; Default: 0; Step width: 1

**Manual Calibrate**

64-xx	ALX 92x	DPM	PEM	ALX 73x (PMA)
-------	---------	-----	-----	---------------

For endless material, the label length information is sent in the printjob. For punched material, the label length has to be detected by activating this function.

**YES**

Label length calculation for punched material.

- ▣▣▣▣▶ Activate this function, if label material has changed.
- ▣▣▣▣▶ Calibration should be done after changing material, when there are no printjobs loaded in the printer.
- ▣▣▣▣▶ Shortcut (in offline mode): press the feed + prog buttons simultaneously to activate the calibration.

**Resolution**

64-xx	ALX 92x	DPM	PEM	ALX 73x (PMA)
-------	---------	-----	-----	---------------

Print resolution in dpi. A 200 dpi graphic printjob can be printed with a 300 dpi printhead.

**xxx DPI**

Setting range: 200/300 dpi; Default: 300 dpi;

64-xx – DPM – PEM – ALX 92x – ALX 73x (PMA)

## Error Indication

64-xx ALX 92x DPM PEM ALX 73x (PMA)

Selects the way, in which the printer responds in the event of error occurring during printing.

Low  
High  
Off

Error Level	Setting		
	LOW	HIGH	OFF
0	Ignore	Ignore	Ignore
1	Ignore	Flash on the display	Ignore
2	Prompt user for action	Prompt user for action	Ignore

[12] Error handling settings.

## Error Checking

64-xx ALX 92x DPM PEM ALX 73x (PMA)

Enables or disables error checking, when the printer is handling print fields.

YES

Error checking is enabled. (Default)

NO

Error checking is disabled.

## 305 DPI Scaling

64-xx ALX 92x DPM PEM ALX 73x (PMA)

Enables the printer to emulate the printing with a 11.8 dots/mm printhead.

When a printjob is designed for a printer that uses ZPL with 300 dpi (11.8 dots/mm) and is to be printed on a 64-0x series printer (12 dots/mm), this parameter has to be set to YES.

YES

305 DPI Scaling is enabled. (Default)

NO

305 DPI Scaling is disabled.

## Image Save Path

64-xx ALX 92x DPM PEM ALX 73x (PMA)

Selects the memory to be used by the ^IS and ^IL commands.

■■■► Interpreter version: 1.10 or higher.

CF Card

Optional CompactFlash card

Internal RAM

The printer's internal RAM. (Default)

## Command ^PR

64-xx ALX 92x DPM PEM ALX 73x (PMA)

Disable

The print rate sent in the ZPL printjob is ignored.

**Enable** The print rate is not ignored.

### Command **^MT**

64-xx	ALX 92x	DPM	PEM	ALX 73x (PMA)
-------	---------	-----	-----	---------------

**Disable** The **material type** sent in the ZPL printjob is ignored (thermo-transfer or thermo-direct).

**Enable** The material type is not ignored.

### Label Invert

64-xx	ALX 92x	DPM	PEM	ALX 73x (PMA)
-------	---------	-----	-----	---------------

Rotates the printout by 180°. Equals the parameter [PRINT PARAMETERS > Print direction](#), which will be ignored, when ZPL printjobs are printed.

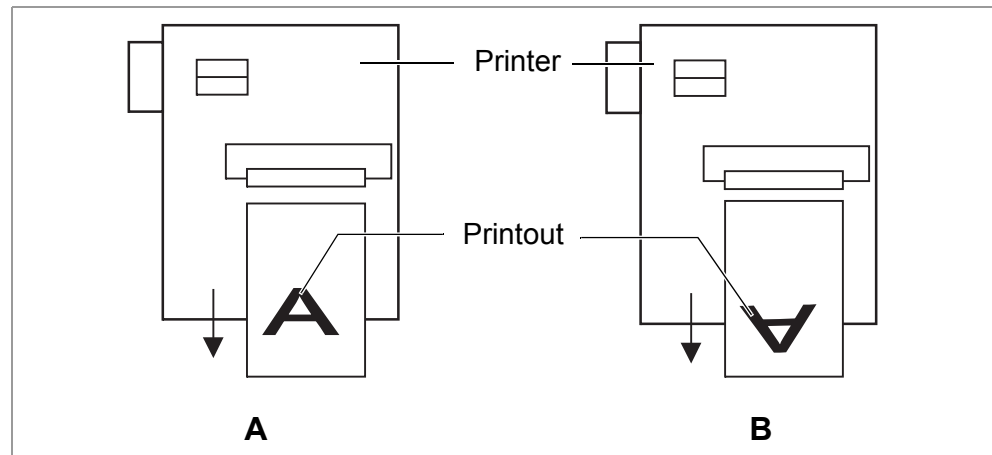

[19] Orientation of the printout: Setting „Disable“ (A) or „Enable“ (B).

**Disable** The label is printed with „normal“ orientation [19A].

**Enable** The label printout is rotated by 180° [19B].

### Command **^JM**

64-xx	ALX 92x	DPM	PEM	ALX 73x (PMA)
-------	---------	-----	-----	---------------

▣▣▣▣► Interpreter version: 1.32 or higher

The ^JM command changes the printer resolution:

- ^JMA sets the resolution to the default value = printhead resolution.
- ^JMB sets the resolution to 200 dpi, if the actual resolution is 300 dpi. If the actual resolution is 200 dpi, this command is ignored.

**Disable** The resolution setting sent in the ZPL printjob is ignored.

**Enable** The resolution setting is not ignored.

**Command ^MD/~SD**

---

64-xx	ALX 92x	DPM	PEM	ALX 73x (PMA)
-------	---------	-----	-----	---------------

---

The ZPL commands ^MD and ~SD (set printhead darkness value) are processed optionally.

**Enable**

^MD- and ~SD are processed.

**Disable**

^MD- and ~SD are ignored.

## SPECIAL FUNCTION

### Printer type

64-xx	ALX 92x	DPM	PEM	ALX 73x (PMA)
-------	---------	-----	-----	---------------

▣▣▣▣➔ Only in production mode.

Selection of the machine type. Must be set after the CPU board was replaced or after new firmware was loaded. The „x“ in the machine name stands for the printhead width. It is detected and replaced automatically.



#### CAUTION!

Selecting an inappropriate machine type can lead to malfunctions or damage of the printer.

➔ Select the printer type that is named on the printers rating plate.

64-0x	64-04/05/06/08 desktop printer.
DPM-0x LH	Printing and dispensing module DPM, lefthand machine.
DPM-0x RH	Printing and dispensing module DPM, righthand machine.
ALX 92x LH	Printing and dispensing machine ALX 924/925/926, lefthand version.
ALX 92x RH	Printing and dispensing machine ALX 924/925/926, righthand version.
MICROJET 64-0x	
MICROJET 64-0xX	
MICROJET 64-0xXX	
PEM-0x LH	Print engine module PEM, lefthand machine.
PEM-0x RH	Print engine module PEM, righthand machine.

### Printhead type

64-xx	ALX 92x	DPM	PEM	ALX 73x (PMA)
-------	---------	-----	-----	---------------

▣▣▣▣➔ This parameter is only visible in production mode!

This parameter chooses the applied printhead type. In most cases equals the printhead width the maximum printwidth of the printer. This parameter is called automatically, after you have modified the printer type setting (SPECIAL FUNCTION > Printer type).

KCE 8Inch	Printhead Kyocera KCE, 8" width, is applied in the following printer type: 64-08
KCE 6Inch	Printhead Kyocera KCE, 6" width, is applied in the following printer types: 64-06, DPM 6", PEM 6", ALX 926
KCE 5Inch	Printhead Kyocera KCE, 5" width, is applied in the following printer types: 64-05, DPM 5", PEM 5", ALX 925, PM 3000
KCE 4Inch	Printhead Kyocera KCE, 4" width, is applied in the following printer types: 64-04, DPM 4", PEM 4", ALX 924

## Sensor type

---

	PEM ALX 73x (PMA)
--	-------------------

---

- Combined sensor** |||▶ Only in production mode.  
Required setting, if the printer is equipped with a combined reflex/punch sensor.
- Standard** Required setting, if the printer is equipped with separate light sensors for reflex marks or gaps.

## Disp. Head Offs.

---

64-xx

---

- |||▶ Only with 64-xx dispenser equipped with a 4" printhead.  
|||▶ Only in production mode.  
Dispenser Head Offset
- Yes** Setting required for 64-04 dispenser with 4" printhead: At the inner side end of the printhead exists a non-printable area of 13 mm width.
- No** Setting required for 64-05 dispenser with 4" printhead: Full 4" print width without restrictions. Precondition: The printhead is positioned at least 13 mm away from the inner side printhead end.

## Default Values

---

64-xx	ALX 92x	DPM	PEM	ALX 73x (PMA)
-------	---------	-----	-----	---------------

---

- User defined** |||▶ Parameter appears only in production mode.  
The presently selected settings of all parameters will be taken as default values. That is you will get those settings back even after a firmware update. All you have to do is to call the parameter "Factory settings".
- Standard** Calling the parameter "Factory settings" will set all parameters to the factory preset values.

## Command sequence

---

64-xx	ALX 92x	DPM	PEM	ALX 73x (PMA)
-------	---------	-----	-----	---------------

---

- ~** |||▶ Parameter appears only in production mode.  
„~“ is used as start sign for Easy-Plug command sequences.
- #** (Default setting) „#“ is used as start sign for Easy-Plug command sequences.

## Delete job

---

64-xx	ALX 92x	DPM	PEM	ALX 73x (PMA)
-------	---------	-----	-----	---------------

---

Press the Online-key to cancel the active print job.

Delete Job  
Clearing . . .

## Delete spooler

---

64-xx	ALX 92x	DPM	PEM	ALX 73x (PMA)
-------	---------	-----	-----	---------------

---

Press the Online-key to delete all print jobs contained in the spooler.

Delete Spooler  
Clearing . . .

## Factory settings

---

64-xx	ALX 92x	DPM	PEM	ALX 73x (PMA)
-------	---------	-----	-----	---------------

---

All parameters are preset ex works to values specific to each device type. These factory settings can be restored at any time.

- ▣▣▣▣► All parameters are then overwritten by the factory settings.
- ▣▣▣▣► All data present in the spooler, including data belonging to an interrupted print job, is deleted!

**No** (Default) No factory setting.

**Custom defaults** If custom parameter settings were stored before (see parameter *Custom defaults*), those are restored.

- ▣▣▣▣► „Custom defaults“ only appears, if custom settings have already been stored.

**Factory defaults** The parameters are set to factory defaults.

## Custom defaults

---

64-xx	ALX 92x	DPM	PEM	ALX 73x (PMA)
-------	---------	-----	-----	---------------

---

- ▣▣▣▣► Parameter appears only in production mode.

**Apply current** Stores the current parameter settings as values for the default setup. Those settings are restored by calling parameter *SPECIAL FUNCTION > Factory settings = „Custom defaults“*.

**Delete** Deletes the stored custom default settings. „Delete“ is only visible, if settings have already been stored.

## Store Parameters

---

64-xx	ALX 92x	DPM	PEM	ALX 73x (PMA)
-------	---------	-----	-----	---------------

---

Parameter settings are saved in a text file on memory card (directory *FORMATS\*). Considered are also parameters which belong to options, which are not activated.

**Without adj. par** (Default) Parameters, which contain device specific settings, are *not* saved.

(Default file name: SETUP.FOR).

*Application example:* Transfer of printer settings to another printer (device specific settings as printhead resistance or sensor settings should not be overwritten).

#### With adjust para

Parameters, which contain device specific settings, are *also* saved. The relevant parameter names are marked with a \* in the text file.

(Default file name: SETUPALL.FOR).

*Application example:* Service

- For more information about saving and reading parameter settings read topic section „Advanced Applications“, chapter „Saving and Transferring parameter settings“.

### Store Diagnosis

64-xx	ALX 92x	DPM	PEM	ALX 73x (PMA)
-------	---------	-----	-----	---------------

Stores the diagnostic data on memory card. The default file name composes as follows:

„Diagnose AP 5.4 203 Dpi A429403110613.log“

- *AP 5.4 203 Dpi*: printer type and printhead resolution
- *A429403110613*: serial number of the CPU board; equals the value displayed under `SERVICE DATA > CPU board data > Serial number`
- For details read the service manual, topic section „Fault Location“, chapter „Reading out diagnostic data“.

### Gen.Support Data

64-xx	ALX 92x	DPM	PEM	ALX 73x (PMA)
-------	---------	-----	-----	---------------

Generate support data

Generates the folder „SupportData“ on the selected memory medium and stores the following diagnosis files therein:

- Setup.for (for details see `SPECIAL FUNCTION > Store Parameters`)
- SetupAll.for (for details see `SPECIAL FUNCTION > Store Parameters`)
- Diagnose.log (for details see `SPECIAL FUNCTION > Store diagnosis`)

Each of the file names is completed by the printer type and the serial number of the CPU board. The file content is english, regardless of the language setting at the printer.

Those data are very helpful for the technical support for fault diagnosis purposes.

### EasyPI. file log

Easy-Plug file log

64-xx	ALX 92x	DPM	PEM	ALX 73x (PMA)
-------	---------	-----	-----	---------------



- ▣▣▣▣ Only visible, if a memory card is inserted.
- ▣▣▣▣ Activating this parameter may slow down the label rate. Therefore disable the function after error analysis.
- ▣▣▣▣ Activating this parameter may cause error messages, which may be difficult to understand. Therefore disable the function after error analysis. If an error occurs, disable the function and restart the printer.

**Off**

The file log function is switched off.

**All data**

All received data, including immediate commands, are written into the log file.

**Interpreter data**All data is written into the log file, which the Easy-Plug interpreter reads out of the reception spooler. Immediate commands are *not* included.

### Log files delete

64-xx	ALX 92x	DPM	PEM	ALX 73x (PMA)
-------	---------	-----	-----	---------------

**No**

- ▣▣▣▣ Only visible, if a memory card is inserted.
- (Default setting) No function.

**Yes**

Deletes all log files on the inserted memory card, which fulfil the following conditions:

- Filename matches the scheme „EPxxxxxx.log“  
xxxxx = number from 1 to 999999, preceding digits filled with „0“. Example: „EP000001.log“.
- Location: folder \LOGFILES on memory card

Those conditions are matched by logfiles, which are automatically generated by `SPECIAL FUNCTION > EasyPl. file log.`

### Data blocks del.

Delete data blocks

64-xx	ALX 92x	DPM	PEM	ALX 73x (PMA)
-------	---------	-----	-----	---------------

**Bxx**

- ▣▣▣▣ Only appears, if at least one data block is in the flash memory.
- (Default setting) After calling the parameter, data block number 01 is displayed:

```
Data blocks del.
B01 diagnose inf
```

„B01“: block number 01

„diagnose inf“: name of the data block, is contained in the data block header.

If the flash memory contains more than one data block:

- Press the cut button several times, until the wanted data block appears.

Deleting a data block:

- Press the online button.

```
Data blocks del.
Delete? --> no
```

- Press the feed button to change to „yes“.

→ Press the online button to delete the block.

**All**

All data blocks contained in the flash memory are deleted.

**RFID stat. del.**

---

64-xx	ALX 92x	DPM	PEM	ALX 73x (PMA)
-------	---------	-----	-----	---------------

---

|||▶ Only with activated RFID option.

Sets all RFID counters to zero.

○ See PRINT INFO > RFID status.

## SERVICE FUNCTION

### Service

64-xx	ALX 92x	DPM	PEM	ALX 73x (PMA)
-------	---------	-----	-----	---------------

Parameter only appears in production mode.

Increases the counter level of the "Service" counter on the "Service Status" printout by one.

- See parameter [Service Status](#) on page 36.

yes

Increases the counter "Services" by one

no

Doesn't increase the counter

### Head exchange

64-xx	ALX 92x	DPM	PEM	ALX 73x (PMA)
-------	---------	-----	-----	---------------

Parameter only appears in production mode.

Increases the counter „Head number“ on the info printout „Service Status“ by one.

- See parameter [Service Status](#) on page 36.

yes

Increases the counter "Head number" by one

no

Doesn't increase the counter

### Roller exchange

64-xx	ALX 92x	DPM	PEM	ALX 73x (PMA)
-------	---------	-----	-----	---------------

Parameter only appears in production mode.

Increases the counter „Roll number“ on the info printout „Service Status“ by one.

- See parameter [Service Status](#) on page 36.

yes

Increases the counter "Roll number" by one

no

Doesn't increase the counter

### Cutter exchange

64-xx
-------

Parameter only appears in production mode and only with a cutter mounted and activated.

Increases the counter „Cutter number“ on the info printout „Service Status“ by one.

- See parameter [Service Status](#) on page 36.

- yes Increases the counter "Cutter number" by one
- no Doesn't increase the counter

**Serv. data reset**

64-xx	ALX 92x	DPM	PEM	ALX 73x (PMA)
-------	---------	-----	-----	---------------

Parameter only appears in production mode.  
Sets all counters on the info printout „Service Status“ to zero.

- See parameter [Service Status](#) on page 36.

**Head dot test**

64-xx	ALX 92x	DPM	PEM	ALX 73x (PMA)
-------	---------	-----	-----	---------------

Checks the print head for defective dots. The test ends with a status printout [20], listing the defective dots. The printout is also made without having found any defective dots.



**CAUTION!**

Risk of printhead damage.

- ➔ Never switch off the printer while the dot check is running. If not observed, dots of the print head can be damaged.

During the test appears the display:

Head dot test  
running ...

- Parameter requires 100 mm wide and 200 mm long label material.

Head Dot Test Status									
<b>Head data</b>									
<b>Head resistance</b>					: 1364 Ohm				
<b>Print width</b>					: 128.0 mm				
<b>Print resolution</b>					: 12.0 Dots/mm				
<b>Number of dots</b>					: 1536 Dots				
<b>25 defective print dots</b>									
1,	417,	418,	419,	557,	700,	761,	770,	771,	
772,	773,	774,	775,	776,	777,	778,	779,	780,	
781,	782,	783,	784,	833,	834,	835,			

[20] Status printout after successfully proceeded dot check. Upper section: technical data of the print head; Lower section: list of defective dots.

## 64-xx – DPM – PEM – ALX 92x – ALX 73x (PMA)

▣▣▣▣ The dot check can also be started by pressing the Cut(Apply)+Feed buttons in Off-line mode. However, in this case is no status report printed.

### Head step tune

64-xx	ALX 92x	DPM	PEM	ALX 73x (PMA)
-------	---------	-----	-----	---------------

▣▣▣▣ Only in production mode.

Fine adjustment of the printhead movement during the ribbon autoeconomy motion.

x step(s)

Setting range: -15 to +15; Unit interval: 1; Default setting: 0

### EasyPlug monitor

64-xx	ALX 92x	DPM	PEM	ALX 73x (PMA)
-------	---------	-----	-----	---------------

▣▣▣▣ Parameter only appears in production mode.

The parameter activates the logging of received Easy Plug data. Data is transmitted to COM1 or COM2.

▣▣▣▣ Activating this parameter may slow down the label rate. Therefore disable the function after error analysis.

▣▣▣▣ To keep the influence of the monitoring function on the data rate as low as possible, the baud rate should be set to 115,000!  
(Default setting) The monitor function is disabled.

Off

Serial Com1

The Easy-Plug monitor data is transmitted to Com1.

Serial Com2

The Easy-Plug monitor data is transmitted to Com2.

### EP Monitor Mode

64-xx	ALX 92x	DPM	PEM	ALX 73x (PMA)
-------	---------	-----	-----	---------------

▣▣▣▣ Parameter only appears in production mode.

▣▣▣▣ Activating this parameter may slow down the label rate. Therefore disable the function after error analysis.

Interpreter data

(Default setting) All received Easy-Plug data, apart from immediate commands, are transmitted.

All data

All received Easy-Plug data, including immediate commands, are transmitted.

### Head adjust

64-xx	ALX 92x	DPM	PEM	ALX 73x (PMA)
-------	---------	-----	-----	---------------

▣▣▣▣ Parameter only for authorised, trained service personnel!

### Sensor adjust

64-xx	ALX 92x	DPM	PEM	ALX 73x (PMA)
-------	---------	-----	-----	---------------

- ▣▣▣▣▶ Parameter only appears in production mode.
- For detailed instructions sensor adjustment, please refer to the service manual, topic section "Service Electronics", paragraph "Settings".

### Sensor test

64-xx	ALX 92x	DPM	PEM	ALX 73x (PMA)
-------	---------	-----	-----	---------------

- The description of the sensor test can be found in the printer service manual, topic section „Service Electronics“, chapter [Sensor test](#) .

The values displayed are for checking the sensors (sensor check) and can be adjusted by service personnel.

### Cutter test

64-xx
-------

Makes it possible to test the cutter function without having to set the parameter `SYSTEM PARAMETER > Periph. device` to „cutter“.

Press Cut Key

Triggers a cut, if a cutter is installed. Without a cutter nothing will happen.

### Matend tolerance

64-xx	ALX 92x	DPM	PEM	ALX 73x (PMA)
-------	---------	-----	-----	---------------

Material end tolerance

This is relevant for label stock with very long punches. To avoid those punches being recognized as material end by mistake, can here the distance be set, after which the gap over the light sensor is interpreted as material end.

▣▣▣▣▶ By choosing a very high material end tolerance, you loose the protection of the print roller against being printed on!

Setting range: 20-300 mm; Default setting: 35 mm

xxx mm

### Feedadjust label

64-xx	ALX 92x	DPM	PEM	ALX 73x (PMA)
-------	---------	-----	-----	---------------

Prints a scale, which enables to calculate the feed adjust value (see next parameter).

For application instructions, refer to the Service Manual, topic section „Electronics Gen. 3“, chapter [Adjusting the imprint position](#) .

### Feed adjust

64-xx	ALX 92x	DPM	PEM	ALX 73x (PMA)
-------	---------	-----	-----	---------------

Corrects the material feed length. Such a correction can be necessary when printing on very long labels, to compensate slippage-related feeding inaccuracy.

For application instructions, refer to the Service Manual, topic section „Electronics Gen. 3“, chapter [Adjusting the imprint position](#) .

**%2.1f %% [ribbon]**

Setting for *thermal transfer printing*

Setting range: -10.0 to +10.0; Step width: 0.1%; Default setting: 0%

▣▣▣▣▣ Only appears if thermal transfer printing was selected (see SYSTEM PARAMETER > Ribbon autoecon.)

**%2.1f %% [direct]**

Setting for *thermal direct printing*

Setting range: -10.0 to +10.0; Step width: 0.1%; Default setting: 0%

▣▣▣▣▣ Only appears if thermal direct printing was selected (see SYSTEM PARAMETER > Ribbon autoecon.)

### Punch y calibr.

64-xx	ALX 92x	DPM	PEM	ALX 73x (PMA)
-------	---------	-----	-----	---------------

▣▣▣▣▣ Only in production mode

Compensating the variation of distance between punch sensor and thermal bar of the printhead.

**x.x mm**

Setting range: -3.0 to 3.0; Default setting: 0.0; Unit interval: 0.1

### Foil feed adjust

64-xx	ALX 92x	DPM	PEM	ALX 73x (PMA)
-------	---------	-----	-----	---------------

▣▣▣▣▣ Only in production mode.

Modifies the foil feed speed in comparison to the material feed speed.

**xx,x %**

Setting range: -20.0 to 20.0; Default setting: 0.0

- Decreasing the setting: Foil transport gets faster
- Increasing the setting: Foil transport gets slower

### Punch y calibr

64-xx	ALX 92x	DPM	PEM	ALX 73x (PMA)
-------	---------	-----	-----	---------------

▣▣▣▣▣ Only in production mode.

Compensating of variations between the label sensor and the thermal bar at the printhead.

**x.xmm**

Setting range: -3.0 to 3.0; Default: 0.0; Step width: 0.1

### PS registers

64-xx	ALX 92x	DPM	PEM	ALX 73x (PMA)
-------	---------	-----	-----	---------------

▣▣▣▣▣ Only in production mode.

▣▣▣▣▣ Parameter only for authorised, trained service personnel.

▣▣▣▣▣ Concerns the following power supplies: HME, ME 500

By means of this parameter, the register contents of the power supply can be changed.



## Scanner test

64-xx	ALX 92x	DPM	PEM	ALX 73x (PMA)
-------	---------	-----	-----	---------------

The scanner test is required for the ex-works adjustment of an optional scanner.

- On** Switches the Scanner-Laser on.  
**Off** Switches the Scanner-Laser off.

## Memory card test

64-xx	ALX 92x	DPM	PEM	ALX 73x (PMA)
-------	---------	-----	-----	---------------

Pressing the online button starts a test routine for the Compact Flash Card memory. The following display shows up after successful testing:

```
Memory card test
Card Test O.K.
```

If the memory card is defective or not available, a corresponding error report shows up.

For test purposes, the printer creates a file named TESTXXXX.TXT in the root directory of the card. An already existing file with this name will be overwritten.



### Parallel connection

The parallel data transfer is done bidirectionally in the Nibble Mode. The transfer test requires an aid program which is available to service engineers.

### Receive test

64-xx	ALX 92x	DPM	PEM	ALX 73x (PMA)
-------	---------	-----	-----	---------------

### Serial connection

Assumption is a serial data line between PC and printer; the parameter `INTERF.PARAM. > Interface` must be set to „Serial Com1“.

1. Start the MS-DOS-prompt (using Windows).
2. Set the interface to the values adjusted at the printer by means of MS-DOS command `MODE`:

Example of printer settings:

- Baud rate: 19200
- No. of data bits: 8
- Parity: none
- Stop Bits: 1
- Data synch.: RTS/CTS

DOS-Command: `mode COM1 baud=19200 parity=n data=8 stop=1`  
(if com1 is the serial port)

3. Press the Online-key to start Receive test.

```
Receive test
0 Bytes
```

4. Send any file to the printer (Condition: com1 = Printer port; anyfile.txt = any file):

`copy anyfile.txt com1` (add /b for binary files)

The following shows up on the printer display:

```
Receive test
xxxxx Bytes
```

xxxxxx is the size of the sent file in bytes. This value is being counted up during the test. The test is complete if the file size does not vary any more. If the bytes announced at the printer match the size visible in the MS-DOS window, transfer was successful. Otherwise, transmission errors occurred.

### Parallel connection

Assumption is a parallel data line between PC and printer; the parameter `INTERF.PARAM. > Interface` must be set up on Centronics. Proceed as follows:

1. Run Receive test. To this call the parameter `SERVICE FUNCTION > Receive test` and press the Online-key.

```
Receive test
0 Bytes
```

2. Start the MS-DOS-window (using Windows).
3. Send any file to the printer (Condition: lpt1 = printer port; anyfile.txt = any file):

*copy anyfile.txt lpt1* (add /b for binary files)

The following shows up on the printer display:

```
Receive test
xxxxx Bytes
```

xxxxxx is the size of the sent file in bytes. This value is being counted up during the test. The test is complete if the file size does not vary any more. If the bytes announced at the printer match the size visible in the MS-DOS window, transfer was successful. Otherwise, transmission errors occurred.

### Com2 commun. test

64-xx	ALX 92x	DPM	PEM
-------	---------	-----	-----

▣ 64-xx/ALX 92x/DPM/PEM/PM 3000: Only with installed options board. After calling this parameter, Com2 puts out all data which are received by the set Easy Plug port.

- See parameter [Print interface](#) on page 54.  
If this parameter is set to RS232, data can also be sent in reverse direction (that is, reception by Com2, output by Com1).

### Com2 port test

64-xx	ALX 92x	DPM	PEM
-------	---------	-----	-----

▣ 64-xx/ALX 92x/DPM/PEM/PM 3000: Only with installed options board. Starts a selftest of the Com2 port.

▣ Only works with RS 232.

▣ Pins 2/3 and 7/8 at the interface have to be connected (use a plug with shunted pins)!

During the selftest, data transfer and handshake are tested. The test ends with one of the following display messages:

```
Com2 port test
Test failed
```

An error has occurred while testing the interface.

```
Com2 port test
Test O.K.
```

Interface test successfully terminated.

## Headvo. adj. 20 V

---

64-xx

---

▣ Not valid for 64-08.

▣ Only in production mode.

Adjusting the lower head voltage limit to 20 V. The head voltage adjustment makes printouts comparable.

- For details about adjusting the printhead voltage, refer to the Service Manual, topic section "Service print module", paragraph "Adjusting the printhead voltage".

## Headvo. adj. 28 V

---

64-xx

---

▣ Not valid for 64-08.

▣ Only in production mode.

Adjusting the upper head voltage limit to 28 V. The head voltage adjustment makes printouts comparable.

- For details about adjusting the printhead voltage, refer to the Service Manual, topic section "Service print module", paragraph "Adjusting the printhead voltage".

## Printtest

---

64-xx	ALX 92x	DPM	PEM	ALX 73x (PMA)
-------	---------	-----	-----	---------------

---

General printtest, prints line by line the set printer type and the firmware version. Material settings (Material type, length, width) are considered.

Stop the printtest by pressing the Online button.

## Rewinder adjust

---

64-xx	ALX 92x
-------	---------

---

▣ 64-xx: Only with „Rewinder 2000“ installed.

▣ ALX 92x: Only valid for backing paper rewinder.

Setting up the rewinder.

The rewinder setup compensates differences in characteristic or assembly of the light barrier.

▣ This parameter counts for both, the external *rewinder option* for 64-xx and the *backing paper rewinder* of the ALX 92x. But mind that the setting values are different!

- A setting description for the *64-xx rewinder option* is given in the „User Manual Rewinder 2000“, topic section „Attachment, Setup“, chapter „Settings“ > „Setting up 64-xx“ > [Adjusting the sensor](#) .

- A setting description for the dancer arm of the *ALX 92x backing paper rewinder* can be found in the Service Manual, topic section „Service Electronics“, chapter „Settings“ > [Light sensor at the rewinder dancer lever \(ALX 92x\)](#) .

**loose xxx**

Setup of the loose dancer arm (xxx = actual sensor value).

**tightened xxx**

Setup of the tightened dancer arm (xxx = actual sensor value).

The setting follows in both cases this scheme:

1. Bring the dancer arm to its loose position.
2. Press the cut button (ALX 92x: Apply button)
3. Pull the dancer arm tight.
4. Press the Online button.

### Rewinder values



64-xx	ALX 92x
-------	---------

▣▣▣▣ 64-xx: Only with „Rewinder 2000“ installed.

▣▣▣▣ ALX 92x: Only valid for backing paper rewinder.

Shows the values of the position sensor at the rewinder dancer arm in middle/tightened and in loose position.

Rewinder values  
xxx <----- text -----> yyy

- xxx = Sensor value in *loose* position
- text = Sensor type (Opto = light barrier; Hall = hall sensor; ???? = no explicit sensor type)
- yyy = Sensor value in one of the following positions:
  - *Middle* for 64-xx with „Rewinder 2000“ and for ALX 92x with R04A rewinder motor output stage (--> 01/2012, recognizable with SYSTEM PARAMETER >MODULE FW VERS. > Rewinder driver = „V2-T36“)
  - *Tightened* for ALX 92x with M5A rewinder motor output stage (01/2012-->, recognizable with SYSTEM PARAMETER >MODULE FW VERS. > Rewinder driver = „V4-T5“)
- For detailed information about setting the rewinder dancer arm refer to:
  - ALX 92x: Service manual, topic section „Electronics Gen. 3“, „Settings“ > [Light sensor at the rewinder dancer lever \(ALX 92x\)](#) 
  - Rewinder 2000: Technical Manual Rewinder 2000, topic section „Attachment, Setup“, chapter „Settings“ > „Setting up 64-xx“ > [Adjusting the sensor](#) 

## SERVICE DATA

### > MODULE FW VERS.

#### System version

64-xx	ALX 92x	DPM	PEM	ALX 73x (PMA)
-------	---------	-----	-----	---------------

Shows the firmware version number.

#### System revision

64-xx	ALX 92x	DPM	PEM	ALX 73x (PMA)
-------	---------	-----	-----	---------------

Shows a consecutive revision number.

▣▣▣▣► Only for factory-internal use.

#### System date

64-xx	ALX 92x	DPM	PEM	ALX 73x (PMA)
-------	---------	-----	-----	---------------

Shows the date, at which the firmware was generated.

#### Bootloader

64-xx	ALX 92x	DPM	PEM	ALX 73x (PMA)
-------	---------	-----	-----	---------------

Shows the bootloader version number.

#### uMon

64-xx	ALX 92x	DPM	PEM	ALX 73x (PMA)
-------	---------	-----	-----	---------------

Shows the bootloader version number.

#### Feed driver

64-xx	ALX 92x	DPM	PEM	ALX 73x (PMA)
-------	---------	-----	-----	---------------

Applied PIC version on the output stage board driving the feed motor.

#### Foil driver

64-xx	ALX 92x	DPM	PEM	ALX 73x (PMA)
-------	---------	-----	-----	---------------

Applied PIC version on the output stage board driving the foil feed motor.

---

 64-xx – DPM – PEM – ALX 92x – ALX 73x (PMA)
 

---

### Head driver

---

64-xx	ALX 92x	DPM	PEM	ALX 73x (PMA)
-------	---------	-----	-----	---------------

---

Applied PIC version on the output stage board driving the head motor.

### Peripheraldriver

---

 64-xx
 

---

▣▣▣▣► Only with mounted (optional) peripheral output stage board.  
Applied PIC version on the output stage board driving the peripheral motor.

64-xx: Applied PIC version on the output stage board driving the deflection motor.

### Rewinder

---

64-xx	ALX 92x
-------	---------

---

▣▣▣▣► 64-xx Dispenser only.

Applied PIC version on the rewinder motor output stage board.

### USI interface

---

64-xx	ALX 92x	DPM	PEM	ALX 73x (PMA)
-------	---------	-----	-----	---------------

---

▣▣▣▣► Only with USI mounted.

Applied PIC version on the USI.

### Applicator int.

(Applicator Interface)

---

 ALX 92x
 

---

▣▣▣▣► Only with mounted Applicator Interface.

Applied PIC version on the Applicator Interface.

### Dispenser lift

---

 64-xx
 

---

▣▣▣▣► 64-xx: Only 64-xx dispenser version

Applied PIC version on the lift motor output stage.



64-xx – DPM – PEM – ALX 92x – ALX 73x (PMA)

## Dispenser feed

64-xx

▣▣▣▣▶ 64-xx: Only 64-xx dispenser version

Applied PIC version on the dispenser rewinder and feed motor output stages.

## > OPERATION DATA

### Serv. operations

64-xx	ALX 92x	DPM	PEM	ALX 73x (PMA)
-------	---------	-----	-----	---------------

Shows the number of service operations. The counter is increased by calling the parameter SERVICE FUNCTION > Service = yes. Maximum value: 4 billions.

### Headnumber

64-xx	ALX 92x	DPM	PEM	ALX 73x (PMA)
-------	---------	-----	-----	---------------

Shows the number of printhead changes. The counter is increased by calling the parameter SERVICE FUNCTION > Cutter exchange = yes. Maximum value: 4 billions.

### Roll number

64-xx	ALX 92x	DPM	PEM	ALX 73x (PMA)
-------	---------	-----	-----	---------------

Shows the number of exchanged print rollers. The counter is increased by calling the parameter SERVICE FUNCTION > Roller exchange > yes. Maximum value: 4 billions.

### Cutter number

64-xx

▣▣▣▣▶ Only with mounted and activated cutter.

Shows the number of exchanged cutters. The counter is increased by calling the parameter SERVICE FUNCTION > Cutter exchange = yes. Maximum value: 4 billions.

### Head run length

64-xx	ALX 92x	DPM	PEM	ALX 73x (PMA)
-------	---------	-----	-----	---------------

Shows the total "covered distance" of the printhead. The counter is reset with each calling of the parameter SERVICE FUNCTION > Cutter exchange = yes. Maximum value: 4 billions.

64-xx – DPM – PEM – ALX 92x – ALX 73x (PMA)

## Roll run length

64-xx	ALX 92x	DPM	PEM	ALX 73x (PMA)
-------	---------	-----	-----	---------------

Shows the total "covered distance" of the print roller. The counter is reset with each calling of the parameter SERVICE FUNCTION > Roller exchange = yes. Maximum value: 4 billions.

## Cuts on knife

64-xx
-------

▣▣▣▣▶ Only with mounted and activated cutter.

Shows the number of cuts done by one knife. The counter is reset with each calling of the parameter SERVICE FUNCTION > Cutter exchange = yes. Maximum value: 4 billions.

## Tot. mat. length

64-xx	ALX 92x	DPM	PEM	ALX 73x (PMA)
-------	---------	-----	-----	---------------

Shows the total "covered distance" of the feed roller. In comparison to the counter Roll run length, this counter is not reset after a roller exchange. Maximum value: 4 billions.

## Tot. foil length

64-xx	ALX 92x	DPM	PEM	ALX 73x (PMA)
-------	---------	-----	-----	---------------

Shows the total "covered distance" of the ribbon roller.

## Total cuts

64-xx
-------

▣▣▣▣▶ Only with mounted and activated cutter.

Shows the number of cuts done by all knives. In comparison to the counter Cuts on knife, this counter is not reset after a knife exchange. Maximum value: 4 billions.

## Total head moves

64-xx	ALX 92x	DPM	PEM
-------	---------	-----	-----

▣▣▣▣▶ Only with mounted and activated cutter.

Shows the counter for every up and down movement of the printhead. Maximum value: 4 billions.

64-xx – DPM – PEM – ALX 92x – ALX 73x (PMA)

## Head strobes

64-xx	ALX 92x	DPM	PEM	ALX 73x (PMA)
-------	---------	-----	-----	---------------

Shows the counted head strobes, which are a measure for the service life of the printhead. A strobe is counted for each line in which at least one dot is printed. Maximum value: 4 billions.

## Head temperature

64-xx	ALX 92x	DPM	PEM	ALX 73x (PMA)
-------	---------	-----	-----	---------------

Shows the current printhead temperature in °C.

## Foil diameter

64-xx	ALX 92x	DPM	PEM	ALX 73x (PMA)
-------	---------	-----	-----	---------------

Shows the calculated foil diameter: A measurement routine calculates the actual ribbon roll diameter with an exactness of 7.5%.

The parameter `SYSTEM PARAMETER > Foil end warning` can be used to set a critical foil roll diameter. If the foil roll diameter equals this value, a message appears on the printer display.

- See parameter [Foil end warning](#) on page 73.

64-xx, DPM / PEM, ALX 92x:

At the (optional) USI is set a signal indicating the near foil end (additionally to the display warning).

## Dispensing cycl.

(Dispensing cycles)

64-xx	ALX 92x	DPM
-------	---------	-----

▮▮▮▮▶ 64-xx: Dispenser version only.

Shows the number of dispensed labels.

## Operation time

64-xx	ALX 92x	DPM	PEM	ALX 73x (PMA)
-------	---------	-----	-----	---------------

Shows the elapsed time since the last switch-on of the machine.

**> POWERSUPPLYDATA****Type**

64-xx	ALX 92x	DPM	PEM	ALX 73x (PMA)
-------	---------	-----	-----	---------------

Shows the type of power supply, e.g. „Blue Mountain“.

**PS temperature**

64-xx	ALX 92x	DPM	PEM	ALX 73x (PMA)
-------	---------	-----	-----	---------------

Shows the current power supply temperature in °C. If for any reason the function is not supported, „??? °C“ is displayed.

**Version**

64-xx	ALX 92x	DPM	PEM	ALX 73x (PMA)
-------	---------	-----	-----	---------------

Availability depends on the type of power supply.  
Shows the power supply version.

**Serial number**

64-xx	ALX 92x	DPM	PEM	ALX 73x (PMA)
-------	---------	-----	-----	---------------

Availability depends on the type of power supply.  
Shows the power supply serial number.

**Standby+On time**

64-xx	ALX 92x	DPM	PEM	ALX 73x (PMA)
-------	---------	-----	-----	---------------

Availability depends on the type of power supply.  
Shows the power supply operation time including the standby time.

*Standby time* is the duration of time, during which the printer was switched on with the power switch, but *not* with the remote on/off switch on the operation panel.

Doesn't count for 64-xx. At the 64-xx, the same time as under

SERVICE DATA > POWERSUPPLY DATA > On time

The operation time tells nothing about the printing time of the printer.

64-xx – DPM – PEM – ALX 92x – ALX 73x (PMA)

**On time**

64-xx	ALX 92x	DPM	PEM	ALX 73x (PMA)
-------	---------	-----	-----	---------------

▣▣▣▣▶ Availability depends on the type of power supply.

Shows the operation time of the printer. This does *not comprise* the standby time (see SERVICE DATA > POWERSUPPLY DATA > Standby+On time).

▣▣▣▣▶ The operation time tells nothing about the printing time of the printer.

**> CPU BOARD DATA****CPU identifier**

64-xx	ALX 92x	DPM	PEM	ALX 73x (PMA)
-------	---------	-----	-----	---------------

Shows the designation of the applied processor.

**PCB revision**

64-xx	ALX 92x	DPM	PEM	ALX 73x (PMA)
-------	---------	-----	-----	---------------

Shows the layout revision and part number of the CPU board.

**FPGA version**

64-xx	ALX 92x	DPM	PEM	ALX 73x (PMA)
-------	---------	-----	-----	---------------

Shows the FPGA version.

**MAC address**

64-xx	ALX 92x	DPM	PEM	ALX 73x (PMA)
-------	---------	-----	-----	---------------

Shows the MAC Address, an unchanging board address, which is programmed by the board manufacturer.

**Serial number**

64-xx	ALX 92x	DPM	PEM	ALX 73x (PMA)
-------	---------	-----	-----	---------------

Serial number: Is programmed by the board manufacturer.

**Production date**

64-xx	ALX 92x	DPM	PEM	ALX 73x (PMA)
-------	---------	-----	-----	---------------

Production date: Is programmed by the board manufacturer.

64-xx – DPM – PEM – ALX 92x – ALX 73x (PMA)

**PCB part number**

64-xx	ALX 92x	DPM	PEM	ALX 73x (PMA)
-------	---------	-----	-----	---------------

Shows the part number of the board without components.

**Board part numb.**

64-xx	ALX 92x	DPM	PEM	ALX 73x (PMA)
-------	---------	-----	-----	---------------

Shows the part number of the board with components.

**Manufacturer**

64-xx	ALX 92x	DPM	PEM	ALX 73x (PMA)
-------	---------	-----	-----	---------------

Parameter appears only in production mode.  
Shows the board manufacturer.

**Work place**

64-xx	ALX 92x	DPM	PEM	ALX 73x (PMA)
-------	---------	-----	-----	---------------

Parameter appears only in production mode.  
Shows the printer work place.

**Company name**

64-xx	ALX 92x	DPM	PEM	ALX 73x (PMA)
-------	---------	-----	-----	---------------

Parameter appears only in production mode.  
Shows the company name.

**> DISPLAY DATA****Display version**

64-xx	ALX 92x	DPM	PEM	ALX 73x (PMA)
-------	---------	-----	-----	---------------

Shows the *version number* of the operation panel.

**Display SerialNr**

64-xx	ALX 92x	DPM	PEM	ALX 73x (PMA)
-------	---------	-----	-----	---------------

Shows the *serial number* of the operation panel.

64-xx – DPM – PEM – ALX 92x – ALX 73x (PMA)

**Remote disp. vers.**

64-xx	ALX 92x	DPM	PEM	ALX 73x (PMA)
-------	---------	-----	-----	---------------

▣▣▣▣➔ Only if remote operation panel is connected.

Shows the *version number* of the remote operation panel.

**Remote disp. #**

64-xx	ALX 92x	DPM	PEM	ALX 73x (PMA)
-------	---------	-----	-----	---------------

▣▣▣▣➔ Only if remote operation panel is connected.

Shows the *serial number* of the remote operation panel.

**> MEMORY DATA****Ram memory size**

64-xx	ALX 92x	DPM	PEM	ALX 73x (PMA)
-------	---------	-----	-----	---------------

Shows the available RAM memory size.

**Flash mem size**

64-xx	ALX 92x	DPM	PEM	ALX 73x (PMA)
-------	---------	-----	-----	---------------

Shows the available Flash memory size. The abbreviation which is displayed behind the memory size indicates the manufacturer of the applied Flash-RAM:

Abbreviation	Manufacturer
MX	Macronix
AMD	AMD
FUJ	Fuji

[13] The displayed abbreviations indicate the manufacturer of the Flash-RAM.

**CompactFlash**

64-xx	ALX 92x	DPM	PEM	ALX 73x (PMA)
-------	---------	-----	-----	---------------

▣▣▣▣➔ Only with plugged-in CompactFlash card

Shows the memory size of the CompactFlash card:

CompactFlash 971 MB / 1024 MB (c:)
---------------------------------------

- 971 MB of 1024 MB are free
- Drive letter, which is assigned to the CompactFlash card (here: „C:“)

64-xx – DPM – PEM – ALX 92x – ALX 73x (PMA)

- Assigning a drive letter: see chapter > [DRIVEASSIGNMENT](#)  on page 71.

### SD card

64-xx	ALX 92x	DPM	PEM	ALX 73x (PMA)
-------	---------	-----	-----	---------------

▣▶ Only with plugged-in SD card

Shows the memory size of the SD card:

SD card 971 MB / 1024 MB (c:)
----------------------------------

- 971 MB of 1024 MB are free
- Drive letter, which is assigned to the SD card (here: „C:“)

- Assigning a drive letter: see chapter > [DRIVEASSIGNMENT](#)  on page 71.

### USB

64-xx	ALX 92x	DPM	PEM	ALX 73x (PMA)
-------	---------	-----	-----	---------------

▣▶ Only with plugged-in USB stick

Shows the memory size of the USB stick:

USB 971 MB / 1024 MB (c:)
------------------------------

- 971 MB of 1024 MB are free
- Drive letter, which is assigned to the USB stick (here: „C:“)

- Assigning a drive letter: see chapter > [DRIVEASSIGNMENT](#)  on page 71.

### Space for Jobs

64-xx	ALX 92x	DPM	PEM	ALX 73x (PMA)
-------	---------	-----	-----	---------------

Shows the memory size, which is available for print jobs.

### Max. Labellength

64-xx	ALX 92x	DPM	PEM	ALX 73x (PMA)
-------	---------	-----	-----	---------------

Shows the maximum printable label length, which results from the memory allocation.

### Default values

64-xx	ALX 92x	DPM	PEM	ALX 73x (PMA)
-------	---------	-----	-----	---------------

Shows the setting of parameter [SPECIAL FUNCTION](#) > Default values.





# Status Reports

General information about status reports..... 7	1033	Uninit flash par ..... 14
Area of application ..... 7	1034	Uninit restrict ..... 14
Display of status reports..... 7	1035	Uninit combi ..... 14
Acknowledging status reports ..... 7	1036	Wrong combi para..... 14
General software errors..... 8	1037	Software error ..... 14
Easy-Plug errors..... 8	1038	Software error ..... 14
Unspecific errors ..... 8	1087	OLV not active ..... 14
Not listed status reports..... 9	1088	No realltimeclock ..... 14
Listing of all Status reports..... 10	1089	Seek Fkt. Error ..... 15
1000 No new command ..... 10	1090	Incomplete Job..... 15
1001 Parameter Table..... 10	1091	Wrong var field..... 15
1002 Comm. sorting ..... 10	1092	Rename file..... 15
1003 Too many slashes ..... 10	1093	Delete file ..... 15
1004 Slash w/o param..... 10	1094	More than 3 figs ..... 15
1005 2 same commands ..... 10	1097	Out of memory ..... 15
1006 Letter incorrect ..... 10	1099	File end ..... 15
1007 Command incorr..... 10	1101	Wrong time/date..... 16
1008 Subcomm. incorr. .... 10	1102	Counter offset ..... 16
1009 Param. tab inc. .... 11	1110	Opening Bracket ..... 16
1010 #ER x #Q !..... 11	1111	Closing Bracket..... 16
1011 #ER missing ..... 11	1112	Para: No Value..... 16
1012 #IM x #Q !..... 11	1113	No Default Value..... 16
1013 Comm. flag inc. .... 11	1114	< Limit value..... 16
1014 Uninit integer ..... 11	1115	> Limit value..... 17
1015 Uninit float ..... 11	1120	Incorr. logo no. .... 17
1016 Uninit string ..... 11	1121	Logo exists..... 17
1017 Uninit discr..... 12	1122	Creating logo..... 17
1018 Too many discr..... 12	1123	Rename logo..... 17
1019 Uninit BCD para. .... 12	1124	Logo file ..... 17
1020 Too much image..... 12	1125	Delete error ..... 17
1021 Uninit image par ..... 12	1126	File creation ..... 18
1022 Too many files ..... 12	1127	File format..... 18
1023 Uninit File Para..... 12	1128	File exists ..... 18
1024 Com. too long ..... 12	1130	Float overflow..... 18
1025 Com twice there ..... 13	1131	Logo cache full..... 18
1026 Comm. w/o. flag ..... 13	1140	Line too long ..... 18
1027 Uninit parameter..... 13	1141	Para. incorr. Bl ..... 18
1028 Parameter uninit..... 13	1150	Integer overflow ..... 18
1029 Param. incorr..... 13	1160	String too long..... 19
1030 Command incorr..... 13	1170	X Pos > width ..... 19
1031 Too many slashes ..... 13	1171	X Pos < zero ..... 19
1032 Incorrect char. .... 13	1172	Y Pos > length ..... 19

1173	Y Pos < zero.....	19	1333	Logo not there.....	24
1174	Max width: right.....	19	1334	#YV Data incorr.....	24
1175	Max width: left.....	20	1335	#YV Field cont.....	25
1176	Max length: top.....	20	1336	#YV no. incorr.....	25
1177	Max length: bot.....	20	1390	Web width zero.....	25
1178	x Dots < zero.....	20	1391	Web > Width.....	25
1200	GetRLE reset st.....	20	1392	Job memory full.....	25
1201	GetRLE error st.....	20	1393	Job struct creat.....	25
1210	itoa Short Strin.....	20	1394	Invalidation.....	25
1240	New FS>E.....	20	1395	Label too wide.....	26
1241	New Read Pointer.....	21	1396	Label too long.....	26
1242	New FE in job.....	21	1397	Label too short.....	26
1243	New delete order.....	21	1398	Label too small.....	26
1244	New wrong pos.....	21	1404	UTF8 data wrong.....	26
1245	New no space.....	21	1470	X-Offset.....	26
1246	New HP no space.....	21	1471	Y-Offset.....	27
1247	Out of memory.....	21	<b>1501-1535 Messages, which can occur in ZPL emulation mode.....</b>		<b>27</b>
1260	TimeDate string.....	21	1501	Unknown MLI Cmd.....	27
1270	#-comm. invalid.....	21	1502	MLI Hash Error.....	27
1272	Wrong #!.....	21	1503	Filename Too Long.....	27
1273	Wrong #!C.....	22	1504	Param > Max.....	27
1276	#!P wrong number.....	22	1505	Param < Min.....	27
1277	Wrong #!S.....	22	1506	No Previous.....	27
1278	Wrong #!X.....	22	1507	Not enough data.....	28
1279	#!X wrong number.....	22	1508	String Too Long.....	28
1282	Spooler FB > L.....	22	1509	Wrong Byte Cnts.....	28
1285	#!-comm. incorr.....	22	1510	Wrong Param.....	28
1290	Label limit.....	23	1511	Bar Parm Error.....	28
1291	Draw field.....	23	1512	Code128 Mode Err.....	28
1300	Invalid Command.....	23	1513	Wrong Mode.....	28
1301	Table full.....	23	1514	^BX Parm Err.....	29
1310	Wrong Field ID.....	23	1515	Conv to ECC200.....	29
1320	No Default Value.....	23	1516	Bad Drive: x.....	29
1321	Bar Code Object.....	23	1517	Mask String: x.....	29
1322	Logo Object.....	23	1518	Bad Format: x.....	29
1323	Line Object.....	23	1519	Cmd Init Error.....	29
1324	Rectangle Object.....	23	1520	Unsupported Cmd.....	29
1325	Truedoc Object.....	24	1521	Unsupported: x.....	29
1326	Fix Field Creati.....	24	1522	Bad Char Set x.....	30
1327	Update Field Cre.....	24	1523	Cmd Parm Error.....	30
1328	Var Field Creati.....	24	1524	d/mm not chg x.....	30
1329	Count Field Crea.....	24	1525	USI not exist.....	30
1330	Create clk. field.....	24	1526	Can't Off CV.....	30
1331	Field type inv.....	24	1527	Offset illegal.....	30
1332	Field length inc.....	24			

1528	Language illegal .....	30	5006	Head-fault .....	39
1529	Invalid Prn Mode .....	31	5008	Ribbon end.....	39
1530	Inc free str mem .....	31	5009	USI start error .....	40
1531	Inc RAM disc .....	31	5012	Delete H8 loader .....	40
1532	No Fixfont.....	31	5013	Prog H8 loader.....	40
1533	No Speedo Font .....	31	5015	Scanner.....	41
1534	^XA missing.....	31	5016	ALX Rewinder .....	41
1535	^XZ missing.....	31	5017	Power Supply.....	41
<b>2000-2009 Messages caused by Easy-Plug variables.....</b>		<b>32</b>	5018	Dot check area .....	42
2000	Double var name .....	32	5020	I2C Timeout xx.....	42
2002	Var. data length .....	32	5021	I2C Conf. xx .....	42
2003	Expr. bracket .....	32	5022	I2C Busy xx.....	42
2004	Exp. quotemark .....	32	5023	I2C LAB xx.....	42
2005	Exp. comma pos.....	32	5024	I2C BER xx .....	42
2006	Exp.functionname.....	32	5025	I2C Polling xx.....	42
2007	Exp.fct.paratype .....	32	5026	Motorprotect CPU .....	43
2008	Exp.fct.paraCnt.....	32	5028	PS overheat .....	43
2009	Exp. name wrong .....	32	5029	I2C checksum xx.....	43
2010	Fct. para value.....	33	<b>5051-5058 Messages which can only occur with a TT4 printer .....</b>		<b>44</b>
2011	OLV variable.....	33	5051	Barcode Infeed 1.....	44
2111	Invalid Date .....	33	5052	Barcode Infeed 2.....	44
2500	Multiple texts .....	33	5053	Barcode Infeed 3.....	44
3000/3003/3006/3012/3015			5054	Barcode Infeed 4.....	44
	Com x Overrun .....	33	5055	Infeed 1 empty .....	44
3001/3004/3007/3013/3016			5056	Infeed 2 empty .....	44
	Com x Parity .....	33	5057	Infeed 3 empty .....	45
3002/3005/3008/3015/3017			5058	Infeed 4 empty .....	45
	Com x Frame .....	33	5059	Stacker full .....	45
3010	Spooler Overflow.....	34	5060	Stacker full .....	45
3011	Send buffer full .....	34	5061	Dispenser motor.....	46
<b>4100-4106 Message, which can only occur with OLV-Option .....</b>		<b>35</b>	5062	Disp. lift motor .....	46
4100	No OLV data.....	35	5063	Press roll .....	46
4101	OLV limit exceed .....	35	5063	Lever open .....	46
4103	OLV barcode type .....	35	5064	Backing paper .....	46
4104	OLV Timeout .....	35	5071	Material end unw.....	46
4105	No OLV response.....	36	5072	Material end unw.....	47
4106	OLV Software .....	36	5100	No H8 response .....	47
5000	Bus device.....	36	5100	Printengine lock .....	47
5001	No gap found.....	38	5101	Headadjust error .....	47
5002	Material end.....	38	5102	Dot Defective .....	47
5003	Cover open.....	38	5110	Foil low.....	48
5004	Rewinder mat. tear .....	39	5120	Home position .....	48
5005	Knife-fault .....	39	5121	Touch down .....	48
			5122	PLC not ready.....	48

5123	USI Material low .....	48	5541	ISO error #2 .....	58
5125	Vn for USI req.....	49	5542	ISO error #3 .....	59
5130	PSU xxxxxxxx.....	50	5543	ISO error #15 .....	59
5131	PSU communicat.....	52	5544	ISO error #16 .....	59
5140	Rewinder control .....	52	5545	ISO error #17 .....	59
5144	Rewinder Init .....	52	5546	ISO error #18 .....	59
5145	Rewinder full.....	53	5547	ISO error #19 .....	59
5150	No USI interface.....	53	5548	ISO error #20 .....	59
5151	Applic. interf.....	53	5549	ISO error ??? .....	59
5152	Winding direct.....	53	5550	Wrong tag type.....	59
5200	Home position .....	53	5551	Max Tags failed.....	59
5201	Touch down.....	54	5560	TCS full / cover .....	59
5203	Touch down sens. ....	54	5590	Odd hex string.....	60
5204	Appl. Startererror .....	54	5600	Job without #Q.....	60
5205	Applicator gen. ....	54	5601	Job memory full.....	60
5206	Applicator resp. ....	54	6000	Param. incorrect.....	60
5207	Appl. driver 1 .....	54	6001	Nov. prog. err. ....	60
5208	Appl. driver 2 .....	55	6002	New prog. vers.....	60
5209	Appl. driver 3 .....	55	6003	Memory error .....	60
5210	Appl. driver 4 .....	55	6004	Load H8 program .....	61
5212	Vx.x for AI rec.....	55	6005	Fixfont data .....	61
5300	BLDC EEPROM err.....	55	6006	Speedofont data.....	61
5301	BLDC rewinder Ø .....	56	6007	Print ctrl. stop .....	61
5500	Unknown .....	56	6008	ZPL Fixfont data.....	61
5501	General.....	56	6009	ZPL Speedo data .....	62
<b>5502-5551 Messages, which can only occur with RFID option .....</b>		<b>56</b>	6010	Printengine soft.....	62
5502	RFID internal .....	56	6012	Start next job.....	62
5504	No RFID job.....	56	6030	Param. checksum .....	62
5510	RFID COM timeout.....	56	6031	New Parameters .....	62
5512	COM open failed .....	56	6101	No sensor found.....	62
5513	Get baud failed .....	57	6200	Filesystem regis .....	62
5521	No transponder.....	57	6201	File sys. format.....	62
5522	Tag write err .....	57	6202	Drive open.....	62
5523	Tag address err .....	57	6203	Filesystem close .....	63
5524	CMD not applicable .....	57	6204	Disk directory .....	63
5525	Tag read err.....	57	6205	Write disk .....	63
5526	Tag select first.....	57	6206	Read disk .....	63
5527	Tag RF comm err .....	58	6207	No file card.....	63
5528	EEPROM failure .....	58	6208	Drive xx full .....	63
5529	Parameter range .....	58	6300	Out of memory .....	64
5530	Unknown CMD .....	58	6301	Incomplete job.....	64
5531	Protocol length .....	58	6310	Centr. Timeout .....	64
5532	CMD not avail.....	58	6311	Centr. Timeout .....	64
5540	ISO error #1.....	58	8001	Shared Memory .....	64
			8002	Stream Buffer.....	64

8103	TrueDoc Font .....	64	8804	Maxi. Sec. mess.....	69
8104	Speedo alloc.....	64	8805	Maxicode Country .....	69
8105	Load TrueType .....	64	8830	Cod49 Datalength.....	70
8106	Fonttype wrong.....	65	8031	Cod49 wrong data.....	70
8107	Character set.....	65	8850	Unknown filetype.....	70
8108	Symbol set.....	65	8851	Graphic open .....	70
8109	TT-specifications .....	65	8852	Graphic header .....	70
8110	Unknown char. ....	65	8853	Graphic palette.....	70
8111	Stream type .....	65	8854	Graphic read .....	70
8112	Font not supp. ....	65	8856	Free store size .....	71
8200	Fixfont number .....	65	8857	Wrong mem config.....	71
8201	Font downl. full .....	66	8900	Codablock columns.....	71
8202	Font deleted .....	66	8901	Codablock rows .....	71
8300	Bar code corr.....	66	8902	Codablock softw.....	71
8301	Bar code data .....	66	8903	Codablock infogr .....	71
8302	Barcode checksum.....	66	8950	Logo open .....	72
8303	Bar code sample .....	66	8951	File format .....	72
8304	Bar c. plain-copy.....	66	8952	Not installed .....	72
8305	Bar code print.....	67	9000	Wrong errornum.....	72
8306	Plain-copy len.....	67	9001	Software Error.....	72
8307	Readline dist.....	67	9003	Print head type.....	72
8308	Bar code ratio .....	67	9005	No Printhead .....	72
8309	Module range .....	67	9007	Bad MAC Address .....	73
8310	Bar code element .....	67	9008	Powerfail signal.....	73
8311	Barcode table .....	67	9009	Temporary MAC.....	73
8400	PDF417 ECC.....	67	9011	Bootloader ext.....	74
8401	PDF417 Lines.....	67	9013	Head voltage.....	74
8402	PDF417 Columns .....	68	9014	Motor voltage .....	74
8403	PDF417 Style .....	68	9015	Network init. ....	74
8404	PDF417 Command.....	68	9016	DHCP Failed .....	74
8405	PDF417 Size .....	68	9017	RTC read failed.....	74
8406	PDF417 Details .....	68	9018	#!CA wrong Pos.....	75
8407	PDF417 Coding.....	68	9021	Unmg. Exception.....	75
8500	Code 25Int len.....	68	9022	No network link .....	75
8501	Postcode length.....	68	9023	Filename: Functionname() Line: xxx.....	75
8600	EAN Length .....	68	9024	Not possible ! .....	75
8601	UPCE Numbers sys. ....	68	9030	Log file:CF full .....	76
8705	IDM rows/columns.....	69	9031	Log file: nnnn .....	76
8760	EAN128 field len.....	69	9032	EP file log stop .....	76
8761	EAN128 Data type.....	69	9034	Use min 16MB RAM .....	76
8762	EAN128 Ident. ....	69	9035	No printpr. stop .....	76
8800	Maxicode Mode .....	69	9039	Ribbon mode chg.....	76
8801	Maxicode Sys no.....	69	9040	No Time Server.....	76
8802	Maxicode Zipcode .....	69			
8803	Maxicode Class .....	69			

9100-9119 Messages during firmware update .....	77	9111 PIC Update Fail.....	78
9100 Invalid format.....	77	9112 PIC missing.....	78
9101 Invalid Header .....	77	9113 RFID Update Fail. ....	78
9102 Inv.Board Rev.....	77	9114 RFID missing .....	78
9103 Inval. firmware .....	77	9115 AWID missing .....	78
9104 Inv. Data Size .....	77	9116 Ser. Disp. Missing.....	78
9107 Flash Overflow .....	77	9117 Device Unknown.....	78
9108 Flash Ovf. Diag.....	77	9118 H8 Update Fail.....	78
9109 Flash Ovf. Params.....	77	9119 H8 missing .....	79
9110 Flash Write Err. ....	78	9122 Checksum error .....	79
		9123 Memory unavailable.....	80

## General information about status reports

### Area of application

This description of the status reports is valid for the print components of all the devices listed in the header bar and their options.

### Display of status reports

During operation, tests are continually carried out to determine whether a malfunction has occurred. If a malfunction is detected, the corresponding status report appears on the display.

- 64-xx / ALX 92x / DPM / PEM / PM 3000 only:  
If the parameter `SYSTEM PARAMETER > Signal buzzer` is set to *On*, an additional tone signal is given.
- 64-xx / ALX 92x / DPM / PEM / PM 3000 with “Gen. 3” electronics only:  
During a status message, the background light changes from green to red.  
The status can be requested using the serial interface (see Easy-Plug command `#!Xn`).

### Display

The status report shown on the display is assembled as follows:

```
Status      xxxx
TextTextTextTextTextTe
```

- *Status*: Is replaced by either „PrintStatus“ or „QueueStatus“.  
-- *PrintStatus* means, the error is caused by malfunction of the printer, independent of the sent print job. This is a message of the printer control.  
-- *QueueStatus* means, the error is caused by a faulty Easy-Plug command in the print job. This is a message of the Easy-Plug interpreter.
- *xxxx* signifies a status number in the range from 0001 to 9999. Using this number the user can look up the status of the printer in the following directory of status reports.
- *TextTextTextText* stands for a short display text which belongs to each status number. In many cases, the status of the printer can be identified just on the basis of this short display text.

More detailed information about the status reports and any measures which may need to be taken is given in the descriptions of the status reports which follow the list of status reports.

### Example

```
PrintStatus      8704
IDM Init. Error
```

### Acknowledging status reports

#### Self-acknowledging

Self-acknowledging status reports only show an event taking place in the device, and are simply for informing the operator about this event. The message appears for a short period on the display and is accompanied by

a short signal tone. The device continues to operate without any intervention from the user.

▶ Pay attention to each message in order to punctually prevent malfunctions.

**Acknowledging**

Status reports which are to be acknowledged must be confirmed by the operator as the activating event or malfunction endangers normal operation. The message appears on the display for so long until the malfunction has been corrected and acknowledged with the Enter button. A short signal tone is also given when the message appears.

**Disabling**

Messages which are shown following serious errors. This condition can be ended with a "warm start" (press Cut+Online+Feed buttons) or by switching off the printer.

<b>Self-acknowledging</b>	Header not underlined
<b><u>Acknowledging</u></b>	Header underlined once
<b><u><u>Disabling</u></u></b>	Header underlined twice

Tab. 1 The way of acknowledgment, a status message requires, can be detected by the text format used for the header. The gravity of a status message increases with the number of underlines.

**General software errors**

Errors in the firmware can never be completely ruled out. Such errors are described in the error directory as "General software errors". They can only be corrected by the manufacturer.

→ If errors which are described in the error directory as "General software errors" repeatedly occur, please notify the manufacturer, quoting the error number and the circumstances in which the error occurred.

**Easy-Plug errors**

Errors in the Easy-Plug code can be detected much easier with firmware version x.33 or higher. This requires the following setting:

SYSTEM PARAMETERS > EasyPlug error = "Strict handling"

The Easy-Plug command, which caused the error, is displayed after approx. 2 seconds in the lower display line. The displayed text is up to 30 characters long and is scrolled automatically.

If a single character caused the error, this character is marked with „>> <<„, in the display text, to facilitate the detection.

By pressing the cut button, the display can be toggled between error message and Easy-Plug command text.

**Unspecific errors**

Some errors can have more than one cause. To be able to find the specific reason for such an error, it is important that it can be reproduced.

→ Send the following items of information as complete as possible to the manufacturer – preferably as files:



- *Layout and/or printjob*, which makes the status message appear
  - *Parameter configuration* of the printer, when the error occurs
  - *Log file* of the printjob until the error occurs
- Use parameter **SPECIAL FUNCTION > Parameter to CF**, to save the current parameter configuration.
- Use parameter **SERVICE FUNCTION > EasyPlug monitor**, to send the received Easy-Plug data to a serial interface. Alternatively, with some printer types, log files of the printjob can be saved on memory card (**SPECIAL FUNCTION > Parameter to CF**).

Our Technical Support will try hard to find a solution by reproducing the situation which caused the error.

### **Not listed status reports**

Some status reports are not shown in the list of status reports. They provide developers of the printer firmware and trained service personnel with information about special conditions, particularly with regards to the printer firmware.

- ▣▣▣▣▶ If your printer displays status reports which are not included in the following list, please refer to the authorised service office. Make a note of the status number and the circumstances in which the message occurred.

## Listing of all Status reports

### **1000 No new command**

- Status** General software error
- Measure** → Switch printer off and then back on again after thirty seconds.  
→ Please read the notes in section [General software errors](#) .

### **1001 Parameter Table**

- Status** General software error
- Measure** → Switch printer off and then back on again after thirty seconds.  
→ Please read the notes in section [General software errors](#) .

### **1002 Comm. sorting**

- Status** General software error
- Measure** → Switch printer off and then back on again after thirty seconds.  
→ Please read the notes in section [General software errors](#) .

### **1003 Too many slashes**

- Status** General software error
- Measure** → Please read the notes in section [General software errors](#) .

### **1004 Slash w/o param.**

- Status** General software error
- Measure** → Acknowledge by pressing the on-line button.  
→ Please read the notes in section [General software errors](#) .

### **1005 2 same commands**

- Status** General software error
- Measure** → Acknowledge by pressing the on-line button.  
→ Please read the notes in section [General software errors](#) .

### **1006 Letter incorrect**

- Status** General software error: self-acknowledging
- Measure** → Please read the notes in section [General software errors](#) .

### **1007 Command incorr.**

- Status** Unknown command.
- Measure** → Check Easy Plug sequence.

### **1008 Subcomm. incorr.**

- Status** Unknown letter in a subcommand.
- Measure** → Check Easy Plug sequence.

**1009 Param. tab inc.**

**Status** General software error

**Measure** → Acknowledge by pressing the on-line button.  
→ Please read the notes in section [General software errors](#) .

**1010 #ER x #Q !**

**Status** One or more illegal commands between #ER and #Q.

**Measure** → Check transmitted Easy Plug sequence.  
→ Please read the notes in section [Easy-Plug errors](#) .

**1011 #ER missing**

**Status** One or more format commands without leading #ER (self-acknowledging)

**Measure** → None. The command is still carried out.  
→ Please read the notes in section [Easy-Plug errors](#) .

**1012 #IM x #Q !**

**Status** One or more illegal commands between #IM and #Q.

**Measure** → Check Easy Plug sequence.  
→ Please read the notes in section [Easy-Plug errors](#) .

**1013 Comm. flag inc.**

**Status** General software error

**Measure** → Switch printer off and then back on again after thirty seconds.  
→ Please read the notes in section [General software errors](#) .

**1014 Uunit integer**

**Status** General software error

**Measure** → Switch printer off and then back on again after thirty seconds.  
→ Please read the notes in section [General software errors](#) .

**1015 Uunit float**

**Status** General software error

**Measure** → Switch printer off and then back on again after thirty seconds.  
→ Please read the notes in section [General software errors](#) .

**1016 Uunit string**

**Status** General software error

**Measure** → Switch printer off and then back on again after thirty seconds.  
→ Please read the notes in section [General software errors](#) .

**1017    Unit discr**

**Status**                    General software error

**Measure**                → Switch printer off and then back on again after thirty seconds.  
                                 → Please read the notes in section [General software errors](#) .

**1018    Too many discr**

**Status**                    General software error

**Measure**                → Switch printer off and then back on again after thirty seconds.  
                                 → Please read the notes in section [General software errors](#) .

**1019    Unit BCD para.**

**Status**                    General software error

**Measure**                → Switch printer off and then back on again after thirty seconds.  
                                 → Please pay attention to the notes in chapter [General software errors](#) .

**1020    Too much image**

**Status**                    General software error

**Measure**                → Switch printer off and then back on again after thirty seconds.  
                                 → Please pay attention to the notes in chapter [General software errors](#) .

**1021    Unit image par**

**Status**                    General software error

**Measure**                → Switch printer off and then back on again after thirty seconds.  
                                 → Please pay attention to the notes in chapter [General software errors](#) .

**1022    Too many files**

**Status**                    General software error

**Measure**                → Switch printer off and then back on again after thirty seconds.  
                                 → Pay attention to the notes in section [General software errors](#) .

**1023    Unit File Para**

**Status**                    General software error

**Measure**                → Switch printer off and then back on again after thirty seconds.  
                                 → Please pay attention to the notes in chapter [General software errors](#) .

**1024    Com. too long**

**Status**                    General software error

**Measure**                → Switch printer off and then back on again after thirty seconds.  
                                 → Please pay attention to the notes in chapter [General software errors](#) .

**1025 Com twice there**

**Status** General software error

- Measure**
- Switch printer off and then back on again after thirty seconds.
  - Please pay attention to the notes in chapter [General software errors](#) .

**1026 Comm. w/o. flag**

**Status** General software error

- Measure**
- Switch printer off and then back on again after thirty seconds.
  - Please read the notes in section [General software errors](#) .

**1027 Uinit parameter**

**Status** Parameter could not be initialised.

- Measure**
- Acknowledge by pressing the Online button.

**1028 Parameter uninit**

**Status** General software error

- Measure**
- Acknowledge by pressing the Online button.
  - Please read the notes in section [General software errors](#) .

**1029 Param. incorr.**

**Status** Incorrect parameter in the command.

- Measure**
- Check Easy Plug sequence.
  - Please read the notes in section [Easy-Plug errors](#) .

**1030 Command incorr.**

**Status** Error during the command interpretation.

- Measure**
- Check Easy Plug sequence.
  - Please read the notes in section [Easy-Plug errors](#) .

**1031 Too many slashes**







**Status** Too many parameters between two slashes.

- Measure**
- Check Easy Plug sequence.
  - Please read the notes in section [Easy-Plug errors](#) .

**1032 Incorrect char.**

**Status** Parameter contains an invalid character.

- Measure**
- Check Easy Plug sequence.
  - Please read the notes in section [Easy-Plug errors](#) .

**1033    Uninit flash par****Status**                    General software error**Measure**                → Switch printer off and then back on again after thirty seconds.  
                                  → Please read the notes in section [General software errors](#) .**1034    Uninit restrict****Status**                    A „restricted string“ parameter could not be initialized.**Measure**                → Switch printer off and then back on again after thirty seconds.  
                                  → Please read the notes in section [General software errors](#) .**1035    Uninit combi****Status**                    General software error. A combi parameter could not be initialized.**Measure**                → Confirm by pressing the Online button.  
                                  → Please read the notes in section [General software errors](#) .**1036    Wrong combi para****Status**                    General software error. A combi parameter could not be initialized.**Measure**                → Confirm by pressing the Online button.  
                                  → Please read the notes in section [General software errors](#) .**1037    Software error****Status**                    General software error**Measure**                → Switch printer off and then back on again after thirty seconds.  
                                  → Please read the notes in section [General software errors](#) .**1038    Software error****Status**                    General software error**Measure**                → Switch printer off and then back on again after thirty seconds.  
                                  → Please read the notes in section [General software errors](#) .**1087    OLV not active****Status**                    OLV- specific Easy Plug commands have been used (#OLVI or #OLVD), *without* having set the printer to OLV use at first.**Measure**                → Set the printer to OLV use.  
                                  ○ See parameter INTERF. PARAM > COM2 PORT > Function Option.**1088    No realtimeclock****Status**                    RTC-specific Easy Plug commands have been used (#YS or #YC), *without* having a RTC installed.**Measure**                → Install a RTC.  
                                  ○ For details refer to the Service Manual, topic section "General Service", chapter "Assembling accessories" / "Option board".

**1089 Seek Fkt. Error**

**Status** General software error. An error occurred while processing the function „seek“ in the internal file system of the printer.

**Measure** → Confirm by pressing the Online button.  
→ Please read the notes in section [General software errors](#) .

**1090 Incomplete Job**

**Status** The actual print job was not terminated by the #Q command. In other words, after a start command #ER for a label format follows another #ER command without the first format being terminated by #Q.

**Measure** → Confirm by pressing the Online button.  
→ Terminate the print job with a #Q command.

**1091 Wrong var field**

**Status** An error occurred while interpreting the text string of a variable data field. The error could e.g. be caused by a #YT or a #YB command (Easy Plug). Self-acknowledging error.

**Measure** → Check the text strings of variable data fields.

**1092 Rename file**

**Status** General software error

**Measure** → Please read the notes in section [General software errors](#) .

**1093 Delete file**

**Status** File cannot be deleted.

**Measure** → Check whether the file name is written correctly; check whether the file is write-protected.

**1094 More than 3 figs**

**Status** General software error

**Measure** → Switch printer off and then back on again after thirty seconds.  
→ Please read the notes in section [General software errors](#) .

**1097 Out of memory**

**Status** General software error

**Measure** → Switch printer off and then back on again after thirty seconds.  
→ Please read the notes in section [General software errors](#) .

**1099 File end**

**Status** General software error

**Measure** → Please read the notes in section [General software errors](#) .

**1101 Wrong time/date**

**Status** Easy-Plug command #RTC (set realtime clock): invalid date or wrong date/time format.

**Measure** → Check command #RTC in the current printjob.  
→ Please read the notes in section [Easy-Plug errors](#) .

**1102 Counter offset**

**Status** Applies to all Easy-Plug commands with counter function, e. g. #YT: A non-valid digit was used in the offset.

**Measure** → Check all commands with counter function in the current printjob.  
→ Please read the notes in section [Easy-Plug errors](#) .

**1110 Opening Bracket**

**Status** General software error

**Measure** → Switch printer off and then back on again after thirty seconds.  
→ Please read the notes in section [General software errors](#) .

**1111 Closing Bracket**

**Status** General software error

**Measure** → Switch printer off and then back on again after thirty seconds.  
→ Please read the notes in section [General software errors](#) .

**1112 Para: No Value**

**Status** General software error

**Measure** → Switch printer off and then back on again after thirty seconds.  
→ Please read the notes in section [General software errors](#) .

**1113 No Default Value**

**Status** General software error

**Measure** → Switch printer off and then back on again after thirty seconds.  
→ Please read the notes in section [General software errors](#) .

**1114 < Limit value**

**Status** A sent Easy Plug command contains a value which exceeds the admissible range at the bottom limit. The faulty value is replaced automatically by a default value matching the limits.

Example: #YT109/-1/. The value -1 has been assigned to the parameter d. Admissible for d are the values 0, 1, 2, 3. Therefore, -1 exceeds the value range at the bottom limit.

**Measure** → Check the Easy Plug command on admissible values and correct them if necessary.  
→ Please read the notes in section [Easy-Plug errors](#) .



**1115 > Limit value**

**Status** A sent Easy Plug command contains a value which exceeds the admissible range at the top limit. The faulty value is replaced automatically by a default value matching the limits.

Example: #YT109/5/. The value 5 has been assigned to the parameter d. Admissible for d are the values 0, 1, 2, 3. Therefore, 5 exceeds the value range at the top limit.

**Measure** → Check the Easy Plug command on admissible values and correct them if necessary.

→ Please read the notes in section [Easy-Plug errors](#) .

**1120 Incorr. logo no.**

**Status** Logo no. is invalid because it is outside of the address field. (self-acknowledging)

**Measure** → Check whether the logo no. has been given as being smaller than 0 (zero) or larger than 255.

**1121 Logo exists**

**Status** Logo already exists.

**Measure** → Change the designation of the logo; repeat saving.

**1122 Creating logo**

**Status** General software error

**Measure** → Please read the notes in section [General software errors](#) .

**1123 Rename logo**

**Status** General software error

**Measure** → Please read the notes in section [General software errors](#) .

**1124 Logo file**

**Status** General software error

**Measure** → Please read the notes in section [General software errors](#) .

**1125 Delete error**

**Status** General software error

**Measure** → Switch printer off and then back on again after thirty seconds.

→ Please read the notes in section [General software errors](#) .

**1126 File creation**

**Status** Faulty Easy-Plug code. A file could not be created. The error may e.g. be caused by a faulty filename or by too less printer memory.

- Measure**
- Check all used filenames for length, applied characters, etc. Change the name if faulty.
  - Check the printer for enough memory.
  - Please read the notes in section [Easy-Plug errors](#) .

**1127 File format**

**Status** A file name doesn't match the (DOS-) filename convention.

- Measure**
- Check all used filenames for length, applied characters, etc. Change the name if faulty.

**1128 File exists**

**Status** Faulty Easy-Plug code. A file is ought to be loaded into the printer memory via #DF command. The command was used without adding the parameter "O" for "Overwrite", but a file already exists under the given name.

- Measure**
- Rename one of both files or set the parameter "O".
  - Please read the notes in section [Easy-Plug errors](#) .

**1130 Float overflow**

**Status** Number of figures is too high for a floating comma variable.

- Measure**
- Switch printer off and then back on again after thirty seconds.
  - Reduce the number of figures.

**1131 Logo cache full**

**Status** A logo or several logos was/were sent which is/are too huge for the logo buffer.

- Measure**
- Switch printer off and then back on again after thirty seconds.
  - Reduce the logo size.

**1140 Line too long**

**Status** Error during conversion from EPT into BIN: permitted line length exceeded.

- Measure**
- Reduce line length.

**1141 Para. incorr. BI**

**Status** Error during processing of a Bit Image parameter.

- Measure**
- Acknowledge by pressing the on-line button.

**1150 Integer overflow**

**Status** Too many figures for an integer variable.

- Measure**
- Switch printer off and then back on again after thirty seconds.
  - Reduce the number of figures.

**1160 String too long**

**Status** A string parameter exceeds the maximum string length of 256 characters (1024 characters in 2-dimensional bar codes respectively).

**Measure** → Reduce the number of characters in the string.

**1170 X Pos > width**

**Status** Faulty Easy-Plug code. X position exceeds permitted maximum value.

**Result** The previously set print offset is retained.

**Measure** → Reduce value for X position.  
→ Please read the notes in section [Easy-Plug errors](#) .

**1171 X Pos < zero**

**Status** Faulty Easy-Plug code. Value for X position < zero.

**Result** The previously set print offset is retained.

**Measure** → Check value for X position for signs.  
→ Please read the notes in section [Easy-Plug errors](#) .

**1172 Y Pos > length**

**Status** Faulty Easy-Plug code. Y position exceeds the label length.

**Result** The previously set print offset is retained.

**Measure** → Reduce value for Y position.  
→ Select a longer label.  
→ Please read the notes in section [Easy-Plug errors](#) .

**1173 Y Pos < zero**

**Status** Faulty Easy-Plug code. Value for Y position < zero.

**Result** The previously set print offset is retained.

**Measure** → Check value for Y position for signs.  
→ Please read the notes in section [Easy-Plug errors](#) .

**1174 Max width: right**

**Status** Maximum label width, right, reached. Elements such as character, line or logo do not fit into the physical print format (self-acknowledging)

**result** Only elements which completely fit into the print format are printed.

**Measure** → Alter value for width or position of elements.  
→ Please read the notes in section [Easy-Plug errors](#) .

**1175 Max width: left**

**Status** Faulty Easy-Plug code. Maximum label width, left, reached. Elements such as character, line or logo do not fit into the physical print format (self-acknowledging)

**result** Only elements which completely fit into the print format are printed.

**Measure** → Alter value for width or position of elements.  
→ Please read the notes in section [Easy-Plug errors](#) .

**1176 Max length: top**

**Status** Faulty Easy-Plug code. Maximum label length, top, reached.

**Measure** → Correct label layout: Position the drawing elements in a way that they fit on the label or modify the label length.

→ Please read the notes in section [Easy-Plug errors](#) .

**1177 Max length: bot.**

**Status** Faulty Easy-Plug code. Maximum label length, bottom, reached.

**Measure** → Correct label layout: Position the drawing elements in a way that they fit on the label.

→ Please read the notes in section [Easy-Plug errors](#) .

**1178 x Dots < zero**

**Status** Bit Image:

**Measure** → Switch printer off and then back on again after thirty seconds.

**1200 GetRLE reset st**

**Status** (number of bytes) \* (number of lines) does not correspond to the file length.

**Measure** → Switch printer off and then back on again after thirty seconds.

**1201 GetRLE error st**

**Status** GetRLE byte has error status.

**Measure** → Switch printer off and then back on again after thirty seconds.

**1210 itoa Short Strin**

**Status** General software error

**Measure** → Please read the notes in section [General software errors](#) .

**1240 New FS>E**

**Status** General software error

**Measure** → Please read the notes in section [General software errors](#) .

**1241 New Read Pointer**

**Status** Faulty memory assignment for print jobs.

**Measure** → Please read the notes in section [Unspecific errors](#) .

**1242 New FE in job**

**Status** Faulty memory assignment for print jobs.

**Measure** → Please read the notes in section [Unspecific errors](#) .

**1243 New delete order**

**Status** Faulty memory assignment for print jobs.

**Measure** → Please read the notes in section [Unspecific errors](#) .

**1244 New wrong pos.**

**Status** Faulty memory assignment for print jobs.

**Measure** → Please read the notes in section [Unspecific errors](#) .

**1245 New no space**

**Status** Faulty memory assignment for print jobs.

**Measure** → Please read the notes in section [Unspecific errors](#) .

**1246 New HP no space**

**Status** Faulty memory assignment for print jobs.

**Measure** → Please read the notes in section [Unspecific errors](#) .

**1247 Out of memory**

**Status** Faulty memory assignment for print jobs.

**Measure** → Please read the notes in section [Unspecific errors](#) .

**1260 TimeDate string**

**Status** General software error

**Measure** → Acknowledge by pressing the on-line button.

→ Please read the notes in section [General software errors](#) .

**1270 #-comm. invalid**

**Status** General software error

**Measure** → Please read the notes in section [General software errors](#) .

**1272 Wrong #!..**

**Status** Faulty Easy-Plug code. Faulty use of the immediate command "#!A..". The specified parameter value exceeds the admissible value range (0 to 31).

**Measure** → Specify an admissible parameter value.

→ Please read the notes in section [Easy-Plug errors](#) .

**1273 Wrong #!C..**

**Status** Faulty Easy-Plug code. Faulty use of the immediate command "#!C..". The specified parameter value exceeds the admissible value range (A, F).

**Measure** → Specify an admissible parameter value.  
→ Please read the notes in section [Easy-Plug errors](#) .

**1276 #!P wrong number**

**Status** Faulty Easy-Plug code. Faulty use of the immediate command "#!P..". The specified parameter value exceeds the admissible value range (0 to 31).

**Measure** → Specify an admissible parameter value.  
→ Please read the notes in section [Easy-Plug errors](#) .

**1277 Wrong #!S..**

**Status** Faulty Easy-Plug code. Faulty use of the immediate command "#!S..". The specified parameter value exceeds the admissible value range (P, R).

**Measure** → Specify an admissible parameter value.  
→ Please read the notes in section [Easy-Plug errors](#) .

**1278 Wrong #!X..**

**Status** Faulty Easy-Plug code. Faulty use of the immediate command "#!X..". The specified parameter value exceeds the admissible value range (S, B, P).

**Measure** → Specify an admissible parameter value.  
→ Please read the notes in section [Easy-Plug errors](#) .

**1279 #!X wrong number**

**Status** Faulty Easy-Plug code. Faulty use of the immediate command "#!X..". The specified parameter value exceeds the admissible value range.

**Measure** → Specify an admissible parameter value.  
→ Please read the notes in section [Easy-Plug errors](#) .

**1282 Spooler FB > L**

**Status** General software error

**Measure** → Switch printer off and then back on again after thirty seconds.  
→ Please read the notes in section [General software errors](#) .

**1285 #!-comm. incorr.**

**Status** Faulty Easy-Plug code. Faulty use of the immediate command "#!..!". The specified letter is unknown.

**Measure** → Specify an admissible letter.  
→ Please read the notes in section [Easy-Plug errors](#) .

**1290 Label limit**

**Status** Faulty Easy-Plug code. Value for x or y position exceeds the label limit.

**Measure** → Reduce the value for the x or y position.  
→ Please read the notes in section [Easy-Plug errors](#) .

**1291 Draw field**

**Status** Faulty Easy-Plug code. Function call, drawing object, unsuccessful.

→ Please read the notes in section [Easy-Plug errors](#) .

**1300 Invalid Command**

**Status** General software error

**Measure** → Please read the notes in section [General software errors](#) .

**1301 Table full**

**Status** General software error

**Measure** → Please read the notes in section [General software errors](#) .

**1310 Wrong Field ID**

**Status** The error can have several causes.

**Measure** → Please read the notes in section [Unspecific errors](#) .

**1320 No Default Value**

**Status** Faulty Easy-Plug code.

**Measure** → Please read the notes in section [Easy-Plug errors](#) .

**1321 Bar Code Object**

**Status** Faulty Easy-Plug code regarding the declaration of a bar code.

**Measure** → Please read the notes in section [Easy-Plug errors](#) .

**1322 Logo Object**

**Status** Faulty Easy-Plug code regarding the declaration of a logo.

**Measure** → Please read the notes in section [Easy-Plug errors](#) .

**1323 Line Object**

**Status** Faulty Easy-Plug code regarding the declaration of a line.

**Measure** → Please read the notes in section [Easy-Plug errors](#) .

**1324 Rectangle Object**

**Status** Faulty Easy-Plug code regarding the declaration of a rectangle.

**Measure** → Please read the notes in section [Easy-Plug errors](#) .

**1325 Truedoc Object**

**Status** The error can have several causes.

**Measure** → Please read the notes in section [Unspecific errors](#) .

**1326 Fix Field Creati**

**Status** Faulty Easy-Plug code regarding the declaration of a field.

**Measure** → Please read the notes in section [Easy-Plug errors](#) .

**1327 Update Field Cre**

**Status** Faulty Easy-Plug code regarding the declaration of a field.

**Measure** → Please read the notes in section [Easy-Plug errors](#) .

**1328 Var Field Creati**

**Status** Faulty Easy-Plug code regarding the declaration of a field.

**Measure** → Please read the notes in section [Easy-Plug errors](#) .

**1329 Count Field Crea**

**Status** Faulty Easy-Plug code regarding the declaration of a counting field.

**Measure** → Please read the notes in section [Easy-Plug errors](#) .

**1330 Create clk. field**

**Status** General software error

**Measure** → Please read the notes in section [General software errors](#) .

**1331 Field type inv.**

**Status** Invalid field type

**Measure** → Acknowledge by pressing the Online button.

**1332 Field length inc.**

**Status** General software error

**Measure** → Switch printer off and then back on again after thirty seconds.

→ Please read the notes in section [General software errors](#) .

**1333 Logo not there**

**Status** Selected logo does not exist.

**Measure** → Check file name / existence of the logo.

**1334 #YV Data incorr.**

**Status** Illegal entries for a #YV field (variables data field).

**Measure** → Acknowledge by pressing the Online button.

→ Correct data.

→ Please read the notes in section [Easy-Plug errors](#) .



**1335 #YV Field cont.**

- Status** Content of the #YV field (variables data field) could not be pasted.
- Measure** → Acknowledge by pressing the Online button.  
→ Please read the notes in section [Easy-Plug errors](#) .

**1336 #YV no. incorr.**

- Status** #YV field (variables data field) with the given no. not found.
- Measure** → Acknowledge by pressing the Online button.  
→ Check the number of the #YV field.  
→ Please read the notes in section [Easy-Plug errors](#) .

**1390 Web width zero**

- Status** The printer was set to printing several label rows (Easy Plug command #ER,  $n > 1$ ); but the label width was by fault set to zero ( $b = 0$ ).
- Measure** → Correct the #ER command regarding the setting of parameter b.  
→ Please read the notes in section [Easy-Plug errors](#) .

**1391 Web > Width**

- Status** The printer was set to printing several label rows (Easy Plug command #ER,  $n > 1$ ); but both or one of the parameters  $n$  and  $b$  are set in a way that  $n * b$  (label row width \* no. of rows) exceeds the material width.
- Measure** → Correct the #ER command regarding the setting of parameters  $n$  and  $b$ .  
→ Please read the notes in section [Easy-Plug errors](#) .

**1392 Job memory full**

- Status** The error can have several causes.
- Measure** → Please read the notes in section [Unspecific errors](#) .

**1393 Job struct creat**

- Status** The error can have several causes.
- Measure** → Please read the notes in section [Unspecific errors](#) .

**1394 Invalidation**

- Status** General software error
- Measure** → Switch printer off and then back on again after thirty seconds.  
→ Please read the notes in section [General software errors](#) .

**1395 Label too wide****Status**

A printjob contains an #IM-command which sets the label width to a measure exceeding the maximum print width. The maximum print width depends on the printer type.

- Refer to the user manual, topic section „Specifications“ for the maximum label width.

**Measure**

- Reduce the label width set by the #IM-command in the concerned print job, until the label width matches the maximum print width.
- Please read the notes in section [Easy-Plug errors](#) .

**1396 Label too long****Status**

Label length setting exceeds the maximum label length. The maximum label length depends on the memory configuration of the printer.

- The info-printout „Memory Status“ shows among other data the maximum label length. Read more about info-printouts in topic section „Info-Printouts and Parameters“.

**Measure**

- Reduce the label width setting.
- Please read the notes in section [Easy-Plug errors](#) .

**1397 Label too short****Status**

The label length defined in the #IM command is smaller than the minimum admissible length. The label length is set to the minimum value.

**Measure**

- Correct the length value in the label layout definition.
- Please read the notes in section [Easy-Plug errors](#) .

**1398 Label too small****Status**

The label width defined in the #IM command is smaller than the minimum admissible width. The label width is set to the minimum value.

**Measure**

- Correct the width value in the label layout definition.
- Please read the notes in section [Easy-Plug errors](#) .

**1404 UTF8 data wrong****Status**

Character code > 0xffff

**Measure**

- Check/change the character code.

**1470 X-Offset****Status**

The x-position of a layout element (graphics, text, ...) is beyond the label margin. The element is shifted automatically to the first admissible position at the correct side of the margin.

**Measure**

- Check the x-positions of the layout elements and change them, if necessary.
- Please read the notes in section [Easy-Plug errors](#) .

**1471 Y-Offset**

**Status** The y-position of a layout element (graphics, text, ...) is beyond the label margin. The element is shifted automatically to the first admissible position at the correct side of the margin.

**Measure** → Check the y-positions of the layout elements and change them, if necessary.  
→ Please read the notes in section [Easy-Plug errors](#) .

**1501-1535 Messages, which can occur in ZPL emulation mode**

This section lists all error messages that may appear when using the ZPL II<sup>®</sup> interpreter function.

**1501 Unknown MLI Cmd**

**Error level** 1

**Status** An uninterpretable command was encountered.

**Measure** → Check, if the printjob was proceeded correctly. If yes, ignore the message, if no, modify the printjob.

**1502 MLI Hash Error**

**Error level** 1

**Status** General software error.

**Measure** Read chapter [General software errors](#)  on page 8.

**1503 Filename Too Long**

**Error level** 1

**Status** Filename is too long.

**Measure** → Rename the file with a shorter name.

**1504 Param > Max**

**Error level** 1

**Status** Parameter exceeds the maximum value defined

**Measure** → Shorten the parameter.

**1505 Param < Min**

**Error level** 1

**Status** Parameter is shorter than the admissible minimum value allowed.

**Measure** → Modify the parameter.

**1506 No Previous**

**Error level** 1

**Status** Graphics command is to set current row data to previous row data, but previous row data doesn't exist.

**Measure** →

**1507 Not enough data****Error level** 1**Status** Data for graphics command is not enough.**Measure** → Check and modify graphics data.**1508 String Too Long****Error level** 1**Status** String characters exceeds the maximum number of characters which the particular string parameter can take.**Measure** → Check and modify the command.**1509 Wrong Byte Cnts****Error level** 1**Status** The row size or total size parameters is not valid (equals 0). Occurs when download graphic or download font commands in process.**Measure** → Check and modify the command.**1510 Wrong Param****Error level** 1**Status** Control characters are not allowed for discrete parameter (single letter parameter).**Measure** → Check and modify the command.**1511 Bar Parm Error****Error level** 1**Status** Parameters to a barcode command is wrong or does not conform with specs.**Measure** → Modify the bar code command.**1512 Code128 Mode Err****Error level** 1**Status** Code128 barcode command specifying mode type other than 'AUTO'.**Measure** → Modify the bar code command.**1513 Wrong Mode****Error level** 2**Status** Coda block barcode command specifying mode type other than 'F'.**Measure** → Modify the bar code command.

**1514    ^BX Parm Err.**

Error level            2

Status                 Data Matrix bar code command specified an escape sequence character.  
This is not supported in this printer.

Measure              → Modify the bar code command.

**1515    Conv to ECC200**

Error level            1

Status                 Data Matrix barcode command specified non ECC200 level. Program is  
attempting to convert to ECC200.

Measure              → Modify the bar code command.

**1516    Bad Drive: x**

Error level            2

Status                 The drive selected is not a valid drive. (We support only 'R' and 'B').

Measure              → Select a valid drive.

**1517    Mask String: x**

Error level            2

Status                 The mask string used in ^SF command is not supported.

Measure              → Modify the print job.

**1518    Bad Format: x**

Error level            2

Status                 The graphic format selected is not supported by Avery ZPL Emulation  
(Compressed binary and PNG format).

Measure              → Convert graphic into a supported format.

**1519    Cmd Init Error**

Error level            1

Status                 General software error.

Measure              Read chapter [General software errors](#) □ on page 8.**1520    Unsupported Cmd**

Error level            1

Status                 Non critical commands that is not supported by this printer.

Measure              → Check and modify the commands in the printjob.

**1521    Unsupported: x**

Error level            2

Status                 Critical commands that is not supported by this printer.

Measure              → Check and modify the commands in the printjob.

**1522 Bad Char Set x**

**Error level** 2  
**Status** The character set selected by ^CI command is not supported.  
**Measure** → Replace the character set by a supported set.

**1523 Cmd Parm Error**

**Error level** 1  
**Status** Error encountered while parsing command parameter.  
**Measure** → Check and modify the commands in the printjob.

**1524 d/mm not chg x**

**Error level** 2  
**Status** Command attempting to lower print density assuming a 200 dpi printer.  
**Measure** → Check and modify the commands in the printjob.

**1525 USI not exist**

**Error level** 1  
**Status** The printer is not equipped with a USI board.  
**Measure** → Modify the printjob.  
→ Install a USI board.

**1526 Can't Off CV**

**Error level** 1  
**Status** Command attempting to turn off barcode validations.  
**Measure** → Check and modify the commands in the printjob.

**1527 Offset illegal**

**Error level** 2  
**Status** RTC command specified a clock offset not supported by this printer (possibly a negative offset).  
**Measure** → Correct the command.

**1528 Language illegal**

**Error level** 2  
**Status** Language specified by RTC command is not English or German.  
**Measure** → Correct the command.

**1529 Invalid Prn Mode**

Error level 1

Status Print modes other than cutter mode are selected (Tear-off, Rewind or Peel-off modes in ^MM command).

Measure → Correct the command.

**1530 Inc free str mem**

Error level 2

Status Not enough free store memory.

Measure → Increase the value set in SYSTEM PARAMETER &gt; Free store size (at least 2048 Kbytes).

**1531 Inc RAM disc**

Error level 2

Status Not enough RAM disc.

Measure → Increase the value set in SYSTEM PARAMETER &gt; Ram disk size (at least 2048 Kbytes).

**1532 No Fixfont**

Error level 2

Status No fixfonts in Flash.

Measure → Load fixfont.

**1533 No Speedo Font**

Error level 2

Status No Speedo font in Flash.

Measure → Load speedo font.

**1534 ^XA missing**

Error level 1

Status Command should be placed inside of ^XA...^XZ pair.

Measure → Modify the printjob.

**1535 ^XZ missing**

Error level 1

Status Command should be placed outside of ^XA...^XZ pair.

Measure → Modify the printjob.

**1561 Wrong Font Format**

Status Format error in a Fixfont file.

Measure → Check font file.

## **2000-2009 Messages caused by Easy-Plug variables**

### **2000 Double var name**

**Status** Attempt to define a variable with an already existing name.

**Measure** → Choose another name for the variable.

### **2002 Var. data length**

**Status** The maximum allowed length of a variable was exceeded.

**Measure** → Correct the variable length.

### **2003 Expr. bracket**

**Status** The number of open and close brackets in the expression is not equal.

**Measure** → Check the brackets in the expression and correct their number.

### **2004 Exp. quotemark**

**Status** The number of quotemarks in the expression is *not* a multiple of two.

**Measure** → Check the quotemarks in the expression and correct their number.

### **2005 Exp. comma pos.**

**Status** Unexpected comma in the expression.

**Measure** → Check the syntax of the expression regarding commas.

### **2006 Exp.functionname**

**Status** A wrong function name is used in the expression.

**Measure** → Check, if the function names used in the expression are spelled correctly and if the functions exist. Change the function name.

### **2007 Exp.fct.paratype**

**Status** A wrong parameter type in an expression was detected.

Example: SubStr("Text",o,"A") would provoke this message, because "A" is not a number.

**Measure** → Check the expressions. Correct the wrong expression.

### **2008 Exp.fct.paraCnt**

**Status** Wrong number of function parameters in the expression.

**Measure** → Check the expressions. Correct the wrong expression.

### **2009 Exp. name wrong**

**Status** A not defined variable name is used in an expression.

**Measure** → Check the variable names. Correct the spelling if necessary or define a new variable.



**2010 Fct. para value**

**Status** The error is caused by the Easy-Plug function chr(). The argument, which was assigned to the function, exceeds the admissible value range 0...255.

**Measure** → Change the argument (details see Easy-Plug manual)

**2011 OLV variable**

**Status** Wrong naming of the variable in Easy-Plug command #VDO (details see Easy-Plug manual)

**Measure** → Check the Easy-Plug command #VDO in the current printjob.

**2111 Invalid Date**

**Status** Invalid date specification in a string.  
Example: Function call *DayOfYear*("31", "6", "2005") would produce this error message (because the date did not exist).

**Measure** → Correct the date specification.

- See Easy-Plug Manual, topic section "Description of commands", chapter "Easy-Plug variables".

**2500 Multiple texts**

**Status** This status number may be combined with variety of texts, which all are generated by the Basic interpreter. The Basic interpreter is a function which is not released nor supported.

**Measure** → Switch off the Basic interpreter (SYSTEM PARAMETERS > Print Interpret.).

**3000/3003/3006/3012/3015 Com x Overrun**

**Status** Receive error at the RS232 interface COMx (x = [1...5]).

**Measure** → Acknowledge by pressing the Online button.

**3001/3004/3007/3013/3016 Com x Parity**

**Status** Receive error at the RS232 interface COMx (x = [1...5]).

**Measure** → Acknowledge by pressing the Online button.

→ Check parameter setting at printer (INTERF. PARAM. > COM1 PORT > Parity) and PC.

- Notes about setting the printer parameters are given in the chapter "Info Print-outs and Parameters" in the User Manual.

**3002/3005/3008/3015/3017 Com x Frame**

**Status** Receive error at the RS232 interface COMx (x = [1...5]).

**Measure** → Acknowledge by pressing the Online button.

→ Check parameter setting at printer (INTERF. PARAM. > COM1 PORT > Baud rate and INTERF. PARAM. > COM1 PORT > stop bits) and PC.

- Notes about setting the printer parameters are given in the chapter "Info Print-outs and Parameters" in the User Manual.

**3010 Spooler Overflow**

**Status** Fault which is caused by a faulty handshake at an interface. The consequence is an overflowing data buffer at the printer, because the host doesn't stop to send data to the printer.

**Measure**

- Acknowledge by pressing the Online button.
- Check the connections of the data line, especially the signal wires belonging to the handshake.
- Check the interface settings, especially the handshake settings.

**3011 Send buffer full**

**Status** The send buffer is full. This error may happen, if the printer status was requested several times (#!Xn), but the status reply was not read out.

**Measure** → Make sure that the status reply is read out.

## **4100-4106      Message, which can only occur with OLV-Option**

### **4100      No OLV data**

**Status**                      The OLV found out, that the bar code type and/or the bar code data, which was just printed and read, doesn't match the bar code specified in the print job. The error may have one of the following causes:

- OLV is not connected/switched on
- The bar code has not been printed
- The bar code has been printed poorly, so that the OLV can not detect it.

**Measure**                    → Check, if the OLV is connected correctly

→ Check the printout quality. If the printout is poor, change the print parameters and/or use a different material/ribbon-combination.

→ Make a dot check. May be, that a dot is defective, which was ought to print an important line of the bar code.

→ If the bar code has not been printed at all: check the print job.

### **4101      OLV limit exceed**

**Status**                      The read bar code exceeds a user-specified limit. The limits, e.g. contrast or readability, can be set via the parameter menu or via Easy Plug command.

**Measure**                    → Check the printout quality.

→ Change the limit.

→ Eventually modify the print parameters or the material/ribbon combination.

### **4103      OLV barcode type**

**Status**                      The OLV found out, that the bar code type, which was just printed and read, doesn't match the bar code specified in the print job.

**Measure**                    → Check the printout.

### **4104      OLV Timeout**

**Status**                      General software error

**Measure**                    ○ Please read the notes in section [General software errors](#) .

### 4105 **No OLV response**

**Status** This error may occur shortly after switching on the printer with the OLV device already switched on. It indicates, that the OLV version number was not successfully read.

Possible causes are:

- Wrong connection cable between OLV and printer
- Faulty interface parameter setting for Com2
- Power supply of the OLV interrupted or not available
- Defective I/O board (Com2)

**Measure** → Check the possible causes of failure and exchange defective parts.

### 4106 **OLV Software**

**Status** General software error

**Measure** ○ Please read the notes in section [General software errors](#) .

### 5000 **Bus device**

**Status** One of the devices connected to the I<sup>2</sup>C bus (e.g. output stage boards) does not respond. This message appears mostly first in a sequence of two or three status messages, which help to isolate the error source.

- Measure**
- Acknowledge by pressing the Online button.
  - Switch printer off and back on again after 30 sec. If the error message continues to appear, please contact the manufacturer.

**Example** The parameter SYSTEM PARAMETERS > Periph. device is set to "Cutter" without an output stage board for a cutter being installed. The following status messages appear one after another:

1.	Status	5000	Generally tells, that something went wrong with I <sup>2</sup> C bus communication.
	Bus device		

→ Press Online button.

2.	Status	5005	Either no output stage board is prepared to drive a cutter, or the I <sup>2</sup> C bus data cable is not connected to the output stage board (this message appears only in one of those two cases, alternative status messages see Tab. 2)
	Knife-fault		

→ Press Online button.

3.	Status	5020	Time limit exceeded without getting an answer from device no. 4 (4 = Cutter, see Tab. 4) (alternative status messages see Tab. 3)
	I2C Timeout	4	

→ Press Online button

One of the following status messages may follow second:

Status #	Text	Missing output stage for the following
----------	------	--

		<b>device:</b>
5005	Knife-fault	Cutter motor
5006	Head-fault	Print head liftmotor
5008	Ribbon end	Ribbon motor

Tab. 2 Those status messages indicate, that the device is not connected to the I<sup>2</sup>C bus.

Third may follow one of the status messages listed below:

<b>Status #</b>	<b>Text</b>
5020	I2C Timeout xx
5021	I2C Conf. xx
5022	I2C Busy xx
5023	I2C LAB xx
5024	I2C BER xx
5025	I2C Polling xx

Tab. 3 Status messages, which help to further locate the I<sup>2</sup>C bus error. xx = Device ID of the concerned device (see 0)

#	Device	64-xx	DPM / PEM	ALX 92x	AP 5.4	AP 7.t
0	CPU	X	X	X	X	X
1	Feed motor	X	X	X		X
2	Foil motor	X	X	X		
3	Printhead motor	X	X	X		X
4	Peripheral motor	X				X
5	Dispenser motor	X				
5	Rewinder motor			X		
8	Rewinder (internal)			X	X	
12	(Reserved)					
13	USI board	X	X	X		
15	I/O board	X	X	X	X	X
16	EEPROM	X	X	X	X	X
17	Realtime-clock	X	X	X	X	X
18	Power supply	X <sup>1)</sup>	X	X		

Tab. 4 Assignment of device IDs as used in status messages related to the I<sup>2</sup>C bus.

1) Only with the power supply types HME and ME 500.

**5001 No gap found**

- Status** No gap found or several blank labels fed.
- Measure**
- Acknowledge by pressing the Online button.
  - Check the print mask for gap definition (material length).
  - Check whether the correct material has been inserted.
  - Check that the photoelectric switch is clean.
  - Check material feed and position of photoelectric switch.
  - Check sensitivity of the photoelectric switch (Parameter SYSTEM PARAMETERS > Sens. punch-LS). Materials providing a poor contrast between label and backing paper or between reflex mark and label require a higher sensitivity setting.
  - After confirmation using the Online button, the material is fed forward automatically and the next gap is sought.

**5002 Material end**

- Status** Material end. Material no longer in the gap LS.
- Measure**
1. Press Online button in order to acknowledge the status report.  
Display: *OFFLINE x JOBS*
  2. Insert material and check the position of the photoelectric switch, correct if necessary.
  3. Press Online button: processing of the job continues, gap is reinitialised.

**5003 Cover open**

- Status** 64-xx / DPM / PEM / ALX 92x: *Cover open*
- Housing cover is open. Opening the cover causes all other eventually waiting status messages (e.g. ribbon end) to be deleted and the "Cover open" message immediately to be displayed. Closing the cover automatically acknowledges the message.
- AP 4.4 / 5.4: *Printhead pressure lever open*
- The printhead pressure lever was opened, during:
- the feeding of material or
  - printing.
- The error message is automatically acknowledged with the closing of the printhead pressure lever.
- Measure** → Close the cover or printhead lever respectively.

**5004 Rewinder mat. tear**

- Status** Label material at the backing paper rewinder is torn off.  
The *AP 5.4 Dispenser* shows this message also if the backing paper sleeve was too large during material initialization; the backing paper web could not be tightened.
- Measure** → Acknowledge by pressing the Online button.  
→ Secure label material to the rewinder.

**5005 Knife-fault**

- Status** Faults at the cutter.
- Measure** → Acknowledge by pressing the Online button.

**5006 Head-fault**

- Status** Print head lifting malfunction (head sensor).
- Measure** → Check whether dirt is preventing the head contact lever from moving freely, if necessary clean.  
→ If not successful, call Service.

**5008 Ribbon end**

- Status** Ribbon end
- Measure**
- When using thermal printing:
    1. Check whether the parameter `SYSTEM PARAMETER > Ribbonautoecon.` is set to "deactivated".
    2. Acknowledge by pressing the Online button.
    3. Switch off the ribbon end detection, parameter: `SYSTEM PARAMETER > Ribbonautoecon.`
    4. Press the Online button: processing of the job continues, gap LS is reinitialised.
  - When using heat transfer printing:
 

Measure 1

    1. Tighten ribbon or set the spring plate on the ribbon unwind mandrel so that the ribbon core turns the mandrel with it and the ribbon core can still be removed.
    2. Press the Feed button in order to acknowledge the status report.  
Display: OFFLINE x JOBS
    3. Press the Online button: processing of the job continues, gap LS is reinitialised.

**Measure 2**

1. Press the Cut button to deactivate the acoustic signal.
2. Press the Feed button in order to acknowledge the status report.  
Display: OFFLINE x JOBS
3. Insert a new ribbon.
4. Press the Online button: processing of the job continues, gap LS is reinitialised.

**5009 USI start error**

**Status** This status message can only be triggered with activated parameter DP INTERFACE > Start error stop. It occurs, if another start signal is given while printing a label.

**Measure** → Acknowledge by pressing the Online button. Press the Feed button afterwards to proceed with the print job.

**5012 Delete H8 loader**

**Status** Error while loading the H8 firmware: the old firmware on the machine could not be deleted.

**Measure**

- Acknowledge by pressing the Online button.
- Retry loading the firmware.
- If the error occurs repeatedly, the bootloader must be loaded newly.

**5013 Prog H8 loader**

**Status** Error while loading the H8 firmware: the new firmware could not be written.

**Measure**

- Acknowledge by pressing the Online button.
- Retry loading the firmware.
- If the error occurs repeatedly, the bootloader must be loaded newly.



**5015 Scanner****Status**

Faults at the scanner.

The scanner is tested during printer initialization by switching it on for a moment. A properly working scanner will afterwards send a reply signal to the printer. A missing reply signal provokes the status message. The missing of the reply signal can have several reasons.

**Measure**

- Acknowledge by pressing the Online button.
- Red scanner LED lights up? – If not, there is a lack of power supply. Check, if the scanner connection cable is plugged in correctly and if the connection cable is damaged.
- Yellow scanner LED lights up shortly after switching the printer on. – If not, the scanner test was faulty.

**5016 ALX Rewinder****Status**

(Only ALX 92x)

The output stage board belonging to the Rewinder motor is not connected or damaged.

**Measure**

- Check, if the board is connected properly.
- Exchange the board to verify if it is damaged.

**5017 Power Supply****Status**

Communication fault of the power supply during the running of the service function "Head dot test".

The power supply didn't succeed in switching to the dot check mode (that is, reducing the head voltage to 10 V). Also in this case, temporary disturbances on the measurement line of the H8 processor, caused by the power supply, are a possible reason. Even if the switchover is defective (the status message is displayed continuously), can the printer be used in normal operation mode.

**Measure**

- Acknowledge by pressing the Online button.
- Try again. If the error message continues to appear, exchange the power supply.
- For detailed information refer to the appropriate service manual, topic section "General Service", chapter "Connections and electrics", "Powerpack".

**5018 Dot check area**

**Status** A value is measured at the AD transformer, which should not occur with a proper working printer. That means, the current measurement circuit inside the power supply delivers a value which is too high. This can be a sporadically occurring fault of the power supply (noise voltages) or a durable defect. Another possibility is, that a dot of the printhead has a much too low resistance – a rather unlikely option, because this dot would be quickly overheated while printing, what would damage it and lead to a high resistance.

**Measure** → Acknowledge by pressing the Online button.  
→ Try again. If the error message continues to appear, please contact the manufacturer.

**5020 I2C Timeout xx**

**Status** Timeout error during communication via the I<sup>2</sup>C bus with the device xx (see Tab. 4 on page 37).

**Measure** → Switch printer off and then back on again after 30 sec. If the error message continues to appear, please contact the manufacturer.

**5021 I2C Conf. xx**

**Status** Confirmation error during communication via the I<sup>2</sup>C bus with the device xx (see Tab. 4 on page 37).

**Measure** → Switch printer off and then back on again after 30 sec. If the error message continues to appear, please contact the manufacturer.

**5022 I2C Busy xx**

**Status** Error during communication via the I<sup>2</sup>C bus with the device xx (see Tab. 4 on page 37). Device always reports that it is busy.

**Measure** → Switch printer off and then back on again after 30 sec. If the error message continues to appear, please contact the manufacturer.

**5023 I2C LAB xx**

**Status** Error during communication via the I<sup>2</sup>C bus with the device xx (see Tab. 4 on page 37).

**Measure** → Switch printer off and then back on again after 30 sec. If the error message continues to appear, please contact the manufacturer.

**5024 I2C BER xx**

**Status** Error during communication via the I<sup>2</sup>C bus with the device xx (see Tab. 4 on page 37).

**Measure** → Switch printer off and then back on again after 30 sec. If the error message continues to appear, please contact the manufacturer.

**5025 I2C Polling xx**

**Status** Polling error during communication via the I<sup>2</sup>C bus with the device xx (see Tab. 4 on page 37).

**Measure** → Switch printer off and then back on again after 30 sec. If the error message continues to appear, please contact the manufacturer.

### **5026 Motorprotect CPU**

**Status** (AP x.x only) The motor driver board (output stage board) is overheated or defective.

**Measure** → Switch printer off and then back on again after 30 sec.  
If the error message continues to appear:  
→ Replace the motordriver board.

### **5028 PS overheat**

(AP x.x only)

**Status** The temperature inside of the power supply exceeded the admissible range.

**Measure** → Let the power supply cool down for some minutes.

### **5029 I2C checksum xx**

**Status** During I<sup>2</sup>C communication with device xx occurred a checksum error.  
xx = I<sup>2</sup>C device number (see Tab. 4 on page 37).

**Measure** → Switch printer off and then back on again after 30 sec. If the error message continues to appear, please contact the manufacturer.

## **5051-5058 Messages which can only occur with a TT4 printer**

### **5051 Barcode Infeed 1**

- Status** (TT4 only) Error while reading the bar code on the material in infeed 1
- Measure**
- Check, whether material in infeed 1 is inserted correctly. The bar code must be in front (in advance direction) on the material bottom. Insert material correctly, if necessary.
  - Check, whether the bar code print is erroneous on material in infeed 1. Exchange material, if necessary.

### **5052 Barcode Infeed 2**

- Status** (TT4 only) Error while reading the bar code on the material in infeed 2
- Measure**
- Check, whether material in infeed 2 is inserted correctly. The bar code must be in front (in advance direction) on the material bottom. Insert material correctly, if necessary.
  - Check, whether the bar code print is erroneous on material in infeed 2. Exchange material, if necessary.

### **5053 Barcode Infeed 3**

- Status** (TT4 only) Error while reading the bar code on the material in infeed 3
- Measure**
- Check, whether material in infeed 3 is inserted correctly. The bar code must be in front (in advance direction) on the material bottom. Insert material correctly, if necessary.
  - Check, whether the bar code print is erroneous on material in infeed 3. Exchange material, if necessary.

### **5054 Barcode Infeed 4**

- Status** (TT4 only) Error while reading the bar code on the material in infeed 4
- Measure**
- Check, whether material in infeed 4 is inserted correctly. The bar code must be in front (in advance direction) on the material bottom. Insert material correctly, if necessary.
  - Check, whether the bar code print is erroneous on material in infeed 4. Exchange material, if necessary.

### **5055 Infeed 1 empty**

- Status** (TT4 only) While initializing, TT4 reports no material in infeed 1.
- ▶ Precondition for this status message is, that parameter `SYSTEM PARAMETERS > w/wo magazine` is set to „with“.
- Measure**
- Check, if the material in infeed 1 is loaded correctly, respectively if it's loaded at all. Acknowledge by pressing the Online button.

### **5056 Infeed 2 empty**

- Status** (TT4 only) While initializing, TT4 reports no material in infeed 1.

- ▶▶▶▶ Precondition for this status message is, that parameter SYSTEM PARAMETERS > w/wo magazine is set to „with“.

**Measure** → Check, if the material in infeed 1 is loaded correctly, respectively if it's loaded at all. Acknowledge by pressing the Online button.

### **5057 Infeed 3 empty**

**Status** (TT4 only) While initializing, TT4 reports no material in infeed 1.

- ▶▶▶▶ Precondition for this status message is, that parameter SYSTEM PARAMETERS > w/wo magazine is set to „with“.

**Measure** → Check, if the material in infeed 1 is loaded correctly, respectively if it's loaded at all. Acknowledge by pressing the Online button.

### **5058 Infeed 4 empty**

**Status** (TT4 only) While initializing, TT4 reports no material in infeed 1.

- ▶▶▶▶ Precondition for this status message is, that parameter SYSTEM PARAMETERS > w/wo magazine is set to „with“.

**Measure** → Check, if the material in infeed 1 is loaded correctly, respectively if it's loaded at all. Acknowledge by pressing the Online button.

### **5059 Stacker full**

**Status** (AP 7.t only) This message can only appear if a TCS is applied as peripheral device. It indicates, that the stacker is full or the protection cover is opened.

**Measure** → Empty stacker  
 → Close cover  
 → If the message appears in spite of a closed cover and an emptied stacker, check the function of lid switch and microswitch.

### **5060 Stacker full**

**Status** This message can only appear if a TCS is applied as peripheral device. It indicates, that the stacker is full or the protection cover is opened.

**Measure** → Empty stacker  
 → Close cover  
 → If the message appears in spite of a closed cover and an emptied stacker, check the function of lid switch and microswitch.

**5061 Dispenser motor**

- Status** The output stage board for the dispenser motor is not present or defective.
- Measure** → Press the Online button to acknowledge.
- Check the output stage board for the dispenser motor and eventually exchange it.

**5062 Disp. lift motor**

- Status** The output stage board for the dispenser lift motor is not present or defective.
- Measure** → Press the Online button to acknowledge.
- Check the output stage board for the dispenser lift motor and eventually exchange it.

**5063 Press roll**

64-xx dispenser / DPM / PEM / ALX 92x

- Status** The press roll lever is not closed. Opening the lever causes the immediate deletion of all potentially queued status messages (e. g. ribbon end) and display of the “Press roll” message. Closing the lever automatically acknowledges the status message..
- Measure** → Close the press roll lever.

**5063 Lever open**

AP 5.4/5.6

- Status** The printhead lever is not closed. Opening the lever causes the immediate deletion of all potentially queued status messages (e. g. ribbon end) and display of the “Lever open” message. Closing the lever automatically acknowledges the status message.
- Measure** → Close the printhead lever.

**5064 Backing paper**

- Status** Happens with dispenser version printers: Shows up, when the diameter of the rewinded backing paper roll has become too large.
- Measure** → Clear the rewinding mandrel.
- Press the Online button to acknowledge.

**5071 Material end unw**

- Status** Occurs during operation with activated *internal* OD control. The message appears, if the material roll diameter has reached the critical value (setable by MACHINE SETUP >Materialend err).
- Measure** → Replenish the material roll.

**5072 Material end unw**

**Status** Occurs during operation with activated *internal* OD control. The message appears, if no rotation of the material roll has been registered during at least 600 mm of material feeding.

**Measure** → Check the material feeding; if necessary, replenish the material roll.

**5100 No H8 response**

**Status** Communication fault with H8 processor (occurs only at devices with Gen. 2 electronics).

**Measure** → Acknowledge by pressing the Online button.

→ Switch device off and on again.

If the message continues to appear:

→ Contact service technician.

Instructions for service technicians:

The error can occur in connection with the exchange of the CPU board of an ALX 92x machine.

→ Acknowledge error, set all sensors, restart.

→ If the error message still appears: Reload firmware and/or carry out a forced bootloader start with "Clear params".

→ If the error continues to appear: send CPU board with a fault description to the manufacturer.

**5100 Printengine lock**

**Status** Printengine error (occurs only at devices with Gen. 3 electronics).

**Measure** → Acknowledge by pressing the Online button.

→ Switch device off and on again.

If the message continues to appear:

→ Contact service technician.

**5101 Headadjust error**

**Status** Error during the running of the "Head Alignment" service function.

**Measure** → Acknowledge by pressing the Online button.

→ Contact service technician.

**5102 Dot Defective**

**Status** Defective dot detected during the running of the "Head dot test" service function.

**Measure** → Acknowledge by pressing the Online button.

**5110 Foil low**

**Status** The diameter of the foil roll fell below the set warning diameter (see SYSTEM PARAMETER > Foil warning).

The message is caused by a foil warning in addition with the following setting: SYSTEM PARAMETER > Foil warn stop = „Enabled“.

**Measure** → Acknowledge by pressing the Online button, then press the Feed button to continue printing.

**5120 Home position**

**Status** The applied applicator cannot reach the home position; this can be caused by an impact from outside (e.g. extending it manually), which has moved the applicator. In those cases, the stepper motor loses steps and doesn't regain its home position.

Preconditions for this error to occur:

- The parameter DP INTERFACE > Interface type is set to *USI Applicator*.
- Internal inputs are enabled.

**Measure** → Take care not to move the applicator by force.  
→ Acknowledge by pressing the Online button.

**5121 Touch down**

**Status** The applied applicator doesn't reach the Touch Down Position, what means that it extends completely without reaching any product or other resistance. .

Preconditions for this error to occur:

- The parameter DP INTERFACE > Interface type is set to *USI Applicator*.
- Internal inputs are enabled.

**Measure** → Correct the applicator position. The applicator must reach the product before it is completely extended.  
→ Acknowledge by pressing the Online button.

**5122 PLC not ready**

Situation:

- The parameter DP INTERFACE > Interface type is set to *USI Applicator*.
- Internal inputs are enabled.

**Status** The connected PLC is not on line.

**Measure** → Check if the PLC is powered on.  
→ Check if the PLC shows any error status.  
→ Acknowledge by pressing the Online button.

**5123 USI Material low**

The error can only occur with an ALX 92x with optional OD control sensor.

**Status** The outer diameter of the material roll has reached the set minimum value.

**Measure** → Insert a new material roll.  
→ Acknowledge by pressing the Online button.



**5125 Vn for USI req.****Status**

This message shows up, if the firmware of the USI doesn't match the printer firmware.

n = Required USI firmware version

- USI firmware version is higher than the required version:

Message is automatically quit after approx. 2 s. This combination should work without problems.

**Measure**

- USI firmware version is older than the required version:  
→ Update the USI firmware.
- See service manual, topic section [Firmware Gen. 3](#) 

**5130 PSU xxxxxxxx**

**Status**

Failure of the power supply. "xxxxxxx" = four byte long error code in hexadecimal form. Every bit stands for a certain status of the power supply. The bit is set to "1", if the status occurred.

- Byte 1: xxxxxxXX

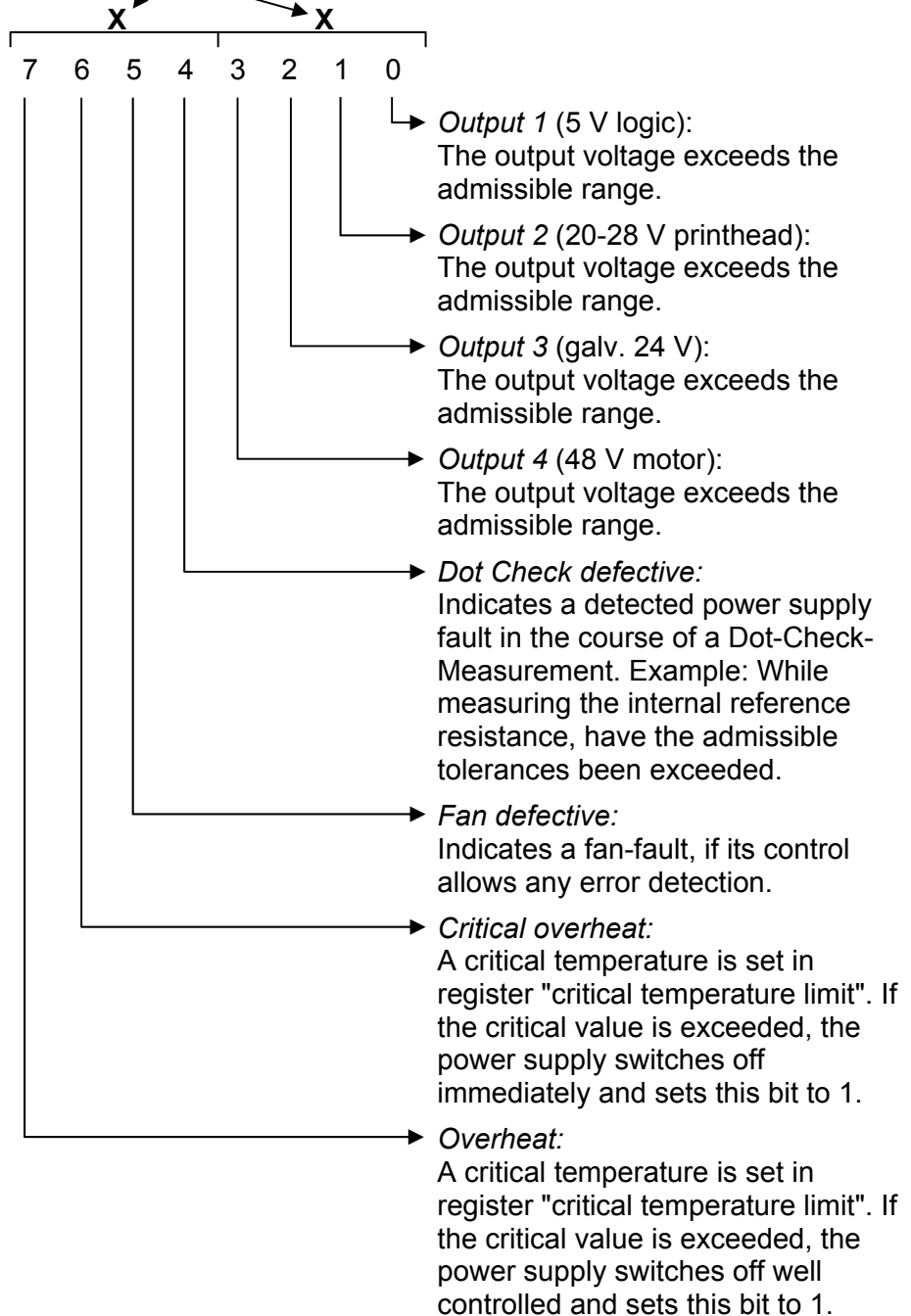

- Byte 2: xxxx**XX**xx

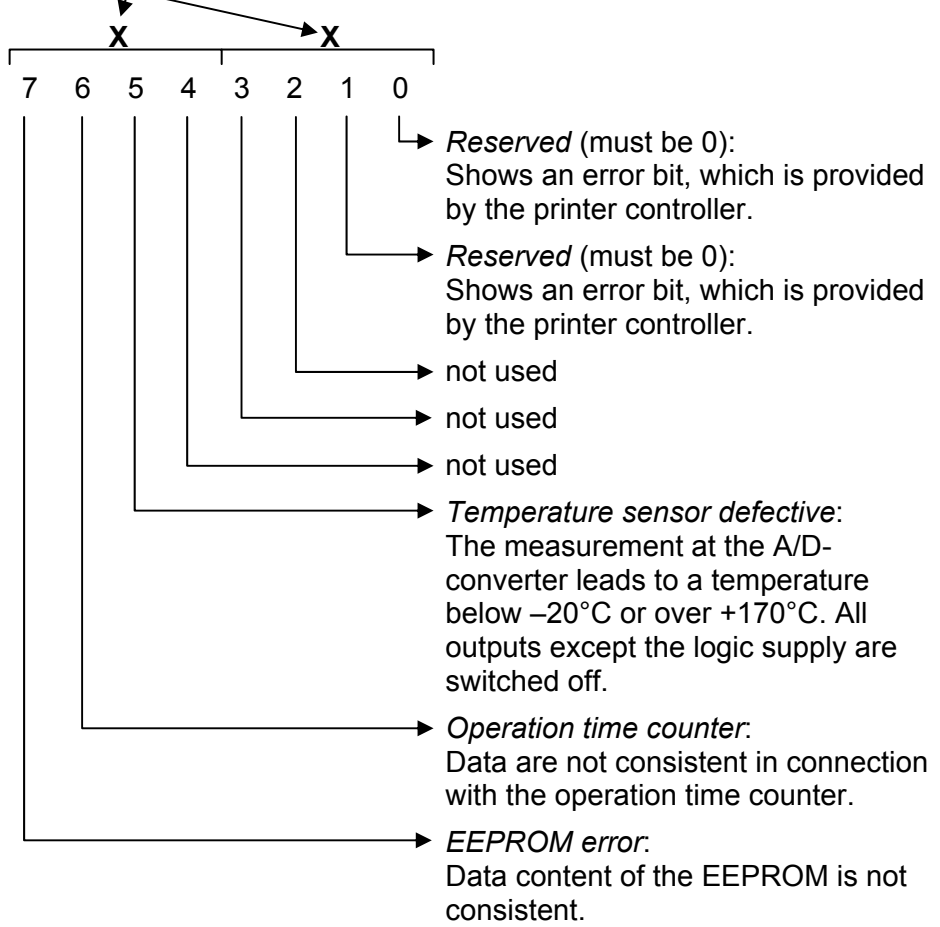

- Byte 3: xx**XX**xxxx

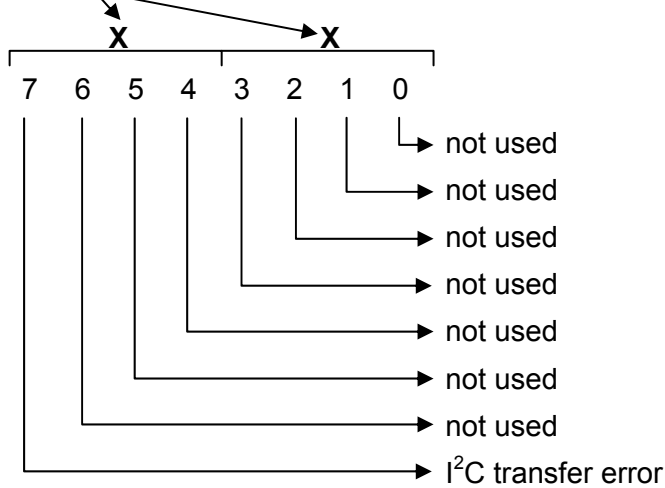

- Byte 4: **XX**xxxxxx (is not being used yet)



Example: 0000F020

Bit no.	7	6	5	4	3	2	1	0	Meaning
Byte 1 (here: 20)	0	0	1	0	0	0	0	0	Fan defective
Byte 2 (here: F0)	1	1	1	1	0	0	0	0	Temperature sensor defective, operation time counter is not consistent, EEPROM error
Byte 3	0	0	0	0	0	0	0	0	
Byte 4	0	0	0	0	0	0	0	0	

### **5131 PSU communicat.**

Power supply communication  
(64-xx / DPM / PEM / ALX 92x / PM 3000 only)

**Status** A fault occurred during communication with the power supply via I<sup>2</sup>C bus.

**Measure** → Switch the printer off and after 30 seconds on again. If the message continues to appear, contact the manufacturer.

### **5140 Rewinder control**

(ALX 92x with M5A motor output stages only)

 During problem-free operation, the rewind unit dancer arm only moves a minimal distance around the "control position". This is the position the dancer arm takes up after initialisation of the machine.

**Status** *Cause:* Any force applied that moves the dancer arm from its control position.

Example: The feed motor is blocked; the backing paper is not conveyed quickly enough; as a result the dancer arm is pulled upwards.

Example: The backing paper is torn; the dancer arm springs downwards.

**Measure** → Press the Enter-key.  
This reinitialises the dancer arm control; the dancer arm moves back into the control position.

### **5144 Rewinder Init**

(ALX 92x with M5A motor output stages only)

**Status** The message has a couple of possible causes:

- No label material inserted.
  - Rewinder sensors are not or not properly connected.
  - Sensor board position is faulty.
  - Sensor defective.
- Insert material.  
→ Check the connection. Connect the sensors properly.  
→ Correct the position of the sensor board.  
→ Exchange the sensor board.

**5145 Rewinder full**

(ALX 92x with M5A motor output stages only)

**Status** The maximum permitted diameter (205mm) for the rewinder roll has been reached.



This error can only occur if the end of a new label roll was glued on to backing paper that had already been wound onto the rewinder.

**Measure** → Remove the rewound backing paper.  
→ Press the Enter-key to confirm the error message.

**5150 No USI interface**

**Status** (DPM / PEM / ALX 92x only)  
This error appears, if no USI is detected while the printer is powering up.

**Measure** → Check, if the USI is defective or not built in.

**5151 Applic. interf.**

Applicator interface

**Status** (DPM / PEM / ALX 92x only)  
Neither Applicator Interface (AI), nor USI are connected to the device.

**Measure** → Connect a USI or AI to the device.

**5152 Winding direct.**

(ALX 92x with M5A motor output stages only)

**Status** The backing paper end is not correctly attached to the rewinder mandrel.  
Wrong machine type selected (SPECIAL FUNCTION > Printer type).

- Attach the backing paper web to the rewinding mandrel as described in the user manual.  
→ Setting „RH“ at a LH machine or vice versa.

**5200 Home position**

**Status** The applicator did not reach its home position within the given time frame.  
Possible causes:

- The applicator is jammed
- Applicators driven by compressed air: The air supply may be interrupted or switched off
- Cable not connected properly

**Measure** → Check cable and compressed air connections; reconnect them properly, if necessary.  
→ May the applicator move unhindered? – remove any obstacles.

**5201 Touch down**

**Status** The applicator did not reach its touch down position within the given time frame.

**Measure** → Check cable and compressed air connections; reconnect them properly, if necessary.  
→ May the applicator move unhindered? – remove any obstacles.

**5203 Touch down sens.**

**Status** The touchdown sensor(s) was/were already triggered before the application.

**Measure** → Check cable and compressed air connections; reconnect them properly, if necessary.

**5204 Appl. Startererror**

**Status** The device received another start signal during printing/applying a label.

Precondition: Parameter `APPLICATOR PARA > Start error stop` or `DP INTERFACE > Start error stop` is set to *On*.

**Measure** → Check the labelling procedure; increase the product distance.  
→ Set parameter *Start error stop* to *Off*.

**5205 Applicator gen.**

**Status** General software error

**Measure** ○ Please read the notes in section [General software errors](#) □.

**5206 Applicator resp.**

**Status** Communication with the AI exceeded a given time frame.

**Measure** → Switch the printer off and on again after half a minute. If the error still occurs after several tries, please contact our technical support.

**5207 Appl. driver 1**

**Status** Shortcut or overheat at power output 1 at the applicator connector (CN603) on the AI board. The power output 1 comprises the following output signals:

- Cylinder
- Vacuum
- Airstream Support
- Blow On

**Measure** → Check the connections.

**5208 Appl. driver 2**

**Status** Shortcut or overheat at power output 2 at the applicator connector (CN603) on the AI board. The power output 2 comprises the following output signals:

- BTS
- Reserved 1
- Reserved 2
- Reserved 3

**Measure** → Check the connections.

**5209 Appl. driver 3**

**Status** Shortcut or overheat at power output 3 at the machine status connector (CN602) on the AI board. The power output 3 comprises the following output signals:

- Error
- Warning
- Ready

**Measure** → Check the connections.

**5210 Appl. driver 4**

**Status** Shortcut or overheat at power output 4 at the machine status connector (CN602) on the AI board. The power output 4 comprises the following output signals:

- Cycle
- OD-Foil
- OD-Sensor
- Offline

**Measure** → Check the connections.

**5212 Vx.x for AI rec**

**Status** The required AI firmware (version x.x) is not installed.

**Measure** If the installed AI firmware is older than the required version:

→ Acknowledge message. Load AI firmware version x.x.

If the installed AI firmware is newer than the required version:

The message is acknowledged automatically.

**5300 BLDC EEPROM err.**

**Status** General EEPROM read/write error on the BLDC driver board (AP 5.4 with internal rewinder).

**Measure** → Switch printer off and then on again after 30 seconds. If the status message continues to appear, change the BLDC board.

**5301 BLDC rewinder Ø**

**Status** The stored rewinder diameter exceeds the admissible range (AP 5.4 with internal rewinder).

- Measure**
- Acknowledge the status message by pressing the online button.
  - Switch to offline mode and feed the label web for approx. 200 mm. This re-initializes the rewinder diameter.
  - ▮▮▮▮→ If the printer is switched off and on again *without prior initialization*, the status message will be displayed again.

**5500 Unknown**

**Status** General software error

- Measure** ○ Please read the notes in section [General software errors](#) .

**5501 General**

**Status** General software error

- Measure** ○ Please read the notes in section [General software errors](#) .

**5502-5551 Messages, which can only occur with RFID option****5502 RFID internal**

**Status** General software error

- Measure** ○ Please read the notes in section [General software errors](#) .

**5504 No RFID job**

**Status** A print job, which is not declared as RFID printjob, contains RFID-specific Easy-Plug commands (e. g. #RT, #RFW, ...).

RFID printjobs are declared in the #IM command by defining the distance between label edge and optimum of transponder antenna (parameter "d").

- Measure** → Modify the print job.

**5510 RFID COM timeout**

**Status** Timeout error. There was no communication between reader module and COM2 in the time slot where it should be performed.

- Measure**
- Repeat the operation, in the course of which the error occurred.
  - Check, if the reader module board is connected correctly.
  - Check if the reader module board is defective.

**5512 COM open failed**

**Status** There was a communication problem at COM2 while powering up the printer. The interface cannot be opened by the printer firmware – or it is used by another firmware part.

- Measure**
- Check, if COM2 is available (that is, if it is built-in).
  - Check the function of the COM2 interface.



**5513 Get baud failed**

**Status** There was a communication problem between COM2 and reader module while powering up the printer. The baud rate of the reader module is not detected correctly by the printer firmware. Baud rate and/or parity and/or another setting of transmission parameters at the reader module is faulty.

**Measure**

- Check, if the reader module board is connected correctly.
- Check if the reader module board is defective.
- Check the setting of the transmission parameters at the reader module.

**5521 No transponder**

**Status** Either there is no transponder (=tag) or more than one transponder within reach of the antenna.

**Measure** → Check the label material feeding; remove paper jam, if necessary.

**5522 Tag write err**

**Status** A transponder (=tag) cannot be written on for one of the following reasons:

- Faulty address: e.g. an attempt to write into a protected area.
- The tag is out of reach of the antenna, after it has already been recognized.
- Noise signals avoid the transmission.

**Measure** → Check the system for the mentioned error causes and correct them.

**5523 Tag address err**

**Status** Faulty address: The address data targets beyond the logical or physical address range of the transponder.

**Measure** → Change the address.

**5524 CMD not applicable**

**Status** A command cannot be interpreted by the transponder.

**Measure** → Change or remove the command.

**5525 Tag read err**

**Status** The plausibility test of the read data failed. Possible reasons are:

- The tag is out of reach of the antenna, after it has already been recognized.
- Noise signals avoid the transmission.

**Measure** → Check the system for the mentioned error causes and correct them.

**5526 Tag select first**

**Status** A read or write command was given without selecting the transponder at first.

**Measure** → Add a select command before using the read/write command.

**5527 Tag RF comm err**

**Status** Transponder and reader are unable to communicate. Possible reasons are:

- More than one transponder is within reach of the antenna.
- No transponder is within reach of the antenna.

**Measure** → Check the label material feeding; eventually remove paper jam.

**5528 EEPROM failure**

**Status**

- The reader cannot write on the transponder EEPROM.
- A faulty checksum was detected before writing on the EEPROM.

**Measure** → Repeat the writing attempt.

→ Try another transponder

**5529 Parameter range**

**Status** Faulty address. Transponders of the same type may have memory ranges of different sizes; according to this, the admissible addresses differ too.

The fault occurs, if a block address targets beyond the address range of the transponder.

**Measure** → Change the address.

→ Use a transponder with a wider address range.

**5530 Unknown CMD**

**Status** The reader doesn't support the used command.

**Measure** → Change or replace the command.

**5531 Protocol length**

**Status** General software error

**Measure** ○ Please read the notes in section [General software errors](#) .

**5532 CMD not avail.**

**Status** The sent command cannot be executed at the moment.

**Measure** → Check, if all system components match the specifications.

**5540 ISO error #1**

**Status** Faulty system configuration. Possible reasons may be:

- Faulty firmware version of the reader
- The applied transponders doesn't match the reader.

**Measure** → Check if the reader has the correct firmware version installed.

→ Compare the applied transponder type with the specification of the reader. If necessary, use another transponder type.

**5541 ISO error #2**

○ See [ISO error #1](#) .

**5542 ISO error #3**

○ See [ISO error #1](#).

**5543 ISO error #15**

○ See [ISO error #1](#).

**5544 ISO error #16**

○ See [ISO error #1](#).

**5545 ISO error #17**

○ See [ISO error #1](#).

**5546 ISO error #18**

○ See [ISO error #1](#).

**5547 ISO error #19**

○ See [ISO error #1](#).

**5548 ISO error #20**

○ See [ISO error #1](#).

**5549 ISO error ???**

○ See [ISO error #1](#).

**5550 Wrong tag type**

**Status** A transponder type was detected, which is not known by the reader – it cannot be used.

**Measure** → Use another transponder type, which is known to the reader.

**5551 Max Tags failed**

**Status** The maximum permissible number of invalid labels was reached. This value is to be set via parameter `RFID PARAMETERS > Max Tags To Stop`.

||||➡ Invalid labels are being printed on with diagonal stripes.

**Measure** → Find out, why the labels are invalid; put things right.

→ Increase the maximum value.

**5560 TCS full / cover**

**Status** This message can only appear, if a TCS is applied as peripheral device. The message shows up, if:

- the stacker is full
- the stacker cover is open

**Measure** → Empty the stacker, or

→ close the cover

**5590 Odd hex string**

**Status** A character string was sent to the transponder (Easy Plug command #RFS) and was ought to be interpreted hexadecimal (use #RFS with parameter "B"). For this, the character string must consist of an equal number of characters. This was not the case, what triggered this error message.

**Measure** → Send an equal number of characters.

**5600 Job without #Q**

**Status** The print job misses the declaration of the print amount (Easy-Plug command #Q).

**Measure** → Insert a #Q command with the print amount.

**5601 Job memory full**

**Status** The job memory for Easy-Plug printjobs is full.

**Measure** → Reduce the reserved memory for one or more of the following memory areas:

- Free store size (SYSTEM PARAMETER > Free store size)
- RAM disk size (SYSTEM PARAMETER > Ram disk size)
- Font download size (SYSTEM PARAMETER > Font downl. area)

→ If there are already some printjobs in the printer queue: wait until those are processed.

**6000 Param. incorrect**

**Status** Novram check sum error.

||||▶ Check the setting of the printhead resistance (parameter SYSTEM PARAMETER > Head resistance) , before you press the Online button – possibly the value is faulty.

**Measure** → Confirm error by pressing the Online button. All parameters are set back to the factory settings.

**6001 Nov. prog. err.**

**Status** Error during allocation of main memory.

**Measure** → Switch printer off and then back on again after 30 sec. If the error message continues to appear, please contact the manufacturer.

**6002 New prog. vers.**

**Status** Occurs after firmware update. The printer hereby reports that new firmware is available.

**Measure** → Confirm by pressing the Online button. All parameters are set back to the factory settings.

**6003 Memory error**

**Status** Error during partitioning of the main memory.

**Measure** → Switch printer off and back on again after 30 sec. If the error message continues to appear, please contact the manufacturer.

**6004 Load H8 program**

**Status** Appears, when  
 a) no valid H8 firmware is loaded  
 b) after a forced start of the boot loader

**Measure** Case a)  
 1. Press the Online button to confirm.  
 2. Load H8 firmware.  
 ○ For details, refer to the service manual, topic section "Firmware", section "Loading the H8 system".  
 Case b)  
 → Press the Online button to confirm.  
 ○ For details, refer to the service manual, topic section "Firmware", section "Loading the Firmware (using boot loader)".

**6005 Fixfont data**

**Status** Defective fixfonts.

**Measure** → Load the firmware new.  
 ○ Refer to the service manual, topic section "Firmware".

**6006 Speedofont data**

**Status** Defective speedo fonts.

**Measure** → Load the firmware new.  
 ○ Refer to the service manual, topic section "Firmware".

**6007 Print ctrl. stop**

**Status** The print control doesn't start, what means that the printer doesn't finish the initialization phase after switching it on.

**Measure** → Read in the service manual, what to do:  
 ○ Refer to the service manual, topic section "Firmware" or "Firmware Gen. 3", chapter "Error messages".

**6008 ZPL Fixfont data**

**Status** Defective fixfonts.

**Measure** → Load the firmware new.  
 ○ Refer to the service manual, topic section "Firmware".

**6009 ZPL Speedo data**

**Status** Defective speedo fonts.

**Measure** → Load the firmware new.

○ Refer to the service manual, topic section "Firmware".

**6010 Printengine soft**

**Status** General software error.

**Measure** → Switch printer off and then back on again after thirty seconds.

○ Please read the notes in section [General software errors](#) .

**6012 Start next job**

**Status** The message appears at the end of a printjob, if the single job mode (SYSTEM PARAMETERS > Single job mode) is activated. It indicates, that the next printjob should be started.

**Measure** → Acknowledge by pressing the online button. Start next printjob.

**6030 Param. checksum**

**Status** Wrong parameter checksum.

**Measure** → None. The message is merely informativ.

**6031 New Parameters**

**Status** By loading a new firmware version, some new parameters have been added to the parameter menu.

**Measure** → None. The message is merely informativ.

**6101 No sensor found**

**Status** Error during the running of the "Sensor Test" service function.

**Measure** → Acknowledge by pressing the online button.

→ Contact service technician.

**6200 Filesystem regis**

**Status** General software error.

**Measure** → Switch printer off and then back on again after thirty seconds.

○ Please read the notes in section [General software errors](#) .

**6201 File sys. format**

**Status** Error during formatting of the RAM disk or the memory card.

**Measure** → Switch printer off and then back on again after thirty seconds. If the error message continues to appear, please contact the manufacturer.

**6202 Drive open**

**Status** Accessing the memory card failed.

- Measure** → Format the memory card using the PC card drive. Try again to write onto the card.
- Try another memory card.

### **6203 Filesystem close**

**Status** Accessing the memory card failed.

- Measure** → Format the memory card using the PC card drive. Try again to write onto the card.
- Try another memory card.

### **6204 Disk directory**

**Status** Work directory cannot be opened.

- Measure** → Acknowledge by pressing the Online button.
- Check designation existence of the work directory.

### **6205 Write disk**

**Status** Error during writing on RAM disk or memory card.

- Measure** → Acknowledge by pressing the Online button.

### **6206 Read disk**

**Status** Error during reading from RAM disk or memory card.

- Measure** → Acknowledge by pressing the Online button.

### **6207 No file card**

**Status** No CompactFlash-card found.

- Measure** → Acknowledge by pressing the Online button.
- Check, if a memory card is inserted.
- If the memory card was inserted after switching on the printer: switch the printer off and on again.

### **6208 Drive xx full**

**Status** Writing on drive xx failed, because there is not enough free space.

- Measure** → Acknowledge by pressing the Online button.
- Free space on the drive.

**6300 Out of memory**

**Status** Not enough free memory available, to load additional print jobs. The job buffer is completely filled with print jobs.

**Measure** → Delete spooler using the parameter `SPECIAL FUNCTION > Delete spooler`.

**6301 Incomplete job**

**Status** The Easy Plug interpreter failed interpreting a certain print job to the end. The print job has possibly not been terminated by a #Q-command.

**Measure** → Check, if the print job is properly terminated with #Q.

**6310 Centr. Timeout**

**Status** The Easy Plug command #!Xn triggers a status acknowledgement via centronics Interface. But the PC doesn't pick up the supplied data.

**Measure** → Check the data line connecting printer and PC.

**6311 Centr. Timeout**

**Status** The Easy Plug command #!Xn triggers a status acknowledgement via centronics Interface. But the PC doesn't pick up the supplied data.

**Measure** → Check the data line connecting printer and PC.

**8001 Shared Memory**

**Status** General software error.

**Measure** → Switch printer off and then back on again after thirty seconds.  
○ Please read the notes in section [General software errors](#) .

**8002 Stream Buffer**

**Status** General software error.

**Measure** → Switch printer off and then back on again after thirty seconds.  
○ Please read the notes in section [General software errors](#) .

**8103 TrueDoc Font**

**Status** Error: font with the number given is not contained in the system.

**Measure** → Check font no., if necessary select another font.

**8104 Speedo alloc**

**Status** Fault while initializing the speedo fonts.

**Measure** → Load firmware new.  
○ Refer to the service manual, topic section "Firmware".

**8105 Load TrueType**

**Status** Damaged font file.

**Measure** → Switch printer off and then back on again after thirty seconds.  
→ Reload font file, if necessary select another font.



**8106 Fonttype wrong**

**Status** General software error.

**Measure** → Switch printer off and then back on again after thirty seconds.  
○ Please read the notes in section [General software errors](#) .

**8107 Character set**

**Status** General software error.

**Measure** → Switch printer off and then back on again after thirty seconds.  
○ Please read the notes in section [General software errors](#) .

**8108 Symbol set**

**Status** General software error.

**Measure** → Switch printer off and then back on again after thirty seconds.  
○ Please read the notes in section [General software errors](#) .

**8109 TT-specifications**

**Status** General software error.

**Measure** → Switch printer off and then back on again after thirty seconds.  
○ Please read the notes in section [General software errors](#) .

**8110 Unknown char.**

**Status** Character is not included in the character set (character set does not support all characters).

**Measure** → Select another character / character set.

**8111 Stream type**

**Status** General software error.

**Measure** → Switch printer off and then back on again after thirty seconds.  
○ Please read the notes in section [General software errors](#) .

**8112 Font not supp.**

**Status** The applied TrueType font is not supported by the system. Text, which uses this font, is ignored.

**Measure** → Use another TrueType font.

**8200 Fixfont number**

**Status** Incorrect fix font no.

**Measure** → Check fix font no., alter if necessary.

**8201 Font downl. full**

**Status** The font download buffer is full.

- Measure**
- Allocate more memory for the download buffer using the parameter SYSTEM PARAMETERS > Font downl. area.
  - Rename some speedo-fonts on the CompactFlash-Card, you actually don't use. All speedo-fonts named fontxxx.spd (xxx = font no.) are being loaded into the font download buffer while system startup.
  - For Details refer to the manual „Cards“, subject section „Using cards“, paragraph „memory card“.

**8202 Font deleted**

**Status** Attempt to access a font, which is no longer available on memory card or on RAM disk (font was deleted or renamed).

- Measure**
- Check the label layout. Load the not available font or use another, available, font.

**8300 Bar code corr.**

**Status** Error: a bar code correction factor greater than +/- 25% has been selected.

- Measure**
- Reduce correction factor.

**8301 Bar code data**

**Status** Incorrect bar code data. The bar code data is not permitted for the selected bar code type.

- Measure**
- Use data permitted for the bar code type.

**8302 Barcode checksum**

**Status** Error during calculation of the bar code check sum.

- Measure**
- Check transmitted data.
  - If the error continues to occur please contact the manufacturer. Send the transmitted Easy Plug data.

**8303 Bar code sample**

**Status** Error during calculation of the bar code sample.

- Measure**
- Check whether the transmitted data is permitted for the bar code type; if necessary alter the data.

**8304 Bar c. plain-copy**

**Status** Error during integration of the plain-copy line in the bar code sample.

- Measure**
- Check whether the transmitted data is permitted for the bar code type; if necessary alter the data.

**8305 Bar code print**

- Status** Error during calculation of the bar code print image.
- Measure** → Acknowledge by pressing the Online button.
- Measure** → Check whether the transmitted data is permitted for the bar code type; if necessary alter the data.

**8306 Plain-copy len.**

- Status** Illegal: bar code plain-copy line has more than 300 characters.
- Measure** → Reduce line length.

**8307 Readline dist.**

- Status** General software error.
- Measure** → Switch printer off and then back on again after thirty seconds.  
○ Please read the notes in section [General software errors](#) .

**8308 Bar code ratio**

- Status** Illegal bar code ratio.
- Measure** → Select another ratio.

**8309 Module range**

- Status** Maximum range of the bar code module exceeded.
- Measure** → Reduce module range.

**8310 Bar code element**

- Status** Bar code element exceeds the maximum permitted size of 253 dots (21 mm).
- Measure** → Reduce size of the bar code element.

**8311 Barcode table**

- Status** General software error.
- Measure** → Switch printer off and then back on again after thirty seconds.  
○ Please read the notes in section [General software errors](#) .

**8400 PDF417 ECC**

- Status** Bar code PDF417: incorrect ECC level (Error Correction Level).
- Measure** → Alter ECC level.

**8401 PDF417 Lines**

- Status** Bar code PDF417: illegal number of lines.
- Measure** → Alter number of lines.

**8402 PDF417 Columns**

**Status** Bar code PDF417: illegal number of columns.

**Measure** → Alter number of columns.

**8403 PDF417 Style**

**Status** Bar code PDF417: incorrect style.

**Measure** → Alter style.

**8404 PDF417 Command**

**Status** Bar code PDF417: incorrect command.

**Measure** → Acknowledge by pressing the on-line button.

→ Check and alter commands.

**8405 PDF417 Size**

**Status** Bar code PDF417: incorrect size.

**Measure** → Alter size.

**8406 PDF417 Details**

**Status** Bar code PDF417: incorrect details.

**Measure** → Alter details.

**8407 PDF417 Coding**

**Status** Bar code PDF417: coding error.

**Measure** → Switch printer off and then back on again after thirty seconds.

→ Acknowledge by pressing the Online button.

**8500 Code 25Int len.**

**Status** Bar code Code 25 Interleaved: input line too long.

**Measure** → Shorten input line.

**8501 Postcode length**

**Status** Bar code postcode: illegal data length.

**Measure** → Check length of the transmitted data and set it to the permitted length.

**8600 EAN Length**

**Status** Bar code EAN: illegal data length.

**Measure** → Check length of the transmitted data and set it to the permitted length.

**8601 UPCE Numbers sys.**

**Status** Error: First data character of the transmitted data is not 0 or 1.

**Measure** → Alter first data character to 0 or 1.

**8705 IDM rows/columns**

**Status** The input data does not match the given matrix or the number of rows/columns is invalid.

**Measure** → Change the number of rows/columns or the input data.

**8760 EAN128 field len**

**Status** The number of data after a data identifier does not correspond to the definition for this data identifier.

**Measure** → Change the number of data.

**8761 EAN128 Data type**

**Status** The data type (alphanumeric, numeric) after a data identifier does not correspond to the definition for this data identifier.

**Measure** → Change the data type.

**8762 EAN128 Ident.**

**Status** Invalid data identifier.

**Measure** → Change the data identifier.

**8800 Maxicode Mode**

**Status** Maxicode: faulty mode

**Measure** → Change mode.

**8801 Maxicode Sys no**

**Status** Maxicode: incorrect system no.

**Measure** → Correct system no.

**8802 Maxicode Zipcode**

**Status** Maxicode: incorrect zipcode.

**Measure** → Correct zipcode.

**8803 Maxicode Class**

**Status** Maxicode: faulty class code.

**Measure** → Correct class code.

**8804 Maxi. Sec. mess.**

**Status** Maxicode: secondary message has an illegal length.

**Measure** → Correct length of secondary message.

**8805 Maxicode Country**

**Status** Maxicode: faulty country code.

**Measure** → Correct country code.

**8830 Cod49 Datalength**

**Status** The user data string is too long. Not all characters can be coded in the bar code. The bar code is not printed.

**Measure** → Shorten the data string.

**8031 Cod49 wrong data**

**Status** The data string contains wrong characters. The bar code is not printed.

**Measure** → Correct the content of the data string.

**8850 Unknown filetype**

Graphic files with the extension declared in the Easy Plug command #YG are not supported.

**Measure** → Transform the graphics file into another file format or use another graphic in a supported format. Check, if the spelling of the file extension is correct.

**8851 Graphic open**

**Status** The graphics file declared in the Easy Plug #YG command cannot be found on the compactflash card. Possible reasons are:

- Path and/or designation of the graphics file stored on the compactflash card doesn't match the path and/or designation declared by the #YG command.
- The file is not available on the compactflash card.

**Measure** → Check if the spelling of the graphics file is the same both in the #YG command and on the compactflash card.

**8852 Graphic header**

**Status** A graphics file declared by a Easy Plug #YG command should be proceeded. The file header doesn't match the file.

**Measure** → The graphics file is possibly faulty. Check the file and replace it if necessary.

**8853 Graphic palette**

**Status** A graphics file declared by a Easy Plug #YG command should be proceeded. Error reading the graphics palette.

**Measure** → The graphics file is possibly faulty. Check the file and replace it if necessary.

**8854 Graphic read**

**Status** A graphics file declared by a Easy Plug #YG command should be proceeded. Error reading the file.

**Measure** → The graphics file is possibly faulty. Check the file and replace it if necessary.

**8856 Free store size**

- Status** By setting parameter `SYSTEM PARAMETER > Free store size`, a part of the memory is reserved, which the printer firmware can use if necessary (dynamic memory allocation). If this memory area is dimensioned too small, the printer firmware can not work and this error message shows up. One cause may for example be, that data are supposed to be loaded, whose size exceeds the reserved memory (e. g. graphics).
- Measure** → Enlarging the reserved memory partition, that is increasing the value of `SYSTEM PARAMETER > Free store size`.

**8857 Wrong mem config**

Wrong memory configuration

- Status** Too much memory requested by parameters. The following parameters request more or less memory:

- `SYSTEM PARAMETER > Font downl. area`
- `SYSTEM PARAMETER > Ram disk size`
- `SYSTEM PARAMETER > Free store size`

The fault occurs, if the sum of requested memory space exceeds the amount of available memory.

After error confirmation, the relevant parameters are set back to their default values. Furthermore, a restart is triggered.

- Measure** → Change the settings of the relevant parameters.

**8900 Codablock columns**

- Status** Bar code Codablock: illegal number of columns.

- Measure** → Correct number of columns.

**8901 Codablock rows**

- Status** Bar code Codablock: illegal number of rows.

- Measure** → Correct number of rows.

**8902 Codablock softw.**

- Status** Bar code Codablock: software error.

- Measure** →

**8903 Codablock infogr**

- Status** Bar code Codablock: info not in line.

- Measure** →

**8950 Logo open**

**Status** Failure when attempting to read a logo, which has previously been copied on RAM disk or on memory card (thus using Easy Plug command #DK).

**Measure** → Repeat loading the logo via #DK command.  
 → In cases of continuous occurrence of this error, please contact the technical support.

**8951 File format**

**Status** General software error.

**Measure** → Switch printer off and then back on again after thirty seconds.  
 ○ Please read the notes in section [General software errors](#) .

**8952 Not installed**

**Status** General software error.

**Measure** → Switch printer off and then back on again after thirty seconds.  
 ○ Please read the notes in section [General software errors](#) .

**9000 Wrong errornum**

**Status** General software error.

**Measure** → Switch printer off and then back on again after thirty seconds.  
 ○ Please read the notes in section [General software errors](#) .

**9001 Software Error**

**Status** General software error.

**Measure** → Switch printer off and then back on again after thirty seconds.  
 ○ Please read the notes in section [General software errors](#) .

**9003 Print head type**

**Status** A wrong printhead type is selected in the printer menu.

**Measure** → Correct the setting of the printhead type.  
 ○ Set the printhead type using parameter `SPECIAL FUNCTION > Printhead type`.

**9005 No Printhead**

**Status** Printhead could not be detected. Possible causes:

- Printhead cable not connected
- Wrong printhead type
- Defective printhead cable
- Defective CPU board
- Printhead cable plugged into wrong connector on the CPU board

**Measure** → Check printhead cable, printhead and CPU board and replace defective parts.



**9007 Bad MAC Address**

- Status** This error message is displayed, if an invalid MAC address is programmed to the CPU board. Valid means, the MAC address matches the range *00.0a.44.xx.xx.xx*.  
In this case, the network will not be initialised. To enable work with the network, a valid (Avery-) MAC address must be programmed on the board. This can only be done by an authorized service technician or by the manufacturer.
- Measure**
- Acknowledge the status message by pressing the Online button. The printer will be starting, but cannot be used with a network.
  - Contact the technical support for a new programming of the board's MAC address.
  - If a new programming is not possible, exchange the CPU board.

**9008 Powerfail signal**

- "powerfail" is a signal at the power supply, which is normally activated for a short time, after the printer has been switched off. It triggers the storing of parameter settings and counter values, using the leftover of supply voltage.
- Status** The powerfail signal is already active after switching the printer on. The following causes are possible:
- Defektive power supply
  - Defektive data cable
  - Defektive board
- Measure**
- Switch the printer off and on again. If the error occurs repeatedly:
  - Check the hardware (see above).
  - |||▶ After acknowledging the message (pressing the online button), the printer works normal. But be aware that the powerfail signal is deactivated, what means, that no parameter settings and counter values are stored, when the printer is switched off.

**9009 Temporary MAC**

- Temporary MAC address.
- Status** This error message is displayed, if the MAC address has the value *00.0a.44.00.00.00*. This MAC address is used only during production.
- Measure**
- Acknowledge the status message by pressing the Online button. The printer will be starting and the network can be used.
  - Contact the technical support for a new programming of the board's MAC address.
  - If a new programming is not possible, exchange the CPU board.

**9011 Load firmware for x**

**Status** At least one external device has no valid (e.g. an incomplete) application program loaded. This is the reason, why the device remains in the bootloading status and signalizes this status message. „x“ can be one of the following module names:

- Feed driver
- Foil driver
- Peripheraldriver
- USI interface
- Intern. rewinder
- Applicator int.

**Measure** → Load a valid application program.

**9013 Head voltage**

**Status** Faulty 5 V print head supply voltage. Possible causes are:

- *Only AP 5.4:* Printhead was connected to the wrong connector on the CPU board.
- Short circuit, possibly is the printhead defective.

**Measure** → *Only AP 5.4:* Check if the printhead is connected to the correct connector on the CPU board. Change the connector, if necessary.

→ Replace the printhead

**9014 Motor voltage**

**Status** Faulty 45 V motor supply voltage. A possible cause is a short circuit, that is the printhead is defective.

**Measure** → Replace the printhead

**9015 Network init.**

**Status** Error during the network initialization.

**Measure** → Contact your network administrator.

**9016 DHCP Failed**

**Status** DHCP failed. This may happen, if parameter `INTERF. PARAM. > ETHERNET PARAM. > IP Adressassign` is set to *DHCP*, but no IP-address can be drawn.

**Measure** → Contact your network administrator.

**9017 RTC read failed**

**Status** Error, while trying to read the realtime clock (RTC). Happens, if an Easy-Plug command to read out the RTC is sent, but no RTC is built in.

**Measure** → Check, if the printer is supplied with a RTC. To do so, print a status printout.

- See parameter `INFO PRINTOUT > Printer status`  
You find the actual date on the printout, below the header „Systemversion“, if a RTC is installed.
- Check, if the error occurs repeatedly or sometimes.  
If it occurs repeatedly:
- *AP 5.4*: replace the CPU board.  
*64-xx / ALX 92x / DPM / PEM*: Replace the RTC. If the error still occurs, replace the CPU board.
- If the error occurs sometimes, please refer to the notes in section [General software errors](#) .

### **9018 #!CA wrong Pos.**

**Status** The #!CA command is placed at an inadmissible position – the Easy-Plug interpreter can not proceed the command at this position (e. .g during the loading of files onto a memory card).

**Measure** → Call the #!CA command at an admissible position.

### **9021 Unmg. Exception**

Unmanaged exception

**Status** General software error.

**Measure** → Switch printer off and then back on again after thirty seconds.  
○ Please read the notes in section [General software errors](#) .

### **9022 No network link**

**Status** This message can only occur, if the Ethernet address assign is set to DHCP. The cause is nearly always a badly connected network connector.

**Measure** → Check, if the network connector is plugged in properly.

### **9023 Filename: Functionname() Line: xxx**

**Status** This status message indicates a software error. The error source is located in the source file “Filename” in function “Functionname()” in line xxx.

**Measure** → Switch device off and on again.  
If the error occurs repeatedly:

- Contact the manufacturer.  
When doing so, it is important to be able to reproduce the error. Gather the following informations before calling the technical support of the manufacturer:
  - Displayed information about the error source
  - Label layout, logfiles, etc. as described in chapter [Unspecific errors](#) .

### **9024 Not possible !**

**Status** Detecting the material length (a function, which is normally used with MLI) is not possible, because a printjob is currently processed.

**Measure** → Retry as soon as the printjob is processed.

**9030 Log file:CF full**

- Status** An attempt to store data on the memory card was not successful, because of a full card.
- Measure** → Clear some storage space on the memory card, or  
→ Insert an empty memory card.

**9031 Log file: nnnn**

- Status** File access error. *nnnn* = error code of the operating system.
- Measure** → Repeat the operation, which led to this message. If it comes to this message repeatedly, send a message to the Technical Support, including the error code.

**9032 EP file log stop**

- Status** Internal error during Easy-Plug file logging (`SPECIAL PARAMETER > EasyPl. file log`).
- Measure** → Repeat operation. If the error occurs repeatedly: switch off the file logging.  
 Use parameter `SPECIAL PARAMETER > EasyPl. file log` only for error analysis purposes. Using the parameter in continuous operation can cause error messages, which are hard to understand.

**9034 Use min 16MB RAM**

- Status** The printer has not enough RAM. The applied firmware version needs at least 16 MB RAM for faultless operation.
- Measure** → Extend the printers RAM.

**9035 No printpr. stop**

- Status** This status message may appear during the loading of new firmware onto the H8 (64 Bit) or onto boards, which are connected to the H8 (e.g. Applikator Interface).
- Measure** → Switch the printer off and on again and retry the firmware loading.

**9039 Ribbon mode chg.**

- Status** The ribbon mode was changed between two consecutive printjobs via Easy-Plug command (from thermal transfer to thermo or vice-versa).
- Measure** → Check the ribbon mode setting and, if necessary, change the setting (`SYSTEM PARAMETERS > Ribbon autoecon.`).

**9040 No Time Server**

- Status** Comes up one times at startup, if `INTERFACE PARA > NETWORK PARAM. > Time client` is set to "On" and there is no response from the set time server.
- Measure** → Check the time server availability respectively the time server settings.

## **9100-9119 Messages during firmware update**

### **9100 Invalid format**

**Status** Occurs during a download. The sent data is faulty, e. g. regarding an

- invalid data format
- invalid check sum
- invalid address
- invalid record type

**Measure** → Switch printer off and on again. Check the download data.

### **9101 Invalid Header**

**Status** Occurs during a download. The sent files have a format error in the header.

**Measure** → Switch printer off and on again. Check the download data.

### **9102 Inv.Board Rev.**

**Status** Occurs during a firmware download. The sent firmware does not match the *version* of the CPU board.

**Measure** → Switch printer off and on again. Check the download data.

### **9103 Inval. firmware**

**Status** Occurs during a firmware download. The sent firmware does not match the installed CPU board.

**Measure** → Switch printer off and on again. Check the firmware file.

### **9104 Inv. Data Size**

**Status** Occurs during a download. The size of the sent data doesn't match the file size indicated in the header.

**Measure** → Switch printer off and on again. Check the download data.

### **9107 Flash Overflow**

**Status** Occurs during a download. The flash memory on the CPU board is full. No more data can be loaded.

**Measure** → Switch printer off and on again.

### **9108 Flash Ovf. Diag.**

**Status** Occurs during a download. The flash memory on the CPU board has not enough free memory space left for diagnose data.

**Measure** → Delete data blocks in the flash memory or reduce max. size of the diagnose data.

### **9109 Flash Ovf. Params.**

**Status** Occurs during a download. The flash memory on the CPU board has not enough free memory space left to store the current parameter settings.

||||▶ After a restart, the parameters are set to "Factory setting".

**Measure** → Delete data blocks in the flash memory.

**9110 Flash Write Err.**

**Status** Occurs during a download. The flash memory can't be accessed for writing.

**Measure** → Switch printer off and on again.

**9111 PIC Update Fail.**

**Status** Occurs during a firmware update or a PIC-controlled device, if the update failed.

**Measure** → Switch printer off and on again.

**9112 PIC missing**

**Status** Occurs during a firmware update of a PIC-controlled device, if no such device was found.

**Measure** → Check the configuration.  
The status message is cancelled automatically. The download continues.

**9113 RFID Update Fail.**

**Status** Occurs during a firmware update of a RFID module, if the update failed.

**Measure** → Switch printer off and on again.

**9114 RFID missing**

**Status** Occurs during a firmware update of a RFID module, if no such device was found.

**Measure** → Check the configuration.  
The status message is cancelled automatically. The download continues.

**9115 AWID missing**

**Status** Occurs during a firmware update of an AWID RFID module, if a RFID module of another manufacturer was found.

**Measure** → Check the configuration.  
The status message is cancelled automatically. The download continues.

**9116 Ser. Disp. Missing**

**Status** Occurs during a firmware update of a serial operation panel, if no such device was found.

**Measure** → Check the configuration.  
The status message is cancelled automatically. The download continues.

**9117 Device Unknown**

**Status** Occurs during a firmware update, if the device information in the header is missing.

**Measure** → Switch printer off and on again. Check the configuration.

**9118 H8 Update Fail.**

**Status** The update of a H8 device failed.

**Measure** → Switch printer off and on again.

**9119 H8 missing**

**Status** Occurs during a firmware update of a H8 device, if no such device was found.

**Measure** → Check the configuration.  
The status message is cancelled automatically. The download continues.

**9122 Checksum error**

**Status** Checksum error while loading a firmware file. The checksum of the loaded data doesn't match the calculated checksum.

**Measure** → Repeat the download.  
→ If the error continues to occur, the file is probably damaged or corrupted. Check/ exchange the firmware file.

**9123 Memory unavailable**

**Status** Error while loading a firmware file. There is not enough free memory available.

**Measure**

- Restart machine and repeat the download.
- If the error continues to occur: Reduce the memory which is assigned by the following parameters:
  - SYSTEM PARAMETERS > Ram disc size
  - SYSTEM PARAMETERS > Font downl. area
  - SYSTEM PARAMETERS > Free store size





# Technical Data

Device Types, Use .....	1	Automatic ribbon economy .....	10
Printer names .....	1	Connections, device data .....	11
64-0x Basic .....	1	Ambient conditions .....	11
64-0x Peripheral .....	1	Interfaces 64-0x Gen. 2 .....	11
64-0x Dispenser M .....	2	Interfaces 64-0x Gen. 3 .....	12
64-0x Dispenser A .....	2	Electronics 64-0x Gen. 2 .....	12
Options 64-0x Gen. 2 .....	2	Electronics 64-0x Gen. 3 .....	12
Options 64-0x Gen. 3 .....	3	Operation features .....	13
Technical Specifications .....	5	Status messages / Test functions .....	13
Dimensions .....	5	Certificates and Markings .....	13
Performance data .....	6	Appendix .....	14
Label material .....	8	Important distances to the print line .....	14
Ribbon .....	9		

## Device Types, Use

### Printer names

#### 64-0x

The x in the printer name is a placeholder for the numbers 4, 5, 6 or 8. The higher this number is, the wider label material can be used with this printer (roughly, the number equals the max. printwidth in inches).

#### Gen. 2 / Gen. 3

This documentation refers to 64-0x printers with two different generations of CPU boards:

- Gen. 2: CPU boards with article number A2292 (with Ethernet) or A2293 (without Ethernet). Those printers are *not* RoHS-compliant.
- Gen. 3: CPU board with article number A6621. Those printers are RoHS-compliant.

If a chapter refers to only one of both generations, the generation is added to the printer name („64-0x Gen. 2“ or „64-0x Gen. 3“).

### 64-0x Basic

- Monotone printing of labelling materials for thermal and thermotransfer processes
  - Printing on different materials, e.g. cardboard or self-adhesive labels
  - Processing roll and fan-folded material
  - Print width:
    - 64-04 up to 106.6 mm
    - 64-05 up to 127.9 mm
    - 64-06 up to 159.9 mm
    - 64-08 up to 213.2 mm
  - Resolution: 12 dots/mm (300 dpi)
  - Interfaces: RS 232, RS 422/485 (optional), USB, Centronics, Ethernet (optional)
- ▣► The 64-0x Basic may *not* be used with peripheral devices!

### 64-0x Peripheral

- Basic equipment as 64-0x Basic
- The 64-0x Peripheral is additionally equipped with a motor driver and a connector for peripheral devices. Thus it offers the possibility of driving a cutter or a rewinder.

## 64-0x Dispenser M

- Basic equipment as 64-0x Peripheral
- Additional features: Dispensing edge and internal backing paper rewinder
- Dispensing of self-adhesive labels after printing; the backing paper is wound up inside of the printer.
- „M“ stands for manual application of the labels, what means that the label is taken off the dispensing edge and is applied to the product by hand. For this reason, the dispensing edge provides a light barrier which triggers the dispensing of the next label, if the current one is taken off.
  - ▣▣▣▣▣ Alternatively, the dispensing can be triggered by a foot switch. The switch must be connected to the *optional* single-start connector.

## 64-0x Dispenser A

- Basic equipment as 64-0x Peripheral
- Additional features: Dispensing edge and internal backing paper rewinder
- Dispensing of self-adhesive labels after printing; the backing paper is wound up inside of the printer.
- “A” stands for automatic label application, what means, that the label is applied by an applicator. The dispensing edge is longer than the type “M” edge and has no light barrier.

## Options 64-0x Gen. 2

### Internal Options

...should be factory-fitted or installed by a service engineer:

- *Reflex sensor*: Light barrier fork that apart from the transmission sensor, also contains a reflex sensor.
- *Fullsize sensor*: Punch sensor which can be shifted across the full material width.
  - ▣▣▣▣▣ The fullsize sensor can not be used under one of the following conditions:
    - The printer is a 64-0x Dispenser (type A or M).
    - The printer is operated with the online verifier (see below) option.
- *USI* (Universal Signal Interface): can e.g. be used to control an applicator or a scanner.
- *Options board* with an additional serial interface (COM 2) and a PS/2 keyboard connector.
- *Antistatic kit*: reduces electrostatic charge, which can especially arise of the processing of plastic labels. Electrostatic discharge can damage or destroy electronic circuits of the printer.
- *Realtime clock*
- *Single-Start option*: Connector for a foot switch or another external signal, which is supposed to start or stop the printer.

### External Options

...do not require any special alterations to the printer, however, the printer must be prepared for the use of peripheral devices:

- *Cutter*: Optional high-performance, low-noise cutter with double-cut function from 1 to 5 mm
- *Rewinder*: is mounted to the printer and rewinds the printed label materials with the printed side facing inwards or outwards

- *Online Verifier*: The online verifier (OLV) checks printed bar code immediately after printing it. If the bar code has not been printed or has not been printed in a readable way, the OLV stops the printer.
- *Keyboard* for standalone operation
- *Foot switch* for triggering the label dispenser (printer must be equipped with single-start option)

## Options 64-0x Gen. 3

### Internal Options

...should be factory-fitted or installed by a service engineer:

- *Reflex sensor*: Light barrier fork that apart from the transmission sensor, also contains a reflex sensor.
- *Fullsize sensor*: Punch sensor which can be shifted across the full material width.
  - ▣▶ The fullsize sensor can not be used under one of the following conditions:
    - The printer is a 64-0x Dispenser (type A or M).
    - The printer is operated with the online verifier (see below) option.
- *USI* (Universal Signal Interface): can e.g. be used to control an applicator or a scanner.
- *CompactFlash card slot* on a daughter board
- *Antistatic kit*: reduces electrostatic charge, which can especially arise of the processing of plastic labels. Electrostatic discharge can damage or destroy electronic circuits of the printer.
- *Single-Start option*: Connector for a foot switch or another external signal, which is supposed to start or stop the printer.

- *External control panel*





[1] Right: External control panel.

An external control panel [1] can be connected in addition to the integrated control panel. An external control panel is useful if the standard control panel is difficult to access due to the position in which the unit is installed (min. firmware: 5.31).

[Optional boards](#) : Service manual, topic section „Electronic Gen. 3“.

## External Options

...do not require any special alterations to the printer, however, the printer must be prepared for the use of peripheral devices:

- *Cutter*: Optional high-performance, low-noise cutter with double-cut function from 1 to 5 mm  
[Manual „Cutter 2000“](#)  on the Documentation-CD
- *Rewinder*: is mounted to the printer and rewinds the printed label materials with the printed side facing inwards or outwards  
[Manual „Rewinder 2000“](#)  on the Documentation-CD
- *Online Verifier*: The online verifier (OLV) checks printed bar code immediately after printing it. If the bar code has not been printed or has not been printed in a readable way, the OLV stops the printer.
- *Keyboard* for standalone operation  
Standalone operation: User manual, topic section [Advanced Applications](#) , paragraph „Standalone Operation“
- *Foot switch* for triggering the label dispenser (printer must be equipped with single-start option)
- *USB thumb drive*: All types of USB mass storage class devices connected to the USB host port are supported. Those are e. g. USB sticks (min. firmware: 5.31).
- *USB-Scanner*: USB scanner can be operated at one of the USB host ports. Scanned data is interpreted as keyboard input (min. firmware: 5.31).

# Technical Specifications

## Dimensions

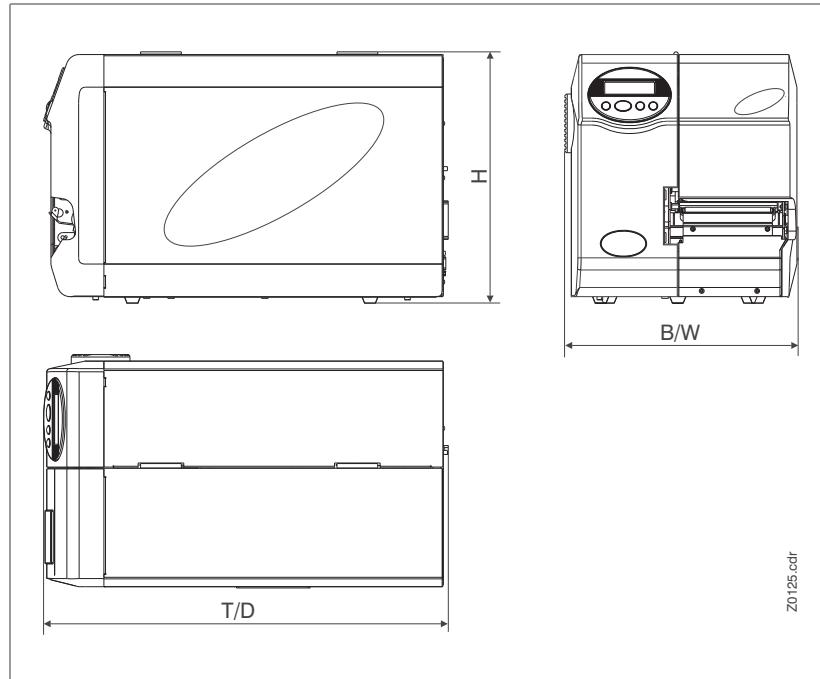

[2] Dimensions of the 64-xx series standard printers. Refer to the following table for the values.

Printer	W(idth) / mm	H(eight) / mm	D(epth) / mm	Weight in kg
64-04/05	320	305	490	20.0
64-04/05 with cutter	320	305	540	21.5
64-04/05 Dispenser	320	305	490	23.5
64-06	350	305	490	21.5
64-06 with cutter	350	305	540	23.0
64-06 Dispenser	350	305	490	25.0
64-08	450	305	490	26.0
64-08 with cutter	450	305	540	27.5
64-08 Dispenser	450	305	490	29.5

[Tab. 1] Dimensions and weights of the 64-xx series printers. All width measures refer to the housing without the approx. 5 mm wide motor cover.

- The dispenser versions of the printers have equal dimensions as the standard types, respectively.
- Dimensioned drawings of the 64-xx with and without dispenser, cutter or rewinder are contained in DXF format (Autocad) on the Documentation-CD in folder \Dimensional Drawings\.

## Performance data

**Print technology** Thermal direct printing, thermal transfer printing

**Printhead** "Corner Edge" type

**Resolution** 12 dots/mm (300 dpi<sup>1</sup>)

### Print speed

Printer	Print speed (mm/s)	Print speed (inch/s)
64-04/05	50 to 406	2 to 16
64-06	50 to 359	2 to 14
64-08	50 to 229	2 to 9

[Tab. 2] Print speeds of the 64-xx printers  
(Unit interval 25,4 mm/s (1 "/s), respectively)

### Print speed 64-0x Dispenser

Printer	Ribbon auto-econ.	Setting of parameter „Transport mode“		
		„Dispenser motor“	„Dual motors“	„Printer motor“
64-04/05 Dispenser	Off	12 "/s	12 "/s	16 "/s
	On	8 "/s	12 "/s	16 "/s
64-06 Dispenser	Off	12 "/s	12 "/s	14 "/s
	On	8 "/s	12 "/s	14 "/s
64-08 Dispenser	Off	10 "/s	10 "/s	9 "/s
	On	8 "/s	10 "/s	9 "/s

[Tab. 3] The maximum print speed of the dispenser printers depends on the setting of the parameter SYSTEM PARAMETERS > Transport mode. The values are recommendations, up to which proper functioning of the printer is guaranteed.

**Print width (actual)**

- 64-04:106.6 mm
- 64-05:127.9 mm
- 64-06:159.9 mm
- 64-08:213.2 mm

**Output mode** 1:1 and 100 % printable, either with or without cut.

▣► Non-printable area:

- 1 mm from the front label edge (1st edge in feed direction) and
- 1 mm from the left band border (right border in feed direction).

1. Exact: 304.8 dpi

**Gap detection**

- Self-initialising light transmission sensor, optional reflex sensor (at the bottom side of the material).
- Correction of gap displacement in feed direction is possible by modifying the gap offset (parameter PRINT PARAMETERS > Punch offset),
  - ▮ The trigger point of the reflex mark (that is the actual label beginning) is at the dark-to-bright change of the reflex mark.

	Light transmission sensor	Reflex sensor
Setting range	2-17 mm	13-26 mm
Punch length (in feed direction)	0.8-14 mm	4 mm (recommended)
Punch width (across the web)	min. 4 mm	12 mm (recommended)

[Tab. 4] Punch dimensions and setting ranges.

**Interpreter**

Easy Plug, Line Printer, Hex Dump

**Character sets**

- 17 fonts including OCR-A and OCR-B,
- 3 scalable fonts,
- Truetype fonts supported

**Character modification**

- Scaling in X/Y direction up to factor 16,
- Rotation 0, 90, 180, 270 degrees

**Impression accuracy**

- In printing (y-) direction:
 

The impression accuracy depends on the print position. With the printout starting directly at the punch position, the accuracy is  $\pm 0.5$  mm. A distance between punch (that is label start) and print position will add  $\pm 1\%$  of this distance to the accuracy fault (see fig. [3]).
- X-direction:  $\pm 0.5$  mm.

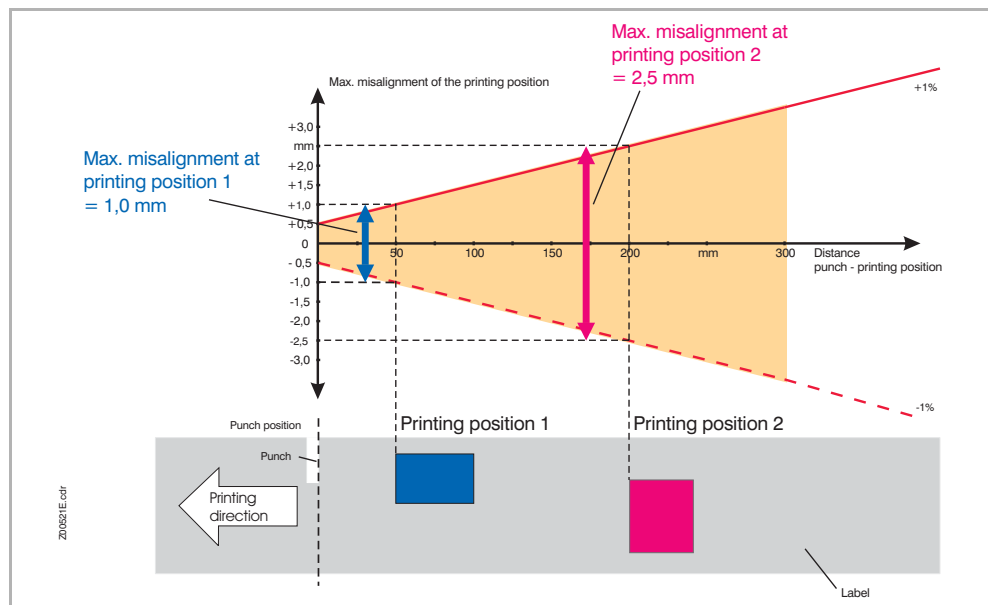

[3] Impression accuracy in printing direction, depending on the printing position.



**Bar codes**

Codabar	Code 128 A, B, C
Code 128	Code 128 UPS
Code 128 pharmacy	ITF
Code 2/5 matrix	MSI
Code 2/5 interleaved	EAN 13 add-on 2
Code 2/5 5-line	EAN 13 add-on 5
Code 2/5 interleaved ratio 1:3	EAN 128
Code 2/5 matrix ratio 1:2,5	Postcode (guide and identity code)
Code 2/5 matrix ratio 1:3	UPC A
Code 39	UPC E
Code 39 extended	Code 93
Code 39 ratio 2,5:1	
Code 39 ratio 3:1	

All bar codes scalable in 30 different width and in the height.

**2-dimensional bar codes**

Data Matrix Code (code according to ECC200)
Maxi Code
PDF 417
Codablock F
Code 49
QR Matrix Code

**GS1 Databar & CC bar codes**

Reduced Space Symbology (GS1 Databar) und Composite Component (CC) bar codes:

GS1 Databar-14	UPC-A + CC-A/CC-B
GS1 Databar-14 truncated	UPC-E + CC-A/CC-B
GS1 Databar-14 stacked	EAN 13 + CC-A/CC-B
GS1 Databar-14 stacked omnidirectional	EAN 8 + CC-A/CC-B
GS1 Databar limited	UCC/EAN 128 + CC-A/CC-B
GS1 Databar expanded	UCC/EAN 128 + CC-C

**Label material****Material type**

Self-adhesive, card and synthetic materials, suitable for printing in thermal direct process and thermal transfer process. Use of roll material or leporello possible.

**Material weight**

- 64-04/05/06: max. 240 g/m<sup>2</sup>
- 64-08: max. 160 g/m<sup>2</sup>

**Material width**

Printer	Material width (mm)
64-04/05	25.4 – 154
64-04/05 Dispenser	25.4 – 140
64-06	30.2 – 185
64-06 Dispenser	30.2 – 172
64-08	100 – 254
64-08 Dispenser	100 – 241

[Tab. 5] Max. processable material widths.

**Label length**

- 64-0x: 5 to “max. print length”
  - 64-0x Dispenser: 10 to “max. print length”
- ▮ The max. print length depends on the memory availability of the printer.

**Label roll**

- Max. outer-Ø: 210 mm
- Inner-Ø: 38/76/102 mm (1,5/3/4")
- (Dispenser) Winding direction: Print side in or out
- (Dispenser) max. roll-Ø or rewound backing paper: 100 mm (equals half of the backing paper amount of a „typical“ 210 mm material roll with 4“ core, that is 1x changing material roll = 2x clearing backing paper)

**Roll weight**

Printer	Roll weight
64-04/05	4250 g
64-06	5000 g
64-08	7200 g

[Tab. 6] Max. admissible material roll weights.

**Ribbon****Ribbon roll**

- Max. outer-Ø :90 mm
- Inner core-Ø :25.4 mm (1")
- Winding direction:
  - 64-xx: ink inside or outside
  - 64-xx *Dispenser*: ink inside
- Roll width

Printer	Ribbon width <sup>a)</sup>
64-04/05	30 -132 mm
64-06	30 -164 mm
64-08	40 -217 mm

[Tab. 7] Admissible ribbon width of the different printer types.

a) Counts also for 64-xx dispenser.

### Automatic ribbon economy

In regular print mode, ribbon is fed simultaneously with the labelling material. The automatic ribbon economy (= „ribbon saving“) stops the feeding of the ribbon if there are label areas of a certain size without imprinting. As a result, ribbon is saved [4].

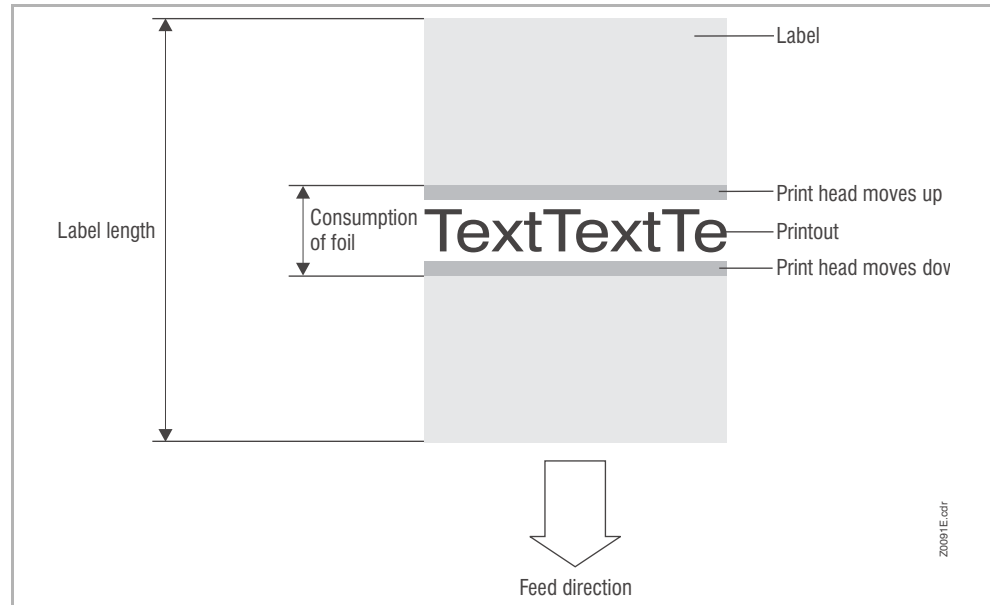

[4] Ribbon (Foil) consumption when printing labels with a small imprinting area and activated automatic ribbon economy. Ribbon consumption is slightly higher than the length of the imprinted area.

The effect of ribbon saving depends on the print speed. The reason for this is the up and down movement of the print head as well as the acceleration and slowing-down of the ribbon. Generally said: With a high print speed, less ribbon is saved as with a low print speed (Tab. 8).

Cutting or dispensing applications can additionally deteriorate the effect of ribbon saving.

*Activate* the automatic ribbon saving: See parameter SYSTEM PARAMETER > Ribbon autoecon..

Setting the *minimum distance* between two print areas from which on ribbon saving should be activated: See parameter SYSTEM PARAMETER > Ribb. eco. limit.

☛ Mind the minimum length of unprinted area, see Tab. 8.

Print speed in mm/s (Inch/s)	Minimum length of unprinted area in mm	Consumed ribbon per saving action in mm
51 (2)	3.7	1.2
76 (3)	4.6	1.9
102 (4)	5.9	3.1
127 (5)	7.4	4.4
152 (6)	8.9	5.9
178 (7)	11.1	7.6
203 (8)	14.1	9.5
229 (9)	17.6	11.3
254 (10)	21.3	13.6
279 (11)	25.3	15.9
305 (12)	30.0	18.5
330 (13)	34.5	21.2

[Tab. 8] The amount (length) of consumed ribbon per saving action (lifting and lowering of the print head) increases with the print speed.

Print speed in mm/s (Inch/s)	Minimum length of unprinted area in mm	Consumed ribbon per saving action in mm
356 (14)	39.9	24.2
381 (15)	45.6	27.3
406 (16)	51.3	30.5

[Tab. 8] The amount (length) of consumed ribbon per saving action (lifting and lowering of the print head) increases with the print speed.

## Connections, device data

<b>Mains voltage</b>	100-240 V
<b>Mains frequency</b>	60/50 Hz
<b>Power consumption</b>	350 W
<b>Input current</b>	max. 4,5 A
<b>Protection class</b>	I

## Ambient conditions

<b>Installation location</b>	<ul style="list-style-type: none"> <li>• Inside buildings</li> <li>• Protected from wind and spray water</li> <li>• Dry</li> <li>• Not in areas with potentially explosive atmosphere</li> </ul>
<b>Operating temp.</b>	+5 to +35 °C
<b>Storage temp.</b>	-20 to +70 °C
<b>Humidity</b>	45 to 75 %, non-condensing
<b>Noise</b>	70 dB(A)
<b>Protection category</b>	IP 21
<b>Sea level</b>	Operation to max. 2000 m above sea level

## Interfaces 64-0x Gen. 2

- Serial Interface (Com1)
  - RS 232 or RS 422/485; selection via parameter menu
  - Max. baud rate 115200
- Parallel Interface
  - Centronics
  - Bidirectional mode (nibble mode); conforms with IEEE 1284 B
- *Optional*: Ethernet interface 10/100 Base T with TCP/IP, LPD, RawIP printing, DHCP, HTTPD, FTPD, SNMP
- *Optional*: Universal Signal Interface (USI)
- *Optional*: Second serial interface (Com2)
  - RS 232
  - Max. baud rate 115200

- *Optional*: PS/2 keyboard connector for use in standalone mode and for putting in variable print data.

[Pin assignment](#) □: read service manual, topic section „Electronics Gen. 2“

### Interfaces 64-0x Gen. 3

- Serial Interface (Com1)
  - RS 232
  - Max. baud rate 115200
- *Optional*: Second serial interface (Com2)
  - RS 232 or RS 422/485
  - Selection via parameter menu
  - Max. baud rate 115200
- USB ports
  - USB 1.1
  - 2 USB-A host ports
  - 1 USB-B device port (full speed)
- Ethernet interface 10/100 Base T with TCP/IP, LPD, RawIP printing, DHCP, HTTPD, FTPD, SNMP
- *Optional*: Universal Signal Interface (USI)

[Pin assignment](#) □: read service manual, topic section „Electronics Gen. 3“

### Electronics 64-0x Gen. 2

<b>Processor</b>	64 Bit IDT MIPS
<b>RAM</b>	16 MB (extendable to max. 144 MB)
<b>ROM</b>	2 MB
<b>Plugin cards</b>	1 slot for CompactFlash T1 up to max. 128 MB
<b>Realtime clock</b>	optional
<b>Signal interface</b>	(USI board) optional

### Electronics 64-0x Gen. 3

<b>Processor</b>	32 Bit AMD MIPS
<b>RAM</b>	64 MB
<b>ROM</b>	4 MB
<b>Plugin cards</b>	<ul style="list-style-type: none"> <li>• (up to index -06 of the CPU board) Slot for CF cards</li> <li>• Slot for SD/MMC cards</li> </ul>
<b>Realtime clock</b>	Standard
<b>Signal interface</b>	Optional: USI board or I/O board

## Operation features

<b>Operation panel</b>	<ul style="list-style-type: none"> <li>• (64-0x Gen. 2) <ul style="list-style-type: none"> <li>– 4-key control panel</li> <li>– 32-figure illuminated LCD display</li> </ul> </li> <li>• (64-0x Gen. 3) <ul style="list-style-type: none"> <li>– 4-key control panel</li> <li>– graphical, 128 x 32 Dot LCD display, illuminated</li> </ul> </li> </ul>
<b>Settings</b>	Definition of parameters using menu or Easy Plug commands

## Status messages / Test functions

<b>Test printouts</b>	Printouts for parameter settings, adding logo and font, line and bar code library
<b>Test functions</b>	Print tests with cut, test routines for memory and sensors, interface test
<b>Error reports</b>	Display of error reports on the display, continuation of print jobs without label loss
<b>Warnings</b>	Ribbon low
<b>Dot check</b>	Checks the printhead on defective dots – automatically or manually

## Certificates and Markings

CE, TÜV-Mark, <sub>C</sub>TÜV<sub>US</sub>-Mark, FCC, EAC, CCC

The regulation EN 55022 demands for class A devices the following text to be printed in the manual:

„WARNING: This is a class A product. In a domestic environment this product may cause radio interference in which case the user may be required to take adequate measures.“

The FCC regulation demands the following information text for class A devices:

„NOTE: This equipment has been tested and found to comply with the limits for a Class A digital device, pursuant to Part 15 of the FCC Rules. These limits are designed to provide reasonable protection against harmful interference when the equipment is operated in a commercial environment. This equipment generates, uses and can radiate radio frequency energy and, if not installed and used in accordance with the instruction manual, may cause harmful interference to radio communications. Operation of this equipment in a residential area is likely to cause harmful interference in which case the user will be required to correct the interference at his own expense.“

IC (Industry Canada) requires the following wording for Class A devices:

„CANADIAN D.O.C. WARNING This digital apparatus does not exceed the Class A limits for radio noise emissions from digital apparatus set out in the Radio Interference Regulations of the Canadian Department of Communications.“

## Appendix

### Important distances to the print line

Distance print line to	mm
Punch sensor (light transmission)	16.0
Punch sensor (reflex)	16.0
Punch sensor (Full-Size)	67.8
Dispensing edge (long)	39.8
Dispensing edge (short)	24.2

[Tab. 9] Important measures regarding the print line.



## Zubehör

Fußschalter, Tastatur .....
Netzkabel .....
Datenkabel .....
USI-Testbox .....

## Accessories

Foot switch, Keyboard .....	2
Power Cables.....	3
Data Cables .....	4
USI Testbox .....	5



## Fußschalter, Tastatur / Foot switch, Keyboard



1



3

ID	Bezeichnung	Designation	Teilenummer / Part Number
1	Fußschalter	Foot switch	A4053 <sup>1</sup> (AP4.4/5.4) A104186 <sup>2</sup>
2	Adapterkabel (Fußschalter - USI)	Adapter cable (foot switch - USI)	A7268
3	Tastatur	Keyboard	A8407 <sup>3</sup> (German layout) A8406 <sup>4</sup> (US layout)

1) Stecker wie abgebildet.  
Plug as illustrated.

2) Fußschalter mit Adapterkabel für den Anschluss an USI.  
Foot switch with adapter cable for connection to USI.

3) Adapter USB-zu-PS/2 wird mitgeliefert.

4) USB-to-PS/2 adapter is included.

## Netzkabel / Power Cables



1



2



3



4



5



6

ID	Bezeichnung	Designation	Teilenummer / Part Number
1	Netzkabel UK	Power cable UK	A0635
2	Netzkabel EU	Power cable EU	A4254
3	Netzkabel USA	Power cable USA	A4255
4	Netzkabel China	Power cable China	A5451
5	Netzkabel DK	Power cable Denmark	A3598
6	Netzkabel Schweiz	Power cable Swiss	A0842

## Datenkabel / Data Cables

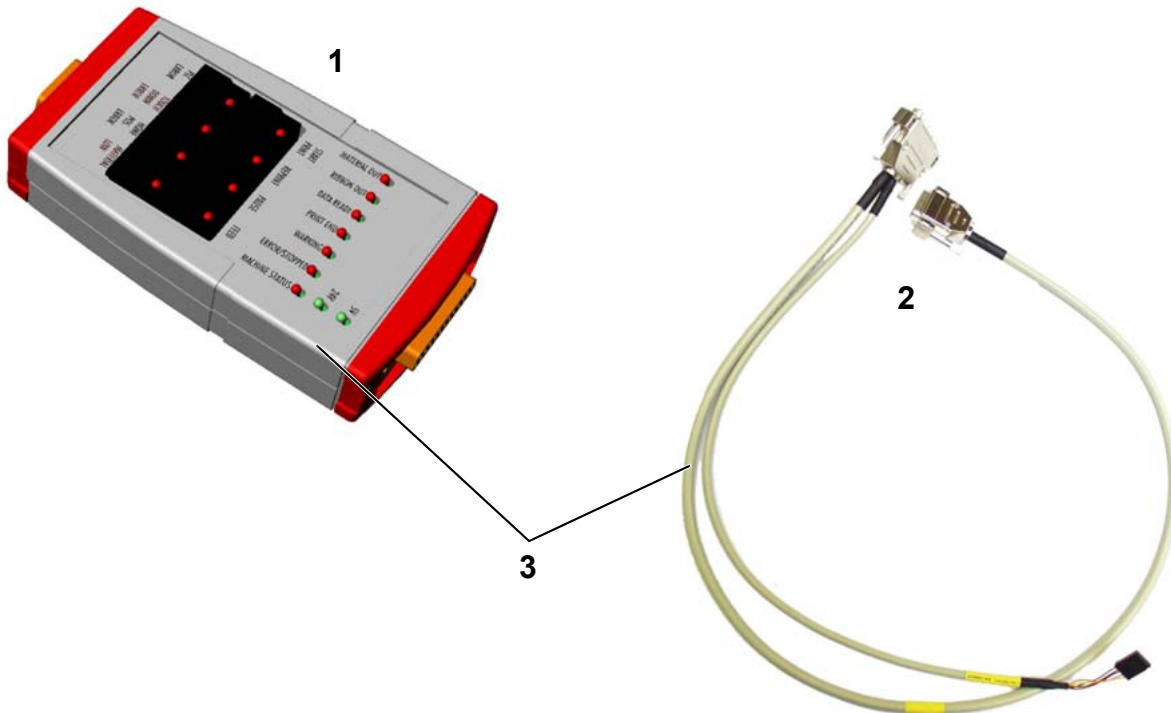

ID	Bezeichnung	Designation	Teilenummer / Part Number
1	RS 232-Kabel	RS 232 cable	A1207
2	Centronics-Kabel (3m lang, bidirektional)	Centronics cable (length: 3m, bidirectional)	A2480 (64-xx)
3	Centronics-Kabel (IEEE 1284 CA)	Centronics cable (IEEE 1284 CA)	A4253 (AP 4.4/5.4/7.t)
4	USB-Kabel 2.0 A zu B	USB cable 2.0 A to B	126738

**USI-Testbox / USI Testbox**

ID	Bezeichnung	Designation	Teilenummer / Part Number
1	USI-Testbox	USI test box	A2739
2	Anschlußkabel für Testbox	Connection cable test box	A2842
3	USI-Testbox + Rundkabel	USI test box + connection cable	A2843



## Disposal

Disposing of the printer .....	2
Before disposal .....	2
Disposal measures .....	2

## Disposing of the printer

### Before disposal



#### WARNING!

This unit operates at mains voltage! Contacting electrically live components can cause potentially lethal electrical shocks and burns.

→ Before disposing of the printer, disconnect all cables.



### Disposal measures

During the production of the individual components, the manufacturer ensures that as little an impact is made on the environment as possible. When it comes to disposal, you as the user have a considerable influence in helping to reduce the strain on the environment.

For details about the disposal of material (e. g. ribbon) please consult the respective manufacturer. Please heed the following notes regarding the disposal of packaging, defect components after maintenance or repair work, or even the disposal of the printer after the end of the product's service life:

→ Dispose of waste properly, i.e. sorted according to the material groups of the parts to be disposed of. The aim should always be to achieve a maximum possible reutilisation of the basic materials combined with the minimum possible environmental impact.

Therefore, pay attention to the following:

- First of all, remove problem materials from the device and dispose of them separately. Problem materials are e.g. batteries, LCD displays and parts containing mercury.
- Then separate the remaining parts as much as possible according to material for recycling.

→ Pay attention to the material and disposal instructions which may be included on certain individual parts.

→ Under no circumstances should you simply throw electrical or electronic scrap into the rubbish bin.

→ Use environmentally compatible alternatives such as returning waste to the suppliers or the manufacturer, disposal by specialised waste disposal firms, exchange services, etc.

→ Fundamentally dispose of waste in as environmentally compatible a manner as today's environmental protection, reprocessing and disposal systems allow.

→ Refer to your supplier, the appropriate disposal firms or directly to the manufacturer if you have any disposal problems. The manufacturer can provide you with information and help you to dispose of components from the printer range in a modern and environmentally compatible manner.

▮▮▮▮ WEEE-Reg.-Nr. DE 46850411

