

User's Guide

ZyWALL USG Series

Default Login Details

LAN Port IP Address	https://192.168.1.1
User Name	admin
Password	1234

Version 4.73 Edition 1, 12/2022

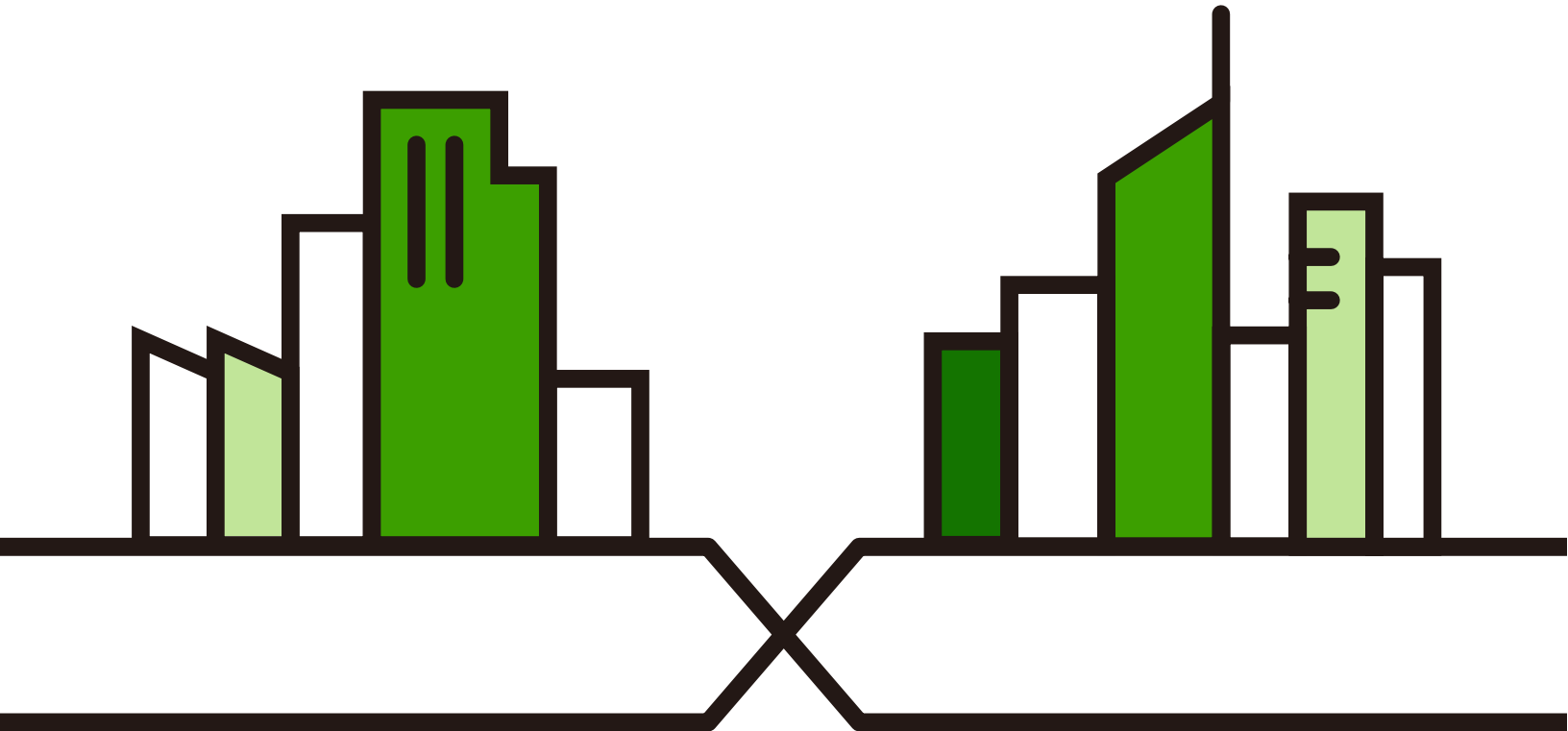

IMPORTANT!

READ CAREFULLY BEFORE USE.

KEEP THIS GUIDE FOR FUTURE REFERENCE.

This is a User's Guide for a series of products. Not all products support all firmware features. Screenshots and graphics in this book may differ slightly from your product due to differences in product features or Web Configurator brand style. Most screen shots in this guide come from the USG110 and USG60W. Screen shots for other models may vary. Every effort has been made to ensure that the information in this manual is accurate.

Note: The version number on the cover page refers to the Zyxel Device's latest firmware version to which this User's Guide applies.

Related Documentation

- Quick Start Guide

The Quick Start Guide shows how to connect the Zyxel Device and access the Web Configurator wizards. (See the wizard real time help for information on configuring each screen.) It also contains a connection diagram and package contents list.

- CLI Reference Guide

The CLI Reference Guide explains how to use the Command-Line Interface (CLI) to configure the Zyxel Device.

Note: It is recommended you use the Web Configurator to configure the Zyxel Device.

- Web Configurator Online Help

Click the help icon in any screen for help in configuring that screen and supplementary information.

- More Information

Go to support.zyxel.com to find other information on the Zyxel Device.



Document Conventions

Warnings and Notes

These are how warnings and notes are shown in this guide.

Warnings tell you about things that could harm you or your device.











Note: Notes tell you other important information (for example, other things you may need to configure or helpful tips) or recommendations.

Syntax Conventions

- All models in this series may be referred to as the “Zyxel Device” in this guide.
- Product labels, screen names, field labels and field choices are all in **bold** font.
- A right angle bracket (>) within a screen name denotes a mouse click. For example, **Configuration > Network > Interface > Ethernet** means you first click **Configuration** in the navigation panel, then **Network**, then the **Interface** sub menu and finally the **Ethernet** tab to get to that screen.

Icons Used in Figures

Figures in this user guide may use the following generic icons. The Zyxel Device icon is not an exact representation of your device.

Zyxel Device 	Generic Router 	Wireless Router / Access Point 
Switch 	Firewall 	Server 
Internet 	Network Cloud 	Smartphone 
USB Dongle 		

Contents Overview

Introduction	28
Initial Setup Wizard	59
Hardware, Interfaces and Zones	74
Easy Mode	89
Quick Setup Wizards	156
Dashboard	199
Monitor	214
Licensing	284
Wireless	291
Interfaces	319
Routing	429
DDNS	456
NAT	462
Redirect Service	471
ALG	477
UPnP	485
IP/MAC Binding	500
Layer 2 Isolation	505
DNS Inbound LB	509
Web Authentication	515
Hotspot	549
Printer Manager	567
Free Time	579
IPnP	584
Walled Garden	587
Advertisement Screen	593
Security Policy	596
Cloud CNM	624
Amazon VPC	633
IPSec VPN	635
SSL VPN	671
SSL User Screens	679
Zyxel Device SecuExtender (Windows)	692
L2TP VPN	696
BWM (Bandwidth Management)	701
Application Patrol	716
Content Filtering	722
IDP	748
Anti-Virus	773

Anti-Spam	785
SSL Inspection	802
Device HA	812
Object	828
System	953
Log and Report	1014
File Manager	1032
Diagnostics	1048
Packet Flow Explore	1069
Shutdown/Reboot	1077
Troubleshooting	1080

Table of Contents

Document Conventions	3
Contents Overview	4
Table of Contents	6
Part I: User's Guide.....	27
Chapter 1	
Introduction.....	28
1.1 Overview	28
1.2 Registration at myZyxel	30
1.2.1 Grace Period	30
1.3 Applications	31
1.4 Management Overview	33
1.5 Web Configurator	35
1.5.1 Web Configurator Access	36
1.5.2 Security Check for Web Interface Overview	39
1.5.3 The Security Check for Web Interface Screen	41
1.5.4 Remote Access to the Zyxel Device Networks	43
1.5.5 Web Configurator Screens Overview	43
1.5.6 SecuReporter Banner	47
1.5.7 Navigation Panel	47
1.5.8 Tables and Lists	56
Chapter 2	
Initial Setup Wizard.....	59
2.1 Initial Setup Wizard Screens	59
2.1.1 Internet Access Setup – WAN Interface	60
2.1.2 Internet Access: Ethernet	60
2.1.3 Internet Access: PPPoE	62
2.1.4 Internet Access: PPTP	63
2.1.5 Internet Access: L2TP	65
2.1.6 Internet Access Setup – Second WAN Interface	66
2.1.7 Internet Access: Congratulations	67
2.1.8 Date and Time Settings	67
2.1.9 Register Device	68
2.1.10 Activate Service	69

2.1.11 Wireless Settings: AP Controller 70
 2.1.12 Wireless Settings: SSID & Security 71
 2.1.13 Remote Management 72

**Chapter 3
 Hardware, Interfaces and Zones74**

3.1 Hardware Overview 74
 3.1.1 Front Panels 74
 3.1.2 Rear Panels 78
 3.2 Installation Scenarios 79
 3.2.1 Desk-mounting 80
 3.2.2 Rack-mounting 80
 3.2.3 USG2200 Rack Mounting 81
 3.2.4 Wall-mounting 85
 3.3 Default Zones, Interfaces, and Ports 86
 3.4 Stopping the Zyxel Device 88

**Chapter 4
 Easy Mode89**

4.1 Overview 89
 4.1.1 Objects and Rules 89
 4.1.2 Wizards and Links 90
 4.1.3 Easy Mode Settings 91
 4.1.4 Easy Mode Dashboard 92
 4.2 Initial Setup Wizard – Language and Overview 94
 4.2.1 Initial Setup Wizard – Internet 96
 4.2.2 Initial Setup Wizard – Internet Access Errors 97
 4.2.3 Initial Setup Wizard – Date and Time 98
 4.2.4 Initial Setup Wizard – Register Device 99
 4.2.5 Initial Setup Wizard – Activate Services 101
 4.2.6 Initial Setup Wizard – Wi-Fi 102
 4.2.7 Initial Setup Wizard – Remote Management 103
 4.2.8 Initial Setup Wizard – Congratulations 104
 4.3 Initial Setup Wizard – Security Service 105
 4.4 Initial Setup Wizard – Port Forwarding 107
 4.5 Initial Setup Wizard – Guest LAN 108
 4.5.1 Connecting AP Scenarios 110
 4.6 Initial Setup Wizard – VPN 112
 4.6.1 VPN Setup Wizard: Wizard Type 113
 4.6.2 VPN Express Wizard – Scenario 113
 4.6.3 VPN Express Wizard – Configuration 116
 4.6.4 VPN Express Wizard – Summary 116
 4.6.5 VPN Express Wizard – Finish 117

4.6.6 VPN Advanced Wizard – Scenario	118
4.6.7 VPN Advanced Wizard – Phase 1 Settings	119
4.6.8 VPN Advanced Wizard – Phase 2	120
4.6.9 VPN Advanced Wizard – Summary	121
4.6.10 VPN Advanced Wizard – Finish	122
4.7 VPN Settings for Configuration Provisioning Wizard: Wizard Type	123
4.7.1 Configuration Provisioning Express Wizard – VPN Settings	124
4.7.2 Configuration Provisioning VPN Express Wizard – Configuration	125
4.7.3 VPN Settings for Configuration Provisioning Express Wizard – Summary	126
4.7.4 VPN Settings for Configuration Provisioning Express Wizard – Finish	127
4.7.5 VPN Settings for Configuration Provisioning Advanced Wizard – Scenario	128
4.7.6 VPN Settings for Configuration Provisioning Advanced Wizard – Phase 1 Settings ...	129
4.7.7 VPN Settings for Configuration Provisioning Advanced Wizard – Phase 2	130
4.7.8 VPN Settings for Configuration Provisioning Advanced Wizard – Summary	131
4.7.9 VPN Settings for Configuration Provisioning Advanced Wizard – Finish	134
4.8 VPN Settings for L2TP VPN Settings Wizard	135
4.8.1 L2TP VPN Settings	136
4.8.2 L2TP VPN Settings 2	137
4.8.3 VPN Settings for L2TP VPN Setting Wizard – Summary	137
4.8.4 VPN Settings for L2TP VPN Setting Wizard Completed	139
4.9 Port Forwarding	140
4.9.1 Port Forwarding > Add Client	141
4.9.2 Port Forwarding > Add Service	141
4.9.3 Port Forwarding > UPnP	141
4.10 Wi-Fi and Guest Network Wizard	142
4.10.1 Guest LAN (Wired Network)	143
4.10.2 Connecting AP Scenarios	145
4.11 Security Service Wizard	146
4.11.1 Security Service Wizard 2 – Content Filter Categories	148
4.11.2 Security Service Wizard 3 – Websites	150
4.11.3 Security Service Wizard 4 – Exemptions	151
4.11.4 Security Service Wizard 5 – IDP/AV	152
4.12 MyZyxel Portal	153
4.13 One Security Portal	154

Chapter 5

Quick Setup Wizards..... 156

5.1 Quick Setup Overview	156
5.2 WAN Interface Quick Setup	157
5.2.1 Choose an Ethernet Interface	157
5.2.2 Select WAN Type	158
5.2.3 Configure WAN IP Settings	159
5.2.4 ISP and WAN and ISP Connection Settings	160

5.2.5 Quick Setup Interface Wizard: Summary	162
5.3 Remote Access VPN Setup Wizard	163
5.4 Remote Access VPN Setup – Scenario	164
5.4.1 Zyxel VPN Client – VPN Configuration	164
5.4.2 Zyxel VPN Client – User Authentication	166
5.4.3 Zyxel VPN Client – Summary	167
5.4.4 L2TP over IPSec Client – VPN Configuration	168
5.4.5 L2TP over IPSec Client – User Authentication	170
5.4.6 L2TP over IPSec Client – Summary	171
5.4.7 L2TP over IPSec Client – Config Provision	172
5.5 VPN Setup	173
5.5.1 VPN Setup Wizard: Wizard Type	174
5.5.2 VPN Express Wizard – Scenario	175
5.5.3 VPN Express Wizard – Configuration	176
5.5.4 VPN Express Wizard – Summary	176
5.5.5 VPN Express Wizard – Finish	177
5.5.6 VPN Advanced Wizard – Scenario	178
5.5.7 VPN Advanced Wizard – Phase 1 Settings	179
5.5.8 VPN Advanced Wizard – Phase 2	180
5.5.9 VPN Advanced Wizard – Summary	181
5.5.10 VPN Advanced Wizard – Finish	183
5.6 VPN Settings for Configuration Provisioning Wizard: Wizard Type	184
5.6.1 Configuration Provisioning Express Wizard – VPN Settings	184
5.6.2 Configuration Provisioning VPN Express Wizard – Configuration	185
5.6.3 VPN Settings for Configuration Provisioning Express Wizard – Summary	186
5.6.4 VPN Settings for Configuration Provisioning Express Wizard – Finish	187
5.6.5 VPN Settings for Configuration Provisioning Advanced Wizard – Scenario	188
5.6.6 VPN Settings for Configuration Provisioning Advanced Wizard – Phase 1 Settings	189
5.6.7 VPN Settings for Configuration Provisioning Advanced Wizard – Phase 2	190
5.6.8 VPN Settings for Configuration Provisioning Advanced Wizard – Summary	191
5.6.9 VPN Settings for Configuration Provisioning Advanced Wizard – Finish	193
5.7 VPN Settings for L2TP VPN Settings Wizard	194
5.7.1 L2TP VPN Settings	195
5.7.2 L2TP VPN Settings	196
5.7.3 VPN Settings for L2TP VPN Setting Wizard – Summary	197
5.7.4 VPN Settings for L2TP VPN Setting Wizard Completed	198

Chapter 6

Dashboard	199
6.1 Overview	199
6.1.1 What You Can Do in this Chapter	199
6.2 Main Dashboard Screen	199
6.2.1 Device Information Screen	201

6.2.2 System Status Screen	202
6.2.3 DHCP Table Screen	203
6.2.4 Number of Login Users Screen	204
6.2.5 System Resources Screen	205
6.2.6 Extension Slot Screen	206
6.2.7 Interface Status Summary Screen	207
6.2.8 Secured Service Status Screen	208
6.2.9 Content Filter Statistics Screen	209
6.2.10 Top 5 Viruses Screen	209
6.2.11 Top 5 Intrusions Screen	210
6.2.12 Top 5 IPv4/IPv6 Security Policy Rules that Blocked Traffic Screen	210
6.2.13 The Latest Alert Logs Screen	211
6.3 VPN Screen	211

Part II: Technical Reference..... 213

Chapter 7 Monitor.....214

7.1 Overview	214
7.1.1 What You Can Do in this Chapter	214
7.2 Port Statistics Screen	216
7.2.1 The Port Statistics Graph Screen	217
7.3 Interface Status Screen	218
7.4 The Traffic Statistics Screen	222
7.5 The Session Monitor Screen	225
7.6 IGMP Statistics	227
7.7 The DDNS Status Screen	228
7.8 IP/MAC Binding	228
7.9 The Login Users Screen	229
7.10 The Dynamic Guest Screen	230
7.11 Cellular Status Screen	232
7.11.1 More Information	234
7.12 The UPnP Port Status Screen	235
7.13 USB Storage Screen	236
7.14 Ethernet Neighbor Screen	237
7.15 FQDN Object Screen	238
7.16 AP Information: AP List	240
7.16.1 AP List: More Information	244
7.16.2 AP List: Config AP	247
7.17 AP Information: Radio List	250
7.17.1 Radio List: More Information	252

7.18 AP Information: Top N APs	253
7.19 AP Information: Single AP	255
7.20 ZyMesh	256
7.21 SSID Info	257
7.22 Station Info: Station List	257
7.23 Station Info: Top N Stations	259
7.24 Station Info: Single Station	260
7.25 Detected Device	261
7.26 The Printer Status Screen	262
7.27 The IPSec Screen	263
7.28 The SSL Screen	264
7.29 The L2TP over IPSec Screen	265
7.30 The App Patrol Screen	266
7.31 The Content Filter Screen	267
7.32 The IDP Screen	268
7.33 The Anti-Virus Screen	270
7.34 The Anti-Spam Screens	272
7.34.1 Anti-Spam Summary	273
7.34.2 The Anti-Spam Status Screen	274
7.35 The SSL Inspection Screens	276
7.35.1 Certificate Cache List	277
7.36 Log Screens	278
7.36.1 View Log	278
7.36.2 View AP Log	280
7.36.3 Dynamic Users Log	282
Chapter 8	
Licensing.....	284
8.1 Registration Overview	284
8.1.1 What you Need to Know	284
8.1.2 Registration Screen	284
8.1.3 Service Screen	285
8.2 Signature Update	287
8.2.1 What you Need to Know	287
8.2.2 The Anti-Virus Update Screen	287
8.2.3 The IDP/AppPatrol Update Screen	288
Chapter 9	
Wireless.....	291
9.1 Overview	291
9.1.1 What You Can Do in this Chapter	291
9.2 Controller Screen	291
9.3 AP Management Screens	293

9.3.1 Mgnt. AP List	293
9.3.2 AP Policy	301
9.3.3 AP Group	303
9.3.4 Firmware	309
9.4 Rogue AP	311
9.4.1 Add/Edit Rogue/Friendly List	313
9.5 Auto Healing	314
9.6 RTLS Overview	315
9.6.1 What You Can Do in this Chapter	315
9.6.2 Before You Begin	315
9.6.3 Configuring RTLS	316
9.7 Technical Reference	317
9.7.1 Dynamic Channel Selection	317
9.7.2 Load Balancing	318

Chapter 10
Interfaces.....319

10.1 Interface Overview	319
10.1.1 What You Can Do in this Chapter	319
10.1.2 What You Need to Know	320
10.1.3 What You Need to Do First	324
10.2 Port Role	324
10.3 Port Configuration	325
10.4 Ethernet Summary Screen	326
10.4.1 Ethernet Edit	328
10.4.2 Proxy ARP	347
10.4.3 Virtual Interfaces	349
10.4.4 References	350
10.4.5 Add/Edit DHCPv6 Request/Release Options	351
10.4.6 Add/Edit DHCP Extended Options	351
10.5 PPP Interfaces	353
10.5.1 PPP Interface Summary	353
10.5.2 PPP Interface Add or Edit	355
10.6 Cellular Configuration Screen	359
10.6.1 Cellular Choose Slot	363
10.6.2 Add / Edit Cellular Configuration	363
10.7 Tunnel Interfaces	369
10.7.1 Configuring a Tunnel	371
10.7.2 Tunnel Add or Edit Screen	372
10.8 VLAN Interfaces	376
10.8.1 VLAN Summary Screen	377
10.8.2 VLAN Add/Edit	379
10.9 Bridge Interfaces	391

10.9.1 Bridge Summary	393
10.9.2 Bridge Add/Edit	394
10.10 LAG	405
10.10.1 LAG Summary Screen	405
10.10.2 LAG Add/Edit	407
10.11 VTI	412
10.11.1 Restrictions for IPSec Virtual Tunnel Interface	412
10.11.2 VTI Screen	412
10.11.3 VTI Add/Edit	413
10.12 Trunk Overview	417
10.12.1 What You Need to Know	417
10.13 The Trunk Summary Screen	420
10.13.1 Configuring a User-Defined Trunk	421
10.13.2 Configuring the System Default Trunk	423
10.14 Interface Technical Reference	424
Chapter 11	
Routing	429
11.1 Policy and Static Routes Overview	429
11.1.1 What You Can Do in this Chapter	429
11.1.2 What You Need to Know	430
11.2 Policy Route Screen	431
11.2.1 Policy Route Edit Screen	433
11.3 IP Static Route Screen	438
11.3.1 Static Route Add/Edit Screen	438
11.4 Policy Routing Technical Reference	440
11.5 Routing Protocols Overview	440
11.5.1 What You Need to Know	441
11.6 RIP Screen	441
11.7 OSPF Screen	443
11.7.1 Configuring the OSPF Screen	446
11.7.2 OSPF Area Add/Edit Screen	447
11.7.3 Virtual Link Add/Edit Screen	449
11.8 BGP (Border Gateway Protocol)	450
11.8.1 Allow BGP Packets to Enter the Zyxel Device	451
11.8.2 Configuring the BGP Screen	451
11.8.3 BGP Neighbors Screen	453
11.8.4 Example Scenario	454
Chapter 12	
DDNS	456
12.1 DDNS Overview	456
12.1.1 What You Can Do in this Chapter	456

12.1.2 What You Need to Know	456
12.2 The DDNS Screen	457
12.2.1 The Dynamic DNS Add/Edit Screen	458
Chapter 13	
NAT	462
13.1 Overview	462
13.2 NAT Overview	462
13.2.1 What You Can Do in this Chapter	462
13.2.2 What You Need to Know	462
13.3 The NAT Screen	464
13.3.1 The NAT Add/Edit Screen	465
13.4 NAT Technical Reference	468
Chapter 14	
Redirect Service	471
14.1 Overview	471
14.1.1 HTTP Redirect	471
14.1.2 SMTP Redirect	471
14.1.3 What You Can Do in this Chapter	472
14.1.4 What You Need to Know	472
14.2 The Redirect Service Screen	474
14.2.1 The Redirect Service Edit Screen	475
Chapter 15	
ALG	477
15.1 ALG Overview	477
15.1.1 What You Need to Know	477
15.1.2 Before You Begin	480
15.2 The ALG Screen	480
15.3 ALG Technical Reference	483
Chapter 16	
UPnP	485
16.1 UPnP and NAT-PMP Overview	485
16.2 What You Need to Know	485
16.2.1 NAT Traversal	485
16.2.2 Cautions with UPnP and NAT-PMP	486
16.3 UPnP Screen	486
16.4 Technical Reference	487
16.4.1 Turning on UPnP in Windows 7 Example	487
16.4.2 Turn on UPnP in Windows 10 Example	491
16.4.3 Auto-discover Your UPnP-enabled Network Device	493

16.4.4 Web Configurator Easy Access in Windows 7	496
16.4.5 Web Configurator Easy Access in Windows 10	498
Chapter 17	
IP/MAC Binding	500
17.1 IP/MAC Binding Overview	500
17.1.1 What You Can Do in this Chapter	500
17.1.2 What You Need to Know	500
17.2 IP/MAC Binding Summary	501
17.2.1 IP/MAC Binding Edit	501
17.2.2 Static DHCP Edit	503
17.3 IP/MAC Binding Exempt List	503
Chapter 18	
Layer 2 Isolation	505
18.1 Overview	505
18.1.1 What You Can Do in this Chapter	505
18.2 Layer-2 Isolation General Screen	505
18.3 White List Screen	506
18.3.1 Add/Edit White List Rule	507
Chapter 19	
DNS Inbound LB	509
19.1 DNS Inbound Load Balancing Overview	509
19.1.1 What You Can Do in this Chapter	509
19.2 The DNS Inbound LB Screen	510
19.2.1 The DNS Inbound LB Add/Edit Screen	511
19.2.2 The DNS Inbound LB Add/Edit Member Screen	514
Chapter 20	
Web Authentication	515
20.1 Web Auth Overview	515
20.1.1 What You Can Do in this Chapter	515
20.1.2 What You Need to Know	516
20.2 Web Authentication General Screen	516
20.2.1 User-aware Access Control Example	521
20.2.2 Authentication Type Screen	527
20.2.3 Custom Web Portal / User Agreement File Screen	531
20.2.4 Facebook Wi-Fi Screen	532
20.3 SSO Overview	536
20.4 SSO – Zyxel Device Configuration	538
20.4.1 Configuration Overview	538
20.4.2 Configure the Zyxel Device to Communicate with SSO	538

20.4.3 Enable Web Authentication	539
20.4.4 Create a Security Policy	541
20.4.5 Configure User Information	542
20.4.6 Configure an Authentication Method	543
20.4.7 Configure Active Directory	544
20.5 SSO Agent Configuration	545
Chapter 21	
Hotspot.....	549
21.1 Overview	549
21.2 Billing Overview	549
21.2.1 What You Need to Know	549
21.3 The Billing > General Screen	550
21.4 The Billing > Billing Profile Screen	552
21.4.1 The Account Generator Screen	553
21.4.2 The Account Redeem Screen	556
21.4.3 The Billing Profile Add/Edit Screen	558
21.5 The Billing > Discount Screen	559
21.5.1 The Discount Add/Edit Screen	561
21.6 The Billing > Payment Service Screen	561
21.6.1 The Payment Service > Desktop / Mobile View Screen	563
Chapter 22	
Printer Manager	567
22.1 Printer Manager Overview	567
22.1.1 What You Can Do in this Chapter	567
22.2 The Printer Manager > General Screen	567
22.2.1 Add Printer Rule	570
22.2.2 Edit Printer Rule	570
22.2.3 Discover Printer	571
22.2.4 Edit Printer Manager (Discover Printer)	573
22.3 The Printout Configuration Screen	574
22.4 Printer Reports Overview	575
22.4.1 Key Combinations	575
22.4.2 Daily Account Summary	575
22.4.3 Monthly Account Summary	576
22.4.4 Account Report Notes	576
22.4.5 System Status	577
Chapter 23	
Free Time.....	579
23.1 Free Time Overview	579
23.1.1 What You Can Do in this Chapter	579

23.2 The Free Time Screen	579
Chapter 24	
IPnP.....	584
24.1 IPnP Overview	584
24.1.1 What You Can Do in this Chapter	585
24.1.2 IPnP Screen	585
Chapter 25	
Walled Garden.....	587
25.1 Walled Garden Overview	587
25.2 Walled Garden > General Screen	587
25.3 Walled Garden > URL Base Screen	588
25.3.1 Adding/Editing a Walled Garden URL	589
25.4 Walled Garden > Domain/IP Base Screen	590
25.4.1 Adding/Editing a Walled Garden Domain or IP	591
25.4.2 Walled Garden Login Example	591
Chapter 26	
Advertisement Screen.....	593
26.1 Advertisement Overview	593
26.1.1 Adding/Editing an Advertisement URL	594
Chapter 27	
Security Policy.....	596
27.1 Overview	596
27.2 One Security	597
27.3 What You Can Do in this Chapter	600
27.3.1 What You Need to Know	601
27.4 Security Policy Screen	602
27.4.1 Configuring the Security Policy Control Screen	603
27.4.2 Security Check for Web Interface Screen	606
27.4.3 Security Policy Control Add/Edit Screen	608
27.5 Anomaly Detection and Prevention Overview	610
27.5.1 Anomaly Detection and Prevention General Screen	611
27.5.2 Creating New ADP Profiles	612
27.5.3 Traffic Anomaly Profiles	613
27.5.4 Protocol Anomaly Profiles	616
27.6 Session Control Screen	619
27.6.1 Session Control Add/Edit Screen	620
27.7 Security Policy Example Applications	621
Chapter 28	
Cloud CNM.....	624

28.1 Cloud CNM Overview	624
28.1.1 What You Can Do in this Chapter	624
28.2 Cloud CNM SecuManager	624
28.3 Cloud CNM SecuReporter	627
Chapter 29	
Amazon VPC	633
29.1 Overview	633
29.2 Amazon VPC Configuration Process	633
Chapter 30	
IPSec VPN	635
30.1 Virtual Private Networks (VPN) Overview	635
30.1.1 What You Can Do in this Chapter	637
30.1.2 What You Need to Know	637
30.1.3 Before You Begin	640
30.2 VPN Connection Screen	640
30.2.1 VPN Connection Add/Edit Screen	642
30.3 VPN Gateway Screen	649
30.3.1 VPN Gateway Add/Edit Screen	650
30.4 VPN Concentrator	657
30.4.1 VPN Concentrator Requirements and Suggestions	657
30.4.2 VPN Concentrator Screen	658
30.4.3 VPN Concentrator Add/Edit Screen	658
30.5 Zyxel Device IPSec VPN Client Configuration Provisioning	659
30.6 IPSec VPN Background Information	662
Chapter 31	
SSL VPN.....	671
31.1 Overview	671
31.1.1 What You Can Do in this Chapter	671
31.1.2 What You Need to Know	671
31.2 The SSL Access Privilege Screen	672
31.2.1 The SSL Access Privilege Policy Add/Edit Screen	673
31.3 The SSL Global Setting Screen	676
31.3.1 How to Upload a Custom Logo	677
Chapter 32	
SSL User Screens.....	679
32.1 Overview	679
32.1.1 What You Need to Know	679
32.2 Remote SSL User Login	680
32.3 The SSL VPN User Screens	682

32.4	Bookmarking the Zyxel Device	682
32.5	Logging Out of the SSL VPN User Screens	683
32.6	SSL User Application Screen	683
32.7	SSL User File Sharing	684
32.7.1	The Main File Sharing Screen	684
32.7.2	Opening a File or Folder	685
32.7.3	Downloading a File	686
32.7.4	Saving a File	686
32.7.5	Creating a New Folder	687
32.7.6	Renaming a File or Folder	687
32.7.7	Deleting a File or Folder	688
32.7.8	Uploading a File	688
32.8	SecuExtender Screen	689
32.8.1	Installing the SecuExtender Client	689
Chapter 33		
Zyxel Device SecuExtender (Windows)		692
33.1	The Zyxel Device SecuExtender Icon	692
33.2	Status	692
33.3	View Log	693
33.4	Suspend and Resume the Connection	694
33.5	Stop the Connection	694
33.6	Uninstalling the Zyxel Device SecuExtender	694
Chapter 34		
L2TP VPN		696
34.1	Overview	696
34.1.1	What You Can Do in this Chapter	696
34.1.2	What You Need to Know	696
34.2	L2TP VPN Screen	697
34.2.1	Example: L2TP and Zyxel Device Behind a NAT Router	699
Chapter 35		
BWM (Bandwidth Management)		701
35.1	Overview	701
35.1.1	What You Can Do in this Chapter	701
35.1.2	What You Need to Know	701
35.2	The Bandwidth Management Configuration	705
35.2.1	The Bandwidth Management Add/Edit Screen	708
Chapter 36		
Application Patrol		716
36.1	Overview	716

36.1.1 What You Can Do in this Chapter	716
36.1.2 What You Need to Know	716
36.2 Application Patrol Profile	717
36.2.1 The Application Patrol Profile Add/Edit Screen	719
36.2.2 The Application Patrol Profile Rule Add Application Screen	720
Chapter 37	
Content Filtering.....	722
37.1 Overview	722
37.1.1 What You Can Do in this Chapter	722
37.1.2 What You Need to Know	722
37.1.3 Before You Begin	724
37.2 Content Filter Profile Screen	724
37.2.1 Content Filter Add Profile Category Service	726
37.2.2 Content Filter Add Filter Profile Custom Service	741
37.3 Content Filter Trusted Web Sites Screen	744
37.4 Content Filter Forbidden Web Sites Screen	745
37.5 Content Filter Technical Reference	746
Chapter 38	
IDP	748
38.1 Overview	748
38.1.1 What You Can Do in this Chapter	748
38.1.2 What You Need To Know	748
38.1.3 Before You Begin	748
38.2 The IDP Profile Screen	749
38.2.1 Base Profiles	750
38.2.2 Adding / Editing Profiles	751
38.2.3 Profile > Group View Screen	752
38.2.4 Add Profile > Query View	755
38.2.5 Query Example	759
38.3 IDP Custom Signatures	760
38.3.1 Add / Edit Custom Signatures	763
38.3.2 Custom Signature Example	767
38.3.3 Applying Custom Signatures	769
38.3.4 Verifying Custom Signatures	769
38.4 IDP Technical Reference	770
Chapter 39	
Anti-Virus.....	773
39.1 Overview	773
39.1.1 What You Can Do in this Chapter	775
39.2 Anti-Virus Profile Screen	775

39.2.1 Anti-Virus Profile Add or Edit	777
39.3 Anti-Virus Black List	779
39.3.1 Anti-Virus Black List or White List Add/Edit	780
39.3.2 Anti-Virus Black/White List	781
39.4 AV Signature Searching	782
39.5 Anti-Virus Technical Reference	783
Chapter 40	
Anti-Spam.....	785
40.1 Overview	785
40.1.1 What You Can Do in this Chapter	785
40.1.2 What You Need to Know	785
40.2 Before You Begin	786
40.3 The Anti-Spam Profile Screen	787
40.3.1 The Anti-Spam Profile Add or Edit Screen	788
40.4 The Mail Scan Screen	790
40.5 The Anti-Spam Black List Screen	791
40.5.1 The Anti-Spam Black or White List Add/Edit Screen	793
40.5.2 Regular Expressions in Black or White List Entries	794
40.6 The Anti-Spam White List Screen	794
40.7 The DNSBL Screen	796
40.8 Anti-Spam Technical Reference	798
Chapter 41	
SSL Inspection.....	802
41.1 Overview	802
41.1.1 What You Can Do in this Chapter	802
41.1.2 What You Need To Know	802
41.1.3 Before You Begin	803
41.2 The SSL Inspection Profile Screen	803
41.2.1 Add / Edit SSL Inspection Profiles	804
41.3 Exclude List Screen	807
41.4 Certificate Update Screen	808
41.5 Install a CA Certificate in a Browser	809
Chapter 42	
Device HA.....	812
42.1 Device HA Overview	812
42.1.1 Device HA and Device HA Pro Differences	812
42.1.2 What You Can Do in These Screens	813
42.2 Device HA General	813
42.2.1 Before You Begin	814
42.3 The Device HA Screen	816

42.3.1 Configuring Device HA	817
42.3.2 Device HA Edit Monitored Interface	820
42.3.3 Device HA Technical Reference	822
42.4 Device HA > Device HA Pro	825
42.4.1 Deploying Device HA Pro	825
42.4.2 Configuring Device HA Pro	826
Chapter 43	
Object	828
43.1 Zones Overview	828
43.1.1 What You Need to Know	828
43.1.2 The Zone Screen	829
43.2 User/Group Overview	831
43.2.1 What You Need To Know	831
43.2.2 User/Group User Summary Screen	833
43.2.3 User Add/Edit General Screen	834
43.2.4 User Add/Edit Two-factor Authentication Screen	837
43.2.5 User/Group Group Summary Screen	839
43.2.6 User/Group Setting Screen	841
43.2.7 User/Group MAC Address Summary Screen	845
43.2.8 User /Group Technical Reference	847
43.3 AP Profile Overview	847
43.3.1 Radio Screen	848
43.3.2 SSID Screen	854
43.4 MON Profile	874
43.4.1 Overview	874
43.4.2 Configuring MON Profile	874
43.4.3 Add/Edit MON Profile	875
43.4.4 Technical Reference	877
43.5 ZyMesh Overview	878
43.5.1 ZyMesh Profile	880
43.5.2 Add/Edit ZyMesh Profile	881
43.6 Application	881
43.6.1 Add Application Rule	884
43.6.2 Application Group Screen	886
43.7 Address/Geo IP Overview	888
43.7.1 What You Need To Know	888
43.7.2 Address Summary Screen	888
43.7.3 Address Group Summary Screen	892
43.7.4 Geo IP Summary Screen	894
43.8 Service Overview	897
43.8.1 What You Need to Know	897
43.8.2 The Service Summary Screen	898

43.8.3 The Service Group Summary Screen	900
43.9 Schedule Overview	902
43.9.1 What You Need to Know	902
43.9.2 The Schedule Screen	902
43.9.3 The Schedule Group Screen	905
43.10 AAA Server Overview	907
43.10.1 Directory Service (AD/LDAP)	908
43.10.2 RADIUS Server	908
43.10.3 ASAS	908
43.10.4 What You Need To Know	909
43.10.5 Active Directory or LDAP Server Summary	910
43.10.6 RADIUS Server Summary	914
43.11 Auth. Method Overview	916
43.11.1 Before You Begin	916
43.11.2 Example: Selecting a VPN Authentication Method	916
43.11.3 Authentication Method Objects	917
43.11.4 Two-Factor Authentication	919
43.11.5 Two-Factor Authentication Admin Access	923
43.12 Certificate Overview	925
43.12.1 What You Need to Know	925
43.12.2 Verifying a Certificate	926
43.12.3 The My Certificates Screen	927
43.12.4 The Trusted Certificates Screen	936
43.12.5 Certificates Technical Reference	941
43.13 ISP Account Overview	941
43.13.1 ISP Account Summary	941
43.14 SSL Application Overview	944
43.14.1 What You Need to Know	944
43.14.2 The SSL Application Screen	946
43.15 DHCPv6 Overview	949
43.15.1 The DHCPv6 Request Screen	949
43.15.2 The DHCPv6 Lease Screen	951

Chapter 44

System.....953

44.1 Overview	953
44.1.1 What You Can Do in this Chapter	953
44.2 Host Name	954
44.3 USB Storage	954
44.4 Date and Time	955
44.4.1 Pre-defined NTP Time Servers List	958
44.4.2 Time Server Synchronization	958
44.5 Console Port Speed	959

44.6 DNS Overview	960
44.6.1 DNS Server Address Assignment	960
44.6.2 Configuring the DNS Screen	960
44.6.3 (IPv6) Address Record	963
44.6.4 PTR Record	964
44.6.5 Adding an (IPv6) Address/PTR Record	964
44.6.6 CNAME Record	964
44.6.7 Adding a CNAME Record	965
44.6.8 Domain Zone Forwarder	965
44.6.9 Adding a Domain Zone Forwarder	965
44.6.10 MX Record	966
44.6.11 Adding a MX Record	967
44.6.12 Security Option Control	967
44.6.13 Editing a Security Option Control	967
44.6.14 Adding a DNS Service Control Rule	968
44.7 WWW Overview	969
44.7.1 Service Access Limitations	969
44.7.2 System Timeout	970
44.7.3 HTTPS	970
44.7.4 Configuring WWW Service Control	971
44.7.5 Service Control Rules	974
44.7.6 Customizing the WWW Login Page	975
44.7.7 HTTPS Example	980
44.8 SSH	987
44.8.1 How SSH Works	988
44.8.2 SSH Implementation on the Zyxel Device	989
44.8.3 Requirements for Using SSH	989
44.8.4 Configuring SSH	989
44.8.5 Secure Telnet Using SSH Examples	990
44.9 Telnet	992
44.9.1 Configuring Telnet	992
44.10 FTP	993
44.10.1 Configuring FTP	993
44.11 SNMP	994
44.11.1 SNMPv3 and Security	995
44.11.2 Supported MIBs	996
44.11.3 SNMP Traps	996
44.11.4 Configuring SNMP	996
44.11.5 Add SNMPv3 User	998
44.12 Authentication Server	999
44.12.1 Add/Edit Trusted RADIUS Client	1001
44.13 Notification > Mail Server	1001
44.14 Notification > SMS	1003

44.15 Notification > Response Message	1004
44.16 Language Screen	1006
44.17 IPv6 Screen	1006
44.18 Zyxel One Network (ZON) Utility	1007
44.18.1 Requirements	1007
44.18.2 Run the ZON Utility	1008
44.18.3 Zyxel One Network (ZON) System Screen	1011
44.19 Advanced Screen	1012
44.19.1 Fast Forwarding Technical Reference	1012
Chapter 45	
Log and Report.....	1014
45.1 Overview	1014
45.1.1 What You Can Do In this Chapter	1014
45.2 Email Daily Report	1014
45.3 Log Setting Screens	1016
45.3.1 Log Setting Summary	1016
45.3.2 Edit System Log Settings	1017
45.3.3 Edit Log on USB Storage Setting	1022
45.3.4 Edit Remote Server Log Settings	1024
45.3.5 Log Category Settings Screen	1027
Chapter 46	
File Manager	1032
46.1 Overview	1032
46.1.1 What You Can Do in this Chapter	1032
46.1.2 What you Need to Know	1032
46.2 The Configuration Screen	1034
46.2.1 The Configuration Schedule Backup Screen	1039
46.3 Firmware Management	1040
46.3.1 Firmware Upload and Device HA Pro	1041
46.3.2 Cloud Helper	1041
46.3.3 The Firmware Management Screen	1043
46.3.4 Firmware Upgrade via USB Stick	1045
46.4 The Shell Script Screen	1045
Chapter 47	
Diagnostics	1048
47.1 Overview	1048
47.1.1 What You Can Do in this Chapter	1048
47.2 The Diagnostics Screens	1048
47.2.1 Scripts	1048
47.2.2 The Diagnostics Controller Screen	1049

47.2.3 The Diagnostics AP Screen	1051
47.2.4 The Diagnostics Files Screen	1052
47.3 The Packet Capture Screen	1053
47.3.1 The Packet Capture on AP Screen	1056
47.3.2 The Packet Capture Files Screen	1059
47.4 The CPU / Memory Status Screen	1060
47.5 The System Log Screen	1062
47.6 The Network Tool Screen	1063
47.7 The Routing Traces Screen	1065
47.8 The Wireless Frame Capture Screen	1066
47.8.1 The Wireless Frame Capture Files Screen	1068
Chapter 48	
Packet Flow Explore	1069
48.1 Overview	1069
48.1.1 What You Can Do in this Chapter	1069
48.2 The Routing Status Screen	1069
48.3 The SNAT Status Screen	1074
Chapter 49	
Shutdown/Reboot	1077
49.1 Overview	1077
49.1.1 What You Need To Know	1077
49.2 The Shutdown Screen	1077
 Part III: Appendices and Troubleshooting	 1079
Chapter 50	
Troubleshooting	1080
50.1 Resetting the Zyxel Device	1092
50.2 Getting More Troubleshooting Help	1093
Appendix A Customer Support	1094
Appendix B Common Services	1099
Appendix C Product Features	1102
Appendix D Legal Information	1108
Index	1121

PART I

User's Guide

CHAPTER 1

Introduction

1.1 Overview

ZyXel Device refers to these models as outlined below.

- ZyWALL
- ZyWALL USG (Unified Security Gateway)

Table 1 ZyXel Device Model

ZYWALL	ZYWALL USG
ZyWALL 110	USG40
ZyWALL 310	USG40W
ZyWALL 1100	USG60
	USG60W
	USG110
	USG210
	USG310
	USG1100
	USG1900
	USG2200

The next table shows the key feature differences between the models besides performance variance. Note that your ZyXel Device may not support all UTM features.

Table 2 ZyWALL USG Key Feature Comparison Table

FEATURE	ZYWALL			USG									
	110	310	1100	40	60	40W	60W	110	210	310	1100	1900	2200
Amazon VPC (on Web Configurator)	CLI Only	CLI Only	CLI Only	CLI Only	CLI Only	CLI Only	CLI Only	CLI Only	CLI Only	CLI Only	CLI Only	CLI Only	CLI Only
Anomaly Detection & Prevention	YES	YES	YES	YES	YES	YES	YES	YES	YES	YES	YES	YES	YES
Anti-Spam	YES	YES	YES	YES	YES	YES	YES	YES	YES	YES	YES	YES	YES
Anti-Virus	YES	YES	YES	YES	YES	YES	YES	YES	YES	YES	YES	YES	YES
AP Controller	YES	YES	YES	YES	YES	YES	YES	YES	YES	YES	YES	YES	YES
App Patrol	YES	YES	YES	YES	YES	YES	YES	YES	YES	YES	YES	YES	YES
Content Filtering	YES	YES	YES	YES	YES	YES	YES	YES	YES	YES	YES	YES	YES
Device HA Pro	YES	YES	YES	NO	NO	NO	NO	YES	YES	YES	YES	YES	YES
Easy Mode	YES	NO	NO	YES	YES	YES	YES	YES	NO	NO	NO	NO	NO
Hotspot Management	YES	YES	YES	NO	YES	NO	YES	YES	YES	YES	YES	YES	YES
IDP	YES	YES	YES	YES	YES	YES	YES	YES	YES	YES	YES	YES	YES

Table 2 ZyWALL USG Key Feature Comparison Table (continued)

FEATURE	ZYWALL			USG									
	110	310	1100	40	60	40W	60W	110	210	310	1100	1900	2200
IP Exception	NO	NO	NO	NO	NO	NO	NO	NO	NO	NO	NO	NO	NO
LAG	NO	YES	YES	NO	NO	NO	NO	NO	NO	YES	YES	YES	YES
Microsoft Azure	YES	YES	YES	YES	YES	YES	YES	YES	YES	YES	YES	YES	YES
Port Role	NO	YES	YES	NO	NO	NO	NO	NO	NO	YES	YES	YES	YES
Port Group	YES	NO	NO	YES	YES	YES	YES	YES	YES	NO	NO	NO	NO
Reputation Filter (IP and DNS)	NO	NO	NO	NO	NO	NO	NO	NO	NO	NO	NO	NO	NO
Sandboxing	NO	NO	NO	NO	NO	NO	NO	NO	NO	NO	NO	NO	NO
SD-WAN mode	NO	NO	NO	NO	NO	NO	NO	NO	NO	NO	NO	NO	NO
SecuReporter	YES	YES	YES	YES	YES	YES	YES	YES	YES	YES	YES	YES	YES
SSL Application	YES	YES	YES	YES	YES	YES	YES	YES	YES	YES	YES	YES	YES
SSL Encrypted Traffic Inspection	YES	YES	YES	NO	NO	NO	NO	YES	YES	YES	YES	YES	YES
URL Threat Filter	NO	NO	NO	NO	NO	NO	NO	NO	NO	NO	NO	NO	NO
UTM feature License-need to buy	YES	YES	YES	after 1yr	after 1yr	after 1yr	after 1yr	after 1yr	after 1yr	after 1yr	after 1yr	after 1yr	after 1yr
Built-in AP	NO	NO	NO	NO	NO	YES	YES	NO	NO	NO	NO	NO	NO

- Not all models support all UTM (Unified Threat Management) features. See [Table 2 on page 28](#) for the specific UTM features that your model supports.

Table 3 UTM Feature List

• Application Patrol (AP)	• Intrusion Detection & Prevention (IDP)
• Anomaly Detection & Prevention (ADP)	• Content Filtering (CF)
• Anti-Virus (AV)	• Anti-Spam (AS)
• Secure Socket Layer (SSL) encrypted traffic Inspection	

The following UTM features work without a UTM license:

- Configuration > Content Filter > Trusted Web Sites
- Configuration > IDP > Custom Signatures
- Configuration > Anti-Virus > Black/White List
- Configuration > Anti-Spam > Black/White List
- Models that came with firmware versions 4.10 to 4.25 support both Device HA and Device HA Pro even after upgrading to versions 4.30 and later:

- | | | |
|--------------|--------------|---------------|
| • ZyWALL 110 | • ZyWALL 310 | • ZyWALL 1100 |
| • USG110 | • USG210 | • USG310 |
| • USG1100 | • USG1900 | • USG2200 |

Some interface names vary by model - see [Table 22 on page 86](#) and [Table 23 on page 87](#) for default port / interface name mapping. See [Table 24 on page 87](#) and [Table 25 on page 88](#) for default interface / zone mapping.

See the product's datasheet for detailed information on a specific model.

1.2 Registration at myZyxel

myZyxel is Zyxel's online services center where you can register your Zyxel Device and manage subscription services available for your Zyxel Device (see **Configuration > Licensing > Registration > Service** for services available for your Zyxel Device).

- For Zyxel Devices that already have firmware version 4.25 or later, you have to register your Zyxel Device and activate the corresponding service at myZyxel (through your Zyxel Device).
- For Zyxel Devices upgrading to firmware version 4.25 or later, you may skip registering your Zyxel Device and activating the corresponding service at myZyxel (through your Zyxel Device). However, it is highly recommended to at least register your Zyxel Device. At the time of writing, the Firmware Upgrade license providing Cloud Helper new firmware notifications, is free when you register your Zyxel Device.

Note: You need to create a myZyxel account at <http://portal.myZyxel.com> before you can register your device and activate the services at myZyxel.

You may need your Zyxel Device's serial number and LAN MAC address to register it at myZyxel. See the label at the back of the Zyxel Device's for details.

Figure 1 myZyxel Login

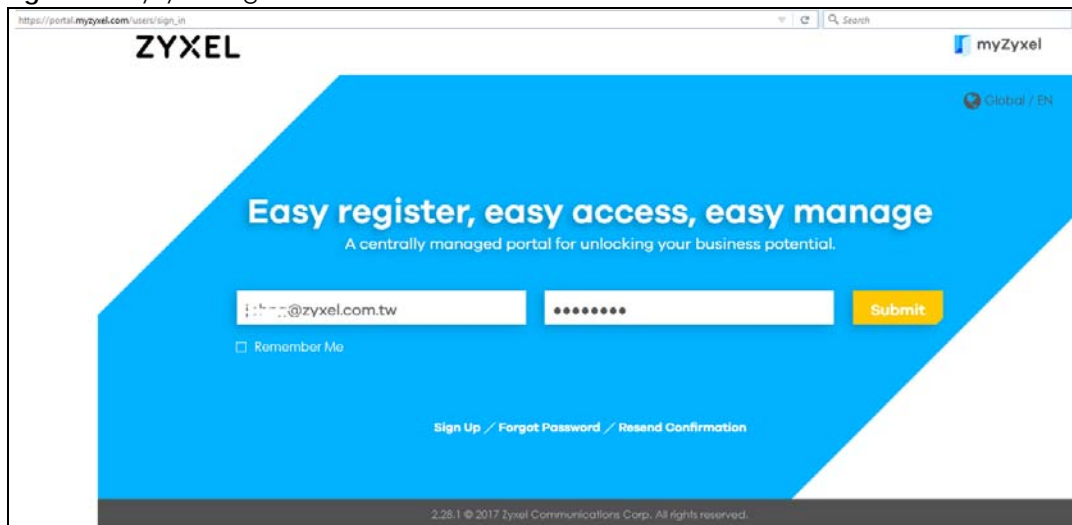

1.2.1 Grace Period

UTM licenses have a 15-day grace period after a license expires. Services will continue to work in this period during which you will receive notifications to renew your license(s). New license(s) are valid for 1 year from the date of purchase.

1.3 Applications

These are some Zyxel Device application scenarios.

Security Router

Security includes a Stateful Packet Inspection (SPI) firewall, and UTM (Unified Threat Management). All models need a license to use UTM (Unified Threat Management) features.

Figure 2 Applications: Security Router Applications: Security Router

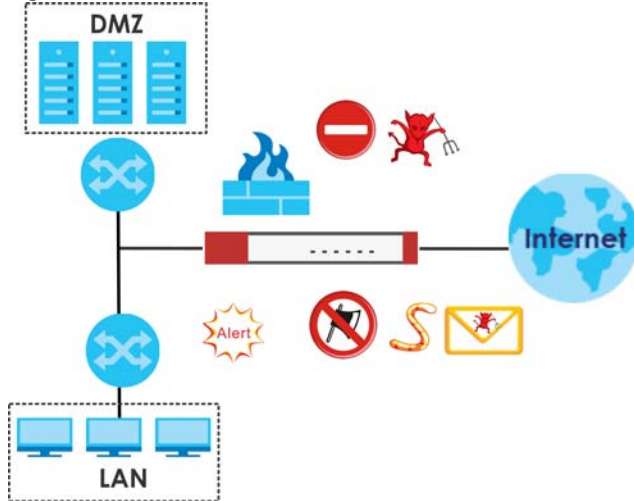

IPv6 Routing

The Zyxel Device supports IPv6 Ethernet, PPP, VLAN, and bridge routing. You may also create IPv6 policy routes and IPv6 objects. The Zyxel Device can also route IPv6 packets through IPv4 networks using different tunneling methods.

Figure 3 Applications: IPv6 Routing

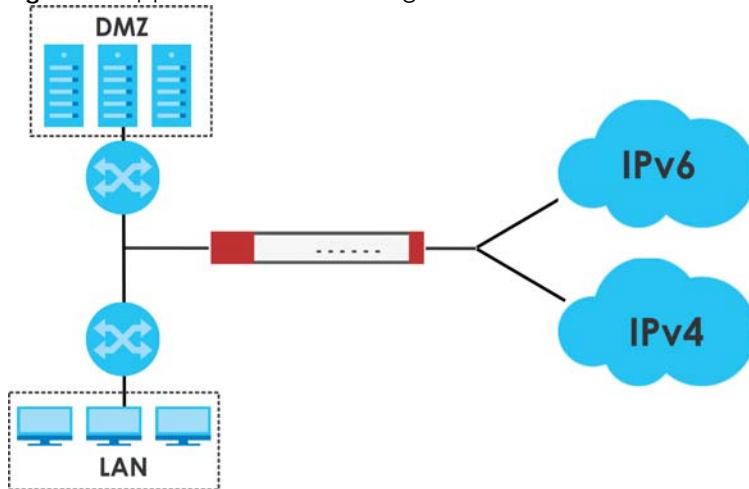

VPN Connectivity

Set up VPN tunnels with other companies, branch offices, telecommuters, and business travelers to provide secure access to your network. AS is an Authentication Server in the below figure.

Figure 4 Applications: VPN Connectivity

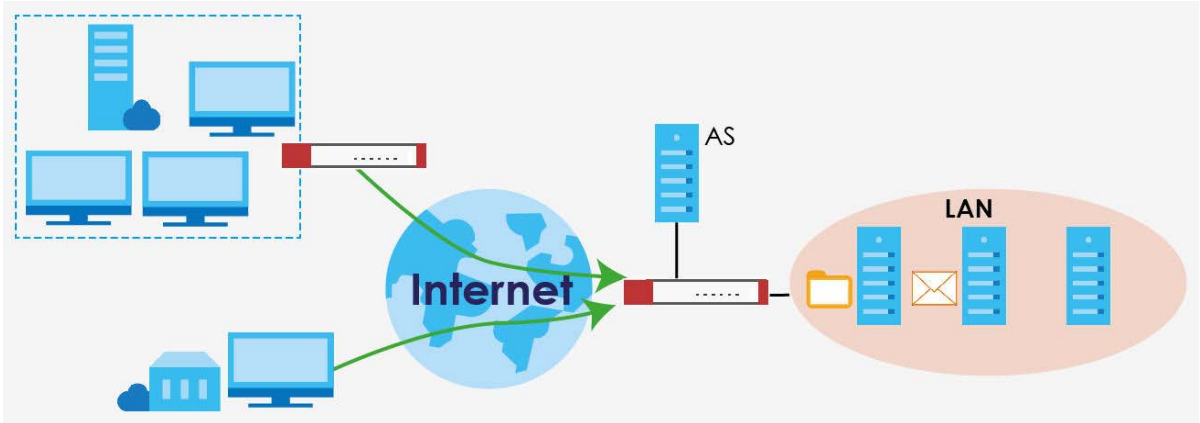

SSL VPN Network Access

SSL VPN lets remote users use their web browsers for a very easy-to-use VPN solution. A user just browses to the ZyWALL Device's web address and enters his user name and password to securely connect to the ZyWALL Device's network. Here full tunnel mode creates a virtual connection for a remote user and gives him a private IP address in the same subnet as the local network so he can access network resources in the same way as if he were part of the internal network.

Figure 5 SSL VPN With Full Tunnel Mode

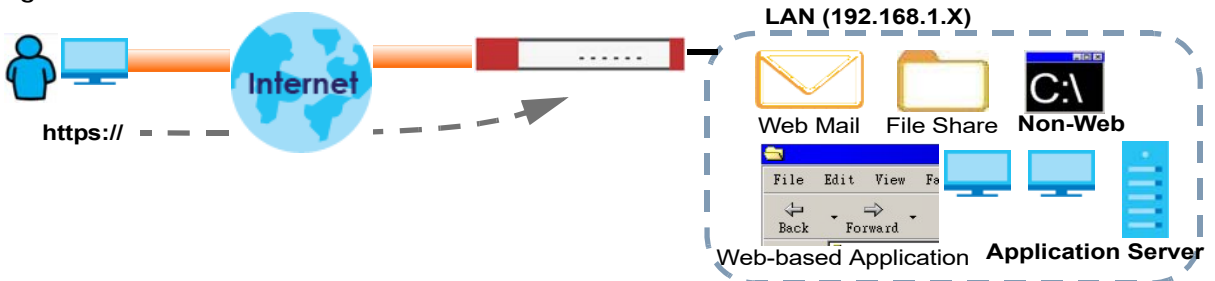

User-Aware Access Control

Set up security policies to restrict access to sensitive information and shared resources based on the user who is trying to access it. In the following figure user **A** can access both the Internet and an internal file server. User **B** has a lower level of access and can only access the Internet. User **C** is not even logged in, so and cannot access either the Internet or the file server.

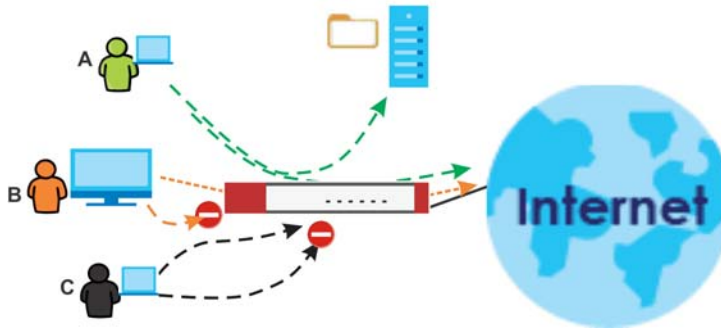
Figure 6 Applications: User-Aware Access Control

Load Balancing

Set up multiple connections to the Internet on the same port, or different ports, including cellular interfaces. In either case, you can balance the traffic loads between them.

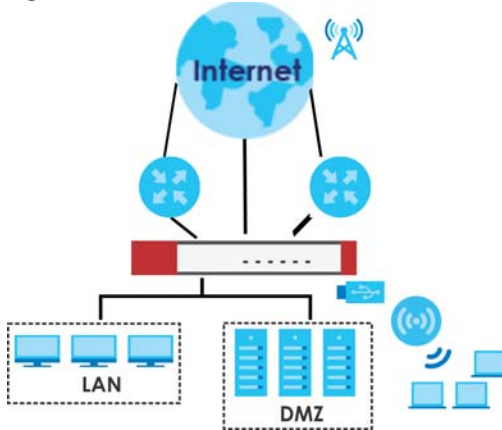
Figure 7 Applications: Multiple WAN Interfaces

1.4 Management Overview

You can manage the Zyxel Device in the following ways.

Web Configurator

If you log into the Zyxel Device for the first time, the **Choose A Mode To Start** screen appears. See [Chapter 4 on page 89](#) for the differences between **Easy Mode** and **Expert Mode**.

Select **Easy Mode** to go to the **Initial Setup Wizard** in **Easy Mode**, and enter **Easy Mode** every time you log in. Choose **Expert Mode** to go to the **Initial Setup Wizard** in **Expert Mode**, and enter **Expert Mode** every time you log in.

Note: This screen is only available for models that support **Easy Mode** and **Expert Mode**. See Chapter 1 on page 28 to see which models support **Easy Mode**.

Note: You can still switch between modes after selecting a mode in this screen.

Figure 8 Choose a Mode

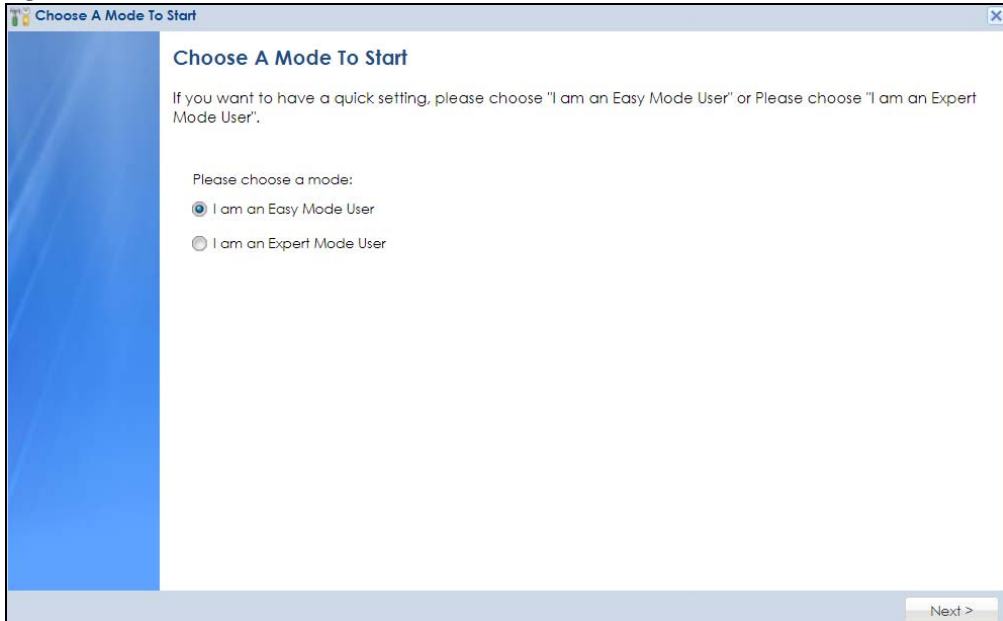

The Web Configurator allows easy Zyxel Device setup and management using an Internet browser. This User's Guide provides information about the Web Configurator.

Figure 9 Managing the Zyxel Device: Web Configurator

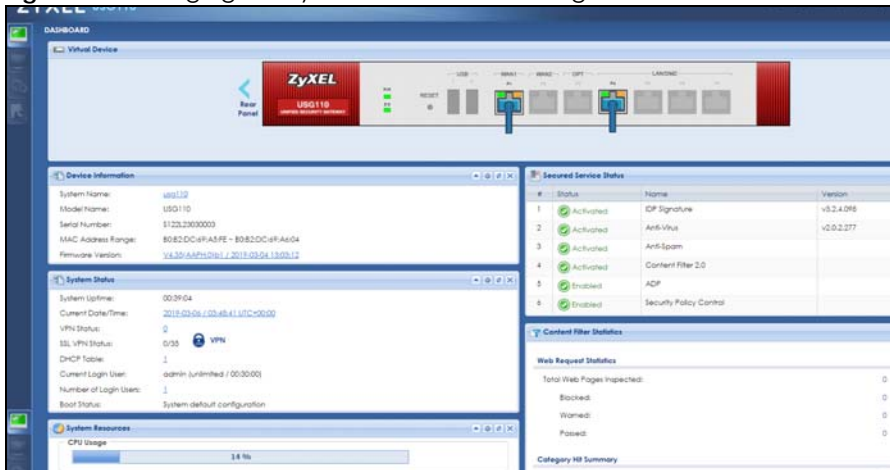

Command-Line Interface (CLI)

The CLI allows you to use text-based commands to configure the Zyxel Device. Access it using remote management (for example, SSH or Telnet) or via the physical or Web Configurator console port. See the Command Reference Guide for CLI details. The default settings for the console port are:

Table 4 Console Port Default Settings

SETTING	VALUE
Speed	115200 bps
Data Bits	8
Parity	None

Table 4 Console Port Default Settings

SETTING	VALUE
Stop Bit	1
Flow Control	Off

FTP

Use File Transfer Protocol for firmware upgrades and configuration backup/restore.

SNMP

The device can be monitored and/or managed by an SNMP manager. See [Section 44.11 on page 994](#).

Cloud CNM

Use the **Cloud CNM** screen (see [Section 44.16 on page 1006](#)) to enable and configure management of the Zyxel Device by a Central Network Management system.

Management Authentication

Managers must be authenticated with a user name and password, using one of:

- Local Zyxel Device authentication
- An external RADIUS server
- An external LDAP server
- Certificates

1.5 Web Configurator

The Web Configurator is an HTML-based management interface that allows easy system setup and management through Internet browser. Use a browser that supports HTML5, such as Microsoft Edge, Mozilla Firefox, or Google Chrome.

In order to use the Web Configurator you need to allow:

- Web browser pop-up windows from your device.
- JavaScript (enabled by default).
- Java permissions (enabled by default).

The recommended screen resolution is 1024 x 768 pixels.

Note: Screenshots and graphics in this book may differ slightly from your product due to differences in product features or Web Configurator brand style. Most screen shots in this guide come from the USG110 and USG60W.

1.5.1 Web Configurator Access

- 1 Make sure your Zyxel Device hardware is properly connected. See the Quick Start Guide.
- 2 In your browser go to <http://192.168.1.1>. By default, the Zyxel Device automatically routes this request to its HTTPS server, and it is recommended to keep this setting. The **Login** screen appears.

- 3 Type the user name (default: "admin") and password (default: "1234").
If you have a OTP (One-Time Password) token generate a number and enter it in the **One-Time Password** field. The number is only good for one login. You must use the token to generate a new number the next time you log in.
- 4 Click **Login**. After you log in for the first time using the default user name and password, you must change the default admin password in the **Update Admin Info** screen. Enter a new password of from 1 to 64 characters.

In **Configuration > Object > User/Group > Setting**, you can enable **Password Complexity** to require a new password to consist of at least 8 characters and at most 64, where at least 1 character must be a number, at least 1 a lower case letter, at least 1 an upper case letter and at least 1 a special character from the keyboard, such as !@#\$%^&*()_+. You can also require periodic changing of the password in that screen by configuring **Password must changed every (days)**.

Make a note of your new password, enter it in the following screen, then click **Apply**.

- 5 A **Terms of Use** screen displays. Read the statement, select the checkbox, and then click **Acknowledge** to proceed.

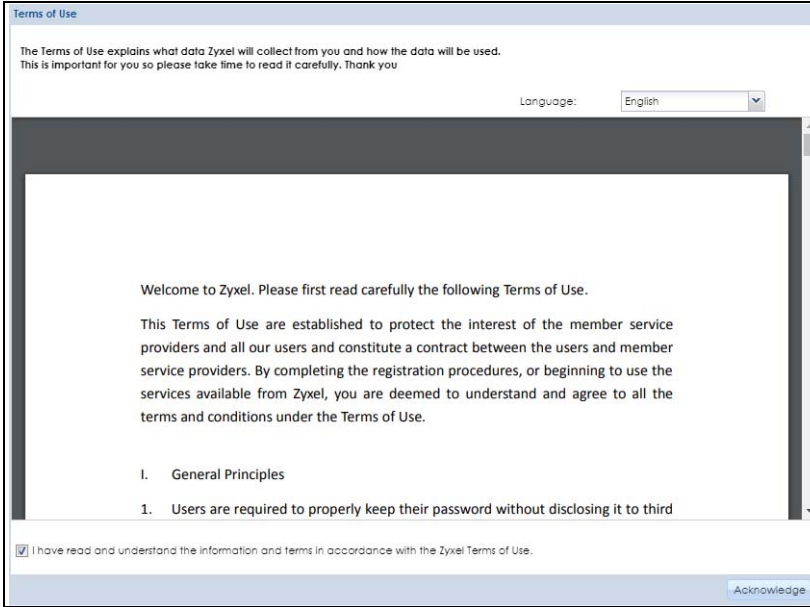

- 6 The **Network Risk Warning** screen displays any unregistered or disabled security services. If your Zyxel Device is not registered, you will see a prompt to register it. Select how often to display the screen and click **OK**.

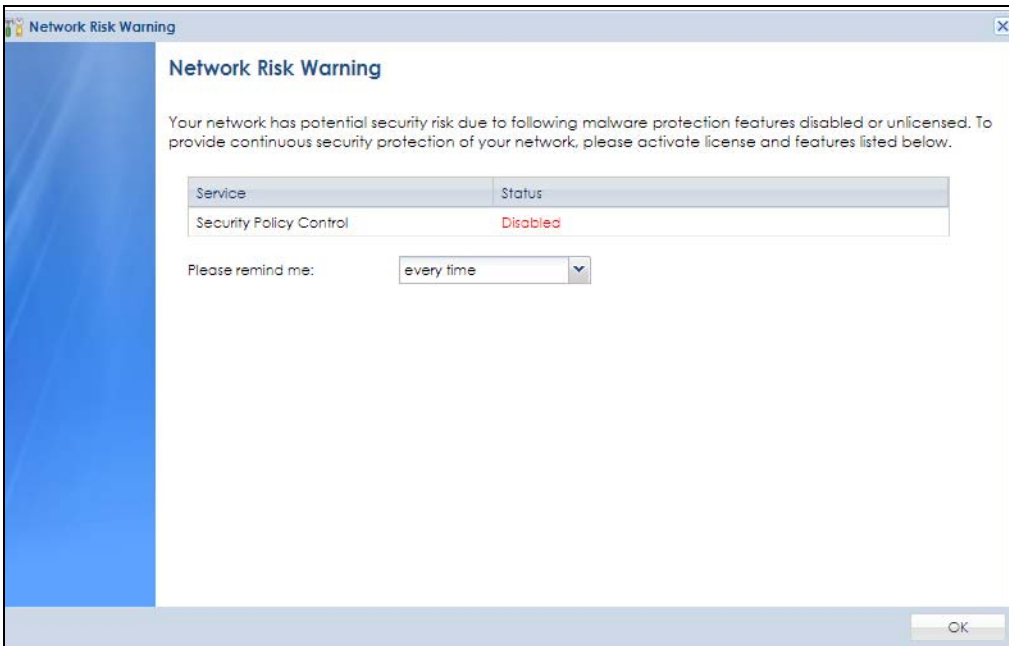

If you select **Never** and you later want to bring this screen back, use these commands (note the space before the underscore).

```
Router> enable
Router#
Router# configure terminal
Router (config)#
Router (config)# service-register _setremind
after-10-days
after-180-days
after-30-days
every-time
never
Router (config)# service-register _setremind every-time
Router (config)#
```

See the Command Line Interface (CLI) Reference Guide (RG) for details on all supported commands.

- 7 Follow the directions in the **Update Admin Info** screen. If you change the default password, the **Login** screen appears after you click **Apply**. If you click **Ignore**, the **Installation Setup Wizard** opens if the ZyWALL is using its default configuration; otherwise the dashboard appears.

Figure 10 Dashboard

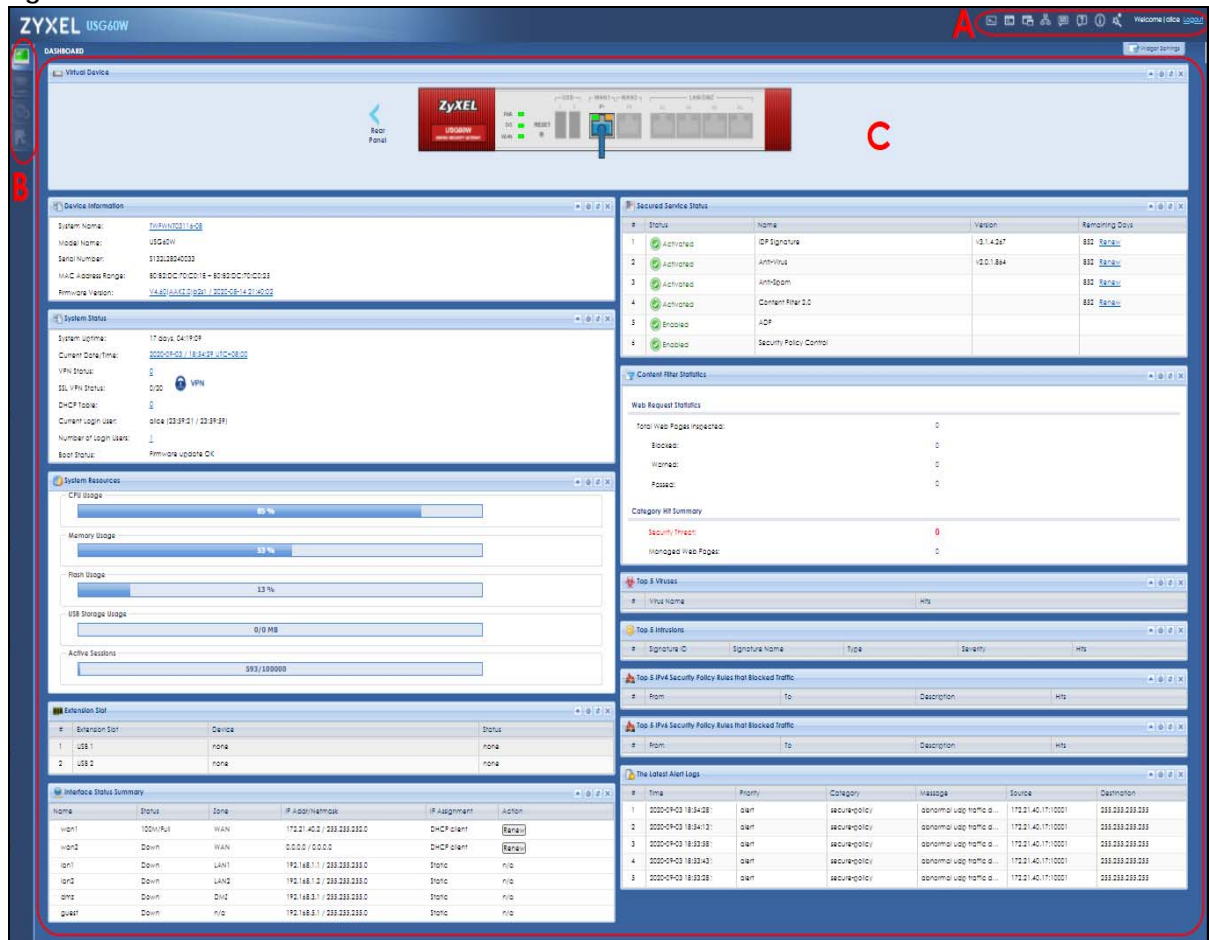

1.5.2 Security Check for Web Interface Overview

Use this screen to configure settings to secure your Zyxel Device. You can configure:

- Secure SSL access from the Internet to the Zyxel Device.
- Secure SSL access from the Internet to the network behind the Zyxel Device.
- The default port that IPSec VPN clients use to retrieve VPN rule settings from the Zyxel Device.
- The default port for two-factor authentication for VPN clients to access the network behind the Zyxel Device.

1.5.2.1 Secure SSL Access from the Internet to the Zyxel Device

You can configure up to 3 trusted computers to access the Zyxel Device using secure SSL. The default HTTPS SSL port is 443. If you change this, remote connections from the Internet must use this port. For example, if you change this to port 8800 and the Zyxel Device is using IP address 1.1.1.1, then remote users must use `https://1.1.1.1:8800`.

In [Figure 11 on page 39](#), **A**, **B** and **C** can connect to the Zyxel Device to access the Zyxel Device web configurator for remote management.

Configure a new port between 1024 to 65535 that is not in use by other services.

Figure 11 Secure SSL Access Example

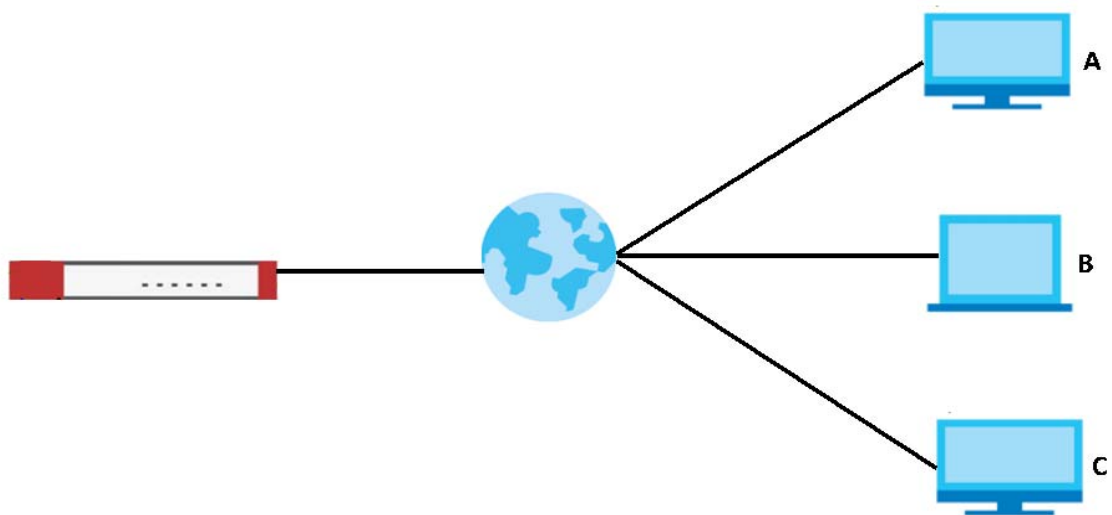

1.5.2.2 Secure SSL VPN Access from the Internet to the Network Behind the Zyxel Device

The default SSL VPN port is 443. If you change the default SSL VPN port on the Zyxel Device, make sure to make the same change to SecuExtender, the SSL VPN client software. Configure a new port between 1024 to 65535 that is not in use by other services.

You can also restrict SSL VPN access to up to 3 locations on the Internet.

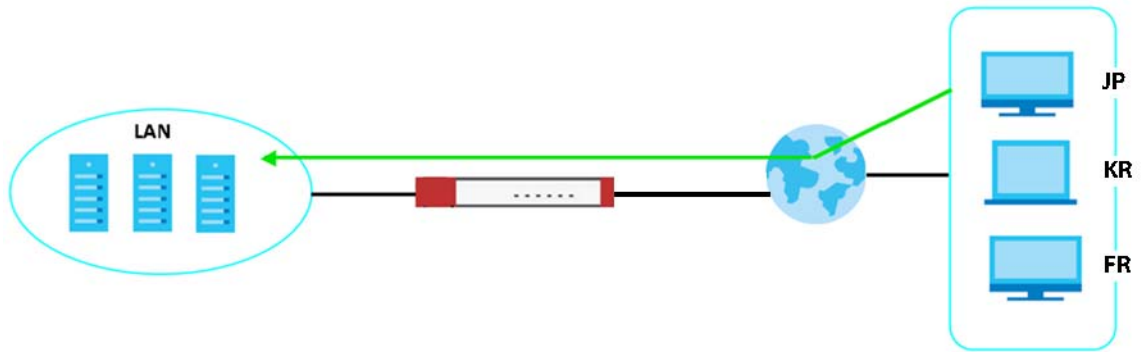
Figure 12 Secure SSL VPN Access Example

The table below describes the abbreviations used in the figure.

Table 5 Countries Abbreviations

ABBREVIATION	COUNTRY
JP	Japan
KR	Korea
FR	France

1.5.2.3 Change the Default IPSec VPN Provisioning Port

Change the default port that IPSec VPN clients use to retrieve VPN rule settings from the Zyxel Device. The default is 443 which is already in use for remote management by default. If you change the default IPSec VPN port on the Zyxel Device, make sure to make the same change to the Zyxel IPSec VPN client.

Configure a new port between 1024 to 65535 that is not in use by other services.

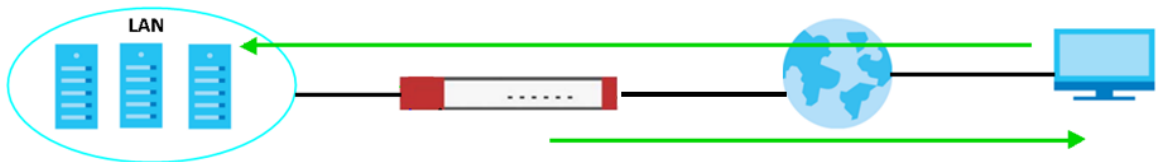
Figure 13 IPSec VPN Provisioning Example

Note: The remote management port, the SSL VPN port and the IPSec VPN port all use 443 by default. If you do not change the default ports, then only 3 connections of the remote management and SSL VPN will be allowed at one time.

1.5.2.4 Change the Default Port for Two-Factor VPN Access Authentication

Change the default port for two-factor authentication for VPN clients to access the network behind the Zyxel Device. VPN clients do not need to change the port number on their devices, because the link to access the network behind the Zyxel Devices will contain the new port number. For example, if you change this to port 8008 and the link is using a.b.c.d, then VPN clients will see this link in their email or SMS to retrieve settings: <https://a.b.c.d:8008>.

You can also change this port in **Object > Auth. Method > Two-factor Authentication > VPN Access**. See [Section 43.11.5 on page 923](#) for more information on two-factor authentication.

Configure a new port between 1024 to 65535 that is not in use by other services.

Figure 14 Two-Factor Authentication Example

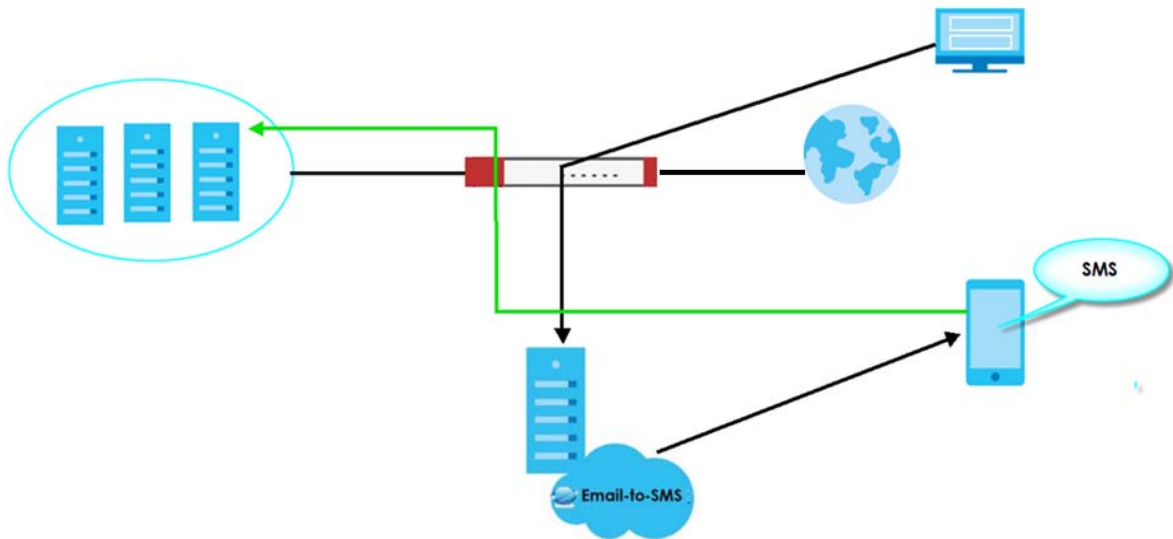

Overall Port Configuration Example

Below is an example of configuring these ports to avoid port conflict.

Table 6 Port Configuration Example

REMOTE MANAGEMENT	SSL VPN	IPSEC VPN PROVISIONING	TWO-FACTOR VPN ACCESS AUTHENTICATION
8800	8080	443 (default)	8008

1.5.2.5 Other Security Measures

New firmware contains patches to enhance security. Make sure to check for new firmware regularly and update firmware in **Maintenance > Firmware Management**.

Change admin passwords regularly. Select **Enable Password Complexity** in **Object > User/Group > Setting** to require the user to use a password that's not easy to guess. The password must include:

- at least 8 characters
- at least one upper case alphabetic character and at least one lower case alphabetic character
- one numeric character
- one special character such as @#\$%^

1.5.3 The Security Check for Web Interface Screen

The following screen appears when the Zyxel Device detects a rule that allows traffic such as HTTP, HTTPS, SSL and so on to access to your Zyxel Device from any IPv4 source on the WAN. This may expose your Zyxel Device to a security risk. Configure settings in this screen to allow access only from specified IP addresses, FQDNs or regions to secure your Zyxel Device.

Figure 15 Security Check for Web Interface

Security Check for Web Interface

You have a rule that allows anyone from the Internet to access the Device web configurator and SSL VPN service. To reduce risk, please restrict access by source IP address and geolocation respectively.
Strongly suggest to update your device and change passwords regularly.

Restrict Device management from the WAN

Port: (1...65535)

Restrict access only to trusted host

Trusted Host 1: (IP or FQDN)

Trusted Host 2: (IP or FQDN) (Optional)

Trusted Host 3: (IP or FQDN) (Optional)

Restrict SSL VPN access from the WAN

Port: (1...65535)

Restrict access by GeolP

Trusted Geolocation 1:

Trusted Geolocation 2: (Optional)

Trusted Geolocation 3: (Optional)

Change Two-Factor Authentication Port

Port: (1...65535)

Change the Zyxel IPSec VPN Client Provisioning Port

Port: ! (1...65535)

Please remind me:

OK Cancel

The following table describes the labels in this screen.

Table 7 Security Check for Web Interface

LABEL	DESCRIPTION
Allow secure remote management from WAN	Select this to allow access to the Zyxel Device remotely only from specified IP addresses or Fully Qualified Domain Names (FQDNs), such as 1.1.1.1 or www.zyxel.com. See Section 1.5.2.1 on page 39 for more information.
Port	Configure a new port between 1024 to 65535 to use it to access the web configurator. Do not use a port number that has been used. For example, use https://1.1.1.1:8800 if you changed the default HTTPS port to 8800.
Trusted Host 1-3	Configure the IP addresses or FQDNs that are allowed to access the Zyxel Device.
Allow SSL VPN access from WAN	Select this to allow SSL VPN clients to access the Zyxel Device only from specified regions. See Section 1.5.2.2 on page 39 for more information.
Port	Configure a new port between 1024 to 65535 to use it to access the web configurator using SSL VPN. Do not use a port number that has been used. The port you configure here must be the same as the port you use in SecuExtender. See Section 1.5.2.2 on page 39 for more information on SecuExtender.
Trusted Geolocation 1-3	Select the regions that are allowed to access the Zyxel Device from the drop-down list box.

Table 7 Security Check for Web Interface (continued)

LABEL	DESCRIPTION
Change Two-Factor Authentication Port	Select this to change the port VPN clients use to access the Zyxel Device LAN with two-factor authentication. See Section 1.5.2.4 on page 40 for more information. Configure a new port between 1024 to 65535. Do not use a port number that has been used.
Change Zyxel IPSec VPN Client Provisioning Port	Select this to change the port IPSec VPN clients use to retrieve VPN rule settings from the Zyxel Device. See Section 1.5.2.3 on page 40 for more information. Configure a new port between 1024 to 65535. Do not use a port number that has been used. The port you configure here must be the same as the port you use when logging in as a Zyxel IPSec VPN client.
Please remind me	Select how often to display the screen from the drop-down list box.
OK	Click OK to save your changes back to the Zyxel Device.
Cancel	Click Cancel to exit this screen without saving your changes.

1.5.4 Remote Access to the Zyxel Device Networks

Your Zyxel Device keeps your networks safe while allowing external access by applying the security measures below:

- **Two-Factor Authentication:** Use two-factor authentication to have double-layer security to access a secured network behind the Zyxel Device. The first layer is the VPN client/Zyxel Device's login user name / password. The second layer is an authorized SMS (via mobile phone number) or email address. See [Section 43.11.4 on page 919](#) for more information on two-factor authentication.
- **IPSec VPN:** You can create highly secure connections with IKEv2 or EAP authentication to access networks behind the Zyxel Device. For example, home workers can securely access company resources if they have proper authentication. See [Chapter 30 on page 635](#) for more information on IPSec VPN.
- **Upload Bandwidth Limit:** Zyxel subscription-based SecuExtender IPSec VPN clients with Windows version 5.6.80.007 or later or macOS version 1.2.0.7 or later support upload bandwidth limit. Use this to set the maximum bandwidth for uploading traffic from IPSec VPN clients over IPSec VPN tunnels. See [Section 30.5 on page 659](#) for more information on upload bandwidth limit.

1.5.5 Web Configurator Screens Overview

The Web Configurator screen is divided into these parts (as illustrated on [Figure 10 on page 38](#)):

- **A** – title bar
- **B** – navigation panel
- **C** – main window

Title Bar

Figure 16 Title Bar



The title bar icons in the upper right corner provide the following functions.

Table 8 Title Bar: Web Configurator Icons

LABEL	DESCRIPTION
Web Console	Click this to open one or multiple console windows from which you can run command line interface (CLI) commands. You will be prompted to enter your user name and password. See the Command Reference Guide for information about the commands. Logging in to the Zyxel Device with HTTPS, so you can open one or multiple console windows.
CLI	Click this to open a popup window that displays the CLI commands sent by the Web Configurator to the Zyxel Device.
Reference	Click this to check which configuration items reference an object.
Site Map	Click this to see an overview of links to the Web Configurator screens.
Community	Go to https://businessforum.zyxel.com/categories/security for security product discussions.
Help	Click this to open the help page for the current screen.
About	Click this to display basic information about the Zyxel Device.
Easy Mode	Click this to go to a mode that contains wizards that help you configure the Zyxel Device, and links to portals. Not all models have this mode.
Logout	Click this to log out of the Web Configurator.

CLI Messages

Click **CLI** to look at the CLI commands sent by the Web Configurator. Open the pop-up window and then click some menus in the Web Configurator to display the corresponding commands.

Figure 17 CLI Messages

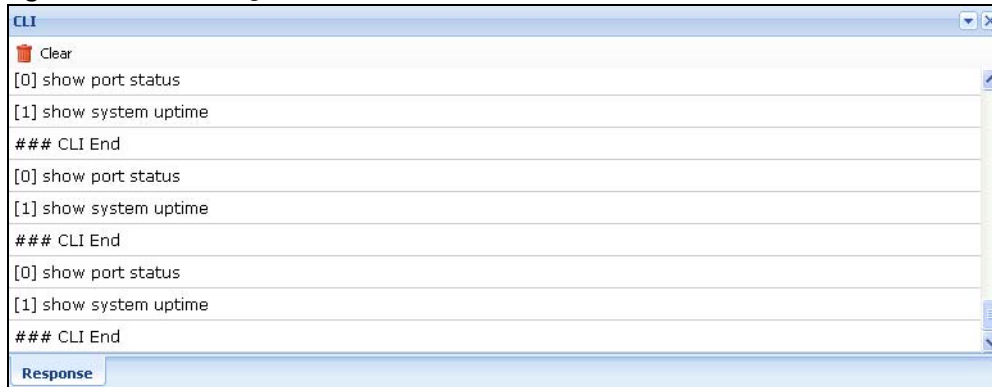

Reference

Click **Reference** to open the **Reference** screen. Select the type of object and the individual object and click **Refresh** to show which configuration settings reference the object.

Figure 18 Reference

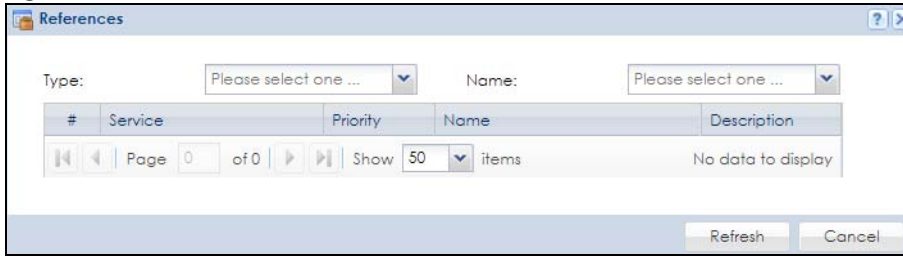

The fields vary with the type of object. This table describes labels that can appear in this screen.

Table 9 References

LABEL	DESCRIPTION
Type	Select the type of reference from the drop-down list box.
Name	Select the specific reference for the type selected. The settings then display in the table below.
#	This field is a sequential value, and it is not associated with any entry.
Service	This is the type of setting that references the selected object. Click a service's name to display the service's configuration screen in the main window.
Priority	If it is applicable, this field lists the referencing configuration item's position in its list, otherwise N/A displays.
Name	This field identifies the configuration item that references the object.
Description	If the referencing configuration item has a description configured, it displays here.
Refresh	Click this to update the information in this screen.
Cancel	Click Cancel to close the screen.

Web Console

Click **Web Console** to open one or multiple console windows from which you can run CLI commands. You will be prompted to enter your user name and password. See the Command Reference Guide for information about the commands. Logging in to the Zyxel Device with HTTPS, so you can open one or multiple console windows.

Figure 19 Web Console Window

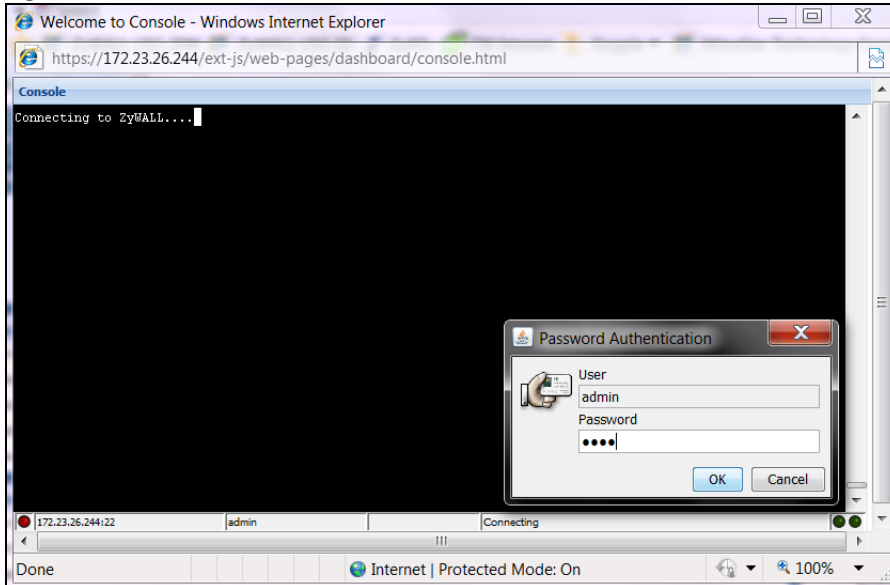

Site Map

Click **Site MAP** to see an overview of links to the Web Configurator screens. Click a screen's link to go to that screen.

Figure 20 Site Map

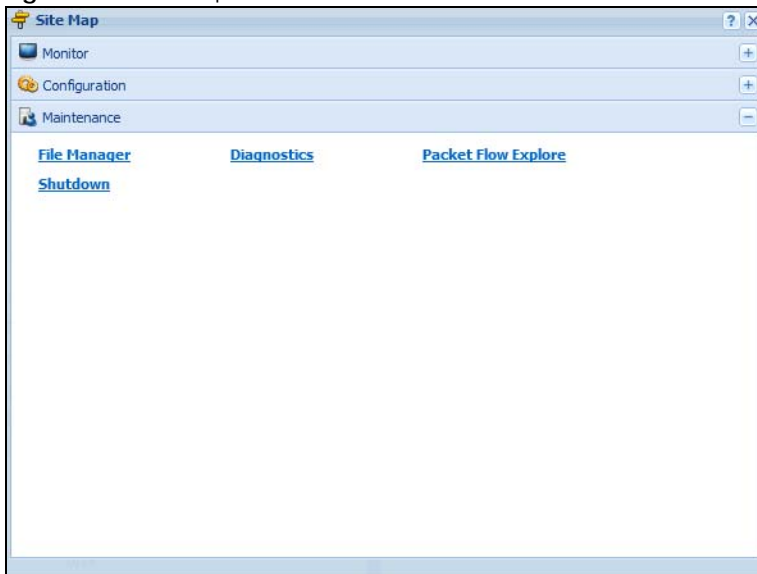

About

Click **About** to display basic information about the Zyxel Device.

Figure 21 About

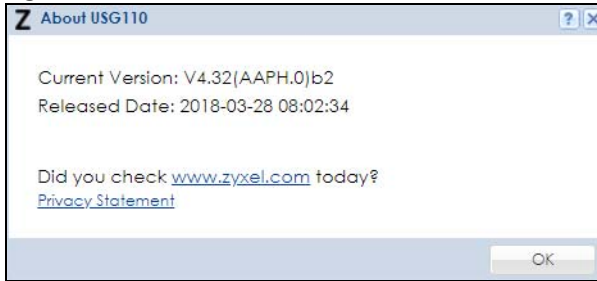

1.5.6 SecuReporter Banner

Next to the Title Bar, you may see a SecuReporter banner. Click the banner is to configure an organization in SecuReporter and set the Data Protection Policy for this Zyxel Device.

Figure 22 SecuReporter Banner



If you click x to close the banner, the banner will still display the next time you log in.

You will not see the SecuReporter banner if you:

- Have enabled SecuReporter in **CloudCNM > SecuReporter** and the Zyxel Device was added to an organization.
- Clicked "Don't ask me again" in the banner.

If you close the SecuReporter banner, and later decide you want to configure SecuReporter, go to **CloudCNM > SecuReporter** and click the 'set Org/Network site' hyperlink in the second note.

1.5.7 Navigation Panel

Table 10 About

LABEL	DESCRIPTION
Current Version	This shows the firmware version of the Zyxel Device.
Released Date	This shows the date (yyyy-mm-dd) and time (hh:mm:ss) when the firmware is released.
OK	Click this to close the screen.

Use the navigation panel menu items to open status and configuration screens. Click the arrow in the middle of the right edge of the navigation panel to hide the panel or drag to resize it. The following sections introduce the Zyxel Device's navigation panel menus and their screens.

Figure 23 Navigation Panel

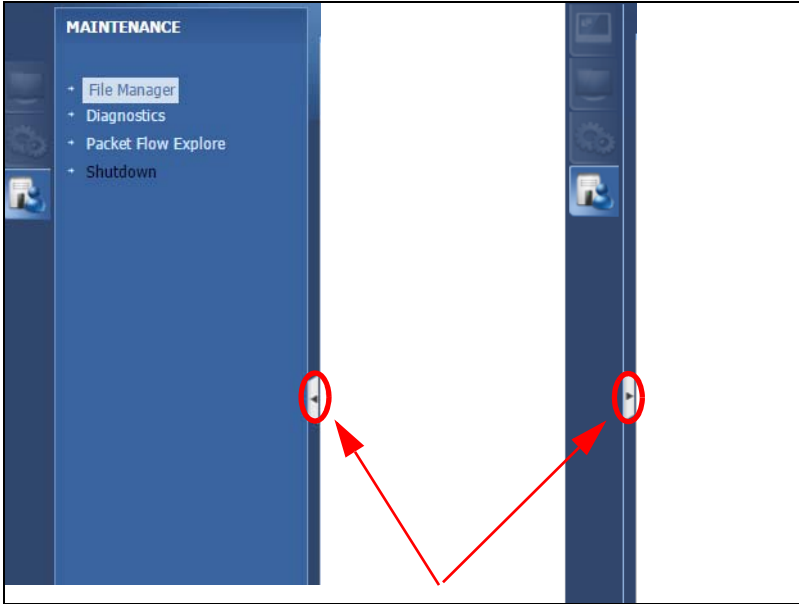

Dashboard

The dashboard displays general device information, system status, system resource usage, licensed service status, and interface status in widgets that you can re-arrange to suit your needs. See the Web Help for details on the dashboard.

Monitor Menu

The monitor menu screens display status and statistics information.

Table 11 Monitor Menu Screens Summary

FOLDER OR LINK	TAB	FUNCTION
System Status		
Port Statistics	Port Statistics	Displays packet statistics for each physical port.
Interface Status	Interface Summary	Displays general interface information and packet statistics.
Traffic Statistics	Traffic Statistics	Collect and display traffic statistics.
Session Monitor	Session Monitor	Displays the status of all current sessions.
IGMP Statistics	IGMP Statistics	Collect and display IGMP statistics.
DDNS Status	DDNS Status	Displays the status of the Zyxel Device's DDNS domain names.
IP/MAC Binding	IP/MAC Binding	Lists the devices that have received an IP address from Zyxel Device interfaces using IP/MAC binding.
Login Users	Login Users	Lists the users currently logged into the Zyxel Device.
Dynamic Guest	Dynamic Guest	List the dynamic guest accounts in the Zyxel Device's local database.
Cellular Status	Cellular Status	Displays details about the Zyxel Device's mobile broadband connection status.

Table 11 Monitor Menu Screens Summary (continued)

FOLDER OR LINK	TAB	FUNCTION
UPnP Port Status	Port Statistics	Displays details about UPnP connections going through the Zyxel Device.
USB Storage	Storage Information	Displays details about USB device connected to the Zyxel Device.
Ethernet Neighbor	Ethernet Neighbor	View and manage the Zyxel Device's neighboring devices via Smart Connect (Layer Link Discovery Protocol (LLDP)). Use the Zyxel One Network (ZON) utility to view and manage the Zyxel Device's neighboring devices via the Zyxel Discovery Protocol (ZDP).
FQDN Object	FQDN Object	Displays FQDN (Fully Qualified Domain Name) object cache lists used in DNS queries.
Wireless		
AP Information	AP List	Lists APs managed by the Zyxel Device.
	Radio List	Lists wireless details of APs managed by the Zyxel Device.
	Top N APs	Lists managed APs with the most wireless traffic usage and most associated wireless stations.
	Single AP	Lists APs wireless traffic usage and associated wireless stations for a managed AP.
ZyMesh	ZyMesh Link Info	Display statistics about ZyMesh wireless connections between managed APs.
SSID Info	SSID Info	Display information about the SSID's wireless clients.
Station Info	Station List	Lists wireless clients associated with the APs managed by the Zyxel Device.
	Top N Stations	Lists wireless stations with the most wireless traffic usage.
	Single Station	Lists wireless traffic usage for an associated wireless station.
Detected Device	Detected Device	Display information about suspected rogue APs.
Printer Status	Printer Status	Display information about the connected statement printers.
VPN Monitor		
IPSec	IPSec	Displays and manages the active IPSec SAs.
SSL	SSL	Lists users currently logged into the VPN SSL client portal. You can also log out individual users and delete related session information.
L2TP over IPSec	L2TP over IPSec	Displays details about current L2TP sessions.
UTM Statistics		
App Patrol	Summary	Displays application patrol statistics.
Content Filter	Summary	Collect and display content filter statistics
IDP	Summary	Collect and display statistics on the intrusions that the Zyxel Device has detected.
Anti-Virus	Summary	Collect and display statistics on the viruses that the Zyxel Device has detected.
Anti-Spam	Summary	Collect and display spam statistics.
	Status	Displays how many mail sessions the ZyWALL is currently checking and DNSBL (Domain Name Service-based spam Black List) statistics.
SSL Inspection	Summary	Collect and display SSL Inspection statistics.
	Certificate Cache List	Displays traffic to destination servers using certificates.

Table 11 Monitor Menu Screens Summary (continued)

FOLDER OR LINK	TAB	FUNCTION
Log	View Log	Lists log entries.
	View AP Log	Lists AP log entries.
	Dynamic Users Log	Display the Zyxel Device's dynamic guest account log messages.

Configuration Menu

Use the configuration menu screens to configure the Zyxel Device's features.

Table 12 Configuration Menu Screens Summary

FOLDER OR LINK	TAB	FUNCTION
Quick Setup		Quickly configure WAN interfaces or VPN connections.
Licensing		
Registration	Registration	Register the device and activate trial services.
	Service	View the licensed service status and upgrade licensed services.
Signature Update	Anti-Virus	Update anti-virus signatures immediately or by a schedule.
	IDP/AppPatrol	Update IDP signatures immediately or by a schedule.
Wireless		
Controller	Configuration	Configure manual or automatic controller registration.
AP Management	Mgmt AP List	Edit or remove entries in the lists of APs managed by the Zyxel Device.
	AP Policy	Configure the AP controller's IP address on the managed APs and determine the action the managed APs take if the current AP controller fails.
	AP Group	Create groups of APs, define their radio, VLAN, port and load balancing settings.
	Firmware	Update the firmware on APs connected to your Zyxel Device.
Rogue AP	Rogue/Friendly AP List	Configure how the Zyxel Device monitors rogue APs.
Load Balancing	Load Balancing	Configure load balancing for traffic moving to and from wireless clients.
DCS	DCS	Configure dynamic wireless channel selection.
Auto Healing	Auto Healing	Enable auto healing to extend the wireless service coverage area of the managed APs when one of the APs fails.
RTLS	Real Time Location System	Use the managed APs as part of an Ekahau RTLS to track the location of Ekahau WiFi tags.
Network		

Table 12 Configuration Menu Screens Summary (continued)

FOLDER OR LINK	TAB	FUNCTION
Interface	Port	Use the Port Role screen to set the Zyxel Device's flexible ports such as LAN, OPT, WLAN, or DMZ.
	Port Role/Port Configuration	Use the Port Configuration screen to configure settings for individual Zyxel Device ports.
	Ethernet	Manage Ethernet interfaces and virtual Ethernet interfaces.
	PPP	Create and manage PPPoE and PPTP interfaces.
	Cellular	Configure a cellular Internet connection for an installed mobile broadband card.
	Tunnel	Configure tunneling between IPv4 and IPv6 networks.
	VLAN	Create and manage VLAN interfaces and virtual VLAN interfaces.
	Bridge	Create and manage bridges and virtual bridge interfaces.
Routing	VTI	Configure IP address assignment and interface parameters for VTI (Virtual Tunnel Interface).
	Trunk	Create and manage trunks (groups of interfaces) for load balancing.
	Policy Route	Create and manage routing policies.
	Static Route	Create and manage IP static routing information.
	RIP	Configure device-level RIP settings.
DDNS	OSPF	Configure device-level OSPF settings, including areas and virtual links.
	BGP	Configure exchange of Border Gateway Protocol (BGP) information over an IPSec tunnel.
NAT	NAT	Set up and manage port forwarding rules.
Redirect Service	Redirect Service	Set up and manage HTTP and SMTP redirection rules.
ALG	ALG	Configure SIP, H.323, and FTP pass-through settings.
UPnP	UPnP	Configure interfaces that allow UPnP and NAT-PMP connections.
IP/MAC Binding	Summary	Configure IP to MAC address bindings for devices connected to each supported interface.
	Exempt List	Configure ranges of IP addresses to which the Zyxel Device does not apply IP/MAC binding.
Layer 2 Isolation	General	Enable layer-2 isolation on the Zyxel Device and the internal interface(s).
	White List	Enable and configure the white list.
DNS Inbound LB	DNS Load Balancing	Configure DNS Load Balancing.
Web Authentication	Web Authentication	Define a web portal and exempt services from authentication.
	General/Authentication Type/Custom Web Portal File/Custom User Agreement File/Facebook Wi-Fi	
	SSO	Configure the Zyxel Device to work with a Single Sign On agent.
Hotspot		

Table 12 Configuration Menu Screens Summary (continued)

FOLDER OR LINK	TAB	FUNCTION
Billing	General	Configure the general billing settings, such as the accounting method.
	Billing Profile	Configure the billing profiles for the web-based account generator and each button on the connected statement printer.
	Discount	Configure discount price plans.
	Payment Service	Enable online payment service and configure the service pages.
Printer Manager	General	Configure the printer list, enable printer management and customize the account printout.
	Printout Configuration	Detect the connected statement printers, change their IP addresses and/or add them to the managed printer list.
Free Time	Free Time	Allow users to get a free account for Internet surfing during the specified time period.
IPnP	IPnP	Enable IPnP on the Zyxel Device and the internal interface(s).
Walled Garden	Walled Garden	Create walled garden links that display in the login screen.
	General/URL Base/Domain/IP Base	
Advertisement	Advertisement	Enable and set advertisement links.
Security Policy		
Policy Control	Policy	Create and manage level-3 traffic rules and apply UTM profiles.
ADP	General	Display and manage ADP bindings.
	Profile	Create and manage ADP profiles.
Session Control	Session Control	Limit the number of concurrent client NAT/security policy sessions.
Cloud CNM	SecuManager	Enable and configure management of the Zyxel Device by a Central Network Management system.
	SecuReporter	Enable SecuReporter logging and access the SecuReporter security analytics portal that collects and analyzes logs from your Zyxel Device in order to identify anomalies, alert on potential internal / external threats, and report on network usage.
VPN		
IPSec VPN	VPN Connection	Configure IPSec tunnels.
	VPN Gateway	Configure IKE tunnels.
	Concentrator	Combine IPSec VPN connections into a single secure network
	Configuration Provisioning	Set who can retrieve VPN rule settings from the Zyxel Device using the Zyxel Device IPSec VPN Client.
SSL VPN	Access Privilege	Configure SSL VPN access rights for users and groups.
	Global Setting	Configure the Zyxel Device's SSL VPN settings that apply to all connections.
L2TP VPN	L2TP VPN	Configure L2TP over IPSec tunnels.
BWM	BWM	Enable and configure bandwidth management rules.
UTM Profile		
AppPatrol	Profile	Manage different types of traffic in this screen. Create App Patrol template(s) of settings to apply to a traffic flow using a security policy.

Table 12 Configuration Menu Screens Summary (continued)

FOLDER OR LINK	TAB	FUNCTION
Content Filter	Profile	Create and manage the detailed filtering rules for content filtering profiles and then apply to a traffic flow using a security policy.
	Trusted Web Sites	Create a list of allowed web sites that bypass content filtering policies.
	Forbidden Web Sites	Create a list of web sites to block regardless of content filtering policies.
IDP	Profile	Create IDP template(s) of settings to apply to a traffic flow using a security policy.
	Custom Signatures	Create, import, or export custom signatures.
Anti-Virus	Profile	Create anti-virus template(s) of settings to apply to a traffic flow using a security policy.
	Black/White List	Set up a black list to identify files with virus file patterns and a white list to identify files that should not be checked for AV.
	Signature	Search for signatures by signature name or attributes and configure how the Zyxel Device uses them.
Anti-Spam	Profile	Turn anti-spam on or off and manage anti-spam policies. Create anti-spam template(s) of settings to apply to a traffic flow using a security policy.
	Mail Scan	Configure e-mail scanning details.
	Black/White List	Set up a black list to identify spam and a white list to identify legitimate e-mail.
	DNSBL	Have the ZyWALL check e-mail against DNS Black Lists.
SSL Inspection	Profile	Decrypt HTTPS traffic for UTM inspection. Create SSL Inspection template(s) of settings to apply to a traffic flow using a security policy.
	Exclude List	Configure services to be excluded from SSL Inspection.
	Certificate Update	Use this screen to update the latest certificates of servers using SSL connections to the Zyxel Device network.
Device HA	General	Configure Device HA global settings, and see the status of each interface monitored by Device HA. View Device HA Pro license information.
	Device HA Pro	Configure Device HA Pro global, monitored interfaces and synchronization settings.
	Device HA	Configure active-passive mode Device HA. See Device HA Pro logs.
Object		
Zone	Zone	Configure zone template(s) used to define various policies.
User/Group	User	Create and manage users.
	Group	Create and manage groups of users.
	Setting	Manage default settings for all users, general settings for user sessions, and rules to force user authentication.
	MAC Address	Configure the MAC addresses of wireless clients for MAC authentication using the local user database.
AP Profile	Radio	Create template(s) of radio settings to apply to policies as an object.
	SSID	Create template(s) of wireless settings to apply to radio profiles or policies as an object.
	SSID List/Security List/ MAC Filter List	

Table 12 Configuration Menu Screens Summary (continued)

FOLDER OR LINK	TAB	FUNCTION
MON Profile	MON Profile	Create and manage rogue AP monitoring files that can be associated with different APs.
ZyMesh Profile	ZyMesh Profile	Create and manage ZyMesh files that can be associated with different APs.
Application	Application	Create template(s) of services to apply to policies as an object.
	Application Group	Create and manage groups of applications to apply to policies as a single object.
Address/Geo IP	Address	Create and manage host, range, and network (subnet) addresses.
	Address Group	Create and manage groups of addresses to apply to policies as a single objects.
	Geo IP	Update the database of country-to-IP address mappings and manually configure country-to-IP address mappings for geographic address objects that can be used in security policies.
Service	Service	Create and manage TCP and UDP services.
	Service Group	Create and manage groups of services to apply to policies as a single object.
Schedule	Schedule	Create one-time and recurring schedules.
	Schedule Group	Create and manage groups of schedules to apply to policies as a single object.
AAA Server	Active Directory	Configure the Active Directory settings.
	LDAP	Configure the LDAP settings.
	RADIUS	Configure the RADIUS settings.
Auth. Method	Authentication Method	Create and manage ways of authenticating users.
	Two-factor Authentication	Configure SMS/email authentication to access a secured network behind the Zyxel Device via a VPN tunnel.
Certificate	My Certificates	Create and manage the Zyxel Device's certificates.
	Trusted Certificates	Import and manage certificates from trusted sources.
ISP Account	ISP Account	Create and manage ISP account information for PPPoE/PPTP interfaces.
SSL Application	SSL Application	Create SSL web application or file sharing objects to apply to policies.
System		
Host Name	Host Name	Configure the system and domain name for the Zyxel Device.
USB Storage	Settings	Configure the settings for the connected USB devices.
Date/Time	Date/Time	Configure the current date, time, and time zone in the Zyxel Device.
Console Speed	Console Speed	Set the console speed.
DNS	DNS	Configure the DNS server and address records for the Zyxel Device.
WWW	Service Control	Configure HTTP, HTTPS, and general authentication.
	Login Page Desktop View/ Mobile View	Configure how the login and access user screens look.
SSH	SSH	Configure SSH server and SSH service settings.
TELNET	TELNET	Configure telnet server settings for the Zyxel Device.
FTP	FTP	Configure FTP server settings.
SNMP	SNMP	Configure SNMP communities and services.

Table 12 Configuration Menu Screens Summary (continued)

FOLDER OR LINK	TAB	FUNCTION
Auth. Server	Auth. Server	Configure the Zyxel Device to act as a RADIUS server.
Notification	Mail Server	Configure a mail server with authentication to send reports and password expiration notification emails.
	SMS	Enable the SMS service to send dynamic guest account information in text messages and authorization for VPN tunnel access to a secured network.
Language	Language	Select the Web Configurator language.
IPv6	IPv6	Enable IPv6 globally on the Zyxel Device here.
ZON	ZON	Use the Zyxel One Network (ZON) utility to view and manage the Zyxel Device's neighboring devices via the Zyxel Discovery Protocol (ZDP).
Log & Report		
Email Daily Report	Email Daily Report	Configure where and how to send daily reports and what reports to send.
Log Settings	Log Settings	Configure the system log, e-mail logs, and remote syslog servers.

Maintenance Menu

Use the maintenance menu screens to manage configuration and firmware files, run diagnostics, and reboot or shut down the Zyxel Device.

Table 13 Maintenance Menu Screens Summary

FOLDER OR LINK	TAB	FUNCTION
File Manager	Configuration File	Manage and upload configuration files for the Zyxel Device.
	Firmware Management	View the current firmware version and upload firmware. Reboot with your choice of firmware.
	Shell Script	Manage and run shell script files for the Zyxel Device.
Diagnostics	Diagnostics Collect Collect on AP Files	Collect diagnostic information.
	Packet Capture Capture/Capture on AP/Files	Capture packets for analysis.
	CPU/Memory Status	View CPU and memory usage statistics.
	System Log	Connect a USB device to the Zyxel Device and archive the Zyxel Device system logs to it here.
	Network Tool	Identify problems with the connections. You can use Ping or Traceroute to help you identify problems.
	Routing Traces	Configure traceroute to identify where packets are dropped for troubleshooting.
Packet Flow Explore	Routing Status	Check how the Zyxel Device determines where to route a packet.
	SNAT Status	View a clear picture on how the Zyxel Device converts a packet's source IP address and check the related settings.
Shutdown	Shutdown	Turn off the Zyxel Device.

1.5.8 Tables and Lists

Web Configurator tables and lists are flexible with several options for how to display their entries.

Click a column heading to sort the table's entries according to that column's criteria.

Figure 24 Sorting Table Entries by a Column's Criteria

The screenshot shows a table titled 'Configuration' with columns '#', 'User Name', and 'Description'. The 'User Name' column header is highlighted with a red oval. Below the header, there are three rows of data:

#	User Name	Description
4	ad-users	External AD Users
1	admin	Administration account

Click the down arrow next to a column heading for more options about how to display the entries. The options available vary depending on the type of fields in the column. Here are some examples of what you can do:

- Sort in ascending or descending (reverse) alphabetical order
- Select which columns to display
- Group entries by field
- Show entries in groups
- Filter by mathematical operators (<, >, or =) or searching for text

Figure 25 Common Table Column Options

The screenshot shows the same 'Configuration' table. A context menu is open over the 'Description' column header. The menu options are:

- Sort Ascending (A-Z)
- Sort Descending (Z-A)
- Columns (with a sub-menu open showing checkboxes for #, User Name, and Description)
- Group By This Field
- Show in Groups
- Filters

The 'Columns' sub-menu is highlighted, and the 'User Name' option is being selected. The table data is partially visible behind the menu.

Select a column heading cell's right border and drag to re-size the column.

Figure 26 Resizing a Table Column

The screenshot shows the 'Configuration' table. A red oval highlights the right border of the 'Description' column header, which has a double-headed arrow (resize handle) next to it.

Select a column heading and drag and drop it to change the column order. A green check mark displays next to the column's title when you drag the column to a valid new location.

Figure 27 Moving Columns

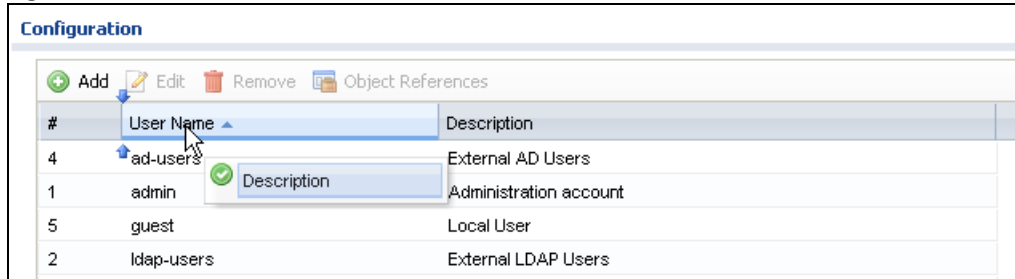

Use the icons and fields at the bottom of the table to navigate to different pages of entries and control how many entries display at a time.

Figure 28 Navigating Pages of Table Entries

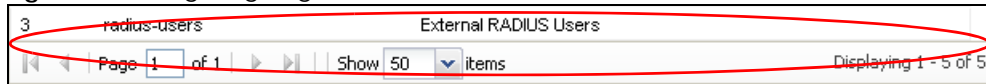

The tables have icons for working with table entries. You can often use the [Shift] or [Ctrl] key to select multiple entries to remove, activate, or deactivate.

Figure 29 Common Table Icons

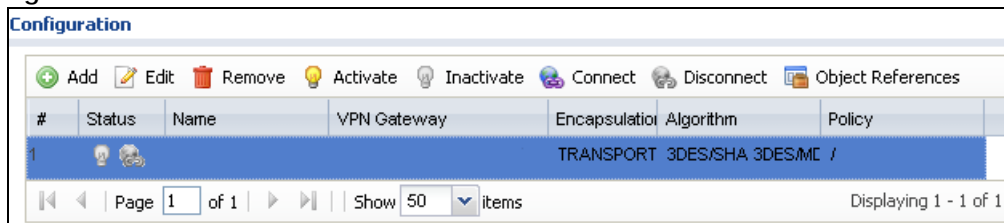

Here are descriptions for the most common table icons.

Table 14 Common Table Icons

LABEL	DESCRIPTION
Add	Click this to create a new entry. For features where the entry's position in the numbered list is important (features where the Zyxel Device applies the table's entries in order like the security policy for example), you can select an entry and click Add to create a new entry after the selected entry.
Edit	Double-click an entry or select it and click Edit to open a screen where you can modify the entry's settings. In some tables you can just click a table entry and edit it directly in the table. For those types of tables small red triangles display for table entries with changes that you have not yet applied.
Remove	To remove an entry, select it and click Remove . The Zyxel Device confirms you want to remove it before doing so.
Activate	To turn on an entry, select it and click Activate .
Inactivate	To turn off an entry, select it and click Inactivate .
Connect	To connect an entry, select it and click Connect .
Disconnect	To disconnect an entry, select it and click Disconnect .
References	Select an entry and click References to check which settings use the entry.
Move	To change an entry's position in a numbered list, select it and click Move to display a field to type a number for where you want to put that entry and press [ENTER] to move the entry to the number that you typed. For example, if you type 6, the entry you are moving becomes number 6 and the previous entry 6 (if there is one) gets pushed up (or down) one.

Working with Lists

When a list of available entries displays next to a list of selected entries, you can often just double-click an entry to move it from one list to the other. In some lists you can also use the [Shift] or [Ctrl] key to select multiple entries, and then use the arrow button to move them to the other list.

Figure 30 Working with Lists

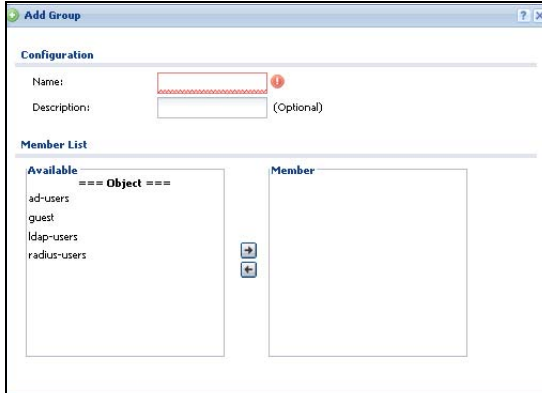

CHAPTER 2

Initial Setup Wizard

2.1 Initial Setup Wizard Screens

When you log into the Web Configurator for the first time or when you reset the Zyxel Device to its default configuration, the **Initial Setup Wizard** screen displays. This wizard helps you configure Internet connection settings and activate subscription services.

Some models (see [Chapter 1 on page 28](#) to see which models have them) have Easy Mode wizards. Initial setup wizards in models with Easy Mode wizards have a different style to the other models.

Note: For Zyxel Devices that already have firmware version 4.25 or later, you have to register your Zyxel Device and activate the corresponding service at myZyxel (through your Zyxel Device).

This chapter provides information on configuring the Web Configurator's **Initial Setup Wizard**. See the feature-specific chapters in this User's Guide for background information.

- Click the double arrow in the upper right corner to display or hide the help.
- Click **Logout** to exit the **Initial Setup Wizard** or click **Next** to continue the wizard. Click **Finish** at the end of the wizard to complete the wizard.

Figure 31 Initial Setup Wizard

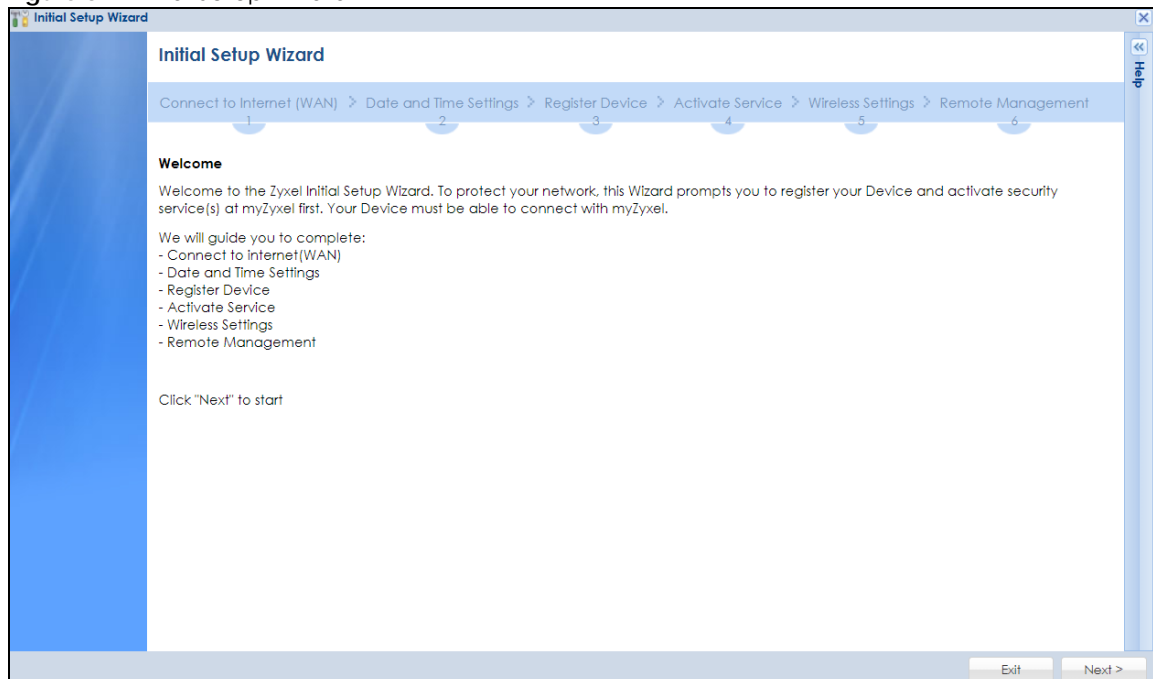

2.1.1 Internet Access Setup – WAN Interface

Use this screen to set how many WAN interfaces to configure and the first WAN interface's type of encapsulation and method of IP address assignment.

The screens vary depending on the encapsulation type. Refer to information provided by your ISP to know what to enter in each field.

Note: Enter the Internet access information exactly as your ISP gave it to you. Leave a field blank if you do not have that information.

- **I have two ISPs:** Select this option to configure two Internet connections. Leave it cleared to configure just one. This option appears when you are configuring the first WAN interface.
- **Encapsulation:** Choose the **Ethernet** option when the WAN port is used as a regular Ethernet. Choose **PPPoE**, **PPTP** or **L2TP** for a dial-up connection according to the information from your ISP.
- **WAN Interface:** This is the interface you are configuring for Internet access.
- **Zone:** This is the security zone to which this interface and Internet connection belong.
- **IP Address Assignment:** Select **Auto** if your ISP did not assign you a fixed IP address. Select **Static** if the ISP assigned a fixed IP address.

Figure 32 Internet Access

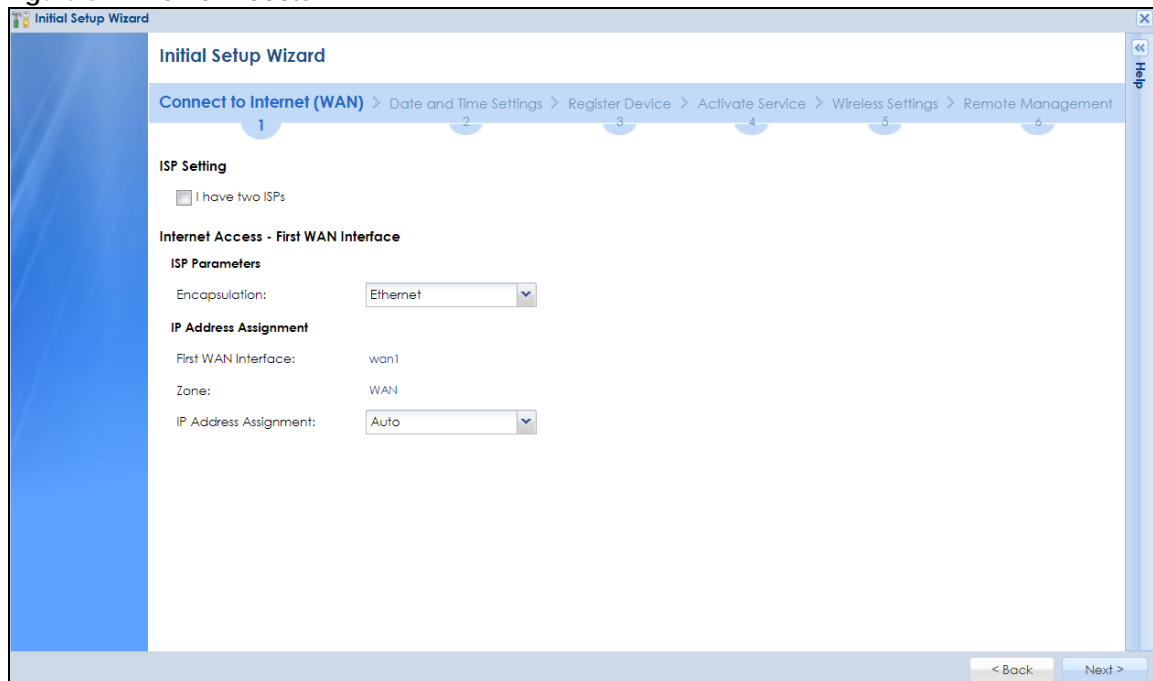

2.1.2 Internet Access: Ethernet

This screen is read-only if you set the previous screen's **IP Address Assignment** field to **Auto**. If you set the previous screen's **IP Address Assignment** field to **Static**, use this screen to configure your IP address settings.

- **Encapsulation:** This displays the type of Internet connection you are configuring.
- **First WAN Interface:** This is the number of the interface that will connect with your ISP.
- **Zone:** This is the security zone to which this interface and Internet connection will belong.

- **IP Address:** Enter your (static) public IP address. **Auto** displays if you selected **Auto** as the **IP Address Assignment** in the previous screen.

The following fields display if you selected static IP address assignment.

- **IP Subnet Mask:** Enter the subnet mask for this WAN connection's IP address.
- **Gateway IP Address:** Enter the IP address of the router through which this WAN connection will send traffic (the default gateway).
- **First / Second DNS Server:** These fields display if you selected static IP address assignment. The Domain Name System (DNS) maps a domain name to an IP address and vice versa. Enter a DNS server's IP address(es). The DNS server is extremely important because without it, you must know the IP address of a computer before you can access it. The Zyxel Device uses these (in the order you specify here) to resolve domain names for VPN, DDNS and the time server. Leave the field as 0.0.0.0 if you do not want to configure DNS servers.

2.1.2.1 Possible Errors

- Check that your cable connection is coming from the correct interface you are using for the WAN connection on the Zyxel Device.
- Check that the interface is connected to the device you are using for Internet access such as a broadband router and that the router is turned on. The LED of the interface you are using for the WAN connection on the Zyxel Device should be orange.
- If your Zyxel Device was not able to obtain an IP address, check that your Internet access information uses DHCP as the WAN connection type. If it fails again, check with your Internet service provider or administrator for correct WAN settings.
- If your Zyxel Device was not able to use the IP address entered, check that you were given an IP address, subnet mask and gateway address as part of your Internet access information. Re-enter your IP address, subnet mask and gateway IP address exactly as given. If it fails again, check with your Internet service provider or administrator for correct IP address, subnet mask and gateway address and other WAN settings.

Figure 33 Internet Access: Ethernet Encapsulation

Initial Setup Wizard

Connect to Internet (WAN) > Date and Time Settings > Register Device > Activate Service > Wireless Settings > Remote Management

1 2 3 4 5 6

Internet Access - First WAN Interface

ISP Parameters

Encapsulation: Ethernet

IP Address Assignment

First WAN Interface: wan1

Zone: WAN

IP Address: 0.0.0.0

IP Subnet Mask: 255.255.255.0

Gateway IP Address: 0.0.0.0

First DNS Server:

Second DNS Server:

< Back Next >

2.1.3 Internet Access: PPPoE

2.1.3.1 ISP Parameters

- Type the PPPoE **Service Name** from your service provider. PPPoE uses a service name to identify and reach the PPPoE server. You can use alphanumeric and `_@$./` characters, and it can be up to 64 characters long.
- **Authentication Type** – Select an authentication protocol for outgoing connection requests. Options are:
 - **Chap/PAP** – Your Zyxel Device accepts either CHAP or PAP when requested by the remote node.
 - **Chap** – Your Zyxel Device accepts CHAP only.
 - **PAP** – Your Zyxel Device accepts PAP only.
 - **MSCHAP** – Your Zyxel Device accepts MSCHAP only.
 - **MSCHAP-V2** – Your Zyxel Device accepts MSCHAP-V2 only.
- Type the **User Name** given to you by your ISP. You can use alphanumeric and `_@$./` characters, and it can be up to 31 characters long.
- Type the **Password** associated with the user name. Use up to 64 ASCII characters except the `[]` and `?`. This field can be blank.
- Select **Nailed-Up** if you do not want the connection to time out. Otherwise, type the **Idle Timeout** in seconds that elapses before the router automatically disconnects from the PPPoE server.

2.1.3.2 WAN IP Address Assignments

- **WAN Interface:** This is the name of the interface that will connect with your ISP.
- **Zone:** This is the security zone to which this interface and Internet connection will belong.
- **IP Address:** Enter your (static) public IP address. **Auto** displays if you selected **Auto** as the **IP Address Assignment** in the previous screen.
- **First / Second DNS Server:** These fields display if you selected static IP address assignment. The Domain Name System (DNS) maps a domain name to an IP address and vice versa. Enter a DNS server's IP address(es). The DNS server is extremely important because without it, you must know the IP address of a computer before you can access it. The Zyxel Device uses these (in the order you specify here) to resolve domain names for VPN, DDNS and the time server. Leave the field as 0.0.0.0 if you do not want to configure DNS servers. If you do not configure a DNS server, you must know the IP address of a machine in order to access it.

2.1.3.3 Possible Errors

- Check that you are using the correct PPPoE **Service Name** and **Authentication Type**.
- Make sure that your Internet access information uses PPPoE as the WAN connection type. Re-enter your PPPoE user name and password exactly as given. If it fails again, check with your Internet service provider or administrator for correct WAN settings and user credentials.
- If you were given an IP address and DNS server information as part of your Internet access information, re-enter them exactly as given. If it fails again, check with your Internet service provider or administrator for correct IP address, subnet mask and gateway address and other WAN settings.

Figure 34 Internet Access: PPPoE Encapsulation

Connect to Internet (WAN) > Date and Time Settings > Register Device > Activate Service > Wireless Settings > Remote Management

1 2 3 4 5 6

Internet Access - First WAN Interface

ISP Parameters

Encapsulation: PPPoE

Service Name: (Optional)

Authentication Type: Chap/PAP

User Name : [Redacted] ⓘ

Password: [Redacted] ⓘ

Retype to Confirm: [Redacted] ⓘ

Nailed-Up

Idle timeout: 100 Seconds

IP Address Assignment

First WAN Interface: wan1_ppp

Zone: WAN

IP Address: Auto

< Back Next >

2.1.4 Internet Access: PPTP

2.1.4.1 ISP Parameters

- **Authentication Type** – Select an authentication protocol for outgoing calls. Options are:
 - **Chap/PAP** – Your Zyxel Device accepts either CHAP or PAP when requested by the remote node.
 - **Chap** – Your Zyxel Device accepts CHAP only.
 - **PAP** – Your Zyxel Device accepts PAP only.
 - **MSCHAP** – Your Zyxel Device accepts MSCHAP only.
 - **MSCHAP-V2** – Your Zyxel Device accepts MSCHAP-V2 only.
- Type the **User Name** given to you by your ISP. You can use alphanumeric and `-_@$./` characters, and it can be up to 31 characters long.
- Type the **Password** associated with the user name. Use up to 64 ASCII characters except the `[]` and `?`. This field can be blank. Re-type your password in the next field to confirm it.
- Select **Nailed-Up** if you do not want the connection to time out. Otherwise, type the **Idle Timeout** in seconds that elapses before the router automatically disconnects from the PPTP server.

2.1.4.2 PPTP Configuration

- **Base Interface:** This identifies the Ethernet interface you configure to connect with a modem or router.
- Type a **Base IP Address** (static) assigned to you by your ISP.
- Type the **IP Subnet Mask** assigned to you by your ISP (if given).
- **Server IP:** Type the IP address of the PPTP server.
- Type a **Connection ID** or connection name. It must follow the “c:id” and “n:name” format. For example, C:12 or N:My ISP. This field is optional and depends on the requirements of your broadband modem or router. You can use alphanumeric and `-_:` characters, and it can be up to 31 characters long.

2.1.4.3 WAN IP Address Assignments

- **First WAN Interface:** This is the connection type on the interface you are configuring to connect with your ISP.
- **Zone** This is the security zone to which this interface and Internet connection will belong.
- **IP Address:** Enter your (static) public IP address. Auto displays if you selected **Auto** as the **IP Address Assignment** in the previous screen.
- **First / Second DNS Server:** These fields display if you selected static IP address assignment. The Domain Name System (DNS) maps a domain name to an IP address and vice versa. Enter a DNS server's IP address(es). The DNS server is extremely important because without it, you must know the IP address of a computer before you can access it. The Zyxel Device uses these (in the order you specify here) to resolve domain names for VPN, DDNS and the time server. Leave the field as 0.0.0.0 if you do not want to configure DNS servers.

2.1.4.4 Possible Errors

- Check that you're using the correct PPTP **Service IP, Base IP Address, IP Subnet Mask, Gateway IP Address, Connection ID** and **Authentication Type**.
- Make sure that your Internet access information uses PPTP as the WAN connection type. Re-enter your PPTP user name and password exactly as given. If it fails again, check with your Internet service provider or administrator for correct WAN settings and user credentials.
- If you were given an IP address and DNS server information as part of your Internet access information, re-enter them exactly as given. If it fails again, check with your Internet service provider or administrator for correct IP address, subnet mask and gateway address and other WAN settings.

Figure 35 Internet Access: PPTP Encapsulation

The screenshot shows the 'Initial Setup Wizard' for 'Internet Access - First WAN Interface'. The wizard is at step 1 of 6. The 'ISP Parameters' section is configured with Encapsulation: PPTP, Authentication Type: Chap/PAP, and Idle timeout: 100 Seconds. The 'PPTP Configuration' section shows Base Interface: wan1, Base IP Address: 0.0.0.0 (with a red error icon), IP Subnet Mask: 255.255.255.0, Gateway IP Address: (Optional), Server IP: 0.0.0.0 (with a red error icon and 'IP Address' label), and Connection ID: (Optional). The 'IP Address Assignment' section shows First WAN Interface: wan1_ppp, Zone: WAN, and IP Address: Auto. A '< Back' button and 'Next >' button are visible at the bottom right.

2.1.5 Internet Access: L2TP

2.1.5.1 ISP Parameters

- **Authentication Type** – Select an authentication protocol for outgoing connection requests. Options are:
 - **Chap/PAP** – Your Zyxel Device accepts either CHAP or PAP when requested by the remote node.
 - **Chap** – Your Zyxel Device accepts CHAP only.
 - **PAP** – Your Zyxel Device accepts PAP only.
 - **MSCHAP** – Your Zyxel Device accepts MSCHAP only.
 - **MSCHAP-V2** – Your Zyxel Device accepts MSCHAP-V2 only.
- Type the **User Name** given to you by your ISP. You can use alphanumeric and `_@$./` characters, and it can be up to 31 characters long.
- Type the **Password** associated with the user name. Use up to 64 ASCII characters except the `[]` and `?`. This field can be blank.
- Select **Nailed-Up** if you do not want the connection to time out. Otherwise, type the **Idle Timeout** in seconds that elapses before the router automatically disconnects from the PPPoE server.

2.1.5.2 L2TP Configuration

- **Base Interface**: This identifies the Ethernet interface you configure to connect with a modem or router.
- Type a **Base IP Address** (static) assigned to you by your ISP.
- **IP Subnet Mask**: Enter the subnet mask for this WAN connection's IP address.
- **Gateway IP Address**: Enter the IP address of the router through which this WAN connection will send traffic (the default gateway).
- **Server IP**: Type the IP address of the L2TP server.

2.1.5.3 WAN IP Address Assignments

- **WAN Interface**: This is the name of the interface that will connect with your ISP.
- **Zone**: This is the security zone to which this interface and Internet connection will belong.
- **IP Address**: Enter your (static) public IP address. **Auto** displays if you selected **Auto** as the **IP Address Assignment** in the previous screen.
- **First / Second DNS Server**: These fields display if you selected static IP address assignment. The Domain Name System (DNS) maps a domain name to an IP address and vice versa. Enter a DNS server's IP address(es). The DNS server is extremely important because without it, you must know the IP address of a computer before you can access it. The Zyxel Device uses these (in the order you specify here) to resolve domain names for VPN, DDNS and the time server. Leave the field as 0.0.0.0 if you do not want to configure DNS servers.

2.1.5.4 Possible Errors

- Check that you're using the correct **L2TP Server IP, Subnet Mask, Gateway IP Address, IP Subnet Mask** and **Authentication Type**.
- Make sure that your Internet access information uses L2TP as the WAN connection type. Re-enter your L2TP user name and password exactly as given. If it fails again, check with your Internet service provider or administrator for correct WAN settings and user credentials.
- If you were given an IP address and DNS server information as part of your Internet access information, re-enter them exactly as given. If it fails again, check with your Internet service provider or administrator for correct IP address, subnet mask and gateway address and other WAN settings.

Figure 36 Internet Access: L2TP Encapsulation

Initial Setup Wizard

Connect to Internet (WAN) > Date and Time Settings > Register Device > Activate Service > Wireless Settings > Remote Management

1 2 3 4 5 6

Internet Access - First WAN Interface

ISP Parameters

Encapsulation: L2TP

Authentication Type: Chap/PAP

User Name : ⓘ

Password: ⓘ

Retype to Confirm: ⓘ

Nailed-Up

Idle timeout: 100 Seconds

Base Interface: wan1

Base IP Address: 0.0.0.0 ⓘ

IP Subnet Mask: 255.255.255.0

Gateway IP Address: (Optional)

Server IP: 0.0.0.0 ⓘ IP Address

IP Address Assignment

First WAN Interface: wan1_ppp

Zone: WAN

IP Address: Auto

< Back Next >

2.1.6 Internet Access Setup – Second WAN Interface

If you selected **I have two ISPs**, after you configure the **First WAN Interface**, you can configure the **Second WAN Interface**. The screens for configuring the second WAN interface are similar to the first (see [Section 2.1.1 on page 60](#)).

Figure 37 Internet Access: Step 3: Second WAN Interface

Internet Access - Second WAN Interface

ISP Parameters

Encapsulation: Ethernet

WAN IP Address Assignments

Second WAN Interface: wan2

Zone: WAN

IP Address Assignment: Auto

Back Next

2.1.7 Internet Access: Congratulations

You have set up your Zyxel Device to access the Internet. A screen displays with your settings. Click **Connection Test** to check that you can access the Internet. If you cannot, click **Back** and confirm that you entered the settings correctly. If you have, check that you got the correct settings from your ISP or network administrator.

Figure 38 Internet Access: Summary

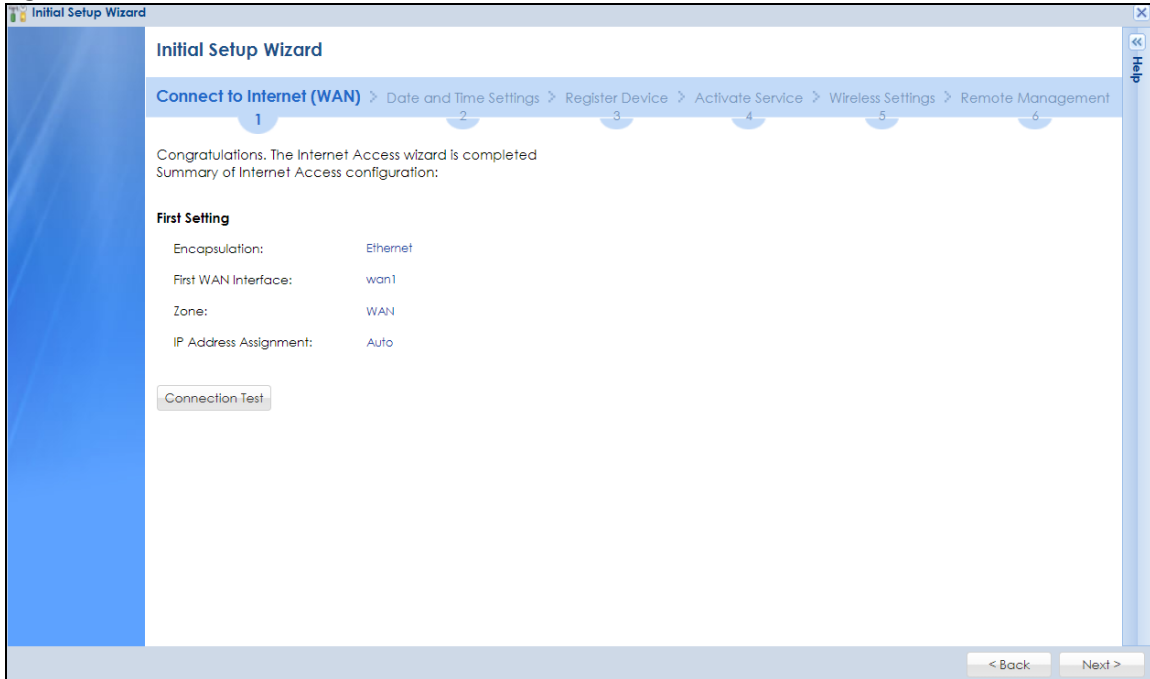

2.1.8 Date and Time Settings

It's important to have correct date and time values in the logs. The Zyxel Device can automatically update the time and date by detecting your time zone and whether Daylight Savings is in effect in that time zone.

If your Zyxel Device cannot get the correct date and time, it may not be able to connect to a time server. Check that the Zyxel Device has Internet access, then click **Sync. Now**.

Figure 39 Date and Time Settings

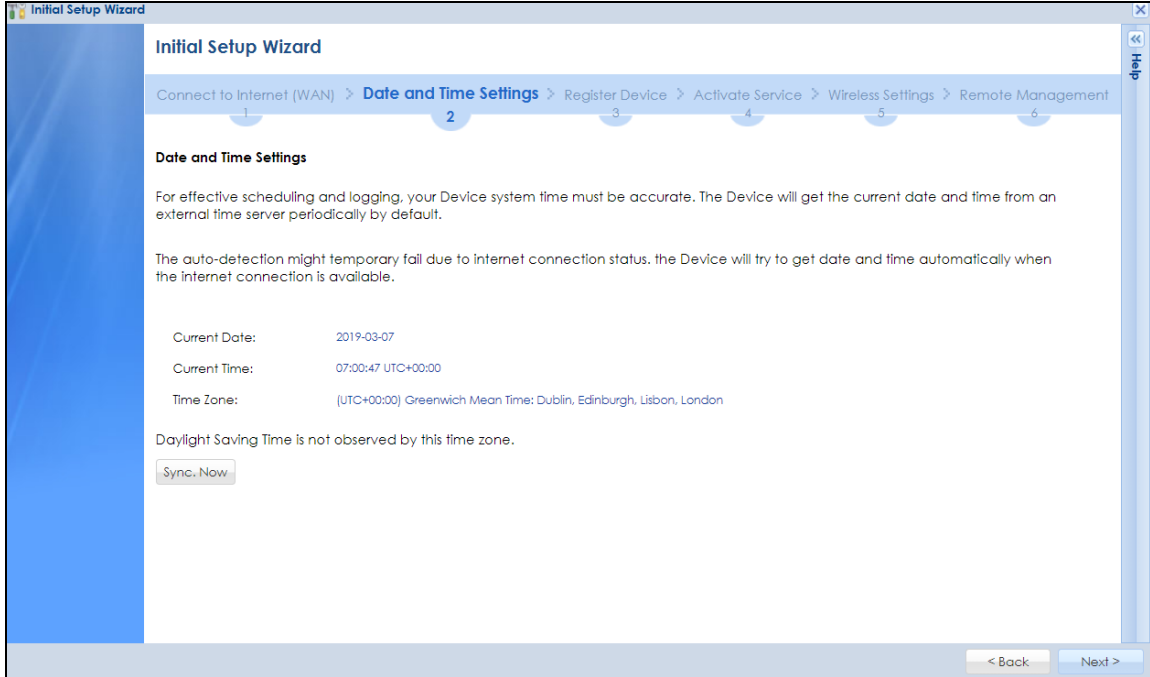

2.1.9 Register Device

Click the **Register** button in this screen to register your device at portal.myzyxel.com.

Note: The Zyxel Device must be connected to the Internet in order to register.

Figure 40 Register Device

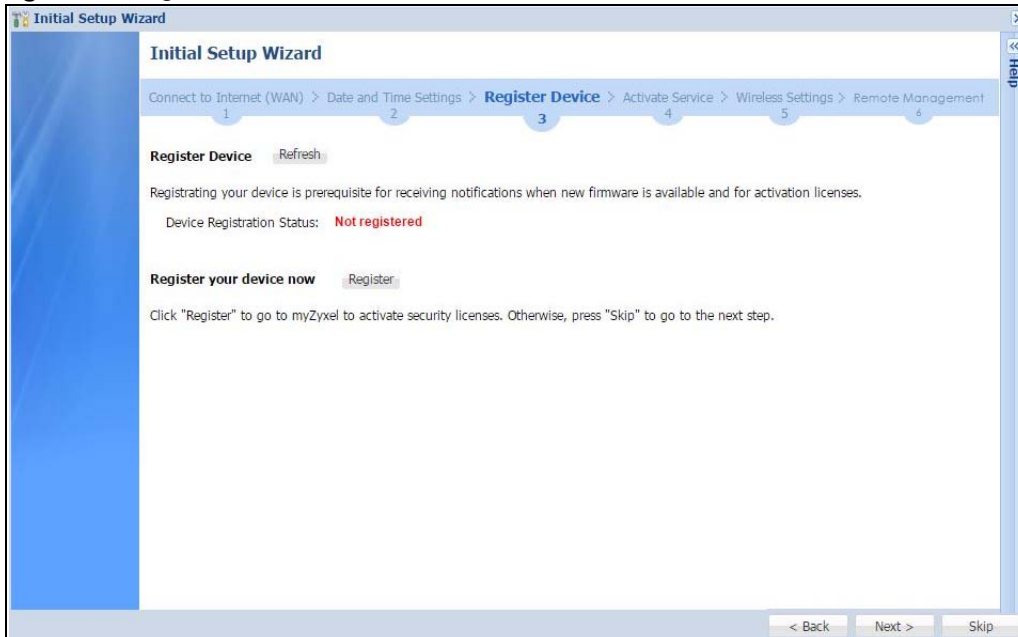

You may need the Zyxel Device's serial number and LAN MAC address to register it at myZyxel if you have not already done so. Refer to the label at the back of the Zyxel Device's for details.

Figure 41 myZyxel Login

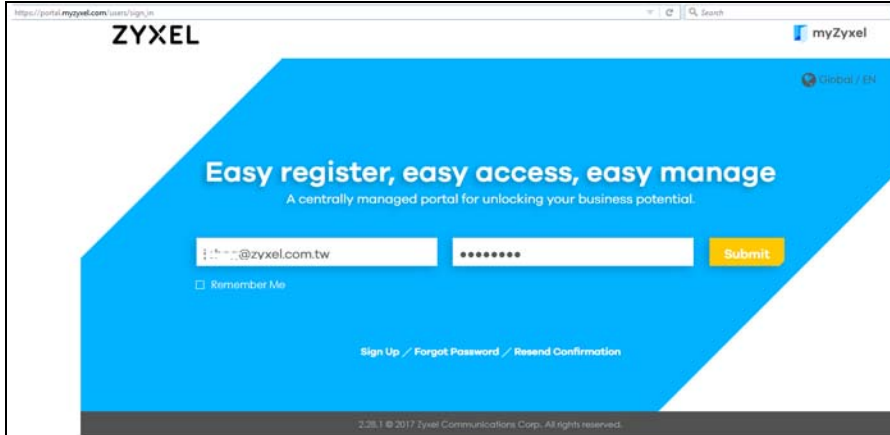

Click **Refresh** or use the **Configuration > Licensing > Registration** screen to update your Zyxel Device registration status.

Figure 42 Registered Device

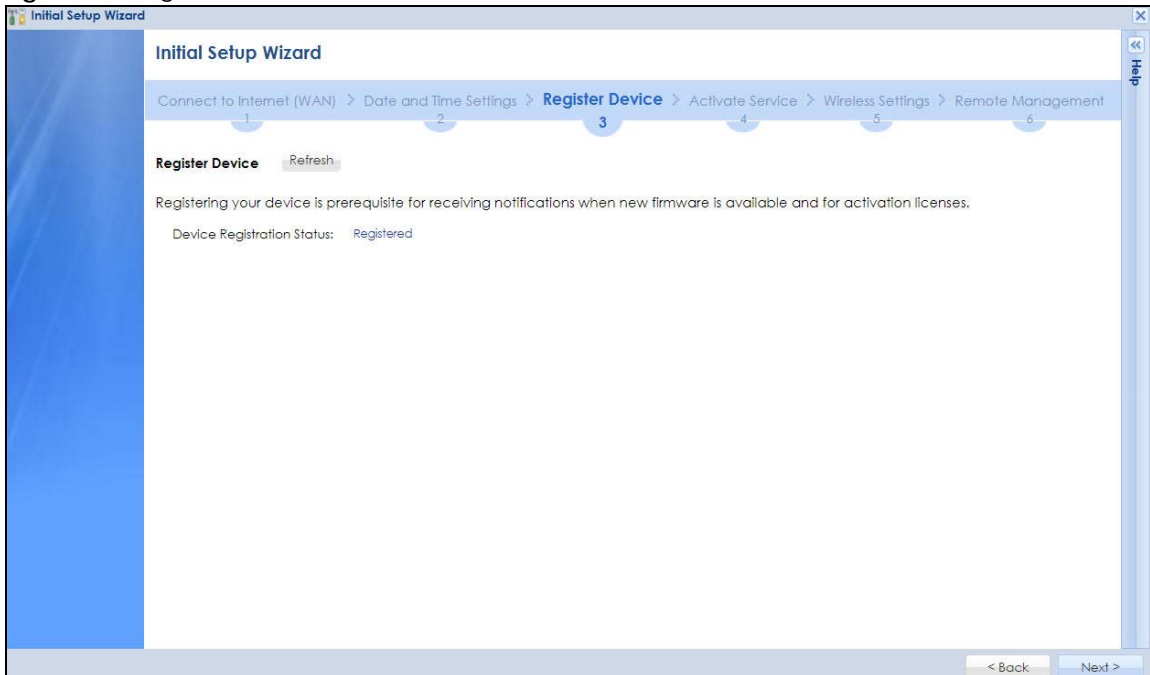

2.1.10 Activate Service

After you register your Zyxel Device, you can register for the services supported by your model. Examples of services are:

- Content Filter (to block websites by category, such as Gambling)
- IDP (to recognize and drop traffic with Intrusion, Detection & Protection attack patterns)
- Anti-Virus (to detect virus patterns in files)
- Anti-Spam (to mark or discard unsolicited commercial or junk e-mail suspect of being sent by spammers).

Click **Refresh** and wait a few moments for the registration information to update in this screen. If the page does not refresh, make sure the Internet connection is working and click **Refresh** again. To check your Internet connection, try to access the Internet from a computer connected to a LAN port on the Zyxel Device. If you cannot, then check your Internet access settings on the Zyxel Device.

Figure 43 Activate Service

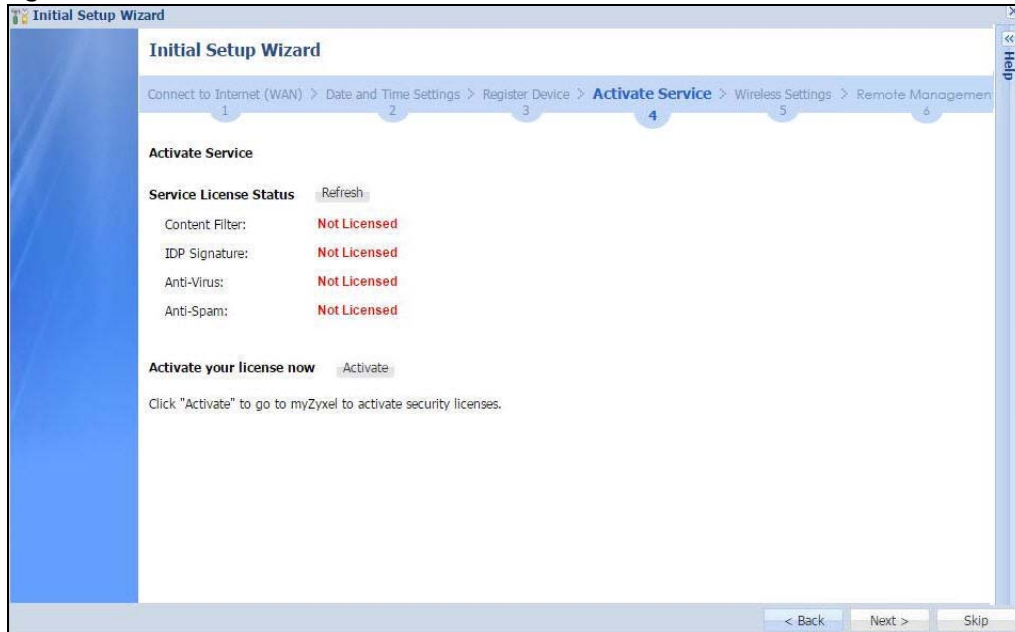
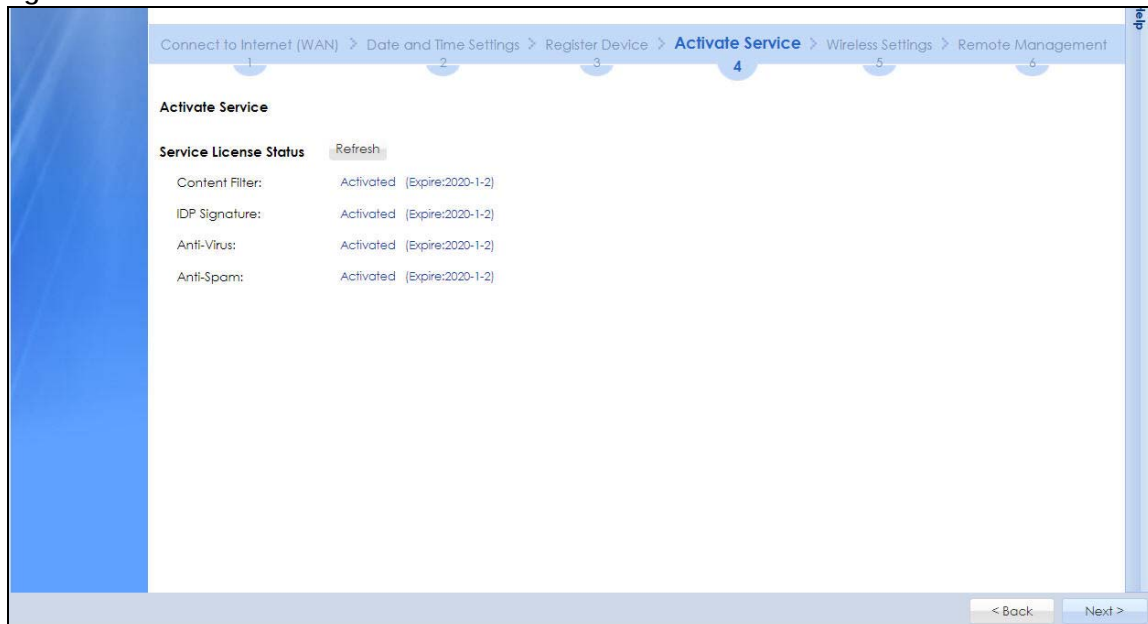

Figure 44 Activated Service



2.1.11 Wireless Settings: AP Controller

The Zyxel Device can act as an AP Controller that can manage APs in the same network as the Zyxel Device. Select **Yes** if you want your Zyxel Device to manage APs in your network; otherwise select **No**.

Figure 45 Wireless Settings: AP Controller

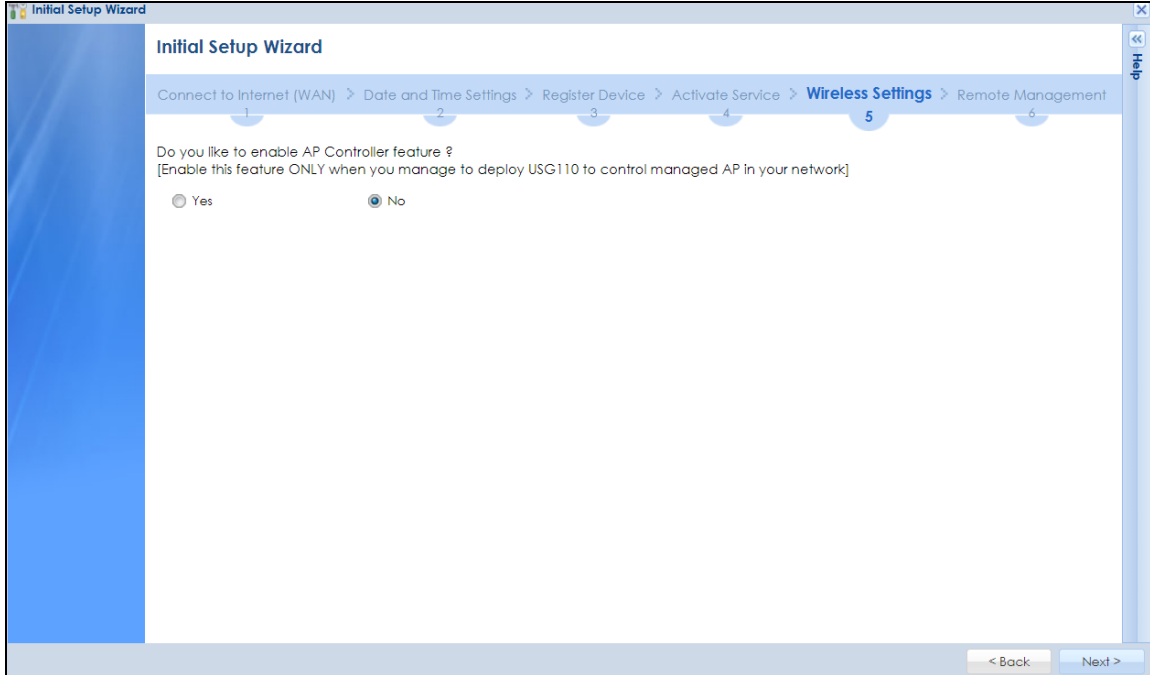

2.1.12 Wireless Settings: SSID & Security

Configure SSID and wireless security in this screen.

SSID Setting

- **SSID** – Enter a descriptive name of up to 32 printable characters for the wireless LAN.
- **Security Mode** – Select **Pre-Shared Key** to add security on this wireless network. Otherwise, select **None** to allow any wireless client to associate this network without authentication.
- **Pre-Shared Key** – Enter a pre-shared key of between 8 and 63 case-sensitive ASCII characters (including spaces and symbols) or 64 hexadecimal characters.
- **Hidden SSID** – Select this option if you want to hide the SSID in the outgoing beacon frame. A wireless client then cannot obtain the SSID through scanning using a site survey tool.
- **Enable Intra-BSS Traffic Blocking** – Select this option if you want to prevent crossover traffic from within the same SSID. Wireless clients can still access the wired network but cannot communicate with each other.

For Built-in Wireless AP Only

Bridged to: Zyxel Devices with W in the model name have a built-in AP. Select an interface to bridge with the built-in AP wireless network. Devices connected to this interface will then be in the same broadcast domain as devices in the AP wireless network.

Figure 46 Wireless Settings: SSID & Security

2.1.13 Remote Management

Configure settings in this screen to add a rule that has priority over other rules in **Policy Control**. It restricts access to the Web Configurator and SSL VPN service from the Internet.

Figure 47 Remote Management

- Enable **Allow secure remote management from WAN** to create a rule in the **Policy Control** screen. It allows you to access the Zyxel Device from the WAN using HTTPS.
- Enable **Restrict access only to trusted host** to have the Zyxel Device allow access only from the IP addresses or FQDNs specified in the fields below.
- Enable **Allow SSL VPN access from WAN** to allow access to the Zyxel Device remotely through the SSL VPN tunnel.

- Enable **Restrict access by GeoIP** to have the Zyxel Device allow access only from countries specified in the fields below.

Figure 48 Object > Service > Service Group – HTTPS

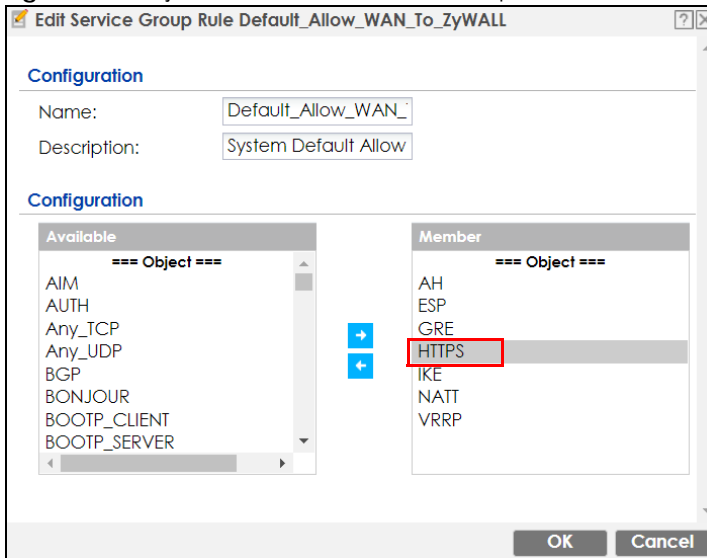

CHAPTER 3

Hardware, Interfaces and Zones

3.1 Hardware Overview

This section describes the front and rear panels for each model.

3.1.1 Front Panels

The LED indicators are located on the front panel.

Figure 49 ZyWALL 110 / USG110 / USG210 Front Panel

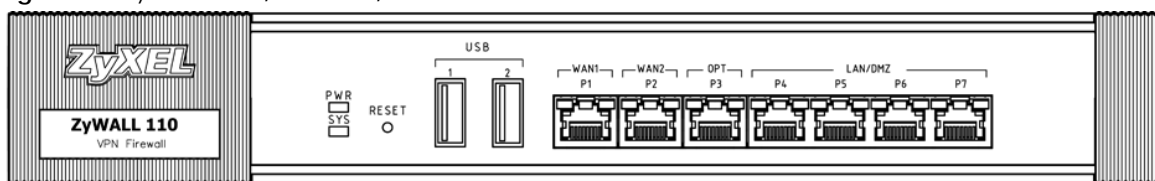

Figure 50 ZyWALL 310 / ZyWALL 1100 / USG310 / USG1100 / USG1900 Front Panel

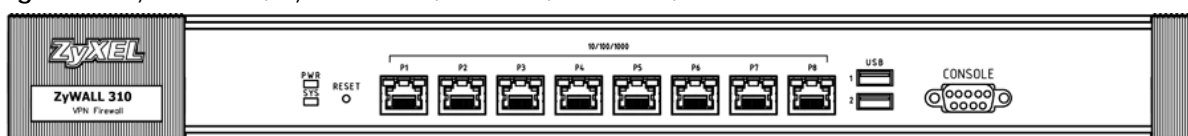

Figure 51 USG40 Front Panel

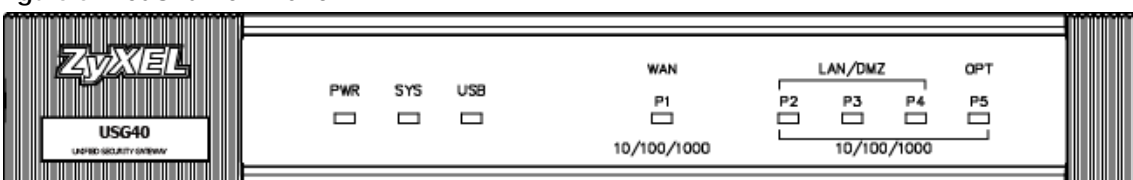

Figure 52 USG40W Front Panel

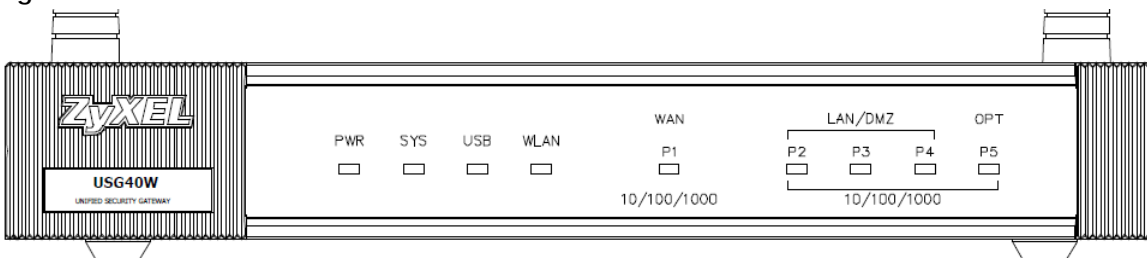

Figure 53 USG60 Front Panel

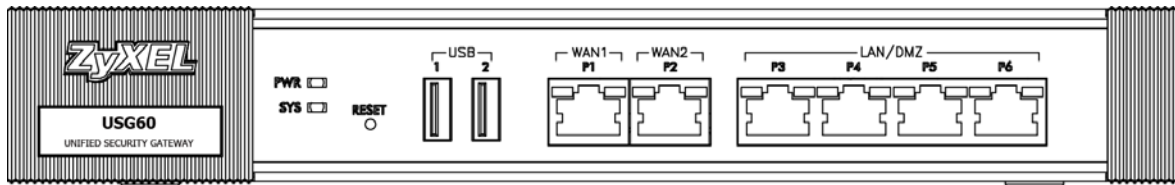

Figure 54 USG60W Front Panel

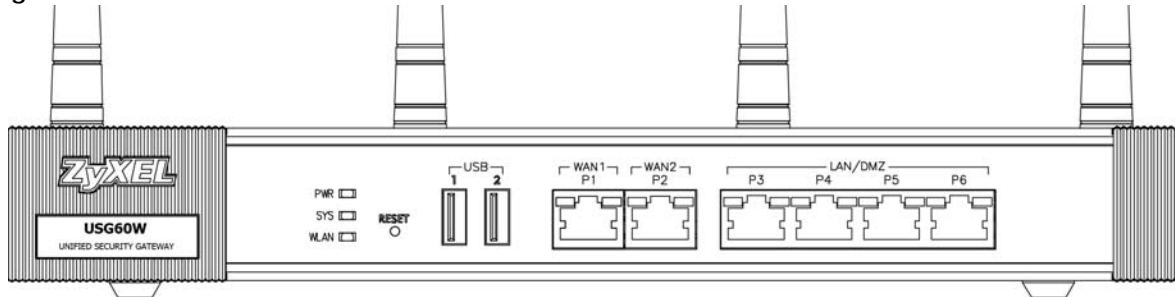
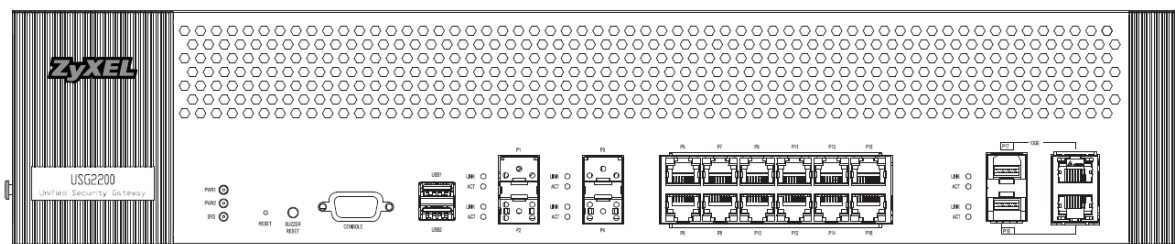

Figure 55 USG2200 Front Panel



The following table describes the front panel LEDs.

Table 15 LED Descriptions

LED	COLOR	STATUS	DESCRIPTION
PWR		Off	The Zyxel Device is turned off.
	Green	On	The Zyxel Device is turned on.
	Red	On	There is a hardware component failure. Shut down the device, wait for a few minutes and then restart the device. If the LED turns red again, then please contact your vendor.
SYS	Green	Off	The Zyxel Device is not ready or has failed.
		On	The Zyxel Device is ready and running.
		Blinking	The Zyxel Device is booting.
	Red	On	The Zyxel Device has an error or has failed.
USB	Green	Off	No device is connected to the Zyxel Device's USB port or the connected device is not supported by the Zyxel Device.
		On	A mobile broadband USB card or USB storage device is connected to the USB port.
	Orange	On	Connected to a mobile broadband network through the connected mobile broadband USB card.
P1, P2...	Green	Off	There is no traffic on this port.
		Blinking	The Zyxel Device is sending or receiving packets on this port.
	Orange	Off	There is no connection on this port.
		On	This port has a successful link.
		Blinking	The Zyxel Device is sending or receiving packets on this port.

The following table describes the USG2200 LEDs.

Table 16 USG2200 LED Descriptions

LED	COLOR	STATUS	DESCRIPTION
PWR1, 2		Off	The Zyxel Device is turned off.
	Green	On	The Zyxel Device is turned on.
	Red	On	There is a hardware component failure. Shut down the device, wait for a few minutes and then restart the device. If the LED turns red again, then please contact your vendor.
SYS	Green	Off	The Zyxel Device is not ready or has failed.
		On	The Zyxel Device is ready and running.
		Blinking	The Zyxel Device is booting.
	Red	On	The Zyxel Device has an error or has failed.
P1 – P4 (SFP) Link	Green	Off	There is no connection on this port.
		On	This port has a successful 100Mbps link.
	Orange	Off	There is no connection on this port.
		On	This port has a successful 1000Mbps link.
P1 – P4 (SFP) ACT	Green	Off	There is no traffic on this port.
		On	The Zyxel Device is sending or receiving packets on this port.
P5 – P16 (WAN/ LAN))	Green	Off	There is no connection on this port.
		On	This port has a successful 10/100Mbps link.
		Blinking	The Zyxel Device is sending or receiving packets on this port.
	Orange	Off	There is no connection on this port.
		On	This port has a successful 1000Mbps link.
		Blinking	The Zyxel Device is sending or receiving packets on this port.
P17 – P18 (SFP+) Link	Blue	Off	There is no connection on this port.
		On	This port has a successful 10Gbps link.
P17 – P18 (SFP+) ACT	Green	Off	There is no traffic on this port.
		Blinking	The Zyxel Device is sending or receiving packets on this port.
P17 – P18 (10GE) Link	Blue	Off	There is no connection on this port.
		On	This port has a successful 10Gbps link.
P17 – P18 (10GE) ACT	Green	Off	There is no traffic on this port.
		Blinking	The Zyxel Device is sending or receiving packets on this port.

The following table describes the ports on the front panel.

Table 17 Front Panel Ports

LABEL	DESCRIPTION
RESET	Press the button in for about 5 seconds (or until the SYS LED starts to blink), then release it to return the Zyxel Device to the factory defaults (password is 1234, LAN IP address 192.168.1.1 etc.)
CONSOLE	<p>You can use the console port to manage the Zyxel Device using CLI commands. You will be prompted to enter your user name and password. See the Command Reference Guide for more information about the CLI.</p> <p>When configuring using the console port, you need a computer equipped with communications software configured to the following parameters:</p> <ul style="list-style-type: none"> • Speed 115200 bps • Data Bits 8 • Parity None • Stop Bit 1 • Flow Control Off
USB	Connect a storage device for system logs (see Maintenance > Diagnostics > System Log) and storage (see Configuration > System > USB Storage).
P1 – P6	These are 1G RJ-45 Ethernet ports.

The following table describes the ports on the USG2200 front panel.

Table 18 USG2200 Front Panel Ports

LABEL	DESCRIPTION
RESET	Press the button in for about 5 seconds (or until the SYS LED starts to blink), then release it to return the Zyxel Device to the factory defaults (password is 1234, LAN IP address 192.168.1.1, and so on.)
BUZZER RESET	The buzzer alarms when a power module fails. Use this to mute the buzzer alarm.
CONSOLE	<p>You can use the console port to manage the Zyxel Device using CLI commands. You will be prompted to enter your user name and password. See the Command Reference Guide for more information about the CLI.</p> <p>When configuring using the console port, you need a computer equipped with communications software configured to the following parameters:</p> <ul style="list-style-type: none"> • Speed 115200 bps • Data Bits 8 • Parity None • Stop Bit 1 • Flow Control Off
USB	Connect a storage device for system logs (see Maintenance > Diagnostics > System Log) and storage (see Configuration > System > USB Storage).
P1 – P4	<p>These are SFP (1G) ports. These are compatible 1G transceiver modules (at the time of writing):</p> <ul style="list-style-type: none"> • SFP-1000T • SFP-SX-D • SFP-LX-10-D • SFP-BX1310-10-D • SFP-BX1490-10-D • SFP-LHX1310-40-D • SFP-ZX-80-D

Table 18 USG2200 Front Panel Ports (continued)

LABEL	DESCRIPTION
P5 – P16	These are 1G RJ-45 Ethernet ports.
P17 – P18	These are 10G combo (SFP+ & RJ-45) ports. These are compatible 10G transceiver modules (at the time of writing:) <ul style="list-style-type: none"> • SFP10G-SR • SFP10G-LR

3.1.2 Rear Panels

The connection ports are located on the rear panel.

Figure 56 ZyWALL 110 / USG110 / USG210 Rear Panel

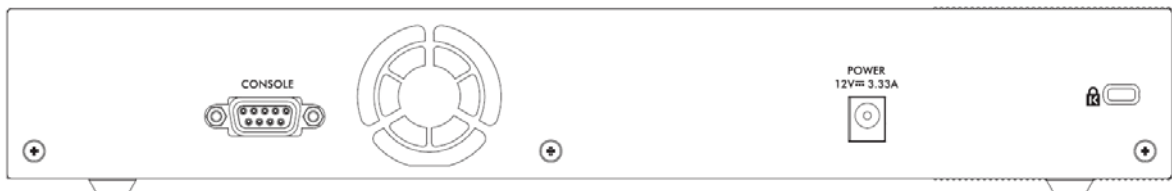

Figure 57 ZyWALL 310 / ZyWALL 1100 / USG310 / USG1100 / USG1900 Rear Panel

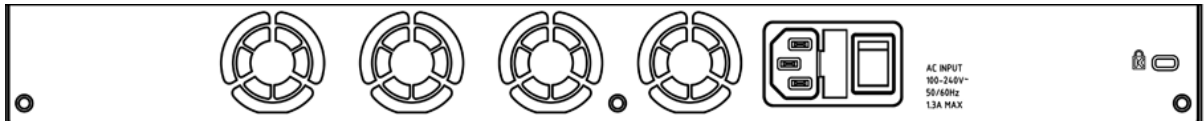

Figure 58 USG40 / USG40W Rear Panel

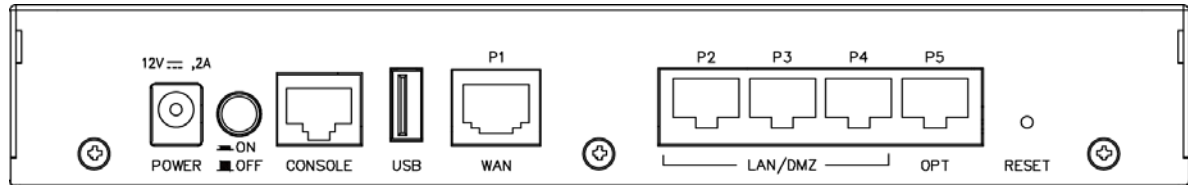
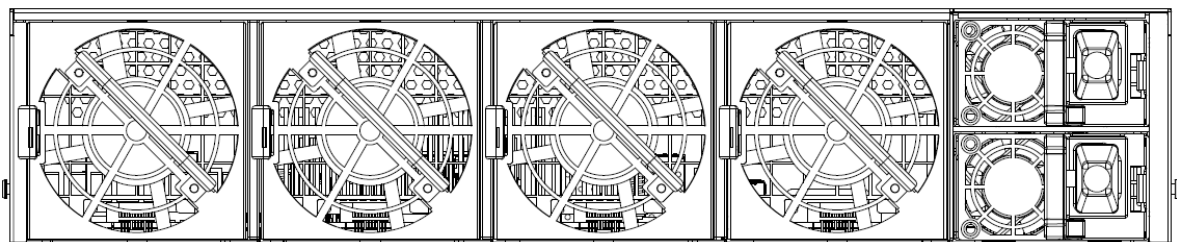

Figure 59 USG60 / USG60W Rear Panel



Figure 60 USG2200 Rear Panel



The following table describes the items on the rear panel.

Table 19 Rear Panel Items

LABEL	DESCRIPTION
Console	<p>You can use the console port to manage the Zyxel Device using CLI commands. You will be prompted to enter your user name and password. See the Command Reference Guide for more information about the CLI.</p> <p>When configuring using the console port, you need a computer equipped with communications software configured to the following parameters:</p> <ul style="list-style-type: none"> • Speed 115200 bps • Data Bits 8 • Parity None • Stop Bit 1 • Flow Control Off
Power	Use the included power cord to connect the power socket to a power outlet. Turn the power switch on if your Zyxel Device has a power switch.
Lock	Attach a lock-and-cable from the Kensington lock (the small, metal-reinforced, oval hole) to a permanent object, such as a pole, to secure the Zyxel Device in place.
Fan	The fans are for cooling the Zyxel Device. Make sure they are not obstructed to allow maximum ventilation.

Note: Use an 8-wire Ethernet cable to run your Gigabit Ethernet connection at 1000 Mbps. Using a 4-wire Ethernet cable limits your connection to 100 Mbps. Note that the connection speed also depends on what the Ethernet device at the other end can support.

3.2 Installation Scenarios

The Zyxel Device can be:

- Placed on a desk.
- Wall-mounted on a wall.
- Rack-mounted on a standard EIA rack.

The following table summarizes the installation scenarios of the Zyxel Device by mounting method.

Table 20 Mounting Method

DESK-MOUNTING	RACK-MOUNTING	WALL-MOUNTING
• USG60	• ZyWALL 110	• USG40
• USG60W	• ZyWALL 310	• USG40W
• USG110	• ZyWALL 1100	• USG60
• USG210	• USG110	• USG60W
• ZyWALL 110	• USG210	
	• USG310	
	• USG1100	
	• USG1900	

WARNING! Do NOT block the ventilation holes on the Zyxel Device. Allow 100 mm clearance for the ventilation holes to prevent your Zyxel Device from overheating. Do not store things on the Zyxel Device. Do not place a Zyxel Device on another high temperature device. Overheating could affect the performance of your Zyxel Device, or even damage it.

3.2.1 Desk-mounting

- 1 Make sure the Zyxel Device is clean and dry.
- 2 Remove the adhesive backing from the rubber feet.
- 3 Attach the rubber feet to each corner on the bottom of the Zyxel Device. These rubber feet help protect the Zyxel Device from shock or vibration, and allow air circulation.

Figure 61 Attaching Rubber Feet

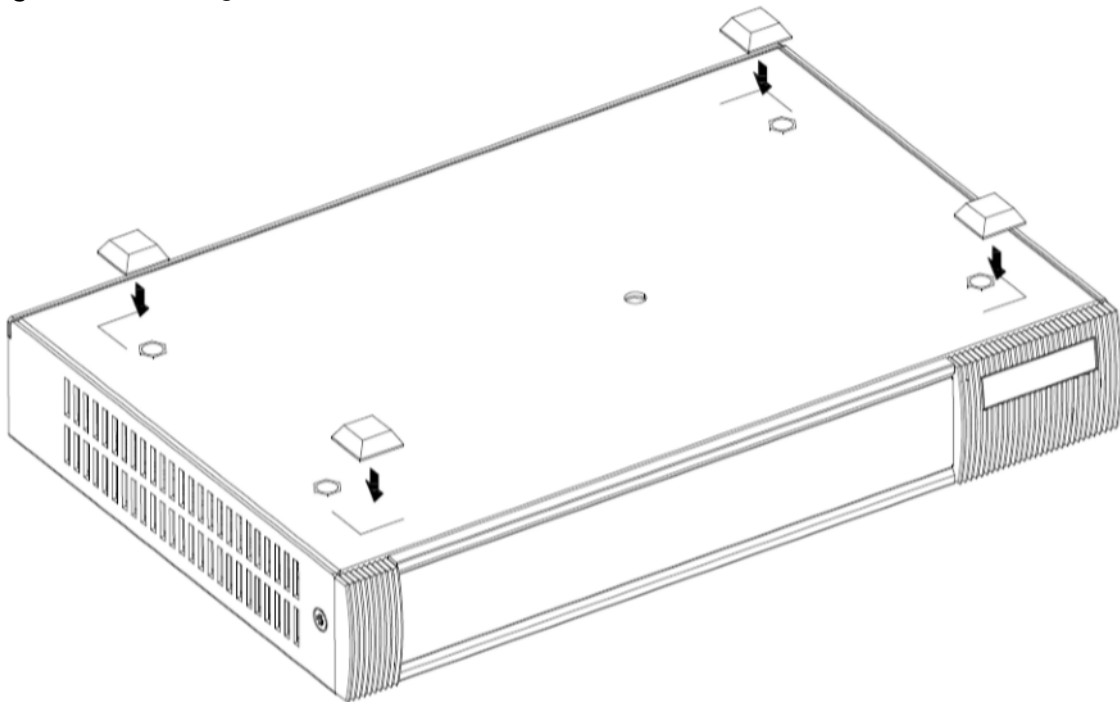

3.2.2 Rack-mounting

Use the following steps to mount the Zyxel Device on an EIA standard size, 19-inch rack or in a wiring closet with other equipment using a rack-mounting kit. Make sure the rack will safely support the combined weight of all the equipment it contains and that the position of the ZyWALL does not make the rack unstable or top-heavy. Take all necessary precautions to anchor the rack securely before installing the unit.

Note: Leave 10 cm of clearance at the sides and 20 cm in the rear.

Use a #2 Phillips screwdriver to install the screws.

Note: Failure to use the proper screws may damage the unit.

- 1 Align one bracket with the holes on one side of the Zyxel Device and secure it with the included bracket screws (smaller than the rack-mounting screws).
- 2 Attach the other bracket in a similar fashion.

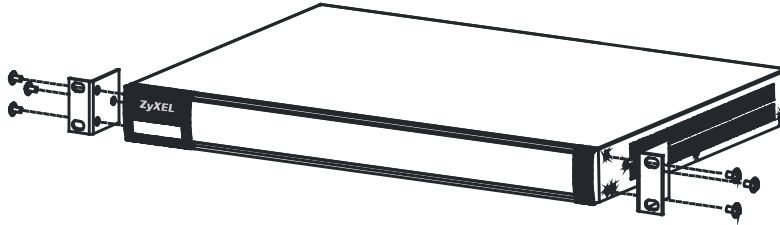

- 3 After attaching both mounting brackets, position the Zyxel Device in the rack and match up the bracket holes with the rack holes. Secure the Zyxel Device to the rack with the rack-mounting screws.

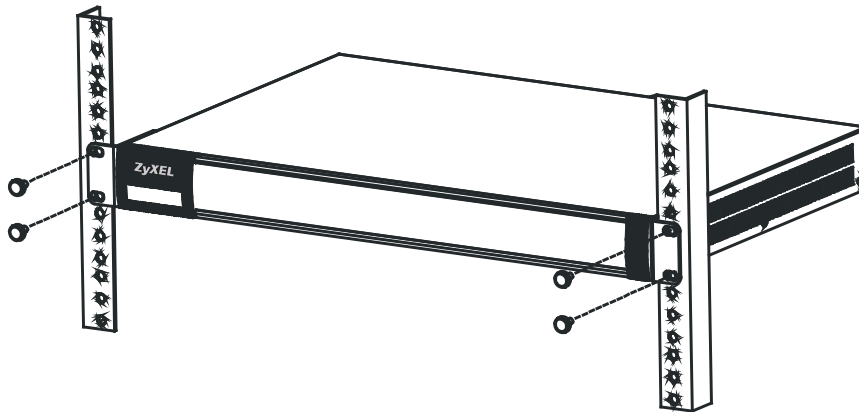

3.2.3 USG2200 Rack Mounting

3.2.3.1 Installation Requirements

- Two front mounting brackets (short) and two rear mounting brackets (long).
- Two railings (inner and outer)

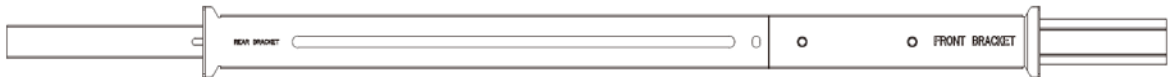

- Front Brackets & M3 Screws

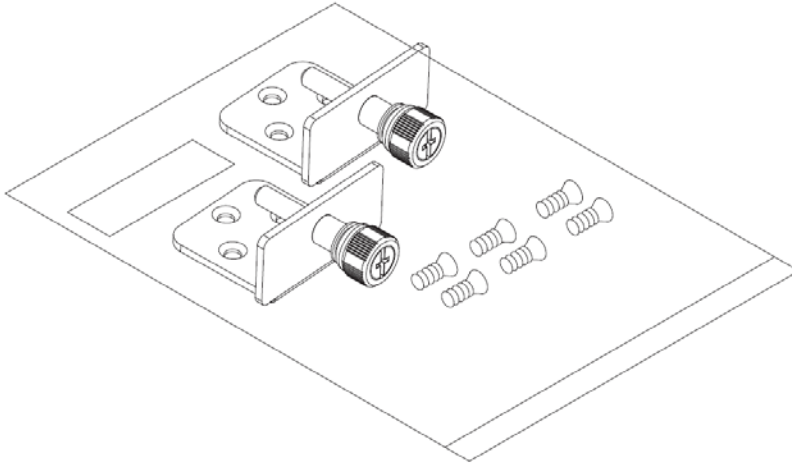

- Rack M6 Screws and Nuts

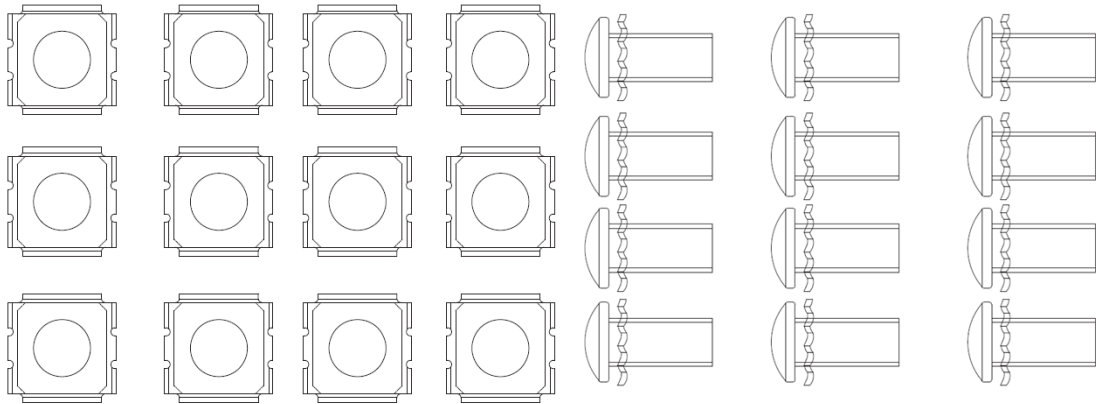

Note: Failure to use the proper screws may damage the unit.

3.2.3.2 Procedure

- 1 Connect the front brackets to the USG2200 using the M3 bracket screws.

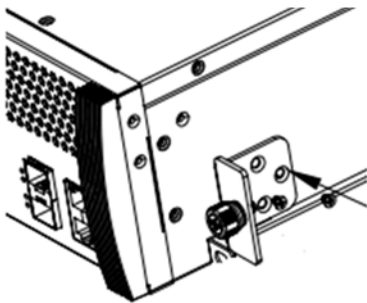

- 2 To separate the inner and outer railings, press tab B (white) and slide out the outer railing.

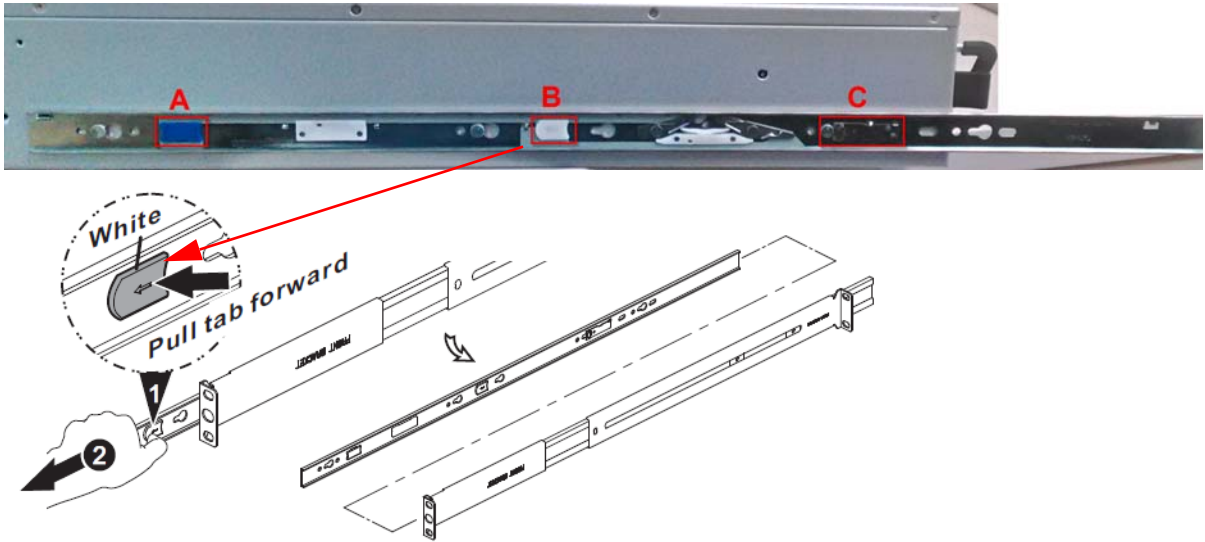

- 3 Connect the inner railings to the USG2200 as shown. Align the holes on the inner rail with the screws on the side of the USG2200 and slide until it clicks in place. Do the same for the other inner rail on the other side of the USG2200. (Use tab C to remove the inner rail from the USG2200.)

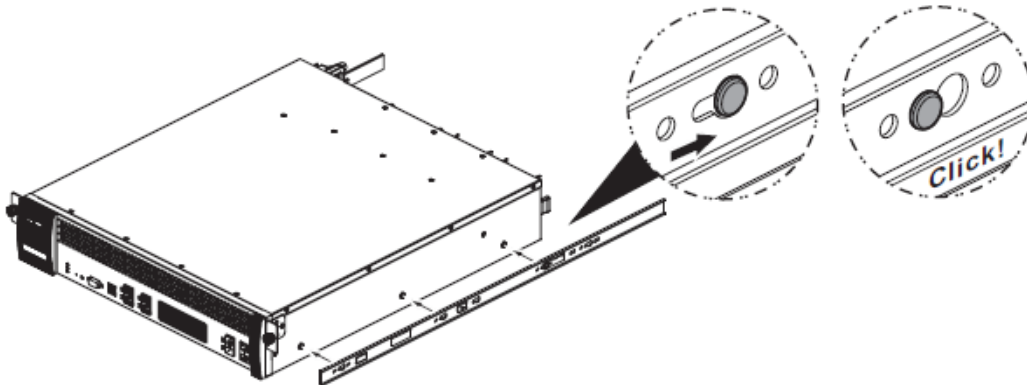

- 4 Connect the front of an outer railing to the front of the rack using the M6 rack screws. Similarly, connect the rear of an outer railing to the back of the rack using the rack screws. Repeat for the second outer rail on the other side of the rack.

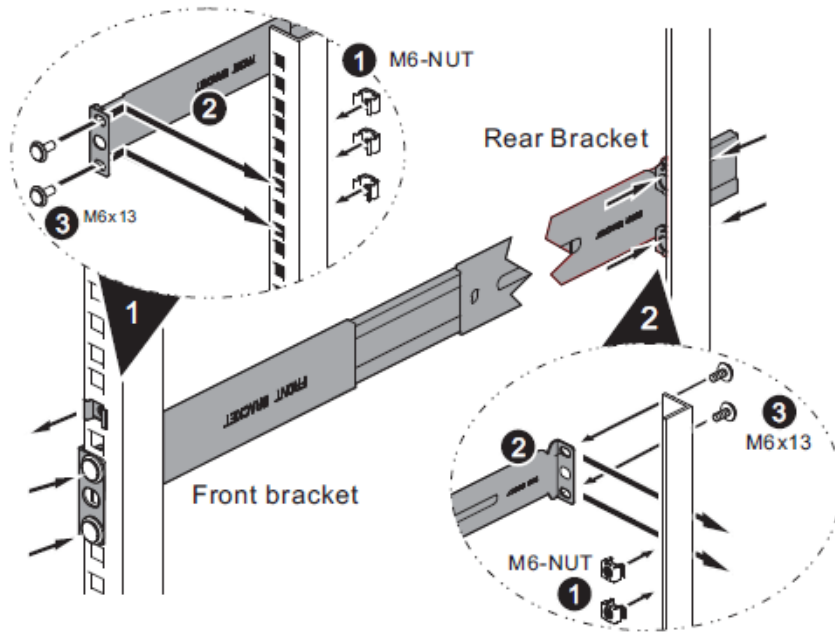

- 5 Carefully lift the USG2200 with the inner rails attached and slide it onto the outer rails of the rack. Use the blue tab (A in step 2 above) to slide the USG2200 along the inner rail. Secure the USG2200 in the rack using the front bracket screws.

Precautions

- Make sure the rack will safely support the combined weight of all the equipment it contains.
- Make sure the position of the USG2200 does not make the rack unstable or top-heavy. Take all necessary precautions to anchor the rack securely before installing the unit.

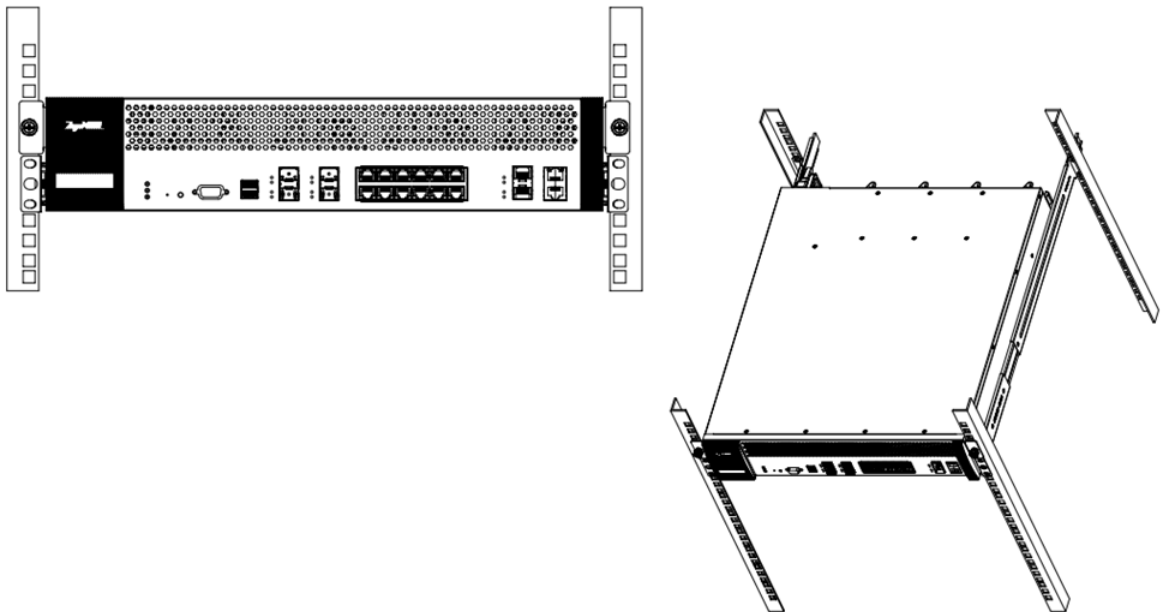

3.2.4 Wall-mounting

Do the following to attach the Zyxel Device to a wall.

The following table lists the distance "X" between mounting holes for each model:

Table 21 Distance "X" between mounting holes

MODEL NAME	DISTANCE "X"
USG40	174 mm (6.85")
USG40W	174 mm (6.85")
USG60	206 mm (8.11")
USG60W	206 mm (8.11")

- 1 Drill into a wall two holes 3 mm – 4 mm (0.12" – 0.16") wide, 20 mm – 30 mm (0.79" – 1.18") deep, and a distance X (see the preceding table) apart. Place two screw anchors in the holes.

Figure 62 Wall Mounting Screw Specifications

unit: mm
 D = 6.5~7.5
 H = 1.5
 L = 20~30
 d = 3.0~4.0

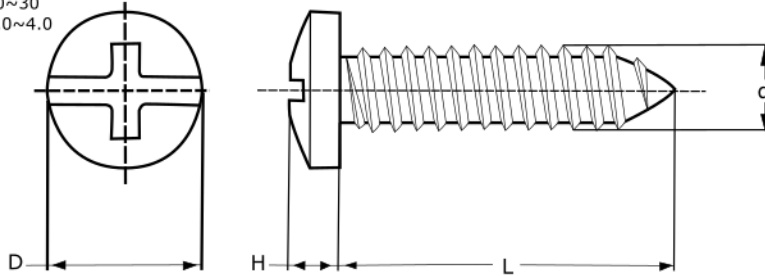
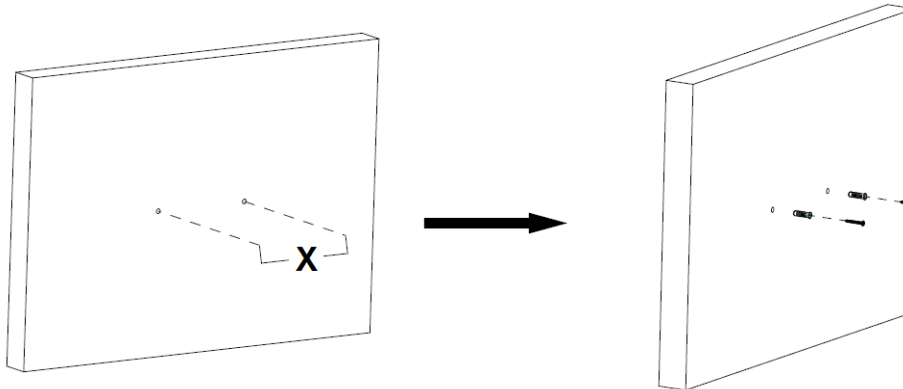

Figure 63 Wall Mounting



- 2 Screw two screws with 6 mm – 8 mm (0.24" – 0.31") wide heads into the screw anchors. Do not screw the screws all the way in to the wall; leave a small gap of between 1 – 1.5 mm (0.04" – 0.06") between the head of the screw and the wall.

The gap must be big enough for the screw heads to slide into the screw slots and the connection cables to run down the back of the Zyxel Device.

Note: Make sure the screws are securely fixed to the wall and strong enough to hold the weight of the Zyxel Device with the connection cables.

Figure 64 Gap for Cables

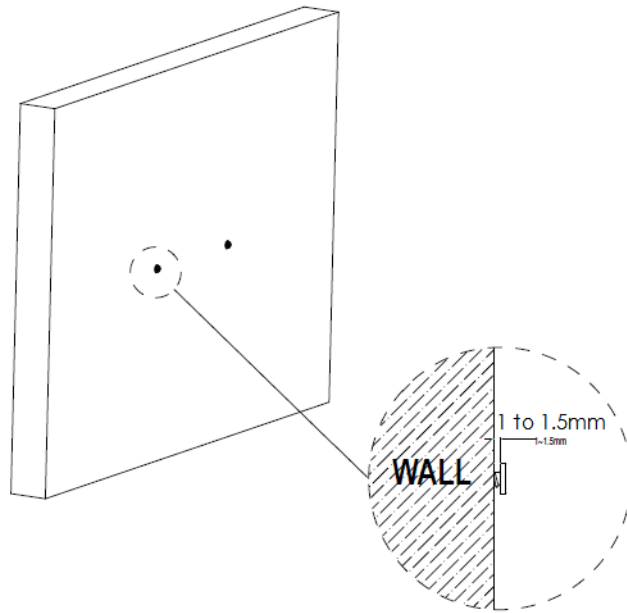

- 3 Use the holes on the Zyxel Device to hang the Zyxel Device on the screws.

Wall-mount the Zyxel Device horizontally. The Zyxel Device's side panels with ventilation slots should not be facing up or down as this position is less safe.

3.3 Default Zones, Interfaces, and Ports

The default configurations for zones, interfaces, and ports are as follows. References to interfaces may be generic rather than the specific name used in your model. For example, this guide may use "the WAN interface" rather than "wan1" or "wan2", "ge2" or "ge3" (USG2200 is "ge5" or "ge6").

An OPT (optional) Ethernet port can be configured as an additional WAN port, LAN, WLAN, or DMZ port.

The following table shows the default physical port and interface mapping for each model at the time of writing.

Table 22 Default Physical Port - Interface Mapping

PORT / INTERFACE	P1	P2	P3	P4	P5	P6	P7	P8
• USG40	wan1	lan1	lan1	lan1	opt			
• USG40W	wan1	lan1	lan1	lan1	opt			
• USG60	wan1	wan2	lan1	lan1	lan1	lan1		
• USG60W	wan1	wan2	lan1	lan1	lan1	lan1		

Table 22 Default Physical Port - Interface Mapping (continued)

PORT / INTERFACE	P1	P2	P3	P4	P5	P6	P7	P8
<ul style="list-style-type: none"> ZyWALL 110 USG110 USG210 	wan1	wan2	opt	lan1	lan1	lan1	dmz	
<ul style="list-style-type: none"> ZyWALL 310 ZyWALL 1100 USG310 USG1100 USG1900 	ge1	ge2	ge3	ge4	ge5	ge6	ge7	ge8

Table 23 Default Physical Port - Interface Mapping – USG2200

PORT / INTERFACE	P1	P2	P3	P4	P5	P6	P7	P8	P9	P10	P11	P12	P13	P14	P15	P16	P17	P18
USG2200	ge1	ge2	ge3	ge4	ge5	ge6	ge7	ge8	ge9	ge10	ge11	ge12	ge13	ge14	ge15	ge16	te1	te2

The following table shows the default interface and zone mapping for each model at the time of writing.

Table 24 Default Zone – Interface Mapping

ZONE / INTERFACE	WAN	LAN1	LAN2	DMZ	OPT	NO DEFAULT ZONE
<ul style="list-style-type: none"> USG40 	WAN1 WAN1_PPP	LAN1	LAN2	DMZ	OPT OPT_PPP	
<ul style="list-style-type: none"> USG40W 	WAN1 WAN1_PPP	LAN1	LAN2	DMZ	OPT OPT_PPP	
<ul style="list-style-type: none"> USG60 	WAN1 WAN1_PPP WAN2 WAN2_PPP	LAN1	LAN2	DMZ		
<ul style="list-style-type: none"> USG60W 	WAN1 WAN1_PPP WAN2 WAN2_PPP	LAN1	LAN2	DMZ		
<ul style="list-style-type: none"> ZyWALL 110 USG110 USG210 	WAN1 WAN1_PPP WAN2 WAN2_PPP	LAN1	LAN2	DMZ	OPT OPT_PPP	
<ul style="list-style-type: none"> ZyWALL 310 ZyWALL 1100 USG310 USG1100 USG1900 	GE1 GE1_PPP GE2 GE2_PPP	GE3	GE4	GE5		GE3_PPP GE4_PPP GE5_PPP GE6 GE7 GE8

Table 25 Default Zone – Interface Mapping USG2200

ZONE / INTERFACE	WAN	LAN1	LAN2	DMZ	10G	NO DEFAULT ZONE
<ul style="list-style-type: none"> USG2200 	GE5, GE5_PPP	GE7	GE8	GE9, GE10	TE1, TE1_PPP TE2, TE2_PPP	GE1, GE1_PPP GE2, GE2_PPP GE3, GE3_PPP GE4, GE4_PPP GE7_PPP GE8_PPP GE9_PPP GE10_PPP GE11, GE11_PPP GE12, GE12_PPP GE13, GE13_PPP GE14, GE14_PPP GE15, GE15_PPP GE16, GE16_PPP

3.4 Stopping the Zyxel Device

Always use **Maintenance > Shutdown > Shutdown** or the `shutdown` command before you turn off the Zyxel Device or remove the power. Not doing so can cause the firmware to become corrupt.

CHAPTER 4

Easy Mode

4.1 Overview

Easy Mode contains wizards that help you configure the Zyxel Device, links to portals and the advanced menus in **Expert Mode**.

Note: See [Section 1.1 on page 28](#) to see which models support Easy Mode wizards.

Use the **Easy Mode** screens if you have a relatively simple network environment with one WAN (**WAN1**) and one LAN (**LAN1**) connections. If your Zyxel Device has two WAN ports, use **WAN1** as the WAN connection. If you use **WAN2** as the WAN connection or want to use both WAN ports, then please use the **Expert Mode** screens.

If you prefer to start directly with the advanced screens, then simply click **Expert Mode**  and select the **Expert Mode** option.

Figure 65 Switch Modes



Note: Enabling guest network renames the **OPT** or **P6** port to "guest". Go to the **Configuration > Network > Interface > Port Role** screen in **Expert Mode** to check. A guest interface is created. The **OPT** port or the highest-numbered copper Ethernet port in the Zyxel Device will be bound with the guest interface. If Device HA is used, then the second-highest numbered port will be used instead.

4.1.1 Objects and Rules

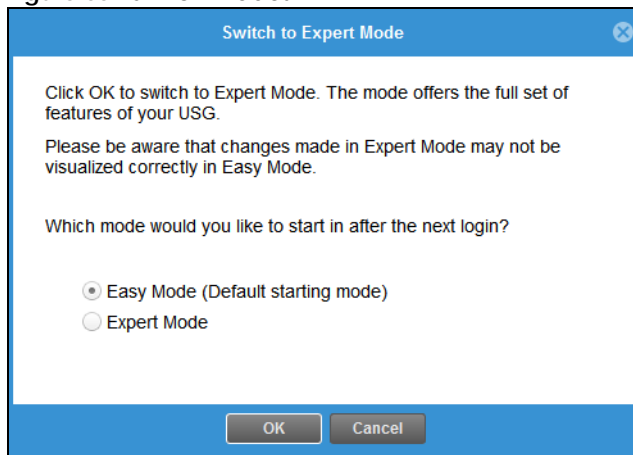
The Zyxel Device automatically creates **EZ_** objects and rules in **Expert Mode** for settings configured in **Easy Mode**. The following table shows whether you can edit or delete the **EZ_** objects and rules in the listed screens. When creating objects and rules in **Expert Mode**, you cannot use "EZ_" at the beginning of the name.



Go back to **Easy Mode** to edit your settings on **EZ_** rules. If you edit an **EZ_** rule in **Expert Mode**, the corresponding policies created in **Easy Mode** may work differently.

You cannot delete **EZ_** objects or rules if they are used in a policy. To delete an **EZ_** object or rule, you need to delete all corresponding policies. If you delete an **EZ_** object or rule in **Expert Mode**, the corresponding policies created in **Easy Mode** may not work.

Table 26 Editing & Deleting **EZ_** Objects

OBJECT/ RULE	SCREEN	EDIT	DELETE
X: The action is not allowed.			
V: The action is allowed.			
guest interface	Configuration > Network > Interface > Ethernet	X	X
Content filtering	Configuration > UTM Profile	V	V
IDP		V	V
Anti-Virus		V	V
Static DHCP Binding	Configuration > Network > IP/MAC Binding	X	V
Address		X	V
Connection	Configuration > VPN > IPSec VPN	X	V
Gateway		X	V
AP group	Configuration > Wireless	X	V
Radio		X	V
NAT	Configuration > Network > NAT	X	V
Security policy	Configuration > Security Policy	X	V
Zone	Configuration > Object	X	V
AP profile		X	V
Security		X	V
SSID		X	V
Address/Geo IP		X	V
Service		X	V

4.1.2 Wizards and Links

In the wizards, click the question mark on the right  to display or hide the help. Click **Next >** to continue to the following screen, **< Back** to return to the previous screen and **Exit** or **X**  (top right) to close the wizard screen without saving any changes.

The following are the **Easy Mode** wizards and links.

Figure 66 Easy Mode Wizards and Links

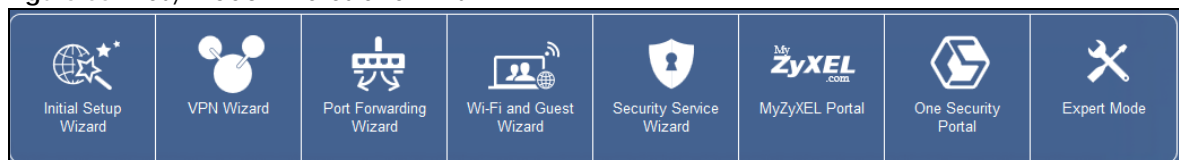

- **Initial Setup Wizard** for Internet access – you should have your Internet access account information at hand
- **VPN Wizard** for a site-to-site tunnel between Zyxel Device networks, a tunnel from a remote client using the Zyxel client VPN software to the Zyxel Device network, or a tunnel from a remote client using other VPN software to the Zyxel Device network
- **Port Forwarding Wizard** to set up a server, such as a NAS in your network that you or other people can access from outside the network
- **Wi-Fi and Guest Wizard** to set up a wireless name and security for normal and guest (Internet only) wireless access to the Zyxel Device
- **Security Service Wizard** to configure subscriptions for content filtering, IDP, and anti-virus services.

There are also links to:

- **MyZyxel Portal** where you can subscribe for security services such as content filtering, IDP, and anti-virus
- **One Security Portal** where you can get configuration walkthroughs, troubleshooting help and other help on security services and VPN
- **Expert Mode** which contains all the advanced menus.

4.1.3 Easy Mode Settings

Click  to display the **Easy Mode Settings** menu.

Figure 67 Easy Mode Settings

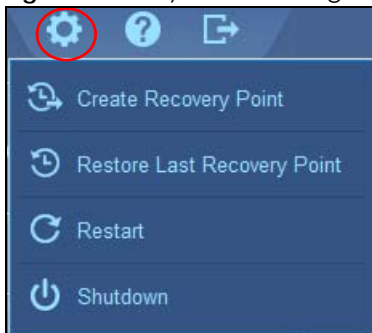

- **Create Recovery Point** – a recovery point is a point to which all the Zyxel Device's configuration can be reset to after you click **Create Recovery Point**. Choose this when you have some configurations done and everything is working correctly.
- **Restore Last Recovery Point** – choose this if you have problems with recent configurations done on the Zyxel Device and you want to return to a previous configuration point where everything was working correctly. You will lose all configurations done after the restore point.
- **Restart** – reboot the Zyxel Device after upgrading new firmware. It may also be useful when troubleshooting. Changes in the Web Configurator are saved automatically and do not change when you reboot. If you made changes in the CLI, however, you have to use the write command to save the configuration before you reboot.
- **Shutdown** – use this to safely turn off the Zyxel Device in preparation for disconnecting the power. Shutdown writes all cached data to the local storage and stops the system processes. It does not turn off the power. Wait for the device to shut down before you manually turn off or remove the power.

4.1.4 Easy Mode Dashboard

Cloud Helper



Click the Cloud Helper icon  to check if there is new firmware available at myZyXel.



If there is new firmware available at myZyXel, then the icon displays a red N . Click the icon with the red N to display a **What's New** pop-up screen. You need a Firmware Upgrade license to upgrade the firmware. If you do not have a license, **Upgrade Now** is grayed out. If you have a license, click **Upgrade Now** to directly upgrade firmware. The ZyXel Device will reboot automatically.

Figure 68 Cloud Helper – What's New



The Easy Mode dashboard is shown next.

Figure 69 Easy Mode Dashboard

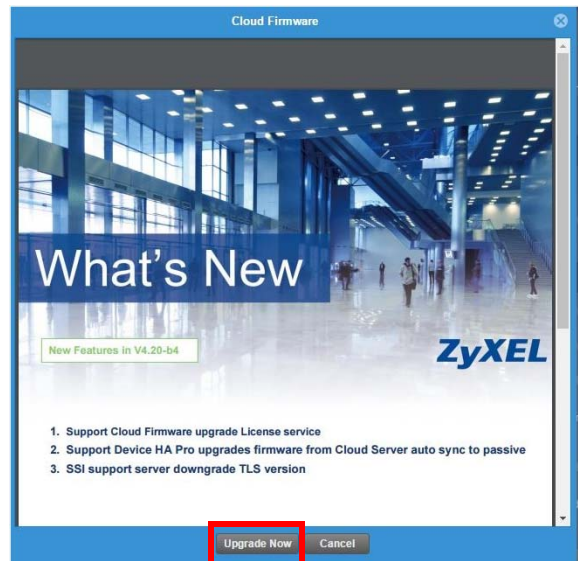
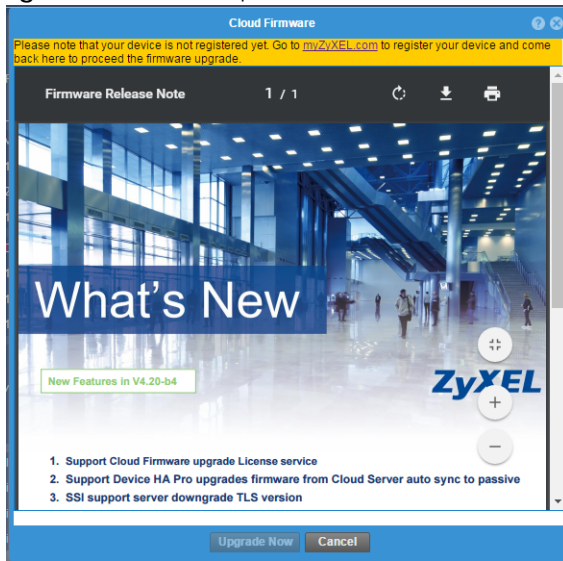
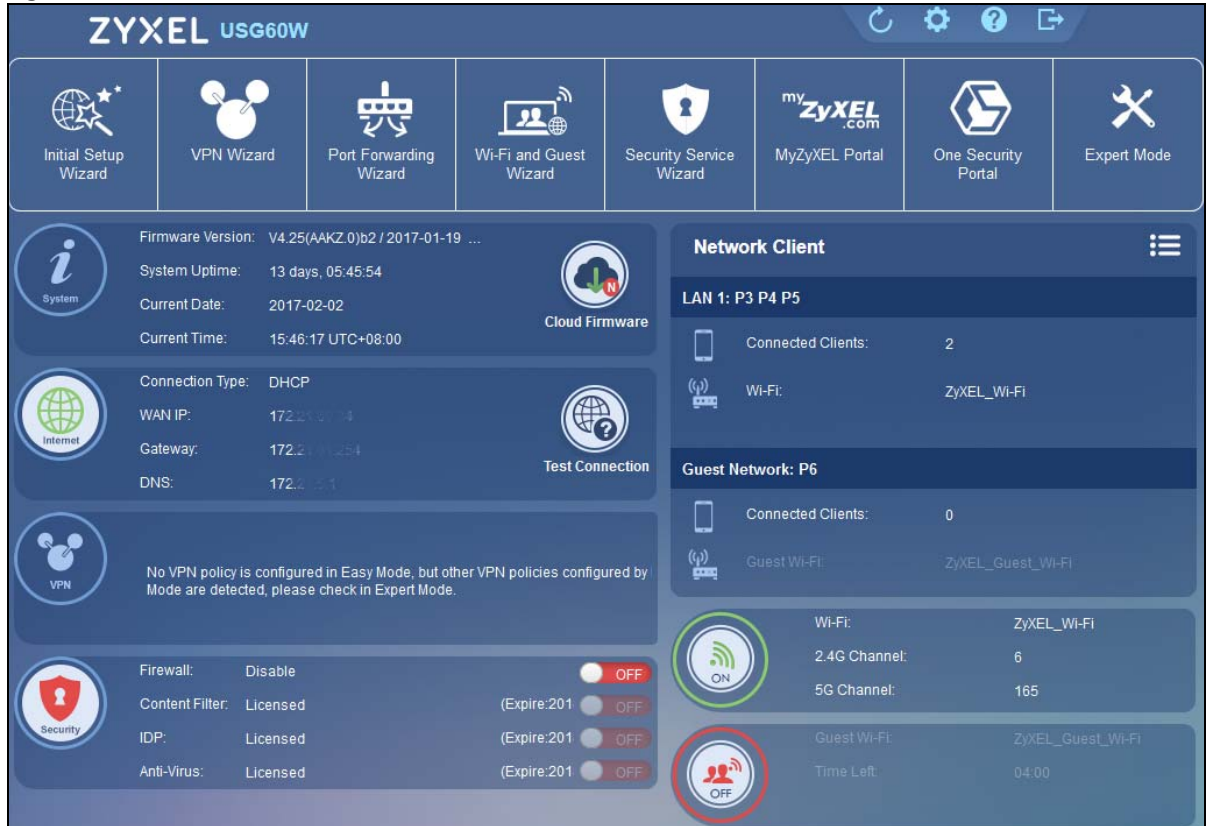

The Easy Mode dashboard contains the following.

- **System** information, such as firmware version, the length of time the Zyxel Device has been on, date and time.
- **Internet** information such as Internet connection type, WAN IP address and a button to test the connection.
- **VPN** tunnel information and a button to monitor and create VPN tunnels.
- **Security** information such as if the firewall is enabled and if supported security services are licensed. You will be prompted to create a secure policy when a service is licensed and you turn it on in order for the service to be used.
- **Network Client**

Click the settings icon  to manage clients. Click + to add a new network client. In the pop-up screen, you can add a new client by entering its interface (**LAN1** or **Guest**), **IP Address**, **MAC Address** and **Name**.

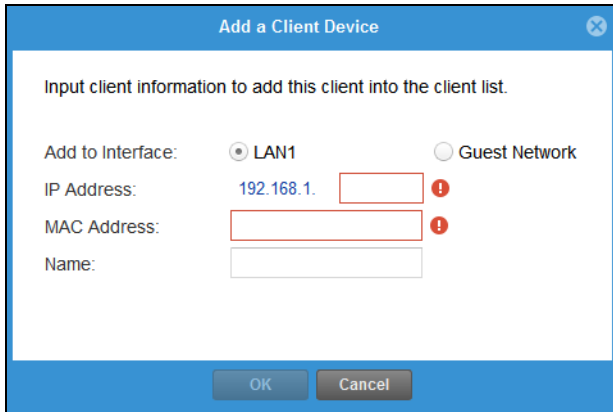

This is the information you see under **Network Client**:

- **LAN** information on wired and wireless connections to the Zyxel Device
- **Guest Network** information on guest wired and wireless connections to the Zyxel Device
- **Wi-Fi** button to change Wi-Fi channel
- **Guest** button turn the guest wireless network off or on.

4.2 Initial Setup Wizard – Language and Overview

Figure 70 Initial Setup Wizard Language

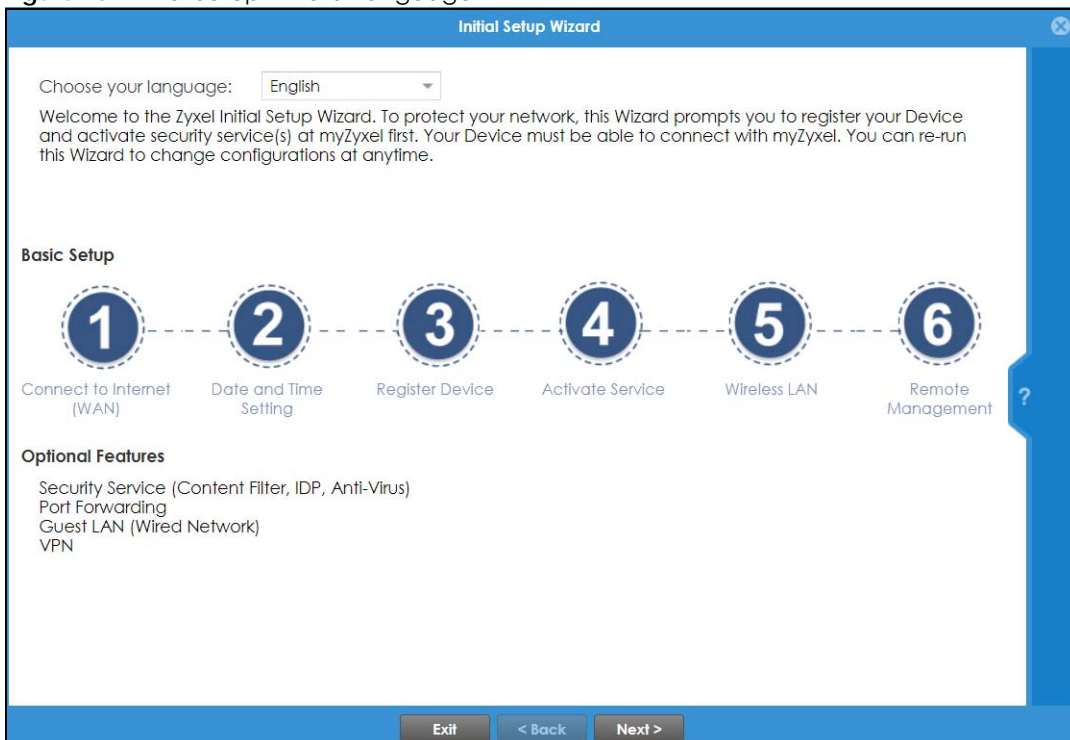

Choose the language for the **Easy Mode** and **Expert Mode** screens.

The initial wizard helps you set up basic options as shown in the screen. At the end, you will have the choice of finishing the wizard or continuing the wizard to configure the optional features as listed. If you choose to finish the wizard, you can configure the optional features later using their own separate links in the Easy Mode main screen.

4.2.1 Initial Setup Wizard – Internet

Figure 71 Initial Setup Wizard Connect to Internet

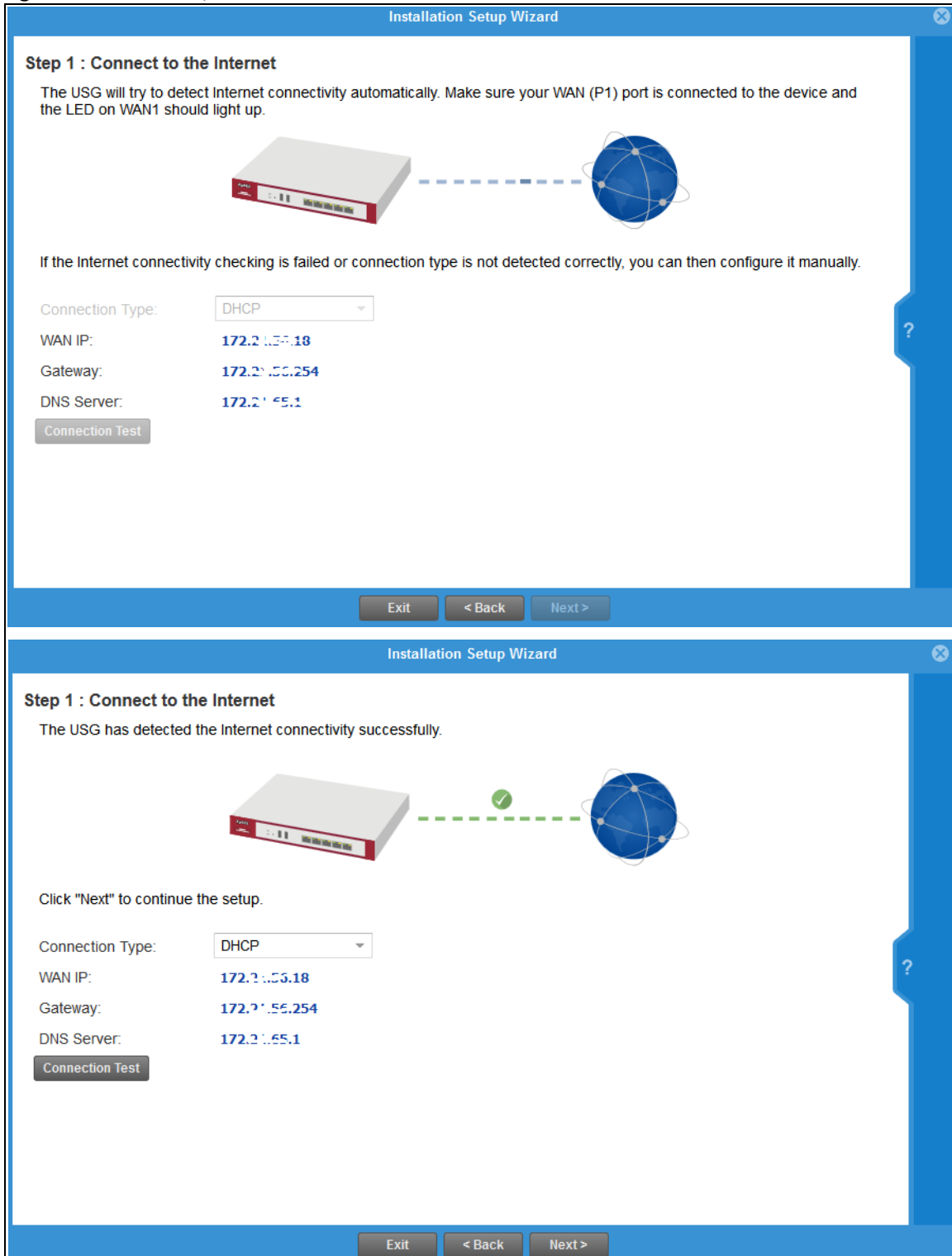

This screen displays the Internet settings if the ZyWALL Device can detect them automatically.

If the Zyxel Device cannot detect the Internet settings automatically, then you have to enter them manually.

- Choose **DHCP** if you were not given a specific IP address for the Zyxel Device. This allows the Zyxel Device to be able to get one automatically.
- Choose **Ethernet Fixed IP** if you were given a specific IP address for the Zyxel Device.
- Choose **PPPoE** if you were given a PPPoE user name and password.

Note: Enter the Internet access information exactly as your ISP gave you.

4.2.2 Initial Setup Wizard – Internet Access Errors

These are some things you can do if you see Internet access error messages.

WAN 1 Down

Check that your cable connection from the **WAN1** interface on the Zyxel Device is connected to the device you're using for Internet access such as a broadband router and that the router is turned on. The LED of the **WAN1** interface on the Zyxel Device should be orange.

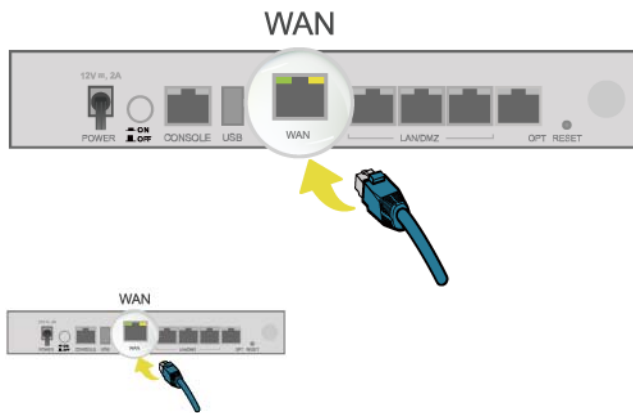

PPPoE Error

Your Zyxel Device was not able to obtain an IP address. Check that your Internet access information uses PPPoE as the WAN connection type. Re-enter your PPPoE user name and password exactly as given. If it fails again, check with your Internet service provider for correct WAN settings and user credentials.

DHCP Error

Your Zyxel Device was not able to obtain an IP address. Check that your Internet access information uses DHCP as the WAN connection type. If it fails again, check with your Internet service provider for correct WAN settings and user credentials.

Ethernet Fixed IP Error

Your Zyxel Device was not able to use the IP address entered. Check that you were given an IP address, subnet mask and gateway address as part of your Internet access information. Re-enter your IP address,

subnet mask and gateway address exactly as given. If it fails again, check with your Internet service provider for correct IP address, subnet mask and gateway address and other WAN settings.

4.2.3 Initial Setup Wizard – Date and Time

Figure 72 Initial Setup Wizard Date and Time

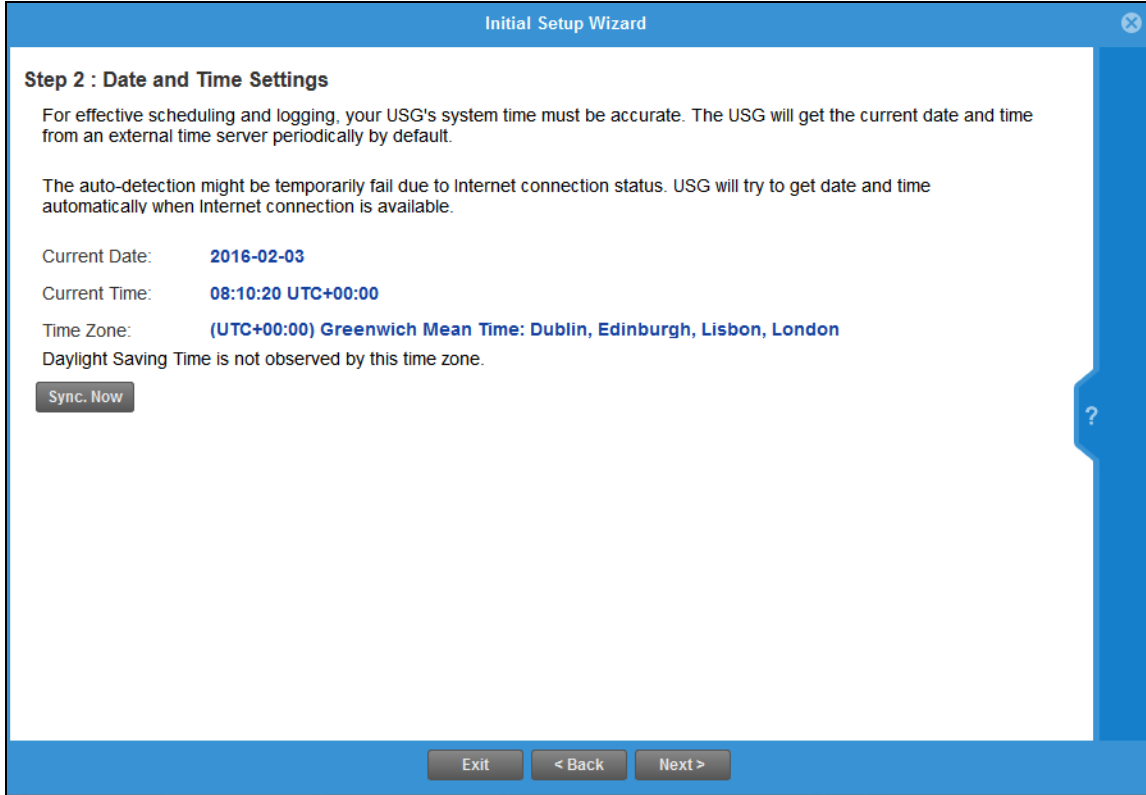

It's important to have correct date and time values in the logs. The Zyxel Device can automatically update the time and date by detecting your time zone and whether Daylight Savings is in effect in that time zone.

If your Zyxel Device cannot get the correct date and time, it may not be able to connect to a time server. Check that the Zyxel Device has Internet access, then click **Sync Now**.

4.2.4 Initial Setup Wizard – Register Device

Figure 73 Initial Setup Wizard Non-Registered Device

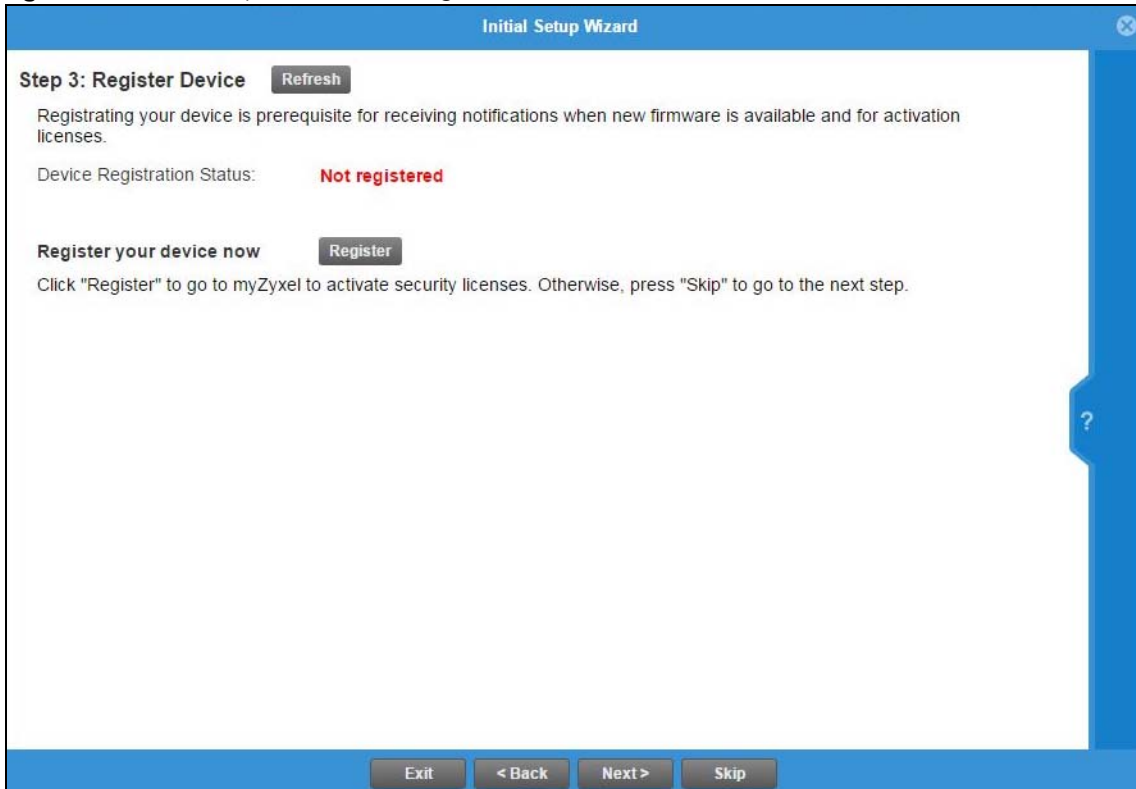
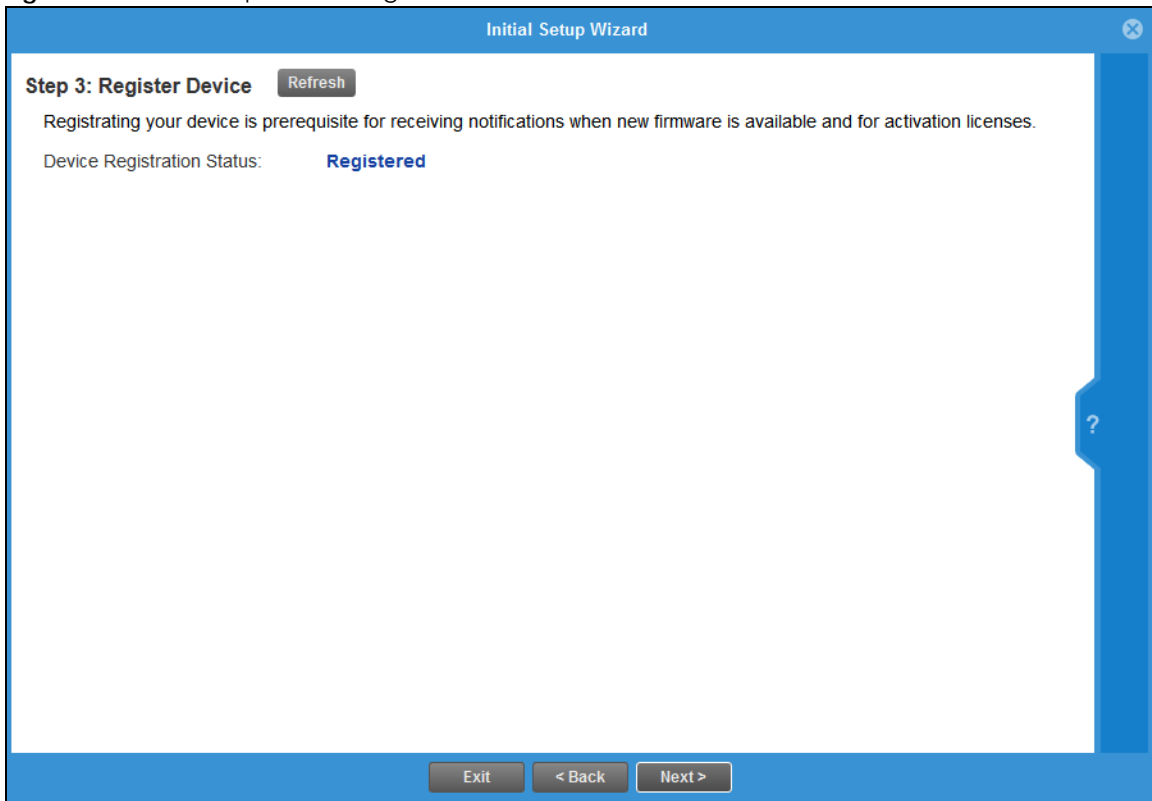
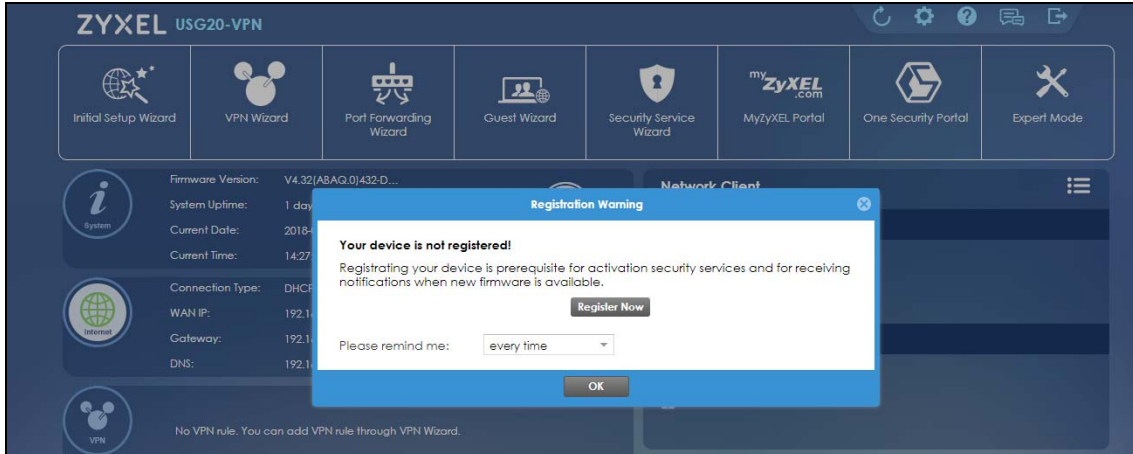

Figure 74 Initial Setup Wizard Registered Device



- For Zyxel Devices that already have firmware version 4.25 or later, you have to register your Zyxel Device and activate the corresponding service at myZyxel (through your Zyxel Device).
- For Zyxel Devices upgrading to firmware version 4.25, you may skip registering your Zyxel Device and activating the corresponding service at myZyxel. However, it is highly recommended to at least register your Zyxel Device.

You will see the following prompt if your Zyxel Device is not registered.



Click the **Register** button in this screen to register your device at portal.myzyxel.com. You need to create a myZyxel account at portal.myzyxel.com before you can register your device and activate the services at myZyxel.

When registering the Zyxel Device at myZyxel, if you are prompted for the Zyxel Device's serial number and LAN MAC address, see the label at the back of the Zyxel Device's.

Note: The Zyxel Device must be connected to the Internet in order to register.

4.2.5 Initial Setup Wizard – Activate Services

Figure 75 Initial Setup Wizard Non-Activated Services

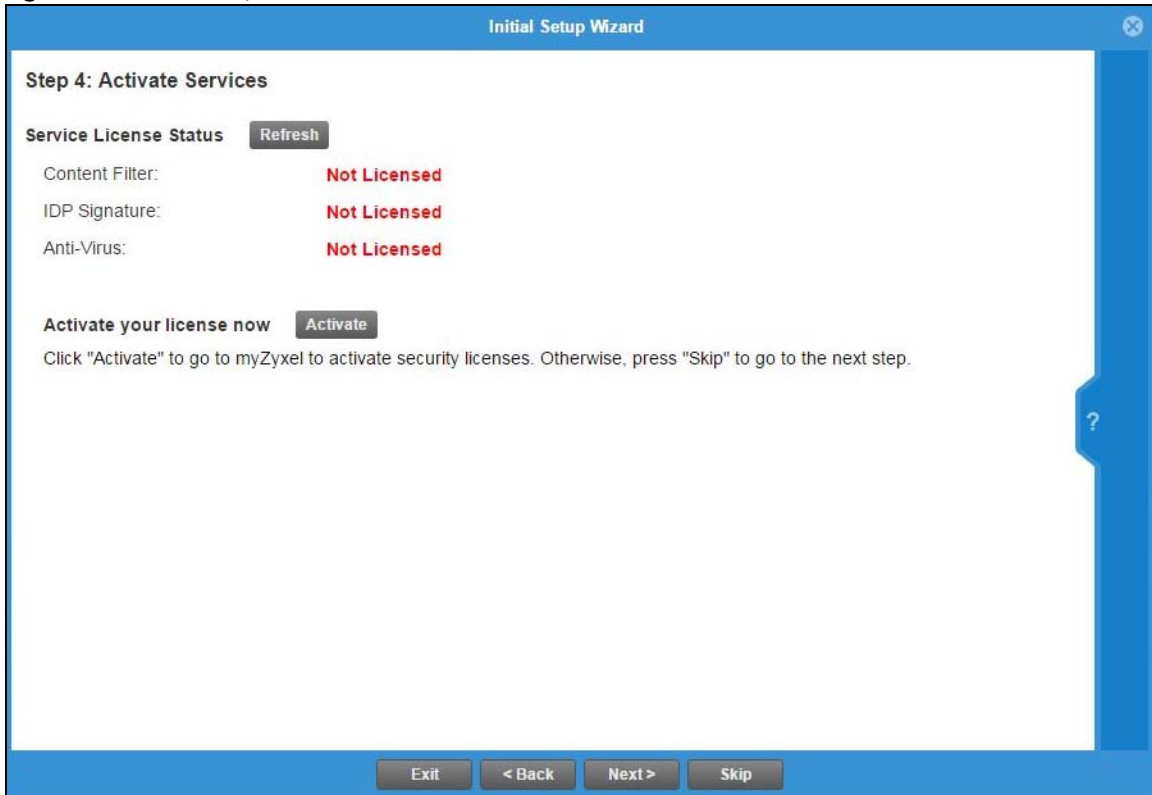
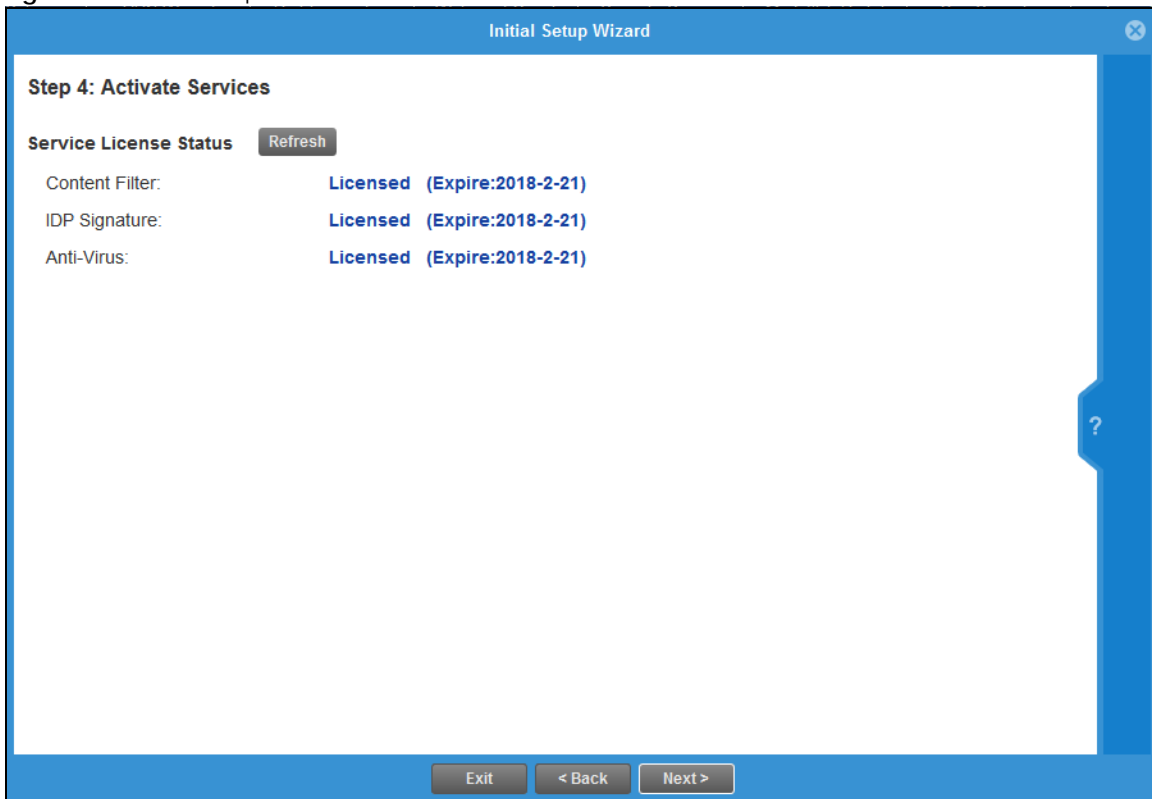

Figure 76 Initial Setup Wizard Activated Services



After you register your Zyxel Device, you can activate the services supported by your model if you have service licenses. Examples of services are:

- Content Filter (to block websites by category, such as Gambling)
- IDP (to recognize and drop traffic with Intrusion, Detection & Protection attack patterns)
- Anti-Virus (to detect virus patterns in files)
- Anti-Spam (to mark or discard unsolicited commercial or junk e-mail suspect of being sent by spammers).

Click **Refresh** and wait a few moments for the service information to update in this screen. If the page does not refresh, make sure the Internet connection is working and click **Refresh** again. To check your Internet connection, try to access the Internet from a computer connected to a LAN port on the Zyxel Device. If you cannot, then check your Internet access settings on the Zyxel Device.

4.2.6 Initial Setup Wizard – Wi-Fi

Figure 77 Initial Setup Wizard Wi-Fi

Select **Enable Wi-Fi Network** if you want wireless devices to be able to wirelessly access the Zyxel Device and all resources connected to the Zyxel Device. Configure a descriptive name of from 1 to 32 alphanumeric characters, hyphens or underscores (a–z A–Z 0–9 –_) for the wireless network name (**Wi-Fi**). Set a **Password** of between 8 and 63 printable ASCII characters (including spaces and symbols) or 64 hexadecimal characters (0–9 a–f) that wireless users will have to enter for access to the Zyxel Device wireless network.

Note: You must change the **Password** to continue.

Select **Enable Guest Wi-Fi Network** if you want wireless devices to only be able to wirelessly access the Internet through the Zyxel Device for up to 4 hours. Configure a descriptive name of from 1 to 32 alphanumeric characters, hyphens or underscores (a–z A–Z 0–9 –_) for the wireless network name (**Wi-Fi**). Set a

Password of between 8 and 63 printable ASCII characters (including spaces and symbols) or 64 hexadecimal characters (0–9 a–f) that wireless users will have to enter for access to the Zyxel Device Guest wireless network.

The Guest Wi-Fi Network allows Internet access only for up to 4 hours by default. Log in again if the time has elapsed. You can change the default time for Guest Wi-Fi access in the **Wi-Fi and Guest Wizard**.

The Zyxel Device uses WPA2-PSK with AES encryption so wireless clients must be able to support AES encryption to wirelessly connect to the Zyxel Device using WPA2-PSK.

4.2.7 Initial Setup Wizard – Remote Management

Select this to allow access to the Zyxel Device using HTTP or HTTPS from the Internet.

Figure 78 Remote Management

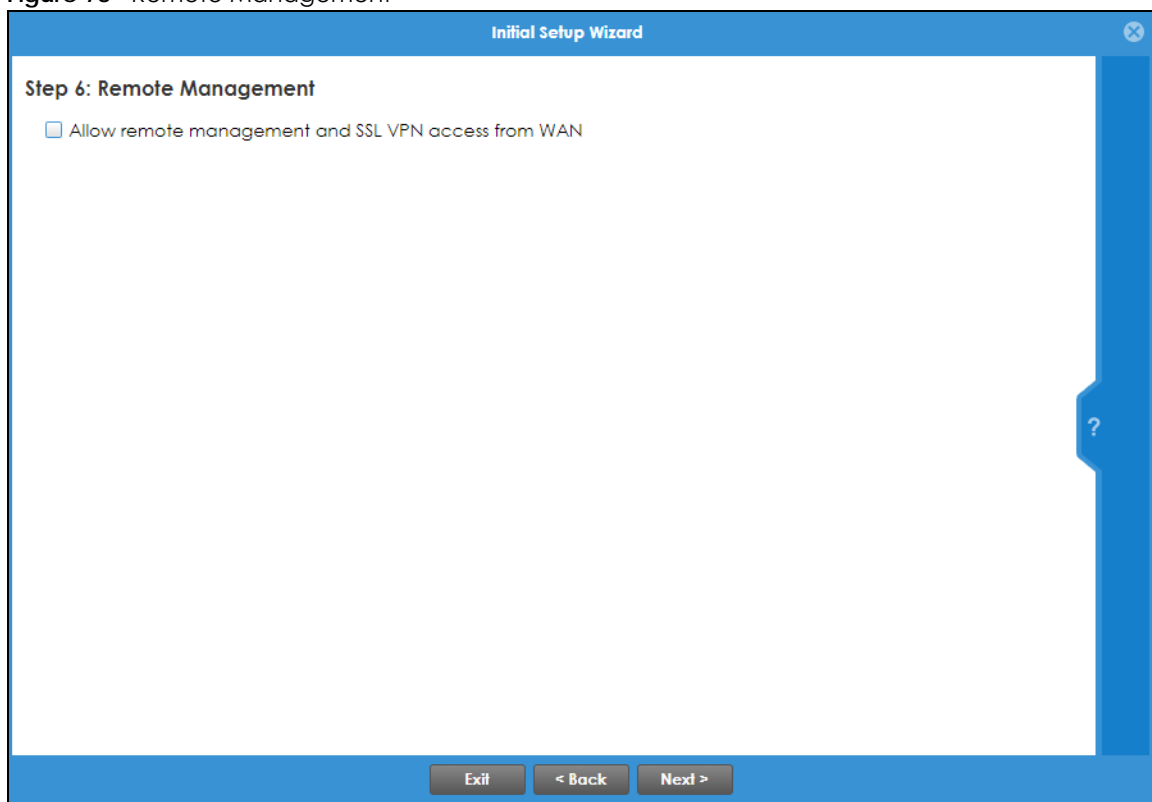

HTTPS is added to the **Default_Allow_WAN_to_ZyWALL** rule in **Object > Service > Service Group** screen when you enable **Remote Management**.

Figure 79 Object > Service > Service Group – HTTPS

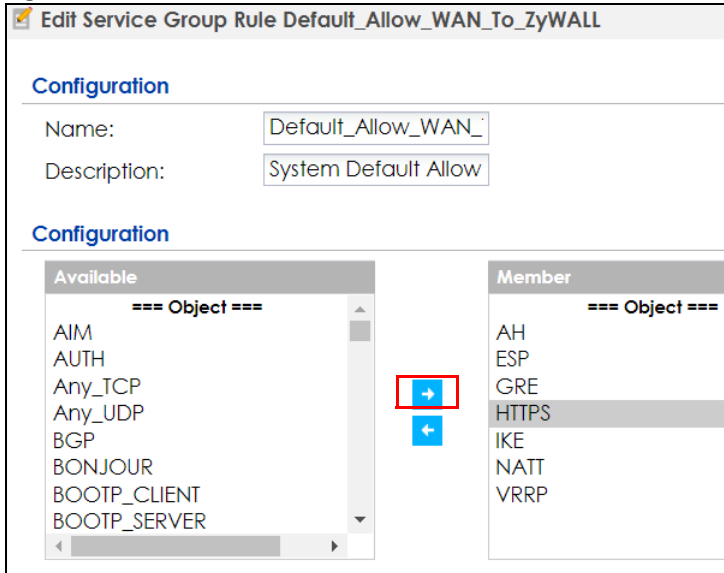

4.2.8 Initial Setup Wizard – Congratulations

Figure 80 Initial Setup Wizard Congratulations

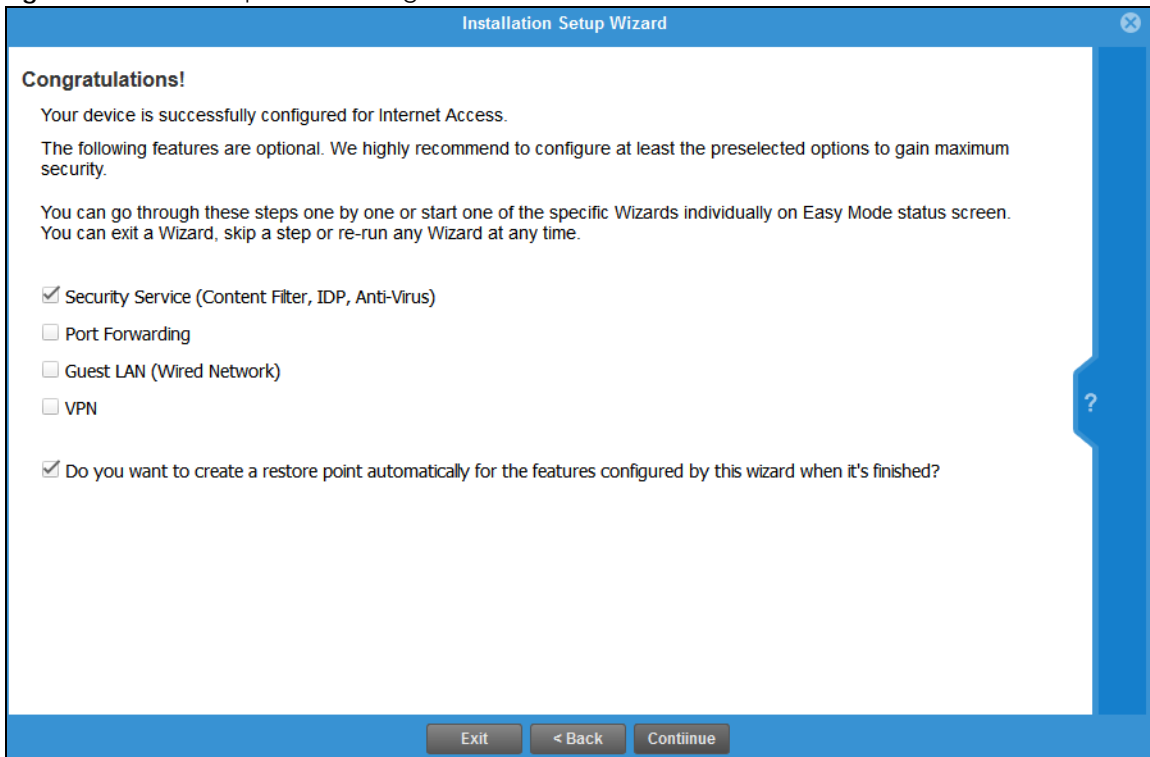

This screen shows if your Internet access is successfully configured. You can save changes and exit the **Initial Wizard** here by clearing **Security Service**, **Port Forwarding**, **Guest LAN** and **VPN** service selections and clicking **Finish**. Alternatively, select desired security services to continue configuring them as part of the **Initial Wizard** (**Finish** becomes **Continue**). If you want to configure these services later you can access them from the tabs in the dashboard.

Select from the following to continue configuring in this screen:

- **Security Service (Content Filter, IDP, Anti Virus)** to configure subscriptions for these services
- **Port Forwarding** to set up a server in your network that people outside the network can access
- **Guest LAN (Wired Network)** to set up a guest network where users can access the Internet only from a wired connection to the OPT port for a limited time
- **VPN** for a site-to-site tunnel between Zyxel Device networks, a tunnel from a remote client using the Zyxel client VPN software to the Zyxel Device network, or a tunnel from a remote client using other VPN software to the Zyxel Device network.

A **restore point** is a recovery point where you can reset the Zyxel Device's configuration to if you have problems later.

4.3 Initial Setup Wizard – Security Service

Figure 81 Initial Setup Wizard Security Service

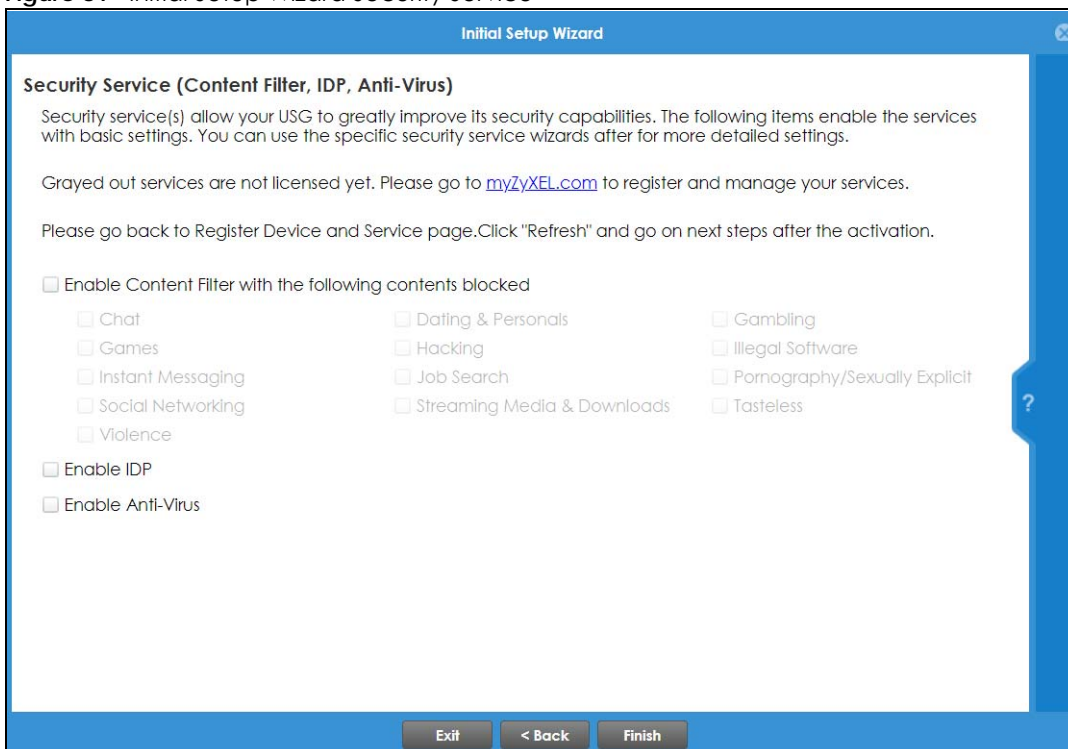

Configure licensed (non-grayed-out) services in this screen. After you buy a license for a service, you must activate it at myZyxel. Make sure the Zyxel Device Internet connection is working correctly.

Select **Enable Content Filter** to block websites by category, such as **Chat** websites. Note that if you select **Chat**, the Content Filter blocks chat websites and not chat apps. Therefore, the Skype app can still be used although the Skype website would be blocked. Select the categories you want to block.

- **Chat:** Sites that enable web-based exchange of real time messages through chat services or chat rooms. For example, me.sohu.com, blufiles.storage.live.com.

- **Dating & Personals:** Sites that promote networking for interpersonal relationships such as dating and marriage. Includes sites for match-making, online dating, spousal introduction. For example, www.i-part.com.tw, www.imatchi.com.
- **Gambling:** Sites that offer or are related to online gambling, lottery, casinos and betting agencies involving chance. For example, www.taiwanlottery.com.tw, www.i-win.com.tw, www.hkjc.com.
- **Games:** Sites relating to computer or other games, information about game producers, or how to obtain cheat codes. Game-related publication sites. For example, www.gamer.com.tw, www.wowtaiwan.com.tw, tw.lineage.gamania.com.
- **Hacking:** Sites that promote or give advice about how to gain unauthorized access to proprietary computer systems, for the purpose of stealing information, perpetrating fraud, creating viruses, or committing other illegal activity related to theft of digital information. For example, www.hackbase.com, www.chinahacker.com.
- **Illegal Software:** Sites that illegally distribute software or copyrighted materials such as movies or music, software cracks, illicit serial numbers, illegal license key generators. For example, www.zhaokey.com.cn, www.tiansha.net.
- **Instant Messaging:** Sites that enable logging in to instant messaging services such as ICQ, AOL Instant Messenger, IRC, MSN, Jabber, Yahoo Messenger, and the like. For example, www.meebo.com, www.aim.com, www.ebuddy.com.
- **Job Search:** Sites containing job listings, career information, assistance with job searches (such as resume writing, interviewing tips, etc.), employment agencies or head hunters. For example, www.104.com.tw, www.1111.com.tw, www.yes123.com.tw.
- **Pornography/Sexually Explicit:** Sites that contain explicit sexual content. Includes adult products such as sex toys, CD-ROMs, and videos, adult services such as videoconferencing, escort services, and strip clubs, erotic stories and textual descriptions of sexual acts. For example, www.dvd888.com, www.18center.com, blog.sina.com.tw.
- **Social Networking:** Sites that enable social networking for online communities of various topics, for friendship, dating, or professional reasons. For example, www.facebook.com, www.flickr.com, www.groups.google.com.
- **Streaming Media & Downloads:** Sites that deliver streaming content, such as Internet radio, Internet TV or MP3 and live or archived media download sites. Includes fan sites, or official sites run by musicians, bands, or record labels. For example, www.youtube.com, pfp.sina.com.cn, my.xunlei.com.
- **Tasteless:** Sites with offensive or tasteless content such as bathroom humor or profanity. For example, comedycentral.com, dilbert.com.
- **Violence:** Sites that contain images or text depicting or advocating physical assault against humans, animals, or institutions. Sites of a particularly gruesome nature such as shocking depictions of blood or wounds, or cruel animal treatment. For example, crimescene.com, deathnet.com, michiganmilitia.com.

Select **Enable IDP** to drop traffic with recognized Intrusion, Detection & Protection attack patterns.

Select **Enable Anti-Virus** to detect virus patterns in files.

Use the **Security Service Wizard** if you need more detailed settings. Grayed-out services are not licensed yet. Please go to portal.myzyxel.com to register and manage your services.

4.4 Initial Setup Wizard – Port Forwarding

Figure 82 Initial Setup Wizard Port Forwarding

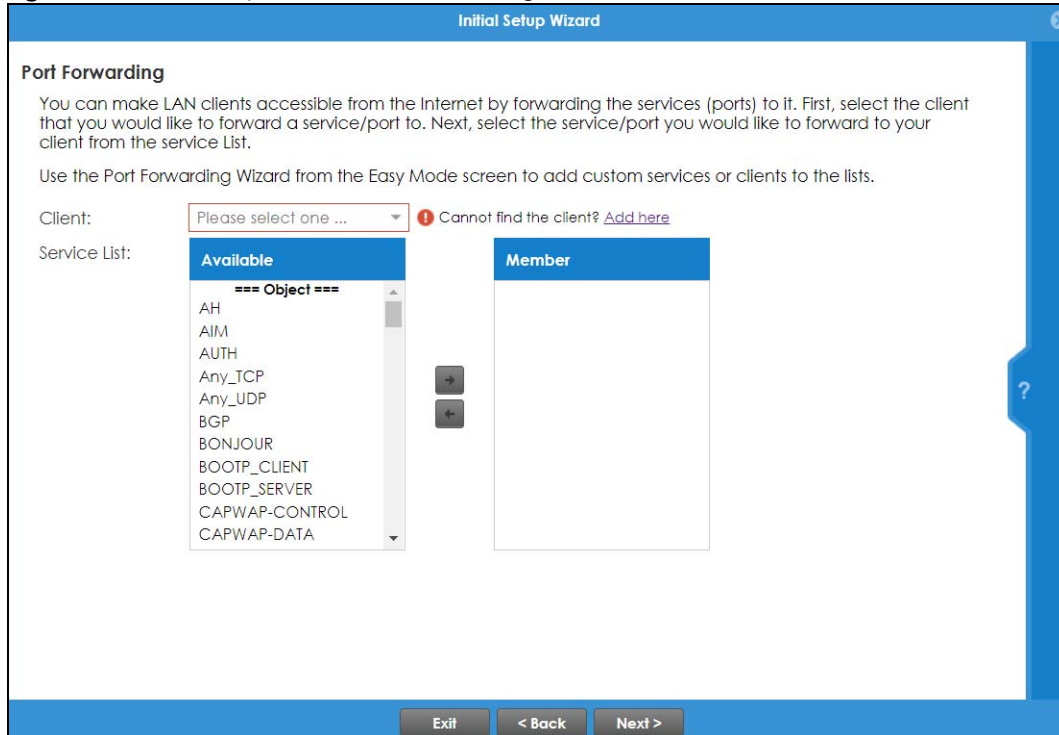

NAT port forwarding allows the Zyxel Device to direct incoming traffic from the Internet to the correct virtual server in your network. For example, if you have a NAS server in your network that you or other people need access to from outside your network, select the IP address of the NAS from **Client**. Then, select the service(s) that your NAS provides (for example **FTP**, **HTTP**, **HTTPS**) from the **Available** box and use the right arrow to move each service to the **Member** box.

Even though the NAS is in your local network receiving the protection of the Zyxel Device, you can still access that NAS using these services from anywhere outside your network.

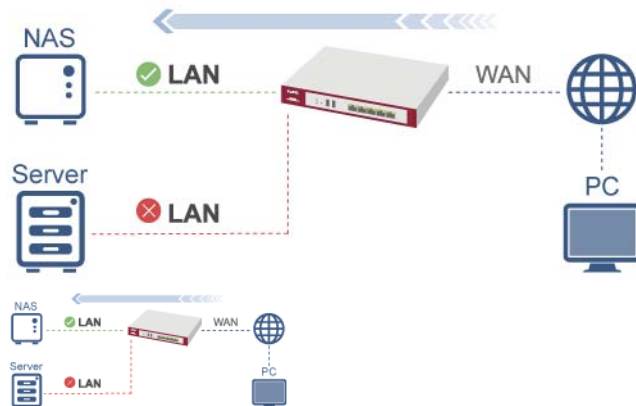

Run the main **Port Forwarding Wizard** if you cannot see service you need in the list. In that wizard you can define other services.

A client or device in your network acting as a server for forwarded services (for example, the NAS) needs to have a static address. If the client selected does not have a static IP address, the IP address may change when the client reboots, so the Zyxel Device may not be able to find it. If this happens, check for the new IP address of the client. Then add the new IP address by clicking **Add here** and entering it in the pop-up screen.

4.5 Initial Setup Wizard – Guest LAN

Figure 83 Initial Setup Wizard Guest LAN

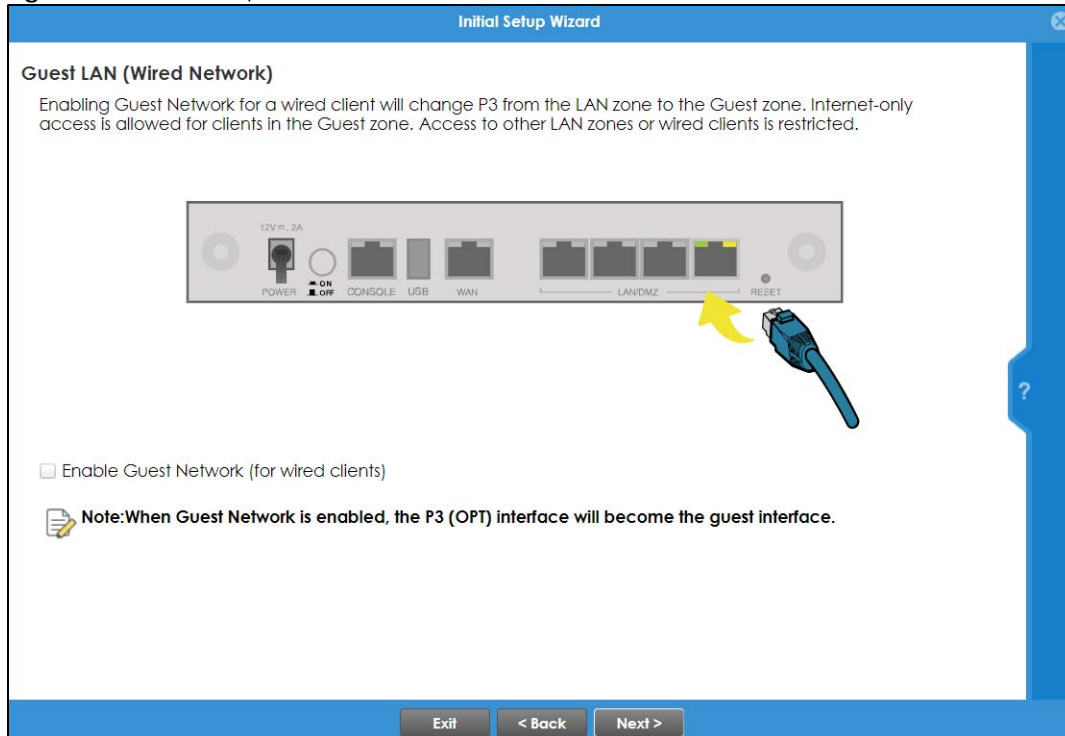

Select **Enable Guest Network (for wired clients)** to convert the **OPT** or **P6** port (depending on your model) to be a guest port and isolate it from the **LAN/DMZ** ports. Devices connected to the guest port are allowed Internet access only and do not have access to networks connected to the other ports.

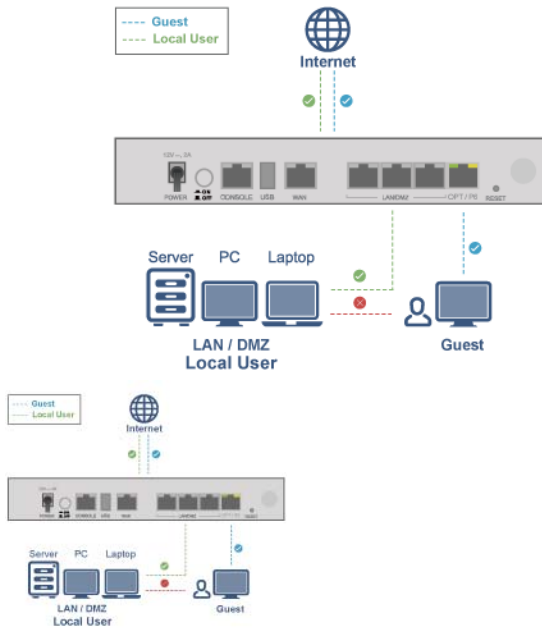

When the **OPT** or **P6** port is not a guest port, then guest devices connected to that port can communicate with all networks, including devices connected to the **LAN/DMZ** ports. If that is not your intention, make sure **Enable Guest Network (for wired clients)** is selected and that guest devices are only connected to the **OPT** or **P6** port on the Zykel Device.

4.5.1 Connecting AP Scenarios

If you connect an AP to a LAN port, then users can use the AP's SSID to wirelessly access all wired resources connected to the LAN ports and Internet access.

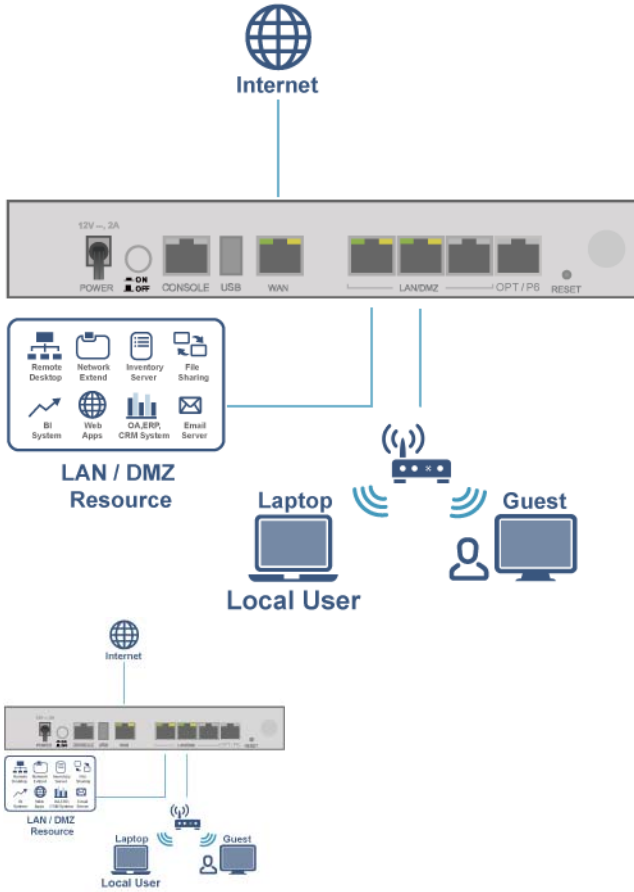

If you connect an AP to the Guest port, then users can use the AP's SSID to wirelessly access all wired resources connected to the Guest port (only) and Internet access. You must select both **Enable Guest Wi-Fi Network** and **Guest LAN (Wired Network)**.

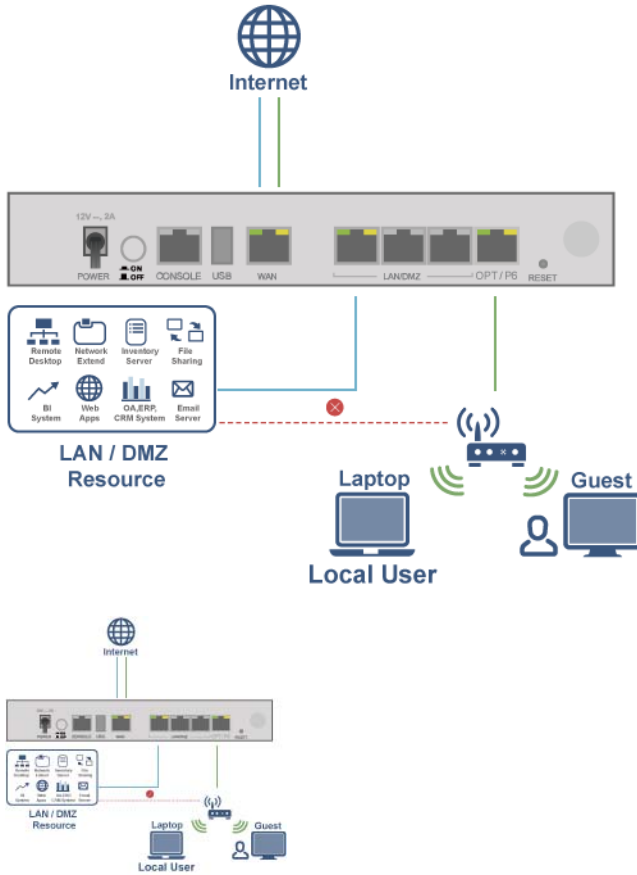

4.6 Initial Setup Wizard – VPN

Figure 84 Initial Setup Wizard VPN

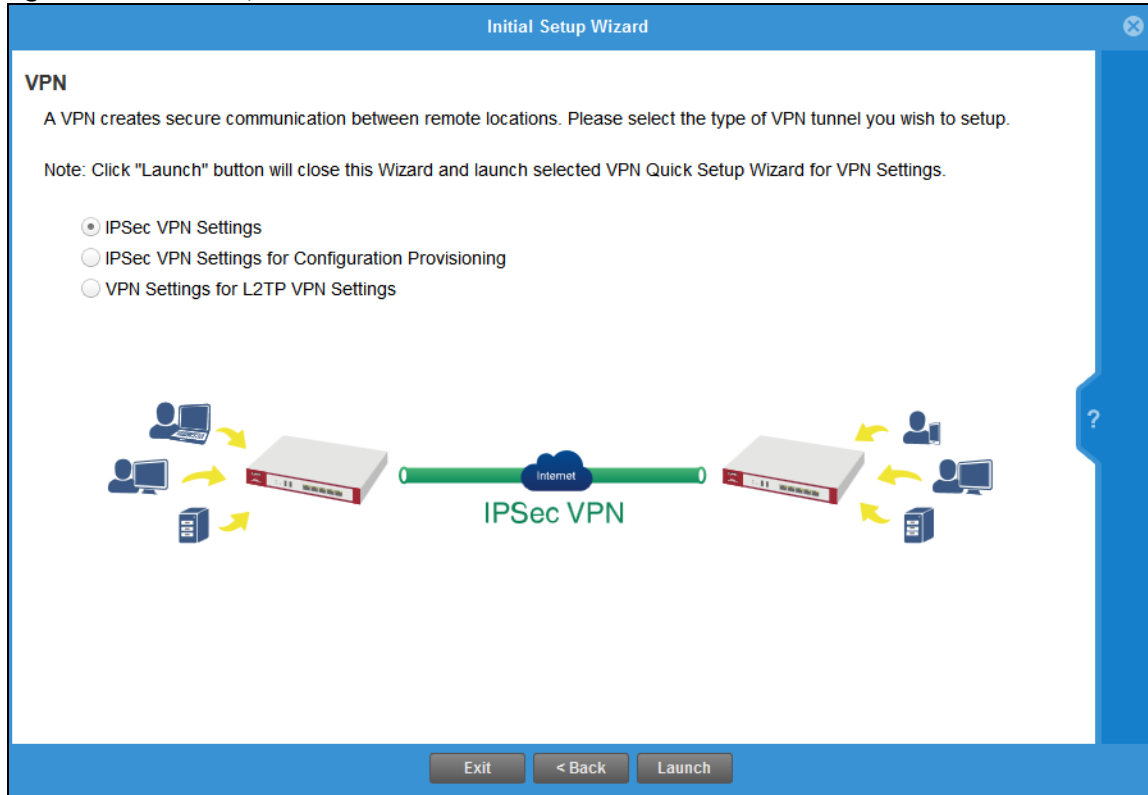

A VPN is a secure, private connection between two end points. An end point could be a VPN gateway like the Zyxel Device itself or a computer with VPN software installed. Select a VPN wizard type and click **Launch** to begin that wizard and end the **Initial Setup Wizard** with changes saved. Click **Exit** to leave the wizard with changes unsaved.

- Select **IPSec VPN Settings** to create a secure, private connection between two Zyxel Devices. Two networks (sites) behind the Zyxel Devices can then communicate securely with each other. Make sure that the settings on both Zyxel Devices are correct and reciprocal. What is a local setting for one should be the equivalent remote setting on the other. Make sure the pre-shared key, negotiation mode, encryption, authentication settings, DH key group and so on are the same on both Zyxel Devices.

Make sure that both Zyxel Devices are able to communicate with each other. Try pinging one gateway from a computer behind the other.

Make sure that there is not a firewall blocking VPN traffic in front of one of the Zyxel Devices.

- Select **IPSec VPN Settings for Configuration Provisioning** to create a secure, private connection between a Zyxel Device and a computer with Zyxel client VPN software installed. See the client VPN software's help to see how to configure it. The computer with client VPN software installed and the Zyxel Device can then communicate securely with each other. Make sure the client VPN software is installed and configured correctly on the computer. See the client VPN software's help if anything is unclear.

Make sure the VPN settings such as the pre-shared key (or certificate), negotiation mode, encryption, authentication settings, DH key group on the computer and the Zyxel Device are correct. Make sure that the client is able to communicate with the Zyxel Device. Try pinging the Zyxel Device from the client.

- Select **VPN Settings for L2TP VPN Settings** to create a secure, private connection between the Zyxel Device and a computer with L2TP VPN software installed. Many computer operating systems come with L2TP installed. See your computer's help to see how to configure it. The L2TP computer and the Zyxel Device will then communicate securely with each other.

Make sure that the computer with L2TP is able to communicate with the Zyxel Device. Try pinging the Zyxel Device from the computer. Make sure that L2TP traffic is allowed through the WAN on the Zyxel Device.

4.6.1 VPN Setup Wizard: Wizard Type

Choose **Express** to create a VPN rule with the default phase 1 and phase 2 settings to connect to another ZLD-based Zyxel Device using a pre-shared key.

Choose **Advanced** to change the default settings and/or use certificates instead of a pre-shared key to create a VPN rule to connect to another IPSec device.

Figure 85 VPN Setup Wizard: Wizard Type

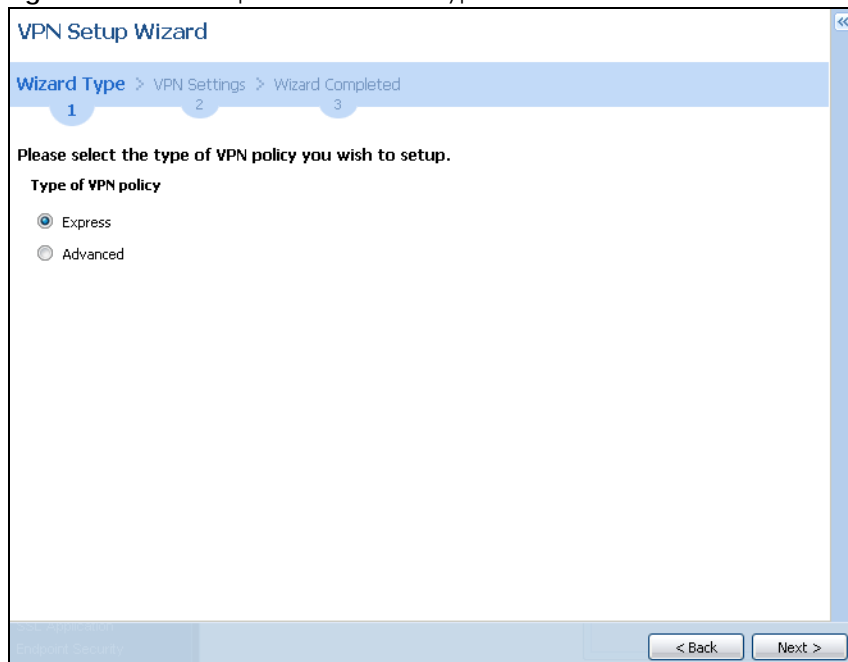

4.6.2 VPN Express Wizard – Scenario

Click the **Express** radio button as shown in the previous figure to display the following screen.

Figure 86 VPN Express Wizard: Scenario

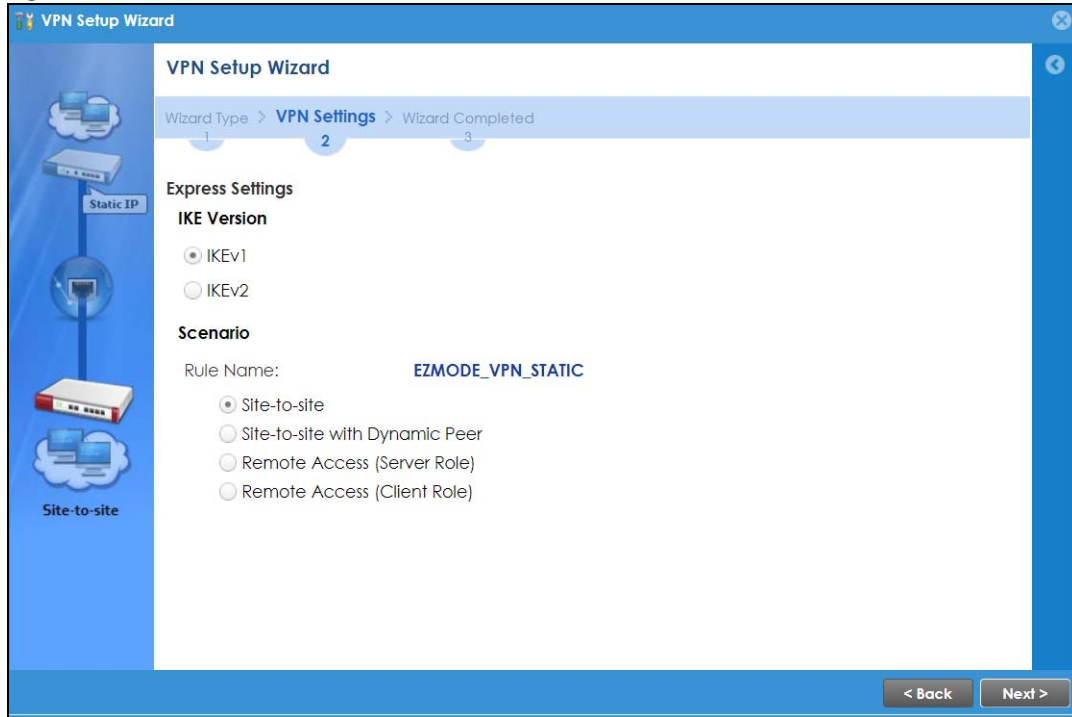

IKE (Internet Key Exchange) Version: IKE is a protocol used in security associations to send data securely. IKE uses certificates or pre-shared keys for authentication and a Diffie–Hellman key exchange to set up a shared session secret from which encryption keys are derived.

IKEv2 supports Extended Authentication Protocol (EAP) authentication, and IKEv1 supports X-Auth. EAP is important when connecting to existing enterprise authentication systems.

Rule Name: Type the name used to identify this VPN connection (and VPN gateway). You may use 1 – 31 alphanumeric characters, underscores (`_`), or dashes (`-`), but the first character cannot be a number. This value is case-sensitive.

Select the scenario that best describes your intended VPN connection. The figure on the left of the screen changes to match the scenario you select.

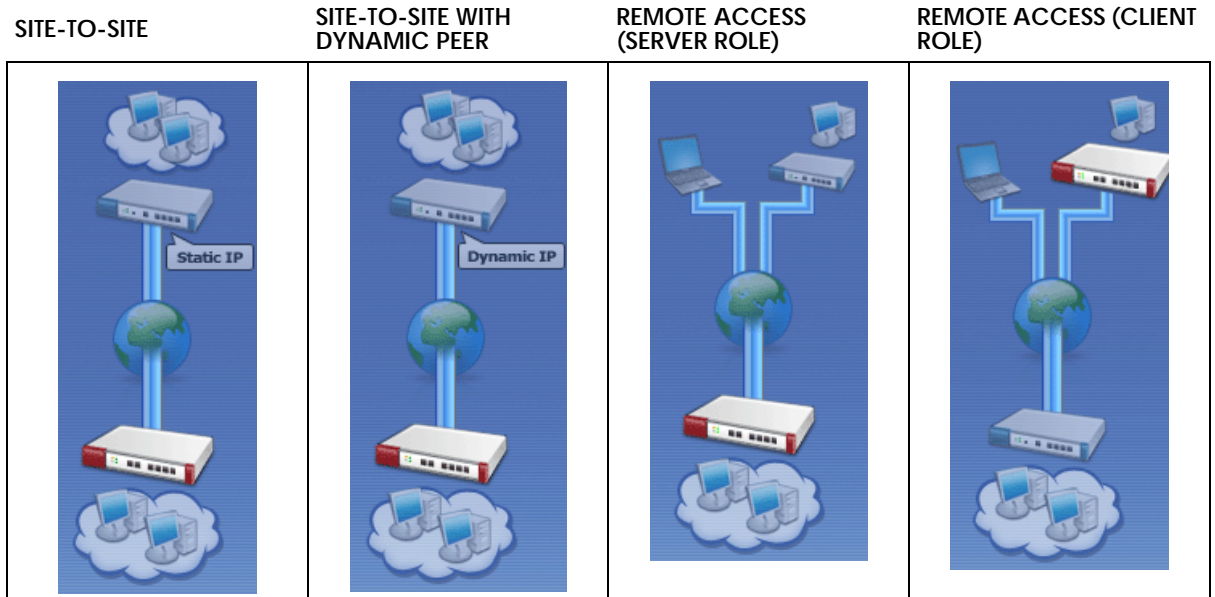

- **Site-to-site** – choose this if the remote IPSec router has a static IP address or a domain name. This Zyxel Device can initiate the VPN tunnel. The remote IPSec router can also initiate the VPN tunnel if this Zyxel Device has a static IP address or a domain name.
- **Site-to-site with Dynamic Peer** – choose this if the remote IPSec router has a dynamic IP address. You don't specify the remote IPSec router's address, but you specify the remote policy (the addresses of the devices behind the remote IPSec router). This Zyxel Device must have a static IP address or a domain name. Only the remote IPSec router can initiate the VPN tunnel.
- **Remote Access (Server Role)** – choose this to allow incoming connections from IPSec VPN clients. The clients have dynamic IP addresses and are also known as dial-in users. You don't specify the addresses of the client IPSec routers or the remote policy. This creates a dynamic IPSec VPN rule that can let multiple clients connect. Only the clients can initiate the VPN tunnel.
- **Remote Access (Client Role)** – choose this to connect to an IPSec server. This Zyxel Device is the client (dial-in user). Client role Zyxel Devices initiate IPSec VPN connections to a server role Zyxel Device. This Zyxel Device can have a dynamic IP address. The IPSec server does not configure this Zyxel Device's IP address or the addresses of the devices behind it. Only this Zyxel Device can initiate the VPN tunnel.

4.6.3 VPN Express Wizard – Configuration

Figure 87 VPN Express Wizard: Configuration

- **My Address (interface):** Select an interface from the drop-down list box to use on your Zyxel Device.
- **Secure Gateway:** **Any** displays in this field if it is not configurable for the chosen scenario. Otherwise, enter the WAN IP address or domain name of the remote IPsec device (secure gateway) to identify the remote IPsec router by its IP address or a domain name. Use 0.0.0.0 if the remote IPsec router has a dynamic WAN IP address.
- **Pre-Shared Key:** Type the password. Both ends of the VPN tunnel must use the same password. Use up to 128 case-sensitive ASCII characters or up to 128 pairs of hexadecimal (“0–9”, “A–F”) characters. Proceed a hexadecimal key with “0x”. You will receive a PYLD_MALFORMED (payload malformed) packet if the same pre-shared key is not used on both ends.
- **Local Policy (IP/Mask):** Type the IP address of a computer on your network that can use the tunnel. You can also specify a subnet. This must match the remote IP address configured on the remote IPsec device.
- **Remote Policy (IP/Mask):** **Any** displays in this field if it is not configurable for the chosen scenario. Otherwise, type the IP address of a computer behind the remote IPsec device. You can also specify a subnet. This must match the local IP address configured on the remote IPsec device.

4.6.4 VPN Express Wizard – Summary

This screen provides a read-only summary of the VPN tunnel's configuration and commands that you can copy and paste into another ZLD-based Zyxel Device's command line interface to configure it.

Figure 88 VPN Express Wizard: Summary

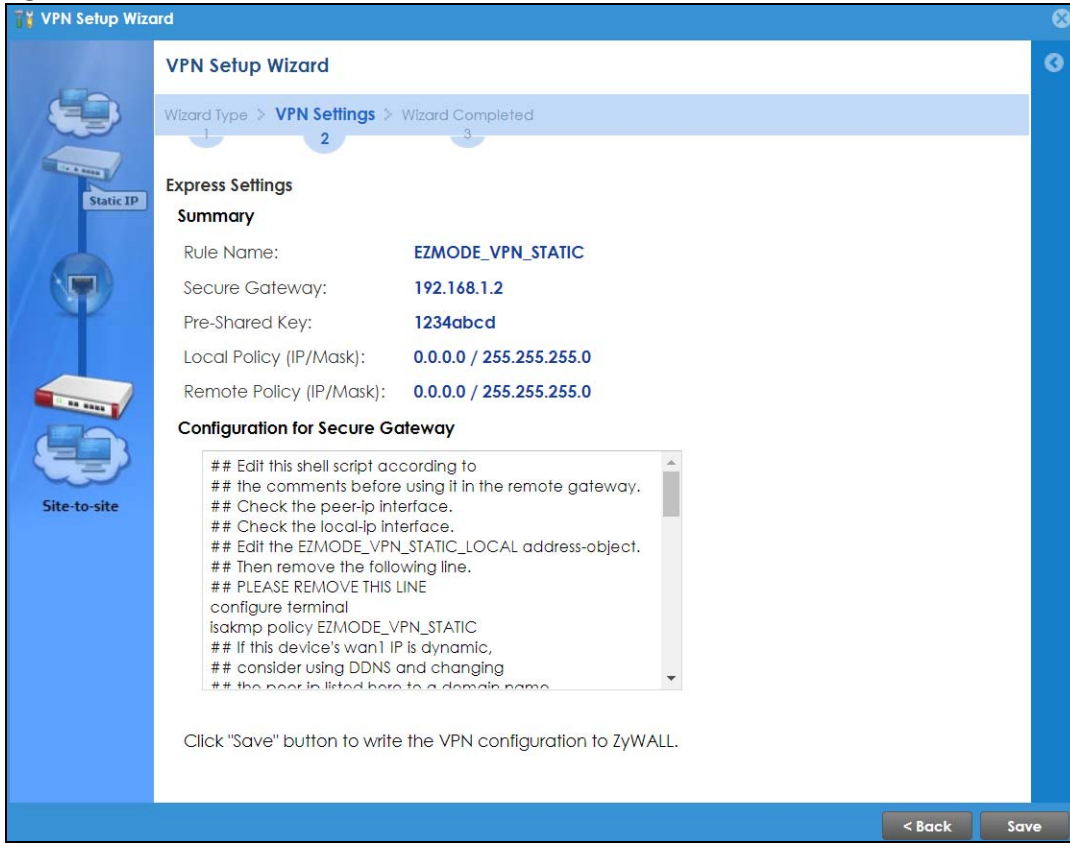

- **Rule Name:** Identifies the VPN gateway policy.
- **Secure Gateway:** IP address or domain name of the remote IPsec device. If this field displays **Any**, only the remote IPsec device can initiate the VPN connection.
- **Pre-Shared Key:** VPN tunnel password. It identifies a communicating party during a phase 1 IKE negotiation.
- **Local Policy:** IP address and subnet mask of the computers on the network behind your Zyxel Device that can use the tunnel.
- **Remote Policy:** IP address and subnet mask of the computers on the network behind the remote IPsec device that can use the tunnel. If this field displays **Any**, only the remote IPsec device can initiate the VPN connection.
- Copy and paste the **Configuration for Secure Gateway** commands into another ZLD-based Zyxel Device's command line interface to configure it to serve as the other end of this VPN tunnel. You can also use a text editor to save these commands as a shell script file with a ".zysh" filename extension. Use the file manager to run the script in order to configure the VPN connection. See the commands reference guide for details on the commands displayed in this list.

4.6.5 VPN Express Wizard – Finish

Now the rule is configured on the Zyxel Device. The Phase 1 rule settings appear in the **VPN > IPsec VPN > VPN Gateway** screen and the Phase 2 rule settings appear in the **VPN > IPsec VPN > VPN Connection** screen.

Figure 89 VPN Express Wizard: Finish

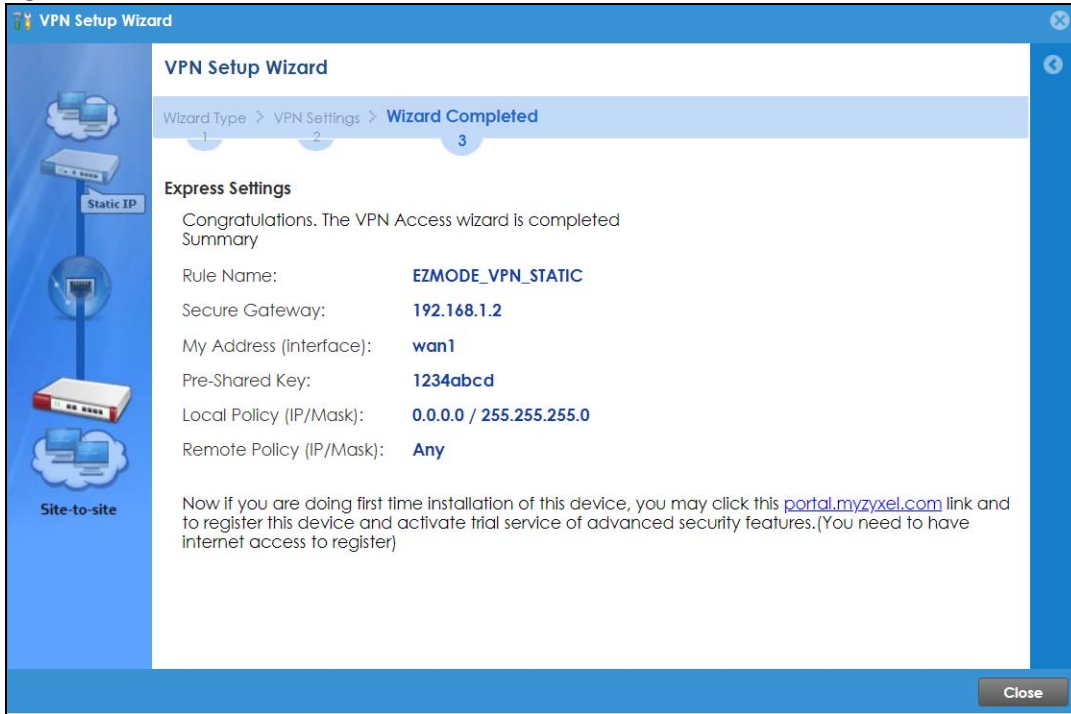

Click **Close** to exit the wizard.

4.6.6 VPN Advanced Wizard – Scenario

Click the **Advanced** radio button as shown in [Figure 85 on page 113](#) to display the following screen.

Figure 90 VPN Advanced Wizard: Scenario

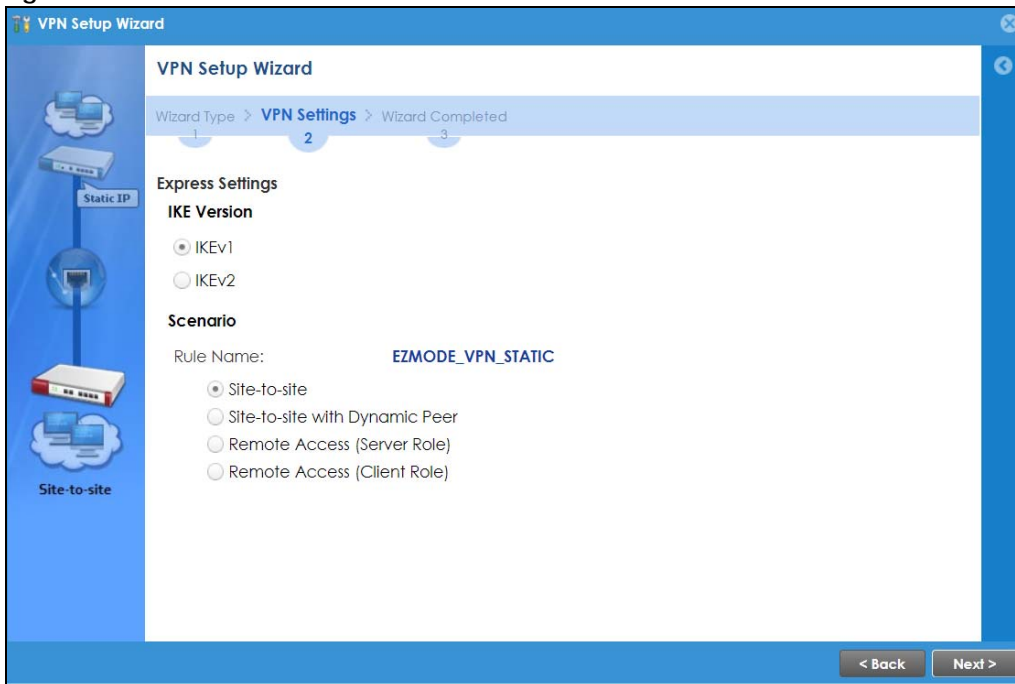

IKE (Internet Key Exchange) Version: IKE is a protocol used in security associations to send data securely. IKE uses certificates or pre-shared keys for authentication and a Diffie–Hellman key exchange to set up a shared session secret from which encryption keys are derived.

IKEv2 supports Extended Authentication Protocol (EAP) authentication, and IKEv1 supports X-Auth. EAP is important when connecting to existing enterprise authentication systems.

Rule Name: Type the name used to identify this VPN connection (and VPN gateway). You may use 1-31 alphanumeric characters, underscores (`_`), or dashes (`-`), but the first character cannot be a number. This value is case-sensitive.

Select the scenario that best describes your intended VPN connection. The figure on the left of the screen changes to match the scenario you select.

- **Site-to-site** – The remote IPsec device has a static IP address or a domain name. This Zyxel Device can initiate the VPN tunnel.
- **Site-to-site with Dynamic Peer** – The remote IPsec device has a dynamic IP address. Only the remote IPsec device can initiate the VPN tunnel.
- **Remote Access (Server Role)** – Allow incoming connections from IPsec VPN clients. The clients have dynamic IP addresses and are also known as dial-in users. Only the clients can initiate the VPN tunnel.
- **Remote Access (Client Role)** – Connect to an IPsec server. This Zyxel Device is the client (dial-in user) and can initiate the VPN tunnel.

4.6.7 VPN Advanced Wizard – Phase 1 Settings

There are two phases to every IKE (Internet Key Exchange) negotiation – phase 1 (Authentication) and phase 2 (Key Exchange). A phase 1 exchange establishes an IKE SA (Security Association).

Figure 91 VPN Advanced Wizard: Phase 1 Settings

- **Secure Gateway:** **Any** displays in this field if it is not configurable for the chosen scenario. Otherwise, enter the WAN IP address or domain name of the remote IPsec device (secure gateway) to identify the remote IPsec device by its IP address or a domain name. Use 0.0.0.0 if the remote IPsec device has a dynamic WAN IP address.
- **My Address (interface):** Select an interface from the drop-down list box to use on your Zyxel Device.

- **Negotiation Mode:** This displays **Main** or **Aggressive**:
 - **Main** encrypts the ZyWALL/USG's and remote IPsec router's identities but takes more time to establish the IKE SA
 - **Aggressive** is faster but does not encrypt the identities.

The ZyWALL/USG and the remote IPsec router must use the same negotiation mode. Multiple SAs connecting through a secure gateway must have the same negotiation mode.

- **Encryption Algorithm:** **3DES** and **AES** use encryption. The longer the key, the higher the security (this may affect throughput). Both sender and receiver must use the same secret key, which can be used to encrypt and decrypt the message or to generate and verify a message authentication code. The DES encryption algorithm uses a 56-bit key. Triple DES (**3DES**) is a variation on DES that uses a 168-bit key. As a result, 3DES is more secure than DES. It also requires more processing power, resulting in increased latency and decreased throughput. **AES128** uses a 128-bit key and is faster than 3DES. AES192 uses a 192-bit key, and AES256 uses a 256-bit key.
- **Authentication Algorithm:** **MD5** gives minimal security and **SHA512** gives the highest security. MD5 (Message Digest 5) and SHA (Secure Hash Algorithm) are hash algorithms used to authenticate packet data. The stronger the algorithm the slower it is.
- **Key Group:** **DH5** is more secure than **DH1** or **DH2** (although it may affect throughput). DH1 (default) refers to Diffie-Hellman Group 1 a 768 bit random number. DH2 refers to Diffie-Hellman Group 2 a 1024 bit (1Kb) random number. DH5 refers to Diffie-Hellman Group 5 a 1536 bit random number.
- **SA Life Time:** Set how often the Zyxel Device renegotiates the IKE SA. A short SA life time increases security, but renegotiation temporarily disconnects the VPN tunnel.
- **NAT Traversal:** Select this if the VPN tunnel must pass through NAT (there is a NAT router between the IPsec devices).

Note: The remote IPsec device must also have NAT traversal enabled. See the help in the main IPsec VPN screens for more information.

- **Dead Peer Detection (DPD)** has the Zyxel Device make sure the remote IPsec device is there before transmitting data through the IKE SA. If there has been no traffic for at least 15 seconds, the Zyxel Device sends a message to the remote IPsec device. If it responds, the Zyxel Device transmits the data. If it does not respond, the Zyxel Device shuts down the IKE SA.
- **Authentication Method:** Select **Pre-Shared Key** to use a password or **Certificate** to use one of the Zyxel Device's certificates.

4.6.8 VPN Advanced Wizard – Phase 2

Phase 2 in an IKE uses the SA that was established in phase 1 to negotiate SAs for IPsec.

Figure 92 VPN Advanced Wizard: Phase 2 Settings

Advanced Settings	
Phase 2 Setting	
Active Protocol:	ESP
Encapsulation:	Tunnel
Encryption Algorithm:	DES
Authentication Algorithm:	SHA1
SA Life Time:	86400 (180 - 3000000 Seconds)
Perfect Forward Secrecy (PFS):	None
Policy Setting	
Local Policy (IP/Mask)	0.0.0.0 / 255.255.255.0
Remote Policy (IP/Mask)	0.0.0.0 / 255.255.255.0
Property	
<input checked="" type="checkbox"/> Nailed-Up	

- **Active Protocol:** **ESP** is compatible with NAT, **AH** is not.
- **Encapsulation:** **Tunnel** is compatible with NAT, **Transport** is not.
- **Encryption Algorithm:** **3DES** and **AES** use encryption. The longer the **AES** key, the higher the security (this may affect throughput). **Null** uses no encryption.
- **Authentication Algorithm:** **MD5** gives minimal security and **SHA512** gives the highest security. MD5 (Message Digest 5) and SHA (Secure Hash Algorithm) are hash algorithms used to authenticate packet data. The stronger the algorithm the slower it is.
- **SA Life Time:** Set how often the Zyxel Device renegotiates the IKE SA. A short SA life time increases security, but renegotiation temporarily disconnects the VPN tunnel.
- **Perfect Forward Secrecy (PFS):** Disabling PFS allows faster IPsec setup, but is less secure. Select DH1, DH2 or DH5 to enable PFS. **DH5** is more secure than **DH1** or **DH2** (although it may affect throughput). DH1 refers to Diffie-Hellman Group 1 a 768 bit random number. DH2 refers to Diffie-Hellman Group 2 a 1024 bit (1Kb) random number. DH5 refers to Diffie-Hellman Group 5 a 1536 bit random number (more secure, yet slower).
- **Local Policy (IP/Mask):** Type the IP address of a computer on your network. You can also specify a subnet. This must match the remote IP address configured on the remote IPsec device.
- **Remote Policy (IP/Mask):** Type the IP address of a computer behind the remote IPsec device. You can also specify a subnet. This must match the local IP address configured on the remote IPsec device.
- **Nailed-Up:** This displays for the site-to-site and remote access client role scenarios. Select this to have the Zyxel Device automatically renegotiate the IPsec SA when the SA life time expires.

4.6.9 VPN Advanced Wizard – Summary

This is a read-only summary of the VPN tunnel settings.

Figure 93 VPN Advanced Wizard: Summary

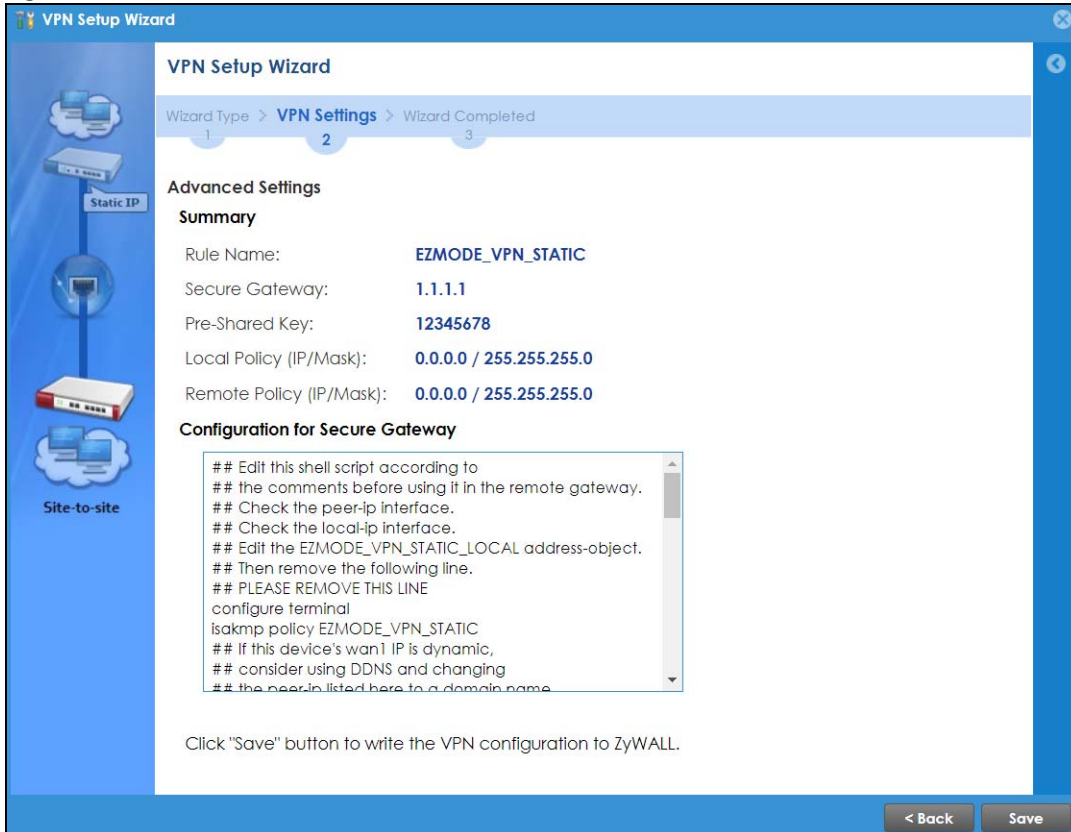

- **Rule Name:** Identifies the VPN connection (and the VPN gateway).
- **Secure Gateway:** IP address or domain name of the remote IPsec device.
- **Pre-Shared Key:** VPN tunnel password.
- **Local Policy:** IP address and subnet mask of the computers on the network behind your Zyxel Device that can use the tunnel.
- **Remote Policy:** IP address and subnet mask of the computers on the network behind the remote IPsec device that can use the tunnel.
- Copy and paste the **Configuration for Remote Gateway** commands into another ZLD-based Zyxel Device's command line interface.
- Click **Save** to save the VPN rule.

4.6.10 VPN Advanced Wizard – Finish

Now the rule is configured on the Zyxel Device. The Phase 1 rule settings appear in the **VPN > IPsec VPN > VPN Gateway** screen and the Phase 2 rule settings appear in the **VPN > IPsec VPN > VPN Connection** screen.

Figure 94 VPN Wizard: Finish

VPN Setup Wizard

Wizard Type > VPN Settings > **Wizard Completed**

1 2 3

Advanced Settings

Congratulations. The VPN Access wizard is completed
Summary

Rule Name: **EZMODE_VPN_STATIC**

Secure Gateway: **1.1.1.1**

My Address (Interface): **wan1**

Pre-Shared Key: **12345678**

Phase 1

Negotiation Mode: **main**

Encryption Algorithm: **aes128**

Authentication Algorithm: **sha**

Key Group: **DH2**

SA Life Time: **86400**

NAT Traversal: **true**

Dead Peer Detection (DPD): **true**

Phase 2

Active Protocol: **esp**

Encapsulation: **tunnel**

Encryption Algorithm: **aes128**

Authentication Algorithm: **sha**

SA Life Time: **28800**

Perfect Forward Secrecy (PFS): **DH2**

Policy

Local Policy (IP/Mask): **0.0.0.0 / 255.255.255.0**

Remote Policy (IP/Mask): **0.0.0.0 / 255.255.255.0**

Nailed-Up: **false**

Now if you are doing first time installation of this device, you may click this portal.myzyxel.com link and to register this device and activate trial service of advanced security features.(You need to have internet access to register)

Close

Click **Close** to exit the wizard.

4.7 VPN Settings for Configuration Provisioning Wizard: Wizard Type

Use **VPN Settings for Configuration Provisioning** to set up a VPN rule that can be retrieved with the Zyxel Device IPSec VPN Client.

VPN rules for the Zyxel Device IPSec VPN Client have certain restrictions. They must *not* contain the following settings:

- **AH** active protocol
- **NULL** encryption
- **SHA512** authentication
- A subnet or range remote policy

Choose **Express** to create a VPN rule with the default phase 1 and phase 2 settings and to use a pre-shared key.

Choose **Advanced** to change the default settings and/or use certificates instead of a pre-shared key in the VPN rule.

Figure 95 VPN Settings for Configuration Provisioning Express Wizard: Wizard Type

VPN Setup Wizard

Wizard Type > VPN Settings > Wizard Completed

1 2 3

Please select the type of VPN policy you wish to setup.

Type of VPN policy

Express

Advanced

< Back Next >

4.7.1 Configuration Provisioning Express Wizard – VPN Settings

Click the **Express** radio button as shown in the previous screen to display the following screen.

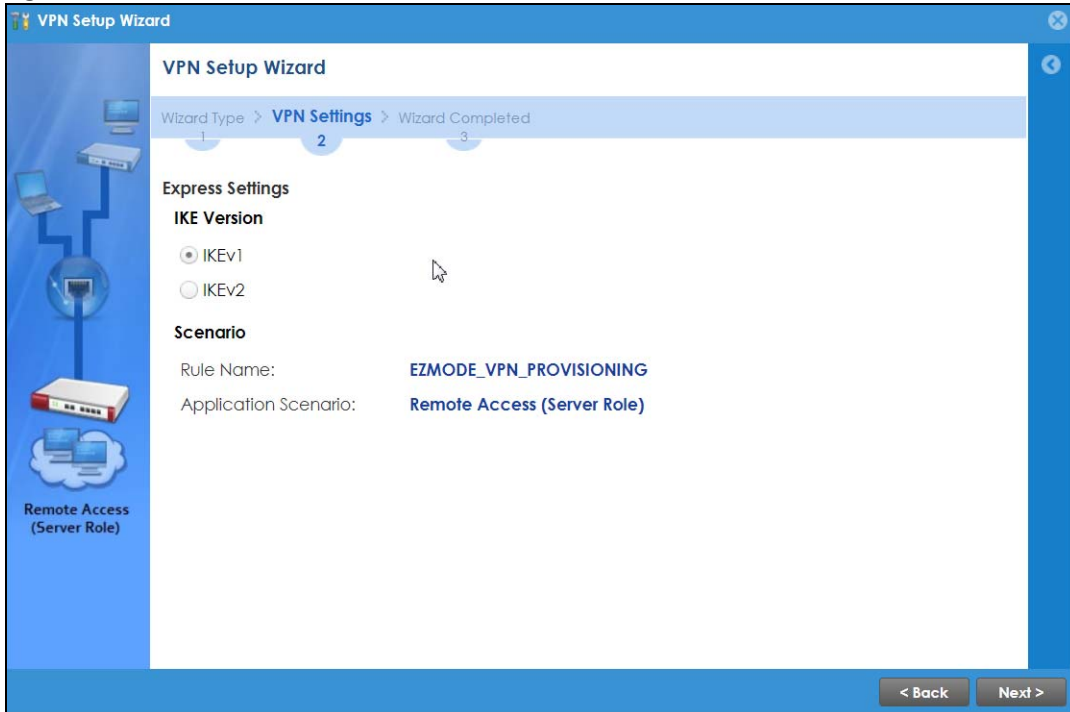
Figure 96 VPN for Configuration Provisioning Express Wizard: Settings Scenario

IKE (Internet Key Exchange) Version: IKE is a protocol used in security associations to send data securely. IKE uses certificates or pre-shared keys for authentication and a Diffie–Hellman key exchange to set up a shared session secret from which encryption keys are derived.

IKEv2 supports Extended Authentication Protocol (EAP) authentication, and IKEv1 supports X-Auth. EAP is important when connecting to existing enterprise authentication systems.

Rule Name: Type the name used to identify this VPN connection (and VPN gateway). You may use 1-31 alphanumeric characters, underscores (`_`), or dashes (`-`), but the first character cannot be a number. This value is case-sensitive.

Application Scenario: Only the **Remote Access (Server Role)** is allowed in this wizard. It allows incoming connections from the Zyxel Device IPsec VPN Client.

4.7.2 Configuration Provisioning VPN Express Wizard – Configuration

Click **Next** to continue the wizard.

Figure 97 VPN for Configuration Provisioning Express Wizard: Configuration

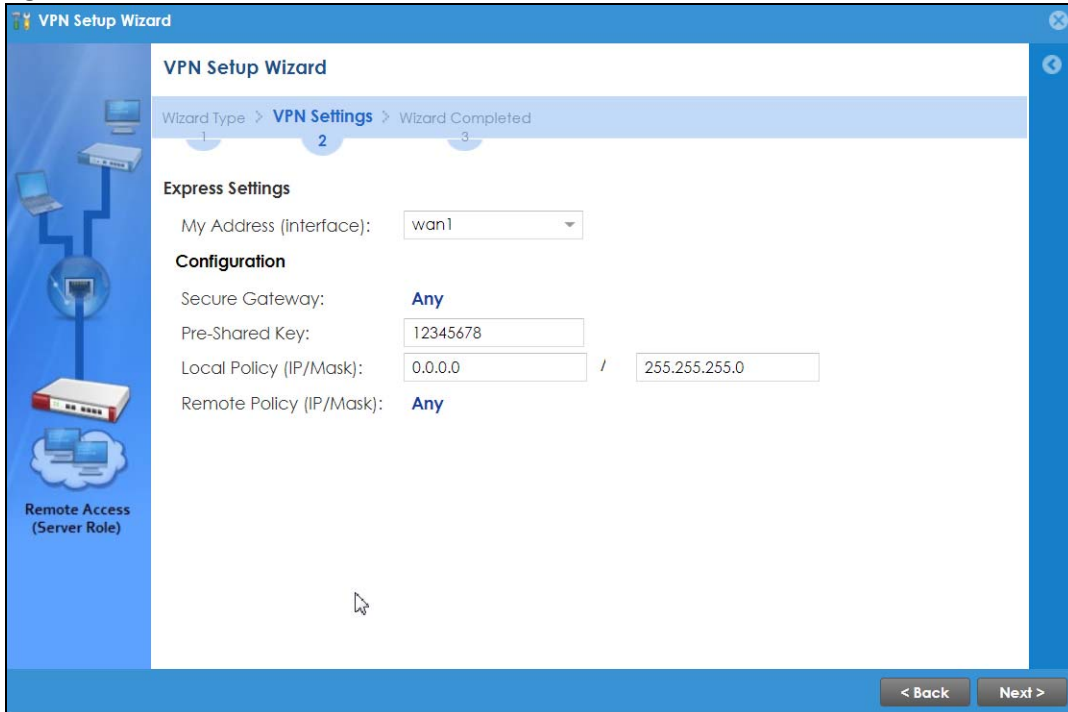

- **My Address (interface):** Select an interface from the drop-down list box to use on your Zyxel Device.
- **Secure Gateway:** **Any** displays in this field because it is not configurable in this wizard. It allows incoming connections from the Zyxel Device IPsec VPN Client.
- **Pre-Shared Key:** Type the password. Both ends of the VPN tunnel must use the same password. Use up to 128 case-sensitive ASCII characters or up to 128 pairs of hexadecimal ("0-9", "A-F") characters. Proceed a hexadecimal key with "0x". You will receive a PYLD_MALFORMED (payload malformed) packet if the same pre-shared key is not used on both ends.
- **Local Policy (IP/Mask):** Type the IP address of a computer on your network. You can also specify a subnet. This must match the remote IP address configured on the remote IPsec device.
- **Remote Policy (IP/Mask):** **Any** displays in this field because it is not configurable in this wizard.

4.7.3 VPN Settings for Configuration Provisioning Express Wizard – Summary

This screen has a read-only summary of the VPN tunnel's configuration and commands you can copy and paste into another ZLD-based Zyxel Device's command line interface to configure it.

Figure 98 VPN for Configuration Provisioning Express Wizard: Summary

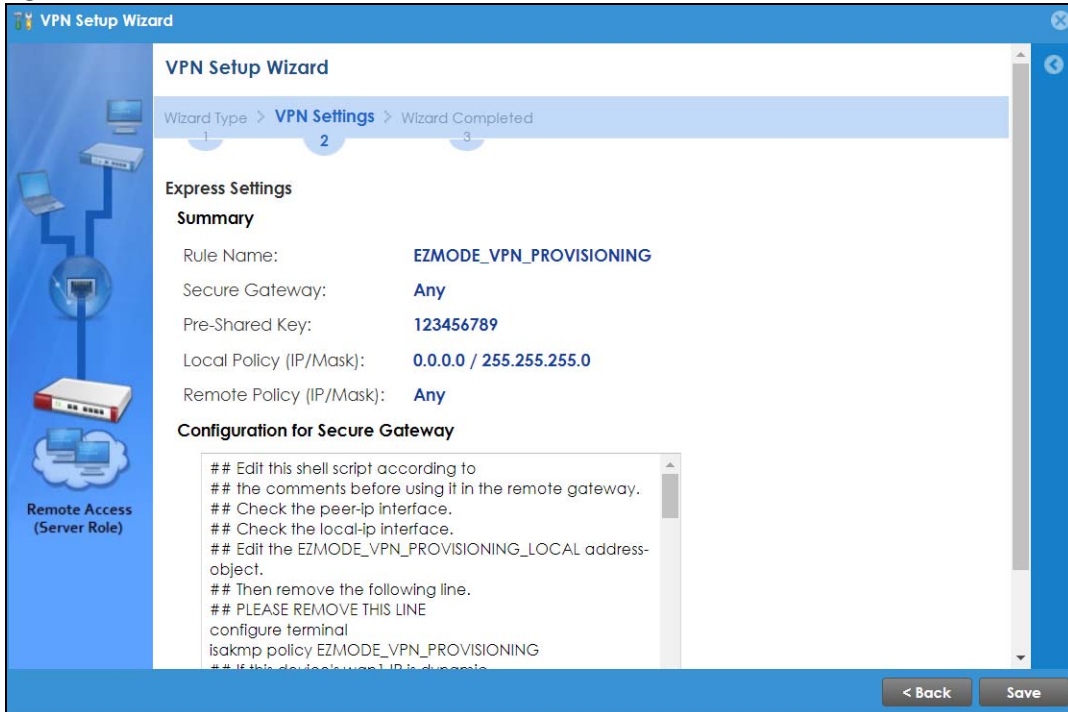

- **Rule Name:** Identifies the VPN gateway policy.
- **Secure Gateway:** **Any** displays in this field because it is not configurable in this wizard. It allows incoming connections from the Zyxel Device IPsec VPN Client.
- **Pre-Shared Key:** VPN tunnel password. It identifies a communicating party during a phase 1 IKE negotiation.
- **Local Policy:** (Static) IP address and subnet mask of the computers on the network behind your Zyxel Device that can be accessed using the tunnel.
- **Remote Policy:** **Any** displays in this field because it is not configurable in this wizard.
- The **Configuration for Secure Gateway** displays the configuration that the Zyxel Device IPsec VPN Client will get from the Zyxel Device.
- Click **Save** to save the VPN rule.

4.7.4 VPN Settings for Configuration Provisioning Express Wizard – Finish

Now the rule is configured on the Zyxel Device. The Phase 1 rule settings appear in the **VPN > IPsec VPN > VPN Gateway** screen and the Phase 2 rule settings appear in the **VPN > IPsec VPN > VPN Connection** screen. Enter the IP address of the Zyxel Device in the Zyxel Device IPsec VPN Client to get all these VPN settings automatically from the Zyxel Device.

Figure 99 VPN for Configuration Provisioning Express Wizard: Finish

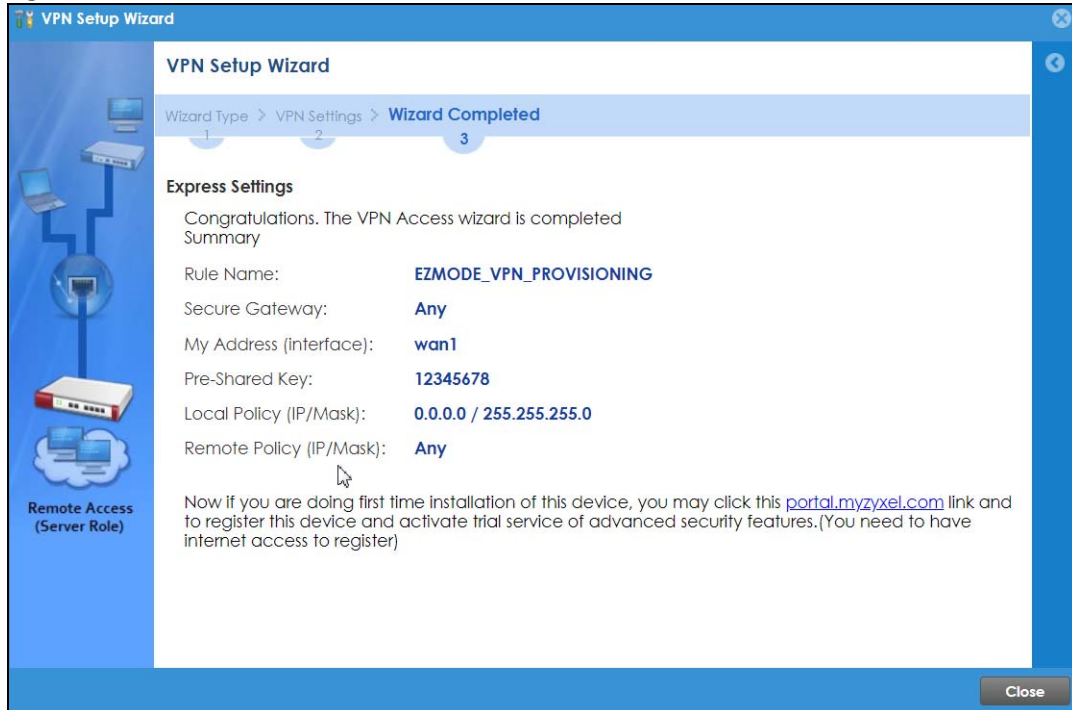

Click **Close** to exit the wizard.

4.7.5 VPN Settings for Configuration Provisioning Advanced Wizard – Scenario

Click the **Advanced** radio button as shown in the screen shown in [Figure 95 on page 124](#) to display the following screen.

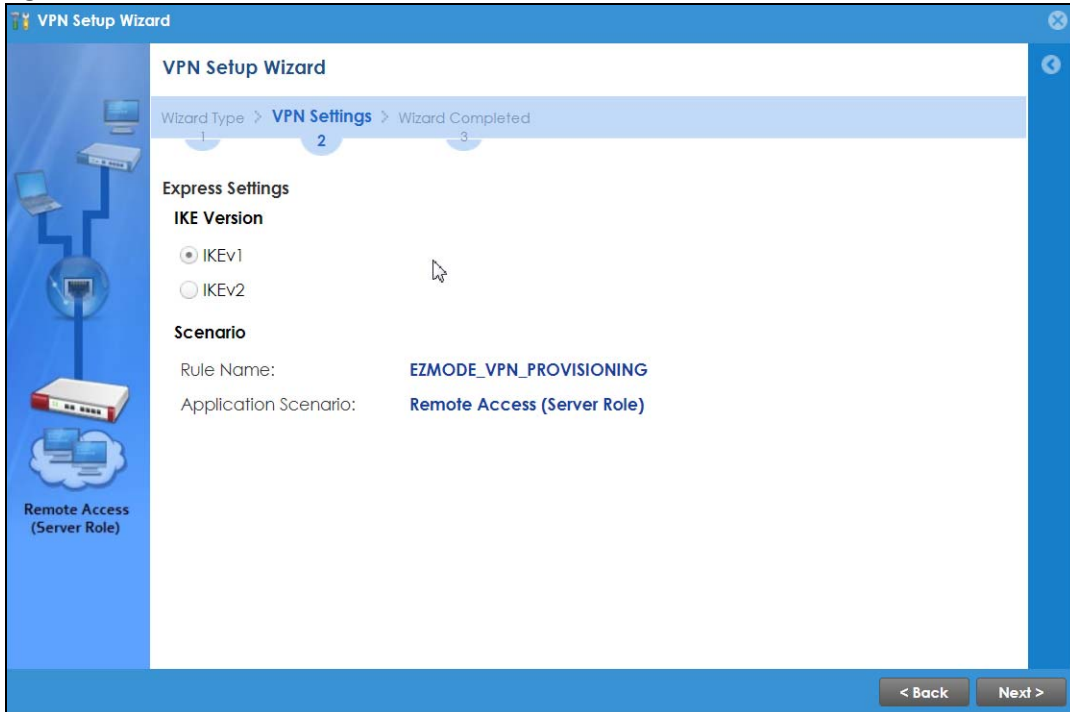
Figure 100 VPN for Configuration Provisioning Advanced Wizard: Scenario Settings

IKE (Internet Key Exchange) Version: IKE is a protocol used in security associations to send data securely. IKE uses certificates or pre-shared keys for authentication and a Diffie–Hellman key exchange to set up a shared session secret from which encryption keys are derived.

IKEv2 supports Extended Authentication Protocol (EAP) authentication, and IKEv1 supports X-Auth. EAP is important when connecting to existing enterprise authentication systems.

Rule Name: Type the name used to identify this VPN connection (and VPN gateway). You may use 1-31 alphanumeric characters, underscores (`_`), or dashes (`-`), but the first character cannot be a number. This value is case-sensitive.

Application Scenario: Only the **Remote Access (Server Role)** is allowed in this wizard. It allows incoming connections from the Zyxel Device IPsec VPN Client.

Click **Next** to continue the wizard.

4.7.6 VPN Settings for Configuration Provisioning Advanced Wizard – Phase 1 Settings

There are two phases to every IKE (Internet Key Exchange) negotiation – phase 1 (Authentication) and phase 2 (Key Exchange). A phase 1 exchange establishes an IKE SA (Security Association).

Figure 101 VPN for Configuration Provisioning Advanced Wizard: Phase 1 Settings

Advanced Settings

Phase 1 Setting

Secure Gateway: Any

My Address (interface): wan1

Negotiation Mode: Main

Encryption Algorithm: DES

Authentication Algorithm: MD5

Key Group: DH1

SA Life Time: 86400 (180 - 3000000 seconds)

Authentication Method

Pre-Shared Key

Certificate

- **Secure Gateway:** Any displays in this field because it is not configurable in this wizard. It allows incoming connections from the Zyxel Device IPsec VPN Client.
- **My Address (interface):** Select an interface from the drop-down list box to use on your Zyxel Device.
- **Negotiation Mode:** This displays **Main** or **Aggressive**:
 - **Main** encrypts the ZyWALL/USG's and remote IPsec router's identities but takes more time to establish the IKE SA
 - **Aggressive** is faster but does not encrypt the identities.

The ZyWALL/USG and the remote IPsec router must use the same negotiation mode. Multiple SAs connecting through a secure gateway must have the same negotiation mode.

- **Encryption Algorithm:** 3DES and AES use encryption. The longer the key, the higher the security (this may affect throughput). Both sender and receiver must know the same secret key, which can be used to encrypt and decrypt the message or to generate and verify a message authentication code. The DES encryption algorithm uses a 56-bit key. Triple DES (3DES) is a variation on DES that uses a 168-bit key. As a result, 3DES is more secure than DES. It also requires more processing power, resulting in increased latency and decreased throughput. AES128 uses a 128-bit key and is faster than 3DES. AES192 uses a 192-bit key and AES256 uses a 256-bit key.
- **Authentication Algorithm:** MD5 (Message Digest 5) and SHA (Secure Hash Algorithm) are hash algorithms used to authenticate packet data. MD5 gives minimal security. SHA1 gives higher security and SHA256 gives the highest security. The stronger the algorithm, the slower it is.
- **Key Group:** DH5 is more secure than DH1 or DH2 (although it may affect throughput). DH1 (default) refers to Diffie-Hellman Group 1 a 768 bit random number. DH2 refers to Diffie-Hellman Group 2 a 1024 bit (1Kb) random number. DH5 refers to Diffie-Hellman Group 5 a 1536 bit random number.
- **SA Life Time:** Set how often the Zyxel Device renegotiates the IKE SA. A short SA life time increases security, but renegotiation temporarily disconnects the VPN tunnel.
- **Authentication Method:** Select **Pre-Shared Key** to use a password or **Certificate** to use one of the Zyxel Device's certificates.

4.7.7 VPN Settings for Configuration Provisioning Advanced Wizard – Phase 2

Phase 2 in an IKE uses the SA that was established in phase 1 to negotiate SAs for IPsec.

Figure 102 VPN for Configuration Provisioning Advanced Wizard: Phase 2 Settings

Advanced Settings	
Phase 2 Setting	
Active Protocol:	ESP
Encapsulation:	Tunnel
Encryption Algorithm:	DES
Authentication Algorithm:	SHA1
SA Life Time:	86400 (180 - 3000000 seconds)
Perfect Forward Secrecy (PFS):	None
Policy Setting	
Local Policy (IP/Mask)	0.0.0.0 / 255.255.255.0
Remote Policy (IP/Mask):	Any

- **Active Protocol:** ESP is compatible with NAT. AH is not available in this wizard.
- **Encapsulation:** Tunnel is compatible with NAT, Transport is not.
- **Encryption Algorithm:** 3DES and AES use encryption. The longer the AES key, the higher the security (this may affect throughput). Null uses no encryption.
- **Authentication Algorithm:** MD5 (Message Digest 5) and SHA (Secure Hash Algorithm) are hash algorithms used to authenticate packet data. MD5 gives minimal security. SHA1 gives higher security and SHA256 gives the highest security. The stronger the algorithm, the slower it is.
- **SA Life Time:** Set how often the Zyxel Device renegotiates the IKE SA. A short SA life time increases security, but renegotiation temporarily disconnects the VPN tunnel.
- **Perfect Forward Secrecy (PFS):** Disabling PFS allows faster IPsec setup, but is less secure. Select DH1, DH2 or DH5 to enable PFS. DH5 is more secure than DH1 or DH2 (although it may affect throughput). DH1 refers to Diffie-Hellman Group 1 a 768 bit random number. DH2 refers to Diffie-Hellman Group 2 a 1024 bit (1Kb) random number. DH5 refers to Diffie-Hellman Group 5 a 1536 bit random number (more secure, yet slower).
- **Local Policy (IP/Mask):** Type the IP address of a computer on your network. You can also specify a subnet. This must match the remote IP address configured on the remote IPsec device.
- **Remote Policy (IP/Mask):** Any displays in this field because it is not configurable in this wizard.
- **Nailed-Up:** This displays for the site-to-site and remote access client role scenarios. Select this to have the Zyxel Device automatically renegotiate the IPsec SA when the SA life time expires.

4.7.8 VPN Settings for Configuration Provisioning Advanced Wizard – Summary

This is a read-only summary of the VPN tunnel settings.

Figure 103 VPN for Configuration Provisioning Advanced Wizard: Summary

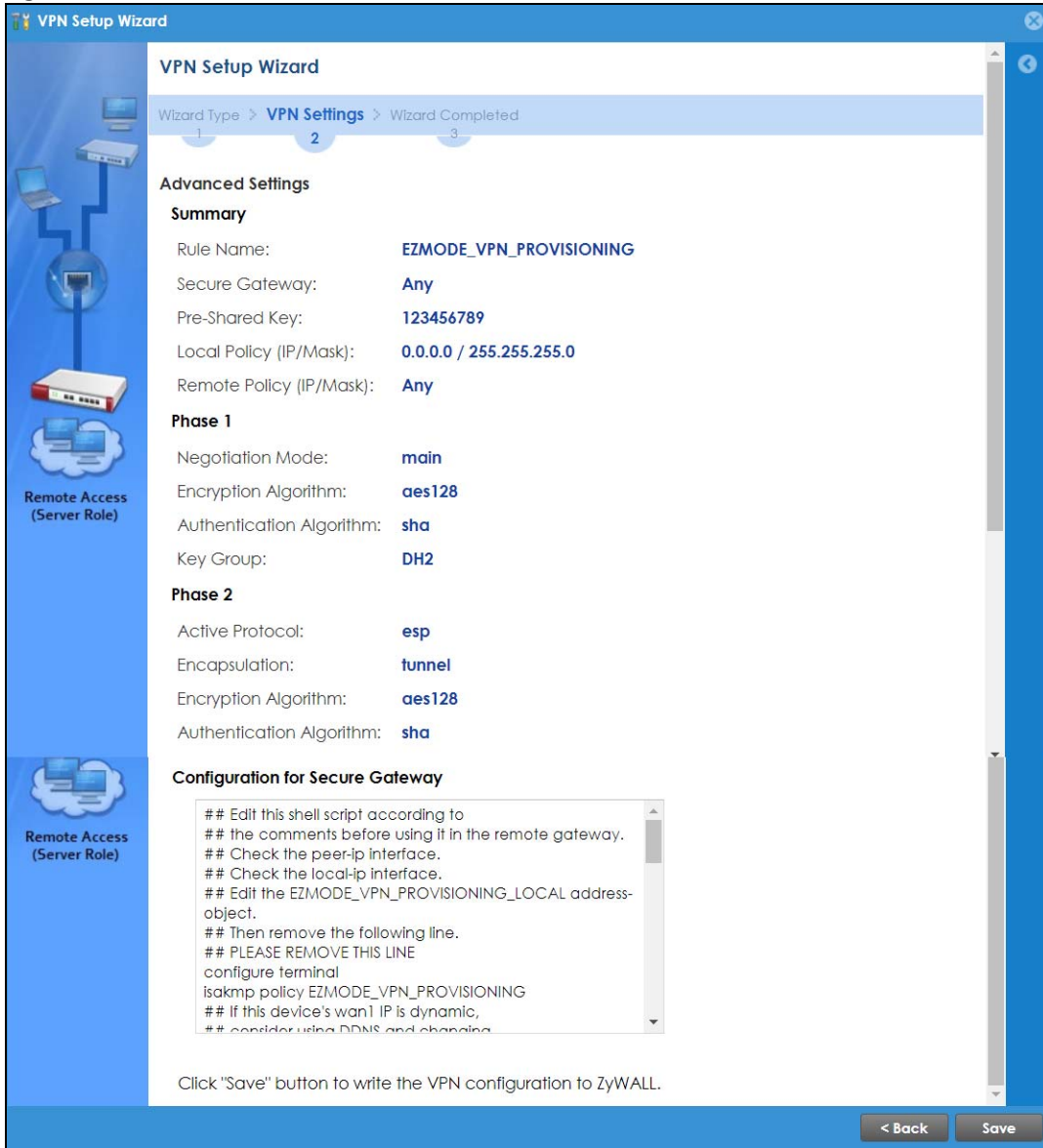

Summary

- **Rule Name:** Identifies the VPN connection (and the VPN gateway).
- **Secure Gateway:** **Any** displays in this field because it is not configurable in this wizard. It allows incoming connections from the Zyxel Device IPsec VPN Client.
- **Pre-Shared Key:** VPN tunnel password.
- **Local Policy:** IP address and subnet mask of the computers on the network behind your Zyxel Device that can use the tunnel.
- **Remote Policy:** **Any** displays in this field because it is not configurable in this wizard.

Phase 1

- **Negotiation Mode:** This displays **Main** or **Aggressive**:

- **Main** encrypts the ZyWALL/USG's and remote IPSec router's identities but takes more time to establish the IKE SA
- **Aggressive** is faster but does not encrypt the identities.

The ZyWALL/USG and the remote IPSec router must use the same negotiation mode. Multiple SAs connecting through a secure gateway must have the same negotiation mode.

- **Encryption Algorithm:** This displays the encryption method used. The longer the key, the higher the security, the lower the throughput (possibly).
 - **DES** uses a 56-bit key.
 - **3DES** uses a 168-bit key.
 - **AES128** uses a 128-bit key.
 - **AES192** uses a 192-bit key.
 - **AES256** uses a 256-bit key.
- **Authentication Algorithm:** This displays the authentication algorithm used. The stronger the algorithm, the slower it is.
 - **MD5** gives minimal security.
 - **SHA1** gives higher security.
 - **SHA256** gives the highest security.
- **Key Group:** This displays the Diffie-Hellman (DH) key group used. **DH5** is more secure than **DH1** or **DH2** (although it may affect throughput).
 - **DH1** uses a 768 bit random number.
 - **DH2** uses a 1024 bit (1Kb) random number.
 - **DH5** uses a 1536 bit random number.

Phase 2

- **Active Protocol:** This displays **ESP** (compatible with NAT) or **AH**.
- **Encapsulation:** This displays **Tunnel** (compatible with NAT) or **Transport**.
- **Encryption Algorithm:** This displays the encryption method used. The longer the key, the higher the security, the lower the throughput (possibly).
 - **DES** uses a 56-bit key.
 - **3DES** uses a 168-bit key.
 - **AES128** uses a 128-bit key.
 - **AES192** uses a 192-bit key.
 - **AES256** uses a 256-bit key.
 - **Null** uses no encryption.
- **Authentication Algorithm:** This displays the authentication algorithm used. The stronger the algorithm, the slower it is.
 - **MD5** gives minimal security.
 - **SHA1** gives higher security.
 - **SHA256** gives the highest security.

The **Configuration for Secure Gateway** displays the configuration that the Zyxel Device IPSec VPN Client will get from the Zyxel Device.

Click **Save** to save the VPN rule.

4.7.9 VPN Settings for Configuration Provisioning Advanced Wizard – Finish

Now the rule is configured on the Zyxel Device. The Phase 1 rule settings appear in the **VPN > IPSec VPN > VPN Gateway** screen and the Phase 2 rule settings appear in the **VPN > IPSec VPN > VPN Connection** screen. Enter the IP address of the Zyxel Device in the Zyxel Device IPSec VPN Client to get all these VPN settings automatically from the Zyxel Device.

Figure 104 VPN for Configuration Provisioning Advanced Wizard: Finish

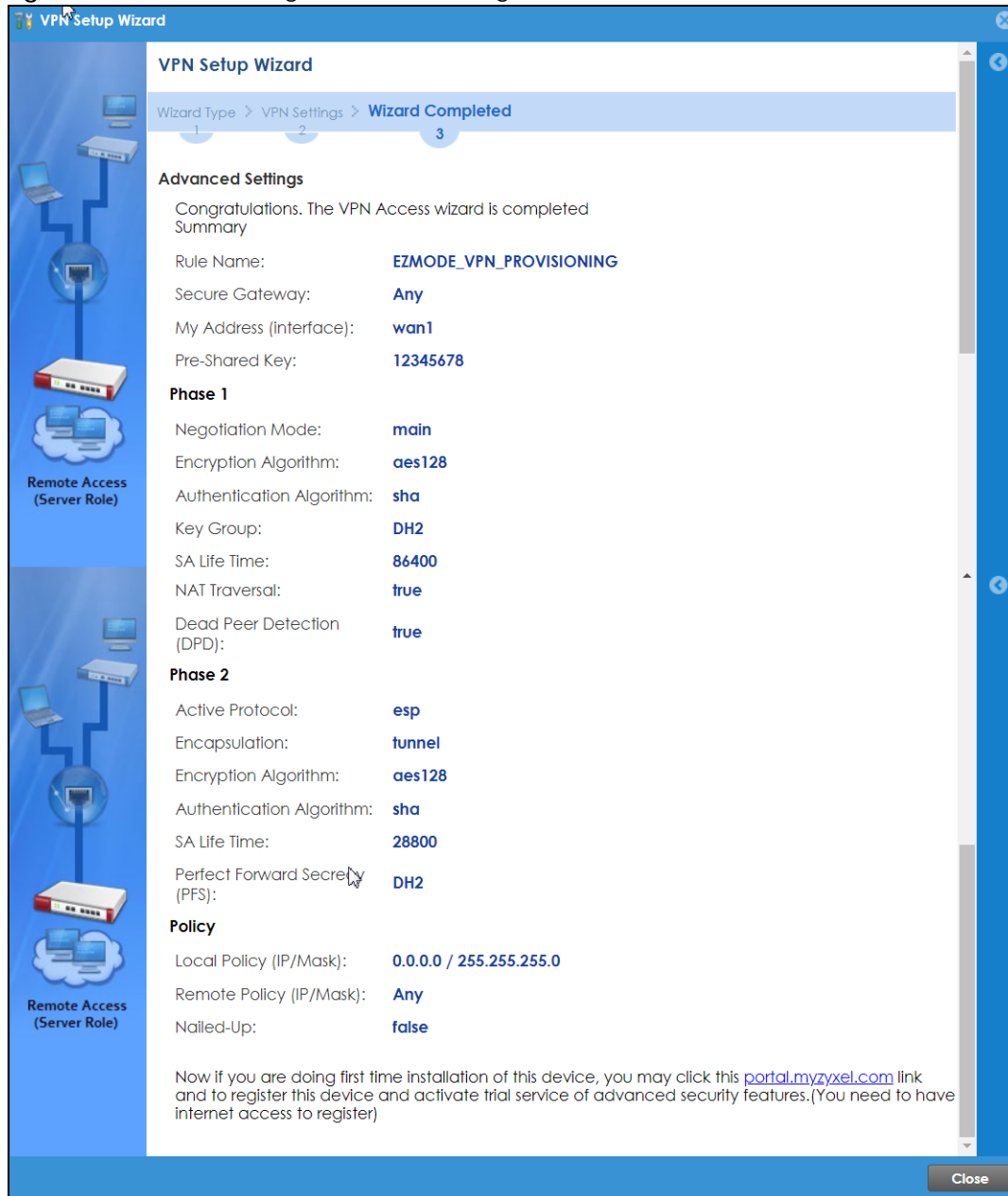

Click **Close** to exit the wizard.

4.8 VPN Settings for L2TP VPN Settings Wizard

Use **VPN Settings for L2TP VPN Settings** to set up an L2TP VPN rule. Click **Configuration > Quick Setup > VPN Settings** and select **VPN Settings for L2TP VPN Settings** to see the following screen.

Figure 105 VPN Settings for L2TP VPN Settings Wizard: L2TP VPN Settings

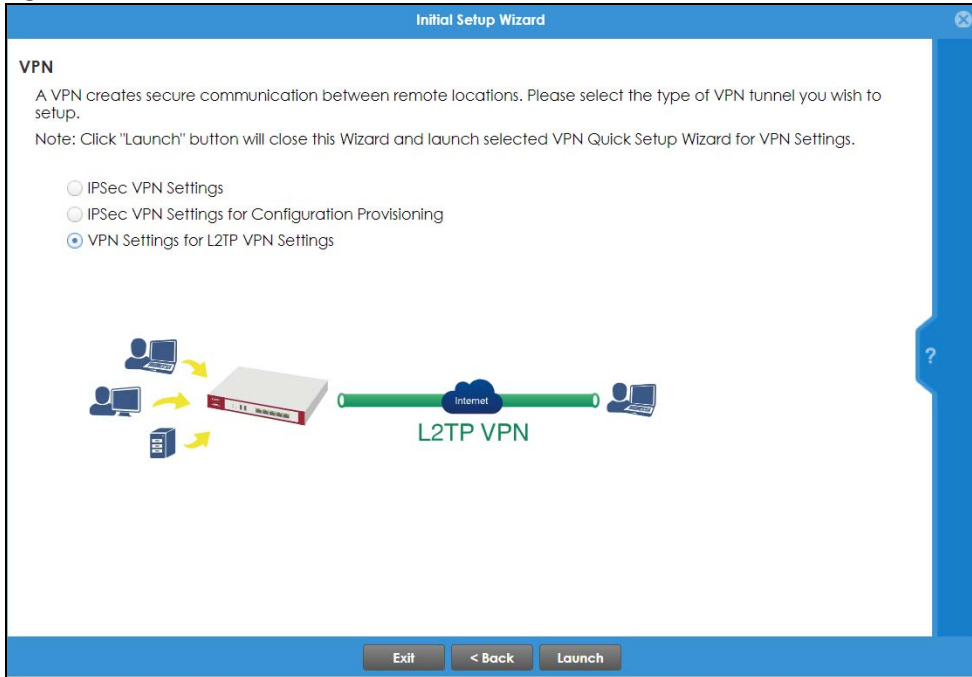

Click **Next** to continue the wizard.

4.8.1 L2TP VPN Settings

Figure 106 VPN Settings for L2TP VPN Settings Wizard: L2TP VPN Settings

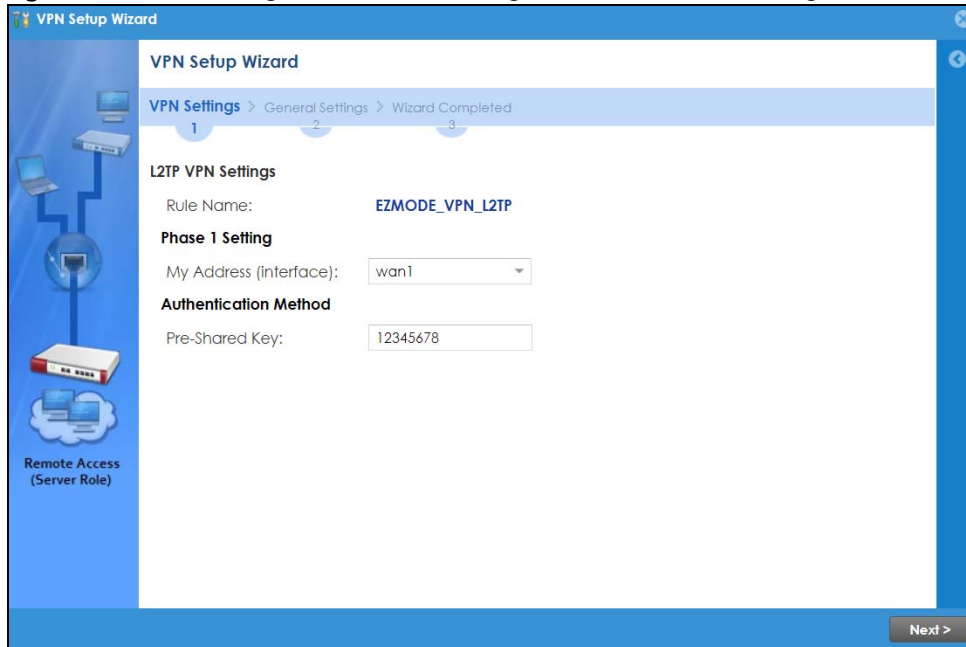

- **Rule Name:** Type the name used to identify this L2TP VPN connection (and L2TP VPN gateway). You may use 1 –31 alphanumeric characters, underscores (_), or dashes (-), but the first character cannot be a number. This value is case-sensitive.
- **My Address (interface):** Select one of the interfaces from the pull down menu to apply the L2TP VPN rule.
- **Pre-Shared Key:** Type the password. Both ends of the VPN tunnel must use the same password. Use up to 128 case-sensitive ASCII characters or up to 128 pairs of hexadecimal ("0–9", "A–F") characters. Proceed a hexadecimal key with "0x". You will receive a PYLD_MALFORMED (payload malformed) packet if the same pre-shared key is not used on both ends.

Click **Next** to continue the wizard.

4.8.2 L2TP VPN Settings 2

Figure 107 VPN Settings for L2TP VPN Settings Wizard: L2TP VPN Settings

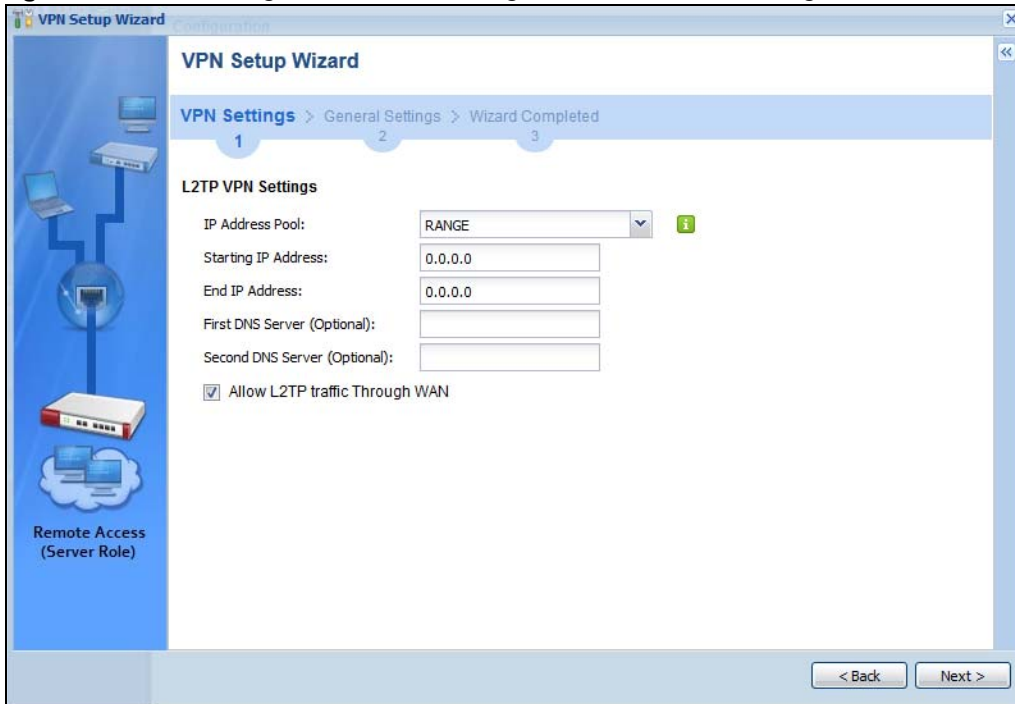

- **IP Address Pool:** Select Range or Subnet from the pull down menu. This IP address pool is used to assign to the L2TP VPN clients.
- **Starting IP Address:** Enter the starting IP address in the field.
- **End IP Address:** Enter the ending IP address in the field.
- **First DNS Server (Optional):** Enter the first DNS server IP address in the field. Leave the field as 0.0.0.0 if you do not want to configure DNS servers. If you do not configure a DNS server you must know the IP address of a machine in order to access it.
- **Second DNS Server (Optional):** Enter the second DNS server IP address in the field. Leave the field as 0.0.0.0 if you do not want to configure DNS servers. If you do not configure a DNS server you must know the IP address of a machine in order to access it.
- **Allow L2TP traffic Through WAN:** Select this check box to allow traffic from L2TP clients to go to the Internet.

Click **Next** to continue the wizard.

Note: DNS (Domain Name System) is for mapping a domain name to its corresponding IP address and vice versa. The DNS server is extremely important because without it, you must know the IP address of a computer before you can access it. The Zyxel Device uses a system DNS server (in the order you specify here) to resolve domain names for VPN, DDNS and the time server.

4.8.3 VPN Settings for L2TP VPN Setting Wizard – Summary

This is a read-only summary of the L2TP VPN settings.

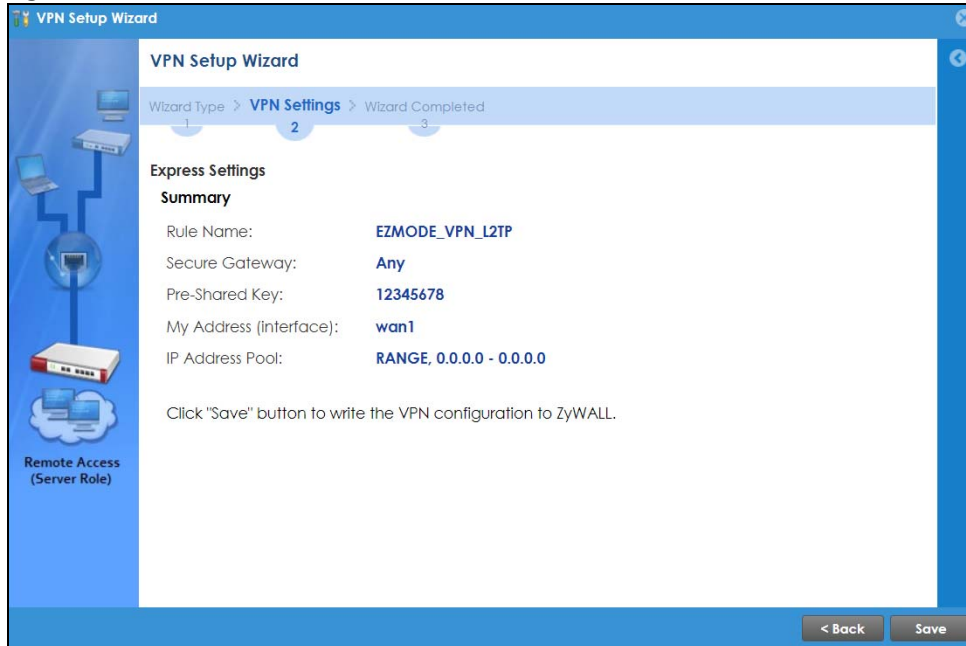
Figure 108 VPN Settings for L2TP VPN Settings Advanced Settings Wizard: Summary

Summary

- **Rule Name:** Identifies the L2TP VPN connection (and the L2TP VPN gateway).
- **Secure Gateway “Any”** displays in this field because it is not configurable in this wizard. It allows incoming connections from the L2TP VPN Client.
- **Pre-Shared Key:** L2TP VPN tunnel password.
- **My Address (Interface):** This displays the interface to use on your Zyxel Device for the L2TP tunnel.
- **IP Address Pool:** This displays the IP address pool used to assign to the L2TP VPN clients.

Click **Save** to complete the L2TP VPN Setting and the following screen will show.

4.8.4 VPN Settings for L2TP VPN Setting Wizard Completed

Figure 109 VPN Settings for L2TP VPN Settings Wizard: Finish

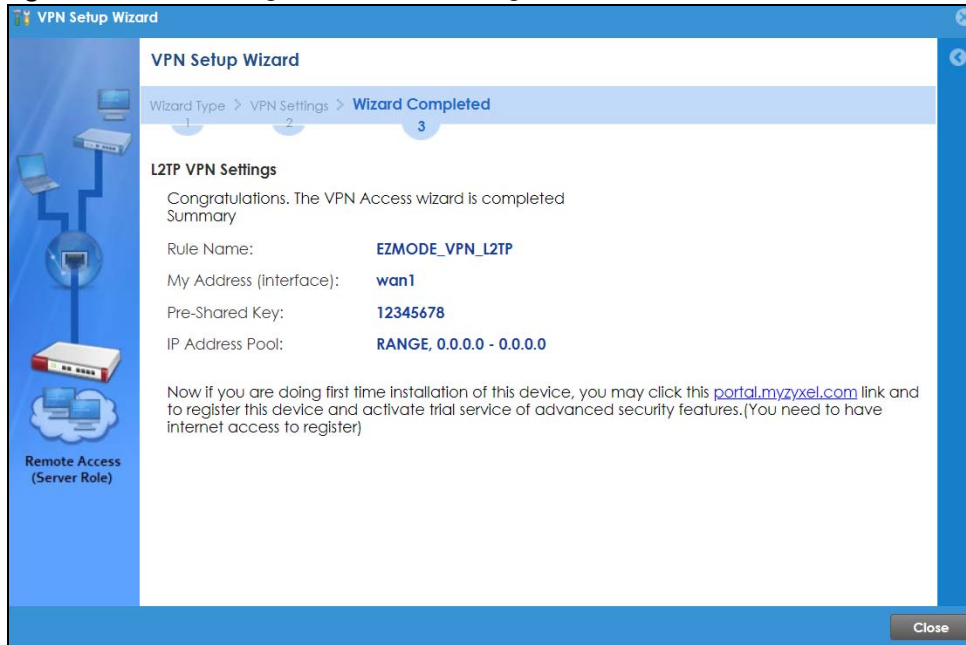

Now the rule is configured on the Zyxel Device. The L2TP VPN rule settings appear in the **VPN > L2TP VPN** screen and also in the **VPN > IPSec VPN > VPN Connection** and **VPN Gateway** screen. S

4.9 Port Forwarding

Figure 110 Port Forwarding > Wizard 1

NAT port forwarding allows the Zyxel Device to direct incoming traffic from the Internet to the correct virtual server in your network. Even though the NAS is in your local network receiving the protection of the Zyxel Device, you can still access that NAS using these services from anywhere outside your network.

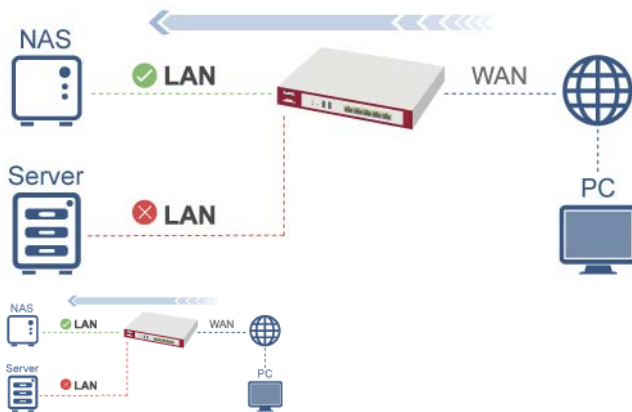

For example, if you have a NAS server in your network that you or other people need access to from outside your network, select the IP address of the NAS from **Client**. Then, select the service(s) that your NAS provides (for example **FTP**, **HTTP**, **HTTPS**) from the **Available** box and use the right arrow to move each service to the **Member** box.

4.9.1 Port Forwarding > Add Client

Click the **Edit** icon next to **Client List** if you cannot see the client in the list. In the pop-up screen, you can add a new client by entering its **Name**, **IP Address** and **MAC Address**.

A client or device in your network acting as a server for forwarded services (for example, the NAS) needs to have a static address. If the client selected does not have a static IP address, the IP address may change when the client reboots, so the Zyxel Device may not be able to find it. If this happens, check for the new IP address of the client. Then add the new IP address by clicking the **Edit** icon next to **Client List** and entering it in the pop-up screen.

4.9.2 Port Forwarding > Add Service

Click the **Edit** icon next to **Service List** if you cannot see the service in the list. In the pop-up screen, click **Add**, then enter the service name and port range that defines the service. For example, if you have a FileZilla Server in your network, then enter FileZilla Server as the **Service Name**, 14147 as the **Starting Port** and 14147 as the **Ending Port**.

4.9.3 Port Forwarding > UPnP

The Zyxel Device supports both UPnP (Universal Plug and Play) and NAT-PMP (NAT Port Mapping Protocol) to permit networking devices to discover each other and connect seamlessly. An enabled-UPnP or NAT-PMP device can dynamically join a network, obtain an IP address, convey its capabilities and learn about other devices on the network. If you have a service that requires UPnP or NAT-PMP, such as a game server, then select **Enable UPnP** in this screen and click **Refresh**. All UPnP-enabled or NAT-PMP-enabled devices may communicate freely with each other without additional configuration. Do not select **Enable UPnP** if this is not your intention.

Click **Finish** to complete the **Port Forwarding Wizard**.

Port Forwarding Wizard

Some services and network appliances use UPnP to dynamically configure network access. Many game consoles required UPnP to fully support online gaming.

The USG supports both UPnP and NAT-PMP to permit networking devices to discover each other and connect seamlessly.

Enable UPnP

UPnP Port Status

Remote Host	External Port	Internal Port	Internal Client

4.10 Wi-Fi and Guest Network Wizard

Figure 111 Wi-Fi and Guest Network Setup

Wi-Fi and Guest Network Wizard

Wi-Fi Network Setup

You can enable the settings even if your USG does not include a wireless LAN module. A manageable Zyxel AP, such as the NWA and WAC series, will be added to this network automatically after connection.

The Guest Wi-Fi Network allows Internet access only. Access to other clients in the Guest WiFi network is restricted to 4 hours by default, and then disabled automatically. You can change the time duration below.

Enable Wi-Fi Network

Wi-Fi:

Password:

Enable Guest Wi-Fi Network

Guest Wi-Fi:

Password:

Duration: hrs mins

Always

Select **Enable Wi-Fi Network** if you want wireless devices to be able to wirelessly access the Zyxel Device and all resources connected to the Zyxel Device. Configure a descriptive name of from 1 to 32 alphanumeric characters, hyphens or underscores (a-z A-Z 0-9 -_) for the wireless network name (**Wi-Fi**). Set a **Password** of between 8 and 63 printable ASCII characters (including spaces and symbols) or 64 hexadecimal characters (0-9 a-f) that wireless users will have to enter for access to the Zyxel Device wireless network.

Select **Enable Guest Wi-Fi Network** if you want wireless devices to only be able to wirelessly access the Internet via the Zyxel Device for up to the period specified in **Duration**. Configure a descriptive name of from 1 to 32 alphanumeric characters, hyphens or underscores (a-z A-Z 0-9 -_) for the wireless network name (**Wi-Fi**). Set a **Password** of between 8 and 63 printable ASCII characters (including spaces and symbols) or 64 hexadecimal characters (0-9 a-f) that wireless users will have to enter for access to the Zyxel Device Guest wireless network.

The **Guest Wi-Fi Network** allows Internet access for up to the period specified in **Duration**. Wireless users will have to log in again if the time has elapsed.

The Zyxel Device uses WPA2-PSK with AES encryption so wireless clients must be able to support AES encryption to wirelessly connect to the Zyxel Device using WPA2-PSK.

4.10.1 Guest LAN (Wired Network)

Figure 112 Wi-Fi and Guest Network Setup

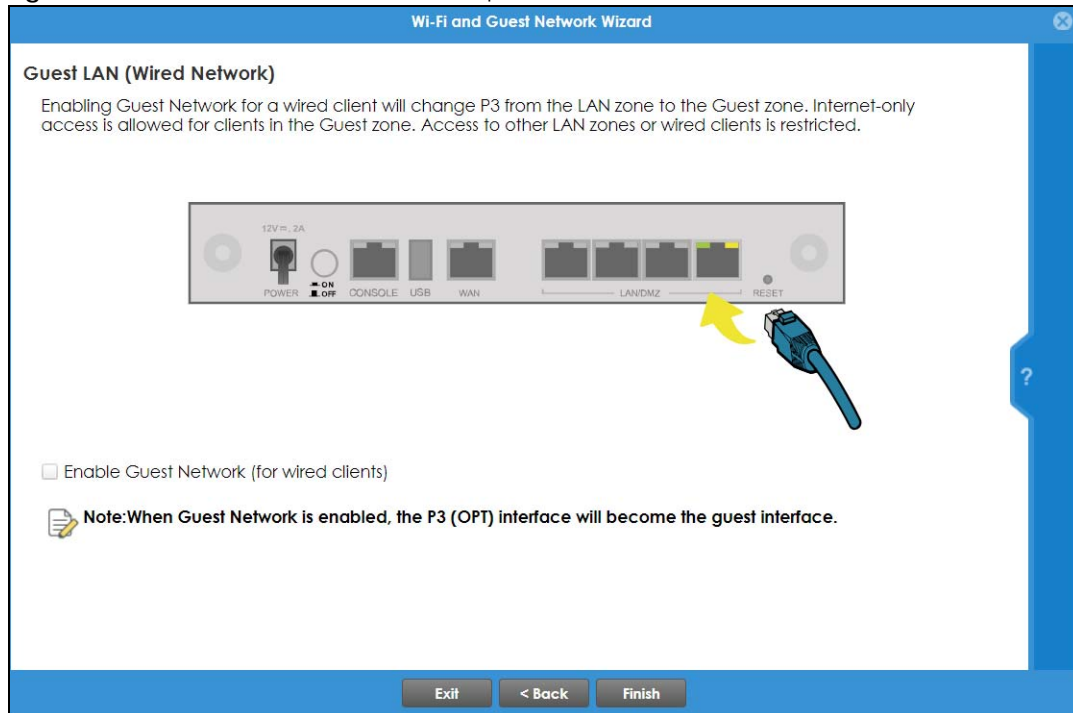

Select **Enable Guest Network (for wired clients)** to convert the **OPT** or **P6** port (depending on your model) to be a guest port and isolate it from the **LAN/DMZ** ports. Devices connected to the guest port are allowed Internet access only and do not have access to networks connected to the other ports.

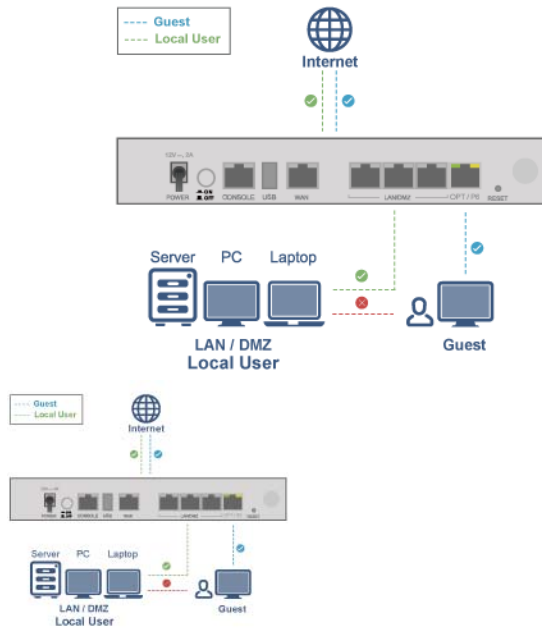

When the **OPT** or **P6** port is not a guest port, then guest devices connected to that port can communicate with all networks, including devices connected to the **LAN/DMZ** ports. To avoid this, make sure **Enable Guest Network (for wired clients)** is selected and that guest devices are only connected to the **OPT** or **P6** port on the Zyxel Device.

4.10.2 Connecting AP Scenarios

If you connect an AP to a LAN port, then users can use the AP's SSID to wirelessly access all wired resources connected to the LAN ports and Internet access.

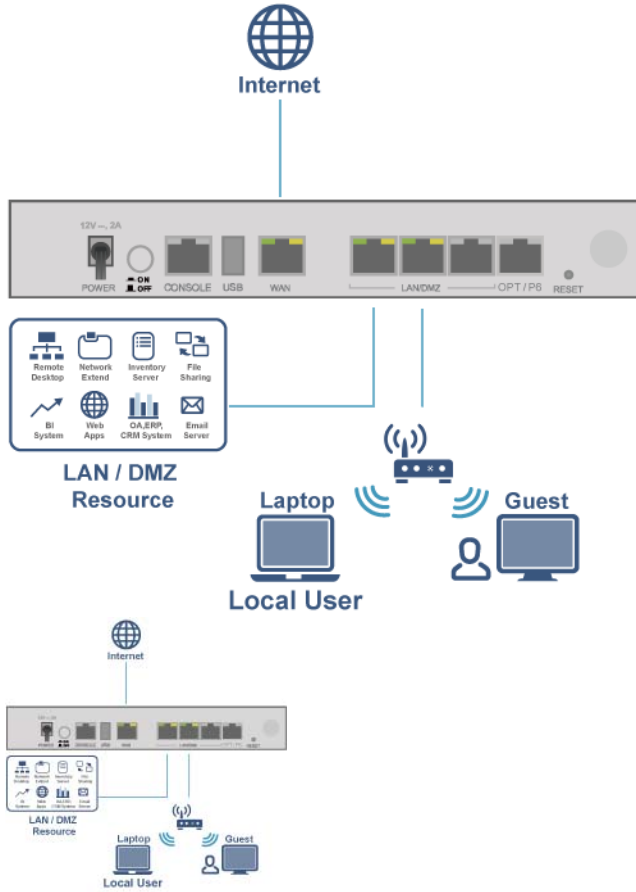

If you connect an AP to the Guest port, then users can use the AP's SSID to wirelessly access all wired resources connected to the Guest port (only) and Internet access. You must select both **Enable Guest Wi-Fi Network** and **Guest LAN (Wired Network)**.

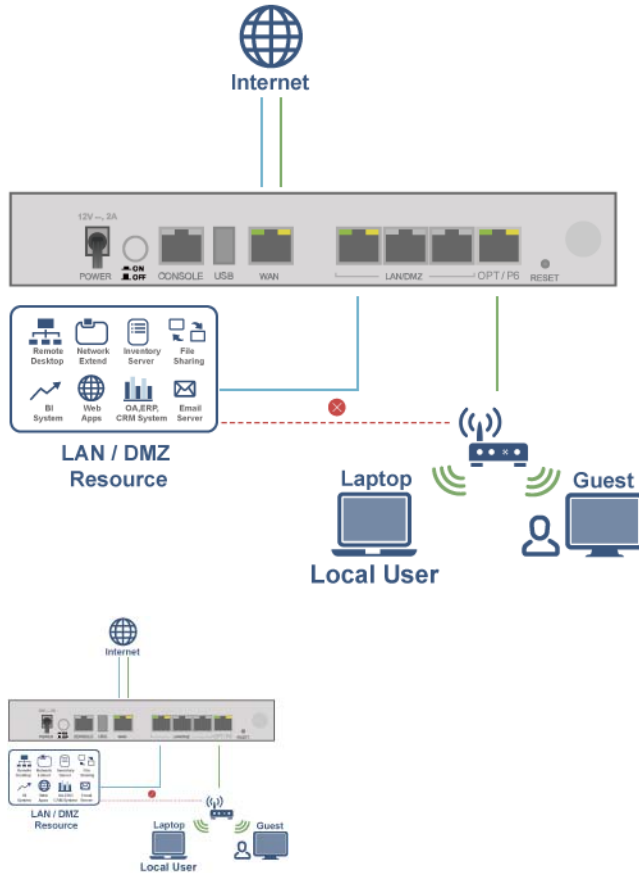

4.11 Security Service Wizard

Figure 113 Register First

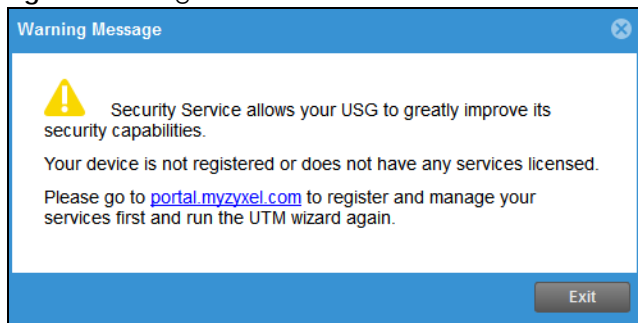

You must first register the Zyxel Device at portal.myzyxel.com and activate licenses for required services.

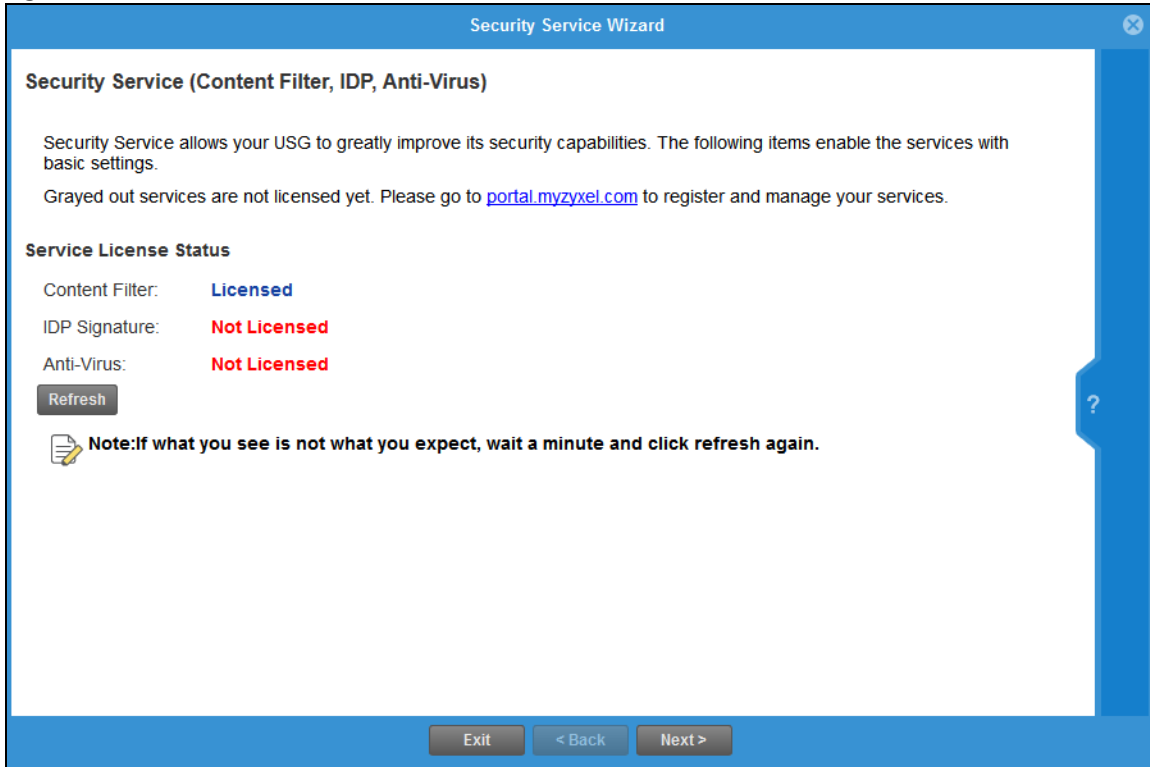
Figure 114 Security Service Wizard 1 – Service License Status

This screen shows if you have registered your Zyxel Device at portal.myzyxel.com. After you register your Zyxel Device, you can register for the services supported by your model. For example, some models only support content filtering.

- Content Filtering (to block websites by category, such as Gambling)
- IDP (to recognize and drop traffic with Intrusion, Detection & Protection attack patterns)
- Anti-Virus (to detect virus patterns in files)

Click **Refresh** and wait a few moments for the registration information to update in this screen. If the page does not refresh, make sure the Internet connection is working and click **Refresh** again. To check your Internet connection, try to access the Internet from a computer connected to a LAN port on the Zyxel Device. If you cannot, then check your Internet access settings on the Zyxel Device.

4.11.1 Security Service Wizard 2 – Content Filter Categories

Figure 115 Security Service Wizard 2 – Content Filter Categories

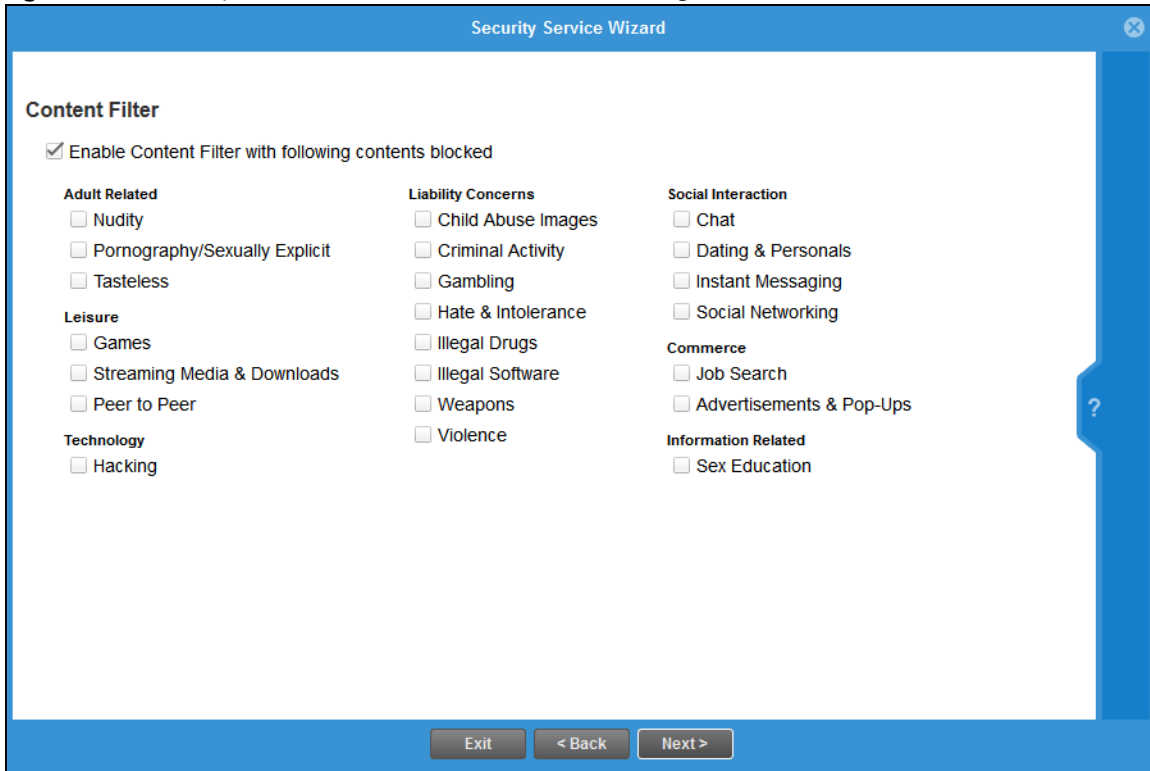

Configure licensed (non-grayed-out) services in this screen. After you buy a license for a service, you must activate it at myZyxel. Make sure the Zyxel Device Internet connection is working correctly.

Select **Enable Content Filter with following contents blocked** to block websites by category, such as **Chat** websites. Note that if you select **Chat**, the Content Filter blocks chat websites and not chat apps. Therefore, the Skype app can still be used although the Skype website would be blocked. Select the categories you want to block.

- Adult Related
 - Nudity: Sites that contain full or partial nudity that are not necessarily overtly sexual in intent. Includes sites that advertise or sell lingerie, intimate apparel, or swim wear. For example, www.easystore.com.tw, www.faster-swim.com.tw, image.baidu.com.
 - Pornography/Sexually Explicit: Sites that contain explicit sexual content. Includes adult products such as sex toys, CD-ROMs, and videos, adult services such as videoconferencing, escort services, and strip clubs, erotic stories and textual descriptions of sexual acts. For example, www.dvd888.com, www.18center.com, blog.sina.com.tw.
 - Tasteless: Sites with offensive or tasteless content such as bathroom humor or profanity. For example, comedycentral.com, dilbert.com.
- Leisure
 - Games: Sites relating to computer or other games, information about game producers, or how to obtain cheat codes. Game-related publication sites. For example, www.gamer.com.tw, www.wowtaiwan.com.tw, tw.lineage.gamania.com.

- Streaming Media & Downloads: Sites that deliver streaming content, such as Internet radio, Internet TV or MP3 and live or archived media download sites. Includes fan sites, or official sites run by musicians, bands, or record labels. For example, www.youtube.com, pfp.sina.com.cn, my.xunlei.com.
- Peer to Peer: Sites that enable direct exchange of files between users without dependence on a central server. For example, www.eyny.com.
- Technology
 - Hacking: Sites that promote or give advice about how to gain unauthorized access to proprietary computer systems, for the purpose of stealing information, perpetrating fraud, creating viruses, or committing other illegal activity related to theft of digital information. For example, www.hackbase.com, www.chinahacker.com.
- Liability Concerns
 - Child Abuse Images: Sites that portray or discuss children in sexual or other abusive acts. For example, a.uuzhijia.info.
 - Criminal Activity: Sites that offer advice on how to commit illegal or criminal activities, or to avoid detection. These can include how to commit murder, build bombs, pick locks, and so on. Also includes sites with information about illegal manipulation of electronic devices, hacking, fraud and illegal distribution of software. For example, www.hackbase.com, jia.hackbase.com, ad.adver.com.tw.
 - Gambling: Sites that offer or are related to online gambling, lottery, casinos and betting agencies involving chance. For example, www.taiwanlottery.com.tw, www.i-win.com.tw, www.hkjc.com.
 - Hate & Intolerance: Sites that promote a supremacist political agenda, encouraging oppression of people or groups of people based on their race, religion, gender, age, disability, sexual orientation or nationality. For example, www.racist-jokes.com, aryan-nations.org, whitepower.com.
 - Illegal Drugs: Sites with information on the purchase, manufacture, and use of illegal or recreational drugs and their paraphernalia, and misuse of prescription drugs and other compounds For example, www.cannabis.net, www.amphetamines.com.
 - Illegal Software: Sites that illegally distribute software or copyrighted materials such as movies or music, software cracks, illicit serial numbers, illegal license key generators. For example, www.zhaokey.com.cn, www.tiansha.net.
 - Weapons: Sites that depict, sell, review or describe guns and weapons, including for sport. For example, www.ak-47.net, warfare.ru.
 - Violence: Sites that contain images or text depicting or advocating physical assault against humans, animals, or institutions. Sites of a particularly gruesome nature such as shocking depictions of blood or wounds, or cruel animal treatment. For example, crimescene.com, deathnet.com, michiganmilitia.com.
- Social Interaction
 - Chat: Sites that enable web-based exchange of real time messages through chat services or chat rooms. For example, me.sohu.com, blufiles.storage.live.com.
 - Dating & Personals: Sites that promote networking for interpersonal relationships such as dating and marriage. Includes sites for match-making, online dating, spousal introduction. For example, www.i-part.com.tw, www.imatchi.com.
 - Instant Messaging: Sites that enable logging in to instant messaging services such as ICQ, AOL Instant Messenger, IRC, MSN, Jabber, Yahoo Messenger, and the like. For example, www.meebo.com, www.aim.com, www.ebuddy.com.
 - Social Networking: Sites that enable social networking for online communities of various topics, for friendship, dating, or professional reasons. For example, www.facebook.com, www.flickr.com, www.groups.google.com.
- Commerce

- **Job Search:** Sites containing job listings, career information, assistance with job searches (such as resume writing, interviewing tips, etc.), employment agencies or head hunters. For example, www.104.com.tw, www.1111.com.tw, www.yes123.com.tw.
- **Advertisements & Pop-Ups:** Sites that provide advertising graphics or other ad content files such as banners and pop-ups. For example, pagead2.googleadsyndication.com, ad.yieldmanager.com.
- **Information Related**
 - **Sex Education:** Sites relating to sex education, including subjects such as respect for partner, abortion, gay and lesbian lifestyle, contraceptives, sexually transmitted diseases, and pregnancy. For example, apps.rockyou.com, www.howmama.com.tw, www.mombaby.com.tw.

Select **Enable IDP** to drop traffic with recognized Intrusion, Detection & Protection attack patterns.

Select **Enable Anti-Virus** to detect virus patterns in files.

4.11.2 Security Service Wizard 3 – Websites

Figure 116 Security Wizard 3 – Trusted and Forbidden Websites

Here, you can create a list of good (trusted) web site addresses and a list of bad (forbidden) web site addresses. Click **Add** to create a new trusted or forbidden web site. Enter host names such as www.good-site.com or www.bad-site.com into this text field. Do not enter the complete URL of the site – that is, do not include “http://”. All sub-domains are allowed. For example, entering “*zyxel.com” also allows or forbids “www.zyxel.com”, “partner.zyxel.com”, “press.zyxel.com”, and so on. You can also enter just a top level domain. For example, enter “*.com” to allow or forbid all .com domains.

Use up to 127 characters (0–9a–z–). The casing does not matter. “*” can be used as a wild-card to match any string. The entry must contain at least one period “.” or it will be invalid.

Click the trash can to remove a trusted or forbidden web site.

4.11.3 Security Service Wizard 4 – Exemptions

Figure 117 Security Wizard 4 – Exemptions



Select devices which are exempted from content file category and trusted/forbidden web site policies. Click **Add Client Address** under **Client List** if you cannot see the client to exempt in the list. In the pop-up screen, you can add a new client by entering its **Name**, **IP Address** and **MAC Address**.

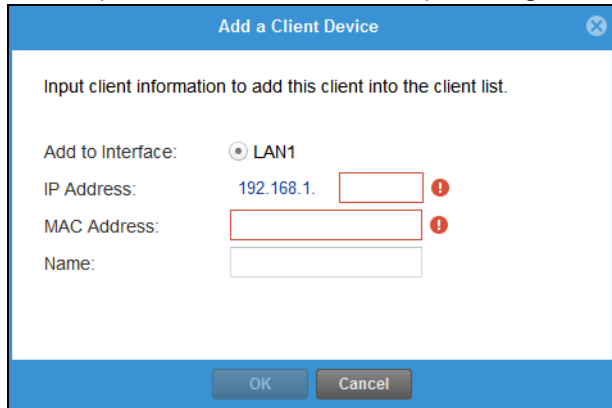

4.11.4 Security Service Wizard 5 – IDP/AV

Figure 118 Security Wizard 5 – IDP/AV

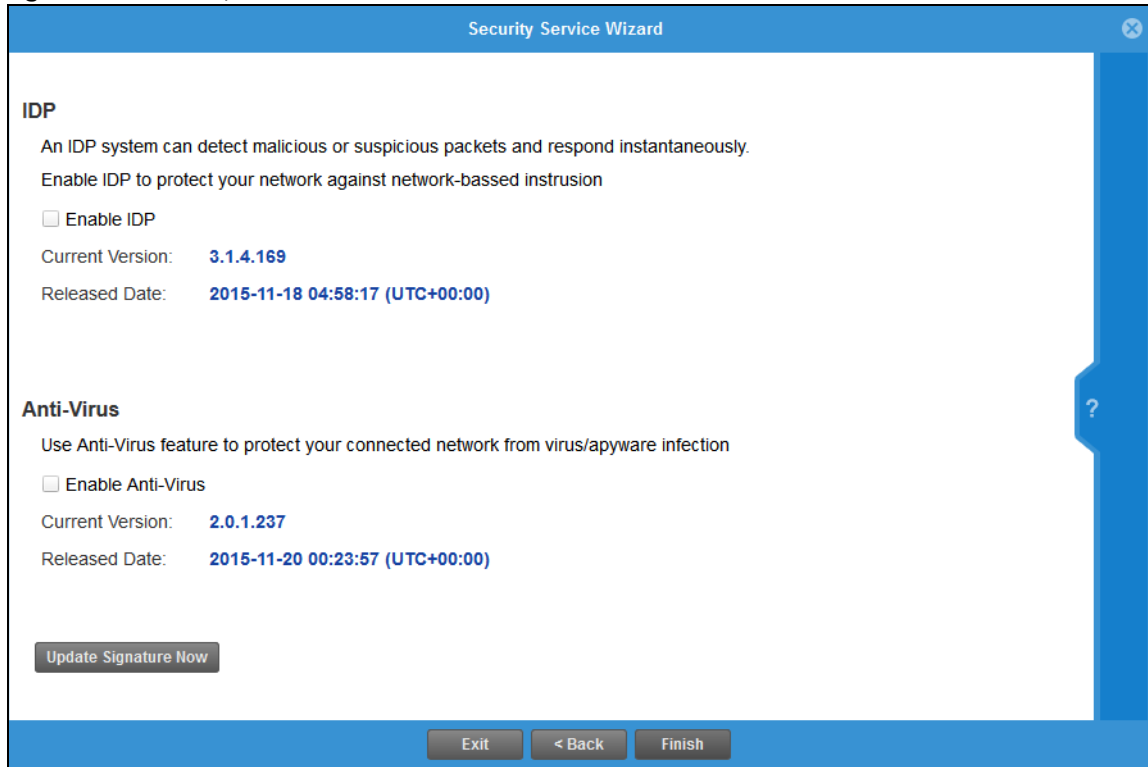

IDP (Intrusion, Detection and Prevention) consists of a set of signatures which examine packet content for known malicious data. You need to subscribe for IDP service in order to be able to download new signatures. It's important to keep the signatures up to date as new types of malicious data are constantly evolving.

Use the Zyxel Device's Anti-Virus (AV) feature to protect your connected network from virus/spyware infection. A computer virus is a small program designed to corrupt and/or alter the operation of other legitimate programs. A worm is a self-replicating virus that resides in active memory and duplicates itself. Zyxel Device's Anti-Virus consists of a set of signatures which examine packet content for known viruses and worms. You need to subscribe for AV service in order to be able to download new signatures. It's important to keep the signatures up to date as new viruses and worms are constantly evolving.

4.12 MyZyxel Portal

Figure 119 MyZyxel Portal

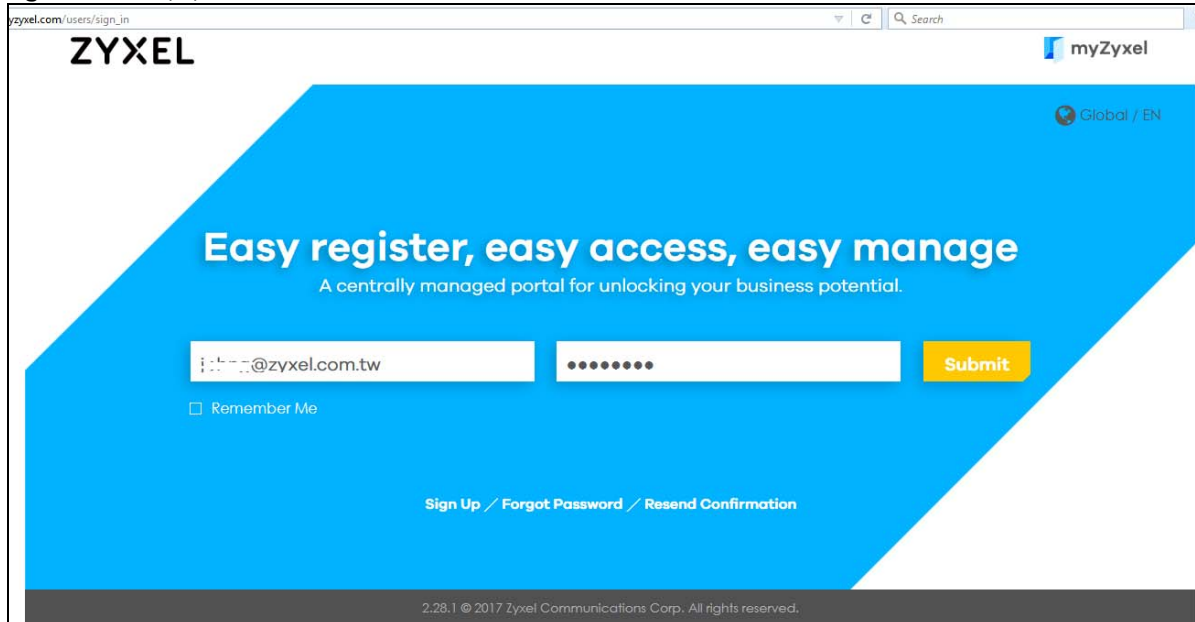

myZyxel is Zyxel's online services center where you can register your Zyxel Device and manage subscription services available for the Zyxel Device. To update signature files or use a subscription service, you have to register the Zyxel Device and activate the corresponding service at myZyxel (through the Zyxel Device).

Use the **MyZyxel Portal** link to create an account at myZyxel.

Then, register your device. You may need your Zyxel Device's serial number and LAN MAC address to register it at myZyxel. Refer to the myZyxel web site's on-line help for details.

To have the Zyxel Device use subscription services, please purchase an iCard and enter the license key from it at **MyZyxel Portal** (through the Zyxel Device).

4.13 One Security Portal

Figure 120 One Security Portal



OneSecurity is a website with guidance on configuration walkthroughs, troubleshooting, and other information. In the Zyxel Device advanced menus, you will see icons that link to OneSecurity walkthroughs, troubleshooting and so on as shown in the following table.

Table 27 OneSecurity Links









ONESECURITY ICON	SCREEN
 Configuration Walkthrough	Click this icon to go to a series of screens that guide you how to configure the feature. Note that the walkthroughs do not perform the actual configuring, but just show you how to do it.
 Troubleshooting	Click this icon to go to a series of screens that guide you how to fix problems with the feature.
 Application Patrol	Click this icon for more information on Application Patrol, which identifies traffic that passes through the Zyxel Device, so you can decide what to do with specific types of traffic. Traffic not recognized by application patrol is ignored.
 Content Filter	Click this icon for more information on Content Filter, which controls access to specific web sites or web content.
 Intrusion Detection	Click this icon for more information on Intrusion Detection which can detect malicious or suspicious packets used in network-based intrusions.

Table 27 OneSecurity Links (continued)

ONESECURITY ICON	SCREEN
Anti-Virus  Anti-Virus	Click this icon for more information on Anti-Virus, which checks traffic flows through your network for known virus and spyware signature patterns.
Anti-Spam  Anti-Spam	Click this icon for more information on Anti-Spam which can mark or discard spam (unsolicited commercial or junk e-mail) and e-mail from certain servers suspect of being used by spammers.
VPN  VPN	Click this icon for more information on IPsec and SSL VPN. Internet Protocol Security (IPsec) VPN connects IPsec routers or remote users using IPsec client software. SSL VPN allows users to use a web browser for secure remote user login without need of a VPN router or VPN client software.
Download VPN Client  Download VPN Client	Click this icon to download VPN client software.

CHAPTER 5

Quick Setup Wizards

5.1 Quick Setup Overview

The Web Configurator's quick setup wizards help you configure Internet and VPN connection settings. This chapter provides information on configuring the quick setup screens in the Web Configurator. See the feature-specific chapters in this User's Guide for background information.

In the Web Configurator, click **Configuration** > **Quick Setup** to open the first **Quick Setup** screen.

Figure 121 Quick Setup

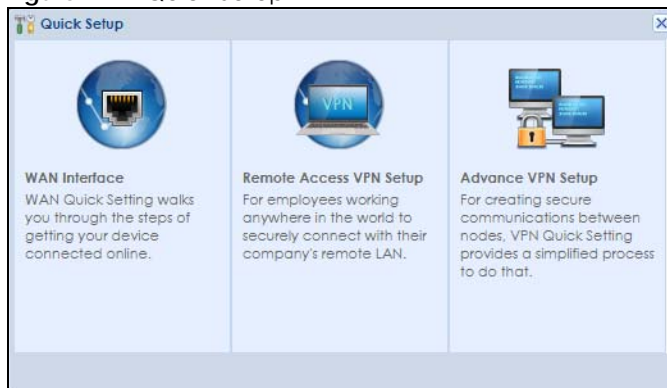

- **WAN Interface**
Click this link to open a wizard to set up a WAN (Internet) connection. This wizard creates matching ISP account settings in the Zyxel Device if you use PPPoE or PPTP. See [Section 5.2 on page 157](#).
- **Remote Access VPN Setup**
Click this link to open a wizard to configure a VPN (Virtual Private Network) rule for a secure connection to another computer or network. **Zyxel VPN Client** creates a full or split tunnel VPN rule for clients with SecuExtender IPsec. **L2TP over IPsec Client** creates full tunnel VPN rule for clients with supported mobile devices. See [Section 5.3 on page 163](#).
- **VPN Setup**
Click this link to open a wizard to configure an **Express VPN policy** or **Advanced VPN policy**. **Express VPN policy** creates a VPN rule with the default phase 1 and phase 2 settings using a pre-shared key. **Advanced VPN policy** creates a VPN rule by changing the default settings and/or use certificates instead of a pre-shared key in the VPN rule. See [Section 5.5 on page 173](#).

- Wizard Help

If the help does not automatically display when you run the wizard, click the arrow to display it.

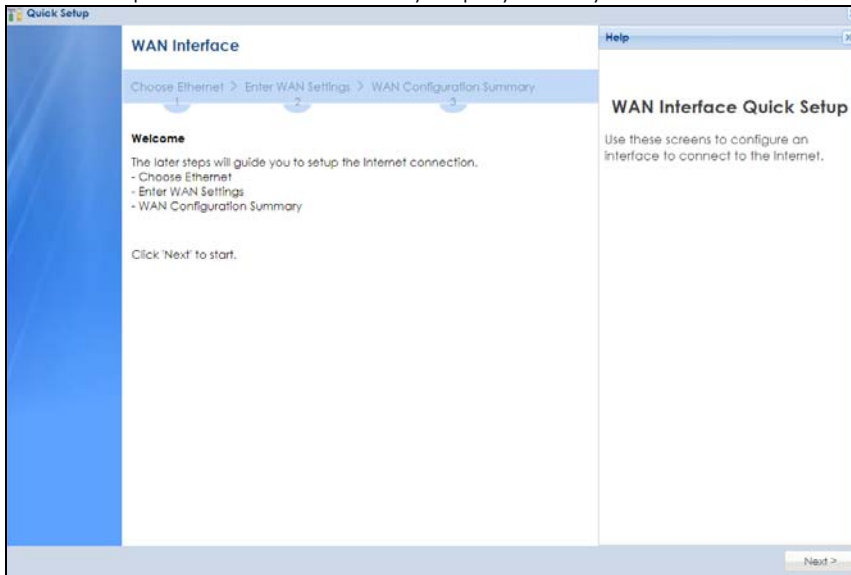

5.2 WAN Interface Quick Setup

Click **WAN Interface** in the main **Quick Setup** screen to open the **WAN Interface Quick Setup Wizard Welcome** screen. Use these screens to configure an interface to connect to the Internet. Click **Next**.

Figure 122 WAN Interface Quick Setup Wizard

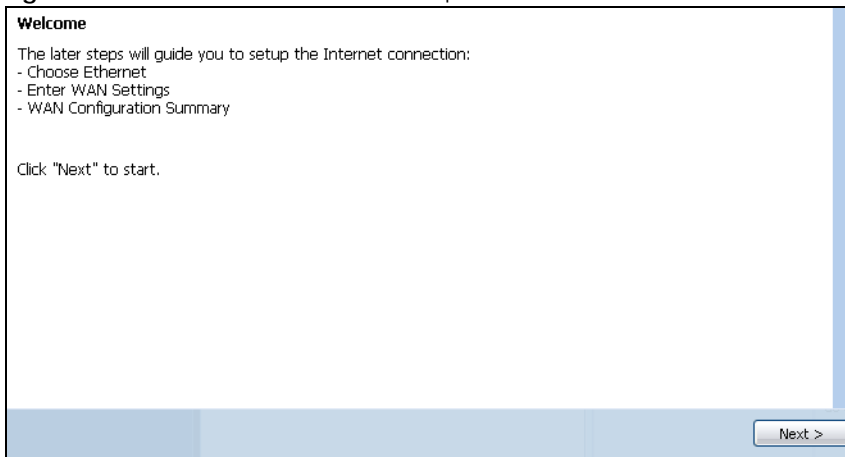

5.2.1 Choose an Ethernet Interface

Select a WAN interface (names vary by model) that you want to configure for a WAN connection and click **Next**.

Figure 123 Choose an Ethernet Interface

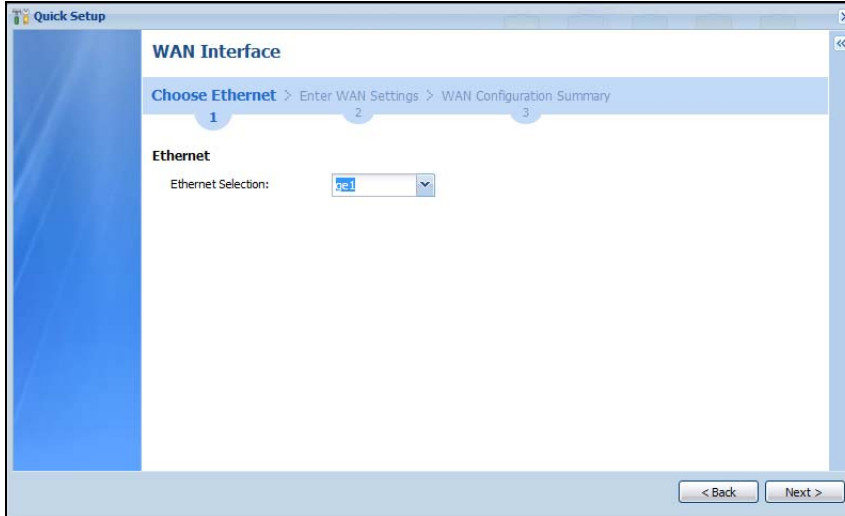

5.2.2 Select WAN Type

WAN Type Selection: Select the type of encapsulation this connection is to use. Choose **Ethernet** when the WAN port is used as a regular Ethernet.

Otherwise, choose **PPPoE**, **PPTP** or **L2TP** for a dial-up connection according to the information from your ISP.

Figure 124 WAN Interface Setup: Step 2

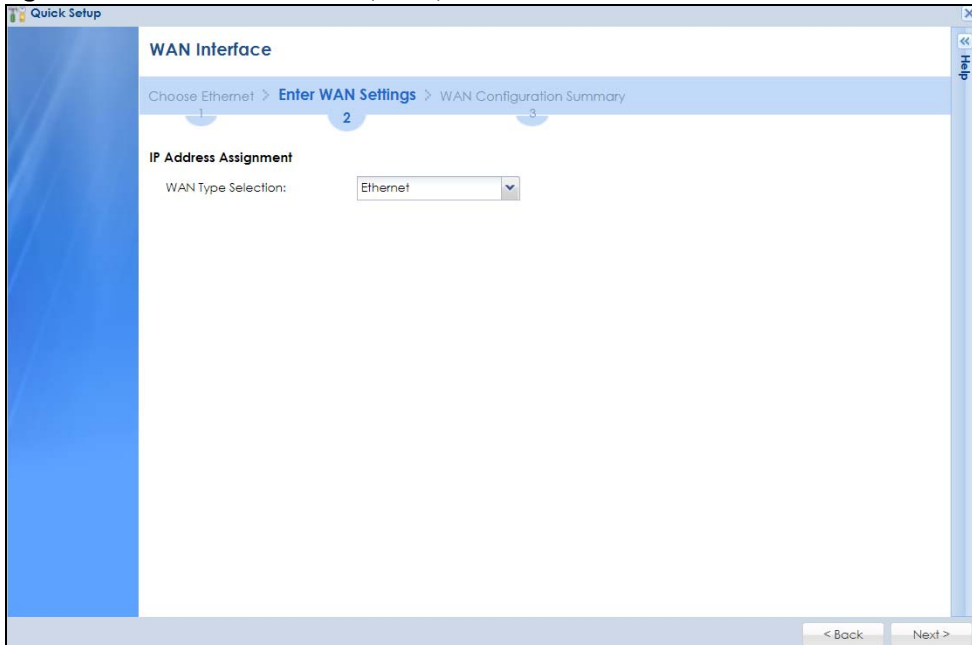

The screens vary depending on what encapsulation type you use. Refer to information provided by your ISP to know what to enter in each field. Leave a field blank if you do not have that information.

Note: Enter the Internet access information exactly as your ISP gave it to you.

5.2.3 Configure WAN IP Settings

Use this screen to select whether the interface should use a fixed or dynamic IP address.

Figure 125 WAN Interface Setup: Step 2 Ethernet Dynamic IP

Figure 126 WAN Interface Setup: Step 2 Ethernet Static IP

- **WAN Interface:** This is the interface you are configuring for Internet access.
- **Zone:** This is the security zone to which this interface and Internet connection belong.
- **IP Address Assignment:** Select **Auto** If your ISP did not assign you a fixed IP address. Select **Static** if you have a fixed IP address and enter the IP address, subnet mask, gateway IP address (optional) and DNS server IP address(es).

5.2.4 ISP and WAN and ISP Connection Settings

Use this screen to configure the ISP and WAN interface settings. This screen is read-only if you select **Ethernet** and set the **IP Address Assignment** to **Auto**. If you set the **IP Address Assignment** to **static** and/or select **PPTP** or **PPPoE**, enter the Internet access information exactly as your ISP gave it to you.

Note: Enter the Internet access information exactly as your ISP gave it to you.

Figure 127 WAN and ISP Connection Settings: (PPTP)

ISP Parameters

Encapsulation: PPTP

Authentication Type: Chap/PAP

User Name : ⓘ

Password: ⓘ

Retype to Confirm: ⓘ

Nailed-Up

Idle timeout: Seconds

PPTP Configuration

Base Interface: wan1

Base IP Address: ⓘ

IP Subnet Mask:

Gateway IP Address: (Optional)

Server IP: ⓘ

Connection ID: (Optional)

IP Address Assignment

WAN Interface: wan1_ppp

Zone: WAN

IP Address: ⓘ

Gateway IP Address: (Optional)

First DNS Server:

Second DNS Server:

< Back Next >

Figure 128 WAN and ISP Connection Settings: (PPPoE)

ISP Parameters

Encapsulation: PPPoE

Service Name: (Optional)

Authentication Type: Chap/PAP

User Name : ⓘ

Password: ⓘ

Retype to Confirm: ⓘ

Nailed-Up

Idle timeout: Seconds

IP Address Assignment

WAN Interface: wan1_ppp

Zone: WAN

IP Address: ⓘ

Gateway IP Address: (Optional)

First DNS Server:

Second DNS Server:

Note

Configure PPPoE will change ethernet interface ip address as 0.0.0.0.

< Back Next >

Figure 129 WAN and ISP Connection Settings: (L2TP)

ISP Parameters

Encapsulation: L2TP

Authentication Type: Chap/PAP

User Name : ⓘ

Password: ⓘ

Retype to Confirm: ⓘ

Nailed-Up

Idle timeout: Seconds

Base Interface: wan1

IP Subnet Mask:

Gateway IP Address: (Optional)

Server IP: ⓘ

IP Address Assignment

WAN Interface: wan1_ppp

Zone: WAN

IP Address: ⓘ

Gateway IP Address: (Optional)

First DNS Server:

Second DNS Server:

- **ISP Parameter:** This section appears if the interface uses a PPPoE or PPTP Internet connection.
- **Encapsulation:** This displays the type of Internet connection you are configuring.
- **Service Name:** Type the PPPoE service name if you were given one by your ISP.

- **Authentication Type:** Use the drop-down list box to select an authentication protocol for outgoing calls. Options are:
 - **CHAP/PAP** – Your Zyxel Device accepts either CHAP or PAP when requested by this remote node.
 - **CHAP** – Your Zyxel Device accepts CHAP only.
 - **PAP** – Your Zyxel Device accepts PAP only.
 - **MSCHAP** – Your Zyxel Device accepts MSCHAP only.
 - **MSCHAP-V2** – Your Zyxel Device accepts MSCHAP-V2 only.
- **User Name:** Type the user name given to you by your ISP. You can use alphanumeric and `_-@$./` characters, and it can be up to 31 characters long.
- **Password:** Type the password associated with the user name above. Use up to 64 ASCII characters except the `[]` and `?`. This field can be blank.
- **Retype to Confirm:** Type your password again for confirmation.
- **Nailed-Up:** Select **Nailed-Up** if you do not want the connection to time out.
- **Idle Timeout:** Type the time in seconds that elapses before the router automatically disconnects from the PPPoE server. 0 means no timeout.
- **PPTP Configuration:** This section only appears if the interface uses a PPTP Internet connection.
- **Base Interface:** This displays the identity of the Ethernet interface you configure to connect with a modem or router.
- **Base IP Address:** Type the (static) IP address assigned to you by your ISP.
- **IP Subnet Mask:** Type the subnet mask assigned to you by your ISP (if given).
- **Gateway IP Address:** For PPTP or L2TP, type the gateway IP address if you were given one by your ISP.
- **Server IP:** Type the IP address of the PPTP server.
- **Connection ID:** Enter the connection ID or connection name in this field. It must follow the "c:id" and "n:name" format. For example, C:12 or N:My ISP. This field is optional and depends on the requirements of your DSL modem. You can use alphanumeric and `_:` characters, and it can be up to 31 characters long.

IP Address Assignment

- **WAN Interface:** This displays the identity of the interface you configure to connect with your ISP.
- **Zone:** This field displays to which security zone this interface and Internet connection will belong.
- **IP Address:** This field is read-only when the WAN interface uses a dynamic IP address. If your WAN interface uses a static IP address, enter it in this field.
- **IP Subnet Mask:** If your WAN interface uses Ethernet encapsulation with a static IP address, enter the subnet mask in this field.
- **Gateway IP Address:** Type the IP address of the Ethernet device connected to this WAN port.
- **First DNS Server / Second DNS Server:** These fields only display for an interface with a static IP address. Enter the DNS server IP address(es) in the field(s) to the right. Leave the field as **0.0.0.0** if you do not want to configure DNS servers. If you do not configure a DNS server, you must know the IP address of a machine in order to access it.

5.2.5 Quick Setup Interface Wizard: Summary

This screen displays an example WAN interface's settings.

Figure 130 Interface Wizard: Summary WAN

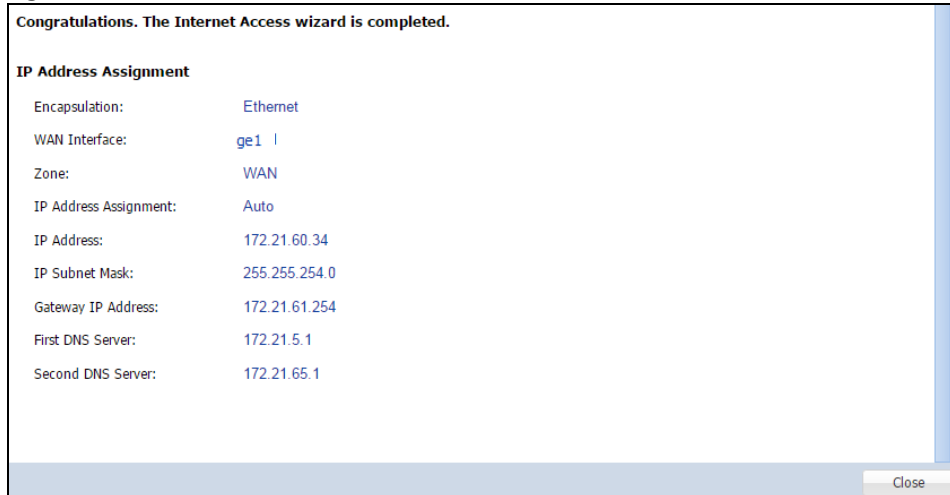

- **Encapsulation:** This displays what encapsulation this interface uses to connect to the Internet.
- **Service Name:** This field only appears for a PPPoE interface. It displays the PPPoE service name specified in the ISP account.
- **Server IP:** This field only appears for a PPTP interface. It displays the IP address of the PPTP server.
- **User Name:** This is the user name given to you by your ISP.
- **Nailed-Up:** If **No** displays the connection will not time out. **Yes** means the Zyxel Device uses the idle timeout.
- **Idle Timeout:** This is how many seconds the connection can be idle before the router automatically disconnects from the PPPoE server. 0 means no timeout.
- **Connection ID:** If you specified a connection ID, it displays here.
- **WAN Interface:** This identifies the interface you configure to connect with your ISP.
- **Zone:** This field displays to which security zone this interface and Internet connection will belong.
- **IP Address Assignment:** This field displays whether the WAN IP address is static or dynamic (**Auto**).
- **IP Address:** This field displays the current IP address of the Zyxel Device WAN interface selected in this wizard.
- **IP Subnet Mask:** This field displays the subnet mask of the Zyxel Device WAN interface selected in this wizard.
- **Gateway IP Address:** This field displays the IP address of the Ethernet device connected to this WAN port.
- **First DNS Server /Second DNS Server:** If the **IP Address Assignment** is **Static**, these fields display the DNS server IP address(es).

5.3 Remote Access VPN Setup Wizard

You can use the **Remote Access VPN Setup** to configure a VPN (Virtual Private Network) rule for a secure connection to another computer or network.

Select **Zyxel VPN Client** to configure a full or split tunnel VPN rule for clients with SecuExtender IPsec.

Select **L2TP over IPSec Client** to configure a full tunnel VPN rule for clients with supported mobile devices. You can download the VPN configuration script and send it to the remote VPN client along with the pre-shared key.

5.4 Remote Access VPN Setup – Scenario

The purpose of this wizard is to set up a VPN authentication rule on the Zyxel Device so that approved remote VPN clients can acquire the VPN rule settings automatically by logging into the Zyxel Device.

Use the **Zyxel VPN Client (IKEv2)** scenario if the VPN client has SecuExtender IPSec and you want to create a **Full Tunnel** or **Split Tunnel** VPN rule.

Use the **L2TP over IPSec Client** scenario if the VPN client has a supported mobile device and you want to create a **Full Tunnel** VPN rule only. This scenario supports clients with:

- Windows 10 and later versions.
- iOS 13 and later versions.
- MAC OS 10.12.2 and later versions.
- Android 10.0 and later versions.

Figure 131 Remote Access VPN Setup Wizard Welcome

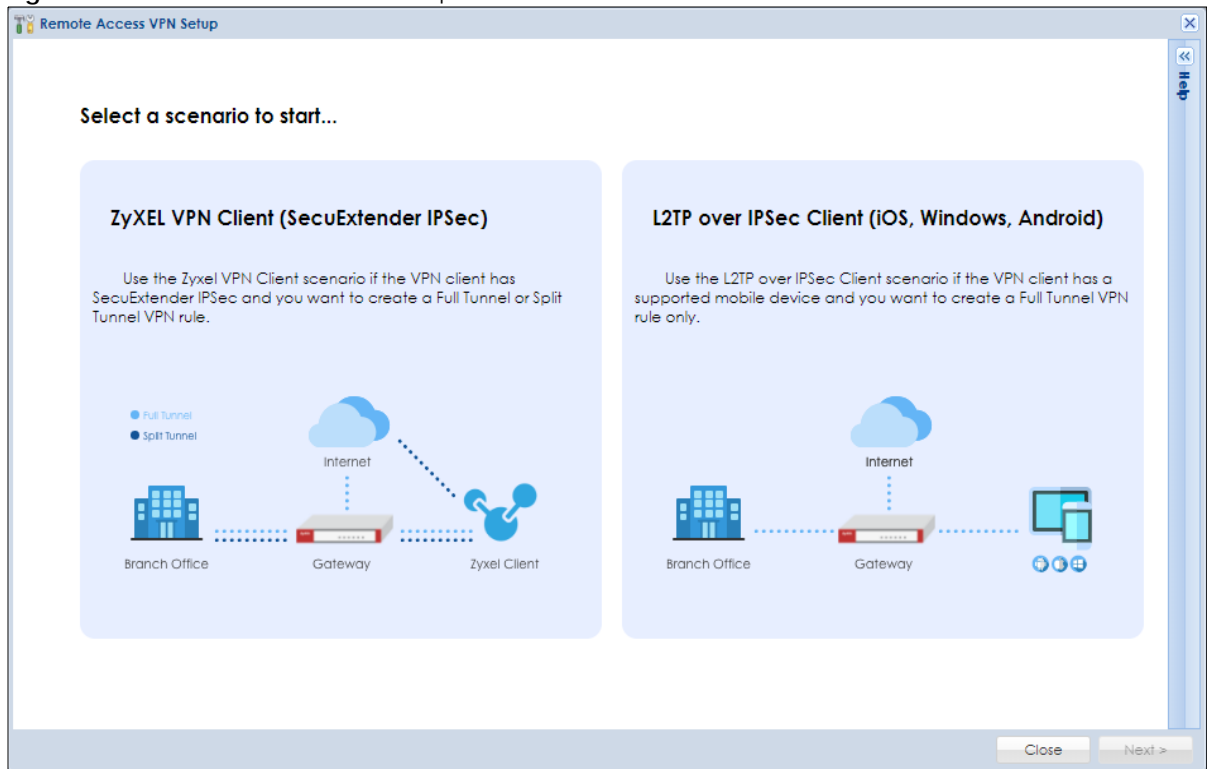

5.4.1 Zyxel VPN Client – VPN Configuration

This scenario is for a **Zyxel VPN Client** with SecuExtender IPSec that wants to create **Full Tunnel** or **Split Tunnel** VPN rule. Use this screen to configure basic settings such as pre-shared key, incoming interface and tunnel mode.

Figure 132 Zyxel VPN Client: VPN Configuration

- Zyxel VPN Client supports Extended Authentication Protocol (EAP) authentication. EAP is important when connecting to existing enterprise authentication systems.
- Choose **Interface** if you want to use a pre-configured interface on the Zyxel Device. Select an interface from the drop-down list box for incoming traffic to your Zyxel Device.
- Choose **Domain Name/ IPv4** if you are using a static IP address or if you are using DDNS to assign the interface a dynamic IP address. Enter the domain name or the IP address in the text box. For example, vpn.zyxel.com.
- Choose **Auto** to have the Zyxel Device generate a certificate from the current wizard settings. This is the certificate the Zyxel Device uses to identify itself when setting up the VPN tunnel.
- Choose **Manual** to select an existing certificate from the drop down list box. This field is not available if there is no existing certificate for the wizard rule you are configuring.
- **Full Tunnel** encrypts all traffic through the VPN. Clear **Allow Client VPN Traffic Through WAN** if you want to block traffic from the remote client to the Internet. Select **Allow Client VPN Traffic Through WAN** to allow only traffic encrypted by the Zyxel Device from the remote client to the Internet.
- **Split Tunnel** only encrypts traffic going to a networks behind the Zyxel Device. Select the interface to the **LAN, DMZ or guest** network from the drop-down list box. Traffic going to the Internet through this interface is encrypted. Traffic going to the Internet from the remote client does not go through the Zyxel Device and is not encrypted.

Figure 133 Zyxel VPN Client: VPN Configuration for Zyxel Client

- The **IP Address Pool** is used to assign IP addresses to the Zyxel VPN clients. You can define the range of the IP Address Pool by entering a starting IP address and an ending IP address under **Customer Defined**.
- The Domain Name System (DNS) maps a domain name to an IP address and vice versa. The Zyxel Device uses these to resolve domain names for VPN. The Zyxel Device can act as a DNS proxy. Alternatively, assign a custom DNS server that is reachable from the network behind the Zyxel Device.
- For the **Second DNS Server**, enter a secondary DNS server's IP address that is checked if the first one is unavailable.
- **Upload Bandwidth Limit** is only available for Zyxel subscription-based SecuExtender IPsec VPN clients with Windows version 5.6.80.007 or later or macOS version 1.2.0.7 or later.
- Use **Upload Bandwidth Limit** to set the maximum bandwidth for uploading traffic from Zyxel IPsec VPN clients over IPsec VPN tunnels. You can also change the bandwidth limit in **Configuration > VPN > IPsec VPN > Configuration Provisioning**.

5.4.2 Zyxel VPN Client – User Authentication

Use this screen to add users to allow them to access the VPN tunnel.

Figure 134 Zyxel VPN Client: User Authentication

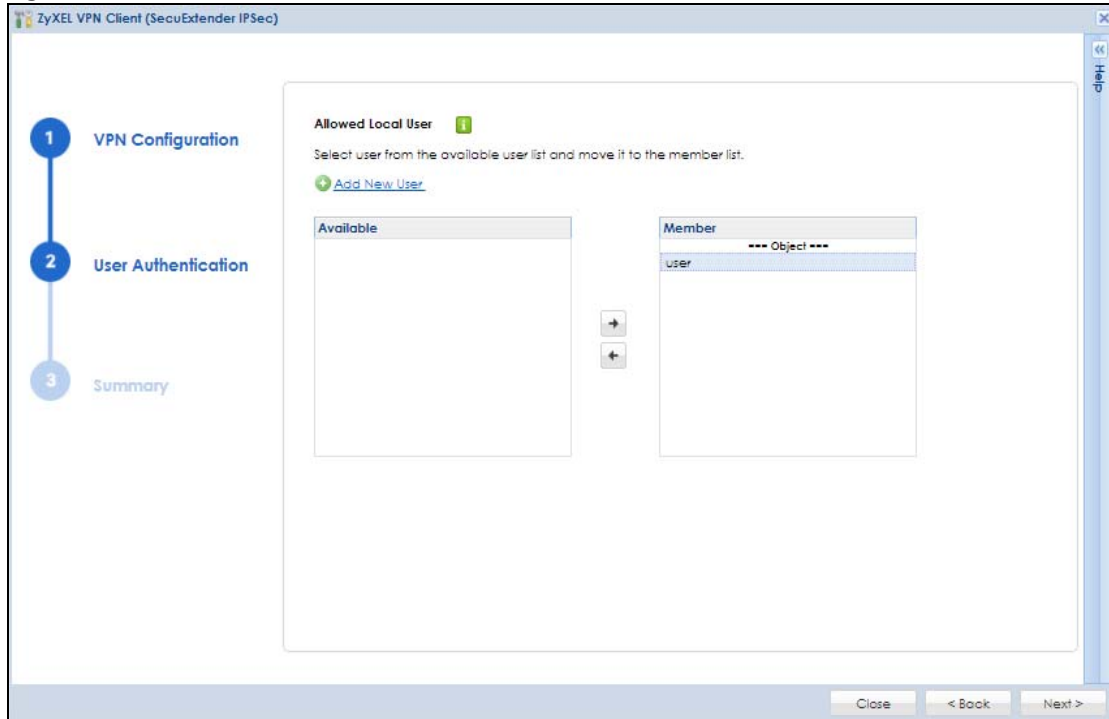

- Only local users configured on the Zyxel Device can be added to the **Member** list to be allowed VPN access in the wizard.
- If you want to add users from external databases, you may modify the rule in **Configuration > Object > User/Group > User > Add A User** in Expert Mode.

5.4.3 Zyxel VPN Client – Summary

Use this screen to view the summary of your previous configuration.

Figure 135 ZyXEL VPN Client: Summary

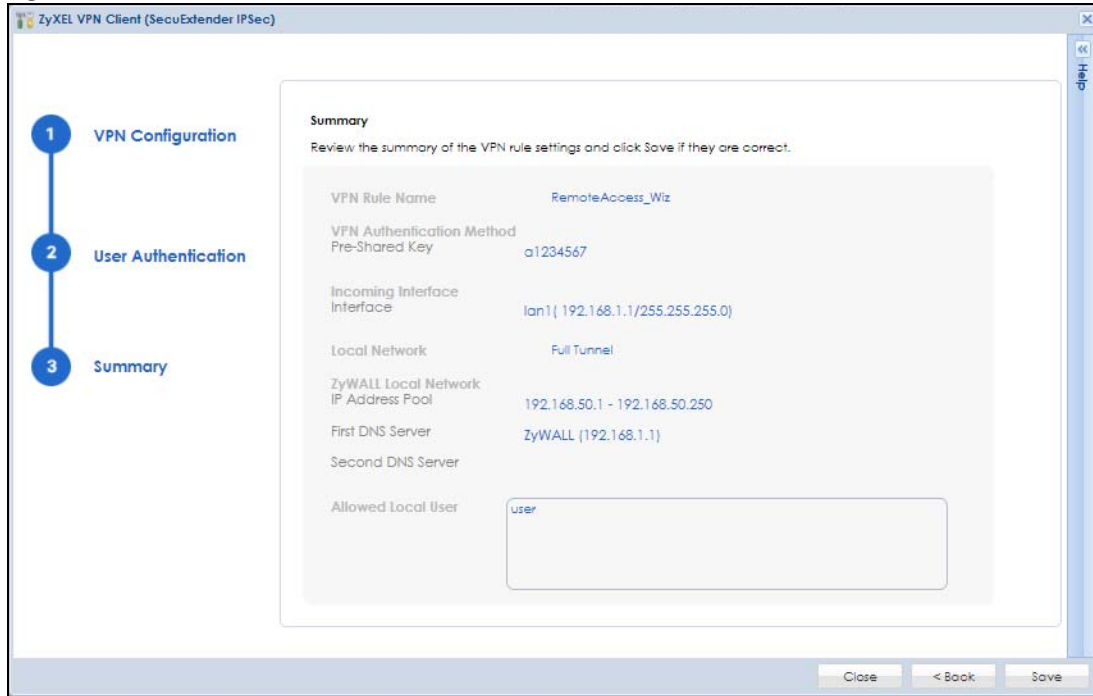

- The default name for the VPN rule created using the wizard is **RemoteAccess_Wiz**.
- After you click **Save**, the **RemoteAccess_Wiz** rule now appears in **VPN > IPSec VPN > VPN Connection** and **VPN > IPSec VPN > VPN Gateway**. If you modify a rule created using the wizard here, please change the name. If you want to rerun the wizard without changing the name, you will be prompted to overwrite the previously modified VPN rule.

5.4.4 L2TP over IPSec Client – VPN Configuration

This scenario is for a **L2TP over IPSec Client** with supported mobile devices that wants to create a **Full Tunnel** VPN rule only. Use this screen to configure basic settings such as pre-shared key, incoming interface and tunnel mode.

Figure 136 L2TP over IPSec Client: VPN Configuration

- For **Pre-Shared Key**, enter 8 – 128 alphanumeric characters (0–9, a–z, A_Z) or 8 – 128 pairs of hexadecimal characters (0–9, A–F) beginning with 0x.
- Choose **Interface** if you are using a static IP address. Select an interface from the drop-down list box to use on your Zyxel Device.
- Choose **Domain Name/ IPv4** if you are using a static or dynamic IP address. Enter the domain name in the text box. For example, vpn.zyxel.com.
- **Full Tunnel** encrypts all traffic through the VPN. Clear **Allow Client VPN Traffic Through WAN** if you want to block remote traffic from the remote client to the Internet. Select **Allow Client VPN Traffic Through WAN** to allow only traffic encrypted by the Zyxel Device from the remote client to the Internet.

Figure 137 L2TP over IPsec Client: VPN Configuration for Zyxel Client

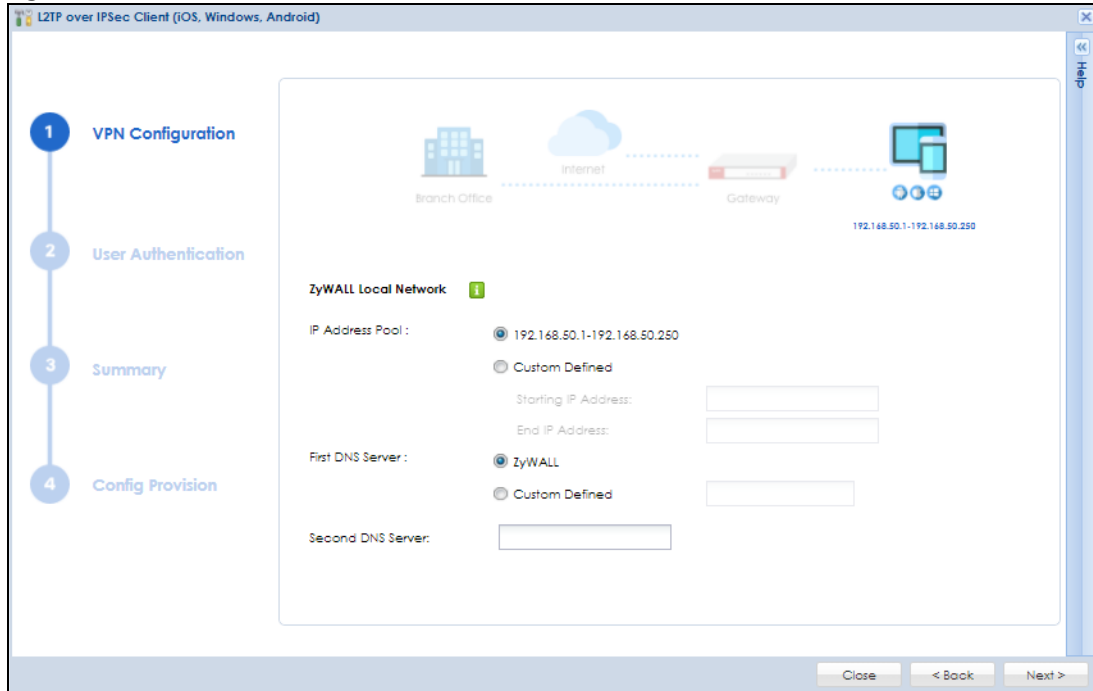

- The **IP Address Pool** is used to assign to the L2TP VPN clients. Alternatively, you can define the range of the IP Address Pool by entering a starting IP address and an ending IP address under **Customer Defined**.
- The Domain Name System (DNS) maps a domain name to an IP address and vice versa. The Zyxel Device uses these to resolve domain names for VPN. The Zyxel Device can act as a DNS proxy. Alternatively, assign a custom DNS server that is reachable from then network behind the Zyxel Device.
- For the **Second DNS Server**, enter a secondary DNS server's IP address that is checked if the first one is unavailable.

5.4.5 L2TP over IPsec Client – User Authentication

Use this screen to add users to allow them to access the VPN.

Figure 138 L2TP over IPsec Client: User Authentication

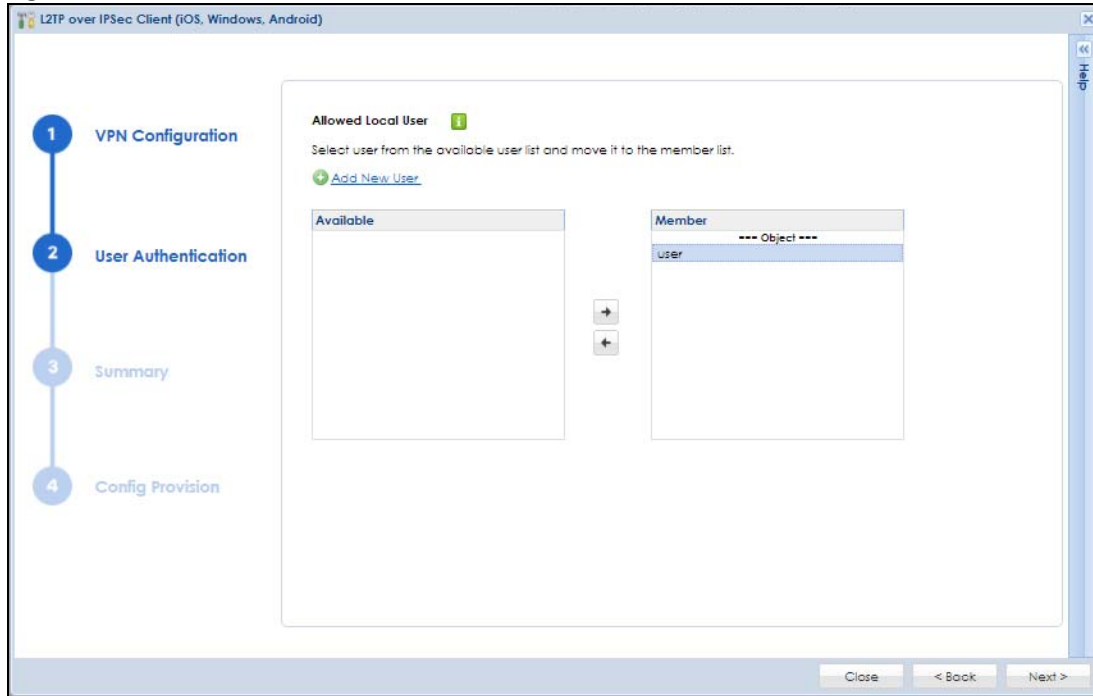

- Only local users configured on the Zyxel Device can be added to the **Member** list to be allowed VPN access in the wizard.
- If you want to add users from external databases, you may modify the rule in **Configuration > Object > User/Group > User > Add A User** in Expert Mode.

5.4.6 L2TP over IPsec Client – Summary

Use this screen to view the summary of your previous configuration.

Figure 139 L2TP over IPsec Client: Summary

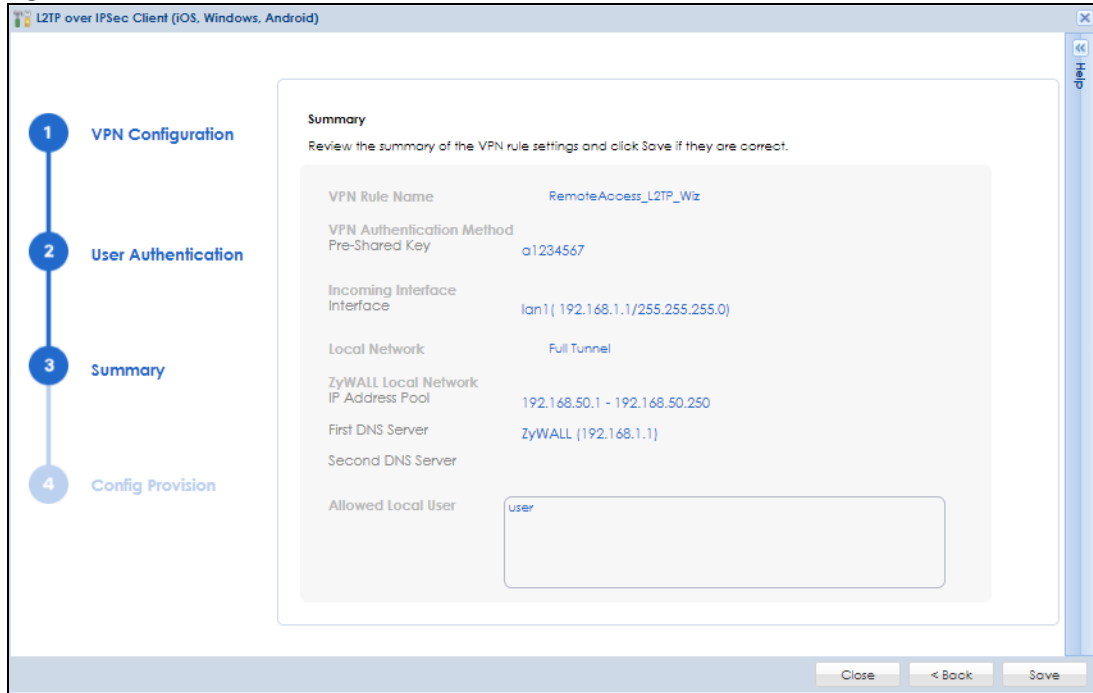

- The default name for the VPN rule created using the wizard is **RemoteAccess_L2TP_Wiz**.
- After you click **Save**, the **RemoteAccess_L2TP_Wiz** rule now appears in **VPN> L2TP VPN**. If you modify a rule created using the wizard here, please change the name. If you want to rerun the wizard without changing the name, you will be prompted to overwrite the previously modified VPN rule.

5.4.7 L2TP over IPsec Client – Config Provision

Use this screen to download a VPN configuration script to send to VPN clients using supported operating systems.

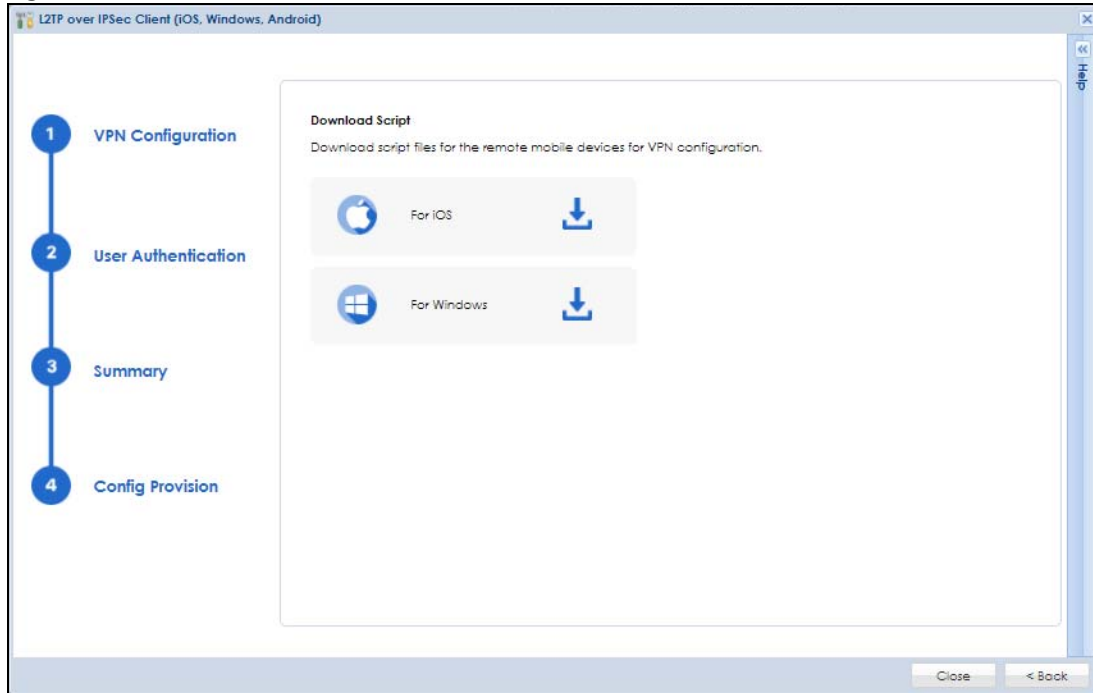
Figure 140 L2TP over IPSec Client: Config Provision

To use the Download Script, your device needs to support:

- Windows 8 and later version. For Windows clients, click the link to download the VPN configuration script and send it to the remote VPN client.
- iOS 13 and later version. For iOS clients, click the link to download the VPN configuration script and send it to the client along with the Pre-Shared Key.
- MAC OS 10.12.2 and later version. For iOS clients, click the link to download the VPN configuration script and send it to the client along with the Pre-Shared Key.
- For clients with Android 10.0 and later versions or Windows 7, you need to configure the rule manually. Send the Pre-Shared Key and the Zyxel Device interface IP or domain name to the client. Users with Android 10.0 and later versions or Windows 7 must configure an L2TP over IPSec rule on their mobile device using this information.

5.5 VPN Setup

Use wizards to create Virtual Private Network (VPN) rules. After you complete the wizard, the Phase 1 rule settings appear in the **Configuration > VPN > IPSec VPN > VPN Gateway** screen and the Phase 2 rule settings appear in the **Configuration > VPN > IPSec VPN > VPN Connection** screen.

- **Express VPN policy** creates a VPN rule with the default phase 1 and phase 2 settings using a pre-shared key.
- **Advanced VPN policy** creates a VPN rule by changing the default settings and/or use certificates instead of a pre-shared key in the VPN rule.

Figure 141 VPN Setup Wizard Welcome

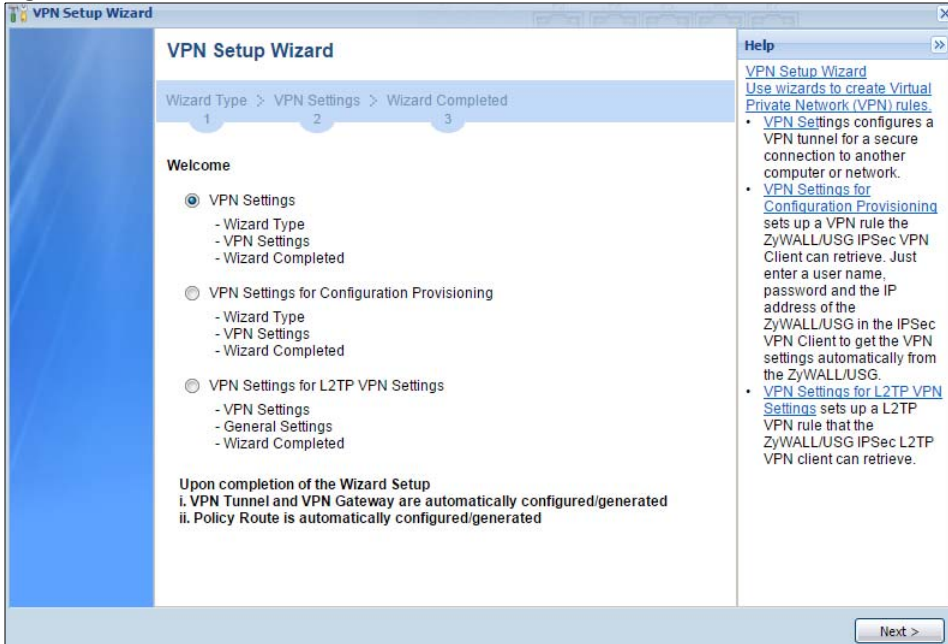

5.5.1 VPN Setup Wizard: Wizard Type

Choose **Express** to create a VPN rule with the default phase 1 and phase 2 settings to connect to another ZLD-based Zyxel Device using a pre-shared key.

Choose **Advanced** to change the default settings and/or use certificates instead of a pre-shared key to create a VPN rule to connect to another IPSec device.

Figure 142 VPN Setup Wizard: Wizard Type

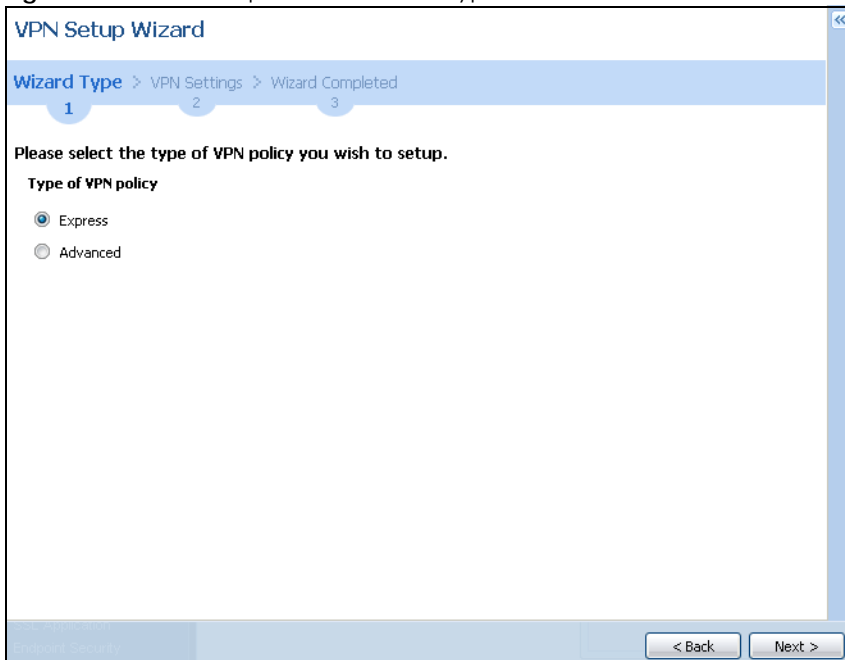

5.5.2 VPN Express Wizard – Scenario

Click the **Express** radio button as shown in [Figure 142 on page 174](#) to display the following screen.

Figure 143 VPN Express Wizard: Scenario

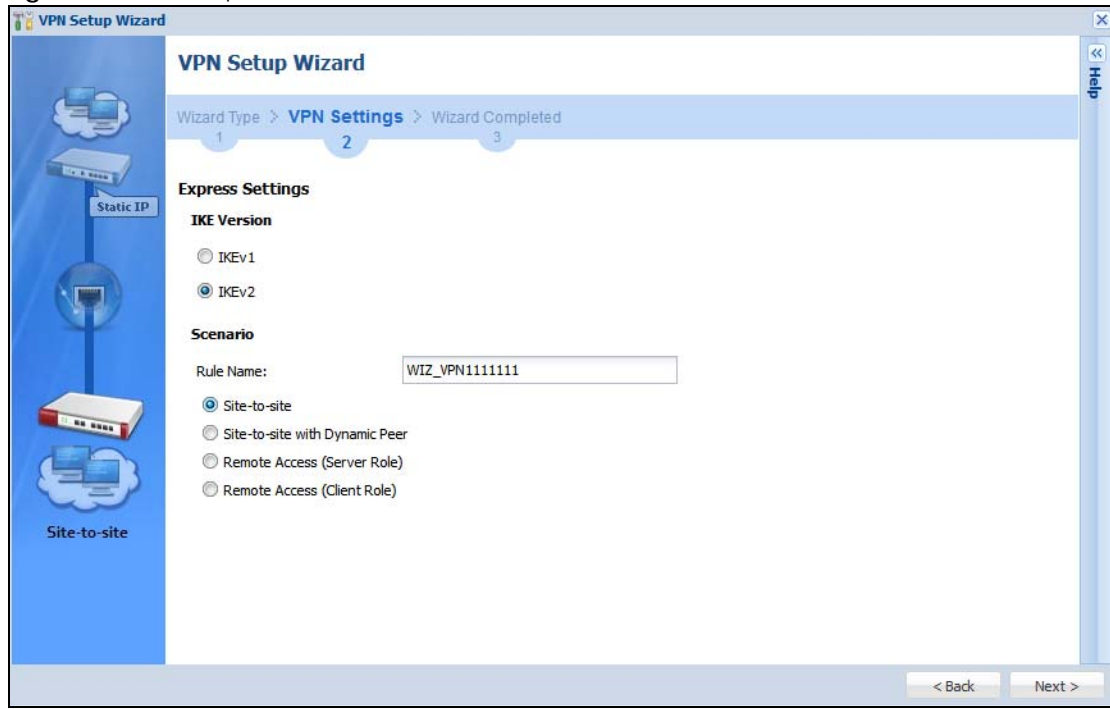

IKE (Internet Key Exchange) Version: IKEv1 and IKEv2

- **IKE** (Internet Key Exchange) is a protocol used in security associations to send data securely. IKE uses certificates or pre-shared keys for authentication and a Diffie–Hellman key exchange to set up a shared session secret from which encryption keys are derived.
- **IKEv2** supports Extended Authentication Protocol (EAP) authentication, and IKEv1 supports X-Auth. EAP is important when connecting to existing enterprise authentication systems.

Scenario

Rule Name: Type the name used to identify this VPN connection (and VPN gateway). You may use 1 – 31 alphanumeric characters, underscores (`_`), or dashes (`-`), but the first character cannot be a number. This value is case-sensitive.

Select the scenario that best describes your intended VPN connection. The figure on the left of the screen changes to match the scenario you select.

- **Site-to-site** – The remote IPSec device has a static IP address or a domain name. This Zyxel Device can initiate the VPN tunnel.
- **Site-to-site with Dynamic Peer** – The remote IPSec device has a dynamic IP address. Only the remote IPSec device can initiate the VPN tunnel.
- **Remote Access (Server Role)** – Allow incoming connections from IPSec VPN clients. The clients have dynamic IP addresses and are also known as dial-in users. Only the clients can initiate the VPN tunnel.
- **Remote Access (Client Role)** – Connect to an IPSec server. This Zyxel Device is the client (dial-in user) and can initiate the VPN tunnel.

5.5.3 VPN Express Wizard – Configuration

Figure 144 VPN Express Wizard: Configuration

The screenshot shows the 'VPN Express Wizard: Configuration' screen. At the top, there are three numbered steps: 1, 2, and 3. Step 2 is highlighted. The 'Express Settings' section has a dropdown menu for 'My Address (interface)' with 'wan1' selected. The 'Configuration' section contains several input fields: 'Secure Gateway' with '1.1.1.1' and '(IP or FQDN)' to its right; 'Pre-Shared Key' with '12345678'; 'Local Policy (IP/Mask)' with '0.0.0.0' and '255.255.255.0' in a separate box; and 'Remote Policy (IP/Mask)' with '0.0.0.0' and '255.255.255.0' in a separate box. At the bottom right, there are '< Back' and 'Next >' buttons.

- **My Address (interface):** Select an interface from the drop-down list box to use on your Zyxel Device.
- **Secure Gateway:** **Any** displays in this field if it is not configurable for the chosen scenario. Otherwise, enter the WAN IP address or domain name of the remote IPSec device (secure gateway) to identify the remote IPSec router by its IP address or a domain name. Use 0.0.0.0 if the remote IPSec router has a dynamic WAN IP address.
- **Pre-Shared Key:** Type the password. Both ends of the VPN tunnel must use the same password. Use up to 128 case-sensitive ASCII characters or up to 128 pairs of hexadecimal ("0-9", "A-F") characters. Proceed a hexadecimal key with "0x". You will receive a PYLD_MALFORMED (payload malformed) packet if the same pre-shared key is not used on both ends.
- **Local Policy (IP/Mask):** Type the IP address of a computer on your network that can use the tunnel. You can also specify a subnet. This must match the remote IP address configured on the remote IPSec device.
- **Remote Policy (IP/Mask):** **Any** displays in this field if it is not configurable for the chosen scenario. Otherwise, type the IP address of a computer behind the remote IPSec device. You can also specify a subnet. This must match the local IP address configured on the remote IPSec device.

5.5.4 VPN Express Wizard – Summary

This screen provides a read-only summary of the VPN tunnel's configuration and commands that you can copy and paste into another ZLD-based Zyxel Device's command line interface to configure it.

Figure 145 VPN Express Wizard: Summary

Express Settings

Summary

Rule Name: WIZ_VPN

Secure Gateway: 1.2.3.4

Pre-Shared Key: 12345678

Local Policy (IP/Mask): 192.168.2.0 / 255.255.255.0

Remote Policy (IP/Mask): 10.0.0.0 / 255.255.255.0

Configuration for Secure Gateway

```
## Edit this shell script according to
## the comments before using it in the remote gateway.
## Check the peer-ip interface.
## Check the local-ip interface.
## Then remove the following line.
## PLEASE REMOVE THIS LINE
configure terminal
isakmp policy WIZ_VPN
## If this device's wan1 IP is dynamic,
## consider using DDNS and changing
## the peer-ip listed here to a domain name.
peer-ip 172.21.60.34
## Use the correct interface name in the
## next command line and remove the "#".
# local-ip interface wan1
authentication mode sha
```

Click "Save" button to write the VPN configuration to ZyWALL.

< Back Save

- **Rule Name:** Identifies the VPN gateway policy.
- **Secure Gateway:** IP address or domain name of the remote IPSec device. If this field displays **Any**, only the remote IPSec device can initiate the VPN connection.
- **Pre-Shared Key:** VPN tunnel password. It identifies a communicating party during a phase 1 IKE negotiation.
- **Local Policy:** IP address and subnet mask of the computers on the network behind your Zyxel Device that can use the tunnel.
- **Remote Policy:** IP address and subnet mask of the computers on the network behind the remote IPSec device that can use the tunnel. If this field displays **Any**, only the remote IPSec device can initiate the VPN connection.
- Copy and paste the **Configuration for Secure Gateway** commands into another ZLD-based Zyxel Device's command line interface to configure it to serve as the other end of this VPN tunnel. You can also use a text editor to save these commands as a shell script file with a ".zysh" filename extension. Use the file manager to run the script in order to configure the VPN connection. See the commands reference guide for details on the commands displayed in this list.

5.5.5 VPN Express Wizard – Finish

Now the rule is configured on the Zyxel Device. The Phase 1 rule settings appear in the **Configuration > VPN > IPSec VPN > VPN Gateway** screen and the Phase 2 rule settings appear in the **Configuration > VPN > IPSec VPN > VPN Connection** screen.

Figure 146 VPN Express Wizard: Finish

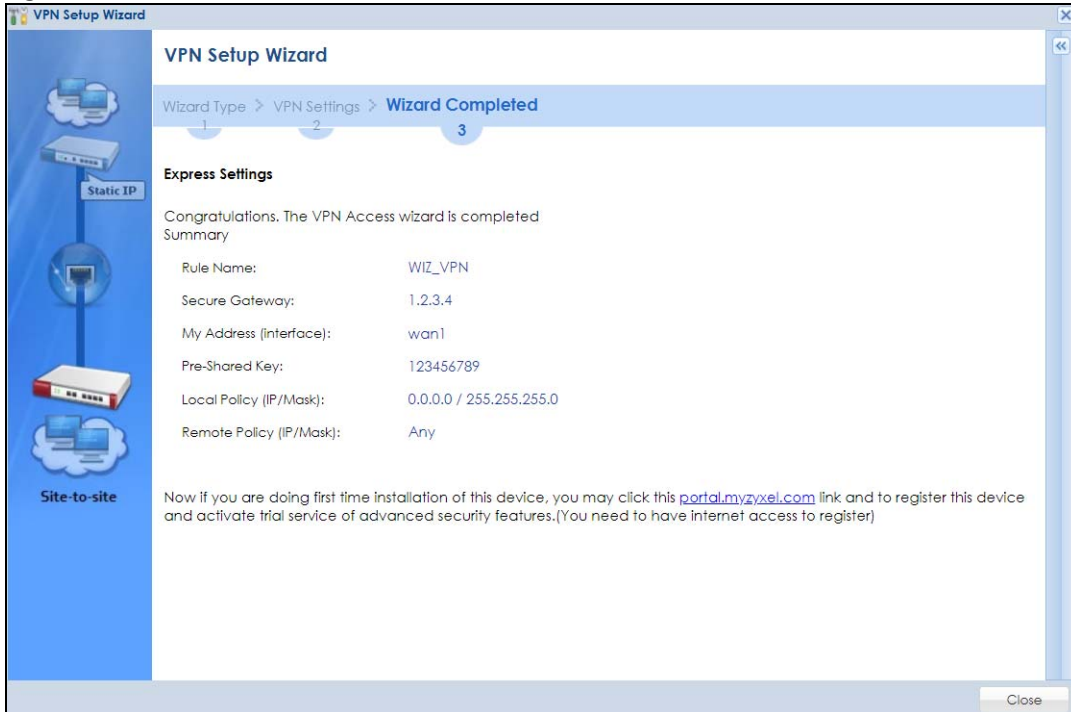

Click **Close** to exit the wizard.

5.5.6 VPN Advanced Wizard – Scenario

Click the **Advanced** radio button as shown in [Figure 142 on page 174](#) to display the following screen.

Figure 147 VPN Advanced Wizard: Scenario

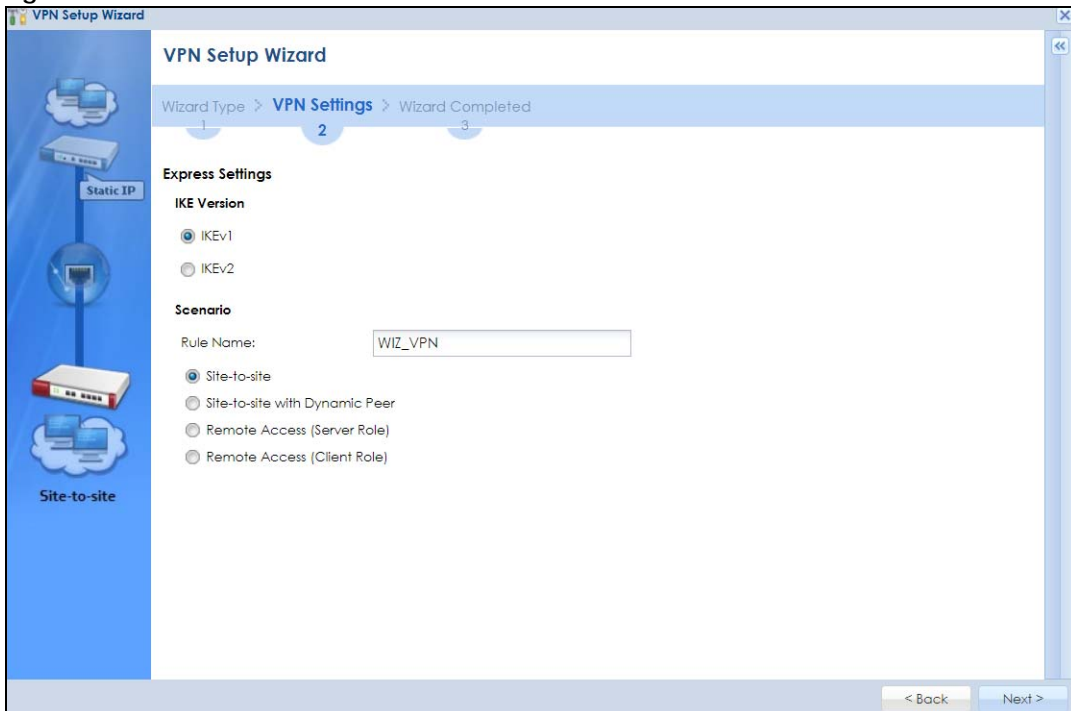

IKE (Internet Key Exchange) Version: IKEv1 and IKEv2

- **IKE** (Internet Key Exchange) is a protocol used in security associations to send data securely. IKE uses certificates or pre-shared keys for authentication and a Diffie–Hellman key exchange to set up a shared session secret from which encryption keys are derived.
- **IKEv2** supports Extended Authentication Protocol (EAP) authentication, and IKEv1 supports X-Auth. EAP is important when connecting to existing enterprise authentication systems.

Scenario

- **Rule Name:** Type the name used to identify this VPN connection (and VPN gateway). You may use 1 – 31 alphanumeric characters, underscores (`_`), or dashes (`-`), but the first character cannot be a number. This value is case-sensitive.

Select the scenario that best describes your intended VPN connection. The figure on the left of the screen changes to match the scenario you select.

- **Site-to-site** – The remote IPSec device has a static IP address or a domain name. This Zyxel Device can initiate the VPN tunnel.
- **Site-to-site with Dynamic Peer** – The remote IPSec device has a dynamic IP address. Only the remote IPSec device can initiate the VPN tunnel.
- **Remote Access (Server Role)** – Allow incoming connections from IPSec VPN clients. The clients have dynamic IP addresses and are also known as dial-in users. Only the clients can initiate the VPN tunnel.
- **Remote Access (Client Role)** – Connect to an IPSec server. This Zyxel Device is the client (dial-in user) and can initiate the VPN tunnel.

5.5.7 VPN Advanced Wizard – Phase 1 Settings

There are two phases to every IKE (Internet Key Exchange) negotiation – phase 1 (Authentication) and phase 2 (Key Exchange). A phase 1 exchange establishes an IKE SA (Security Association).

Figure 148 VPN Advanced Wizard: Phase 1 Settings

Advanced Settings

Phase 1 Setting

Secure Gateway: ⓘ/FQDN

My Address (interface):

Negotiation Mode:

Encryption Algorithm:

Authentication Algorithm:

Key Group:

SA Life Time: (180 - 3000000 Seconds)

NAT Traversal

Dead Peer Detection (DPD)

Authentication Method

Pre-Shared Key ⓘ

Certificate

< Back Next >

- **Secure Gateway: Any** displays in this field if it is not configurable for the chosen scenario. Otherwise, enter the WAN IP address or domain name of the remote IPSec device (secure gateway) to identify the remote IPSec device by its IP address or a domain name. Use 0.0.0.0 if the remote IPSec device has a dynamic WAN IP address.
- **My Address (interface)**: Select an interface from the drop-down list box to use on your Zyxel Device.
- **Negotiation Mode**: This displays **Main** or **Aggressive**:
 - **Main** encrypts the Zyxel Device's and remote IPSec router's identities but takes more time to establish the IKE SA.
 - **Aggressive** is faster but does not encrypt the identities.

The Zyxel Device and the remote IPSec router must use the same negotiation mode. Multiple SAs connecting through a secure gateway must have the same negotiation mode.

- **Encryption Algorithm**: **3DES** and **AES** use encryption. The longer the key, the higher the security (this may affect throughput). Both sender and receiver must use the same secret key, which can be used to encrypt and decrypt the message or to generate and verify a message authentication code. The DES encryption algorithm uses a 56-bit key. Triple DES (**3DES**) is a variation on DES that uses a 168-bit key. As a result, 3DES is more secure than DES. It also requires more processing power, resulting in increased latency and decreased throughput. **AES128** uses a 128-bit key and is faster than 3DES. **AES192** uses a 192-bit key, and **AES256** uses a 256-bit key.
- **Authentication Algorithm**: **MD5** gives minimal security and **SHA512** gives the highest security. MD5 (Message Digest 5) and SHA (Secure Hash Algorithm) are hash algorithms used to authenticate packet data. The stronger the algorithm the slower it is.
- **Key Group**: **DH5** is more secure than **DH1** or **DH2** (although it may affect throughput). DH1 (default) refers to Diffie-Hellman Group 1 a 768 bit random number. DH2 refers to Diffie-Hellman Group 2 a 1024 bit (1Kb) random number. DH5 refers to Diffie-Hellman Group 5 a 1536 bit random number.
- **SA Life Time**: Set how often the Zyxel Device renegotiates the IKE SA. A short SA life time increases security, but renegotiation temporarily disconnects the VPN tunnel.
- **NAT Traversal**: Select this if the VPN tunnel must pass through NAT (there is a NAT router between the IPSec devices).

Note: The remote IPSec device must also have NAT traversal enabled. See the help in the main IPSec VPN screens for more information.

- **Dead Peer Detection (DPD)** has the Zyxel Device make sure the remote IPSec device is there before transmitting data through the IKE SA. If there has been no traffic for at least 15 seconds, the Zyxel Device sends a message to the remote IPSec device. If it responds, the Zyxel Device transmits the data. If it does not respond, the Zyxel Device shuts down the IKE SA.
- **Authentication Method**: Select **Pre-Shared Key** to use a password or **Certificate** to use one of the Zyxel Device's certificates.

5.5.8 VPN Advanced Wizard – Phase 2

Phase 2 in an IKE uses the SA that was established in phase 1 to negotiate SAs for IPSec.

Figure 149 VPN Advanced Wizard: Phase 2 Settings

Advanced Settings	
Phase 2 Setting	
Active Protocol:	ESP
Encapsulation:	Tunnel
Encryption Algorithm:	DES
Authentication Algorithm:	SHA1
SA Life Time:	86400 (180 - 3000000 Seconds)
Perfect Forward Secrecy (PFS):	None
Policy Setting	
Local Policy (IP/Mask)	0.0.0.0 / 255.255.255.0
Remote Policy (IP/Mask)	0.0.0.0 / 255.255.255.0
Property	
<input checked="" type="checkbox"/> Nailed-Up	

- **Active Protocol:** **ESP** is compatible with NAT, **AH** is not.
- **Encapsulation:** **Tunnel** is compatible with NAT, **Transport** is not.
- **Encryption Algorithm:** **3DES** and **AES** use encryption. The longer the **AES** key, the higher the security (this may affect throughput). **Null** uses no encryption.
- **Authentication Algorithm:** **MD5** gives minimal security and **SHA512** gives the highest security. MD5 (Message Digest 5) and SHA (Secure Hash Algorithm) are hash algorithms used to authenticate packet data. The stronger the algorithm the slower it is.
- **SA Life Time:** Set how often the Zyxel Device renegotiates the IKE SA. A short SA life time increases security, but renegotiation temporarily disconnects the VPN tunnel.
- **Perfect Forward Secrecy (PFS):** Disabling PFS allows faster IPsec setup, but is less secure. Select DH1, DH2 or DH5 to enable PFS. **DH5** is more secure than **DH1** or **DH2** (although it may affect throughput). DH1 refers to Diffie-Hellman Group 1 a 768 bit random number. DH2 refers to Diffie-Hellman Group 2 a 1024 bit (1Kb) random number. DH5 refers to Diffie-Hellman Group 5 a 1536 bit random number (more secure, yet slower).
- **Local Policy (IP/Mask):** Type the IP address of a computer on your network. You can also specify a subnet. This must match the remote IP address configured on the remote IPsec device.
- **Remote Policy (IP/Mask):** Type the IP address of a computer behind the remote IPsec device. You can also specify a subnet. This must match the local IP address configured on the remote IPsec device.
- **Nailed-Up:** This displays for the site-to-site and remote access client role scenarios. Select this to have the Zyxel Device automatically renegotiate the IPsec SA when the SA life time expires.

5.5.9 VPN Advanced Wizard – Summary

This is a read-only summary of the VPN tunnel settings.

Figure 150 VPN Advanced Wizard: Summary

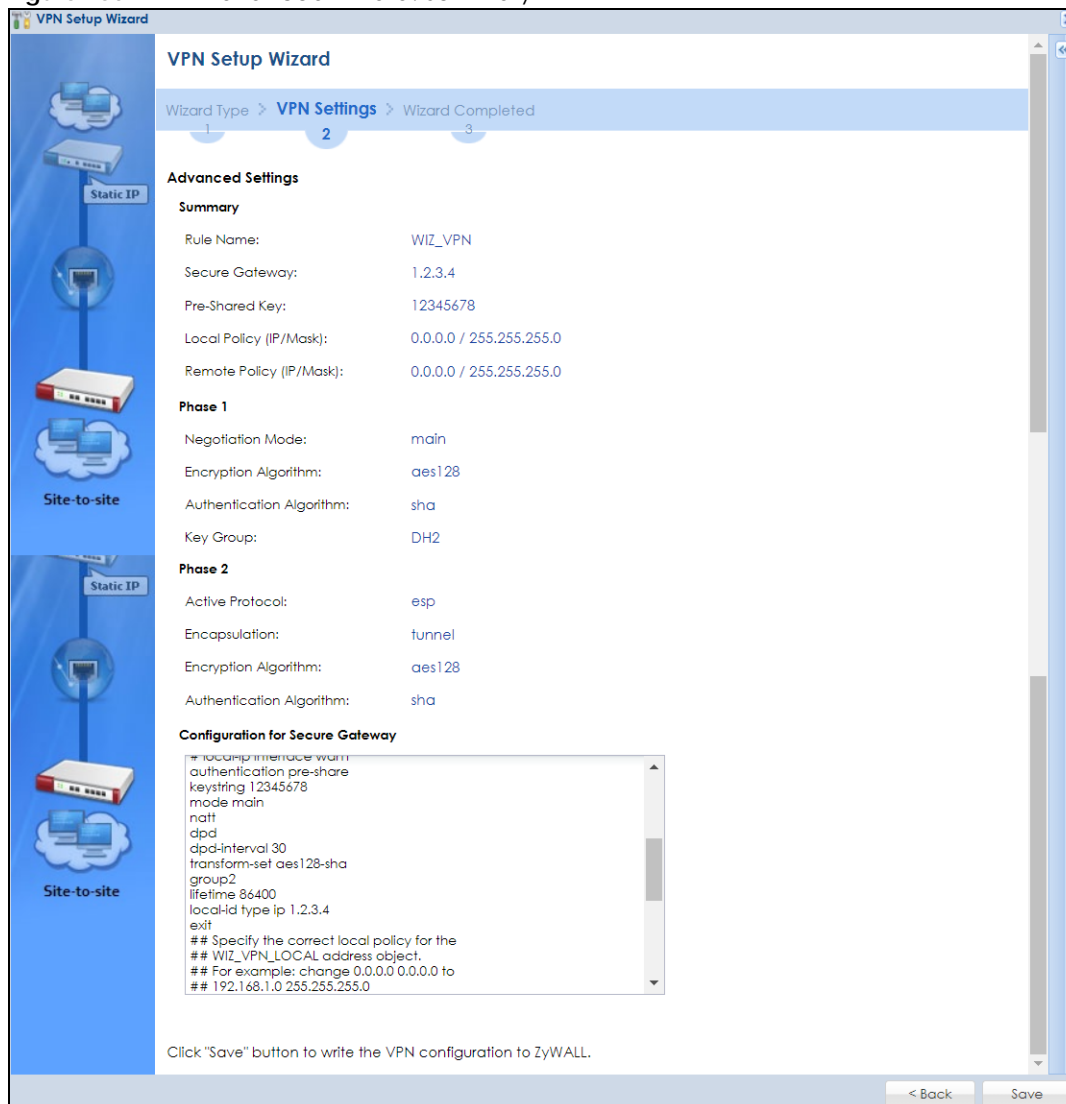

- **Rule Name:** Identifies the VPN connection (and the VPN gateway).
- **Secure Gateway:** IP address or domain name of the remote IPsec device.
- **Pre-Shared Key:** VPN tunnel password.
- **Certificate:** The certificate the Zyxel Device uses to identify itself when setting up the VPN tunnel.
- **Local Policy:** IP address and subnet mask of the computers on the network behind your Zyxel Device that can use the tunnel.
- **Remote Policy:** IP address and subnet mask of the computers on the network behind the remote IPsec device that can use the tunnel.
- Copy and paste the **Configuration for Remote Gateway** commands into another ZLD-based Zyxel Device's command line interface.
- Click **Save** to save the VPN rule.

5.5.10 VPN Advanced Wizard – Finish

Now the rule is configured on the Zyxel Device. The Phase 1 rule settings appear in the **VPN > IPsec VPN > VPN Gateway** screen and the Phase 2 rule settings appear in the **VPN > IPsec VPN > VPN Connection** screen.

Figure 151 VPN Wizard: Finish

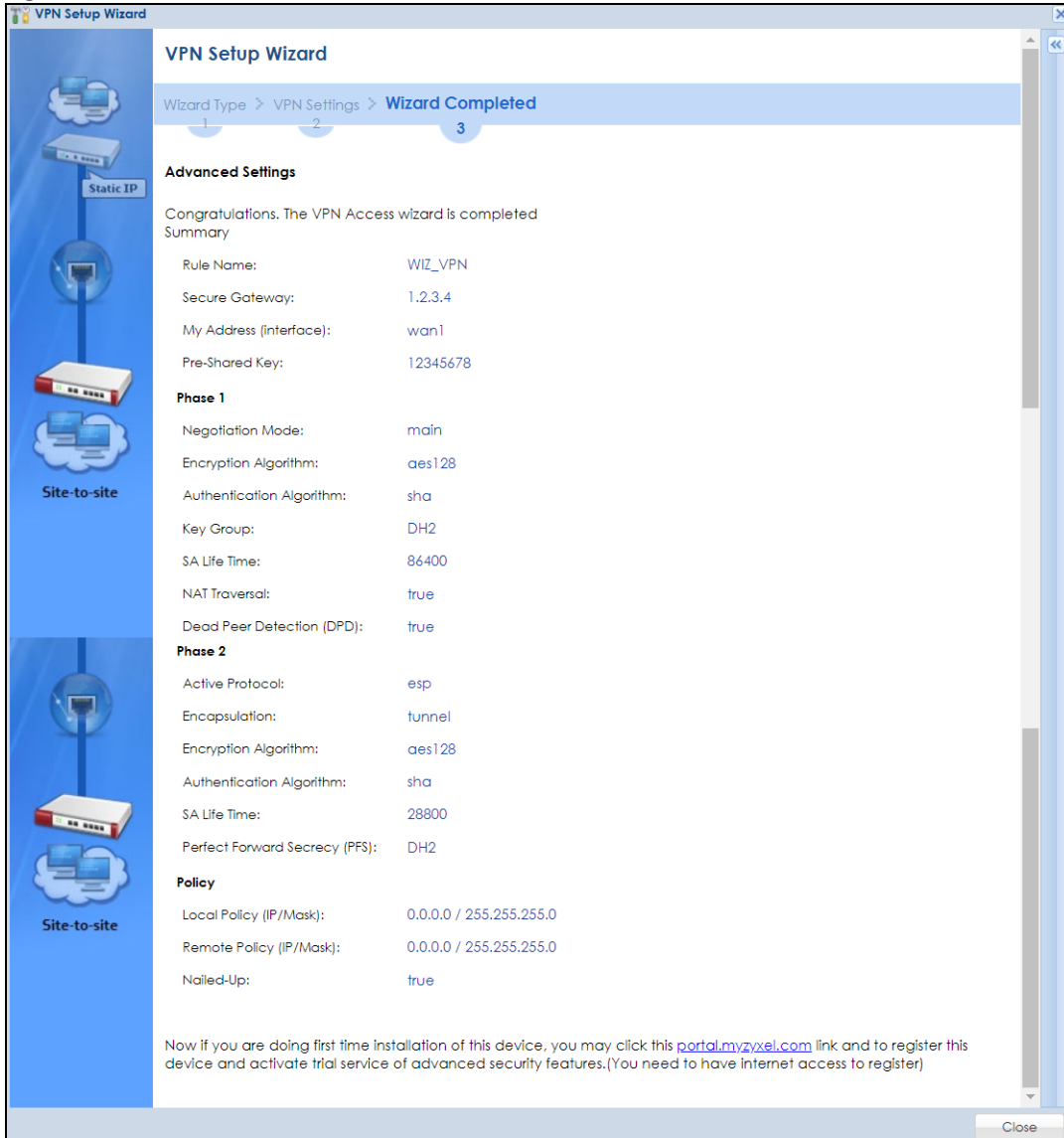

Click **Close** to exit the wizard.

5.6 VPN Settings for Configuration Provisioning Wizard: Wizard Type

Use **VPN Settings for Configuration Provisioning** to set up a VPN rule that can be retrieved with the Zyxel Device IPSec VPN Client.

VPN rules for the Zyxel Device IPSec VPN Client have certain restrictions. They must *not* contain the following settings:

- **AH** active protocol
- **NULL** encryption
- **SHA512** authentication
- A subnet or range remote policy

Choose **Express** to create a VPN rule with the default phase 1 and phase 2 settings and to use a pre-shared key.

Choose **Advanced** to change the default settings and/or use certificates instead of a pre-shared key in the VPN rule.

Figure 152 VPN Settings for Configuration Provisioning Express Wizard: Wizard Type

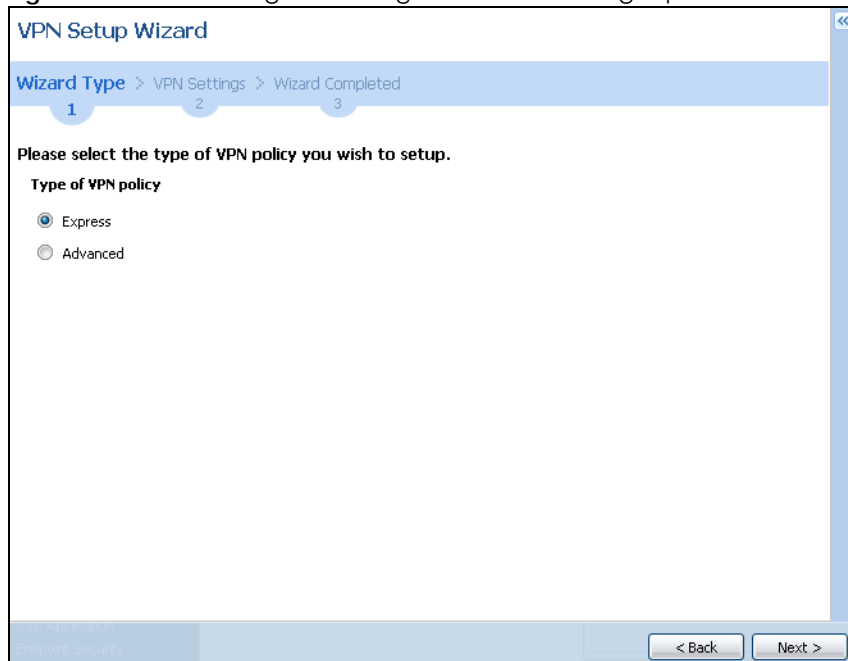

5.6.1 Configuration Provisioning Express Wizard – VPN Settings

Click the **Express** radio button as shown in the previous screen to display the following screen.

Figure 153 VPN for Configuration Provisioning Express Wizard: Settings Scenario

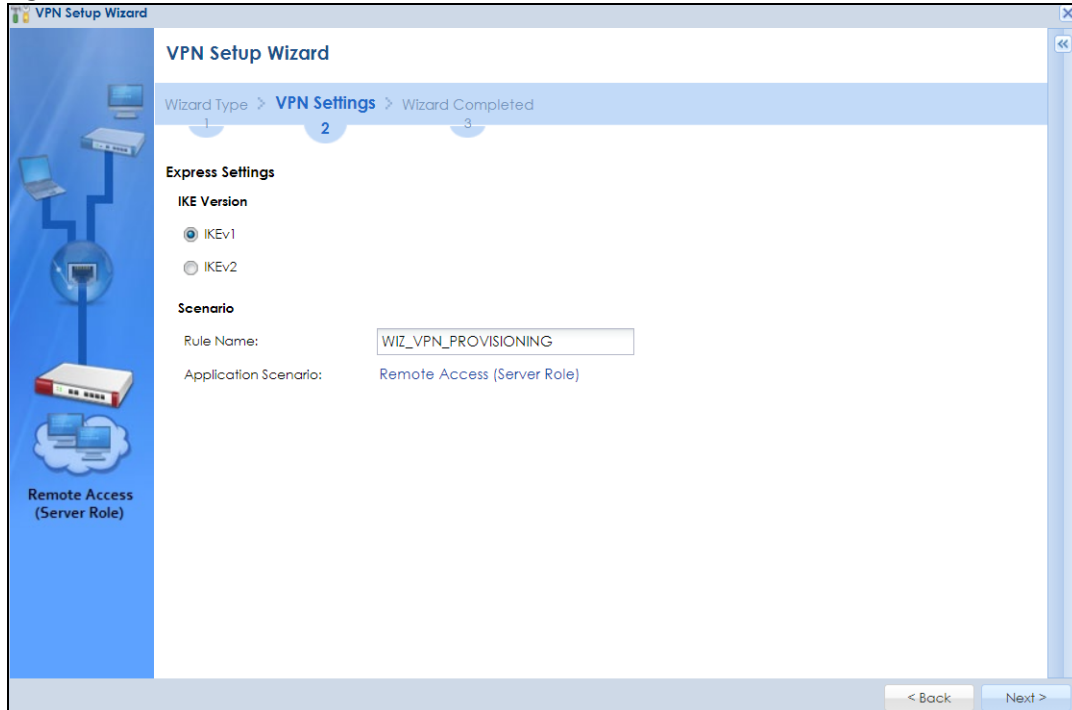

- **IKE** (Internet Key Exchange) is a protocol used in security associations to send data securely. IKE uses certificates or pre-shared keys for authentication and a Diffie–Hellman key exchange to set up a shared session secret from which encryption keys are derived.
- **IKEv2** supports Extended Authentication Protocol (EAP) authentication, and IKEv1 supports X-Auth. EAP is important when connecting to existing enterprise authentication systems.
- **Rule Name:** Type the name used to identify this VPN connection (and VPN gateway). You may use 1 – 31 alphanumeric characters, underscores (`_`), or dashes (`-`), but the first character cannot be a number. This value is case-sensitive.
- **Application Scenario:** Only the **Remote Access (Server Role)** is allowed in this wizard. It allows incoming connections from the Zyxel Device IPSec VPN Client.

5.6.2 Configuration Provisioning VPN Express Wizard – Configuration

Click **Next** to continue the wizard.

Figure 154 VPN for Configuration Provisioning Express Wizard: Configuration

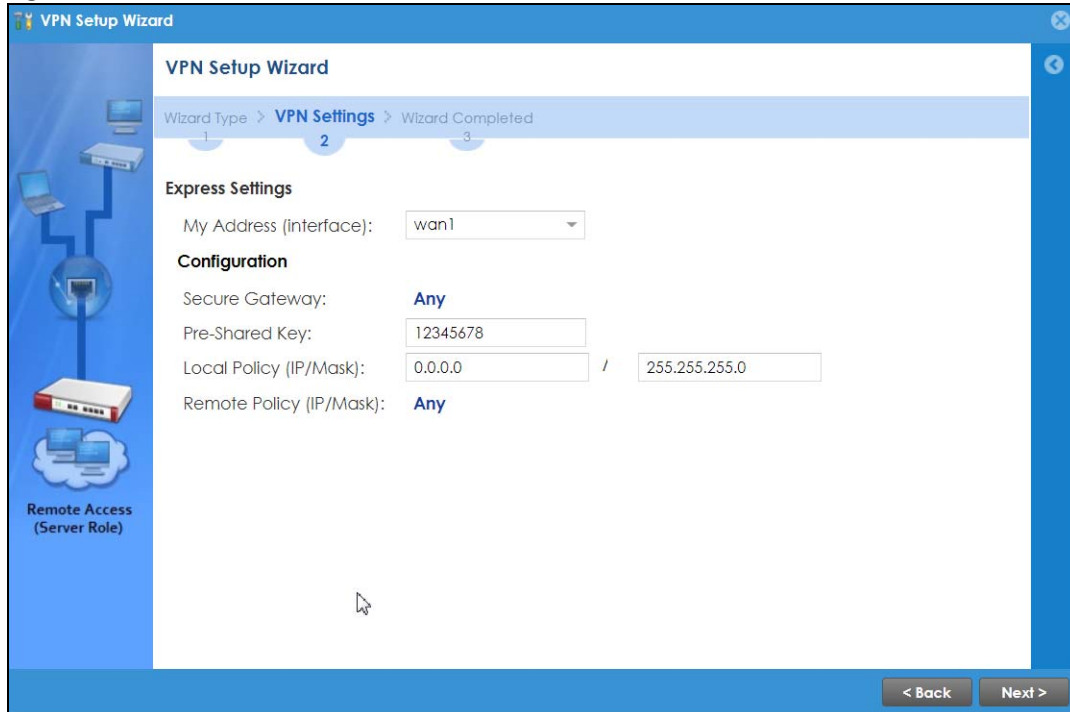

- **My Address (interface):** Select an interface from the drop-down list box to use on your Zyxel Device.
- **Secure Gateway:** **Any** displays in this field because it is not configurable in this wizard. It allows incoming connections from the Zyxel Device IPsec VPN Client.
- **Pre-Shared Key:** Type the password. Both ends of the VPN tunnel must use the same password. Use up to 128 case-sensitive ASCII characters or up to 128 pairs of hexadecimal ("0-9", "A-F") characters. Proceed a hexadecimal key with "0x". You will receive a PYLD_MALFORMED (payload malformed) packet if the same pre-shared key is not used on both ends.
- **Local Policy (IP/Mask):** Type the IP address of a computer on your network. You can also specify a subnet. This must match the remote IP address configured on the remote IPsec device.
- **Remote Policy (IP/Mask):** **Any** displays in this field because it is not configurable in this wizard.

5.6.3 VPN Settings for Configuration Provisioning Express Wizard – Summary

This screen has a read-only summary of the VPN tunnel's configuration and commands you can copy and paste into another ZLD-based Zyxel Device's command line interface to configure it.

Figure 155 VPN for Configuration Provisioning Express Wizard: Summary

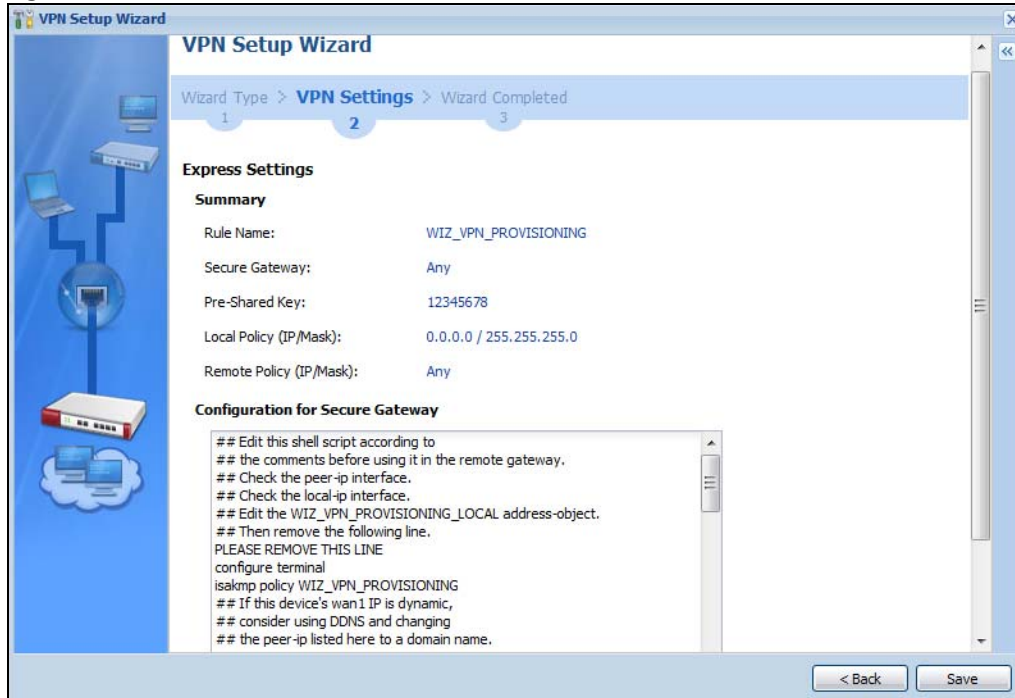

- **Rule Name:** Identifies the VPN gateway policy.
- **Secure Gateway: Any** displays in this field because it is not configurable in this wizard. It allows incoming connections from the Zyxel Device IPSec VPN Client.
- **Pre-Shared Key:** VPN tunnel password. It identifies a communicating party during a phase 1 IKE negotiation.
- **Local Policy:** (Static) IP address and subnet mask of the computers on the network behind your Zyxel Device that can be accessed using the tunnel.
- **Remote Policy: Any** displays in this field because it is not configurable in this wizard.
- The **Configuration for Secure Gateway** displays the configuration that the Zyxel Device IPSec VPN Client will get from the Zyxel Device.
- Click **Save** to save the VPN rule.

5.6.4 VPN Settings for Configuration Provisioning Express Wizard – Finish

Now the rule is configured on the Zyxel Device. The Phase 1 rule settings appear in the **Configuration > VPN > IPSec VPN > VPN Gateway** screen and the Phase 2 rule settings appear in the **Configuration > VPN > IPSec VPN > VPN Connection** screen. Enter the IP address of the Zyxel Device in the Zyxel Device IPSec VPN Client to get all these VPN settings automatically from the Zyxel Device.

Figure 156 VPN for Configuration Provisioning Express Wizard: Finish

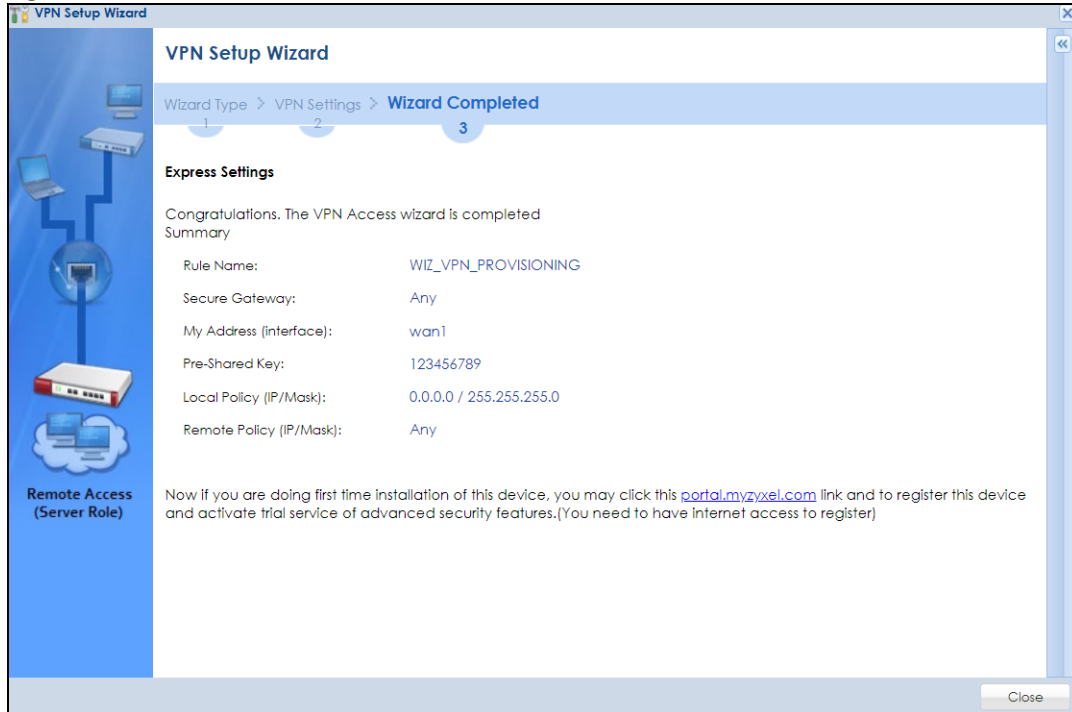

Click **Close** to exit the wizard.

5.6.5 VPN Settings for Configuration Provisioning Advanced Wizard – Scenario

Click the **Advanced** radio button as shown in the screen shown in [Figure 152 on page 184](#) to display the following screen.

Figure 157 VPN for Configuration Provisioning Advanced Wizard: Scenario Settings

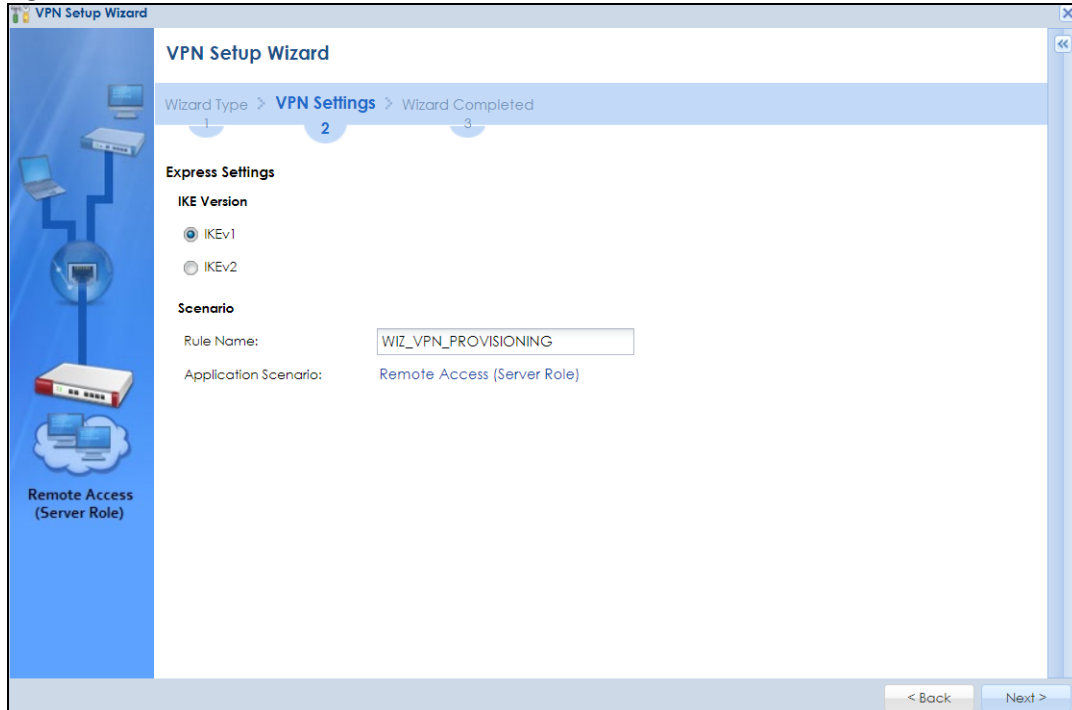

- **IKE** (Internet Key Exchange) is a protocol used in security associations to send data securely. IKE uses certificates or pre-shared keys for authentication and a Diffie–Hellman key exchange to set up a shared session secret from which encryption keys are derived.
- **IKEv2** supports Extended Authentication Protocol (EAP) authentication, and IKEv1 supports X-Auth. EAP is important when connecting to existing enterprise authentication systems.
- **Rule Name:** Type the name used to identify this VPN connection (and VPN gateway). You may use 1 – 31 alphanumeric characters, underscores (`_`), or dashes (`-`), but the first character cannot be a number. This value is case-sensitive.
- **Application Scenario:** Only the **Remote Access (Server Role)** is allowed in this wizard. It allows incoming connections from the Zyxel Device IPSec VPN Client.

Click **Next** to continue the wizard.

5.6.6 VPN Settings for Configuration Provisioning Advanced Wizard – Phase 1 Settings

There are two phases to every IKE (Internet Key Exchange) negotiation – phase 1 (Authentication) and phase 2 (Key Exchange). A phase 1 exchange establishes an IKE SA (Security Association).

Figure 158 VPN for Configuration Provisioning Advanced Wizard: Phase 1 Settings

Advanced Settings

Phase 1 Setting

Secure Gateway: Any

My Address (interface): wan1

Negotiation Mode: Main

Encryption Algorithm: DES

Authentication Algorithm: MD5

Key Group: DH1

SA Life Time: 86400 (180 - 3000000 seconds)

Authentication Method

Pre-Shared Key !

Certificate

default

- **Secure Gateway:** Any displays in this field because it is not configurable in this wizard. It allows incoming connections from the Zyxel Device IPsec VPN Client.
- **My Address (interface):** Select an interface from the drop-down list box to use on your Zyxel Device.
- **Negotiation Mode:** This displays **Main** or **Aggressive**:
 - **Main** encrypts the Zyxel Device's and remote IPsec router's identities but takes more time to establish the IKE SA.
 - **Aggressive** is faster but does not encrypt the identities.

The Zyxel Device and the remote IPsec router must use the same negotiation mode. Multiple SAs connecting through a secure gateway must have the same negotiation mode.

- **Encryption Algorithm:** 3DES and AES use encryption. The longer the key, the higher the security (this may affect throughput). Both sender and receiver must know the same secret key, which can be used to encrypt and decrypt the message or to generate and verify a message authentication code. The DES encryption algorithm uses a 56-bit key. Triple DES (3DES) is a variation on DES that uses a 168-bit key. As a result, 3DES is more secure than DES. It also requires more processing power, resulting in increased latency and decreased throughput. AES128 uses a 128-bit key and is faster than 3DES. AES192 uses a 192-bit key and AES256 uses a 256-bit key.
- **Authentication Algorithm:** MD5 (Message Digest 5) and SHA (Secure Hash Algorithm) are hash algorithms used to authenticate packet data. MD5 gives minimal security. SHA1 gives higher security and SHA256 gives the highest security. The stronger the algorithm, the slower it is.
- **Key Group:** DH5 is more secure than DH1 or DH2 (although it may affect throughput). DH1 (default) refers to Diffie-Hellman Group 1 a 768 bit random number. DH2 refers to Diffie-Hellman Group 2 a 1024 bit (1Kb) random number. DH5 refers to Diffie-Hellman Group 5 a 1536 bit random number.
- **SA Life Time:** Set how often the Zyxel Device renegotiates the IKE SA. A short SA life time increases security, but renegotiation temporarily disconnects the VPN tunnel.
- **Authentication Method:** Select **Pre-Shared Key** to use a password or **Certificate** to use one of the Zyxel Device's certificates.

5.6.7 VPN Settings for Configuration Provisioning Advanced Wizard – Phase 2

Phase 2 in an IKE uses the SA that was established in phase 1 to negotiate SAs for IPsec.

Figure 159 VPN for Configuration Provisioning Advanced Wizard: Phase 2 Settings

Advanced Settings	
Phase 2 Setting	
Active Protocol:	ESP
Encapsulation:	Tunnel
Encryption Algorithm:	DES
Authentication Algorithm:	SHA1
SA Life Time:	86400 (180 - 3000000 seconds)
Perfect Forward Secrecy (PFS):	None
Policy Setting	
Local Policy (IP/Mask)	0.0.0.0 / 255.255.255.0
Remote Policy (IP/Mask):	Any

- **Active Protocol:** ESP is compatible with NAT. AH is not available in this wizard.
- **Encapsulation:** Tunnel is compatible with NAT, Transport is not.
- **Encryption Algorithm:** 3DES and AES use encryption. The longer the AES key, the higher the security (this may affect throughput). Null uses no encryption.
- **Authentication Algorithm:** MD5 (Message Digest 5) and SHA (Secure Hash Algorithm) are hash algorithms used to authenticate packet data. MD5 gives minimal security. SHA1 gives higher security and SHA256 gives the highest security. The stronger the algorithm, the slower it is.
- **SA Life Time:** Set how often the Zyxel Device renegotiates the IKE SA. A short SA life time increases security, but renegotiation temporarily disconnects the VPN tunnel.
- **Perfect Forward Secrecy (PFS):** Disabling PFS allows faster IPsec setup, but is less secure. Select DH1, DH2 or DH5 to enable PFS. DH5 is more secure than DH1 or DH2 (although it may affect throughput). DH1 refers to Diffie-Hellman Group 1 a 768 bit random number. DH2 refers to Diffie-Hellman Group 2 a 1024 bit (1Kb) random number. DH5 refers to Diffie-Hellman Group 5 a 1536 bit random number (more secure, yet slower).
- **Local Policy (IP/Mask):** Type the IP address of a computer on your network. You can also specify a subnet. This must match the remote IP address configured on the remote IPsec device.
- **Remote Policy (IP/Mask):** Any displays in this field because it is not configurable in this wizard.
- **Nailed-Up:** This displays for the site-to-site and remote access client role scenarios. Select this to have the Zyxel Device automatically renegotiate the IPsec SA when the SA life time expires.

5.6.8 VPN Settings for Configuration Provisioning Advanced Wizard – Summary

This is a read-only summary of the VPN tunnel settings.

Figure 160 VPN for Configuration Provisioning Advanced Wizard: Summary

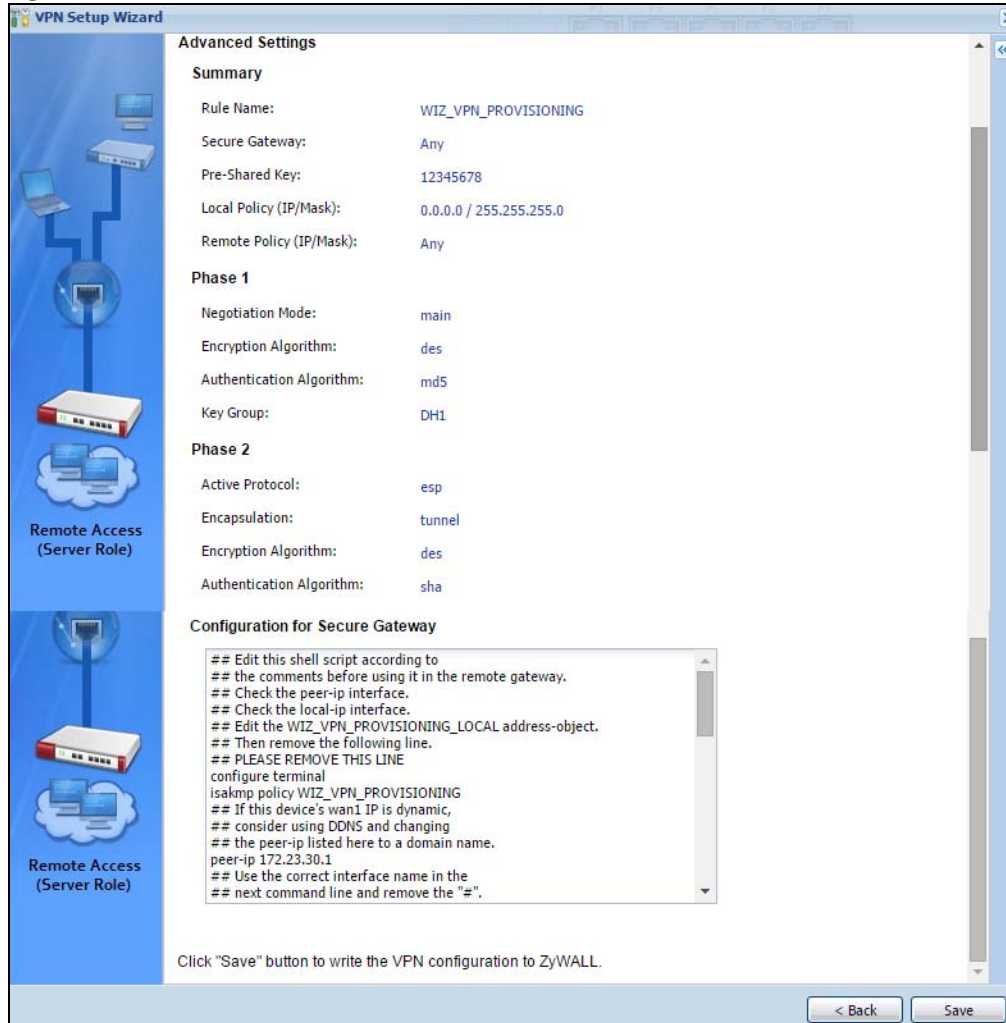

Summary

- **Rule Name:** Identifies the VPN connection (and the VPN gateway).
- **Secure Gateway:** **Any** displays in this field because it is not configurable in this wizard. It allows incoming connections from the Zyxel Device IPsec VPN Client.
- **Pre-Shared Key:** VPN tunnel password.
- **Local Policy:** IP address and subnet mask of the computers on the network behind your Zyxel Device that can use the tunnel.
- **Remote Policy:** **Any** displays in this field because it is not configurable in this wizard.

Phase 1

- **Negotiation Mode:** This displays **Main** or **Aggressive**:
 - **Main** encrypts the Zyxel Device's and remote IPsec router's identities but takes more time to establish the IKE SA.
 - **Aggressive** is faster but does not encrypt the identities.

The Zyxel Device and the remote IPsec router must use the same negotiation mode. Multiple SAs connecting through a secure gateway must have the same negotiation mode.

- **Encryption Algorithm:** This displays the encryption method used. The longer the key, the higher the security, the lower the throughput (possibly).
 - **DES** uses a 56-bit key.
 - **3DES** uses a 168-bit key.
 - **AES128** uses a 128-bit key.
 - **AES192** uses a 192-bit key.
 - **AES256** uses a 256-bit key.
- **Authentication Algorithm:** This displays the authentication algorithm used. The stronger the algorithm, the slower it is.
 - **MD5** gives minimal security.
 - **SHA1** gives higher security.
 - **SHA256** gives the highest security.
- **Key Group:** This displays the Diffie-Hellman (DH) key group used. **DH5** is more secure than **DH1** or **DH2** (although it may affect throughput).
 - **DH1** uses a 768 bit random number.
 - **DH2** uses a 1024 bit (1Kb) random number.
 - **DH5** uses a 1536 bit random number.

Phase 2

- **Active Protocol:** This displays **ESP** (compatible with NAT) or **AH**.
- **Encapsulation:** This displays **Tunnel** (compatible with NAT) or **Transport**.
- **Encryption Algorithm:** This displays the encryption method used. The longer the key, the higher the security, the lower the throughput (possibly).
 - **DES** uses a 56-bit key.
 - **3DES** uses a 168-bit key.
 - **AES128** uses a 128-bit key.
 - **AES192** uses a 192-bit key.
 - **AES256** uses a 256-bit key.
 - **Null** uses no encryption.
- **Authentication Algorithm:** This displays the authentication algorithm used. The stronger the algorithm, the slower it is.
 - **MD5** gives minimal security.
 - **SHA1** gives higher security.
 - **SHA256** gives the highest security.

The **Configuration for Secure Gateway** displays the configuration that the Zyxel Device IPSec VPN Client will get from the Zyxel Device.

Click **Save** to save the VPN rule.

5.6.9 VPN Settings for Configuration Provisioning Advanced Wizard – Finish

Now the rule is configured on the Zyxel Device. The Phase 1 rule settings appear in the **Configuration > VPN > IPSec VPN > VPN Gateway** screen and the Phase 2 rule settings appear in the **Configuration >**

VPN > IPSec VPN > VPN Connection screen. Enter the IP address of the Zyxel Device in the Zyxel Device IPSec VPN Client to get all these VPN settings automatically from the Zyxel Device.

Figure 161 VPN for Configuration Provisioning Advanced Wizard: Finish

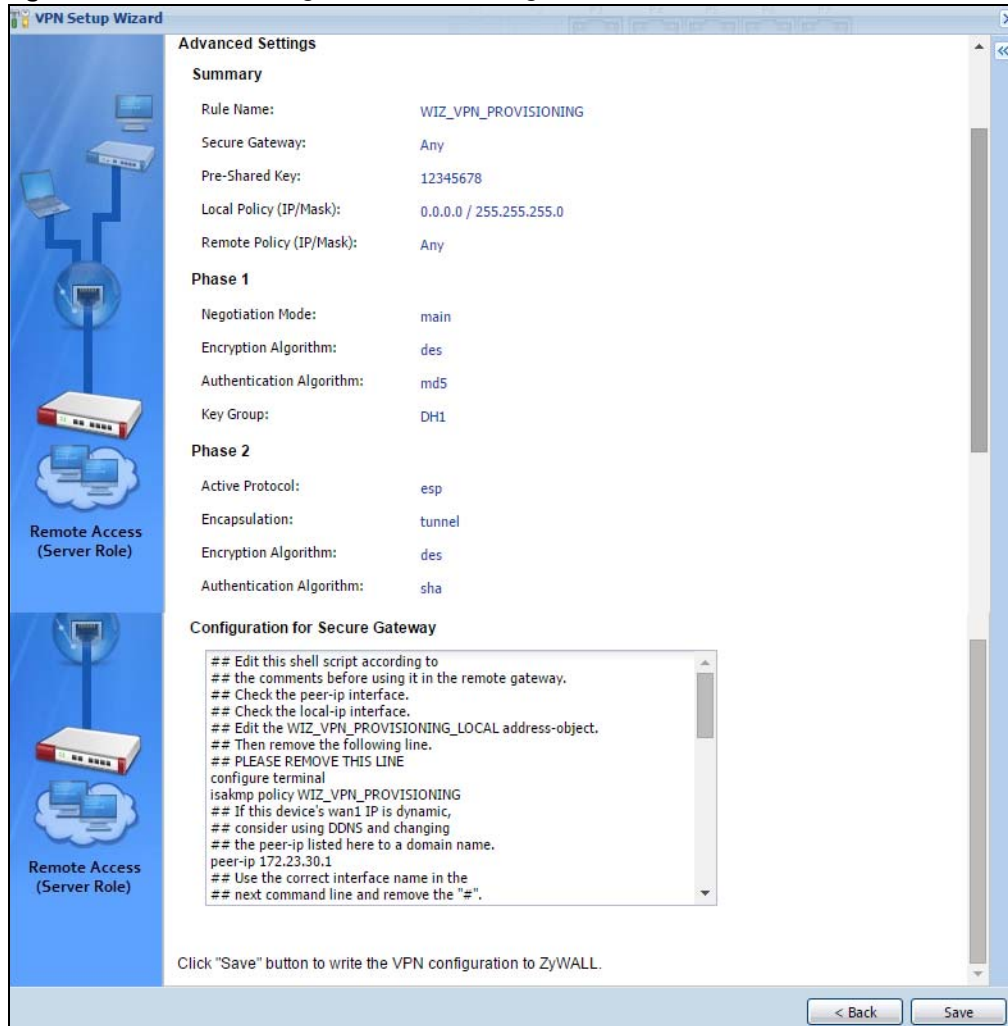

Click **Close** to exit the wizard.

5.7 VPN Settings for L2TP VPN Settings Wizard

Use **VPN Settings for L2TP VPN Settings** to set up an L2TP VPN rule. Click **Configuration > Quick Setup > VPN Setup** and select **VPN Settings for L2TP VPN Settings** to see the following screen.

Figure 162 VPN Settings for L2TP VPN Settings Wizard: L2TP VPN Settings

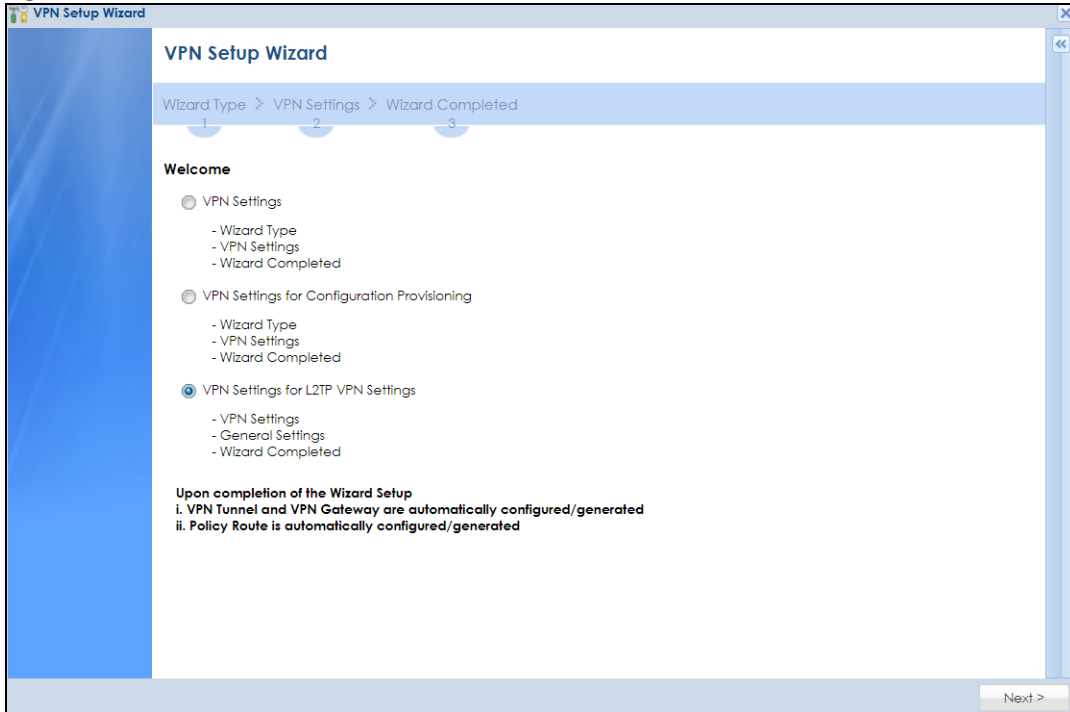

Click **Next** to continue the wizard.

5.7.1 L2TP VPN Settings

Figure 163 VPN Settings for L2TP VPN Settings Wizard: L2TP VPN Settings

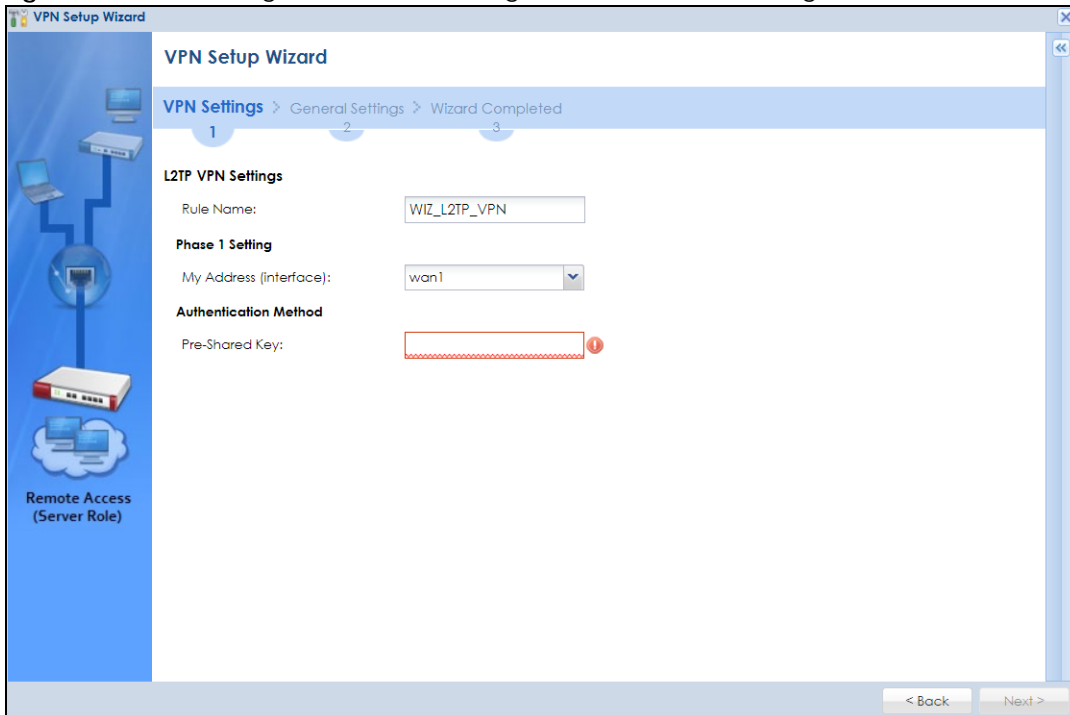

- **Rule Name:** Type the name used to identify this L2TP VPN connection (and L2TP VPN gateway). You may use 1-31 alphanumeric characters, underscores (_), or dashes (-), but the first character cannot be a number. This value is case-sensitive.
- **My Address (interface):** Select one of the interfaces from the pull down menu to apply the L2TP VPN rule.
- **Pre-Shared Key:** Type the password. Both ends of the VPN tunnel must use the same password. Use up to 128 case-sensitive ASCII characters or up to 128 pairs of hexadecimal ("0-9", "A-F") characters. Proceed a hexadecimal key with "0x". You will receive a PYLD_MALFORMED (payload malformed) packet if the same pre-shared key is not used on both ends.

Click **Next** to continue the wizard.

5.7.2 L2TP VPN Settings

Figure 164 VPN Settings for L2TP VPN Settings Wizard: L2TP VPN Settings

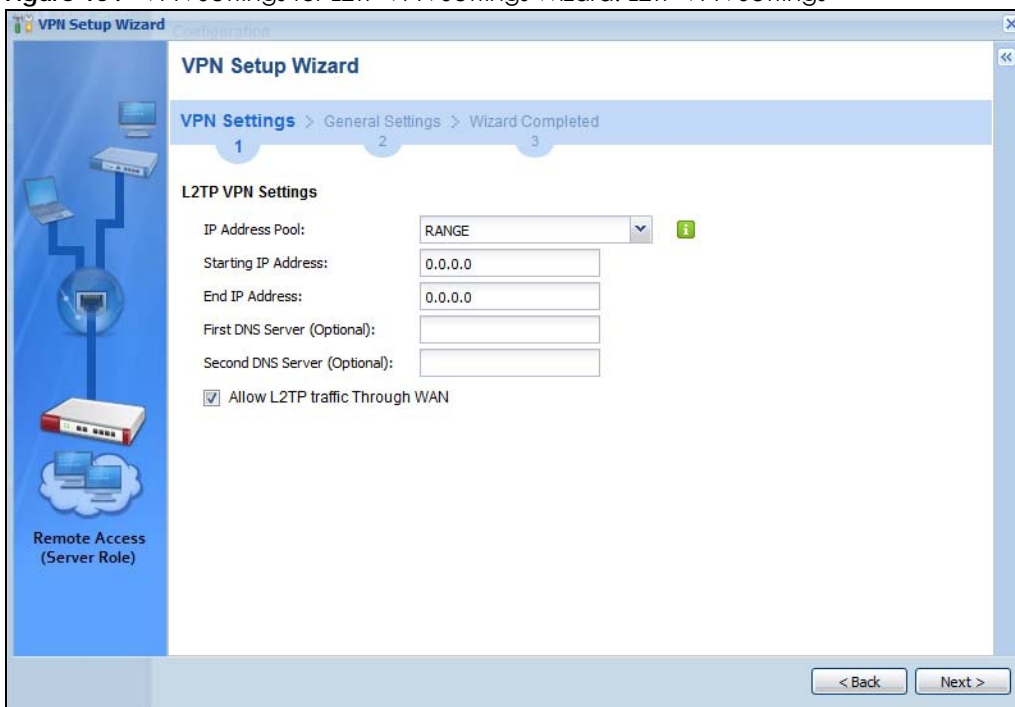

- **IP Address Pool:** Select **Range** or **Subnet** from the pull down menu. This IP address pool is used to assign to the L2TP VPN clients.
- **Starting IP Address:** Enter the starting IP address in the field.
- **End IP Address:** Enter the ending IP address in the field.
- **Network:** Enter the IPv4 IP address in this field if you selected **SUBNET**.
- **Netmask:** Enter the associated subnet mask of the subnet in this field.
- **First DNS Server (Optional):** Enter the first DNS server IP address in the field. Leave the field as 0.0.0.0 if you do not want to configure DNS servers. If you do not configure a DNS server you must know the IP address of a machine in order to access it.
- **Second DNS Server (Optional):** Enter the second DNS server IP address in the field. Leave the field as 0.0.0.0 if you do not want to configure DNS servers. If you do not configure a DNS server you must know the IP address of a machine in order to access it.
- **Allow L2TP traffic Through WAN:** Select this check box to allow traffic from L2TP clients to go to the Internet.

Click **Next** to continue the wizard.

Note: DNS (Domain Name System) is for mapping a domain name to its corresponding IP address and vice versa. The DNS server is extremely important because without it, you must know the IP address of a computer before you can access it. The Zyxel Device uses a system DNS server (in the order you specify here) to resolve domain names for VPN, DDNS and the time server.

5.7.3 VPN Settings for L2TP VPN Setting Wizard – Summary

This is a read-only summary of the L2TP VPN settings.

Figure 165 VPN Settings for L2TP VPN Settings Advanced Settings Wizard: Summary

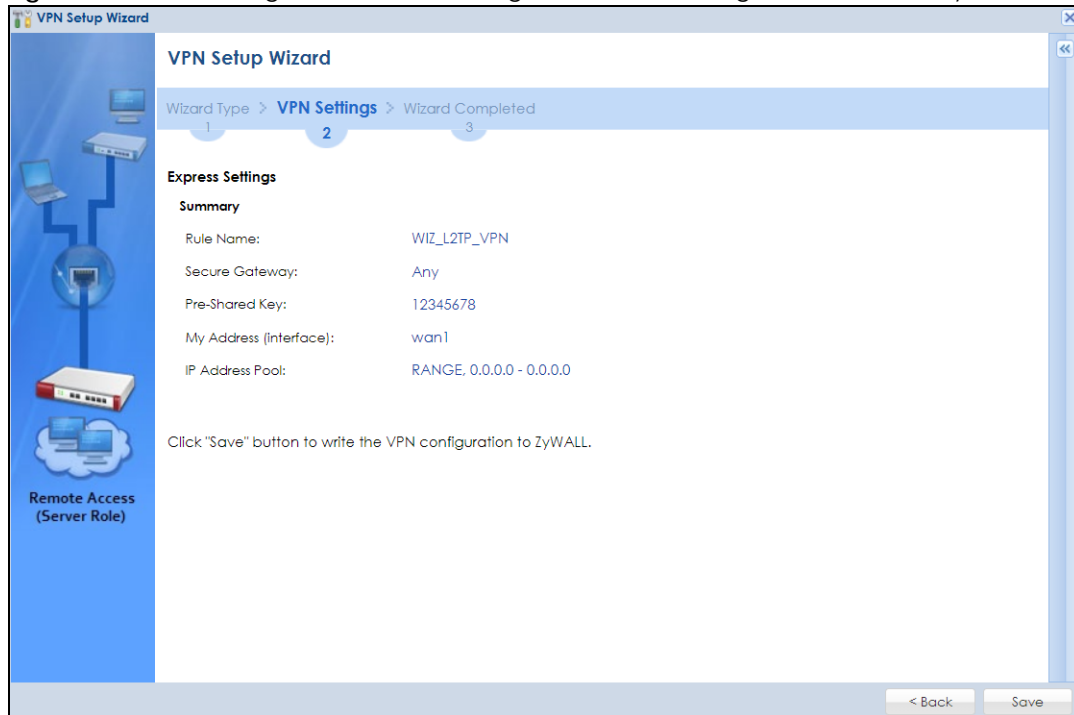

- **Rule Name:** Identifies the L2TP VPN connection (and the L2TP VPN gateway).
- **Secure Gateway “Any”** displays in this field because it is not configurable in this wizard. It allows incoming connections from the L2TP VPN Client.
- **Pre-Shared Key:** L2TP VPN tunnel password.
- **My Address (Interface):** This displays the interface to use on your Zyxel Device for the L2TP tunnel.
- **IP Address Pool:** This displays the IP address pool used to assign to the L2TP VPN clients.

Click **Save** to complete the L2TP VPN Setting and the following screen will show.

5.7.4 VPN Settings for L2TP VPN Setting Wizard Completed

Figure 166 VPN Settings for L2TP VPN Settings Wizard: Finish

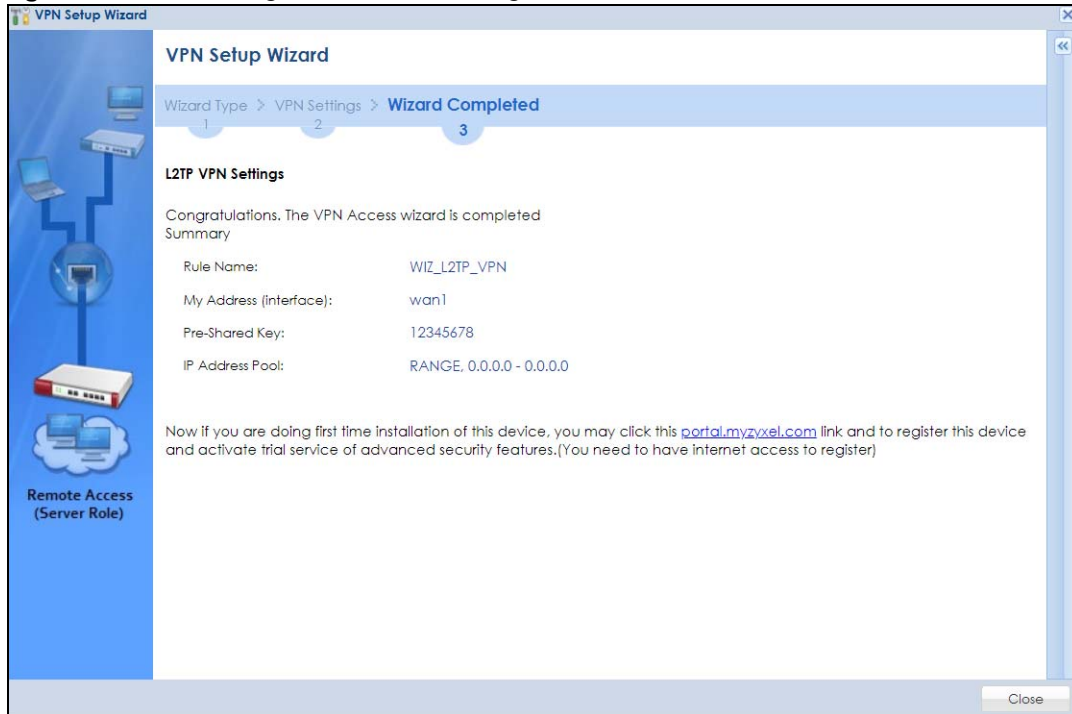

Now the rule is configured on the Zyxel Device. The L2TP VPN rule settings appear in the **Configuration > VPN > L2TP VPN** screen and also in the **Configuration > VPN > IPsec VPN > VPN Connection** and **VPN Gateway** screen.

CHAPTER 6

Dashboard

6.1 Overview

Use the **Dashboard** screens to check status information about the Zyxel Device.

6.1.1 What You Can Do in this Chapter

Use the main **Dashboard** screen to see the Zyxel Device's general device information, system status, system resource usage, licensed service status, and interface status. You can also display other status screens for more information.

Use the **Dashboard** screens to view the following.

- [Device Information Screen on page 201](#)
- [System Status Screen on page 202](#)
- [Extension Slot Screen on page 206](#)
- [Interface Status Summary Screen on page 207](#)
- [Secured Service Status Screen on page 208](#)
- [Content Filter Statistics Screen on page 209](#)
- [Top 5 Viruses Screen on page 209](#)
- [Top 5 Intrusions Screen on page 210](#)
- [Top 5 IPv4/IPv6 Security Policy Rules that Blocked Traffic Screen on page 210](#)
- [The Latest Alert Logs Screen on page 211](#)

6.2 Main Dashboard Screen

The **Dashboard** screen displays when you log into the Zyxel Device or click **Dashboard** in the navigation panel. The dashboard displays general device information, system status, system resource usage, licensed service status, and interface status in widgets that you can re-arrange to suit your needs. You can also collapse, refresh, and close individual widgets.

Click on the icon to go to the OneSecurity website where there is guidance on configuration walkthroughs, troubleshooting, and other information.

Figure 167 Zyxel Device Dashboard

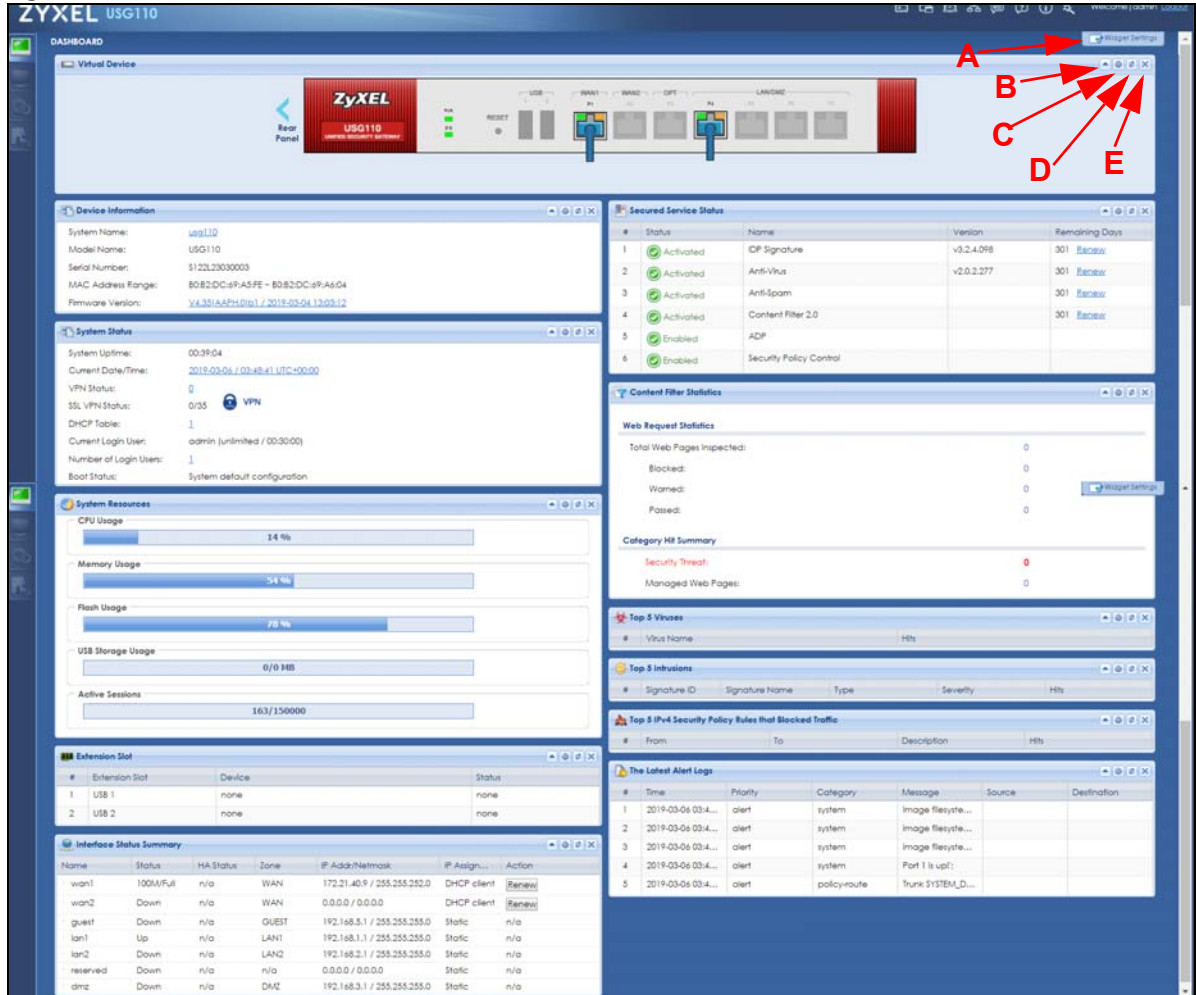

The following table describes the labels in this screen.

Table 28 Dashboard

LABEL	DESCRIPTION
Widget Settings (A)	Use this link to open or close widgets by selecting/clearing the associated checkbox.
Up Arrow (B)	Click this to collapse a widget. It then becomes a down arrow. Click it again to enlarge the widget again.
Refresh Time Setting (C)	Set the interval for refreshing the information displayed in the widget.
Refresh Now (D)	Click this to update the widget's information immediately.
Close Widget (E)	Click this to close the widget. Use Widget Settings to re-open it.
Virtual Device	
Rear Panel	Click this to view details about the Zyxel Device's rear panel. Hover your cursor over a connected interface or slot to display status details.
Front Panel	Click this to view details about the status of the Zyxel Device's front panel LEDs and connections. See Section 3.1.1 on page 74 for LED descriptions. An unconnected interface or slot appears grayed out.
	The following front and rear panel labels display when you hover your cursor over a connected interface or slot.

Table 28 Dashboard (continued)

LABEL	DESCRIPTION
Name	This field displays the name of each interface.
Status	<p>This field displays the current status of each interface or device installed in a slot. The possible values depend on what type of interface it is.</p> <p>Inactive - The Ethernet interface is disabled.</p> <p>Down - The Ethernet interface does not have any physical ports associated with it or the Ethernet interface is enabled but not connected.</p> <p>Speed / Duplex - The Ethernet interface is enabled and connected. This field displays the port speed and duplex setting (Full or Half).</p> <p>The status for a WLAN card is none.</p> <p>For cellular (mobile broadband) interfaces, see Section 10.6 on page 359 for the status that can appear.</p> <p>For the auxiliary interface:</p> <p>Inactive - The auxiliary interface is disabled.</p> <p>Connected - The auxiliary interface is enabled and connected.</p> <p>Disconnected - The auxiliary interface is not connected.</p>
HA Status	<p>This field displays the status of the interface in the virtual router.</p> <p>Active - This interface is the master interface in the virtual router.</p> <p>Stand-By - This interface is a backup interface in the virtual router.</p> <p>Fault - This VRRP group is not functioning in the virtual router right now. For example, this might happen if the interface is down.</p> <p>n/a - Device HA is not active on the interface.</p>
Zone	This field displays the zone to which the interface is currently assigned.
IP Address/ Mask	This field displays the current IP address and subnet mask assigned to the interface. If the interface is a member of an active virtual router, this field displays the IP address it is currently using. This is either the static IP address of the interface (if it is the master) or the management IP address (if it is a backup).

6.2.1 Device Information Screen

The Device Information screen displays Zyxel Device's system and model name, serial number, MAC address and firmware version shown in the below screen.

Figure 168 Dashboard > Device Information (Example)



This table describes the fields in the above screen.

Table 29 Dashboard > Device Information

LABEL	DESCRIPTION
Device Information	This identifies a device installed in one of the Zyxel Device's extension slots, the Security Extension Module slot, or USB ports. For an installed SEM (Security Extension Module) card, this field displays what kind of SEM card is installed. SEM-VPN - The VPN accelerator. The SEM-VPN provides 500 Mbps VPN throughput, 2,000 IPSec VPN tunnels, and 750 SSL VPN users. SEM-DUAL - accelerator for both VPN and UTM. The SEM-DUAL provides the benefits of the SEM-VPN and increases the maximum anti-virus and IDP traffic throughput from 100 Mbps to 400 Mbps.
System Name	This field displays the name used to identify the Zyxel Device on any network. Click the link and open the Host Name screen where you can edit and make changes to the system and domain name.
Model Name	This field displays the model name of this Zyxel Device.
Serial Number	This field displays the serial number of this Zyxel Device. The serial number is used for device tracking and control.
MAC Address Range	This field displays the MAC addresses used by the Zyxel Device. Each physical port has one MAC address. The first MAC address is assigned to physical port 1, the second MAC address is assigned to physical port 2, and so on.
Firmware Version	This field displays the version number and date of the firmware the Zyxel Device is currently running. Click the link to open the Firmware Package screen where you can upload firmware.

6.2.2 System Status Screen

Figure 169 Dashboard > System Status (Example)

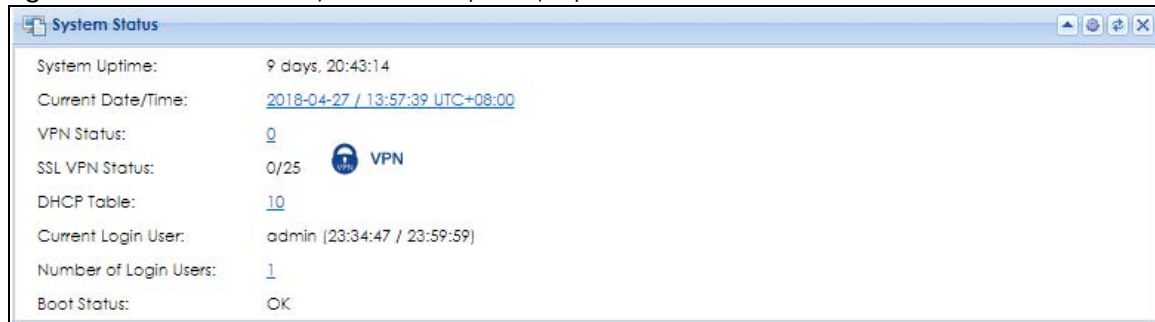

LABEL	DESCRIPTION
System Uptime:	9 days, 20:43:14
Current Date/Time:	2018-04-27 / 13:57:39 UTC+08:00
VPN Status:	0
SSL VPN Status:	0/25  VPN
DHCP Table:	10
Current Login User:	admin (23:34:47 / 23:59:59)
Number of Login Users:	1
Boot Status:	OK

This table describes the fields in the above screen.

Table 30 Dashboard > System Status

LABEL	DESCRIPTION
System Uptime	This field displays how long the Zyxel Device has been running since it last restarted or was turned on.
Current Date/Time	This field displays the current date and time in the Zyxel Device. The format is yyyy-mm-dd hh:mm:ss. Click on the link to see the Date/Time screen where you can make edits and changes to the date, time and time zone information.
VPN Status	Click on the link to look at the VPN tunnels that are currently established. See Section 6.2.3 on page 203 . Click on the VPN icon to go to the Zyxel VPN Client product page at the Zyxel website.
SSL VPN Status	The first number is the actual number of VPN tunnels up and the second number is the maximum number of SSL VPN tunnels allowed.

Table 30 Dashboard > System Status

LABEL	DESCRIPTION
DHCP Table	Click this to look at the IP addresses currently assigned to the Zyxel Device's DHCP clients and the IP addresses reserved for specific MAC addresses. See Section 6.2.3 on page 203 .
Current Login User	This field displays the user name used to log in to the current session, the amount of reauthentication time remaining, and the amount of lease time remaining.
Number of Login Users	This field displays the number of users currently logged in to the Zyxel Device. Click the icon to pop-open a list of the users who are currently logged in to the Zyxel Device.
Boot Status	<p>This field displays details about the Zyxel Device's startup state.</p> <p>OK - The Zyxel Device started up successfully.</p> <p>Firmware update OK - A firmware update was successful.</p> <p>Problematic configuration after firmware update - The application of the configuration failed after a firmware upgrade.</p> <p>System default configuration - The Zyxel Device successfully applied the system default configuration. This occurs when the Zyxel Device starts for the first time or you intentionally reset the Zyxel Device to the system default settings.</p> <p>Fallback to lastgood configuration - The Zyxel Device was unable to apply the startup-config.conf configuration file and fell back to the lastgood.conf configuration file.</p> <p>Fallback to system default configuration - The Zyxel Device was unable to apply the lastgood.conf configuration file and fell back to the system default configuration file (system-default.conf).</p> <p>Booting in progress - The Zyxel Device is still applying the system configuration.</p>

6.2.3 DHCP Table Screen

Click on the DHCP Table link to look at the IP addresses currently assigned to DHCP clients and the IP addresses reserved for specific MAC addresses. The following screen will show.

Figure 170 Dashboard > System Status > DHCP Table

#	Interface	IP Address	Host Name	MAC Address	Expiration T...	Description	Res...
1	lan1	192.168.1.33	"nwa5123-nl"	b0:b2:dc:6e:7e:5e	2018-04-28 ...		<input type="checkbox"/>
2	lan1	192.168.1.40	"android-c...	e8:99:c4:ad:15:48	2018-04-28 ...		<input type="checkbox"/>
3	lan1	192.168.1.59	"android-3...	00:ee:bd:9a:a9:f8	2018-04-28 ...		<input type="checkbox"/>
4	lan1	192.168.1.71	"android-8f...	f8:32:e4:36:9e:53	2018-04-28 ...		<input type="checkbox"/>
5	lan1	192.168.1.79	"zzz-teki-6s"	b4:8b:19:00:ee:77	2018-04-29 ...		<input type="checkbox"/>
6	lan1	192.168.1.81	"TWNBT02...	10:0b:a9:74:11:70	2018-04-27 ...		<input type="checkbox"/>
7	lan1	192.168.1.86	"RedmiNot...	b0:e2:35:9e:86:fe	2018-04-28 ...		<input type="checkbox"/>
8	lan1	192.168.1.87	"iRhoneX"	3c:2e:f9:bd:a2:7e	2018-04-29 ...		<input type="checkbox"/>
9	lan1	192.168.1.88	"android-7...	e4:47:90:8a:05:6b	2018-04-29 ...		<input type="checkbox"/>
10	lan1	192.168.1.89	"iPhone"	20:a2:e4:26:ff:a1	2018-04-29 ...		<input type="checkbox"/>

Refresh Interval: 5 minutes Refresh Now

Page 1 of 1 Show 50 items Displaying 1 - 10 of 10

Cancel

This table describes the fields in the above screen.

Table 31 Dashboard > System Status > DHCP Table

LABEL	DESCRIPTION
#	This field is a sequential value, and it is not associated with a specific entry.
Interface	This field identifies the interface that assigned an IP address to a DHCP client.
IP Address	This field displays the IP address currently assigned to a DHCP client or reserved for a specific MAC address. Click the column's heading cell to sort the table entries by IP address. Click the heading cell again to reverse the sort order.
Host Name	This field displays the name used to identify this device on the network (the computer name). The Zyxel Device learns these from the DHCP client requests. "None" shows here for a static DHCP entry.
MAC Address	This field displays the MAC address to which the IP address is currently assigned or for which the IP address is reserved. Click the column's heading cell to sort the table entries by MAC address. Click the heading cell again to reverse the sort order.
Description	For a static DHCP entry, the host name or the description you configured shows here. This field is blank for dynamic DHCP entries.
Reserve	If this field is selected, this entry is a static DHCP entry. The IP address is reserved for the MAC address. If this field is clear, this entry is a dynamic DHCP entry. The IP address is assigned to a DHCP client. To create a static DHCP entry using an existing dynamic DHCP entry, select this field, and then click Apply . To remove a static DHCP entry, clear this field, and then click Apply .
Refresh Interval	Select how often you want this window to be updated automatically.
Refresh Now	Click this to update the information in the window right away.

6.2.4 Number of Login Users Screen

Click the Number of Login Users link to see the following screen.

Figure 171 Dashboard > System Status > Number of Login Users

#	User ID	Reauth/Lease Time	Session Timeout	Remaining Time	Remaining Quota (T / U / ...)	Type	IP Address	User Info	Force Logout
1	admin	unlimited / 00:30:00	unlimited	n/a	- / - / -	http/https	192.168.1...	admin(admin)	

This table describes the fields in the above screen.

Table 32 Dashboard > System Status > Number of Login Users

LABEL	DESCRIPTION
#	This field is a sequential value and is not associated with any entry.
User ID	This field displays the user name of each user who is currently logged in to the Zyxel Device.
Reauth/Lease Time	This field displays the amount of reauthentication time remaining and the amount of lease time remaining for each user.
Session Timeout	This field displays the total amount of time the account (authenticated by an external server) can use to log into the UAG or access the Internet through the Zyxel Device. This shows unlimited for an administrator account.

Table 32 Dashboard > System Status > Number of Login Users

LABEL	DESCRIPTION
	This field displays how much longer the account can use to log into the Zyxel Device or access the Internet through the Zyxel Device. This shows N/A for an administrator account.
Remaining Quota (T /U /D)	This field displays the remaining amount of data that can be transmitted or received by each account. You can see the amount of either data in both directions (Total) or upstream data (Upload) and downstream data (Download). This shows -/-/ for an administrator account.
Type	This field displays the way the user logged in to the Zyxel Device.
IP address	This field displays the IP address of the computer used to log in to the Zyxel Device.
User Info	This field displays the types of user accounts the Zyxel Device uses. If the user type is ext-user (external user), this field will show its external-group information when you move your mouse over it. If the external user matches two external-group objects, both external-group object names will be shown.
Force Logout	Click this icon to end a user's session.

6.2.5 System Resources Screen

Hover your mouse over an item and click the arrow on the right to see more details on that resource.

Figure 172 Dashboard > System Resources

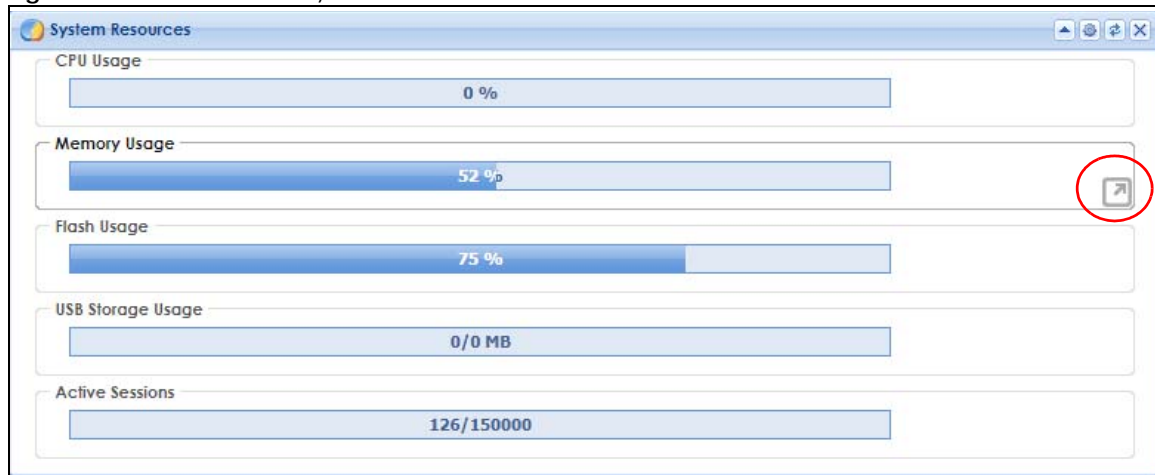

This table describes the fields in the above screen.

Table 33 Dashboard > System Resources

LABEL	DESCRIPTION
CPU Usage	This field displays what percentage of the Zyxel Device's processing capability is currently being used. Hover your cursor over this field to display the Show CPU Usage icon that takes you to a chart of the Zyxel Device's recent CPU usage.
Memory Usage	This field displays what percentage of the Zyxel Device's RAM is currently being used. Hover your cursor over this field to display the Show Memory Usage icon that takes you to a chart of the Zyxel Device's recent memory usage.
Flash Usage	This field displays what percentage of the Zyxel Device's onboard flash memory is currently being used.

Table 33 Dashboard > System Resources

LABEL	DESCRIPTON
USB Storage Usage	This field shows how much storage in the USB device connected to the Zyxel Device is in use.
Active Sessions	This field shows how many sessions, established and non-established, that pass through/from/to/within the ZyWALL. Hover your cursor over this field to display icons. Click the Detail icon to go to the Session Monitor screen to see details about the active sessions. Click the Show Active Sessions icon to display a chart of Zyxel Device's recent session usage.

6.2.6 Extension Slot Screen

Figure 173 Dashboard > Extension Slot



#	Extension Slot	Device	Status
1	USB 1	none	none
2	USB 2	none	none

This table describes the fields in the above screen.

Table 34 Dashboard > Extension Slot

LABEL	DESCRIPTION
#	This is the index number of the entry.
Extension Slot	This field displays the name of each extension slot.
Device	<p>This field displays the name of the device connected to the extension slot (or none if no device is detected). For an installed SEM (Security Extension Module) card, this field displays what kind of SEM card is installed.</p> <p>SEM-VPN - VPN accelerator. The SEM-VPN provides 500 Mbps VPN throughput, 2,000 IPSec VPN tunnels, and 750 SSL VPN users.</p> <p>SEM-DUAL - accelerator for both VPN and UTM. The SEM-DUAL provides the benefits of the SEM-VPN and increases the maximum anti-virus and IDP traffic throughput from 100 Mbps to 400 Mbps.</p> <p>USB Flash Drive - Indicates a connected USB storage device and the drive's storage capacity.</p>
Status	<p>The status for an installed 3G USB dongle is none. For cellular (mobile broadband) interfaces, see Section 7.11 on page 232 for the status that can appear. For an installed SEM (Security Extension Module) card, this field displays one of the following:</p> <p>Active - The SEM card is working properly.</p> <p>Ready to activate - The SEM was inserted while the Zyxel Device was operating. Restart the Zyxel Device to use the SEM.</p> <p>Driver load failed - An error occurred during the Zyxel Device's attempt to activate the SEM card. Make sure the SEM is installed properly and the thumbscrews are tightened. If this status still displays, contact your vendor.</p> <p>For a USB storage device, this field displays one of the following:</p> <p>Ready - A USB storage device connected to the Zyxel Device is ready for the Zyxel Device to use.</p> <p>Unused - The Zyxel Device is unable to mount a USB storage device connected to the Zyxel Device.</p>

6.2.7 Interface Status Summary Screen

Interfaces per Zyxel Device model vary.

Figure 174 Dashboard > Interface Status Summary

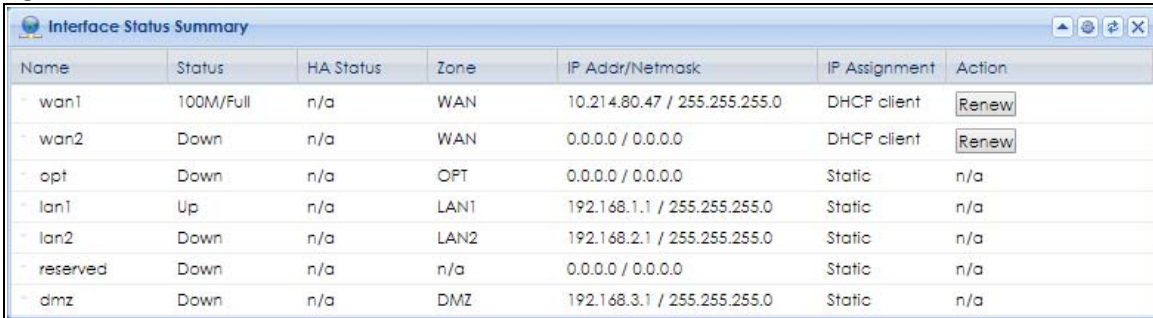

Name	Status	HA Status	Zone	IP Addr/Netmask	IP Assignment	Action
wan1	100M/Full	n/a	WAN	10.214.80.47 / 255.255.255.0	DHCP client	<input type="button" value="Renew"/>
wan2	Down	n/a	WAN	0.0.0.0 / 0.0.0.0	DHCP client	<input type="button" value="Renew"/>
opt	Down	n/a	OPT	0.0.0.0 / 0.0.0.0	Static	n/a
lan1	Up	n/a	LAN1	192.168.1.1 / 255.255.255.0	Static	n/a
lan2	Down	n/a	LAN2	192.168.2.1 / 255.255.255.0	Static	n/a
reserved	Down	n/a	n/a	0.0.0.0 / 0.0.0.0	Static	n/a
dmz	Down	n/a	DMZ	192.168.3.1 / 255.255.255.0	Static	n/a

This table describes the fields in the above screen.

Table 35 Dashboard > Interface Status Summary

LABEL	DESCRIPTION
Name	This field displays the name of each interface.
Status	<p>This field displays the current status of each interface. The possible values depend on what type of interface it is.</p> <p>For Ethernet interfaces:</p> <p>Inactive - The Ethernet interface is disabled.</p> <p>Down - The Ethernet interface does not have any physical ports associated with it or the Ethernet interface is enabled but not connected.</p> <p>Speed / Duplex - The Ethernet interface is enabled and connected. This field displays the port speed and duplex setting (Full or Half).</p> <p>For cellular (mobile broadband) interfaces, see Section 7.11 on page 232 for the status that can appear.</p> <p>For the auxiliary interface:</p> <p>Inactive - The auxiliary interface is disabled.</p> <p>Connected - The auxiliary interface is enabled and connected.</p> <p>Disconnected - The auxiliary interface is not connected.</p> <p>For PPP interfaces:</p> <p>Connected - The PPP interface is connected.</p> <p>Disconnected - The PPP interface is not connected.</p> <p>If the PPP interface is disabled, it does not appear in the list.</p> <p>For WLAN interfaces:</p> <p>Up - The WLAN interface is enabled.</p> <p>Down - The WLAN interface is disabled.</p>

Table 35 Dashboard > Interface Status Summary

LABEL	DESCRIPTION
HA Status	This field displays the status of the interface in the virtual router. Active - This interface is the master interface in the virtual router. Stand-By - This interface is a backup interface in the virtual router. Fault - This VRRP group is not functioning in the virtual router right now. For example, this might happen if the interface is down. n/a - Device HA is not active on the interface.
Zone	This field displays the zone to which the interface is currently assigned.
IP Addr/Netmask	This field displays the current IP address and subnet mask assigned to the interface. If the IP address is 0.0.0.0/0.0.0.0, the interface is disabled or did not receive an IP address and subnet mask via DHCP. If this interface is a member of an active virtual router, this field displays the IP address it is currently using. This is either the static IP address of the interface (if it is the master) or the management IP address (if it is a backup).
IP Assignment	This field displays the interface's IP assignment. It will show DHCP or Static .
Action	Use this field to get or to update the IP address for the interface. Click Renew to send a new DHCP request to a DHCP server. Click the Connect icon to have the Zyxel Device try to connect a PPPoE/PPTP interface. If the interface cannot use one of these ways to get or to update its IP address, this field displays n/a . Click the Disconnect icon to stop a PPPoE/PPTP connection.

6.2.8 Secured Service Status Screen

This part shows what Unified Threat Management (UTM) services are available and enabled.

Figure 175 Dashboard > Secured Service Status

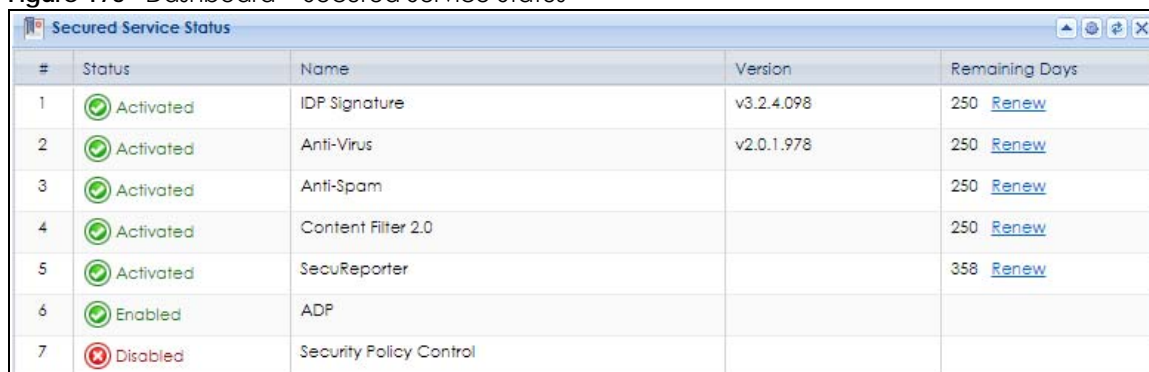

#	Status	Name	Version	Remaining Days
1	Activated	IDP Signature	v3.2.4.098	250 Renew
2	Activated	Anti-Virus	v2.0.1.978	250 Renew
3	Activated	Anti-Spam		250 Renew
4	Activated	Content Filter 2.0		250 Renew
5	Activated	SecuReporter		358 Renew
6	Enabled	ADP		
7	Disabled	Security Policy Control		

This table describes the fields in the above screen.

Table 36 Dashboard > Secured Service Status

LABEL	DESCRIPTION
#	This field is a sequential value, and it is not associated with a specific status.
Status	This field displays the status of the Zyxel Device's secure services. It will show four types of status, Activated or Not Activated or Disabled or Enabled .
Name	This field displays the name of the service, for example Anti-Spam .

Table 36 Dashboard > Secured Service Status

LABEL	DESCRIPTION
Version	This field displays the version number of the services.
Remaining Days	This field displays the number of days remaining before the license expires. Click Activate to connect with the myZyxel server and activate the license.

6.2.9 Content Filter Statistics Screen

Configure **Configuration > UTM Profile > Content Filter** and then view results here.

Figure 176 Dashboard > Content Filter Statistics

Web Request Statistics	
Total Web Pages Inspected:	0
Blocked:	0
Warned:	0
Passed:	0
Category Hit Summary	
Security Threat:	0
Managed Web Pages:	0

This table describes the fields in the above screen.

Table 37 Dashboard > Content Filter Statistics

LABEL	DESCRIPTION
Web Request Statistics	
Total Web Pages Inspected	This is the number of web pages the Zyxel Device has checked to see whether they belong to the categories you selected in the content filter screen.
Blocked	This is the number of web pages that the Zyxel Device blocked access.
Warned	This is the number of web pages for which the Zyxel Device has displayed a warning message to the access requesters.
Passed	This is the number of web pages that the Zyxel Device allowed access.
Category Hit Summary	
Security Threat	This is the number of requested web pages that belong to the Security Threat categories you have selected in the content filter screen.
Managed Web pages	This is the number of requested web pages that belong to the managed categories you have selected in the content filter screen.

6.2.10 Top 5 Viruses Screen

Figure 177 Dashboard > Top 5 Viruses

#	Virus Name	Hits
---	------------	------

This table describes the fields in the above screen.

Table 38 Dashboard > Top 5 Viruses

LABEL	DESCRIPTION
#	This is the entry's rank in the list of the most commonly detected viruses.
Virus Name	This is the name of a detected virus.
Hits	This is how many times the Zyxel Device has detected the event described in the entry.

6.2.11 Top 5 Intrusions Screen

Figure 178 Dashboard > Top 5 Intrusions

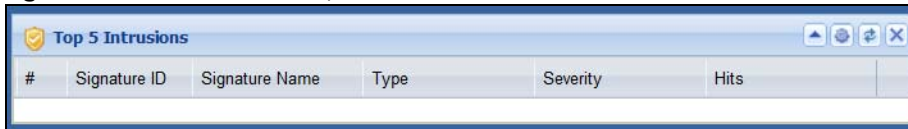

#	Signature ID	Signature Name	Type	Severity	Hits

This table describes the fields in the above screen.

Table 39 Dashboard > Top 5 Intrusions

LABEL	DESCRIPTION
#	This is the entry's rank in the list of the most commonly triggered signature policies.
Signature ID	This is the identification number of the signature.
Signature Name	This is the name of the signature.
Type	This is the type of the signature, for example Schedule .
Severity	This is the level of threat that the intrusions may pose.
Hits	This is how many times the Zyxel Device has detected the event described in the entry.

6.2.12 Top 5 IPv4/IPv6 Security Policy Rules that Blocked Traffic Screen

Figure 179 Dashboard > Top 5 IPv4/IPv6 Security Policy Rules that Blocked Traffic

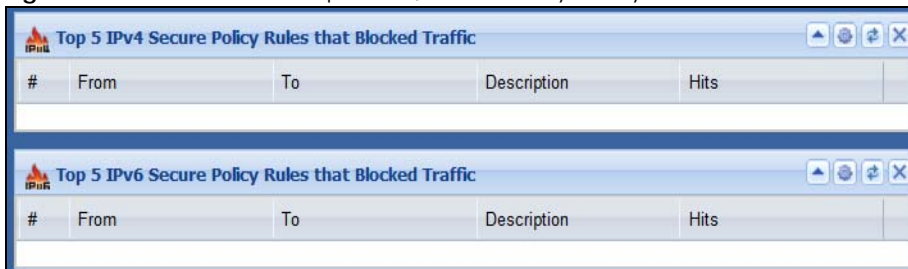

#	From	To	Description	Hits

#	From	To	Description	Hits

This table describes the fields in the above screen.

Table 40 Dashboard > IPv4/IPv6 Security Policy Rules that Blocked Traffic

LABEL	DESCRIPTION
#	This is the entry's rank in the list of the most commonly triggered security policies.
From	This shows the zone packets came from that the triggered security policy.
To	This shows the zone packets went to that the triggered security policy.

Table 40 Dashboard > IPv4/IPv6 Security Policy Rules that Blocked Traffic

LABEL	DESCRIPTION
Description	This field displays the descriptive name (if any) of the triggered security policy.
Hits	This field displays how many times the security policy was triggered.

6.2.13 The Latest Alert Logs Screen

Figure 180 Dashboard > The Latest Alert Logs

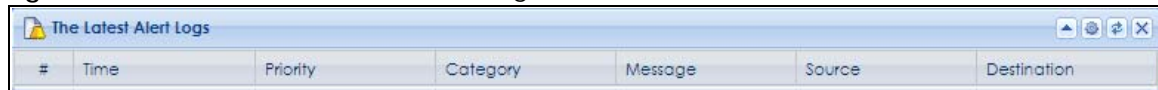

#	Time	Priority	Category	Message	Source	Destination
---	------	----------	----------	---------	--------	-------------

This table describes the fields in the above screen.

Table 41 Dashboard > The Latest Alert Logs

LABEL	DESCRIPTION
#	This is the entry's rank in the list of alert logs.
Time	This field displays the date and time the log was created.
Priority	This field displays the severity of the log.
Category	This field displays the type of log generated.
Message	This field displays the actual log message.
Source	This field displays the source address (if any) in the packet that generated the log.
Destination	This field displays the destination address (if any) in the packet that generated the log.
Source Interface	This field displays the incoming interface of the packet that generated the log.

6.3 VPN Screen

VPN models have a VPN tab. If no VPN tunnels are configured, a link to the **Configuration > VPN < IPSec VPN** screen appears.

Figure 181 Dashboard > VPN Status

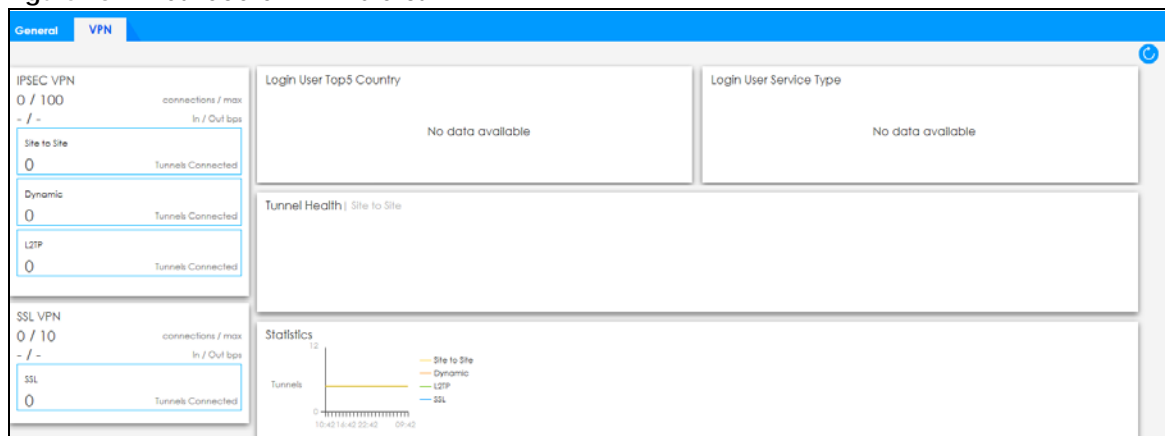

This screen gives information such as:

- The actual number of connections and the maximum number of tunnel connections for each VPN type (IPSec/L2TP/SSL)
- The Incoming and Outgoing traffic amount in bps for each VPN type (IPSec/L2TP/SSL)
- The number of connected tunnels for each type of tunnel: Site to Site/Dynamic/ L2TP / SSL
- The Top 5 Logged in VPN Users per country
- The Top 5 Logged in VPN Users per Service Type
- The Top 5 Logged in VPN Users that are online
- Tunnel Health by Top 5 DPD (Dead Peer Detection) failures
- The top 5 connectivity Failures
- Graphical tunnel statistics.

Click the **Refresh** icon to update the information in the window right away.

PART II

Technical Reference

CHAPTER 7

Monitor

7.1 Overview

Use the **Monitor** screens to check status and statistics information.

7.1.1 What You Can Do in this Chapter

Use the **Monitor** screens for the following.

- Use the **System Status > Port Statistics** screen (see [Section 7.2.1 on page 217](#)) to look at packet statistics for each physical port.
- Use the **System Status > Port Statistics > Graph View** screen (see [Section 7.2.1 on page 217](#)) to look at a line graph of packet statistics for each physical port.
- Use the **System Status > Interface Status** screen ([Section 7.3 on page 218](#)) to see all of the Zyxel Device's interfaces and their packet statistics.
- Use the **System Status > Traffic Statistics** screen (see [Section 7.4 on page 222](#)) to start or stop data collection and view statistics.
- Use the **System Status > Session Monitor** screen (see [Section 7.5 on page 225](#)) to view sessions by user or service.
- Use the **System Status > IGMP Statistics** screen (see [Section 7.6 on page 227](#)) to view multicasting details.
- Use the **System Status > DDNS Status** screen (see [Section 7.7 on page 228](#)) to view the status of the Zyxel Device's DDNS domain names.
- Use the **System Status > IP/MAC Binding** screen ([Section 7.8 on page 228](#)) to view a list of devices that have received an IP address from Zyxel Device interfaces with IP/MAC binding enabled.
- Use the **System Status > Login Users** screen ([Section 7.9 on page 229](#)) to look at a list of the users currently logged into the Zyxel Device.
- Use the **System Status > Dynamic Guest** screen (see [Section 7.10 on page 230](#)) to look at a list of the automatically created users allowed to access the Zyxel Device's services.
- Use the **System Status > Cellular Status** screen ([Section 7.11 on page 232](#)) to check your mobile broadband connection status.
- Use the **System Status > UPnP Port Status** screen (see [Section 7.12 on page 235](#)) to look at a list of the NAT port mapping rules that UPnP creates on the Zyxel Device.
- Use the **System Status > USB Storage** screen ([Section 7.13 on page 236](#)) to view information about a connected USB storage device.
- Use the **System Status > Ethernet Neighbor** screen ([Section 7.14 on page 237](#)) to view and manage the Zyxel Device's neighboring devices through Layer Link Discovery Protocol (LLDP).
- Use the **System Status > FQDN Object** screen ([Section 7.15 on page 238](#)) to display fully qualified domain name (FQDN) object cache lists used in DNS queries.
- Use the **Wireless > AP Information > AP List** screen ([Section 7.16 on page 240](#)) to display which APs are currently connected to the Zyxel Device.

- Use the **Wireless > AP Information > Radio List** screen ([Section 7.17 on page 250](#)) to display statistics about the wireless radio transmitters in each of the APs connected to the Zyxel Device.
- Use the **Wireless > AP Information > Top N APs** screen ([Section 7.18 on page 253](#)) to view managed APs with the most wireless traffic usage and most associated wireless stations.
- Use the **Wireless > AP Information > Single AP** screen ([Section 7.19 on page 255](#)) to view APs wireless traffic usage and associated wireless stations for a managed AP.
- Use the **Wireless > ZyMesh** screen ([Section 7.20 on page 256](#)) to display statistics about the ZyMesh wireless connections between the managed APs.
- Use the **Wireless > SSID Info** screen ([Section 7.21 on page 257](#)) to display the number of wireless clients that are currently connected to an SSID and the SSID's security mode.
- Use the **Wireless > Station Info > Station List** screen ([Section 7.23 on page 259](#)) to view information on connected wireless stations.
- Use the **Wireless > Station Info > Top N Stations** screen ([Section 7.23 on page 259](#)) to view wireless stations with the most wireless traffic usage.
- Use the **Wireless > Station Info > Single Station** screen ([Section 7.24 on page 260](#)) to view wireless traffic usage for an associated wireless station.
- Use the **Wireless > Detected Device** screen ([Section 7.23 on page 259](#)) to view information about suspected rogue APs.
- Use the **Printer Status** screen (see [Section 7.26 on page 262](#)) to view information about the connected statement printers.
- Use the **SecuDeployer** screen (see [Section 7.27 on page 263](#)) to view Zyxel Device SecuDeployer client(s) managed by the Zyxel Device SecuDeployer server. A Zyxel Device SecuDeployer server provisions local interfaces and IPSec tunnels to Zyxel Device SecuDeployer clients.
- Use the **VPN Monitor > IPSec** screen ([Section 7.27 on page 263](#)) to display and manage active IPSec SAs.
- Use the **VPN Monitor > SSL** screen (see [Section 7.28 on page 264](#)) to list the users currently logged into the VPN SSL client portal. You can also log out individual users and delete related session information.
- Use the **VPN Monitor > L2TP over IPSec** screen (see [Section 7.29 on page 265](#)) to display and manage the Zyxel Device's connected L2TP VPN sessions.
- Use the **UTM Statistics > App Patrol** screen (see [Section 7.30 on page 266](#)) to start or stop data collection and view virus statistics
- Use the **UTM Statistics > Content Filter** screen ([Section 7.31 on page 267](#)) to start or stop data collection and view content filter statistics.
- Use the **UTM Statistics > IDP** screen ([Section 7.32 on page 268](#)) to start or stop data collection and view IDP statistics.
- Use the **UTM Statistics > Anti-Virus** screen (see [Section 7.33 on page 270](#)) to start or stop data collection and view virus statistics.
- Use the **UTM Statistics > Anti-Spam > Summary** screen ([Section 7.34 on page 272](#)) to start or stop data collection and view spam statistics.
- Use the **UTM Statistics > Anti-Spam > Status** screen ([Section 7.34.2 on page 274](#)) to see how many mail sessions the Zyxel Device is currently checking and DNSBL statistics.
- Use the **UTM Statistics > SSL Inspection** screen ([Section 7.35 on page 276](#)) to see a report on SSL Inspection and a certificate cache list.
- Use the **UTM Statistics > Certificate Cache List** screen ([Section 7.35.1 on page 277](#)) to display traffic to destination servers using certificates.
- Use the **Log > View Log** screen (see [Section 7.36.1 on page 278](#)) to view the Zyxel Device's current log messages. You can change the way the log is displayed, you can e-mail the log, and you can also clear the log in this screen.

- Use the **Log > View AP Log** screen (see [Section 7.36.2 on page 280](#)) to view the Zyxel Device's current wireless AP log messages.
- Use the **Log > Dynamic Users Log** screen (see [Section 7.36.3 on page 282](#)) to view the Zyxel Device's dynamic guest account log messages.

7.2 Port Statistics Screen

Use this screen to look at packet statistics for each Gigabit Ethernet port. To access this screen, click **Monitor > System Status > Port Statistics**.

Figure 182 Monitor > System Status > Port Statistics

The screenshot shows the 'Port Statistics' screen. At the top, there's a 'General Settings' section with a 'Poll Interval' set to 5 seconds, a '(1-60 seconds)' label, a 'Set Interval' button, and a 'Stop' button. Below this is a 'Statistics Table' section with a 'Switch To Graphic View' button. The table has columns for '#', 'Port', 'Status', 'TxPkts', 'RxPkts', 'Collisions', 'Tx B/s', 'Rx B/s', and 'Up Time'. The data rows are as follows:

#	Port	Status	TxPkts	RxPkts	Collisions	Tx B/s	Rx B/s	Up Time
1	1	Down	0	0	0	0	0	00:00:00
2	2	100M/Full	43408	961210	0	57	1758	46:07:52
3	3	Down	0	0	0	0	0	00:00:00
4	4	Down	0	0	0	0	0	00:00:00
5	5	Down	0	0	0	0	0	00:00:00

At the bottom of the table, there are navigation controls: 'Page 1 of 1', 'Show 50 items', and 'Displaying 1 - 5 of 5'. Below the table, it shows 'System Up Time: 1 days, 22:03:21'.

The following table describes the labels in this screen.

Table 42 Monitor > System Status > Port Statistics

LABEL	DESCRIPTION
Poll Interval	Enter how often you want this window to be updated automatically, and click Set Interval .
Set Interval	Click this to set the Poll Interval the screen uses.
Stop	Click this to stop the window from updating automatically. You can start it again by setting the Poll Interval and clicking Set Interval .
Switch to Graphic View	Click this to display the port statistics as a line graph.
#	This field is a sequential value, and it is not associated with a specific port.
Port	This field displays the physical port number.
Status	This field displays the current status of the physical port. Down - The physical port is not connected. Speed / Duplex - The physical port is connected. This field displays the port speed and duplex setting (Full or Half).
TxPkts	This field displays the number of packets transmitted from the Zyxel Device on the physical port since it was last connected.
RxPkts	This field displays the number of packets received by the Zyxel Device on the physical port since it was last connected.
Collisions	This field displays the number of collisions on the physical port since it was last connected.

Table 42 Monitor > System Status > Port Statistics (continued)

LABEL	DESCRIPTION
Tx B/s	This field displays the transmission speed, in bytes per second, on the physical port in the one-second interval before the screen updated.
Rx B/s	This field displays the reception speed, in bytes per second, on the physical port in the one-second interval before the screen updated.
Up Time	This field displays how long the physical port has been connected.
System Up Time	This field displays how long the Zyxel Device has been running since it last restarted or was turned on.

7.2.1 The Port Statistics Graph Screen

Use this screen to look at a line graph of packet statistics for each physical port. To access this screen, click **Port Statistics** in the **Status** screen and then the **Switch to Graphic View Button**.

Figure 183 Monitor > System Status > Port Statistics > Switch to Graphic View



The following table describes the labels in this screen.

Table 43 Monitor > System Status > Port Statistics > Switch to Graphic View

LABEL	DESCRIPTION
Refresh Interval	Enter how often you want this window to be automatically updated.
Refresh Now	Click this to update the information in the window right away.
Port Selection	Select the number of the physical port for which you want to display graphics.
Switch to Grid View	Click this to display the port statistics as a table.
bps	The y-axis represents the speed of transmission or reception.
time	The x-axis shows the time period over which the transmission or reception occurred

Table 43 Monitor > System Status > Port Statistics > Switch to Graphic View (continued)

LABEL	DESCRIPTION
TX	This line represents traffic transmitted from the Zyxel Device on the physical port since it was last connected.
RX	This line represents the traffic received by the Zyxel Device on the physical port since it was last connected.
Last Update	This field displays the date and time the information in the window was last updated.

7.3 Interface Status Screen

This screen lists all of the Zyxel Device's interfaces and gives packet statistics for them. Click **Monitor > System Status > Interface Status** to access this screen.

Figure 184 Monitor > System Status > Interface Status

Interface Status							
Name	Port/Binding	Status	Zone	IP Addr/Netmask	IP Assignment	Services	Action
wan1	P1	100M/Full	WAN	172.21.60.34 / ...	DHCP client	n/a	Renew
wan1_ppp	P1	Inactive	WAN	0.0.0.0 / 0.0.0.0	Dynamic	n/a	n/a
wan2	P2	Down	WAN	0.0.0.0 / 0.0.0.0	DHCP client	n/a	Renew
wan2_ppp	P2	Inactive	WAN	0.0.0.0 / 0.0.0.0	Dynamic	n/a	n/a
lan1	P3, P4, P5, P6	Down	LAN1	192.168.1.1 / ...	Static	DHCP server	n/a
lan2	n/a	Down	LAN2	192.168.2.1 / ...	Static	DHCP server	n/a
dmz	n/a	Down	DMZ	192.168.3.1 / ...	Static	DHCP server	n/a

Tunnel Interface Status							
Name	Status	Zone	IP Address	My Address	Remote Gateway Address	Mode	

IPv6 Interface Status							
Name	Port	Status	Zone	IP Address	Services	Action	
wan1	P1	Inactive	WAN	::	n/a,n/a	n/a	
wan1_ppp	P1	Inactive	WAN	::	n/a,n/a	n/a	
wan2	P2	Down	WAN	::	n/a,n/a	n/a	
wan2_ppp	P2	Inactive	WAN	::	n/a,n/a	n/a	
lan1	P3, P4...	Down	LAN1	::	n/a,n/a	n/a	
lan2	n/a	Down	LAN2	::	n/a,n/a	n/a	
dmz	n/a	Down	DMZ	::	n/a,n/a	n/a	

Interface Statistics						
Refresh						
Name	Status	TxPkts	RxPkts	Tx B/s	Rx B/s	
wan1	100M/Full	1066861	1092915	0	538	
wan2	Down	2	0	0	0	
lan1	Down	11	8	0	0	
lan2	Down	1	0	0	0	
dmz	Down	1	0	0	0	

Each field is described in the following table.

Table 44 Monitor > System Status > Interface Status

LABEL	DESCRIPTION
Interface Status	If an Ethernet interface does not have any physical ports associated with it, its entry is displayed in light gray text.
Name	This field displays the name of each interface. If there is an Expand icon (plus-sign) next to the name, click this to look at the status of virtual interfaces on top of this interface.
Port/Binding	This field displays the physical port number.
Status	<p>This field displays the current status of each interface. The possible values depend on what type of interface it is.</p> <p>For Ethernet interfaces:</p> <ul style="list-style-type: none"> • Inactive - The Ethernet interface is disabled. • Down - The Ethernet interface does not have any physical ports associated with it or the Ethernet interface is enabled but not connected. • Speed / Duplex - The Ethernet interface is enabled and connected. This field displays the port speed and duplex setting (Full or Half). <p>For cellular (mobile broadband) interfaces, see Section 7.13 on page 236 the Web Help for the status that can appear.</p> <p>For the auxiliary interface:</p> <ul style="list-style-type: none"> • Inactive - The auxiliary interface is disabled. • Connected - The auxiliary interface is enabled and connected. • Disconnected - The auxiliary interface is not connected. <p>For virtual interfaces, this field always displays Up. If the virtual interface is disabled, it does not appear in the list.</p> <p>For VLAN and bridge interfaces, this field always displays Up. If the VLAN or bridge interface is disabled, it does not appear in the list.</p> <p>For PPP interfaces:</p> <ul style="list-style-type: none"> • Connected - The PPP interface is connected. • Disconnected - The PPP interface is not connected. <p>If the PPP interface is disabled, it does not appear in the list.</p> <p>For WLAN interfaces:</p> <ul style="list-style-type: none"> • Up - The WLAN interface is enabled. • Down - The WLAN interface is disabled.
HA Status	<p>This field displays the status of the interface in the virtual router.</p> <ul style="list-style-type: none"> • Active - This interface is the master interface in the virtual router. • Stand-By - This interface is a backup interface in the virtual router. • Fault - This VRRP group is not functioning in the virtual router right now. For example, this might happen if the interface is down. • n/a - Device HA is not active on the interface.
Zone	This field displays the zone to which the interface is assigned.
IP Addr/Netmask	<p>This field displays the current IP address and subnet mask assigned to the interface. If the IP address and subnet mask are 0.0.0.0, the interface is disabled or did not receive an IP address and subnet mask via DHCP.</p> <p>If this interface is a member of an active virtual router, this field displays the IP address it is currently using. This is either the static IP address of the interface (if it is the master) or the management IP address (if it is a backup).</p>

Table 44 Monitor > System Status > Interface Status (continued)

LABEL	DESCRIPTION
IP Assignment	This field displays how the interface gets its IP address. <ul style="list-style-type: none"> • Static - This interface has a static IP address. • DHCP Client - This interface gets its IP address from a DHCP server.
Services	This field lists which services the interface provides to the network. Examples include DHCP relay , DHCP server , DDNS , RIP , and OSPF . This field displays n/a if the interface does not provide any services to the network.
Action	Use this field to get or to update the IP address for the interface. Click Renew to send a new DHCP request to a DHCP server. Click Connect to try to connect a PPPoE/PPTP interface. If the interface cannot use one of these ways to get or to update its IP address, this field displays n/a .
Tunnel Interface Status	
This displays the details of the Zyxel Device's configured tunnel interfaces.	
Name	This field displays the name of the interface.
Status	The activate (light bulb) icon is lit when the entry is active and dimmed when the entry is inactive.
Zone	This field displays the zone to which the interface is assigned.
IP Address	This is the IP address of the interface. If the interface is active (and connected), the Zyxel Device tunnels local traffic sent to this IP address to the Remote Gateway Address .
My Address	This is the interface or IP address uses to identify itself to the remote gateway. The Zyxel Device uses this as the source for the packets it tunnels to the remote gateway.
Remote Gateway Address	This is the IP address or domain name of the remote gateway to which this interface tunnels traffic.
Mode	This field displays the tunnel mode that you are using.
IPv6 Interface Status	
If an Ethernet interface does not have any physical ports associated with it, its entry is displayed in light gray text.	
Name	This field displays the name of each interface. If there is an Expand icon (plus-sign) next to the name, click this to look at the status of virtual interfaces on top of this interface.
Port	This field displays the physical port number.

Table 44 Monitor > System Status > Interface Status (continued)

LABEL	DESCRIPTION
Status	<p>This field displays the current status of each interface. The possible values depend on what type of interface it is.</p> <p>For Ethernet interfaces:</p> <ul style="list-style-type: none"> • Inactive - The Ethernet interface is disabled. • Down - The Ethernet interface does not have any physical ports associated with it or the Ethernet interface is enabled but not connected. • Speed / Duplex - The Ethernet interface is enabled and connected. This field displays the port speed and duplex setting (Full or Half). <p>For cellular (mobile broadband) interfaces, see Section 7.13 on page 236 the Web Help for the status that can appear.</p> <p>For the auxiliary interface:</p> <ul style="list-style-type: none"> • Inactive - The auxiliary interface is disabled. • Connected - The auxiliary interface is enabled and connected. • Disconnected - The auxiliary interface is not connected. <p>For virtual interfaces, this field always displays Up. If the virtual interface is disabled, it does not appear in the list.</p> <p>For VLAN and bridge interfaces, this field always displays Up. If the VLAN or bridge interface is disabled, it does not appear in the list.</p> <p>For PPP interfaces:</p> <ul style="list-style-type: none"> • Connected - The PPP interface is connected. • Disconnected - The PPP interface is not connected. <p>If the PPP interface is disabled, it does not appear in the list.</p> <p>For WLAN interfaces:</p> <ul style="list-style-type: none"> • Up - The WLAN interface is enabled. • Down - The WLAN interface is disabled.
Zone	This field displays the zone to which the interface is assigned.
IP Address	<p>This field displays the current IPv6 address assigned to the interface. If the IPv6 address is ::, the interface is disabled or did not receive an IPv6 address via DHCP.</p> <p>If this interface is a member of an active virtual router, this field displays the IPv6 address it is currently using. This is either the static IPv6 address of the interface (if it is the master) or the management IPv6 address (if it is a backup).</p>
Services	This field lists which services the interface provides to the network. Examples include DHCP relay , DHCP server , DDNS , RIP , and OSPF . This field displays n/a if the interface does not provide any services to the network.
Action	Use this field to get or to update the IP address for the interface. Click Renew to send a new DHCP request to a DHCP server. Click Connect to try to connect a PPPoE/PPTP interface. If the interface cannot use one of these ways to get or to update its IP address, this field displays n/a .
<p>Interface Statistics</p> <p>This table provides packet statistics for each interface.</p>	
Refresh	Click this button to update the information in the screen.
Expand/Close	Click this button to show or hide statistics for all the virtual interfaces on top of the Ethernet interfaces.
Name	This field displays the name of each interface. If there is a Expand icon (plus-sign) next to the name, click this to look at the statistics for virtual interfaces on top of this interface.

Table 44 Monitor > System Status > Interface Status (continued)

LABEL	DESCRIPTION
Status	<p>This field displays the current status of the interface.</p> <ul style="list-style-type: none"> • Down - The interface is not connected. • Speed / Duplex - The interface is connected. This field displays the port speed and duplex setting (Full or Half). <p>This field displays Connected and the accumulated connection time (hh:mm:ss) when the PPP interface is connected.</p>
TxPkts	This field displays the number of packets transmitted from the Zyxel Device on the interface since it was last connected.
RxPkts	This field displays the number of packets received by the Zyxel Device on the interface since it was last connected.
Tx B/s	This field displays the transmission speed, in bytes per second, on the interface in the one-second interval before the screen updated.
Rx B/s	This field displays the reception speed, in bytes per second, on the interface in the one-second interval before the screen updated.

7.4 The Traffic Statistics Screen

Click **Monitor > System Status > Traffic Statistics** to display the **Traffic Statistics** screen. This screen provides basic information about the following for example:

- Most-visited Web sites and the number of times each one was visited. This count may not be accurate in some cases because the Zyxel Device counts HTTP GET packets. Please see [Table 45 on page 223](#) for more information.
- Most-used protocols or service ports and the amount of traffic on each one
- LAN IP with heaviest traffic and how much traffic has been sent to and from each one

You use the **Traffic Statistics** screen to tell the Zyxel Device when to start and when to stop collecting information for these reports. You cannot schedule data collection; you have to start and stop it manually in the **Traffic Statistics** screen.

Figure 185 Monitor > System Status > Traffic Statistics

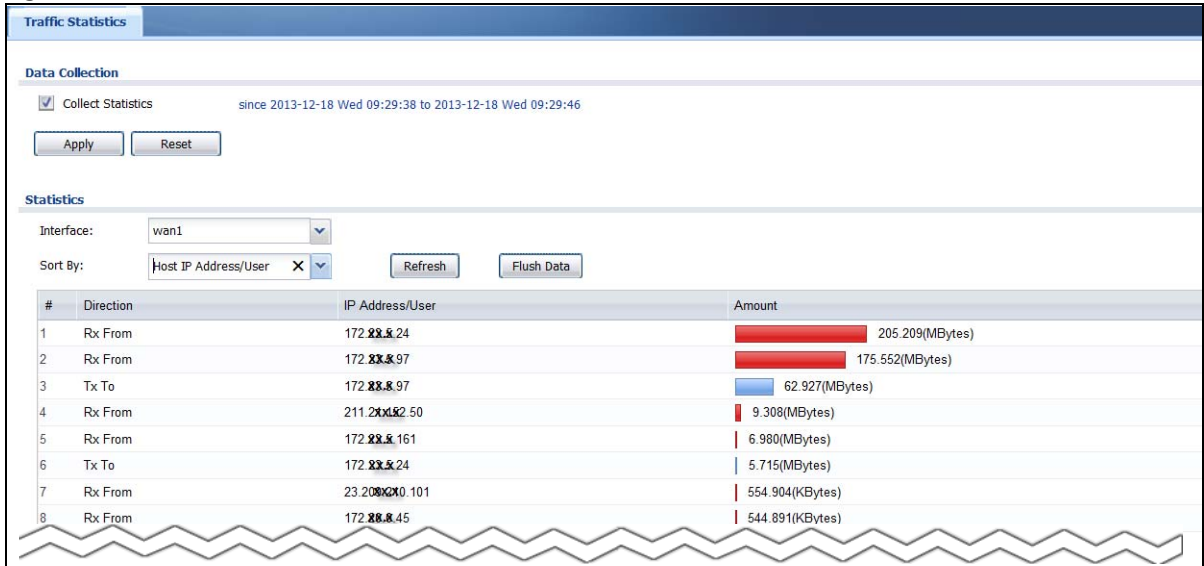

There is a limit on the number of records shown in the report. Please see [Table 46 on page 224](#) for more information. The following table describes the labels in this screen.

Table 45 Monitor > System Status > Traffic Statistics

LABEL	DESCRIPTION
Data Collection	
Collect Statistics	Select this to have the Zyxel Device collect data for the report. If the Zyxel Device has already been collecting data, the collection period displays to the right. The progress is not tracked here real-time, but you can click the Refresh button to update it.
Apply	Click Apply to save your changes back to the Zyxel Device.
Reset	Click Reset to return the screen to its last-saved settings.
Statistics	
Interface	Select the interface from which to collect information. You can collect information from Ethernet, VLAN, bridge and PPPoE/PPTP interfaces.
Sort By	Select the type of report to display. Choices are: <ul style="list-style-type: none"> • Host IP Address/User - displays the IP addresses or users with the most traffic and how much traffic has been sent to and from each one. • Service/Port - displays the most-used protocols or service ports and the amount of traffic for each one. • Web Site Hits - displays the most-visited Web sites and how many times each one has been visited. • Country - displays the countries with the most traffic and the amount of traffic for each one. Each type of report has different information in the report (below).
Refresh	Click this button to update the report display.
Flush Data	Click this button to discard all of the screen's statistics and update the report display.
	These fields are available when the Traffic Type is Host IP Address/User .
#	This field is the rank of each record. The IP addresses and users are sorted by the amount of traffic.
Direction	This field indicates whether the IP address or user is sending or receiving traffic. <ul style="list-style-type: none"> • Ingress - traffic is coming from the IP address or user to the Zyxel Device. • Egress - traffic is going from the Zyxel Device to the IP address or user.

Table 45 Monitor > System Status > Traffic Statistics (continued)

LABEL	DESCRIPTION
IP Address/ User	This field displays the IP address or user in this record.
Amount	This field displays how much traffic was sent or received from the indicated IP address or user. If the Direction is Ingress , a red bar is displayed; if the Direction is Egress , a blue bar is displayed. The unit of measure is bytes, Kbytes, Mbytes or Gbytes, depending on the amount of traffic for the particular IP address or user. The count starts over at zero if the number of bytes passes the byte count limit. See Table 46 on page 224 .
	These fields are available when the Traffic Type is Service/Port .
#	This field is the rank of each record. The protocols and service ports are sorted by the amount of traffic.
Service/Port	This field displays the service and port in this record. The maximum number of services and service ports in this report is indicated in Table 46 on page 224 .
Protocol	This field indicates what protocol the service was using.
Direction	This field indicates whether the indicated protocol or service port is sending or receiving traffic. <ul style="list-style-type: none"> • Ingress - traffic is coming into the Zyxel Devicethrough the interface • Egress - traffic is going out from the Zyxel Device through the interface
Amount	This field displays how much traffic was sent or received from the indicated service / port. If the Direction is Ingress , a red bar is displayed; if the Direction is Egress , a blue bar is displayed. The unit of measure is bytes, Kbytes, Mbytes, Gbytes, or Tbytes, depending on the amount of traffic for the particular protocol or service port. The count starts over at zero if the number of bytes passes the byte count limit. See Table 46 on page 224 .
	These fields are available when the Traffic Type is Web Site Hits .
#	This field is the rank of each record. The domain names are sorted by the number of hits.
Web Site	This field displays the domain names most often visited. The Zyxel Device counts each page viewed on a Web site as another hit. The maximum number of domain names in this report is indicated in Table 46 on page 224 .
Hits	This field displays how many hits the Web site received. The Zyxel Device counts hits by counting HTTP GET packets. Many Web sites have HTTP GET references to other Web sites, and the Zyxel Device counts these as hits too. The count starts over at zero if the number of hits passes the hit count limit. See Table 46 on page 224 .
	These fields are available when the Traffic Type is Country .
#	This field is the rank of each record. The country name is sorted by the amount of traffic.
Country Name	This field displays the name of the country.
Country	This field displays the country code.
Amount	This field displays how much traffic was sent or received from the indicated country. If the Direction is Ingress , a red bar is displayed; if the Direction is Egress , a blue bar is displayed. The unit of measure is bytes, Kbytes, Mbytes, Gbytes, or Tbytes, depending on the amount of traffic for the particular protocol or service port. The count starts over at zero if the number of bytes passes the byte count limit. See Table 46 on page 224 . <ul style="list-style-type: none"> • Ingress - traffic is coming into the Zyxel Device from the country. • Egress - traffic is going from the Zyxel Device to the country.

The following table displays the maximum number of records shown in the report, the byte count limit, and the hit count limit.

Table 46 Maximum Values for Reports

LABEL	DESCRIPTION
Maximum Number of Records	20

Table 46 Maximum Values for Reports (continued)

LABEL	DESCRIPTION
Byte Count Limit	2^{64} bytes; this is just less than 17 million terabytes.
Hit Count Limit	2^{64} hits; this is over 1.8×10^{19} hits.

7.5 The Session Monitor Screen

The **Session Monitor** screen displays all established sessions that pass through the Zyxel Device for debugging or statistical analysis. It is not possible to manage sessions in this screen. The following information is displayed.

- User who started the session
- Protocol or service port used
- Source address
- Destination address
- Number of bytes received (so far)
- Number of bytes transmitted (so far)
- Duration (so far)

You can look at all established sessions that passed through the Zyxel Device by user, service, source IP address, or destination IP address. You can also filter the information by user, protocol / service or service group, source address, and/or destination address and view it by user.

Click **Monitor > System Status > Session Monitor** to display the following screen.

Figure 186 Monitor > System Status > Session Monitor

The screenshot shows the Session Monitor interface. At the top, there's a 'Session Monitor' header. Below it, there's a 'Session' section with various filters: 'View:' set to 'all sessions', 'User:', 'Source Address:', 'Source Country:' (set to 'any'), 'Service:', 'Destination Address:', and 'Destination Country:' (set to 'any'). There are 'Refresh' and 'Search' buttons. Below the filters are 'Clear' and 'Clear All' buttons. At the bottom, there's a table with columns: '#', 'User', 'Service', 'Source', 'Source C...', 'Destination', 'Destination Cou...', 'Rx', 'Tx', and 'Duration'. The table is empty, and the status at the bottom right says 'No data to display'.

The following table describes the labels in this screen.

Table 47 Monitor > System Status > Session Monitor

LABEL	DESCRIPTION
View	<p>Select how you want the established sessions that passed through the Zyxel Device to be displayed. Choices are:</p> <ul style="list-style-type: none"> • sessions by users - display all active sessions grouped by user • sessions by services - display all active sessions grouped by service or protocol • sessions by source IP - display all active sessions grouped by source IP address • session by source region - display all active sessions grouped by where the traffic is coming from by country • sessions by destination IP - display all active sessions grouped by destination IP address • sessions by destination region - display all active sessions grouped by where the traffic is going to by country • all sessions - filter the active sessions by the User, Service, Source Address, and Destination Address, and display each session individually (sorted by user).
Refresh	<p>Click this button to update the information on the screen. The screen also refreshes automatically when you open and close the screen.</p>
	<p>The User, Service, Source Address, Destination Address, Source Country and Destination Country fields display if you view all sessions. Select your desired filter criteria and click the Refresh button to filter the list of sessions.</p>
User	<p>This field displays when View is set to all sessions. Type the user whose sessions you want to view. It is not possible to type part of the user name or use wildcards in this field; you must enter the whole user name.</p>
Service	<p>This field displays when View is set to all sessions. Select the service or service group whose sessions you want to view. The Zyxel Device identifies the service by comparing the protocol and destination port of each packet to the protocol and port of each services that is defined.</p>
Source Address	<p>This field displays when View is set to all sessions. Type the source IP address whose sessions you want to view. You cannot include the source port.</p>
Source Country	<p>This field displays when View is set to all sessions. Select the country where the traffic is coming from.</p>
Destination Address	<p>This field displays when View is set to all sessions. Type the destination IP address whose sessions you want to view. You cannot include the destination port.</p>
Destination Country	<p>This field displays when View is set to all sessions. Select the country where the traffic is going to.</p>
Search	<p>Click this to display all sessions in the table below according to the criteria you defined above.</p>
Clear Clear All	<p>Administrators can use these buttons to forcibly terminate selected TCP/UDP connections. Select one or multiple connections and then click Clear; click Clear All to terminate all connections displayed. Cleared sessions display in the Log > View Log screen.</p>
#	<p>This field is the rank of each record. The names are sorted by the name of user in active session. You can use the pull down menu on the right to choose sorting method.</p>
User	<p>This field displays the user in each active session.</p> <p>If you are looking at the sessions by users (or all sessions) report, click + or - to display or hide details about a user's sessions.</p>
Service	<p>This field displays the protocol used in each active session.</p> <p>If you are looking at the sessions by services report, click + or - to display or hide details about a protocol's sessions.</p>
Source	<p>This field displays the source IP address and port in each active session.</p> <p>If you are looking at the sessions by source IP report, click + or - to display or hide details about a source IP address's sessions.</p>
Source Country	<p>This field displays the source country in each active session.</p>

Table 47 Monitor > System Status > Session Monitor (continued)

LABEL	DESCRIPTION
Destination	This field displays the destination IP address and port in each active session. If you are looking at the sessions by destination IP report, click + or - to display or hide details about a destination IP address's sessions.
Destination Country	This field displays the destination country in each active session.
Rx	This field displays the amount of information received by the source in the active session.
Tx	This field displays the amount of information transmitted by the source in the active session.
Duration	This field displays the length of the active session in seconds.

7.6 IGMP Statistics

The Internet Group Management Protocol (IGMP) Statistics is used by Zyxel Device IP hosts to inform adjacent router about multicast group memberships. It can also be used for one-to-many networking applications such as online streaming video and gaming, distribution of company newsletters, updating address book of mobile computer users in the field allowing more efficient use of resources when supporting these types of applications. Click **Monitor > System Status > IGMP Statistics** to open the following screen.

Figure 187 Monitor > System Status > IGMP Statistics

The following table describes the labels in this screen.

Table 48 Monitor > System Status > IGMP Statistics

LABEL	DESCRIPTION
#	This field is a sequential value, and it is not associated with a specific IGMP Statistics.
Group	This field displays the group of devices in the IGMP.
Source IP	This field displays the host source IP information of the IGMP.
Incoming Interface	This field displays the incoming interface that's connected on the IGMP.
Packet Count	This field displays the packet size of the data being transferred.
Bytes	This field displays the size of the data being transferred in Bytes.
Outgoing Interface	This field displays the outgoing interface that's connected on the IGMP.

7.7 The DDNS Status Screen

The **DDNS Status** screen shows the status of the Zyxel Device's DDNS domain names. Click **Monitor > System Status > DDNS Status** to open the following screen.

Figure 188 Monitor > System Status > DDNS Status

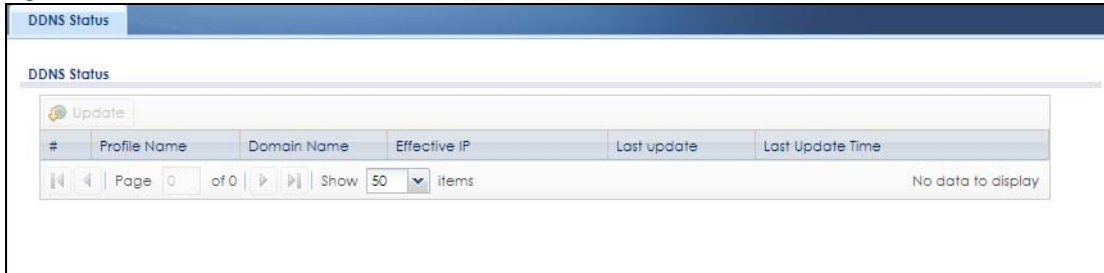

The following table describes the labels in this screen.

Table 49 Monitor > System Status > DDNS Status

LABEL	DESCRIPTION
Update	Click this to have the Zyxel Device update the profile to the DDNS server. The Zyxel Device attempts to resolve the IP address for the domain name.
#	This field is a sequential value, and it is not associated with a specific DDNS server.
Profile Name	This field displays the descriptive profile name for this entry.
Domain Name	This field displays each domain name the Zyxel Device can route.
Effective IP	This is the (resolved) IP address of the domain name.
Last Update Status	This shows whether the last attempt to resolve the IP address for the domain name was successful or not. Updating means the Zyxel Device is currently attempting to resolve the IP address for the domain name.
Last Update Time	This shows when the last attempt to resolve the IP address for the domain name occurred (in year-month-day hour:minute:second format).

7.8 IP/MAC Binding

Click **Monitor > System Status > IP/MAC Binding** to open the **IP/MAC Binding** screen. This screen lists the devices that have received an IP address from Zyxel Device interfaces with IP/MAC binding enabled and have ever established a session with the Zyxel Device. Devices that have never established a session with the Zyxel Device do not display in the list.

Figure 189 Monitor > System Status > IP/MAC Binding



The following table describes the labels in this screen.

Table 50 Monitor > System Status > IP/MAC Binding

LABEL	DESCRIPTION
Interface	Select a Zyxel Device interface that has IP/MAC binding enabled to show to which devices it has assigned an IP address.
#	This field is a sequential value, and it is not associated with a specific IP/MAC binding entry.
IP Address	This is the IP address that the Zyxel Device assigned to a device.
Host Name	This field displays the name used to identify this device on the network (the computer name). The Zyxel Device learns these from the DHCP client requests.
MAC Address	This field displays the MAC address to which the IP address is currently assigned.
Last Access	This is when the device last established a session with the Zyxel Device through this interface.
Description	This field displays the description of the IP/MAC binding.

7.9 The Login Users Screen

Use this screen to look at a list of the users currently logged into the Zyxel Device. To access this screen, click **Monitor > System Status > Login Users**.

Figure 190 Monitor > System Status > Login Users

The screenshot shows the 'Login Users' screen with a 'Cancel User List' button and a 'Force Logout' icon. The table below represents the data shown in the screenshot:

#	User ID	Reauth/Lease Time	Session Timeout	Remaining Time	Remaining Quota (T / U / D)	Type	IP Address	Country	MAC	User Info	Ac.	RADIUS Profile Name
1	admin	19:06:26 / 19:06:33	unlimited	n/a	- / - / -	http/https	10.214.80.37	Private IP	74:27:5A:28:FA:AA	admin(jas...	-	N/A
2	admin	19:12:13 / 20:26:23	unlimited	n/a	- / - / -	http/https	10.214.80.37	Private IP	74:27:5A:28:FA:AA	admin(jas...	-	N/A
3	admin	20:51:40 / 23:59:59	unlimited	n/a	- / - / -	http/https	10.214.80.37	Private IP	74:27:5A:28:FA:AA	admin(jas...	-	N/A

At the bottom of the table, there is a pagination control: 'Page 1 of 1' and 'Show 50 items'. A 'Refresh' button is located below the table.

The following table describes the labels in this screen.

Table 51 Monitor > System Status > Login Users

LABEL	DESCRIPTION
Force Logout	Select a user ID and click this icon to end a user's session.
#	This field is a sequential value and is not associated with any entry.
User ID	This field displays the user name of each user who is currently logged in to the Zyxel Device.
Reauth/Lease Time	This field displays the amount of reauthentication time remaining and the amount of lease time remaining for each user.
Session Timeout	This field displays the total account of time the account (authenticated by an external server) can use to log into the Zyxel Device or access the Internet through the Zyxel Device. This shows unlimited for an administrator account.
Remaining time	This field displays how much longer the account can use to log into the Zyxel Device or access the Internet through the Zyxel Device. This shows N/A for an administrator account.

Table 51 Monitor > System Status > Login Users (continued)

LABEL	DESCRIPTION
Remaining Quota (T/U/D)	This field displays the remaining amount of data that can be transmitted or received by each account. You can see the amount of either data in both directions (Total) or upstream data (Upload) and downstream data (Download). This shows -/-/- for an administrator account.
Type	This field displays the way the user logged in to the Zyxel Device.
IP Address	This field displays the IP address of the computer used to log in to the Zyxel Device.
Country	The Internet Assigned Numbers Authority (IANA) has reserved the following blocks of Private IP addresses specifically for private networks: <ul style="list-style-type: none"> • 10.0.0.0-10.255.255.255 • 172.16.0.0-172.31.255.255 • 192.168.0.0-192.168.255.255 • 224.0.0.0-239.255.255.255
MAC	This field displays the MAC address of the computer used to log in to the Zyxel Device.
User Info	This field displays the types of user accounts the Zyxel Device uses. If the user type is ext-user (external user), this field will show its external-group information when you move your mouse over it. If the external user matches two external-group objects, both external-group object names will be shown.
Acct. Status	For a captive portal login, this field displays the accounting status of the account used to log into the Zyxel Device. Accounting-on means accounting is being performed for the user login. Accounting-off means accounting has stopped for this user login. A "-" displays if accounting is not enabled for this login.
RADIUS Profile Name	This field displays the name of the RADIUS profile used to authenticate the login through the captive portal. N/A displays for logins that do not use the captive portal and RADIUS server authentication.
Refresh	Click this button to update the information in the screen.

7.10 The Dynamic Guest Screen

Dynamic guest accounts can be automatically generated for guest users by using a connected statement printer or the web configurator with the guest-manager account (see [Chapter 21 on page 549](#) for more information). A dynamic guest account has a dynamically-created user name and password. Guest users can log in with the dynamic guest accounts when connecting to an SSID for a specified time unit. Use this screen to look at a list of dynamic guest user accounts on the Zyxel Device's local database. To access this screen, click **Monitor > System Status > Dynamic Guest**.

Figure 191 Monitor > System Status > Dynamic Guest







The following table describes the labels in this screen.

Table 52 Monitor > System Status > Dynamic Guest

LABEL	DESCRIPTION
Remove	Select an entry and click this button to remove it from the list. Note: If you delete a valid user account which is in use, the Zyxel Device ends the user session.
Refresh	Click this button to update the information in the screen.
#	This is the index number of the dynamic guest account in the list.
Status	This field displays whether an account expires or not.
Username	This field displays the user name of the account.
Create Time	This field displays when the account was created.
Remaining Time	This field displays the amount of Internet access time remaining for each account.
Time Period	This field displays the total account of time the account can use to access the Internet through the Zyxel Device.
Expiration Time	This field displays the date and time the account becomes invalid. Note: Once the time allocated to a dynamic account is used up or a dynamic account remains un-used after the expiration time, the account is deleted from the account list.
Quota (T/U/D)	This field displays how much data in both directions (Total) or upstream data (Upload) and downstream data (Download) can be transmitted through the WAN interface before the account expires.
Remaining Quota (T/U/D)	This field displays the remaining amount of data that can be transmitted or received by each account. You can see the amount of either data in both directions (Total) or upstream data (Upload) and downstream data (Download).
Bandwidth (U/D)	This field displays the maximum upstream (Upload) and downstream (Download) bandwidth allowed for the user account in kilobits per second.
Charge	This field displays the total cost of the account.
Payment Info	This field displays the method of payment for each account.
Real Name	This field displays the user's name of the account.
Email	This field displays the email address of the account.
Phone Num	This field displays the mobile phone number for the account.
User Role	This field displays the role of the account.

The following table describes the icons in this screen.

Table 53 Monitor > System Status > Dynamic Guest Icons

LABEL	DESCRIPTION
	This guest account is un-used.
	This guest account is in use and online.
	This guest account has been used but is offline now.
	This guest account expired.
	This guest account has been deleted.

7.11 Cellular Status Screen

This screen displays your mobile broadband connection status. Click **Monitor > System Status > Cellular Status** to display this screen.

Figure 192 Monitor > System Status > Cellular Status

The screenshot shows the 'Cellular Status' screen. At the top, there is a 'Cellular Device Status' section with a 'Refresh' button and a 'More Information' link. Below this is a table with the following data:

#	Extension Slot	Connected Device	Status	Service Provider	Cellular System	Signal Quality
1	USB 1	Huawei E220	Device ready	Chunghwa Telecom	WCDMA	Excellent

At the bottom of the table, there is a pagination control showing 'Page 1 of 1' and 'Show 50 items'. The status 'Displaying 1 - 1 of 1' is also visible.

The following table describes the labels in this screen.

Table 54 Monitor > System Status > Cellular Status

LABEL	DESCRIPTION
Refresh	Click this button to update the information in the screen.
More Information	Click this to display more information on your mobile broadband, such as the signal strength, IMEA/ESN and IMSI. This is only available when the mobile broadband device attached and activated on your Zyxel Device. Refer to Section 7.11.1 on page 234 .
#	This field is a sequential value, and it is not associated with any interface.
Extension Slot	This field displays where the entry's cellular card is located.
Connected Device	This field displays the model name of the cellular card.

Table 54 Monitor > System Status > Cellular Status (continued)

LABEL	DESCRIPTION
Status	<ul style="list-style-type: none"> • No device - no mobile broadband device is connected to the Zyxel Device. • No Service - no mobile broadband network is available in the area; you cannot connect to the Internet. • Limited Service - returned by the service provider in cases where the SIM card is expired, the user failed to pay for the service and so on; you cannot connect to the Internet. • Device detected - displays when you connect a mobile broadband device. • Device error - a mobile broadband device is connected but there is an error. • Probe device fail - the Zyxel Device's test of the mobile broadband device failed. • Probe device ok - the Zyxel Device's test of the mobile broadband device succeeded. • Init device fail - the Zyxel Device was not able to initialize the mobile broadband device. • Init device ok - the Zyxel Device initialized the mobile broadband card. • Check lock fail - the Zyxel Device's check of whether or not the mobile broadband device is locked failed. • Device locked - the mobile broadband device is locked. • SIM error - there is a SIM card error on the mobile broadband device. • SIM locked-PUK - the PUK is locked on the mobile broadband device's SIM card. • SIM locked-PIN - the PIN is locked on the mobile broadband device's SIM card. • Unlock PUK fail - Your attempt to unlock a WCDMA mobile broadband device's PUK failed because you entered an incorrect PUK. • Unlock PIN fail - Your attempt to unlock a WCDMA mobile broadband device's PIN failed because you entered an incorrect PIN. • Unlock device fail - Your attempt to unlock a CDMA2000 mobile broadband device failed because you entered an incorrect device code. • Device unlocked - You entered the correct device code and unlocked a CDMA2000 mobile broadband device. • Get dev-info fail - The Zyxel Device cannot get cellular device information. • Get dev-info ok - The Zyxel Device succeeded in retrieving mobile broadband device information. • Searching network - The mobile broadband device is searching for a network. • Get signal fail - The mobile broadband device cannot get a signal from a network. • Network found - The mobile broadband device found a network. • Apply config - The Zyxel Device is applying your configuration to the mobile broadband device. • Inactive - The mobile broadband interface is disabled. • Active - The mobile broadband interface is enabled. • Incorrect device - The connected mobile broadband device is not compatible with the Zyxel Device. • Correct device - The Zyxel Device detected a compatible mobile broadband device. • Set band fail - Applying your band selection was not successful. • Set band ok - The Zyxel Device successfully applied your band selection. • Set profile fail - Applying your ISP settings was not successful. • Set profile ok - The Zyxel Device successfully applied your ISP settings. • PPP fail - The Zyxel Device failed to create a PPP connection for the cellular interface. • Need auth-password - You need to enter the password for the mobile broadband card in the cellular edit screen. • Device ready - The Zyxel Device successfully applied all of your configuration and you can use the mobile broadband connection.
Service Provider	<p>This displays the name of your network service provider. This shows Limited Service if the service provider has stopped service to the mobile broadband card. For example if the bill has not been paid or the account has expired.</p>

Table 54 Monitor > System Status > Cellular Status (continued)

LABEL	DESCRIPTION
Cellular System	This field displays what type of cellular network the mobile broadband connection is using. The network type varies depending on the mobile broadband card you inserted and could be UMTS , UMTS/HSDPA , GPRS or EDGE when you insert a GSM mobile broadband card, or 1xRTT , EVDO Rev.0 or EVDO Rev.A when you insert a CDMA mobile broadband card.
Signal Quality	This displays the strength of the signal. The signal strength mainly depends on the antenna output power and the distance between your Zyxel Device and the service provider's base station.

7.11.1 More Information

This screen displays more information on your mobile broadband, such as the signal strength, IMEA/ESN and IMSI that helps identify your mobile broadband device and SIM card. Click **Monitor > System Status > Cellular Status > More Information** to display this screen.

Note: This screen is only available when the mobile broadband device is attached to and activated on the Zyxel Device.

Figure 193 Monitor > System Status > Cellular Status > More Information



The following table describes the labels in this screen.

Table 55 Monitor > System Status > Cellular Status > More Information

LABEL	DESCRIPTION
Extension Slot	This field displays where the entry's cellular card is located.
Service Provider	This displays the name of your network service provider. This shows Limited Service if the service provider has stopped service to the mobile broadband card. For example if the bill has not been paid or the account has expired.
Cellular System	This field displays what type of cellular network the mobile broadband connection is using. The network type varies depending on the mobile broadband card you inserted and could be UMTS , UMTS/HSDPA , GPRS or EDGE when you insert a GSM mobile broadband card, or 1xRTT , EVDO Rev.0 or EVDO Rev.A when you insert a CDMA mobile broadband card.

Table 55 Monitor > System Status > Cellular Status > More Information (continued)

LABEL	DESCRIPTION
Signal Strength	This is the Signal Quality measured in dBm.
Signal Quality	This displays the strength of the signal. The signal strength mainly depends on the antenna output power and the distance between your Zyxel Device and the service provider's base station.
Device Manufacturer	This shows the name of the company that produced the mobile broadband device.
Device Model	This field displays the model name of the cellular card.
Device Firmware	This shows the software version of the mobile broadband device.
Device IMEI/ESN	IMEI (International Mobile Equipment Identity) is a 15-digit code in decimal format that identifies the mobile broadband device. ESN (Electronic Serial Number) is an 8-digit code in hexadecimal format that identifies the mobile broadband device.
SIM Card IMSI	IMSI (International Mobile Subscriber Identity) is a 15-digit code that identifies the SIM card.

7.12 The UPnP Port Status Screen

Use this screen to look at the NAT port mapping rules that UPnP creates on the Zyxel Device. To access this screen, click **Monitor > System Status > UPnP Port Status**.

Figure 194 Monitor > System Status > UPnP Port Status

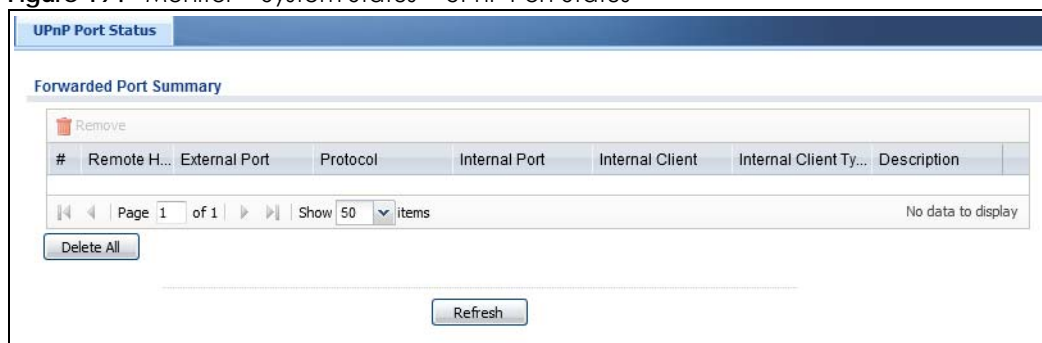

The following table describes the labels in this screen.

Table 56 Monitor > System Status > UPnP Port Status

LABEL	DESCRIPTION
Remove	Select an entry and click this button to remove it from the list.
#	This is the index number of the UPnP-created NAT mapping rule entry.
Remote Host	This field displays the source IP address (on the WAN) of inbound IP packets. Since this is often a wild-card, the field may be blank. When the field is blank, the Zyxel Device forwards all traffic sent to the External Port on the WAN interface to the Internal Client on the Internal Port . When this field displays an external IP address, the NAT rule has the Zyxel Device forward inbound packets to the Internal Client from that IP address only.

Table 56 Monitor > System Status > UPnP Port Status (continued)

LABEL	DESCRIPTION
External Port	This field displays the port number that the Zyxel Device "listens" non the WAN port) for connection requests destined for the NAT rule's Internal Port and Internal Client . The Zyxel Device forwards incoming packets (from the WAN) with this port number to the Internal Client on the Internal Port (on the LAN). If the field displays "0", the Zyxel Device ignores the Internal Port value and forwards requests on all external port numbers (that are otherwise unmapped) to the Internal Client .
Protocol	This field displays the protocol of the NAT mapping rule (TCP or UDP).
Internal Port	This field displays the port number on the Internal Client to which the Zyxel Device should forward incoming connection requests.
Internal Client	This field displays the DNS host name or IP address of a client on the LAN. Multiple NAT clients can use a single port simultaneously if the internal client field is set to 255.255.255.255 for UDP mappings.
Internal Client Type	This field displays the type of the client application on the LAN.
Description	This field displays a text explanation of the NAT mapping rule.
Delete All	Click this to remove all mapping rules from the NAT table.
Refresh	Click this button to update the information in the screen.

7.13 USB Storage Screen

This screen displays information about a connected USB storage device. Click **Monitor > System Status > USB Storage** to display this screen.

Figure 195 Monitor > System Status > USB Storage



The following table describes the labels in this screen.

Table 57 Monitor > System Status > USB Storage

LABEL	DESCRIPTION
Device description	This is a basic description of the type of USB device.
Usage	This field displays how much of the USB storage device's capacity is currently being used out of its total capacity and what percentage that makes.
Filesystem	This field displays what file system the USB storage device is formatted with. This field displays Unknown if the file system of the USB storage device is not supported by the Zyxel Device, such as NTFS.
Speed	This field displays the connection speed the USB storage device supports.

Table 57 Monitor > System Status > USB Storage (continued)

LABEL	DESCRIPTION
Status	<p>Ready - you can have the Zyxel Device use the USB storage device.</p> <p>Click Remove Now to stop the Zyxel Device from using the USB storage device so you can remove it.</p> <p>Unused - the connected USB storage device was manually unmounted by using the Remove Now button or for some reason the Zyxel Device cannot mount it.</p> <p>Click Use It to have the Zyxel Device mount a connected USB storage device. This button is grayed out if the file system is not supported (unknown) by the Zyxel Device.</p> <p>none - no USB storage device is connected.</p>
Detail	<p>This field displays any other information the Zyxel Device retrieves from the USB storage device.</p> <ul style="list-style-type: none"> • Deactivated - the use of a USB storage device is disabled (turned off) on the Zyxel Device. • OutOfSpace - the available disk space is less than the disk space full threshold. • Mounting - the Zyxel Device is mounting the USB storage device. • Removing - the Zyxel Device is unmounting the USB storage device. • none - the USB device is operating normally or not connected.

7.14 Ethernet Neighbor Screen

The Ethernet Neighbor screen allows you to view the Zyxel Device's neighboring devices in one place.

It uses Smart Connect, that is Link Layer Discovery Protocol (LLDP) for discovering and configuring LLDP-aware devices in the same broadcast domain as the Zyxel Device that you're logged into using the web configurator.

LLDP is a layer-2 protocol that allows a network device to advertise its identity and capabilities on the local network. It also allows the device to maintain and store information from adjacent devices which are directly connected to the network device. This helps you discover network changes and perform necessary network reconfiguration and management.

Note: Enable Smart Connect in the **System > ZON** screen.

See also **System > ZON** for more information on the Zyxel One Network (ZON) utility that uses the Zyxel Discovery Protocol (ZDP) for discovering and configuring ZDP-aware Zyxel devices in the same network as the computer on which the ZON utility is installed.

Click **Monitor > System Status > Ethernet Neighbor** to see the following screen

Figure 196 Monitor > System Status > Ethernet Neighbor



The following table describes the fields in the previous screen.

Table 58 Monitor > System Status > Ethernet Neighbor

LABEL	DESCRIPTION
Local Port (Description)	This field displays the port of the Zyxel Device, on which the neighboring device is discovered. For Zyxel Devices that support Port Role , if ports 3 to 5 are grouped together and there is a connection to P5 only, the Zyxel Device will display P3 as the interface port number (even though there is no connection to that port).
Model Name	This field displays the model name of the discovered device.
System Name	This field displays the system name of the discovered device.
Firmware Version	This field displays the firmware version of the discovered device.
Port (Description)	This field displays the first internal port on the discovered device. Internal is an interface type displayed in the Network > Interface > Ethernet > Edit screen. For example, if P1 and P2 are WAN, P3 to P5 are LAN, and P6 is DMZ, then Zyxel Device will display P3 as the first internal interface port number. For Zyxel Devices that support Port Role , if ports 3 to 5 are grouped together and there is a connection to P5 only, the Zyxel Device will display P3 as the first internal interface port number (even though there is no connection to that port).
IP Address	This field displays the IP address of the discovered device.
MAC Address	This field displays the MAC address of the discovered device.
Refresh	Click this button to update the information in the screen.

7.15 FQDN Object Screen

Click **Monitor > System Status > FQDN Object** to open the **FQDN Object** screen. View FQDN-to-IP address mappings cached in this screen. An FQDN is resolved to its IP address using the DNS server configured on the Zyxel Device. If the Zyxel Device receives a DNS query for an FQDN and the Zyxel Device has an FQDN cache entry, the Zyxel Device can map the IP address in a DNS response without having to query a DNS name server. The Zyxel Device updates FQDN-to-IP address mappings when the TTL (Time To Live) setting expires.

You can configure FQDN objects in **Configuration > Object > Address/Geo IP > Address** or **Configuration > Object > Address/Geo IP > Address Group**.

FQDN can be used in Security Policy, Policy Route, BWM and Web Authentication profiles as source and destination criteria. FQDN with a wildcard (for example, *.zyxel.com) can be used in these profiles as destination criteria only.

Suppose you want to block certain users from going to a website with a dynamically updated IP address using DDNS. Create an FQDN object for the website in **Object > Address**, and then create a Security Policy in **Security Policy > Policy Control > Add**. Use the FQDN object to identify the website as a destination, and configure specific users to block. When a user tries to connect to the forbidden website, the Zyxel Device first checks the IP address - website mapping in response to the DNS query and then finds the FQDN object match. The Security Policy that has this FQDN object match can then block the configured users from accessing the website.

Figure 197 Monitor > System Status > FQDN Object

FQDN Object

FQDN Object Cache List

Interface:

#	Name	FQDN	IP Address	TTL
1	panda	www.hack.com	54.175.11.184	36
2	panda	www.hack.com	54.236.97.240	36

Page 1 of 1 Show 50 items Displaying 1 - 2 of 2

IPv6 FQDN Object Cache List

FQDN Object:

#	Name	FQDN	IP Address	TTL
No data to display				

Page 0 of 0 Show 50 items

Refresh

The following table describes the fields in the previous screen.

Table 59 Monitor > System Status > FQDN Object

LABEL	DESCRIPTION
FQDN Object Cache List	
You must first configure IPv4 FQDN objects in Configuration > Object > Address/Geo IP in the IPv4 Address Configuration field.	
FQDN Object	Select a previously created object from the drop-down list box to display related FQDN object caches used in DNS queries.
#	This is the index number of the FQDN entry.
Name	This field displays the name of the selected FQDN object used in DNS queries.
FQDN	This field displays a host's fully qualified domain name.
IP Address	This field displays the mapping of the FQDN to an IP address. This is the IP address of a host.
TTL	This field displays the number of seconds the Zyxel Device holds IP address - FQDN object mapping in its cache. The mapping is updated when the TTL (Time To Live) setting expires.
IPv6 FQDN Object Cache List	
You must first configure IPv6 FQDN objects in Configuration > Object > Address/Geo IP in the IPv6 Address Configuration field.	
FQDN Object	Select an object from the drop-down list box to display related IPv6 FQDN object caches used in DNS queries.
#	This is the index number of the IPv6 FQDN entry.
Name	This field displays the name of the selected IPv6 FQDN object used in DNS queries.
FQDN	This field displays a host's fully qualified domain name.
IP Address	This field displays the mapping of the FQDN to an IPv6 address. This is the IPv6 address of a host.

Table 59 Monitor > System Status > FQDN Object

LABEL	DESCRIPTION
TTL	This field displays the number of seconds the Zyxel Device holds IP address - FQDN object mapping in its cache. The mapping is updated when the TTL (Time To Live) setting expires.
Refresh	Click this button to update the information in the screen.

7.16 AP Information: AP List

The **AP Information** menu contains **AP List**, **Radio List**, **Top N APs** and **Single AP** screens. Click **Monitor > Wireless > AP Information** to display the **AP List** screen.

Figure 198 Monitor > Wireless > AP Information > AP List

#	Status	Description	CPU Usage	IP Address	MAC Address	Station 2.4G	Station 5G
1		AP-B082DC6E7E5E	0 %	0.0.0.0	B0:82:DC:6E:7E:5E	0	0
2		AP-BCCF4F8752CF	4 %	192.168.1.33	BC:CF:4F:87:52:CF	0	0
3		Local-AP	6 %	127.0.0.1	B0:82:DC:70:C0:1E	0	0

The following table describes the labels in this screen.

Table 60 Monitor > Wireless > AP Information > AP List

LABEL	DESCRIPTION
Filter	Click Show Advanced Settings to reveal Filter fields where you can display managed APs by status, keyword or those managed by the Nebula portal.
AP List	Select the type of APs you want to display. Select All to show all kinds of APs that are currently or used to be connected to the Zyxel Device. Select NebulaFlexPRO to show the APs that can work in Nebula cloud management mode.

Table 60 Monitor > Wireless > AP Information > AP List

LABEL	DESCRIPTION
Status	<p>Select the status of APs you want to display.</p> <p>You can display APs managed by the Zyxel Device according to the following:</p> <ul style="list-style-type: none"> • Online All: APs that are online now + APs with configuration conflict + APs with non-supported features + APs that are now updating firmware • Online: APs that are online now • Conflict: APs with configurations in conflict with the Zyxel Device • Non Support: APs with features not supported by the Zyxel Device • Updating: APs that are have updated firmware and rebooted • Offline All: Offline + Offline for Firmware Update • Offline: The CAPWAP server did not receive keep-alive packets from these APs in the last 2 minutes (Offline All - Offline for Firmware Update) • Offline for Firmware Update: APs that were rebooted before updating firmware • Un-Mgmt: APs that are not managed by the Zyxel Device
Keyword	Enter a keyword to display the APs that include it in their AP information, such as model number, firmware version, MAC address and so on. This field is case-sensitive.
Search	<p>Click this to update the list of APs based on the search criteria.</p> <p>Your search criteria is retained when navigating between screens.</p>
Reset	Click this to return the search criteria to the factory defaults and display all currently or previously connected APs without a filter.
Enable Column Freeze	Select this to lock the index columns in place while scrolling to the right.
Edit Selected Rule	Select an AP and click this to change the selected AP's group, radio, VLAN and port settings.
Add to Mgmt	Select an AP and click this to add the selected AP to the managed AP list.
Reboot Device	Select an AP and click this button to force it to restart.
Remove Rule	<p>Select an AP and click this button to remove the AP from the managed AP list.</p> <p>Note: If on the Configuration > Wireless > Controller screen you set the Registration Type to Always Accept, then as soon as you remove an AP from this list it reconnects.</p>
DCS Now	<p>Select one or multiple APs and click this button to use DCS (Dynamic Channel Selection) to allow the AP to automatically find a less-used channel in an environment where there are many APs and there may be interference.</p> <p>Note: You should have enabled DCS in the applied AP radio profile before the APs can use DCS.</p> <p>Note: DCS is not supported on the radio which is working in repeater AP mode.</p>
More Information	Click this icon to see AP Information and Station count.
Radio Info	Select an online AP and click this button to go to the Monitor > Wireless > AP Information > Radio List screen to view detailed information about the AP's radios.
Query Controller Log	Select an AP and click this button to go to the Monitor > Log > View AP Log screen to view the selected AP's current log messages.
Nebula	<p>Select an AP and click this to open a screen where you can set whether the AP's IP address and VLAN settings will be changed when it goes into Nebula cloud management mode.</p> <p>Note: The AP will be set to Nebula cloud management mode and removed from the managed AP list right after you click OK.</p>
Upgrade FW	Select an APs and click this button to update the APs' firmware version.

Table 60 Monitor > Wireless > AP Information > AP List

LABEL	DESCRIPTION
Suppression On	Select an AP and click this button to enable the AP's LED suppression mode. All the LEDs of the AP will turn off after the AP is ready. This button is not available if the selected AP doesn't support suppression mode.
Suppression Off	Select an AP and click this button to disable the AP's LED suppression mode. The AP LEDs stay lit after the AP is ready. This button is not available if the selected AP doesn't support suppression mode.
Locator On	Select an AP and click this button to run the locator feature. The AP's Locator LED will start to blink for 10 minutes by default. It will show the actual location of the AP between several devices on the network.
#	This field is a sequential value, and it is not associated with a specific AP.
Status	This field displays the on-line or off-line status of the AP, move the cursor to the AP icon and a status pop up message will appear.
Description	This field displays the AP's description, which you can configure by selecting the AP's entry and clicking the Edit button.
CPU Usage	This field displays what percentage of the AP's processing capability is currently being used.
IP Address	This field displays the IP address of the AP.
MAC Address	This field displays the MAC address of the AP.
Station 2.4G/5G	This field displays the station count information.
Recent On-line Time	This field displays the latest date and time that the AP was logged on.
Power	<p>This field displays the AP's power status.</p> <p>Full - the AP receives power using a power adaptor and/or through a PoE switch/injector using IEEE 802.3at PoE plus. The PoE device that supports IEEE 802.3at PoE Plus can supply power of up to 30W per Ethernet port.</p> <p>Limited - the AP receives power through a PoE switch/injector using IEEE 802.3af PoE even when it is also connected to a power source using a power adaptor. The PoE device that supports IEEE 802.3af PoE can supply power of up to 15.4W per Ethernet port.</p> <p>When the AP is in limited power mode, the AP throughput decreases and has just one transmitting radio chain.</p> <p>It always shows Full if the AP does not support power detection.</p>
Type	<p>This indicates whether the AP is on the managed AP list (Mgmt) or not (Un-Mgmt).</p> <p>This displays Limited when the AP is configured by conflicted or unsupported setting(s).</p>
Model	This field displays the AP's hardware model information. It displays N/A (not applicable) only when the AP disconnects from the Zyxel Device and the information is unavailable as a result.
R1 Mode/ Profile/ ZyMesh Profile	This field displays the operating mode (AP , MON , rootap , or repeater), AP radio profile name and ZyMesh profile name for Radio1. It displays- for the ZyMesh profile for a radio not using a ZyMesh profile.
R2 Mode/ Profile/ ZyMesh Profile	This field displays the operating mode (AP , MON , rootap , or repeater), AP radio profile name and ZyMesh profile name for Radio2. It displays- for the ZyMesh profile for a radio not using a ZyMesh profile.
Version	This field displays the AP's current firmware version.
Group	This displays the name of the AP group to which the AP belongs.
Mgmt. VLAN ID (AC/AP)	This displays the Access Controller (the Zyxel Device) and runtime management VLAN ID setting for the AP. VLAN Conflict displays if the AP's management VLAN ID does not match the Mgmt. VLAN ID(AC) . This field displays n/a if the Zyxel Device cannot get VLAN information from the AP.

Table 60 Monitor > Wireless > AP Information > AP List

LABEL	DESCRIPTION
Last Off-line Time	This field displays the date and time that the AP was last logged out.
LED Status	<p>This field displays the AP LED status.</p> <p>N/A displays if the AP does not support LED suppression mode and/or have a locator LED to show the actual location of the AP.</p> <p>A gray LED icon signifies that the AP LED suppression mode is enabled. All the LEDs of the AP will turn off after the AP is ready.</p> <p>A green LED icon signifies that the AP LED suppression mode is disabled and the AP LEDs stay lit after the AP is ready.</p> <p>A sun icon signifies that the AP's locator LED is blinking.</p> <p>A circle signifies that the AP's locator LED is extinguished.</p>
Ethernet Uplink	This field displays the AP's uplink port speed and duplex mode (Full or Half).
Bluetooth	<p>This field displays the AP's Bluetooth Low Energy (BLE) capability. Bluetooth Low Energy, which is also known as Bluetooth Smart, transmits less data over a shorter distance and consumes less power than classic Bluetooth. APs communicate with other BLE enabled devices using advertisements.</p> <p>N/A displays if the AP does not support BLE.</p> <p>Unavailable displays if the AP supports Bluetooth, but there is no BLE USB dongle connected to the USB port of the AP. Some APs, such as the WAC5302D-S, need to have a supported BLE USB dongle attached to act as a beacon to broadcast packets.</p> <p>Available displays if the AP supports Bluetooth, detects a BLE device and advertising is inactive.</p> <p>Advertising displays if the AP supports Bluetooth, detects a BLE device and advertising is activated, which means the BLE device can broadcasts packets to every device around it.</p>
Location	This field displays the AP's location you configured.
Roaming Group	This field displays the name of roaming group to which the AP belongs.
Load Balancing Group	This field displays the AP's load balance status when load balancing is enabled on the Zyxel Device. Otherwise, it shows nothing when load balancing is disabled or the radio is in monitor mode.
S/N	This field displays the serial number of the AP.
System Name	This field displays the system name to identify the AP on a network.

The following table describes the icons in this screen.

Table 61 Monitor > Wireless > AP Information > AP List Icons





LABEL	DESCRIPTION
	This AP is not on the management list.
	This AP is on the management list and online.
	This AP is in the process of having its firmware updated.

Table 61 Monitor > Wireless > AP Information > AP List Icons (continued)

LABEL	DESCRIPTION
	This AP is on the management list but offline.
	This indicates one of the following cases: <ul style="list-style-type: none"> This AP has a runtime management VLAN ID setting that conflicts with the VLAN ID setting on the Access Controller (the Zyxel Device). A setting the Zyxel Device assigns to this AP does not match the AP's capability.

7.16.1 AP List: More Information

Use this screen to look at station statistics for the connected AP. To access this screen, select an entry and click the **More Information** button in the **AP List** screen. Use this screen to look at configuration information, port status and station statistics for the connected AP. To access this screen, select an entry and click the **More Information** button in the **AP List** screen.

Figure 199 Monitor > Wireless > AP Information > AP List > More Information

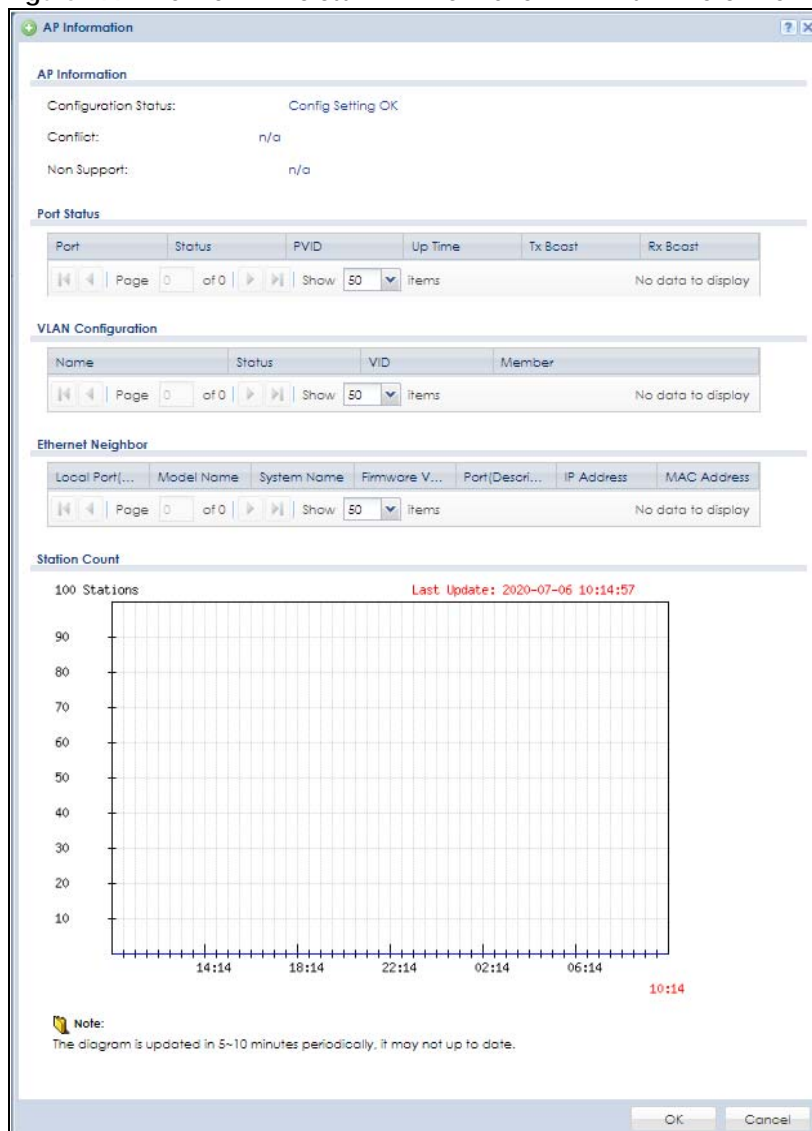

The following table describes the labels in this screen.

Table 62 Monitor > Wireless > AP Information > AP List > More Information

LABEL	DESCRIPTION
Configuration Status	This displays whether or not any of the AP's configuration is in conflict with the Zyxel Device's settings for the AP.
Conflict	If any of the AP's configuration conflicts with the ZyWALL's settings for the AP, this field displays which configuration conflicts. It displays n/a if none of the AP's configuration conflicts with the ZyWALL's settings for the AP.
Non Support	If any of the AP's configuration conflicts with the Zyxel Device's settings for the AP, this field displays which configuration conflicts. It displays n/a if none of the AP's configuration conflicts with the Zyxel Device's settings for the AP.
Port Status	
Port	This shows the name of the physical Ethernet port on the Zyxel Device.
Status	This field displays the current status of each physical port on the AP. Down - The port is not connected. Speed / Duplex - The port is connected. This field displays the port speed and duplex setting (Full or Half).
PVID	This shows the port's PVID. A PVID (Port VLAN ID) is a tag that adds to incoming untagged frames received on a port so that the frames are forwarded to the VLAN group that the tag defines.
Up Time	This field displays how long the physical port has been connected.
TX Bcast	This field displays the number of broadcast packets transmitted on the port.
RX Bcast	This field displays the number of broadcast packets received on the port.
VLAN Configuration	
Name	This shows the name of the VLAN.
Status	This displays whether or not the VLAN is activated.
VID	This shows the VLAN ID number.
Member	This field displays the Ethernet port(s) that is a member of this VLAN.
Ethernet Neighbor	
Local Port (Description)	This field displays the port of the Zyxel Device, on which the neighboring device is discovered. For Zyxel Devices that support Port Role , if ports 3 to 5 are grouped together and there is a connection to P5 only, the Zyxel Device will display P3 as the interface port number (even though there is no connection to that port).
Model Name	This field displays the model name of the discovered device.
System Name	This field displays the system name of the discovered device.
Firmware Version	This field displays the firmware version of the discovered device.
Port (Description)	This field displays the first internal port on the discovered device. Internal is an interface type displayed on the Network > Interface > Ethernet > Edit screen. For example, if P1 and P2 are WAN, P3 to P5 are LAN, and P6 is DMZ, then Zyxel Device will display P3 as the first internal interface port number. For Zyxel Devices that support Port Role, if ports 3 to 5 are grouped together and there is a connection to P5 only, the Zyxel Device will display P3 as the first internal interface port number (even though there is no connection to that port).
IP Address	This field displays the IP address of the discovered device.
MAC Address	This field displays the MAC address of the discovered device.

Table 62 Monitor > Wireless > AP Information > AP List > More Information (continued)

LABEL	DESCRIPTION
Station Count	
	The y-axis represents the number of connected stations.
	The x-axis shows the time over which a station was connected.
Last Update	This field displays the date and time the information in the window was last updated.
OK	Click OK to save your changes back to the Zyxel Device.
Cancel	Click Cancel to exit this screen without saving your changes.

7.16.2 AP List: Config AP

Select an AP and click the **Config AP** button in the **Monitor > Wireless > AP Information > AP List** table to display this screen.

Figure 200 Monitor > Wireless > AP Information > AP List > Config AP

Each field is described in the following table.

Table 63 Monitor > Wireless > AP Information > AP List > Config AP

LABEL	DESCRIPTION
Create new Object	Use this menu to create a new Radio Profile object to associate with this AP.
MAC	This displays the MAC address of the selected AP.

Table 63 Monitor > Wireless > AP Information > AP List > Config AP (continued)

LABEL	DESCRIPTION
Model	This field displays the AP's hardware model information. It displays N/A (not applicable) only when the AP disconnects from the Zyxel Device and the information is unavailable as a result.
S/N	This displays the serial number of the selected AP.
Description	Enter a description for this AP. You can use up to 31 characters, spaces and underscores allowed.
Group Setting	Select an AP group to which you want this AP to belong.
System Name	Enter a name to identify the AP on a network. This is usually the AP's fully qualified domain name.
Location	Specify the name of the place where the AP is located.
Roaming Group	<p>Specify the name of the roaming group to which the AP belongs. You can use up to 31 alphanumeric and @# characters. Dashes and underscores are also allowed. The name should start with a letter or digit.</p> <p>The 802.11k neighbor list a client requests from the AP is generated according to the roaming group and RCPI (Received Channel Power Indicator) value of its neighbor APs.</p> <p>When a client wants to roam from the current AP to another, other APs in the same roaming group or not in a roaming group will be candidates for roaming. Neighbor APs in a different roaming group will be excluded from the 802.11k neighbor lists even when the neighbor AP has the best signal strength.</p> <p>If the AP's roaming group is not configured, any neighbor APs can be candidates for roaming.</p>
Load Balancing Group 1/2	<p>Load balancing is only applied to APs within the same group. If a load balancing group is not assigned to an AP, it will belong to a default group.</p> <p>Each AP can belong to up to two groups.</p>
Radio 1/2 Setting	
Override Group Radio Setting	Select this option to overwrite the AP radio settings with the settings you configure here.
Radio 1/2 OP Mode	<p>Select the operating mode for radio 1 or radio 2.</p> <p>AP Mode means the AP can receive connections from wireless clients and pass their data traffic through to the Zyxel Device to be managed (or subsequently passed on to an upstream gateway for managing).</p> <p>MON Mode means the AP monitors the broadcast area for other APs, then passes their information on to the Zyxel Device where it can be determined if those APs are friendly or rogue. If an AP is set to this mode it cannot receive connections from wireless clients.</p>
Radio 1/2 Profile	Select a profile from the list. If no profile exists, you can create a new one through the Create new Object menu.
Override Group Output Power Setting	Select this option to overwrite the AP output power setting with the setting you configure here.
Output Power	Set the output power of the AP.
Override Group SSID Setting	<p>Select this option to overwrite the AP SSID profile setting with the setting you configure here.</p> <p>This section allows you to associate an SSID profile with the radio.</p>
Edit	Select an SSID and click this button to reassign it. The selected SSID becomes editable immediately upon clicking.
#	This is the index number of the SSID profile. You can associate up to eight SSID profiles with an AP radio.
SSID Profile	Indicates which SSID profile is associated with this radio profile.

Table 63 Monitor > Wireless > AP Information > AP List > Config AP (continued)

LABEL	DESCRIPTION
IP Setting	
Force Overwrite IP Setting	Select this to change the AP's IP address setting to match the configuration in this screen.
Get Automatically	Select this to have the AP act as a DHCP client and automatically get the IP address, subnet mask, and gateway address from a DHCP server.
Used Fixed IP Address	Select this if you want to specify the IP address, subnet mask, gateway and DNS server address manually.
IP Address	Enter the IP address for the AP.
Subnet Mask	Enter the subnet mask of the AP in dot decimal notation. The subnet mask indicates what part of the IP address is the same for all devices in the network.
Gateway	Enter the IP address of the gateway. The AP sends packets to the gateway when it does not know how to route the packet to its destination. The gateway should be on the same network as the AP.
DNS Server IP Address	Enter the IP address of the DNS server.
VLAN Settings	
Force Overwrite VLAN Config	Select this to have the Zyxel Device change the AP's management VLAN to match the configuration in this screen.
Management VALN ID	Enter a VLAN ID for this AP.
As Native VLAN	Select this option to treat this VLAN ID as a VLAN created on the Zyxel Device and not one assigned to it from outside the network.
Storm Control Setting	<p>Traffic storm control limits the number of broadcast and/or multicast packets the Zyxel Device receives on the ports. When the maximum number of allowable broadcast and/or multicast packets is reached, the subsequent packets are discarded.</p> <p>Select Broadcast Storm Control to enable broadcast storm control on the Zyxel Device. Enabling this will drop ingress broadcast traffic in the physical Ethernet port if it exceeds the maximum traffic rate.</p> <p>Select Multicast Storm Control to enable multicast storm control on the Zyxel Device. Enabling this will drop ingress multicast traffic in the physical Ethernet port if it exceeds the maximum traffic rate.</p>
Rogue AP Detection Setting	<p>This feature allows the Zyxel Device to monitor the WiFi signals for other wireless APs. A rogue AP is a wireless access point operating in a network's coverage area that is not under the control of the network administrator, and which can potentially open up holes in a network's security.</p> <p>Select this check box to detect Rogue APs in the network.</p>
Antenna Setting	Select Wall if you mount the Zyxel Device to a wall. Select <i>Ceiling</i> if the Zyxel Device is mounted on a ceiling. You can switch from Wall to Ceiling if there are still wireless dead zones, and vice versa.
LED Suppression Mode Configuration	<p>If the Suppression On check box is checked, the LEDs of your Zyxel Device will turn off after it's ready.</p> <p>If the check box is unchecked, the LEDs will stay lit after the Zyxel Device is ready.</p>

Table 63 Monitor > Wireless > AP Information > AP List > Config AP (continued)

LABEL	DESCRIPTION
Power Setting	Select this check box if you are using a PoE injector that does not support PoE negotiation. Otherwise, the Zyxel Device cannot draw full power from the power sourcing equipment. Enable this power mode to improve the Zyxel Device's performance in this situation. Note: Ensure that the power sourcing equipment can supply enough power to the AP to avoid abnormal system reboots. Note: Only enable this if you are using a passive PoE injector that is not IEEE 802.3at/bt compliant but can still provide full power.
Locator LED Configuration	Click Turn On button to activate the locator. The Locator function will show the actual location of the Zyxel Device between several devices in the network. Otherwise, click Turn Off to disable the locator feature.
Automatically Extinguish After	Enter a time interval between 1 and 60 minutes to stop the locator LED from blinking. Default is 10 minutes.
Reset AP Configuration	Click Apply Factory Default to reset all of the AP settings to the factory defaults.
OK	Click OK to save your changes back to the Zyxel Device.
Cancel	Click Cancel to close the window with changes unsaved.

7.17 AP Information: Radio List

Use this screen to view the summary of the basic information of the radios. Click **Monitor > Wireless > AP Information > Radio List** to display the **Radio List** screen.

Figure 201 Monitor > Wireless > AP Information > Radio List

#	Loading	AP De...	Frequ...	Chan...	Tx Pow...	Station	Rx	Tx	Model	MAC ...	Radio	OP M...	AP / Z...	Anten...
1	-	Local...	2.4GHz	11	19 dBm	0	5024	3890	USG60...	B0:B2...	1	AP	EZMO...	N/A
2	-	Local...	5GHz	165	26 dBm	0	4004	2042	USG60...	B0:B2...	2	AP	EZMO...	N/A

The following table describes the labels in this screen.

Table 64 Monitor > Wireless > AP information > Radio List

LABEL	DESCRIPTION
More Information	Click this icon to see the traffic statistics, station count, SSID, Security Mode and VLAN ID information on the AP.
#	This field is a sequential value, and it is not associated with a specific radio.
Loading	This indicates the AP's load balance status (UnderLoad or OverLoad) when load balancing is enabled on the AP. Otherwise, it shows - when load balancing is disabled or the radio is in monitor mode.
AP Description	Enter a description for this AP. You can use up to 31 characters, spaces and underscores allowed.
Frequency Band	This field displays the WLAN frequency band using the IEEE 802.11 a/b/g/n standard of 2.4 or 5 GHz.

Table 64 Monitor > Wireless > AP information > Radio List

LABEL	DESCRIPTION
Channel ID	This field displays the WLAN channels using the IEEE 802.11 protocols.
Tx Power	This shows the radio's output power (in dBm).
Station	This field displays the station count information.
Rx	This field displays the total number of bytes received by the radio.
Tx	This field displays the total number of bytes transmitted by the radio.
Model	This field displays the AP's hardware model information. It displays N/A (not applicable) only when the AP disconnects from the Zyxel Device and the information is unavailable as a result.
MAC Address	This field displays the MAC address of the AP.
Radio	This field displays the Radio number. For example 1.
OP Mode	<p>This field displays the operating mode of the AP. It displays n/a for the profile for a radio not using an AP profile.</p> <p>AP Mode means the AP can receive connections from wireless clients and pass their data traffic through to the Zyxel Device to be managed (or subsequently passed on to an upstream gateway for managing).</p>
AP / ZyMesh Profile	This indicates the AP radio and ZyMesh profile names to which the radio belongs.
Antenna	<p>This indicates the antenna orientation for the radio (Wall or Ceiling).</p> <p>This shows N/A if the AP does not allow you to adjust coverage depending on the orientation of the antenna for each radio using the web configurator or a physical switch.</p>

7.17.1 Radio List: More Information

This screen allows you to view detailed information about a selected radio's SSID(s), wireless traffic and wireless clients for the preceding 24 hours. To access this window, select an entry and click the **More Information** button in the **Radio List** screen.

Figure 202 Monitor > Wireless > AP Information > Radio List > More Information

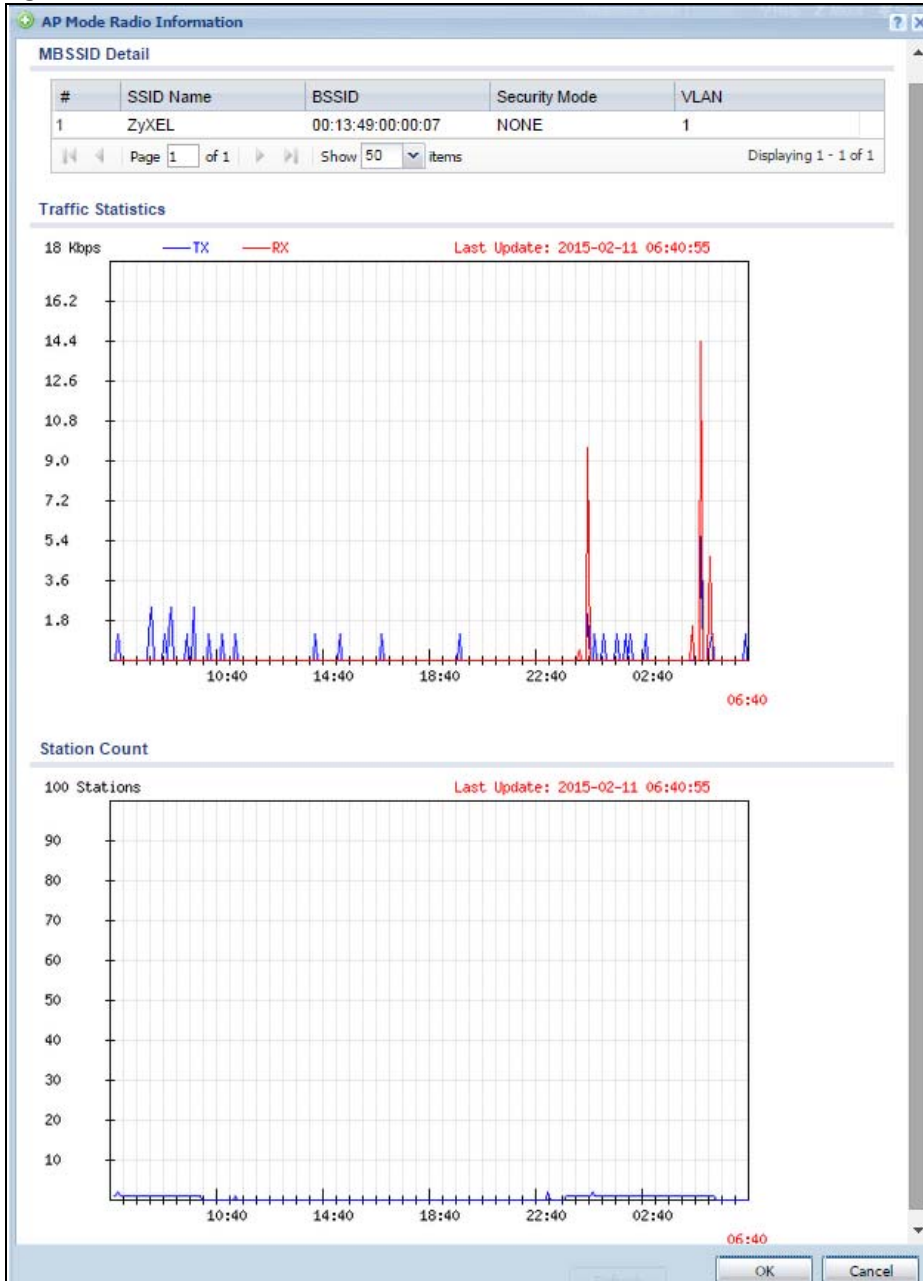

The following table describes the labels in this screen.

Table 65 Monitor > Wireless > AP Information > Radio List > More Information

LABEL	DESCRIPTION
MBSSID Detail	This list shows information about the SSID(s) that is associated with the radio over the preceding 24 hours.
#	This is the items sequential number in the list. It has no bearing on the actual data in this list.
SSID Name	This displays an SSID associated with this radio. There can be up to eight maximum.
BSSID	This displays the MAC address associated with the SSID.
Security Mode	This displays the security mode in which the SSID is operating.
Forwarding Mode	This field indicates the forwarding mode (Local Bridge or Tunnel) associated with the SSID profile.
VLAN	This displays the VLAN ID associated with the SSID.
Traffic Statistics	This graph displays the overall traffic information about the radio over the preceding 24 hours.
y-axis	This axis represents the amount of data moved across this radio in megabytes per second.
x-axis	This axis represents the amount of time over which the data moved across this radio.
Station Count	This graph displays information about all the wireless clients that have connected to the radio over the preceding 24 hours.
y-axis	The y-axis represents the number of connected wireless clients.
x-axis	The x-axis shows the time over which a wireless client was connected.
Last Update	This field displays the date and time the information in the window was last updated.
OK	Click this to close this window.
Cancel	Click this to close this window.

7.18 AP Information: Top N APs

Use this screen to view the top five or top ten wireless traffic usage and associated wireless stations for the preceding 24 hours. Click **Monitor > Wireless > AP Information > Top N APs** to display the **Top N APs** screen.

Figure 203 Monitor > Wireless > AP Information > Top N APs

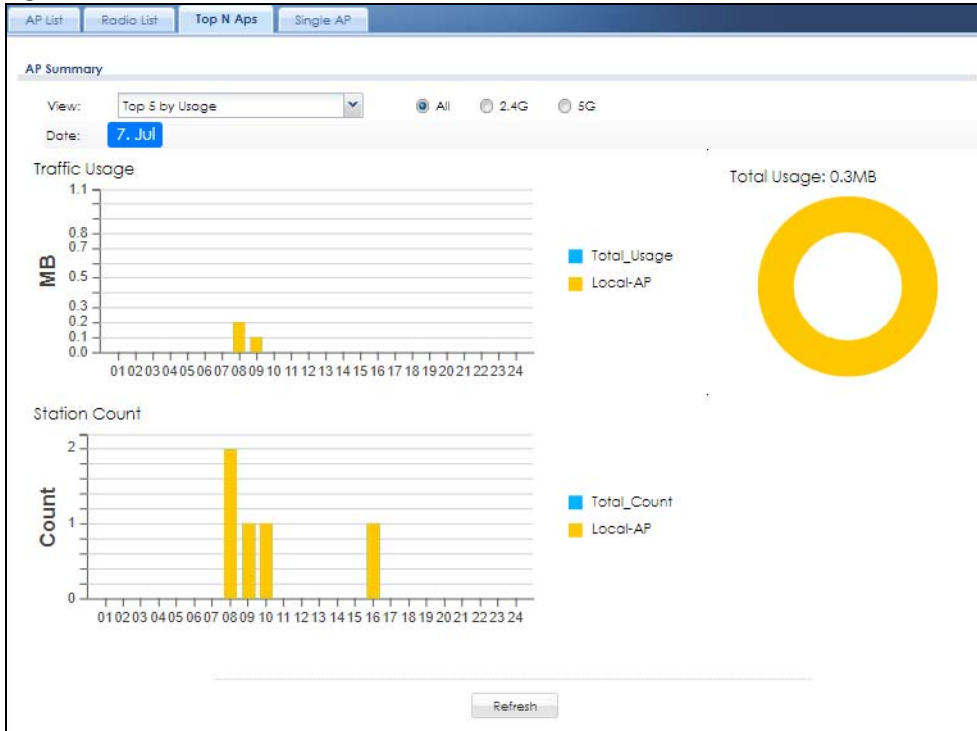

The following table describes the labels in this screen.

Table 66 Monitor > Wireless > AP Information > Top N APs

LABEL	DESCRIPTION
View	Select this to view the top five or top ten wireless traffic usage and associated wireless stations for the preceding 24 hours.
Usage by	If you view the data usage by Usage , select the frequency band and the measure unit in GB or MB to display the graph. If you view the date usage by Station Number , select the measure unit in GB or MB to display the graph.
Date	This field displays the date of your Zyxel Device. Each time you reload this page, the Zyxel Device synchronizes the date with the timer server.
Traffic Usage	This graph displays the overall traffic information about the top five or top ten wireless traffic for the preceding 24 hours.
y-axis	The y-axis represents the amount of traffic in megabytes/gigabytes.
x-axis	The x-axis represents the time over which wireless traffic flows transmitting from/to the AP.
Station Count	This graph displays information about all the wireless stations that have connected to the AP for the preceding 24 hours.
y-axis	The y-axis represents the number of connected wireless stations.
x-axis	The x-axis represents the time over which a wireless client was connected.
Refresh	Click Refresh to update this screen.

7.19 AP Information: Single AP

Use this screen to view wireless traffic usage and wireless stations for a managed AP. Click **Monitor > Wireless > AP Information > Single AP** to display the **Single AP** screen.

Figure 204 Monitor > Wireless > AP Information > Single AP

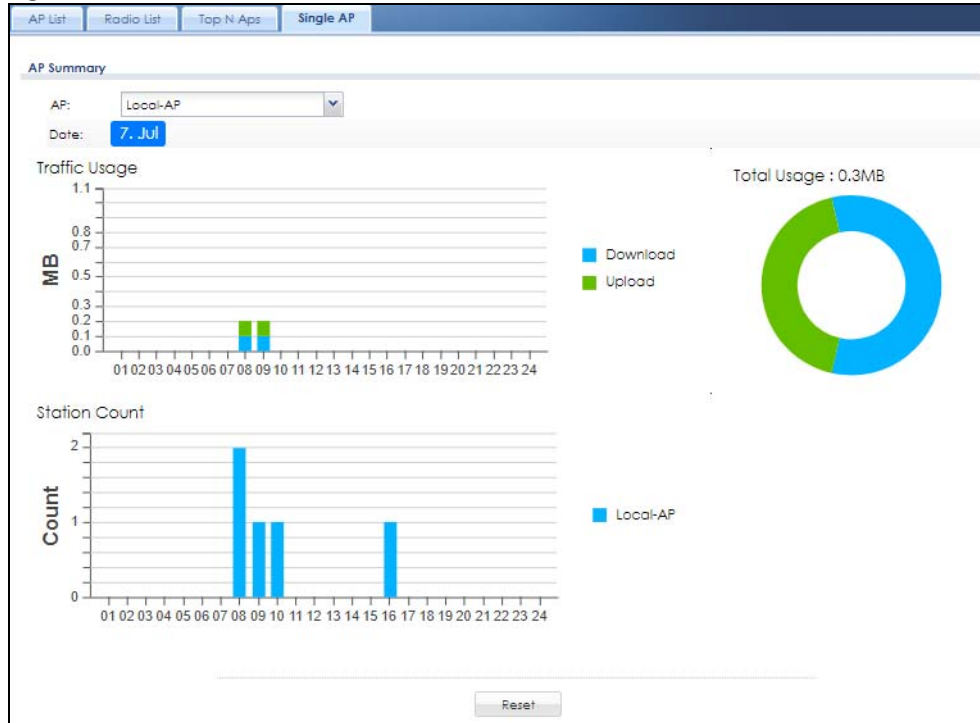

The following table describes the labels in this screen.

Table 67 Monitor > Wireless > AP Information > Single AP

LABEL	DESCRIPTION
AP Selection	Select a managed AP from the drop-down list box to view its wireless traffic usage and wireless stations.
Usage by	Select the measure unit in GB or MB to display the graph.
Date	This field displays the date of your Zyxel Device. Each time you reload this page, the Zyxel Device synchronizes the date with the timer server.
Traffic Usage	This graph displays the overall traffic information about the AP you specified for the preceding 24 hours.
y-axis	The y-axis represents the amount of traffic in megabytes/gigabytes.
x-axis	The x-axis represents the time over which wireless traffic flows transmitting from/to the AP.
Station Count	This graph displays information about all the wireless stations that have connected to the AP for the preceding 24 hours.
y-axis	The y-axis represents the number of connected wireless stations.
x-axis	The x-axis represents the time over which a wireless client was connected.
Reset	Click Reset to update this screen.

7.20 ZyMesh

Use this screen to view the ZyMesh traffic statistics between the managed APs. Click **Monitor > Wireless > ZyMesh** to display this screen.

Figure 205 Monitor > Wireless > ZyMesh

#	Description	IP Address	Channel ID	Hop	Uplink AP Info	SSID Name	Signal Strength	Link Up Time	MAC Address	Tx Power	Root AP	Tx Rate	Rx Rate
No data to display													

The following table describes the labels in this screen.

Table 68 Monitor > Wireless > ZyMesh

LABEL	DESCRIPTION
#	This field displays the index number of the managed AP (in repeater mode) in this list.
Description	This field displays the descriptive name of the managed AP (in repeater mode).
IP Address	This field displays the IP address of the managed AP (in repeater mode).
Channel ID	This field displays the number of the channel used by the managed AP (in repeater mode).
Hop	This is the hop count of the managed AP. For example, "1" means the managed AP is connected to a root AP directly. "2" means there is another repeater AP between the managed AP and the root AP.
Uplink AP Info	This shows the role and descriptive name of the managed AP to which this managed AP is connected wirelessly.
SSID Name	This indicates the name of the wireless network (SSID) the managed AP uses to associated with another managed AP.
Signal Strength	Before the slash, this shows the signal strength the uplink AP (a root AP or a repeater) receives from this managed AP (in repeater mode). After the slash, this shows the signal strength this managed AP (in repeater mode) receives from the uplink AP.
Link Up Time	This field displays the time the managed AP first associated with the root AP or repeater.
MAC Address	This field displays the MAC address of the managed AP (in repeater mode).
Transmit Power	This is the upstream and downstream far end actual aggregate transmit power (in dBm). Upstream is how much power the port is using to transmit to the service provider. Downstream is how much port the service provider is using to transmit to the port.
Root AP	This field displays the descriptive name of the root AP to which the managed AP is connected wirelessly.
Rx Rate	This field displays the maximum reception rate of the root AP or repeater to which the managed AP is connected.
Tx Rate	This field displays the maximum transmission rate of the root AP or repeater to which the managed AP is connected.

7.21 SSID Info

Use this screen to view the number of wireless clients currently connected to an SSID and the security type used by the SSID. Click **Monitor > Wireless > SSID Info** to display this screen.

Figure 206 Monitor > Wireless > SSID Info

The screenshot shows the 'SSID Info' screen with a table titled 'Station information for each SSID'. The table has five columns: '#', 'SSID', '2.4GHz', '5GHz', 'SSID Profile Name', and 'Security Mode'. There are three rows of data. Below the table is a pagination control showing 'Page 1 of 1', 'Show 50 items', and 'Displaying 1 - 3 of 3'.

#	SSID	2.4GHz	5GHz	SSID Profile Name	Security Mode
1	ZyXEL	0	0	default	wpa2-psk
2	ZyXEL_Guest_Wi-Fi	0	0	EZMODE_SSID_GUEST_WIFI	wpa2-psk
3	ZyXEL_Wi-Fi	0	0	EZMODE_SSID_WIFI	wpa2-psk

The following table describes the labels in this screen.

Table 69 Monitor > Wireless > SSID Info

LABEL	DESCRIPTION
#	This is the SSID's index number in this list.
SSID	This indicates the name of the wireless network to which the client is connected. A single AP can have multiple SSIDs or networks.
2.4GHz	This shows the number of wireless clients which are currently connected to the SSID using the 2.4 GHz frequency band. Click the number to go to the Station Info > Station List screen. See Section 7.23 on page 259 .
5GHz	This shows the number of wireless clients which are currently connected to the SSID using the 5 GHz frequency band. Click the number to go to the Station Info > Station List screen. See Section 7.23 on page 259 .
SSID Profile Name	This indicates the name of the SSID profile in which the SSID is defined,
Security Mode	This indicates which secure encryption methods is being used by the SSID.

7.22 Station Info: Station List

The **Station Info** menu contains **Station List**, **Top N Stations** and **Single Station** screens. This screen displays information about connected wireless stations. Click **Monitor > Wireless > Station Info > Station List** to display this screen.

Figure 207 Monitor > Wireless > Station Info > Station List

The following table describes the labels in this screen.

Table 70 Monitor > Wireless > Station Info > Station List

LABEL	DESCRIPTION
Hide/Show Advanced Settings	Click this button to display a greater or lesser number of configuration fields.
Show Filter/ Hide Filer	Click this button to show or hide the filter settings.
Filter	
IP Address	Enter the IP address of the station you want to display. This field is case-sensitive.
Associated AP	Select the AP(s) with which the stations you want to display associate.
SSID Name	Select the SSID(s) to which the stations you want to display are connected.
MAC Address	Enter the MAC address of the station you want to display. This field is case-sensitive.
Security Mode	Select the security mode(s) used by the stations you want to display.
Account	Enter the user account name of the station you want to display. This field is case-sensitive.
Login Type	Select the login method(s) used by the stations you want to display.
Band	Select the frequency band used by the stations you want to display.
Search	Click this to update the list of stations based on the search criteria. Your search criteria is retained when navigating between screens.
Reset	Click this to return the search criteria to the factory defaults and display all connected stations without a filter.
Enable Column Freeze	Select this to lock the index columns in place while scrolling to the right.
Station List	
#	This field is a sequential value, and it is not associated with a specific station.
MAC Address	This field displays the MAC address of the station.
SSID Name	This field displays the SSID names of the station.
Associated AP	This field displays the APs that are associated with the station.
IP Address	This field displays the IP address of the station.

Table 70 Monitor > Wireless > Station Info > Station List

LABEL	DESCRIPTION
Channel	This field displays the number of the channel used by the station to connect to the network.
Rx Rate	This field displays the receive data rate of the station.
Tx Rate	This field displays the transmit data rate of the station.
Signal Strength	This field displays the signal strength of the station.
Association Time	This field displays the time duration the station was online and offline.
Enterprise	This field displays the RADIUS server of the station.
Captive Portal	This displays whether the station logged into the network via the captive portal login page.
MAC Auth	This displays whether the station logged into the network via MAC authentication.
Band	This field displays the frequency band which is currently being used by the station.
Capability	This displays the supported standard currently being used by the station or the standards supported by the station.
802.11 Features	This displays whether the station supports IEEE802.11r, IEEE 802.11k, IEEE 802.11v or none of the above (N/A).
Security Mode	This field displays the security mode the station is using.
Download	This field displays the number of bytes received by the station.
Upload	This field displays the number of bytes transmitted from the station.

7.23 Station Info: Top N Stations

Use this screen to view the top five or top ten traffic statistics of the wireless stations. Click **Monitor > Wireless > Station Info > Top N Stations** to display this screen.

Figure 208 Monitor > Wireless > Station Info > Top N Stations

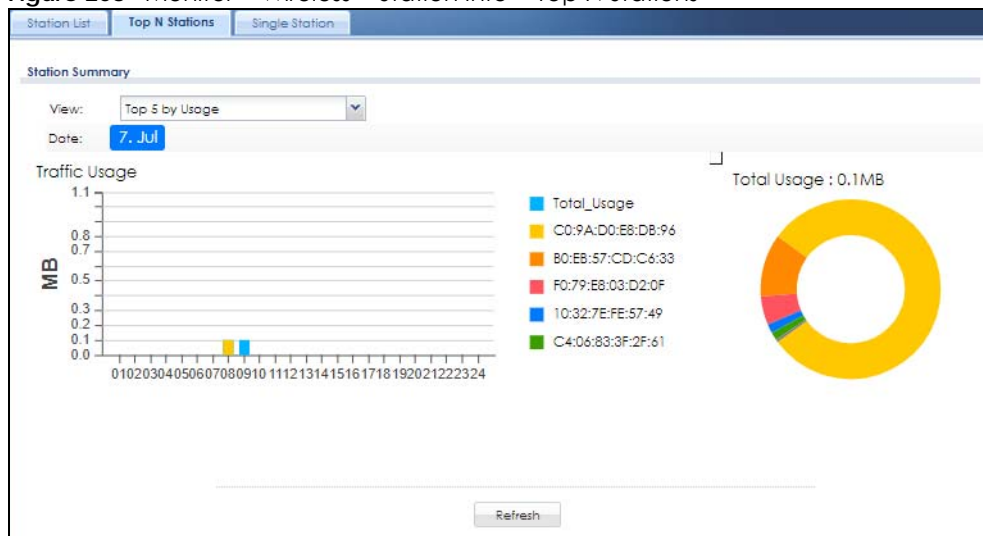

The following table describes the labels in this screen.

Table 71 Monitor > Wireless > Station Info > Top N Stations

LABEL	DESCRIPTION
View	Select this to view the top five or top ten traffic statistics of the wireless stations.
Usage by	Select the measure unit in GB or MB to display the graph.
Date	This field displays the date of your Zyxel Device. Each time you reload this page, the Zyxel Device synchronizes the date with the timer server.
Traffic Usage	This graph displays the overall traffic information about the stations for the preceding 24 hours.
y-axis	This axis represents the amount of data moved across stations in megabytes per second.
Refresh	Click Refresh to update this screen.

7.24 Station Info: Single Station

Use this screen to view traffic statistics of the wireless station you specified. Click **Monitor > Wireless > Station Info > Single Station** to display this screen.

Figure 209 Monitor > Wireless > Station Info > Single Station

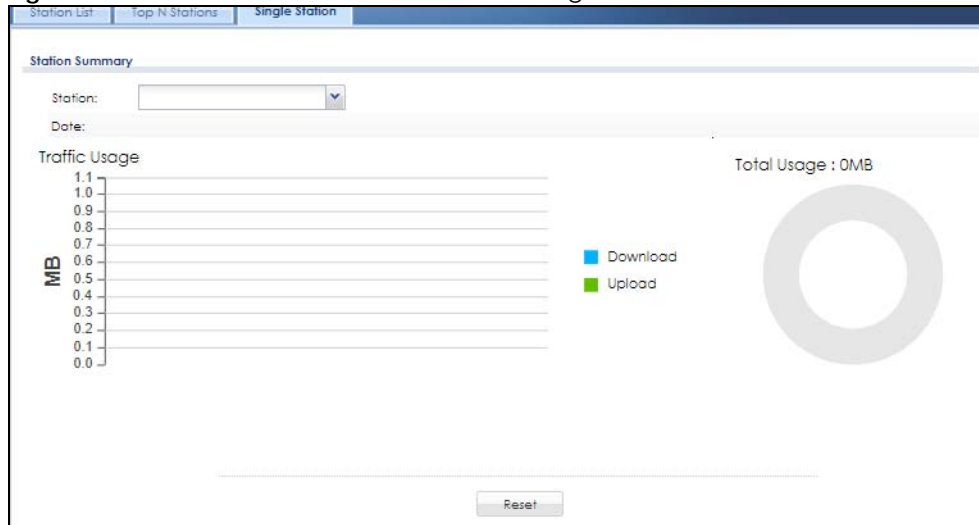

The following table describes the labels in this screen.

Table 72 Monitor > Wireless > Station Info > Single Station

LABEL	DESCRIPTION
Station Selection	Select this to view the traffic statistics of the wireless station.
Usage by	Select the measure unit in GB or MB to display the graph.
Date	This field displays the date of your Zyxel Device. Each time you reload this page, the Zyxel Device synchronizes the date with the timer server.

Table 72 Monitor > Wireless > Station Info > Single Station

LABEL	DESCRIPTION
Traffic Usage	This graph displays the overall traffic information about the station over the preceding 24 hours.
y-axis	This axis represents the amount of data moved across this station in megabytes per second.
Refresh	Click Refresh to update this screen.

7.25 Detected Device

Use this screen to view information about wireless devices detected by the AP. Click **Monitor > Wireless > Detected Device** to access this screen.

Note: At least one radio of the APs connected to the Zyxel Device must be set to monitor mode (in the **Configuration > Wireless > AP Management** screen) in order to detect other wireless devices in its vicinity.

Figure 210 Monitor > Wireless > Detected Device

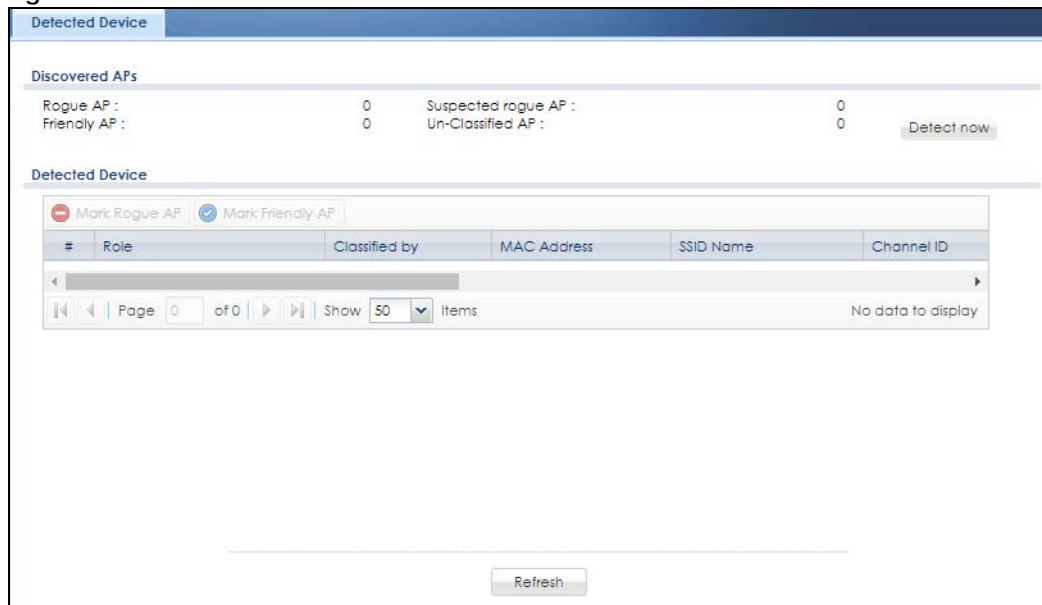

The following table describes the labels in this screen.

Table 73 Monitor > Wireless > Detected Device

LABEL	DESCRIPTION
Discovered APs	
Rogue AP	This shows how many devices are detected as rogue APs.
Suspected rogue AP	This shows how many devices are detected as possible rogue APs.
Friendly AP	This shows how many devices are detected as friendly APs.
Un-Classified AP	This shows how many devices are detected, but have not been classified as either Rogue or Friendly by the Zyxel Device.
Detect now	Click this button for the Zyxel Device to scan for APs in the network.

Table 73 Monitor > Wireless > Detected Device

LABEL	DESCRIPTION
Mark as Rogue AP	Click this button to mark the selected AP as a rogue AP. A rogue AP can be contained in the Configuration > Wireless > MON Mode screen.
Mark as Friendly AP	Click this button to mark the selected AP as a friendly AP. For more on managing friendly APs, see the Configuration > Wireless > MON Mode screen.
#	This is the station's index number in this list.
Role	This indicates the detected device's role (such as friendly or rogue).
Classified by	This indicates the detected device's classification rule.
MAC Address	This indicates the detected device's MAC address.
SSID Name	This indicates the detected device's SSID.
Channel ID	This indicates the detected device's channel ID.
802.11 Mode	This indicates the 802.11 mode (a/b/g/n) transmitted by the detected device.
Security	This indicates the encryption method (if any) used by the detected device.
Seen by	This indicates which AP detects the device. If an AP in monitor mode detected this AP, this column will show "N/A". If an AP using Rogue AP Detection detected this device, it will show the name of the AP and the signal strength from the detected device. If the wireless device is detected by more than one AP, only the top 5 APs with the highest signal strength will be shown.
Group	This indicates which group the detected device belongs.
Description	This displays the detected device's description. For more on managing friendly and rogue APs, see the Configuration > Wireless > MON Mode screen.
Last Seen	This indicates the last time the device was detected by the Zyxel Device.
Refresh	Click this to refresh the items displayed on this page.

7.26 The Printer Status Screen

This screen displays information about the connected statement printer, such as SP350E. Click **Monitor > Printer Status** to display this screen.

Figure 211 Monitor > Printer Status

#	IPv4 Address	Update Time	Status	Description	Nickname	Firmware Vers...	MAC
No data to display							

The following table describes the labels in this screen.

Table 74 Monitor > Printer Status

LABEL	DESCRIPTION
#	This is the index number of the printer in the list.
IPv4 Address	This field displays the IP address of the printer that you configured in the Configuration > Hotspot > Printer Manager > General: Add screen.

Table 74 Monitor > Printer Status

LABEL	DESCRIPTION
Update Time	This field displays the date and time the Zyxel Device last synchronized with the printer. This shows n/a when the printer status is sync fail .
Status	This field displays whether the Zyxel Device can connect to the printer and update the printer information.
Description	This field displays the descriptive name of the printer that you configured in the Configuration > Hotspot > Printer Manager > General: Add screen.
Nickname	This field displays the nickname of the printer that you configured in the Configuration > Hotspot > Printer Manager > General: Edit screen.
Firmware Version	This field displays the model number and firmware version of the printer. This shows n/a when the printer status is sync fail .
MAC	This field displays the MAC address of the printer.

7.27 The IPSec Screen

You can use the **IPSec Monitor** screen to display and to manage active IPSec SAs. To access this screen, click **Monitor > VPN Monitor > IPSec**. The following screen appears. Click a column's heading cell to sort the table entries by that column's criteria. Click the heading cell again to reverse the sort order.

Figure 212 Monitor > VPN Monitor > IPSec

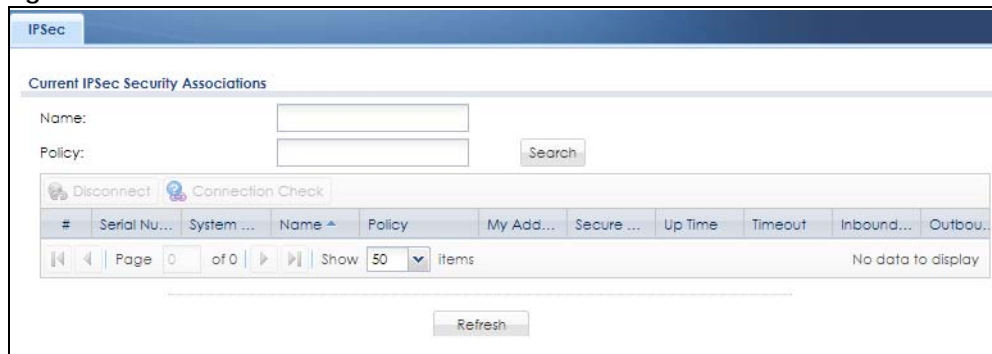

Each field is described in the following table.

Table 75 Monitor > VPN Monitor > IPSec

LABEL	DESCRIPTION
Name	Type the name of a IPSec SA here and click Search to find it (if it is associated). You can use a keyword or regular expression. Use up to 30 alphanumeric and <code>_+-.()!\$*^:~? {} [] <> /</code> characters. See Section on page 264 for more details.
Policy	Type the IP address(es) or names of the local and remote policies for an IPSec SA and click Search to find it. You can use a keyword or regular expression. Use up to 30 alphanumeric and <code>_+-.()!\$*^:~? {} [] <> /</code> characters. See Section on page 264 for more details.
Search	Click this button to search for an IPSec SA that matches the information you specified above.
Disconnect	Select an IPSec SA and click this button to disconnect it.
Connection Check	Select an IPSec SA and click this button to check the connection.

Table 75 Monitor > VPN Monitor > IPsec (continued)

LABEL	DESCRIPTION
#	This field is a sequential value, and it is not associated with a specific SA.
Serial Number	This field displays the serial number of this ZyXEL device.
System Name	This field displays the name used to identify this ZyXEL device
Name	This field displays the name of the IPsec SA.
Policy	This field displays the content of the local and remote policies for this IPsec SA. The IP addresses, not the address objects, are displayed.
IKE Name	This field displays the Internet Key Exchange (IKE) name.
Cookies	This field displays the cookies information that initiates the IKE.
My Address	This field displays the IP address of local computer.
Secure Gateway	This field displays the secure gateway information.
Up Time	This field displays how many seconds the IPsec SA has been active. This field displays N/A if the IPsec SA uses manual keys.
Timeout	This field displays how many seconds remain in the SA life time, before the Zyxel Device automatically disconnects the IPsec SA. This field displays N/A if the IPsec SA uses manual keys.
Inbound (Bytes)	This field displays the amount of traffic that has gone through the IPsec SA from the remote IPsec router to the Zyxel Device since the IPsec SA was established.
Outbound (Bytes)	This field displays the amount of traffic that has gone through the IPsec SA from the Zyxel Device to the remote IPsec router since the IPsec SA was established.

Regular Expressions in Searching IPsec SAs

A question mark (?) lets a single character in the VPN connection or policy name vary. For example, use "a?c" (without the quotation marks) to specify abc, acc and so on.

Wildcards (*) let multiple VPN connection or policy names match the pattern. For example, use "*abc" (without the quotation marks) to specify any VPN connection or policy name that ends with "abc". A VPN connection named "testabc" would match. There could be any number (of any type) of characters in front of the "abc" at the end and the VPN connection or policy name would still match. A VPN connection or policy name named "testacc" for example would not match.

A * in the middle of a VPN connection or policy name has the Zyxel Device check the beginning and end and ignore the middle. For example, with "abc*123", any VPN connection or policy name starting with "abc" and ending in "123" matches, no matter how many characters are in between.

The whole VPN connection or policy name has to match if you do not use a question mark or asterisk.

7.28 The SSL Screen

The Zyxel Device keeps track of the users who are currently logged into the VPN SSL client. Click **Monitor > VPN Monitor > SSL** to display the user list.

Use this screen to do the following:

- View a list of active SSL VPN connections.
- Log out individual users and delete related session information.

Once a user logs out, the corresponding entry is removed from the screen.

Figure 213 Monitor > VPN Monitor > SSL

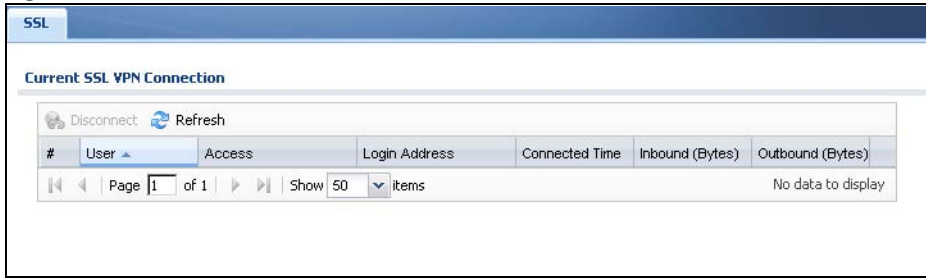

The following table describes the labels in this screen.

Table 76 Monitor > VPN Monitor > SSL

LABEL	DESCRIPTION
Disconnect	Select a connection and click this button to terminate the user's connection and delete corresponding session information from the Zyxel Device.
Refresh	Click Refresh to update this screen.
#	This field is a sequential value, and it is not associated with a specific SSL.
User	This field displays the account user name used to establish this SSL VPN connection.
Access	This field displays the name of the SSL VPN application the user is accessing.
Login Address	This field displays the IP address the user used to establish this SSL VPN connection.
Connected Time	This field displays the time this connection was established.
Inbound (Bytes)	This field displays the number of bytes received by the Zyxel Device on this connection.
Outbound (Bytes)	This field displays the number of bytes transmitted by the Zyxel Device on this connection.

7.29 The L2TP over IPsec Screen

Click **Monitor > VPN Monitor > L2TP over IPsec** to open the following screen. Use this screen to display and manage the Zyxel Device's connected L2TP VPN sessions.

Figure 214 Monitor > VPN Monitor > L2TP over IPsec

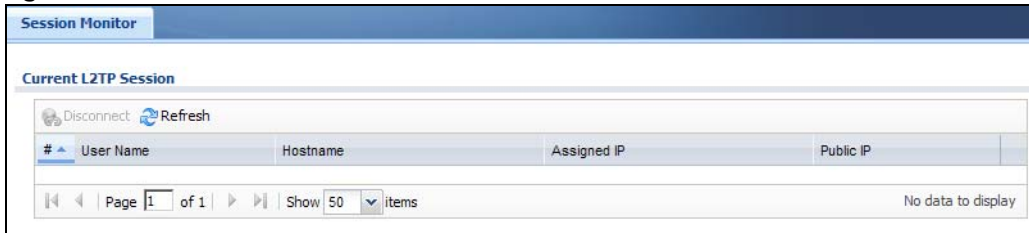

The following table describes the fields in this screen.

Table 77 Monitor > VPN Monitor > L2TP over IPsec

LABEL	DESCRIPTION
Disconnect	Select a connection and click this button to disconnect it.
Refresh	Click Refresh to update this screen.

Table 77 Monitor > VPN Monitor > L2TP over IPSec (continued)

LABEL	DESCRIPTION
#	This field is a sequential value, and it is not associated with a specific L2TP VPN session.
User Name	This field displays the remote user's user name.
Hostname	This field displays the name of the computer that has this L2TP VPN connection with the Zyxel Device.
Assigned IP	This field displays the IP address that the Zyxel Device assigned for the remote user's computer to use within the L2TP VPN tunnel.
Public IP	This field displays the public IP address that the remote user is using to connect to the Internet.

7.30 The App Patrol Screen

Application patrol provides a convenient way to manage the use of various applications on the network. It manages general protocols (for example, HTTP and FTP) and instant messenger (IM), peer-to-peer (P2P), Voice over IP (VoIP), and streaming (RSTP) applications. You can even control the use of a particular application's individual features (like text messaging, voice, video conferencing, and file transfers).

Click **Monitor > UTM Statistics > App Patrol** to display the following screen. This screen displays **Application Patrol** statistics based on the **App Patrol** profiles bound to **Security Policy** profiles.

Figure 215 Monitor > UTM Statistics > App Patrol

The following table describes the labels in this screen.

Table 78 Monitor > UTM Statistics > App Patrol

LABEL	DESCRIPTION
Collect Statistics	Select this check box to have the Zyxel Device collect app patrol statistics. The collection starting time displays after you click Apply . All of the statistics in this screen are for the time period starting at the time displayed here. The format is year, month, day and hour, minute, second. All of the statistics are erased if you restart the Zyxel Device or click Flush Data . Collecting starts over and a new collection start time displays.
Apply	Click Apply to save your changes back to the Zyxel Device.
Reset	Click Reset to return the screen to its last-saved settings.
Refresh	Click this button to update the report display.
Flush Data	Click this button to discard all of the screen's statistics and update the report display.
App Patrol Statistics	

Table 78 Monitor > UTM Statistics > App Patrol

LABEL	DESCRIPTION
#	This field is a sequential value, and it is not associated with a specific App Patrol session.
Application	This is the protocol.
Forwarded Data (KB)	This is how much of the application's traffic the Zyxel Device has sent (in kilobytes).
Dropped Data (KB)	This is how much of the application's traffic the Zyxel Device has discarded without notifying the client (in kilobytes). This traffic was dropped because it matched an application policy set to "drop".
Rejected Data (KB)	This is how much of the application's traffic the Zyxel Device has discarded and notified the client that the traffic was rejected (in kilobytes). This traffic was rejected because it matched an application policy set to "reject".
Matched Auto Connection	This is how much of the application's traffic the Zyxel Device identified by examining the IP payload.
Inbound Kbps	This field displays the amount of the application's traffic that has gone to the ZyWALL (in kilo bits per second).
Outbound Kbps	This field displays the amount of the application's traffic that has gone from the ZyWALL (in kilo bits per second).

7.31 The Content Filter Screen

Click **Monitor > UTM Statistics > Content Filter** to display the following screen. This screen displays content filter statistics.

Figure 216 Monitor > UTM Statistics > Content Filter

The screenshot shows the 'Content Filter' screen with the following sections and data:

Report	
General Settings	
<input type="checkbox"/> Collect Statistics	
Apply	Reset
Refresh	Flush Data
Web Request Statistics	
Total Web Pages Inspected:	0
Blocked:	0
Warned:	0
Passed:	0
Category Hit Summary	
Security Threat:	0
Managed Web Pages:	0
Block Hit Summary	
Web Pages Blocked by Category Service:	0
Web Pages Blocked by Custom Service:	0
Restricted Web Features:	0
Forbidden Web Sites:	0
URL Keywords:	0

The following table describes the labels in this screen.

Table 79 Monitor > UTM Statistics > Content Filter

LABEL	DESCRIPTION
General Settings	
Collect Statistics	Select this check box to have the Zyxel Device collect content filtering statistics. The collection starting time displays after you click Apply . All of the statistics in this screen are for the time period starting at the time displayed here. The format is year, month, day and hour, minute, second. All of the statistics are erased if you restart the Zyxel Device or click Flush Data . Collecting starts over and a new collection start time displays.
Apply	Click Apply to save your changes back to the Zyxel Device.
Reset	Click Reset to return the screen to its last-saved settings.
Refresh	Click this button to update the report display.
Flush Data	Click this button to discard all of the screen's statistics and update the report display.
Web Request Statistics	
Total Web Pages Inspected	This field displays the number of web pages that the Zyxel Device's content filter feature has checked.
Blocked	This is the number of web pages that the Zyxel Device blocked access.
Warned	This is the number of web pages for which the Zyxel Device displayed a warning message to the access requesters.
Passed	This is the number of web pages to which the Zyxel Device allowed access.
Category Hit Summary	
Security Threat	This is the number of requested web pages that the Zyxel Device's content filtering service identified as posing a security threat to users.
Managed Web Pages	This is the number of requested web pages that the Zyxel Device's content filtering service identified as belonging to a category that was selected to be managed.
Block Hit Summary	
Web Pages Warned by Category Service	This is the number of web pages that matched an external database content filtering category selected in the Zyxel Device and for which the Zyxel Device displayed a warning before allowing users access.
Web Pages Blocked by Custom Service	This is the number of web pages to which the Zyxel Device did not allow access due to the content filtering custom service configuration.
Restricted Web Features	This is the number of web pages to which the ZyWALL limited access or removed cookies due to the content filtering custom service's restricted web features configuration.
Forbidden Web Sites	This is the number of web pages to which the Zyxel Device did not allow access because they matched the content filtering custom service's forbidden web sites list.
URL Keywords	This is the number of web pages to which the Zyxel Device did not allow access because they contained one of the content filtering custom service's list of forbidden keywords.

7.32 The IDP Screen

Click **Monitor > UTM Statistics > IDP** to display the following screen. This screen displays IDP (Intrusion Detection and Prevention) statistics.

Figure 217 Monitor > UTM Statistics > IDP: Signature Name

The following table describes the labels in this screen.

Table 80 Monitor > UTM Statistics > IDP

LABEL	DESCRIPTION
Collect Statistics	Select this check box to have the Zyxel Device collect IDP statistics. The collection starting time displays after you click Apply . All of the statistics in this screen are for the time period starting at the time displayed here. The format is year, month, day and hour, minute, second. All of the statistics are erased if you restart the Zyxel Device or click Flush Data . Collecting starts over and a new collection start time displays.
Apply	Click Apply to save your changes back to the Zyxel Device.
Reset	Click Reset to return the screen to its last-saved settings.
Refresh	Click this button to update the report display.
Flush Data	Click this button to discard all of the screen's statistics and update the report display.
Total Session Scanned	This field displays the number of sessions that the Zyxel Device has checked for intrusion characteristics.
Total Packet Dropped	The Zyxel Device can detect and drop malicious packets from network traffic. This field displays the number of packets that the Zyxel Device has dropped.
Total Packet Reset	The Zyxel Device can detect and drop malicious packets from network traffic. This field displays the number of packets that the Zyxel Device has reset.
Top Entries By	Use this field to have the following (read-only) table display the top IDP log entries by Signature Name , Source or Destination . This table displays the most common, recent IDP logs. See the log screen for less common IDP logs or use a syslog server to record all IDP logs. Select Signature Name to list the most common signatures that the Zyxel Device has detected. Select Source to list the source IP addresses from which the Zyxel Device has detected the most intrusion attempts. Select Destination to list the most common destination IP addresses for intrusion attempts that the Zyxel Device has detected.
#	This field displays the entry's rank in the list of the top entries.
Signature Name	This column displays when you display the entries by Signature Name . The signature name identifies the type of intrusion pattern. Click the hyperlink for more detailed information on the intrusion.

Table 80 Monitor > UTM Statistics > IDP (continued)

LABEL	DESCRIPTION
Signature ID	This column displays when you display the entries by Signature Name . The signature ID is a unique value given to each intrusion detected.
Type	This column displays when you display the entries by Signature Name . It shows the categories of intrusions.
Severity	This column displays when you display the entries by Signature Name . It shows the level of threat that the intrusions may pose.
Source IP	This column displays when you display the entries by Source . It shows the source IP address of the intrusion attempts.
Destination IP	This column displays when you display the entries by Destination . It shows the destination IP address at which intrusion attempts were targeted.
Occurrences	This field displays how many times the Zykel Device has detected the event described in the entry.

The statistics display as follows when you display the top entries by source.

Figure 218 Monitor > UTM Statistics > IDP: Source

#	Source IP	Occurrence
No data to display		

The statistics display as follows when you display the top entries by destination.

Figure 219 Monitor > UTM Statistics > IDP: Destination

#	Destination IP	Occurrence
No data to display		

7.33 The Anti-Virus Screen

Click **Monitor > UTM Statistics > Anti-Virus** to display the following screen. This screen displays anti-virus statistics.

Figure 220 Monitor > UTM Statistics > Anti-Virus: Virus Name

The following table describes the labels in this screen.

Table 81 Monitor > UTM Statistics > Anti-Virus

LABEL	DESCRIPTION
Collect Statistics	Select this check box to have the Zyxel Device collect anti-virus statistics. The collection starting time displays after you click Apply . All of the statistics in this screen are for the time period starting at the time displayed here. The format is year, month, day and hour, minute, second. All of the statistics are erased if you restart the Zyxel Device or click Flush Data . Collecting starts over and a new collection start time displays.
Apply	Click Apply to save your changes back to the Zyxel Device.
Reset	Click Reset to return the screen to its last-saved settings.
Refresh	Click this button to update the report display.
Flush Data	Click this button to discard all of the screen's statistics and update the report display.
Total Viruses Detected	This field displays the number of different viruses that the Zyxel Device has detected.
Top Entries By	Use this field to have the following (read-only) table display the top anti-virus log entries by Virus Name , Source IP , Destination IP , Source IPv6 and Destination IPv6 . This table displays the most common, recent virus logs. See the log screen for less common virus logs or use a syslog server to record all virus logs. Select Virus Name to list the most common viruses that the Zyxel Device has detected. Select Source IP to list the source IP addresses from which the Zyxel Device has detected the most virus-infected files. Select Destination IP to list the most common destination IP addresses for virus-infected files that Zyxel Device has detected. Select Source IPv6 to list the source IPv6 addresses from which the Zyxel Device has detected the most virus-infected files. Select Destination IPv6 to list the most common destination IPv6 addresses for virus-infected files that Zyxel Device has detected.
#	This field displays the entry's rank in the list of the top entries.
Virus name	This column displays when you display the entries by Virus Name . This displays the name of a detected virus.
Source IP	This column displays when you display the entries by Source IP . It shows the source IP address of virus-infected files that the Zyxel Device has detected.
Source IPv6	This column displays when you display the entries by Source IPv6 . It shows the source IPv6 address of virus-infected files that the Zyxel Device has detected.

Table 81 Monitor > UTM Statistics > Anti-Virus (continued)

LABEL	DESCRIPTION
Destination IP	This column displays when you display the entries by Destination IP . It shows the destination IP address of virus-infected files that the Zyxel Device has detected.
Destination IPv6	This column displays when you display the entries by Destination IPv6 . It shows the destination IPv6 address of virus-infected files that the Zyxel Device has detected.
Occurrences	This field displays how many times the Zyxel Device has detected the event described in the entry.

The statistics display as follows when you display the top entries by source IP.

Figure 221 Monitor > UTM Statistics > Anti-Virus: Source IP

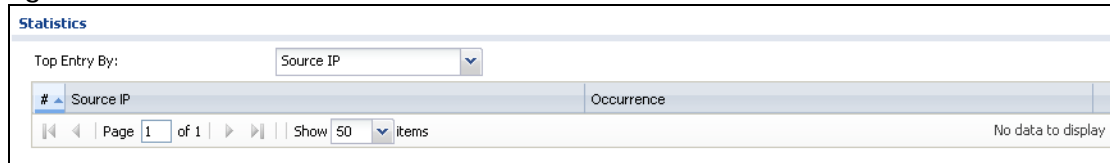

The statistics display as follows when you display the top entries by source IPv6.

Figure 222 Monitor > UTM Statistics > Anti-Virus: Source IPv6

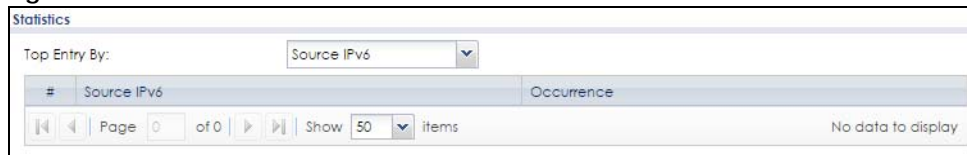

The statistics display as follows when you display the top entries by destination IP.

Figure 223 Monitor > UTM Statistics > Anti-Virus: Destination IP

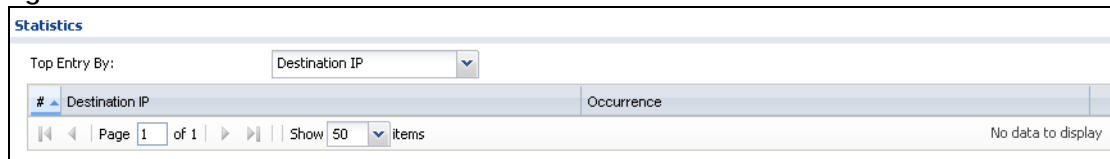

The statistics display as follows when you display the top entries by destination IPv6.

Figure 224 Monitor > UTM Statistics > Anti-Virus: Destination IPv6

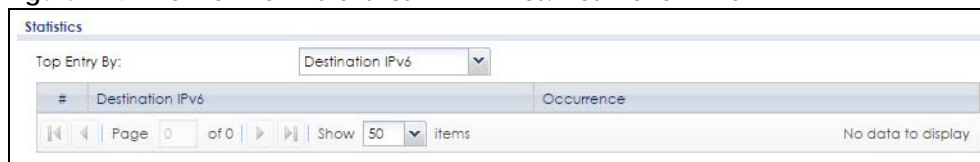

7.34 The Anti-Spam Screens

The Anti-Spam menu contains the **Summary** and **Status** screens.

7.34.1 Anti-Spam Summary

Click **Monitor > UTM Statistics > Anti-Spam > Summary** to display the following screen. This screen displays spam statistics.

Figure 225 Monitor > UTM Statistics > Anti-Spam > Summary

The following table describes the labels in this screen.

Table 82 Monitor > UTM Statistics > Anti-Spam > Summary

LABEL	DESCRIPTION
Collect Statistics	Select this check box to have the Zyxel Device collect anti-spam statistics. The collection starting time displays after you click Apply . All of the statistics in this screen are for the time period starting at the time displayed here. The format is year, month, day and hour, minute, second. All of the statistics are erased if you restart the Zyxel Device or click Flush Data . Collecting starts over and a new collection start time displays.
Apply	Click Apply to save your changes back to the Zyxel Device.
Reset	Click Reset to return the screen to its last-saved settings.
Refresh	Click this button to update the report display.
Flush Data	Click this button to discard all of the screen's statistics and update the report display.
Email Summary	
Total Mails Scanned	This field displays the number of e-mails that the Zyxel Device's anti-spam feature has checked.
Safe Mails	This is the number of e-mails that the Zyxel Device has determined to not be spam.
Safe Mails Detected by White list	This is the number of e-mails that matched an entry in the Zyxel Device's anti-spam white list.

Table 82 Monitor > UTM Statistics > Anti-Spam > Summary (continued)

LABEL	DESCRIPTION
Spam Mails	This is the number of e-mails that the Zyxel Device has determined to be spam.
Spam Mails Detected by Black List	This is the number of e-mails that matched an entry in the Zyxel Device's anti-spam black list.
Spam Mails Detected by Malicious Mail	This is the number of emails that the Zyxel Device has determined to have malicious contents.
Spam Mails Detected by DNSBL	The Zyxel Device can check the sender and relay IP addresses in an e-mail's header against DNS (Domain Name Service)-based spam Black Lists (DNSBLs). This is the number of e-mails that had a sender or relay IP address in the header which matched one of the DNSBLs that the Zyxel Device uses.
Query Timeout	This is how many queries that were sent to the Zyxel Device's configured list of DNSBL domains or Mail Scan services and did not receive a response in time.
When mail session threshold is reached	
Mail Sessions Forwarded	This is how many e-mail sessions the Zyxel Device allowed because they exceeded the maximum number of e-mail sessions that the anti-spam feature can check at a time. You can see the Zyxel Device's threshold of concurrent e-mail sessions in the Anti-Spam > Status screen. Use the Anti-Spam > General screen to set whether the Zyxel Device forwards or drops sessions that exceed this threshold.
Mail Sessions Dropped	This is how many e-mail sessions the Zyxel Device dropped because they exceeded the maximum number of e-mail sessions that the anti-spam feature can check at a time. You can see the Zyxel Device's threshold of concurrent e-mail sessions in the Anti-Spam > Status screen. Use the Anti-Spam > General screen to set whether the Zyxel Device forwards or drops sessions that exceed this threshold.
Statistics	
Top Sender By	Use this field to list the top e-mail or IP addresses from which the Zyxel Device has detected the most spam. Select Sender IP to list the source IP addresses from which the Zyxel Device has detected the most spam. Select Sender Email Address to list the top e-mail addresses from which the Zyxel Device has detected the most spam.
#	This field displays the entry's rank in the list of the top entries.
Sender IP	This column displays when you display the entries by Sender IP . It shows the source IP address of spam e-mails that the Zyxel Device has detected.
Sender Email Address	This column displays when you display the entries by Sender Email Address . This column displays the e-mail addresses from which the Zyxel Device has detected the most spam.
Occurrence	This field displays how many spam e-mails the Zyxel Device detected from the sender.

7.34.2 The Anti-Spam Status Screen

Click **Monitor > UTM Statistics > Anti-Spam > Status** to display the **Anti-Spam Status** screen.

Use the **Anti-Spam Status** screen to see how many e-mail sessions the anti-spam feature is scanning and statistics for the DNSBLs.

Figure 226 Monitor > UTM Statistics > Anti-Spam > Status

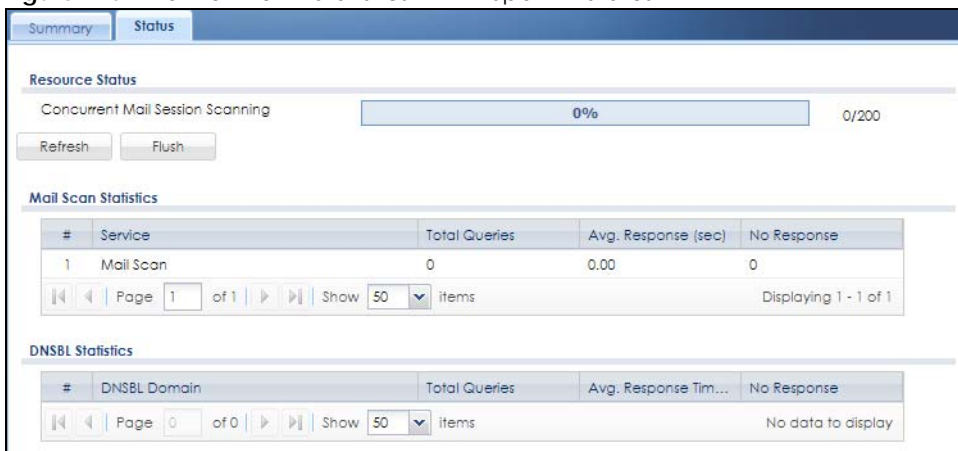

The following table describes the labels in this screen.

Table 83 Monitor > UTM Statistics > Anti-Spam > Status

LABEL	DESCRIPTION
Resource Status	
Concurrent Mail Session Scanning	The darker shaded part of the bar shows how much of the Zyxel Device's total spam checking capability is currently being used. The lighter shaded part of the bar and the pop-up show the historical high. The first number to the right of the bar is how many e-mail sessions the Zyxel Device is presently checking for spam. The second number is the maximum number of e-mail sessions that the Zyxel Device can check at once. An e-mail session is when an e-mail client and e-mail server (or two e-mail servers) connect through the Zyxel Device.
Refresh	Click this button to update the information displayed on this screen.
Flush	Click this button to clear the DNSBL statistics. This also clears the concurrent mail session scanning bar's historical high.
Mail Scan Statistics	These are the statistics for the service the Zyxel Device uses. These statistics are for when the Zyxel Device actually queries the service servers.
#	This is the entry's index number in the list.
Service	This displays the name of the service.
Total Queries	This is the total number of queries the Zyxel Device has sent to this service.
Avg. Response Time (sec)	This is the average for how long it takes to receive a reply from this service.
No Response	This is how many queries the Zyxel Device sent to this service without receiving a reply.
DNSBL Statistics	These are the statistics for the DNSBL the Zyxel Device uses. These statistics are for when the Zyxel Device actually queries the DNSBL servers. Matches for DNSBL responses stored in the cache do not affect these statistics.
#	This is the entry's index number in the list.
DNSBL Domain	These are the DNSBLs the Zyxel Device uses to check sender and relay IP addresses in e-mails.
Total Queries	This is the total number of DNS queries the Zyxel Device has sent to this DNSBL.
Avg. Response Time (sec)	This is the average for how long it takes to receive a reply from this DNSBL.
No Response	This is how many DNS queries the Zyxel Device sent to this DNSBL without receiving a reply.

7.35 The SSL Inspection Screens

The Zyxel Device uses SSL Inspection to decrypt SSL traffic, sends it to the UTM engines for inspection, then encrypts traffic that passes inspection and forwards it. You must enable SSL Inspection if you want to use Content Filtering 2.0 Safe Search.

Click **Monitor > UTM Statistics > SSL Inspection > Summary** to display the following screen.

Figure 227 Monitor > UTM Statistics > SSL Inspection > Summary

General Settings	
<input type="checkbox"/> Collect Statistics	
Apply	Reset Refresh Flush Data
Status	
Maximum Concurrent Sessions:	1000
Concurrent Sessions:	0
Summary	
Total SSL Sessions:	0
Sessions Inspected:	0
Decrypted (Kbytes):	0
Encrypted (Kbytes):	0
Sessions Blocked:	0
Sessions Passed:	0

The following table describes the labels in this screen.

Table 84 Monitor > UTM Statistics > SSL Inspection > Summary

LABEL	DESCRIPTION
Collect Statistics	Select this check box to have the Zyxel Device collect SSL Inspection statistics. The collection starting time displays after you click Apply . All of the statistics in this screen are for the time period starting at the time displayed here. The format is year, month, day and hour, minute, second. All of the statistics are erased if you restart the Zyxel Device or click Flush Data . Collecting starts over and a new collection start time displays.
Apply	Click Apply to save your changes back to the Zyxel Device.
Reset	Click Reset to return the screen to its last-saved settings.
Refresh	Click this button to update the report display.
Flush Data	Click this button to discard all of the screen's statistics and update the report display.
Status	
Maximum Concurrent Sessions	This shows the maximum number of simultaneous SSL Inspection sessions allowed for your Zyxel Device model.
Concurrent Sessions	This shows the actual number of simultaneous SSL Inspection sessions in progress.
Summary	
Total SSL Sessions	This is the total of SSL sessions inspected and number of sessions blocked and number of sessions passed since data was last flushed or the Zyxel Device last rebooted after Collect Statistics was enabled.

Table 84 Monitor > UTM Statistics > SSL Inspection > Summary (continued)

LABEL	DESCRIPTION
Sessions Inspected	This shows the total number of SSL sessions inspected since data was last flushed or the Zyxel Device last rebooted after Collect Statistics was enabled
Decrypted (Kbytes)	This shows the number of kilobytes (KB) of data that was decrypted for UTM inspection.
Encrypted (Kbytes)	This shows the number of kilobytes (KB) of data that was re-encrypted after UTM inspection and then forwarded.
Sessions Blocked	This shows the number of SSL sessions blocked.
Sessions Passed	This shows the number of SSL sessions passed.

7.35.1 Certificate Cache List

SSL traffic to a server to be excluded from SSL Inspection is identified by its certificate. Traffic in an **Exclude List** is not intercepted by **SSL Inspection**.

Click **Monitor > UTM Statistics > SSL Inspection > Certificate Cache List** to display a screen that shows details on SSL traffic going to servers identified by its certificate and an option to add that traffic to the **Exclude List**.

Figure 228 Monitor > UTM Statistics > SSL Inspection > Certificate Cache List

The screenshot shows the 'Certificate Cache List' interface. At the top, there is a 'Report' tab and a 'Certificate Cache List' sub-tab. Below this is a header 'Certificate Cache List' and a button 'Add to Exclude List'. The main content is a table with the following columns: #, In Exclude List, Time, Common Name, SNI, SSL Version, Destination, and Valid Tim... The table contains 17 rows of data, each with a small icon in the 'In Exclude List' column. At the bottom of the table is a 'Refresh' button.

#	In Exclude List	Time	Common Name	SNI	SSL Version	Destination	Valid Tim...
1		2014-02-13 10:50:07	*.gstatic.com	p5-vj2x6jop6mqc-jl2h64i24gpevstv-155532...	TLS1.0	74.125.203.120:443	86340
2		2014-02-13 10:49:55	*.mail.google.com	chatenabled.mail.google.com	TLS1.0	74.125.203.189:443	86340
3		2014-02-13 10:49:51	*.google.com	csi.gstatic.com	TLS1.0	173.194.41.175:443	86340
4		2014-02-13 10:49:38	mail.google.com	mail.google.com	TLS1.0	74.125.203.17:443	86280
5		2014-02-13 10:49:38	*.gstatic.com	p5-vj2x6jop6mqc-jl2h64i24gpevstv-155532...	TLS1.0	74.125.203.120:443	86340
6		2014-02-13 10:49:37	*.gstatic.com	p5-vj2x6jop6mqc-jl2h64i24gpevstv-155532...	TLS1.0	74.125.203.120:443	86340
7		2014-02-13 10:49:35	*.google.com	plus.google.com	TLS1.0	74.125.203.101:443	86220
8		2014-02-13 10:49:33	*.google.com	s.yimg.com	TLS1.0	74.125.203.100:443	86220
9		2014-02-13 10:49:26	*.google.com	ssl.gstatic.com	TLS1.0	74.125.203.120:443	86220
10		2014-02-13 10:49:23	*.google.com.tw	accounts.google.com.tw	TLS1.0	74.125.203.94:443	86280
11		2014-02-13 10:49:22	*.google.com	apis.google.com	TLS1.0	74.125.203.138:443	86280
12		2014-02-13 10:49:20	*.googleusercontent.com	mail-attachment.googleusercontent.com	TLS1.0	74.125.203.132:443	86280
13		2014-02-13 10:49:20	*.google.com	clients2.google.com	TLS1.0	74.125.203.138:443	86280
14		2014-02-13 10:49:20	*.google.com	www.gstatic.com	TLS1.0	74.125.203.120:443	86220
15		2014-02-13 10:49:11	*.google.com	accounts.youtube.com	TLS1.0	74.125.203.100:443	86280
16		2014-02-13 10:49:11	www.googleadservices.com	www.googleadservices.com	TLS1.0	74.125.203.157:443	86280
17		2014-02-13 10:49:04	*.googleusercontent.com	oauth.googleusercontent.com	TLS1.0	74.125.203.132:443	86280

The following table describes the labels in this screen.

Table 85 Monitor > UTM Statistics > SSL Inspection > Certificate Cache List

LABEL	DESCRIPTION
Certificate Cache List	
Add to Exclude list	Select and item in the list and click this icon to add the common name (CN) to the Exclude List .
#	This field is a sequential value, and it is not associated with a specific entry.

Table 85 Monitor > UTM Statistics > SSL Inspection > Certificate Cache List (continued)

LABEL	DESCRIPTION
In Exclude List	<p>If any one of common name, DNS name, email address or IP address of the certificate is in the Exclude List, then traffic to the server identified by the certificate is excluded from inspection.</p> <p>The icons here are defined as follows:</p> <ul style="list-style-type: none"> • Gray: The identity of the certificate is not in the Exclude List • Green: The common name of the certificate is in the Exclude List • Yellow: The common name of certificate is not in the Exclude List but one of the DNS name, email address or IP address is.
Time	This is the latest date (yyyy-mm-dd) and time (hh-mm-ss) that the record in the certificate cache list was met.
Common Name	This displays the common name in the certificate of the SSL traffic destination server.
SNI	Server Name Indication (SNI) is the domain name entered in the browser, FTP client, etc. to begin the SSL session with the server. It allows multiple SSL sessions to the same IP address and port number with different certificates from different SNI. This field displays the SNI for this SSL session.
SSL Version	This field shows the SSL version. SSLv3/TLS1.0 is currently supported.
Destination	This displays the IP address and port number of the SSL traffic destination server.
Valid Time	This displays the cache item expiry time in seconds. The cache item is deleted when the remaining time expires.
Refresh	Click this button to update the information in the screen.

7.36 Log Screens

Log messages are stored in two separate logs, one for regular log messages and one for debugging messages. In the regular log, you can look at all the log messages by selecting **All Logs**, or you can select a specific category of log messages (for example, security policy or user). You can also look at the debugging log by selecting **Debug Log**. All debugging messages have the same priority.

7.36.1 View Log

To access this screen, click **Monitor > Log**. The log is displayed in the following screen.

Note: When a log reaches the maximum number of log messages, new log messages automatically overwrite existing log messages, starting with the oldest existing log message first.

- The maximum possible number of log messages in the Zyxel Device varies by model.

Events that generate an alert (as well as a log message) display in red. Regular logs display in black. Click a column's heading cell to sort the table entries by that column's criteria. Click the heading cell again to reverse the sort order. The Web Configurator saves the filter settings if you leave the **View Log** screen and return to it later.

Figure 229 Monitor > Log > View Log

#	Time	Priority	Categ...	Message	Source	Destination	Note
1	2016-05-23 03:44:08	error	myZyX...	GetTimeZone: Can not get correct feed...			
2	2016-05-23 03:44:08	error	myZyX...	An SSL error has occurred and a secure...			
3	2016-05-23 03:44:05	info	IKE	Send:[SA][VID][VID][VID][VID][VI...	172.2...	1.1.1.1:500	IKE_L...
4	2016-05-23 03:44:05	info	IKE	Send Main Mode request to [1.1.1.1]	172.2...	1.1.1.1:500	IKE_L...
5	2016-05-23 03:44:05	info	IKE	Tunnel [WIZ] Sending IKE request	172.2...	1.1.1.1:500	IKE_L...
6	2016-05-23 03:44:05	info	IKE	The cookie pair is : 0x8bb86ae1c47311f...	172.2...	1.1.1.1:500	IKE_L...
7	2016-05-23 03:44:03	notice	myZyX...	GetTimeZone: Processing...			
8	2016-05-23 03:43:44	error	myZyX...	GetTimeZone: Can not get correct feed...			
9	2016-05-23 03:43:44	error	myZyX...	An SSL error has occurred and a secure...			
10	2016-05-23 03:43:39	notice	myZyX...	GetTimeZone: Processing...			
11	2016-05-23 03:43:06	error	myZyX...	GetTimeZone: Can not get correct feed...			
12	2016-05-23 03:43:06	error	myZyX...	An SSL error has occurred and a secure...			
13	2016-05-23 03:43:01	notice	myZyX...	GetTimeZone: Processing...			
14	2016-05-23 03:42:45	info	IKE	Peer not reachable	172.2...	1.1.1.1:500	IKE_L...
15	2016-05-23 03:42:45	info	IKE	ISAKMP SA [WIZ] is disconnected	172.2...	1.1.1.1:500	IKE_L...
16	2016-05-23 03:42:45	info	IKE	The cookie pair is : 0x5ad7f515c20eadf...	172.2...	1.1.1.1:500	IKE_L...
17	2016-05-23 03:42:30	error	myZyX...	GetTimeZone: Can not get correct feed...			
18	2016-05-23 03:42:30	error	myZyX...	An SSL error has occurred and a secure...			

The following table describes the labels in this screen.

Table 86 Monitor > Log > View Log

LABEL	DESCRIPTION
Show (Hide) Filter	Click this button to show or hide criteria that allow you to filter logs that will be displayed. If the filter settings are hidden, the Category , Email Log Now , Refresh , and Clear Log fields are available. If the filter settings are shown, the Category , Priority , Source Address , Destination Address , Source Interface , Destination Interface , Service , Keyword , criteria and Search fields are available.
Category	Select the type of log message(s) you want to view. You can also view All Logs at one time, or you can view the Debug Log .
Email Log Now	Click this button to send log message(s) to the Active e-mail address(es) specified in the Send Log To field on the Log Settings page.\
Refresh	Click this button to update the information in the screen.
Clear	Click this button to clear the whole log, regardless of what is currently displayed on the screen.
#	This field is a sequential value, and it is not associated with a specific log message.
Time	This field displays the time the log message was recorded.

Table 86 Monitor > Log > View Log (continued)

LABEL	DESCRIPTION
Priority	This field displays the priority of the log message. It has the same range of values as the Priority field above.
Category	This field displays the log that generated the log message. It is the same value used in the Category field above.
Message	This field displays the reason the log message was generated. The text "[count=x]", where <i>x</i> is a number, appears at the end of the Message field if log consolidation is turned on and multiple entries were aggregated to generate into this one.
Source	This displays when you show the filter. Type the source IP address of the incoming packet that generated the log message. Do not include the port in this filter.
Source Interface	This displays when you show the filter. Type the source interface of the incoming packet that generated the log message.
Destination	This displays when you show the filter. Type the IP address of the destination of the incoming packet when the log message was generated. Do not include the port in this filter.
Destination Interface	This displays when you show the filter. Type the interface of the destination of the incoming packet when the log message was generated.
Protocol	This displays when you show the filter. Select a service protocol whose log messages you would like to see.
Note	This field displays any additional information about the log message.

7.36.2 View AP Log

Click on **Monitor > Log > View AP Log** to open the following screen. Use this screen to view the log messages of the APs managed by your Zyxel Device.

Figure 230 Monitor > Log > View AP Log

#	Time	Pr...	Ca...	Message	Source	Destination	Note
1	2014-02-21 08:2...	n...	Wi...	Station has disassoc. Interface:wlan-1-1 Station: A...			IEEE 802.11
2	2014-02-21 08:2...	n...	Wi...	Station has authorized. Interface:wlan-1-1 Station: 1...			IEEE 802.11
3	2014-02-21 08:2...	n...	Wi...	Station has associated. Interface:wlan-1-1 Station: ...			IEEE 802.11
4	2014-02-21 08:2...	n...	Wi...	Station has authorized. Interface:wlan-1-1 Station: A...			IEEE 802.11
5	2014-02-21 08:2...	n...	Wi...	Station has associated. Interface:wlan-1-1 Station: ...			IEEE 802.11
6	2014-02-21 07:0...	n...	Wi...	Station has disassoc. Interface:wlan-2-1 Station: 8...			IEEE 802.11

The following table describes the labels in this screen.

Table 87 Monitor > Log > View AP Log

LABEL	DESCRIPTION
Show Filter	Click this button to show or hide the filter settings. If the filter settings are hidden, the Display , Email Log Now , Refresh , and Clear Log fields are available. If the filter settings are shown, the Display , Priority , Source Address , Destination Address , Service , Keyword , and Search fields are available.
Select an AP	Click the pull down menu to choose an AP.
Query	Click Query to create a Query log.
Log Query Status	The field displays the
AP Information	This field displays the AP information. N/A is displayed when
Log File Status	This field displays how many logs are available. It will display Empty if there's none.
Last Log Query Time	This field displays the most recent time a log query was solicited.
Display	Select the category of log message(s) you want to view. You can also view All Logs at one time, or you can view the Debug Log .
Email Log Now	Click this button to send log message(s) to the Active e-mail address(es) specified in the Send Log To field on the Log Settings page.
Refresh	Click this button to update the information in the screen.
Clear	Click this button to clear the whole log, regardless of what is currently displayed on the screen.
#	This field is a sequential value, and it is not associated with a specific log message.
Time	This field displays the time the log message was recorded.
Priority	This displays when you show the filter. Select the priority of log messages to display. The log displays the log messages with this priority or higher. Choices are: any , emerg , alert , crit , error , warn , notice , and info , from highest priority to lowest priority. This field is read-only if the Category is Debug Log .
Category	This field displays the log that generated the log message. It is the same value used in the Display and (other) Category fields.
Message	This field displays the message of the log.
Source	This displays the source IP address of the selected log message.
Source Interface	Select the interface of the source AP from the pull down menu. Choose Any to search all interface.
Destination	Type the IP address of the destination.
Destination Interface	Select the destination interface from the pull down menu.
Protocol	Select the protocol of the AP from the pull down menu.
Note	This field displays any additional information about the log message.

7.36.3 Dynamic Users Log

Use this screen to view the Zyxel Device's dynamic guest account log messages. Click **Monitor > Log > Dynamic Users Log** to access this screen.

Figure 231 Monitor > Log > Dynamic Users Log

The following table describes the labels in this screen.

Table 88 Monitor > Log > Dynamic Users Log

LABEL	DESCRIPTION
Begin/End Date	Select the first and last dates to specify a time period. The Zyxel Device displays log messages only for the accounts created during the specified time period after you click Search .
Begin/End Time	Select the begin time of the first date and the end time of the last date to specify a time period. The Zyxel Device displays log messages only for the accounts created during the specified time period after you click Search .
Search	Click this button to update the information on the screen using the filter criteria in the date and time fields.
Refresh	Click this button to update the information in the screen.
Clear Log	Click this button to delete the log messages for invalid accounts.
#	This is the index number of the dynamic guest account in the list.
Status	This field displays whether an account expires or not.
Username	This field displays the user name of the account.
Create Time	This field displays when the account was created.
Remaining Time	This field displays the amount of Internet access time remaining for each account.
Time Period	This field displays the total account of time the account can use to access the Internet through the Zyxel Device.
Expiration Time	This field displays the date and time the account becomes invalid. Note: Once the time allocated to a dynamic account is used up or a dynamic account remains un-used after the expiration time, the account is deleted from the account list.
Quota (T/U/D)	This field displays how much data in both directions (Total) or upstream data (Upload) and downstream data (Download) can be transmitted through the WAN interface before the account expires.

Table 88 Monitor > Log > Dynamic Users Log

LABEL	DESCRIPTION
Remaining Quota (T/U/D)	This field displays the remaining amount of data that can be transmitted or received by each account. You can see the amount of either data in both directions (Total) or upstream data (Upload) and downstream data (Download).
Bandwidth (U/D)	This field displays the maximum upstream (Upload) and downstream (Download) bandwidth allowed for the user account in kilobits per second.
Real Name	This field displays the user's name of the account.
Email	This field displays the email of the account.
Charge	This field displays the total cost of the account.
Payment Info	This field displays the method of payment for each account.
Phone Num	This field displays the telephone number for the user account.

CHAPTER 8

Licensing

8.1 Registration Overview

Use the **Configuration > Licensing > Registration** screens to register your Zyxel Device and manage its service subscriptions.

- Use the **Registration** screen (see [Section 8.1.2 on page 284](#)) to refresh Zyxel Device registration, go to portal.myZyxel.com to register your Zyxel Device and activate a service, such as content filtering.
- Use the **Service** screen (see [Section 8.1.3 on page 285](#)) to display the status of your service registrations and upgrade licenses.

Note: ZyWALL models need a license for UTM (Unified Threat management) functionality.

8.1.1 What you Need to Know

This section introduces the topics covered in this chapter.

Subscription Services Available

See **Configuration > Licensing > Registration > Service** for the subscription services that your Zyxel Device supports.

ZyWALL models need a license for UTM (Unified Threat Management) functionality - see [Section 1.1 on page 28](#) for details.

You can purchase an iCard and enter its license key at myZyxel to have a Zyxel Device use UTM services or use more counts of a service or extend a service. See the respective chapters in this guide for more information about UTM features.

8.1.2 Registration Screen

Click the link in this screen to register your Zyxel Device at myZyxel. Then click **Refresh** in this screen and wait a few moments for the registration information to update. If the page does not refresh, make sure the Internet connection is working and click **Refresh** again. The Zyxel Device should already have Internet access and be able to access myZyxel. Click **Configuration > Licensing > Registration** in the navigation panel to open the screen as shown next.

Click on the icon to go to the OneSecurity website where there is guidance on configuration walkthrough and other information.

Figure 232 Configuration > Licensing > Registration

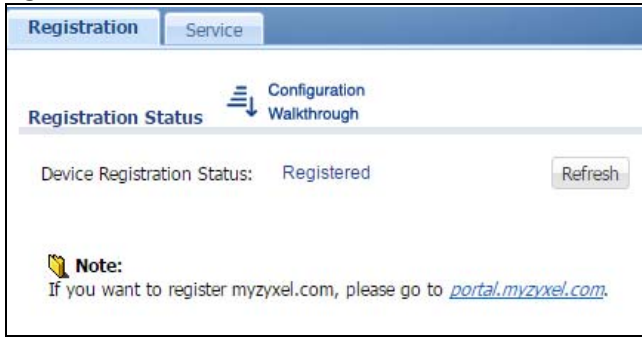

8.1.3 Service Screen

Use this screen to display the status of your service registrations and upgrade licenses. To activate or extend a standard service subscription, purchase an iCard and enter the iCard's PIN number (license key) at myZyxel. Click **Activate** in this screen to enable both Trial and Standard services on this Zyxel Device. Click **Configuration > Licensing > Registration > Service** to open the screen as shown next.

Figure 233 Configuration > Licensing > Registration > Service

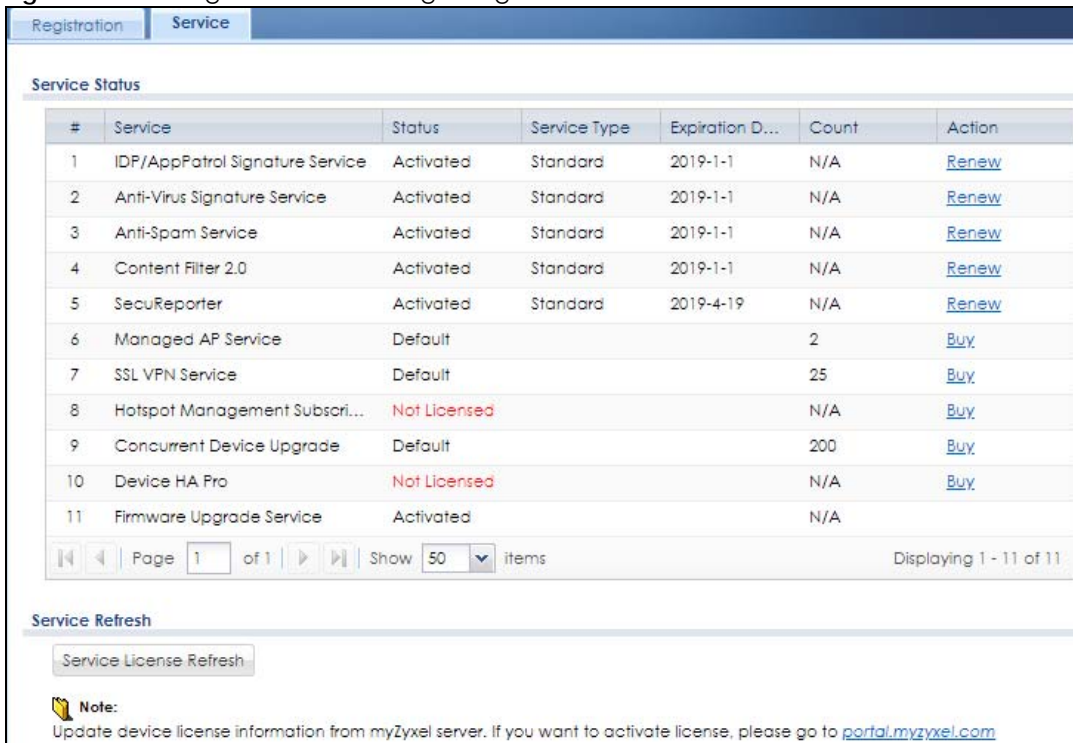

The following table describes the labels in this screen.

Table 89 Configuration > Licensing > Registration > Service

LABEL	DESCRIPTION
Service Status	
#	This is the entry's position in the list.
Service	This lists the services that available on the Zyxel Device.

Table 89 Configuration > Licensing > Registration > Service (continued)

LABEL	DESCRIPTION
IDP/AppPatrol Signature Service	This is a license for signatures for Intrusion Detection and Prevention attacks and Application Patrol inspection.
Anti-Virus	This is a license for signatures to detect virus patterns in files.
Anti-Spam Service	This is a license for signatures to recognize unsolicited commercial or junk e-mail suspect of being sent by spammers.
Content Filter 2.0	This is a license to a database that can block websites by category, such as Gambling.
SSL VPN Service	This is a license to create more SSL VPN than the default for your Zyxel Device.
Managed AP Service	This is a license to manage more APs than the default for your Zyxel Device when the AP controller is enabled.
Zymesh Service	This is a license to have more than the default number of Zymesh root APs for your Zyxel Device. ZyMesh is a Zyxel proprietary protocol that creates wireless mesh links between managed APs to expand the wireless network.
Hotspot Management Subscription Service	This is a license to manage hotspot functions such as: <ul style="list-style-type: none"> • Billing • Printer Manager • Free Time • SMS • IPnP • Walled Garden • Advertisement
Concurrent Device Upgrade	This is a license to increase the number of devices (based on unique MAC address) that can log in and use the Zyxel Device Hotspot at the same time. Default displays when the Zyxel Device is currently using the allowed free number without a license.
Device HA Pro	This is a license for professional High Availability (HA) that lets a backup Zyxel Device automatically take over if the master Zyxel Device fails.
Firmware Upgrade Service	This is a free license to get Cloud Helper notifications when new firmware is available. You must register your Zyxel Device at myZyxel.
SecuReporter	This is a license that allows SecuReporter to collect and analyze logs from your Zyxel Device in order to identify anomalies, alert on potential internal / external threats, and report on network usage.
SecuDeployer	This is a license that allows a Zyxel Device SecuDeployer server to manage and apply profile template settings to remote Zyxel Device clients. Provisioning can include the settings of one to multiple LAN/DMZ interfaces, Hub & Spoke IPSec tunnels, and/or static route settings for VTI IPSec VPNs.
Status	This field displays whether a service license is enabled at myZyxel (Activated) or not (Not Activated) or expired (Expired). It displays the remaining Grace Period if your license has Expired . It displays Not Licensed if there isn't a license to be activated for this service. Default displays for quantity-based licenses when the Zyxel Device is currently using the allowed free number without a license. For example, if a Zyxel Device is allowed to manage x number of APs without a license and it is currently using that number, then Managed AP Service Status displays Default .
Service Type	This field displays whether you applied for a trial application (Trial) or registered a service with your iCard's PIN number (Standard). This field is blank when a service is not activated.

Table 89 Configuration > Licensing > Registration > Service (continued)

LABEL	DESCRIPTION
Expiration Date	<p>This field displays the date your service license expires or the date the grace period expires if the license has already expired.</p> <p>You can continue to use IDP/AppPatrol, Anti-Virus (AV), Content Filter, Anti-Spam (AS) during the grace period.</p> <p>After the grace period ends, all these features are disabled except the following:</p> <ul style="list-style-type: none"> • Content Filter Trusted Web Sites • IDP Custom Signatures • Anti-Virus Black/White List • Email Security Black/White List
Count	<p>This field displays how many instances of a service you can use with your current license. N/A means a count does not apply to this service.</p>
Action	<p>If you need a license or a trial license has expired, click Buy to buy a new one. If a Standard license has expired, click Renew to extend the license.</p> <p>Then, click Activate to connect with the myZyxel server to activate the new license.</p>
Service License Refresh	<p>Click this button to renew service license information (such as the registration status and expiration day).</p> <p>Note: It is recommended you use this button after you register for a new service.</p>

8.2 Signature Update

This section shows you how to update the signature packages of ZyWALL VPN and USG devices.

- Use the **Configuration > Licensing > Signature Update > Anti-virus** screen ([Section 8.2.2 on page 287](#)) to update the anti-virus signatures.
- Use the **Configuration > Licensing > Signature Update > IDP/AppPatrol** screen ([Section 8.2.3 on page 288](#)) to update the signatures used for IDP and application patrol.

8.2.1 What you Need to Know

- You need a valid service registration to update the anti-virus signatures and the IDP/AppPatrol signatures.
- You do not need a service registration to update the system-protection signatures.
- Schedule signature updates for a day and time when your network is least busy to minimize disruption to your network.
- Your custom signature configurations are not over-written when you download new signatures.

Note: The Zyxel Device does not have to reboot when you upload new signatures.

8.2.2 The Anti-Virus Update Screen

Click **Configuration > Licensing > Signature Update > Anti-Virus** to display the following screen.

Figure 234 Configuration > Licensing > Signature Update >Anti-Virus

The following table describes the labels in this screen.

Table 90 Configuration > Licensing > Signature Update >Anti-Virus

LABEL	DESCRIPTION
Signature Information	The following fields display information on the current signature set that the Zyxel Device is using.
Current Version	This field displays the anti-virus signatures version number currently used by the Zyxel Device. This number gets larger as new signatures are added.
Signature Number	This field displays the number of signatures in this set.
Released Date	This field displays the date and time the set was released.
Signature Update	Use these fields to have the Zyxel Device check for new signatures at myZyXel. If new signatures are found, they are then downloaded to the Zyxel Device.
Update Now	Click this button to have the Zyxel Device check for new signatures immediately. If there are new ones, the Zyxel Device will then download them.
Auto Update	Select this check box to have the Zyxel Device automatically check for new signatures regularly at the time and day specified. You should select a time when your network is not busy for minimal interruption.
Hourly	Select this option to have the Zyxel Device check for new signatures every hour.
Daily	Select this option to have the Zyxel Device check for new signatures every day at the specified time. The time format is the 24 hour clock, so '23' means 11 PM for example.
Weekly	Select this option to have the Zyxel Device check for new signatures once a week on the day and at the time specified.
Apply	Click this button to save your changes to the Zyxel Device.
Reset	Click this button to return the screen to its last-saved settings.

8.2.3 The IDP/AppPatrol Update Screen

Click **Configuration > Licensing > Signature Update > IDP/AppPatrol** to display the following screen.

The Zyxel Device comes with signatures for the IDP and application patrol features. These signatures are continually updated as new attack types evolve. New signatures can be downloaded to the Zyxel Device periodically if you have subscribed for the IDP/AppPatrol signatures service.

You need to create an account at myZyxel, register your Zyxel Device and then subscribe for IDP service in order to be able to download new packet inspection signatures from myZyxel (see the **Registration** screens). Use the **Update IDP /AppPatrol** screen to schedule or immediately download IDP signatures.

Figure 235 Configuration > Licensing > Signature Update > IDP/AppPatrol

The following table describes the fields in this screen.

Table 91 Configuration > Licensing > Signature Update > IDP/AppPatrol

LABEL	DESCRIPTION
Signature Information	The following fields display information on the current signature set that the Zyxel Device is using.
Current Version	This field displays the IDP signature and anomaly rule set version number. This number gets larger as the set is enhanced.
Signature Number	This field displays the number of IDP signatures in this set. This number usually gets larger as the set is enhanced. Older signatures and rules may be removed if they are no longer applicable or have been supplanted by newer ones.
Released Date	This field displays the date and time the set was released.
Signature Update	Use these fields to have the Zyxel Device check for new IDP signatures at myZyxel. If new signatures are found, they are then downloaded to the Zyxel Device.
Update Now	Click this button to have the Zyxel Device check for new IDP signatures immediately. If there are new ones, the Zyxel Device will then download them.
Auto Update	Select this check box to have the Zyxel Device automatically check for new IDP signatures regularly at the time and day specified. You should select a time when your network is not busy for minimal interruption.
Hourly	Select this option to have the Zyxel Device check for new IDP signatures every hour.
Daily	Select this option to have the Zyxel Device check for new IDP signatures everyday at the specified time. The time format is the 24 hour clock, so '23' means 11 PM for example.

Table 91 Configuration > Licensing > Signature Update > IDP/AppPatrol (continued)

LABEL	DESCRIPTION
Weekly	Select this option to have the Zyxel Device check for new IDP signatures once a week on the day and at the time specified.
Apply	Click this button to save your changes to the Zyxel Device.
Reset	Click this button to return the screen to its last-saved settings.

CHAPTER 9

Wireless

9.1 Overview

Use the **Wireless** screens to configure how the Zyxel Device manages supported Access Points (APs). Supported APs should be in managed mode. See the product page **Licenses** tab for a list of supported APs.

Note: See [Section 1.1 on page 28](#) to see which models have built-in Wi-Fi functionality and which models do not support the AP controller function.

9.1.1 What You Can Do in this Chapter

- Use the **Controller** screen ([Section 9.2 on page 291](#)) to set how the Zyxel Device allows new APs to connect to the network and set the country code of APs that are connected to the Zyxel Device.
- Use the **AP Management** screens ([Section 9.3 on page 293](#)) to manage all of the APs connected to the Zyxel Device.
- Use the **Rogue AP** screen ([Section 9.4 on page 311](#)) to assign APs either to the rogue AP list or the friendly AP list.
- Use the **Auto Healing** screen ([Section 9.5 on page 314](#)) to extend the wireless service coverage area of the managed APs when one of the APs fails.
- Use the **RTLS** screen ([Section 9.6 on page 315](#)) to allow managed APs with battery-powered Wi-Fi tags be part of Ekahau RTLS (Real Time Location Service). RTLS can track the location of APs managed by the Zyxel Device to create maps, alerts, and reports.

9.2 Controller Screen

Use this screen to set how the Zyxel Device allows new APs to connect to the network. Click **Configuration > Wireless > Controller** to access this screen.

Figure 236 Configuration > Wireless > Controller (with built-in AP)

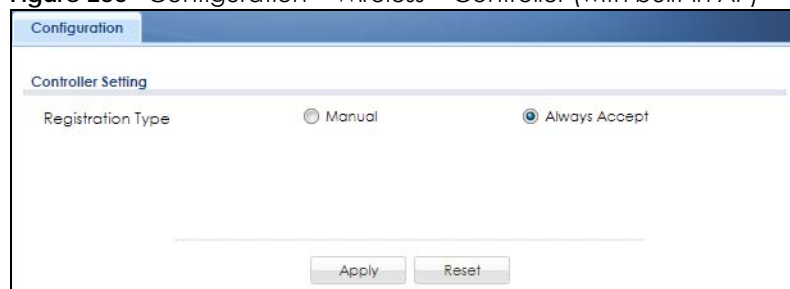

Figure 237 Configuration > Wireless > Controller (without built-in AP)

The screenshot shows a web interface for configuring wireless settings. At the top, there is a blue header with the word 'Configuration'. Below it, a sub-header reads 'Controller Setting'. Under this sub-header, there are two main settings:

- Country Code:** A dropdown menu currently displaying 'Switzerland'.
- Registration Type:** Two radio buttons are present. The first is labeled 'Manual' and is selected (indicated by a filled circle). The second is labeled 'Always Accept' and is unselected (indicated by an empty circle).

Each field is described in the following table.

Table 92 Configuration > Wireless > Controller

LABEL	DESCRIPTION
Country Code	Select the country code of where the Zyxel Device is located/installed. The available channels vary depending on the country you selected. Please note that the Zyxel Devices with built-in AP do not support country code, see Section 1.1 on page 28 for more information.
Registration Type	Select Manual to add each AP to the Zyxel Device for management, or Always Accept to automatically add APs to the Zyxel Device for management. If you select Manual , then go to Monitor > Wireless > AP Information > AP List , select an AP to be managed and then click Add to Mgmt AP List . That AP will then appear in Configuration > Wireless > Controller > Mgmt. AP List . Note: Select the Manual option for managing a specific set of APs. This is recommended as the registration mechanism cannot automatically differentiate between friendly and rogue APs. APs must be connected to the Zyxel Device by a wired connection or network.
Apply	Click Apply to save your changes back to the Zyxel Device.
Reset	Click Reset to return the screen to its last-saved settings.

9.3 AP Management Screens

Use these screens to manage all of the APs connected to the Zyxel Device. Click **Configuration > Wireless > AP Management** to access these screens.

Click on the icon to go to the OneSecurity website where there is guidance on configuration walkthroughs and other information.

9.3.1 Mgnt. AP List

Figure 238 Configuration > Wireless > AP Management > Mgnt. AP List

#	Status	Description	CPU Usage	IP Address	MAC Address	Station 2.4G
1		AP-B0B2DC6E7E5E	0 %	0.0.0.0	B0:B2:DC:6E:7E:5E	0
2		AP-BCCF4FB752CF	4 %	192.168.1.33	BC:CF:4F:B7:52:CF	0
3		Local-AP	5 %	127.0.0.1	B0:B2:DC:70:C0:1E	0

Each field is described in the following table.

Table 93 Configuration > Wireless > AP Management > Mgnt. AP List

LABEL	DESCRIPTION
Hide/ Show Advanced Settings	Click this button to display a greater or lesser number of configuration fields.
AP List	Select the type of APs you want to display. Select All to show all kinds of APs that are currently or used to be connected to the ZyWALL. Select NebulaFlexPRO to show the APs that can work in Nebula cloud management mode.
Status	Select the status of APs you want to display.
Keyword	Enter a keyword to display the APs that include it in their AP information, such as model number, firmware version, MAC address and so on. This field is case-sensitive.
Search	Click this to update the list of APs based on the search criteria. Your search criteria is retained when navigating between screens.
Reset	Click this to return the search criteria to the factory defaults and display all currently or previously connected APs without a filter.
Enable Column Freeze	Select the check box to freeze the first column (#) so it will be always visible when you scroll through the list. Clear the check box to unfreeze the column.
Edit Selected Rule	Select an AP and click this button to edit its properties.

Table 93 Configuration > Wireless > AP Management > Mgnt. AP List (continued)

LABEL	DESCRIPTION
Add to Mgnt	Select an AP and click this to add the selected AP to the managed AP list.
Reboot device	Select an AP and click this button to force it to restart.
Remove Rule	Select an AP and click this button to remove it from the list. Note: If in the Configuration > Wireless > Controller screen you set the Registration Type to Always Accept , then as soon as you remove an AP from this list it reconnects.
DCS Now	Select one or multiple APs and click this button to use DCS (Dynamic Channel Selection) to allow the AP to automatically find a less-used channel in an environment where there are many APs and there may be interference. Note: You should have enabled DCS in the applied AP radio profile before the APs can use DCS. Note: DCS is not supported on the radio which is working in repeater AP mode.
More Information	Select an AP and click this to view a daily station count about the selected AP. The count records station activity on the AP over a consecutive 24 hour period.
Radio Info	Select an online AP and click this button to go to the Monitor > Wireless > AP Information > Radio List screen to view detailed information about the AP's radios.
Query Controller Log	Select an AP and click this button to go to the Monitor > Log > View AP Log screen to view the selected AP's current log messages.
Nebula	Select an AP and click this to open a screen where you can set whether the AP's IP address and VLAN settings will be changed when it goes into Nebula cloud management mode. Note: The AP will be set to Nebula cloud management mode and removed from the managed AP list right after you click OK .
Upgrade FW	Select one or more APs and click this button to update the APs' firmware version.
Suppression On	Select an AP and click this button to enable the AP's LED suppression mode. All the LEDs of the AP will turn off after the AP is ready. This button is not available if the selected AP doesn't support suppression mode.
Suppression Off	Select an AP and click this button to disable the AP's LED suppression mode. The AP LEDs stay lit after the AP is ready. This button is not available if the selected AP doesn't support suppression mode.
Locator On	Select an AP and click this button to run the locator feature. The AP's Locator LED will start to blink for 10 minutes by default. It will show the actual location of the AP between several devices in the network.
#	This field is a sequential value, and it is not associated with any entry.
Status	This visually displays the AP's connection status with icons.
Description	This field displays the AP's description, which you can configure by selecting the AP's entry and clicking the Edit button.
CPU Usage	This displays what percentage of the AP's processing capability is currently being used.
IP Address	This field displays the IP address of the AP.
MAC Address	This field displays the MAC address of the AP.
Station 2.4G	This displays the number of stations (aka wireless clients) associated with the AP's 2.4 GHz WiFi network.
Station 5G	This displays the number of stations (aka wireless clients) associated with the AP's 5 GHz WiFi network.
Recent On-line Time	

Table 93 Configuration > Wireless > AP Management > Mgmt. AP List (continued)

LABEL	DESCRIPTION
Power	<p>This displays the AP's power status.</p> <p>Full power - the AP receives optimal power from the power sourcing equipment.</p> <p>Force Full Power- the power sourcing equipment provides full power to the AP even in cases where a PoE injector that does not support PoE negotiation is used.</p> <p>Limited power - the AP receives less than optimal power from the power sourcing equipment. This may be due to the PoE switch/injector using an earlier PoE standard. This may impact wireless transmission throughput or disable a radio transmitter, depending on the AP's power requirements.</p> <p>Off-Line - the AP is not receiving power.</p>
Type	<p>This indicates whether the AP is on the managed AP list (Mgmt) or not (Un-Mgmt).</p> <p>This displays Limited when the AP is configured by conflicted or unsupported setting(s).</p>
Model	<p>This field displays the AP's hardware model information. It displays N/A (not applicable) only when the AP disconnects from the NXC and the information is unavailable as a result.</p>
R1 Mode/ Profile/ ZyMesh Profile	<p>This field displays the operating mode (AP, MON, root, or repeater), AP radio profile name and ZyMesh profile name for Radio 1. It displays n/a for the AP profile for a radio not using an AP profile or - for the ZyMesh profile for a radio not using a ZyMesh profile.</p>
R2 Mode/ Profile/ ZyMesh Profile	<p>This field displays the operating mode (AP, MON, root, or repeater), AP radio profile name and ZyMesh profile name for Radio 2. It displays n/a for the AP profile for a radio not using an AP profile or - for the ZyMesh profile for a radio not using a ZyMesh profile.</p>
Version	<p>This displays the AP's current firmware version.</p>
Group	<p>This field displays the name of the AP group to which the AP belongs.</p> <p>The group becomes editable immediately upon clicking.</p>
Mgmt. VLAN ID(AC/ AP)	<p>This displays the Access Controller (the NXC) management VLAN ID setting for the AP and the runtime management VLAN ID setting on the AP.</p> <p>VLAN Conflict displays if the AP's management VLAN ID does not match the NXC's management VLAN ID setting for the AP. This field displays n/a if the NXC cannot get VLAN information from the AP.</p>
Last Off-line Time	<p>This displays the most recent time the AP went off-line. N/A displays if the AP has either not come on-line or gone off-line since the NXC last started up.</p>
LED status	<p>This displays the AP LED status.</p> <p>N/A displays if the AP does not support LED suppression mode and/or have a locator LED to show the actual location of the AP.</p> <p>A gray LED icon signifies that the AP LED suppression mode is enabled. All the LEDs of the AP will turn off after the AP is ready.</p> <p>A green LED icon signifies that the AP LED suppression mode is disabled and the AP LEDs stay lit after the AP is ready.</p> <p>A sun icon signifies that the AP's locator LED is blinking.</p> <p>A circle signifies that the AP's locator LED is extinguished.</p>
Ethernet Uplink	<p>This field displays the AP's uplink port speed and duplex mode (Full or Half).</p>

Table 93 Configuration > Wireless > AP Management > Mgnt. AP List (continued)

LABEL	DESCRIPTION
Bluetooth	<p>This field displays the AP's Bluetooth Low Energy (BLE) capability. Bluetooth Low Energy, which is also known as Bluetooth Smart, transmits less data over a shorter distance and consumes less power than classic Bluetooth. APs communicate with other BLE enabled devices using advertisements.</p> <p>N/A displays if the AP does not support BLE.</p> <p>Unavailable displays if the AP supports Bluetooth, but there is no BLE USB dongle connected to the USB port of the AP.</p> <p>Available displays if the AP supports Bluetooth, detects a BLE device and advertising is inactive. Some APs, such as the WAC5302D-S, need to have a supported BLE USB dongle attached to act as a beacon to broadcast packets.</p> <p>Advertising displays if the AP supports Bluetooth, detects a BLE device and advertising is activated, which means the BLE device can broadcasts packets to every device around it.</p>
Location	This field displays the AP's location you configured.
Roaming Group	This field displays the name of roaming group to which the AP belongs.
Load Balancing Group	This field displays the load balancing group(s) to which the AP belongs.
S/N	This field displays the serial number of the AP.
System Name	This field displays the system name to identify the AP on a network.
Apply	Click Apply to save your changes back to the Zyxel Device.
Refresh	Click Refresh to update the information in this screen.

9.3.1.1 Edit AP List

Select an AP and click the **Edit** button in the **Configuration > Wireless > AP Management** table to display this screen.

Figure 239 Configuration > Wireless > AP Management > Mgmt. AP List > Edit AP List

Configuration

MAC: BC:DF:4F:B7:52:CF
 Model: WAX510D
 S/N: S192L4329011
 Description: AP-BCDF4FB752CF
 Group setting: EEMODE_AP_GROUP
 System Name: (Optional)
 Location: (Optional)
 Roaming Group: (Optional)
 Load Balancing Group 1: (Optional)
 Load Balancing Group 2: (Optional)

Radio 1 setting

Override Group Radio Setting
 RF Mode: AP Mode MDN Mode Root AP Repeater AP
 Radio 1 AP Profile: EEMODE_RADIO_24G
 Override Group Output Power Setting
 Output Power: 30 dBm (0-30)
 Override Group SSID Setting

Radio 2 setting

Override Group Radio Setting
 RF Mode: AP Mode MDN Mode Root AP Repeater AP
 Radio 2 AP Profile: EEMODE_RADIO_2G
 Override Group Output Power Setting
 Output Power: 30 dBm (0-30)
 Override Group SSID Setting

IP Setting

Force Override IP Setting
 Get Automatically
 Use Fixed IP Address
 IP Address:
 Subnet Mask:
 Gateway: (Optional)
 DNS Server IP Address: (Optional)

VLAN Settings

Force Override VLAN Config
 Force Override VLAN Config
 Management VLAN ID: 1 (1-4094)
 As Native VLAN

Storm Control Setting

Broadcast Storm Control
 Multicast Storm Control

Rogue AP Detection Setting

Override Group Rogue AP Detection Setting
 Enable Rogue AP Detection

Antenna Setting

Wall Ceiling

LED Suppression Mode Configuration

Suppression On

Note:
 Followings are the exceptions when LED suppression mode is on:
 1. Device is performing Firmware Upgrade.
 2. Device is booting.
 3. Suppression mode does not apply to Locator LED.

Power Setting

Force override the power mode to full power.

Note:
 Only enable this when you are using a passive PoE injector which is not IEEE 802.3at/er compliant. Abnormal records will happen in case of insufficient power wattage.

Locator LED Configuration

Turn On | Turn Off
 Automatically Extinguish After: 10 (1-60 minutes)

Reset AP Configuration

Apply Factory Default

OK Cancel

Each field is described in the following table.

Table 94 Configuration > Wireless > AP Management > Mgnt. AP List > Edit AP List

LABEL	DESCRIPTION
Create new Object	Use this menu to create a new Radio Profile object to associate with this AP.
MAC	This displays the MAC address of the selected AP.
Model	This field displays the AP's hardware model information. It displays N/A (not applicable) only when the AP disconnects from the Zyxel Device and the information is unavailable as a result.
S/N	This displays the serial number of the selected AP.
Description	Enter a description for this AP. You can use up to 31 characters, spaces and underscores allowed.
Group Setting	Select an AP group to which you want this AP to belong.
System Name	Enter a name to identify the AP on a network. This is usually the AP's fully qualified domain name.
Location	Specify the name of the place where the AP is located.
Roaming Group	<p>Specify the name of the roaming group to which the AP belongs. You can use up to 31 alphanumeric and @# characters. Dashes and underscores are also allowed. The name should start with a letter or digit.</p> <p>The 802.11k neighbor list a client requests from the AP is generated according to the roaming group and RCPI (Received Channel Power Indicator) value of its neighbor APs.</p> <p>When a client wants to roam from the current AP to another, other APs in the same roaming group or not in a roaming group will be candidates for roaming. Neighbor APs in a different roaming group will be excluded from the 802.11k neighbor lists even when the neighbor AP has the best signal strength.</p> <p>If the AP's roaming group is not configured, any neighbor APs can be candidates for roaming.</p>
Load Balancing Group 1/2	<p>Load balancing is only applied to APs within the same group. If a load balancing group is not assigned to an AP, it will belong to a default group.</p> <p>Each AP can belong to up to two groups.</p>
Radio 1/2 Setting	
Override Group Radio Setting	Select this option to overwrite the AP radio settings with the settings you configure here.

Table 94 Configuration > Wireless > AP Management > Mgnt. AP List > Edit AP List (continued)

LABEL	DESCRIPTION
OP Mode	<p>Select the operating mode for radio 1 or radio 2.</p> <p>AP Mode means the AP can receive connections from wireless clients and pass their data traffic through to the Zyxel Device to be managed (or subsequently passed on to an upstream gateway for managing).</p> <p>MON Mode means the AP monitors the broadcast area for other APs, then passes their information on to the Zyxel Device where it can be determined if those APs are friendly or rogue. If an AP is set to this mode it cannot receive connections from wireless clients.</p> <p>Root AP means the radio acts as an AP and also supports the wireless connections with other APs (in repeater mode) to form a ZyMesh to extend its wireless network.</p> <p>Repeater AP means the radio can establish a wireless connection with other APs (in either root AP or repeater mode).</p> <p>Note: To prevent bridge loops, do NOT set both radios on a managed AP to Repeater AP mode.</p> <p>Note: The root AP and repeater AP(s) in a ZyMesh must use the same country code and AP radio profile settings in order to communicate with each other.</p> <p>Note: Ensure you restart the managed AP after you change its operating mode.</p>
Radio 1/2 AP Profile	Select an AP profile from the list. If no profile exists, you can create a new one through the Create new Object menu.
Radio 1/2 Profile	Select a monitor profile from the list. If no profile exists, you can create a new one through the Create new Object menu.
Radio 1/2 ZyMesh Profile	This field is available only when the radio is in Root AP or Repeater AP mode. Select the ZyMesh profile the radio uses to connect to a root AP or repeater.
Enable Wireless Bridging	<p>This field is available only when the radio is in Repeater AP mode.</p> <p>Select this option to enable wireless bridging on the radio.</p> <p>The managed AP must support LAN provision and the radio should be in repeater mode. VLAN and bridge interfaces are created automatically according to the LAN port's VLAN settings. When wireless bridging is enabled, the managed repeater AP can still transmit data through its Ethernet port(s) after the ZyMesh link is up. Be careful to avoid bridge loops. The managed APs in the same ZyMesh must use the same static VLAN ID.</p>
Override Group Output Power Setting	Select this option to overwrite the AP output power setting with the setting you configure here.
Output Power	Set the output power of the AP.
Override Group SSID Setting	<p>Select this option to overwrite the AP SSID profile setting with the setting you configure here.</p> <p>This section allows you to associate an SSID profile with the radio.</p>
IP Setting	
Force Overwrite IP Setting	Select this to have the Zyxel Device change the AP's IP address setting to match the configuration in this screen.
Get Automatically	Select this to have the AP act as a DHCP client and automatically get the IP address, subnet mask, and gateway address from a DHCP server.
Use Fixed IP Address	Select this if you want to specify the IP address, subnet mask, gateway and DNS server address manually.
IP Address	Enter the IP address for the AP.
Subnet Mask	Enter the subnet mask of the AP in dot decimal notation. The subnet mask indicates what part of the IP address is the same for all devices in the network.

Table 94 Configuration > Wireless > AP Management > Mgnt. AP List > Edit AP List (continued)

LABEL	DESCRIPTION
Gateway	Enter the IP address of the gateway. The AP sends packets to the gateway when it does not know how to route the packet to its destination. The gateway should be on the same network as the AP.
DNS Server IP Address	Enter the IP address of the DNS server.
VLAN Settings	
Override Group VLAN Setting	Select this option to overwrite the AP VLAN setting with the setting you configure here.
Force Overwrite VLAN Config	Select this to have the Zyxel Device change the AP's management VLAN to match the configuration in this screen.
Management VLAN ID	Enter a VLAN ID for this AP.
As Native VLAN	Select this option to treat this VLAN ID as a VLAN created on the NXC and not one assigned to it from outside the network.
Storm Control Setting	
Broadcast Storm Control	Enabling this will drop ingress broadcast traffic in the physical Ethernet port if it exceeds the maximum traffic rate. The maximum traffic rate can be changed using the CLI (see CLI Reference Guide).
Multicast Storm Control	Enabling this will drop ingress multicast traffic in the physical Ethernet port if it exceeds the maximum traffic rate. The maximum traffic rate can be changed using the CLI (see CLI Reference Guide)
Rogue AP Detection Setting	
Override Group Rogue AP Detection Setting	Select this option to overwrite the AP Rogue Detection Settings with the settings you configure here
Enable Rogue AP Detection	Select this option to detect Rogue APs in the network.
Antenna Setting	This section is available only when the AP has an antenna switch. The screen varies depending on whether the AP has a physical antenna switch or allows you to change antenna orientation settings on a per-radio basis or on a per-AP basis.
Wall/ Ceiling	This allows you to adjust coverage depending on the antenna orientation of the AP's radios for better coverage. Select Wall if you mount the AP to a wall. Select Ceiling if the AP is mounted on a ceiling. You can switch from Wall to Ceiling if there are still wireless dead zones, and vice versa.
LED Suppression Mode Configuration	This section is available only when the AP supports LED suppression mode.
Suppression On	Select this option to enable the AP's LED suppression mode. All the LEDs of the AP will turn off after the AP is ready. If the check box is unchecked, it means the LEDs will stay lit after the AP is ready.
Power Setting	Enable Force override the power mode to full power if you are using a PoE injector that does not support PoE negotiation. Otherwise, the AP cannot draw full power from the power sourcing equipment. Enable this power mode to improve the AP's performance in this situation. Note: Ensure that the power sourcing equipment can supply enough power to the AP to avoid abnormal system reboots. Note: Only enable this if you are using a passive PoE injector that is not IEEE 802.3at/bt compliant but can still provide full power.

Table 94 Configuration > Wireless > AP Management > Mgnt. AP List > Edit AP List (continued)

LABEL	DESCRIPTION
Locator LED Configuration	This section is available only when the AP has a locator LED.
Turn On/ Turn Off	When the locator LED is off, click the Turn On button to activate the locator function. It will show the actual location of the AP between several devices in the network. If the locator LED is blinking, click the Turn Off button to stop the locator LED from blinking immediately.
Automatically Extinguish After	Enter a time interval between 1 and 60 minutes to stop the locator LED from blinking. The locator LED will start to blink for the number of minutes set here. If you make changes to the time default setting, it will be stored as the default when the AP restarts.
Reset AP Configuration	This section is available only when the AP is online.
Apply Factory Default	Click the button to reset all of the AP settings to the factory defaults.
OK	Click OK to save your changes back to the Zyxel Device.
Cancel	Click Cancel to close the window with changes unsaved.

9.3.2 AP Policy

Use this screen to configure the AP controller's IP address on the managed APs and determine the action the managed APs take if the current AP controller fails. Click **Configuration > Wireless > AP Management > AP Policy** to access this screen.

Figure 240 Configuration > Wireless > AP Management > AP Policy

The screenshot displays the 'AP Policy' configuration page. At the top, there are navigation tabs: 'Mgnt. AP List', 'AP Policy' (selected), 'AP Group', and 'Firmware'. Below the tabs is a header for 'Wireless AP Controller' with a 'General Settings' section. In 'General Settings', the 'Force Override AC IP Config on AP' checkbox is checked, and the 'Override Type' is set to 'Auto'. There are empty input fields for 'Primary Controller' and 'Secondary Controller'. The 'Fall back to Primary Controller when possible' checkbox is also checked, and the 'Fall Back Check Interval' is set to 30 seconds. The 'Firmware Updating' section below has 'Updating Type' set to 'CAPWAP' and 'Updating Mode' set to 'Auto'. At the bottom of the page, there are 'Apply' and 'Reset' buttons.

Each field is described in the following table.

Table 95 Configuration > Wireless > AP Management > AP Policy

LABEL	DESCRIPTION
Force Override AC IP Config on AP	Select this to have the Zyxel Device change the AP controller's IP address on the managed AP(s) to match the configuration in this screen.
Override Type	<p>Select Auto to have the managed AP(s) automatically send broadcast packets to find any other available AP controllers.</p> <p>Select Manual to replace the AP controller's IP address configured on the managed AP(s) with the one(s) you specified below.</p>
Primary Controller	Specify the IP address of the primary AP controller if you set Override Type to Manual .
Secondary Controller	Specify the IP address of the secondary AP controller if you set Override Type to Manual .
Fall back to Primary Controller when possible	Select this option to have the managed AP(s) change back to associate with the primary AP controller as soon as the primary AP controller is available.
Fall Back Check Interval	Set how often the managed AP(s) check whether the primary AP controller is available.
Firmware Updating	
Updating Type	<p>Specify how you want the Zyxel Device to upgrade AP firmware.</p> <p>Select CAPWAP to have the Zyxel Device use CAPWAP (Control and Provisioning of Wireless Access Points protocol) to automatically update firmware on the managed APs.</p> <p>Select FTP to allow the managed APs to download the latest firmware from the Zyxel Device using FTP.</p>
Updating Mode	<p>Select Auto so the Zyxel Device checks the AP's firmware version and updates it automatically to the Zyxel Device's latest supported version.</p> <p>Select Manual so you update the AP firmware manually.</p>
Apply	Click Apply to save your changes back to the Zyxel Device.
Reset	Click Reset to return the screen to its last-saved settings.

9.3.3 AP Group

Use this screen to configure AP groups, which define the radio, port, VLAN and load balancing settings and apply the settings to all APs in the group. An AP can belong to one AP group at a time. Click **Configuration > Wireless > AP Management > AP Group** to access this screen.

Figure 241 Configuration > Wireless > AP Management > AP Group

Each field is described in the following table.

Table 96 Configuration > Wireless > AP Management > AP Group

LABEL	DESCRIPTION
Group Setting	
Default Group	Select a group that is used as the default group. Any AP that is not configured to associate with a specific AP group belongs to the default group automatically.
Group Summary	
Add	Click this button to create a new AP group.
Edit	Select an entry and click this button to edit its properties.
Remove	Select an entry and click this button to remove it from the list. Note: You cannot remove a group with which an AP is associated.
Reboot	Select an AP group and click this button to force the AP(s) in this group to restart.
DCS Now	Select one or multiple groups and click this button to use DCS (Dynamic Channel Selection) to allow the APs in the group(s) to automatically find a less-used channel in an environment where there are many APs and there may be interference. Note: You should have enabled DCS in the applied AP radio profile before the APs can use DCS. Note: DCS is not supported on the radio which is working in repeater AP mode.
Upgrade Now	Select an AP group and click this button to upgrade the firmware of the APs to the Zyxel Device's latest supported version.

Table 96 Configuration > Wireless > AP Management > AP Group (continued)

LABEL	DESCRIPTION
#	This is the index number of the group in the list.
Group Name	This is the name of the group.
Member Count	This is the total number of APs which belong to this group.
Apply	Click Apply to save your changes back to the Zyxel Device.
Reset	Click Reset to return the screen to its last-saved settings.

9.3.3.1 Add/Edit AP Group

Click **Add** or select an AP group and click the **Edit** button in the **Configuration > Wireless > AP Management > AP Group** table to display this screen.

Figure 242 Configuration > Wireless > AP Management > AP Group > Add/Edit

General Settings

Group Name: default
 Description: (Optional)
 Location: (Optional)

Radio 1 Setting

OP Mode: AP Mode MON Mode Root AP Repeater AP

Radio 1 AP Profile: default

Output Power: 30 dBm (0-30)

Radio 2 Setting

OP Mode: AP Mode MON Mode Root AP Repeater AP

Radio 2 AP Profile: default

Output Power: 30 dBm (0-30)

VLAN Settings

Force Override VLAN Config
 Management VLAN ID: 1 (1-4094)
 Alternative VLAN

Port Settings

Model Specific Setting: nwa5301-rj

Port Setting

#	Status	Port	PVID
1	🔆	uplink	n/a
2	🔆	lan1	1
3	🔆	lan2	1
4	🔆	lan3	1

Page 1 of 1 | Show 50 Items | Displaying 1 - 4 of 4

VLAN Configuration

#	Status	Name	VID	Member
1	🔆	vlan0	1	lan1,lan2,lan3

Page 1 of 1 | Show 50 Items | Displaying 1 - 1 of 1

Load Balancing Setting

Enable Load Balancing

Mode: 8j Station Number

Radio1 Max Station Number: 10 (1-127)
 Radio2 Max Station Number: 10 (1-127)

Dissociate station when overloaded

Rogue AP Detection Setting

Enable Rogue AP Detection

AP List

Available	Member
*** EMODE_AP_GROUP *** AP-BCC4F8752C7BC7CF8752C7	*** default *** AP-B082DC6E7E5E[80:82:DC:6E:7E:5E] Local-AP[80:82:DC:70:00:1E]

OK Cancel Override Member AP setting

Each field is described in the following table.

Table 97 Configuration > Wireless > AP Management > AP Group > Add/Edit

LABEL	DESCRIPTION
General Settings	
Group Name	Enter a name for this group. You can use up to 31 alphanumeric characters. Dashes and underscores are also allowed. The name should start with a letter.
Description	Enter a description for this group. You can use up to 31 characters, spaces and underscores allowed.
Location	Specify the name of the place where the AP group is located.
Radio 1/2 Setting	
OP Mode	<p>Select the operating mode for radio 1 or radio 2.</p> <p>AP Mode means the AP can receive connections from wireless clients and pass their data traffic through to the Zyxel Device to be managed (or subsequently passed on to an upstream gateway for managing).</p> <p>MON Mode means the AP monitors the broadcast area for other APs, then passes their information on to the Zyxel Device where it can be determined if those APs are friendly or rogue. If an AP is set to this mode it cannot receive connections from wireless clients.</p> <p>Root AP means the radio acts as an AP and also supports the wireless connections with other APs (in repeater mode) to form a ZyMesh to extend its wireless network.</p> <p>Repeater AP means the radio can establish a wireless connection with other APs (in either root AP or repeater mode).</p> <p>Note: To prevent bridge loops, do NOT set both radios on a managed AP to Repeater AP mode.</p> <p>Note: The root AP and repeater AP(s) in a ZyMesh must use the same country code and AP radio profile settings in order to communicate with each other.</p> <p>Note: Ensure you restart the managed AP after you change its operating mode.</p>
Radio 1/2 AP Profile	Select an AP profile from the list. If no profile exists, you can create a new one through the Create new Object menu.
Radio 1/2 Profile	Select a monitor profile from the list. If no profile exists, you can create a new one through the Create new Object menu.
Radio 1/2 ZyMesh Profile	This field is available only when the radio is in Root AP or Repeater AP mode.
Enable Wireless Bridging	<p>Select the ZyMesh profile the radio uses to connect to a root AP or repeater.</p> <p>This field is available only when the radio is in Repeater AP mode.</p> <p>Select this option to enable wireless bridging on the radio.</p> <p>The managed AP must support LAN provision and the radio should be in repeater mode.</p> <p>VLAN and bridge interfaces are created automatically according to the LAN port's VLAN settings. When wireless bridging is enabled, the managed repeater AP can still transmit data through its Ethernet port(s) after the ZyMesh link is up. Be careful to avoid bridge loops.</p> <p>The managed APs in the same ZyMesh must use the same static VLAN ID.</p>

Table 97 Configuration > Wireless > AP Management > AP Group > Add/Edit (continued)

LABEL	DESCRIPTION
Output Power	Set the maximum output power of the AP. If there is a high density of APs in an area, decrease the output power of the managed AP to reduce interference with other APs. Note: Reducing the output power also reduces the Zyxel Device's effective broadcast radius.
Edit	Select an SSID and click this button to reassign it. The selected SSID becomes editable immediately upon clicking.
#	This is the index number of the SSID profile. You can associate up to eight SSID profiles with an AP radio.
SSID Profile	Indicates which SSID profile is associated with this radio profile.
VLAN Settings	
Force Overwrite VLAN Config	Select this to have the Zyxel Device change the AP's management VLAN to match the configuration in this screen.
Management VLAN ID	Enter a VLAN ID for this AP.
As Native VLAN	Select this option to treat this VLAN ID as a VLAN created on the Zyxel Device and not one assigned to it from outside the network.
Port Settings	
Model Specific Setting	Select the model of the managed AP to display the model-specific port and VLAN settings in the tables below.
Port Setting	You can activate or deactivate a non-uplink port.
Edit	Double-click an entry or select it and click Edit to open a screen where you can modify the entry's settings.
Activate/Inactivate	To turn on an entry, select it and click Activate. To turn off an entry, select it and click Inactivate.
#	This is the port's index number in this list.
Status	This displays whether or not the port is activated.
Port	This shows the name of the physical Ethernet port on the managed AP.
PVID	This shows the port's PVID. A PVID (Port VLAN ID) is a tag that adds to incoming untagged frames received on a port so that the frames are forwarded to the VLAN group that the tag defines.
VLAN Configuration	
Add	Click this to create a new entry.
Edit	Double-click an entry or select it and click Edit to open a screen where you can modify the entry's settings.
Remove	To remove an entry, select it and click Remove . The NXC confirms you want to remove it before doing so.
Activate/ Inactivate	To turn on an entry, select it and click Activate . To turn off an entry, select it and click Inactivate .
#	This is the VLAN's index number in this list.
Status	This displays whether or not the VLAN is activated.
Name	This shows the name of the VLAN.
VID	This shows the VLAN ID number.
Member	This field displays the Ethernet port(s) that is a member of this VLAN.

Table 97 Configuration > Wireless > AP Management > AP Group > Add/Edit (continued)

LABEL	DESCRIPTION
Load Balancing Setting	
Enable Load Balancing	<p>Select this to enable load balancing on the Zyxel Device.</p> <p>Use this section to configure wireless network traffic load balancing between the managed APs in this group.</p> <p>Note: Load balancing is not supported on the radio which is working in root AP or repeater AP mode.</p>
Mode	<p>Select a mode by which load balancing is carried out.</p> <p>Select By Station Number to balance network traffic based on the number of specified stations connected to an AP.</p> <p>Select By Traffic Level to balance network traffic based on the volume generated by the stations connected to an AP.</p> <p>Select By Smart Classroom to balance network traffic based on the number of specified stations connected to an AP. The AP ignores association request and authentication request packets from any new station when the maximum number of stations is reached.</p> <p>If you select By Station Number or By Traffic Level, once the threshold is crossed (either the maximum station numbers or with network traffic), the AP delays association request and authentication request packets from any new station that attempts to make a connection. This allows the station to automatically attempt to connect to another, less burdened AP if one is available.</p>
Radio 1/2 Max Station Number	Enter the threshold number of stations at which an AP begins load balancing its connections.
Disassociate station when overloaded	<p>This function is enabled by default and the disassociation priority is always Signal Strength when you set Mode to By Station Number.</p> <p>Select this option to disassociate wireless clients connected to the AP when it becomes overloaded. If you do not enable this option, then the AP simply delays the connection until it can afford the bandwidth it requires, or it transfers the connection to another AP within its broadcast radius.</p> <p>The disassociation priority is determined automatically by the Zyxel Device and is as follows:</p> <ul style="list-style-type: none"> • Idle Timeout - Devices that have been idle the longest will be disassociated first. If none of the connected devices are idle, then the priority shifts to Signal Strength. • Signal Strength - Devices with the weakest signal strength will be disassociated first. <p>Note: If you enable this function, you should ensure that there are multiple APs within the broadcast radius that can accept any rejected or kicked wireless clients; otherwise, a wireless client attempting to connect to an overloaded AP will be kicked continuously and never be allowed to connect.</p>
Radio 1/2 Traffic Level	<p>Select the threshold traffic level of the radio slot at which the AP begins load balancing its connections (Low, Medium, High).</p> <p>The maximum bandwidth allowed for each level is:</p> <ul style="list-style-type: none"> • Low - 11 Mbps • Medium - 23 Mbps • High - 35 Mbps
Rogue AP Detection Setting	
Enable Rogue AP Detection	Select this option to detect Rogue APs in the network.
AP List	

Table 97 Configuration > Wireless > AP Management > AP Group > Add/Edit (continued)

LABEL	DESCRIPTION
Available	This lists the APs that do not belong to this group. Select the APs that you want to add to the group you are editing, and click the right arrow button to add them.
Member	This lists the APs that belong to this group. Select any APs that you want to remove from the group, and click the left arrow button to remove them.
OK	Click OK to save your changes back to the Zyxel Device.
Cancel	Click Cancel to close the window with changes unsaved.
Override Member AP Setting	Click this button to overwrite the settings of all managed APs in this group with the settings you configure here. All Override Group check boxes on the AP Management > Mgnt. AP List > Edit AP List screen for the APs in this group will be deselected.

9.3.4 Firmware

The Zyxel Device stores an AP firmware in order to manage supported APs. This screen allows the Zyxel Device to check for and download new AP firmware when it becomes available on the firmware server. All APs managed by the Zyxel Device must have the same firmware version as the AP firmware on the Zyxel Device.

When an AP connects to the Zyxel Device wireless controller, the Zyxel Device will check if the AP has the same firmware version as the AP firmware on the Zyxel Device. If yes, then the Zyxel Device can manage it. If no, then the AP must upgrade (or downgrade) its firmware to be the same version as the AP firmware on the Zyxel Device (and reboot).

The Zyxel Device should always have the latest AP firmware so that:

- APs don't have to downgrade firmware in order to be managed
- All new APs are supported.

Use **Check** to see if the Zyxel Device has the latest AP firmware. Use **Apply** to have the Zyxel Device download the latest AP firmware (see **More Details** for more information on the firmware) from the firmware server. If the Zyxel Device does not have enough space for the latest AP firmware, then the Zyxel Device will delete an existing firmware that no AP is using before downloading the new AP firmware.

Click **Configuration > Wireless > AP Management > Firmware** to access this screen.

Figure 243 Configuration > Wireless > AP Management > Firmware

#	Model	Runtime Firmware
1	NWA5121-NI	- / V5.10(AAID.8)
2	NWA5123-NI	- / V5.10(AAHT.8)
3	NWA5121-N	- / V5.10(AAIF.8)
4	WAX510D	- / V6.00(ABTF.6)
5	WAC6103D-I	- / V6.00(AAXH.6)
6	WAC6303D-S	- / V6.00(ABGL.6)
7	NWA5160N	- / V5.10(AA8.3)
8	NWA5560-N	- / V5.10(UJE.3)
9	NWA5550-N	- / V5.10(UJD.3)
10	NWA3160-N	- / V5.10(UJA.3)
11	NWA3550-N	- / V5.10(UJB.3)
12	NWA3560-N	- / V5.10(UJC.3)
13	WAC5302D-S	- / V6.00(ABFH.6)
14	NWA5123-AC	Local / V6.00(AAZY.6)
15	WAC6502D-E	- / V6.00(AASD.6)
16	WAC6502D-S	- / V6.00(AASE.6)
17	WAC6503D-S	- / V6.00(AASF.6)

Each field is described in the following table.

Table 98 Configuration > Wireless > AP Management > Firmware

LABEL	DESCRIPTION
AP Firmware	
Runtime Firmware	This displays the current AP firmware version on the Zyxel Device. The Zyxel Device must have the latest AP firmware to manage all supported APs.
Available Firmware	This field displays if there is a later AP firmware version available on the firmware server. It displays N/A if the Zyxel Device cannot connect with the firmware server. Check that the Zyxel Device has Internet access if N/A displays and then click the Check button below.
Check	Click this button to have the Zyxel Device display the latest AP firmware version available on the firmware server.
Last Check Success	This displays the date and time the last check for new firmware was made and whether the check is in progress (checking), was successful (success), or has failed (fail).

Table 98 Configuration > Wireless > AP Management > Firmware (continued)

LABEL	DESCRIPTION
Apply AP Firmware	Due to space limitations, the Zyxel Device only downloads and keeps AP firmware for APs it is currently managing. If you connect a new AP to the Zyxel Device, the Zyxel Device may need to download a new AP firmware. Please wait while downloading new firmware as the speed depends on your Internet connection speed. Make sure to maintain the Internet connection while downloading new firmware.
Apply	Click this to download newer Available Firmware from the firmware server and update the Runtime Firmware version.
#	This is an index number of a managed AP.
Model	This displays the name of all manageable AP models.
Runtime Firmware	This displays the firmware version that the managed AP must have in order to be managed by the Zyxel Device. Firmware for APs that the Zyxel Device already has displays in bold; firmware that the Zyxel Device doesn't have or is still downloading is grayed out. Firmware that is in the download queue will show To be downloaded .
Refresh	Click this to update the model firmware table.

9.4 Rogue AP

Use this screen to assign APs either to the rogue AP list or the friendly AP list. A rogue AP is a wireless access point operating in a network's coverage area that is not under the control of the network administrator, and which can potentially open up holes in a network's security.

Click **Configuration > Wireless > Rogue AP** to access this screen.

Figure 244 Configuration > Wireless > Rogue AP

Each field is described in the following table.

Table 99 Configuration > Wireless > Rogue AP

LABEL	DESCRIPTION
Suspected Rogue AP Classification Rule	Click the check boxes (Weak Security (Open, WEP, WPA-PSK) , Un-managed AP , Hidden SSID , SSID Keyword) of the characteristics an AP should have for the Zyxel Device to rule it as a rogue AP.
Add	Click this to add an SSID Keyword.
Edit	Select an SSID Keyword and click this button to modify it.
Remove	Select an existing SSID keyword and click this button to delete it.
#	This is the SSID Keyword's index number in this list.
SSID Keyword	This field displays the SSID Keyword.
Rogue/Friendly AP List	
Add	Click this button to add an AP to the list and assign it either friendly or rogue status.
Edit	Select an AP in the list to edit and reassign its status.
Remove	Select an AP in the list to remove.
Containment	Click this button to quarantine the selected AP. A quarantined AP cannot grant access to any network services. Any stations that attempt to connect to a quarantined AP are disconnected automatically.

Table 99 Configuration > Wireless > Rogue AP (continued)

LABEL	DESCRIPTION
Dis-Containment	Click this button to take the selected AP out of quarantine. An unquarantined AP has normal access to the network.
#	This field is a sequential value, and it is not associated with any interface.
Containment	This field indicates the selected AP's containment status.
Role	This field indicates whether the selected AP is a rogue-ap or a friendly-ap . To change the AP's role, click the Edit button.
MAC Address	This field indicates the AP's radio MAC address.
Description	This field displays the AP's description. You can modify this by clicking the Edit button.
Rogue/Friendly AP List Importing/Exporting	These controls allow you to export the current list of rogue and friendly APs or import existing lists.
File Path / Browse / Importing	Enter the file name and path of the list you want to import or click the Browse button to locate it. Once the File Path field has been populated, click Importing to bring the list into the Zyxel Device.
Exporting	Click this button to export the current list of either rogue APs or friendly APs.
Monitor Mode Settings	
Enable Rogue AP Containment	Select this to enable rogue AP containment.
Apply	Click Apply to save your changes back to the Zyxel Device.
Reset	Click Reset to return the screen to its last-saved settings.

9.4.1 Add/Edit Rogue/Friendly List

Select an AP and click the **Edit** button in the **Configuration > Wireless > Rogue AP** table to display this screen.

Figure 245 Configuration > Wireless > Rogue AP > Add/Edit Rogue/Friendly

Each field is described in the following table.

Table 100 Configuration > Wireless > Rogue AP > Add/Edit Rogue/Friendly

LABEL	DESCRIPTION
MAC	Enter the MAC address of the AP you want to add to the list. A MAC address is a unique hardware identifier in the following hexadecimal format: xx:xx:xx:xx:xx:xx where xx is a hexadecimal number separated by colons.
Description	Enter up to 60 characters for the AP's description. Spaces and underscores are allowed.
Role	Select either Rogue AP or Friendly AP for the AP's role.

Table 100 Configuration > Wireless > Rogue AP > Add/Edit Rogue/Friendly (continued)

LABEL	DESCRIPTION
OK	Click OK to save your changes back to the Zyxel Device.
Cancel	Click Cancel to close the window with changes unsaved.

9.5 Auto Healing

Use this screen to enable auto healing, which allows you to extend the wireless service coverage area of the managed APs when one of the APs fails. Click **Configuration > Wireless > Auto Healing** to access this screen.

Figure 246 Configuration > Wireless > Auto Healing

Each field is described in the following table.

Table 101 Configuration > Wireless > Auto Healing

LABEL	DESCRIPTION
Enable Auto Healing	Select this option to turn on the auto healing feature.
Save Current State	Click this button to have all managed APs immediately scan their neighborhoods three times in a row and update their neighbor lists to the AP controller (Zyxel Device).
Auto Healing Interval	Set the time interval (in minutes) at which the managed APs scan their neighborhoods and report the status of neighbor APs to the AP controller (Zyxel Device). An AP is considered "failed" if the AP controller obtains the same scan result that the AP is missing from the neighbor list of other APs three times.
Power Threshold	Set the power level (in dBm) to which the neighbor APs of the failed AP increase their output power in order to extend their wireless service coverage areas. When the failed AP is working again, its neighbor APs return their output power to the original level.
Apply	Click Apply to save your changes back to the Zyxel Device.
Reset	Click Reset to return the screen to its last-saved settings.

9.6 RTLS Overview

Ekahau RTLS (Real Time Location Service) tracks battery-powered Wi-Fi tags attached to APs managed by the Zyxel Device to create maps, alerts, and reports.

The Ekahau RTLS Controller is the centerpiece of the RTLS system. This server software runs on a Windows computer to track and locate Ekahau tags from Wi-Fi signal strength measurements. Use the Zyxel Device with the Ekahau RTLS system to take signal strength measurements at the APs (Integrated Approach / Blink Mode).

The following example shows the Ekahau RTLS Integrated Approach (Blink Mode).

- 1 The Wi-Fi tag sends blink packets at specified intervals (or triggered by something like motion or button presses).
- 2 The APs pick up the blink packets, measure the signal strength, and send it to the Zyxel Device.
- 3 The Zyxel Device forwards the signal measurements to the Ekahau RTLS Controller.
- 4 The Ekahau RTLS Controller calculates the tag positions.

Figure 247 RTLS Example

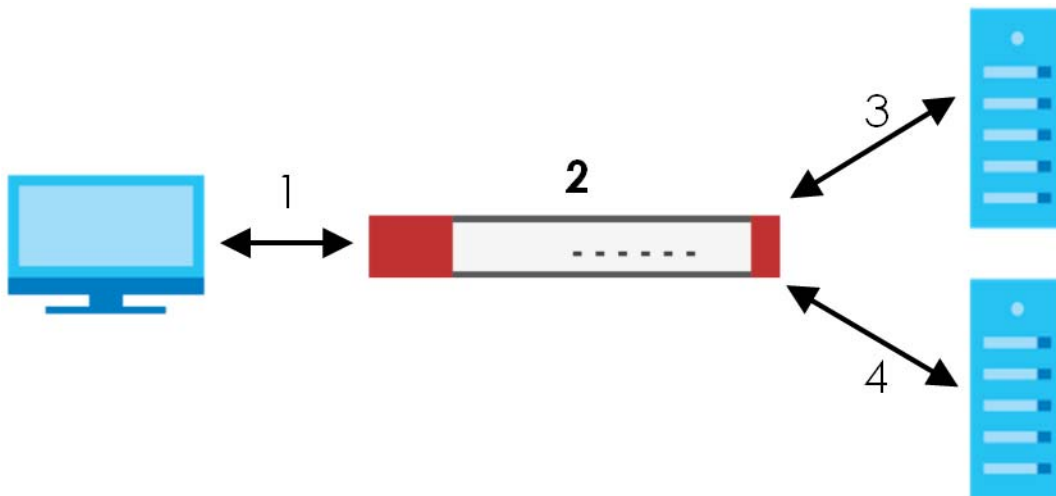

9.6.1 What You Can Do in this Chapter

Use the **RTLS** screen ([Section 9.6.3 on page 316](#)) to use the managed APs as part of an Ekahau RTLS (Real Time Location Service) to track the location of Ekahau Wi-Fi tags.

9.6.2 Before You Begin

You need:

- At least three APs managed by the Zyxel Device (the more APs the better since it increases the amount of information the Ekahau RTLS Controller has for calculating the location of the tags)
- IP addresses for the Ekahau Wi-Fi tags
- A dedicated RTLS SSID is recommended

- Ekahau RTLS Controller in blink mode with TZSP Updater enabled
- Security policies to allow RTLS traffic if the Zyxel Device security policy control is enabled or the Ekahau RTLS Controller is behind a firewall.

For example, if the Ekahau RTLS Controller is behind a firewall, open ports 8550, 8553, and 8569 to allow traffic the APs send to reach the Ekahau RTLS Controller.

The following table lists default port numbers and types of packets RTLS uses.

Table 102 RTLS Traffic Port Numbers

PORT NUMBER	TYPE	DESCRIPTION
8548	TCP	Ekahau T201 location update.
8549	UDP	Ekahau T201 location update.
8550	TCP	Ekahau T201 tag maintenance protocol and Ekahau RTLS Controller user interface.
8552	UDP	Ekahau Location Protocol
8553	UDP	Ekahau Maintenance Protocol
8554	UDP	Ekahau T301 firmware update.
8560	TCP	Ekahau Vision web interface
8562	UDP	Ekahau T301W firmware update.
8569	UDP	Ekahau TZSP Listener Port

9.6.3 Configuring RTLS

Click **Configuration > Wireless > RTLS** to open this screen. Use this screen to turn RTLS (Real Time Location System) on or off and specify the IP address and server port of the Ekahau RTLS Controller.

Figure 248 Configuration > Wireless > RTLS

The screenshot shows the 'Real Time Location System' configuration page. Under the 'Ekahau Location Engine' heading, there is a checked 'Enable' checkbox. Below it are two input fields: 'IP Address' (which is empty and has a red error icon) and 'Server Port' (which contains the value '8569'). At the bottom of the form are two buttons: 'Apply' and 'Reset'.

The following table describes the labels in this screen.

Table 103 Configuration > Wireless > RTLS

LABEL	DESCRIPTION
Enable	Select this to use Wi-Fi to track the location of Ekahau Wi-Fi tags.
IP Address	Specify the IP address of the Ekahau RTLS Controller.
Server Port	Specify the server port number of the Ekahau RTLS Controller.
Apply	Click Apply to save your changes back to the Zyxel Device.
Reset	Click Reset to return the screen to its last-saved settings.

9.7 Technical Reference

The following section contains additional technical information about wireless features.

9.7.1 Dynamic Channel Selection

When numerous APs broadcast within a given area, they introduce the possibility of heightened radio interference, especially if some or all of them are broadcasting on the same radio channel. If the interference becomes too great, then the network administrator must open his AP configuration options and manually change the channel to one that no other AP is using (or at least a channel that has a lower level of interference) in order to give the connected stations a minimum degree of interference. Dynamic channel selection frees the network administrator from this task by letting the AP do it automatically. The AP can scan the area around it looking for the channel with the least amount of interference.

In the 2.4 GHz spectrum, each channel from 1 to 13 is broken up into discrete 22 MHz segments that are spaced 5 MHz apart. Channel 1 is centered on 2.412 GHz while channel 13 is centered on 2.472 GHz.

Figure 249 An Example Three-Channel Deployment

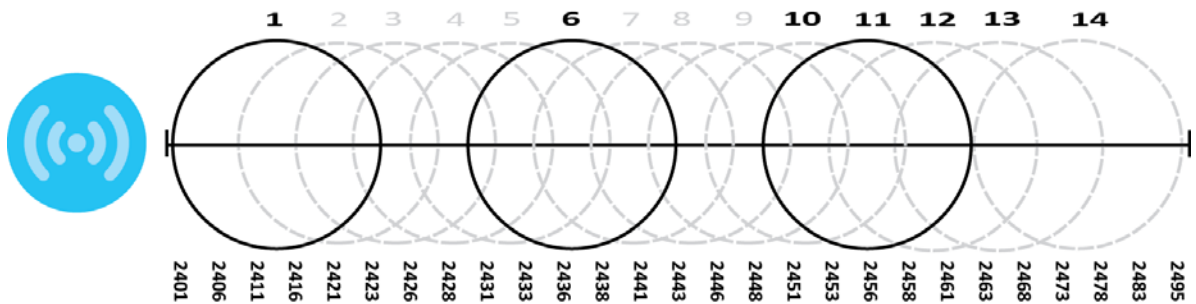

Three channels are situated in such a way as to create almost no interference with one another if used exclusively: 1, 6 and 11. When an AP broadcasts on any of these three channels, it should not interfere with neighboring APs as long as they are also limited to same trio.

Figure 250 An Example Four-Channel Deployment

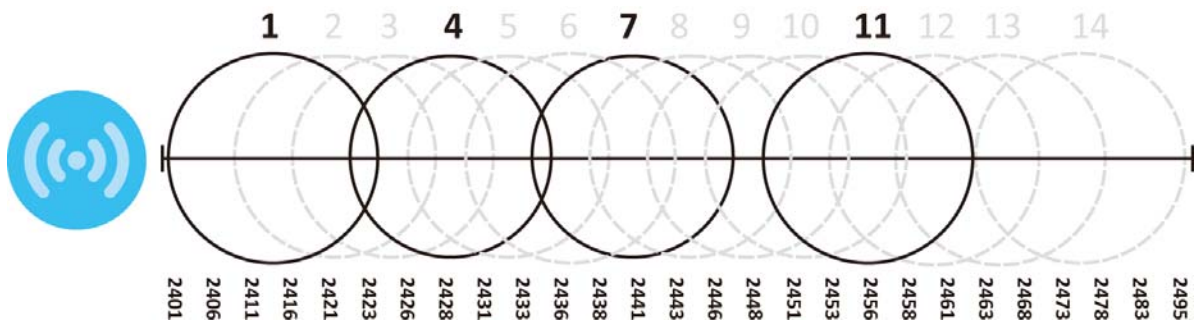

However, some regions require the use of other channels and often use a safety scheme with the following four channels: 1, 4, 7 and 11. While they are situated sufficiently close to both each other and the three so-called "safe" channels (1,6 and 11) that interference becomes inevitable, the severity of it is dependent upon other factors: proximity to the affected AP, signal strength, activity, and so on.

Finally, there is an alternative four channel scheme for ETSI, consisting of channels 1, 5, 9, 13. This offers significantly less overlap than the other one.

Figure 251 An Alternative Four-Channel Deployment

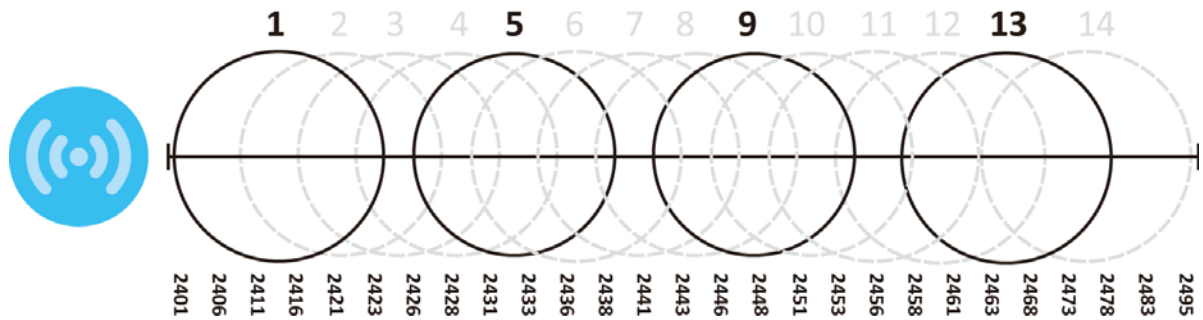

9.7.2 Load Balancing

Because there is a hard upper limit on an AP's wireless bandwidth, load balancing can be crucial in areas crowded with wireless users. Rather than let every user connect and subsequently dilute the available bandwidth to the point where each connecting device receives a meager trickle, the load balanced AP instead limits the incoming connections as a means to maintain bandwidth integrity.

There are two kinds of wireless load balancing available on the Zyxel Device:

Load balancing by station number limits the number of devices allowed to connect to your AP. If you know exactly how many stations you want to let connect, choose this option.

For example, if your company's graphic design team has their own AP and they have 10 computers, you can load balance for 10. Later, if someone from the sales department visits the graphic design team's offices for a meeting and he tries to access the network, his computer's connection is delayed, giving it the opportunity to connect to a different, neighboring AP. If he still connects to the AP regardless of the delay, then the AP may boot other people who are already connected in order to associate with the new connection.

Load balancing by traffic level limits the number of connections to the AP based on maximum bandwidth available. If you are uncertain as to the exact number of wireless connections you will have then choose this option. By setting a maximum bandwidth cap, you allow any number of devices to connect as long as their total bandwidth usage does not exceed the configured bandwidth cap associated with this setting. Once the cap is hit, any new connections are rejected or delayed provided that there are other APs in range.

Imagine a coffee shop in a crowded business district that offers free wireless connectivity to its customers. The coffee shop owner can't possibly know how many connections his AP will have at any given moment. As such, he decides to put a limit on the bandwidth that is available to his customers but not on the actual number of connections he allows. This means anyone can connect to his wireless network as long as the AP has the bandwidth to spare. If too many people connect and the AP hits its bandwidth cap then all new connections must basically wait for their turn or get shunted to the nearest identical AP.

CHAPTER 10

Interfaces

10.1 Interface Overview

Use the **Interface** screens to configure the Zyxel Device's interfaces. You can also create interfaces on top of other interfaces.

- **Ports** are the physical ports to which you connect cables.
- **Interfaces** are used within the system operationally. You use them in configuring various features. An interface also describes a network that is directly connected to the Zyxel Device. For example, You connect the LAN network to the LAN interface.
- **Zones** are groups of interfaces used to ease security policy configuration.

10.1.1 What You Can Do in this Chapter

- Use the **Port Role** screen ([Section 10.2 on page 324](#)) to create port groups and to assign physical ports and port groups to Ethernet interfaces.
- Use the **Port Configuration** screen ([Section 10.3 on page 325](#)) to configure Zyxel Device port settings.
- Use the **Ethernet** screens ([Section 10.4 on page 326](#)) to configure the Ethernet interfaces. Ethernet interfaces are the foundation for defining other interfaces and network policies. RIP and OSPF are also configured in these interfaces.
- Use the **Virtual Interface** screen ([Section 10.4.3 on page 349](#)) to create virtual interfaces on top of Ethernet interfaces to tell the Zyxel Device where to route packets. You can create virtual Ethernet interfaces, virtual VLAN interfaces, and virtual bridge interfaces.
- Use the **PPP** screens ([Section 10.5 on page 353](#)) for PPPoE, PPTP or L2TP Internet connections.
- Use the **Cellular** screens ([Section 10.6 on page 359](#)) to configure settings for interfaces for Internet connections through an installed mobile broadband card.
- Use the **Tunnel** screens ([Section 10.7 on page 369](#)) to configure tunnel interfaces to be used in Generic Routing Encapsulation (GRE), IPv6 in IPv4, and 6to4 tunnels.
- Use the **VLAN** screens ([Section 10.8 on page 376](#)) to divide the physical network into multiple logical networks. VLAN interfaces receive and send tagged frames. The Zyxel Device automatically adds or removes the tags as needed. Each VLAN can only be associated with one Ethernet interface.
- Use the **Bridge** screens ([Section 10.9 on page 391](#)) to combine two or more network segments into a single network.
- Use the **LAG** screens ([Section 10.10 on page 405](#)) to combine multiple physical Ethernet interfaces into a single logical interface.
- Use the **VTI** screens ([Section 10.11 on page 412](#)) to encrypt or decrypt IPv4 traffic from or to the interface according to the IP routing table.
- Use the **Trunk** screens ([Section 10.12 on page 417](#)) to configure load balancing.

10.1.2 What You Need to Know

Interface Characteristics

Interfaces generally have the following characteristics (although not all characteristics apply to each type of interface).

- An interface is a logical entity through which (layer-3) packets pass.
- An interface is bound to a physical port or another interface.
- Many interfaces can share the same physical port.
- An interface belongs to at most one zone.
- Many interfaces can belong to the same zone.
- Layer-3 virtualization (IP alias, for example) is a kind of interface.

Types of Interfaces

You can create several types of interfaces in the Zyxel Device.

- Setting interfaces to the same port role forms a port group. Port groups creates a hardware connection between physical ports at the layer-2 (data link, MAC address) level. Port groups are created when you use the **Interface > Port Roles** or **Interface > Port Groups** screen to set multiple physical ports to be part of the same interface.
- **Ethernet interfaces** are the foundation for defining other interfaces and network policies. RIP and OSPF are also configured in these interfaces.
- **Tunnel interfaces** send IPv4 or IPv6 packets from one network to a specific network through the Internet or a public network.
- **VLAN interfaces** receive and send tagged frames. The Zyxel Device automatically adds or removes the tags as needed. Each VLAN can only be associated with one Ethernet interface.
- **Bridge interfaces** create a software connection between Ethernet or VLAN interfaces at the layer-2 (data link, MAC address) level. Unlike port groups, bridge interfaces can take advantage of some security features in the Zyxel Device. You can also assign an IP address and subnet mask to the bridge.
- **PPP interfaces** support Point-to-Point Protocols (PPP). ISP accounts are required for PPPoE/PPTP/L2TP interfaces.
- **Cellular interfaces** are for mobile broadband WAN connections via a connected mobile broadband device.
- **Virtual interfaces** provide additional routing information in the Zyxel Device. There are three types: **virtual Ethernet interfaces**, **virtual VLAN interfaces**, and **virtual bridge interfaces**.
- **Trunk interfaces** manage load balancing between interfaces.

Port groups and trunks have a lot of characteristics that are specific to each type of interface. The other types of interfaces--Ethernet, PPP, cellular, VLAN, bridge, and virtual--have a lot of similar characteristics. These characteristics are listed in the following table and discussed in more detail below.

Table 104 Ethernet, PPP, Cellular, VLAN, Bridge, and Virtual Interface Characteristics

CHARACTERISTICS	ETHERNET	ETHERNET	PPP	CELLULAR	VLAN	BRIDGE	VIRTUAL
Name*	wan1, wan2	lan1, lan2, dmz	pppx	cellularx	vlanx	brx	**
Configurable Zone	No	No	Yes	Yes	Yes	Yes	No

Table 104 Ethernet, PPP, Cellular, VLAN, Bridge, and Virtual Interface Characteristics (continued)

CHARACTERISTICS	ETHERNET	ETHERNET	PPP	CELLULAR	VLAN	BRIDGE	VIRTUAL
IP Address Assignment							
Static IP address	Yes	Yes	Yes	Yes	Yes	Yes	Yes
DHCP client	Yes	No	Yes	Yes	Yes	Yes	No
Routing metric	Yes	Yes	Yes	Yes	Yes	Yes	Yes
Interface Parameters							
Bandwidth restrictions	Yes	Yes	Yes	Yes	Yes	Yes	Yes
Packet size (MTU)	Yes	Yes	Yes	Yes	Yes	Yes	No
DHCP							
DHCP server	No	Yes	No	No	Yes	Yes	No
DHCP relay	No	Yes	No	No	Yes	Yes	No
Connectivity Check	Yes	No	Yes	Yes	Yes	Yes	No

Note: - * The format of interface names other than the Ethernet and ppp interface names is strict. Each name consists of 2-4 letters (interface type), followed by a number (x). For most interfaces, x is limited by the maximum number of the type of interface. For VLAN interfaces, x is defined by the number you enter in the VLAN name field. For example, Ethernet interface names are wan1, wan2, lan1, lan2, dmz; VLAN interfaces are vlan0, vlan1, vlan2,...; and so on.

** - The names of virtual interfaces are derived from the interfaces on which they are created. For example, virtual interfaces created on Ethernet interface wan1 are called wan1:1, wan1:2, and so on. Virtual interfaces created on VLAN interface vlan2 are called vlan2:1, vlan2:2, and so on. You cannot specify the number after the colon(:) in the Web Configurator; it is a sequential number. You can specify the number after the colon if you use the CLI to set up a virtual interface.

Relationships Between Interfaces

In the Zyxel Device, interfaces are usually created on top of other interfaces. Only Ethernet interfaces are created directly on top of the physical ports or port groups. The relationships between interfaces are explained in the following table.

Table 105 Relationships Between Different Types of Interfaces

INTERFACE	REQUIRED PORT / INTERFACE
Ethernet interface	physical port
VLAN interface	Ethernet interface
bridge interface	Ethernet interface* VLAN interface*
PPP interface	Ethernet interface* VLAN interface* bridge interface WAN1, WAN2, OPT*

Table 105 Relationships Between Different Types of Interfaces (continued)

INTERFACE	REQUIRED PORT / INTERFACE
virtual interface (virtual Ethernet interface) (virtual VLAN interface) (virtual bridge interface)	Ethernet interface* VLAN interface* bridge interface
trunk	Ethernet interface Cellular interface VLAN interface bridge interface PPP interface

Note: * You cannot set up a PPP interface, virtual Ethernet interface or virtual VLAN interface if the underlying interface is a member of a bridge. You also cannot add an Ethernet interface or VLAN interface to a bridge if the member interface has a virtual interface or PPP interface on top of it.

IPv6 Overview

IPv6 (Internet Protocol version 6), is designed to enhance IP address size and features. The increase in IPv6 address size to 128 bits (from the 32-bit IPv4 address) allows up to 3.4×10^{38} IP addresses.

IPv6 Addressing

An 128-bit IPv6 address is written as eight 16-bit hexadecimal blocks separated by colons (:). This is an example IPv6 address `2001:0db8:1a2b:0015:0000:0000:1a2f:0000`.

IPv6 addresses can be abbreviated in two ways:

- Leading zeros in a block can be omitted. So `2001:0db8:1a2b:0015:0000:0000:1a2f:0000` can be written as `2001:db8:1a2b:15:0:0:1a2f:0`.
- Any number of consecutive blocks of zeros can be replaced by a double colon. A double colon can only appear once in an IPv6 address. So `2001:0db8:0000:0000:1a2f:0000:0000:0015` can be written as `2001:0db8::1a2f:0000:0000:0015`, `2001:0db8:0000:0000:1a2f::0015`, `2001:db8::1a2f:0:0:15` Or `2001:db8:0:0:1a2f::15`.

Prefix and Prefix Length

Similar to an IPv4 subnet mask, IPv6 uses an address prefix to represent the network address. An IPv6 prefix length specifies how many most significant bits (start from the left) in the address compose the network address. The prefix length is written as "/x" where x is a number. For example,

```
2001:db8:1a2b:15::1a2f:0/32
```

means that the first 32 bits (`2001:db8`) from the left is the network prefix.

Link-local Address

A link-local address uniquely identifies a device on the local network (the LAN). It is similar to a "private IP address" in IPv4. You can have the same link-local address on multiple interfaces on a device. A link-local unicast address has a predefined prefix of fe80::/10. The link-local unicast address format is as follows.

Table 106 Link-local Unicast Address Format

1111 1110 10	0	Interface ID
10 bits	54 bits	64 bits

Subnet Masking

Both an IPv6 address and IPv6 subnet mask compose of 128-bit binary digits, which are divided into eight 16-bit blocks and written in hexadecimal notation. Hexadecimal uses four bits for each character (1 ~ 10, A ~ F). Each block's 16 bits are then represented by four hexadecimal characters. For example, FFFF:FFFF:FFFF:FFFF:FC00:0000:0000:0000.

Stateless Autoconfiguration

With stateless autoconfiguration in IPv6, addresses can be uniquely and automatically generated. Unlike DHCPv6 (Dynamic Host Configuration Protocol version six) which is used in IPv6 stateful autoconfiguration, the owner and status of addresses don't need to be maintained by a DHCP server. Every IPv6 device is able to generate its own and unique IP address automatically when IPv6 is initiated on its interface. It combines the prefix and the interface ID (generated from its own Ethernet MAC address) to form a complete IPv6 address.

When IPv6 is enabled on a device, its interface automatically generates a link-local address (beginning with fe80).

When the Zyxel Device's WAN interface is connected to an ISP with a router and the Zyxel Device is set to automatically obtain an IPv6 network prefix from the router for the interface, it generates another address which combines its interface ID and global and subnet information advertised from the router. (In IPv6, all network interfaces can be associated with several addresses.) This is a routable global IP address.

Prefix Delegation

Prefix delegation enables an IPv6 router (the Zyxel Device) to use the IPv6 prefix (network address) received from the ISP (or a connected uplink router) for its LAN. The Zyxel Device uses the received IPv6 prefix (for example, 2001:db2::/48) to generate its LAN IP address. Through sending Router Advertisements (RAs) regularly by multicast, the router passes the IPv6 prefix information to its LAN hosts. The hosts then can use the prefix to generate their IPv6 addresses.

IPv6 Router Advertisement

An IPv6 router sends router advertisement messages periodically to advertise its presence and other parameters to the hosts in the same network.

DHCPv6

The Dynamic Host Configuration Protocol for IPv6 (DHCPv6, RFC 3315) is a server-client protocol that allows a DHCP server to assign and pass IPv6 network addresses, prefixes and other configuration information to DHCP clients. DHCPv6 servers and clients exchange DHCP messages using UDP.

Each DHCP client and server has a unique DHCP Unique Identifier (DUID), which is used for identification when they are exchanging DHCPv6 messages. The DUID is generated from the MAC address, time, vendor assigned ID and/or the vendor's private enterprise number registered with the IANA. It should not change over time even after you reboot the device.

10.1.3 What You Need to Do First

For IPv6 settings, go to the **Configuration > System > IPv6** screen to enable IPv6 support on the Zyxel Device first.

10.2 Port Role

To access this screen, click **Configuration > Network > Interface > Port Role**. Use the **Port Role** screen to set the Zyxel Device's flexible ports as part of the **lan1**, **lan2**, **ext-wlan**, **ext-lan** or **dmz** interfaces. This creates a hardware connection between the physical ports at the layer-2 (data link, MAC address) level. This provides wire-speed throughput but no security.

Note: See [Section 1.1 on page 28](#) to see which models support port role.

Note the following if you are configuring from a computer connected to a **lan1**, **lan2**, **ext-wlan**, **ext-lan** or **dmz** port and change the port's role:

- A port's IP address varies as its role changes, make sure your computer's IP address is in the same subnet as the Zyxel Device's **lan1**, **lan2**, **ext-wlan**, **ext-lan** or **dmz** IP address.
- Use the appropriate **lan1**, **lan2**, **ext-wlan**, **ext-lan** or **dmz** IP address to access the Zyxel Device.

Figure 252 Configuration > Network > Interface > Port Role

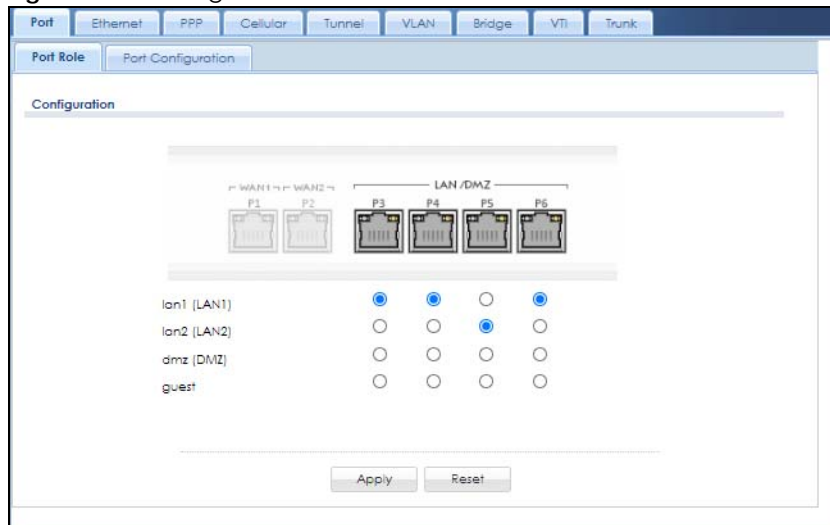

The physical Ethernet ports are shown at the top and the Ethernet interfaces and zones are shown at the bottom of the screen. Use the radio buttons to select for which interface (network) you want to use each physical port. For example, select a port's LAN radio button to use the port as part of the LAN interface. The port will use the Zyxel Device's LAN IP address and MAC address.

When you assign more than one physical port to a network, you create a port group. Port groups have the following characteristics:

- There is a layer-2 Ethernet switch between physical ports in the port group. This provides wire-speed throughput but no security.
- It can increase the bandwidth between the port group and other interfaces.
- The port group uses a single MAC address.

Click **Apply** to save your changes and apply them to the Zyxel Device.

Click **Reset** to change the port groups to their current configuration (last-saved values).

10.3 Port Configuration

Use this screen to configure port settings. Click **Configuration > Network > Interface > Port Configuration** in the navigation panel to display the configuration screen.

Note: You can't configure the speed and duplex mode of the fiber ports on the USG2200 and UGS2200-VPN.

Figure 253 Configuration > Network > Interface > Port Configuration

Name	Interface	Type	Settings	Status
P1	wan1	Copper	Auto Negotiate	1000M/Full
P2	wan2	Copper	Auto Negotiate	Down
P3	opt	Copper	Auto Negotiate	Down
P4	lan1	Copper	Auto Negotiate	Down
P5	lan1	Copper	Auto Negotiate	Down
P6	lan1	Copper	Auto Negotiate	Down
P7	dmz	Copper	Auto Negotiate	Down

Page 1 of 1 | Show 50 items | Displaying 1 - 7 of 7

Apply Reset

Each field is described in the following table.

Table 107 Configuration > Network > Interface > Port Configuration

LABEL	DESCRIPTION
Edit	Select an entry, and click this button to configure the speed and the duplex mode of the Ethernet connection on this port.
Name	This field displays the name of the port.
Interface	This field displays the interface for the port.
Type	This field displays the cable type that is used on the port.
Settings	Select the speed and the duplex mode of the Ethernet connection on this port. Choices are Auto Negotiate , 1000Mbps-Full Duplex , 100Mbps-Full Duplex , 100Mbps-Half Duplex , 10Mbps-Full Duplex , and 10Mbps-Half Duplex . Selecting Auto Negotiate allows one port to negotiate with a peer port automatically to obtain the connection speed (of up to 1000M) and duplex mode that both ends support. When auto-negotiation is turned on, a port on the Zyxel Device negotiates with the peer automatically to determine the connection speed and duplex mode. If the peer port does not support auto-negotiation or turns off this feature, the Zyxel Device determines the connection speed by detecting the signal on the cable and using half duplex mode. When the Zyxel Device's auto-negotiation is turned off, a port uses the pre-configured speed and duplex mode when making a connection, thus requiring you to make sure that the settings of the peer port are the same in order to connect.
Status	This field displays the speed and the duplex mode of the Ethernet connection on the port.
Apply	Click Apply to save your changes back to the Zyxel Device.
Reset	Click Reset to return the screen to its last-saved settings.

10.4 Ethernet Summary Screen

This screen lists every Ethernet interface and virtual interface created on top of Ethernet interfaces. If you enabled IPv6 in the **Configuration > System > IPv6** screen, you can also configure Ethernet interfaces used for your IPv6 networks on this screen. To access this screen, click **Configuration > Network > Interface > Ethernet**.

Unlike other types of interfaces, you cannot create new Ethernet interfaces nor can you delete any of them. If an Ethernet interface does not have any physical ports assigned to it, the Ethernet interface is effectively removed from the Zyxel Device, but you can still configure it.

Ethernet interfaces are similar to other types of interfaces in many ways. They have an IP address, subnet mask, and gateway used to make routing decisions. They restrict the amount of bandwidth and packet size. They can provide DHCP services, and they can verify the gateway is available.

Use Ethernet interfaces to control which physical ports exchange routing information with other routers and how much information is exchanged through each one. The more routing information is exchanged, the more efficient the routers should be. However, the routers also generate more network traffic, and some routing protocols require a significant amount of configuration and management. The Zyxel Device supports the following routing protocols: RIP, OSPF and BGP. See [Chapter 11 on page 440](#) for background information about these routing protocols.

Figure 254 Configuration > Network > Interface > Ethernet

The screenshot displays the configuration page for Ethernet interfaces. At the top, there are tabs for different interface types: Port, Ethernet (selected), PPP, Cellular, Tunnel, VLAN, Bridge, VTI, and Trunk. Below the tabs is the 'Configuration' section, which includes a toolbar with 'Edit', 'Remove', 'Activate', 'Inactivate', 'Create Virtual Interface', and 'References' buttons. A table lists 7 interfaces with columns for #, Status, Name, Description, IP Address, and Mask. The interfaces are: wan1 (DHCP -- 172.21.40.35, 255.255.252.0), wan2 (DHCP -- 0.0.0.0, 0.0.0.0), opt (STATIC -- 0.0.0.0, 0.0.0.0), lan1 (STATIC -- 192.168.1.1, 255.255.255.0), lan2 (STATIC -- 192.168.2.1, 255.255.255.0), reserved (STATIC -- 0.0.0.0, 0.0.0.0), and dmz (STATIC -- 192.168.3.1, 255.255.255.0). Below the table is a pagination control showing 'Page 1 of 1' and 'Show 50 items'. The 'IPv6 Configuration' section is also visible, with a similar toolbar and a table listing the same 7 interfaces, but with 'IP Address' set to '::'. At the bottom of the page are 'Apply' and 'Reset' buttons.

Each field is described in the following table.

Table 108 Configuration > Network > Interface > Ethernet

LABEL	DESCRIPTION
Configuration / IPv6 Configuration	Use the Configuration section for IPv4 network settings. Use the IPv6 Configuration section for IPv6 network settings if you connect your Zyxel Device to an IPv6 network. Both sections have similar fields as described below.
Edit	Double-click an entry or select it and click Edit to open a screen where you can modify the entry's settings.
Remove	To remove a virtual interface, select it and click Remove . The Zyxel Device confirms you want to remove it before doing so.
Activate	To turn on an interface, select it and click Activate .
Inactivate	To turn off an interface, select it and click Inactivate .
Create Virtual Interface	To open the screen where you can create a virtual Ethernet interface, select an Ethernet interface and click Create Virtual Interface .
References	Select an entry and click References to open a screen that shows which settings use the entry. See Section 10.4.4 on page 350 for an example.
#	This field is a sequential value, and it is not associated with any interface.
Status	This icon is lit when the entry is active and dimmed when the entry is inactive.
Name	This field displays the name of the interface.
Description	This field displays the description of the interface.

Table 108 Configuration > Network > Interface > Ethernet (continued)

LABEL	DESCRIPTION
IP Address	<p>This field displays the current IP address of the interface. If the IP address is 0.0.0.0 (in the IPv4 network) or :: (in the IPv6 network), the interface does not have an IP address yet.</p> <p>In the IPv4 network, this screen also shows whether the IP address is a static IP address (STATIC) or dynamically assigned (DHCP). IP addresses are always static in virtual interfaces.</p> <p>In the IPv6 network, this screen also shows whether the IP address is a static IP address (STATIC), link-local IP address (LINK LOCAL), dynamically assigned (DHCP), or an IPv6 StateLess Address AutoConfiguration IP address (SLAAC). See Section 10.1.2 on page 320 for more information about IPv6.</p>
Mask	This field displays the interface's subnet mask in dot decimal notation.
Apply	Click Apply to save your changes back to the Zyxel Device.
Reset	Click Reset to return the screen to its last-saved settings.

10.4.1 Ethernet Edit

The **Ethernet Edit** screen lets you configure IP address assignment, interface parameters, RIP settings, OSPF settings, DHCP settings, connectivity check, and MAC address settings. To access this screen, click an **Edit** icon in the **Ethernet Summary** screen. (See [Section 10.4 on page 326](#).)

The OPT interface's **Edit > Configuration** screen is shown here as an example. The screens for other interfaces are similar and contain a subset to the OPT interface screen's fields.

Note: If you create IP address objects based on an interface's IP address, subnet, or gateway, the Zyxel Device automatically updates every rule or setting that uses the object whenever the interface's IP address settings change. For example, if you change the VLAN's IP address, the Zyxel Device automatically updates the corresponding interface-based, LAN subnet address object.

With RIP, you can use Ethernet interfaces to do the following things.

- Enable and disable RIP in the underlying physical port or port group.
- Select which direction(s) routing information is exchanged - The Zyxel Device can receive routing information, send routing information, or do both.
- Select which version of RIP to support in each direction - The Zyxel Device supports RIP-1, RIP-2, and both versions.
- Select the broadcasting method used by RIP-2 packets - The Zyxel Device can use subnet broadcasting or multicasting.

With OSPF, you can use Ethernet interfaces to do the following things.

- Enable and disable OSPF in the underlying physical port or port group.
- Select the area to which the interface belongs.
- Override the default link cost and authentication method for the selected area.
- Select in which direction(s) routing information is exchanged - The Zyxel Device can receive routing information, send routing information, or do both.

Set the priority used to identify the DR or BDR if one does not exist.

10.4.1.1 IGMP Proxy

Internet Group Management Protocol (IGMP) proxy is used for multicast routing. IGMP proxy enables the Zyxel Device to issue IGMP host messages on behalf of hosts that the Zyxel Device discovered on its IGMP-enabled interfaces. The Zyxel Device acts as a proxy for its hosts. Refer to the following figure.

- DS: Downstream traffic
- US: Upstream traffic
- R: Router
- MS: Multicast Server
- Enable IGMP Upstream (US) on the Zyxel Device interface that connects to a router (R) running IGMP that is closer to the multicast server (MS).
- Enable IGMP Downstream on the Zyxel Device interface which connects to the multicast hosts.

Figure 255 IGMP Proxy

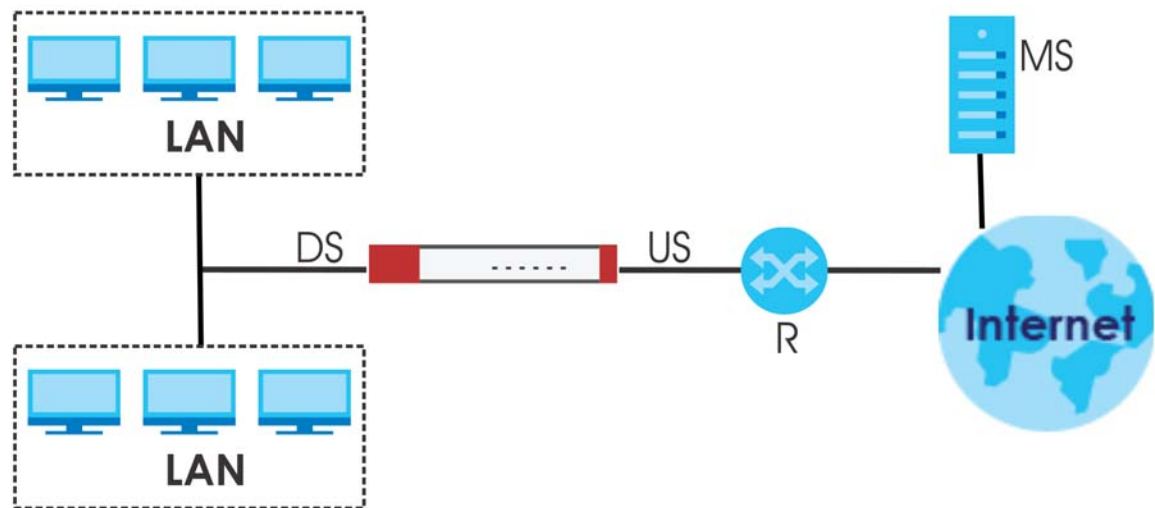

Figure 256 Configuration > Network > Interface > Ethernet > Edit (External Type)

IPv4/IPv6 View Hide Advanced Settings Create New Object

General Settings

Enable Interface

General IPv6 Setting

Enable IPv6 i

Interface Properties

Interface Type: external

Interface Name:

Port: P1

Zone: WAN

MAC Address: 80:B2:DC:69:A5:FE

Description: (Optional)

IP Address Assignment

Get Automatically 172.21.40.25

Advance

DHCP Option 60: (Optional)

Use Fixed IP Address

IP Address:

Subnet Mask:

Gateway: (Optional)

Metric: (0-15)

Enable IGMP Support

IGMP Upstream

IGMP Downstream

IPv6 Address Assignment

Enable Stateless Address Auto-configuration (SLAAC)

Link-Local Address: n/a

IPv6 Address/Prefix Length: (Optional)

Advance

Gateway: (Optional)

Metric: (0-15)

Address from DHCPv6 Prefix Delegation

#	Delegated Prefix	Suffix Address	Address
No data to display			

Add Edit Remove References

Page 0 of 0 Show 50 items

DHCPv6 Setting

DHCPv6:

IPv6 Router Advertisement Setting

Enable Router Advertisement

Advertised Hosts Get Network Configuration From DHCP

IPv6 Router Advertisement

Advertised Hosts Get Network Configuration From DHCPv6

Advertised Hosts Get Other Configuration From DHCPv6

Router Preference:

Advance

MTU: (1280-1500, 0 is disabled)

Hop Limit: (0-255, 0 is disabled)

Advertised Prefix Table

#	IPv6 Address/Prefix Length
No data to display	

Advance

Advertised Prefix from DHCPv6 Prefix Delegation

#	Delegated Prefix	Suffix Address	Address
No data to display			

Interface Parameters

Egress Bandwidth: Kbps

Advance

Ingress Bandwidth: Kbps

MTU: Bytes

Connectivity Check

Enable Connectivity Check

Check Method:

Check Period: (5-600 seconds)

Check Timeout: (1-10 seconds)

Check Fail Tolerance: (1-10)

Check Default Gateway

Check These Addresses (Domain Name or IP Address)

(Optional)

Probe Succeeds When: respond(s)

RIP Setting

Enable RIP

Direction:

Send Version:

Receive Version:

V2-Broadcast

OSPF Setting

Area:

Priority: (0-255)

USG Bridge

OSPF Setting

Area: ▼

Priority: (0-255)

Link Cost: (1-65535)

Passive Interface

Authentication: ▼

MAC Address Setting

Use Default MAC Address

Overwrite Default MAC Address

Proxy ARP

Enable Proxy ARP

#	IP Address
No data to display	

Page 0 of 0 | Show 50 items

Related Setting

Configure [PPPoE/PPTP](#)

Figure 257 Configuration > Network > Interface > Ethernet > Edit (Internal Type)

IPv4/IPv6 View Hide Advanced Settings Create New Object

General Settings

Enable Interface

General IPv6 Setting

Enable IPv6 i

Interface Properties

Interface Type: internal

Interface Name:

Port: P3, P4, P5, P6

Zone: LAN1

MAC Address: B0:B2:DC:69:A6:01

Description: (Optional)

IP Address Assignment

IP Address:

Subnet Mask:

Enable IGMP Support

IGMP Upstream

IGMP Downstream

IPv6 Address Assignment

Enable Stateless Address Auto-configuration (SLAAC)

Link-Local Address: n/a

IPv6 Address/Prefix Length: (Optional)

Advance

Gateway: (Optional)

Metric: (0-15)

Address from DHCPv6 Prefix Delegation

+ Add ✎ Edit ✖ Remove 🔗 References

#	Delegated Prefix	Suffix Address	Address
No data to display			

Page 0 of 0 | Show 50 items

DHCPv6 Setting

DHCPv6:

IPv6 Router Advertisement Setting

Enable Router Advertisement

Advance

Advertised Hosts Get Network Configuration From DHCPv6

Advertised Hosts Get Other Configuration From DHCPv6

Router Preference:

Advance

MTU: (1280-1500, 0 is disabled)

Hop Limit: (0-255, 0 is disabled)

Advertised Prefix Table

+ Add ✖ Remove

Router Reference: medium

Advance

MTU: 1480 (disabled)
(0-255, 0=disabled)

Advertised Prefix Table

+ Add ✎ Edit ✖ Remove

#	IPv6 Address/Prefix Length
No data to display	

Page 0 of 0 Show 50 items

Advance

Advertised Prefix from DHCPv6 Prefix Delegation

+ Add ✎ Edit ✖ Remove 📄 References

#	Delegated Prefix	Suffix Address	Address
No data to display			

Page 0 of 0 Show 50 items

Interface Parameters

Egress Bandwidth: 1048576 Kbps 1

Advance

Ingress Bandwidth: 1048576 Kbps

MTU: 1500 Bytes

Connectivity Check

Enable Connectivity Check

Check Method: icmp

Check Period: 30 (5-600 seconds)

Check Timeout: 5 (1-10 seconds)

Check Fail Tolerance: 5 (1-10)

Check These Addresses: (Domain Name or IP Address)
 (Optional)

Probe Succeeds When: any one respond(s)

DHCP Setting

DHCP: DHCP Server

IP Pool Start Address: 192.168.1.33 Pool Size: 200

First DNS Server (Optional): ZyWALL

Second DNS Server (Optional): None

Third DNS Server (Optional): None

First WINS Server (Optional):

Second WINS Server (Optional):

Default Router: lan1 IP

Lease Time: infinite
 2 days 0 hours (Optional) 0 minutes (Optional)

Advance

Extended Options

+ Add ✎ Edit ✖ Remove

#	Name	Code	Type	Value
No data to display				

Page 0 of 0 Show 50 items

IPv6 Server:

IPv6 Address Pool File:

Extended Options

PXE Server:

PXE Boot Loader File:

Enable IP/MAC Binding

Enable Logs for IP/MAC Binding Violation

Static DHCP Table

#	IP Address	MAC	Description
---	------------	-----	-------------

Page 0 of 0 items No data to display

Advance

RIP Setting

Enable RIP

Direction:

Send Version:

Receive Version:

V2-Broadcast

OSPF Setting

Area:

Priority: (0-255)

Link Cost: (1-65535)

Passive Interface

Authentication:

Figure 258 Configuration > Network > Interface > Ethernet > Edit (OPT)

IPv4/IPv6 View ▾ Hide Advanced Settings Create New Object

General Settings

Enable Interface

General IPv6 Setting

Enable IPv6 ⓘ

Interface Properties

Interface Type: internal ⓘ

Interface Name: opt

Port: none

Zone: OPT ⓘ

MAC Address: B0:B2:DC:69:A6:00

Description: (Optional)

IP Address Assignment

IP Address: 192.168.5.1

Subnet Mask: 255.255.255.0

Enable IGMP Support

IGMP Upstream

IGMP Downstream

IPv6 Address Assignment

Enable Stateless Address Auto-configuration (SLAAC)

Link-Local Address: n/a

IPv6 Address/Prefix Length: (Optional)

Advance

Gateway: (Optional)

Metric: (0-15)

Address from DHCPv6 Prefix Delegation

#	Delegated Prefix	Suffix Address	Address
No data to display			

DHCPv6 Setting

DHCPv6: N/A

IPv6 Router Advertisement Setting

Enable Router Advertisement

Advance

Advertised Hosts Get Network Configuration From DHCPv6

Advertised Hosts Get Other Configuration From DHCPv6

Router Preference: Medium

Advance

MTU: 1480 (1280-1500, 0 is disabled)

Hop Limit: 64 (0-255, 0 is disabled)

Advertised Prefix

IPv6 Address/Prefix Length

MTU:
(0-255, 0 = disabled)

Advertised Prefix Table

[Add](#) [Edit](#) [Remove](#)

#	IPv6 Address/Prefix Length
No data to display	

Page 0 of 0
Show 50 items

Advertised Prefix from DHCPv6 Prefix Delegation

[Add](#) [Edit](#) [Remove](#) [References](#)

#	Delegated Prefix	Suffix Address	Address
No data to display			

Page 0 of 0
Show 50 items

Interface Parameters

Egress Bandwidth: Kbps

Ingress Bandwidth: Kbps

MTU: Bytes

Connectivity Check

Enable Connectivity Check

Check Method:

Check Period: (5-600 seconds)

Check Timeout: (1-10 seconds)

Check Fail Tolerance: (1-10)

Check These Addresses: (Domain Name or IP Address)

(Optional)

Probe Succeeds When: respond(s)

DHCP Setting

DHCP:

IP Pool Start Address: Pool Size:

First DNS Server (Optional):

Second DNS Server (Optional):

Third DNS Server (Optional):

First WINS Server (Optional):

Second WINS Server (Optional):

Default Router:

Lease Time: infinite

days hours (Optional) minutes (Optional)

Extended Options

[Add](#) [Edit](#) [Remove](#)

#	Name	Code	Type	Value
No data to display				

Page 0 of 0
Show 50 items

DNS Server:

The screenshot displays the configuration page for an Ethernet interface. At the top, there are fields for 'PXE Server' and 'PXE Boot Loader File'. Below these are checkboxes for 'Enable IP/MAC Binding' and 'Enable Logs for IP/MAC Binding Violation'. A 'Static DHCP Table' section contains a table with columns for '#', 'IP Address', 'MAC', and 'Description', currently showing 'No data to display'. The 'Advance' section is expanded to show 'RIP Setting' and 'OSPF Setting'. Under 'RIP Setting', there are checkboxes for 'Enable RIP' and 'V2-Broadcast', and dropdown menus for 'Direction' (BiDir), 'Send Version' (2), and 'Receive Version' (2). Under 'OSPF Setting', there are dropdown menus for 'Area' (none), 'Priority' (1), 'Link Cost' (10), and 'Authentication' (None), along with a checkbox for 'Passive Interface'.

These screens' fields are described in the table below.

Table 109 Configuration > Network > Interface > Ethernet > Edit

LABEL	DESCRIPTION
IPv4/IPv6 View / IPv4 View / IPv6 View	Use this button to display both IPv4 and IPv6, IPv4-only, or IPv6-only configuration fields.
Show Advanced Settings / Hide Advanced Settings	Click this button to display a greater or lesser number of configuration fields.
Create New Object	Click this button to create a DHCPv6 lease or DHCPv6 request object that you may use for the DHCPv6 settings in this screen.
General Settings	
Enable Interface	Select this to enable this interface. Clear this to disable this interface.
General IPv6 Setting	
Enable IPv6	Select this to enable IPv6 on this interface. Otherwise, clear this to disable it.
Interface Properties	

Table 109 Configuration > Network > Interface > Ethernet > Edit (continued)

LABEL	DESCRIPTION
Interface Type	<p>This field is configurable for the OPT interface only. Select to which type of network you will connect this interface. When you select internal or external the rest of the screen's options automatically adjust to correspond. The Zyxel Device automatically adds default route and SNAT settings for traffic it routes from internal interfaces to external interfaces; for example LAN to WAN traffic.</p> <p>internal is for connecting to a local network. Other corresponding configuration options: DHCP server and DHCP relay. The Zyxel Device automatically adds default SNAT settings for traffic flowing from this interface to an external interface.</p> <p>external is for connecting to an external network (like the Internet). The Zyxel Device automatically adds this interface to the default WAN trunk.</p> <p>For general, the rest of the screen's options do not automatically adjust and you must manually configure a policy route to add routing and SNAT settings for the interface.</p>
Interface Name	Specify a name for the interface. It can use alphanumeric characters, hyphens, and underscores, and it can be up to 11 characters long.
Port	This is the name of the Ethernet interface's physical port.
Zone	Select the zone to which this interface is to belong. You use zones to apply security settings such as security policy, IDP, remote management, anti-virus, and application patrol. Make sure to select the correct zone as otherwise traffic may be blocked by a security policy.
MAC Address	This field is read-only. This is the MAC address that the Ethernet interface uses.
Description	Enter a description of this interface. You can use alphanumeric and () + / : = ? ! * # @ \$ _ % - characters, and it can be up to 60 characters long. Spaces are allowed, but the string can't start with a space.
IP Address Assignment	These IP address fields configure an IPv4 IP address on the interface itself. If you change this IP address on the interface, you may also need to change a related address object for the network connected to the interface. For example, if you use this screen to change the IP address of your LAN interface, you should also change the corresponding LAN subnet address object.
Get Automatically	<p>This option appears when Interface Type is external or general. Select this to make the interface a DHCP client and automatically get the IP address, subnet mask, and gateway address from a DHCP server.</p> <p>You should not select this if the interface is assigned to a VRRP group. See Chapter 42 on page 812.</p>
DHCP Option 60	<p>DHCP Option 60 is used by the Zyxel Device for identification to the DHCP server using the VCI (Vendor Class Identifier) on the DHCP server. The Zyxel Device adds it in the initial DHCP discovery message that a DHCP client broadcasts in search of an IP address. The DHCP server can assign different IP addresses or options to clients with the specific VCI or reject the request from clients without the specific VCI.</p> <p>Type a string using up to 64 of these characters [a-zA-Z0-9!\"#\$%&\'()*+,-./:;<=>?@\[\]\^_`{ }~] to identify this Zyxel Device to the DHCP server. For example, Zyxel-TW.</p>
Use Fixed IP Address	This option appears when Interface Type is external or general . Select this if you want to specify the IP address, subnet mask, and gateway manually.
IP Address	Enter the IP address for this interface.
Subnet Mask	Enter the subnet mask of this interface in dot decimal notation. The subnet mask indicates what part of the IP address is the same for all computers in the network.
Gateway	This option appears when Interface Type is external or general . Enter the IP address of the gateway. The Zyxel Device sends packets to the gateway when it does not know how to route the packet to its destination. The gateway should be on the same network as the interface.

Table 109 Configuration > Network > Interface > Ethernet > Edit (continued)

LABEL	DESCRIPTION
Metric	This option appears when Interface Type is external or general . Enter the priority of the gateway (if any) on this interface. The Zyxel Device decides which gateway to use based on this priority. The lower the number, the higher the priority. If two or more gateways have the same priority, the Zyxel Device uses the one that was configured first.
Enable IGMP Support	Select this to allow the Zyxel Device to act as an IGMP proxy for hosts connected on the IGMP downstream interface.
IGMP Upstream	Enable IGMP Upstream on the interface which connects to a router running IGMP that is closer to the multicast server.
IGMP Downstream	Enable IGMP Downstream on the interface which connects to the multicast hosts.
IPv6 Address Assignment	These IP address fields configure an IPv6 IP address on the interface itself.
Enable Stateless Address Auto-configuration (SLAAC)	Select this to enable IPv6 stateless auto-configuration on this interface. The interface will generate an IPv6 IP address itself from a prefix obtained from an IPv6 router in the network.
Link-Local address	This displays the IPv6 link-local address and the network prefix that the Zyxel Device generates itself for the interface.
IPv6 Address/Prefix Length	Enter the IPv6 address and the prefix length for this interface if you want to use a static IP address. This field is optional. The prefix length indicates what the left-most part of the IP address is the same for all computers in the network, that is, the network address.
Gateway	Enter the IPv6 address of the default outgoing gateway using colon (:) hexadecimal notation.
Metric	Enter the priority of the gateway (if any) on this interface. The Zyxel Device decides which gateway to use based on this priority. The lower the number, the higher the priority. If two or more gateways have the same priority, the Zyxel Device uses the one that was configured first.
Address from DHCPv6 Prefix Delegation	Use this table to have the Zyxel Device obtain an IPv6 prefix from the ISP or a connected uplink router for an internal network, such as the LAN or DMZ. You have to also enter a suffix address which is appended to the delegated prefix to form an address for this interface. See Prefix Delegation on page 323 for more information. To use prefix delegation, you must: <ul style="list-style-type: none"> • Create at least one DHCPv6 request object before configuring this table. • The external interface must be a DHCPv6 client. You must configure the DHCPv6 request options using a DHCPv6 request object with the type of prefix-delegation. • Assign the prefix delegation to an internal interface and enable router advertisement on that interface.
Add	Click this to create an entry.
Edit	Select an entry and click this to change the settings.
Remove	Select an entry and click this to delete it from this table.
References	Select an entry and click References to check which settings use the entry.
#	This field is a sequential value, and it is not associated with any entry.
Delegated Prefix	Select the DHCPv6 request object to use from the drop-down list.
Suffix Address	Enter the ending part of the IPv6 address, a slash (/), and the prefix length. The Zyxel Device will append it to the delegated prefix. For example, you got a delegated prefix of 2003:1234:5678/48. You want to configure an IP address of 2003:1234:5678:1111::1/128 for this interface, then enter ::1111:0:0:1/128 in this field.

Table 109 Configuration > Network > Interface > Ethernet > Edit (continued)

LABEL	DESCRIPTION
Address	This field displays the combined IPv6 IP address for this interface. Note: This field displays the combined address after you click OK and reopen this screen.
DHCPv6 Setting	
DHCPv6	Select N/A to not use DHCPv6. Select Client to set this interface to act as a DHCPv6 client. Select Server to set this interface to act as a DHCPv6 server which assigns IP addresses and provides subnet mask, gateway, and DNS server information to clients. Select Relay to set this interface to route DHCPv6 requests to the DHCPv6 relay server you specify. The DHCPv6 server(s) may be on another network.
DUID	This field displays the DHCP Unique Identifier (DUID) of the interface, which is unique and used for identification purposes when the interface is exchanging DHCPv6 messages with others. See DHCPv6 on page 324 for more information.
DUID as MAC	Select this if you want the DUID is generated from the interface's default MAC address.
Customized DUID	If you want to use a customized DUID, enter it here for the interface.
Enable Rapid Commit	Select this to shorten the DHCPv6 message exchange process from four to two steps. This function helps reduce heavy network traffic load. Note: Make sure you also enable this option in the DHCPv6 clients to make rapid commit work.
Information Refresh Time	Enter the number of seconds a DHCPv6 client should wait before refreshing information retrieved from DHCPv6.
Request Address	This field is available if you set this interface to DHCPv6 Client . Select this to get an IPv6 IP address for this interface from the DHCP server. Clear this to not get any IP address information through DHCPv6.
DHCPv6 Request Options / DHCPv6 Lease Options	If this interface is a DHCPv6 client, use this section to configure DHCPv6 request settings that determine what additional information to get from the DHCPv6 server. If the interface is a DHCPv6 server, use this section to configure DHCPv6 lease settings that determine what additional information to offer to the DHCPv6 clients.
Add	Click this to create an entry in this table. See Section 10.4.5 on page 351 for more information.
Remove	Select an entry and click this to delete it from this table.
Reference	Select an entry and click References to open a screen that shows which settings use the entry. See Section 10.4.4 on page 350 for an example.
#	This field is a sequential value, and it is not associated with any entry.
Name	This field displays the name of the DHCPv6 request or lease object.
Type	This field displays the type of the object.
Value	This field displays the IPv6 prefix that the Zyxel Device obtained from an uplink router (Server is selected) or will advertise to its clients (Client is selected).
Interface	When Relay is selected, select this check box and an interface from the drop-down list if you want to use it as the relay server.
Relay Server	When Relay is selected, select this check box and enter the IP address of a DHCPv6 server as the relay server.
IPv6 Router Advertisement Setting	

Table 109 Configuration > Network > Interface > Ethernet > Edit (continued)

LABEL	DESCRIPTION
Enable Router Advertisement	Select this to enable this interface to send router advertisement messages periodically. See IPv6 Router Advertisement on page 323 for more information.
Advertised Hosts Get Network Configuration From DHCPv6	Select this to have the Zyxel Device indicate to hosts to obtain network settings (such as prefix and DNS settings) through DHCPv6. Clear this to have the Zyxel Device indicate to hosts that DHCPv6 is not available and they should use the prefix in the router advertisement message.
Advertised Hosts Get Other Configuration From DHCPv6	Select this to have the Zyxel Device indicate to hosts to obtain DNS information through DHCPv6. Clear this to have the Zyxel Device indicate to hosts that DNS information is not available in this network.
Router Preference	Select the router preference (Low , Medium or High) for the interface. The interface sends this preference in the router advertisements to tell hosts what preference they should use for the Zyxel Device. This helps hosts to choose their default router especially when there are multiple IPv6 router in the network. Note: Make sure the hosts also support router preference to make this function work.
MTU	The Maximum Transmission Unit. Type the maximum size of each IPv6 data packet, in bytes, that can move through this interface. If a larger packet arrives, the Zyxel Device discards the packet and sends an error message to the sender to inform this.
Hop Limit	Enter the maximum number of network segments that a packet can cross before reaching the destination. When forwarding an IPv6 packet, IPv6 routers are required to decrease the Hop Limit by 1 and to discard the IPv6 packet when the Hop Limit is 0.
Advertised Prefix Table	Configure this table only if you want the Zyxel Device to advertise a fixed prefix to the network.
Add	Click this to create an IPv6 prefix address.
Edit	Select an entry in this table and click this to modify it.
Remove	Select an entry in this table and click this to delete it.
#	This field is a sequential value, and it is not associated with any entry.
IPv6 Address/Prefix Length	Enter the IPv6 network prefix address and the prefix length. The prefix length indicates what the left-most part of the IP address is the same for all computers in the network, that is, the network address.
Advertised Prefix from DHCPv6 Prefix Delegation	This table is available when the Interface Type is internal . Use this table to configure the network prefix if you want to use a delegated prefix as the beginning part of the network prefix.
Add	Click this to create an entry in this table.
Edit	Select an entry in this table and click this to modify it.
Remove	Select an entry in this table and click this to delete it.
References	Select an entry and click References to open a screen that shows which settings use the entry.
#	This field is a sequential value, and it is not associated with any entry.
Delegated Prefix	Select the DHCPv6 request object to use for generating the network prefix for the network.

Table 109 Configuration > Network > Interface > Ethernet > Edit (continued)

LABEL	DESCRIPTION
Suffix Address	<p>Enter the ending part of the IPv6 network address plus a slash (/) and the prefix length. The Zyxel Device will append it to the selected delegated prefix. The combined address is the network prefix for the network.</p> <p>For example, you got a delegated prefix of 2003:1234:5678/48. You want to divide it into 2003:1234:5678:1111/64 for this interface and 2003:1234:5678:2222/64 for another interface. You can use ::1111/64 and ::2222/64 for the suffix address respectively. But if you do not want to divide the delegated prefix into subnetworks, enter ::0/48 here, which keeps the same prefix length (/48) as the delegated prefix.</p>
Address	<p>This is the final network prefix combined by the delegated prefix and the suffix.</p> <p>Note: This field displays the combined address after you click OK and reopen this screen.</p>
Interface Parameters	
Egress Bandwidth	Enter the maximum amount of traffic, in kilobits per second, the Zyxel Device can send through the interface to the network. Allowed values are 0 - 1048576.
Ingress Bandwidth	<p>This is reserved for future use.</p> <p>Enter the maximum amount of traffic, in kilobits per second, the Zyxel Device can receive from the network through the interface. Allowed values are 0 - 1048576.</p>
MTU	Maximum Transmission Unit. Type the maximum size of each data packet, in bytes, that can move through this interface. If a larger packet arrives, the Zyxel Device divides it into smaller fragments. Allowed values are 576 - 1500. Usually, this value is 1500.
Connectivity Check	<p>These fields appear when Interface Properties is External or General.</p> <p>The interface can regularly check the connection to the gateway you specified to make sure it is still available. You specify how often the interface checks the connection, how long to wait for a response before the attempt is a failure, and how many consecutive failures are required before the Zyxel Device stops routing to the gateway. The Zyxel Device resumes routing to the gateway the first time the gateway passes the connectivity check.</p>
Enable Connectivity Check	Select this to turn on the connection check.
Check Method	<p>Select the method that the gateway allows.</p> <p>Select icmp to have the Zyxel Device regularly ping the gateway you specify to make sure it is still available.</p> <p>Select tcp to have the Zyxel Device regularly perform a TCP handshake with the gateway you specify to make sure it is still available.</p>
Check Period	Enter the number of seconds between connection check attempts.
Check Timeout	Enter the number of seconds to wait for a response before the attempt is a failure.
Check Fail Tolerance	Enter the number of consecutive failures before the Zyxel Device stops routing through the gateway.
Check Default Gateway	Select this to use the default gateway for the connectivity check.
Check this address	Select this to specify a domain name or IP address for the connectivity check. Enter that domain name or IP address in the field next to it.
Check Port	This field only displays when you set the Check Method to tcp . Specify the port number to use for a TCP connectivity check.
Check these addresses	Type one or two domain names or IP addresses for the connectivity check.

Table 109 Configuration > Network > Interface > Ethernet > Edit (continued)

LABEL	DESCRIPTION
Probe Succeeds When	<p>This field applies when you specify two domain names or IP addresses for the connectivity check.</p> <p>Select any one if you want the check to pass if at least one of the domain names or IP addresses responds.</p> <p>Select all if you want the check to pass only if both domain names or IP addresses respond.</p>
DHCP Setting	This section appears when Interface Type is internal or general .
DHCP	<p>Select what type of DHCP service the Zyxel Device provides to the network. Choices are:</p> <p>None - the Zyxel Device does not provide any DHCP services. There is already a DHCP server on the network.</p> <p>DHCP Relay - the Zyxel Device routes DHCP requests to one or more DHCP servers you specify. The DHCP server(s) may be on another network.</p> <p>DHCP Server - the Zyxel Device assigns IP addresses and provides subnet mask, gateway, and DNS server information to the network. The Zyxel Device is the DHCP server for the network.</p>
	These fields appear if the Zyxel Device is a DHCP Relay .
Relay Server 1	Enter the IP address of a DHCP server for the network.
Relay Server 2	This field is optional. Enter the IP address of another DHCP server for the network.
	These fields appear if the Zyxel Device is a DHCP Server .
IP Pool Start Address	<p>Enter the IP address from which the Zyxel Device begins allocating IP addresses. If you want to assign a static IP address to a specific computer, use the Static DHCP Table.</p> <p>If this field is blank, the Pool Size must also be blank. In this case, the Zyxel Device can assign every IP address allowed by the interface's IP address and subnet mask, except for the first address (network address), last address (broadcast address) and the interface's IP address.</p>
Pool Size	<p>Enter the number of IP addresses to allocate. This number must be at least one and is limited by the interface's Subnet Mask. For example, if the Subnet Mask is 255.255.255.0 and IP Pool Start Address is 10.10.10.10, the Zyxel Device can allocate 10.10.10.10 to 10.10.10.254, or 245 IP addresses.</p> <p>If this field is blank, the IP Pool Start Address must also be blank. In this case, the Zyxel Device can assign every IP address allowed by the interface's IP address and subnet mask, except for the first address (network address), last address (broadcast address) and the interface's IP address.</p>
First DNS Server, Second DNS Server, Third DNS Server	<p>Specify the IP addresses up to three DNS servers for the DHCP clients to use. Use one of the following ways to specify these IP addresses.</p> <p>Custom Defined - enter a static IP address.</p> <p>From ISP - select the DNS server that another interface received from its DHCP server.</p> <p>Zyxel Device - the DHCP clients use the IP address of this interface and the Zyxel Device works as a DNS relay.</p>
First WINS Server, Second WINS Server	Type the IP address of the WINS (Windows Internet Naming Service) server that you want to send to the DHCP clients. The WINS server keeps a mapping table of the computer names on your network and the IP addresses that they are currently using.
Default Router	<p>If you set this interface to DHCP Server, you can select to use either the interface's IP address or another IP address as the default router. This default router will become the DHCP clients' default gateway.</p> <p>To use another IP address as the default router, select Custom Defined and enter the IP address.</p>

Table 109 Configuration > Network > Interface > Ethernet > Edit (continued)

LABEL	DESCRIPTION
Lease time	Specify how long each computer can use the information (especially the IP address) before it has to request the information again. Choices are: infinite - select this if IP addresses never expire. days, hours, and minutes - select this to enter how long IP addresses are valid.
Extended Options	This table is available if you selected DHCP server . Configure this table if you want to send more information to DHCP clients through DHCP packets.
Add	Click this to create an entry in this table. See Section 10.4.6 on page 351 .
Edit	Select an entry in this table and click this to modify it.
Remove	Select an entry in this table and click this to delete it.
#	This field is a sequential value, and it is not associated with any entry.
Name	This is the name of the DHCP option.
Code	This is the code number of the DHCP option.
Type	This is the type of the set value for the DHCP option.
Value	This is the value set for the DHCP option.
PXE Server	PXE (Preboot eXecution Environment) allows a client computer to use the network to boot up and install an operating system via a PXE-capable Network Interface Card (NIC). PXE is available for computers on internal interfaces to allow them to boot up using boot software on a PXE server. The Zyxel Device acts as an intermediary between the PXE server and the computers that need boot software. The PXE server must have a public IPv4 address. You must enable DHCP Server on the Zyxel Device so that it can receive information from the PXE server.
PXE Boot Loader File	A boot loader is a computer program that loads the operating system for the computer. Type the exact file name of the boot loader software file, including filename extension, that is on the PXE server. If the wrong filename is typed, then the client computers cannot boot.
Enable IP/MAC Binding	Select this option to have this interface enforce links between specific IP addresses and specific MAC addresses. This stops anyone else from manually using a bound IP address on another device connected to this interface. Use this to make use only the intended users get to use specific IP addresses.
Enable Logs for IP/MAC Binding Violation	Select this option to have the Zyxel Device generate a log if a device connected to this interface attempts to use an IP address that is bound to another device's MAC address.
Static DHCP Table	Configure a list of static IP addresses the Zyxel Device assigns to computers connected to the interface. Otherwise, the Zyxel Device assigns an IP address dynamically using the interface's IP Pool Start Address and Pool Size .
Add	Click this to create a new entry.
Edit	Select an entry and click this to be able to modify it.
Remove	Select an entry and click this to delete it.
#	This field is a sequential value, and it is not associated with a specific entry.
IP Address	Enter the IP address to assign to a device with this entry's MAC address.
MAC	Enter the MAC address to which to assign this entry's IP address.
Description	Enter a description to help identify this static DHCP entry. You can use alphanumeric and () + / : = ? ! * # @ \$ % - characters, and it can be up to 60 characters long.
RIP Setting	See Section 11.6 on page 441 for more information about RIP.
Enable RIP	Select this to enable RIP in this interface.

Table 109 Configuration > Network > Interface > Ethernet > Edit (continued)

LABEL	DESCRIPTION
Direction	This field is effective when RIP is enabled. Select the RIP direction from the drop-down list box. BiDir - This interface sends and receives routing information. In-Only - This interface receives routing information. Out-Only - This interface sends routing information.
Send Version	This field is effective when RIP is enabled. Select the RIP version(s) used for sending RIP packets. Choices are 1 , 2 , and 1 and 2 .
Receive Version	This field is effective when RIP is enabled. Select the RIP version(s) used for receiving RIP packets. Choices are 1 , 2 , and 1 and 2 .
V2-Broadcast	This field is effective when RIP is enabled. Select this to send RIP-2 packets using subnet broadcasting; otherwise, the Zyxel Device uses multicasting.
OSPF Setting	See Section 11.7 on page 443 for more information about OSPF.
Area	Select the area in which this interface belongs. Select None to disable OSPF in this interface.
Priority	Enter the priority (between 0 and 255) of this interface when the area is looking for a Designated Router (DR) or Backup Designated Router (BDR). The highest-priority interface identifies the DR, and the second-highest-priority interface identifies the BDR. Set the priority to zero if the interface can not be the DR or BDR.
Link Cost	Enter the cost (between 1 and 65,535) to route packets through this interface.
Passive Interface	Select this to stop forwarding OSPF routing information from the selected interface. As a result, this interface only receives routing information.
Authentication	Select an authentication method, or disable authentication. To exchange OSPF routing information with peer border routers, you must use the same authentication method that they use. Choices are: Same-as-Area - use the default authentication method in the area None - disable authentication Text - authenticate OSPF routing information using a plain-text password MD5 - authenticate OSPF routing information using MD5 encryption
Text Authentication Key	This field is available if the Authentication is Text . Type the password for text authentication. The key can consist of alphanumeric characters and the underscore, and it can be up to 16 characters long.
MD5 Authentication ID	This field is available if the Authentication is MD5 . Type the ID for MD5 authentication. The ID can be between 1 and 255.
MD5 Authentication Key	This field is available if the Authentication is MD5 . Type the password for MD5 authentication. The password can consist of alphanumeric characters and the underscore, and it can be up to 16 characters long.
MAC Address Setting	This section appears when Interface Properties is External or General . Have the interface use either the factory assigned default MAC address, a manually specified MAC address, or clone the MAC address of another device or computer.
Use Default MAC Address	Select this option to have the interface use the factory assigned default MAC address. By default, the Zyxel Device uses the factory assigned MAC address to identify itself.
Overwrite Default MAC Address	Select this option to have the interface use a different MAC address. Either enter the MAC address in the fields or click Clone by host and enter the IP address of the device or computer whose MAC you are cloning. Once it is successfully configured, the address will be copied to the configuration file. It will not change unless you change the setting or upload a different configuration file.
Proxy ARP	Proxy ARP is available for external or general interfaces on the Zyxel Device. See Section 10.4.2 on page 347 for more information on Proxy ARP.

Table 109 Configuration > Network > Interface > Ethernet > Edit (continued)

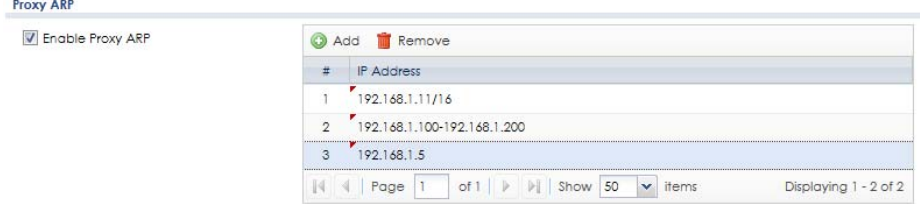
LABEL	DESCRIPTION								
Enable Proxy ARP	<p>Select this to allow the Zyxel Device to answer external interface ARP requests on behalf of a device on its internal interface. Interfaces supported are:</p> <ul style="list-style-type: none"> • Ethernet • VLAN • Bridge <p>See Section 10.4.2 on page 347 for more information.</p>								
Add	<p>Click Add to create an IPv4 Address, an IPv4 CIDR (for example, 192.168.1.1/24) or an IPv4 Range (for example, 192.168.1.2-192.168.1.100) as the target IP address. The Zyxel Device answers external ARP requests only if they match one of these inputted target IP addresses. For example, if the IPv4 Address is 192.168.1.5, then the Zyxel Device will answer ARP requests coming from the WAN only if it contains 192.168.1.5 as the target IP address.</p> <p>Select an existing entry and click Remove to delete that entry.</p>  <p>The screenshot shows the 'Proxy ARP' configuration page. It has a checkbox for 'Enable Proxy ARP' which is checked. To the right, there are 'Add' and 'Remove' buttons. Below these is a table with the following entries:</p> <table border="1" data-bbox="829 722 1442 869"> <thead> <tr> <th>#</th> <th>IP Address</th> </tr> </thead> <tbody> <tr> <td>1</td> <td>192.168.1.11/16</td> </tr> <tr> <td>2</td> <td>192.168.1.100-192.168.1.200</td> </tr> <tr> <td>3</td> <td>192.168.1.5</td> </tr> </tbody> </table> <p>At the bottom of the screenshot, there are navigation controls: 'Page 1 of 1', 'Show 50 items', and 'Displaying 1 - 2 of 2'.</p>	#	IP Address	1	192.168.1.11/16	2	192.168.1.100-192.168.1.200	3	192.168.1.5
#	IP Address								
1	192.168.1.11/16								
2	192.168.1.100-192.168.1.200								
3	192.168.1.5								
Related Setting									
Configure PPPoE/PPTP	Click PPPoE/PPTP if this interface's Internet connection uses PPPoE or PPTP or L2TP.								
Configure VLAN	Click VLAN if you want to configure a VLAN interface for this Ethernet interface.								
Configure WAN TRUNK	Click WAN TRUNK to go to a screen where you can set this interface to be part of a WAN trunk for load balancing.								
Configure Policy Route	<p>Click Policy Route to go to the policy route summary screen where you can manually associate traffic with this interface.</p> <p>You must manually configure a policy route to add routing and SNAT settings for an interface with the Interface Type set to general. You can also configure a policy route to override the default routing and SNAT behavior for an interface with an Interface Type of internal or external.</p>								
OK	Click OK to save your changes back to the Zyxel Device.								
Cancel	Click Cancel to exit this screen without saving.								

10.4.2 Proxy ARP

An Address Resolution Protocol (ARP) is a protocol for mapping an IP address to a MAC address. An ARP broadcast is sent to all devices in the same Ethernet network to request the MAC address of a target IP address.

In the following figure, a host in a WAN subnet (A) broadcasts an ARP request to all devices within its network in order to find the MAC address of a target IP address (172.16.x.x). However, the target IP address may be in another subnet (B) that has the same network IP address (172.16.x.x). A router, such as the Zyxel Device, does not forward broadcasts, so the request will not reach its destination.

Enable **Proxy ARP** (RFC 1027) to allow the Zyxel Device to answer external interface ARP requests on behalf of a device on its internal interface. Interfaces supported are:

- Ethernet

- VLAN
- Bridge

The Zyxel Device sends its external MAC address to the WAN sender as the destination for the target IP address. From then on the sender will send packets containing that target IP address directly to the external interface of the Zyxel Device. The Zyxel Device then forwards the packet to the correct target IP address in its LAN.

Figure 259 Proxy ARP

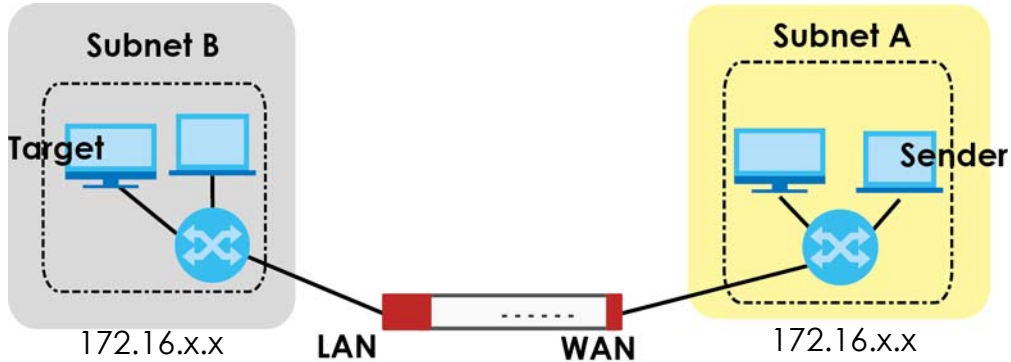

To allow the Zyxel Device to answer external interface ARP requests on behalf of a device on a supported interface, select the interface, click **Add** or **Edit**, then click **Add** in the **Proxy ARP** section of the screen.

Figure 260 Interface > Edit > Add Proxy ARP

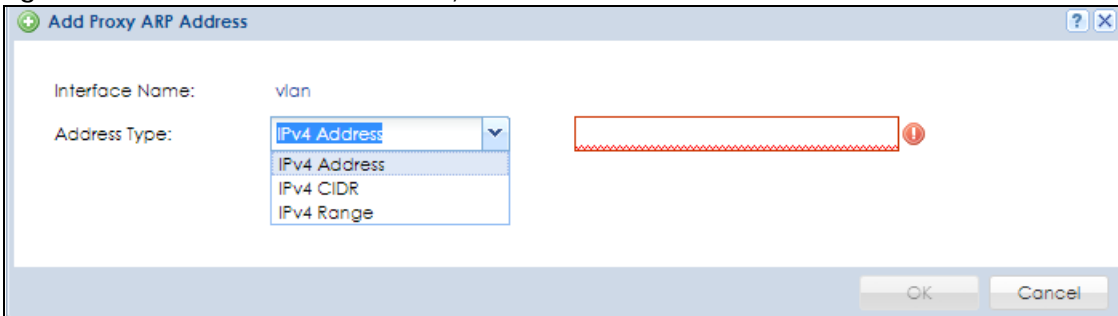

The following table describes labels that can appear in this screen.

Table 110 Interface > Edit > Add Proxy ARP

LABEL	DESCRIPTION
Interface Name	This identifies the interface for which the configuration settings that use it are displayed.
Address Type	Choose IPv4 Address , or IPv4 CIDR (for example, 192.168.1.1/24) or an IPv4 Range (for example, 192.168.1.2-192.168.1.100) and then enter the target IP address information. The Zyxel Device answers external ARP requests only if they match one of these inputted target IP addresses. For example, if the IPv4 Address is 192.168.1.5, then the Zyxel Device will answer ARP requests coming from the WAN only if it contains 192.168.1.5 as the target IP address.
OK	Click OK to save your changes back to the Zyxel Device.
Cancel	Click Cancel to exit this screen without saving.

10.4.3 Virtual Interfaces

Use virtual interfaces to tell the Zyxel Device where to route packets. Virtual interfaces can also be used in VPN gateways (see [Chapter 30 on page 635](#)) and VRRP groups (see [Chapter 42 on page 812](#)).

Virtual interfaces can be created on top of Ethernet interfaces, VLAN interfaces, or bridge interfaces. Virtual VLAN interfaces recognize and use the same VLAN ID. Otherwise, there is no difference between each type of virtual interface. Network policies (for example, security policies) that apply to the underlying interface automatically apply to the virtual interface as well.

Like other interfaces, virtual interfaces have an IP address, subnet mask, and gateway used to make routing decisions. However, you have to manually specify the IP address and subnet mask; virtual interfaces cannot be DHCP clients. The virtual interface uses the same MTU and bandwidth settings that the underlying interface uses. Unlike other interfaces, virtual interfaces do not provide DHCP services, and they do not verify that the gateway is available.

This screen lets you configure IP address assignment and interface parameters for virtual interfaces. To access this screen, click the **Create Virtual Interface** icon in the Ethernet, VLAN, or bridge interface summary screen.

Figure 261 Configuration > Network > Interface > Create Virtual Interface

Each field is described in the table below.

Table 111 Configuration > Network > Interface > Create Virtual Interface

LABEL	DESCRIPTION
Interface Properties	
Interface Name	This field is read-only. It displays the name of the virtual interface, which is automatically derived from the underlying Ethernet interface, VLAN interface, or bridge interface.
Description	Enter a description of this interface. It is not used elsewhere. You can use alphanumeric and () + / : = ? ! * # @ \$ _ % - characters, and it can be up to 60 characters long.
IP Address Assignment	
IP Address	Enter the IP address for this interface.
Subnet Mask	Enter the subnet mask of this interface in dot decimal notation. The subnet mask indicates what part of the IP address is the same for all computers in the network.

Table 111 Configuration > Network > Interface > Create Virtual Interface (continued)

LABEL	DESCRIPTION
Gateway	Enter the IP address of the gateway. The Zyxel Device sends packets to the gateway when it does not know how to route the packet to its destination. The gateway should be on the same network as the interface.
Metric	Enter the priority of the gateway (if any) on this interface. The Zyxel Device decides which gateway to use based on this priority. The lower the number, the higher the priority. If two or more gateways have the same priority, the Zyxel Device uses the one that was configured first.
OK	Click OK to save your changes back to the Zyxel Device.
Cancel	Click Cancel to exit this screen without saving.

10.4.4 References

When a configuration screen includes a **References** icon, select a configuration object and click **References** to open the below screen. This screen displays which configuration settings reference the selected object. The fields shown vary with the type of object.

Figure 262 References

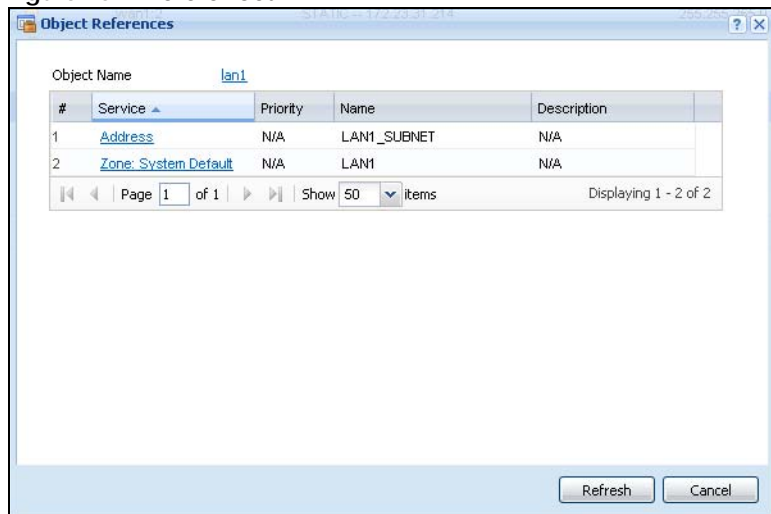

The following table describes labels that can appear in this screen.

Table 112 References

LABEL	DESCRIPTION
Object Name	This identifies the object for which the configuration settings that use it are displayed. Click the object's name to display the object's configuration screen in the main window.
#	This field is a sequential value, and it is not associated with any entry.
Service	This is the type of setting that references the selected object. Click a service's name to display the service's configuration screen in the main window.
Priority	If it is applicable, this field lists the referencing configuration item's position in its list, otherwise N/A displays.
Name	This field identifies the configuration item that references the object.
Description	If the referencing configuration item has a description configured, it displays here.
Refresh	Click this to update the information in this screen.
Cancel	Click Cancel to close the screen.

10.4.5 Add/Edit DHCPv6 Request/Release Options

When you configure an interface as a DHCPv6 server or client, you can additionally add DHCPv6 request or lease options which have the Zyxel Device to add more information in the DHCPv6 packets. To open the screen, click **Configuration > Network > Interface > Ethernet > Edit**, select **DHCPv6 Server** or **DHCPv6 Client** in the **DHCPv6 Setting** section, and then click **Add** in the **DHCPv6 Request Options** or **DHCPv6 Lease Options** table.

Figure 263 Configuration > Network > Interface > Ethernet > Edit > Add DHCPv6 Request/Lease Options

Select a DHCPv6 request or lease object in the **Select one object** field and click **OK** to save it. Click **Cancel** to exit without saving the setting.

10.4.6 Add/Edit DHCP Extended Options

When you configure an interface as a DHCPv4 server, you can additionally add DHCP extended options which have the Zyxel Device to add more information in the DHCP packets. The available fields vary depending on the DHCP option you select in this screen. To open the screen, click **Configuration > Network > Interface > Ethernet > Edit**, select **DHCP Server** in the **DHCP Setting** section, and then click **Add** or **Edit** in the **Extended Options** table.

Figure 264 Configuration > Network > Interface > Ethernet > Edit > Add/Edit Extended Options

The following table describes labels that can appear in this screen.

Table 113 Configuration > Network > Interface > Ethernet > Edit > Add/Edit Extended Options

LABEL	DESCRIPTION
Option	Select which DHCP option that you want to add in the DHCP packets sent through the interface. See the next table for more information.
Name	This field displays the name of the selected DHCP option. If you selected User Defined in the Option field, enter a descriptive name to identify the DHCP option. You can enter up to 16 characters ("a-z", "A-Z", "0-9", "-", and "_") with no spaces allowed. The first character must be alphabetical (a-z, A-Z).

Table 113 Configuration > Network > Interface > Ethernet > Edit > Add/Edit Extended Options

LABEL	DESCRIPTION
Code	This field displays the code number of the selected DHCP option. If you selected User Defined in the Option field, enter a number for the option. This field is mandatory.
Type	This is the type of the selected DHCP option. If you selected User Defined in the Option field, select an appropriate type for the value that you will enter in the next field. Only advanced users should configure User Defined . Misconfiguration could result in interface lockout.
Value	Enter the value for the selected DHCP option. For example, if you selected TFTP Server Name (66) and the type is TEXT , enter the DNS domain name of a TFTP server here. This field is mandatory.
First IP Address, Second IP Address, Third IP Address	If you selected Time Server (4) , NTP Server (41) , SIP Server (120) , CAPWAP AC (138) , or TFTP Server (150) , you have to enter at least one IP address of the corresponding servers in these fields. The servers should be listed in order of your preference.
First Enterprise ID, Second Enterprise ID	If you selected VIVC (124) or VIVS (125) , you have to enter at least one vendor's 32-bit enterprise number in these fields. An enterprise number is a unique number that identifies a company.
First Class, Second Class	If you selected VIVC (124) , enter the details of the hardware configuration of the host on which the client is running, or of industry consortium compliance.
First Information, Second Information	If you selected VIVS (125) , enter additional information for the corresponding enterprise number in these fields.
OK	Click this to close this screen and update the settings to the previous Edit screen.
Cancel	Click Cancel to close the screen.

The following table lists the available DHCP extended options (defined in RFCs) on the Zyxel Device. See RFCs for more information.

Table 114 DHCP Extended Options

OPTION NAME	CODE	DESCRIPTION
Time Offset	2	This option specifies the offset of the client's subnet in seconds from Coordinated Universal Time (UTC).
Time Server	4	This option specifies a list of Time servers available to the client.
NTP Server	42	This option specifies a list of the NTP servers available to the client by IP address.
TFTP Server Name	66	This option is used to identify a TFTP server when the "sname" field in the DHCP header has been used for DHCP options. The minimum length of the value is 1.
Bootfile	67	This option is used to identify a bootfile when the "file" field in the DHCP header has been used for DHCP options. The minimum length of the value is 1.
SIP Server	120	This option carries either an IPv4 address or a DNS domain name to be used by the SIP client to locate a SIP server.
VIVC	124	Vendor-Identifying Vendor Class option A DHCP client may use this option to unambiguously identify the vendor that manufactured the hardware on which the client is running, the software in use, or an industry consortium to which the vendor belongs.
VIVS	125	Vendor-Identifying Vendor-Specific option DHCP clients and servers may use this option to exchange vendor-specific information.

Table 114 DHCP Extended Options (continued)

OPTION NAME	CODE	DESCRIPTION
CAPWAP AC	138	CAPWAP Access Controller addresses option The Control And Provisioning of Wireless Access Points Protocol allows a Wireless Termination Point (WTP) to use DHCP to discover the Access Controllers to which it is to connect. This option carries a list of IPv4 addresses indicating one or more CAPWAP ACs available to the WTP.
TFTP Server	150	The option contains one or more IPv4 addresses that the client may use. The current use of this option is for downloading configuration from a VoIP server via TFTP; however, the option may be used for purposes other than contacting a VoIP configuration server.

10.5 PPP Interfaces

Use PPPoE/PPTP/L2TP interfaces to connect to your ISP. This way, you do not have to install or manage PPPoE/PPTP/L2TP software on each computer in the network.

Figure 265 Example: PPPoE/PPTP/L2TP Interfaces

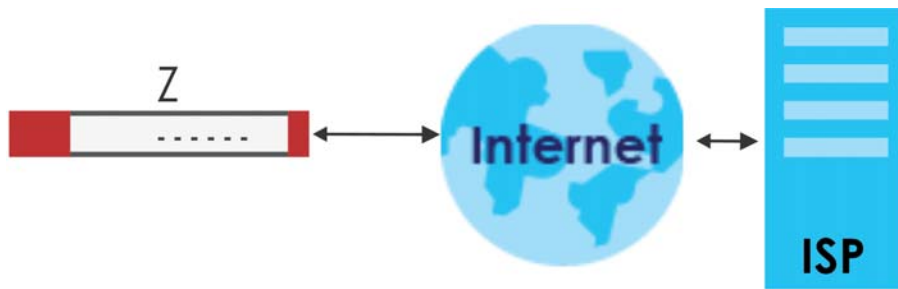

PPPoE/PPTP/L2TP interfaces are similar to other interfaces in some ways. They have an IP address, subnet mask, and gateway used to make routing decisions; they restrict bandwidth and packet size; and they can verify the gateway is available. There are two main differences between PPPoE/PPTP/L2TP interfaces and other interfaces.

- You must also configure an ISP account object for the PPPoE/PPTP/L2TP interface to use.
Each ISP account specifies the protocol (PPPoE or PPTP or L2TP), as well as your ISP account information. If you change ISPs later, you only have to create a new ISP account, not a new PPPoE/PPTP/L2TP interface. You should not have to change any network policies.
- You do not set up the subnet mask or gateway.
PPPoE/PPTP/L2TP interfaces are interfaces between the Zyxel Device and only one computer. Therefore, the subnet mask is always 255.255.255.255. In addition, the Zyxel Device always treats the ISP as a gateway.

10.5.1 PPP Interface Summary

This screen lists every PPPoE/PPTP/L2TP interface. To access this screen, click **Configuration > Network > Interface > PPP**.

Figure 266 Configuration > Network > Interface > PPP

#	Status	Name	Descri...	Base Interface	Account Profile
1		wan1_ppp		wan1	WAN1_PPPOE_ACCOUNT
2		wan2_ppp		wan2	WAN2_PPPOE_ACCOUNT
3		opt_ppp		opt	OPT_PPPOE_ACCOUNT

Each field is described in the table below.

Table 115 Configuration > Network > Interface > PPP

LABEL	DESCRIPTION
User Configuration / System Default	The Zyxel Device comes with the (non-removable) System Default PPP interfaces pre-configured. You can create (and delete) User Configuration PPP interfaces. System Default PPP interfaces vary by model.
Add	Click this to create a new user-configured PPP interface.
Edit	Double-click an entry or select it and click Edit to open a screen where you can modify the entry's settings.
Remove	To remove a user-configured PPP interface, select it and click Remove . The Zyxel Device confirms you want to remove it before doing so.
Activate	To turn on an entry, select it and click Activate .
Inactivate	To turn off an entry, select it and click Inactivate .
Connect	To connect an interface, select it and click Connect . You might use this in testing the interface or to manually establish the connection for a Dial-on-Demand PPPoE/PPTP interface.
Disconnect	To disconnect an interface, select it and click Disconnect . You might use this in testing the interface.
References	Select an entry and click References to open a screen that shows which settings use the entry. See Section 10.4.4 on page 350 for an example.
#	This field is a sequential value, and it is not associated with any interface.
Status	The activate (light bulb) icon is lit when the entry is active and dimmed when the entry is inactive. The connect icon is lit when the interface is connected and dimmed when it is disconnected.
Name	This field displays the name of the interface.
Description	This field displays the description of the interface.
Base Interface	This field displays the interface on the top of which the PPPoE/PPTP/L2TP interface is.

Table 115 Configuration > Network > Interface > PPP (continued)

LABEL	DESCRIPTION
Account Profile	This field displays the ISP account used by this PPPoE/PPTP interface.
Apply	Click Apply to save your changes back to the Zyxel Device.
Reset	Click Reset to return the screen to its last-saved settings.

10.5.2 PPP Interface Add or Edit

Note: You have to set up an ISP account before you create a PPPoE/PPTP/L2TP interface.

This screen lets you configure a PPPoE or PPTP or L2TP interface. If you enabled IPv6 in the **Configuration > System > IPv6** screen, you can also configure PPP interfaces used for your IPv6 networks on this screen. To access this screen, click the **Add** icon or an **Edit** icon in the PPP Interface screen.

Figure 267 Configuration > Network > Interface > PPP > Add

+ Add PPPoE/PPTP
? X

IPv4/IPv6 View Hide Advanced Settings Create new Object

General Settings

Enable Interface

General IPv6 Setting

Enable IPv6 i

Interface Properties

Interface Name: !

Base Interface: lan1 v

Zone: none v i

Description: (Optional)

Connectivity

Nailed-Up

Dial-on-Demand

ISP Setting

Account Profile: v

IP Address Assignment

Get Automatically 0.0.0.0

Use Fixed IP Address

IP Address:

Gateway: (Optional)

Metric: 0 (0-15)

IPv6 Address Assignment

Enable Stateless Address Auto-configuration (SLAAC)

Metric: (0-15)

Address from DHCPv6 Prefix Delegation

+ Add
✎ Edit
✖ Remove
Object References

#	Delegated Prefix	Suffix Address	Address
No data to display			

⏪
⏩
Page 1 of 1
Show 50 ns

DHCPv6 Setting

DHCPv6: Client v

Interface Parameters

Egress Bandwidth: 1048576 Kbps

Ingress Bandwidth: 1048576 Kbps

MTU: 1492 Bytes

Connectivity Check

Enable Connectivity Check

Check Method: tcp v

Check Period: 30 (5-600 seconds)

Check Timeout: 5 (1-10 seconds)

Check Fail Tolerance: 5 (1-10)

Check Default Gateway 0.0.0.0

Check this address (Domain Name or IP Address)

Check Port: 1 (1-65535)

Related Setting

[Configure WAN TRUNK](#)

[Configure Policy Route](#)

OK
Cancel

Each field is explained in the following table.

Table 116 Configuration > Network > Interface > PPP > Add

LABEL	DESCRIPTION
IPv4/IPv6 View / IPv4 View / IPv6 View	Use this button to display both IPv4 and IPv6, IPv4-only, or IPv6-only configuration fields.
Show Advanced Settings / Hide Advanced Settings	Click this button to display a greater or lesser number of configuration fields.
Create New Object	Click this button to create an ISP Account or a DHCPv6 request object that you may use for the ISP or DHCPv6 settings in this screen.
General Settings	
Enable Interface	Select this to enable this interface. Clear this to disable this interface.
General IPv6 Setting	
Enable IPv6	Select this to enable IPv6 on this interface. Otherwise, clear this to disable it.
Interface Properties	
Interface Name	Specify a name for the interface. It can use alphanumeric characters, hyphens, and underscores, and it can be up to 11 characters long.
Base Interface	Select the interface upon which this PPP interface is built. Note: Multiple PPP interfaces can use the same base interface.
Zone	Select the zone to which this PPP interface belongs. The zone determines the security settings the Zyxel Device uses for the interface.
Description	Enter a description of this interface. You can use alphanumeric and () + / : = ? ! * # @ \$ _ % - characters, and it can be up to 60 characters long. Spaces are allowed, but the string can't start with a space.
Connectivity	
Nailed-Up	Select this if the PPPoE/PPTP/L2TP connection should always be up. Clear this to have the Zyxel Device establish the PPPoE/PPTP/L2TP connection only when there is traffic. You might use this option if a lot of traffic needs to go through the interface or it does not cost extra to keep the connection up all the time.
Dial-on-Demand	Select this to have the Zyxel Device establish the PPPoE/PPTP/L2TP connection only when there is traffic. You might use this option if there is little traffic through the interface or if it costs money to keep the connection available.
ISP Setting	
Account Profile	Select the ISP account that this PPPoE/PPTP/L2TP interface uses. The drop-down box lists ISP accounts by name. Use Create new Object if you need to configure a new ISP account (see Chapter 43 on page 941 for details).
Protocol	This field is read-only. It displays the protocol specified in the ISP account.
User Name	This field is read-only. It displays the user name for the ISP account.
Service Name	This field is read-only. It displays the PPPoE service name specified in the ISP account. This field is blank if the ISP account uses PPTP.
IP Address Assignment	Click Show Advanced Settings to display more settings. Click Hide Advanced Settings to display fewer settings.
Get Automatically	Select this if this interface is a DHCP client. In this case, the DHCP server configures the IP address automatically. The subnet mask and gateway are always defined automatically in PPPoE/PPTP/L2TP interfaces.
Use Fixed IP Address	Select this if you want to specify the IP address manually.
IP Address	This field is enabled if you select Use Fixed IP Address . Enter the IP address for this interface.

Table 116 Configuration > Network > Interface > PPP > Add (continued)

LABEL	DESCRIPTION
Gateway	This field is enabled if you select Use Fixed IP Address. Enter the IP address of the gateway. The Zyxel Device sends packets to the gateway when it does not know how to route the packet to its destination. The gateway should be on the same network as the interface.
Metric	Enter the priority of the gateway (the ISP) on this interface. The Zyxel Device decides which gateway to use based on this priority. The lower the number, the higher the priority. If two or more gateways have the same priority, the Zyxel Device uses the one that was configured first.
IPv6 Address Assignment	These IP address fields configure an IPv6 IP address on the interface itself.
Enable Stateless Address Auto-configuration (SLAAC)	Select this to enable IPv6 stateless auto-configuration on this interface. The interface will generate an IPv6 IP address itself from a prefix obtained from an IPv6 router in the network.
Metric	Enter the priority of the gateway (if any) on this interface. The Zyxel Device decides which gateway to use based on this priority. The lower the number, the higher the priority. If two or more gateways have the same priority, the Zyxel Device uses the one that was configured first.
Address from DHCPv6 Prefix Delegation	Use this table to have the Zyxel Device obtain an IPv6 prefix from the ISP or a connected uplink router for an internal network, such as the LAN or DMZ. You have to also enter a suffix address which is appended to the delegated prefix to form an address for this interface. See Prefix Delegation on page 323 for more information. To use prefix delegation, you must: <ul style="list-style-type: none"> • Create at least one DHCPv6 request object before configuring this table. • The external interface must be a DHCPv6 client. You must configure the DHCPv6 request options using a DHCPv6 request object with the type of prefix-delegation. • Assign the prefix delegation to an internal interface and enable router advertisement on that interface.
Add	Click this to create an entry.
Edit	Select an entry and click this to change the settings.
Remove	Select an entry and click this to delete it from this table.
References	Select an entry and click References to open a screen that shows which settings use the entry.
#	This field is a sequential value, and it is not associated with any entry.
Delegated Prefix	Select the DHCPv6 request object to use from the drop-down list.
Suffix Address	Enter the ending part of the IPv6 address, a slash (/), and the prefix length. The Zyxel Device will append it to the delegated prefix. For example, you got a delegated prefix of 2003:1234:5678/48. You want to configure an IP address of 2003:1234:5678:1111::1/128 for this interface, then enter ::1111:0:0:0/128 in this field.
Address	This field displays the combined IPv6 IP address for this interface. Note: This field displays the combined address after you click OK and reopen this screen.
DHCPv6 Setting	
DHCPv6	Select Client to obtain an IP address and DNS information from the service provider for the interface. Otherwise, select N/A to disable the function.
Interface Parameters	
Egress Bandwidth	Enter the maximum amount of traffic, in kilobits per second, the Zyxel Device can send through the interface to the network. Allowed values are 0 - 1048576.

Table 116 Configuration > Network > Interface > PPP > Add (continued)

LABEL	DESCRIPTION
Ingress Bandwidth	This is reserved for future use. Enter the maximum amount of traffic, in kilobits per second, the Zyxel Device can receive from the network through the interface. Allowed values are 0 - 1048576.
MTU	Maximum Transmission Unit. Type the maximum size of each data packet, in bytes, that can move through this interface. If a larger packet arrives, the Zyxel Device divides it into smaller fragments. Allowed values are 576 - 1492. Usually, this value is 1492.
Connectivity Check	The interface can regularly check the connection to the gateway you specified to make sure it is still available. You specify how often the interface checks the connection, how long to wait for a response before the attempt is a failure, and how many consecutive failures are required before the Zyxel Device stops routing to the gateway. The Zyxel Device resumes routing to the gateway the first time the gateway passes the connectivity check.
Enable Connectivity Check	Select this to turn on the connection check.
Check Method	Select the method that the gateway allows. Select icmp to have the Zyxel Device regularly ping the gateway you specify to make sure it is still available. Select tcp to have the Zyxel Device regularly perform a TCP handshake with the gateway you specify to make sure it is still available.
Check Period	Enter the number of seconds between connection check attempts.
Check Timeout	Enter the number of seconds to wait for a response before the attempt is a failure.
Check Fail Tolerance	Enter the number of consecutive failures before the Zyxel Device stops routing through the gateway.
Check Default Gateway	Select this to use the default gateway for the connectivity check.
Check this address	Select this to specify a domain name or IP address for the connectivity check. Enter that domain name or IP address in the field next to it.
Check Port	This field only displays when you set the Check Method to tcp . Specify the port number to use for a TCP connectivity check.
Related Setting	
Configure WAN TRUNK	Click WAN TRUNK to go to a screen where you can configure the interface as part of a WAN trunk for load balancing.
Policy Route	Click Policy Route to go to the screen where you can manually configure a policy route to associate traffic with this interface.
OK	Click OK to save your changes back to the Zyxel Device.
Cancel	Click Cancel to exit this screen without saving.

10.6 Cellular Configuration Screen

Mobile broadband is a digital, packet-switched wireless technology. Bandwidth usage is optimized as multiple users share the same channel and bandwidth is only allocated to users when they send data. It allows fast transfer of voice and non-voice data and provides broadband Internet access to mobile devices.

Note: The actual data rate you obtain varies depending on the mobile broadband device you use, the signal strength to the service provider's base station, and so on.

You can configure how the Zyxel Device's mobile broadband device connects to a network (refer to [Section 10.6.1 on page 363](#)):

- You can set the mobile broadband device to connect only to the home network, which is the network to which you are originally subscribed.
- You can set the mobile broadband device to connect to other networks if the signal strength of the home network is too low or it is unavailable.

3G

3G (Third Generation) is a digital, packet-switched wireless technology. Bandwidth usage is optimized as multiple users share the same channel and bandwidth is only allocated to users when they send data. It allows fast transfer of voice and non-voice data and provides broadband Internet access to mobile devices.

4G

4G is the fourth generation of the mobile telecommunications technology and a successor of 3G. Both the WiMAX and Long Term Evolution (LTE) standards are the 4G candidate systems. 4G only supports all-IP-based packet-switched telephony services and is required to offer Gigabit speed access.

Note: The actual data rate you obtain varies depending on your mobile environment. The environmental factors may include the number of mobile devices which are currently connected to the mobile network, the signal strength to the mobile network, and so on.

See the following table for a comparison between 2G, 2.5G, 2.75G, 3G and 4G wireless technologies.

Table 117 2G, 2.5G, 2.75G, 3G, 3.5G and 4G Wireless Technologies

NAME	TYPE	MOBILE PHONE AND DATA STANDARDS		DATA SPEED
		GSM-BASED	CDMA-BASED	
2G	Circuit-switched	GSM (Global System for Mobile Communications), Personal Handy-phone System (PHS), etc.	Interim Standard 95 (IS-95), the first CDMA-based digital cellular standard pioneered by Qualcomm. The brand name for IS-95 is cdmaOne. IS-95 is also known as TIA-EIA-95.	
2.5G	Packet-switched	GPRS (General Packet Radio Services), High-Speed Circuit-Switched Data (HSCSD), etc.	CDMA2000 is a hybrid 2.5G / 3G protocol of mobile telecommunications standards that use CDMA, a multiple access scheme for digital radio.	
2.75G	Packet-switched	Enhanced Data rates for GSM Evolution (EDGE), Enhanced GPRS (EGPRS), etc.	CDMA2000 1xRTT (1 times Radio Transmission Technology) is the core CDMA2000 wireless air interface standard. It is also known as 1x, 1xRTT, or IS-2000 and considered to be a 2.5G or 2.75G technology.	
3G	Packet-switched	UMTS (Universal Mobile Telecommunications System), a third-generation (3G) wireless standard defined in ITU specification, is sometimes marketed as 3GSM. The UMTS uses GSM infrastructures and W-CDMA (Wideband Code Division Multiple Access) as the air interface. The International Telecommunication Union (ITU) is an international organization within which governments and the private sector coordinate global telecom networks and services.	CDMA2000 EV-DO (Evolution-Data Optimized, originally 1x Evolution-Data Only), also referred to as EV-DO, EVDO, or just EV, is an evolution of CDMA2000 1xRTT and enables high-speed wireless connectivity. It is also denoted as IS-856 or High Data Rate (HDR).	
3.5G	Packet-switched	HSDPA (High-Speed Downlink Packet Access) is a mobile telephony protocol, used for UMTS-based 3G networks and allows for higher data transfer speeds.		
4G/LTE	Packet-switched	The LTE (Long Term Evolution) standard is based on the GSM and UMTS network technologies.		

To change your mobile broadband WAN settings, click **Configuration > Network > Interface > Cellular**.

Note: Install (or connect) a compatible mobile broadband USB device to use a cellular connection.

Note: The WAN IP addresses of a Zyxel Device with multiple WAN interfaces must be on different subnets.

Figure 268 Configuration > Network > Interface > Cellular

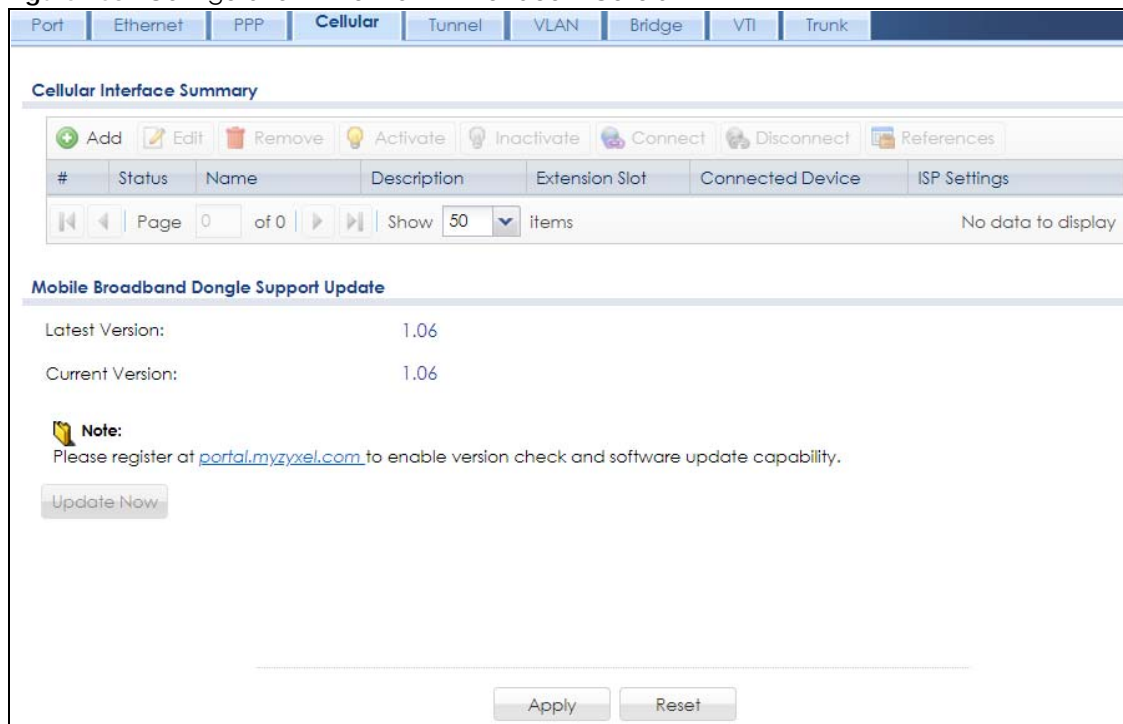

The following table describes the labels in this screen.

Table 118 Configuration > Network > Interface > Cellular

LABEL	DESCRIPTION
Add	Click this to create a new cellular interface.
Edit	Double-click an entry or select it and click Edit to open a screen where you can modify the entry's settings.
Remove	To remove an entry, select it and click Remove . The Zyxel Device confirms you want to remove it before doing so.
Activate	To turn on an entry, select it and click Activate .
Inactivate	To turn off an entry, select it and click Inactivate .
Connect	To connect an interface, select it and click Connect . You might use this in testing the interface or to manually establish the connection.
Disconnect	To disconnect an interface, select it and click Disconnect . You might use this in testing the interface.
References	Select an entry and click References to open a screen that shows which settings use the entry. See Section 10.4.4 on page 350 for an example.
#	This field is a sequential value, and it is not associated with any interface.
Status	The activate (light bulb) icon is lit when the entry is active and dimmed when the entry is inactive. The connect icon is lit when the interface is connected and dimmed when it is disconnected.
Name	This field displays the name of the interface.
Description	This field displays the description of the interface.
Extension Slot	This field displays where the entry's cellular card is located.
Connected Device	This field displays the name of the cellular card.

Table 118 Configuration > Network > Interface > Cellular (continued)

LABEL	DESCRIPTION
ISP Settings	This field displays the profile of ISP settings that this cellular interface is set to use.
Mobile Broadband Dongle Support	You should have registered your Zyxel Device at myZyxel. myZyxel hosts a list of supported mobile broadband dongle devices. You should have an Internet connection to access this website.
Latest Version	This displays the latest supported mobile broadband dongle list version number.
Current Version	This displays the currently supported (by the Zyxel Device) mobile broadband dongle list version number.
Update Now	If the latest version number is greater than the current version number, then click this button to download the latest list of supported mobile broadband dongle devices to the Zyxel Device.
Apply	Click Apply to save your changes back to the Zyxel Device.
Reset	Click Reset to return the screen to its last-saved settings.

10.6.1 Cellular Choose Slot

To change your mobile broadband settings, click **Configuration > Network > Interface > Cellular > Add** (or **Edit**). In the pop-up window that displays, select the slot that contains the mobile broadband device, then the **Add Cellular configuration** screen displays.



10.6.2 Add / Edit Cellular Configuration

This screen displays after you select the slot that contains the mobile broadband device in the previous pop-up window.

Figure 269 Configuration > Network > Interface > Cellular > Add / Edit

Edit Cellular configuration

Hide Advanced Settings

General Settings

Enable Interface

Interface Properties

Interface Name: cellular1

Zone: none ?

Extension Slot: USB 1

Connected Device: Huawei E398/E3276 LTE

Description: (Optional)

Connectivity

Nailed-Up

Idle timeout: seconds

ISP Settings

Profile Selection: Device Custom

Profile 1

APN:

Dial String: *99***1#

SIM Card Setting

PIN Code:

Retype to Confirm:

Interface Parameters

Egress Bandwidth: Kbps

Ingress Bandwidth: Kbps

MTU: Bytes

Connectivity Check

Enable Connectivity Check

Check Method: icmp

Check Period: (5-600 seconds)

Check Timeout: (1-10 seconds)

Check Fail Tolerance: (1-10)

Check Default Gateway 0.0.0.0

Check this address (Domain Name or IP Address)

Related Setting

[Configure WAN TRUNK](#)

[Configure Policy Route](#)

IP Address

Get Automatically 0.0.0.0

Use Fixed IP Address

IP Address Assignment:

Metric: (0-15)

Device Settings

Network Selection: auto

Budget Setup

Enable Budget Control

Time Budget: hours per month

Data Budget: Mbytes per month

Reset time and data budget counters on: day of each month

Actions when over budget

Log: None

New connection: Allow

Current connection: Keep

Actions when over % of time budget or % of data budget

Log: None

The following table describes the labels in this screen.

Table 119 Configuration > Network > Interface > Cellular > Add / Edit

LABEL	DESCRIPTION
Show Advanced Settings / Hide Advanced Settings	Click this button to display a greater or lesser number of configuration fields.
General Settings	
Enable Interface	Select this option to turn on this interface.
Interface Properties	
Interface Name	Select a name for the interface.
Zone	Select the zone to which you want the cellular interface to belong. The zone determines the security settings the Zyxel Device uses for the interface.
Extension Slot	This is the USB slot that you are configuring for use with a mobile broadband card.
Connected Device	This displays the manufacturer and model name of your mobile broadband card if you inserted one in the Zyxel Device. Otherwise, it displays none .
Description	Enter a description of this interface. You can use alphanumeric and () + / : = ? ! * # @ \$ % _ - characters, and it can be up to 60 characters long. Spaces are allowed, but the string can't start with a space.
Connectivity	
Nailed-Up	Select this if the connection should always be up. Clear this to have the Zyxel Device to establish the connection only when there is traffic. You might not nail up the connection if there is little traffic through the interface or if it costs money to keep the connection available.
Idle timeout	This value specifies the time in seconds (0~360) that elapses before the Zyxel Device automatically disconnects from the ISP's server. Zero disables the idle timeout.
ISP Settings	
Profile Selection	Select Device to use one of the mobile broadband device's profiles of device settings. Then select the profile (use Profile 1 unless your ISP instructed you to do otherwise). Select Custom to configure your device settings yourself.
APN	This field is read-only if you selected Device in the profile selection. Select Custom in the profile selection to be able to manually input the APN (Access Point Name) provided by your service provider. This field applies with a GSM or HSDPA mobile broadband card. Enter the APN from your service provider. Connections with different APNs may provide different services (such as Internet access or MMS (Multi-Media Messaging Service)) and charge method. You can enter up to 63 ASCII printable characters. Spaces are allowed.
Dial String	Enter the dial string if your ISP provides a string, which would include the APN, to initialize the mobile broadband card. You can enter up to 63 ASCII printable characters. Spaces are allowed. This field is available only when you insert a GSM mobile broadband card.
Authentication Type	The Zyxel Device supports PAP (Password Authentication Protocol) and CHAP (Challenge Handshake Authentication Protocol). CHAP is more secure than PAP; however, PAP is readily available on more platforms. Use the drop-down list box to select an authentication protocol for outgoing calls. Options are: None: No authentication for outgoing calls. CHAP - Your Zyxel Device accepts CHAP requests only. PAP - Your Zyxel Device accepts PAP requests only.

Table 119 Configuration > Network > Interface > Cellular > Add / Edit (continued)

LABEL	DESCRIPTION
User Name	<p>This field displays when you select an authentication type other than None. This field is read-only if you selected Device in the profile selection. If this field is configurable, enter the user name for this mobile broadband card exactly as the service provider gave it to you.</p> <p>You can use 1 ~ 64 alphanumeric and # : % - _ @ \$. / characters. The first character must be alphanumeric or - _ @ \$. / . Spaces are not allowed.</p>
Password	<p>This field displays when you select an authentication type other than None. This field is read-only if you selected Device in the profile selection and the password is included in the mobile broadband card's profile. If this field is configurable, enter the password for this SIM card exactly as the service provider gave it to you.</p> <p>You can use 0 ~ 63 alphanumeric and ~ ! @ # \$ % ^ & * () _ - + = { } ; : ' < , > . / characters. Spaces are not allowed.</p>
Retype to Confirm	<p>This field displays when you select an authentication type other than None. This field is read-only if you selected Device in the profile selection and the password is included in the mobile broadband card's profile. If this field is configurable, re-enter the password for this SIM card exactly as the service provider gave it to you.</p>
SIM Card Setting	
PIN Code	<p>This field displays with a GSM or HSDPA mobile broadband card. A PIN (Personal Identification Number) code is a key to a mobile broadband card. Without the PIN code, you cannot use the mobile broadband card.</p> <p>Enter the 4-digit PIN code (0000 for example) provided by your ISP. If you enter the PIN code incorrectly, the mobile broadband card may be blocked by your ISP and you cannot use the account to access the Internet.</p> <p>If your ISP disabled PIN code authentication, enter an arbitrary number.</p>
Retype to Confirm	Type the PIN code again to confirm it.
Interface Parameters	
Egress Bandwidth	Enter the maximum amount of traffic, in kilobits per second, the Zyxel Device can send through the interface to the network. Allowed values are 0 - 1048576. This setting is used in WAN load balancing and bandwidth management.
Ingress Bandwidth	<p>This is reserved for future use.</p> <p>Enter the maximum amount of traffic, in kilobits per second, the Zyxel Device can receive from the network through the interface. Allowed values are 0 - 1048576.</p>
MTU	Maximum Transmission Unit. Type the maximum size of each data packet, in bytes, that can move through this interface. If a larger packet arrives, the Zyxel Device divides it into smaller fragments. Allowed values are 576 - 1492. Usually, this value is 1492.
Connectivity Check	The interface can regularly check the connection to the gateway you specified to make sure it is still available. You specify how often the interface checks the connection, how long to wait for a response before the attempt is a failure, and how many consecutive failures are required before the Zyxel Device stops routing to the gateway. The Zyxel Device resumes routing to the gateway the first time the gateway passes the connectivity check.
Enable Connectivity Check	Select this to turn on the connection check.
Check Method	<p>Select the method that the gateway allows.</p> <p>Select icmp to have the Zyxel Device regularly ping the gateway you specify to make sure it is still available.</p> <p>Select tcp to have the Zyxel Device regularly perform a TCP handshake with the gateway you specify to make sure it is still available.</p>

Table 119 Configuration > Network > Interface > Cellular > Add / Edit (continued)

LABEL	DESCRIPTION
Check Period	Enter the number of seconds between connection check attempts.
Check Timeout	Enter the number of seconds to wait for a response before the attempt is a failure.
Check Fail Tolerance	Enter the number of consecutive failures before the Zyxel Device stops routing through the gateway.
Check Default Gateway	Select this to use the default gateway for the connectivity check.
Check this address	Select this to specify a domain name or IP address for the connectivity check. Enter that domain name or IP address in the field next to it.
Check Port	This field only displays when you set the Check Method to tcp . Specify the port number to use for a TCP connectivity check.
Related Setting	
Configure WAN TRUNK	Click WAN TRUNK to go to a screen where you can configure the interface as part of a WAN trunk for load balancing.
Configure Policy Route	Click Policy Route to go to the policy route summary screen where you can configure a policy route to override the default routing and SNAT behavior for the interface.
IP Address Assignment	
Get Automatically	Select this option If your ISP did not assign you a fixed IP address. This is the default selection.
Use Fixed IP Address	Select this option If the ISP assigned a fixed IP address.
IP Address Assignment	Enter the cellular interface's WAN IP address in this field if you selected Use Fixed IP Address .
Metric	Enter the priority of the gateway (if any) on this interface. The Zyxel Device decides which gateway to use based on this priority. The lower the number, the higher the priority. If two or more gateways have the same priority, the Zyxel Device uses the one that was configured first.
Device Settings	
Band Selection	<p>This field appears if you selected a mobile broadband device that allows you to select the type of network to use. Select the type of mobile broadband service for your mobile broadband connection. If you are unsure what to select, check with your mobile broadband service provider to find the mobile broadband service available to you in your region.</p> <p>Select auto to have the card connect to an available network. Choose this option if you do not know what networks are available.</p> <p>You may want to manually specify the type of network to use if you are charged differently for different types of network or you only have one type of network available to you.</p> <p>Select GPRS / EDGE (GSM) only to have this interface only use a 2.5G or 2.75G network (respectively). If you only have a GSM network available to you, you may want to select this so the Zyxel Device does not spend time looking for a WCDMA network.</p> <p>Select UMTS / HSDPA (WCDMA) only to have this interface only use a 3G or 3.5G network (respectively). You may want to do this if you want to make sure the interface does not use the GSM network.</p> <p>Select LTE only to have this interface only use a 4G LTE network. This option only appears when a USG dongle for 4G technology is inserted.</p>

Table 119 Configuration > Network > Interface > Cellular > Add / Edit (continued)

LABEL	DESCRIPTION
Network Selection	<p>Home network is the network to which you are originally subscribed.</p> <p>Select Home to have the mobile broadband device connect only to the home network. If the home network is down, the Zyxel Device's mobile broadband Internet connection is also unavailable.</p> <p>Select Auto (Default) to allow the mobile broadband device to connect to a network to which you are not subscribed when necessary, for example when the home network is down or another mobile broadband base station's signal is stronger. This is recommended if you need continuous Internet connectivity. If you select this, you may be charged using the rate of a different network.</p>
Budget Setup	
Enable Budget Control	<p>Select this to set a monthly limit for the user account of the installed mobile broadband card. You can set a limit on the total traffic and/or call time. The Zyxel Device takes the actions you specified when a limit is exceeded during the month.</p>
Time Budget	<p>Select this and specify the amount of time (in hours) that the mobile broadband connection can be used within one month. If you change the value after you configure and enable budget control, the Zyxel Device resets the statistics.</p>
Data Budget	<p>Select this and specify how much downstream and/or upstream data (in Mega bytes) can be transmitted via the mobile broadband connection within one month.</p> <p>Select Download to set a limit on the downstream traffic (from the ISP to the Zyxel Device).</p> <p>Select Upload to set a limit on the upstream traffic (from the Zyxel Device to the ISP).</p> <p>Select Download/Upload to set a limit on the total traffic in both directions.</p> <p>If you change the value after you configure and enable budget control, the Zyxel Device resets the statistics.</p>
Reset time and data budget counters on	<p>Select the date on which the Zyxel Device resets the budget every month. If the date you selected is not available in a month, such as 30th or 31st, the Zyxel Device resets the budget on the last day of the month.</p>
Reset time and data budget counters	<p>This button is available only when you enable budget control in this screen.</p> <p>Click this button to reset the time and data budgets immediately. The count starts over with the mobile broadband connection's full configured monthly time and data budgets. This does not affect the normal monthly budget restart; so if you configured the time and data budget counters to reset on the second day of the month and you use this button on the first, the time and data budget counters will still reset on the second.</p>
Actions when over budget	<p>Specify the actions the Zyxel Device takes when the time or data limit is exceeded.</p>
Log	<p>Select None to not create a log, Log to create a log, or Log-alert to create an alert log. If you select Log or Log-alert you can also select recurring every to have the Zyxel Device send a log or alert for this event periodically. Specify how often (from 1 to 65535 minutes) to send the log or alert.</p>
New connection	<p>Select Allow to permit new mobile broadband connections or Disallow to drop/block new mobile broadband connections.</p>
Current connection	<p>Select Keep to maintain an existing mobile broadband connection or Drop to disconnect it. You cannot set New connection to Allow and Current connection to Drop at the same time.</p> <p>If you set New connection to Disallow and Current connection to Keep, the Zyxel Device allows you to transmit data using the current connection, but you cannot build a new connection if the existing connection is disconnected.</p>
Actions when over % of time budget or % of data budget	<p>Specify the actions the Zyxel Device takes when the specified percentage of time budget or data limit is exceeded. Enter a number from 1 to 99 in the percentage fields. If you change the value after you configure and enable budget control, the Zyxel Device resets the statistics.</p>

Table 119 Configuration > Network > Interface > Cellular > Add / Edit (continued)

LABEL	DESCRIPTION
Log	Select None to not create a log when the Zyxel Device takes this action, Log to create a log, or Log-alert to create an alert log. If you select Log or Log-alert you can also select recurring every to have the Zyxel Device send a log or alert for this event periodically. Specify how often (from 1 to 65535 minutes) to send the log or alert.
OK	Click OK to save your changes back to the Zyxel Device.
Cancel	Click Cancel to exit this screen without saving.

10.7 Tunnel Interfaces

The Zyxel Device uses tunnel interfaces in Generic Routing Encapsulation (GRE), IPv6 in IPv4, and 6to4 tunnels.

GRE Tunneling

GRE tunnels encapsulate a wide variety of network layer protocol packet types inside IP tunnels. A GRE tunnel serves as a virtual point-to-point link between the Zyxel Device and another router over an IPv4 network. At the time of writing, the Zyxel Device only supports GRE tunneling in IPv4 networks.

Figure 270 GRE Tunnel Example

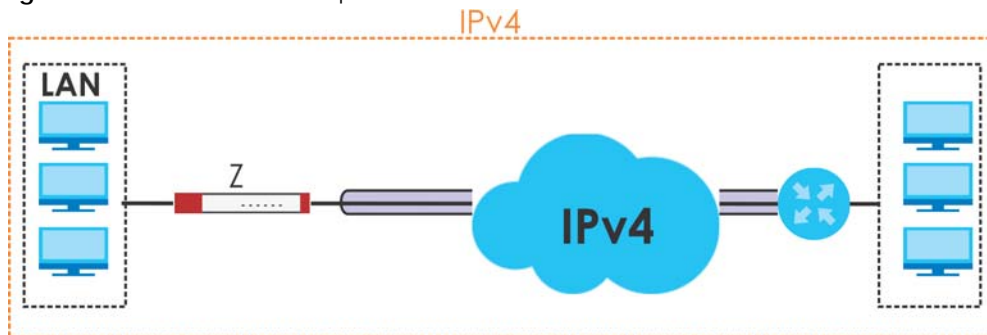

IPv6 Over IPv4 Tunnels

To route traffic between two IPv6 networks over an IPv4 network, an IPv6 over IPv4 tunnel has to be used.

Figure 271 IPv6 over IPv4 Network



On the Zyxel Device, you can either set up a manual IPv6-in-IPv4 tunnel or an automatic 6to4 tunnel. The following describes each method:

IPv6-in-IPv4 Tunneling

Use this mode on the WAN of the Zyxel Device if

- your Zyxel Device has a public IPv4 IP address given from your ISP,

and

- you want to transmit your IPv6 packets to one and only one remote site whose LAN network is also an IPv6 network.

With this mode, the Zyxel Device encapsulates IPv6 packets within IPv4 packets across the Internet. You must know the WAN IP address of the remote gateway device. This mode is normally used for a site-to-site application such as two branch offices.

Figure 272 IPv6-in-IPv4 Tunnel

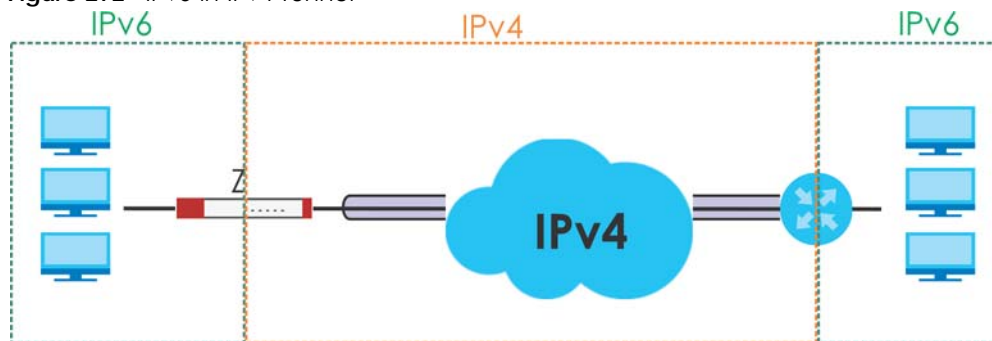

In the Zyxel Device, you must also manually configure a policy route for an IPv6-in-IPv4 tunnel to make the tunnel work.

6to4 Tunneling

This mode also enables IPv6 packets to cross IPv4 networks. Unlike IPv6-in-IPv4 tunneling, you do not need to configure a policy route for a 6to4 tunnel. Through your properly pre-configuring the destination router's IP address in the IP address assignments to hosts, the Zyxel Device can automatically forward 6to4 packets to the destination they want to go. A 6to4 relay router is required to route 6to4 packets to a native IPv6 network if the packet's destination do not match your specified criteria.

In this mode, the Zyxel Device should get a public IPv4 address for the WAN. The Zyxel Device adds an IPv4 IP header to an IPv6 packet when transmitting the packet to the Internet. In reverse, the Zyxel Device removes the IPv4 header from an IPv6 packet when receiving it from the Internet.

An IPv6 address using the 6to4 mode consists of an IPv4 address, the format is as the following:

```
2002:[a public IPv4 address in hexadecimal]::/48
```

For example, a public IPv4 address is 202.156.30.41. The converted hexadecimal IP string is ca.9c.1Ee.29. The IPv6 address prefix becomes 2002:ca9c:1e29::/48.

Figure 273 6to4 Tunnel

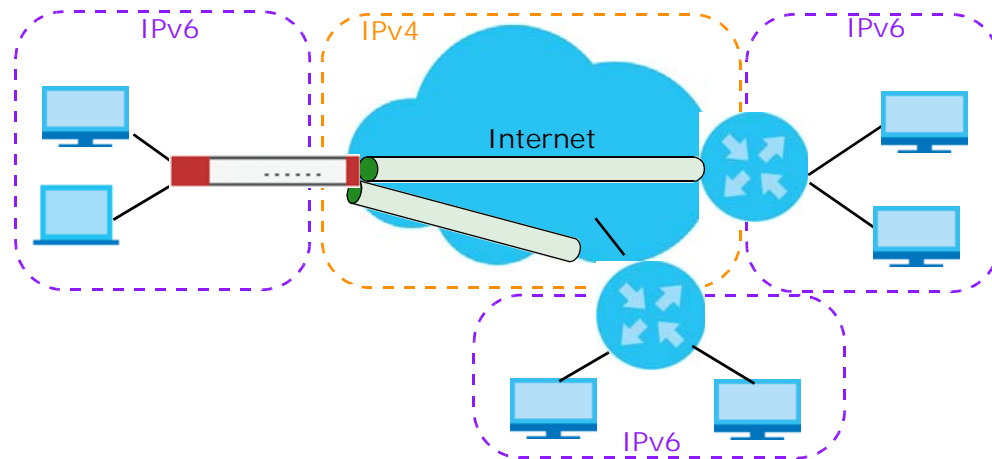

10.7.1 Configuring a Tunnel

This screen lists the Zykel Device's configured tunnel interfaces. To access this screen, click **Network > Interface > Tunnel**.

Figure 274 Network > Interface > Tunnel

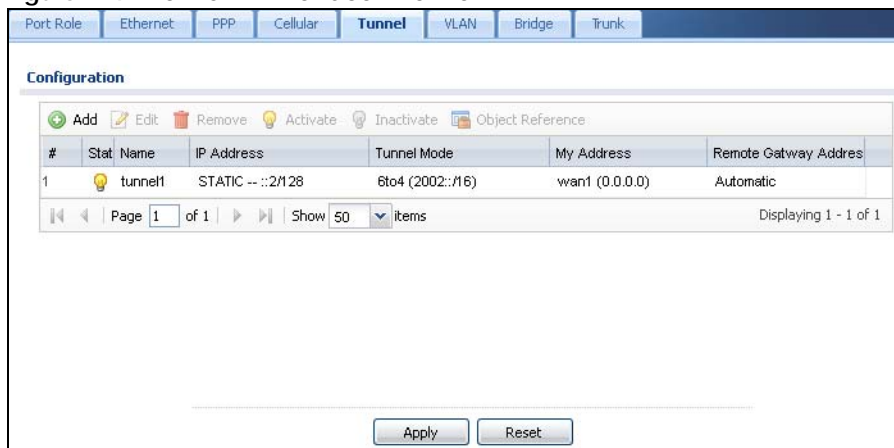

Each field is explained in the following table.

Table 120 Network > Interface > Tunnel

LABEL	DESCRIPTION
Add	Click this to create a new GRE tunnel interface.
Edit	Double-click an entry or select it and click Edit to open a screen where you can modify the entry's settings.
Remove	To remove an entry, select it and click Remove . The Zykel Device confirms you want to remove it before doing so.
Activate	To turn on an entry, select it and click Activate .
Inactivate	To turn off an entry, select it and click Inactivate .
References	Select an entry and click References to open a screen that shows which settings use the entry. See Section 10.4.4 on page 350 for an example.
#	This field is a sequential value, and it is not associated with any interface.

Table 120 Network > Interface > Tunnel (continued)

LABEL	DESCRIPTION
Status	The activate (light bulb) icon is lit when the entry is active and dimmed when the entry is inactive.
Name	This field displays the name of the interface.
IP Address	This is the IP address of the interface. If the interface is active (and connected), the Zyxel Device tunnels local traffic sent to this IP address to the Remote Gateway Address .
Tunnel Mode	This is the tunnel mode of the interface (GRE, IPv6-in-IPv4 or 6to4). This field also displays the interface's IPv4 IP address and subnet mask if it is a GRE tunnel. Otherwise, it displays the interface's IPv6 IP address and prefix length.
My Address	This is the interface or IP address uses to identify itself to the remote gateway. The Zyxel Device uses this as the source for the packets it tunnels to the remote gateway.
Remote Gateway Address	This is the IP address or domain name of the remote gateway to which this interface tunnels traffic.
Apply	Click Apply to save your changes back to the Zyxel Device.
Reset	Click Reset to begin configuring this screen afresh.

10.7.2 Tunnel Add or Edit Screen

This screen lets you configure a tunnel interface. Click **Configuration > Network > Interface > Tunnel > Add (or Edit)** to open the following screen.

Figure 275 Network > Interface > Tunnel > Add/Edit

Each field is explained in the following table.

Table 121 Network > Interface > Tunnel > Add/Edit

LABEL	DESCRIPTION
Show Advanced Settings / Hide Advanced Settings	Click this button to display a greater or lesser number of configuration fields.
General Settings	
Enable	Select this to enable this interface. Clear this to disable this interface.
Interface Properties	
Interface Name	This field is read-only if you are editing an existing tunnel interface. Enter the name of the tunnel interface. The format is tunnelx, where x is 0 - 3. For example, tunnel0.

Table 121 Network > Interface > Tunnel > Add/Edit (continued)

LABEL	DESCRIPTION
Zone	Use this field to select the zone to which this interface belongs. This controls what security settings the Zyxel Device applies to this interface.
Tunnel Mode	Select the tunneling protocol of the interface (GRE , IPv6-in-IPv4 or 6to4). See Section 10.7 on page 369 for more information.
IP Address Assignment	This section is available if you are configuring a GRE tunnel.
IP Address	Enter the IP address for this interface.
Subnet Mask	Enter the subnet mask of this interface in dot decimal notation. The subnet mask indicates what part of the IP address is the same for all computers in the network.
Metric	Enter the priority of the gateway (if any) on this interface. The Zyxel Device decides which gateway to use based on this priority. The lower the number, the higher the priority. If two or more gateways have the same priority, the Zyxel Device uses the one that was configured first.
IPv6 Address Assignment	This section is available if you are configuring an IPv6-in-IPv4 or a 6to4 tunnel.
IPv6 Address/ Prefix Length	Enter the IPv6 address and the prefix length for this interface if you want to use a static IP address. This field is optional. The prefix length indicates what the left-most part of the IP address is the same for all computers in the network, that is, the network address.
Metric	Enter the priority of the gateway (if any) on this interface. The Zyxel Device decides which gateway to use based on this priority. The lower the number, the higher the priority. If two or more gateways have the same priority, the Zyxel Device uses the one that was configured first.
6to4 Tunnel Parameter	This section is available if you are configuring a 6to4 tunnel which encapsulates IPv6 to IPv4 packets.
6to4 Prefix	Enter the IPv6 prefix of a destination network. The Zyxel Device forwards IPv6 packets to the hosts in the matched network. If you enter a prefix starting with 2002, the Zyxel Device will forward the matched packets to the IPv4 IP address converted from the packets' destination address. The IPv4 IP address can be converted from the next 32 bits after the prefix you specified in this field. See 6to4 Tunneling on page 370 for an example. The Zyxel Device forwards the unmatched packets to the specified Relay Router .
Relay Router	Enter the IPv4 address of a 6to4 relay router which helps forward packets between 6to4 networks and native IPv6 networks.
Remote Gateway Prefix	Enter the IPv4 network address and network bits of a remote 6to4 gateway, for example, 14.15.0.0/16. This field works if you enter a 6to4 Prefix not starting with 2002 (2003 for example). The Zyxel Device forwards the matched packets to a remote gateway with the network address you specify here, and the bits converted after the 6to4 Prefix in the packets. For example, you configure the 6to4 prefix to 2003:A0B::/32 and the remote gateway prefix to 14.15.0.0/16. If a packet's destination is 2003:A0B:1011:5::8, the Zyxel Device forwards the packet to 14.15.16.17, where the network address is 14.15.0.0 and the host address is the remain bits converted from 1011 after the packet's 6to4 prefix (2003:A0B).
Gateway Settings	
My Address	Specify the interface or IP address to use as the source address for the packets this interface tunnels to the remote gateway. The remote gateway sends traffic to this interface or IP address.

Table 121 Network > Interface > Tunnel > Add/Edit (continued)

LABEL	DESCRIPTION
Remote Gateway Address	Enter the IP address or domain name of the remote gateway to which this interface tunnels traffic. Automatic displays in this field if you are configuring a 6to4 tunnel. It means the 6to4 tunnel will help forward packets to the corresponding remote gateway automatically by looking at the packet's destination address.
Interface Parameters	
Egress Bandwidth	Enter the maximum amount of traffic, in kilobits per second, the Zyxel Device can send through the interface to the network. Allowed values are 0 - 1048576. This setting is used in WAN load balancing and bandwidth management.
Ingress Bandwidth	This is reserved for future use. Enter the maximum amount of traffic, in kilobits per second, the Zyxel Device can receive from the network through the interface. Allowed values are 0 - 1048576.
MTU	Maximum Transmission Unit. Type the maximum size of each data packet, in bytes, that can move through this interface. If a larger packet arrives, the Zyxel Device divides it into smaller fragments. Allowed values are 576 - 1500. Usually, this value is 1500.
Connectivity Check	This section is available if you are configuring a GRE tunnel. The interface can regularly check the connection to the gateway you specified to make sure it is still available. You specify how often the interface checks the connection, how long to wait for a response before the attempt is a failure, and how many consecutive failures are required before the Zyxel Device stops routing to the gateway. The Zyxel Device resumes routing to the gateway the first time the gateway passes the connectivity check.
Enable Connectivity Check	Select this to turn on the connection check.
Check Method	Select the method that the gateway allows. Select icmp to have the Zyxel Device regularly ping the gateway you specify to make sure it is still available. Select tcp to have the Zyxel Device regularly perform a TCP handshake with the gateway you specify to make sure it is still available.
Check Period	Enter the number of seconds between connection check attempts.
Check Timeout	Enter the number of seconds to wait for a response before the attempt is a failure.
Check Fail Tolerance	Enter the number of consecutive failures before the Zyxel Device stops routing through the gateway.
Check Default Gateway	Select this to use the default gateway for the connectivity check.
Check this address	Select this to specify a domain name or IP address for the connectivity check. Enter that domain name or IP address in the field next to it.
Check Port	This field displays when you set the Check Method to tcp . Specify the port number to use for a TCP connectivity check.
Related Setting	
WAN TRUNK	Click this link to go to a screen where you can configure WAN trunk load balancing.
Policy Route	Click this link to go to the screen where you can manually configure a policy route to associate traffic with this interface.
OK	Click OK to save your changes back to the Zyxel Device.
Cancel	Click Cancel to exit this screen without saving.

10.8 VLAN Interfaces

A Virtual Local Area Network (VLAN) divides a physical network into multiple logical networks. The standard is defined in IEEE 802.1q.

Figure 276 Example: Before VLAN

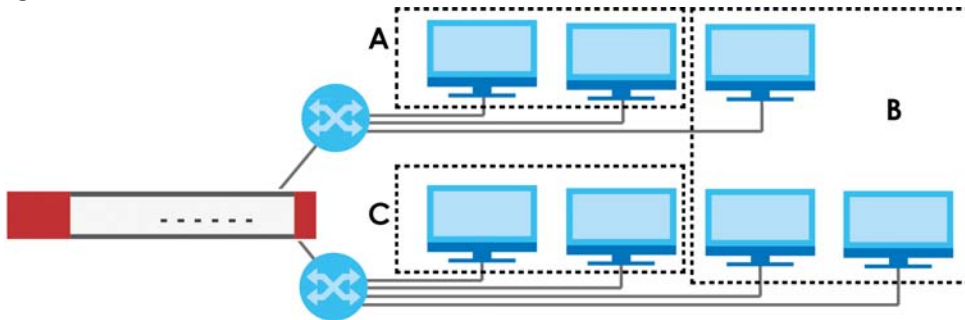

In this example, there are two physical networks and three departments **A**, **B**, and **C**. The physical networks are connected to hubs, and the hubs are connected to the router.

Alternatively, you can divide the physical networks into three VLANs.

Figure 277 Example: After VLAN

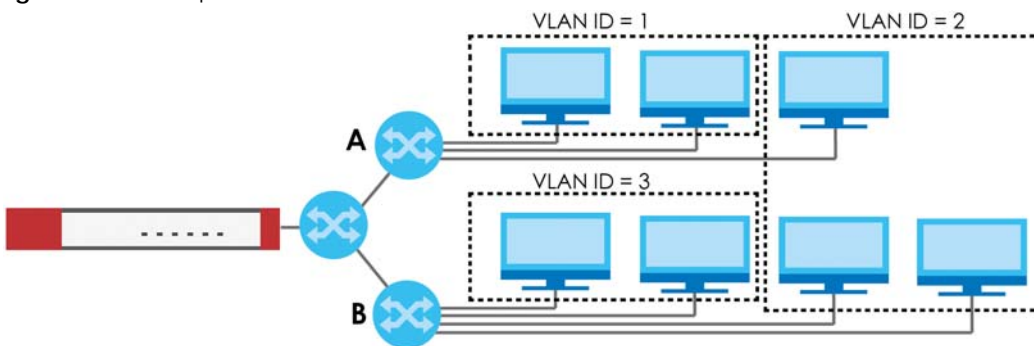

Each VLAN is a separate network with separate IP addresses, subnet masks, and gateways. Each VLAN also has a unique identification number (ID). The ID is a 12-bit value that is stored in the MAC header. The VLANs are connected to switches, and the switches are connected to the router. (If one switch has enough connections for the entire network, the network does not need switches **A** and **B**.)

- Traffic inside each VLAN is layer-2 communication (data link layer, MAC addresses). It is handled by the switches. As a result, the new switch is required to handle traffic inside VLAN 2. Traffic is only broadcast inside each VLAN, not each physical network.
- Traffic between VLANs (or between a VLAN and another type of network) is layer-3 communication (network layer, IP addresses). It is handled by the router.

This approach provides a few advantages.

- Increased performance - In VLAN 2, the extra switch should route traffic inside the sales department faster than the router does. In addition, broadcasts are limited to smaller, more logical groups of users.
- Higher security - If each computer has a separate physical connection to the switch, then broadcast traffic in each VLAN is never sent to computers in another VLAN.

- Better manageability - You can align network policies more appropriately for users. For example, you can create different content filtering rules for each VLAN (each department in the example above), and you can set different bandwidth limits for each VLAN. These rules are also independent of the physical network, so you can change the physical network without changing policies.

In this example, the new switch handles the following types of traffic:

- Inside VLAN 2.
- Between the router and VLAN 1.
- Between the router and VLAN 2.
- Between the router and VLAN 3.

VLAN Interfaces Overview

In the Zyxel Device, each VLAN is called a VLAN interface. As a router, the Zyxel Device routes traffic between VLAN interfaces, but it does not route traffic within a VLAN interface. All traffic for each VLAN interface can go through only one Ethernet interface, though each Ethernet interface can have one or more VLAN interfaces.

Note: Each VLAN interface is created on top of only one Ethernet interface.

Otherwise, VLAN interfaces are similar to other interfaces in many ways. They have an IP address, subnet mask, and gateway used to make routing decisions. They restrict bandwidth and packet size. They can provide DHCP services, and they can verify the gateway is available.

10.8.1 VLAN Summary Screen

This screen lists every VLAN interface and virtual interface created on top of VLAN interfaces. If you enabled IPv6 in the **Configuration > System > IPv6** screen, you can also configure VLAN interfaces used for your IPv6 networks on this screen. To access this screen, click **Configuration > Network > Interface > VLAN**.

Figure 278 Configuration > Network > Interface > VLAN

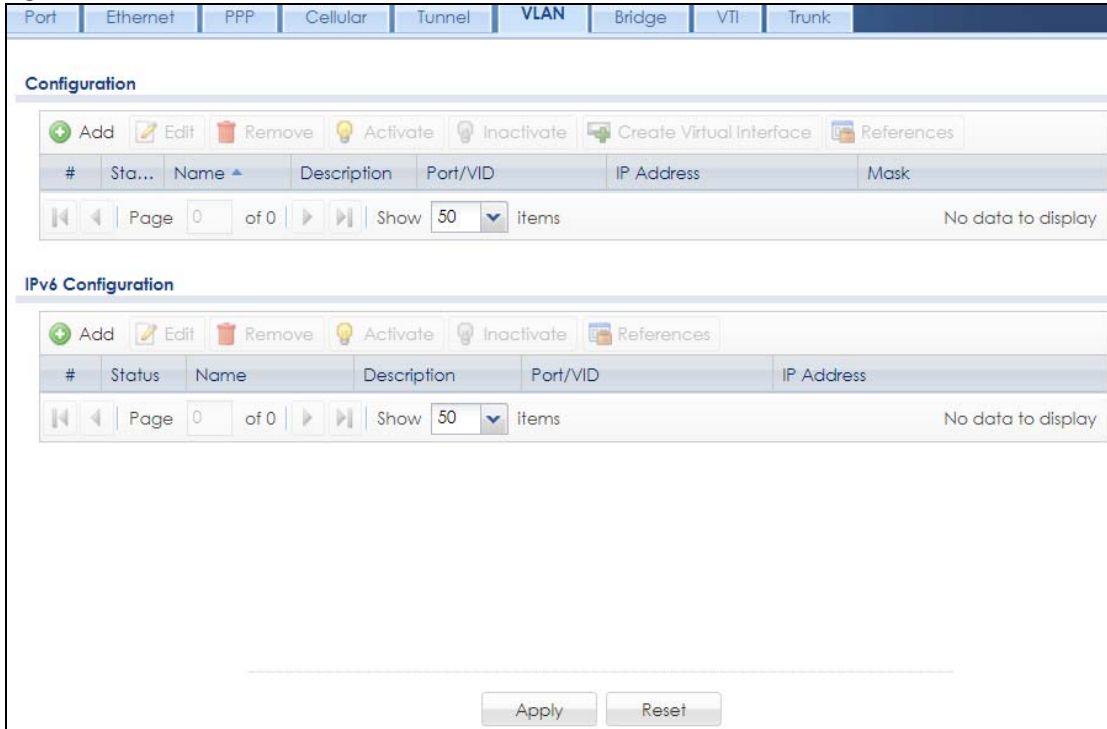

Each field is explained in the following table.

Table 122 Configuration > Network > Interface > VLAN

LABEL	DESCRIPTION
Configuration / IPv6 Configuration	Use the Configuration section for IPv4 network settings. Use the IPv6 Configuration section for IPv6 network settings if you connect your Zyxel Device to an IPv6 network. Both sections have similar fields as described below.
Edit	Double-click an entry or select it and click Edit to open a screen where you can modify the entry's settings.
Remove	To remove an entry, select it and click Remove . The Zyxel Device confirms you want to remove it before doing so.
Activate	To turn on an entry, select it and click Activate .
Inactivate	To turn off an entry, select it and click Inactivate .
Create Virtual Interface	To open the screen where you can create a virtual interface, select an interface and click Create Virtual Interface .
References	Select an entry and click References to open a screen that shows which settings use the entry. See Section 10.4.4 on page 350 for an example.
#	This field is a sequential value, and it is not associated with any interface.
Status	This icon is lit when the entry is active and dimmed when the entry is inactive.
Name	This field displays the name of the interface.
Description	This field displays the description of the interface.
Port/VID	For VLAN interfaces, this field displays <ul style="list-style-type: none"> the Ethernet interface on which the VLAN interface is created the VLAN ID For virtual interfaces, this field is blank.

Table 122 Configuration > Network > Interface > VLAN (continued)

LABEL	DESCRIPTION
IP Address	This field displays the current IP address of the interface. If the IP address is 0.0.0.0, the interface does not have an IP address yet. This screen also shows whether the IP address is a static IP address (STATIC) or dynamically assigned (DHCP). IP addresses are always static in virtual interfaces.
Mask	This field displays the interface's subnet mask in dot decimal notation.
Apply	Click Apply to save your changes back to the Zyxel Device.
Reset	Click Reset to return the screen to its last-saved settings.

10.8.2 VLAN Add/Edit

Select an existing entry in the previous screen and click **Edit** or click **Add** to create a new entry. The following screen appears.

Figure 279 Configuration > Network > Interface > VLAN > Add /Edit

IPv4/IPv6 View Hide Advanced Settings Create New Object

General Settings

Enable Interface

General IPv6 Setting

Enable IPv6 i

Interface Properties

Interface Type: i

Interface Name: i

Zone: i

Base Port:

VLAN ID: i (1-4094)

Priority Code: (0-7) i

Description: (Optional)

IP Address Assignment

Get Automatically

DHCP Option 60: (Optional)

Use Fixed IP Address

IP Address:

Subnet Mask:

Gateway: (Optional)

Metric: (0-15)

Enable IGMP Support

IGMP Upstream

IGMP Downstream

IPv6 Address Assignment

Enable Stateless Address Auto-configuration (SLAAC)

Link-Local Address:

IPv6 Address/Prefix Length: (Optional)

Gateway: (Optional)

Metric: (0-15)

Address from DHCPv6 Prefix Delegation

#	Delegated Prefix	Suffix Address	Address
No data to display			

Page 0 of 0 Show 50 items

DHCPv6 Setting

DHCPv6:

IPv6 Router Advertisement Setting

Enable Router Advertisement

DHCPv6 Setting

IPv6 Router Advertisement Setting

Enable Router Advertisement

Advance

Advertised Hosts Get Network Configuration From DHCPv6

Advertised Hosts Get Other Configuration From DHCPv6

Router Preference:

Advance

MTU: (1280-1500)

Hop Limit: (1-255)

Advertised Prefix Table

#	IPv6 Address/Prefix Length
No data to display	

Page 0 of 0 | Show 50 items

Advance

Advertised Prefix from DHCPv6 Prefix Delegation

#	Delegated Prefix	Suffix Address	Address
No data to display			

Page 0 of 0 | Show 50 items

Interface Parameters

Egress Bandwidth: Kbps

Advance

Ingress Bandwidth: Kbps

MTU: Bytes

Connectivity Check

Enable Connectivity Check

Check Method:

Check Period: (5-600 seconds)

Check Timeout: (1-10 seconds)

Check Fail Tolerance: (1-10)

Check Default Gateway

Check These Addresses (Domain Name or IP Address)

(Optional)

Probe Succeeds When: respond(s)

DHCP Setting

DHCP:

Enable IP/MAC Binding

Enable Logs for IP/MAC Binding Violation

Static DHCP Table

#	IP Address	MAC	Description
No data to display			

Page 0 of 0 | Show 50 items

Advance

The screenshot displays the configuration page for a network interface, specifically the 'Advance' section. It is organized into several functional areas:

- RIP Setting:** Includes a checkbox for 'Enable RIP', a 'Direction' dropdown set to 'BiDir', 'Send Version' and 'Receive Version' dropdowns both set to '2', and a checkbox for 'V2-Broadcast'.
- OSPF Setting:** Features an 'Area' dropdown set to 'none', 'Priority' and 'Link Cost' input fields with values '1' and '10' respectively, a checkbox for 'Passive Interface', and an 'Authentication' dropdown set to 'None'.
- MAC Address Setting:** Offers two radio button options: 'Use Default MAC Address' (selected) with the value '00:00:00:00:00:00', and 'Overwrite Default MAC Address' with an empty text field.
- Proxy ARP:** Contains a checked checkbox for 'Enable Proxy ARP' and a table management interface with 'Add' and 'Remove' buttons, a table header '# IP Address', and a pagination control showing 'Page 0 of 0' and 'Show 50 items'.
- Related Setting:** Provides links to 'Configure WAN TRUNK' and 'Configure Policy Route'.

Each field is explained in the following table.

Table 123 Configuration > Network > Interface > VLAN > Add / Edit

LABEL	DESCRIPTION
IPv4/IPv6 View / IPv4 View / IPv6 View	Use this button to display both IPv4 and IPv6, IPv4-only, or IPv6-only configuration fields.
Show Advanced Settings / Hide Advanced Settings	Click this button to display a greater or lesser number of configuration fields.
Create New Object	Click this button to create a DHCPv6 lease or DHCPv6 request object that you may use for the DHCPv6 settings in this screen.
General Settings	
Enable Interface	Select this to turn this interface on. Clear this to disable this interface.
General IPv6 Setting	
Enable IPv6	Select this to enable IPv6 on this interface. Otherwise, clear this to disable it.
Interface Properties	

Table 123 Configuration > Network > Interface > VLAN > Add / Edit (continued)

LABEL	DESCRIPTION
Interface Type	<p>Select one of the following option depending on the type of network to which the Zyxel Device is connected or if you want to additionally manually configure some related settings.</p> <p>internal is for connecting to a local network. Other corresponding configuration options: DHCP server and DHCP relay. The Zyxel Device automatically adds default SNAT settings for traffic flowing from this interface to an external interface.</p> <p>external is for connecting to an external network (like the Internet). The Zyxel Device automatically adds this interface to the default WAN trunk.</p> <p>For general, the rest of the screen's options do not automatically adjust and you must manually configure a policy route to add routing and SNAT settings for the interface.</p>
Interface Name	<p>This field is read-only if you are editing an existing VLAN interface. Enter the number of the VLAN interface. You can use a number from 0~4094. For example, use vlan0, vlan8, and so on. The total number of VLANs you can configure on the Zyxel Device depends on the model.</p>
Zone	<p>Select the zone to which the VLAN interface belongs.</p>
Base Port	<p>Select the Ethernet interface on which the VLAN interface runs.</p>
VLAN ID	<p>Enter the VLAN ID. This 12-bit number uniquely identifies each VLAN. Allowed values are 1 - 4094. (0 and 4095 are reserved.)</p>
Priority Code	<p>This is a 3-bit field within a 802.1Q VLAN tag that's used to prioritize associated outgoing VLAN traffic. "0" is the lowest priority level and "7" is the highest. See Table 248 on page 707. The setting configured in Configuration > BWM overwrites the priority setting here.</p>
Description	<p>Enter a description of this interface. You can use alphanumeric and () + / : = ? ! * # @ \$ _ % - characters, and it can be up to 60 characters long. Spaces are allowed, but the string can't start with a space.</p>
IP Address Assignment	
Get Automatically	<p>Select this if this interface is a DHCP client. In this case, the DHCP server configures the IP address, subnet mask, and gateway automatically.</p> <p>You should not select this if the interface is assigned to a VRRP group.</p>
DHCP Option 60	<p>DHCP Option 60 is used by the Zyxel Device for identification to the DHCP server using the VCI (Vendor Class Identifier) on the DHCP server. The Zyxel Device adds it in the initial DHCP discovery message that a DHCP client broadcasts in search of an IP address. The DHCP server can assign different IP addresses or options to clients with the specific VCI or reject the request from clients without the specific VCI.</p> <p>Type a string using up to 64 of these characters [a-zA-Z0-9!\\"#\$%&\'()*+,-./:;<=>?@\[\]\^_`{ }~] to identify this Zyxel Device to the DHCP server. For example, Zyxel-TW.</p>
Use Fixed IP Address	<p>Select this if you want to specify the IP address, subnet mask, and gateway manually.</p>
IP Address	<p>This field is enabled if you select Use Fixed IP Address.</p> <p>Enter the IP address for this interface.</p>
Subnet Mask	<p>This field is enabled if you select Use Fixed IP Address.</p> <p>Enter the subnet mask of this interface in dot decimal notation. The subnet mask indicates what part of the IP address is the same for all computers in the network.</p>
Gateway	<p>This field is enabled if you select Use Fixed IP Address.</p> <p>Enter the IP address of the gateway. The Zyxel Device sends packets to the gateway when it does not know how to route the packet to its destination. The gateway should be on the same network as the interface.</p>

Table 123 Configuration > Network > Interface > VLAN > Add / Edit (continued)

LABEL	DESCRIPTION
Metric	Enter the priority of the gateway (if any) on this interface. The Zyxel Device decides which gateway to use based on this priority. The lower the number, the higher the priority. If two or more gateways have the same priority, the Zyxel Device uses the one that was configured first.
Enable IGMP Support	Select this to allow the Zyxel Device to act as an IGMP proxy for hosts connected on the IGMP downstream interface.
IGMP Upstream	Enable IGMP Upstream on the interface which connects to a router running IGMP that is closer to the multicast server.
IGMP Downstream	Enable IGMP Downstream on the interface which connects to the multicast hosts.
IPv6 Address Assignment	These IP address fields configure an IPv6 IP address on the interface itself.
Enable Stateless Address Auto-configuration (SLAAC)	Select this to enable IPv6 stateless auto-configuration on this interface. The interface will generate an IPv6 IP address itself from a prefix obtained from an IPv6 router in the network.
Link-Local address	This displays the IPv6 link-local address and the network prefix that the Zyxel Device generates itself for the interface.
IPv6 Address/Prefix Length	Enter the IPv6 address and the prefix length for this interface if you want to configure a static IP address for this interface. This field is optional. The prefix length indicates what the left-most part of the IP address is the same for all computers in the network, that is, the network address.
Gateway	Enter the IPv6 address of the default outgoing gateway using colon (:) hexadecimal notation.
Metric	Enter the priority of the gateway (if any) on this interface. The Zyxel Device decides which gateway to use based on this priority. The lower the number, the higher the priority. If two or more gateways have the same priority, the Zyxel Device uses the one that was configured first.
Address from DHCPv6 Prefix Delegation	Use this table to have the Zyxel Device obtain an IPv6 prefix from the ISP or a connected uplink router for an internal network, such as the LAN or DMZ. You have to also enter a suffix address which is appended to the delegated prefix to form an address for this interface. See Prefix Delegation on page 323 for more information. To use prefix delegation, you must: <ul style="list-style-type: none"> • Create at least one DHCPv6 request object before configuring this table. • The external interface must be a DHCPv6 client. You must configure the DHCPv6 request options using a DHCPv6 request object with the type of prefix-delegation. • Assign the prefix delegation to an internal interface and enable router advertisement on that interface.
Add	Click this to create an entry.
Edit	Select an entry and click this to change the settings.
Remove	Select an entry and click this to delete it from this table.
References	Select an entry and click References to open a screen that shows which settings use the entry.
#	This field is a sequential value, and it is not associated with any entry.
Delegated Prefix	Select the DHCPv6 request object to use from the drop-down list.
Suffix Address	Enter the ending part of the IPv6 address, a slash (/), and the prefix length. The Zyxel Device will append it to the delegated prefix. For example, you got a delegated prefix of 2003:1234:5678/48. You want to configure an IP address of 2003:1234:5678:1111::1/128 for this interface, then enter ::1111:0:0:0/128 in this field.

Table 123 Configuration > Network > Interface > VLAN > Add / Edit (continued)

LABEL	DESCRIPTION
Address	This field displays the combined IPv6 IP address for this interface. Note: This field displays the combined address after you click OK and reopen this screen.
DHCPv6 Setting	
DHCPv6	Select N/A to not use DHCPv6. Select Client to set this interface to act as a DHCPv6 client. Select Server to set this interface to act as a DHCPv6 server which assigns IP addresses and provides subnet mask, gateway, and DNS server information to clients. Select Relay to set this interface to route DHCPv6 requests to the DHCPv6 relay server you specify. The DHCPv6 server(s) may be on another network.
DUID	This field displays the DHCP Unique Identifier (DUID) of the interface, which is unique and used for identification purposes when the interface is exchanging DHCPv6 messages with others. See DHCPv6 on page 324 for more information.
DUID as MAC	Select this to have the DUID generated from the interface's default MAC address.
Customized DUID	If you want to use a customized DUID, enter it here for the interface.
Enable Rapid Commit	Select this to shorten the DHCPv6 message exchange process from four to two steps. This function helps reduce heavy network traffic load. Note: Make sure you also enable this option in the DHCPv6 clients to make rapid commit work.
Information Refresh Time	Enter the number of seconds a DHCPv6 client should wait before refreshing information retrieved from DHCPv6.
Request Address	This field is available if you set this interface to DHCPv6 Client . Select this to get an IPv6 IP address for this interface from the DHCP server. Clear this to not get any IP address information through DHCPv6.
DHCPv6 Request Options / DHCPv6 Lease Options	If this interface is a DHCPv6 client, use this section to configure DHCPv6 request settings that determine what additional information to get from the DHCPv6 server. If this interface is a DHCPv6 server, use this section to configure DHCPv6 lease settings that determine what to offer to the DHCPv6 clients.
Add	Click this to create an entry in this table. See Section 10.4.5 on page 351 for more information.
Remove	Select an entry and click this to change the settings.
Reference	Select an entry and click References to open a screen that shows which settings use the entry.
#	This field is a sequential value, and it is not associated with any entry.
Name	This field displays the name of the DHCPv6 request or lease object.
Type	This field displays the type of the object.
Value	This field displays the IPv6 prefix that the Zyxel Device obtained from an uplink router (Server is selected) or will advertise to its clients (Client is selected).
Interface	When Relay is selected, select this check box and an interface from the drop-down list if you want to use it as the relay server.
Relay Server	When Relay is selected, select this check box and enter the IP address of a DHCPv6 server as the relay server.
IPv6 Router Advertisement Setting	

Table 123 Configuration > Network > Interface > VLAN > Add / Edit (continued)

LABEL	DESCRIPTION
Enable Router Advertisement	Select this to enable this interface to send router advertisement messages periodically. See IPv6 Router Advertisement on page 323 for more information.
Advertised Hosts Get Network Configuration From DHCPv6	Select this to have the Zyxel Device indicate to hosts to obtain network settings (such as prefix and DNS settings) through DHCPv6. Clear this to have the Zyxel Device indicate to hosts that DHCPv6 is not available and they should use the prefix in the router advertisement message.
Advertised Hosts Get Other Configuration From DHCPv6	Select this to have the Zyxel Device indicate to hosts to obtain DNS information through DHCPv6. Clear this to have the Zyxel Device indicate to hosts that DNS information is not available in this network.
Router Preference	Select the router preference (Low , Medium or High) for the interface. The interface sends this preference in the router advertisements to tell hosts what preference they should use for the Zyxel Device. This helps hosts to choose their default router especially when there are multiple IPv6 router in the network. Note: Make sure the hosts also support router preference to make this function work.
MTU	The Maximum Transmission Unit. Type the maximum size of each IPv6 data packet, in bytes, that can move through this interface. If a larger packet arrives, the Zyxel Device divides it into smaller fragments.
Hop Limit	Enter the maximum number of network segments that a packet can cross before reaching the destination. When forwarding an IPv6 packet, IPv6 routers are required to decrease the Hop Limit by 1 and to discard the IPv6 packet when the Hop Limit is 0.
Advertised Prefix Table	Configure this table only if you want the Zyxel Device to advertise a fixed prefix to the network.
Add	Click this to create an IPv6 prefix address.
Edit	Select an entry in this table and click this to modify it.
Remove	Select an entry in this table and click this to delete it.
#	This field is a sequential value, and it is not associated with any entry.
IPv6 Address/Prefix Length	Enter the IPv6 network prefix address and the prefix length. The prefix length indicates what the left-most part of the IP address is the same for all computers in the network, that is, the network address.
Advertised Prefix from DHCPv6 Prefix Delegation	Use this table to configure the network prefix if you want to use a delegated prefix as the beginning part of the network prefix.
Add	Click this to create an entry in this table.
Edit	Select an entry in this table and click this to modify it.
Remove	Select an entry in this table and click this to delete it.
References	Select an entry and click References to open a screen that shows which settings use the entry.
#	This field is a sequential value, and it is not associated with any entry.
Delegated Prefix	Select the DHCPv6 request object to use for generating the network prefix for the network.

Table 123 Configuration > Network > Interface > VLAN > Add / Edit (continued)

LABEL	DESCRIPTION
Suffix Address	<p>Enter the ending part of the IPv6 network address plus a slash (/) and the prefix length. The Zyxel Device will append it to the selected delegated prefix. The combined address is the network prefix for the network.</p> <p>For example, you got a delegated prefix of 2003:1234:5678/48. You want to divide it into 2003:1234:5678:1111/64 for this interface and 2003:1234:5678:2222/64 for another interface. You can use ::1111/64 and ::2222/64 for the suffix address respectively. But if you do not want to divide the delegated prefix into subnetworks, enter ::0/48 here, which keeps the same prefix length (/48) as the delegated prefix.</p>
Address	<p>This is the final network prefix combined by the delegated prefix and the suffix.</p> <p>Note: This field displays the combined address after you click OK and reopen this screen.</p>
Interface Parameters	
Egress Bandwidth	<p>Enter the maximum amount of traffic, in kilobits per second, the Zyxel Device can send through the interface to the network. Allowed values are 0 - 1048576.</p>
Ingress Bandwidth	<p>This is reserved for future use.</p> <p>Enter the maximum amount of traffic, in kilobits per second, the Zyxel Device can receive from the network through the interface. Allowed values are 0 - 1048576.</p>
MTU	<p>Maximum Transmission Unit. Type the maximum size of each data packet, in bytes, that can move through this interface. If a larger packet arrives, the Zyxel Device divides it into smaller fragments. Allowed values are 576 - 1500. Usually, this value is 1500.</p>
Connectivity Check	<p>The Zyxel Device can regularly check the connection to the gateway you specified to make sure it is still available. You specify how often to check the connection, how long to wait for a response before the attempt is a failure, and how many consecutive failures are required before the Zyxel Device stops routing to the gateway. The Zyxel Device resumes routing to the gateway the first time the gateway passes the connectivity check.</p>
Enable Connectivity Check	<p>Select this to turn on the connection check.</p>
Check Method	<p>Select the method that the gateway allows.</p> <p>Select icmp to have the Zyxel Device regularly ping the gateway you specify to make sure it is still available.</p> <p>Select tcp to have the Zyxel Device regularly perform a TCP handshake with the gateway you specify to make sure it is still available.</p>
Check Period	<p>Enter the number of seconds between connection check attempts.</p>
Check Timeout	<p>Enter the number of seconds to wait for a response before the attempt is a failure.</p>
Check Fail Tolerance	<p>Enter the number of consecutive failures before the Zyxel Device stops routing through the gateway.</p>
Check Default Gateway	<p>Select this to use the default gateway for the connectivity check.</p>
Check this address	<p>Select this to specify a domain name or IP address for the connectivity check. Enter that domain name or IP address in the field next to it.</p>
Check Port	<p>This field only displays when you set the Check Method to tcp. Specify the port number to use for a TCP connectivity check.</p>
Check these addresses	<p>Type one or two domain names or IP addresses for the connectivity check.</p>

Table 123 Configuration > Network > Interface > VLAN > Add / Edit (continued)

LABEL	DESCRIPTION
Probe Succeeds When	<p>This field applies when you specify two domain names or IP addresses for the connectivity check.</p> <p>Select any one if you want the check to pass if at least one of the domain names or IP addresses responds.</p> <p>Select all if you want the check to pass only if both domain names or IP addresses respond.</p>
DHCP Setting	The DHCP settings are available for the OPT, LAN and DMZ interfaces.
DHCP	<p>Select what type of DHCP service the Zyxel Device provides to the network. Choices are:</p> <p>None - the Zyxel Device does not provide any DHCP services. There is already a DHCP server on the network.</p> <p>DHCP Relay - the Zyxel Device routes DHCP requests to one or more DHCP servers you specify. The DHCP server(s) may be on another network.</p> <p>DHCP Server - the Zyxel Device assigns IP addresses and provides subnet mask, gateway, and DNS server information to the network. The Zyxel Device is the DHCP server for the network.</p>
	These fields appear if the Zyxel Device is a DHCP Relay .
Relay Server 1	Enter the IP address of a DHCP server for the network.
Relay Server 2	This field is optional. Enter the IP address of another DHCP server for the network.
	These fields appear if the Zyxel Device is a DHCP Server .
IP Pool Start Address	<p>Enter the IP address from which the Zyxel Device begins allocating IP addresses. If you want to assign a static IP address to a specific computer, click Add Static DHCP.</p> <p>If this field is blank, the Pool Size must also be blank. In this case, the Zyxel Device can assign every IP address allowed by the interface's IP address and subnet mask, except for the first address (network address), last address (broadcast address) and the interface's IP address.</p>
Pool Size	<p>Enter the number of IP addresses to allocate. This number must be at least one and is limited by the interface's Subnet Mask. For example, if the Subnet Mask is 255.255.255.0 and IP Pool Start Address is 10.10.10.10, the Zyxel Device can allocate 10.10.10.10 to 10.10.10.254, or 245 IP addresses.</p> <p>If this field is blank, the IP Pool Start Address must also be blank. In this case, the Zyxel Device can assign every IP address allowed by the interface's IP address and subnet mask, except for the first address (network address), last address (broadcast address) and the interface's IP address.</p>
First DNS Server Second DNS Server Third DNS Server	<p>Specify the IP addresses up to three DNS servers for the DHCP clients to use. Use one of the following ways to specify these IP addresses.</p> <p>Custom Defined - enter a static IP address.</p> <p>From ISP - select the DNS server that another interface received from its DHCP server.</p> <p>Zyxel Device - the DHCP clients use the IP address of this interface and the Zyxel Device works as a DNS relay.</p>
First WINS Server, Second WINS Server	Type the IP address of the WINS (Windows Internet Naming Service) server that you want to send to the DHCP clients. The WINS server keeps a mapping table of the computer names on your network and the IP addresses that they are currently using.
Default Router	<p>If you set this interface to DHCP Server, you can select to use either the interface's IP address or another IP address as the default router. This default router will become the DHCP clients' default gateway.</p> <p>To use another IP address as the default router, select Custom Defined and enter the IP address.</p>

Table 123 Configuration > Network > Interface > VLAN > Add / Edit (continued)

LABEL	DESCRIPTION
Lease time	Specify how long each computer can use the information (especially the IP address) before it has to request the information again. Choices are: infinite - select this if IP addresses never expire days, hours, and minutes - select this to enter how long IP addresses are valid. The default is 2 days.
Extended Options	This table is available if you selected DHCP server . Configure this table if you want to send more information to DHCP clients through DHCP packets.
Add	Click this to create an entry in this table. See Section 10.4.6 on page 351 .
Edit	Select an entry in this table and click this to modify it.
Remove	Select an entry in this table and click this to delete it.
#	This field is a sequential value, and it is not associated with any entry.
Name	This is the option's name.
Code	This is the option's code number.
Type	This is the option's type.
Value	This is the option's value.
Enable IP/MAC Binding	Select this option to have the Zyxel Device enforce links between specific IP addresses and specific MAC addresses for this VLAN. This stops anyone else from manually using a bound IP address on another device connected to this interface. Use this to make use only the intended users get to use specific IP addresses.
Enable Logs for IP/MAC Binding Violation	Select this option to have the Zyxel Device generate a log if a device connected to this VLAN attempts to use an IP address that is bound to another device's MAC address.
Static DHCP Table	Configure a list of static IP addresses the Zyxel Device assigns to computers connected to the interface. Otherwise, the Zyxel Device assigns an IP address dynamically using the interface's IP Pool Start Address and Pool Size .
Add	Click this to create a new entry.
Edit	Select an entry and click this to be able to modify it.
Remove	Select an entry and click this to delete it.
#	This field is a sequential value, and it is not associated with a specific entry.
IP Address	Enter the IP address to assign to a device with this entry's MAC address.
MAC Address	Enter the MAC address to which to assign this entry's IP address.
Description	Enter a description to help identify this static DHCP entry. You can use alphanumeric and () + / : = ? ! * # @ \$ % - characters, and it can be up to 60 characters long.
RIP Setting	See Section 11.6 on page 441 for more information about RIP.
Enable RIP	Select this to enable RIP on this interface.
Direction	This field is effective when RIP is enabled. Select the RIP direction from the drop-down list box. BiDir - This interface sends and receives routing information. In-Only - This interface receives routing information. Out-Only - This interface sends routing information.
Send Version	This field is effective when RIP is enabled. Select the RIP version(s) used for sending RIP packets. Choices are 1 , 2 , and 1 and 2 .
Receive Version	This field is effective when RIP is enabled. Select the RIP version(s) used for receiving RIP packets. Choices are 1 , 2 , and 1 and 2 .

Table 123 Configuration > Network > Interface > VLAN > Add / Edit (continued)

LABEL	DESCRIPTION
V2-Broadcast	This field is effective when RIP is enabled. Select this to send RIP-2 packets using subnet broadcasting; otherwise, the Zyxel Device uses multicasting.
OSPF Setting	See Section 11.7 on page 443 for more information about OSPF.
Area	Select the area in which this interface belongs. Select None to disable OSPF in this interface.
Priority	Enter the priority (between 0 and 255) of this interface when the area is looking for a Designated Router (DR) or Backup Designated Router (BDR). The highest-priority interface identifies the DR, and the second-highest-priority interface identifies the BDR. Set the priority to zero if the interface can not be the DR or BDR.
Link Cost	Enter the cost (between 1 and 65,535) to route packets through this interface.
Passive Interface	Select this to stop forwarding OSPF routing information from the selected interface. As a result, this interface only receives routing information.
Authentication	Select an authentication method, or disable authentication. To exchange OSPF routing information with peer border routers, you must use the same authentication method that they use. Choices are: Same-as-Area - use the default authentication method in the area None - disable authentication Text - authenticate OSPF routing information using a plain-text password MD5 - authenticate OSPF routing information using MD5 encryption
Text Authentication Key	This field is available if the Authentication is Text . Type the password for text authentication. The key can consist of alphanumeric characters and the underscore, and it can be up to 16 characters long.
MD5 Authentication ID	This field is available if the Authentication is MD5 . Type the ID for MD5 authentication. The ID can be between 1 and 255.
MD5 Authentication Key	This field is available if the Authentication is MD5 . Type the password for MD5 authentication. The password can consist of alphanumeric characters and the underscore, and it can be up to 16 characters long.
MAC Address Setting	This section appears when Interface Properties is External or General . Have the interface use either the factory assigned default MAC address, a manually specified MAC address, or clone the MAC address of another device or computer.
Use Default MAC Address	Select this option to have the interface use the factory assigned default MAC address. By default, the Zyxel Device uses the factory assigned MAC address to identify itself.
Overwrite Default MAC Address	Select this option to have the interface use a different MAC address. Either the MAC address in the field. Once it is successfully configured, the address will be copied to the configuration file. It will not change unless you change the setting or upload a different configuration file.
Proxy ARP	Proxy ARP is available for external or general interfaces on the Zyxel Device. See Section on page 337 for more information on Proxy ARP.
Enable Proxy ARP	Select this to allow the Zyxel Device to answer external interface ARP requests on behalf of a device on its internal interface. Interfaces supported are: <ul style="list-style-type: none"> • Ethernet • VLAN • Bridge See Section 10.4.2 on page 347 for more information.

Table 123 Configuration > Network > Interface > VLAN > Add / Edit (continued)

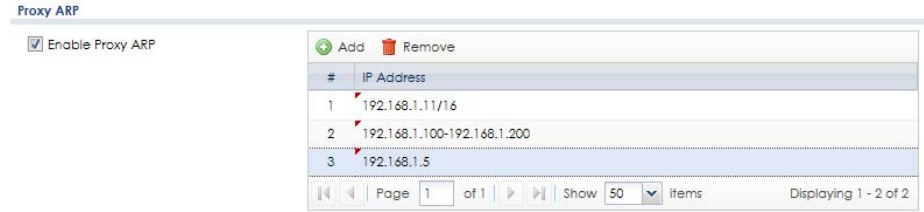
LABEL	DESCRIPTION
Add	<p>Click Add to create an IPv4 Address, an IPv4 CIDR (for example, 192.168.1.1/24) or an IPv4 Range (for example, 192.168.1.2-192.168.1.100) as the target IP address. The Zyxel Device answers external ARP requests only if they match one of these inputted target IP addresses. For example, if the IPv4 Address is 192.168.1.5, then the Zyxel Device will answer ARP requests coming from the WAN only if it contains 192.168.1.5 as the target IP address.</p> <p>Select an existing entry and click Remove to delete that entry.</p> 
Related Setting	
Configure WAN TRUNK	Click WAN TRUNK to go to a screen where you can set this VLAN to be part of a WAN trunk for load balancing.
Configure Policy Route	Click Policy Route to go to the screen where you can manually configure a policy route to associate traffic with this VLAN.
OK	Click OK to save your changes back to the Zyxel Device.
Cancel	Click Cancel to exit this screen without saving.

10.9 Bridge Interfaces

This section introduces bridges and bridge interfaces and then explains the screens for bridge interfaces.

Bridge Overview

A bridge creates a connection between two or more network segments at the layer-2 (MAC address) level. In the following example, bridge X connects four network segments.

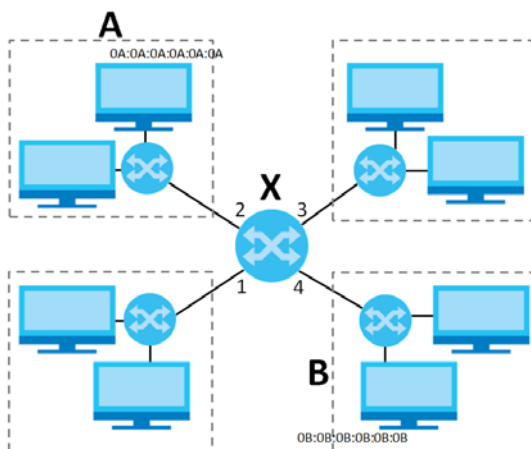

When the bridge receives a packet, the bridge records the source MAC address and the port on which it was received in a table. It also looks up the destination MAC address in the table. If the bridge knows on which port the destination MAC address is located, it sends the packet to that port. If the destination

MAC address is not in the table, the bridge broadcasts the packet on every port (except the one on which it was received).

In the example above, computer A sends a packet to computer B. Bridge X records the source address 0A:0A:0A:0A:0A:0A and port 2 in the table. It also looks up 0B:0B:0B:0B:0B:0B in the table. There is no entry yet, so the bridge broadcasts the packet on ports 1, 3, and 4.

Table 124 Example: Bridge Table After Computer A Sends a Packet to Computer B

MAC ADDRESS	PORT
0A:0A:0A:0A:0A:0A	2

If computer B responds to computer A, bridge X records the source address 0B:0B:0B:0B:0B:0B and port 4 in the table. It also looks up 0A:0A:0A:0A:0A:0A in the table and sends the packet to port 2 accordingly.

Table 125 Example: Bridge Table After Computer B Responds to Computer A

MAC ADDRESS	PORT
0A:0A:0A:0A:0A:0A	2
0B:0B:0B:0B:0B:0B	4

Bridge Interface Overview

A bridge interface creates a software bridge between the members of the bridge interface. It also becomes the Zyxel Device's interface for the resulting network.

Unlike the device-wide bridge mode in ZyNOS-based Zyxel Devices, this Zyxel Device can bridge traffic between some interfaces while it routes traffic for other interfaces. The bridge interfaces also support more functions, like interface bandwidth parameters, DHCP settings, and connectivity check. To use the whole Zyxel Device as a transparent bridge, add all of the Zyxel Device's interfaces to a bridge interface.

A bridge interface may consist of the following members:

- Zero or one VLAN interfaces (and any associated virtual VLAN interfaces)
- Any number of Ethernet interfaces (and any associated virtual Ethernet interfaces)

When you create a bridge interface, the Zyxel Device removes the members' entries from the routing table and adds the bridge interface's entries to the routing table. For example, this table shows the routing table before and after you create bridge interface br0 (250.250.250.0/23) between lan1 and vlan1.

Table 126 Example: Routing Table Before and After Bridge Interface br0 Is Created

IP ADDRESS(ES)	DESTINATION
210.210.210.0/24	lan1
210.211.1.0/24	lan1:1
221.221.221.0/24	vlan0
222.222.222.0/24	vlan1
230.230.230.192/26	wan2
241.241.241.241/32	dmz
242.242.242.242/32	dmz

IP ADDRESS(ES)	DESTINATION
221.221.221.0/24	vlan0
230.230.230.192/26	wan2
241.241.241.241/32	dmz
242.242.242.242/32	dmz
250.250.250.0/23	br0

In this example, virtual Ethernet interface lan1:1 is also removed from the routing table when lan1 is added to br0. Virtual interfaces are automatically added to or removed from a bridge interface when the underlying interface is added or removed.

10.9.1 Bridge Summary

This screen lists every bridge interface and virtual interface created on top of bridge interfaces. If you enabled IPv6 in the **Configuration > System > IPv6** screen, you can also configure bridge interfaces used for your IPv6 network on this screen. To access this screen, click **Configuration > Network > Interface > Bridge**.

Figure 280 Configuration > Network > Interface > Bridge

Each field is described in the following table.

Table 127 Configuration > Network > Interface > Bridge

LABEL	DESCRIPTION
Configuration / IPv6 Configuration	Use the Configuration section for IPv4 network settings. Use the IPv6 Configuration section for IPv6 network settings if you connect your Zyxel Device to an IPv6 network. Both sections have similar fields as described below.
Add	Click this to create a new entry.
Edit	Double-click an entry or select it and click Edit to open a screen where you can modify the entry's settings.
Remove	To remove an entry, select it and click Remove . The Zyxel Device confirms you want to remove it before doing so.
Activate	To turn on an entry, select it and click Activate .
Inactivate	To turn off an entry, select it and click Inactivate .
Create Virtual Interface	To open the screen where you can create a virtual interface, select an interface and click Create Virtual Interface .

Table 127 Configuration > Network > Interface > Bridge (continued)

LABEL	DESCRIPTION
References	Select an entry and click References to open a screen that shows which settings use the entry. See Section 10.4.4 on page 350 for an example.
#	This field is a sequential value, and it is not associated with any interface.
Status	This icon is lit when the entry is active and dimmed when the entry is inactive.
Name	This field displays the name of the interface.
Description	This field displays the description of the interface.
IP Address	This field displays the current IP address of the interface. If the IP address is 0.0.0.0, the interface does not have an IP address yet. This screen also shows whether the IP address is a static IP address (STATIC) or dynamically assigned (DHCP). IP addresses are always static in virtual interfaces.
Member	This field displays the Ethernet interfaces and VLAN interfaces in the bridge interface. It is blank for virtual interfaces.
Apply	Click Apply to save your changes back to the Zyxel Device.
Reset	Click Reset to return the screen to its last-saved settings.

10.9.2 Bridge Add/Edit

This screen lets you configure IP address assignment, interface bandwidth parameters, DHCP settings, and connectivity check for each bridge interface. To access this screen, click the **Add** or **Edit** icon in the **Bridge Summary** screen. The following screen appears.

Figure 281 Configuration > Network > Interface > Bridge > Add / Edit

IPv4/IPv6 View Hide Advanced Settings Create New Object

General Settings

Enable Interface

General IPv6 Setting

Enable IPv6 i

Interface Properties

Interface Type: i

Interface Name: i

Zone: i

Description: (Optional)

Member Configuration

Available	Member
wan1	
wan2	
opt	
lan1	
lan2	
reserved	
dmz	

IP Address Assignment

Get Automatically

Advance

DHCP Option 60: (Optional)

Use Fixed IP Address

IP Address:

Subnet Mask:

Gateway: (Optional)

Metric: (0-15)

Enable IGMP Support

IGMP Upstream

IGMP Downstream

IPv6 Address Assignment

Enable Stateless Address Auto-configuration (SLAAC)

Link-Local Address:

IPv6 Address/Prefix Length: (Optional)

Advance

Gateway: (Optional)

Metric: (0-15)

Address from DHCPv6 Prefix Delegation

#	Delegated Prefix	Suffix Address	Address
No data to display			

Show 50

DHCPv6 Setting

DHCPv6:

IPv6 Router Advertisement Setting

Enable Router Advertisement

Advance

Advertise Hosts Get Network Configuration From DHCPv6

Advertise Hosts Get Other Configuration From DHCPv6

Router Preference:

Advance

MTU: (1280-1500)

Hop Limit: (1-255)

Advertised Prefix Table

#	IPv6 Address/Prefix Length
No data to display	

Page 0 of 0 Show 50 items

Advance

Advertised Prefix from DHCPv6 Prefix Delegation

#	Delegated Prefix	Suffix Address	Address
No data to display			

Page 0 of 0 Show 50 items

Advance

Interface Parameters

Egress Bandwidth: Kbps

Ingress Bandwidth: Kbps

MTU: Bytes

DHCP Setting

DHCP:

Enable IP/MAC Binding

Enable Logs for IP/MAC Binding Violation

Static DHCP Table

#	IP Address	MAC	Description
No data to display			

Page 0 of 0 Show 50 items

Connectivity Check

Enable Connectivity Check

Check Method:

Check Period: (5-600 seconds)

Check Timeout: (1-10 seconds)

Check Fail Tolerance: (1-10)

Check Default Gateway

Check T...

Check Fail Tolerance: 5 (1-10)

Check Default Gateway 0.0.0.0

Check These Addresses (Domain Name or IP Address)

Probe Succeeds When: any one respond(s)

Proxy ARP

Enable Proxy ARP

#	IP Address
No data to display	

Related Setting

Configure [WAN TRUNK](#)

Configure [Policy Route](#)

Each field is described in the table below.

Table 128 Configuration > Network > Interface > Bridge > Add / Edit

LABEL	DESCRIPTION
IPv4/IPv6 View / IPv4 View / IPv6 View	Use this button to display both IPv4 and IPv6, IPv4-only, or IPv6-only configuration fields.
Show Advanced Settings / Hide Advanced Settings	Click this button to display a greater or lesser number of configuration fields.
Create New Object	Click this button to create a DHCPv6 lease or DHCPv6 request object that you may use for the DHCPv6 settings in this screen.
General Settings	
Enable Interface	Select this to enable this interface. Clear this to disable this interface.
General IPv6 Setting	
Enable IPv6	Select this to enable IPv6 on this interface. Otherwise, clear this to disable it.
Interface Properties	
Interface Type	<p>Select one of the following option depending on the type of network to which the Zyxel Device is connected or if you want to additionally manually configure some related settings.</p> <p>internal is for connecting to a local network. Other corresponding configuration options: DHCP server and DHCP relay. The Zyxel Device automatically adds default SNAT settings for traffic flowing from this interface to an external interface.</p> <p>external is for connecting to an external network (like the Internet). The Zyxel Device automatically adds this interface to the default WAN trunk.</p> <p>For general, the rest of the screen's options do not automatically adjust and you must manually configure a policy route to add routing and SNAT settings for the interface.</p>
Interface Name	This field is read-only if you are editing the interface. Enter the name of the bridge interface. The format is brx, where x is 0 - 11. For example, br0, br3, and so on.
Zone	Select the zone to which the interface is to belong. You use zones to apply security settings such as security policy, IDP, remote management, anti-virus, and application patrol.

Table 128 Configuration > Network > Interface > Bridge > Add / Edit (continued)

LABEL	DESCRIPTION
Description	Enter a description of this interface. You can use alphanumeric and () + / : = ? ! * # @ \$ _ % - characters, and it can be up to 60 characters long. Spaces are allowed, but the string can't start with a space.
Member Configuration	
Available	This field displays Ethernet interfaces and VLAN interfaces that can become part of the bridge interface. An interface is not available in the following situations: <ul style="list-style-type: none"> • There is a virtual interface on top of it • It is already used in a different bridge interface Select one, and click the >> arrow to add it to the bridge interface. Each bridge interface can only have one VLAN interface.
Member	This field displays the interfaces that are part of the bridge interface. Select one, and click the << arrow to remove it from the bridge interface.
IP Address Assignment	
Get Automatically	Select this if this interface is a DHCP client. In this case, the DHCP server configures the IP address, subnet mask, and gateway automatically.
DHCP Option 60	DHCP Option 60 is used by the Zyxel Device for identification to the DHCP server using the VCI (Vendor Class Identifier) on the DHCP server. The Zyxel Device adds it in the initial DHCP discovery message that a DHCP client broadcasts in search of an IP address. The DHCP server can assign different IP addresses or options to clients with the specific VCI or reject the request from clients without the specific VCI. Type a string using up to 64 of these characters [a-zA-Z0-9!\\"#\$%&\'()*+,-./:;<=>?@[\\]\^_`{ }~] to identify this Zyxel Device to the DHCP server. For example, Zyxel-TW.
Use Fixed IP Address	Select this if you want to specify the IP address, subnet mask, and gateway manually.
IP Address	This field is enabled if you select Use Fixed IP Address . Enter the IP address for this interface.
Subnet Mask	This field is enabled if you select Use Fixed IP Address . Enter the subnet mask of this interface in dot decimal notation. The subnet mask indicates what part of the IP address is the same for all computers in the network.
Gateway	This field is enabled if you select Use Fixed IP Address . Enter the IP address of the gateway. The Zyxel Device sends packets to the gateway when it does not know how to route the packet to its destination. The gateway should be on the same network as the interface.
Metric	Enter the priority of the gateway (if any) on this interface. The Zyxel Device decides which gateway to use based on this priority. The lower the number, the higher the priority. If two or more gateways have the same priority, the Zyxel Device uses the one that was configured first.
Enable IGMP Support	Select this to allow the Zyxel Device to act as an IGMP proxy for hosts connected on the IGMP downstream interface.
IGMP Upstream	Enable IGMP Upstream on the interface which connects to a router running IGMP that is closer to the multicast server.
IGMP Downstream	Enable IGMP Downstream on the interface which connects to the multicast hosts.
IPv6 Address Assignment	These IP address fields configure an IPv6 IP address on the interface itself.

Table 128 Configuration > Network > Interface > Bridge > Add / Edit (continued)

LABEL	DESCRIPTION
Enable Stateless Address Auto-configuration (SLAAC)	Select this to enable IPv6 stateless auto-configuration on this interface. The interface will generate an IPv6 IP address itself from a prefix obtained from an IPv6 router in the network.
Link-Local address	This displays the IPv6 link-local address and the network prefix that the Zyxel Device generates itself for the interface.
IPv6 Address/Prefix Length	Enter the IPv6 address and the prefix length for this interface if you want to use a static IP address. This field is optional. The prefix length indicates what the left-most part of the IP address is the same for all computers in the network, that is, the network address.
Gateway	Enter the IPv6 address of the default outgoing gateway using colon (:) hexadecimal notation.
Metric	Enter the priority of the gateway (if any) on this interface. The Zyxel Device decides which gateway to use based on this priority. The lower the number, the higher the priority. If two or more gateways have the same priority, the Zyxel Device uses the one that was configured first.
Address from DHCPv6 Prefix Delegation	Use this table to have the Zyxel Device obtain an IPv6 prefix from the ISP or a connected uplink router for an internal network, such as the LAN or DMZ. You have to also enter a suffix address which is appended to the delegated prefix to form an address for this interface. See Prefix Delegation on page 323 for more information. To use prefix delegation, you must: <ul style="list-style-type: none"> • Create at least one DHCPv6 request object before configuring this table. • The external interface must be a DHCPv6 client. You must configure the DHCPv6 request options using a DHCPv6 request object with the type of prefix-delegation. • Assign the prefix delegation to an internal interface and enable router advertisement on that interface.
Add	Click this to create an entry.
Edit	Select an entry and click this to change the settings.
Remove	Select an entry and click this to delete it from this table.
#	This field is a sequential value, and it is not associated with any entry.
Delegated Prefix	Select the DHCPv6 request object to use from the drop-down list.
Suffix Address	Enter the ending part of the IPv6 address, a slash (/), and the prefix length. The Zyxel Device will append it to the delegated prefix. For example, you got a delegated prefix of 2003:1234:5678/48. You want to configure an IP address of 2003:1234:5678:1111:1/128 for this interface, then enter ::1111:0:0:1/128 in this field.
Address	This field displays the combined IPv6 IP address for this interface. Note: This field displays the combined address after you click OK and reopen this screen.
DHCPv6 Setting	
DHCPv6	Select N/A to not use DHCPv6. Select Client to set this interface to act as a DHCPv6 client. Select Server to set this interface to act as a DHCPv6 server which assigns IP addresses and provides subnet mask, gateway, and DNS server information to clients. Select Relay to set this interface to route DHCPv6 requests to the DHCPv6 relay server you specify. The DHCPv6 server(s) may be on another network.

Table 128 Configuration > Network > Interface > Bridge > Add / Edit (continued)

LABEL	DESCRIPTION
DUID	This field displays the DHCP Unique IDentifier (DUID) of the interface, which is unique and used for identification purposes when the interface is exchanging DHCPv6 messages with others. See DHCPv6 on page 324 for more information.
DUID as MAC	Select this if you want the DUID is generated from the interface's default MAC address.
Customized DUID	If you want to use a customized DUID, enter it here for the interface.
Enable Rapid Commit	Select this to shorten the DHCPv6 message exchange process from four to two steps. This function helps reduce heavy network traffic load. Note: Make sure you also enable this option in the DHCPv6 clients to make rapid commit work.
Information Refresh Time	Enter the number of seconds a DHCPv6 client should wait before refreshing information retrieved from DHCPv6.
Request Address	This field is available if you set this interface to DHCPv6 Client . Select this to get an IPv6 IP address for this interface from the DHCP server. Clear this to not get any IP address information through DHCPv6.
DHCPv6 Request Options / DHCPv6 Lease Options	If this interface is a DHCPv6 client, use this section to configure DHCPv6 request settings that determine what additional information to get from the DHCPv6 server. If the interface is a DHCPv6 server, use this section to configure DHCPv6 lease settings that determine what to offer to the DHCPv6 clients.
Add	Click this to create an entry in this table. See Section 10.4.5 on page 351 for more information.
Remove	Select an entry and click this to change the settings.
Object Reference	Select an entry and click this to delete it from this table.
#	This field is a sequential value, and it is not associated with any entry.
Name	This field displays the name of the DHCPv6 request or lease object.
Type	This field displays the type of the object.
Value	This field displays the IPv6 prefix that the Zyxel Device obtained from an uplink router (Server is selected) or will advertise to its clients (Client is selected).
Interface	When Relay is selected, select this check box and an interface from the drop-down list if you want to use it as the relay server.
Relay Server	When Relay is selected, select this check box and enter the IP address of a DHCPv6 server as the relay server.
IPv6 Router Advertisement Setting	
Enable Router Advertisement	Select this to enable this interface to send router advertisement messages periodically. See IPv6 Router Advertisement on page 323 for more information.
Advertised Hosts Get Network Configuration From DHCPv6	Select this to have the Zyxel Device indicate to hosts to obtain network settings (such as prefix and DNS settings) through DHCPv6. Clear this to have the Zyxel Device indicate to hosts that DHCPv6 is not available and they should use the prefix in the router advertisement message.
Advertised Hosts Get Other Configuration From DHCPv6	Select this to have the Zyxel Device indicate to hosts to obtain DNS information through DHCPv6. Clear this to have the Zyxel Device indicate to hosts that DNS information is not available in this network.

Table 128 Configuration > Network > Interface > Bridge > Add / Edit (continued)

LABEL	DESCRIPTION
Router Preference	Select the router preference (Low , Medium or High) for the interface. The interface sends this preference in the router advertisements to tell hosts what preference they should use for the Zyxel Device. This helps hosts to choose their default router especially when there are multiple IPv6 router in the network. Note: Make sure the hosts also support router preference to make this function work.
MTU	The Maximum Transmission Unit. Type the maximum size of each IPv6 data packet, in bytes, that can move through this interface. If a larger packet arrives, the Zyxel Device divides it into smaller fragments.
Hop Limit	Enter the maximum number of network segments that a packet can cross before reaching the destination. When forwarding an IPv6 packet, IPv6 routers are required to decrease the Hop Limit by 1 and to discard the IPv6 packet when the Hop Limit is 0.
Advertised Prefix Table	Configure this table only if you want the Zyxel Device to advertise a fixed prefix to the network.
Add	Click this to create an IPv6 prefix address.
Edit	Select an entry in this table and click this to modify it.
Remove	Select an entry in this table and click this to delete it.
#	This field is a sequential value, and it is not associated with any entry.
IPv6 Address/Prefix Length	Enter the IPv6 network prefix address and the prefix length. The prefix length indicates what the left-most part of the IP address is the same for all computers in the network, that is, the network address.
Advertised Prefix from DHCPv6 Prefix Delegation	Use this table to configure the network prefix if you want to use a delegated prefix as the beginning part of the network prefix.
Add	Click this to create an entry in this table.
Edit	Select an entry in this table and click this to modify it.
Remove	Select an entry in this table and click this to delete it.
References	Select an entry and click References to open a screen that shows which settings use the entry.
#	This field is a sequential value, and it is not associated with any entry.
Delegated Prefix	Select the DHCPv6 request object to use for generating the network prefix for the network.
Suffix Address	Enter the ending part of the IPv6 network address plus a slash (/) and the prefix length. The Zyxel Device will append it to the selected delegated prefix. The combined address is the network prefix for the network. For example, you got a delegated prefix of 2003:1234:5678/48. You want to divide it into 2003:1234:5678:1111/64 for this interface and 2003:1234:5678:2222/64 for another interface. You can use ::1111/64 and ::2222/64 for the suffix address respectively. But if you do not want to divide the delegated prefix into subnetworks, enter ::0/48 here, which keeps the same prefix length (/48) as the delegated prefix.
Address	This is the final network prefix combined by the selected delegated prefix and the suffix. Note: This field displays the combined address after you click OK and reopen this screen.
Interface Parameters	
Egress Bandwidth	Enter the maximum amount of traffic, in kilobits per second, the Zyxel Device can send through the interface to the network. Allowed values are 0 - 1048576.

Table 128 Configuration > Network > Interface > Bridge > Add / Edit (continued)

LABEL	DESCRIPTION
Ingress Bandwidth	This is reserved for future use. Enter the maximum amount of traffic, in kilobits per second, the Zyxel Device can receive from the network through the interface. Allowed values are 0 - 1048576.
MTU	Maximum Transmission Unit. Type the maximum size of each data packet, in bytes, that can move through this interface. If a larger packet arrives, the Zyxel Device divides it into smaller fragments. Allowed values are 576 - 1500. Usually, this value is 1500.
DHCP Setting	
DHCP	Select what type of DHCP service the Zyxel Device provides to the network. Choices are: None - the Zyxel Device does not provide any DHCP services. There is already a DHCP server on the network. DHCP Relay - the Zyxel Device routes DHCP requests to one or more DHCP servers you specify. The DHCP server(s) may be on another network. DHCP Server - the Zyxel Device assigns IP addresses and provides subnet mask, gateway, and DNS server information to the network. The Zyxel Device is the DHCP server for the network.
	These fields appear if the Zyxel Device is a DHCP Relay .
Relay Server 1	Enter the IP address of a DHCP server for the network.
Relay Server 2	This field is optional. Enter the IP address of another DHCP server for the network.
	These fields appear if the Zyxel Device is a DHCP Server .
IP Pool Start Address	Enter the IP address from which the Zyxel Device begins allocating IP addresses. If you want to assign a static IP address to a specific computer, click Add Static DHCP . If this field is blank, the Pool Size must also be blank. In this case, the Zyxel Device can assign every IP address allowed by the interface's IP address and subnet mask, except for the first address (network address), last address (broadcast address) and the interface's IP address.
Pool Size	Enter the number of IP addresses to allocate. This number must be at least one and is limited by the interface's Subnet Mask . For example, if the Subnet Mask is 255.255.255.0 and IP Pool Start Address is 10.10.10.10, the Zyxel Device can allocate 10.10.10.10 to 10.10.10.254, or 245 IP addresses. If this field is blank, the IP Pool Start Address must also be blank. In this case, the Zyxel Device can assign every IP address allowed by the interface's IP address and subnet mask, except for the first address (network address), last address (broadcast address) and the interface's IP address.
First DNS Server Second DNS Server Third DNS Server	Specify the IP addresses up to three DNS servers for the DHCP clients to use. Use one of the following ways to specify these IP addresses. Custom Defined - enter a static IP address. From ISP - select the DNS server that another interface received from its DHCP server. Zyxel Device - the DHCP clients use the IP address of this interface and the Zyxel Device works as a DNS relay.
First WINS Server, Second WINS Server	Type the IP address of the WINS (Windows Internet Naming Service) server that you want to send to the DHCP clients. The WINS server keeps a mapping table of the computer names on your network and the IP addresses that they are currently using.
Default Router	If you set this interface to DHCP Server , you can select to use either the interface's IP address or another IP address as the default router. This default router will become the DHCP clients' default gateway. To use another IP address as the default router, select Custom Defined and enter the IP address.

Table 128 Configuration > Network > Interface > Bridge > Add / Edit (continued)

LABEL	DESCRIPTION
Lease time	Specify how long each computer can use the information (especially the IP address) before it has to request the information again. Choices are: infinite - select this if IP addresses never expire days, hours, and minutes - select this to enter how long IP addresses are valid.
Extended Options	This table is available if you selected DHCP server . Configure this table if you want to send more information to DHCP clients through DHCP packets.
Add	Click this to create an entry in this table. See Section 10.4.6 on page 351 .
Edit	Select an entry in this table and click this to modify it.
Remove	Select an entry in this table and click this to delete it.
#	This field is a sequential value, and it is not associated with any entry.
Name	This is the option's name.
Code	This is the option's code number.
Type	This is the option's type.
Value	This is the option's value.
PXE Server	PXE (Preboot eXecution Environment) allows a client computer to use the network to boot up and install an operating system via a PXE-capable Network Interface Card (NIC). PXE is available for computers on internal interfaces to allow them to boot up using boot software on a PXE server. The Zyxel Device acts as an intermediary between the PXE server and the computers that need boot software. The PXE server must have a public IPv4 address. You must enable DHCP Server on the Zyxel Device so that it can receive information from the PXE server.
PXE Boot Loader File	A boot loader is a computer program that loads the operating system for the computer. Type the exact file name of the boot loader software file, including filename extension, that is on the PXE server. If the wrong filename is typed, then the client computers cannot boot.
Enable IP/MAC Binding	Select this option to have this interface enforce links between specific IP addresses and specific MAC addresses. This stops anyone else from manually using a bound IP address on another device connected to this interface. Use this to make use only the intended users get to use specific IP addresses.
Enable Logs for IP/MAC Binding Violation	Select this option to have the Zyxel Device generate a log if a device connected to this interface attempts to use an IP address that is bound to another device's MAC address.
Static DHCP Table	Configure a list of static IP addresses the Zyxel Device assigns to computers connected to the interface. Otherwise, the Zyxel Device assigns an IP address dynamically using the interface's IP Pool Start Address and Pool Size .
Add	Click this to create a new entry.
Edit	Select an entry and click this to be able to modify it.
Remove	Select an entry and click this to delete it.
#	This field is a sequential value, and it is not associated with a specific entry.
IP Address	Enter the IP address to assign to a device with this entry's MAC address.
MAC Address	Enter the MAC address to which to assign this entry's IP address.
Description	Enter a description to help identify this static DHCP entry. You can use alphanumeric and () + / : = ? ! * # @ \$ _ % - characters, and it can be up to 60 characters long.

Table 128 Configuration > Network > Interface > Bridge > Add / Edit (continued)

LABEL	DESCRIPTION
Connectivity Check	The interface can regularly check the connection to the gateway you specified to make sure it is still available. You specify how often the interface checks the connection, how long to wait for a response before the attempt is a failure, and how many consecutive failures are required before the Zyxel Device stops routing to the gateway. The Zyxel Device resumes routing to the gateway the first time the gateway passes the connectivity check.
Enable Connectivity Check	Select this to turn on the connection check.
Check Method	<p>Select the method that the gateway allows.</p> <p>Select icmp to have the Zyxel Device regularly ping the gateway you specify to make sure it is still available.</p> <p>Select tcp to have the Zyxel Device regularly perform a TCP handshake with the gateway you specify to make sure it is still available.</p>
Check Period	Enter the number of seconds between connection check attempts.
Check Timeout	Enter the number of seconds to wait for a response before the attempt is a failure.
Check Fail Tolerance	Enter the number of consecutive failures before the Zyxel Device stops routing through the gateway.
Check Default Gateway	Select this to use the default gateway for the connectivity check.
Check this address	Select this to specify a domain name or IP address for the connectivity check. Enter that domain name or IP address in the field next to it.
Check Port	This field only displays when you set the Check Method to tcp . Specify the port number to use for a TCP connectivity check.
Check these addresses	Type one or two domain names or IP addresses for the connectivity check.
Probe Succeeds When	<p>This field applies when you specify two domain names or IP addresses for the connectivity check.</p> <p>Select any one if you want the check to pass if at least one of the domain names or IP addresses responds.</p> <p>Select all if you want the check to pass only if both domain names or IP addresses respond.</p>
Proxy ARP	Proxy ARP is available for external or general interfaces on the Zyxel Device. See Section 10.4.2 on page 347 for more information on Proxy ARP.
Enable Proxy ARP	<p>Select this to allow the Zyxel Device to answer external interface ARP requests on behalf of a device on its internal interface. Interfaces supported are:</p> <ul style="list-style-type: none"> • Ethernet • VLAN • Bridge <p>See Section 10.4.2 on page 347 for more information.</p>

Table 128 Configuration > Network > Interface > Bridge > Add / Edit (continued)

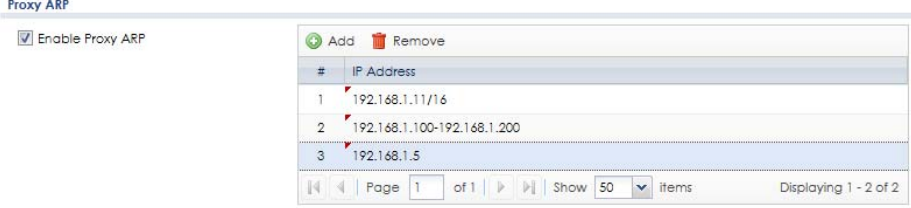
LABEL	DESCRIPTION
Add	<p>Click Add to create an IPv4 Address, an IPv4 CIDR (for example, 192.168.1.1/24) or an IPv4 Range (for example, 192.168.1.2-192.168.1.100) as the target IP address. The Zyxel Device answers external ARP requests only if they match one of these inputted target IP addresses. For example, if the IPv4 Address is 192.168.1.5, then the Zyxel Device will answer ARP requests coming from the WAN only if it contains 192.168.1.5 as the target IP address.</p> <p>Select an existing entry and click Remove to delete that entry.</p> 
Related Setting	
Configure WAN TRUNK	Click WAN TRUNK to go to a screen where you can configure the interface as part of a WAN trunk for load balancing.
Configure Policy Route	Click Policy Route to go to the screen where you can manually configure a policy route to associate traffic with this bridge interface.
OK	Click OK to save your changes back to the Zyxel Device.
Cancel	Click Cancel to exit this screen without saving.

10.10 LAG

Link Aggregation Group (LAG) is a way to combine multiple physical Ethernet interfaces into a single logical interface. This increases uplink bandwidth. It also increases availability as even if a member link goes down, LAG can continue to transmit and receive traffic over the remaining links.

To configure LAG, configure a link number and specify the member ports in the link. All ports must have the same speed and be in full-duplex mode. You must configure the LAG on both sides of the link and you must set the interfaces on either side of the link to be the same speed.

At the time of writing, up to 4 ports can be grouped into a LAG and up to 4 LAGs can be configured on a Zyxel Device.

See [Section 1.1 on page 28](#) to see which models support Link Aggregation Group (LAG).

10.10.1 LAG Summary Screen

This screen lists every LAG created on the Zyxel Device. To access this screen, click **Configuration > Network > Interface > LAG**.

Figure 282 Configuration > Network > Interface > LAG

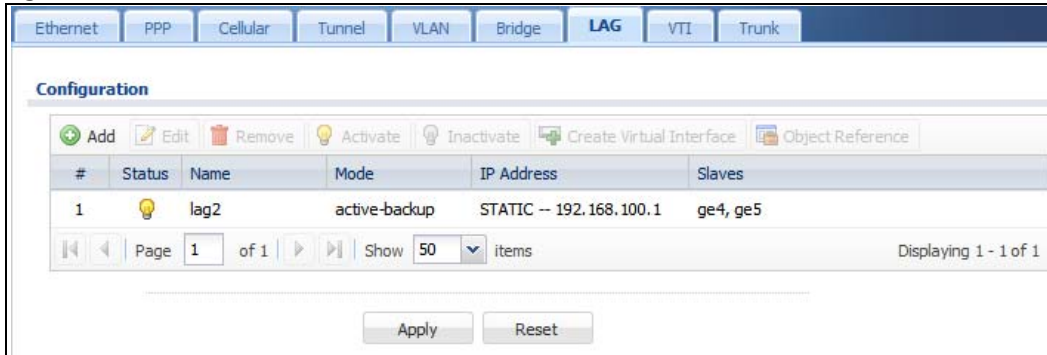

Each field is described in the following table.

Table 129 Configuration > Network > Interface > LAG

LABEL	DESCRIPTION
Configuration	
Add	Click this to create a new entry.
Edit	Double-click an entry or select it and click Edit to open a screen where you can modify the entry's settings.
Remove	To remove an entry, select it and click Remove . The Zyxel Device confirms you want to remove it before doing so.
Activate	To turn on an entry, select it and click Activate .
Inactivate	To turn off an entry, select it and click Inactivate .
Create Virtual Interface	To open the screen where you can create a virtual interface, select an interface and click Create Virtual Interface .
References	Select an entry and click References to open a screen that shows which settings use the entry.
#	This field is a sequential value, and it is not associated with any interface.
Status	This icon is lit when the entry is active and dimmed when the entry is inactive.
Name	This field displays the name of the LAG interface.
Description	This field displays the description of the LAG interface.
Mode	Mode refers to whether the LAG is acting as follows: <ul style="list-style-type: none"> active-backup where only one slave in the LAG interface is active and another slave becomes active only if the active slave fails. 802.3ad (IEEE 802.3ad Dynamic link aggregation) where Link Aggregation Control Protocol (LACP) negotiates automatic combining of links and balances the traffic load across the LAG link by sending LACP packets to the directly connected device that also implements LACP. The slaves must have the same speed and duplex settings. balance-alb (adaptive load balancing) where traffic is distributed according to the current load on each slave by ARP negotiation. Incoming traffic is received by the current slave. If the receiving slave fails, another slave takes over the MAC address of the failed receiving slave.
IP Address	This field displays the current IP address of the LAG interface. If the IP address is 0.0.0.0, the interface does not have an IP address yet. This screen also shows whether the IP address is a static IP address (STATIC) or dynamically assigned (DHCP). IP addresses are always static in virtual interfaces.
Slaves	A slave is a physical Ethernet interface that is a member of a LAG. Slaves do not have an IP Address and in some cases share the same MAC address. This field displays the member Ethernet interfaces and VLAN interfaces in the LAG. It is blank for virtual interfaces.

Table 129 Configuration > Network > Interface > LAG (continued)

LABEL	DESCRIPTION
Apply	Click Apply to save your changes back to the Zyxel Device.
Reset	Click Reset to return the screen to its last-saved settings.

10.10.2 LAG Add/Edit

This screen lets you configure Interface and LAG parameters for each LAG interface. To access this screen, click the **Add** or **Edit** icon in the **LAG** screen. The following screen appears.

Figure 283 Configuration > Network > Interface > LAG > Add

Add LAG

Hide Advanced Settings

General Settings

Enable Interface

Interface Properties

Interface Type: general

Interface Name: lag

Zone: LAN

Description: (Optional)

LAG Configuration

Mode: active-backup

Link Monitoring: none

Available

- ge-1
- ge-2
- ge-3
- ge-6
- ge-7
- ge-8

Slaves

IP Address Assignment

Get Automatically

Use Fixed IP Address

IP Address: 0.0.0.0

Subnet Mask: 0.0.0.0

Gateway: (Optional)

Metric: 0 (0-15)

Enable IGMP Support

IGMP Upstream

IGMP Downstream

Advance

Interface Parameters

Egress Bandwidth: 1048576 Kbps

Ingress Bandwidth: 1048576 Kbps

MTU: 1500 Bytes

DHCP Setting

DHCP: None

Enable IP/MAC Binding

Enable Logs for IP/MAC Binding Violation

Static DHCP Table

#	IP Address	MAC	Description
No data to display			

Connectivity Check

Enable Connectivity Check

Check Method: icmp

Check Period: 30 (5-600 seconds)

Check Timeout: 5 (1-10 seconds)

Check Fail Tolerance: 5 (1-10)

Check Default Gateway: 0.0.0.0

Check this address: (Domain Name or IP Address)

Related Setting

Configure [WAN_TTL/FIR](#)

Configure [Policy Route](#)

OK Cancel

Each field is described in the following table.

Table 130 Configuration > Network > Interface > LAG > Add

LABEL	DESCRIPTION
General Settings	
Enable Interface	Select this to enable this interface. Clear this to disable this interface.
Interface Properties	
Interface Type	Select one of the following option depending on the type of network to which the Zyxel Device is connected or if you want to additionally manually configure some related settings. internal is for connecting to a local network. Other corresponding configuration options: DHCP server and DHCP relay. The Zyxel Device automatically adds default SNAT settings for traffic flowing from this interface to an external interface. external is for connecting to an external network (like the Internet). The Zyxel Device automatically adds this interface to the default WAN trunk. For general , the rest of the screen's options do not automatically adjust and you must manually configure a policy route to add routing and SNAT settings for the interface.
Interface Name	This field is read-only if you are editing the interface. Enter the name of the LAG interface. The format is lagx, where x is 0 - 3. For example, lag0, lag1, and so on.
Zone	Select the zone to which the interface is to belong. You use zones to apply security settings such as security policy, IDP, remote management, anti-virus, and application patrol.
Description	Enter a description of this interface. You can use alphanumeric and () + / : = ? ! * # @ \$ % - characters, and it can be up to 60 characters long. Spaces are allowed, but the string can't start with a space.
LAG Configuration	
Mode	Select a Mode for this LAG interface. Choices are as follows: <ul style="list-style-type: none"> active-backup where only one slave in the LAG interface is active and another slave becomes active only if the active slave fails. 802.3ad (IEEE 802.3ad Dynamic link aggregation) where Link Aggregation Control Protocol (LACP) negotiates automatic combining of links and balances the traffic load across the LAG link by sending LACP packets to the directly connected device that also implements LACP. The slaves must have the same speed and duplex settings. balance-alb (adaptive load balancing) where traffic is distributed according to the current load on each slave by ARP negotiation. Incoming traffic is received by the current slave. If the receiving slave fails, another slave takes over the MAC address of the failed receiving slave.
Link Monitoring	Select from none , mii or arp . none means no link monitoring is done. mii monitoring monitors the state of the local interface; it can't tell if the link can transmit or receive packets. arp monitoring sends ARP queries and uses the reply to know if the link is up and that traffic is flowing over the link.
Miimom	This field displays for mii Link Monitoring. Set the link check interval in milliseconds that the system polls the Media Independent Interface (MII) to get status.
Updelay	This field displays for mii Link Monitoring. Set the waiting time in milliseconds to confirm the slave interface status is up.
Downdelay	This field displays for mii Link Monitoring. Set the waiting time in milliseconds to confirm the slave interface status is down.
Xmit Hash Policy	This field displays in 802.3ad Mode. This field sets the algorithm for slave selection according to the selected TCP/IP layer.
LACP Rate	This field displays in 802.3ad Mode. Select the preferred LACPDU packet transmission rate (slow/fast) to request from 802.3ad partner.
ARP Interval	This field displays for arp Link Monitoring. Select the frequency of ARP requests sent to confirm a that slave interface is up.

Table 130 Configuration > Network > Interface > LAG > Add (continued)

LABEL	DESCRIPTION
ARP IP Target	This field displays for arp Link Monitoring. Set the IP address of the link to send ARP queries.
Available	This field displays Ethernet interfaces and VLAN interfaces that can become part of the LAG interface. An interface is not available in the following situations: <ul style="list-style-type: none"> • There is a virtual interface on top of it • It is already used in a different LAG interface Select one, and click the >> arrow to add it to the LAG interface. Each LAG interface can only have one VLAN interface.
Slaves	A slave is a physical Ethernet interface that is a member of a LAG. This field displays the interfaces that are part of the LAG interface. Select one, and click the << arrow to remove it from the LAG interface.
IP Address Assignment	
Get Automatically	Select this if this interface is a DHCP client. In this case, the DHCP server configures the IP address, subnet mask, and gateway automatically.
Use Fixed IP Address	Select this if you want to specify the IP address, subnet mask, and gateway manually.
IP Address	This field is enabled if you select Use Fixed IP Address . Enter the IP address for this interface.
Subnet Mask	This field is enabled if you select Use Fixed IP Address . Enter the subnet mask of this interface in dot decimal notation. The subnet mask indicates what part of the IP address is the same for all computers in the network.
Gateway	This field is enabled if you select Use Fixed IP Address . Enter the IP address of the gateway. The Zyxel Device sends packets to the gateway when it does not know how to route the packet to its destination. The gateway should be on the same network as the interface.
Metric	Enter the priority of the gateway (if any) on this interface. The Zyxel Device decides which gateway to use based on this priority. The lower the number, the higher the priority. If two or more gateways have the same priority, the Zyxel Device uses the one that was configured first.
Enable IGMP Support	Select this to allow the Zyxel Device to act as an IGMP proxy for hosts connected on the IGMP downstream interface.
IGMP Upstream	Enable IGMP Upstream on the interface which connects to a router running IGMP that is closer to the multicast server.
IGMP Downstream	Enable IGMP Downstream on the interface which connects to the multicast hosts.
DHCP Setting	
DHCP	Select what type of DHCP service the Zyxel Device provides to the network. Choices are: <p>None - the Zyxel Device does not provide any DHCP services. There is already a DHCP server on the network.</p> <p>DHCP Relay - the Zyxel Device routes DHCP requests to one or more DHCP servers you specify. The DHCP server(s) may be on another network.</p> <p>DHCP Server - the Zyxel Device assigns IP addresses and provides subnet mask, gateway, and DNS server information to the network. The Zyxel Device is the DHCP server for the network.</p>
	These fields appear if the Zyxel Device is a DHCP Relay .
Relay Server 1	Enter the IP address of a DHCP server for the network.
Relay Server 2	This field is optional. Enter the IP address of another DHCP server for the network.

Table 130 Configuration > Network > Interface > LAG > Add (continued)

LABEL	DESCRIPTION
	These fields appear if the Zyxel Device is a DHCP Server .
IP Pool Start Address	Enter the IP address from which the Zyxel Device begins allocating IP addresses. If you want to assign a static IP address to a specific computer, click Add Static DHCP . If this field is blank, the Pool Size must also be blank. In this case, the Zyxel Device can assign every IP address allowed by the interface's IP address and subnet mask, except for the first address (network address), last address (broadcast address) and the interface's IP address.
Pool Size	Enter the number of IP addresses to allocate. This number must be at least one and is limited by the interface's Subnet Mask . For example, if the Subnet Mask is 255.255.255.0 and IP Pool Start Address is 10.10.10.10, the Zyxel Device can allocate 10.10.10.10 to 10.10.10.254, or 245 IP addresses. If this field is blank, the IP Pool Start Address must also be blank. In this case, the Zyxel Device can assign every IP address allowed by the interface's IP address and subnet mask, except for the first address (network address), last address (broadcast address) and the interface's IP address.
First DNS Server Second DNS Server Third DNS Server	Specify the IP addresses up to three DNS servers for the DHCP clients to use. Use one of the following ways to specify these IP addresses. Custom Defined - enter a static IP address. From ISP - select the DNS server that another interface received from its DHCP server. Zyxel Device - the DHCP clients use the IP address of this interface and the Zyxel Device works as a DNS relay.
First WINS Server, Second WINS Server	Type the IP address of the WINS (Windows Internet Naming Service) server that you want to send to the DHCP clients. The WINS server keeps a mapping table of the computer names on your network and the IP addresses that they are currently using.
Default Router	If you set this interface to DHCP Server , you can select to use either the interface's IP address or another IP address as the default router. This default router will become the DHCP clients' default gateway. To use another IP address as the default router, select Custom Defined and enter the IP address.
Lease time	Specify how long each computer can use the information (especially the IP address) before it has to request the information again. Choices are: infinite - select this if IP addresses never expire days, hours, and minutes - select this to enter how long IP addresses are valid.
Extended Options	This table is available if you selected DHCP server . Configure this table if you want to send more information to DHCP clients through DHCP packets.
Add	Click this to create an entry in this table. See Section 10.4.6 on page 351 .
Edit	Select an entry in this table and click this to modify it.
Remove	Select an entry in this table and click this to delete it.
#	This field is a sequential value, and it is not associated with any entry.
Name	This is the option's name.
Code	This is the option's code number.
Type	This is the option's type.
Value	This is the option's value.
Enable IP/MAC Binding	Select this option to have this interface enforce links between specific IP addresses and specific MAC addresses. This stops anyone else from manually using a bound IP address on another device connected to this interface. Use this to make use only the intended users get to use specific IP addresses.

Table 130 Configuration > Network > Interface > LAG > Add (continued)

LABEL	DESCRIPTION
Enable Logs for IP/MAC Binding Violation	Select this option to have the Zyxel Device generate a log if a device connected to this interface attempts to use an IP address that is bound to another device's MAC address.
Static DHCP Table	Configure a list of static IP addresses the Zyxel Device assigns to computers connected to the interface. Otherwise, the Zyxel Device assigns an IP address dynamically using the interface's IP Pool Start Address and Pool Size .
Add	Click this to create a new entry.
Edit	Select an entry and click this to be able to modify it.
Remove	Select an entry and click this to delete it.
#	This field is a sequential value, and it is not associated with a specific entry.
IP Address	Enter the IP address to assign to a device with this entry's MAC address.
MAC Address	Enter the MAC address to which to assign this entry's IP address.
Description	Enter a description to help identify this static DHCP entry. You can use alphanumeric and () +/ : = ? ! * # @ \$ % _ - characters, and it can be up to 60 characters long.
Connectivity Check	The interface can regularly check the connection to the gateway you specified to make sure it is still available. You specify how often the interface checks the connection, how long to wait for a response before the attempt is a failure, and how many consecutive failures are required before the Zyxel Device stops routing to the gateway. The Zyxel Device resumes routing to the gateway the first time the gateway passes the connectivity check.
Enable Connectivity Check	Select this to turn on the connection check.
Check Method	Select the method that the gateway allows. Select icmp to have the Zyxel Device regularly ping the gateway you specify to make sure it is still available. Select tcp to have the Zyxel Device regularly perform a TCP handshake with the gateway you specify to make sure it is still available.
Check Period	Enter the number of seconds between connection check attempts.
Check Timeout	Enter the number of seconds to wait for a response before the attempt is a failure.
Check Fail Tolerance	Enter the number of consecutive failures before the Zyxel Device stops routing through the gateway.
Check Default Gateway	Select this to use the default gateway for the connectivity check.
Check this address	Select this to specify a domain name or IP address for the connectivity check. Enter that domain name or IP address in the field next to it.
Check Port	This field only displays when you set the Check Method to tcp . Specify the port number to use for a TCP connectivity check.
Related Setting	
Configure WAN TRUNK	Click WAN TRUNK to go to a screen where you can configure the interface as part of a WAN trunk for load balancing.
Configure Policy Route	Click Policy Route to go to the screen where you can manually configure a policy route to associate traffic with this bridge interface.
OK	Click OK to save your changes back to the Zyxel Device.
Cancel	Click Cancel to exit this screen without saving.

10.11 VTI

IPSec VPN Tunnel Interface (VTI) encrypts or decrypts IPv4 traffic from or to the interface according to the IP routing table.

VTI allows static routes to send traffic over the VPN. The IPSec tunnel endpoint is associated with an actual (virtual) interface. Therefore many interface capabilities such as Policy Route, Static Route, Trunk, and BWM can be applied to the IPSec tunnel as soon as the tunnel is active

IPSec VTIs simplifies network management and load balancing. Create a trunk using VPN tunnel interfaces for load balancing. In the following example configure VPN tunnels with static IP addresses or DNS on both Zyxel Devices (or IPSec routers at the end of the tunnel). Also configure VTI and a trunk on both Zyxel Devices.

Figure 284 VTI and Trunk for VPN Load Balancing

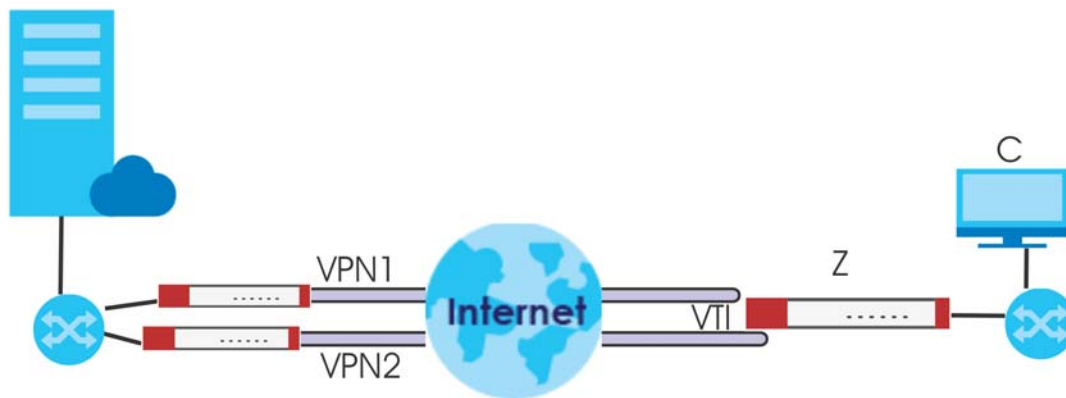

10.11.1 Restrictions for IPSec Virtual Tunnel Interface

- IPv4 traffic only
- IPSec tunnel mode only. A shared keyword must not be configured when using tunnel mode.
- With a VTI VPN you do not add local or remote LANs to your VPN configuration.
- For a VTI VPN you should only have one local and one remote WAN.
- A dynamic peer is not supported
- The IPSec VTI is limited to IP unicast and multicast traffic only.

10.11.2 VTI Screen

To access this screen, click **Configuration > Network > Interface > VTI**.

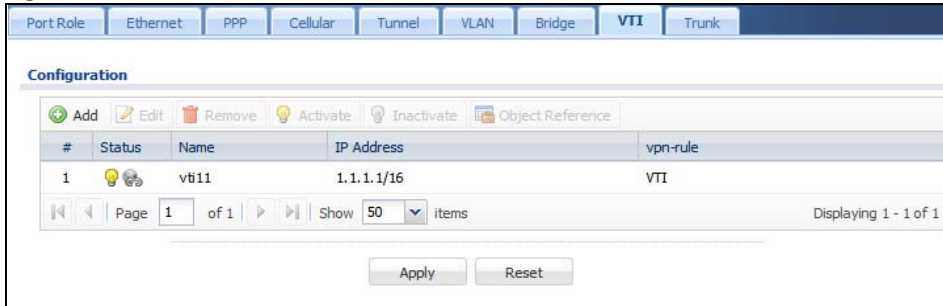
Figure 285 Configuration > Network > Interface > VTI

The following table describes the fields in this screen.

Table 131 Configuration > Network > Interface > VTI

LABEL	DESCRIPTION
Configuration	
Add	Click this to create a new entry.
Edit	Double-click an entry or select it and click Edit to open a screen where you can modify the entry's settings.
Remove	To remove an entry, select it and click Remove . The Zyxel Device confirms you want to remove it before doing so.
Activate	To turn on an entry, select it and click Activate .
Inactivate	To turn off an entry, select it and click Inactivate .
References	Select an entry and click References to open a screen that shows which settings use the entry.
#	This field is a sequential value, and it is not associated with any interface.
Status	This icon is lit when the entry is active and dimmed when the entry is inactive.
Name	This field displays the name of the VTI interface.
IP Address	This field displays the current IP address of the virtual interface and subnet mask in bits. If the IP address is 0.0.0.0, the interface does not have an IP address yet.
vpn-rule	This shows the name of the associated IPSec VPN rule with VPN Tunnel Interface application scenario.
Apply	Click Apply to save your changes back to the Zyxel Device.
Reset	Click Reset to return the screen to its last-saved settings.

10.11.3 VTI Add/Edit

This screen lets you configure IP address assignment and interface parameters for VTI.

Note: You should have created a VPN tunnel for a **VPN Tunnel Interface** scenario first.

To access this screen, click the **Add** or **Edit** icon in **Network > Interface > VTI**. The following screen appears.

Figure 286 Configuration > Network > Interface > VTI > Add

Each field is described in the table below.

Table 132 Configuration > Network > Interface > VTI > Add

LABEL	DESCRIPTION
General Settings	
Enable	Select this to enable VTI. Clear this to disable it.
Interface Properties	
Interface Name	This field is read-only if you are editing an existing VPN tunnel interface. For a new VPN tunnel interface, enter the name of the VPN tunnel interface in vti format, where x is a number from 0 to the maximum number of VPN connections allowed for this model. For example, enter vti10.
Zone	Select a zone. Make sure that the zone you select does not have traffic blocked by a security feature such as a security policy.

Table 132 Configuration > Network > Interface > VTI > Add (continued)

LABEL	DESCRIPTION
vpn-rule	You should have created a VPN tunnel first for a VPN Tunnel Interface scenario. Select one of the VPN Tunnel Interface scenario rules that you created.
IP Address Assignment	
IP Address	Enter the IP address for this interface.
Subnet Mask	Enter the subnet mask of this interface in dot decimal notation. The subnet mask indicates what part of the IP address is the same for all computers in the network.
Metric	Enter the priority of the gateway (if any) on this interface. The Zyxel Device decides which gateway to use based on this priority. The lower the number, the higher the priority. If two or more gateways have the same priority, the Zyxel Device uses the one that was configured first.
Enable IGMP Support	Select this to allow the Zyxel Device to act as an IGMP proxy for hosts connected on the IGMP downstream interface.
IGMP Upstream	Enable IGMP Upstream on the interface which connects to a router running IGMP that is closer to the multicast server.
IGMP Downstream	Enable IGMP Downstream on the interface which connects to the multicast hosts.
Interface Parameters	
Egress Bandwidth	Enter the maximum amount of traffic, in kilobits per second, the Zyxel Device can send through the interface to the network. Allowed values are 0 - 1048576.
Ingress Bandwidth	This is reserved for future use. Enter the maximum amount of traffic, in kilobits per second, the Zyxel Device can receive from the network through the interface. Allowed values are 0 - 1048576.
MTU	The Maximum Transmission Unit. Type the maximum size of each IPv6 data packet, in bytes, that can move through this interface. If a larger packet arrives, the Zyxel Device discards the packet and sends an error message to the sender to inform this.
Connectivity Check	These fields appear when you select a vpn-rule . The interface can regularly check the connection to the gateway you specified to make sure it is still available. You specify how often the interface checks the connection, how long to wait for a response before the attempt is a failure, and how many consecutive failures are required before the Zyxel Device stops routing to the gateway. The Zyxel Device resumes routing to the gateway the first time the gateway passes the connectivity check.
Enable Connectivity Check	Select this to turn on the connection check.
Check Method	Select the method that the gateway allows. Select icmp to have the Zyxel Device regularly ping the gateway you specify to make sure it is still available. Select tcp to have the Zyxel Device regularly perform a TCP handshake with the gateway you specify to make sure it is still available.
Check Period	Enter the number of seconds between connection check attempts.
Check Timeout	Enter the number of seconds to wait for a response before the attempt is a failure.
Check Fail Tolerance	Enter the number of consecutive failures before the Zyxel Device stops routing through the gateway.
Check this address	Select this to specify a domain name or IP address for the connectivity check. Enter that domain name or IP address in the field next to it.
Check Port	This field only displays when you set the Check Method to tcp . Specify the port number to use for a TCP connectivity check.
RIP Setting	See Section 11.6 on page 441 for more information about RIP.

Table 132 Configuration > Network > Interface > VTI > Add (continued)

LABEL	DESCRIPTION
Enable RIP	Select this to enable RIP in this interface.
Direction	This field is effective when RIP is enabled. Select the RIP direction from the drop-down list box. BiDir - This interface sends and receives routing information. In-Only - This interface receives routing information. Out-Only - This interface sends routing information.
Send Version	This field is effective when RIP is enabled. Select the RIP version(s) used for sending RIP packets. Choices are 1 , 2 , and 1 and 2 .
Receive Version	This field is effective when RIP is enabled. Select the RIP version(s) used for receiving RIP packets. Choices are 1 , 2 , and 1 and 2 .
V2-Broadcast	This field is effective when RIP is enabled. Select this to send RIP-2 packets using subnet broadcasting; otherwise, the Zyxel Device uses multicasting.
OSPF Setting	See Section 11.7 on page 443 for more information about OSPF.
Area	Select the area in which this interface belongs. Select None to disable OSPF in this interface.
Priority	Enter the priority (between 0 and 255) of this interface when the area is looking for a Designated Router (DR) or Backup Designated Router (BDR). The highest-priority interface identifies the DR, and the second-highest-priority interface identifies the BDR. Set the priority to zero if the interface can not be the DR or BDR.
Link Cost	Enter the cost (between 1 and 65,535) to route packets through this interface.
Passive Interface	Select this to stop forwarding OSPF routing information from the selected interface. As a result, this interface only receives routing information.
Authentication	Select an authentication method, or disable authentication. To exchange OSPF routing information with peer border routers, you must use the same authentication method that they use. Choices are: Same-as-Area - use the default authentication method in the area None - disable authentication Text - authenticate OSPF routing information using a plain-text password MD5 - authenticate OSPF routing information using MD5 encryption
Text Authentication Key	This field is available if the Authentication is Text . Type the password for text authentication. The key can consist of alphanumeric characters and the underscore, and it can be up to 16 characters long.
MD5 Authentication ID	This field is available if the Authentication is MD5 . Type the ID for MD5 authentication. The ID can be between 1 and 255.
MD5 Authentication Key	This field is available if the Authentication is MD5 . Type the password for MD5 authentication. The password can consist of alphanumeric characters and the underscore, and it can be up to 16 characters long.
Related Setting	
Configure WAN TRUNK	Click WAN TRUNK to go to a screen where you can configure the interface as part of a WAN trunk for load balancing.
Policy Route	Click Policy Route to go to the screen where you can manually configure a policy route to associate traffic with this interface.
OK	Click OK to save your changes back to the Zyxel Device.
Cancel	Click Cancel to exit this screen without saving.

10.12 Trunk Overview

Use trunks for WAN traffic load balancing to increase overall network throughput and reliability. Load balancing divides traffic loads between multiple interfaces. This allows you to improve quality of service and maximize bandwidth utilization for multiple ISP links.

Maybe you have two Internet connections with different bandwidths. You could set up a trunk that uses spillover or weighted round robin load balancing so time-sensitive traffic (like video) usually goes through the higher-bandwidth interface. For other traffic, you might want to use least load first load balancing to even out the distribution of the traffic load.

Suppose ISP A has better connections to Europe while ISP B has better connections to Australia. You could use policy routes and trunks to have traffic for your European branch office primarily use ISP A and traffic for your Australian branch office primarily use ISP B.

Or maybe one of the Zyxel Device's interfaces is connected to an ISP that is also your Voice over IP (VoIP) service provider. You can use policy routing to send the VoIP traffic through a trunk with the interface connected to the VoIP service provider set to active and another interface (connected to another ISP) set to passive. This way VoIP traffic goes through the interface connected to the VoIP service provider whenever the interface's connection is up.

- Use the **Trunk** summary screen ([Section 10.13 on page 420](#)) to view the list of configured trunks and which load balancing algorithm each trunk uses.
- Use the **Add Trunk** screen ([Section 10.13.1 on page 421](#)) to configure the member interfaces for a trunk and the load balancing algorithm the trunk uses.
- Use the **Add System Default** screen ([Section 10.13.2 on page 423](#)) to configure the load balancing algorithm for the system default trunk.

10.12.1 What You Need to Know

- Add WAN interfaces to trunks to have multiple connections share the traffic load.
- If one WAN interface's connection goes down, the Zyxel Device sends traffic through another member of the trunk.
- For example, you connect one WAN interface to one ISP and connect a second WAN interface to a second ISP. The Zyxel Device balances the WAN traffic load between the connections. If one interface's connection goes down, the Zyxel Device can automatically send its traffic through another interface.

You can also use trunks with policy routing to send specific traffic types through the best WAN interface for that type of traffic.

- If that interface's connection goes down, the Zyxel Device can still send its traffic through another interface.
- You can define multiple trunks for the same physical interfaces.

- 1 LAN user **A** logs into server **B** on the Internet. The Zyxel Device uses wan1 to send the request to server **B**.
- 2 The Zyxel Device is using active/active load balancing. So when LAN user **A** tries to access something on the server, the request goes out through wan2.
- 3 The server finds that the request comes from wan2's IP address instead of wan1's IP address and rejects the request.

If link sticking had been configured, the Zyxel Device would have still used wan1 to send LAN user **A**'s request to the server and server would have given the user **A** access.

Load Balancing Algorithms

The following sections describe the load balancing algorithms the Zyxel Device can use to decide which interface the traffic (from the LAN) should use for a session. In the load balancing section, a session may refer to normal connection-oriented, UDP or SNMP2 traffic. The available bandwidth you configure on the Zyxel Device refers to the actual bandwidth provided by the ISP and the measured bandwidth refers to the bandwidth an interface is currently using.

Least Load First

The least load first algorithm uses the current (or recent) outbound bandwidth utilization of each trunk member interface as the load balancing index(es) when making decisions about to which interface a new session is to be distributed. The outbound bandwidth utilization is defined as the measured outbound throughput over the available outbound bandwidth.

Here the Zyxel Device has two WAN interfaces connected to the Internet. The configured available outbound bandwidths for WAN 1 and WAN 2 are 512K and 256K respectively.

Figure 287 Load Balancing Least Load First Example

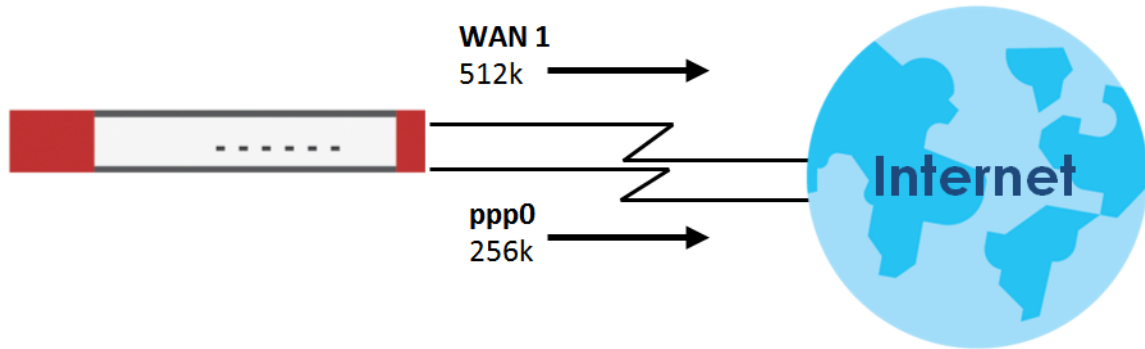

The outbound bandwidth utilization is used as the load balancing index. In this example, the measured (current) outbound throughput of WAN 1 is 412K and WAN 2 is 198K. The Zyxel Device calculates the load balancing index as shown in the table below.

Since WAN 2 has a smaller load balancing index (meaning that it is less utilized than WAN 1), the Zyxel Device will send the subsequent new session traffic through WAN 2.

Table 133 Least Load First Example

INTERFACE	OUTBOUND		LOAD BALANCING INDEX (M/A)
	AVAILABLE (A)	MEASURED (M)	
WAN 1	512 K	412 K	0.8
WAN 2	256 K	198 K	0.77

Weighted Round Robin

Round Robin scheduling services queues on a rotating basis and is activated only when an interface has more traffic than it can handle. A queue is given an amount of bandwidth irrespective of the incoming

traffic on that interface. This queue then moves to the back of the list. The next queue is given an equal amount of bandwidth, and then moves to the end of the list; and so on, depending on the number of queues being used. This works in a looping fashion until a queue is empty.

The Weighted Round Robin (WRR) algorithm is best suited for situations when the bandwidths set for the two WAN interfaces are different. Similar to the Round Robin (RR) algorithm, the Weighted Round Robin (WRR) algorithm sets the Zyxel Device to send traffic through each WAN interface in turn. In addition, the WAN interfaces are assigned weights. An interface with a larger weight gets more chances to transmit traffic than an interface with a smaller weight.

For example, in the figure below, the configured available bandwidth of WAN1 is 1M and WAN2 is 512K. You can set the Zyxel Device to distribute the network traffic between the two interfaces by setting the weight of wan1 and wan2 to 2 and 1 respectively. The Zyxel Device assigns the traffic of two sessions to wan1 and one session's traffic to wan2 in each round of 3 new sessions.

Figure 288 Weighted Round Robin Algorithm Example

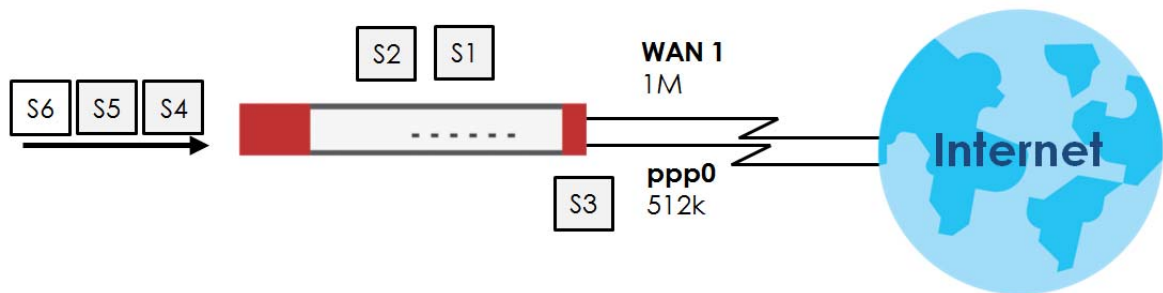

Spillover

The spillover load balancing algorithm sends network traffic to the first interface in the trunk member list until the interface's maximum allowable load is reached, then sends the excess network traffic of new sessions to the next interface in the trunk member list. This continues as long as there are more member interfaces and traffic to be sent through them.

Suppose the first trunk member interface uses an unlimited access Internet connection and the second is billed by usage. Spillover load balancing only uses the second interface when the traffic load exceeds the threshold on the first interface. This fully utilizes the bandwidth of the first interface to reduce Internet usage fees and avoid overloading the interface.

In this example figure, the upper threshold of the first interface is set to 800K. The Zyxel Device sends network traffic of new sessions that exceed this limit to the secondary WAN interface.

Figure 289 Spillover Algorithm Example

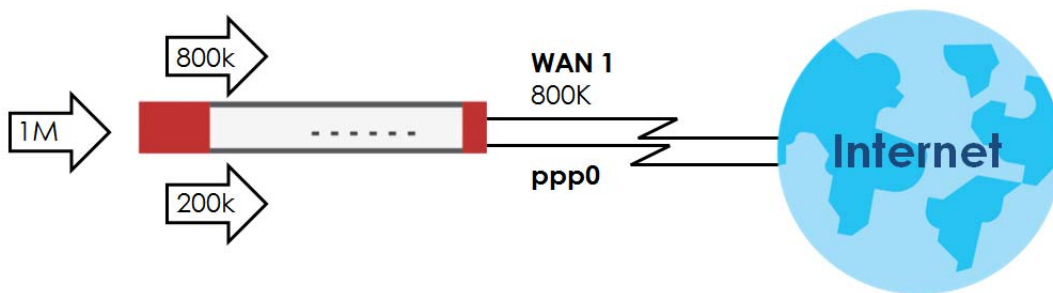

10.13 The Trunk Summary Screen

Click **Configuration > Network > Interface > Trunk** to open the **Trunk** screen. The Trunk Summary screen lists the configured trunks and the load balancing algorithm that each is configured to use.

Figure 290 Configuration > Network > Interface > Trunk

The following table describes the items in this screen.

Table 134 Configuration > Network > Interface > Trunk

LABEL	DESCRIPTION
Show Advanced Settings / Hide Advanced Settings	Click this button to display a greater or lesser number of configuration fields.
Configuration	Configure what to do with existing passive mode interface connections when an interface set to active mode in the same trunk comes back up.
Disconnect Connections Before Falling Back	Select this to terminate existing connections on an interface which is set to passive mode when any interface set to active mode in the same trunk comes back up.
Enable Default SNAT	Select this to have the ZyXel Device use the IP address of the outgoing interface as the source IP address of the packets it sends out through its WAN trunks. The ZyXel Device automatically adds SNAT settings for traffic it routes from internal interfaces to external interfaces.
Default Trunk Selection	Select whether the ZyXel Device is to use the default system WAN trunk or one of the user configured WAN trunks as the default trunk for routing traffic from internal interfaces to external interfaces.

Table 134 Configuration > Network > Interface > Trunk (continued)

LABEL	DESCRIPTION
User Configuration / System Default	The Zyxel Device automatically adds all external interfaces into the pre-configured system default SYSTEM_DEFAULT_WAN_TRUNK . You cannot delete it. You can create your own User Configuration trunks and customize the algorithm, member interfaces and the active/passive mode.
Add	Click this to create a new user-configured trunk.
Edit	Double-click an entry or select it and click Edit to open a screen where you can modify the entry's settings.
Remove	To remove a user-configured trunk, select it and click Remove . The Zyxel Device confirms you want to remove it before doing so.
References	Select an entry and click References to open a screen that shows which settings use the entry. See Section 10.4.4 on page 350 for an example.
#	This field is a sequential value, and it is not associated with any interface.
Name	This field displays the label that you specified to identify the trunk.
Algorithm	This field displays the load balancing method the trunk is set to use.
Apply	Click this button to save your changes to the Zyxel Device.
Reset	Click this button to return the screen to its last-saved settings.

10.13.1 Configuring a User-Defined Trunk

Click **Configuration > Network > Interface > Trunk**, in the **User Configuration** table click the **Add** (or **Edit**) icon to open the **following** screen. Use this screen to create or edit a WAN trunk entry.

Figure 291 Configuration > Network > Interface > Trunk > Add (or Edit)

Each field is described in the table below.

Table 135 Configuration > Network > Interface > Trunk > Add (or Edit)

LABEL	DESCRIPTION
Name	This is read-only if you are editing an existing trunk. When adding a new trunk, enter a descriptive name for this trunk. You may use 1-31 alphanumeric characters, underscores (<u>_</u>), or dashes (-), but the first character cannot be a number. This value is case-sensitive.
Load Balancing Algorithm	<p>Select a load balancing method to use from the drop-down list box.</p> <p>Select Weighted Round Robin to balance the traffic load between interfaces based on their respective weights. An interface with a larger weight gets more chances to transmit traffic than an interface with a smaller weight. For example, if the weight ratio of wan1 and wan2 interfaces is 2:1, the Zyxel Device chooses wan1 for 2 sessions' traffic and wan2 for 1 session's traffic in each round of 3 new sessions.</p> <p>Select Least Load First to send new session traffic through the least utilized trunk member.</p> <p>Select Spillover to send network traffic through the first interface in the group member list until there is enough traffic that the second interface needs to be used (and so on).</p>
Load Balancing Index(es)	<p>This field is available if you selected to use the Least Load First or Spillover method.</p> <p>Select Outbound, Inbound, or Outbound + Inbound to set the traffic to which the Zyxel Device applies the load balancing method. Outbound means the traffic traveling from an internal interface (ex. LAN) to an external interface (ex. WAN). Inbound means the opposite.</p>
	The table lists the trunk's member interfaces. You can add, edit, remove, or move entries for user configured trunks.
Add	Click this to add a member interface to the trunk. Select an interface and click Add to add a new member interface after the selected member interface.
Edit	Select an entry and click Edit to modify the entry's settings.
Remove	To remove a member interface, select it and click Remove . The Zyxel Device confirms you want to remove it before doing so.
Move	To move an interface to a different number in the list, click the Move icon. In the field that appears, specify the number to which you want to move the interface.
#	This column displays the priorities of the group's interfaces. The order of the interfaces in the list is important since they are used in the order they are listed.
Member	<p>Click this table cell and select an interface to be a group member.</p> <p>If you select an interface that is part of another Ethernet interface, the Zyxel Device does not send traffic through the interface as part of the trunk. For example, if you have physical port 5 in the ge2 representative interface, you must select interface ge2 in order to send traffic through port 5 as part of the trunk. If you select interface ge5 as a member here, the Zyxel Device will not send traffic through port 5 as part of the trunk.</p>
Mode	<p>Click this table cell and select Active to have the Zyxel Device always attempt to use this connection.</p> <p>Select Passive to have the Zyxel Device only use this connection when all of the connections set to active are down. You can only set one of a group's interfaces to passive mode.</p>
Weight	This field displays with the weighted round robin load balancing algorithm. Specify the weight (1~10) for the interface. The weights of the different member interfaces form a ratio. This ratio determines how much traffic the Zyxel Device assigns to each member interface. The higher an interface's weight is (relative to the weights of the interfaces), the more sessions that interface should handle.

Table 135 Configuration > Network > Interface > Trunk > Add (or Edit) (continued)

LABEL	DESCRIPTION
Ingress Bandwidth	This is reserved for future use. This field displays with the least load first load balancing algorithm. It displays the maximum number of kilobits of data the Zyxel Device is to allow to come in through the interface per second. Note: You can configure the bandwidth of an interface in the corresponding interface edit screen.
Egress Bandwidth	This field displays with the least load first or spillover load balancing algorithm. It displays the maximum number of kilobits of data the Zyxel Device is to send out through the interface per second. Note: You can configure the bandwidth of an interface in the corresponding interface edit screen.
Spillover	This field displays with the spillover load balancing algorithm. Specify the maximum bandwidth of traffic in kilobits per second (1~1048576) to send out through the interface before using another interface. When this spillover bandwidth limit is exceeded, the Zyxel Device sends new session traffic through the next interface. The traffic of existing sessions still goes through the interface on which they started. The Zyxel Device uses the group member interfaces in the order that they are listed.
OK	Click OK to save your changes back to the Zyxel Device.
Cancel	Click Cancel to exit this screen without saving.

10.13.2 Configuring the System Default Trunk

In the **Configuration > Network > Interface > Trunk** screen and the **System Default** section, select the default trunk entry and click **Edit** to open the **following** screen. Use this screen to change the load balancing algorithm and view the bandwidth allocations for each member interface.

Note: The available bandwidth is allocated to each member interface equally and is not allowed to be changed for the default trunk.

Figure 292 Configuration > Network > Interface > Trunk > Edit (System Default)

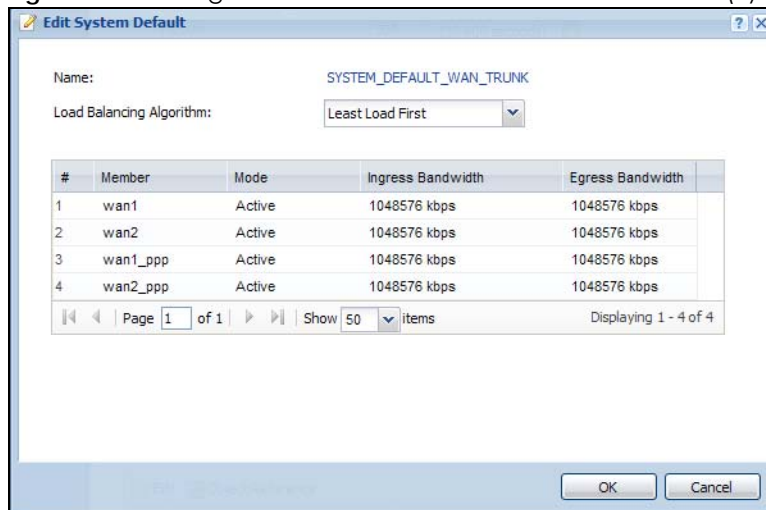

Each field is described in the table below.

Table 136 Configuration > Network > Interface > Trunk > Edit (System Default)

LABEL	DESCRIPTION
Name	This field displays the name of the selected system default trunk.
Load Balancing Algorithm	<p>Select the load balancing method to use for the trunk.</p> <p>Select Weighted Round Robin to balance the traffic load between interfaces based on their respective weights. An interface with a larger weight gets more chances to transmit traffic than an interface with a smaller weight. For example, if the weight ratio of wan1 and wan2 interfaces is 2:1, the Zykel Device chooses wan1 for 2 sessions' traffic and wan2 for 1 session's traffic in each round of 3 new sessions.</p> <p>Select Least Load First to send new session traffic through the least utilized trunk member.</p> <p>Select Spillover to send network traffic through the first interface in the group member list until there is enough traffic that the second interface needs to be used (and so on).</p>
	The table lists the trunk's member interfaces. This table is read-only.
#	This column displays the priorities of the group's interfaces. The order of the interfaces in the list is important since they are used in the order they are listed.
Member	This column displays the name of the member interfaces.
Mode	<p>This field displays Active if the Zykel Device always attempt to use this connection.</p> <p>This field displays Passive if the Zykel Device only use this connection when all of the connections set to active are down. Only one of a group's interfaces can be set to passive mode.</p>
Weight	This field displays with the weighted round robin load balancing algorithm. Specify the weight (1~10) for the interface. The weights of the different member interfaces form a ratio. s
Ingress Bandwidth	<p>This is reserved for future use.</p> <p>This field displays with the least load first load balancing algorithm. It displays the maximum number of kilobits of data the Zykel Device is to allow to come in through the interface per second.</p>
Egress Bandwidth	This field displays with the least load first or spillover load balancing algorithm. It displays the maximum number of kilobits of data the Zykel Device is to send out through the interface per second.
Spillover	<p>This field displays with the spillover load balancing algorithm. Specify the maximum bandwidth of traffic in kilobits per second (1~1048576) to send out through the interface before using another interface. When this spillover bandwidth limit is exceeded, the Zykel Device sends new session traffic through the next interface. The traffic of existing sessions still goes through the interface on which they started.</p> <p>The Zykel Device uses the group member interfaces in the order that they are listed.</p>
OK	Click OK to save your changes back to the Zykel Device.
Cancel	Click Cancel to exit this screen without saving.

10.14 Interface Technical Reference

Here is more detailed information about interfaces on the Zykel Device.

IP Address Assignment

Most interfaces have an IP address and a subnet mask. This information is used to create an entry in the routing table.

Figure 293 Example: Entry in the Routing Table Derived from Interfaces

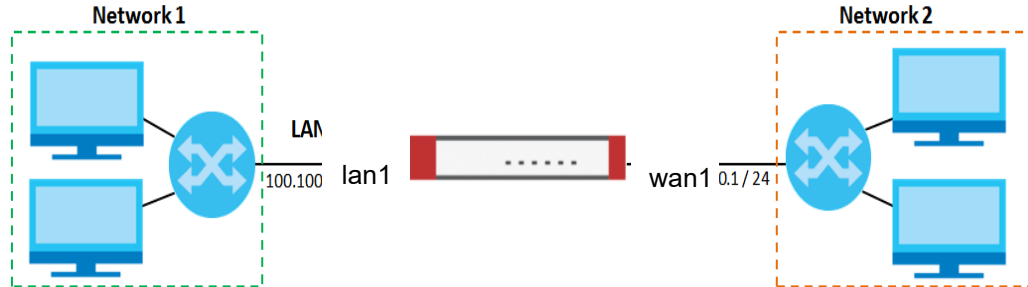

Table 137 Example: Routing Table Entries for Interfaces

IP ADDRESS(ES)	DESTINATION
100.100.1.1/16	lan1
200.200.200.1/24	wan1

For example, if the ZyXel Device gets a packet with a destination address of 100.100.25.25, it routes the packet to interface lan1. If the ZyXel Device gets a packet with a destination address of 200.200.200.200, it routes the packet to interface wan1.

In most interfaces, you can enter the IP address and subnet mask manually. In PPPoE/PPTP/L2TP interfaces, however, the subnet mask is always 255.255.255.255 because it is a point-to-point interface. For these interfaces, you can only enter the IP address.

In many interfaces, you can also let the IP address and subnet mask be assigned by an external DHCP server on the network. In this case, the interface is a DHCP client. Virtual interfaces, however, cannot be DHCP clients. You have to assign the IP address and subnet mask manually.

In general, the IP address and subnet mask of each interface should not overlap, though it is possible for this to happen with DHCP clients.

In the example above, if the ZyXel Device gets a packet with a destination address of 5.5.5.5, it might not find any entries in the routing table. In this case, the packet is dropped. However, if there is a default router to which the ZyXel Device should send this packet, you can specify it as a gateway in one of the interfaces. For example, if there is a default router at 200.200.200.100, you can create a gateway at 200.200.200.100 on ge2. In this case, the ZyXel Device creates the following entry in the routing table.

Table 138 Example: Routing Table Entry for a Gateway

IP ADDRESS(ES)	DESTINATION
0.0.0.0/0	200.200.200.100

The gateway is an optional setting for each interface. If there is more than one gateway, the ZyXel Device uses the gateway with the lowest metric, or cost. If two or more gateways have the same metric, the ZyXel Device uses the one that was set up first (the first entry in the routing table). In PPPoE/PPTP/L2TP interfaces, the other computer is the gateway for the interface by default. In this case, you should specify the metric.

If the interface gets its IP address and subnet mask from a DHCP server, the DHCP server also specifies the gateway, if any.

Interface Parameters

The Zyxel Device restricts the amount of traffic into and out of the Zyxel Device through each interface.

- Egress bandwidth sets the amount of traffic the Zyxel Device sends out through the interface to the network.
- Ingress bandwidth sets the amount of traffic the Zyxel Device allows in through the interface from the network. At the time of writing, the Zyxel Device does not support ingress bandwidth management.

If you set the bandwidth restrictions very high, you effectively remove the restrictions.

The Zyxel Device also restricts the size of each data packet. The maximum number of bytes in each packet is called the maximum transmission unit (MTU). If a packet is larger than the MTU, the Zyxel Device divides it into smaller fragments. Each fragment is sent separately, and the original packet is re-assembled later. The smaller the MTU, the more fragments sent, and the more work required to re-assemble packets correctly. On the other hand, some communication channels, such as Ethernet over ATM, might not be able to handle large data packets.

DHCP Settings

Dynamic Host Configuration Protocol (DHCP, RFC 2131, RFC 2132) provides a way to automatically set up and maintain IP addresses, subnet masks, gateways, and some network information (such as the IP addresses of DNS servers) on computers in the network. This reduces the amount of manual configuration you have to do and usually uses available IP addresses more efficiently.

In DHCP, every network has at least one DHCP server. When a computer (a DHCP client) joins the network, it submits a DHCP request. The DHCP servers get the request; assign an IP address; and provide the IP address, subnet mask, gateway, and available network information to the DHCP client. When the DHCP client leaves the network, the DHCP servers can assign its IP address to another DHCP client.

In the Zyxel Device, some interfaces can provide DHCP services to the network. In this case, the interface can be a DHCP relay or a DHCP server.

As a DHCP relay, the interface routes DHCP requests to DHCP servers on different networks. You can specify more than one DHCP server. If you do, the interface routes DHCP requests to all of them. It is possible for an interface to be a DHCP relay and a DHCP client simultaneously.

As a DHCP server, the interface provides the following information to DHCP clients.

- IP address - If the DHCP client's MAC address is in the Zyxel Device's static DHCP table, the interface assigns the corresponding IP address. If not, the interface assigns IP addresses from a pool, defined by the starting address of the pool and the pool size.

Table 139 Example: Assigning IP Addresses from a Pool

START IP ADDRESS	POOL SIZE	RANGE OF ASSIGNED IP ADDRESS
50.50.50.33	5	50.50.50.33 - 50.50.50.37
75.75.75.1	200	75.75.75.1 - 75.75.75.200
99.99.1.1	1023	99.99.1.1 - 99.99.4.255
120.120.120.100	100	120.120.120.100 - 120.120.120.199

The Zyxel Device cannot assign the first address (network address) or the last address (broadcast address) in the subnet defined by the interface's IP address and subnet mask. For example, in the first entry, if the subnet mask is 255.255.255.0, the Zyxel Device cannot assign 50.50.50.0 or 50.50.50.255. If the subnet mask is 255.255.0.0, the Zyxel Device cannot assign 50.50.0.0 or 50.50.255.255. Otherwise, it can assign every IP address in the range, except the interface's IP address.

If you do not specify the starting address or the pool size, the interface the maximum range of IP addresses allowed by the interface's IP address and subnet mask. For example, if the interface's IP address is 9.9.9.1 and subnet mask is 255.255.255.0, the starting IP address in the pool is 9.9.9.2, and the pool size is 253.

- Subnet mask - The interface provides the same subnet mask you specify for the interface. See [IP Address Assignment on page 425](#).
- Gateway - The interface provides the same gateway you specify for the interface. See [IP Address Assignment on page 425](#).
- DNS servers - The interface provides IP addresses for up to three DNS servers that provide DNS services for DHCP clients. You can specify each IP address manually (for example, a company's own DNS server), or you can refer to DNS servers that other interfaces received from DHCP servers (for example, a DNS server at an ISP). These other interfaces have to be DHCP clients.

It is not possible for an interface to be the DHCP server and a DHCP client simultaneously.

WINS

WINS (Windows Internet Naming Service) is a Windows implementation of NetBIOS Name Server (NBNS) on Windows. It keeps track of NetBIOS computer names. It stores a mapping table of your network's computer names and IP addresses. The table is dynamically updated for IP addresses assigned by DHCP. This helps reduce broadcast traffic since computers can query the server instead of broadcasting a request for a computer name's IP address. In this way WINS is similar to DNS, although WINS does not use a hierarchy (unlike DNS). A network can have more than one WINS server. Samba can also serve as a WINS server.

PPPoE/PPTP/L2TP Overview

Point-to-Point Protocol over Ethernet (PPPoE, RFC 2516) and Point-to-Point Tunneling Protocol (PPTP, RFC 2637) are usually used to connect two computers over phone lines or broadband connections. PPPoE is often used with cable modems and DSL connections. It provides the following advantages:

- The access and authentication method works with existing systems, including RADIUS.
- You can access one of several network services. This makes it easier for the service provider to offer the service
- PPPoE does not usually require any special configuration of the modem.

PPTP is used to set up virtual private networks (VPN) in unsecured TCP/IP environments. It sets up two sessions.

- 1** The first one runs on TCP port 1723. It is used to start and manage the second one.
- 2** The second one uses Generic Routing Encapsulation (GRE, RFC 2890) to transfer information between the computers.

PPTP is convenient and easy-to-use, but you have to make sure that firewalls support both PPTP sessions.

Layer 2 Tunneling Protocol (L2TP) was taken from PPTP of Microsoft and Cisco's L2F (Layer 2 Forwarding technology), so L2TP combines PPTP's control and runs over a faster transport protocol, UDP, although it may be a bit more complicated to set up.

It supports up to 256 bit session keys using the IPSec protocol. When security is a priority, L2TP is a good option as it requires certificates unlike PPTP.

It uses the following ports: UDP 500, Protocol 50, UDP 1701 and UDP 4500.

CHAPTER 11

Routing

11.1 Policy and Static Routes Overview

Use policy routes and static routes to override the Zyxel Device's default routing behavior in order to send packets through the appropriate interface or VPN tunnel.

For example, the next figure shows a computer (**A**) connected to the Zyxel Device's LAN interface. The Zyxel Device routes most traffic from **A** to the Internet through the Zyxel Device's default gateway (**R1**). You create one policy route to connect to services offered by your ISP behind router **R2**. You create another policy route to communicate with a separate network behind another router (**R3**) connected to the LAN.

Figure 294 Example of Policy Routing Topology

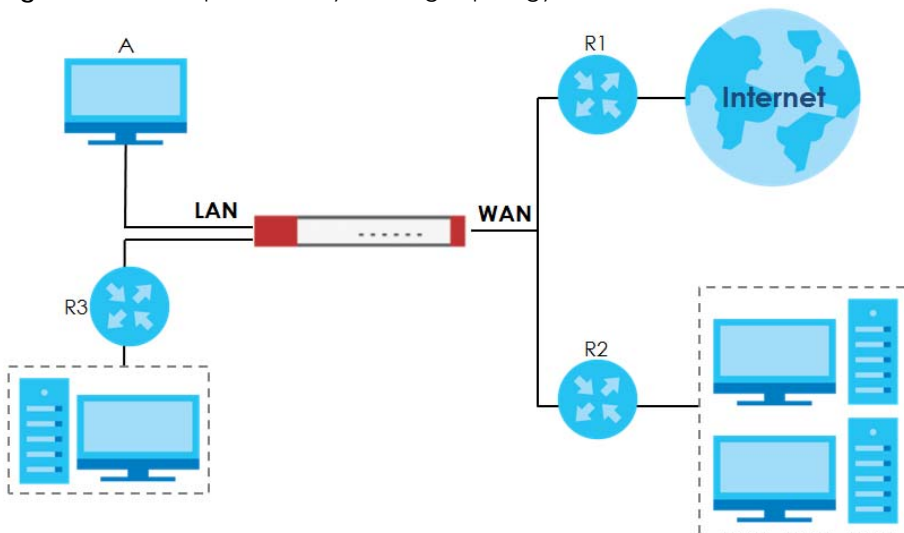

Note: You can generally just use policy routes. You only need to use static routes if you have a large network with multiple routers where you use RIP or OSPF to propagate routing information to other routers.

11.1.1 What You Can Do in this Chapter

- Use the **Policy Route** screens (see [Section 11.2 on page 431](#)) to list and configure policy routes.
- Use the **Static Route** screens (see [Section 11.3 on page 438](#)) to list and configure static routes.

11.1.2 What You Need to Know

Policy Routing

Traditionally, routing is based on the destination address only and the Zyxel Device takes the shortest path to forward a packet. IP Policy Routing (IPPR) provides a mechanism to override the default routing behavior and alter the packet forwarding based on the policy defined by the network administrator. Policy-based routing is applied to incoming packets on a per interface basis, prior to the normal routing.

How You Can Use Policy Routing

- Source-Based Routing – Network administrators can use policy-based routing to direct traffic from different users through different connections.
- Bandwidth Shaping – You can allocate bandwidth to traffic that matches routing policies and prioritize traffic (however the application patrol's bandwidth management is more flexible and recommended for TCP and UDP traffic). You can also use policy routes to manage other types of traffic (like ICMP traffic) and send traffic through VPN tunnels.

Note: Bandwidth management in policy routes has priority over application patrol bandwidth management.

- Cost Savings – IPPR allows organizations to distribute interactive traffic on high-bandwidth, high-cost paths while using low-cost paths for batch traffic.
- Load Sharing – Network administrators can use IPPR to distribute traffic among multiple paths.
- NAT - The Zyxel Device performs NAT by default for traffic going to or from the **WAN** interfaces. A routing policy's SNAT allows network administrators to have traffic received on a specified interface use a specified IP address as the source IP address.

Note: The Zyxel Device automatically uses SNAT for traffic it routes from internal interfaces to external interfaces, such as LAN to WAN traffic.

Static Routes

The Zyxel Device usually uses the default gateway to route outbound traffic from computers on the LAN to the Internet. To have the Zyxel Device send data to devices not reachable through the default gateway, use static routes. Configure static routes if you need to use RIP or OSPF to propagate the routing information to other routers. See [Chapter 11 on page 440](#) for more on RIP and OSPF.

Policy Routes Versus Static Routes

- Policy routes are more flexible than static routes. You can select more criteria for the traffic to match and can also use schedules, NAT, and bandwidth management.
- Policy routes are only used within the Zyxel Device itself. Static routes can be propagated to other routers using RIP or OSPF.
- Policy routes take priority over static routes. If you need to use a routing policy on the Zyxel Device and propagate it to other routers, you could configure a policy route and an equivalent static route.

DiffServ

QoS is used to prioritize source-to-destination traffic flows. All packets in the same flow are given the same priority. CoS (class of service) is a way of managing traffic in a network by grouping similar types of

traffic together and treating each type as a class. You can use CoS to give different priorities to different packet types.

DiffServ (Differentiated Services) is a class of service (CoS) model that marks packets so that they receive specific per-hop treatment at DiffServ-compliant network devices along the route based on the application types and traffic flow. Packets are marked with DiffServ Code Points (DSCPs) indicating the level of service desired. This allows the intermediary DiffServ-compliant network devices to handle the packets differently depending on the code points without the need to negotiate paths or remember state information for every flow. In addition, applications do not have to request a particular service or give advanced notice of where the traffic is going.

DSCP Marking and Per-Hop Behavior

DiffServ defines a new DS (Differentiated Services) field to replace the Type of Service (TOS) field in the IP header. The DS field contains a 2-bit unused field and a 6-bit DSCP field which can define up to 64 service levels. The following figure illustrates the DS field.

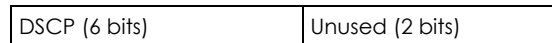

DSCP is backward compatible with the three precedence bits in the ToS octet so that non-DiffServ compliant, ToS-enabled network device will not conflict with the DSCP mapping.

The DSCP value determines the forwarding behavior, the PHB (Per-Hop Behavior), that each packet gets across the DiffServ network. Based on the marking rule, different kinds of traffic can be marked for different kinds of forwarding. Resources can then be allocated according to the DSCP values and the configured policies.

11.2 Policy Route Screen

Click **Configuration > Network > Routing** to open the **Policy Route** screen. Use this screen to see the configured policy routes and turn policy routing based bandwidth management on or off.

A policy route defines the matching criteria and the action to take when a packet meets the criteria. The action is taken only when all the criteria are met. The criteria can include the user name, source address and incoming interface, destination address, schedule, IP protocol (ICMP, UDP, TCP, etc.) and port.

The actions that can be taken include:

- Routing the packet to a different gateway, outgoing interface, VPN tunnel, or trunk.
- Limiting the amount of bandwidth available and setting a priority for traffic.

IPPR follows the existing packet filtering facility of RAS in style and in implementation.

If you enabled IPv6 in the **Configuration > System > IPv6** screen, you can also configure policy routes used for your IPv6 networks on this screen.

Click on the icons to go to the OneSecurity website where there is guidance on configuration walkthroughs, troubleshooting, and other information.

Figure 295 Configuration > Network > Routing > Policy Route

The following table describes the labels in this screen.

Table 140 Configuration > Network > Routing > Policy Route

LABEL	DESCRIPTION
Show Advanced Settings / Hide Advanced Settings	Click this button to display a greater or lesser number of configuration fields.
Enable BWM	This is a global setting for enabling or disabling bandwidth management on the Zyxel Device. You must enable this setting to have individual policy routes or application patrol policies apply bandwidth management. This same setting also appears in the AppPatrol > General screen. Enabling or disabling it in one screen also enables or disables it in the other screen.
IPv4 Configuration / IPv6 Configuration	Use the IPv4 Configuration section for IPv4 network settings. Use the IPv6 Configuration section for IPv6 network settings if you connect your Zyxel Device to an IPv6 network. Both sections have similar fields as described below.
Use IPv4/IPv6 Policy Route to Override Direct Route	Select this to have the Zyxel Device forward packets that match a policy route according to the policy route instead of sending the packets directly to a connected network.
Add	Click this to create a new entry. Select an entry and click Add to create a new entry after the selected entry.
Edit	Double-click an entry or select it and click Edit to open a screen where you can modify the entry's settings.
Remove	To remove an entry, select it and click Remove . The Zyxel Device confirms you want to remove it before doing so.
Activate	To turn on an entry, select it and click Activate .
Inactivate	To turn off an entry, select it and click Inactivate .
Move	To change a rule's position in the numbered list, select the rule and click Move to display a field to type a number for where you want to put that rule and press [ENTER] to move the rule to the number that you typed. The ordering of your rules is important as they are applied in order of their numbering.

Table 140 Configuration > Network > Routing > Policy Route (continued)

LABEL	DESCRIPTION
#	This is the number of an individual policy route.
Status	This icon is lit when the entry is active, red when the next hop's connection is down, and dimmed when the entry is inactive.
User	This is the name of the user (group) object from which the packets are sent. any means all users.
Schedule	This is the name of the schedule object. none means the route is active at all times if enabled.
Incoming	This is the interface on which the packets are received.
Source	This is the name of the source IP address (group) object, including geographic address and FQDN (group) objects. any means all IP addresses.
Destination	This is the name of the destination IP address (group) object, including geographic and FQDN (group) address objects. any means all IP addresses.
DSCP Code	This is the DSCP value of incoming packets to which this policy route applies. any means all DSCP values or no DSCP marker. default means traffic with a DSCP value of 0. This is usually best effort traffic. The " af " entries stand for Assured Forwarding. The number following the " af " identifies one of four classes and one of three drop preferences. See Assured Forwarding (AF) PHB for DiffServ for more details.
Service	This is the name of the service object. any means all services.
Source Port	This is the name of a service object. The Zyxel Device applies the policy route to the packets sent from the corresponding service port. any means all service ports.
Next-Hop	This is the next hop to which packets are directed. It helps forward packets to their destinations and can be a router, VPN tunnel, outgoing interface or trunk.
DSCP Marking	This is how the Zyxel Device handles the DSCP value of the outgoing packets that match this route. If this field displays a DSCP value, the Zyxel Device applies that DSCP value to the route's outgoing packets. preserve means the Zyxel Device does not modify the DSCP value of the route's outgoing packets. default means the Zyxel Device sets the DSCP value of the route's outgoing packets to 0. The " af " choices stand for Assured Forwarding. The number following the " af " identifies one of four classes and one of three drop preferences. See Assured Forwarding (AF) PHB for DiffServ for more details.
SNAT	This is the source IP address that the route uses. It displays none if the Zyxel Device does not perform NAT for this route.
Apply	Click Apply to save your changes back to the Zyxel Device.
Reset	Click Reset to return the screen to its last-saved settings.

11.2.1 Policy Route Edit Screen

Click **Configuration > Network > Routing** to open the **Policy Route** screen. Then click the **Add** or **Edit** icon in the **IPv4 Configuration** or **IPv6 Configuration** section. The **Add Policy Route** or **Policy Route Edit** screen opens. Use this screen to configure or edit a policy route. Both IPv4 and IPv6 policy route have similar settings except the **Address Translation (SNAT)** settings.

Figure 296 Configuration > Network > Routing > Policy Route > Add/Edit (IPv4 Configuration)

Add Policy Route ? X

Hide Advanced Settings

Configuration

Enable
 Description: (Optional)

Criteria

User: ▼
 Incoming: ▼
 Source Address: ▼
 Destination Address: ▼
 DSCP Code: ▼
 Schedule: ▼
 Service: ▼
 Source Port: ▼

Next-Hop

Type: ▼
 Interface: ▼

DSCP Marking

DSCP Marking: ▼

Address Translation

Source Network Address Translation: ▼

Healthy Check

Disable policy route automatically while Interface link down
 Enable Connectivity Check

Check Method: ▼
 Check Period: (5-600 seconds)
 Check Timeout: (1-10 seconds)
 Check Fail Tolerance: (1-10)
 Check Port: (1-65535) !
 Check this address: (Domain Name or IP Address) !

Figure 297 Configuration > Network > Routing > Policy Route > Add/Edit (IPv6 Configuration)

The following table describes the labels in this screen.

Table 141 Configuration > Network > Routing > Policy Route > Add/Edit

LABEL	DESCRIPTION
Show Advanced Settings / Hide Advanced Settings	Click this button to display a greater or lesser number of configuration fields.
Create new Object	Use this to configure any new settings objects that you need to use in this screen.
Configuration	
Enable	Select this to activate the policy.
Description	Enter a descriptive name of up to 31 printable ASCII characters for the policy.
Criteria	
User	Select a user name or user group from which the packets are sent.
Incoming	Select where the packets are coming from; any, an interface, a tunnel, an SSL VPN, or the Zyxel Device itself. For an interface, a tunnel, or an SSL VPN, you also need to select the individual interface, VPN tunnel, or SSL VPN connection.
Source Address	Select a source IP address object, including geographic address and FQDN (group) objects, from which the packets are sent.
Destination Address	Select a destination IP address object, including geographic address and FQDN (group) objects, to which the traffic is being sent. If the next hop is a dynamic VPN tunnel and you enable Auto Destination Address , the Zyxel Device uses the local network of the peer router that initiated an incoming IPsec tunnel as the destination address of the policy instead of your configuration here.

Table 141 Configuration > Network > Routing > Policy Route > Add/Edit (continued)

LABEL	DESCRIPTION
DSCP Code	<p>Select a DSCP code point value of incoming packets to which this policy route applies or select User Define to specify another DSCP code point. The lower the number the higher the priority with the exception of 0 which is usually given only best-effort treatment.</p> <p>any means all DSCP value or no DSCP marker.</p> <p>default means traffic with a DSCP value of 0. This is usually best effort traffic.</p> <p>The "af" choices stand for Assured Forwarding. The number following the "af" identifies one of four classes and one of three drop preferences. See Assured Forwarding (AF) PHB for DiffServ for more details.</p>
User-Defined DSCP Code	Use this field to specify a custom DSCP code point when you select User Define in the previous field.
Schedule	Select a schedule to control when the policy route is active. none means the route is active at all times if enabled.
Service	Select a service or service group to identify the type of traffic to which this policy route applies.
Source Port	Select a service or service group to identify the source port of packets to which the policy route applies.
Next-Hop	
Type	<p>Select Auto to have the Zyxel Device use the routing table to find a next-hop and forward the matched packets automatically.</p> <p>Select Gateway to route the matched packets to the next-hop router or switch you specified in the Gateway field. You have to set up the next-hop router or switch as a HOST address object first.</p> <p>Select VPN Tunnel to route the matched packets via the specified VPN tunnel.</p> <p>Select Trunk to route the matched packets through the interfaces in the trunk group based on the load balancing algorithm.</p> <p>Select Interface to route the matched packets through the specified outgoing interface to a gateway (which is connected to the interface).</p>
Gateway	This field displays when you select Gateway in the Type field. Select a HOST address object. The gateway is an immediate neighbor of your Zyxel Device that will forward the packet to the destination. The gateway must be a router or switch on the same segment as your Zyxel Device's interface(s).
VPN Tunnel	This field displays when you select VPN Tunnel in the Type field. Select a VPN tunnel through which the packets are sent to the remote network that is connected to the Zyxel Device directly.
Auto Destination Address	<p>This field displays when you select VPN Tunnel in the Type field. Select this to have the Zyxel Device use the local network of the peer router that initiated an incoming dynamic IPsec tunnel as the destination address of the policy.</p> <p>Leave this cleared if you want to manually specify the destination address.</p>
Trunk	This field displays when you select Trunk in the Type field. Select a trunk group to have the Zyxel Device send the packets via the interfaces in the group..
Interface	This field displays when you select Interface in the Type field. Select an interface to have the Zyxel Device send traffic that matches the policy route through the specified interface.

Table 141 Configuration > Network > Routing > Policy Route > Add/Edit (continued)

LABEL	DESCRIPTION
DSCP Marking	<p>Set how the Zyxel Device handles the DSCP value of the outgoing packets that match this route.</p> <p>Select one of the pre-defined DSCP values to apply or select User Define to specify another DSCP value. The "af" choices stand for Assured Forwarding. The number following the "af" identifies one of four classes and one of three drop preferences. See Assured Forwarding (AF) PHB for DiffServ for more details.</p> <p>Select preserve to have the Zyxel Device keep the packets' original DSCP value.</p> <p>Select default to have the Zyxel Device set the DSCP value of the packets to 0.</p>
User-Defined DSCP Code	Use this field to specify a custom DSCP value.
Address Translation	Use this section to configure NAT for the policy route. This section does not apply to policy routes that use a VPN tunnel as the next hop.
Source Network Address Translation	<p>Select none to not use NAT for the route.</p> <p>Select outgoing-interface to use the IP address of the outgoing interface as the source IP address of the packets that matches this route.</p> <p>To use SNAT for a virtual interface that is in the same WAN trunk as the physical interface to which the virtual interface is bound, the virtual interface and physical interface must be in different subnets.</p> <p>Otherwise, select a pre-defined address (group) to use as the source IP address(es) of the packets that match this route.</p> <p>Use Create new Object if you need to configure a new address (group) to use as the source IP address(es) of the packets that match this route.</p>
Healthy Check	Use this part of the screen to configure a route connectivity check and disable the policy if the interface is down.
Disable policy route automatically while Interface link down	Select this to disable the policy if the interface is down or disabled. This is available for Interface and Trunk in the Type field above.
Enable Connectivity Check	Select this to turn on the connection check. This is available for Interface and Gateway in the Type field above.
Check Method:	<p>Select the method that the gateway allows.</p> <p>Select icmp to have the Zyxel Device regularly ping the gateway you specify to make sure it is still available.</p> <p>Select tcp to have the Zyxel Device regularly perform a TCP handshake with the gateway you specify to make sure it is still available.</p>
Check Period:	Enter the number of seconds between connection check attempts (5 – 600 seconds).
Check Timeout:	Enter the number of seconds to wait for a response before the attempt is a failure (1 – 10 seconds).
Check Fail Tolerance:	Enter the number of consecutive failures before the Zyxel Device stops routing using this policy (1 – 10).
Check Port:	This field only displays when you set the Check Method to tcp . Specify the port number to use for a TCP connectivity check (1 – 65535).
Check this address:	Select this to specify a domain name or IP address for the connectivity check. Enter that domain name or IP address in the field next to it.
OK	Click OK to save your changes back to the Zyxel Device.
Cancel	Click Cancel to exit this screen without saving.

11.3 IP Static Route Screen

Click **Configuration > Network > Routing > Static Route** to open the **Static Route** screen. This screen displays the configured static routes. Configure static routes to be able to use RIP or OSPF to propagate the routing information to other routers. If you enabled IPv6 in the **Configuration > System > IPv6** screen, you can also configure static routes used for your IPv6 networks on this screen.

Figure 298 Configuration > Network > Routing > Static Route

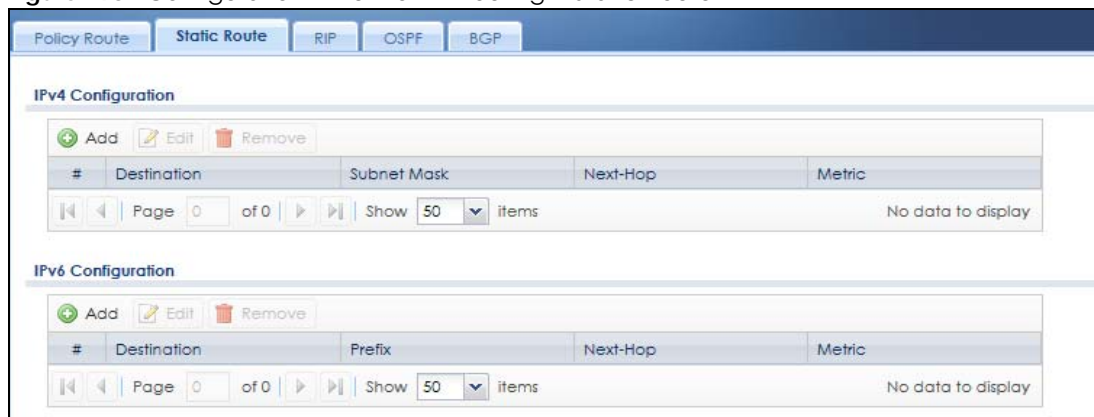

The following table describes the labels in this screen.

Table 142 Configuration > Network > Routing > Static Route

LABEL	DESCRIPTION
IPv4 Configuration / IPv6 Configuration	Use the IPv4 Configuration section for IPv4 network settings. Use the IPv6 Configuration section for IPv6 network settings if you connect your Zyxel Device to an IPv6 network. Both sections have similar fields as described below.
Add	Click this to create a new static route.
Edit	Double-click an entry or select it and click Edit to open a screen where you can modify the entry's settings.
Remove	To remove an entry, select it and click Remove . The Zyxel Device confirms you want to remove it before doing so.
#	This is the number of an individual static route.
Destination	This is the destination IP address.
Subnet Mask	This is the IP subnet mask.
Prefix	This is the IPv6 prefix for the destination IP address.
Next-Hop	This is the IP address of the next-hop gateway or the interface through which the traffic is routed. The gateway is a router or switch on the same segment as your Zyxel Device's interface(s). The gateway helps forward packets to their destinations.
Metric	This is the route's priority among the Zyxel Device's routes. The smaller the number, the higher priority the route has.

11.3.1 Static Route Add/Edit Screen

Select a static route index number and click **Add** or **Edit**. The screen shown next appears. Use this screen to configure the required information for a static route.

Figure 299 Configuration > Network > Routing > Static Route > Add (IPv4 Configuration)

Figure 300 Configuration > Network > Routing > Static Route > Add (IPv6 Configuration)

The following table describes the labels in this screen.

Table 143 Configuration > Network > Routing > Static Route > Add

LABEL	DESCRIPTION
Destination IP	This parameter specifies the IP network address of the final destination. Routing is always based on network number. If you need to specify a route to a single host, enter the specific IP address here and use a subnet mask of 255.255.255.255 (for IPv4) in the Subnet Mask field or a prefix of 128 (for IPv6) in the Prefix Length field to force the network number to be identical to the host ID. For IPv6, if you want to send all traffic to the gateway or interface specified in the Gateway IP or Interface field, enter :: in this field and 0 in the Prefix Length field.
Subnet Mask	Enter the IP subnet mask here.
Prefix Length	Enter the number of left-most digits in the destination IP address, which indicates the network prefix. Enter :: in the Destination IP field and 0 in this field if you want to send all traffic to the gateway or interface specified in the Gateway IP or Interface field.
Gateway IP	Select the radio button and enter the IP address of the next-hop gateway. The gateway is a router or switch on the same segment as your ZyXel Device's interface(s). The gateway helps forward packets to their destinations.
Interface	Select the radio button and a predefined interface through which the traffic is sent.
Metric	Metric represents the "cost" of transmission for routing purposes. IP routing uses hop count as the measurement of cost, with a minimum of 1 for directly connected networks. Enter a number that approximates the cost for this link. The number need not be precise, but it must be 0~127. In practice, 2 or 3 is usually a good number.
OK	Click OK to save your changes back to the ZyXel Device.
Cancel	Click Cancel to exit this screen without saving.

11.4 Policy Routing Technical Reference

Here is more detailed information about some of the features you can configure in policy routing.

NAT and SNAT

NAT (Network Address Translation - NAT, RFC 1631) is the translation of the IP address in a packet in one network to a different IP address in another network. Use SNAT (Source NAT) to change the source IP address in one network to a different IP address in another network.

Assured Forwarding (AF) PHB for DiffServ

Assured Forwarding (AF) behavior is defined in RFC 2597. The AF behavior group defines four AF classes. Inside each class, packets are given a high, medium or low drop precedence. The drop precedence determines the probability that routers in the network will drop packets when congestion occurs. If congestion occurs between classes, the traffic in the higher class (smaller numbered class) is generally given priority. Combining the classes and drop precedence produces the following twelve DSCP encodings from AF11 through AF43. The decimal equivalent is listed in brackets.

Table 144 Assured Forwarding (AF) Behavior Group

	CLASS 1	CLASS 2	CLASS 3	CLASS 4
Low Drop Precedence	AF11 (10)	AF21 (18)	AF31 (26)	AF41 (34)
Medium Drop Precedence	AF12 (12)	AF22 (20)	AF32 (28)	AF42 (36)
High Drop Precedence	AF13 (14)	AF23 (22)	AF33 (30)	AF43 (38)

Maximize Bandwidth Usage

The maximize bandwidth usage option allows the Zyxel Device to divide up any available bandwidth on the interface (including unallocated bandwidth and any allocated bandwidth that a policy route is not using) among the policy routes that require more bandwidth.

When you enable maximize bandwidth usage, the Zyxel Device first makes sure that each policy route gets up to its bandwidth allotment. Next, the Zyxel Device divides up an interface's available bandwidth (bandwidth that is unbudgeted or unused by the policy routes) depending on how many policy routes require more bandwidth and on their priority levels. When only one policy route requires more bandwidth, the Zyxel Device gives the extra bandwidth to that policy route.

When multiple policy routes require more bandwidth, the Zyxel Device gives the highest priority policy routes the available bandwidth first (as much as they require, if there is enough available bandwidth), and then to lower priority policy routes if there is still bandwidth available. The Zyxel Device distributes the available bandwidth equally among policy routes with the same priority level.

11.5 Routing Protocols Overview

Routing protocols give the Zyxel Device routing information about the network from other routers. The Zyxel Device stores this routing information in the routing table it uses to make routing decisions. In turn, the Zyxel Device can also use routing protocols to propagate routing information to other routers.

Routing protocols are usually only used in networks using multiple routers like campuses or large enterprises.

- Use the **RIP** screen (see [Section 11.6 on page 441](#)) to configure the Zyxel Device to use RIP to receive and/or send routing information.
- Use the **OSPF** screen (see [Section 11.7 on page 443](#)) to configure general OSPF settings and manage OSPF areas.
- Use the **OSPF Area Add/Edit** screen (see [Section 11.7.2 on page 447](#)) to create or edit an OSPF area.
- Use the **BGP** screen (see [Section 11.8 on page 450](#)) to configure eBGP (exterior Border Gate Protocol).

11.5.1 What You Need to Know

The Zyxel Device supports two standards, RIP and OSPF, for routing protocols. RIP and OSPF are compared here and discussed further in the rest of the chapter.

Table 145 RIP vs. OSPF

	RIP	OSPF
Network Size	Small (with up to 15 routers)	Large
Metric	Hop count	Bandwidth, hop count, throughput, round trip time and reliability.
Convergence	Slow	Fast

11.6 RIP Screen

RIP (Routing Information Protocol, RFC 1058 and RFC 1389) allows a device to exchange routing information with other routers. RIP is a vector-space routing protocol, and, like most such protocols, it uses hop count to decide which route is the shortest. Unfortunately, it also broadcasts its routes asynchronously to the network and converges slowly. Therefore, RIP is more suitable for small networks (up to 15 routers).

- In the Zyxel Device, you can configure two sets of RIP settings before you can use it in an interface.
- First, the **Authentication** field specifies how to verify that the routing information that is received is the same routing information that is sent.
- Second, the Zyxel Device can also **redistribute** routing information from non-RIP networks, specifically OSPF networks and static routes, to the RIP network. Costs might be calculated differently, however, so you use the **Metric** field to specify the cost in RIP terms.
- RIP uses UDP port 520.

Use the **RIP** screen to specify the authentication method and maintain the policies for redistribution.

Click **Configuration > Network > Routing > RIP** to open the following screen.

Figure 301 Configuration > Network > Routing > RIP

The following table describes the labels in this screen.

Table 146 Configuration > Network > Routing Protocol > RIP

LABEL	DESCRIPTION
Authentication	The transmitting and receiving routers must have the same key. For RIP, authentication is not available in RIP version 1. In RIP version 2, you can only select one authentication type for all interfaces.
Authentication	Select the authentication method used in the RIP network. This authentication protects the integrity, but not the confidentiality, of routing updates. <ul style="list-style-type: none"> • None uses no authentication. • Text uses a plain text password that is sent over the network (not very secure). • MD5 uses an MD5 password and authentication ID (most secure).
Text Authentication Key	This field is available if the Authentication is Text . Type the password for text authentication. The key can consist of alphanumeric characters and the underscore, and it can be up to 16 characters long.
MD5 Authentication ID	This field is available if the Authentication is MD5 . Type the ID for MD5 authentication. The ID can be between 1 and 255.
MD5 Authentication Key	This field is available if the Authentication is MD5 . Type the password for MD5 authentication. The password can consist of alphanumeric characters and the underscore, and it can be up to 16 characters long.
Redistribute	
Active OSPF	Select this to use RIP to advertise routes that were learned through OSPF.
Metric	Type the cost for routes provided by OSPF. The metric represents the "cost" of transmission for routing purposes. RIP routing uses hop count as the measurement of cost, with 1 usually used for directly connected networks. The number does not have to be precise, but it must be between 0 and 16. In practice, 2 or 3 is usually used.
Active Static Route	Select this to use RIP to advertise routes that were learned through the static route configuration.
Metric	Type the cost for routes provided by the static route configuration. The metric represents the "cost" of transmission for routing purposes. RIP routing uses hop count as the measurement of cost, with 1 usually used for directly connected networks. The number does not have to be precise, but it must be between 0 and 16. In practice, 2 or 3 is usually used.
Apply	Click this button to save your changes to the Zyxel Device.
Reset	Click this button to return the screen to its last-saved settings.

11.7 OSPF Screen

OSPF (Open Shortest Path First, RFC 2328) is a link-state protocol designed to distribute routing information within a group of networks, called an Autonomous System (AS). OSPF offers some advantages over vector-space routing protocols like RIP.

- OSPF supports variable-length subnet masks, which can be set up to use available IP addresses more efficiently.
- OSPF filters and summarizes routing information, which reduces the size of routing tables throughout the network.
- OSPF responds to changes in the network, such as the loss of a router, more quickly.
- OSPF considers several factors, including bandwidth, hop count, throughput, round trip time, and reliability, when it calculates the shortest path.
- OSPF converges more quickly than RIP.

Naturally, OSPF is also more complicated than RIP, so OSPF is usually more suitable for large networks.

OSPF uses IP protocol 89.

OSPF Areas

An OSPF Autonomous System (AS) is divided into one or more areas. Each area represents a group of adjacent networks and is identified by a 32-bit ID. In OSPF, this number may be expressed as an integer or as an IP address.

There are several types of areas.

- The backbone is the transit area that routes packets between other areas. All other areas are connected to the backbone.
- A normal area is a group of adjacent networks. A normal area has routing information about the OSPF AS, any networks outside the OSPF AS to which it is directly connected, and any networks outside the OSPF AS that provide routing information to any area in the OSPF AS.
- A stub area has routing information about the OSPF AS. It does not have any routing information about any networks outside the OSPF AS, including networks to which it is directly connected. It relies on a default route to send information outside the OSPF AS.
- A Not So Stubby Area (NSSA, RFC 1587) has routing information about the OSPF AS and networks outside the OSPF AS to which the NSSA is directly connected. It does not have any routing information about other networks outside the OSPF AS.

Each type of area is illustrated in the following figure.

Figure 302 OSPF: Types of Areas

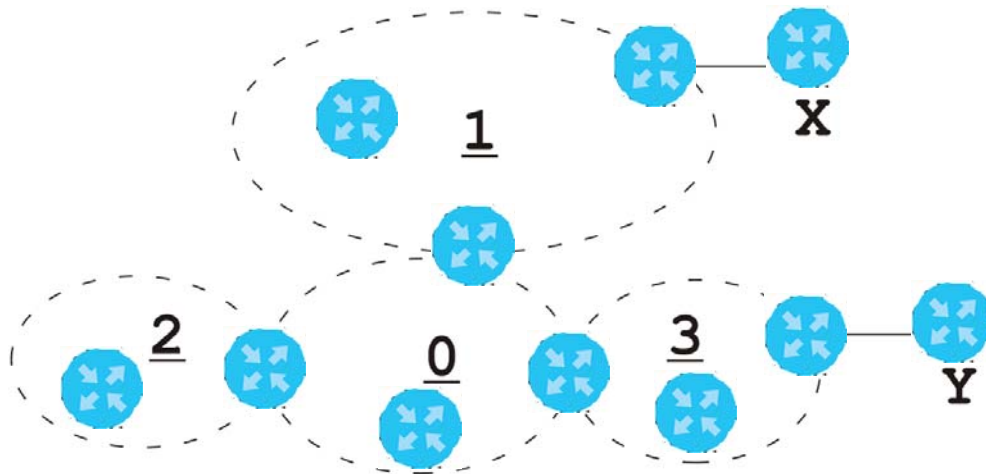

This OSPF AS consists of four areas, areas 0–3. Area 0 is always the backbone. In this example, areas 1, 2, and 3 are all connected to it. Area 1 is a normal area. It has routing information about the OSPF AS and networks X and Y. Area 2 is a stub area. It has routing information about the OSPF AS, but it depends on a default route to send information to networks X and Y. Area 3 is a NSSA. It has routing information about the OSPF AS and network Y but not about network X.

OSPF Routers

Every router in the same area has the same routing information. They do this by exchanging Hello messages to confirm which neighbor (layer-3) devices exist, and then they exchange database descriptions (DDs) to create a synchronized link-state database. The link-state database contains records of router IDs, their associated links and path costs. The link-state database is then constantly updated through Link State Advertisements (LSA). Each router uses the link state database and the Dijkstra algorithm to compute the least cost paths to network destinations.

Like areas, each router has a unique 32-bit ID in the OSPF AS, and there are several types of routers. Each type is really just a different role, and it is possible for one router to play multiple roles at one time.

- An internal router (IR) only exchanges routing information with other routers in the same area.
- An Area Border Router (ABR) connects two or more areas. It is a member of all the areas to which it is connected, and it filters, summarizes, and exchanges routing information between them.
- An Autonomous System Boundary Router (ASBR) exchanges routing information with routers in networks outside the OSPF AS. This is called redistribution in OSPF.

Table 147 OSPF: Redistribution from Other Sources to Each Type of Area

SOURCE \ TYPE OF AREA	NORMAL	NSSA	STUB
Static routes	Yes	Yes	No
RIP	Yes	Yes	Yes

- A backbone router (BR) has at least one interface with area 0. By default, every router in area 0 is a backbone router, and so is every ABR.

Each type of router is illustrated in the following example.

Figure 303 OSPF: Types of Routers

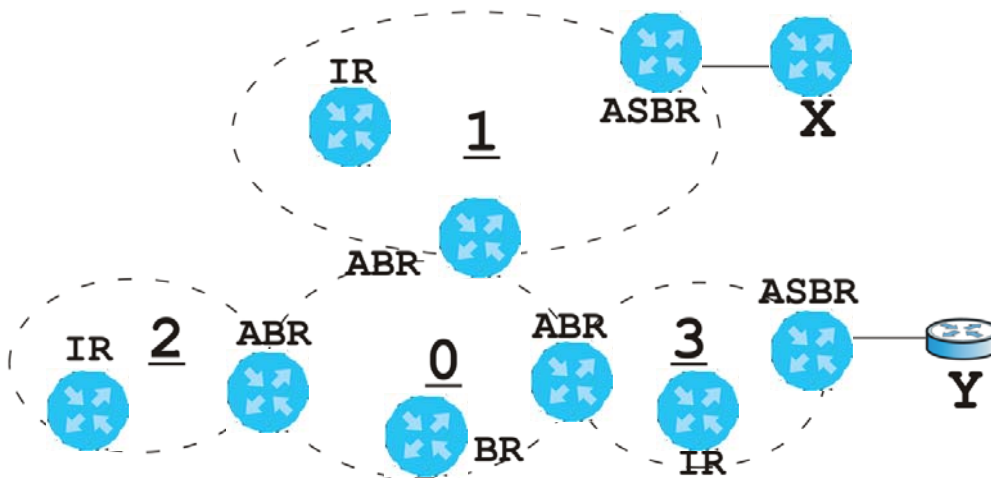

In order to reduce the amount of traffic between routers, a group of routers that are directly connected to each other selects a designated router (DR) and a backup designated router (BDR). All of the routers only exchange information with the DR and the BDR, instead of exchanging information with all of the other routers in the group. The DR and BDR are selected by priority; if two routers have the same priority, the highest router ID is used.

The DR and BDR are selected in each group of routers that are directly connected to each other. If a router is directly connected to several groups, it might be a DR in one group, a BDR in another group, and neither in a third group all at the same time.

Virtual Links

In some OSPF AS, it is not possible for an area to be directly connected to the backbone. In this case, you can create a virtual link through an intermediate area to logically connect the area to the backbone. This is illustrated in the following example.

Figure 304 OSPF: Virtual Link

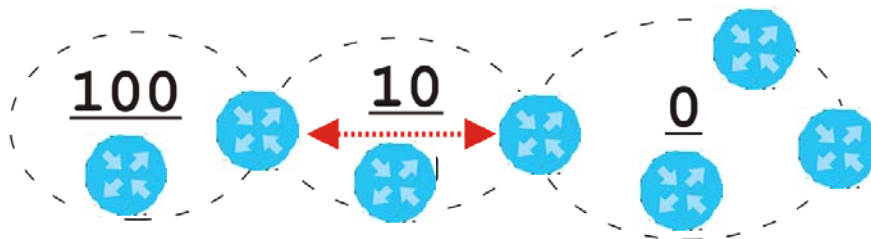

In this example, area 100 does not have a direct connection to the backbone. As a result, you should set up a virtual link on both ABR in area 10. The virtual link becomes the connection between area 100 and the backbone.

You cannot create a virtual link to a router in a different area.

OSPF Configuration

Follow these steps when you configure OSPF on the Zyxel Device.

- 1 Enable OSPF.
- 2 Set up the OSPF areas.
- 3 Configure the appropriate interfaces. See [Section 10.4.1 on page 328](#).
- 4 Set up virtual links, as needed.

11.7.1 Configuring the OSPF Screen

Use the first OSPF screen to specify the OSPF router the Zyxel Device uses in the OSPF AS and maintain the policies for redistribution. In addition, it provides a summary of OSPF areas, allows you to remove them, and opens the **OSPF Add/Edit** screen to add or edit them.

Click **Configuration > Network > Routing > OSPF** to open the following screen.

Figure 305 Configuration > Network > Routing > OSPF

The following table describes the labels in this screen. See [Section 11.7.2 on page 447](#) for more information as well.

Table 148 Configuration > Network > Routing Protocol > OSPF

LABEL	DESCRIPTION
OSPF Router ID	Select the 32-bit ID the Zyxel Device uses in the OSPF AS. Default - the first available interface IP address is the Zyxel Device's ID. User Defined - enter the ID (in IP address format) in the field that appears when you select User Define .
Redistribute	
Active RIP	Select this to advertise routes that were learned from RIP. The Zyxel Device advertises routes learned from RIP to Normal and NSSA areas but not to Stub areas.

Table 148 Configuration > Network > Routing Protocol > OSPF (continued)

LABEL	DESCRIPTION
Type	Select how OSPF calculates the cost associated with routing information from RIP. Choices are: Type 1 and Type 2 . Type 1 – cost = OSPF AS cost + external cost (Metric). Type 2 – cost = external cost (Metric); the OSPF AS cost is ignored.
Metric	Type the external cost for routes provided by RIP. The metric represents the “cost” of transmission for routing purposes. The way this is used depends on the Type field. This value is usually the average cost in the OSPF AS, and it can be between 1 and 16777214.
Active Static Route	Select this to advertise routes that were learned from static routes. The Zyxel Device advertises routes learned from static routes to all types of areas.
Type	Select how OSPF calculates the cost associated with routing information from static routes. Choices are: Type 1 and Type 2 . Type 1 – cost = OSPF AS cost + external cost (Metric) Type 2 – cost = external cost (Metric); the OSPF AS cost is ignored.
Metric	Type the external cost for routes provided by static routes. The metric represents the “cost” of transmission for routing purposes. The way this is used depends on the Type field. This value is usually the average cost in the OSPF AS, and it can be between 1 and 16777214.
Area	This section displays information about OSPF areas in the Zyxel Device.
Add	Click this to create a new OSPF area.
Edit	Double-click an entry or select it and click Edit to open a screen where you can modify the entry's settings.
Remove	To remove an entry, select it and click Remove . The Zyxel Device confirms you want to remove it before doing so.
#	This field is a sequential value, and it is not associated with a specific area.
Area	This field displays the 32-bit ID for each area in IP address format.
Type	This field displays the type of area. This type is different from the Type field above.
Authentication	This field displays the default authentication method in the area.
Apply	Click this button to save your changes to the Zyxel Device.
Reset	Click this button to return the screen to its last-saved settings.

11.7.2 OSPF Area Add/Edit Screen

The **OSPF Area Add/Edit** screen allows you to create a new area or edit an existing one. To access this screen, go to the **OSPF** summary screen (see [Section 11.7 on page 443](#)), and click either the **Add** icon or an **Edit** icon.

Figure 306 Configuration > Network > Routing > OSPF > Add

The following table describes the labels in this screen.

Table 149 Configuration > Network > Routing > OSPF > Add

LABEL	DESCRIPTION
Area ID	Type the unique, 32-bit identifier for the area in IP address format.
Type	Select the type of OSPF area. Normal - This area is a normal area. It has routing information about the OSPF AS and about networks outside the OSPF AS. Stub - This area is an stub area. It has routing information about the OSPF AS but not about networks outside the OSPF AS. It depends on a default route to send information outside the OSPF AS. NSSA - This area is a Not So Stubby Area (NSSA), per RFC 1587. It has routing information about the OSPF AS and networks that are outside the OSPF AS and are directly connected to the NSSA. It does not have information about other networks outside the OSPF AS.
Authentication	Select the default authentication method used in the area. This authentication protects the integrity, but not the confidentiality, of routing updates. None uses no authentication. Text uses a plain text password that is sent over the network (not very secure). MD5 uses an MD5 password and authentication ID (most secure).
Text Authentication Key	This field is available if the Authentication is Text . Type the password for text authentication. The key can consist of alphanumeric characters and the underscore, and it can be up to 16 characters long.
MD5 Authentication ID	This field is available if the Authentication is MD5 . Type the default ID for MD5 authentication in the area. The ID can be between 1 and 255.
MD5 Authentication Key	This field is available if the Authentication is MD5 . Type the default password for MD5 authentication in the area. The password can consist of alphanumeric characters and the underscore, and it can be up to 16 characters long.
Virtual Link	This section is displayed if the Type is Normal . Create a virtual link if you want to connect a different area (that does not have a direct connection to the backbone) to the backbone. You should set up the virtual link on the ABR that is connected to the other area and on the ABR that is connected to the backbone.
Add	Click this to create a new virtual link.

Table 149 Configuration > Network > Routing > OSPF > Add (continued)

LABEL	DESCRIPTION
Edit	Double-click an entry or select it and click Edit to open a screen where you can modify the entry's settings.
Remove	To remove an entry, select it and click Remove . The Zyxel Device confirms you want to remove it before doing so.
#	This field is a sequential value, and it is not associated with a specific area.
Peer Router ID	This is the 32-bit ID (in IP address format) of the other ABR in the virtual link.
Authentication	<p>This is the authentication method the virtual link uses. This authentication protects the integrity, but not the confidentiality, of routing updates.</p> <p>For OSPF, the Zyxel Device supports a default authentication type by area. If you want to use this default in an interface or virtual link, you set the associated Authentication Type field to Same as Area. As a result, you only have to update the authentication information for the area to update the authentication type used by these interfaces and virtual links. Alternatively, you can override the default in any interface or virtual link by selecting a specific authentication method. Please see the respective interface sections for more information.</p> <p>None uses no authentication.</p> <p>Text uses a plain text password that is sent over the network (not very secure). Hover your cursor over this label to display the password.</p> <p>MD5 uses an MD5 password and authentication ID (most secure). Hover your cursor over this label to display the authentication ID and key.</p> <p>Same as Area has the virtual link also use the Authentication settings above.</p>
OK	Click OK to save your changes back to the Zyxel Device.
Cancel	Click Cancel to exit this screen without saving.

11.7.3 Virtual Link Add/Edit Screen

The **Virtual Link Add/Edit** screen allows you to create a new virtual link or edit an existing one. When the OSPF add or edit screen (see [Section 11.7.2 on page 447](#)) has the Type set to Normal, a Virtual Link table displays. Click either the **Add** icon or an entry and the **Edit** icon to display a screen like the following.

Figure 307 Configuration > Network > Routing > OSPF > Add > Add

The following table describes the labels in this screen.

Table 150 Configuration > Network > Routing > OSPF > Add > Add

LABEL	DESCRIPTION
Peer Router ID	Enter the 32-bit ID (in IP address format) of the other ABR in the virtual link.
Authentication	<p>Select the authentication method the virtual link uses. This authentication protects the integrity, but not the confidentiality, of routing updates.</p> <p>For OSPF, the Zyxel Device supports a default authentication type by area. If you want to use this default in an interface or virtual link, you set the associated Authentication Type field to Same as Area. As a result, you only have to update the authentication information for the area to update the authentication type used by these interfaces and virtual links. Alternatively, you can override the default in any interface or virtual link by selecting a specific authentication method. Please see the respective interface sections for more information.</p> <p>None uses no authentication.</p> <p>Text uses a plain text password that is sent over the network (not very secure).</p> <p>MD5 uses an MD5 password and authentication ID (most secure).</p> <p>Same as Area has the virtual link also use the Authentication settings above.</p>
Text Authentication Key	This field is available if the Authentication is Text . Type the password for text authentication. The key can consist of alphanumeric characters and the underscore, and it can be up to 16 characters long.
MD5 Authentication ID	This field is available if the Authentication is MD5 . Type the default ID for MD5 authentication in the area. The ID can be between 1 and 255.
MD5 Authentication Key	This field is available if the Authentication is MD5 . Type the default password for MD5 authentication in the area. The password can consist of alphanumeric characters and the underscore, and it can be up to 16 characters long.
OK	Click OK to save your changes back to the Zyxel Device.
Cancel	Click Cancel to exit this screen without saving.

11.8 BGP (Border Gateway Protocol)

The Zyxel Device supports eBGP (exterior Border Gate Protocol) to route IPv4 traffic between routers in different Autonomous Systems (AS). An AS number is a number from 1 to 4294967295, that identifies an autonomous system. 4200000000 – 4294967294 are private AS numbers.

See [Section 11.7 on page 443](#) for more information on autonomous systems.

Figure 308 eBGP Concept

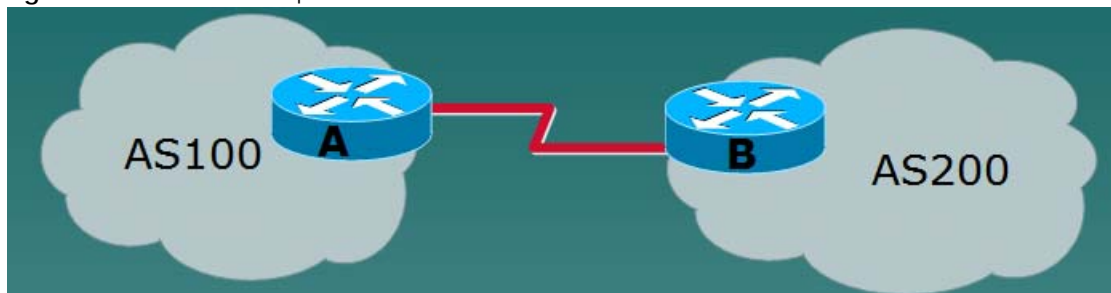

11.8.1 Allow BGP Packets to Enter the Zyxel Device

You must first allow BGP packets to enter the Zyxel Device from the WAN.

- 1 Go to **Configuration > Object > Service > Service Group**.
- 2 Select the **Default_Allow_WAN_To_ZyWALL** rule and click **Edit**.
- 3 Move BGP from **Available** to **Member**.
- 4 Click **OK**.

Figure 309 Allow BGP to the Zyxel Device

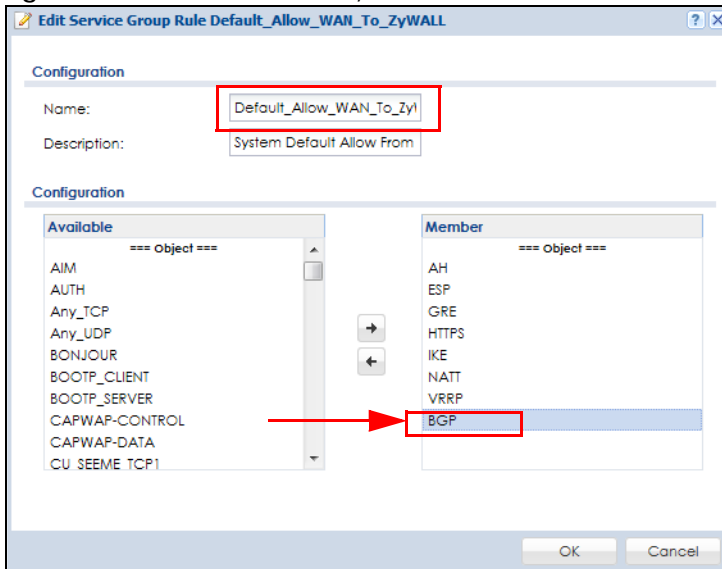

11.8.2 Configuring the BGP Screen

Use this screen to configure BGP information about the Zyxel Device and its peer BGP routers.

Click **Configuration > Network > Routing > BGP** to open the following screen.

Figure 310 Configuration > Network > Routing > BGP

The following table describes the labels in this screen.

Table 151 Configuration > Network > Routing Protocol > BGP

LABEL	DESCRIPTION
AS Number	Type a number from 1 to 4294967295 in this field. Note: The Zyxel Device can only belong to one AS at a time.
Router ID	Type the IP address of the interface on the Zyxel Device. This field is optional.
Redistribute	Select Connected to redistribute routes of directly attached devices to the Zyxel Device into the BGP Routing Information Base (RIB).
Neighbors	This section displays information about peer BGP routers in neighboring AS'. Note: The maximum number of neighboring BGP routers supported by the Zyxel Device is 5.
Add	Click this to configure BGP criteria for a new peer BGP router.
Edit	Double-click an entry or select it and click Edit to open a screen where you can modify the entry's settings.
Remove	To remove an entry, select it and click Remove . The Zyxel Device confirms you want to remove it before doing so.
#	This field is a sequential value, and it is not associated with a specific area.
IP Address	This displays the IPv4 address of the peer BGP router in a neighboring AS.
AS Number	This displays the AS Number of the peer BGP router in a neighboring AS.
Network	Use this section to add routes that will be announced to all BGP neighbors. Note: You may configure up to 16 network routes.
Add	Click this to configure network information for a new route.
Edit	Double-click an entry or select it and click Edit to open a screen where you can modify the entry's settings.
Remove	To remove an entry, select it and click Remove . The Zyxel Device confirms you want to remove it before doing so.
#	This field is a sequential value, and it is not associated with a specific area.

Table 151 Configuration > Network > Routing Protocol > BGP (continued)

LABEL	DESCRIPTION
Network	This displays the IP address and the number of subnet mask bits for the peer BGP route.
Apply	Click this button to save your changes to the Zyxel Device.
Reset	Click this button to return the screen to its last-saved settings.

11.8.3 BGP Neighbors Screen

Use this screen to configure BGP information about a peer BGP router.

Click **Configuration > Network > Routing > BGP > Add Neighbors** to open the following screen.

Figure 311 Configuration > Network > Routing > BGP > Add Neighbors

The following table describes the labels in this screen.

Table 152 Configuration > Network > Routing Protocol > BGP

LABEL	DESCRIPTION
IP Address	Type the IP address of the interface on the peer BGP router.
AS Number	Type a number from 1 to 4294967295 in this field. Get the number from your service provider.
Enable EBGP Multihop	Select this to allow the Zyxel Device to attempt BGP connections to external peers on indirectly connected networks. eBGP neighbors must also perform multihop. Multihop is not established if the only route to the multihop peer is a default route. This avoids loop formation.
EBGP Maximum Hops	Enter a maximum hop count from <1 – 255>. The default is 255.
Update Source	Use this to allow BGP sessions use the selected interface for TCP connections. <ul style="list-style-type: none"> Choose Gateway and then enter the gateway IP address. Choose Interface and then select a Zyxel Device interface. Choose None to use the closest interface.

Table 152 Configuration > Network > Routing Protocol > BGP (continued)

LABEL	DESCRIPTION
MD5 authentication key	Type the default password for MD5 authentication of communication between the Zyxel Device and the peer BGP router. The password can consist of alphanumeric characters and the underscore, and it can be up to 63 characters long.
Weight	Specify a weight value for all routes learned from this peer BGP router in the specified network. The route with the highest weight gets preference.
Keepalive Time	Keepalive messages are sent by the Zyxel Device to a peer BGP router to inform it that the BGP connection between the two is still active. The Keepalive Time is the interval between each Keepalive message sent by the Zyxel Device. We recommend Keepalive Time is 1/3 of the Hold Time time.
Hold Time	This is the maximum time the Zyxel Device waits to receive a Keepalive message from a peer BGP router before it declares that the peer BGP router is dead. Hold Time must be greater than the Keepalive Time .
Maximum Prefix	A prefix is a network address (IP/subnet mask) that a BGP router can reach and that it shares with its neighbors. Set the maximum number, from 1 to 4294967295, of prefixes that can be received from a neighbor. This limits the number of prefixes that the Zyxel Device is allowed to receive from a neighbor. If extra prefixes are received, the Zyxel Device ends the connection with the peer BGP router. You need to edit the peer BGP router configuration to bring the connection back.
OK	Click OK to save your changes back to the Zyxel Device.
Cancel	Click Cancel to exit this screen without saving.

11.8.4 Example Scenario

This is an example scenario for using BGP on the Zyxel Device. See also [Section 29.2 on page 633](#) for information on configuring an IPsec tunnel to an Amazon VPC (Virtual Private Cloud).

11.8.4.1 Scenario: CE – PE (MLPS)

In this scenario, you want to transmit BGP packets from a **CE** router (Zyxel Device) to a peer BGP **PE** router in an **MPLS** network.

- **CE:** The Zyxel Device is the customer edge router located on the customer premises and connects to a PE router in the service provider MPLS network.
- **PE:** The provider edge router is located at the edge of the service provider MPLS network.
- **MPLS:** Multi Protocol Label Switching (MPLS) forwards data from one network node to the next based on path labels rather than network addresses.

Figure 312 Scenario 1: CE Router – to – MPLS

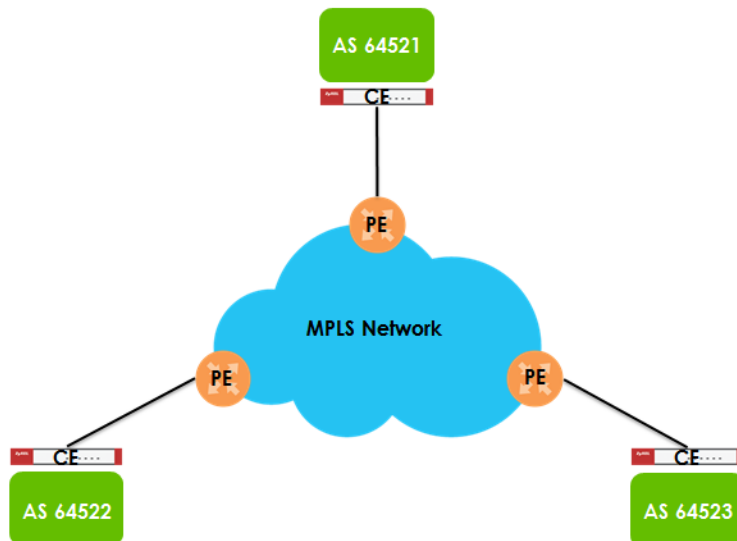

11.8.4.2 CE – PE Configuration Process

The process for configuring BGP in this scenario is:

- 1 Configure the AS number for BGP on the Zyxel Device (CE) in **Configuration > Network > Routing > BGP**.

Note: The Zyxel Device can only belong to one AS at a time.

- 2 Configure the AS number and BGP criteria of the peer BGP routers (PE) in the neighboring AS in **Configuration > Network > Routing > BGP > Add Neighbors**.

Note: The maximum number of neighboring BGP routers supported by the Zyxel Device is 5.

- 3 Configure the network for BGP routes in the neighboring AS.

Note: You may configure up to 16 network routes.

CHAPTER 12

DDNS

12.1 DDNS Overview

Dynamic DNS (DDNS) services let you use a domain name with a dynamic IP address.

12.1.1 What You Can Do in this Chapter

- Use the **DDNS** screen (see [Section 12.2 on page 457](#)) to view a list of the configured DDNS domain names and their details.
- Use the **DDNS Add/Edit** screen (see [Section 12.2.1 on page 458](#)) to add a domain name to the Zyxel Device or to edit the configuration of an existing domain name.

12.1.2 What You Need to Know

DNS maps a domain name to a corresponding IP address and vice versa. Similarly, Dynamic DNS (DDNS) maps a domain name to a dynamic IP address. As a result, anyone can use the domain name to contact you (in NetMeeting, CU-SeeMe, etc.) or to access your FTP server or Web site, regardless of the current (dynamic) IP address.

Note: You must have a public WAN IP address to use Dynamic DNS.

You must set up a dynamic DNS account with a supported DNS service provider before you can use Dynamic DNS services with the Zyxel Device. When registration is complete, the DNS service provider gives you a password or key. At the time of writing, the Zyxel Device supports the following DNS service providers. See the listed websites for details about the DNS services offered by each.

Table 153 DDNS Service Providers

PROVIDER	SERVICE TYPES SUPPORTED	WEBSITE
DynDNS	Dynamic DNS, Static DNS, and Custom DNS	www.dyndns.com
Dynu	Basic, Premium	www.dynu.com
No-IP	No-IP	www.no-ip.com
Peanut Hull	Peanut Hull	www.oray.cn
3322	3322 Dynamic DNS, 3322 Static DNS	www.3322.org
Selfhost	Selfhost	selfhost.de

Note: Record your DDNS account's user name, password, and domain name to use to configure the Zyxel Device.

After you configure the Zyxel Device, it automatically sends updated IP addresses to the DDNS service provider, which helps redirect traffic accordingly.

12.2 The DDNS Screen

The **DDNS** screen provides a summary of all DDNS domain names and their configuration. In addition, this screen allows you to add new domain names, edit the configuration for existing domain names, and delete domain names. Click **Configuration > Network > DDNS** to open the following screen.

Figure 313 Configuration > Network > DDNS

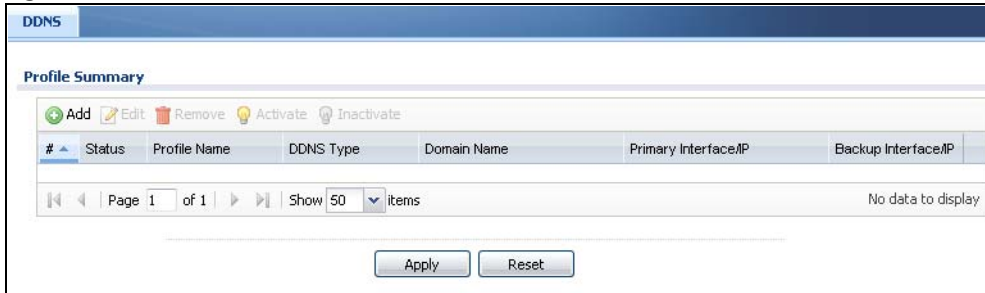

The following table describes the labels in this screen.

Table 154 Configuration > Network > DDNS

LABEL	DESCRIPTION
Add	Click this to create a new entry.
Edit	Double-click an entry or select it and click Edit to open a screen where you can modify the entry's settings.
Remove	To remove an entry, select it and click Remove . The Zyxel Device confirms you want to remove it before doing so.
Activate	To turn on an entry, select it and click Activate .
Inactivate	To turn off an entry, select it and click Inactivate .
#	This is the number of an individual DDNS profile.
Status	This icon is lit when the entry is active and dimmed when the entry is inactive.
Profile Name	This field displays the descriptive profile name for this entry.
DDNS Type	This field displays which DDNS service you are using.
Domain Name	This field displays each domain name the Zyxel Device can route.
Primary Interface/IP	This field displays the interface to use for updating the IP address mapped to the domain name followed by how the Zyxel Device determines the IP address for the domain name. from interface - The IP address comes from the specified interface. auto detected -The DDNS server checks the source IP address of the packets from the Zyxel Device for the IP address to use for the domain name. custom - The IP address is static.
Backup Interface/IP	This field displays the alternate interface to use for updating the IP address mapped to the domain name followed by how the Zyxel Device determines the IP address for the domain name. The Zyxel Device uses the backup interface and IP address when the primary interface is disabled, its link is down or its connectivity check fails. from interface - The IP address comes from the specified interface. auto detected -The DDNS server checks the source IP address of the packets from the Zyxel Device for the IP address to use for the domain name. custom - The IP address is static.

Table 154 Configuration > Network > DDNS (continued)

LABEL	DESCRIPTION
Apply	Click this button to save your changes to the Zyxel Device.
Reset	Click this button to return the screen to its last-saved settings.

12.2.1 The Dynamic DNS Add/Edit Screen

The **DDNS Add/Edit** screen allows you to add a domain name to the Zyxel Device or to edit the configuration of an existing domain name. Click **Configuration > Network > DDNS** and then an **Add** or **Edit** icon to open this screen.

Figure 314 Configuration > Network > DDNS > Add

Add Profile

Hide Advanced Settings

General Settings

Enable DDNS Profile

Profile Name:

DDNS Type: DynDNS

HTTPS

DDNS Account

Username:

Password:

Retype to Confirm:

DDNS Settings

Domain Name:

Primary Binding Address

Interface: wan1

IP Address: Custom

Custom IP:

Backup Binding Address

Interface: wan1

IP Address: Interface

Enable Wildcard

Mail Exchanger: (Optional)

Backup Mail Exchanger

OK Cancel

Figure 315 Configuration > Network > DDNS > Add - Custom

The following table describes the labels in this screen.

Table 155 Configuration > Network > DDNS > Add

LABEL	DESCRIPTION
Show Advanced Settings / Hide Advanced Settings	Click this button to display a greater or lesser number of configuration fields.
Enable DDNS Profile	Select this check box to use this DDNS entry.
Profile Name	When you are adding a DDNS entry, type a descriptive name for this DDNS entry in the Zyxel Device. You may use 1-31 alphanumeric characters, underscores(_), or dashes (-), but the first character cannot be a number. This value is case-sensitive. This field is read-only when you are editing an entry.
DDNS Type	Select the type of DDNS service you are using. Select User custom to create your own DDNS service and configure the DYNDNS Server , URL , and Additional DDNS Options fields below.
HTTPS	Select this to encrypt traffic using SSL (port 443), including traffic with username and password, to the DDNS server. Not all DDNS providers support this option.
Username	Type the user name used when you registered your domain name. You can use up to 31 alphanumeric characters and the underscore. Spaces are not allowed. For a Dynu DDNS entry, this user name is the one you use for logging into the service, not the name recorded in your personal information in the Dynu website.
Password	Type the password provided by the DDNS provider. You can use up to 64 alphanumeric characters and the underscore. Spaces are not allowed.
Retype to Confirm	Type the password again to confirm it.

Table 155 Configuration > Network > DDNS > Add (continued)

LABEL	DESCRIPTION
DDNS Settings	
Domain name	Type the domain name you registered. You can use up to 255 characters.
Primary Binding Address	Use these fields to set how the Zyxel Device determines the IP address that is mapped to your domain name in the DDNS server. The Zyxel Device uses the Backup Binding Address if the interface specified by these settings is not available.
Interface	Select the interface to use for updating the IP address mapped to the domain name. Select Any to let the domain name be used with any interface.
IP Address	<p>The options available in this field vary by DDNS provider.</p> <p>Interface -The Zyxel Device uses the IP address of the specified interface. This option appears when you select a specific interface in the Primary Binding Address Interface field.</p> <p>Auto - If the interface has a dynamic IP address, the DDNS server checks the source IP address of the packets from the Zyxel Device for the IP address to use for the domain name. You may want to use this if there are one or more NAT routers between the Zyxel Device and the DDNS server.</p> <p>Note: The Zyxel Device may not determine the proper IP address if there is an HTTP proxy server between the Zyxel Device and the DDNS server.</p> <p>Custom - If you have a static IP address, you can select this to use it for the domain name. The Zyxel Device still sends the static IP address to the DDNS server.</p>
Custom IP	This field is only available when the IP Address is Custom . Type the IP address to use for the domain name.
Backup Binding Address	Use these fields to set an alternate interface to map the domain name to when the interface specified by the Primary Binding Interface settings is not available.
Interface	Select the interface to use for updating the IP address mapped to the domain name. Select Any to let the domain name be used with any interface. Select None to not use a backup address.
IP Address	<p>The options available in this field vary by DDNS provider.</p> <p>Interface -The Zyxel Device uses the IP address of the specified interface. This option appears when you select a specific interface in the Backup Binding Address Interface field.</p> <p>Auto -The DDNS server checks the source IP address of the packets from the Zyxel Device for the IP address to use for the domain name. You may want to use this if there are one or more NAT routers between the Zyxel Device and the DDNS server.</p> <p>Note: The Zyxel Device may not determine the proper IP address if there is an HTTP proxy server between the Zyxel Device and the DDNS server.</p> <p>Custom - If you have a static IP address, you can select this to use it for the domain name. The Zyxel Device still sends the static IP address to the DDNS server.</p>
Custom IP	This field is only available when the IP Address is Custom . Type the IP address to use for the domain name.
Enable Wildcard	<p>This option is only available with a DynDNS account.</p> <p>Enable the wildcard feature to alias subdomains to be aliased to the same IP address as your (dynamic) domain name. This feature is useful if you want to be able to use, for example, www.yourhost.dyndns.org and still reach your hostname.</p>

Table 155 Configuration > Network > DDNS > Add (continued)

LABEL	DESCRIPTION
Mail Exchanger	<p>This option is only available with a DynDNS account.</p> <p>DynDNS can route e-mail for your domain name to a mail server (called a mail exchanger). For example, DynDNS routes e-mail for john-doe@yourhost.dyndns.org to the host record specified as the mail exchanger.</p> <p>If you are using this service, type the host record of your mail server here. Otherwise leave the field blank.</p> <p>See www.dyndns.org for more information about mail exchangers.</p>
Backup Mail Exchanger	<p>This option is only available with a DynDNS account.</p> <p>Select this check box if you are using DynDNS's backup service for e-mail. With this service, DynDNS holds onto your e-mail if your mail server is not available. Once your mail server is available again, the DynDNS server delivers the mail to you. See www.dyndns.org for more information about this service.</p>
DYNDNS Server	<p>This field displays when you select User custom from the DDNS Type field above. Type the IP address of the server that will host the DDSN service.</p>
URL	<p>This field displays when you select User custom from the DDNS Type field above. Type the URL that can be used to access the server that will host the DDSN service.</p>
Additional DDNS Options	<p>This field displays when you select User custom from the DDNS Type field above. These are the options supported at the time of writing:</p> <ul style="list-style-type: none"> • <code>dyndns_system</code> to specify the DYNDNS Server type - for example, <code>dyndns@dyndns.org</code> • <code>ip_server_name</code> which should be the URL to get the server's public IP address - for example, <code>http://myip.easylife.tw/</code>
OK	<p>Click OK to save your changes back to the Zyxel Device.</p>
Cancel	<p>Click Cancel to exit this screen without saving.</p>

CHAPTER 13

NAT

13.1 Overview

- Use the **Network > NAT** screen ([Section 13.3 on page 464](#)) to enable and configure network address translation.

13.2 NAT Overview

NAT (Network Address Translation - NAT, RFC 1631) is the translation of the IP address of a host in a packet. For example, the source address of an outgoing packet, used within one network is changed to a different IP address known within another network. Use Network Address Translation (NAT) to make computers on a private network behind the Zyxel Device available outside the private network. If the Zyxel Device has only one public IP address, you can make the computers in the private network available by using ports to forward packets to the appropriate private IP address.

Suppose you want to assign ports 21-25 to one FTP, Telnet and SMTP server (**A** in the example), port 80 to another (**B** in the example) and assign a default server IP address of 192.168.1.35 to a third (**C** in the example). You assign the LAN IP addresses and the ISP assigns the WAN IP address. The NAT network appears as a single host on the Internet.

Figure 316 Multiple Servers Behind NAT Example

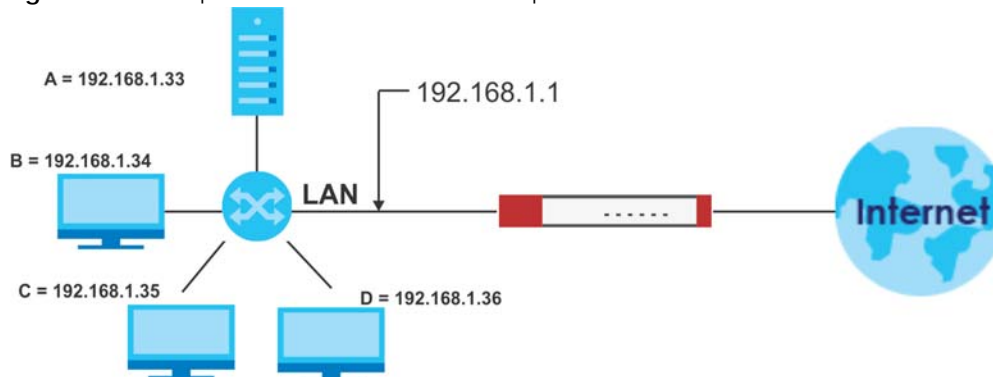

13.2.1 What You Can Do in this Chapter

Use the **NAT** screens (see [Section 13.3 on page 464](#)) to view and manage the list of NAT rules and see their configuration details. You can also create new NAT rules and edit or delete existing ones.

13.2.2 What You Need to Know

NAT is also known as virtual server, port forwarding, or port translation.

Well-known Ports

Port numbers range from 0 to 65535, but only port numbers 0 to 1023 are reserved for privileged services and designated as well-known ports. The following list specifies the ports used by the server process as its contact ports. See **Configuration > Object > Service** ([Section 43.8 on page 897](#)) for more information about service objects.

- Well-known ports range from 0 to 1023.
- Registered ports range from 1024 to 49151.
- Dynamic ports (also called private ports) range from 49152 to 65535.

Table 156 Well-known Ports

PORT	TCP/UDP	DESCRIPTION
1	TCP	TCP Port Service Multiplexer (TCPMUX)
20	TCP	FTP - Data
21	TCP	FTP - Control
22	TCP	SSH Remote Login Protocol
23	TCP	Telnet
25	TCP	Simple Mail Transfer Protocol (SMTP)
42	UDP	Host Name Server (Nameserv)
43	TCP	Whols
53	TCP/UDP	Domain Name System (DNS)
67	UDP	BOOTP/DHCP server
68	UDP	BOOTP/DHCP client
69	UDP	Trivial File Transfer Protocol (TFTP)
79	TCP	Finger
80	TCP	HTTP
110	TCP	POP3
119	TCP	Newsgroup (NNTP)
123	UDP	Network Time Protocol (NTP)
135	TCP/UDP	RPC Locator service
137	TCP/UDP	NetBIOS Name Service
138	UDP	NetBIOS Datagram Service
139	TCP	NetBIOS Datagram Service
143	TCP	Interim Mail Access Protocol (IMAP)
161	UDP	SNMP
179	TCP	Border Gateway Protocol (BGP)
389	TCP/UDP	Lightweight Directory Access Protocol (LDAP)
443	TCP	HTTPS
445	TCP	Microsoft - DS
636	TCP	LDAP over TLS/SSL (LDAPS)
953	TCP	BIND DNS
990	TCP	FTP over TLS/SSL (FTPS)
995	TCP	POP3 over TLS/SSL (POP3S)

13.3 The NAT Screen

The **NAT** summary screen provides a summary of all NAT rules and their configuration. In addition, this screen allows you to create new NAT rules and edit and delete existing NAT rules. To access this screen, login to the Web Configurator and click **Configuration > Network > NAT**. The following screen appears, providing a summary of the existing NAT rules.

Click on the icons to go to the OneSecurity website where there is guidance on configuration walkthroughs, troubleshooting, and other information.

Figure 317 Configuration > Network > NAT

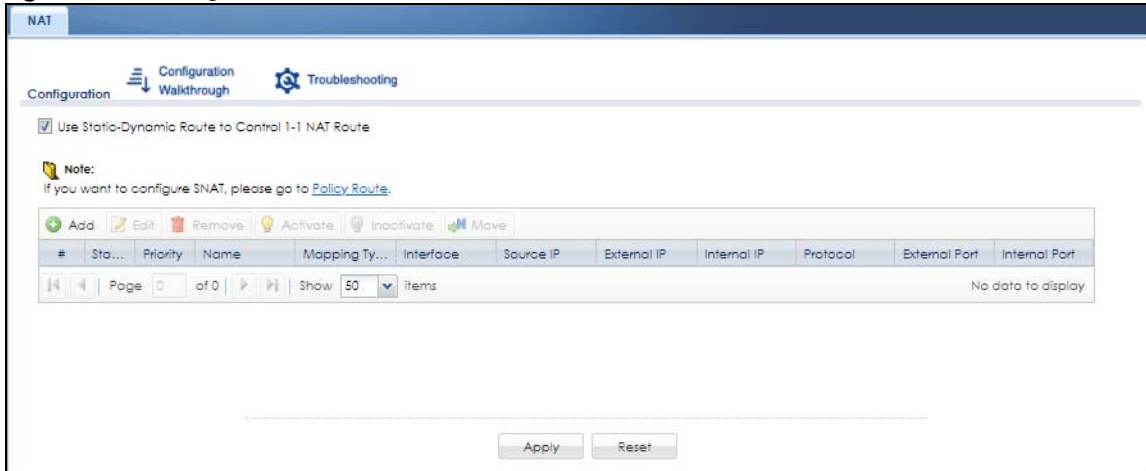

The following table describes the labels in this screen.

Table 157 Configuration > Network > NAT

LABEL	DESCRIPTION
Use Static-Dynamic Route to Control 1-1 NAT Route	If you are using SiteToSite VPN and 1-1 SNAT , it's recommended that you select this checkbox. Otherwise, you'll need to create policy route rules for VPN and destination NAT traffic. Note that the selection of this checkbox will change the priority of the routing flow (SiteToSite VPN , Static-Dynamic Route , and 1-1 SNAT). See Chapter on page 1053 for more information about the packet flow.
Add	Click this to create a new entry.
Edit	Double-click an entry or select it and click Edit to open a screen where you can modify the entry's settings.
Remove	To remove an entry, select it and click Remove . The Zyxel Device confirms you want to remove it before doing so.
Activate	To turn on an entry, select it and click Activate .
Inactivate	To turn off an entry, select it and click Inactivate .
Move	To change an entry's position in a numbered list, select it and click Move to display a field to type a number for where you want to put that entry and press [ENTER] to move the entry to the number that you typed. For example, if you type 6, the entry you are moving becomes number 6 and the previous entry 6 (if there is one) gets pushed up (or down) one.
#	This field is a sequential value, and it is not associated with a specific entry.
Status	This icon is lit when the entry is active and dimmed when the entry is inactive.
Priority	This field displays the priority level of the entry.

Table 157 Configuration > Network > NAT (continued)

LABEL	DESCRIPTION
Name	This field displays the name of the entry.
Mapping Type	This field displays what kind of NAT this entry performs: Virtual Server , 1:1 NAT , or Many 1:1 NAT .
Interface	This field displays the interface on which packets for the NAT entry are received.
Source IP	This field displays the source IP address (or address object) of traffic that matches this NAT entry. It displays any if there is no restriction on the source IP address.
External IP	This field displays the external destination IP address (or address object) of traffic that matches this NAT entry. It displays any if there is no restriction on the external destination IP address.
Internal IP	This field displays the new destination IP address for the packet.
Protocol	This field displays the service used by the packets for this NAT entry. It displays any if there is no restriction on the services.
External Port	This field displays the external destination port(s) of packets for the NAT entry. This field is blank if there is no restriction on the external destination port.
Internal Port	This field displays the new destination port(s) for the packet. This field is blank if there is no restriction on the external destination port.
Apply	Click this button to save your changes to the Zyxel Device.
Reset	Click this button to return the screen to its last-saved settings.

13.3.1 The NAT Add/Edit Screen

The **NAT Add/Edit** screen lets you create new NAT rules and edit existing ones. To open this window, open the **NAT** summary screen. (See [Section 13.3 on page 464](#).) Then, click on an **Add** icon or **Edit** icon to open the following screen.

Figure 318 Configuration > Network > NAT > Add

The following table describes the labels in this screen.

Table 158 Configuration > Network > NAT > Add

LABEL	DESCRIPTION
Create new Object	Use to configure any new settings objects that you need to use in this screen.
Enable Rule	Use this option to turn the NAT rule on or off.
Rule Name	Type in the name of the NAT rule. The name is used to refer to the NAT rule. You may use 1-31 alphanumeric characters, underscores(_), or dashes (-), but the first character cannot be a number. This value is case-sensitive.
Classification	<p>Select what kind of NAT this rule is to perform.</p> <p>Virtual Server - This makes computers on a private network behind the Zyxel Device available to a public network outside the Zyxel Device (like the Internet).</p> <p>1:1 NAT - If the private network server will initiate sessions to the outside clients, select this to have the Zyxel Device translate the source IP address of the server's outgoing traffic to the same public IP address that the outside clients use to access the server.</p> <p>Many 1:1 NAT - If you have a range of private network servers that will initiate sessions to the outside clients and a range of public IP addresses, select this to have the Zyxel Device translate the source IP address of each server's outgoing traffic to the same one of the public IP addresses that the outside clients use to access the server. The private and public ranges must have the same number of IP addresses.</p> <p>One many 1:1 NAT rule works like multiple 1:1 NAT rules, but it eases configuration effort since you only create one rule.</p>

Table 158 Configuration > Network > NAT > Add (continued)

LABEL	DESCRIPTION
Incoming Interface	Select the interface on which packets for the NAT rule must be received. It can be an Ethernet, VLAN, bridge, or PPPoE/PPTP interface.
Source IP	Specify the source IP address of the packets received by this NAT rule's specified incoming interface. any - Select this to use all of the incoming interface's IP addresses including dynamic addresses or those of any virtual interfaces built upon the selected incoming interface. User Defined - Select this to manually enter an IP address in the User Defined field. For example, you could enter a static IP address. Host address - select a address object to use the IP address it specifies.
External IP	Specify the destination IP address of the packets received by this NAT rule's specified incoming interface. The specified IP address will be translated to the Internal IP address. any - Select this to use all of the incoming interface's IP addresses including dynamic addresses or those of any virtual interfaces built upon the selected incoming interface. User Defined - Select this to manually enter an IP address in the User Defined field. For example, you could enter a static public IP assigned by the ISP without having to create a virtual interface for it. Host address - select a host address object to use the IP address it specifies. The list also includes address objects based on interface IPs. So for example you could select an address object based on a WAN interface even if it has a dynamic IP address.
User Defined External IP	This field is available if External IP is User Defined . Type the destination IP address that this NAT rule supports.
External IP Subnet/Range	This field displays for Many 1:1 NAT. Select the destination IP address subnet or IP address range that this NAT rule supports. The external and internal IP address subnets or ranges must have the same number of IP addresses.
Internal IP	Select to which translated destination IP address this NAT rule forwards packets. User Defined - this NAT rule supports a specific IP address, specified in the User Defined field. HOST address - the drop-down box lists all the HOST address objects in the Zyxel Device. If you select one of them, this NAT rule supports the IP address specified by the address object.
User Defined Internal IP	This field is available if Internal IP is User Defined . Type the translated destination IP address that this NAT rule supports.
Internal IP Subnet/Range	This field displays for Many 1:1 NAT . Select to which translated destination IP address subnet or IP address range this NAT rule forwards packets. The external and Internal IP address subnets or ranges must have the same number of IP addresses.
Port Mapping Type	Use the drop-down list box to select how many external destination ports this NAT rule supports for the selected destination IP address (External IP). Choices are: Any - this NAT rule supports all the destination ports. Port - this NAT rule supports one destination port. Ports - this NAT rule supports a range of destination ports. You might use a range of destination ports for unknown services or when one server supports more than one service. Service - this NAT rule supports a service such as FTP (see Object > Service > Service) Service-Group - this NAT rule supports a group of services such as all service objects related to DNS (see Object > Service > Service Group)
Protocol Type	This field is available if Mapping Type is Port or Ports . Select the protocol (TCP , UDP , or Any) used by the service requesting the connection.
External Port	This field is available if Mapping Type is Port . Enter the external destination port this NAT rule supports.

Table 158 Configuration > Network > NAT > Add (continued)

LABEL	DESCRIPTION
Internal Port	This field is available if Mapping Type is Port . Enter the translated destination port if this NAT rule forwards the packet.
External Start Port	This field is available if Mapping Type is Ports . Enter the beginning of the range of external destination ports this NAT rule supports.
External End Port	This field is available if Mapping Type is Ports . Enter the end of the range of external destination ports this NAT rule supports.
Internal Start Port	This field is available if Mapping Type is Ports . Enter the beginning of the range of translated destination ports if this NAT rule forwards the packet.
Internal End Port	This field is available if Mapping Type is Ports . Enter the end of the range of translated destination ports if this NAT rule forwards the packet. The external port range and the internal port range must be the same size.
Enable NAT Loopback	<p>Enable NAT loopback to allow users connected to any interface (instead of just the specified Incoming Interface) to use the NAT rule's specified External IP address to access the Internal IP device. For users connected to the same interface as the Internal IP device, the Zyxel Device uses that interface's IP address as the source address for the traffic it sends from the users to the Internal IP device.</p> <p>For example, if you configure a NAT rule to forward traffic from the WAN to a LAN server, enabling NAT loopback allows users connected to other interfaces to also access the server. For LAN users, the Zyxel Device uses the LAN interface's IP address as the source address for the traffic it sends to the LAN server. See NAT Loopback on page 468 for more details.</p> <p>If you do not enable NAT loopback, this NAT rule only applies to packets received on the rule's specified incoming interface.</p>
Security Policy	<p>By default the security policy blocks incoming connections from external addresses. After you configure your NAT rule settings, click the Security Policy link to configure a security policy to allow the NAT rule's traffic to come in.</p> <p>The Zyxel Device checks NAT rules before it applies To-Zyxel Device security policies, so To-Zyxel Device security policies, do not apply to traffic that is forwarded by NAT rules. The Zyxel Device still checks other security policies, according to the source IP address and internal IP address.</p>
OK	Click OK to save your changes back to the Zyxel Device.
Cancel	Click Cancel to return to the NAT summary screen without creating the NAT rule (if it is new) or saving any changes (if it already exists).

13.4 NAT Technical Reference

Here is more detailed information about NAT on the Zyxel Device.

NAT Loopback

Suppose an NAT 1:1 rule maps a public IP address to the private IP address of a LAN SMTP e-mail server to give WAN users access. NAT loopback allows other users to also use the rule's external IP to access the mail server.

For example, a LAN user's computer at IP address 192.168.1.89 queries a public DNS server to resolve the SMTP server's domain name (xxx.LAN-SMTP.com in this example) and gets the SMTP server's internal public IP address of 1.1.1.1.

Figure 319 LAN Computer Queries a Public DNS Server

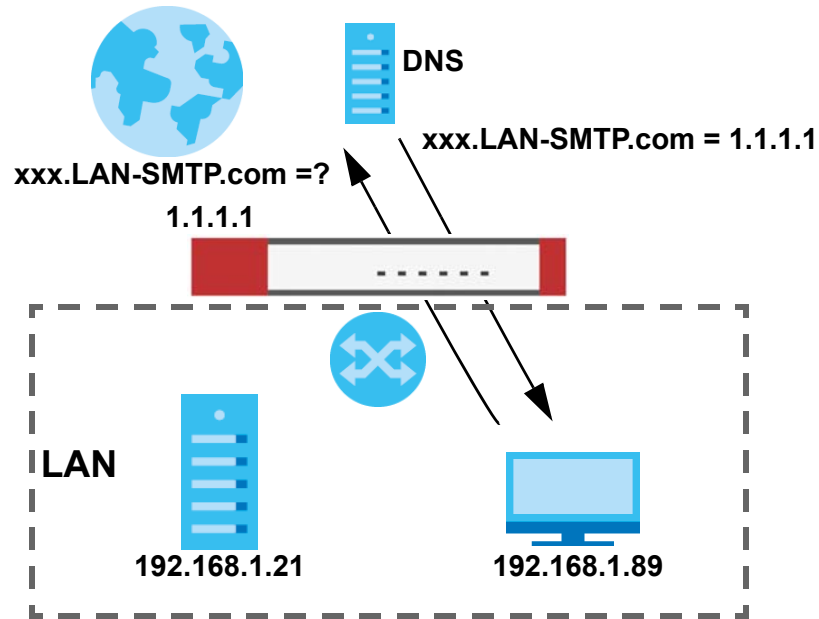

The LAN user's computer then sends traffic to IP address 1.1.1.1. NAT loopback uses the IP address of the Zyxel Device's LAN interface (192.168.1.1) as the source address of the traffic going from the LAN users to the LAN SMTP server.

Figure 320 LAN to LAN Traffic

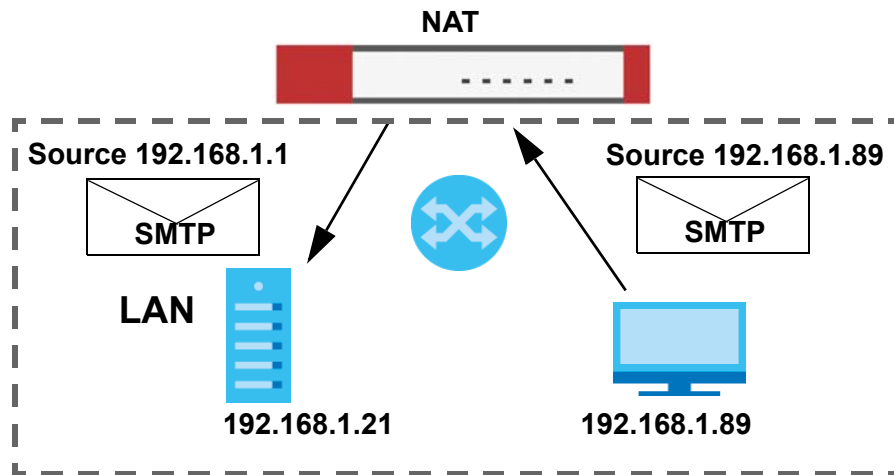

The LAN SMTP server replies to the Zyxel Device's LAN IP address and the Zyxel Device changes the source address to 1.1.1.1 before sending it to the LAN user. The return traffic's source matches the external destination address (1.1.1.1). If the SMTP server replied directly to the LAN user without the traffic going through NAT, the source would not match the external destination address which would cause the LAN user's computer to shut down the session.

Figure 321 LAN to LAN Return Traffic

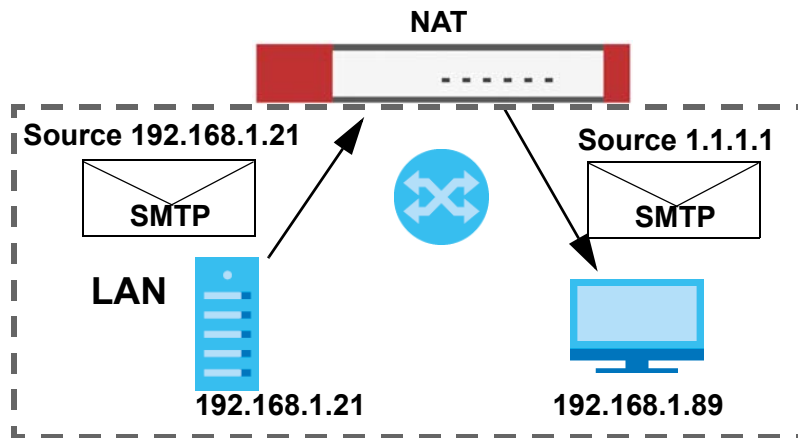

CHAPTER 14

Redirect Service

14.1 Overview

Redirect Service redirects HTTP and SMTP traffic.

14.1.1 HTTP Redirect

HTTP redirect forwards the client's HTTP request (except HTTP traffic destined for the Zyxel Device) to a web proxy server. In the following example, proxy server **A** is connected to the **DMZ** interface. When a client connected to the **LAN1** zone wants to open a web page, its HTTP request is redirected to proxy server **A** first. If proxy server **A** cannot find the web page in its cache, a policy route allows it to access the Internet to get them from a server. Proxy server **A** then forwards the response to the client.

Figure 322 HTTP Redirect Example

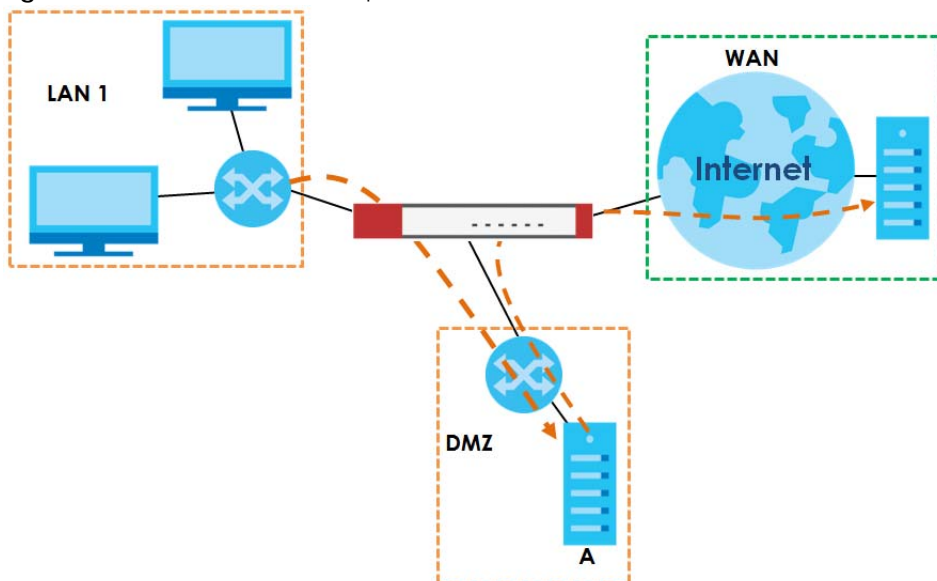

14.1.2 SMTP Redirect

SMTP redirect forwards the authenticated client's SMTP message to a SMTP server, that handles all outgoing e-mail messages. In the following example, SMTP server **A** is connected to the **lan2** interface in the **LAN2** zone. When a client connected to the **lan1** interface in the **LAN1** zone logs into the Zyxel Device and wants to send an e-mail, its SMTP message is redirected to SMTP server **A**. SMTP server **A** then sends it to a mail server, where the message will be delivered to the recipient.

The Zyxel Device forwards SMTP traffic using TCP port 25.

Figure 323 SMTP Redirect Example

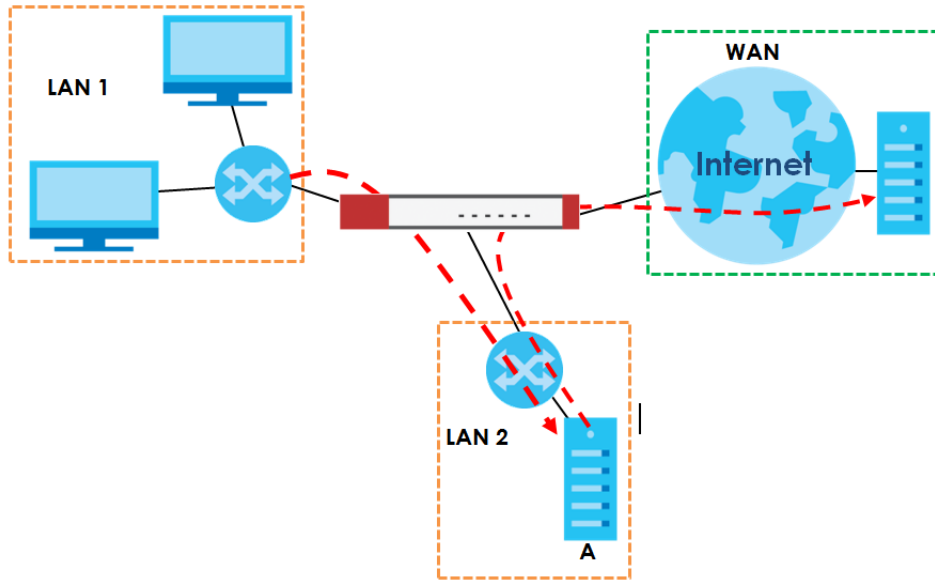

14.1.3 What You Can Do in this Chapter

Use the **Redirect Service** screens (see [Section 14.2 on page 474](#)) to display and edit the HTTP and SMTP redirect rules.

14.1.4 What You Need to Know

Web Proxy Server

A proxy server helps client devices make indirect requests to access the Internet or outside network resources/services. A proxy server can act as a security policy or an ALG (application layer gateway) between the private network and the Internet or other networks. It also keeps hackers from knowing internal IP addresses.

A client connects to a web proxy server each time he/she wants to access the Internet. The web proxy provides caching service to allow quick access and reduce network usage. The proxy checks its local cache for the requested web resource first. If it is not found, the proxy gets it from the specified server and forwards the response to the client.

HTTP Redirect, Security Policy and Policy Route

With HTTP redirect, the relevant packet flow for HTTP traffic is:

- 1 Security Policy
- 2 Application Patrol
- 3 HTTP Redirect
- 4 Policy Route

Even if you set a policy route to the same incoming interface and service as a HTTP redirect rule, the Zyxel Device checks the HTTP redirect rules first and forwards HTTP traffic to a proxy server if matched. You need to make sure there is no security policy blocking the HTTP requests from the client to the proxy server.

You also need to manually configure a policy route to forward the HTTP traffic from the proxy server to the Internet. To make the example in [Figure 322 on page 471](#) work, make sure you have the following settings.

For HTTP traffic between **lan1** and **dmz**:

- a from LAN1 to DMZ security policy (default) to allow HTTP requests from **lan1** to **dmz**. Responses to this request are allowed automatically.
- a application patrol rule to allow HTTP traffic between **lan1** and **dmz**.
- a HTTP redirect rule to forward HTTP traffic from **lan1** to proxy server **A**.

For HTTP traffic between **dmz** and **wan1**:

- a from DMZ to WAN security policy (default) to allow HTTP requests from **dmz** to **wan1**. Responses to these requests are allowed automatically.
- a application patrol rule to allow HTTP traffic between **dmz** and **wan1**.
- a policy route to forward HTTP traffic from proxy server **A** to the Internet.

SMTP

Simple Mail Transfer Protocol (SMTP) is the Internet's message transport standard. It controls the sending of e-mail messages between servers. E-mail clients (also called e-mail applications) then use mail server protocols such as POP (Post Office Protocol) or IMAP (Internet Message Access Protocol) to retrieve e-mail. E-mail clients also generally use SMTP to send messages to a mail server. The older POP2 requires SMTP for sending messages while the newer POP3 can be used with or without it. This is why many e-mail applications require you to specify both the SMTP server and the POP or IMAP server (even though they may actually be the same server).

SMTP Redirect, Firewall and Policy Route

With SMTP redirect, the relevant packet flow for SMTP traffic is:

- 1 Firewall
- 2 SMTP Redirect
- 3 Policy Route

Even if you set a policy route to the same incoming interface and service as a SMTP redirect rule, the Zyxel Device checks the SMTP redirect rules first and forwards SMTP traffic to a SMTP server if matched. You need to make sure there is no firewall rule(s) blocking the SMTP traffic from the client to the SMTP server.

You also need to manually configure a policy route to forward the SMTP traffic from the SMTP server to the Internet. To make the example in [Figure 323 on page 472](#) work, make sure you have the following settings.

For SMTP traffic between **lan1** and **lan2**:

- a from LAN1 to LAN2 firewall rule to allow SMTP messages from **lan1** to **lan2**. Responses to this request are allowed automatically.
- a SMTP redirect rule to forward SMTP traffic from **lan1** to SMTP server **A**.

For SMTP traffic between **lan2** and **wan1**:

- a from LAN2 to WAN firewall rule (default) to allow SMTP messages from **lan2** to **wan1**. Responses to these requests are allowed automatically.
- a policy route to forward SMTP messages from SMTP server **A** to the Internet.

14.2 The Redirect Service Screen

To configure redirection of a HTTP or SMTP request, click **Configuration > Network > HTTP Redirect**. This screen displays the summary of the redirect rules.

Note: You can configure up to one HTTP redirect rule and one SMTP redirect rule for each (incoming) interface.

Figure 324 Configuration > Network > Redirect Service

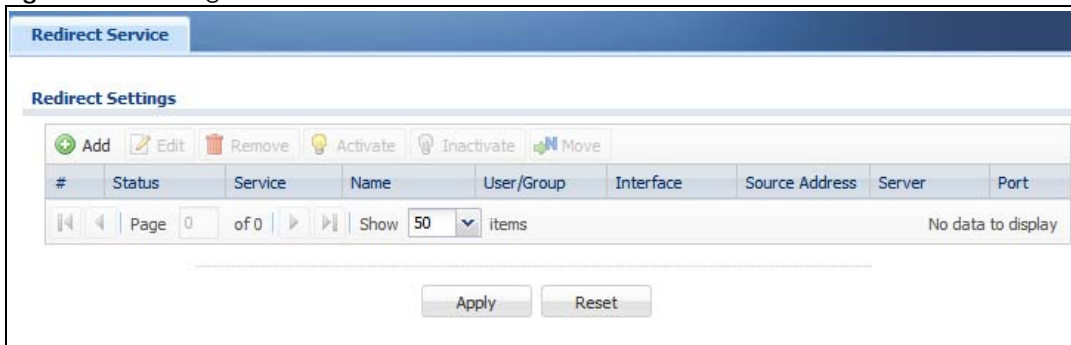

The following table describes the labels in this screen.

Table 159 Configuration > Network > Redirect Service

LABEL	DESCRIPTION
Add	Click this to create a new entry.
Edit	Double-click an entry or select it and click Edit to open a screen where you can modify the entry's settings.
Remove	To remove an entry, select it and click Remove . The Zyxel Device confirms you want to remove it before doing so.
Activate	To turn on an entry, select it and click Activate .
Inactivate	To turn off an entry, select it and click Inactivate .
#	This field is a sequential value, and it is not associated with a specific entry.
Status	This icon is lit when the entry is active and dimmed when the entry is inactive.
Service	This is the name of the service: HTTP or SMTP.
Name	This is the descriptive name of a rule.
User/Group	This is the user account or user group name to which this rule is applied.

Table 159 Configuration > Network > Redirect Service (continued)

LABEL	DESCRIPTION
Interface	This is the interface on which the request must be received.
Source Address	This is the name of the source IP address object from which the traffic should be sent. If any displays, the rule is effective for every source.
Server	This is the IP address of the HTTP proxy server or the SMTP server to which the matched traffic is forwarded.
Port	This is the service port number used by the HTTP proxy server or SMTP server.
Apply	Click Apply to save your changes back to the Zyxel Device.
Reset	Click Reset to return the screen to its last-saved settings.

14.2.1 The Redirect Service Edit Screen

Click **Network > Redirect Service** to open the **Redirect Service** screen. Then click the **Add** or **Edit** icon to open the **Redirect Service Edit** screen where you can configure the rule.

Figure 325 Network > Redirect Service > Edit

The following table describes the labels in this screen.

Table 160 Network > Redirect Service > Edit

LABEL	DESCRIPTION
Enable	Use this option to turn the Redirect Service rule on or off.
Service	Select the service to be redirected: HTTP Redirect or SMTP redirect .
Name	Enter a name to identify this rule. You may use 1-31 alphanumeric characters, underscores(_), or dashes (-), but the first character cannot be a number. This value is case-sensitive.
Criteria	

Table 160 Network > Redirect Service > Edit (continued)

LABEL	DESCRIPTION
User	Select the user account or user group name to which this rule is applied.
Interface	Select the interface on which the request must be received for the Zyxel Device to forward it to the specified server.
Source Address	Select the name of the source IP address object from which the traffic should be sent. Select any for the rule to be effective for every source.
Redirect Settings	
Server	Enter the IP address of the HTTP proxy or SMTP server.
Port	Enter the port number that the HTTP proxy or SMTP server uses.
OK	Click OK to save your changes back to the Zyxel Device.
Cancel	Click Cancel to exit this screen without saving.

CHAPTER 15

ALG

15.1 ALG Overview

Application Layer Gateway (ALG) allows the following applications to operate properly through the Zyxel Device's NAT.

- SIP - Session Initiation Protocol (SIP) – An application-layer protocol that can be used to create voice and multimedia sessions over Internet.
- H.323 – A teleconferencing protocol suite that provides audio, data and video conferencing.
- FTP – File Transfer Protocol – an Internet file transfer service.

The following example shows SIP signaling (1) and audio (2) sessions between SIP clients **A** and **B** and the SIP server.

Figure 326 SIP ALG Example

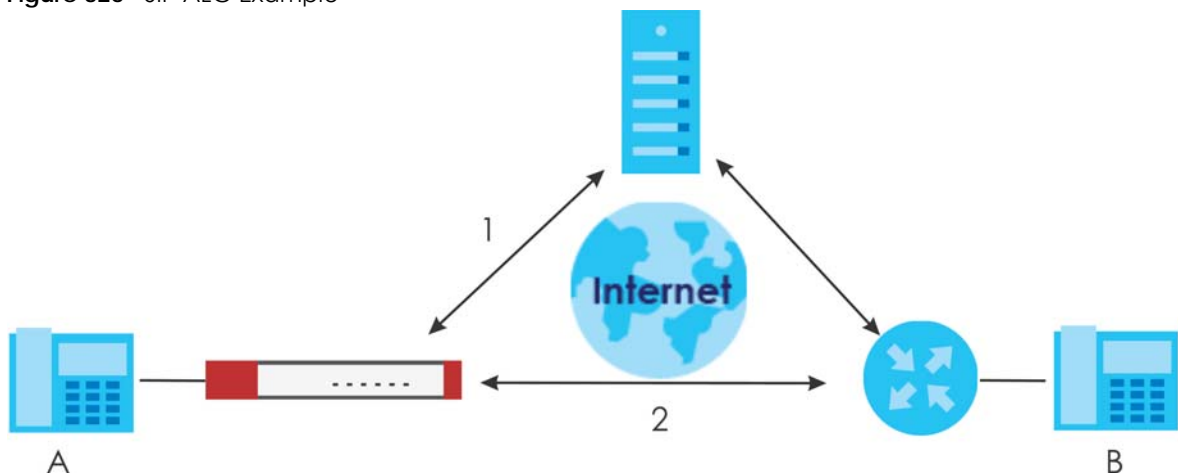

The ALG feature is only needed for traffic that goes through the Zyxel Device's NAT.

15.1.1 What You Need to Know

Application Layer Gateway (ALG), NAT and Security Policy

The Zyxel Device can function as an Application Layer Gateway (ALG) to allow certain NAT un-friendly applications (such as SIP) to operate properly through the Zyxel Device's NAT and security policy. The Zyxel Device dynamically creates an implicit NAT session and security policy session for the application's traffic from the WAN to the LAN. The ALG on the Zyxel Device supports all of the Zyxel Device's NAT mapping types.

FTP ALG

The FTP ALG allows TCP packets with a specified port destination to pass through. If the FTP server is located on the LAN, you must also configure NAT (port forwarding) and security policies if you want to allow access to the server from the WAN. Bandwidth management can be applied to FTP ALG traffic.

H.323 ALG

- The H.323 ALG supports peer-to-peer H.323 calls.
- The H.323 ALG handles H.323 calls that go through NAT or that the Zyxel Device routes. You can also make other H.323 calls that do not go through NAT or routing. Examples would be calls between LAN IP addresses that are on the same subnet.
- The H.323 ALG allows calls to go out through NAT. For example, you could make a call from a private IP address on the LAN to a peer device on the WAN.
- The H.323 ALG operates on TCP packets with a specified port destination.
- Bandwidth management can be applied to H.323 ALG traffic.
- The Zyxel Device allows H.323 audio connections.
- The Zyxel Device can also apply bandwidth management to traffic that goes through the H.323 ALG.

The following example shows H.323 signaling (1) and audio (2) sessions between H.323 devices A and B.

Figure 327 H.323 ALG Example

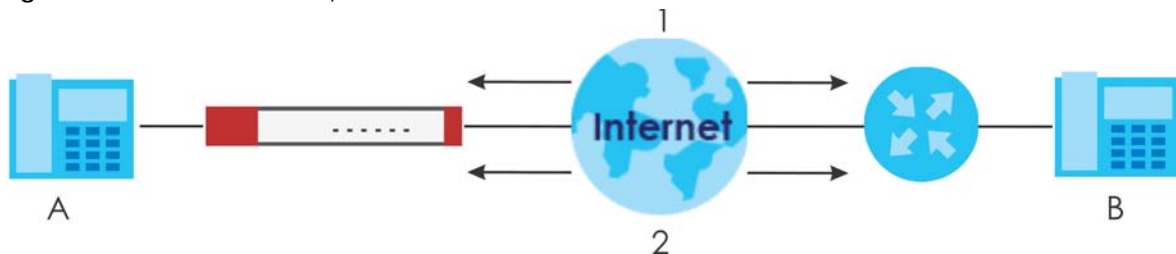

SIP ALG

- SIP phones can be in any zone (including LAN, DMZ, WAN), and the SIP server and SIP clients can be in the same network or different networks. The SIP server cannot be on the LAN. It must be on the WAN or the DMZ.
- There should be only one SIP server (total) on the Zyxel Device's private networks. Any other SIP servers must be on the WAN. So for example you could have a Back-to-Back User Agent such as the IPPBX x6004 or an asterisk PBX on the DMZ or on the LAN but not on both.
- Using the SIP ALG allows you to use bandwidth management on SIP traffic. Bandwidth management can be applied to FTP ALG traffic. Use the option in the **Configuration > BWM** screen to configure the highest bandwidth available for SIP traffic.
- The SIP ALG handles SIP calls that go through NAT or that the Zyxel Device routes. You can also make other SIP calls that do not go through NAT or routing. Examples would be calls between LAN IP addresses that are on the same subnet.
- The SIP ALG supports peer-to-peer SIP calls. The security policy (by default) allows peer to peer calls from the LAN zone to go to the WAN zone and blocks peer to peer calls from the WAN zone to the LAN zone.
- The SIP ALG allows UDP packets with a specified port destination to pass through.
- The Zyxel Device allows SIP audio connections.

- You do not need to use TURN (Traversal Using Relay NAT) for VoIP devices behind the Zyxel Device when you enable the SIP ALG.
- Configuring the SIP ALG to use custom port numbers for SIP traffic also configures the application patrol (see [Chapter on page 716](#)) to use the same port numbers for SIP traffic. Likewise, configuring the application patrol to use custom port numbers for SIP traffic also configures SIP ALG to use the same port numbers for SIP traffic.

Peer-to-Peer Calls and the Zyxel Device

The Zyxel Device ALG can allow peer-to-peer VoIP calls for both H.323 and SIP. You must configure the security policy and NAT (port forwarding) to allow incoming (peer-to-peer) calls from the WAN to a private IP address on the LAN (or DMZ).

VoIP Calls from the WAN with Multiple Outgoing Calls

When you configure the security policy and NAT (port forwarding) to allow calls from the WAN to a specific IP address on the LAN, you can also use policy routing to have H.323 (or SIP) calls from other LAN or DMZ IP addresses go out through a different WAN IP address. The policy routing lets the Zyxel Device correctly forward the return traffic for the calls initiated from the LAN IP addresses.

For example, you configure the security policy and NAT to allow LAN IP address **A** to receive calls from the Internet through WAN IP address **1**. You also use a policy route to have LAN IP address **A** make calls out through WAN IP address **1**. Configure another policy route to have H.323 (or SIP) calls from LAN IP addresses **B** and **C** go out through WAN IP address **2**. Even though only LAN IP address **A** can receive incoming calls from the Internet, LAN IP addresses **B** and **C** can still make calls out to the Internet.

Figure 328 VoIP Calls from the WAN with Multiple Outgoing Calls

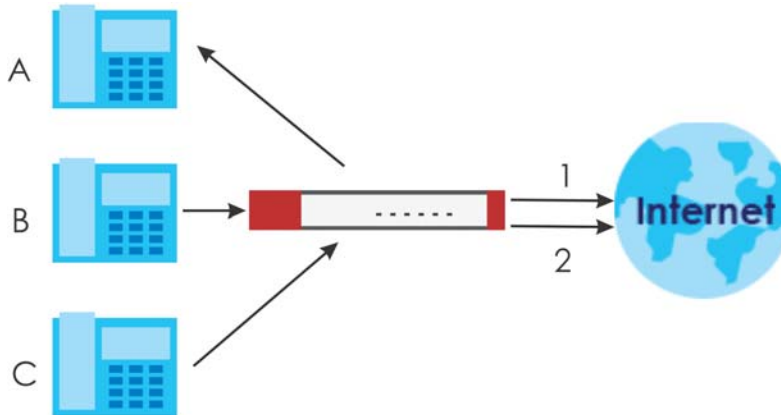

VoIP with Multiple WAN IP Addresses

With multiple WAN IP addresses on the Zyxel Device, you can configure different security policy and NAT (port forwarding) rules to allow incoming calls from each WAN IP address to go to a specific IP address on the LAN (or DMZ). Use policy routing to have the H.323 (or SIP) calls from each of those LAN or DMZ IP addresses go out through the same WAN IP address that calls come in on. The policy routing lets the Zyxel Device correctly forward the return traffic for the calls initiated from the LAN IP addresses.

For example, you configure security policy and NAT rules to allow LAN IP address **A** to receive calls through public WAN IP address **1**. You configure different security policy and port forwarding rules to allow LAN IP address **B** to receive calls through public WAN IP address **2**. You configure corresponding

policy routes to have calls from LAN IP address **A** go out through WAN IP address **1** and calls from LAN IP address **B** go out through WAN IP address **2**.

Figure 329 VoIP with Multiple WAN IP Addresses

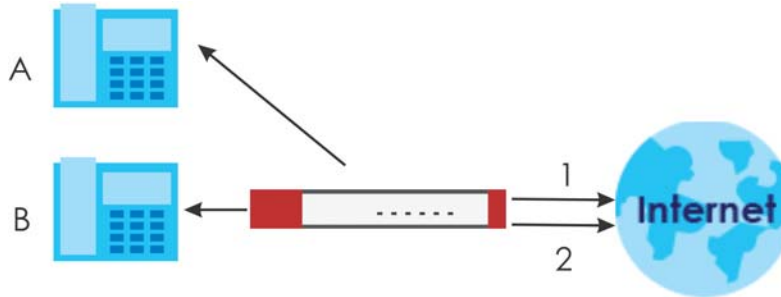

15.1.2 Before You Begin

You must also configure the security policy and enable NAT in the Zyxel Device to allow sessions initiated from the WAN.

15.2 The ALG Screen

Click **Configuration** > **Network** > **ALG** to open the **ALG** screen. Use this screen to turn ALGs off or on, configure the port numbers to which they apply, and configure SIP ALG time outs.

Note: If the Zyxel Device provides an ALG for a service, you must enable the ALG in order to use the application patrol on that service's traffic.

Figure 330 Configuration > Network > ALG

ALG

SIP Settings

Enable SIP ALG

Enable SIP Transformations

Enable Configure SIP Inactivity Timeout

SIP Media Inactivity Timeout : (seconds)

SIP Signaling Inactivity Timeout : (seconds)

Restrict Peer to Peer Signaling Connection

Restrict Peer to Peer Media Connection

SIP Signaling Port :

#	Port
1	5060

H.323 Settings

Enable H.323 ALG

Enable H.323 Transformations

H.323 Signaling Port : (1025-65535)

Additional H.323 Signaling Port for Transformations : (1025-65535) (Optional)

FTP Settings

Enable FTP ALG

Enable FTP Transformations

FTP Signaling Port : (1-65535)

Additional FTP Signaling Port for Transformations : (1-65535) (Optional)

The following table describes the labels in this screen.

Table 161 Configuration > Network > ALG

LABEL	DESCRIPTION
Enable SIP ALG	Turn on the SIP ALG to detect SIP traffic and help build SIP sessions through the Zyxel Device's NAT. Enabling the SIP ALG also allows you to use the application patrol to detect SIP traffic and manage the SIP traffic's bandwidth (see Chapter on page 716).
Enable SIP Transformations	Select this to have the Zyxel Device modify IP addresses and port numbers embedded in the SIP data payload. You do not need to use this if you have a SIP device or server that will modify IP addresses and port numbers embedded in the SIP data payload.
Enable Configure SIP Inactivity Timeout	Select this option to have the Zyxel Device apply SIP media and signaling inactivity time out limits. These timeouts will take priority over the SIP session timeout "Expires" value in a SIP registration response packet.
SIP Media Inactivity Timeout	Use this field to set how many seconds (1~86400) the Zyxel Device will allow a SIP session to remain idle (without voice traffic) before dropping it. If no voice packets go through the SIP ALG before the timeout period expires, the Zyxel Device deletes the audio session. You cannot hear anything and you will need to make a new call to continue your conversation.

Table 161 Configuration > Network > ALG (continued)

LABEL	DESCRIPTION
SIP Signaling Inactivity Timeout	<p>Most SIP clients have an "expire" mechanism indicating the lifetime of signaling sessions. The SIP user agent sends registration packets to the SIP server periodically and keeps the session alive in the Zyxel Device.</p> <p>If the SIP client does not have this mechanism and makes no calls during the Zyxel Device SIP timeout, the Zyxel Device deletes the signaling session after the timeout period. Enter the SIP signaling session timeout value (1~86400).</p>
Restrict Peer to Peer Signaling Connection	<p>A signaling connection is used to set up the SIP connection.</p> <p>Enable this if you want signaling connections to only arrive from the IP address(es) you registered with. Signaling connections from other IP addresses will be dropped.</p>
Restrict Peer to Peer Media Connection	<p>A media connection is the audio transfer in a SIP connection.</p> <p>Enable this if you want media connections to only arrive from the IP address(es) you registered with. Media connections from other IP addresses will be dropped.</p> <p>You should disable this if have registered for cloud VoIP services.</p>
SIP Signaling Port	<p>If you are using a custom UDP port number (not 5060) for SIP traffic, enter it here. Use the Add icon to add fields if you are also using SIP on additional UDP port numbers.</p>
Additional SIP Signaling Port (UDP) for Transformations	<p>If you are also using SIP on an additional UDP port number, enter it here.</p>
Enable H.323 ALG	<p>Turn on the H.323 ALG to detect H.323 traffic (used for audio communications) and help build H.323 sessions through the Zyxel Device's NAT. Enabling the H.323 ALG also allows you to use the application patrol to detect H.323 traffic and manage the H.323 traffic's bandwidth (see Chapter on page 716).</p>
Enable H.323 Transformations	<p>Select this to have the Zyxel Device modify IP addresses and port numbers embedded in the H.323 data payload.</p> <p>You do not need to use this if you have a H.323 device or server that will modify IP addresses and port numbers embedded in the H.323 data payload.</p>
H.323 Signaling Port	<p>If you are using a custom TCP port number (not 1720) for H.323 traffic, enter it here.</p>
Additional H.323 Signaling Port for Transformations	<p>If you are also using H.323 on an additional TCP port number, enter it here.</p>
Enable FTP ALG	<p>Turn on the FTP ALG to detect FTP (File Transfer Program) traffic and help build FTP sessions through the Zyxel Device's NAT. Enabling the FTP ALG also allows you to use the application patrol to detect FTP traffic and manage the FTP traffic's bandwidth (see Chapter on page 716).</p>
Enable FTP Transformations	<p>Select this option to have the Zyxel Device modify IP addresses and port numbers embedded in the FTP data payload to match the Zyxel Device's NAT environment.</p> <p>Clear this option if you have an FTP device or server that will modify IP addresses and port numbers embedded in the FTP data payload to match the Zyxel Device's NAT environment.</p>
FTP Signaling Port	<p>If you are using a custom TCP port number (not 21) for FTP traffic, enter it here.</p>
Additional FTP Signaling Port for Transformations	<p>If you are also using FTP on an additional TCP port number, enter it here.</p>
Apply	<p>Click Apply to save your changes back to the Zyxel Device.</p>
Reset	<p>Click Reset to return the screen to its last-saved settings.</p>

15.3 ALG Technical Reference

Here is more detailed information about the Application Layer Gateway.

ALG

Some applications cannot operate through NAT (are NAT unfriendly) because they embed IP addresses and port numbers in their packets' data payload. The Zyxel Device examines and uses IP address and port number information embedded in the VoIP traffic's data stream. When a device behind the Zyxel Device uses an application for which the Zyxel Device has VoIP pass through enabled, the Zyxel Device translates the device's private IP address inside the data stream to a public IP address. It also records session port numbers and allows the related sessions to go through the security policy so the application's traffic can come in from the WAN to the LAN.

ALG and Trunks

If you send your ALG-managed traffic through an interface trunk and all of the interfaces are set to active, you can configure routing policies to specify which interface the ALG-managed traffic uses.

You could also have a trunk with one interface set to active and a second interface set to passive. The Zyxel Device does not automatically change ALG-managed connections to the second (passive) interface when the active interface's connection goes down. When the active interface's connection fails, the client needs to re-initialize the connection through the second interface (that was set to passive) in order to have the connection go through the second interface. VoIP clients usually re-register automatically at set intervals or the users can manually force them to re-register.

FTP

File Transfer Protocol (FTP) is an Internet file transfer service that operates on the Internet and over TCP/IP networks. A system running the FTP server accepts commands from a system running an FTP client. The service allows users to send commands to the server for uploading and downloading files.

H.323

H.323 is a standard teleconferencing protocol suite that provides audio, data and video conferencing. It allows for real-time point-to-point and multipoint communication between client computers over a packet-based network that does not provide a guaranteed quality of service. NetMeeting uses H.323.

SIP

The Session Initiation Protocol (SIP) is an application-layer control (signaling) protocol that handles the setting up, altering and tearing down of voice and multimedia sessions over the Internet. SIP is used in VoIP (Voice over IP), the sending of voice signals over the Internet Protocol.

SIP signaling is separate from the media for which it handles sessions. The media that is exchanged during the session can use a different path from that of the signaling. SIP handles telephone calls and can interface with traditional circuit-switched telephone networks.

RTP

When you make a VoIP call using H.323 or SIP, the RTP (Real time Transport Protocol) is used to handle voice data transfer. See RFC 1889 for details on RTP.

CHAPTER 16

UPnP

16.1 UPnP and NAT-PMP Overview

The Zyxel Device supports both UPnP and NAT-PMP to permit networking devices to discover each other and connect seamlessly.

Universal Plug and Play (UPnP) is a distributed, open networking standard that uses TCP/IP for simple peer-to-peer network connectivity between devices. A UPnP device can dynamically join a network, obtain an IP address, convey its capabilities and learn about other devices on the network. In turn, a device can leave a network smoothly and automatically when it is no longer in use. A gateway that supports UPnP is called Internet Gateway Device (IGD). The standardized Device Control Protocol (DCP) is defined by the UPnP Forum for IGDs to configure port mapping automatically.

NAT Port Mapping Protocol (NAT-PMP), introduced by Apple and implemented in current Apple products, is used as an alternative NAT traversal solution to the UPnP IGD protocol. NAT-PMP runs over UDP port 5351. NAT-PMP is much simpler than UPnP IGD and mainly designed for small home networks. It allows a client behind a NAT router to retrieve the router's public IP address and port number and make them known to the peer device with which it wants to communicate. The client can automatically configure the NAT router to create a port mapping to allow the peer to contact it.

16.2 What You Need to Know

UPnP hardware is identified as an icon in the Network folder (Windows 7). Each UPnP compatible device installed on your network will appear as a separate icon. Selecting the icon of a UPnP device will allow you to access the information and properties of that device.

16.2.1 NAT Traversal

UPnP NAT traversal automates the process of allowing an application to operate through NAT. UPnP network devices can automatically configure network addressing, announce their presence in the network to other UPnP devices and enable exchange of simple product and service descriptions. NAT traversal allows the following:

- Dynamic port mapping
- Learning public IP addresses
- Assigning lease times to mappings

Windows Messenger is an example of an application that supports NAT traversal and UPnP.

See the NAT chapter for more information on NAT.

16.2.2 Cautions with UPnP and NAT-PMP

The automated nature of NAT traversal applications in establishing their own services and opening security policy ports may present network security issues. Network information and configuration may also be obtained and modified by users in some network environments.

When a UPnP or NAT-PMP device joins a network, it announces its presence with a multicast message. For security reasons, the Zyxel Device allows multicast messages on the LAN only.

All UPnP-enabled or NAT-PMP-enabled devices may communicate freely with each other without additional configuration. Disable UPnP or NAT-PMP if this is not your intention.

16.3 UPnP Screen

Use this screen to enable UPnP and NAT-PMP on your Zyxel Device.

Click **Configuration > Network > UPnP** to display the screen shown next.

Figure 331 Configuration > Network > UPnP

The screenshot shows the UPnP configuration page. The 'General Setting' section includes:

- Enable UPnP
- Enable NAT-PMP
- Allow UPnP or NAT-PMP to pass through Firewall
- Outgoing WAN Interface: ALL

The 'Support LAN List' section shows:

Available	Member
dmz	lan1
lan2	
reserved	

At the bottom of the screen are 'Apply' and 'Reset' buttons.

The following table describes the fields in this screen.

Table 162 Configuration > Network > UPnP

LABEL	DESCRIPTION
Enable UPnP	Select this check box to activate UPnP on the Zyxel Device. Be aware that anyone could use a UPnP application to open the web configurator's login screen without entering the Zyxel Device's IP address (although you must still enter the password to access the web configurator).
Enable NAT-PMP	<p>NAT Port Mapping Protocol (NAT-PMP) automates port forwarding to allow a computer in a private network (behind the Zyxel Device) to automatically configure the Zyxel Device to allow computers outside the private network to contact it.</p> <p>Select this check box to activate NAT-PMP on the Zyxel Device. Be aware that anyone could use a NAT-PMP application to open the web configurator's login screen without entering the Zyxel Device's IP address (although you must still enter the password to access the web configurator).</p>
Allow UPnP or NAT-PMP to pass through Firewall	<p>Select this check box to allow traffic from UPnP-enabled or NAT-PMP-enabled applications to bypass the security policy.</p> <p>Clear this check box to have the security policy block all UPnP or NAT-PMP application packets (for example, MSN packets).</p>
Outgoing WAN Interface	Select through which WAN interface(s) you want to send out traffic from UPnP-enabled or NAT-PMP-enabled applications. If the WAN interface you select loses its connection, the Zyxel Device attempts to use the other WAN interface. If the other WAN interface also does not work, the Zyxel Device drops outgoing packets from UPnP-enabled or NAT-PMP-enabled applications.
Support LAN List	<p>The Available list displays the name(s) of the internal interface(s) on which the Zyxel Device supports UPnP and/or NAT-PMP.</p> <p>To enable UPnP and/or NAT-PMP on an interface, you can double-click a single entry to move it or use the [Shift] or [Ctrl] key to select multiple entries and click the right arrow button to add to the Member list. To remove an interface, select the name(s) in the Member list and click the left arrow button.</p>
Apply	Click Apply to save your changes back to the Zyxel Device.
Reset	Click Reset to return the screen to its last-saved settings.

16.4 Technical Reference

The sections show examples of using UPnP.

16.4.1 Turning on UPnP in Windows 7 Example

This section shows you how to use the UPnP feature in Windows 7. UPnP server is installed in Windows 7. Activate UPnP on the Zyxel Device.

Make sure the computer is connected to a LAN port of the Zyxel Device. Turn on your computer and the Zyxel Device.

- 1 Click the start icon, **Control Panel** and then the **Network and Sharing Center**.

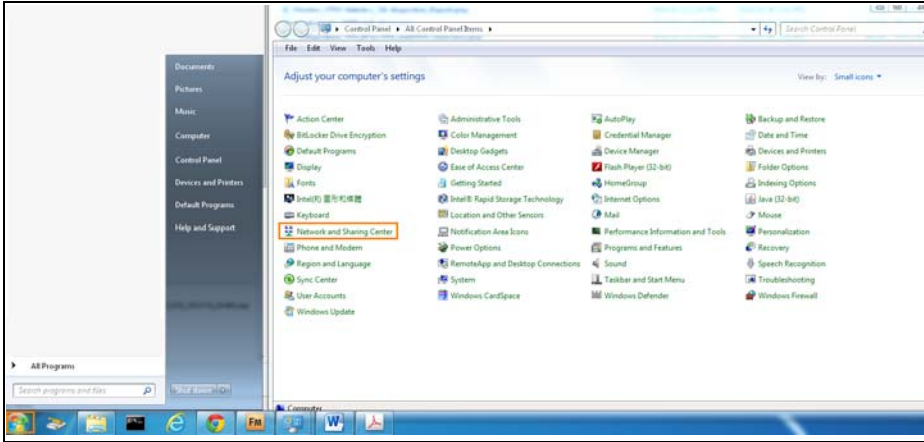

- 2 Click **Change Advanced Sharing Settings**.

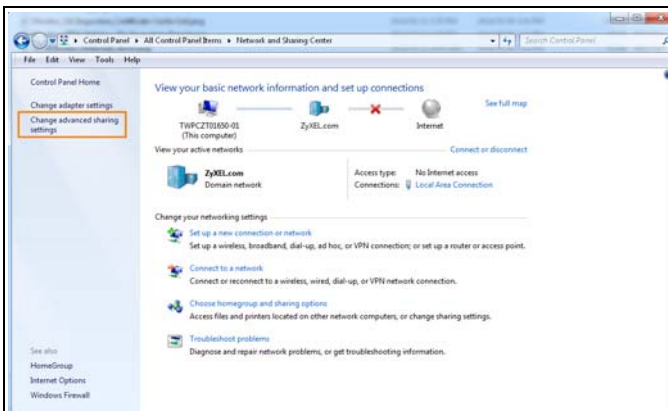

- 3 Select **Turn on network discovery** and click **Save Changes**. Network discovery allows your computer to find other computers and devices on the network and other computers on the network to find your computer. This makes it easier to share files and printers.

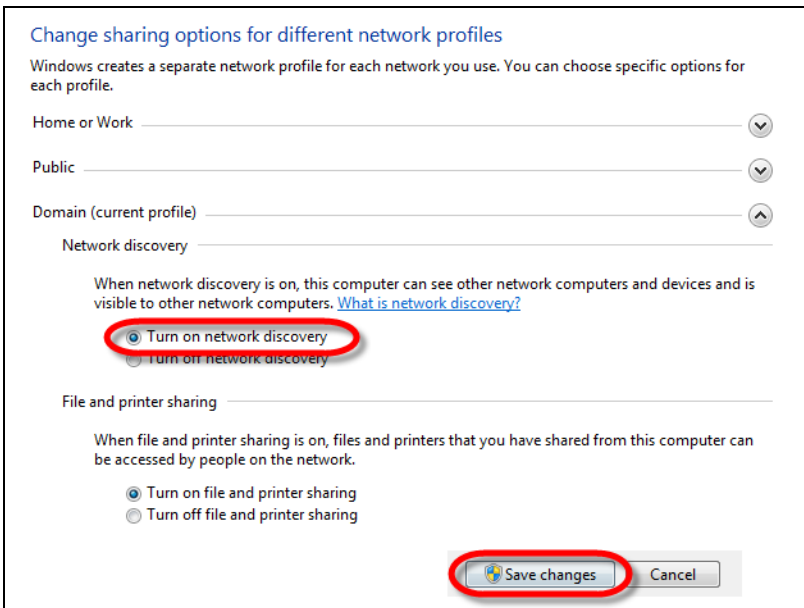

16.4.1.1 Auto-discover Your UPnP-enabled Network Device

Before you follow these steps, make sure you already have UPnP activated on the Zyxel Device and in your computer.

Make sure your computer is connected to a LAN port of the Zyxel Device.

- 1 Open the **Windows Explorer** and click **Network**.
- 2 Right-click the device icon and select **Properties**.

Figure 332 Network Connections

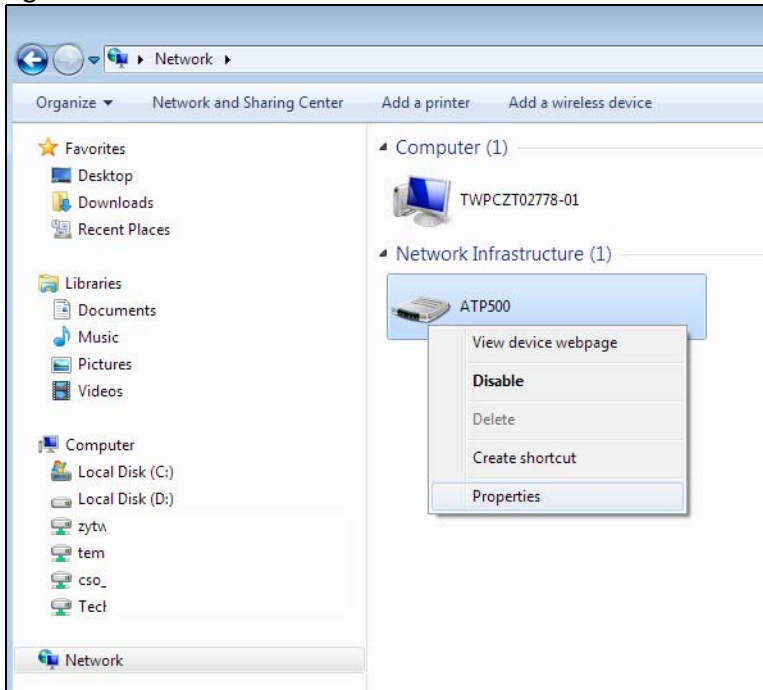

- 3 In the **Internet Connection Properties** window, click **Settings** to see port mappings.

Figure 333 Internet Connection Properties

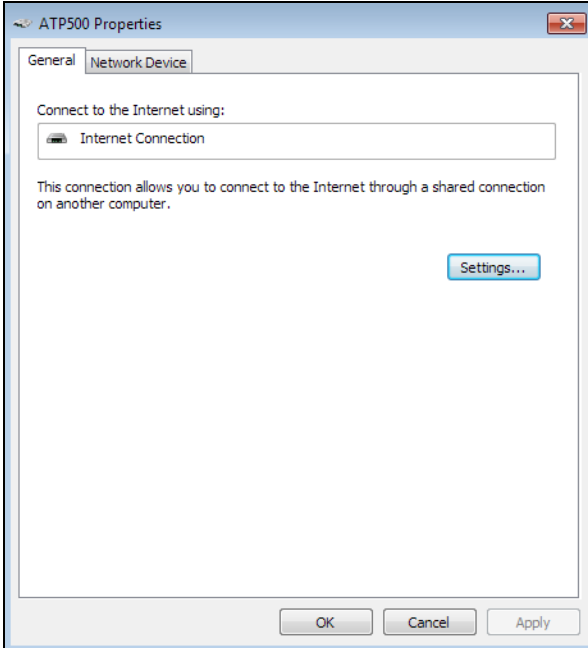

- 4 You may edit or delete the port mappings or click **Add** to manually add port mappings.

Figure 334 Internet Connection Properties: Advanced Settings

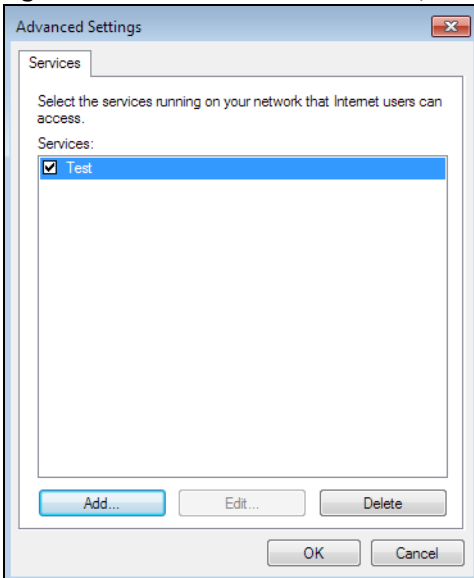
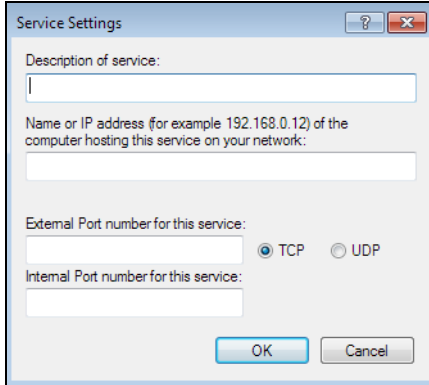

Figure 335 Internet Connection Properties: Advanced Settings: Add

Note: When the UPnP-enabled device is disconnected from your computer, all port mappings will be deleted automatically.

- 5 Click **OK**. Check the network icon on the system tray to see your Internet connection status.

Figure 336 System Tray Icon

- 6 To see more details about your current Internet connection status, right click on the network icon in the system tray and click **Open Network and Sharing Center**. Click **Local Area Network**.

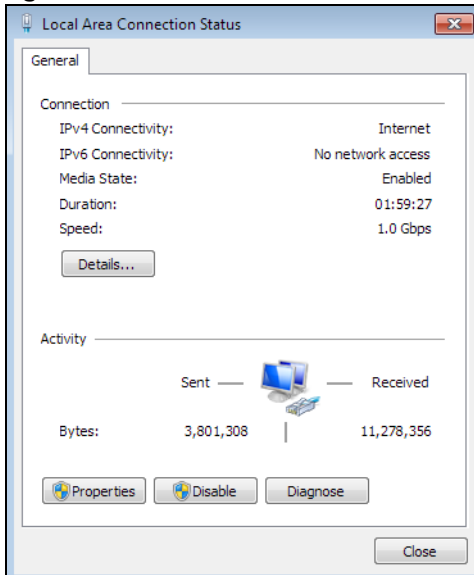
Figure 337 Internet Connection Status

16.4.2 Turn on UPnP in Windows 10 Example

This section shows you how to use the UPnP feature in Windows 10. UPnP server is installed in Windows 10. Activate UPnP on the Zyxel Device by clicking **Network Setting > Home Networking > UPnP**.

Make sure the computer is connected to the LAN port of the Zyxel Device. Turn on your computer and the Zyxel Device.

- 1 Click the start icon, **Settings** and then **Network & Internet**.

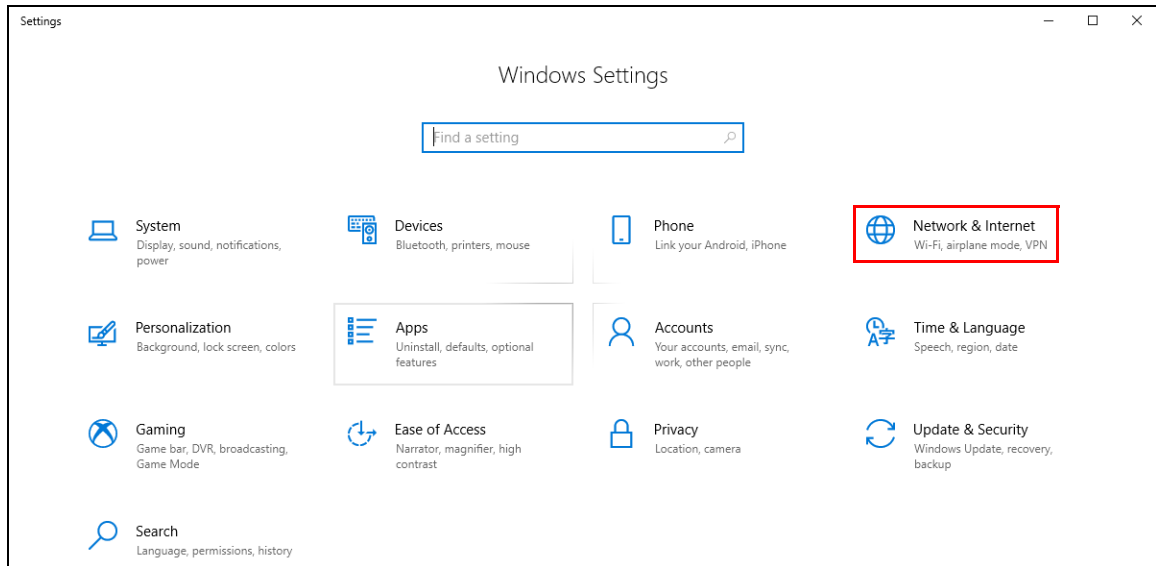

- 2 Click **Network and Sharing Center**.

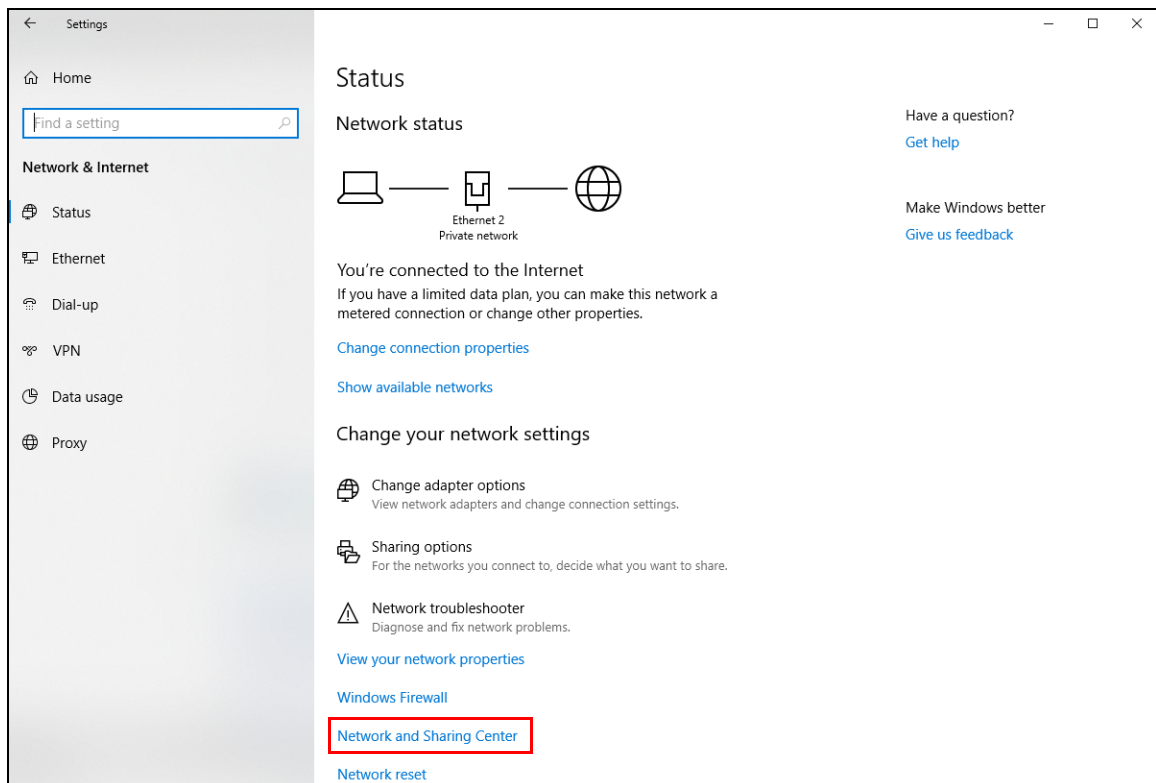

- 3 Click **Change advanced sharing settings**.

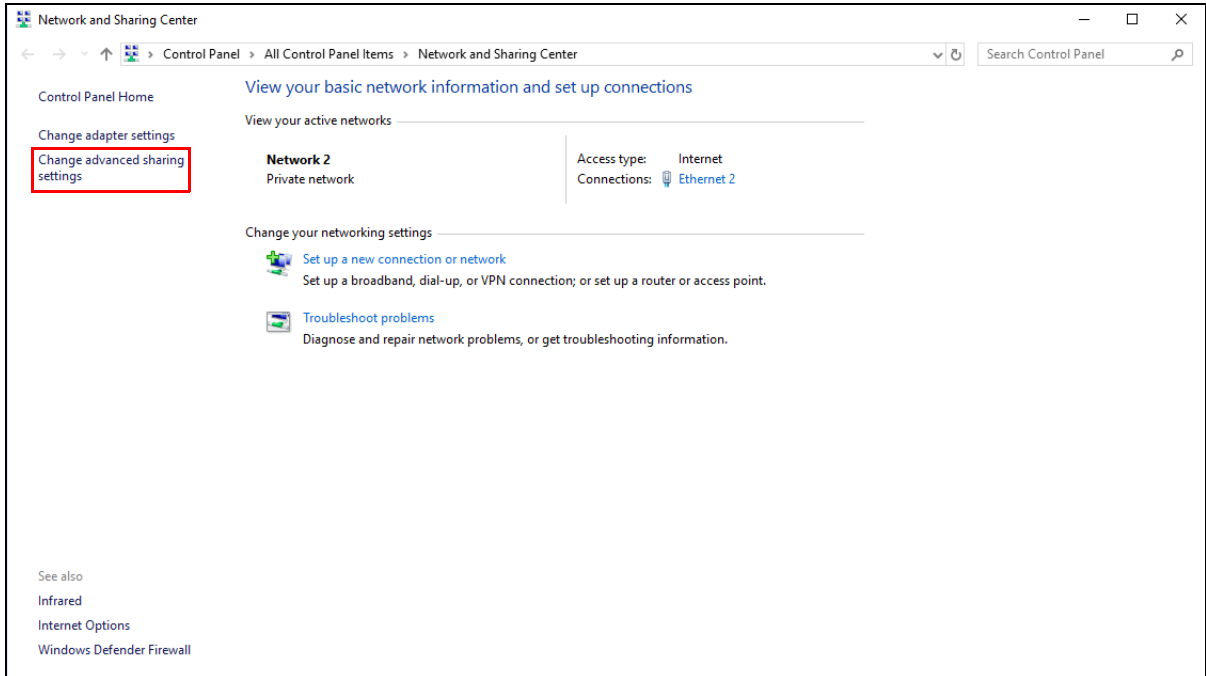

- 4 Under **Domain**, select **Turn on network discovery** and click **Save Changes**. Network discovery allows your computer to find other computers and devices on the network and other computers on the network to find your computer. This makes it easier to share files and printers.

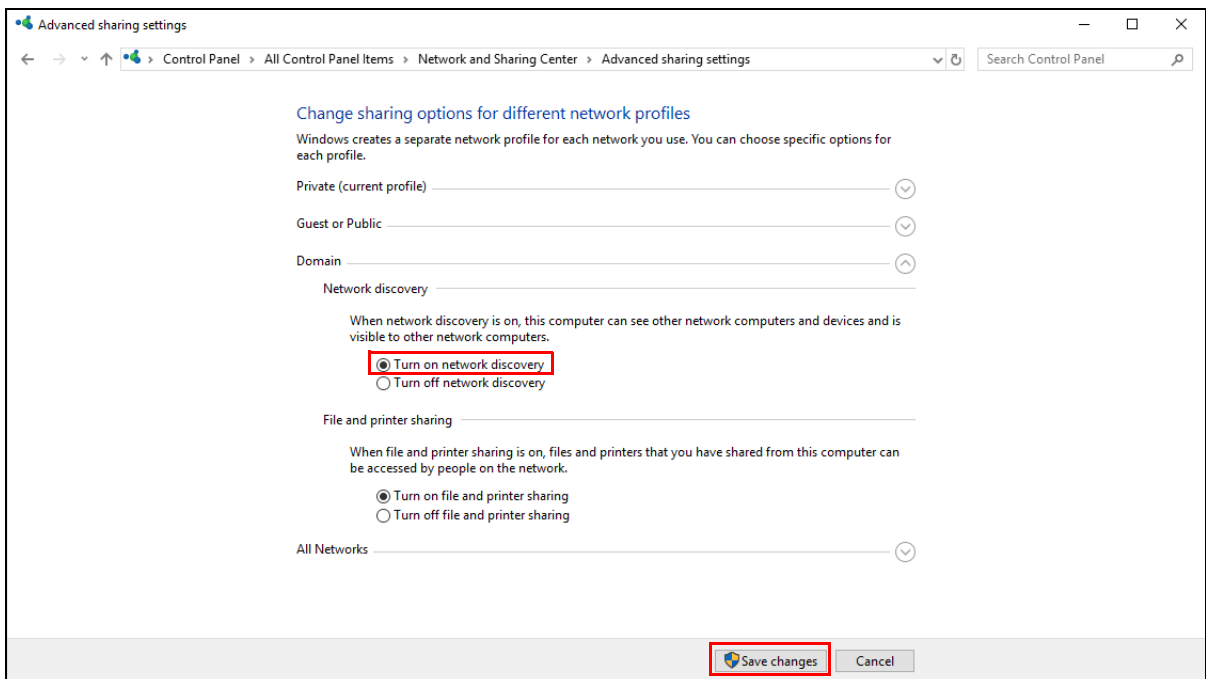

16.4.3 Auto-discover Your UPnP-enabled Network Device

Before you follow these steps, make sure you already have UPnP activated on the Zyxel Device and in your computer.

Make sure your computer is connected to the LAN port of the Zyxel Device.

- 1 Open **File Explorer** and click **Network**.
- 2 Right-click the Zyxel Device icon and select **Properties**.

Figure 338 Network Connections

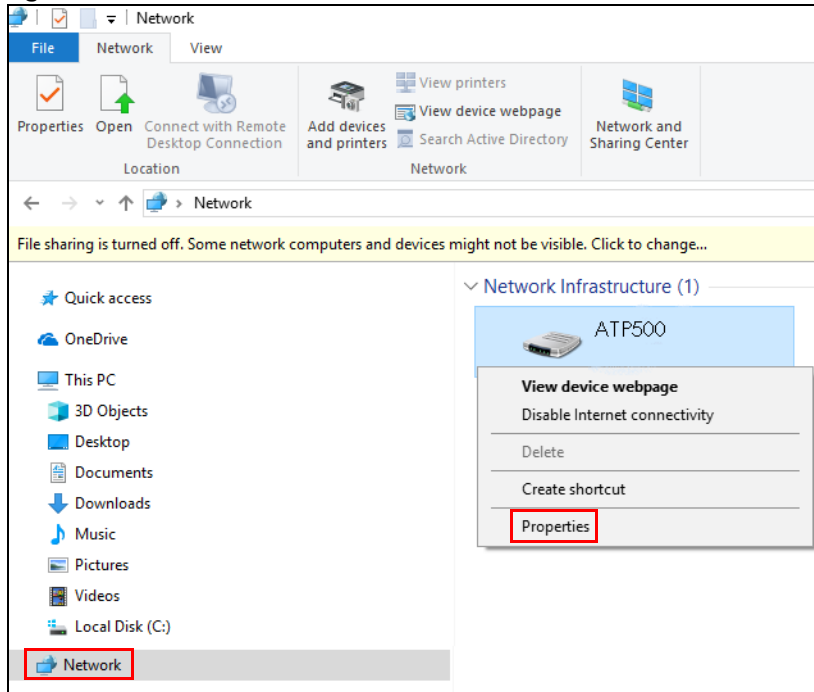

- 3 In the **Internet Connection Properties** window, click **Settings** to see port mappings.

Figure 339 Internet Connection Properties

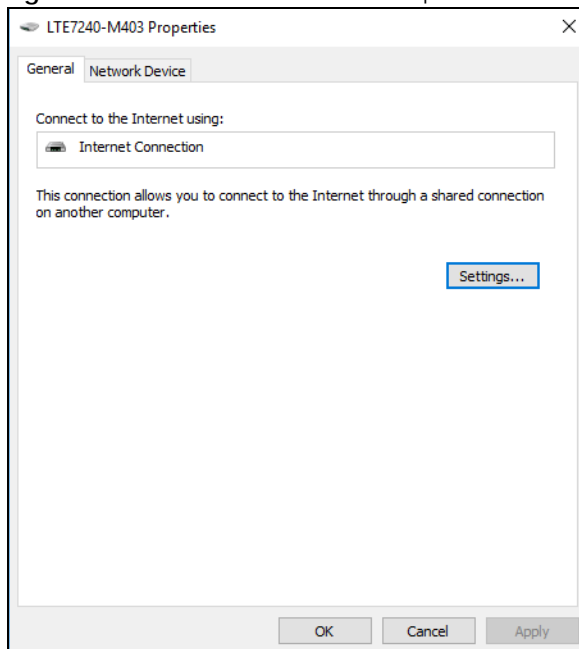

- 4 You may edit or delete the port mappings or click **Add** to manually add port mappings.

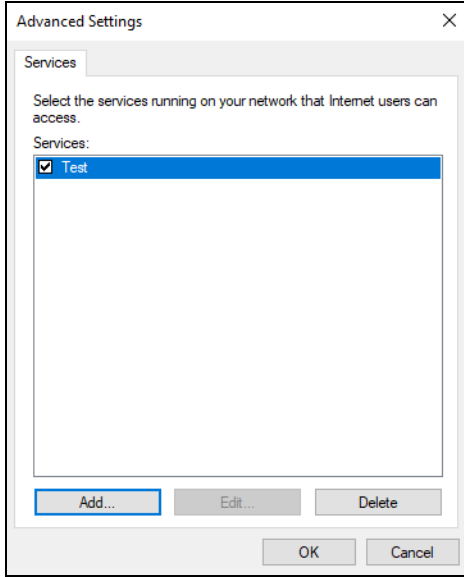
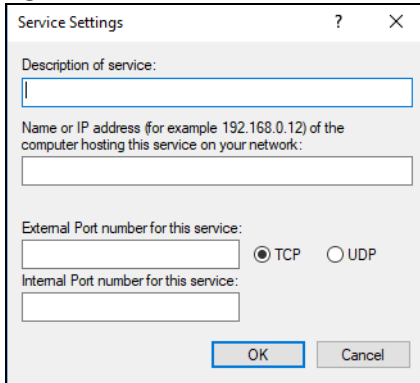
Figure 340 Internet Connection Properties: Advanced Settings**Figure 341** Internet Connection Properties: Advanced Settings: Add

Note: When the UPnP-enabled device is disconnected from your computer, all port mappings will be deleted automatically.

- 5 Click **OK**. Check the network icon on the system tray to see your Internet connection status.

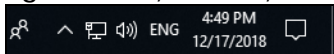
Figure 342 System Tray Icon

- 6 To see more details about your current Internet connection status, right click the network icon in the system tray and click **Open Network & Internet settings**. Click **Network and Sharing Center** and click the **Connections**.

Figure 343 Internet Connection Status

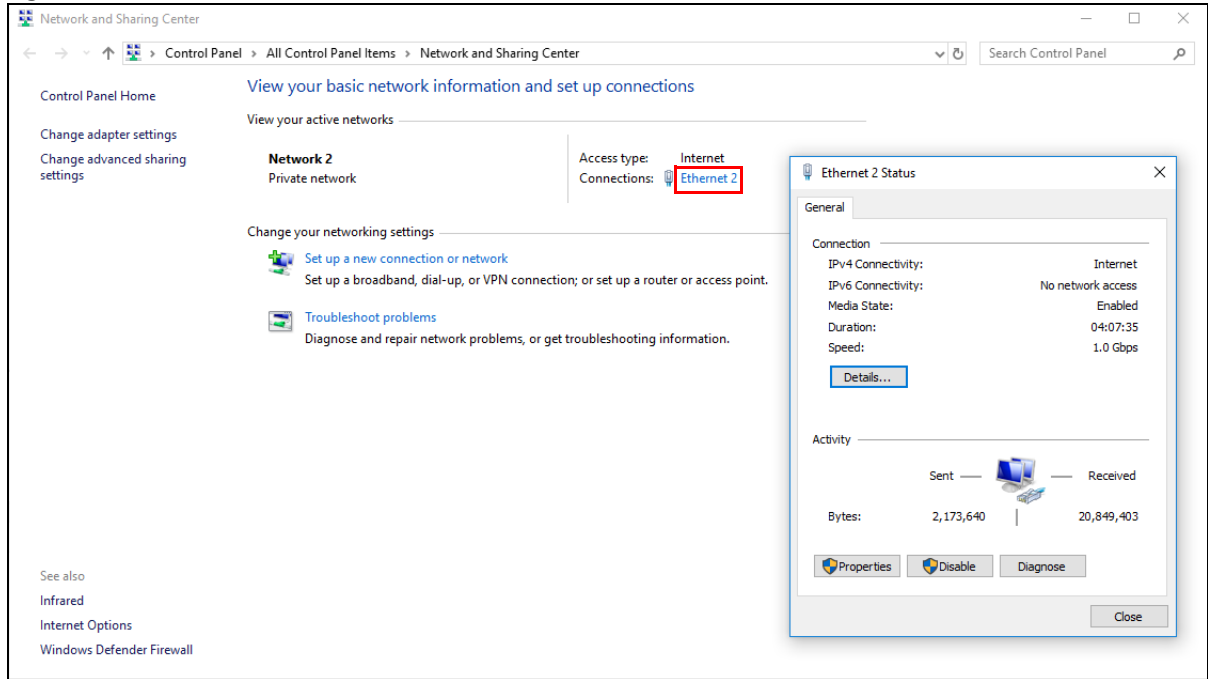

16.4.4 Web Configurator Easy Access in Windows 7

With UPnP, you can access the web-based configurator on the Zyxel Device without finding out the IP address of the Zyxel Device first. This comes helpful if you do not know the IP address of the Zyxel Device.

Follow the steps below to access the web configurator.

- 1 Open **Windows Explorer**.
- 2 Click **Network**. Select **My Network Places** under **Other Places**.

Figure 344 Network Connections

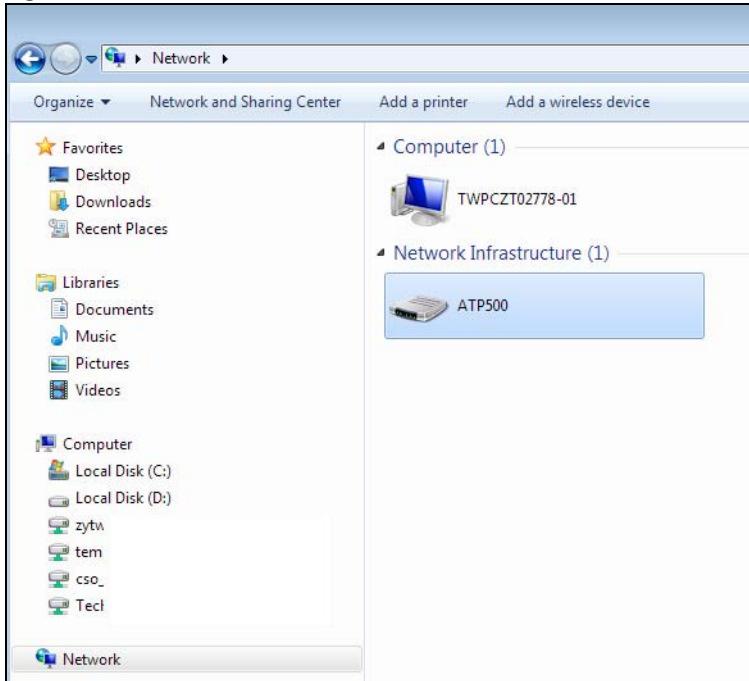

- 3 An icon with the description for each UPnP-enabled device displays under **Network Infrastructure**.
- 4 Right-click on the icon for your Zyxel Device and select **View device webpage**. The web configurator login screen displays.

Figure 345 Network Connections: My Network Places

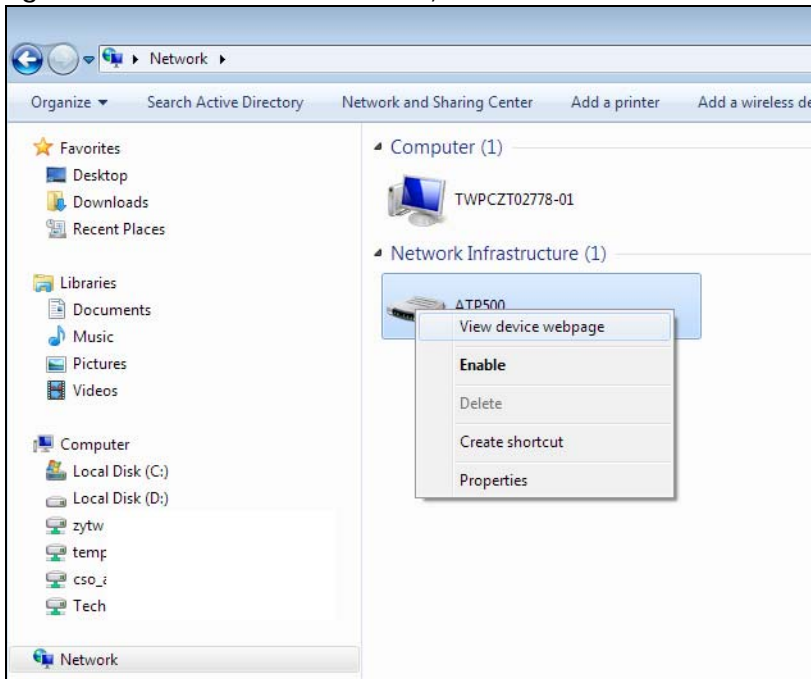

- 5 Right-click on the icon for your Zyxel Device and select **Properties**. Click the **Network Device** tab. A window displays with information about the Zyxel Device.

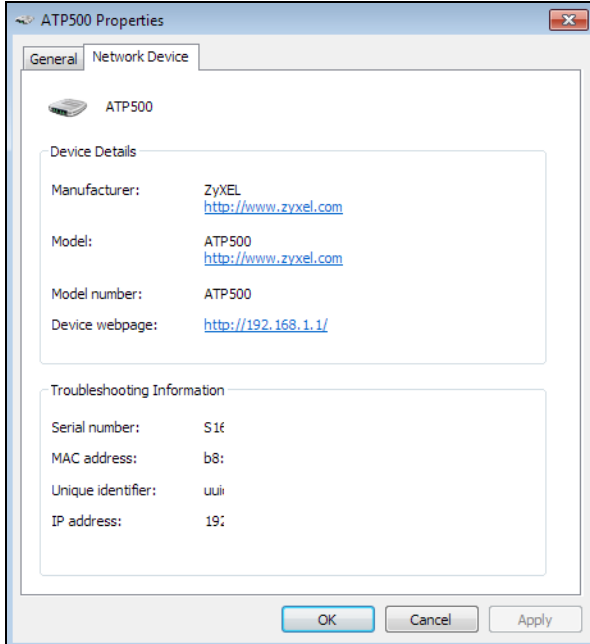
Figure 346 Network Connections: My Network Places: Properties: Example

16.4.5 Web Configurator Easy Access in Windows 10

Follow the steps below to access the Web Configurator.

- 1 Open **File Explorer**.
- 2 Click **Network**.

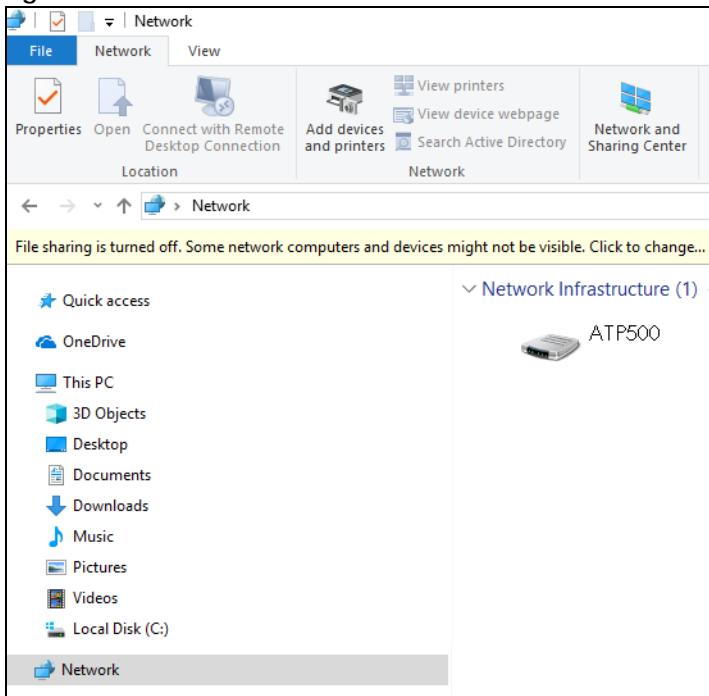
Figure 347 Network Connections

- 3 An icon with the description for each UPnP-enabled device displays under **Network Infrastructure**.
- 4 Right-click the icon for your Zyxel Device and select **View device webpage**. The Web Configurator login screen displays.

Figure 348 Network Connections: Network Infrastructure

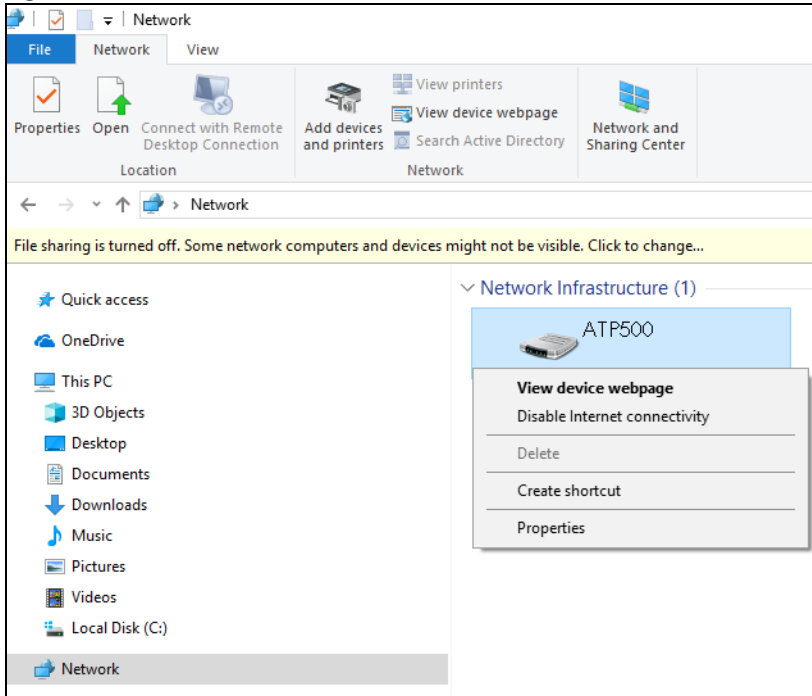

- 5 Right-click the icon for your Zyxel Device and select **Properties**. Click the **Network Device** tab. A window displays information about the Zyxel Device.

Figure 349 Network Connections: Network Infrastructure: Properties: Example

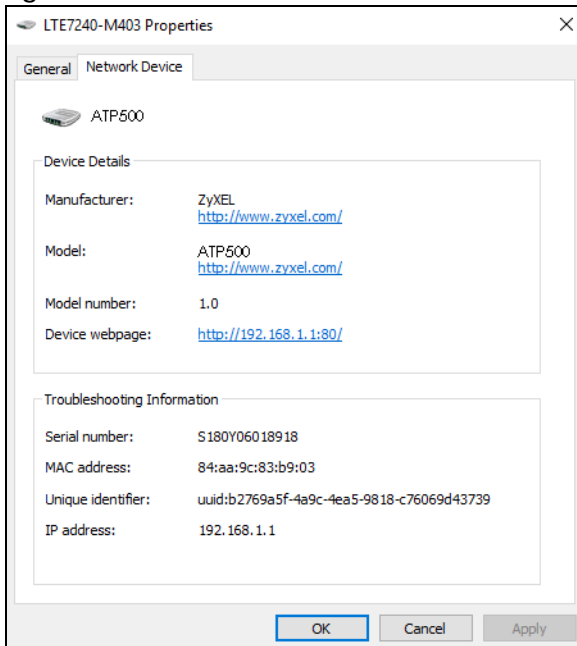

CHAPTER 17

IP/MAC Binding

17.1 IP/MAC Binding Overview

IP address to MAC address binding helps ensure that only the intended devices get to use privileged IP addresses. The Zyxel Device uses DHCP to assign IP addresses and records the MAC address it assigned to each IP address. The Zyxel Device then checks incoming connection attempts against this list. A user cannot manually assign another IP to his computer and use it to connect to the Zyxel Device.

Suppose you configure access privileges for IP address 192.168.1.27 and use static DHCP to assign it to Tim's computer's MAC address of 12:34:56:78:90:AB. IP/MAC binding drops traffic from any computer trying to use IP address 192.168.1.27 with another MAC address.

Figure 350 IP/MAC Binding Example

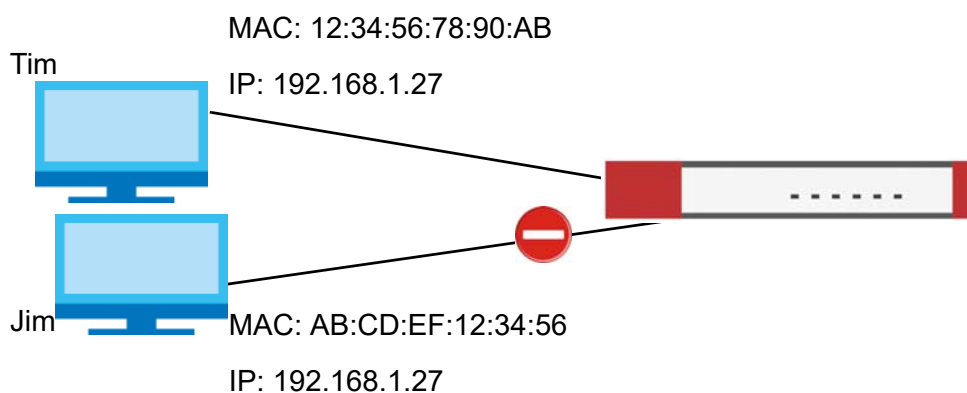

17.1.1 What You Can Do in this Chapter

- Use the **Summary** and **Edit** screens ([Section 17.2 on page 501](#)) to bind IP addresses to MAC addresses.
- Use the **Exempt List** screen ([Section 17.3 on page 503](#)) to configure ranges of IP addresses to which the Zyxel Device does not apply IP/MAC binding.

17.1.2 What You Need to Know

DHCP

IP/MAC address bindings are based on the Zyxel Device's dynamic and static DHCP entries.

Interfaces Used With IP/MAC Binding

IP/MAC address bindings are grouped by interface. You can use IP/MAC binding with Ethernet, bridge, VLAN, and WLAN interfaces. You can also enable or disable IP/MAC binding and logging in an interface's configuration screen.

17.2 IP/MAC Binding Summary

Click **Configuration > Network > IP/MAC Binding** to open the **IP/MAC Binding Summary** screen. This screen lists the total number of IP to MAC address bindings for devices connected to each supported interface.

Figure 351 Configuration > Network > IP/MAC Binding > Summary

#	Status	Interface	Number of Binding
1		br0	0
2		dmz	0
3		lan1	0
4		lan2	0
5		vlan1	0
6		wan1	0
7		wan2	0

The following table describes the labels in this screen.

Table 163 Configuration > Network > IP/MAC Binding > Summary

LABEL	DESCRIPTION
Edit	Double-click an entry or select it and click Edit to open a screen where you can modify the entry's settings.
Activate	To turn on an entry, select it and click Activate .
Inactivate	To turn off an entry, select it and click Inactivate .
#	This field is a sequential value, and it is not associated with a specific entry.
Status	This icon is lit when the entry is active and dimmed when the entry is inactive.
Interface	This is the name of an interface that supports IP/MAC binding.
Number of Binding	This field displays the interface's total number of IP/MAC bindings and IP addresses that the interface has assigned by DHCP.
Apply	Click Apply to save your changes back to the Zyxel Device.

17.2.1 IP/MAC Binding Edit

Click **Configuration > Network > IP/MAC Binding > Edit** to open the **IP/MAC Binding Edit** screen. Use this screen to configure an interface's IP to MAC address binding settings.

Figure 352 Configuration > Network > IP/MAC Binding > Edit

The following table describes the labels in this screen.

Table 164 Configuration > Network > IP/MAC Binding > Edit

LABEL	DESCRIPTION
IP/MAC Binding Settings	
Interface Name	This field displays the name of the interface within the Zyxel Device and the interface's IP address and subnet mask.
Enable IP/MAC Binding	Select this option to have this interface enforce links between specific IP addresses and specific MAC addresses. This stops anyone else from manually using a bound IP address on another device connected to this interface. Use this to make use only the intended users get to use specific IP addresses.
Enable Logs for IP/MAC Binding Violation	Select this option to have the Zyxel Device generate a log if a device connected to this interface attempts to use an IP address not assigned by the Zyxel Device.
Static DHCP Bindings	This table lists the bound IP and MAC addresses. The Zyxel Device checks this table when it assigns IP addresses. If the computer's MAC address is in the table, the Zyxel Device assigns the corresponding IP address. You can also access this table from the interface's edit screen.
Add	Click this to create a new entry.
Edit	Double-click an entry or select it and click Edit to open a screen where you can modify the entry's settings.
Remove	To remove an entry, select it and click Remove . The Zyxel Device confirms you want to remove it before doing so.
#	This is the index number of the static DHCP entry.
IP Address	This is the IP address that the Zyxel Device assigns to a device with the entry's MAC address.
MAC Address	This is the MAC address of the device to which the Zyxel Device assigns the entry's IP address.
Description	This helps identify the entry.
OK	Click OK to save your changes back to the Zyxel Device.
Cancel	Click Cancel to exit this screen without saving.

17.2.2 Static DHCP Edit

Click **Configuration > Network > IP/MAC Binding > Edit** to open the **IP/MAC Binding Edit** screen. Click the **Add** or **Edit** icon to open the following screen. Use this screen to configure an interface's IP to MAC address binding settings.

Figure 353 Configuration > Network > IP/MAC Binding > Edit > Add

The following table describes the labels in this screen.

Table 165 Configuration > Network > IP/MAC Binding > Edit > Add

LABEL	DESCRIPTION
Interface Name	This field displays the name of the interface within the Zyxel Device and the interface's IP address and subnet mask.
IP Address	Enter the IP address that the Zyxel Device is to assign to a device with the entry's MAC address.
MAC Address	Enter the MAC address of the device to which the Zyxel Device assigns the entry's IP address.
Description	Enter up to 64 printable ASCII characters to help identify the entry. For example, you may want to list the computer's owner.
OK	Click OK to save your changes back to the Zyxel Device.
Cancel	Click Cancel to exit this screen without saving.

17.3 IP/MAC Binding Exempt List

Click **Configuration > Network > IP/MAC Binding > Exempt List** to open the **IP/MAC Binding Exempt List** screen. Use this screen to configure ranges of IP addresses to which the Zyxel Device does not apply IP/MAC binding.

Figure 354 Configuration > Network > IP/MAC Binding > Exempt List

The following table describes the labels in this screen.

Table 166 Configuration > Network > IP/MAC Binding > Exempt List

LABEL	DESCRIPTION
Add	Click this to create a new entry.
Edit	Click an entry or select it and click Edit to modify the entry's settings.
Remove	To remove an entry, select it and click Remove . The Zyxel Device confirms you want to remove it before doing so.
#	This is the index number of the IP/MAC binding list entry.
Name	Enter a name to help identify this entry.
Start IP	Enter the first IP address in a range of IP addresses for which the Zyxel Device does not apply IP/MAC binding.
End IP	Enter the last IP address in a range of IP addresses for which the Zyxel Device does not apply IP/MAC binding.
Add icon	Click the Add icon to add a new entry. Click the Remove icon to delete an entry. A window displays asking you to confirm that you want to delete it.
Apply	Click Apply to save your changes back to the Zyxel Device.

CHAPTER 18

Layer 2 Isolation

18.1 Overview

Layer-2 isolation is used to prevent connected devices from communicating with each other in the Zyxel Device's local network(s), except for the devices in the white list, when layer-2 isolation is enabled on the Zyxel Device and the local interface(s).

Note: The security policy control must be enabled before you can use layer-2 isolation.

In the following example, layer-2 isolation is enabled on the Zyxel Device's interface Vlan1. A printer, PC and AP are in the Vlan1. The IP address of network printer (C) is added to the white list. With this setting, the connected AP then cannot communicate with the PC (D), but can access the network printer (C), server (B), wireless client (A) and the Internet.

Figure 355 Layer-2 Isolation Application

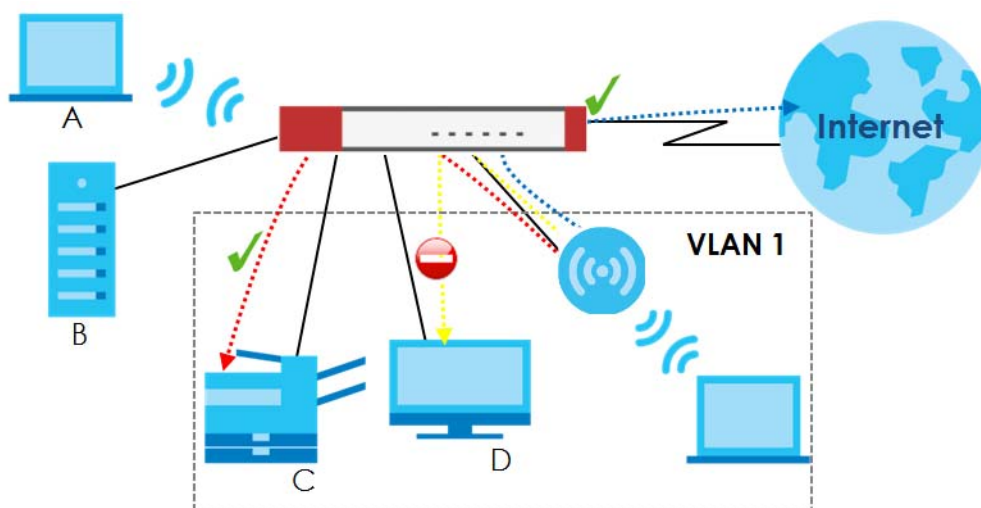

18.1.1 What You Can Do in this Chapter

- Use the **General** screen ([Section 18.2 on page 505](#)) to enable layer-2 isolation on the Zyxel Device and the internal interface(s).
- Use the **White List** screen ([Section 18.3 on page 506](#)) to enable and configures the white list.

18.2 Layer-2 Isolation General Screen

This screen allows you to enable Layer-2 isolation on the Zyxel Device and specific internal interface(s). To access this screen click **Configuration > Network > Layer 2 Isolation**.

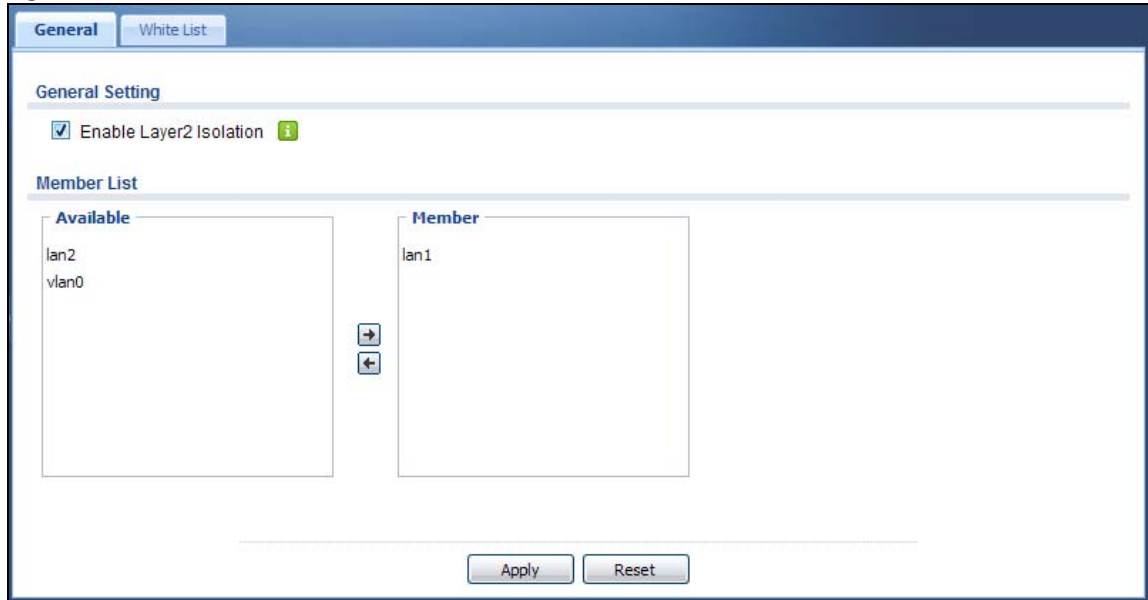
Figure 356 Configuration > Network > Layer 2 Isolation

The following table describes the labels in this screen.

Table 167 Configuration > Network > Layer 2 Isolation

LABEL	DESCRIPTION
Enable Layer2 Isolation	Select this option to turn on the layer-2 isolation feature on the Zyxel Device. Note: You can enable this feature only when the security policy is enabled.
Member List	The Available list displays the name(s) of the internal interface(s) on which you can enable layer-2 isolation. To enable layer-2 isolation on an interface, you can double-click a single entry to move it or use the [Shift] or [Ctrl] key to select multiple entries and click the right arrow button to add to the Member list. To remove an interface, select the name(s) in the Member list and click the left arrow button.
Apply	Click Apply to save your changes back to the Zyxel Device.
Reset	Click Reset to return the screen to its last-saved settings.

18.3 White List Screen

IP addresses that are not listed in the white list are blocked from communicating with other devices in the layer-2-isolation-enabled internal interface(s) except for broadcast packets.

To access this screen click **Configuration > Network > Layer 2 Isolation > White List**.

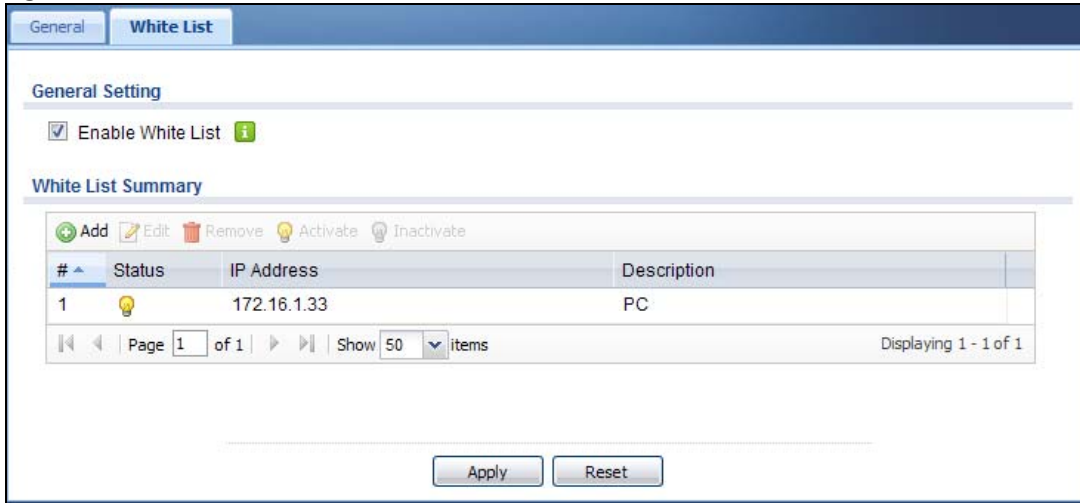
Figure 357 Configuration > Network > Layer 2 Isolation > White List

The following table describes the labels in this screen.

Table 168 Configuration > Network > Layer 2 Isolation > White List

LABEL	DESCRIPTION
Enable White List	Select this option to turn on the white list on the Zyxel Device. Note: You can enable this feature only when the security policy is enabled.
Add	Click this to add a new rule.
Edit	Click this to edit the selected rule.
Remove	Click this to remove the selected rule.
Activate	To turn on an entry, select it and click Activate .
Inactivate	To turn off an entry, select it and click Inactivate .
#	This field is a sequential value, and it is not associated with a specific rule.
Status	This icon is lit when the rule is active and dimmed when the rule is inactive.
IP Address	This field displays the IP address of device that can be accessed by the devices connected to an internal interface on which layer-2 isolation is enabled.
Description	This field displays the description for the IP address in this rule.
Apply	Click Apply to save your changes back to the Zyxel Device.
Reset	Click Reset to return the screen to its last-saved settings.

18.3.1 Add/Edit White List Rule

This screen allows you to create a new rule in the white list or edit an existing one. To access this screen, click the **Add** button or select an entry from the list and click the **Edit** button.

Note: You can configure up to 100 white list rules on the Zyxel Device.

Note: You need to know the IP address of each connected device that you want to allow to be accessed by other devices when layer-2 isolation is enabled.

Figure 358 Configuration > Network > Layer 2 Isolation > White List > Add/Edit

The following table describes the labels in this screen.

Table 169 Configuration > Network > Layer 2 Isolation > White List > Add/Edit

LABEL	DESCRIPTION
Enable	Select this option to turn on the rule.
Host IP Address	Enter an IPv4 address associated with this rule.
Description	Specify a description for the IP address associated with this rule. Enter up to 60 characters, spaces and underscores allowed.
OK	Click OK to save your changes back to the Zyxel Device.
Cancel	Click Cancel to exit this screen without saving your changes.

CHAPTER 19

DNS Inbound LB

19.1 DNS Inbound Load Balancing Overview

Inbound load balancing enables the Zyxel Device to respond to a DNS query message with a different IP address for DNS name resolution. The Zyxel Device checks which member interface has the least load and responds to the DNS query message with the interface's IP address.

In the following figure, an Internet host (A) sends a DNS query message to the DNS server (D) in order to resolve a domain name of www.example.com. DNS server D redirects it to the Zyxel Device (Z)'s WAN1 with an IP address of 1.1.1.1. The Zyxel Device receives the DNS query message and responds to it with the WAN2's IP address, 2.2.2.2, because the WAN2 has the least load at that moment.

Another Internet host (B) also sends a DNS query message to ask where www.example.com is. The Zyxel Device responds to it with the WAN1's IP address, 1.1.1.1, since WAN1 has the least load this time.

Figure 359 DNS Load Balancing Example

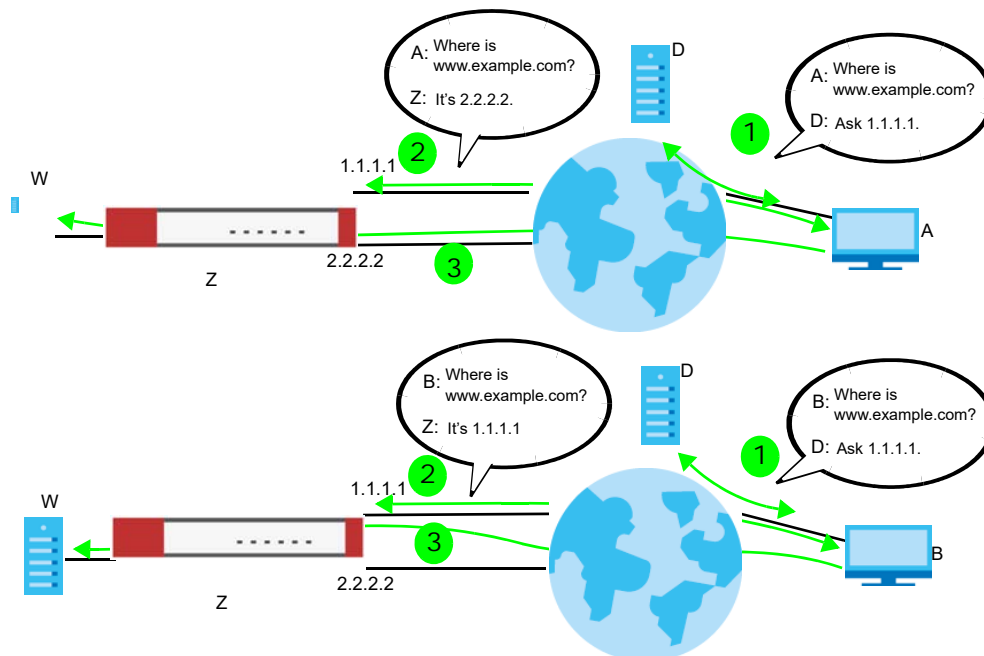

19.1.1 What You Can Do in this Chapter

- Use the **Inbound LB** screen (see [Section 19.2 on page 510](#)) to view a list of the configured DNS load balancing rules.
- Use the **Inbound LB Add/Edit** screen (see [Section 19.2.1 on page 511](#)) to add or edit a DNS load balancing rule.

19.2 The DNS Inbound LB Screen

The **Inbound LB** screen provides a summary of all DNS load balancing rules and the details. You can also use this screen to add, edit, or remove the rules. Click **Configuration > Network > Inbound LB** to open the following screen.

Note: After you finish the inbound load balancing settings, go to security policy and NAT screens to configure the corresponding rule and virtual server to allow the Internet users to access your internal servers.

Figure 360 Configuration > Network > DNS Inbound LB

The following table describes the labels in this screen.

Table 170 Configuration > Network > DNS Inbound LB

LABEL	DESCRIPTION
Global Setting	
Enable DNS Load Balancing	Select this to enable DNS load balancing.
Configuration	
Add	Click this to create a new entry.
Edit	Double-click an entry or select it and click Edit to open a screen where you can modify the entry's settings.
Remove	To remove an entry, select it and click Remove . The Zyxel Device confirms you want to remove it before doing so.
Activate	To turn on an entry, select it and click Activate .
Inactivate	To turn off an entry, select it and click Inactivate .
Move	To move an entry to a different number in the list, click the Move icon. In the field that appears, specify the number to which you want to move the entry.
Status	This icon is lit when the entry is active and dimmed when the entry is inactive.
Priority	This field displays the order in which the Zyxel Device checks the member interfaces of this DNS load balancing rule.
Query Domain Name	This field displays the domain name for which the Zyxel Device manages load balancing between the specified interfaces.
Query From Address	This field displays the source IP address of the DNS query messages to which the Zyxel Device applies the DNS load balancing rule.

Table 170 Configuration > Network > DNS Inbound LB (continued)

LABEL	DESCRIPTION
Query From Zone	The Zyxel Device applies the DNS load balancing rule to the query messages received from this zone.
Load Balancing Member	This field displays the member interfaces which the Zyxel Device manages for load balancing.
Algorithm	<p>This field displays the load balancing method the Zyxel Device uses for this DNS load balancing rule.</p> <p>Weighted Round Robin - Each member interface is assigned a weight. An interface with a larger weight gets more chances to transmit traffic than an interface with a smaller weight. For example, if the weight ratio of wan1 and wan2 interfaces is 2:1, the Zyxel Device chooses wan1 for 2 sessions' traffic and wan2 for 1 session's traffic in each round of 3 new sessions.</p> <p>Least Connection - The Zyxel Device chooses choose a member interface which is handling the least number of sessions.</p> <p>Least Load - Outbound - The Zyxel Device chooses a member interface which is handling the least amount of outgoing traffic.</p> <p>Least Load - Inbound - The Zyxel Device chooses a member interface which is handling the least amount of incoming traffic.</p> <p>Least Load - Total - The Zyxel Device chooses a member interface which is handling the least amount of outgoing and incoming traffic.</p>
Apply	Click this button to save your changes to the Zyxel Device.
Reset	Click this button to return the screen to its last-saved settings.

19.2.1 The DNS Inbound LB Add/Edit Screen

The **Add DNS Load Balancing** screen allows you to add a domain name for which the Zyxel Device manages load balancing between the specified interfaces. You can configure the Zyxel Device to apply DNS load balancing to some specific hosts only by configuring the **Query From** settings. Click **Configuration > Network > Inbound LB** and then the **Add** or **Edit** icon to open this screen.

Figure 361 Configuration > Network > DNS Inbound LB > Add

The following table describes the labels in this screen.

Table 171 Configuration > Network > DNS Inbound LB > Add/Edit

LABEL	DESCRIPTION
Create New Object	Use this to configure any new setting objects that you need to use in this screen.
General Settings	
Enable	Select this to enable this DNS load balancing rule.
DNS Setting	
Query Domain Name	Type up to 255 characters for a domain name for which you want the Zyxel Device to manage DNS load balancing. You can use a wildcard (*) to let multiple domains match the name. For example, use *.example.com to specify any domain name that ends with "example.com" would match.
Time to Live	Enter the number of seconds the Zyxel Device recommends DNS request hosts to keep the DNS entry in their caches before removing it. Enter 0 to have the Zyxel Device not recommend this so the DNS request hosts will follow their DNS server's TTL setting.
Query From Setting	

Table 171 Configuration > Network > DNS Inbound LB > Add/Edit (continued)

LABEL	DESCRIPTION
IP Address	<p>Select the name of an IP address object, including geographic address object, of a computer or a DNS server which makes the DNS queries upon which to apply this rule.</p> <p>DNS servers process client queries using recursion or iteration:</p> <ul style="list-style-type: none"> • In recursion, DNS servers make recursive queries on behalf of clients. So you have to configure this field to the DNS server's IP address when recursion is used. • In iteration, a client asks the DNS server and expects the best and immediate answer without the DNS server contacting other DNS servers. If the primary DNS server cannot provide the best answer, the client makes iteration queries to other configured DNS servers to resolve the name. You have to configure this field to the client's IP address when iteration is used.
Zone	Select the zone of DNS query messages upon which to apply this rule.
Load Balancing Member	
Load Balancing Algorithm	<p>Select a load balancing method to use from the drop-down list box.</p> <p>Select Weighted Round Robin to balance the traffic load between interfaces based on their respective weights. An interface with a larger weight gets more chances to transmit traffic than an interface with a smaller weight. For example, if the weight ratio of wan1 and wan2 interfaces is 2:1, the Zyxel Device chooses wan1 for 2 sessions' traffic and wan2 for every session's traffic in each round of 3 new sessions.</p> <p>Select Least Connection to have the Zyxel Device choose the member interface which is handling the least number of sessions.</p> <p>Select Least Load - Outbound to have the Zyxel Device choose the member interface which is handling the least amount of outgoing traffic.</p> <p>Select Least Load - Inbound to have the Zyxel Device choose the member interface which is handling the least amount of incoming traffic.</p> <p>Select Least Load - Total to have the Zyxel Device choose the member interface which is handling the least amount of outgoing and incoming traffic.</p>
Failover IP Address	Enter an alternate IP address with which the Zyxel Device will respond to a DNS query message when the load balancing algorithm cannot find any available interface.
Add	Click this to create a new member interface for this rule.
Edit	Double-click an entry or select it and click Edit to open a screen where you can modify the entry's settings.
Remove	To remove an entry, select it and click Remove . The Zyxel Device confirms you want to remove it before doing so.
#	This field displays the order in which the Zyxel Device checks this rule's member interfaces.
IP Address	This field displays the IP address of the member interface.
Monitor Interface	This field displays the name of the member interface. The Zyxel Device manages load balancing between the member interfaces.
Weight	This field is available if you selected Weighted Round Robin as the load balancing algorithm. This field displays the weight of the member interface. An interface with a larger weight gets more chances to transmit traffic than an interface with a smaller weight.
OK	Click OK to save your changes back to the Zyxel Device.
Cancel	Click Cancel to exit this screen without saving.

19.2.2 The DNS Inbound LB Add/Edit Member Screen

The **Add Load Balancing Member** screen allows you to add a member interface for the DNS load balancing rule. Click **Configuration > Network > DNS Inbound LB > Add or Edit** and then an **Add** or **Edit** icon to open this screen.

Figure 362 Configuration > Network > DNS Inbound LB > Add/Edit > Add

The following table describes the labels in this screen.

Table 172 Configuration > Network > DNS Inbound LB > Add/Edit > Add/Edit

LABEL	DESCRIPTION
Member	The Zyxel Device checks each member interface's loading in the order displayed here.
Monitor Interface	Select an interface to associate it with the DNS load balancing rule. This field also displays whether the IP address is a static IP address (Static), dynamically assigned (Dynamic) or obtained from a DHCP server (DHCP Client), as well as the IP address and subnet mask.
Weight	This field is available if you selected Weighted Round Robin for the load balancing algorithm. Specify the weight of the member interface. An interface with a larger weight gets more chances to transmit traffic than an interface with a smaller weight.
IP Address	
Same as Monitor Interface	Select this to send the IP address displayed in the Monitor Interface field to the DNS query senders.
Custom	Select this and enter another IP address to send to the DNS query senders.
OK	Click OK to save your changes back to the Zyxel Device.
Cancel	Click Cancel to exit this screen without saving.

CHAPTER 20

Web Authentication

20.1 Web Auth Overview

Web authentication can intercept network traffic, according to the authentication policies, until the user authenticates his or her connection, usually through a specifically designated login web page. This means all web page requests can initially be redirected to a special web page that requires users to authenticate their sessions. Once authentication is successful, they can then connect to the rest of the network or Internet.

As soon as a user attempt to open a web page, the Zyxel Device reroutes his/her browser to a web portal page that prompts him/her to log in.

Figure 363 Web Authentication Example

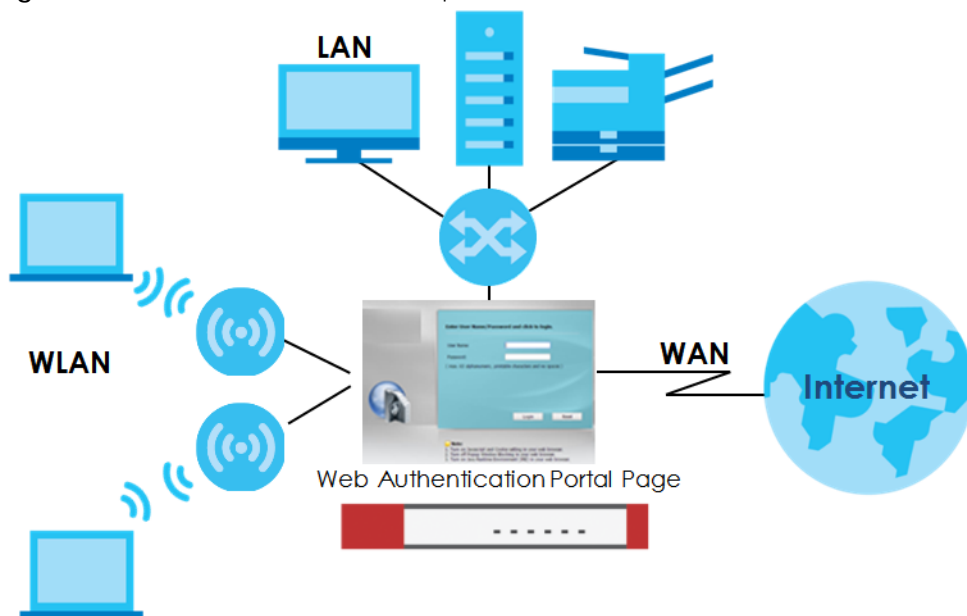

The web authentication page only appears once per authentication session. Unless a user session times out or he/she closes the connection, he or she generally will not see it again during the same session.

20.1.1 What You Can Do in this Chapter

- Use the **Configuration > Web Authentication** screens ([Section 20.2 on page 516](#)) to create and manage web authentication policies.
- Use the **Configuration > Web Authentication > SSO** screen ([Section 20.3 on page 536](#)) to configure how the Zyxel Device communicates with a Single Sign-On agent.

20.1.2 What You Need to Know

Single Sign-On

A SSO (Single Sign On) agent integrates Domain Controller and Zyxel Device authentication mechanisms, so that users just need to log in once (single) to get access to permitted resources.

Forced User Authentication

Instead of making users for which user-aware policies have been configured go to the Zyxel Device **Login** screen manually, you can configure the Zyxel Device to display the **Login** screen automatically whenever it routes HTTP traffic for anyone who has not logged in yet.

Note: This works with HTTP traffic only. The Zyxel Device does not display the **Login** screen when users attempt to send other kinds of traffic.

The Zyxel Device does not automatically route the request that prompted the login, however, so users have to make this request again.

20.2 Web Authentication General Screen

The **Web Authentication General** screen displays the general web portal settings and web authentication policies you have configured on the Zyxel Device. Use this screen to enable web authentication on the Zyxel Device.

Figure 364 Configuration > Web Authentication > General

The screenshot shows the configuration page for Web Authentication > General. It includes sections for Global Setting, Web Portal General Setting, User Agreement General Setting, Exceptional Services, and Web Authentication Policy Summary. The Global Setting section has an unchecked checkbox for 'Enable Web Authentication'. The Web Portal General Setting section has a checked checkbox for 'Enable Session Page' and a text box for 'Logout IP'. The User Agreement General Setting section has an unchecked checkbox for 'Enforce data collection'. The Exceptional Services section shows a table with one entry: '1 DNS'. The Web Authentication Policy Summary section shows a table with one entry: '1 Default any any any none unneces... n/a n/a'. At the bottom, there are 'Apply' and 'Reset' buttons.

The following table gives an overview of the objects you can configure.

Table 173 Configuration > Web Authentication > General

LABEL	DESCRIPTION
Global Setting	
Enable Web Authentication	Select the check box to turn on the web authentication feature. Otherwise, clear the check box to turn it off. Once enabled, all network traffic is blocked until a client authenticates with the Zyxel Device through the specifically designated web portal or user agreement page.
Web Portal General Setting	
Enable Session Page	Select this to display a page showing information on the user session after s/he logs in. It displays remaining time with an option to renew or log out immediately.
Logout IP	Specify an IP address that users can use to terminate their sessions manually by entering the IP address in the address bar of the web browser.
User Agreement General Setting	
Enforce data collection	Select this to require users to fill in their registration information (name, telephone number, address and email address) on the User Agreement (PC or mobile) page.

Table 173 Configuration > Web Authentication > General (continued)

LABEL	DESCRIPTION
Exceptional Services	<p>Use this table to list services that users can access without logging in.</p> <p>Click Add to change the list's membership. A screen appears. Available services appear on the left. Select any services you want users to be able to access without logging in and click the right arrow button to add them. The member services are on the right. Select any service that you want to remove from the member list, and click the left arrow button to remove them.</p> <p>Keeping DNS as a member allows users' computers to resolve domain names into IP addresses.</p> <p>Figure 365 Configuration > Web Authentication > Add Exceptional Service</p>  <p>In the table, select one or more entries and click Remove to delete it or them.</p>
Web Authentication Policy Summary	Use this table to manage the Zyxel Device's list of web authentication policies.
Add	Click this to create a new entry. Select an entry and click Add to create a new entry after the selected entry.
Edit	Double-click an entry or select it and click Edit to open a screen where you can modify the entry's settings.
Remove	To remove an entry, select it and click Remove . The Zyxel Device confirms you want to remove it before doing so.
Activate	To turn on an entry, select it and click Activate .
Inactivate	To turn off an entry, select it and click Inactivate .
Move	To move an entry to a different number in the list, click the Move icon. In the field that appears, specify the number to which you want to move the interface.
Status	This icon is lit when the entry is active and dimmed when the entry is inactive.
Priority	This is the position of the authentication policy in the list. The priority is important as the policies are applied in order of priority. Default displays for the default authentication policy that the Zyxel Device uses on traffic that does not match any exceptional service or other authentication policy. You can edit the default rule but not delete it.
Incoming Interface	This field displays the interface on which packets for this policy are received.
Source	This displays the source address object, including geographic address and FQDN (group) objects, to which this policy applies.
Destination	This displays the destination address object, including geographic address and FQDN (group) objects, to which this policy applies.
Schedule	This field displays the schedule object that dictates when the policy applies. none means the policy is active at all times if enabled.

Table 173 Configuration > Web Authentication > General (continued)

LABEL	DESCRIPTION
Authentication	This field displays the authentication requirement for users when their traffic matches this policy. unnecessary – Users do not need to be authenticated. required – Users need to be authenticated. They must manually go to the login screen or user agreement page. The Zyxel Device will not redirect them to the login screen. force – Users need to be authenticated. The Zyxel Device automatically displays the login screen or user agreement page whenever it routes HTTP traffic for users who have not logged in yet.
Authentication Type	This field displays the name of the authentication type profile used in this policy to define how users authenticate their sessions. It shows n/a if Authentication is set to unnecessary .
Description	If the entry has a description configured, it displays here. This is n/a for the default policy.
Apply	Click this button to save your changes to the Zyxel Device.
Reset	Click this button to return the screen to its last-saved settings.

Creating Exceptional Services

This screen lists services that users can access without logging in. Click **Add** under **Exceptional Services** in the previous screen to display this screen. You can change the list's membership here. Available services appear on the left. Select any services you want users to be able to access without logging in and click the right arrow button -> to add them. The member services are on the right. Select any service that you want to remove from the member list, and click the left arrow <- button to remove them. Then click **OK** to apply the changes and return to the main **Web Authentication** screen. Alternatively, click **Cancel** to discard the changes and return to the main **Web Authentication** screen.

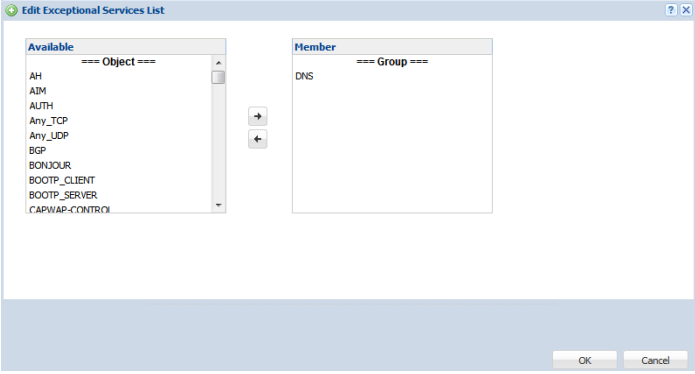
Figure 366 Configuration > Web Authentication > General > Add Exceptional Service

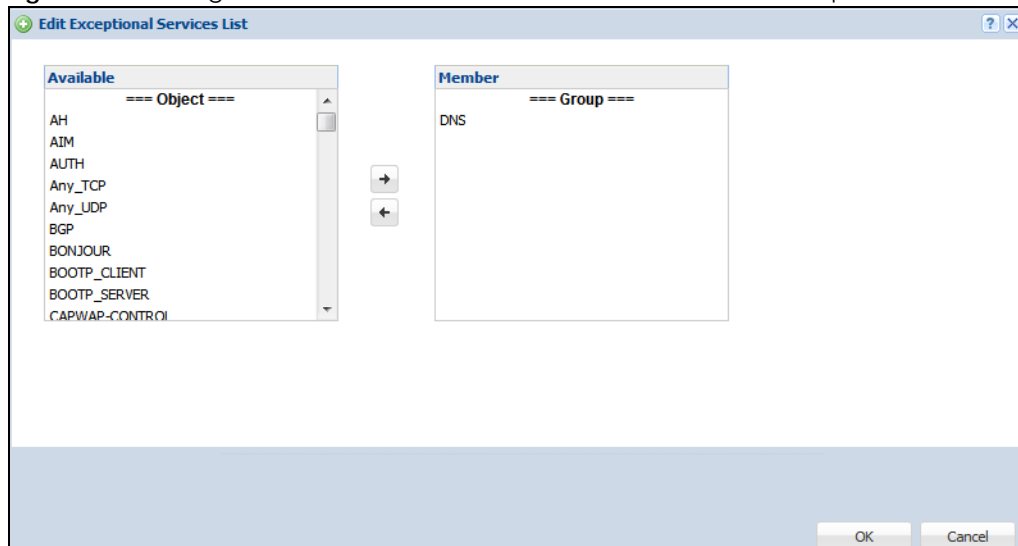

Creating/Editing an Authentication Policy

Open the **Configuration > Web Authentication > General** screen, then click the **Add** icon or select an entry and click the **Edit** icon in the **Web Authentication Policy Summary** section to open the **Auth. Policy Add/Edit** screen. Use this screen to configure an authentication policy.

Figure 367 Configuration > Web Authentication > General > Add Authentication Policy

The following table gives an overview of the objects you can configure.

Table 174 Configuration > Web Authentication > General > Add Authentication Policy

LABEL	DESCRIPTION
Create new Object	Use to configure any new settings objects that you need to use in this screen. Select Address or Schedule.
Enable Policy	Select this check box to activate the authentication policy. This field is available for user-configured policies.
Description	Enter a descriptive name of up to 60 printable ASCII characters for the policy. Spaces are allowed. This field is available for user-configured policies.
User Authentication Policy	Use this section of the screen to determine which traffic requires (or does not require) the senders to be authenticated in order to be routed.
Incoming Interface	Select the interface on which packets for this policy are received.
Source Address	Select a source address or address group, including geographic address and FQDN (group) objects, for whom this policy applies. Select any if the policy is effective for every source. This is any and not configurable for the default policy.
Destination Address	Select a destination address or address group, including geographic address and FQDN (group) objects, for whom this policy applies. Select any if the policy is effective for every destination. This is any and not configurable for the default policy.
Schedule	Select a schedule that defines when the policy applies. Otherwise, select none and the rule is always effective. This is none and not configurable for the default policy.
Authentication	Select the authentication requirement for users when their traffic matches this policy. unnecessary - Users do not need to be authenticated. required - Users need to be authenticated. If Force User Authentication is selected, all HTTP traffic from unauthenticated users is redirected to a default or user-defined login page. Otherwise, they must manually go to the login screen. The Zyxel Device will not redirect them to the login screen.

Table 174 Configuration > Web Authentication > General > Add Authentication Policy (continued)

LABEL	DESCRIPTION
Single Sign-on	This field is available for user-configured policies that require Single Sign-On (SSO). Select this to have the Zyxel Device enable the SSO feature. You can set up this feature in the SSO screen.
Force User Authentication	This field is available for user-configured policies that require authentication. Select this to have the Zyxel Device automatically display the login screen when users who have not logged in yet try to send HTTP traffic.
Authentication Type	Select an authentication method: <ul style="list-style-type: none"> default-web-portal: the default login page built into the Zyxel Device default-user-agreement: the default user agreement page built into the Zyxel Device.
OK	Click OK to save your changes back to the Zyxel Device.
Cancel	Click Cancel to exit this screen without saving.

20.2.1 User-aware Access Control Example

You can configure many policies and security settings for specific users or groups of users. Users can be authenticated locally by the Zyxel Device or by an external (RADIUS) authentication server.

In this example the users are authenticated by an external RADIUS server at 172.16.1.200. First, set up the user accounts and user groups in the Zyxel Device. Then, set up user authentication using the RADIUS server. Finally, set up the policies in the table above.

20.2.1.1 Set Up User Accounts

Set up user accounts in the RADIUS server. This example uses the Web Configurator. If you can export user names from the RADIUS server to a text file, then you might configure a script to create the user accounts instead.

- 1 Click **Configuration > Object > User/Group > User**. Click the **Add** icon.
- 2 Enter the same user name that is used in the RADIUS server, and set the **User Type** to **ext-user** because this user account is authenticated by an external server. Click **OK**.

Figure 368 Configuration > Object > User/Group > User > Add

Add A User

User Configuration

User Name:

User Type:

Description:

User Settings

Use Default Settings Use Manual Settings

Lease Time: 1440 minutes

Reauthentication Time: 1440 minutes

OK Cancel

- 3 Repeat this process to set up the remaining user accounts.

20.2.1.2 Set Up User Groups

Set up the user groups and assign the users to the user groups.

- 1 Click **Configuration > Object > User/Group > Group**. Click the **Add** icon.
- 2 Enter the name of the group. In this example, it is "Finance". Then, select **Object/Leo** and click the right arrow to move him to the **Member** list. This example only has one member in this group, so click **OK**. Of course you could add more members later.

Figure 369 Configuration > Object > User/Group > Group > Add

Add Group

Configuration

Name:

Description: (Optional)

Member List

Available

=== Object ===

billing-users

cafe

radius-users

trial-users

ua-users

Member

=== Object ===

Leo

OK Cancel

- 3 Repeat this process to set up the remaining user groups.

20.2.1.3 Set Up User Authentication Using the RADIUS Server

This step sets up user authentication using the RADIUS server. First, configure the settings for the RADIUS server. Then, set up the authentication method, and configure the Zyxel Device to use the authentication method. Finally, force users to log into the Zyxel Device before it routes traffic for them.

- 1 Click **Configuration > Object > AAA Server > RADIUS**. Double-click the **radius** entry. Configure the RADIUS server's address, authentication port (1812 if you were not told otherwise), and key. Click **OK**.

Figure 370 Configuration > Object > AAA Server > RADIUS > Add

Add RADIUS

General Settings

Name: radius

Description: (Optional)

Authentication Server Settings

Server Address: 172.16.1.200 (IP or FQDN)

Authentication Port: 1812 (1-65535)

Backup Server Address: (IP or FQDN) Optional

Backup Authentication Port: (1-65535) Optional

Key:

Accounting Server Settings

Server Address: (IP or FQDN) (Optional)

Accounting Port: (1-65535) (Optional)

Backup Server Address: (IP or FQDN) (Optional)

Backup Accounting Port: (1-65535) (Optional)

Key:

Maximum retry count: 3 (1~10)

Enable Accounting Interim update

Interim Interval: 10 (1-1440 minutes)

General Server Settings

Timeout: 5 (1-300 seconds)

NAS IP Address: 127.0.0.1 (IP Address)

OK Cancel

- 2 Click **Configuration > Object > Auth. Method**. Double-click the **default** entry. Click the **Add** icon. Select **group radius** because the Zyxel Device should use the specified RADIUS server for authentication. Click **OK**.

Figure 371 Configuration > Object > Auth. method > Edit

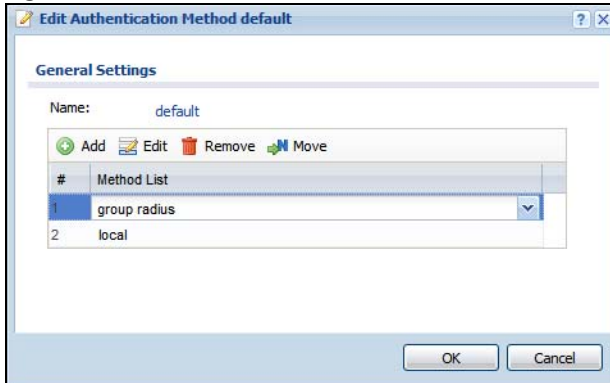

- 3 Click **Configuration > Web Authentication**. In the **Web Authentication > General** screen, select **Enable Web Authentication** to turn on the web authentication feature and click **Apply**.

Figure 372 Configuration > Web Authentication

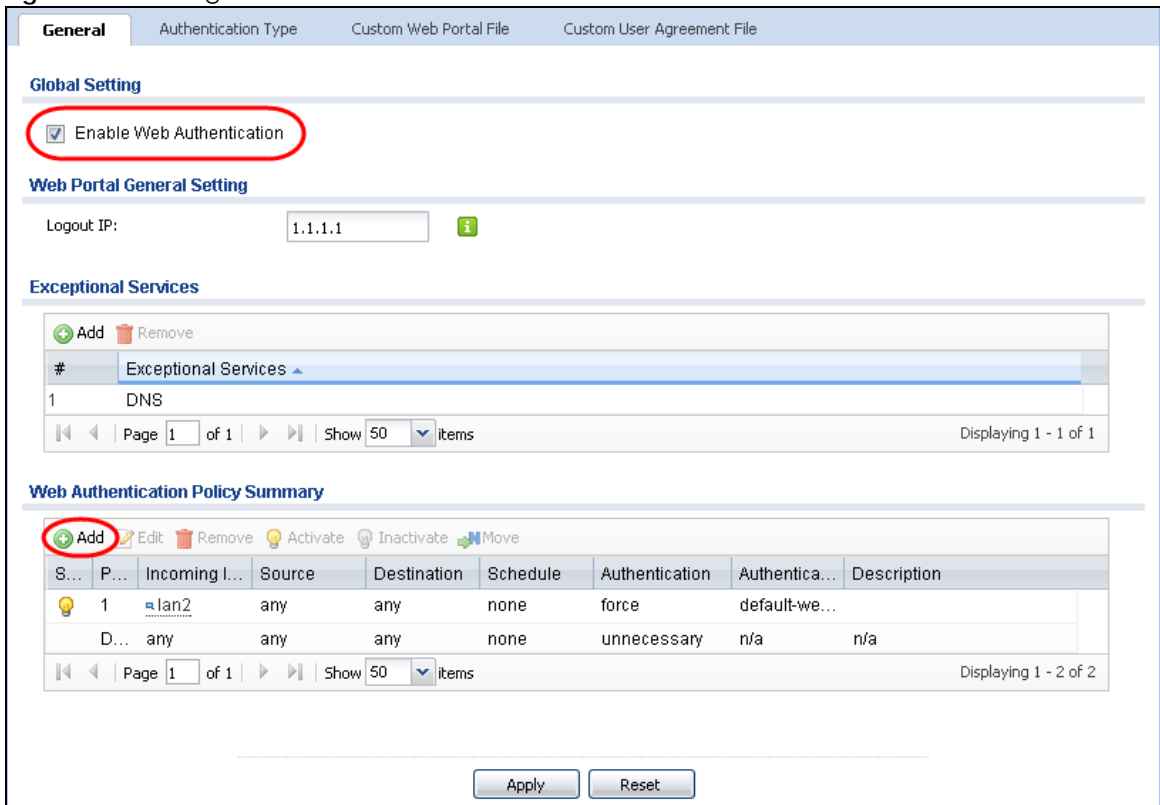

- 4 In the **Web Authentication Policy Summary** section, click the **Add** icon to set up a default policy that has priority over other policies and forces every user to log into the Zyxel Device before the Zyxel Device routes traffic for them.
- 5 Select **Enable Policy**. Enter a descriptive name, "default_policy" for example. Set the **Authentication** field to **required**, and make sure **Force User Authentication** is selected. Select an authentication type profile ("default-web-portal" in this example). Keep the rest of the default settings, and click **OK**.

Note: The users must log in at the Web Configurator login screen before they can use HTTP or MSN.

Figure 373 Configuration > Web Authentication: General: Add

The screenshot shows the 'Auth. Policy Add' configuration window. It has a title bar with a green plus icon and a close button. Below the title bar is a dropdown menu labeled 'Create new Object'. The main content area is divided into two sections: 'General Settings' and 'User Authentication Policy'. In the 'General Settings' section, there is a checked checkbox for 'Enable Policy' and a text field for 'Description' containing 'default_policy'. In the 'User Authentication Policy' section, there are several dropdown menus: 'Incoming Interface' (any), 'Source Address' (any), 'Destination Address' (any), 'Schedule' (none), and 'Authentication' (required). Below these is a checked checkbox for 'Force User Authentication' and another dropdown for 'Authentication Type' set to 'default-web-portal'. At the bottom right, there are 'OK' and 'Cancel' buttons.

When the users try to browse the web (or use any HTTP application), the login screen appears. They have to log in using the user name and password in the RADIUS server.

20.2.1.4 User Group Authentication Using the RADIUS Server

The previous example showed how to have a RADIUS server authenticate individual user accounts. If the RADIUS server has different user groups distinguished by the value of a specific attribute, you can make a couple of slight changes in the configuration to have the RADIUS server authenticate groups of user accounts defined in the RADIUS server.

- 1 Click **Configuration > Object > AAA Server > RADIUS**. Double-click the **radius** entry. Besides configuring the RADIUS server's address, authentication port, and key; set the **Group Membership Attribute** field to the attribute that the Zyxel Device is to check to determine to which group a user belongs. This example uses **Class**. This attributes' value is called a group identifier; it determines to which group a user belongs. In this example the values are Finance, Engineer, Sales, and Boss.

Figure 374 Configuration > Object > AAA Server > RADIUS > Add

Add RADIUS

General Settings

Name: radius

Description: (Optional)

Authentication Server Settings

Server Address: 172.16.1.200 (IP or FQDN)

Authentication Port: 1812 (1-65535)

Backup Server Address: (IP or FQDN) Optional

Backup Authentication Port: (1-65535) Optional

Key:

Accounting Server Settings

Server Address: (IP or FQDN) (Optional)

Accounting Port: (1-65535) (Optional)

Backup Server Address: (IP or FQDN) (Optional)

Backup Accounting Port: (1-65535) (Optional)

Key:

Maximum retry count: 3 (1~10)

Enable Accounting Interim update

Interim Interval: 10 (1-1440 minutes)

General Server Settings

Timeout: 5 (1-300 seconds)

NAS IP Address: 127.0.0.1 (IP Address)

NAS Identifier:

Case-sensitive User Names i

User Login Settings

Group Membership Attribute: Class(25) 25

OK Cancel

- Now you add ext-group-user objects to identify groups based on the group identifier values. Set up one user account for each group of user accounts in the RADIUS server. Click **Configuration > Object > User/Group > User**. Click the **Add** icon.

Enter a user name and set the **User Type** to **ext-group-user**. In the **Group Identifier** field, enter Finance, Engineer, Sales, or Boss and set the **Associated AAA Server Object** to **radius**.

Figure 375 Configuration > Object > User/Group > User > Add

- Repeat this process to set up the remaining groups of user accounts.

20.2.2 Authentication Type Screen

Use this screen to view, create and manage the authentication type profiles on the Zyxel Device. An authentication type profile decides which type of web authentication pages to be used for user authentication. Go to **Configuration > Web Authentication** and then select the **Authentication Type** tab to display the screen.

Figure 376 Configuration > Web Authentication > Authentication Type

The following table describes the labels in this screen.

Table 175 Configuration > Web Authentication > Authentication Type

LABEL	DESCRIPTION
Add	Click this to create a new entry. Select an entry and click Add to create a new entry after the selected entry.
Edit	Double-click an entry or select it and click Edit to open a screen where you can modify the entry's settings.

Table 175 Configuration > Web Authentication > Authentication Type (continued)

LABEL	DESCRIPTION
Remove	To remove an entry, select it and click Remove . The Zyxel Device confirms you want to remove it before doing so.
#	This field is a sequential value, and it is not associated with a specific entry.
Name	This field displays the name of the profile. default-web-portal: the default login page built into the Zyxel Device. Note: You can also customize the default login page built into the Zyxel Device in the System > WWW > Login Page screen. default-web-portal: the default user agreement page built into the Zyxel Device.
Type	This field displays the type of the web authentication page used by this profile.
Web Page	This field displays whether this profile uses the default web authentication page built into the Zyxel Device (System Default Page) or custom web authentication pages from an external web server (External Page).
Apply	Click Apply to save your changes back to the Zyxel Device.
Reset	Click Reset to return the screen to its last-saved settings.

Add/Edit an Authentication Type Profile

Click the **Add** icon or select an entry in the **Web Authentication > Authentication Type** screen and click the **Edit** icon to display the screen. The screen differs depending on what you select in the **Type** field.

Figure 377 Configuration > Web Authentication > Authentication Type: Add/Edit (Web Portal)

Figure 378 Configuration > Web Authentication > Authentication Type: Add/Edit (User Agreement)

The screenshot shows a configuration window titled "Add Authentication Type". At the top, there are two radio buttons: "Web Portal" (unselected) and "User Agreement" (selected). Below this is a section titled "General Settings".

General Settings:

- Profile Name:** A text input field with a red dashed border and a red warning icon to its right.
- Enable Idle Detection:** A checkbox that is currently unchecked.
- Idle timeout:** A text input field containing the value "3", with "(1-60 minutes)" to its right.
- Reauthentication Time:** A text input field containing the value "0", with "(0-1440 minutes, 0 is unlimited)" to its right.
- Internal User Agreement (User Upload Page):** This option is selected with a radio button.
 - Preview:** A dropdown menu showing "Please select one ...".
 - Note:** A yellow notepad icon followed by the text: "If you want to configure customize file, please go to Custom User Agreement File".
 - Customize file:** A dropdown menu showing "Please select one ..." with a red dashed border and a red warning icon to its right.
- External User Agreement:** This option is unselected with a radio button.
 - Agreement URL:** A text input field.
 - Welcome URL:** A text input field with "(Optional)" to its right.
 - Download** the external user agreement example.

At the bottom right of the window are "OK" and "Cancel" buttons.

The following table describes the labels in this screen.

Table 176 Configuration > Web Authentication > Authentication Type: Add/Edit

LABEL	DESCRIPTION
Type	Select the type of the web authentication page through which users authenticate their connections. If you select User Agreement , by agreeing to the policy of user agreement, users can access the Internet without a guest account.
Profile Name	Enter a name for the profile. You can use up to 31 alphanumeric characters (A–Z, a–z, 0–9) and underscores (_). Spaces are not allowed. The first character must be a letter.
The following fields are available if you set Type to Web Portal .	
Internal Web Portal	Select this to use the web portal pages uploaded to the Zyxel Device. The login page appears whenever the web portal intercepts network traffic, preventing unauthorized users from gaining access to the network.
Preview	Select to display the page you uploaded to the Zyxel Device in a new frame. Note: You must select a custom file uploaded to the Zyxel Device before you can preview the pages.
Customize file	Select the file name of the web portal file in the Zyxel Device. Note: You can upload zipped custom web portal files to the Zyxel Device using the Configuration > Web Authentication > Web Portal Customize File screen.

Table 176 Configuration > Web Authentication > Authentication Type: Add/Edit (continued)

LABEL	DESCRIPTION
External Web Portal	Select this to use a custom login page from an external web portal instead of the one uploaded to the Zyxel Device. You can configure the look and feel of the web portal page.
Login URL	Specify the login page's URL; for example, http://IIS server IP Address/login.html. The Internet Information Server (IIS) is the web server on which the web portal files are installed.
Logout URL	Specify the logout page's URL; for example, http://IIS server IP Address/logout.html. The Internet Information Server (IIS) is the web server on which the web portal files are installed.
Welcome URL	Specify the welcome page's URL; for example, http://IIS server IP Address/welcome.html. Users will be redirected to the welcome page after authentication. This field is optional. The Internet Information Server (IIS) is the web server on which the web portal files are installed.
Session URL	Specify the session page's URL; for example, http://IIS server IP Address/session.html. The Internet Information Server (IIS) is the web server on which the web portal files are installed.
Error URL	Specify the error page's URL; for example, http://IIS server IP Address/error.html. The Internet Information Server (IIS) is the web server on which the web portal files are installed.
Download	Click this to download an example external web portal file for your reference.
The following fields are available if you set Type to User Agreement .	
Enable Idle Detection	This is applicable for access users. Select this check box if you want the Zyxel Device to monitor how long each access user is logged in and idle (in other words, there is no traffic for this access user). The Zyxel Device automatically logs out the access user once the Idle timeout has been reached.
Idle timeout	This is applicable for access users. This field is effective when Enable Idle Detection is checked. Type the number of minutes each access user can be logged in and idle before the Zyxel Device automatically logs out the access user.
Reauthentication Time	Enter the number of minutes the user can be logged into the Zyxel Device in one session before having to log in again.
Internal User Agreement	Select this to use the user agreement pages in the Zyxel Device. The user agreement page appears whenever the Zyxel Device intercepts network traffic, preventing unauthorized users from gaining access to the network.
Preview	Select to display the page you uploaded to the Zyxel Device in a new frame. Note: You must select a custom file uploaded to the Zyxel Device before you can preview the pages.
Customize file	Select the file name of the user agreement file in the Zyxel Device. Note: You can upload zipped custom user agreement files to the Zyxel Device using the Configuration > Web Authentication > User Agreement Customize File screen.
External User Agreement	Select this to use custom user agreement pages from an external web server instead of the default one built into the Zyxel Device. You can configure the look and feel of the user agreement page.
Agreement URL	Specify the user agreement page's URL; for example, http://IIS server IP Address/logout.html. The Internet Information Server (IIS) is the web server on which the user agreement files are installed.

Table 176 Configuration > Web Authentication > Authentication Type: Add/Edit (continued)

LABEL	DESCRIPTION
Welcome URL	Specify the welcome page's URL; for example, http://IIS server IP Address/welcome.html. The Internet Information Server (IIS) is the web server on which the user agreement files are installed. If you leave this field blank, the Zyxel Device will use the welcome page of internal user agreement file.
Download	Click this to download an example external user agreement file for your reference.
OK	Click OK to save your changes back to the Zyxel Device.
Cancel	Click Cancel to exit this screen without saving.

20.2.3 Custom Web Portal / User Agreement File Screen

Use this screen to upload the zipped custom web portal or user agreement files to the Zyxel Device. You can also download the custom files to your computer.

Click **Configuration > Web Authentication** and then select the **Custom Web Portal File** or **Custom User Agreement File** tab to display the screen.

Figure 379 Configuration > Web Authentication > Custom Web Portal File

The screenshot displays the 'Custom Web Portal File' configuration screen. At the top, there are tabs for 'Web Authentication' and 'SSO'. Below that, there are sub-tabs for 'General', 'Authentication Type', 'Custom Web Portal File' (which is selected), and 'Custom User Agreement File'. The main content area is titled 'Internal Web Portal Customize File' and contains a table with the following data:

#	File Name	Size	Last Modified
1	default_wp.zip	839693	2016-03-10 17:44:58

Below the table, there are navigation controls: 'Page 1 of 1', 'Show 50 items', and 'Displaying 1 - 1 of 1'. There are also 'Remove' and 'Download' icons for the file. Below the table, there is an 'Upload Internal Web Portal Customize File' section with instructions: 'To upload a customize file, browse to the location of the file (.zip) and then click Upload.' It includes a 'File Path:' field with a 'Select a File Path' dropdown, a 'Browse...' button, and an 'Upload' button. A 'Note' section follows, stating: 'Download default_wp.zip for example. To upload customized web portal pages, browse to the location of the wp.zip file and then click upload. (Please keep welcome.html login.html logout.html session.html error.html file name and location.)' At the bottom, there is a 'Download External Web Portal Example' section with a 'Download' button.

Figure 380 Configuration > Web Authentication > Custom User Agreement File

Web Authentication SSO

General Authentication Type Custom Web Portal File **Custom User Agreement File**

Internal User Agreement Customize File

Remove Download

#	File Name	Size	Last Modified
1	default_ua.zip	800741	2016-03-10 17:44:58

Page 1 of 1 Show 50 items Displaying 1 - 1 of 1

Upload Internal User Agreement Customize File

To upload a customize file, browse to the location of the file (.zip) and then click Upload.

File Path: Browse... Upload

Note:
Download default_ua.zip for example. To upload customized user agreement pages, browse to the location of the ua.zip file and then click upload. (Please keep ua_agree.html, ua_welcome.html, ua.css file name and location.)

Download External User Agreement Example

Download

The following table describes the labels in this screen.

Table 177 Configuration > Web Authentication > Custom Web Portal / User Agreement File

LABEL	DESCRIPTION
Remove	Click a file's row to select it and click Remove to delete it from the Zyxel Device.
Download	Click a file's row to select it and click Download to save the zipped file to your computer.
#	This column displays the index number for each file entry. This field is a sequential value, and it is not associated with a specific entry.
File Name	This column displays the label that identifies a web portal or user agreement file.
Size	This column displays the size (in KB) of a file.
Last Modified	This column displays the date and time that the individual files were last changed or saved.
Browse / Upload	Click Browse... to find the zipped file you want to upload, then click the Upload button to put it on the Zyxel Device.
Download	Click this to download an example external web portal or user agreement file for your reference.

20.2.4 Facebook Wi-Fi Screen

The Zyxel Device supports Facebook Wi-Fi to let users check in to a business on Facebook for free Internet access after connecting to the Zyxel Device's wireless or LAN network. Users then have the option to like the Facebook fan page. This helps promote the Facebook page and then promote the business.

Use this screen to turn on Facebook Wi-Fi on the Zyxel Device and select a Facebook Page. You should already have:

- connected the Zyxel Device to the Internet and registered the Zyxel Device with myZyxel.
- set up a Facebook fan page associated with the business location.

- created an authentication policy in the **Configuration > Web Authentication: General** screen to redirect the matched users to the Facebook page before they can have free Internet access.

Note: If you disable Facebook Wi-Fi or reset the Facebook page settings later, the Zyxel Device automatically logs out existing users who have authenticated their connections through Facebook Wi-Fi.

Click **Configuration > Web Authentication** and then select the **Facebook Wi-Fi** tab to display the following screen. If your Zyxel Device is not registered at myZyxel, the screen displays this additional message '3. Please register your device on portal.myZyxel.com to activate configure Facebook Wi-Fi. Click here to check register status.'

Figure 381 Configuration > Web Authentication: Facebook Wi-Fi

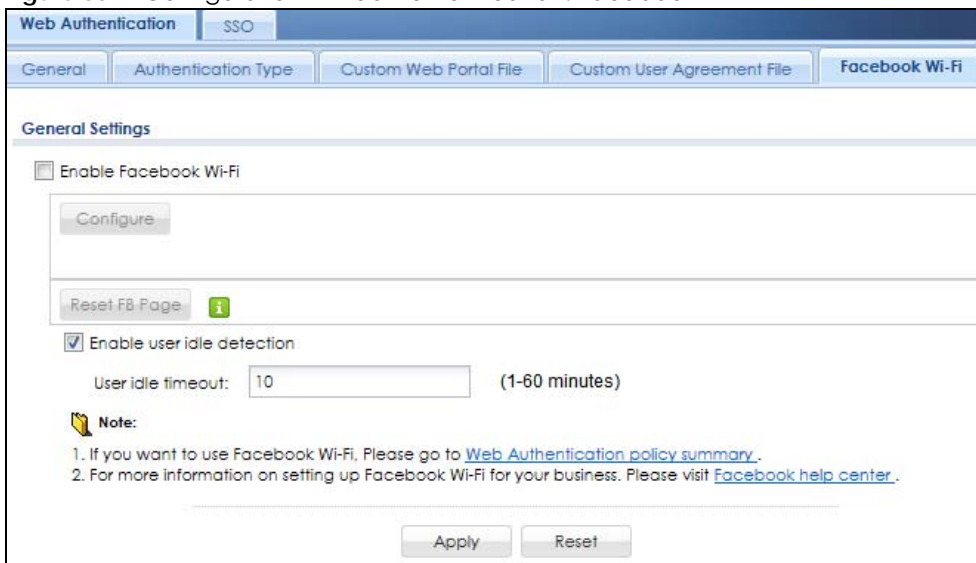

The following table describes the labels in this screen.

Table 178 Configuration > Web Authentication: Facebook Wi-Fi

LABEL	DESCRIPTION
Enable Facebook Wi-Fi	Select the check box and click Apply to turn on Facebook Wi-Fi on the Zyxel Device.
Configure	Click this button to open the Facebook Wi-Fi configuration screen in a new window, where you can select the Facebook Page associated with your location and configure bypass mode and session length. Note: You should have registered your Zyxel Device with myZyxel before you can click Configure to set up Facebook Wi-Fi on the Zyxel Device.
Reset FB Page	Click this button to remove your Facebook Page setting.
Enable user idle detection	Select this check box if you want the Zyxel Device to monitor how long each user (authenticated via Facebook Wi-Fi) is idle (in other words, there is no traffic for this user).
User idle timeout	Specify the User idle timeout between 1 and 60 minutes. The Zyxel Device automatically disconnects a user (authenticated via Facebook Wi-Fi) from the network after a period of inactivity.
Apply	Click Apply to save your changes back to the Zyxel Device.
Reset	Click Reset to return the screen to its last-saved settings.

20.2.4.1 How to Configure Facebook for Facebook Wi-Fi

This section shows you what to do if you have not yet set up a Facebook fan page and see the following message 'This device is not paired with facebook. Please configure this device'.

- 1 Click **Configure**.

The screenshot shows the 'General Settings' interface for Facebook Wi-Fi. At the top, there is a checkbox labeled 'Enable Facebook Wi-Fi' which is checked. Below this, there is a 'Configure' button and a red error message: 'This device is not paired with facebook. Please configure this device.' Underneath the error message is a 'Reset FB Page' button with an information icon. Further down, there is another checked checkbox labeled 'Enable user idle detection'. Below this checkbox is a 'User idle timeout' field with the value '10' and the text '(1-60 minutes)'. At the bottom left, there is a 'Note' section with two numbered instructions: '1. If you want to use Facebook Wi-Fi, Please go to [Web Authentication policy summary](#).' and '2. For more information on setting up Facebook Wi-Fi for your business, Please visit [Facebook help center](#).'. At the bottom right, there are 'Apply' and 'Reset' buttons.

- 2 Log into Facebook and click **Create Page**.

The screenshot shows the 'Facebook Wi-Fi Configuration' page. At the top, it displays the title 'Facebook Wi-Fi Configuration' and a unique identifier 'S122L23030003-1'. Below this, there is a message: 'You must have a compatible local business Page to continue. A compatible Page needs to be claimed and associated with a valid location. For more information, visit the [Facebook Help Center](#).' At the bottom of the page, there is a prominent green 'Create Page' button.

- 3 Select the Facebook page type and fill in the information prompts to create a Facebook page. Then click **Get Started**.

- 4 In the following screen, select the page just created and click **Save Settings**. Your Facebook page is now paired with Facebook Wi-Fi.

20.2.4.2 How to use the Zyxel Device's Facebook Wi-Fi

This section shows how users use Facebook Wi-Fi to access the Internet for free after you enable and set up Facebook Wi-Fi on the Zyxel Device.

- 1 Connect to the Zyxel Device's wireless or LAN network.

- 2 Open a web browser from the connected computer or mobile device.
- 3 The Facebook Page you specified displays. By default, users can log in and check in to the location associated with the Facebook Page, or click a link to skip check-in. If you set **Bypass Mode to Require Wi-Fi code** in the Facebook Wi-Fi configuration screen, users need to enter the Wi-Fi password you provided.

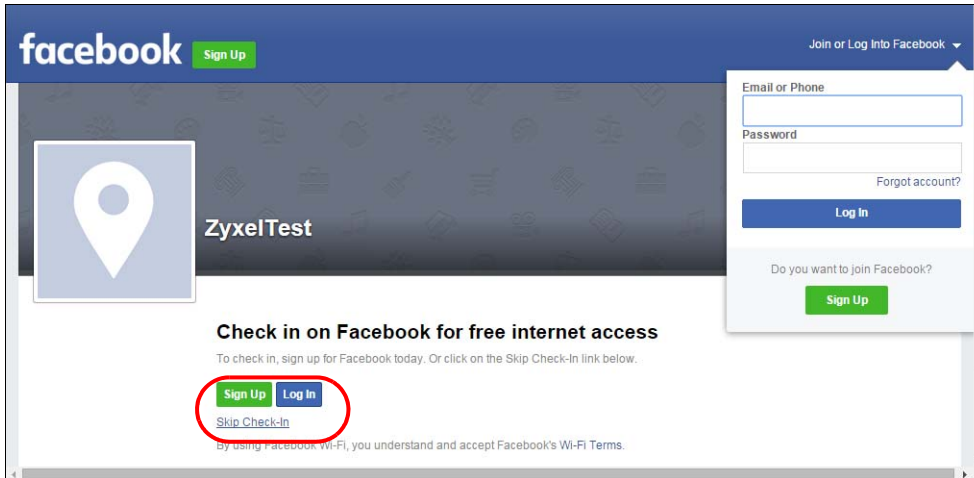

- 4 Users then can click **Continue Browsing** to surf the Internet through the Zyxel Device.

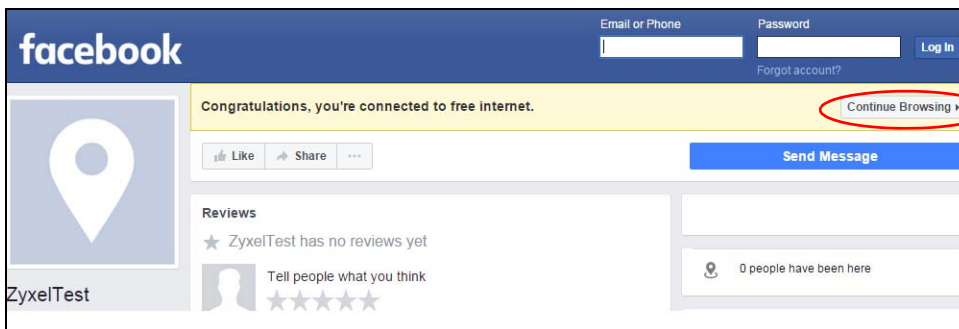

20.3 SSO Overview

The SSO (Single Sign-On) function integrates Domain Controller and Zyxel Device authentication mechanisms, so that users just need to log in once (single login) to get access to permitted resources.

In the following figure, **U** user logs into a Domain Controller (**DC**) which passes the user's login credentials to the SSO agent. The SSO agent checks that these credentials are correct with the AD server, and if the AD server confirms so, the SSO then notifies the Zyxel Device to allow access for the user to the permitted resource (Internet access, for example).

Note: The Zyxel Device, the DC, the SSO agent and the AD server must all be in the same domain and be able to communicate with each other.

SSO does not support IPv6, LDAP or RADIUS; you must use it in an IPv4 network environment with Windows AD (Active Directory) authentication database.

You must enable Web Authentication in the **Configuration > Web Authentication** screen.

Figure 382 SSO Overview

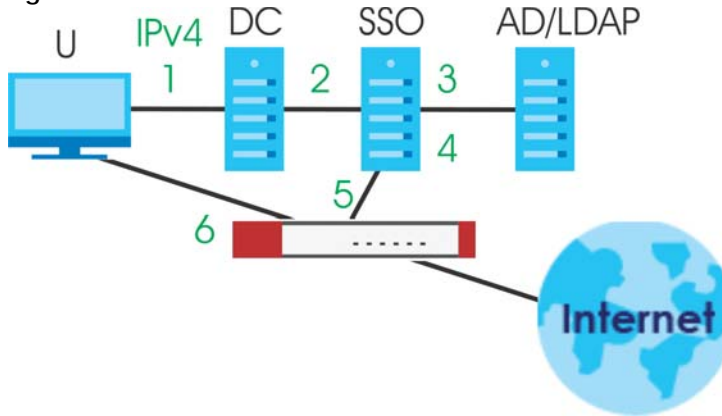

U	User
DC	Domain Controller
SSO	Single Sign-On agent
AD	Active Directory

Install the SSO Agent on one of the following platforms:

- Windows 7 Professional (32-bit and 64-bit)
- Windows Server 2008 Enterprise (32-bit and 64-bit)
- Windows 2008 R2 (64-bit)
- Windows Server 2012 (64-bit)

20.4 SSO – Zyxel Device Configuration

This section shows what you have to do on the Zyxel Device in order to use SSO.

Table 179 Zyxel Device - SSO Agent Field Mapping

ZYXEL DEVICE		SSO	
SCREEN	FIELD	SCREEN	FIELD
Web Authentication > SSO	Listen Port	Agent Configuration Page > Gateway Setting	Gateway Port
Web Authentication > SSO	Primary Agent Port	Agent Configuration Page	Agent Listening Port

Table 179 Zyxel Device - SSO Agent Field Mapping (continued)

ZYXEL DEVICE		SSO	
SCREEN	FIELD	SCREEN	FIELD
Object > User/Group > User > Add	Group Identifier	Agent Configuration Page > Configure LDAP/AD Server	Group Membership
Object > AAA Server > Active Directory > Add	Base DN	Agent Configuration Page > Configure LDAP/AD Server	Base DN
Object > AAA Server > Active Directory > Add	Bind DN	Agent Configuration Page > Configure LDAP/AD Server	Bind DN
Object > User/Group > User > Add	User Name	Agent Configuration Page > Configure LDAP/AD Server	Login Name Attribute
Object > AAA Server > Active Directory > Add	Server Address	Agent Configuration Page > Configure LDAP/AD Server	Server Address
Network > Interface > Ethernet > wan (IPv4)	IP address	Agent Configuration Page > Gateway Setting	Gateway IP

20.4.1 Configuration Overview

These are the screens you need to configure:

- [Configure the Zyxel Device to Communicate with SSO on page 538](#)
- [Enable Web Authentication on page 539](#)
- [Create a Security Policy on page 541](#)
- [Configure User Information on page 542](#)
- [Configure an Authentication Method on page 543](#)
- [Configure Active Directory on page 544](#) or [Configure Active Directory on page 544](#)

20.4.2 Configure the Zyxel Device to Communicate with SSO

Use **Configuration > Web Authentication > SSO** to configure how the Zyxel Device communicates with the Single Sign-On (SSO) agent.

Figure 383 Configuration > Web Authentication > SSO

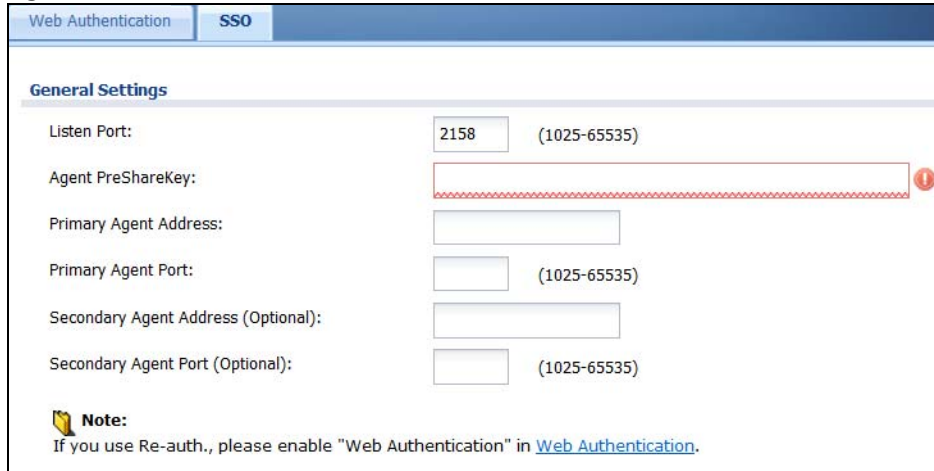

Web Authentication **SSO**

General Settings

Listen Port: (1025-65535)

Agent PreShareKey: ⓘ

Primary Agent Address:

Primary Agent Port: (1025-65535)

Secondary Agent Address (Optional):

Secondary Agent Port (Optional): (1025-65535)

Note:
If you use Re-auth., please enable "Web Authentication" in [Web Authentication](#).

The following table gives an overview of the objects you can configure.

Table 180 Configuration > Web Authentication > SSO

LABEL	DESCRIPTION
Listen Port	The default agent listening port is 2158. If you change it on the Zyxel Device, then change it to the same number in the Gateway Port field on the SSO agent too. Type a number ranging from 1025 to 65535.
Agent PreShareKey	Enter 8 – 32 printable ASCII characters or exactly 32 hex characters (0–9; a–f). The Agent PreShareKey is used to encrypt communications between the Zyxel Device and the SSO agent.
Primary Agent Address	Enter the IPv4 address of the SSO agent. The Zyxel Device and the SSO agent must be in the same domain and be able to communicate with each other.
Primary Agent Port	Enter the same port number here as in the Agent Listening Port field on the SSO agent. Type a number ranging from 1025 to 65535.
Secondary Agent Address (Optional)	Enter the IPv4 address of the backup SSO agent if there is one. The Zyxel Device and the backup SSO agent must be in the same domain and be able to communicate with each other.
Secondary Agent Port (Optional)	Enter the same port number here as in the Agent Listening Port field on the backup SSO agent if there is one. Type a number ranging from 1025 to 65535.
Apply	Click this button to save your changes to the Zyxel Device.
Reset	Click this button to return the screen to its last-saved settings

20.4.3 Enable Web Authentication

Enable **Web Authentication** and add a web authentication policy.

Web Authentication
SSO

General Settings

Enable Web Authentication

Internal Web Portal

External Web Portal

Login URL:

Logout URL: (Optional)

Welcome URL: (Optional)

Session URL: (Optional)

Error URL: (Optional)

[Download](#) the external web portal example.

Exceptional Services

[Add](#) [Remove](#)

#	Exceptional Services
1	DNS

Page 1 of 1 | Show 50 items

Web Authentication Policy Summary

[Add](#) [Edit](#) [Remove](#) [Activate](#) [Inactivate](#) [Move](#)

Status	Priority	Source	Destination	Schedule	Authentication	Description
	Default	any	any	none	unnecessary	n/a

Page 1 of 1 | Show 50 items

Make sure you select **Enable Policy**, **Single Sign-On** and choose **required** in **Authentication**.

Do NOT select **any** as the **source address** unless you want all incoming connections to be authenticated!

See [Table 173 on page 517](#) and [Table 174 on page 520](#) for more information on configuring these screens.

20.4.4 Create a Security Policy

Configure a Security Policy for SSO traffic source and destination direction in order to prevent the security policy from blocking this traffic. Go to **Configuration > Security Policy > Policy** and add a new policy if a default one does not cover the SSO web authentication traffic direction.

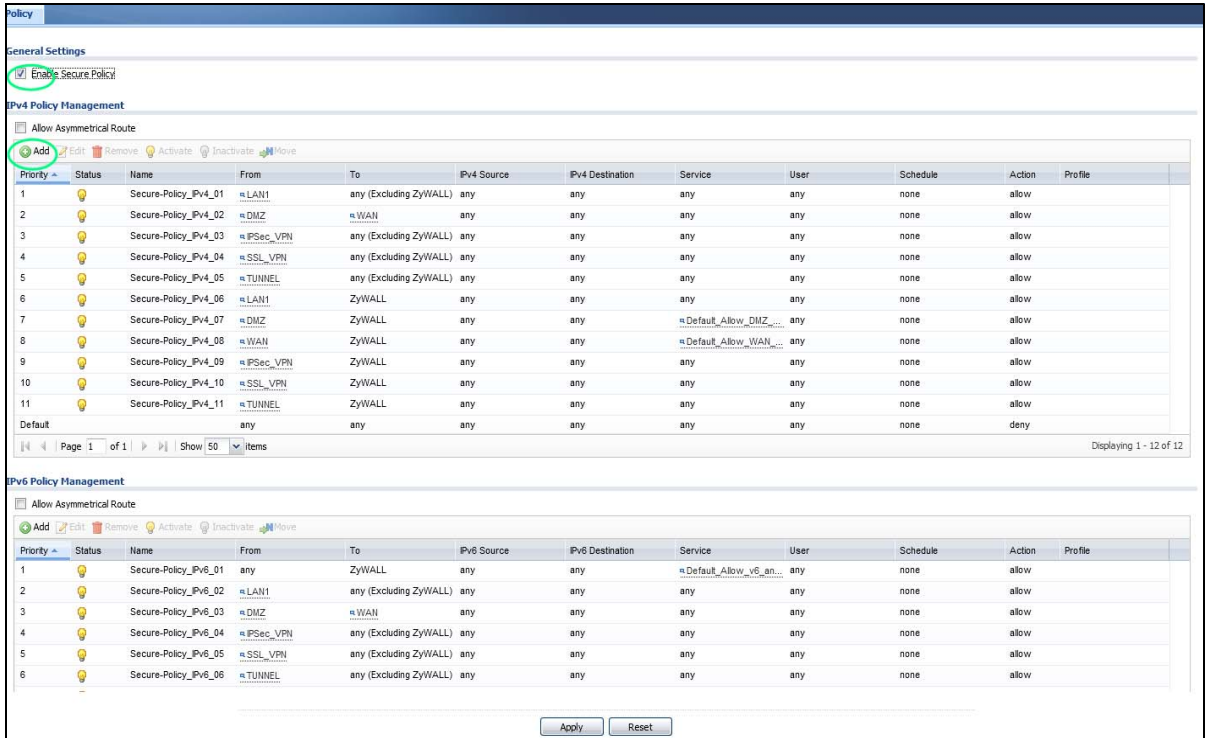

Configure the fields as shown in the following screen. Configure the source and destination addresses according to the SSO web authentication traffic in your network.

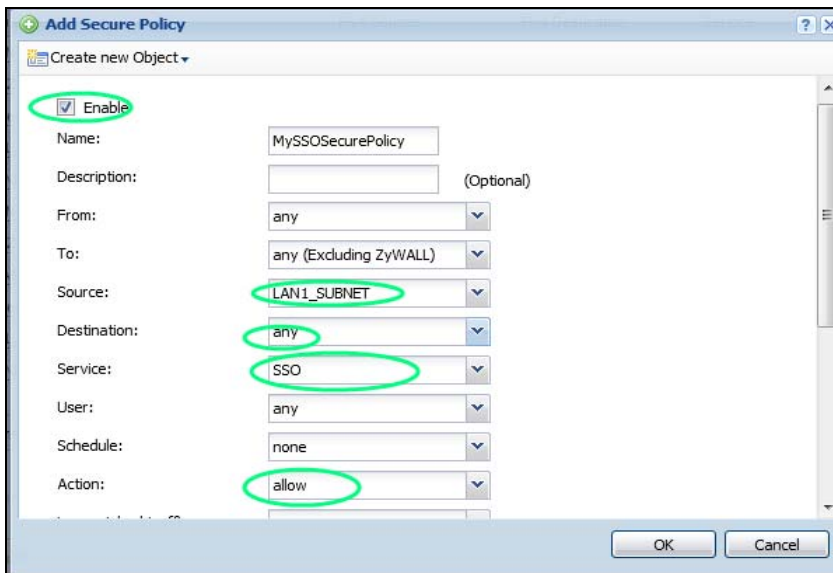

20.4.5 Configure User Information

Configure a **User** account of the **ext-group-user** type.



#	User Name	User Type	Description	Reference
1	admin	admin	Administration account	0
2	ldap-users	ext-user	External LDAP Users	0
3	radius-users	ext-user	External RADIUS Users	0
4	ad-users	ext-user	External AD Users	0
5	llan	admin	Local User	0

Configure **Group Identifier** to be the same as **Group Membership** on the SSO agent.

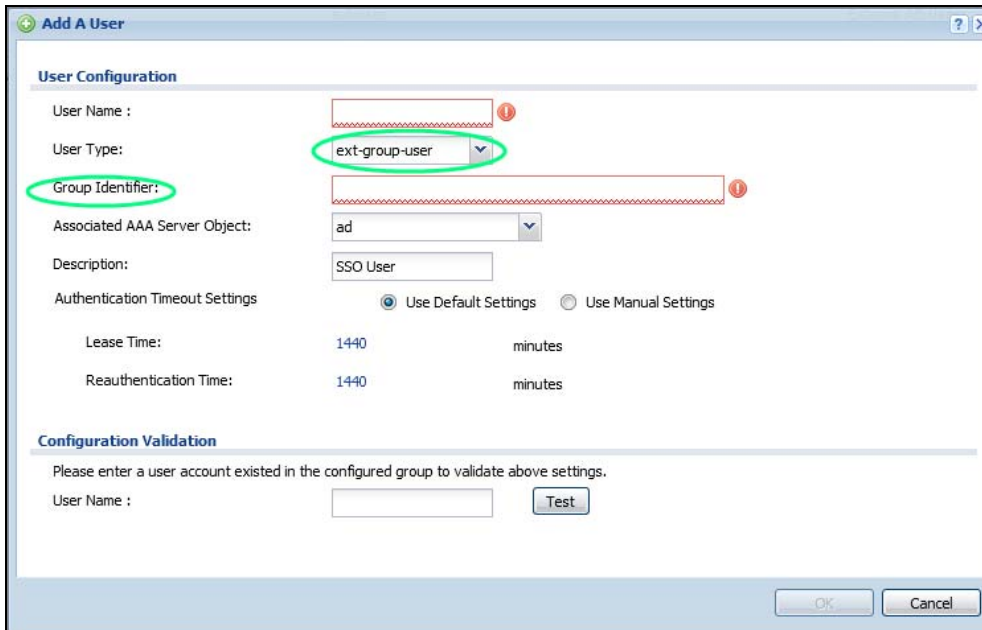

Add A User

User Configuration

User Name :

User Type: **ext-group-user**

Group Identifier:

Associated AAA Server Object: **ad**

Description:

Authentication Timeout Settings
 Use Default Settings Use Manual Settings

Lease Time: 1440 minutes

Reauthentication Time: 1440 minutes

Configuration Validation

Please enter a user account existed in the configured group to validate above settings.

User Name :

20.4.6 Configure an Authentication Method

Configure Active Directory (AD) for authentication with SSO.

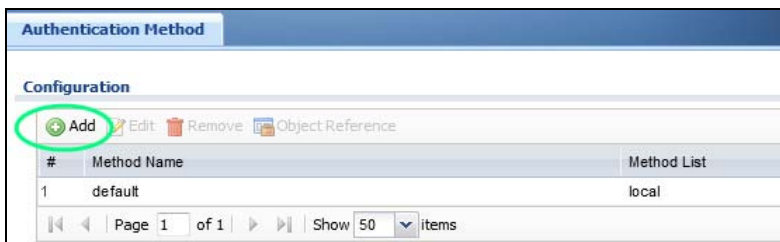

#	Method Name	Method List
1	default	local

Choose **group ad** as the authentication server for SSO.

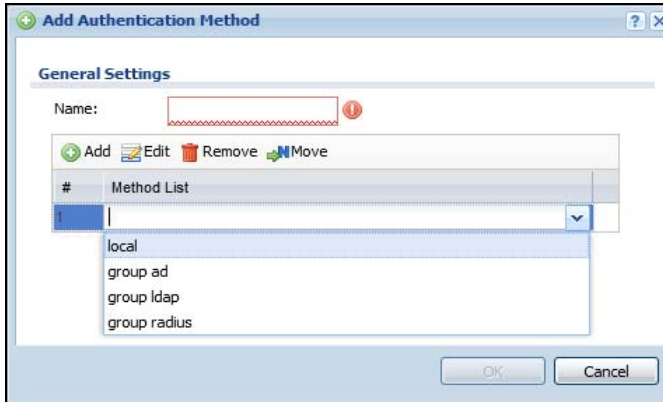

20.4.7 Configure Active Directory

You must configure an Active Directory (AD) server in **AAA Setup** to be the same as AD configured on the SSO agent.



The default AD server port is 389. If you change this, make sure you make the same changes on the SSO. Configure the **Base DN** exactly the same as on the Domain Controller and SSO. **Bind DN** is a user name and password that allows the Zyxel Device to join the domain with administrative privileges. It is a required field.

Add Active Directory

General Settings

Name:

Description: (Optional)

Server Settings

Server Address: (IP or FQDN)

Backup Server Address: (IP or FQDN)(Optional)

Port: (1-65535)

Base DN: (This field is required)

Use SSL

Search time limit: (1-300 seconds)

Case-sensitive User Names i

Server Authentication

Bind DN:

Password:

Retype to Confirm:

User Login Settings

Login Name Attribute:

Alternative Login Name Attribute: (Optional)

Group Membership Attribute:

Domain Authentication for MSChap

Enable

User Name: Must be a user who has rights to add a machine to the

OK Cancel

20.5 SSO Agent Configuration

This section shows what you have to do on the SSO agent in order to work with the Zyxel Device.

After you install the SSO agent, you will see an icon in the system tray (bottom right of the screen).

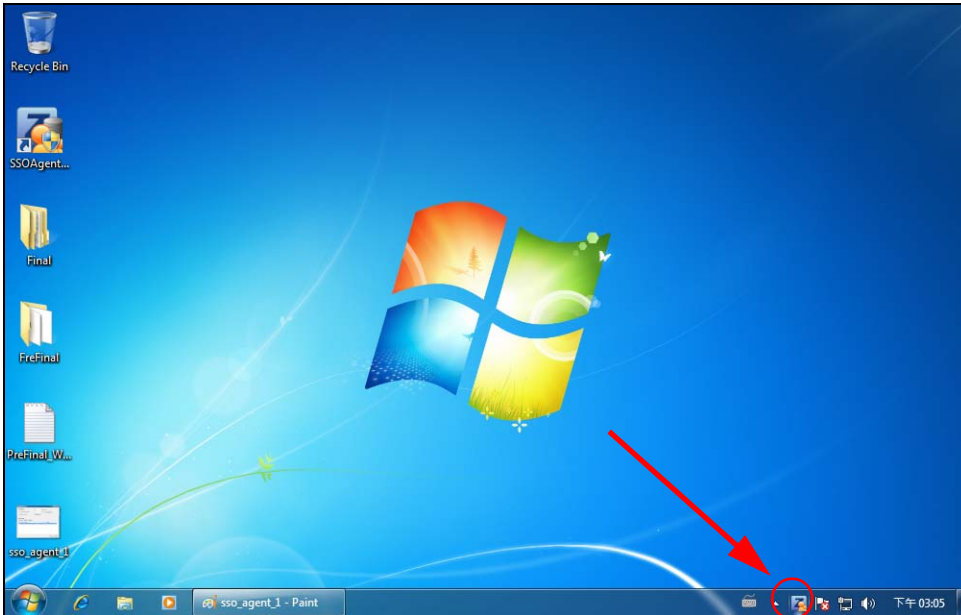

Right-click the SSO icon and select **Configure Zyxel SSO Agent**.

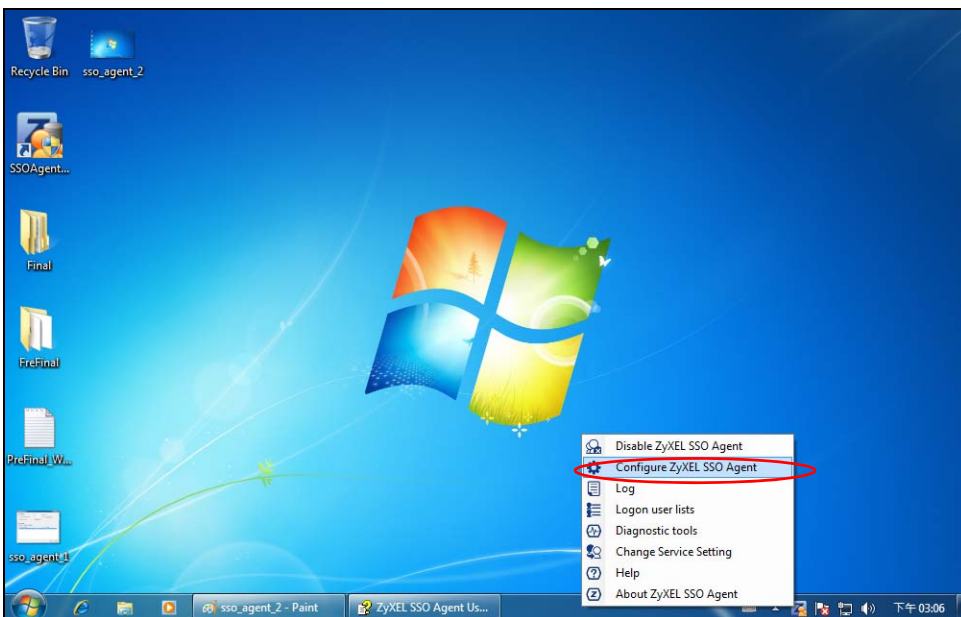

Configure the **Agent Listening Port**, **AD server** exactly as you have done on the Zyxel Device. Add the Zyxel Device IP address as the **Gateway**. Make sure the Zyxel Device and SSO agent are able to communicate with each other.

Agent Configuration Page

General Setting:

Agent Listening Port: 2158 (1025 - 65535)

Logon List Check Interval (minute): 30 (10 - 1440)

Configure LDAP/AD server

Gateway Settings

Active	Index	Description	IP	Port	Share Key
<input checked="" type="checkbox"/>	1	test	192.168.1.1	2158	*****
<input type="checkbox"/>					
<input type="checkbox"/>					
<input type="checkbox"/>					
<input type="checkbox"/>					
<input type="checkbox"/>					
<input type="checkbox"/>					
<input type="checkbox"/>					
<input type="checkbox"/>					
<input type="checkbox"/>					

Configure the **Server Address**, **Port**, **Base DN**, **Bind DN**, **Login Name Attribute** and **Group Membership** for the AD server settings exactly as you have done on the Zyxel Device. **Group Membership** is called **Group Identifier** on the Zyxel Device.

LDAP/AD Server Configuration

LDAP/AD server configuration

General Settings

Name: ad-server

Description:

Server Settings

Server Address: 192.168.1.220

Backup Server Address:

Port: 389

Base DN: dc=sso,dc=win2012,dc=com

Use SSL

Search time limit: 5

Server Authentication

Bind DN: agent

Password: ●●●

Retype to Confirm: ●●●

User Settings

Group Membership Attribute: memberOf

Configuration Validation

Please enter the existing user account in this server to validate the above settings

Username:

Configure the **Gateway IP** address, **Gateway Port** and **PreShareKey** exactly as you have done in the Zykel Device **Configuration > Web Authentication > SSO** screen. If you want to use **Generate Key** to have the SSO create a random password, select **Check** to show **PreShareKey** as clear Text so as to see the password, then copy and paste it to the Zykel Device.

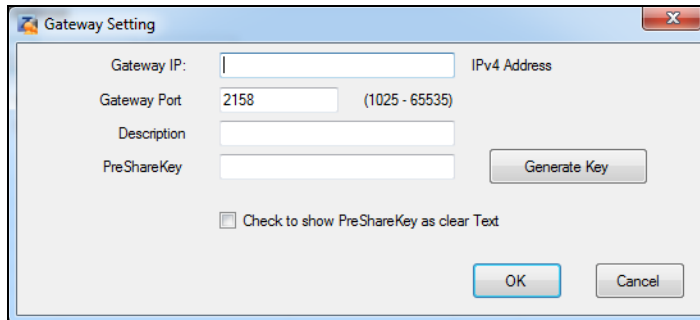

After all SSO agent configurations are done, right-click the SSO icon in the system tray and select **Enable Zykel SSO Agent**.

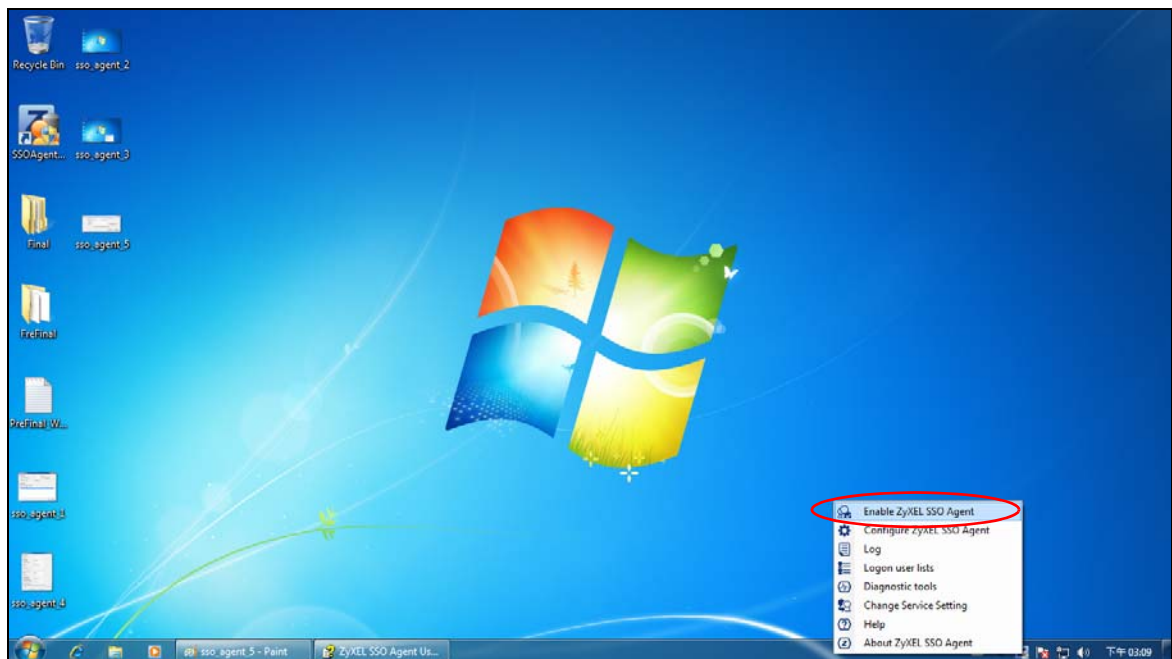

CHAPTER 21

Hotspot

21.1 Overview

See [Section 1.1 on page 28](#) to see which models support Hotspot management.

21.2 Billing Overview

You can use the built-in billing function to setup billing profiles. A billing profile describes how to charge users. This chapter also shows you how to select an accounting method, configure a discount price plan or use an online payment service by credit card.

- Use the **General** screen (see [Section 22.2 on page 567](#)) to configure the general billing settings, such as the accounting method, currency unit and the SSID profiles to which the settings are applied.
- Use the **Billing Profile** screen (see [Section 21.4 on page 552](#)) to configure the billing profiles for the web-based account generator and each button on the connected statement printer.
- Use the **Discount** screen (see [Section 21.5 on page 559](#)) to enable and configure discount price plans.
- Use the **Payment Service** screen (see [Section 21.6 on page 561](#)) to enable online payment service and configure the service pages.

21.2.1 What You Need to Know

Accumulation Accounting Method

The accumulation accounting method allows multiple re-logins until the allocated time period or until the user account is expired. The Zyxel Device accounts the time that the user is logged in for Internet access.

Time-to-finish Accounting Method

The time-to-finish accounting method is good for one-time logins. Once a user logs in, the Zyxel Device stores the IP address of the user's computer for the duration of the time allocated. Thus the user does not have to enter the user name and password again for re-login within the allocated time. Once activated, the user account is valid until the allocated time is reached even if the user disconnects Internet access for a certain period within the allocated time. For example, Joe purchases a one-hour time-to-finish account. He starts using the Internet for the first 20 minutes and then disconnects his Internet access to go to a 20-minute meeting. After the meeting, he only has 20 minutes left on his account.

21.3 The Billing > General Screen

Use this screen to configure the general billing settings, such as the accounting method, currency unit and the SSID profiles to which the settings are applied. Click **Configuration > Hotspot > Billing > General** to open the following screen.

Figure 384 Configuration > Hotspot > Billing > General

The screenshot displays the 'Billing > General' configuration page with the following sections and settings:

- General Settings:**
 - Unused account will be deleted after the time: 24 hour
 - Accounting Method: Time to Finish, Accumulation
 - User idle timeout: 3 (1-60 minutes)
 - Accumulation account will be deleted after the time: 90 day
- Billing User Logon Settings:**
 - Maximum number per billing account: 1 (1-10)
 - Reach maximum number per billing account: Block, Remove previous user and login
 - Username & Password length: 6
 - Keep user logged in
 - Replenish Service
- Currency:**
 - Currency: Currency symbol (€), Currency code (User-Define)
 - Number of decimals places: 2
 - Decimal symbol: comma
 - Tax: 0 %
- SSID Profile Settings:**
 - Selectable SSID Profiles: default, ssid
 - Selected SSID Profiles: (empty)
- Hotspot Service Status:**
 - Service Status: **Not Activated** [Buy](#) [Activate](#)

Buttons: Apply, Reset

The following table describes the labels in this screen.

Table 181 Configuration > Hotspot > Billing > General

LABEL	DESCRIPTION
General Settings	
Unused account will be deleted after the time:	Enter the number and select a time unit from the drop-down list box to specify how long to wait before the Zyxel Device deletes an account that has not been used.
Accounting Method	Select Time to Finish to allow each user a one-time login. Once the user logs in, the system starts counting down the pre-defined usage even if the user stops the Internet access before the time period is finished. If a user disconnects and reconnects before the allocated time expires, the user does not have to enter the user name and password to access the Internet again. Select Accumulation to allow each user multiple re-login until the time allocated is used up. The Zyxel Device accounts the time that the user is logged in for Internet access.
User idle timeout	The Zyxel Device automatically disconnects a computer from the network after a period of inactivity. The user may need to enter the username and password again before access to the network is allowed. If you select Accumulation , specify the idle timeout between 1 and 60 minutes.
Accumulation account will be deleted after the time:	Enter the number and select a time unit from the drop-down list box to specify how long to wait before the Zyxel Device deletes the account. This is for use with accumulation accounting.
Billing User Logon Settings	
Maximum number per billing account	Enter the maximum number of the users that are allowed to log in with the same account.
Reach maximum number per billing account	Select Block to stop new users from logging in when the Maximum number per billing account is reached. Select Remove previous user and login to disassociate the first user that logged in and allow new user to log in when the Maximum number per billing account is reached.
Username & Password length	Select to specify how many characters the username and password of a newly-created dynamic guest account will have after you click Apply .
Keep user logged in	Select to let the users automatically log in without entering their user name and password if the Zyxel Device restarts. Note: This works only for free guest accounts or when the accounting method is Time to Finish .
Currency	Select the appropriate currency symbol or currency unit. If you set Currency code to User-Define , enter a three-letter alphabetic code manually.
Number of decimals places	This shows the number of decimal places to be used for billing.
Decimal symbol	Select whether you would like to use a dot (.) or a comma (,) for the decimal point.
Tax	Select this option to charge sales tax for the account. Enter the tax rate (a 6% sales tax is entered as 6).
SSID Profile Settings	The Selectable SSID Profiles list displays the name(s) of the SSID profile(s) to which you can apply the general billing settings. To apply settings to an SSID profile, you can double-click a single entry to move it or use the [Shift] or [Ctrl] key to select multiple entries and click the right arrow button to add to the Selected SSID Profiles list. To remove an SSID profile, select the name(s) in the Selected SSID Profiles list and click the left arrow button.

Table 181 Configuration > Hotspot > Billing > General (continued)

LABEL	DESCRIPTION
Hotspot Service Status	
Service Status	This field displays whether a service license is enabled at myZyXel (Activated) or not (Not Activated) or expired (Expired). It displays the remaining Grace Period if your license has Expired . It displays Not Licensed if there isn't a license to be activated for this service. If you need a license or a trial license has expired, click Buy to buy a new one. If a Standard license has expired, click Renew to extend the license. Then, click Activate to connect with the myZyXel server to activate the new license.
Service Type	This shows whether you have a trial or standard license or none (Trial, Standard, None).
Expiration Date	This shows when your hotspot license will expire.
Apply	Click this button to save your changes to the ZyXel Device.
Reset	Click this button to return the screen to its last-saved settings.

21.4 The Billing > Billing Profile Screen

Use this screen to configure the billing profiles that defines the maximum Internet access time and charge per time unit. Click **Configuration > Hotspot > Billing > Billing Profile** to open the following screen.

Figure 385 Configuration > Hotspot > Billing > Billing Profile

The following table describes the labels in this screen.

Table 182 Configuration > Hotspot > Billing > Billing Profile

LABEL	DESCRIPTION
Account Generator Settings	
Button A ~ C	Select a billing profile for each button of the web-based account generator. The buttons correspond to the buttons on a connected statement printer.

Table 182 Configuration > Hotspot > Billing > Billing Profile (continued)

LABEL	DESCRIPTION
Preview	Click this button to open the Account Generator screen, where you can generate a dynamic guest account and print the account information using a statement printer connected to the Zyxel Device (see Section 21.4.1 on page 553 for more information).
Billing Profile	
Add	Click this to create a new entry.
Edit	Double-click an entry or select it and click Edit to open a screen where you can modify the entry's settings.
Remove	To remove an entry, select it and click Remove . The Zyxel Device confirms you want to remove it before doing so.
Activate	To turn on an entry, select it and click Activate .
Inactivate	To turn off an entry, select it and click Inactivate .
#	This field is a sequential value, and it is not associated with a specific entry.
Status	This icon is lit when the entry is active and dimmed when the entry is inactive.
Name	This field displays the descriptive profile name for this entry.
Time Period	This field displays the duration of the billing period.
Quota (T/U/D)	This field is NOT available when you set Accounting Method to Time to Finish in the Billing > General screen. This field displays how much data in both directions (Total) or upstream data (Upload) and downstream data (Download) can be transmitted through the WAN interface before the account expires.
Bandwidth (U/D)	This field displays the maximum upstream (Upload) and downstream (Download) bandwidth allowed for the user account in kilobits per second.
Price	This field displays each profile's price per time unit.
Apply	Click this button to save your changes to the Zyxel Device.
Reset	Click this button to return the screen to its last-saved settings.

21.4.1 The Account Generator Screen

The **Account Generator** screen allows you to automatically create dynamic guest accounts (see [Section 7.10 on page 230](#) and [Dynamic-Guest Accounts](#) for more information on dynamic guest accounts).

Click **Configuration > Hotspot > Billing > Billing Profile** and then the **Preview** button to open this screen. You can also open this screen by logging into the Web Configurator with the guest-manager account.

Figure 386 Account Generator

Account Generator Settings

Butt...	Selection	Service Name	Time Period	Quota (T / U / D)	Bandwidth (U / D)	Price
A	<input checked="" type="radio"/>	billing_30mins	30 minute	unlimited / - / -	unlimited / unlimited	€ 0,00
B	<input type="radio"/>	billing_30mins	30 minute	unlimited / - / -	unlimited / unlimited	€ 0,00
C	<input type="radio"/>	billing_30mins	30 minute	unlimited / - / -	unlimited / unlimited	€ 0,00

Button A Unit:

Customer Information

Real Name: (Optional)

Email: (Optional)

Phone Number: (Optional)

Default Thermal Printer

Printer:

Summary

Total: € 0,00

Tax: 0 %

Grand Total: € 0,00

Quantity: (1-50)

The following table describes the labels in this screen.

Table 183 Account Generator

LABEL	DESCRIPTION
Account Generator Settings	Select a button and specify how many units of billing period to be charged for new account in the Button x Unit field.
Discount plan for Button x	This section displays only when you enable the discount price plan in the Billing > Discount screen.
#	This is the number of each discount level. The default (first) level cannot be edited or deleted. It is created automatically according to the billing profile of the button you select.
Name	This field displays the conditions of each discount level.
Unit	This field displays the duration of the billing period that should be reached before the Zyxel Device charges users at this level.
Price	This field displays the price per time unit for each level.
Customer Information	
Real Name	Enter the user's name.
Email	Enter the user's email address.
Phone Number	Enter the user's phone number.

Table 183 Account Generator (continued)

LABEL	DESCRIPTION
Default Thermal Printer	Select a statement printer that is attached to the Zyxel Device. It displays n/a if there is no printer attached.
Summary	
Total	This shows the total price for the account before sales tax is added.
Tax	This shows the tax rate.
Grand Total	This shows the total price including tax.
Quantity	Specify the number of account to be created.
Generate	Click Generate to generate an account based on the billing settings you configure for the selected button in the Billing Profile screen. A window displays showing the SMS message and/or a printout preview of the account generated.
Cancel	Click Cancel to exit this screen without saving.
Logout	Click Logout to log out of the web configurator. This button is available only when you open this screen by logging in with the guest-manager account.

The following figure shows an example SMS message with account information. The **SMS** screen displays only when you enable SMS in the **Configuration > System > Notification > SMS** screen. You can enter the user's mobile phone number and click **Send SMS** to send the account information in an SMS text message to the user's mobile phone. Click **Cancel** to close this window when you are finished viewing it.

The screenshot shows a web browser window titled "Account Generator" with a sub-tab "SMS". The "SMS Content" section displays the following text in a red-bordered box:

Username:g7kqua Password:nhj7mr Activate account before 2014-04-17 09:24

Below this, the "Send SMS" section contains a form with the following fields and buttons:

- Country Code:
- Mobile Number:
- Example: [886][0910123456] (for Taiwan)
-

At the bottom of the window, there are "Cancel" and "Printer" buttons.

The **Printer** screen shows a printout preview example. Click **Printer** to print this subscriber statement. Click **Cancel** to close this window when you are finished viewing it.

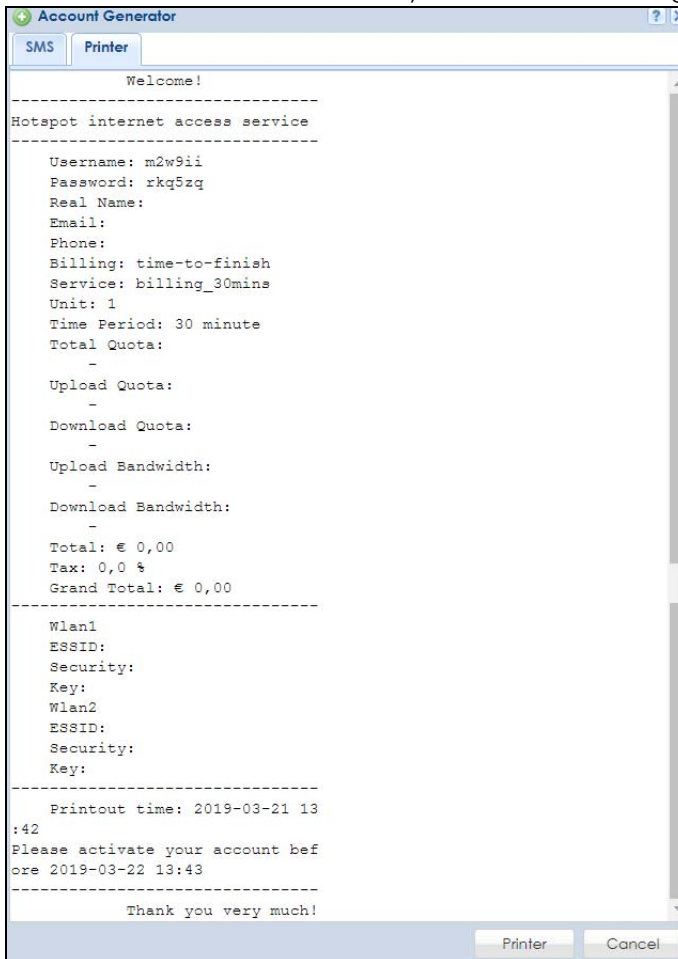

21.4.2 The Account Redeem Screen

The **Account Redeem** screen allows you to send SMS messages for certain accounts. Click the **Account Redeem** tab in the **Account Generator** screen to open this screen.

Figure 387 Account Redeem

The following table describes the labels in this screen.

Table 184 Account Redeem

LABEL	DESCRIPTION
Query Account Information	
Phone Number	Enter the country code and mobile phone number and click Query to display only the account(s) that has the specified phone number.
SMS	Click this button to send text messages for the accounts in the list below. You can use this button only when SMS is enabled and there is at least one account in the list.
#	This is the index number of the dynamic guest account in the list.
Status	This field displays whether an account expires or not.
Username	This field displays the user name of the account.
Create Time	This field displays when the account was created.
Remaining Time	This field displays the amount of Internet access time remaining for each account.
Time Period	This field displays the total account of time the account can use to access the Internet through the Zyxel Device.
Expiration Time	This field displays the date and time the account becomes invalid. Note: Once the time allocated to a dynamic account is used up or a dynamic account remains unused after the expiration time, the account is deleted from the account list.
Charge	This field displays the total cost of the account.
Payment Info	This field displays the method of payment for each account.
Phone Num	This field displays the mobile phone number for the account.

Table 184 Account Redeem (continued)

LABEL	DESCRIPTION
Cancel	Click Cancel to exit this screen without saving.
Logout	Click Logout to log out of the web configurator. This button is available only when you open this screen by logging in with the guest-manager account.

21.4.3 The Billing Profile Add/Edit Screen

The **Billing Profile Add/Edit** screen allows you to create a new billing profile or edit an existing one. Click **Configuration > Hotspot > Billing > Billing Profile** and then an **Add** or **Edit** icon to open this screen.

Figure 388 Configuration > Hotspot > Billing > Billing Profile > Add/Edit

The following table describes the labels in this screen.

Table 185 Configuration > Hotspot > Billing > Billing Profile > Add/Edit

LABEL	DESCRIPTION
Enable billing profile	Select this option to activate the profile.
Name	Enter a name for the billing profile. You can use up to 31 alphanumeric characters (A-Z, a-z, 0-9) and underscores (_). Spaces are not allowed. The first character must be a letter.
Price	Define each profile's price, up to 999999.99, per time unit.
Time Period	Set the duration of the billing period (minute , hour , or day). When this period expires, the user's access will be stopped. The allowed time period ranges are 10 to 60 minutes, 0 to 24 hours, or 0 to 365 days.

Table 185 Configuration > Hotspot > Billing > Billing Profile > Add/Edit (continued)

LABEL	DESCRIPTION
Quota Type	<p>The quota settings section is NOT available when you set Accounting Method to Time to Finish in the Billing > General screen.</p> <p>Set a limit for the user accounts. This only applies to user's traffic that is received or transmitted through the WAN interface.</p> <p>Note: When the limit is exceeded, the user is not allowed to access the Internet through the Zyxel Device.</p> <p>Select Total to set a limit on the total traffic in both directions.</p> <p>Select Upload/Download to set a limit on the upstream traffic and downstream traffic respectively.</p>
Total Quota	<p>If you select Total, specify how much downstream and/or upstream data (in MB (Megabytes) or GB (Gigabytes)) can be transmitted through the WAN interface before the account expires. 0 means there is no data limit for the user account.</p>
Upload Quota	<p>If you select Upload/Download, specify how much upstream data (in MB (Megabytes) or GB (Gigabytes)) can be transmitted through the WAN interface before the account expires.</p> <p>0 means there is no data limit for the user account.</p>
Download Quota	<p>If you select Upload/Download, specify how much downstream data (in MB (Megabytes) or GB (Gigabytes)) can be transmitted through the WAN interface before the account expires.</p> <p>0 means there is no data limit for the user account.</p>
Enable Bandwidth	<p>Select this option to turn on bandwidth management for the user accounts.</p>
Upload	<p>Specify the maximum outgoing bandwidth allowed for the user account in kilobits per second. Upload refers to the traffic the Zyxel Device sends out from a user.</p>
Download	<p>Specify the maximum incoming bandwidth allowed for the user account in kilobits per second. Download refers to the traffic the Zyxel Device sends to a user.</p>
Priority	<p>Enter a number between 1 and 7 to set the priority for the user's traffic. The smaller the number, the higher the priority.</p> <p>Traffic with a higher priority is given bandwidth before traffic with a lower priority.</p> <p>Note: The priority setting here has priority over the priority setting in a bandwidth management rule.</p>
OK	<p>Click OK to save your changes back to the Zyxel Device.</p>
Cancel	<p>Click Cancel to exit this screen without saving.</p>

21.5 The Billing > Discount Screen

Use this screen to configure a custom discount pricing plan. This is useful for providing reduced rates for purchases of longer periods of time. You can charge higher rates per unit at lower levels (fewer units purchased) and lower rates per unit at higher levels (more units purchased). Click **Configuration > Hotspot > Billing > Discount** to open the following screen.

Note: The discount price plan does not apply to users who purchase access time online with a credit card.

Figure 389 Configuration > Hotspot > Billing > Discount

The following table describes the labels in this screen.

Table 186 Configuration > Hotspot > Billing > Discount

LABEL	DESCRIPTION
Discount Settings	
Enable Discount	Select the check box to activate the discount price plan.
Button Select	Select a button from the drop-down list box to assign the base charge.
Charge by levels	Select this to charge the rate at each successive level from the first level (most expensive per unit) to the highest level (least expensive per unit) that the total purchase reaches. Otherwise, clear this to charge all of the user's time units only at the highest level (least expensive) that their total purchase reaches.
Discount Price Plan	
Add	Click this to create a new entry.
Edit	Double-click an entry or select it and click Edit to open a screen where you can modify the entry's settings.
Remove	To remove an entry, select it and click Remove . The Zyxel Device confirms you want to remove it before doing so.
#	This is the number of each discount level. The default (first) level cannot be edited or deleted. It is created automatically according to the billing profile of the button you select.
Name	This field displays the conditions of each discount level.
Unit	This field displays the duration of the billing period that should be reached before the Zyxel Device charges users at this level.
Price	This field displays the price per time unit for each level.
Apply	Click this button to save your changes to the Zyxel Device.
Reset	Click this button to return the screen to its last-saved settings.

21.5.1 The Discount Add/Edit Screen

The **Discount Add/Edit** screen allows you to create a new discount level or edit an existing one. Click **Configuration > Hotspot > Billing > Discount** and then an **Add** or **Edit** icon to open this screen.

Figure 390 Configuration > Hotspot > Billing > Discount > Add/Edit

The following table describes the labels in this screen.

Table 187 Configuration > Hotspot > Billing > Discount > Add/Edit

LABEL	DESCRIPTION
Name	This field displays the conditions of each discount level.
Unit	Set the duration of the billing period that should be reached before the Zyxel Device charges users at this level.
Price	Define this level's charge per time unit.
OK	Click OK to save your changes back to the Zyxel Device.
Cancel	Click Cancel to exit this screen without saving.

21.6 The Billing > Payment Service Screen

Use this screen to use a credit card service to authorize, process, and manage credit card transactions directly through the Internet. You must register with the supported credit card service before you can configure the Zyxel Device to handle credit card transactions. Click **Configuration > Hotspot > Billing > Payment Service** to open the following screen.

Figure 391 Configuration > Hotspot > Billing > Payment Service > General

The following table describes the labels in this screen.

Table 188 Configuration > Hotspot > Billing > Payment Service > General

LABEL	DESCRIPTION
General Setting	
Enable Payment Service	Select the check box to use PayPal to authorize credit card payments. Note: After you set up web authentication policies and enable the online payment service on the Zyxel Device, a link displays in the login screen when users try to access the Internet. The link redirects users to a screen where they can make online payments by credit card to purchase access time and get dynamic guest account information.
Payment Provider Selection	
Account	You should already have a PayPal account to receive credit card payments. Enter your PayPal account name.
Currency	Select the currency in which payments are made. The available options depend on currencies that PayPal supports.
Identity Token	Enter the ID token provided to you by PayPal after successfully applying for your PayPal account.
Payment Gateway	Enter the address of the PayPal gateway provided to you by PayPal after applying for your PayPal account.
Account Delivery Method	

Table 188 Configuration > Hotspot > Billing > Payment Service > General (continued)

LABEL	DESCRIPTION
Delivery Method	<p>Specify how the Zyxel Device provides dynamic guest account information after the user's online payment is done.</p> <p>Select On-Screen to display the user account information in the web screen.</p> <p>Select SMS to use Short Message Service (SMS) to send account information in a text message to the user's mobile device.</p> <p>Select On-Screen and SMS to provide the account information both in the web screen and via SMS text messages.</p> <p>Note: You should have enabled SMS in the Configuration > System > Notification > SMS screen to send text messages to the user's mobile device.</p>
Apply	Click this button to save your changes to the Zyxel Device.
Reset	Click this button to return the screen to its last-saved settings.

21.6.1 The Payment Service > Desktop / Mobile View Screen

Use this screen to customize the online payment service pages that displays after an unauthorized user clicks the link in the Web Configurator login screen to purchase access time. You can configure both the desktop and mobile versions of the service pages. Users click a link in the pages to switch between the two versions.

Click **Configuration > Hotspot > Billing > Payment Service > Desktop View** or **Mobile View** to open the following screen.

Figure 392 Configuration > Hotspot > Billing > Payment Service > Desktop View

The screenshot displays the configuration interface for the Payment Service in Desktop View. The interface is divided into several sections for customizing user-facing messages and a service selection table.

General Settings:

- Navigation tabs: General, Billing Profile, Discount, Payment Service.
- View modes: Desktop View (selected), Mobile View.

Select Type:

- Use Default Page
- Use Customized Page

Customized Profile Selection Page:

Selected Message: Please choose the service plan from the following profile list.

#	Service Name	Time Period	Charge	Quantity
1	AAA	2 hour	\$ 23	1 ▼
2	AAA	2 hour	\$ 23	1 ▼
3	AAA	2 hour	\$ 23	1 ▼
4	AAA	2 hour	\$ 23	1 ▼
5	AAA	2 hour	\$ 23	1 ▼
6	AAA	2 hour	\$ 23	1 ▼

Customized Successfully Page:

Successfully Message: You have now got the internet.
 Information Message: **IMPORTANT!** Please make a note of your username and password for logging in later. This will be your only opportunity to do so. Note upper and lowercase letters.
 Information Date: 11/11/2011 10:00:00 AM
 Account Message: This is your account information, please keep this for your internet service.
 Your username is XXX
 Your password is XXX
 Your time period is 0 day, 00 hour 30 minutes
 Please activate your account before 28/03/2012, 23:00:00

Customized Fail Page:

Failed Message: Sorry! We can't handle your payment transaction at this time.
 Go to [Payment](#) and check your account.

Customized SMS Page:

Information Message: Please check your mobile phone for the account information.

Buttons: Apply, Reset

Figure 393 Configuration > Hotspot > Billing > Payment Service > Mobile View

The screenshot displays the ZyXEL configuration interface for the Payment Service Mobile View. It is organized into four main sections, each with a configuration form on the left and a preview of the user-facing page on the right.

- Customized Profile Selection Page:**
 - Select Type:** Radio buttons for "Use Default Page" and "Use Customized Page" (selected).
 - Customized Profile Selection Page:**
 - Selection Message: "Please choose the service plan from the following profile table"
 - Preview: Shows a table with columns "Time", "Quota", and "Charge".

Time	Quota	Charge
50min	100MB 1000D	€1.00
24hr	unlimited -	€3.00
- Customized Successfully Page:**
 - Successfully Message: "you may now use the internet."
 - Notification Message: "IMPORTANT! MAKE a note for your case-sensitive"
 - Notification Color: "red" (with a color selection dropdown)
 - Preview: Shows a "Successfully" message with a warning icon and text: "IMPORTANT! MAKE a note for your case-sensitive username and password for logging later. This will be your only opportunity to do so." Below this are fields for "Your username" (13qxs3), "Your password" (ze10mk), "Your time period" (30 minutes), and "Please activate your account before" (26/04/2014, 23:00:00). A "Login Now" button is at the bottom.
- Customized Fail Page:**
 - Failed Message: "Sorry! We can't handle your payment transaction at this time"
 - Preview: Shows a "Fail" message with a warning icon and text: "Sorry! We can't handle your payment transaction at this time. Reason: Invalid operation. You can go to PayPal and check your account." Below are "OK" and "Go to PayPal" buttons.
- Customized SMS Page:**
 - Information Message: "Please check your mobile phone for the account inform."
 - Preview: Shows an "SMS Message" with the text "Please check your mobile phone for the account information" and an "OK" button.

At the bottom of the configuration area, there are "Apply" and "Reset" buttons.

The following table describes the labels in this screen.

Table 189 Configuration > Hotspot > Billing > Payment Service > Desktop View or Mobile View

LABEL	DESCRIPTION
Select Type	
Use Default Page	Select this to use the default online payment service page built into the device. If you later create a custom online payment service page, you can still return to the Zyxel Device's default page as it is saved indefinitely.
Use Customized Page	Select this to use a custom online payment service page instead of the default one built into the Zyxel Device. Once this option is selected, the custom page controls below become active.
Customized Profile Selection Page	
Selection Message	Enter a note to display in the first welcome page that allows users to choose a billing period they want. Use up to 256 printable ASCII characters. Spaces are allowed.
Customized Successfully Page	
Successfully Message	Enter a note to display in the second page after the user's online payment is made successfully. Use up to 256 printable ASCII characters. Spaces are allowed.
Notification Message	Enter the important information you want to display. Use up to 256 printable ASCII characters. Spaces are allowed.
Notification Color	Specify the font color of the important information. You can use the color palette chooser, or enter a color value of your own.
Account Message	Enter a note to display above the user account information. Use up to 256 printable ASCII characters. Spaces are allowed.
Day Time	Select the format in which you want to display the date and how long an account is allowed to stay unused before it expires.
Customized Fail Page	
Failed Message	Enter a note to display when the user's online payment failed. Use up to 256 printable ASCII characters. Spaces are allowed.
Customized SMS Page	
Information Message	Enter a note to display when you set the Zyxel Device to send account information via SMS text messages. Use up to 256 printable ASCII characters. Spaces are allowed.
Apply	Click this button to save your changes to the Zyxel Device.
Reset	Click this button to return the screen to its last-saved settings.

CHAPTER 22

Printer Manager

22.1 Printer Manager Overview

You can create dynamic guest accounts and print guest account information by pressing the button on an external statement printer, such as SP350E.

Make sure that the printer is connected to the appropriate power and the Zyxel Device, and that there is printing paper in the printer. Refer to the printer's documentation for details.

22.1.1 What You Can Do in this Chapter

- Use the **Printer Manager > General** screen (see [Section 22.2 on page 567](#)) to configure the printer list and enable printer management.
- Use the **Printer Manager > Printout Configuration** screen (see [Section 22.3 on page 574](#)) to customize the account printout.

22.2 The Printer Manager > General Screen

Use this screen to configure a printer list and allow the Zyxel Device to monitor the printer status. Click **Configuration > Hotspot > Printer Manager > General** to open the following screen.

Figure 394 Configuration > Hotspot > Printer Manager > General

The following table describes the labels in this screen.

Table 190 Configuration > Hotspot > Printer Manager > General

LABEL	DESCRIPTION
General Setting	
Enable Printer Manager	Select the check box to allow the Zyxel Device to manage and monitor the printer status.
Printer Settings	
Encryption	Select the check box to turn on data encryption. Data transmitted between the Zyxel Device and the printer will be encrypted with a secret key
Secret Key	Enter four alphanumeric characters (A-Z, a-z, 0-9) to specify a key for data encryption.
Printer List	Use this section to add the printer(s) that can be managed by the Zyxel Device.
Add	Click this to create a new entry.
Edit	Double-click an entry or select it and click Edit to open a screen where you can modify the entry's settings.
Remove	To remove an entry, select it and click Remove . The Zyxel Device confirms you want to remove it before doing so.
Activate	To turn on an entry, select it and click Activate .
Inactivate	To turn off an entry, select it and click Inactivate .
Discover Printer	Click this to discover the printer(s) that is connected to the Zyxel Device and display the printer information in a pop-up window. IPnP is enabled while discovering the printer and disabled when the discovering process has finished. Note: You need a Hotspot license to use this feature. Use Printer Manager > General > Add to manually configure a printer's IP address and add it to the managed printer list when the printer is not detected or connected to the Zyxel Device.
Refresh	Click this to update the printer list table.

Table 190 Configuration > Hotspot > Printer Manager > General (continued)

LABEL	DESCRIPTION
#	This field is a sequential value, and it is not associated with any entry.
Status	This icon is lit when the entry is active and dimmed when the entry is inactive. Click the Connection icon for the Zyxel Device connect to the printer.
IPv4 Address	This field displays the IP address of the printer.
Update Time	This field displays the date and time the Zyxel Device last synchronized with the printer. This shows n/a when the printer is not in the managed printer list or the printer status is sync fail or sync progressing .
Status	This field is hidden by default. It displays whether the Zyxel Device can connect to the printer and update the printer information. This shows n/a when the printer is not in the managed printer list.
Nickname	This shows an optional friendly name for the printer that you configured.
Firmware Version	This field displays the model number and firmware version of the printer. This shows n/a when the printer is not in the managed printer list or the printer status is sync fail .
MAC	This shows the hardware MAC address of the printer.
Description	This field displays the descriptive name for the printer that you configured.
Printer Firmware Information	
Current Version	This is the version of the printer firmware currently uploaded to the Zyxel Device. The Zyxel Device automatically installs it in the connected printers to make sure the printers are upgraded to the same version.
Hotspot Service Status	The hotspot license must be registered in order to be activated.
Service Status	This field displays whether a service license is enabled at myZyxel (Activated) or not (Not Activated) or expired (Expired). It displays the remaining Grace Period if your license has Expired . It displays Not Licensed if there isn't a license to be activated for this service. If you need a license or a trial license has expired, click Buy to buy a new one. If a Standard license has expired, click Renew to extend the license. Then, click Activate to connect with the myZyxel server to activate the new license.
Service Type	This shows whether you have a trial or standard license or none (Trial, Standard, None).
Expiration Date	This shows when your hotspot license will expire.
Apply	Click this button to save your changes to the Zyxel Device.
Reset	Click this button to return the screen to its last-saved settings.

22.2.1 Add Printer Rule

Click the **Add** icon to open the following screen. Use this screen to add a new printer.

Figure 395 Configuration > Hotspot > Printer Manager > General: Add

The following table describes the labels in this screen.

Table 191 Configuration > Hotspot > Printer Manager > General: Add

LABEL	DESCRIPTION
Enable Printer Manager	Select this option to turn on this entry in order to allow the Zyxel Device to manage this printer.
IPv4 Address	Enter an IPv4 address for the printer.
Description	Enter a description of this printer. You can use alphanumeric and () + , / : = ? ! * # @ \$ _ % - " characters, and it can be up to 60 characters long.
OK	Click OK to save your changes back to the Zyxel Device.
Cancel	Click Cancel to exit this screen without saving.

22.2.2 Edit Printer Rule

Select an entry in the **Printer Manager > General** screen and click the **Edit** icon to open the following screen. Use this screen to modify the printer's settings. You can't click the **Edit** icon when the printer status is **sync fail** or **sync progressing**.

Figure 396 Configuration > Hotspot > Printer Manager > General: Edit

The following table describes the labels in this screen.

Table 192 Configuration > Hotspot > Printer Manager > General: Edit

LABEL	DESCRIPTION
Enable Printer Manager	Select this option to turn on this entry in order to allow the Zyxel Device to manage this printer.
Nickname	Type an optional friendly name for the printer. A nickname must begin with a letter and cannot exceed 15 characters. Valid characters are [a-zA-Z0-9_-].
Description	Enter a description of this printer. You can use alphanumeric and () , / : = ? ! * # @ \$ % _ - " characters, and it can be up to 60 characters long.
IP Address Assignment	
Get Automatically	Select this to make the printer a DHCP client and automatically get the IP address, subnet mask, and gateway address from a DHCP server.
Use Fixed IP Address	Select this if you want to specify the IP address, subnet mask, and gateway manually.
IP Address	This field is enabled if you select Use Fixed IP Address . Enter the IP address for the printer.
Subnet Mask	This field is enabled if you select Use Fixed IP Address . Enter the subnet mask of the printer in dot decimal notation. The subnet mask indicates what part of the IP address is the same for all computers in the network.
Gateway	This field is enabled if you select Use Fixed IP Address . Enter the IP address of the gateway. The Zyxel Device sends packets to the gateway when it does not know how to route the packet to its destination. The gateway should be on the same network as the printer.
OK	Click OK to save your changes back to the Zyxel Device.
Cancel	Click Cancel to exit this screen without saving.

22.2.3 Discover Printer

Click the **Discover Printer** icon in the **Printer Manager > General** screen to open the following screen. Use this screen to find connected printers or edit a connected printer's settings. Use **Printer Manager >**

General > Add to manually configure a printer's IP address and add it to the managed printer list when the printer is not detected or connected to the Zyxel Device.

Figure 397 Configuration > Hotspot > Printer Manager > General: Discover Printer

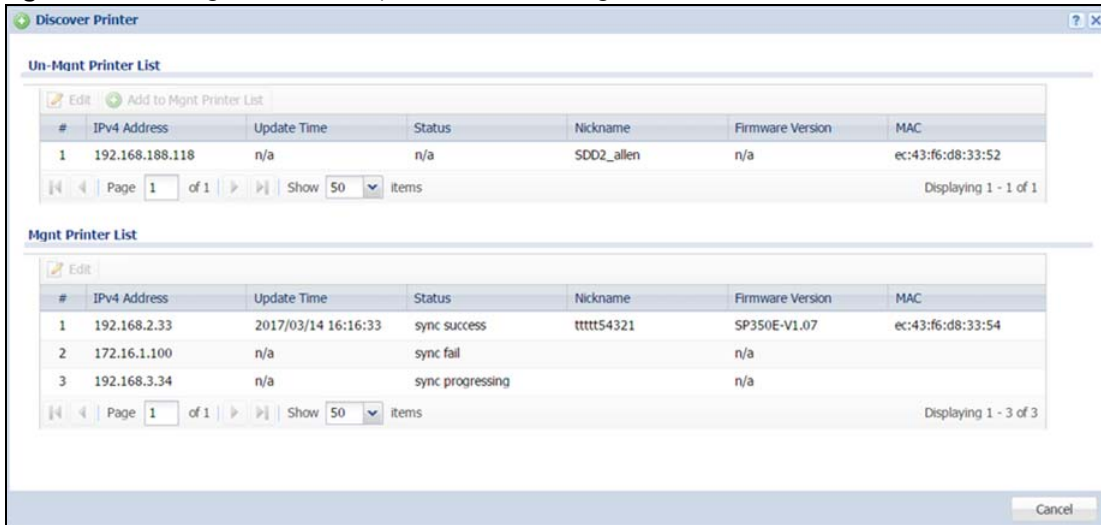

The following table describes the labels in this screen.

Table 193 Configuration > Hotspot > Printer Manager > General > Discover Printer

LABEL	DESCRIPTION
Un-Mgmt Printer List / Mgmt Printer List	The tables displays according to whether the printer is in the unmanaged printer list (Un-Mgmt Printer List) or the managed printer list (Mgmt Printer List).
Edit	Double-click an entry or select it and click Edit to open a screen where you can modify the entry's settings. Note: You cannot edit an entry's settings when the printer status is sync fail or sync progressing .
Add to Mgmt Printer List	Click this to add the selected printer to the managed printer list.
#	This is the index number of the printer in the list.
Registration	This field displays whether the printer is added to the managed printer list (Mgmt Printer) or not (Un-Mgmt Printer).
IPv4 Address	This field displays the IP address of the printer.
Update Time	This field displays the date and time the Zyxel Device last synchronized with the printer. This shows n/a when the printer is not in the managed printer list or the printer status is sync fail or sync progressing .
Status	This field displays whether the Zyxel Device can connect to the printer and update the printer information. This shows n/a when the printer is not in the managed printer list.
Nickname	This field displays the optional friendly name of the printer that you configured.
Firmware Version	This field displays the model number and firmware version of the printer. This shows n/a when the printer is not in the managed printer list or the printer status is sync fail .
MAC	This field displays the MAC address of the printer.

22.2.4 Edit Printer Manager (Discover Printer)

Select an entry in the **Printer Manager > General > Discover Printer** screen and click the **Edit** icon to open the following screen. Use this screen to modify the printer's nickname and IP address.

Figure 398 Configuration > Hotspot > Printer Manager > General > Discover Printer: Edit

The following table describes the labels in this screen.

Table 194 Configuration > Hotspot > Printer Manager > General > Discover Printer: Edit

LABEL	DESCRIPTION
General Settings	
Nickname	Type an optional friendly name for the printer. A nickname must begin with a letter and cannot exceed 15 characters. Valid characters are [a-zA-Z0-9_-].
IP Address Assignment	
Get Automatically	Select this to make the printer a DHCP client and automatically get the IP address, subnet mask, and gateway address from a DHCP server.
Use Fixed IP Address	Select this if you want to specify the IP address, subnet mask, and gateway manually.
IP Address	This field is enabled if you select Use Fixed IP Address . Enter the IP address for the printer.
Subnet Mask	This field is enabled if you select Use Fixed IP Address . Enter the subnet mask of the printer in dot decimal notation. The subnet mask indicates what part of the IP address is the same for all computers in the network.
Gateway	This field is enabled if you select Use Fixed IP Address . Enter the IP address of the gateway. The Zyxel Device sends packets to the gateway when it does not know how to route the packet to its destination. The gateway should be on the same network as the printer.
OK	Click OK to save your changes back to the Zyxel Device.
Cancel	Click Cancel to exit this screen without saving.

22.3 The Printout Configuration Screen

Use this screen to customize the account printout. Click **Configuration > Hotspot > Printer Manager > Printout Configuration** to open the following screen.

Figure 399 Configuration > Hotspot > Printer Manager > Printout Configuration

The following table describes the labels in this screen.

Table 195 Configuration > Hotspot > Printer Manager > Printout Configuration

LABEL	DESCRIPTION
Use Default Printout Configuration	Select this to use the default account printout format built into the device. If you later create a custom account printout format, you can still return to the Zyxel Device's default format as it is saved indefinitely.
Use Customized Printout Configuration	Select this to use a custom account printout format instead of the default one built into the Zyxel Device. Once this option is selected, the custom format controls below become active.
Preview	Click the button to display a preview of account printout format you uploaded to the Zyxel Device.
File Name	This shows the file name of account printout format file in the Zyxel Device. Click Download to download the account printout format file from the Zyxel Device to your computer.
File Path / Browse / Upload	Browse for the account printout format file or enter the file path in the available input box, then click the Upload button to put it on the Zyxel Device.
Restore Customized File to Default	Click Restore to set the Zyxel Device back to use the default built-in account printout format.
Download	Click this to download an example account printout format file from the Zyxel Device for your reference.
Printout	
Number of Copies	Select how many copies of subscriber statements you want to print (1 is the default).
Apply	Click this button to save your changes to the Zyxel Device.
Reset	Click this button to return the screen to its last-saved settings.

22.4 Printer Reports Overview

The SP350E allows you to print status reports about the guest accounts and general Zyxel Device system information. Simply press a key combination on the SP350E to print a report instantly without accessing the web configurator.

The following lists the reports that you can print using the SP300E.

- Daily account summary
- Monthly account summary
- Last month account summary
- System status

22.4.1 Key Combinations

The following table lists the key combination to print each report.

Note: You must press the key combination on the SP350E within five seconds to print.

Table 196 Report Printing Key Combinations

REPORT TYPE	KEY COMBINATION
Daily Account Summary	A B C A A
Monthly Account Summary	A B C B A
Last Month Account Summary	A B C B B
System Status	A B C C A

The following sections describe each report printout in detail.

22.4.2 Daily Account Summary

The daily account report lists the accounts printed during the current day, the current day's total number of accounts and the total charge. It covers the accounts that have been printed during the current day starting from midnight (not the past 24 hours). For example, if you press the daily account key combination on 2013/05/10 at 20:00:00, the daily account report includes the accounts created on 2013/05/10 between 00:00:01 and 19:59:59.

Key combination: A B C A A

The following figure shows an example.

Figure 400 Daily Account Example

```

Daily Account
-----
2013/05/10

Username Price
-----
p2m6pf52 1.00
s4pcms28 2.00
-----
TOTAL ACCOUNTS: 2
TOTAL PRICE: $ 3.00
-----
2013/05/10 20:00:00
---End---

```

22.4.3 Monthly Account Summary

The monthly account report lists the accounts printed during the current month, the current month's total number of accounts and the total charge. It covers the accounts that have been printed during the current month starting from midnight of the first day of the current month (not the past one month period). For example, if you press the monthly account key combination on 2013/05/17 at 20:00:00, the monthly account report includes the accounts created from 2013/05/01 at 00:00:01 to 2013/05/17 at 19:59:59.

Key combination: A B C B A

The following figure shows an example.

Figure 401 Monthly Account Example

```

Monthly Account
-----
2013/05

Username Price
-----
p2m6pf52 1.00
s4pcms28 2.00
7ufm7z22 2.00
qm5fxn95 6.00
-----
TOTAL ACCOUNTS: 4
TOTAL PRICE: $ 11.00
-----
2013/05/17 20:00:11
---End---

```

22.4.4 Account Report Notes

The daily, monthly or last month account report holds up to 2000 entries. If there are more than 2000 accounts created in the same month or same day, the account report's calculations only include the latest 2000.

For example, if 2030 accounts (each priced at \$1) have been created from 2013/05/01 00:00:00 to 2013/05/31 19:59:59, the monthly account report includes the latest 2000 accounts, so the total would be \$2,000 instead of \$2,030.

Use the **Monitor > System Status > Dynamic Guest** screen to see the accounts generated on another day or month (up to 2000 entries total).

22.4.5 System Status

This report shows the current system information such as the host name and WAN IP address.

Key combination: A B C C A

The following figure shows an example.

Figure 402 System Status Example

System Status	
Item	Description
SYST	02:02:35
WAST	Link up
WLST	Activate
FWVR	2.50 (AACG.0)
BTVR	1.22
WAMA	00-90-0E-00-4A-29
LAMA	00-90-0E-00-4A-30
WAIP	10.21.2.267
LAIP	172.16.0.1
WLIP	10.59.1.1
DHSP	10.59.1.33
DHEP	10.59.1.254
CPUS	5%
MEMS	40%
DKST	5%
2012/04/12 17:10:22	
---End---	

The following table describes the labels in this report.

Table 197 System Status

LABEL	DESCRIPTION
SYST	This field displays the time since the system was last restarted.
WAST	This field displays the WAN connection status.
WLST	This field displays the status of the Zyxel Device's wireless LAN.
FWVR	This field displays the version of the firmware on the Zyxel Device.
BTVR	This field displays the version of the bootrom.
WAMA	This field displays the MAC address of the Zyxel Device on the WAN.
LAMA	This field displays the MAC address of the Zyxel Device on the LAN.

Table 197 System Status (continued)

LABEL	DESCRIPTION
WAIP	This field displays the IP address of the WAN port on the Zyxel Device.
LAIP	This field displays the IP address of the LAN port on the Zyxel Device.
WLIP	This field displays the IP address of the wireless LAN interface on the Zyxel Device.
DHSP	This field displays the first of the continuous addresses in the IP address pool.
DHEP	This field displays the end of the continuous addresses in the IP address pool.
CPUS	This field displays the Zyxel Device's recent CPU usage.
MEMS	This field displays the Zyxel Device's recent memory usage.
DKST	This field displays what percentage of the Zyxel Device's on-board flash memory is currently being used.

CHAPTER 23

Free Time

23.1 Free Time Overview

With Free Time, the Zyxel Device can create dynamic guest accounts that allow users to browse the Internet free of charge for a specified period of time.

23.1.1 What You Can Do in this Chapter

Use the Free Time screen (see [Section 23.2 on page 579](#)) to turn on this feature to allow users to get a free account for Internet surfing during the specified time period.

23.2 The Free Time Screen

Use this screen to enable and configure the free time settings. Click **Configuration > Hotspot > Free Time** to open the following screen.

Figure 403 Configuration > Hotspot > Free Time

The screenshot shows the 'Free Time' configuration page. At the top, there is a blue header with the text 'Free Time'. Below this is a section titled 'General Settings' with several configuration options:

- Enable Free Time
- Free Time Period: 30 minute (dropdown)
- Reset Time: Daily (dropdown)
- Time: 00:00 (clock icon)
- Maximum Registration Number Before Reset Time: 1 (1-5)
- Delivery Method: On-Screen (dropdown)
- Auto Login

Below the settings is a 'Note' section with a yellow icon and text: 'If you want to configure ssid profile settings of the account, keep user logged in, please go to [Billing](#)'.

The next section is 'Hotspot Service Status' with the following information:

- Service Status: Not Activated [Buy](#) [Activate](#)
- Service Type: None
- [Register Now](#)

At the bottom of the page, there are two buttons: 'Apply' and 'Reset'.

The following table describes the labels in this screen.

Table 198 Configuration > Hotspot > Free Time

LABEL	DESCRIPTION
Enable Free Time	<p>Select the check box to turn on the free time feature.</p> <p>Note: After you set up web authentication policies and enable the free time feature on the Zyxel Device, a link displays in the login screen when users try to access the Internet. The link redirects users to a screen where they can get a free account.</p>
Free Time Period	<p>Select the duration of time period for which the free time account is allowed to access the Internet.</p>
Reset Time	<p>Select Daily to have the Zyxel Device allow free account access every day at the specified time.</p> <p>Select Weekly to have the Zyxel Device allow free account access once a week on the day you select.</p> <p>Select Monthly to have the Zyxel Device allow free account access once a month on a set date.</p> <p>When your free period ends, you will see a message telling you when you can use free time again. This depends on the Reset Time period chosen.</p>
Time	<p>If you select Daily, select the time in 24-hour format at which the new free time account is allowed to access the Internet.</p>
Day	<p>If you select Weekly, select the day on which the new free time account is allowed to access the Internet.</p> <p>If you select Monthly, enter the date on which the new free time account is allowed to access the Internet. If the date you selected is not available in a month, such as 30th or 31th, the Zyxel Device allows the free account access on the last day of the month.</p>
Maximum Registration Number Before Reset Time	<p>Enter the maximum number of the users that are allowed to log in for Internet access with a free guest account before the time specified in the Reset Time field. This also sets how many free guest accounts a user can get.</p> <p>For example, if you set the Maximum Registration Number Before Reset Time to 1, the Reset Time to Daily and the Reset Time to 13:00, even the first free guest account has expired at 11:30, the user cannot get a second account and/or access the Internet until 13:00.</p>
Delivery Method	<p>Specify how the Zyxel Device provides dynamic guest account information.</p> <p>Select On-Screen to display the user account information in the web screen.</p> <p>Select SMS to use Short Message Service (SMS) to send account information in a text message to the user's mobile device.</p> <p>Select On-Screen and SMS to provide the account information both in the web screen and via SMS text messages.</p> <p>Note: You should have enabled SMS in the Configuration > System > Notification > SMS screen to send text messages to the user's mobile device.</p>
Auto Login	<p>Select this to allow users to log into their free account directly without having to enter their user name and password.</p> <p>Clearing this requires users to enter their user name and password, and click login to access their free account.</p>
Hotspot Service Status	

Table 198 Configuration > Hotspot > Free Time (continued)

LABEL	DESCRIPTION
Service Status	This field displays whether a service license is enabled at myZyxel (Activated) or not (Not Activated) or expired (Expired). It displays the remaining Grace Period if your license has Expired . It displays Not Licensed if there isn't a license to be activated for this service. If you need a license or a trial license has expired, click Buy to buy a new one. If a Standard license has expired, click Renew to extend the license. Then, click Activate to connect with the myZyxel server to activate the new license.
Service Type	This shows whether you have a trial or standard license or none (Trial, Standard, None).
Expiration Date	This shows when your hotspot license will expire.
Apply	Click this button to save your changes to the Zyxel Device.
Reset	Click this button to return the screen to its last-saved settings.

The following figure shows an example login screen with a link to create a free guest account.

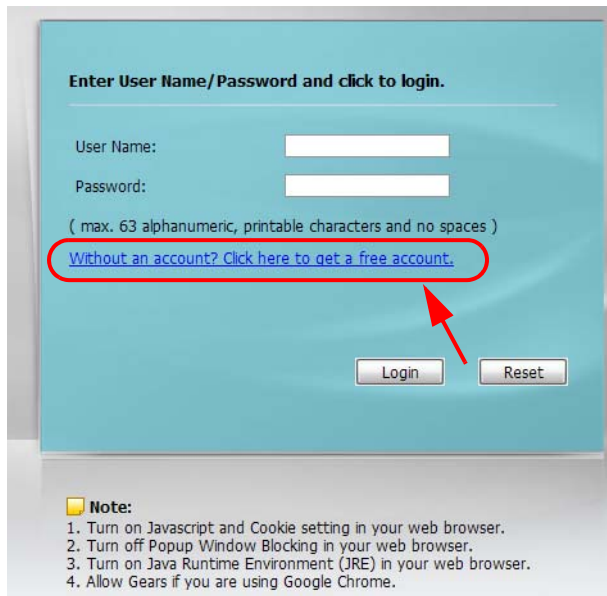

If you enable both online payment service and free time feature on the Zyxel Device, the link description in the login screen will be mainly for online payment service. You can still click the link to get a free account.

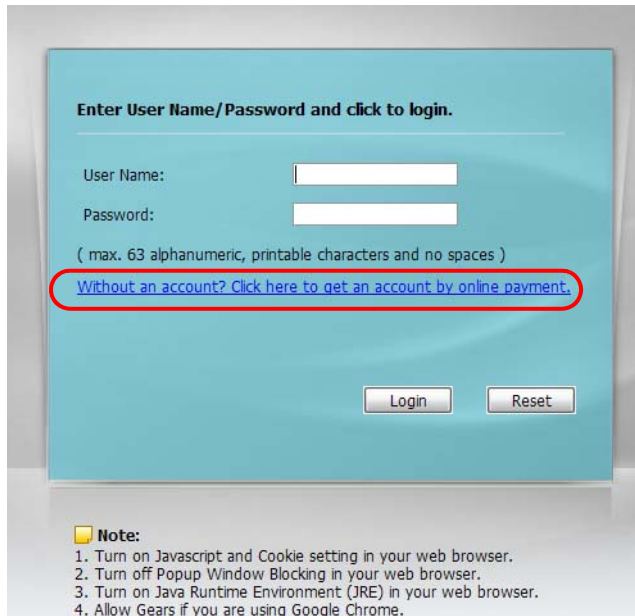

Enter User Name/Password and click to login.

User Name:

Password:

(max. 63 alphanumeric, printable characters and no spaces)

[Without an account? Click here to get an account by online payment.](#)

Login Reset

Note:

1. Turn on Javascript and Cookie setting in your web browser.
2. Turn off Popup Window Blocking in your web browser.
3. Turn on Java Runtime Environment (JRE) in your web browser.
4. Allow Gears if you are using Google Chrome.

If SMS is enabled on the Zyxel Device, you have to enter your mobile phone number before clicking **OK** to get a free guest account.

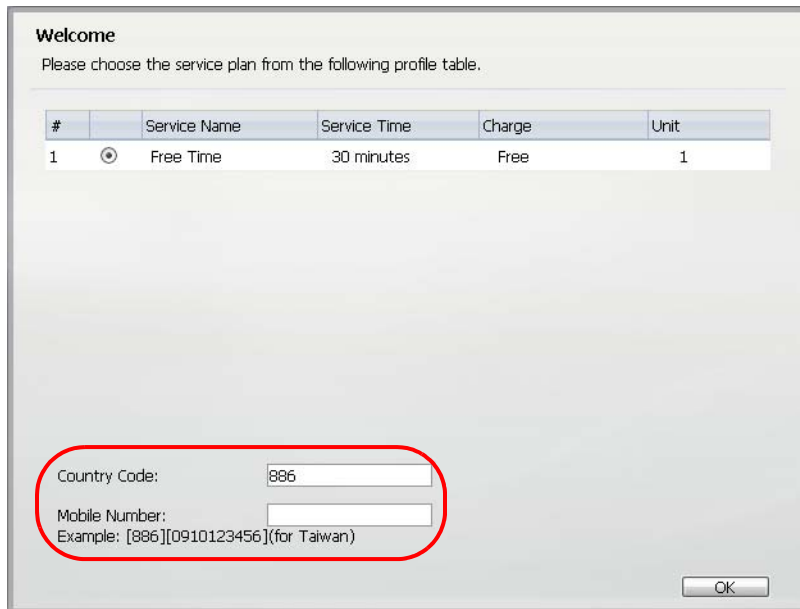

Welcome

Please choose the service plan from the following profile table.

#		Service Name	Service Time	Charge	Unit
1	<input checked="" type="radio"/>	Free Time	30 minutes	Free	1

Country Code:

Mobile Number:

Example: [886][0910123456](for Taiwan)

OK

The guest account information then displays in the screen and/or is sent to the configured mobile phone number.

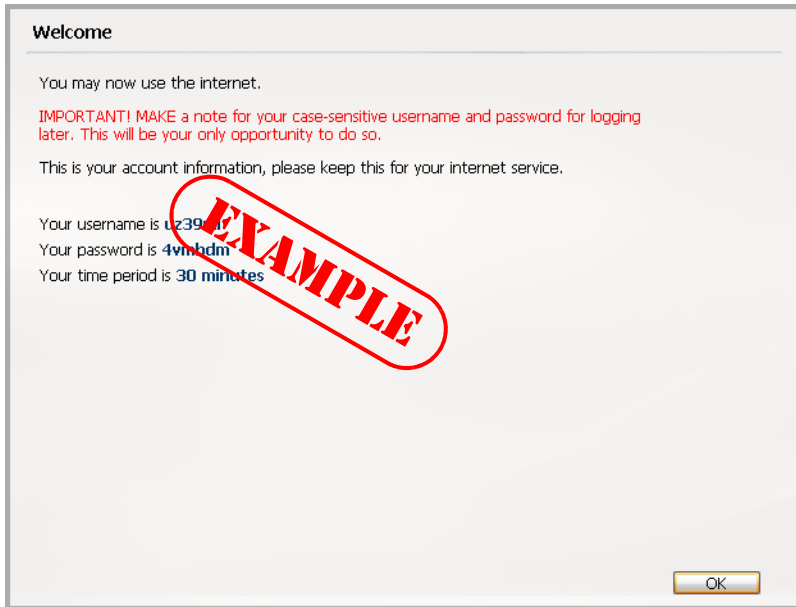

CHAPTER 24

IPnP

24.1 IPnP Overview

IP Plug and Play (IPnP) allows a computer to access the Internet without changing the network settings (such as IP address and subnet mask) of the computer, even when the IP addresses of the computer and the Zyxel Device are not in the same subnet.

When you disable the IPnP feature, only computers with dynamic IP addresses or static IP addresses in the same subnet as the Zyxel Device's LAN IP address can connect to the Zyxel Device or access the Internet through the Zyxel Device.

The IPnP feature does not apply to a computer using either a dynamic IP address or a static IP address that is in the same subnet as the Zyxel Device's IP address.

Note: You must enable NAT to use the IPnP feature.

The following figure depicts a scenario where a computer is set to use a static private IP address in the corporate environment. In a residential house where a Zyxel Device is installed, you can still use the computer to access the Internet without changing the network settings, even when the IP addresses of the computer and the Zyxel Device are not in the same subnet.

Figure 404 IPnP Application

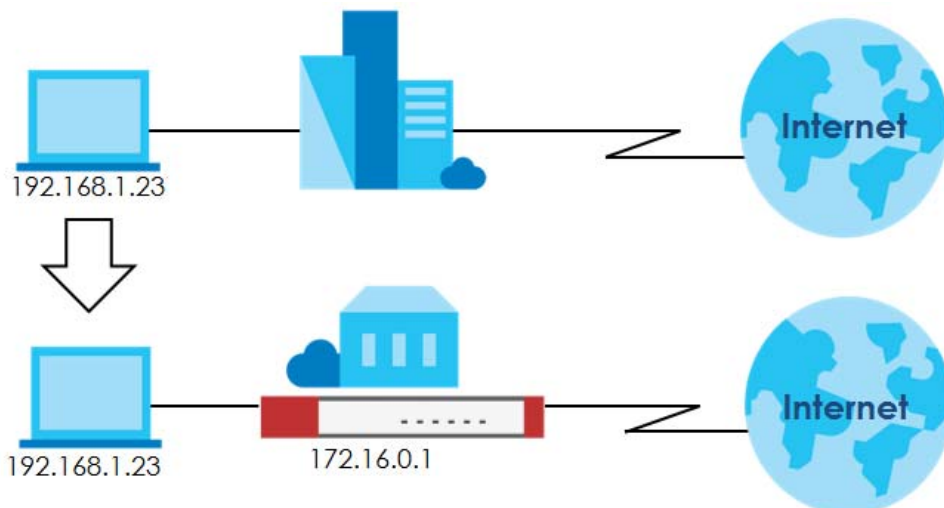

24.1.1 What You Can Do in this Chapter

Use the IP screen (Section 24.1.2 on page 585) to enable IPnP on the Zyxel Device and the internal interface(s).

24.1.2 IPnP Screen

This screen allows you to enable IPnP on the Zyxel Device and specific internal interface(s). To access this screen click **Configuration > Hotspot > IPnP**.

Figure 405 Configuration > Hotspot > IPnP

The following table describes the labels in this screen.

Table 199 Configuration > Hotspot > IPnP

LABEL	DESCRIPTION
Enable IPnP	Select this option to turn on the IPnP feature on the Zyxel Device. Note: You can enable this feature only when the security policy is enabled.
Member List	The Available list displays the name(s) of the internal interface(s) on which you can enable IPnP. To enable IPnP on an interface, you can double-click a single entry to move it or use the [Shift] or [Ctrl] key to select multiple entries and click the right arrow button to add to the Member list. To remove an interface, select the name(s) in the Member list and click the left arrow button.
Hotspot Service Status	
Service Status	This field displays whether a service license is enabled at myZyxel (Activated) or not (Not Activated) or expired (Expired). It displays the remaining Grace Period if your license has Expired . It displays Not Licensed if there isn't a license to be activated for this service. If you need a license or a trial license has expired, click Buy to buy a new one. If a Standard license has expired, click Renew to extend the license. Then, click Activate to connect with the myZyxel server to activate the new license.

Table 199 Configuration > Hotspot > IPnP (continued)

LABEL	DESCRIPTION
Service Type	This shows whether you have a trial or standard license or none (Trial, Standard, None).
Expiration Date	This shows when your hotspot license will expire.
Register Now	Click the link to go to myZykel where you can register your Zyxel Device and activate the service. This link is available only when the service is not activated yet.
Apply	Click Apply to save your changes back to the Zyxel Device.
Reset	Click Reset to return the screen to its last-saved settings.

CHAPTER 25

Walled Garden

25.1 Walled Garden Overview

A user must log in before the Zyxel Device allows the user's access to the Internet. However, with a walled garden, you can define one or more web site addresses that all users can access without logging in. These can be used for advertisements for example.

25.2 Walled Garden > General Screen

Use this screen to turn on the walled garden feature.

Note: You must enable web authentication before you can access the **Walled Garden** screens.

Note: You can configure up to 50 walled garden web site links.

Click **Configuration > Hotspot > Walled Garden** to display the screen.

Figure 406 Configuration > Hotspot > Walled Garden: General

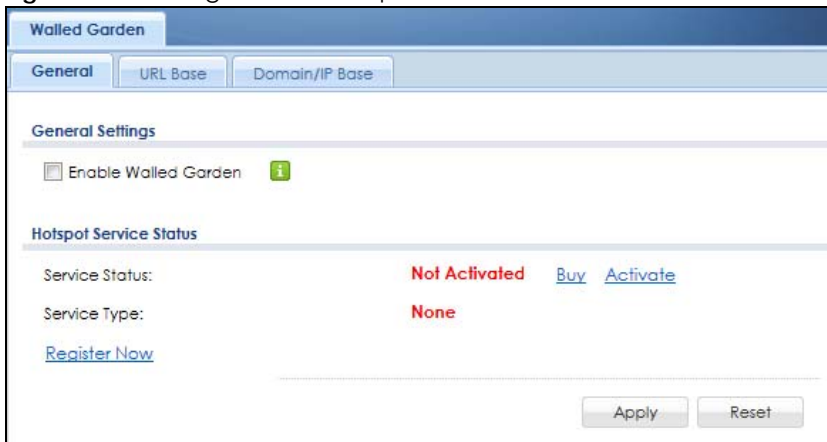

The following table describes the labels in this screen.

Table 200 Configuration > Hotspot > Walled Garden: General

LABEL	DESCRIPTION
Enable Walled Garden	Select this to turn on the walled garden feature. Note: This feature works only with the web portal authentication type.
Hotspot Service Status	

Table 200 Configuration > Hotspot > Walled Garden: General (continued)

LABEL	DESCRIPTION
Service Status	This field displays whether a service license is enabled at myZyxel (Activated) or not (Not Activated) or expired (Expired). It displays the remaining Grace Period if your license has Expired . It displays Not Licensed if there isn't a license to be activated for this service. If you need a license or a trial license has expired, click Buy to buy a new one. If a Standard license has expired, click Renew to extend the license. Then, click Activate to connect with the myZyxel server to activate the new license.
Service Type	This shows whether you have a trial or standard license or none (Trial, Standard, None).
Expiration Date	This shows when your hotspot license will expire.
Register Now	Click the link to go to myZyxel where you can register your Zyxel Device and activate the service. This link is available only when the service is not activated yet.
Apply	Click this button to save your changes to the Zyxel Device.
Reset	Click this button to return the screen to its last-saved settings.

25.3 Walled Garden > URL Base Screen

Use this screen to configure the walled garden web addresses (URLs that use the HTTP or HTTPS protocol) for web sites that all users are allowed to access without logging in. The web site link(s) displays in the user login screen by default.

Click **Configuration > Hotspot > Walled Garden** and then select the **URL Base** tab to display the screen.

Figure 407 Configuration > Hotspot > Walled Garden: URL Base

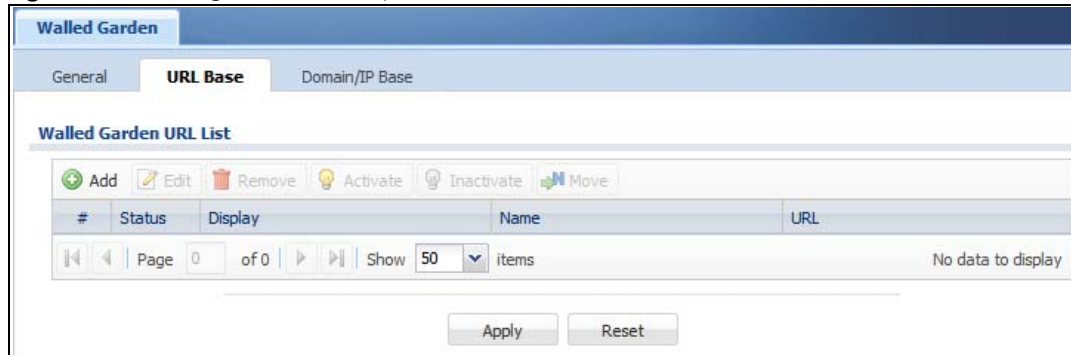

The following table describes the labels in this screen.

Table 201 Configuration > Hotspot > Walled Garden: URL Based

LABEL	DESCRIPTION
Walled Garden URL List	Use this table to manage the list of walled garden web site links.
Add	Click this to create a new entry. Select an entry and click Add to create a new entry after the selected entry.
Edit	Double-click an entry or select it and click Edit to open a screen where you can modify the entry's settings.

Table 201 Configuration > Hotspot > Walled Garden: URL Based (continued)

LABEL	DESCRIPTION
Remove	To remove an entry, select it and click Remove . The Zyxel Device confirms you want to remove it before doing so.
Activate	To turn on an entry, select it and click Activate .
Inactivate	To turn off an entry, select it and click Inactivate .
Move	To move an entry to a different number in the list, click the Move icon. In the field that appears, specify the number to which you want to move the interface.
#	This field is a sequential value, and it is not associated with any entry.
Status	This icon is lit when the entry is active and dimmed when the entry is inactive.
Display	This icon is lit when the web site link is set to display in the user login screen.
Name	This field displays the descriptive name of the web site.
URL	This field displays the URL of the web site.
Apply	Click this button to save your changes to the Zyxel Device.
Reset	Click this button to return the screen to its last-saved settings.

25.3.1 Adding/Editing a Walled Garden URL

Go to the **Configuration > Web Authentication > Walled Garden > URL Base** screen. Click **Add** or select an entry and click the **Edit** to open the **Add/Edit Walled Garden URL** screen. Use this screen to configure a walled garden web site URL entry.

Figure 408 Configuration > Hotspot > Walled Garden: URL Base: Add/Edit

The following table describes the labels in this screen.

Table 202 Configuration > Hotspot > Walled Garden: URL Base: Add/Edit

LABEL	DESCRIPTION
Enable	Select this to activate the entry.
Hide in login page	Select this to not display the web site link in the user login screen. This is helpful if a user's access to a specific web site is required to stay connected but he or she doesn't need to visit that web site.
Name	Enter a descriptive name for the walled garden link to be displayed in the login screen. You can use up to 31 alphanumeric characters (A-Z, a-z, 0-9) and underscores (_). Spaces are also allowed. The first character must be a letter.

Table 202 Configuration > Hotspot > Walled Garden: URL Base: Add/Edit (continued)

LABEL	DESCRIPTION
URL	Enter the URL of the web site. Use "http://" or "https://" followed by up to 262 characters (0-9a-zA-Z/?:@&+\$.~*()%). For example, http://www.example.com or http://172.16.1.35.
Preview	Click this button to open the specified web site in a new frame.
OK	Click OK to save your changes back to the Zyxel Device.
Cancel	Click Cancel to exit this screen without saving.

25.4 Walled Garden > Domain/IP Base Screen

Use this screen to configure walled garden web site links, which use a (wildcard) domain name or an IP address. These links will not display in the login page.

Click **Configuration > Hotspot > Walled Garden** and then select the **Domain/IP Base** tab to display the screen.

Figure 409 Configuration > Hotspot > Walled Garden: Domain/IP Base



The following table describes the labels in this screen.

Table 203 Configuration > Hotspot > Walled Garden: Domain/IP Based

LABEL	DESCRIPTION
Walled Garden Domain/IP List	Use this table to manage the list of walled garden web site links.
Add	Click this to create a new entry. Select an entry and click Add to create a new entry after the selected entry.
Edit	Double-click an entry or select it and click Edit to open a screen where you can modify the entry's settings.
Remove	To remove an entry, select it and click Remove . The Zyxel Device confirms you want to remove it before doing so.
Activate	To turn on an entry, select it and click Activate .
Inactivate	To turn off an entry, select it and click Inactivate .
#	This field is a sequential value, and it is not associated with any entry.
Status	This icon is lit when the entry is active and dimmed when the entry is inactive.
Name	This field displays the descriptive name of the web site.

Table 203 Configuration > Hotspot > Walled Garden: Domain/IP Based (continued)

LABEL	DESCRIPTION
Domain Name/IP Address	This field displays the domain name or IP address and subnet mask of the web site.
Apply	Click this button to save your changes to the Zyxel Device.
Reset	Click this button to return the screen to its last-saved settings.

25.4.1 Adding/Editing a Walled Garden Domain or IP

Go to the **Configuration > Hotspot > Walled Garden > Domain/IP Base** screen. Click **Add** or select an entry and click the **Edit** to open the **Add/Edit Walled Garden Domain/IP** screen. Use this screen to configure the domain name or IP address entry for a walled garden web site.

Figure 410 Configuration > Hotspot > Walled Garden: Domain/IP Base: Add/Edit

The following table describes the labels in this screen.

Table 204 Configuration > Hotspot > Walled Garden: Domain/IP Base: Add/Edit

LABEL	DESCRIPTION
Enable	Select this to activate the entry.
Name	Enter a descriptive name for the walled garden link. You can use up to 31 alphanumeric characters (A-Z, a-z, 0-9) and underscores (_). Spaces are also allowed. The first character must be a letter.
Type	Select whether you want to create the link by entering a domain name or an IP address.
Domain Name / IP Address	If you select Domain , type a Fully-Qualified Domain Name (FQDN) of a web site. An FQDN starts with a host name and continues all the way up to the top-level domain name. For example, www.zyxel.com.tw is a fully qualified domain name, where "www" is the host, "zyxel" is the third-level domain, "com" is the second-level domain, and "tw" is the top level domain. Underscores are not allowed. Use "*" as a prefix in the FQDN for a wildcard domain name (for example, *.example.com). If you select IP , enter the IP address and subnet mask of the web site.
OK	Click OK to save your changes back to the Zyxel Device.
Cancel	Click Cancel to exit this screen without saving.

25.4.2 Walled Garden Login Example

The following figure shows the user login screen with two walled garden links. The links are named **WalledGardenLink1** through **2** for demonstration purposes.

Figure 411 Walled Garden Login Example

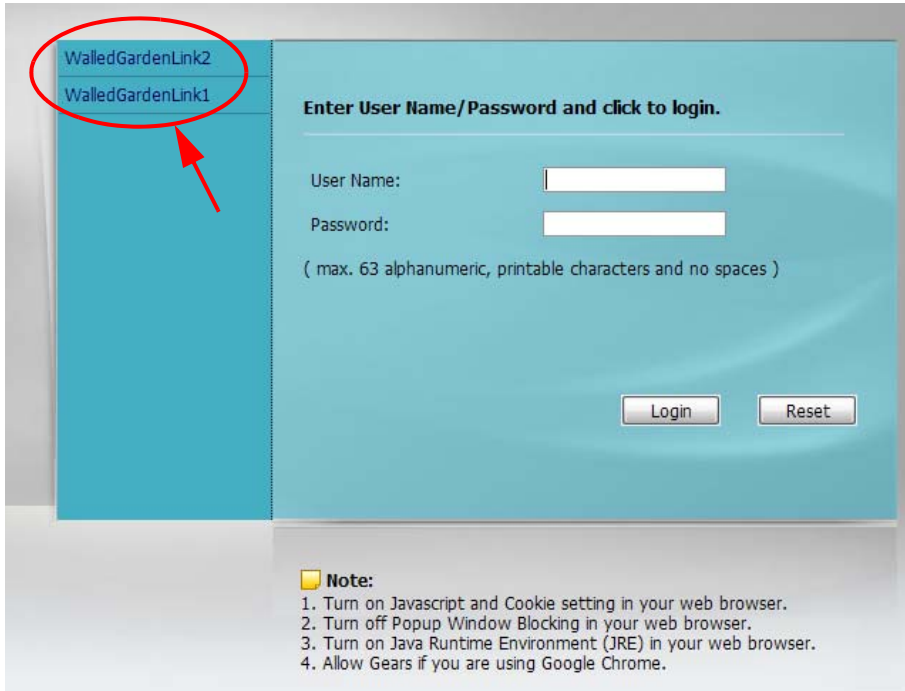

CHAPTER 26

Advertisement Screen

26.1 Advertisement Overview

Use this screen to set the Zyxel Device to display an advertisement web page as the first web page whenever the user connects to the Internet.

Click **Configuration > Hotspot > Advertisement** to display the screen.

Figure 412 Configuration > Hotspot > Advertisement

The following table gives an overview of the objects you can configure.

Table 205 Configuration > Hotspot > Advertisement

LABEL	DESCRIPTION
Enable Advertisement	Select this to turn on the advertisement feature. Note: This feature works only when you enable web authentication.
Advertisement Summary	Use this table to manage the list of advertisement web pages.
Add	Click this to create a new entry. Select an entry and click Add to create a new entry after the selected entry.
Edit	Double-click an entry or select it and click Edit to open a screen where you can modify the entry's settings.
Remove	To remove an entry, select it and click Remove . The Zyxel Device confirms you want to remove it before doing so.
#	This field is a sequential value, and it is not associated with any entry.

Table 205 Configuration > Hotspot > Advertisement (continued)

LABEL	DESCRIPTION
Name	This field displays the descriptive name of web site.
URL	This field displays the address of web site.
Hotspot Service Status	
Service Status	This field displays whether a service license is enabled at myZyxel (Activated) or not (Not Activated) or expired (Expired). It displays the remaining Grace Period if your license has Expired . It displays Not Licensed if there isn't a license to be activated for this service. If you need a license or a trial license has expired, click Buy to buy a new one. If a Standard license has expired, click Renew to extend the license. Then, click Activate to connect with the myZyxel server to activate the new license.
Service Type	This shows whether you have a trial or standard license or none (Trial, Standard, None).
Expiration Date	This shows when your hotspot license will expire.
Register Now	Click the link to go to myZyxel where you can register your Zyxel Device and activate the service. This link is available only when the service is not activated yet.
Apply	Click this button to save your changes to the Zyxel Device.
Reset	Click this button to return the screen to its last-saved settings.

26.1.1 Adding/Editing an Advertisement URL

Click **Configuration > Hotspot > Advertisement** and then the **Add** (or **Edit**) icon in the **Advertisement Summary** section to open the **Add/Edit Advertisement URL** screen. Use this screen to configure an advertisement address entry.

Note: You can create up to 20 advertisement URL entries. The Zyxel Device randomly picks one and open the specified web site in a new frame when an authenticated user is attempts to access the Internet.

Figure 413 Configuration > Hotspot > Advertisement > Add/Edit

The following table gives an overview of the objects you can configure.

Table 206 Configuration > Hotspot > Advertisement > Add/Edit

LABEL	DESCRIPTION
Name	Enter a descriptive name for the advertisement web site. You can use up to 31 alphanumeric characters (A-Z, a-z, 0-9) and underscores (_). Spaces are not allowed. The first character must be a letter.
URL	Enter the URL or IP address of the web site. Use "http://" followed by up to 262 characters (0-9a-zA-Z;/?:@&=+\$\._!~*()%). For example, http://www.example.com or http://172.16.1.35.
Preview	Click this button to open the specified web site in a new frame.
OK	Click OK to save your changes back to the Zyxel Device.
Cancel	Click Cancel to exit this screen without saving.

CHAPTER 27

Security Policy

27.1 Overview

A security policy is a template of security settings that can be applied to specific traffic at specific times. The policy can be applied:

- to a specific direction of travel of packets (from / to)
- to a specific source and destination address objects
- to a specific type of traffic (services)
- to a specific user or group of users
- at a specific schedule

The policy can be configured:

- to allow or deny traffic that matches the criteria above
- send a log or alert for traffic that matches the criteria above
- to apply the actions configured in the UTM profiles (application patrol, content filter, IDP, anti-virus, anti-spam) to traffic that matches the criteria above

Note: Security policies can be applied to both IPv4 and IPv6 traffic.

The security policies can also limit the number of user sessions.

The following example shows the Zyxel Device's default security policies behavior for a specific direction of travel of packets. WAN to LAN traffic and how stateful inspection works. A LAN user can initiate a Telnet session from within the LAN zone and the Zyxel Device allows the response. However, the Zyxel Device blocks incoming Telnet traffic initiated from the WAN zone and destined for the LAN zone.

Figure 414 Default Directional Security Policy Example

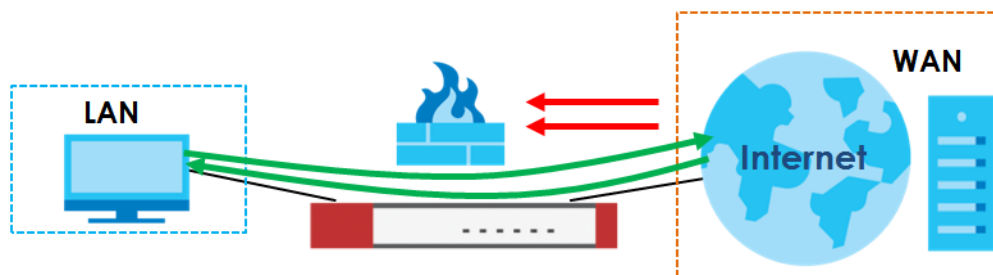

27.2 One Security

OneSecurity is a website with guidance on configuration walkthroughs, troubleshooting, and other information. This is an example of a port forwarding configuration walkthrough.

Figure 415 Example of a Port Forwarding Configuration Walkthrough.

The figure displays four sequential screenshots of a port forwarding configuration wizard:

- Screenshot 1:** Titled "Welcome to the Port Forwarding Wizard". It contains a dropdown menu labeled "Select Wizard Type" with "Port Forwarding" selected. Below the menu is explanatory text about port forwarding. Navigation buttons "← Prev" and "Next →" are at the bottom.
- Screenshot 2:** Also titled "Welcome to the Port Forwarding Wizard". It asks for "Step 1" information: "What is the port # that you need to forward?" and "What is the IP address that you need to forward to?". Each question has a corresponding text input field. Navigation buttons "← Prev" and "Next →" are at the bottom.
- Screenshot 3:** Titled "Step 2". It asks for object names: "What do you want to call the Port Forward Object?" and "What do you want to call the Address Object?". Each question has a text input field. Navigation buttons "← Prev" and "Next →" are at the bottom.
- Screenshot 4:** Titled "Finish Wizard". It displays a summary of the configuration:

Port:	8080
Port Name:	web
Forwarding Address:	1.1.1.1
Forwarding Address Name:	addr

 Navigation buttons "← Prev" and "Next →" are at the bottom.

This is an example of L2TP over IPSec VPN Troubleshooting troubleshooting.

Figure 416 Example of L2TP over IPSec Troubleshooting – 1

L2TP over IPSec VPN Troubleshooting

Is the VPN established?

Yes ¹
 No - I receive an error ²
 My connection is intermittent ³

No Connection 2

Common Configuration Issues

- Verify that the USG has default settings for the Default_L2TP_VPN rules in the IPSec VPN menu
- VPN Gateway, ensure your settings match below. You will also need to click the Show Advanced Settings option at the top;

Phase 1 Settings

SA Life Time: 86400 (180 - 3000000 Seconds)

Negotiation Mode: Main

#	Encryption	Authentication
1	3DES	SHA1
2	3DES	MD5
3	DES	SHA1

Key Group: DH2

NAT Traversal
 Dead Peer Detection (DPD)

Please note that you will not be able to establish the L2TP connection if your WAN connection is assigned a private IP. You must have a public IP address assigned directly to the WAN port.

- VPN Connection, ensure your settings match below. You will also need to click the Show Advanced Settings option at the top;

Phase 2 Setting

SA Life Time: 86400 (180 - 3000000 Seconds)

Active Protocol: ESP

Encapsulation: Transport

#	Encryption	Authentication
1	3DES	SHA1
2	3DES	MD5
3	DES	SHA1

Perfect Forward Secrecy (PFS): None

You will need to create an address object for your WAN (outside/public) IP, and select this object for the Local Policy;

Create Address

Name: WAN-IP

Address Type: HOST

IP Address: 216.237.21.243

 - Alternatively you can SSH into the USG and issue a series of commands to default the L2TP Settings;

Create Address

Name: WAN-IP

Address Type: HOST

IP Address: 216.237.21.243

Once you have the session established you will need to enter `configure terminal` and press enter. Then type the command `ipsec-over-https recover default-ipsec-policy` to default the rules.

 - Verify the firewall is setup properly to allow traffic from IPSec zone to all(any).

Logs To Look For

 - L2TP Connected
 - L2TP Disconnected
 - Incorrect username/password
 - No proposal chose
 - Phase 1 proposal mismatch
 - Incorrect PSK

Go Back To Start

Figure 417 Example of L2TP over IPSec Troubleshooting – 2

3

Intermittent Connection

- ISP Issues:
 - In some cases your ISP may be blocking specific ports necessary to establish and maintain the VPN connection.
 - An easy way to verify this would be to initiate the connection to the USG, if nothing displays in the logs it is likely that certain ports are being blocked even before they reach the USG.
 - Services Necessary:
 - IKE
 - GRE
 - AH
 - NATT
- Slow Speeds:
 - There are several factors that influence the overall bandwidth of the VPN tunnel.
 - Additional delays can be caused by the encryption and decryption process, especially with internet traffic.
 - The network speeds of the L2TP client.
- Remote Network Issues
 - In certain cases we may need to check the settings of the remote router or gateway.
 - If available, we want to ensure that any IPSec or L2TP pass-through is enabled.
 - We may need to forward ports to the L2TP client to ensure a stable connection.
 - Services Necessary
 - L2TP
 - GRE
- Logs to Look For:
 - L2TP Connect/Disconnect
 - No tunnel found errors

Go Back To Start

In the Zyxel Device, you will see icons that link to OneSecurity walkthroughs, troubleshooting and so on in certain screens.

For example, at the time of writing, these are the OneSecurity icons you can see.

Table 207 OneSecurity Icons











ONESECURITY ICON	SCREEN
	<p>Click this icon to go to a series of screens that guide you how to configure the feature. Note that the walkthroughs do not perform the actual configuring, but just show you how to do it.</p> <ul style="list-style-type: none"> • Device HA > General • Licensing > Registration • Network > NAT • Network > Routing > Policy Route • UTM Profile > App Patrol • UTM Profile > Content Filter • UTM Profile > IDP • UTM Profile > Anti-Virus • UTM Profile > Anti-Spam • VPN > IPSec VPN • VPN > SSL VPN • VPN > L2TP VPN
	<p>Click this icon to go to a series of screens that guide you how to fix problems with the feature.</p> <ul style="list-style-type: none"> • Device HA > General • Network > NAT • Network > Routing > Policy Route • UTM Profile > App Patrol • UTM Profile > Content Filter • UTM Profile > IDP • UTM Profile > Anti-Virus • UTM Profile > Anti-Spam • VPN > IPSec VPN • VPN > SSL VPN • VPN > L2TP VPN

Table 207 OneSecurity Icons (continued)

ONESECURITY ICON	SCREEN
 Application Patrol	Click this icon for more information on Application Patrol, which identifies traffic that passes through the Zyxel Device, so you can decide what to do with specific types of traffic. Traffic not recognized by application patrol is ignored. <ul style="list-style-type: none"> UTM Profile > Application Patrol
 Content Filter	Click this icon for more information on Content Filter, which controls access to specific web sites or web content. <ul style="list-style-type: none"> UTM Profile > Content Filter
 Intrusion Detection	Click this icon for more information on Intrusion Detection which can detect malicious or suspicious packets used in network-based intrusions. <ul style="list-style-type: none"> UTM Profile > IDP
 Anti-Virus	Click this icon for more information on Anti-Virus, which checks traffic flows through your network for known virus and spyware signature patterns. <ul style="list-style-type: none"> UTM Profile > Anti-Virus
 Anti-Spam	Click this icon for more information on Anti-Spam which can mark or discard spam (unsolicited commercial or junk email) and email from certain servers suspect of being used by spammers. <ul style="list-style-type: none"> UTM Profile > Anti-Spam
 VPN	Click this icon for more information on IPSec and SSL VPN. Internet Protocol Security (IPSec) VPN connects IPSec routers or remote users using IPSec client software. SSL VPN allows users to use a web browser for secure remote user login without need of a VPN router or VPN client software. <ul style="list-style-type: none"> VPN > IPSec VPN VPN > SSL VPN
 Download VPN Client	Click this icon to download VPN client software. <ul style="list-style-type: none"> VPN > IPSec VPN VPN > SSL VPN
 Wireless AP Controller	Click this icon for more information on the Wireless AP Controller which sets how the Zyxel Device allows APs to connect to the wireless network. <ul style="list-style-type: none"> Wireless > AP Management > Mgnt. AP List

27.3 What You Can Do in this Chapter

- Use the **Security Policy Control** screens ([Section 27.4 on page 602](#)) to enable or disable policies, asymmetrical routes, and manage and configure policies.
- Use the **Anomaly Detection and Prevention (ADP)** screens ([Section 27.5 on page 610](#)) to detect traffic with protocol anomalies and take appropriate action.
- Use the **Session Control** screens (see [Section 27.5 on page 610](#)) to limit the number of concurrent NAT/security policies traffic sessions a client can use.

27.3.1 What You Need to Know

Stateful Inspection

The Zyxel Device uses stateful inspection in its security policies. The Zyxel Device restricts access by screening data packets against defined access rules. It also inspects sessions. For example, traffic from one zone is not allowed unless it is initiated by a computer in another zone first.

Zones

A zone is a group of interfaces. Group the Zyxel Device's interfaces into different zones based on your needs. You can configure security policies for data passing between zones or even between interfaces.

Default Directional Security Policy Behavior

Security Policies can be grouped based on the direction of travel of packets to which they apply. Here is the The Zyxel Device has default Security Policy behavior for traffic going through the Zyxel Device in various directions.

Table 208 Directional Security Policy Behavior

FROM ZONE TO ZONE	BEHAVIOR
From any to Device	DHCP traffic from any interface to the Zyxel Device is allowed.
From LAN1 to any (other than the Zyxel Device)	Traffic from the LAN1 to any of the networks connected to the Zyxel Device is allowed.
From LAN2 to any (other than the Zyxel Device)	Traffic from the LAN2 to any of the networks connected to the Zyxel Device is allowed.
From LAN1 to Device	Traffic from the LAN1 to the Zyxel Device itself is allowed.
From LAN2 to Device	Traffic from the LAN2 to the Zyxel Device itself is allowed.
From WAN to Device	The default services listed in To-Device Policies are allowed from the WAN to the Zyxel Device itself. All other WAN to Zyxel Device traffic is dropped.
From any to any	Traffic that does not match any Security policy is dropped. This includes traffic from the WAN to any of the networks behind the Zyxel Device. This also includes traffic to or from interfaces that are not assigned to a zone (extra-zone traffic).

To-Device Policies

Policies with **Device** as the **To Zone** apply to traffic going to the Zyxel Device itself. By default:

- The Security Policy allows only LAN, or WAN computers to access or manage the Zyxel Device.
- The Zyxel Device allows DHCP traffic from any interface to the Zyxel Device.
- The Zyxel Device drops most packets from the WAN zone to the Zyxel Device itself and generates a log except for AH, ESP, GRE, HTTPS, IKE, NATT.

When you configure a Security Policy rule for packets destined for the Zyxel Device itself, make sure it does not conflict with your service control rule. The Zyxel Device checks the security policy before the service control rules for traffic destined for the Zyxel Device.

A **From Any To Device** direction policy applies to traffic from an interface which is not in a zone.

Global Security Policies

Security Policies with **from any** and/or **to any** as the packet direction are called global Security Policies. The global Security Policies are the only Security Policies that apply to an interface that is not included in a zone. The **from any** policies apply to traffic coming from the interface and the **to any** policies apply to traffic going to the interface.

Security Policy Rule Criteria

The Zyxel Device checks the schedule, user name (user's login name on the Zyxel Device), source IP address and object, destination IP address and object, IP protocol type of network traffic (service) and UTM profile criteria against the Security Policies (in the order you list them). When the traffic matches a policy, the Zyxel Device takes the action specified in the policy.

User Specific Security Policies

You can specify users or user groups in Security Policies. For example, to allow a specific user from any computer to access a zone by logging in to the Zyxel Device, you can set up a policy based on the user name only. If you also apply a schedule to the Security Policy, the user can only access the network at the scheduled time. A user-aware Security Policy is activated whenever the user logs in to the Zyxel Device and will be disabled after the user logs out of the Zyxel Device.

Session Limits

Accessing the Zyxel Device or network resources through the Zyxel Device requires a NAT session and corresponding Security Policy session. Peer to peer applications, such as file sharing applications, may use a large number of NAT sessions. A single client could use all of the available NAT sessions and prevent others from connecting to or through the Zyxel Device. The Zyxel Device lets you limit the number of concurrent NAT/Security Policy sessions a client can use.

27.4 Security Policy Screen

Asymmetrical Routes

If an alternate gateway on the LAN has an IP address in the same subnet as the Zyxel Device's LAN IP address, return traffic may not go through the Zyxel Device. This is called an asymmetrical or "triangle" route. This causes the Zyxel Device to reset the connection, as the connection has not been acknowledged.

You can have the Zyxel Device permit the use of asymmetrical route topology on the network (not reset the connection). However, allowing asymmetrical routes may let traffic from the WAN go directly to the LAN without passing through the Zyxel Device. A better solution is to use virtual interfaces to put the Zyxel Device and the backup gateway on separate subnets. Virtual interfaces allow you to partition your network into logical sections over the same interface. See the chapter about interfaces for more information.

By putting LAN 1 and the alternate gateway (**A** in the figure) in different subnets, all returning network traffic must pass through the Zyxel Device to the LAN. The following steps and figure describe such a scenario.

- 1 A computer on the LAN1 initiates a connection by sending a SYN packet to a receiving server on the WAN.
- 2 The Zyxel Device reroutes the packet to gateway **A**, which is in **Subnet 2**.
- 3 The reply from the WAN goes to the Zyxel Device.
- 4 The Zyxel Device then sends it to the computer on the LAN1 in **Subnet 1**.

Figure 418 Using Virtual Interfaces to Avoid Asymmetrical Routes

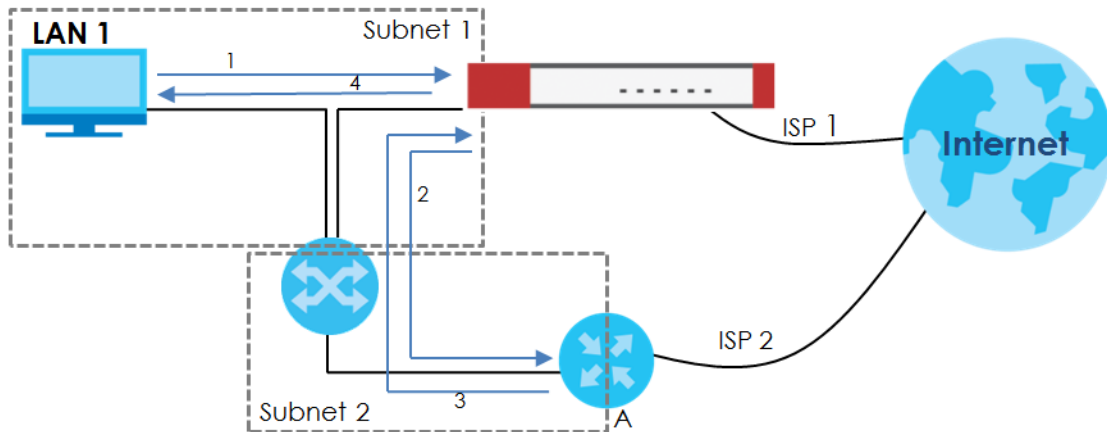

27.4.1 Configuring the Security Policy Control Screen

Click **Configuration > Security Policy > Policy Control** to open the **Security Policy** screen. Use this screen to enable or disable the Security Policy and asymmetrical routes, set a maximum number of sessions per host, and display the configured Security Policies. Specify from which zone packets come and to which zone packets travel to display only the policies specific to the selected direction. Note the following.

- Besides configuring the Security Policy, you also need to configure NAT rules to allow computers on the WAN to access LAN devices.
- The Zyxel Device applies NAT (Destination NAT) settings before applying the Security Policies. So for example, if you configure a NAT entry that sends WAN traffic to a LAN IP address, when you configure a corresponding Security Policy to allow the traffic, you need to set the LAN IP address as the destination.
- The ordering of your policies is very important as policies are applied in sequence.

The following screen shows the Security Policy summary screen.

Figure 419 Configuration > Security Policy > Policy Control

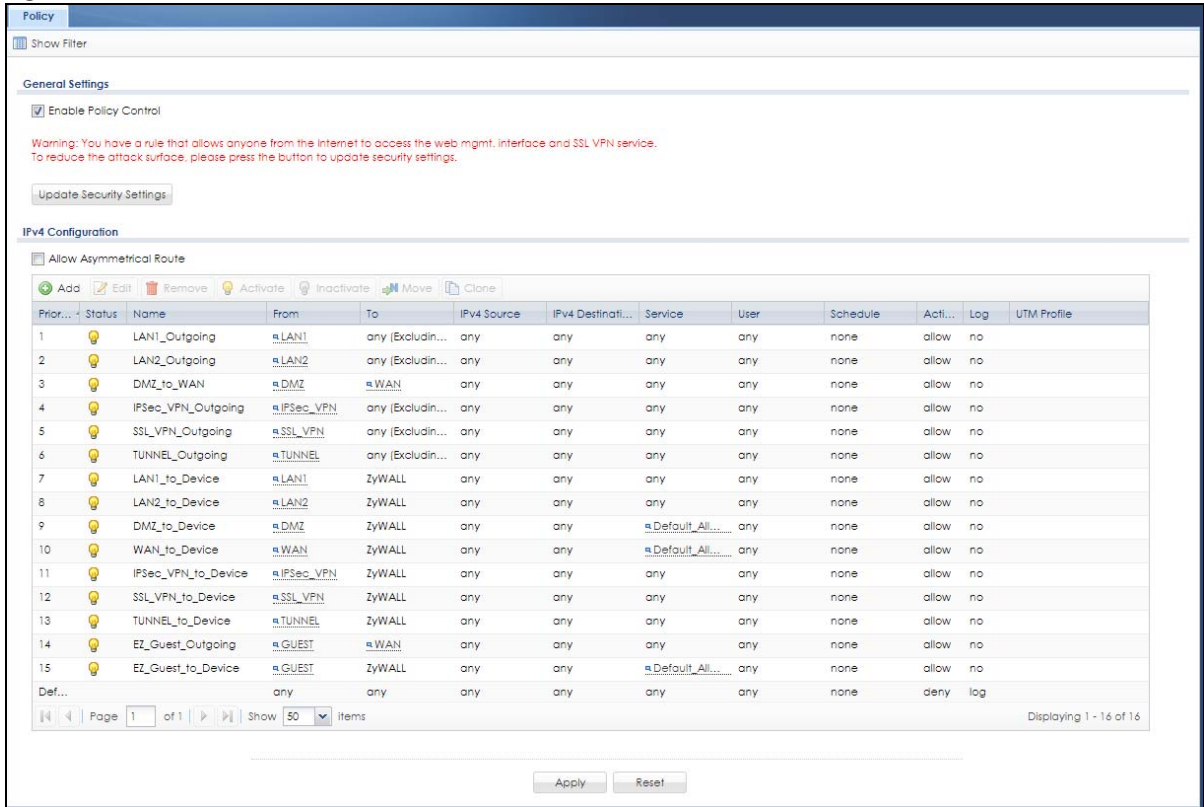

The following table describes the labels in this screen.

Table 209 Configuration > Security Policy > Policy Control

LABEL	DESCRIPTION
Show Filter/Hide Filter	Click Show Filter to display IPv4 and IPv6 (if enabled) security policy search filters.
General Settings	Enable or disable the Security Policy feature on the Zyxel Device.
Enable Policy Control	Select this to activate Security Policy on the Zyxel Device to perform access control.
Update Security Settings	You have a WAN_to_Device rule that allows traffic such as HTTP, HTTPS, SSL and so on to access to your Zyxel Device from any IPv4 source on the WAN. Click this button to secure WAN_to_Device traffic. See Section 1.5.2 on page 39 for more information.
IPv4 / IPv6 Configuration	Use IPv4 / IPv6 search filters to find specific IPv4 and IPv6 (if enabled) security policies based on direction, application, user, source, destination and/or schedule.
From / To	Select a zone to view all security policies from a particular zone and/or to a particular zone. any means all zones.
IPv4 / IPv6 Source	Type an IPv4 or IPv6 IP address to view all security policies based on the IPv4 / IPv6 source address object used. <ul style="list-style-type: none"> An IPv4 IP address is written as four integer blocks separated by periods. This is an example IPv4 address: 172.16.6.7. An 128-bit IPv6 address is written as eight 16-bit hexadecimal blocks separated by colons (:). This is an example IPv6 address: 2001:0db8:1a2b:0015:0000:0000:1a2f:0000.

Table 209 Configuration > Security Policy > Policy Control (continued)

LABEL	DESCRIPTION
IPv4 / IPv6 Destination	<p>Type an IPv4 or IPv6 IP address to view all security policies based on the IPv4 / IPv6 destination address object used.</p> <ul style="list-style-type: none"> An IPv4 IP address is written as four integer blocks separated by periods. This is an example IPv4 address: 172.16.6.7. An 128-bit IPv6 address is written as eight 16-bit hexadecimal blocks separated by colons (:). This is an example IPv6 address: 2001:0db8:1a2b:0015:0000:0000:1a2f:0000.
Service	View all security policies based the service object used.
User	View all security policies based on user or user group object used.
Schedule	View all security policies based on the schedule object used.
IPv4/IPv6 Policy Management	Use the following items to manage IPv4 and IPv6 policies.
Allow Asymmetrical Route	<p>If an alternate gateway on the LAN has an IP address in the same subnet as the Zyxel Device's LAN IP address, return traffic may not go through the Zyxel Device. This is called an asymmetrical or "triangle" route. This causes the Zyxel Device to reset the connection, as the connection has not been acknowledged.</p> <p>Select this check box to have the Zyxel Device permit the use of asymmetrical route topology on the network (not reset the connection).</p> <p>Note: Allowing asymmetrical routes may let traffic from the WAN go directly to the LAN without passing through the Zyxel Device. A better solution is to use virtual interfaces to put the Zyxel Device and the backup gateway on separate subnets.</p>
Add	Click this to create a new entry. Select an entry and click Add to create a new entry after the selected entry.
Edit	Double-click an entry or select it and click Edit to open a screen where you can modify the entry's settings.
Remove	To remove an entry, select it and click Remove . The Zyxel Device confirms you want to remove it before doing so.
Activate	To turn on an entry, select it and click Activate .
Inactivate	To turn off an entry, select it and click Inactivate .
Move	<p>To change a policy's position in the numbered list, select the policy and click Move to display a field to type a number for where you want to put that policy and press [ENTER] to move the policy to the number that you typed.</p> <p>The ordering of your policies is important as they are applied in order of their numbering.</p>
Clone	<p>Use Clone to create a new entry by modifying an existing one.</p> <ul style="list-style-type: none"> Select an existing entry. Click Clone, type a number where the new entry should go and then press [ENTER]. A configuration copy of the selected entry pops up. You must at least change the name as duplicate entry names are not allowed.
The following read-only fields summarize the policies you have created that apply to traffic traveling in the selected packet direction.	
Priority	This is the position of your Security Policy in the global policy list (including all through-Zyxel Device and to-Zyxel Device policies). The ordering of your policies is important as policies are applied in sequence. Default displays for the default Security Policy behavior that the Zyxel Device performs on traffic that does not match any other Security Policy.
Status	This icon is lit when the entry is active and dimmed when the entry is inactive.
Name	This is the name of the Security policy.

Table 209 Configuration > Security Policy > Policy Control (continued)

LABEL	DESCRIPTION
From / To	<p>This is the direction of travel of packets. Select from which zone the packets come and to which zone they go.</p> <p>Security Policies are grouped based on the direction of travel of packets to which they apply. For example, from LAN to LAN means packets traveling from a computer or subnet on the LAN to either another computer or subnet on the LAN.</p> <p>From any displays all the Security Policies for traffic going to the selected To Zone.</p> <p>To any displays all the Security Policies for traffic coming from the selected From Zone.</p> <p>From any to any displays all of the Security Policies.</p> <p>To ZyWALL policies are for traffic that is destined for the Zyxel Device and control which computers can manage the Zyxel Device.</p>
IPv4 / IPv6 Source	This displays the IPv4 / IPv6 source address object, including geographic address and FQDN (group) objects, to which this Security Policy applies.
IPv4 / IPv6 Destination	This displays the IPv4 / IPv6 destination address object, including geographic address and FQDN (group) objects, to which this Security Policy applies.
Service	This displays the service object to which this Security Policy applies.
User	This is the user name or user group name to which this Security Policy applies.
Schedule	This field tells you the schedule object that the policy uses. none means the policy is active at all times if enabled.
Action	This field displays whether the Security Policy silently discards packets without notification (deny), permits the passage of packets (allow) or drops packets with notification (reject)
Log	Select whether to have the Zyxel Device generate a log (log), log and alert (log alert) or not (no) when the policy is matched to the criteria listed above.
Profile	This field shows you which Security Service profiles (application patrol, content filter, IDP, anti-malware, email security) apply to this Security policy. Click an applied Security Service profile icon to edit the profile directly.
Apply	Click Apply to save your changes back to the Zyxel Device.
Reset	Click Reset to return the screen to its last-saved settings.

27.4.2 Security Check for Web Interface Screen

Click the **Update Security Settings** button to show the following screen. Use this screen to configure settings to secure your Zyxel Device. You can configure:

- Secure SSL access from the Internet to the Zyxel Device.
- Secure SSL access from the Internet to the network behind the Zyxel Device.
- The default port that IPSec VPN clients use to retrieve VPN rule settings from the Zyxel Device.
- The default port for two-factor authentication for VPN clients to access the network behind the Zyxel Device.

See [Section 1.5.2 on page 39](#) for more information.

Figure 420 Configuration > Security Policy > Policy Control > Update Security Settings > Security Check for Web Interface

The following table describes the labels in this screen.

Table 210 Configuration > Security Policy > Policy Control > Update Security Settings > Security Check for Web Interface

LABEL	DESCRIPTION
Allow secure remote management from WAN	Select this to allow access to the Zyxel Device remotely only from specified IP addresses or Fully Qualified Domain Names (FQDNs), such as 1.1.1.1 or www.zyxel.com. See Section 1.5.2.1 on page 39 for more information.
Port	Configure a new port between 1024 to 65535 to use it to access the Web Configurator. Do not use a port number that has been used. For example, use https://1.1.1.1:8800 if you changed the default HTTPS port to 8800.
Trusted Host 1-3	Configure the IP addresses or FQDNs that are allowed to access the Zyxel Device.
Allow SSL VPN access from WAN	Select this to allow SSL VPN clients to access the Zyxel Device only from specified regions. See Section 1.5.2.2 on page 39 for more information.
Port	Configure a new port between 1024 to 65535 to use it to access the Web Configurator using SSL VPN. Do not use a port number that has been used. The port you configure here must be the same as the port you use in SecuExtender. See Section 1.5.2.2 on page 39 for more information on SecuExtender.
Trusted Geolocation 1-3	Select the regions that are allowed to access the Zyxel Device from the drop-down list box.

Table 210 Configuration > Security Policy > Policy Control > Update Security Settings > Security Check for Web Interface (continued)

LABEL	DESCRIPTION
Change Two-Factor Authentication Port	<p>Select this to change the port VPN clients use to access the Zyxel Device LAN with two-factor authentication. See Section 1.5.2.4 on page 40 for more information.</p> <p>Configure a new port between 1024 to 65535. Do not use a port number that has been used.</p>
Change Zyxel IPSec VPN Client Provisioning Port	<p>Select this to change the port IPSec VPN clients use to retrieve VPN rule settings from the Zyxel Device. See Section 1.5.2.3 on page 40 for more information.</p> <p>Configure a new port between 1024 to 65535. Do not use a port number that has been used.</p> <p>The port you configure here must be the same as the port you use when logging in as a Zyxel IPSec VPN client.</p>
Please remind me	Select how often to display the screen from the drop-down list box.
OK	Click OK to save your changes back to the Zyxel Device.
Cancel	Click Cancel to exit this screen without saving your changes.

27.4.3 Security Policy Control Add/Edit Screen

In the **Security Policy Control** screen, click the **Edit** or **Add** icon to display the **Security Policy Edit or Add** screen.

Figure 421 Configuration > Security Policy > Policy Control > Add

The screenshot shows the 'Add Secure Policy' configuration window. It includes the following fields and options:

- Enable:** Checked checkbox.
- Name:** Text input field with a red error icon.
- Description:** Text input field with '(Optional)' label.
- From:** Dropdown menu set to 'any'.
- To:** Dropdown menu set to 'any (Excluding ZyWALL)'.
- Source:** Dropdown menu set to 'any'.
- Destination:** Dropdown menu set to 'any'.
- Service:** Dropdown menu set to 'any'.
- User:** Dropdown menu set to 'any'.
- Schedule:** Dropdown menu set to 'none'.
- Action:** Dropdown menu set to 'allow'.
- Log matched traffic:** Dropdown menu set to 'no'.
- Secure Profiles:**
 - Application Patrol: none, Log: no
 - Content Filter: none, Log: no
 - IDP: none, Log: no
 - Anti-Virus: none, Log: no
 - Anti-Spam: none, Log: no
 - SSL Inspection: none, Log: no

The following table describes the labels in this screen.

Table 211 Configuration > Security Policy > Policy Control > Add

LABEL	DESCRIPTION
Create new Object	Use to configure any new settings objects that you need to use in this screen.
Enable	Select this check box to activate the Security policy.
Name	Enter a name to identify the policy.
Description	Enter a descriptive name of up to 60 printable ASCII characters for the Policy. Spaces are allowed.
From To	For through-Zykel Device policies, select the direction of travel of packets to which the policy applies. any means all interfaces. Device means packets destined for the Zykel Device itself.
Source	Select an IPv4 / IPv6 address or address group object, including geographic address and FQDN (group) objects, to apply the policy to traffic coming from it. Select any to apply the policy to all traffic coming from IPv4 / IPv6 addresses.
Destination	Select an IPv4 / IPv6 address or address group, including geographic address and FQDN (group) objects, to apply the policy to traffic going to it. Select any to apply the policy to all traffic going to IPv4 / IPv6 addresses.
Service	Select a service or service group from the drop-down list box.

Table 211 Configuration > Security Policy > Policy Control > Add (continued)

LABEL	DESCRIPTION
User	<p>This field is not available when you are configuring a to-Zyxel Device policy.</p> <p>Select a user name or user group to which to apply the policy. The Security Policy is activated only when the specified user logs into the system and the policy will be disabled when the user logs out.</p> <p>Otherwise, select any and there is no need for user logging.</p> <p>Note: If you specified a source IP address (group) instead of any in the field below, the user's IP address should be within the IP address range.</p>
Schedule	Select a schedule that defines when the policy applies. Otherwise, select none and the policy is always effective.
Action	<p>Use the drop-down list box to select what the Security Policy is to do with packets that match this policy.</p> <p>Select deny to silently discard the packets without sending a TCP reset packet or an ICMP destination-unreachable message to the sender.</p> <p>Select reject to discard the packets and send a TCP reset packet or an ICMP destination-unreachable message to the sender.</p> <p>Select allow to permit the passage of the packets.</p>
Log matched traffic	Select whether to have the Zyxel Device generate a log (log), log and alert (log alert) or not (no) when the policy is matched to the criteria listed above..
UTM Profile	<p>Use this section to apply anti- x profiles (created in the Configuration > UTM Profile screens) to traffic that matches the criteria above. You must have created a profile first; otherwise none displays.</p> <p>Use Log to generate a log (log), log and alert (log alert) or not (no) for all traffic that matches criteria in the profile.</p>
Application Patrol	Select an Application Patrol profile from the list box; none displays if no profiles have been created in the Configuration > UTM Profile > App Patrol screen.
Content Filter	Select a Content Filter profile from the list box; none displays if no profiles have been created in the Configuration > UTM Profile > Content Filter screen.
IDP	Select an IDP profile from the list box; none displays if no profiles have been created in the Configuration > UTM Profile > IDP screen.
Anti-Virus	Select an Anti-Virus profile from the list box; none displays if no profiles have been created in the Configuration > UTM Profile > Anti-Virus screen.
Anti-Spam	Select an Anti-Spam profile from the list box; none displays if no profiles have been created in the Configuration > UTM Profile > Anti-Spam screen.
SSL Inspection	Select an SSL Inspection profile from the list box; none displays if no profiles have been created in the Configuration > UTM Profile > SSL Inspection screen.
OK	Click OK to save your customized settings and exit this screen.
Cancel	Click Cancel to exit this screen without saving.

27.5 Anomaly Detection and Prevention Overview

Anomaly Detection and Prevention (ADP) protects against anomalies based on violations of protocol standards (RFCs – Requests for Comments) and abnormal flows such as port scans. This section introduces ADP, anomaly profiles and applying an ADP profile to a traffic direction.

Traffic Anomalies

Traffic anomaly policies look for abnormal behavior or events such as port scanning, sweeping or network flooding. They operate at OSI layer-2 and layer-3. Traffic anomaly policies may be updated when you upload new firmware.

Protocol Anomalies

Protocol anomalies are packets that do not comply with the relevant RFC (Request For Comments). Protocol anomaly detection includes:

- TCP Decoder
- UDP Decoder
- ICMP Decoder

Protocol anomaly policies may be updated when you upload new firmware.

Note: First, create an ADP profile in the In the **Configuration > Security Policy > ADP > Profile** screen.

Then, apply the profile to traffic originating from a specific zone in the **Configuration > Security Policy > ADP > General** screen.

27.5.1 Anomaly Detection and Prevention General Screen

Click **Configuration > Security Policy > ADP > General** to display the next screen.

Figure 422 Configuration > Security Policy > ADP > General

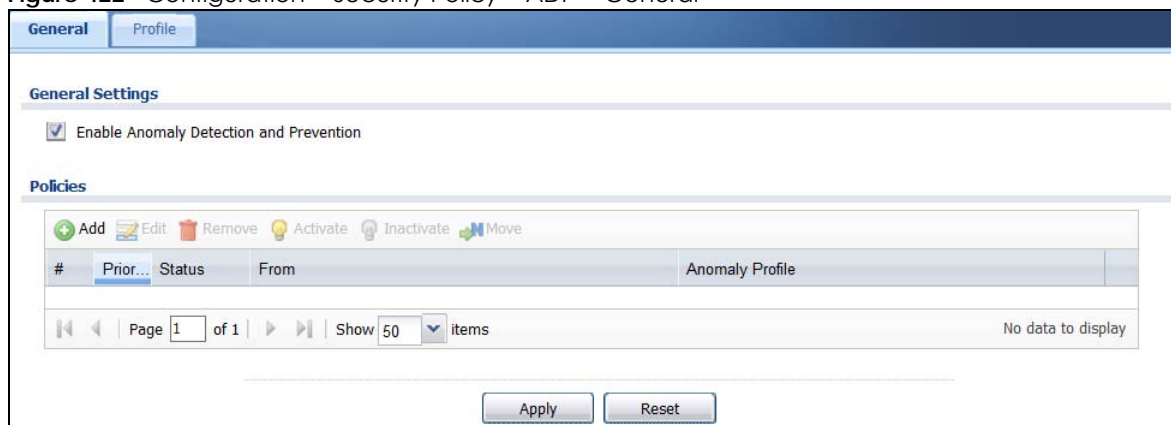

The following table describes the labels in this screen.

Table 212 Configuration > Security Policy > ADP > General

LABEL	DESCRIPTION
General Settings	
Enable Anomaly Detection and Prevention	Select this to enable traffic anomaly and protocol anomaly detection and prevention.
Add	Select an entry and click Add to append a new row beneath the one selected. ADP policies are applied in order (Priority) shown in this screen.

Table 212 Configuration > Security Policy > ADP > General

LABEL	DESCRIPTION
Edit	Select an entry and click this to be able to modify it.
Remove	Select an entry and click this to delete it.
Activate	To turn on an entry, select it and click Activate .
Inactivate	To turn off an entry, select it and click Inactivate .
Move	To change an entry's position in the numbered list, select it and click Move to display a field to type a number for where you want to put that entry and press [ENTER] to move the entry to the number that you typed.
#	This is the entry's index number in the list.
Priority	This is the rank in the list of anomaly profile policies. The list is applied in order of priority.
Status	The activate (light bulb) icon is lit when the entry is active and dimmed when the entry is inactive.
From	<p>This is the direction of travel of packets to which an anomaly profile is bound. Traffic direction is defined by the zone the traffic is coming from.</p> <p>Use the From field to specify the zone from which the traffic is coming. Select ZyWALL to specify traffic coming from the Zyxel Device itself.</p> <p>From LAN means packets traveling from a computer on one LAN subnet to a computer on another subnet via the Zyxel Device's LAN1 zone interfaces. The Zyxel Device does not check packets traveling from a LAN computer to another LAN computer on the same subnet.</p> <p>From WAN means packets that come in from the WAN zone and the Zyxel Device routes back out through the WAN zone.</p> <p>Note: Depending on your network topology and traffic load, applying every packet direction to an anomaly profile may affect the Zyxel Device's performance.</p>
Anomaly Profile	An anomaly profile is a set of anomaly policies with configured activation, log and action settings. This field shows which anomaly profile is bound to which traffic direction. Select an ADP profile to apply to the entry's traffic direction. Configure the ADP profiles in the ADP profile screens.

27.5.2 Creating New ADP Profiles

Create new ADP profiles in the **Configuration > Security Policy > ADP > Profile** screens.

When creating ADP profiles, you may find that certain policies are triggering too many false positives or false negatives. A false positive is when valid traffic is flagged as an attack. A false negative is when invalid traffic is wrongly allowed to pass through the Zyxel Device. As each network is different, false positives and false negatives are common on initial ADP deployment.

To counter this, you could create a 'monitor profile' that creates logs, but all actions are disabled. Observe the logs over time and try to eliminate the causes of the false alarms. When you're satisfied that they have been reduced to an acceptable level, you could then create an 'in-line profile' whereby you configure appropriate actions to be taken when a packet matches a policy.

ADP profiles consist of traffic anomaly profiles and protocol anomaly profiles. To create a new profile, select a base profile and then click **OK** to go to the profile details screen. Type a new profile name, enable or disable individual policies and then edit the default log options and actions.

Click **Configuration > Security Policy > ADP > Profile** to view the following screen.

Figure 423 Configuration > Security Policy > ADP > Profile

#	Name	Description	Base Profile	Reference
1	ADP_PROFILE		all	1
2	APF5838		none	0

The following table describes the labels in this screen.

Table 213 Configuration > Security Policy > ADP > Profile

LABEL	DESCRIPTION
Profile Management	Create ADP profiles here and then apply them in the Configuration > Security Policy > ADP > Profile screen.
Add	Click Add and first choose a none or all Base Profile. <ul style="list-style-type: none"> none base profile sets all ADP entries to have Log set to no and Action set to none by default. all base profile sets all ADP entries to have Log set to log and Action set to block by default.
Edit	Select an entry and click this to be able to modify it.
Remove	Select an entry and click this to delete it.
Clone	Use Clone to create a new entry by modifying an existing one. <ul style="list-style-type: none"> Select an existing entry. Click Clone. A configuration copy of the selected entry pops up. You must at least change the name as duplicate entry names are not allowed.
#	This is the entry's index number in the list.
Name	This is the name of the profile you created.
Description	This is the description of the profile you created.
Base Profile	This is the name of the base profile used to create this profile.
Reference	This is the number of object references used to create this profile.

27.5.3 Traffic Anomaly Profiles

Traffic anomaly detection looks for abnormal behavior such as scan or flooding attempts. In the **Configuration > Security Policy > ADP > Profile** screen, click the **Edit** or **Add** icon and choose a base profile. **Traffic Anomaly** is the first tab in the profile.

Figure 424 Configuration > Security Policy > ADP > Profile > Add-Traffic-Anomaly

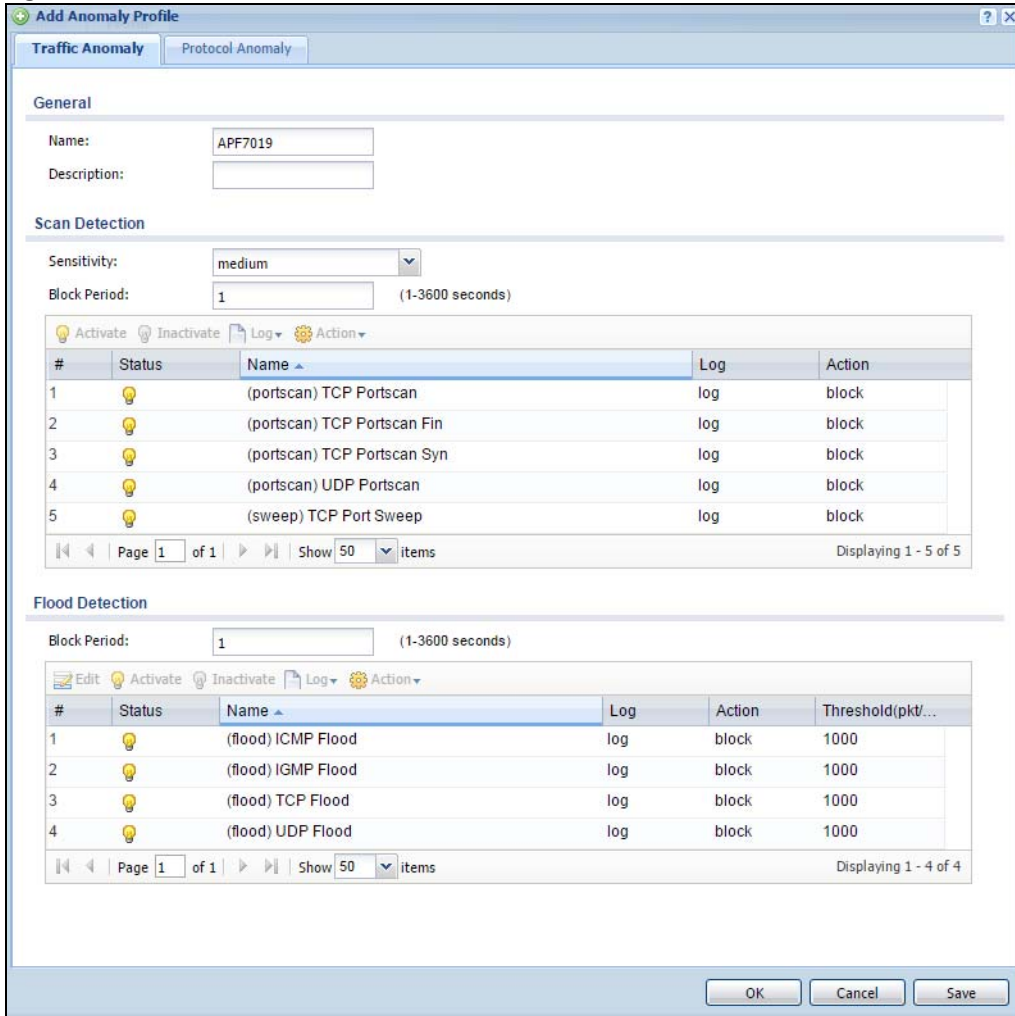

The following table describes the labels in this screen.

Table 214 Configuration > Security Policy > ADP > Profile > Add-Traffic-Anomaly

LABEL	DESCRIPTION
Name	<p>A name is automatically generated that you can edit. The name must be the same in the Traffic Anomaly and Protocol Anomaly screens for the same ADP profile. You may use 1-31 alphanumeric characters, underscores(_), or dashes (-), but the first character cannot be a number. This value is case-sensitive. These are valid, unique profile names:</p> <ul style="list-style-type: none"> • MyProfile • mYProfile • Mymy12_3-4 <p>These are invalid profile names:</p> <ul style="list-style-type: none"> • 1mYProfile • My Profile • MyProfile? • Whatalongprofilename123456789012
Description	In addition to the name, type additional information to help you identify this ADP profile.

Table 214 Configuration > Security Policy > ADP > Profile > Add-Traffic-Anomaly

LABEL	DESCRIPTION
Scan/Flood Detection	Scan detection, such as port scanning, tries to find attacks where an attacker scans device(s) to determine what types of network protocols or services a device supports. Flood detection tries to find attacks that saturate a network with useless data, use up all available bandwidth, and so aim to make communications in the network impossible.
Sensitivity	(Scan detection only.) Select a sensitivity level so as to reduce false positives in your network. If you choose low sensitivity, then scan thresholds and sample times are set low, so you will have fewer logs and false positives; however some traffic anomaly attacks may not be detected. If you choose high sensitivity, then scan thresholds and sample times are set high, so most traffic anomaly attacks will be detected; however you will have more logs and false positives.
Block Period	Specify for how many seconds the Zyxel Device blocks all packets from being sent to the victim (destination) of a detected anomaly attack. Flood Detection applies blocking to the destination IP address and Scan Detection applies blocking to the source IP address.
Edit (Flood Detection only)	Select an entry and click this to be able to modify it.
Activate	To turn on an entry, select it and click Activate .
Inactivate	To turn off an entry, select it and click Inactivate .
Log	To edit an item's log option, select it and use the Log icon. Select whether to have the Zyxel Device generate a log (log), log and alert (log alert) or neither (no) when traffic matches this anomaly policy.
Action	To edit what action the Zyxel Device takes when a packet matches a policy, select the policy and use the Action icon. none : The Zyxel Device takes no action when a packet matches the policy. block : The Zyxel Device silently drops packets that matches the policy. Neither sender nor receiver are notified.
#	This is the entry's index number in the list.
Status	The activate (light bulb) icon is lit when the entry is active and dimmed when the entry is inactive.
Name	This is the name of the anomaly policy. Click the Name column heading to sort in ascending or descending order according to the protocol anomaly policy name.
Log	These are the log options. To edit this, select an item and use the Log icon.
Action	This is the action the Zyxel Device should take when a packet matches a policy. To edit this, select an item and use the Action icon.
Threshold (pkt/sec)	(Flood detection only.) Select a suitable threshold level (the number of packets per second that match the flood detection criteria) for your network. If you choose a low threshold, most traffic anomaly attacks will be detected, but you may have more logs and false positives. If you choose a high threshold, some traffic anomaly attacks may not be detected, but you will have fewer logs and false positives.
OK	Click OK to save your settings to the Zyxel Device, complete the profile and return to the profile summary page.
Cancel	Click Cancel to return to the profile summary page without saving any changes.
Save	Click Save to save the configuration to the Zyxel Device but remain in the same page. You may then go to the another profile screen (tab) in order to complete the profile. Click OK in the final profile screen to complete the profile.

27.5.4 Protocol Anomaly Profiles

Protocol anomalies are packets that do not comply with the relevant RFC (Request For Comments). Protocol anomaly detection includes:

- TCP Decoder
- UDP Decoder
- ICMP Decoder
- IP Decoder

Teardrop

When an IP packet is larger than the Maximum Transmission Unit (MTU) configured in the Zyxel Device, it is fragmented using the TCP or ICMP protocol.

A Teardrop attack falsifies the offset which defines the size of the fragment and the original packet. A series of IP fragments with overlapping offset fields can cause some systems to crash, hang, or reboot when fragment reassembling is attempted at the destination.

IP Spoofing

IP Spoofing is used to gain unauthorized access to network devices by modifying packet headers so that it appears that the packets originate from a host within a trusted network.

- In an IP Spoof from the WAN, the source address appears to be in the same subnet as a Zyxel Device LAN interface.
- In an IP Spoof from a LAN interface, the source address appears to be in a different subnet from that Zyxel Device LAN interface.

Figure 425 Configuration > Security Policy > ADP > Profile > Add-Protocol-Anomaly

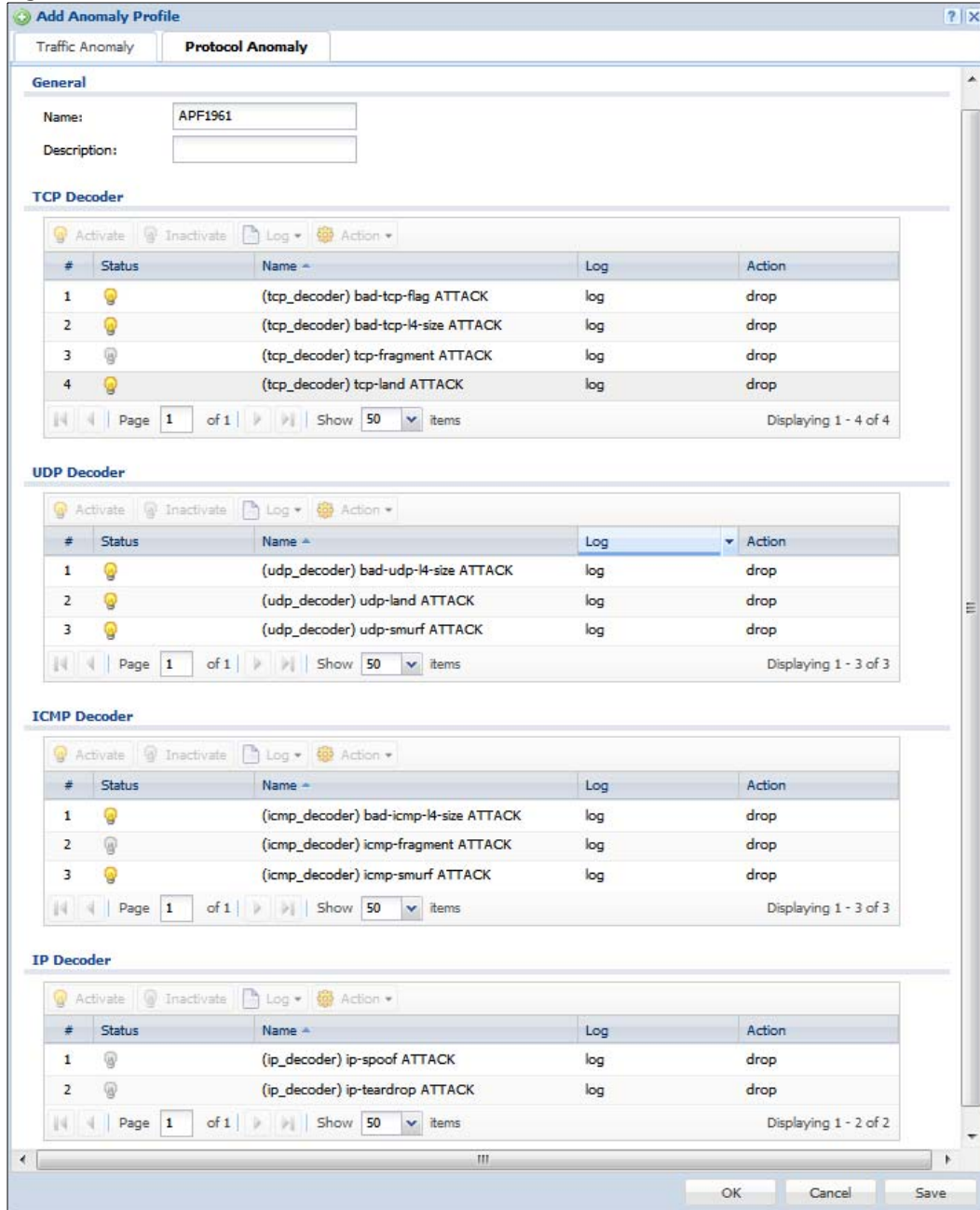

The following table describes the labels in this screen.

Table 215 Configuration > Security Policy > ADP > Profile > Add-Protocol-Anomaly

LABEL	DESCRIPTION
Name	<p>A name is automatically generated that you can edit. The name must be the same in the Traffic Anomaly and Protocol Anomaly screens for the same ADP profile. You may use 1-31 alphanumeric characters, underscores (_), or dashes (-), but the first character cannot be a number. This value is case-sensitive. These are valid, unique profile names:</p> <ul style="list-style-type: none"> • MyProfile • mYProfile • Mymy12_3-4 <p>These are invalid profile names:</p> <ul style="list-style-type: none"> • 1mYProfile • My Profile • MyProfile? • Whatalongprofilename123456789012
Description	In addition to the name, type additional information to help you identify this ADP profile.
TCP Decoder/UDP Decoder/ICMP Decoder/IP Decoder	Perform the following actions for each type of encoder.
Activate	To turn on an entry, select it and click Activate .
Inactivate	To turn off an entry, select it and click Inactivate .
Log	To edit an item's log option, select it and use the Log icon. Select whether to have the Zyxel Device generate a log (log), log and alert (log alert) or neither (no) when traffic matches this anomaly policy.
Action	<p>To edit what action the Zyxel Device takes when a packet matches a policy, select the policy and use the Action icon.</p> <p>original setting: Select this action to return each rule in a service group to its previously saved configuration.</p> <p>none: Select this action to have the Zyxel Device take no action when a packet matches a policy.</p> <p>drop: Select this action to have the Zyxel Device silently drop a packet that matches a policy. Neither sender nor receiver are notified.</p> <p>reject-sender: Select this action to have the Zyxel Device send a reset to the sender when a packet matches the policy. If it is a TCP attack packet, the Zyxel Device will send a packet with a 'RST' flag. If it is an ICMP or UDP attack packet, the Zyxel Device will send an ICMP unreachable packet.</p> <p>reject-receiver: Select this action to have the Zyxel Device send a reset to the receiver when a packet matches the policy. If it is a TCP attack packet, the Zyxel Device will send a packet with an a 'RST' flag. If it is an ICMP or UDP attack packet, the Zyxel Device will do nothing.</p> <p>reject-both: Select this action to have the Zyxel Device send a reset to both the sender and receiver when a packet matches the policy. If it is a TCP attack packet, the Zyxel Device will send a packet with a 'RST' flag to the receiver and sender. If it is an ICMP or UDP attack packet, the Zyxel Device will send an ICMP unreachable packet.</p>
#	This is the entry's index number in the list.
Status	The activate (light bulb) icon is lit when the entry is active and dimmed when the entry is inactive.

Table 215 Configuration > Security Policy > ADP > Profile > Add-Protocol-Anomaly

LABEL	DESCRIPTION
Name	This is the name of the anomaly policy. Click the Name column heading to sort in ascending or descending order according to the protocol anomaly policy name.
Log	These are the log options. To edit this, select an item and use the Log icon.
Action	This is the action the Zyxel Device should take when a packet matches a policy. To edit this, select an item and use the Action icon.
OK	Click OK to save your settings to the Zyxel Device, complete the profile and return to the profile summary page.
Cancel	Click Cancel to return to the profile summary page without saving any changes.
Save	Click Save to save the configuration to the Zyxel Device but remain in the same page. You may then go to the another profile screen (tab) in order to complete the profile. Click OK in the final profile screen to complete the profile.

27.6 Session Control Screen

Click **Configuration > Security Policy > Session Control** to display the **Security Policy Session Control** screen. Use this screen to limit the number of concurrent NAT/Security Policy sessions a client can use. You can apply a default limit for all users and individual limits for specific users, addresses, or both. The individual limit takes priority if you apply both.

Figure 426 Configuration > Security Policy > Session Control

Session Control

General Settings

UDP Session Time Out: (1-300 seconds)

Session Limit Settings

Enable Session Limit

IPv4 Configuration

Default Session per Host: (0-8192, 0 is unlimited)

+ Add Edit Remove Activate Inactivate Move

#	Status	#	User	IPv4 Address	Description	Limit
No data to display						

Page 0 of 0 Show 50 items

IPv6 Configuration

Default Session per Host: (0-8192, 0 is unlimited)

+ Add Edit Remove Activate Inactivate Move

#	Status	#	User	IPv6 Address	Description	Limit
No data to display						

Page 0 of 0 Show 50 items

Apply Reset

The following table describes the labels in this screen.

Table 216 Configuration > Security Policy > Session Control

LABEL	DESCRIPTION
General Settings	
UDP Session Time Out	Set how many seconds the Zyxel Device will allow a UDP session to remain idle (without UDP traffic) before closing it.
Session Limit Settings	
Enable Session limit	Select this check box to control the number of concurrent sessions hosts can have.
IPv4 / IPv6 Rule Summary	This table lists the rules for limiting the number of concurrent sessions hosts can have.
Default Session per Host	This field is configurable only when you enable session limit. Use this field to set a common limit to the number of concurrent NAT/Security Policy sessions each client computer can have. If only a few clients use peer to peer applications, you can raise this number to improve their performance. With heavy peer to peer application use, lower this number to ensure no single client uses too many of the available NAT sessions. Create rules below to apply other limits for specific users or addresses.
Add	Click this to create a new entry. Select an entry and click Add to create a new entry after the selected entry.
Edit	Double-click an entry or select it and click Edit to open a screen where you can modify the entry's settings.
Remove	To remove an entry, select it and click Remove . The Zyxel Device confirms you want to remove it before doing so.
Activate	To turn on an entry, select it and click Activate .
Inactivate	To turn off an entry, select it and click Inactivate .
Move	To change a rule's position in the numbered list, select the rule and click Move to display a field to type a number for where you want to put that rule and press [ENTER] to move the rule to the number that you typed. The ordering of your rules is important as they are applied in order of their numbering.
Status	This icon is lit when the entry is active and dimmed when the entry is inactive.
#	This is the index number of a session limit rule. It is not associated with a specific rule.
User	This is the user name or user group name to which this session limit rule applies.
IPv4 / IPv6 Address	This is the IPv4 / IPv6 address object, including geographic address (group) objects to which this session limit rule applies.
Description	This is the information configured to help you identify the rule.
Limit	This is how many concurrent sessions this user or address is allowed to have.
Apply	Click Apply to save your changes back to the Zyxel Device.
Reset	Click Reset to return the screen to its last-saved settings.

27.6.1 Session Control Add/Edit Screen

Click **Configuration > Security Policy > Session Control** and the **Add** or **Edit** icon to display the **Add or Edit** screen. Use this screen to configure rules that define a session limit for specific users or addresses.

Figure 427 Configuration > Security Policy > Session Control > Edit

The following table describes the labels in this screen.

Table 217 Configuration > Security Policy > Session Control > Add / Edit

LABEL	DESCRIPTION
Create new Object	Use to configure new settings for User or Address objects that you need to use in this screen. Click on the down arrow to see the menu.
Enable Rule	Select this check box to turn on this session limit rule.
Description	Enter information to help you identify this rule. Use up to 60 printable ASCII characters. Spaces are allowed.
User	Select a user name or user group to which to apply the rule. The rule is activated only when the specified user logs into the system and the rule will be disabled when the user logs out. Otherwise, select any and there is no need for user logging. Note: If you specified an IP address (or address group) instead of any in the field below, the user's IP address should be within the IP address range.
Address	Select the IPv4 source address or address group, including geographic address (group) object, to which this rule applies. Select any to apply the rule to all IPv4 source addresses.
IPv6 Address	Select the IPv6 source address or address group, including geographic address (group) object, to which this rule applies. Select any to apply the rule to all IPv6 source addresses.
Session Limit per Host	Use this field to set a limit to the number of concurrent NAT/Security Policy sessions this rule's users or addresses can have. For this rule's users and addresses, this setting overrides the Default Session per Host setting in the general Security Policy Session Control screen.
OK	Click OK to save your customized settings and exit this screen.
Cancel	Click Cancel to exit this screen without saving.

27.7 Security Policy Example Applications

Suppose you decide to block LAN users from using IRC (Internet Relay Chat) through the Internet. To do this, you would configure a LAN to WAN Security Policy that blocks IRC traffic from any source IP address from going to any destination address. You do not need to specify a schedule since you need the Security Policy to always be in effect. The following figure shows the results of this policy.

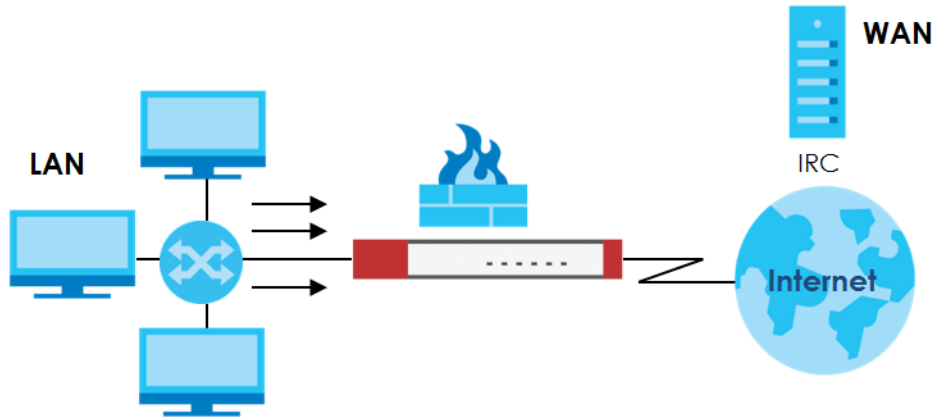
Figure 428 Blocking All LAN to WAN IRC Traffic Example

Your Security Policy would have the following settings.

Table 218 Blocking All LAN to WAN IRC Traffic Example

#	USER	SOURCE	DESTINATION	SCHEDULE	UTM PROFILE	ACTION
1	Any	Any	Any	Any	IRC	Deny
2	Any	Any	Any	Any	Any	Allow

- The first row blocks LAN access to the IRC service on the WAN.
- The second row is the Security Policy's default policy that allows all LAN1 to WAN traffic.

The Zyxel Device applies the security policies in order. So for this example, when the Zyxel Device receives traffic from the LAN, it checks it against the first policy. If the traffic matches (if it is IRC traffic) the security policy takes the action in the policy (drop) and stops checking the subsequent security policies. Any traffic that does not match the first security policy will match the second security policy and the Zyxel Device forwards it.

Now suppose you need to let the CEO use IRC. You configure a LAN1 to WAN security policy that allows IRC traffic from the IP address of the CEO's computer. You can also configure a LAN to WAN policy that allows IRC traffic from any computer through which the CEO logs into the Zyxel Device with his/her user name. In order to make sure that the CEO's computer always uses the same IP address, make sure it either:

- Has a static IP address,
or
- You configure a static DHCP entry for it so the Zyxel Device always assigns it the same IP address.

Now you configure a LAN1 to WAN security policy that allows IRC traffic from the IP address of the CEO's computer (172.16.1.7 for example) to go to any destination address. You do not need to specify a schedule since you want the security policy to always be in effect. The following figure shows the results of your two custom policies.

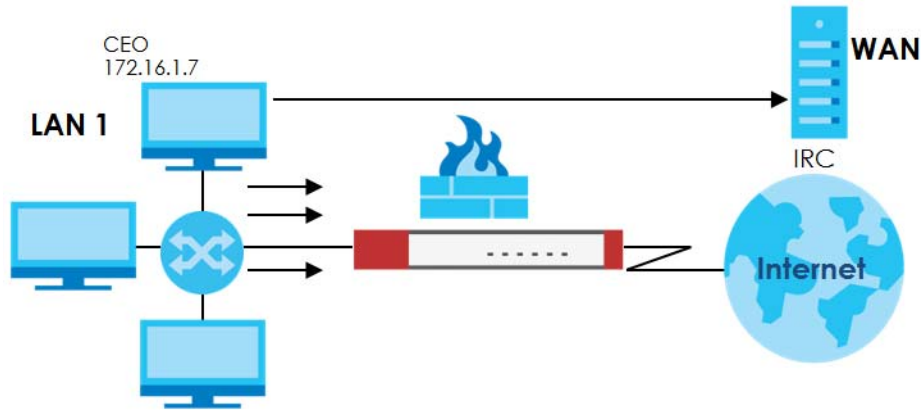
Figure 429 Limited LAN to WAN IRC Traffic Example

Your security policy would have the following configuration.

Table 219 Limited LAN1 to WAN IRC Traffic Example 1

#	USER	SOURCE	DESTINATION	SCHEDULE	UTM PROFILE	ACTION
1	Any	172.16.1.7	Any	Any	IRC	Allow
2	Any	Any	Any	Any	IRC	Deny
3	Any	Any	Any	Any	Any	Allow

- The first row allows the LAN1 computer at IP address 172.16.1.7 to access the IRC service on the WAN.
- The second row blocks LAN1 access to the IRC service on the WAN.
- The third row is the default policy of allowing all traffic from the LAN1 to go to the WAN.

Alternatively, you configure a LAN1 to WAN policy with the CEO's user name (say CEO) to allow IRC traffic from any source IP address to go to any destination address.

Your Security Policy would have the following settings.

Table 220 Limited LAN1 to WAN IRC Traffic Example 2

#	USER	SOURCE	DESTINATION	SCHEDULE	UTM PROFILE	ACTION
1	CEO	Any	Any	Any	IRC	Allow
2	Any	Any	Any	Any	IRC	Deny
3	Any	Any	Any	Any	Any	Allow

- The first row allows any LAN1 computer to access the IRC service on the WAN by logging into the Zyxel Device with the CEO's user name.
- The second row blocks LAN1 access to the IRC service on the WAN.
- The third row is the default policy of allowing all traffic from the LAN1 to go to the WAN.

The policy for the CEO must come before the policy that blocks all LAN1 to WAN IRC traffic. If the policy that blocks all LAN1 to WAN IRC traffic came first, the CEO's IRC traffic would match that policy and the Zyxel Device would drop it and not check any other security policies.

CHAPTER 28

Cloud CNM

28.1 Cloud CNM Overview

You need a SecuManager license to get a **CNM ID** with which you can access the SecuManager server. It is independent from the Zyxel Devices. The SecuReporter license must be activated on each Zyxel Device.

28.1.1 What You Can Do in this Chapter

- Use the **Cloud CNM > SecuManager** screen ([Section 27.9 on page 624](#)) to enable and configure management of the Zyxel Device by a Central Network Management system.
- Use the **Cloud CNM > SecuReporter** screen ([Section 27.10 on page 625](#)) to enable SecuReporter logging on your Zyxel Device, see license status, type, expiration date and access a link to the SecuReporter web portal. The SecuReporter web portal collects and analyzes logs from your Zyxel Device in order to identify anomalies, alert on potential internal / external threats, and report on network usage.

28.2 Cloud CNM SecuManager

Cloud CNM SecuManager is a Virtual Machine-based (VM) management system that uses the TR-069 protocol to encapsulate commands to ZyWALL/USG devices for management and monitoring; these devices must have firmware that supports the TR-069 protocol.

In the following figure, SP is the management service provider, while A and B are sites with devices being managed by SP.

Figure 430 Cloud CNM SecuManager Example Network Topology

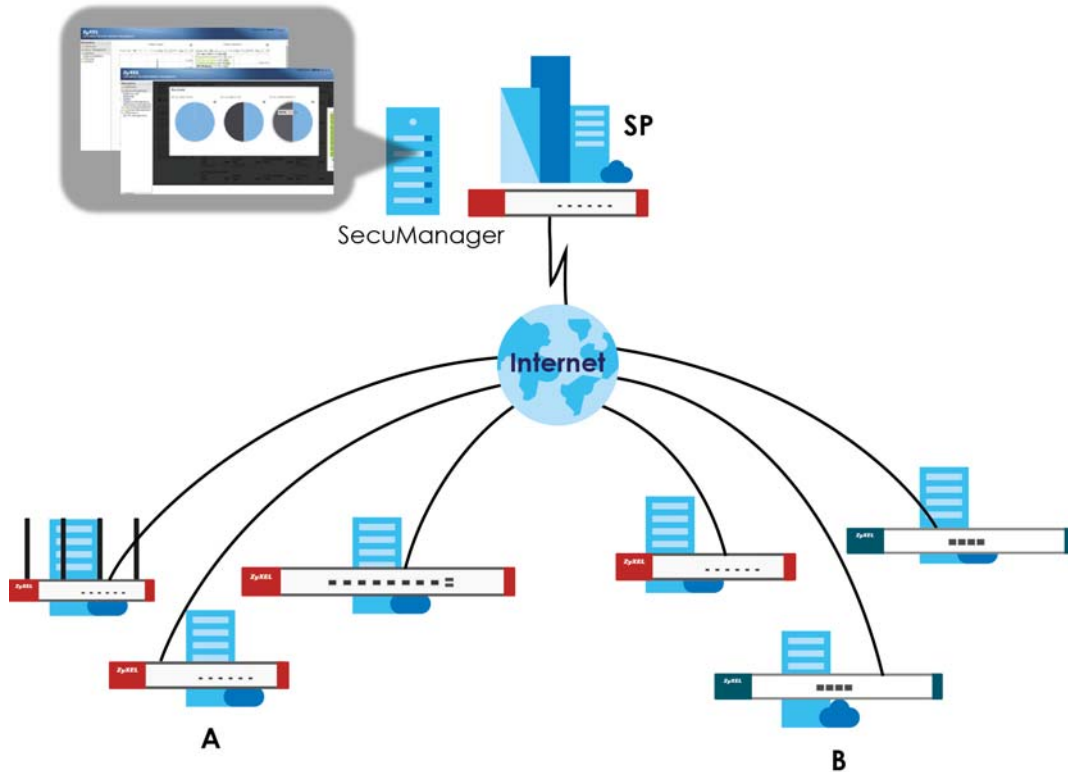

Cloud CNM SecuManager features include:

- Batch import of managed devices at one time using one CSV file
- See an overview of all managed devices and system information in one place
- Monitor and manage devices
- Install firmware to multiple devices of the same model at one time
- Back up and restore device configuration
- View the location of managed devices on a map
- Receive notification for events and alarms, such as when a device goes down
- Graphically monitor individual devices and see related statistics
- Directly access a device for remote configuration
- Create four types of administrators with different privileges
- Perform Site-to-Site, Hub & Spoke, Fully-meshed and Remote Access VPN provisioning.

To allow Cloud CNM SecuManager management of your Zyxel Device:

- You must have a Cloud CNM SecuManager license with CNM ID number or a Cloud CNM SecuManager server URL.
- The Zyxel Device must be able to communicate with the Cloud CNM SecuManager server.

You must configure **Configuration > Cloud CNM > SecuManager** to allow the Zyxel Device to find the Cloud CNM SecuManager server.

Figure 431 Configuration > Cloud CNM > SecuManager

The following table describes the labels in this screen.

Table 221 Configuration > Cloud CNM > SecuManager

LABEL	DESCRIPTION
Show Advanced Settings / Hide Advanced Settings	Click this button to display a greater or lesser number of configuration fields.
Enable	Select this to allow management of the Zyxel Device by Cloud CNM SecuManager.
Auto	Select this if your Cloud CNM SecuManager server can access myZyxel to automatically get the URL from myZyxel. You also need CNM ID from the Cloud CNM SecuManager license.
CNM ID	Enter the CNM ID exactly as on the Cloud CNM SecuManager license.
CNM URL	myZyxel associates the CNM ID with the CNM URL which identifies the server on which Cloud CNM SecuManager is installed. Therefore you don't need to enter the CNM URL when you select Auto .
Custom	Select this if your Cloud CNM SecuManager VM server cannot access myZyxel.
CNM URL	Select this if your VM server or Zyxel Devices are in a private network, or if the VM server is behind a NAT router. You then need to manually enter the VM server URL into the Zyxel Device. Enter the IPv4 IP address of the Cloud CNM SecuManager server followed by the port number (default 7547 for HTTPS or 7549 for HTTP) followed by the CNM ID from the license in CNM URL . For example, if you installed Cloud CNM SecuManager on a server with IP address 1.1.1.1 and CNM ID V6ABQNTPYGD, then type 1.1.1.1:7547/V6ABQNTPYG or 1.1.1.1:7549/V6ABQNTPYG as the CNM URL .
Transfer Protocol	Choose the CNM URL protocol: HTTP or HTTPS . If you enter 1.1.1.1:7547 as the CNM URL , you must choose HTTPS as the Transfer Protocol , and then the whole CNM URL is https://1.1.1.1:7547. If you enter 1.1.1.1:7549 as the CNM URL , you must choose HTTP as the Transfer Protocol , and then the whole CNM URL is http://1.1.1.1:7549.
Periodic Inform	Enable this to have the Zyxel Device inform the Cloud CNM SecuManager server of its presence at regular intervals.
Interval	Type how often the Zyxel Device should inform Cloud CNM SecuManager server of its presence.

Table 221 Configuration > Cloud CNM > SecuManager (continued)

LABEL	DESCRIPTION
HTTPS Authentication	Select the checkbox if you have a HTTPS server trusted certificate.
Server Certificate	Select an available certificate. Available certificates are in Object > Certificate > Trusted Certificates .
Apply	Click Apply to save your changes back to the Zyxel Device.
Reset	Click Reset to return the screen to its last-saved settings.

Note: See the Cloud CNM SecuManager User's Guide for more information on Cloud CNM SecuManager.

28.3 Cloud CNM SecuReporter

Cloud CNM SecuReporter is a security analytics portal that collects and analyzes logs from SecuReporter-licensed Zyxel Devices in order to identify anomalies, alert on potential internal / external threats, and report on network usage. You need to buy a license for SecuReporter for your Zyxel Device and activate it at myZyxel. You must be a registered user at myZyxel.

Figure 432 Cloud CNM SecuReporter Application Scenario
Public Cloud

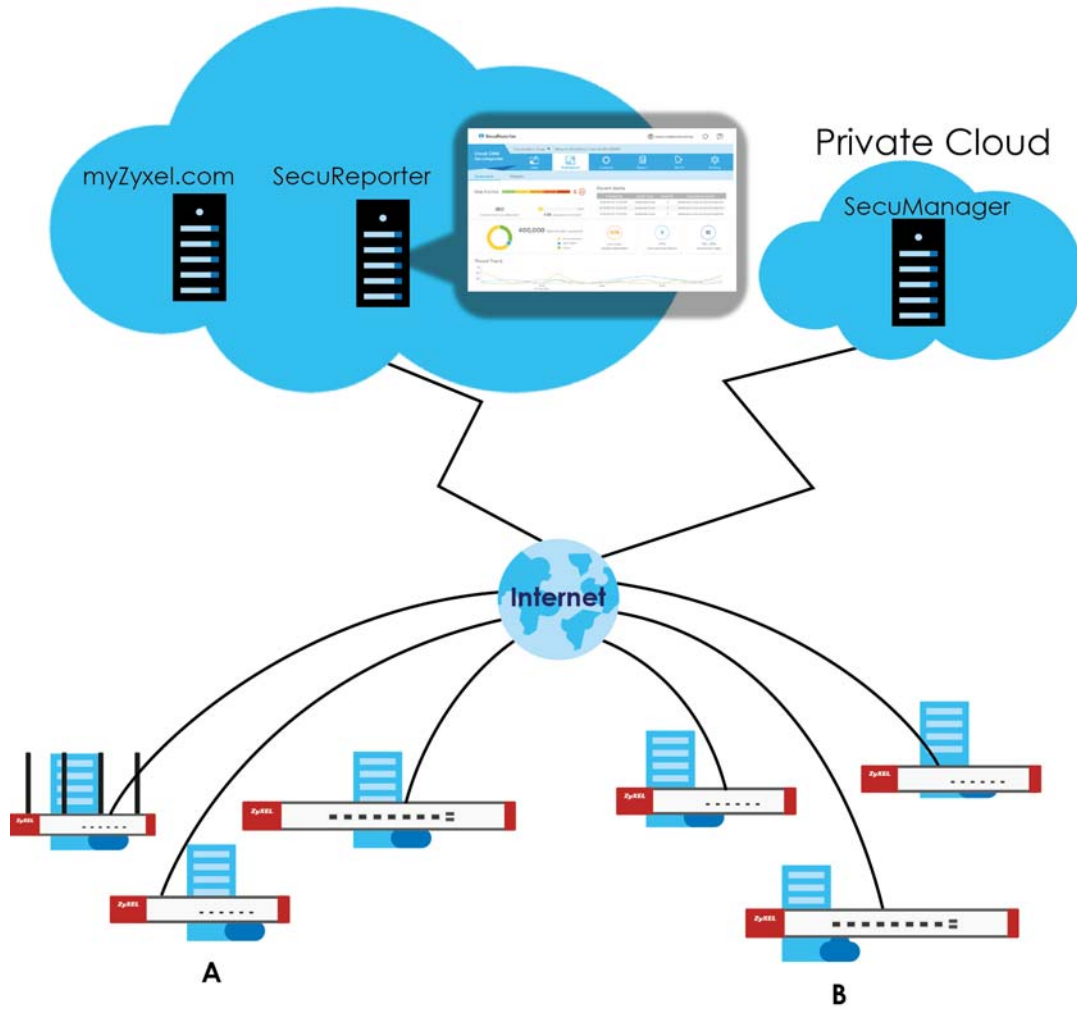

How to activate and enable SecuReporter

- 1 Does **Service Status** displays **Activated** in the **Configuration > Cloud CNM > SecuReporter** screen? If not, you have to log in to myZyxel.com and activate the SecuReporter license for this Zyxel Device. The Zyxel Device must be able to communicate with the myZyxel server. Your SecuReporter license displays in **Configuration > Licensing > Registration > Service** after you activate the SecuReporter license at myZyxel.

Figure 433 Configuration > Licensing > Registration > Service

#	Service	Status	Service Type	Expiration D...	Count	Action
1	IDP/AppPatrol Signature Service	Activated	Standard	2019-1-1	N/A	Renew
2	Anti-Virus Signature Service	Activated	Standard	2019-1-1	N/A	Renew
3	Anti-Spam Service	Activated	Standard	2019-1-1	N/A	Renew
4	Content Filter 2.0	Activated	Standard	2019-1-1	N/A	Renew
5	SecuReporter	Activated	Standard	2019-4-19	N/A	Renew
6	Managed AP Service	Default			2	Buy
7	SSL VPN Service	Default			25	Buy
8	Hotspot Management Subscri...	Not Licensed			N/A	Buy
9	Concurrent Device Upgrade	Default			200	Buy
10	Device HA Pro	Not Licensed			N/A	Buy
11	Firmware Upgrade Service	Activated			N/A	

Page 1 of 1 | Show 50 items | Displaying 1 - 11 of 11

Service Refresh

Service License Refresh

Note:
Update device license information from myZyXel server. If you want to activate license, please go to portal.myzyxel.com

- After the SecuReporter license is activated, go back to the **Configuration > Cloud CNM > SecuReporter** screen, and select the categories of logs that you want this Zyxel Device to send to the SecuReporter portal.
- Select **Enable SecuReporter**. Do not go to the SecuReporter portal until after you have enabled SecuReporter on this Zyxel Device and applied the settings. You can also see license status, type, expiration date.
- Click **Apply** and wait.

How to add this Zyxel Device to SecuReporter at the Portal

- Log in to the SecuReporter portal.
- Go to **Settings > Organization & Devices > Add** to create an organization.
- Add this Zyxel Device to an **Organization** using the hyper link under **Unclaimed Device**.

How to add this Zyxel Device to SecuReporter in the Web Configurator

Click **Configuration > Cloud CNM > SecuReporter** to open the following screen.

Figure 434 Configuration > Cloud CNM > SecuReporter

SecuReporter

General Settings

Enable SecuReporter i

Categories

Security

App Patrol Anti-Malware/Virus Threat Protection (IDP/ADP)

Anti-Spam Content Filter

Network

Traffic Log i Interface Statistics Application Statistics

SecuReporter Service License Status

Service Status: Activated [Buy](#)

Service Type: **Trial**

Expiration Date: 2023-12-30

Note:

1. To activate the license, please go to portal.myzyxel.com.

2. To complete SecuReporter configuration, please active license, enable SecuReporter, and [set Org/Network site](#) at [SecuReporter](#)

The following table describes the labels in this screen.

Table 222 Configuration > Cloud CNM > SecuReporter

LABEL	DESCRIPTION
Enable SecuReporter	Select this to allow SecuReporter to collect and analyze logs from this Zyxel Device for security analytics to identify anomalies, alert on potential internal / external threats, and report on network usage.
Categories	Select the categories of logs that you want this Zyxel Device to send to the SecuReporter portal. There are two types: Security Logs: App Patrol, Anti-Spam, Anti-Malware/Virus, Content Filter, Threat Protection (IDP/ADP) Network: Traffic Log (for analysis of traffic usage). Do not select this if it impacts Zyxel Device performance.
SecuReporter Service License Status	Select this if your Cloud CNM SecuManager VM server cannot access myZyxel.
Service Status	This field displays whether the service license is enabled at myZyxel (Activated) or not (Not Activated) or expired (Expired). There is also a link to buy a license.
Service Type	This field displays whether you applied for a trial application (Trial) or have a standard license (Standard). This field is blank when a service is not activated.
Expiration Date	This field displays the date in yyyy-mm-dd format that your service expires.
Apply	Click Apply to save your changes back to the Zyxel Device.
Reset	Click Reset to return the screen to its last-saved settings.

Click the 'set Org/Network site' hyperlink in the second note in **Configuration > Cloud CNM > SecuReporter** to go to the following screen.

Figure 435 Configuration > Cloud CNM > SecuReporter > set Org/Network site

The screenshot shows the 'SecuReporter Setting' window. At the top, the 'Server Status' is 'Connected'. Below that, the 'Device Name' is 'USG60_John'. There are two radio buttons: 'Select from existing organization' (which is selected) and 'Create new organization'. Under 'Select from existing organization', the 'Organization' dropdown is set to 'Zyxel'. Under 'Create new organization', there is an empty text field for the organization name. Below this is the 'Data Protection Policy' section, which asks the user to choose a level of data protection. There are three radio buttons: 'Partially Anonymous' (selected), 'Fully Anonymous', and 'Non-Anonymous'. Each has a brief description of what data is protected or anonymized. At the bottom, there is a checkbox for 'I have read and accept the SecuReporter Terms of Use' and a 'Complete and Close Window' button.

The following table describes the labels in this screen.

Table 223 Configuration > Cloud CNM > SecuReporter

LABEL	DESCRIPTION
Server Status	This is the connection status between the Zyxel Device and the SecuReporter server. This field shows Connected when the Zyxel Device can synchronize with the SecuReporter server. This field shows Timeout when the Zyxel Device can't synchronize with the SecuReporter server. This field shows Fail when the connection between the Zyxel Device and the SecuReporter server is down.
Device Name	Enter the name of the Zyxel Device. This Zyxel Device will be added to a new or existing organization.
Organization	This field appears if you haven't created an organization in the SecuReporter server. Type a name of up to 255 characters and description to create a new organization.
Organization	Select an existing organization from the drop-down list box to add the Zyxel Device to the selected organization.
Create new organization	Type a name of up to 255 characters and description to create a new organization.
Data Protection Policy	
Partially Anonymous	Select this and personal data, such as user names, MAC addresses, email addresses, and host names, will be replaced with artificial identifiers in downloaded logs.
Fully Anonymous	Select this and personal data, such as user names, MAC addresses, email addresses, and host names, will be replaced with anonymized information in downloaded logs.
Non-Anonymous	Select this and personal data, such as user names, MAC addresses, email addresses, and host names, will be identifiable in downloaded logs.

Table 223 Configuration > Cloud CNM > SecuReporter (continued)

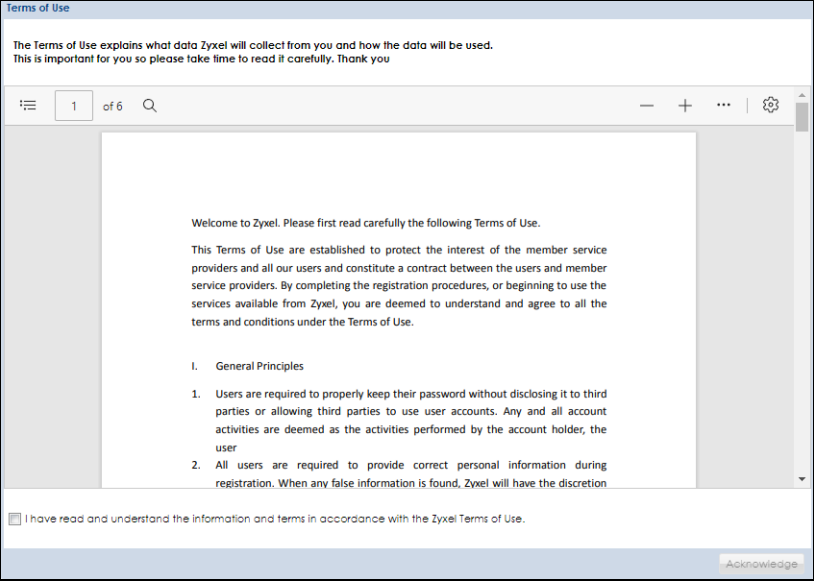
LABEL	DESCRIPTION
<p>I have read and accept the SecuReporter Terms of Use.</p>	<p>Read the Terms of Use and then select this if you agree with them.</p> 
<p>Complete and Close Window</p>	<p>Review your configurations and then click this to apply the SecuReporter settings for this Zyxel Device.</p>

CHAPTER 29

Amazon VPC

29.1 Overview

Use this feature if you want to transmit traffic from a Customer Gateway (CG, the Zyxel Device) through an IPSec tunnel to the Amazon VPC (Virtual Private Cloud).

Note: You must use the Command Line Interface to configure Amazon VPC on the Zyxel Devices.

Figure 436 CG – to – Amazon VPC

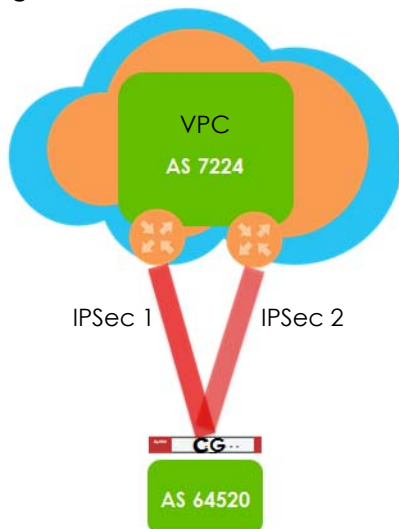

29.2 Amazon VPC Configuration Process

The process to transmit traffic from a Customer Gateway (Zyxel Device) through an IPSec tunnel to an Amazon VPC is:

- 1 Create an Amazon Web Services (AWS) account and configure VPN on Amazon VPC.
- 2 Download the tunnel configurations. Each VPN Connection has a VPN Connection ID, a Customer Gateway Identifier and a Virtual Private Gateway Identifier. This is an example of these settings:
 - Your VPN Connection ID: vpn-cf41a7a6
 - Your Virtual Private Gateway ID: vgw-dac576db

- Your Customer Gateway ID: cgw-57b10356

Two tunnels are used to connect the Zyxel Device to the Amazon VPC. One is redundant and only takes over if the first one fails.

There are 2 routing types for Amazon VPC.

- **Static:** A static route is created to send traffic to AWS. A connectivity check is used to check the tunnel status. If a tunnel is down, the traffic switches to the redundant tunnel. You do not need to configure BGP to route tunnel traffic between the Zyxel Device and AWS.
 - **Dynamic:** Configure BGP to switch tunnel traffic dynamically between the Zyxel Device and AWS. If you're using dynamic routing, configure BGP on the Zyxel Device in **Configuration > Network > Routing > BGP** using the AS, router ID and network information from the tunnel configurations you just downloaded.
- 3 In the Zyxel Device, upload the VPC text file to the Zyxel Device in the **Configuration > VPN > Amazon VPC** screen.

Figure 437 Configuration > VPN > Amazon VPC

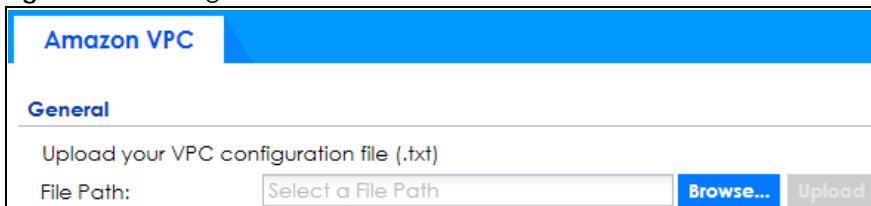

Amazon VPC

General

Upload your VPC configuration file (.txt)

File Path:

- 4 The tunnel then establishes automatically.

CHAPTER 30

IPSec VPN

30.1 Virtual Private Networks (VPN) Overview

A virtual private network (VPN) provides secure communications between sites without the expense of leased site-to-site lines. A secure VPN is a combination of tunneling, encryption, authentication, access control and auditing. It is used to transport traffic over the Internet or any insecure network that uses TCP/IP for communication.

IPSec VPN

Internet Protocol Security (IPSec) VPN connects IPSec routers or remote users using IPSec client software. This standards-based VPN offers flexible solutions for secure data communications across a public network. IPSec is built around a number of standardized cryptographic techniques to provide confidentiality, data integrity and authentication at the IP layer. The Zyxel Device can also combine multiple IPSec VPN connections into one secure network. Here local Zyxel Device **X** uses an IPSec VPN tunnel to remote (peer) Zyxel Device **Y** to connect the local (**A**) and remote (**B**) networks.

Figure 438 IPSec VPN Example

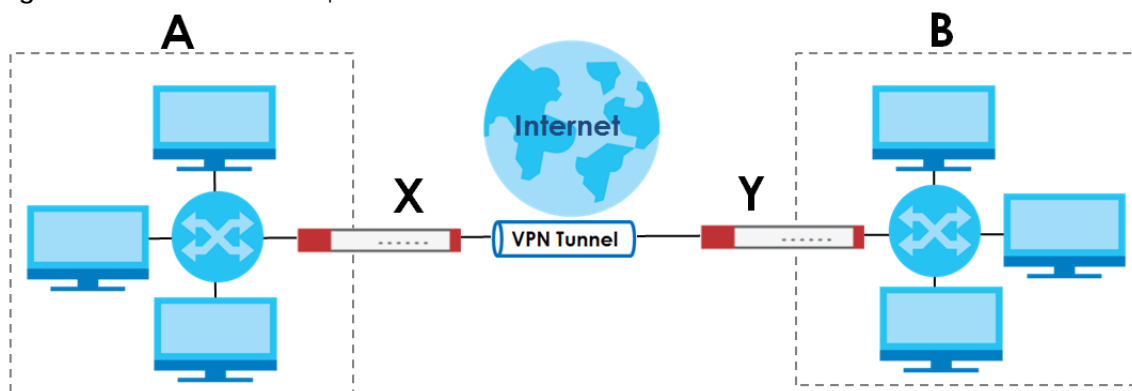

Internet Key Exchange (IKE): IKEv1 and IKEv2

The Zyxel Device supports IKEv1 and IKEv2 for IPv4 and IPv6 traffic. IKE (Internet Key Exchange) is a protocol used in setting up security associations that allows two parties to send data securely.

IKE uses certificates or pre-shared keys for authentication and a Diffie–Hellman key exchange to set up a shared session secret from which encryption keys are derived. A security policy for each peer must be manually created.

IPSec VPN consists of two phases: Phase 1 and Phase 2. Phase 1's purpose is to establish a secure authenticated communication channel by using the Diffie–Hellman key exchange algorithm to generate a shared secret key to encrypt IKE communications. This negotiation results in one single bi-directional ISAKMP Security Association (SA). The authentication can be performed using either pre-

shared key (shared secret), signatures, or public key encryption. Phase 1 operates in either **Main Mode** or **Aggressive Mode**. **Main Mode** protects the identity of the peers, but **Aggressive Mode** does not.

During Phase 2, the remote IPsec routers use the secure channel established in Phase 1 to negotiate Security Associations for IPsec. The negotiation results in a minimum of two unidirectional security associations (one inbound and one outbound). Phase 2 uses Quick Mode (only). Quick mode occurs after IKE has established the secure tunnel in Phase 1. It negotiates a shared IPsec policy, derives shared secret keys used for the IPsec security algorithms, and establishes IPsec SAs. Quick mode is also used to renegotiate a new IPsec SA when the IPsec SA lifetime expires.

In the Zyxel Device, use the **VPN Connection** tab to set up Phase 2 and the **VPN Gateway** tab to set up Phase 1.

Some differences between IKEv1 and IKEv2 include:

- IKEv2 uses less bandwidth than IKEv1. IKEv2 uses one exchange procedure with 4 messages. IKEv1 uses two phases with Main Mode (9 messages) or Aggressive Mode (6 messages) in phase 1.
- IKEv2 supports Extended Authentication Protocol (EAP) authentication, and IKEv1 supports X-Auth. EAP is important when connecting to existing enterprise authentication systems.
- IKEv2 always uses NAT traversal and Dead Peer Detection (DPD), but they can be disabled in IKEv1 using Zyxel Device firmware (the default is on).
- Configuration payload (includes the IP address pool in the VPN setup data) is supported in IKEv2 (off by default), but not in IKEv1.
- Narrowed is supported in IKEv2, but not in IKEv1. Narrowed has the SA apply only to IP addresses in common between the Zyxel Device and the remote IPsec router.
- The IKEv2 protocol supports connectivity checks which is used to detect whether the tunnel is still up or not. If the check fails (the tunnel is down), IKEv2 can re-establish the connection automatically. The Zyxel Device uses firmware to perform connectivity checks when using IKEv1.

SSL VPN

SSL VPN uses remote users' web browsers to provide the easiest-to-use of the Zyxel Device's VPN solutions. A user just browses to the Zyxel Device's web address and enters his user name and password to securely connect to the Zyxel Device's network. Remote users do not need to configure security settings. Here a user uses his browser to securely connect to network resources in the same way as if he were part of the internal network. See [Chapter 31 on page 671](#) for more on SSL VPN.

Figure 439 SSL VPN

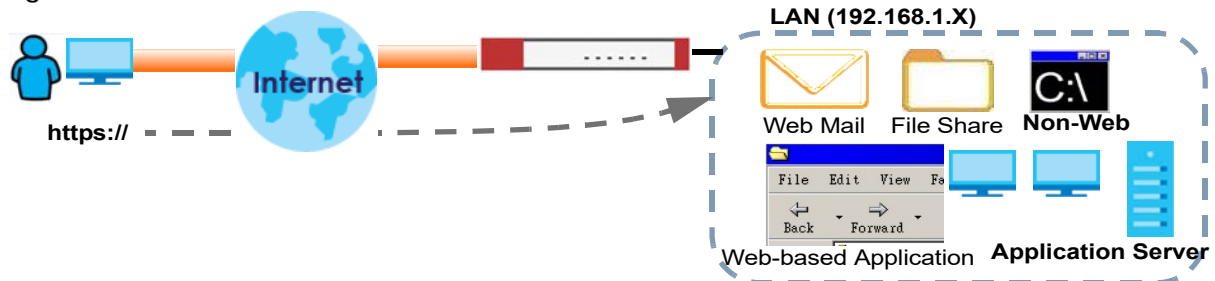

L2TP VPN

L2TP VPN uses the L2TP and IPsec client software included in remote users' Android, iOS, or Windows operating systems for secure connections to the network behind the Zyxel Device. The remote users do

not need their own IPsec gateways or third-party VPN client software. For example, configure sales representatives' laptops, tablets, or smartphones to securely connect to the Zyxel Device's network. See [Chapter 34 on page 696](#) for more on L2TP over IPsec.

Figure 440 L2TP VPN

30.1.1 What You Can Do in this Chapter

- Use the **VPN Connection** screens (see [Section 30.2 on page 640](#)) to specify which IPsec VPN gateway an IPsec VPN connection policy uses, which devices behind the IPsec routers can use the VPN tunnel, and the IPsec SA settings (phase 2 settings). You can also activate or deactivate and connect or disconnect each VPN connection (each IPsec SA).
- Use the **VPN Gateway** screens (see [Section 30.2.1 on page 642](#)) to manage the Zyxel Device's VPN gateways. A VPN gateway specifies the IPsec routers at either end of a VPN tunnel and the IKE SA settings (phase 1 settings). You can also activate and deactivate each VPN gateway.
- Use the **VPN Concentrator** screens (see [Section 30.4 on page 657](#)) to combine several IPsec VPN connections into a single secure network.
- Use the **Configuration Provisioning** screen (see [Section 30.5 on page 659](#)) to set who can retrieve VPN rule settings from the Zyxel Device using the Zyxel Device IPsec VPN Client.

30.1.2 What You Need to Know

An IPsec VPN tunnel is usually established in two phases. Each phase establishes a security association (SA), a contract indicating what security parameters the Zyxel Device and the remote IPsec router will use. The first phase establishes an Internet Key Exchange (IKE) SA between the Zyxel Device and remote IPsec router. The second phase uses the IKE SA to securely establish an IPsec SA through which the Zyxel Device and remote IPsec router can send data between computers on the local network and remote network. This is illustrated in the following figure.

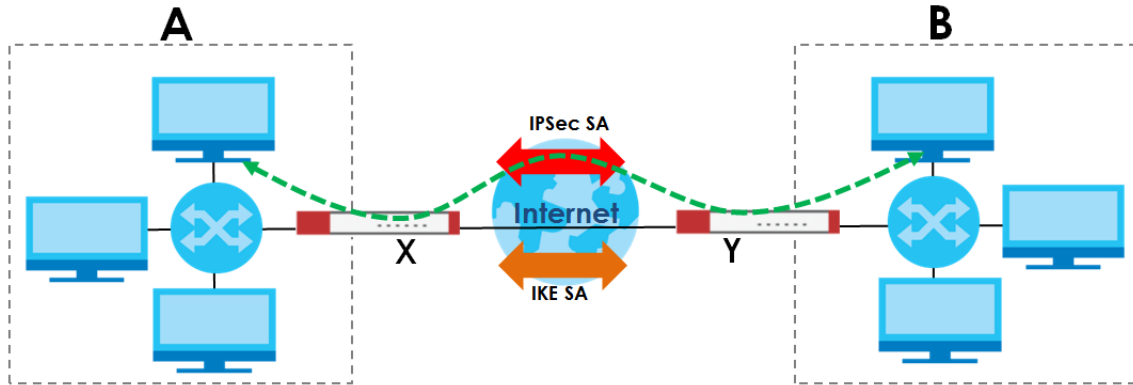
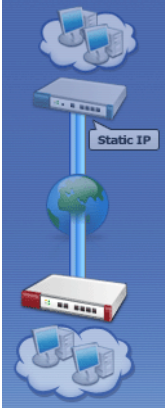
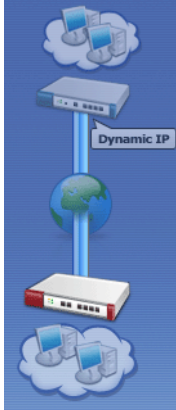



Figure 441 VPN: IKE SA and IPsec SA

In this example, a computer in network **A** is exchanging data with a computer in network **B**. Inside networks **A** and **B**, the data is transmitted the same way data is normally transmitted in the networks. Between routers **X** and **Y**, the data is protected by tunneling, encryption, authentication, and other security features of the IPsec SA. The IPsec SA is secure because routers **X** and **Y** established the IKE SA first.

Application Scenarios

The Zyxel Device's application scenarios make it easier to configure your VPN connection settings.

Table 224 IPsec VPN Application Scenarios

SITE-TO-SITE	SITE-TO-SITE WITH DYNAMIC PEER	REMOTE ACCESS (SERVER ROLE)	REMOTE ACCESS (CLIENT ROLE)	VPN TUNNEL INTERFACE
				
<p>Choose this if the remote IPsec router has a static IP address or a domain name.</p> <p>This Zyxel Device can initiate the VPN tunnel.</p> <p>The remote IPsec router can also initiate the VPN tunnel if this Zyxel Device has a static IP address or a domain name.</p>	<p>Choose this if the remote IPsec router has a dynamic IP address.</p> <p>You don't specify the remote IPsec router's address, but you specify the remote policy (the addresses of the devices behind the remote IPsec router).</p> <p>This Zyxel Device must have a static IP address or a domain name.</p> <p>Only the remote IPsec router can initiate the VPN tunnel.</p>	<p>Choose this to allow incoming connections from IPsec VPN clients.</p> <p>The clients have dynamic IP addresses and are also known as dial-in users.</p> <p>You don't specify the addresses of the client IPsec routers or the remote policy.</p> <p>This creates a dynamic IPsec VPN rule that can let multiple clients connect.</p> <p>Only the clients can initiate the VPN tunnel.</p>	<p>Choose this to connect to an IPsec server.</p> <p>This Zyxel Device is the client (dial-in user).</p> <p>Client role Zyxel Devices initiate IPsec VPN connections to a server role Zyxel Device.</p> <p>This Zyxel Device can have a dynamic IP address.</p> <p>The IPsec server doesn't configure this Zyxel Device's IP address or the addresses of the devices behind it.</p> <p>Only this Zyxel Device can initiate the VPN tunnel.</p>	<p>Choose this to set up a VPN tunnel interface to bind with a VPN connection.</p> <p>The Zyxel Device can use the interface to do load balancing using a specific Trunk. The remote IPsec router should have a static IP address or a domain name.</p>

Finding Out More

- See [Section 30.6 on page 662](#) for IPsec VPN background information.
- See the help in the IPsec VPN quick setup wizard screens.

30.1.3 Before You Begin

This section briefly explains the relationship between VPN tunnels and other features. It also gives some basic suggestions for troubleshooting.

You should set up the following features before you set up the VPN tunnel.

- In any VPN connection, you have to select address objects to specify the local policy and remote policy. You should set up the address objects first.
- In a VPN gateway, you can select an Ethernet interface, virtual Ethernet interface, VLAN interface, or virtual VLAN interface to specify what address the Zyxel Device uses as its IP address when it establishes the IKE SA. You should set up the interface first.
- In a VPN gateway, you can enable extended authentication. If the Zyxel Device is in server mode, you should set up the authentication method (AAA server) first. The authentication method specifies how the Zyxel Device authenticates the remote IPSec router.
- In a VPN gateway, the Zyxel Device and remote IPSec router can use certificates to authenticate each other. Make sure the Zyxel Device and the remote IPSec router will trust each other's certificates.

30.2 VPN Connection Screen

Click **Configuration > VPN > IPSec VPN** to open the **VPN Connection** screen. The **VPN Connection** screen lists the VPN connection policies and their associated VPN gateway(s), and various settings. In addition, it also lets you activate or deactivate and connect or disconnect each VPN connection (each IPSec SA). Click a column's heading cell to sort the table entries by that column's criteria. Click the heading cell again to reverse the sort order.

Click on the icons to go to the OneSecurity website where there is guidance on configuration walkthroughs, troubleshooting and other information.

Figure 442 Configuration > VPN > IPsec VPN > VPN Connection

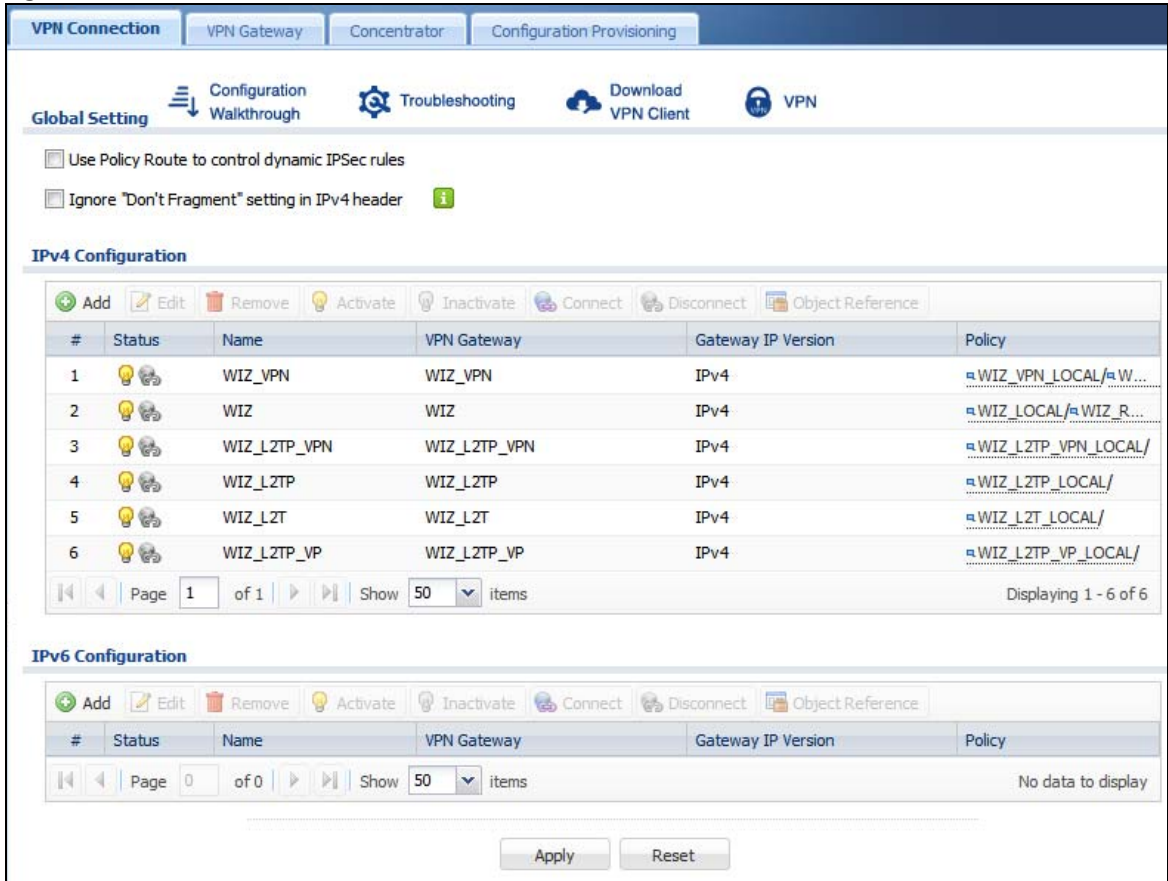

Each field is discussed in the following table.

Table 225 Configuration > VPN > IPsec VPN > VPN Connection

LABEL	DESCRIPTION
Global Setting	The following two fields are for all IPsec VPN policies. Click on the VPN icon to go to the Zyxel VPN Client product page at the Zyxel website.
Use Policy Route to control dynamic IPsec rules	Select this to be able to use policy routes to manually specify the destination addresses of dynamic IPsec rules. You must manually create these policy routes. The Zyxel Device automatically obtains source and destination addresses for dynamic IPsec rules that do not match any of the policy routes. Clear this to have the Zyxel Device automatically obtain source and destination addresses for all dynamic IPsec rules.
Ignore "Don't Fragment" setting in packet header	Select this to fragment packets larger than the MTU (Maximum Transmission Unit) that have the "Don't Fragment" bit in the IP header turned on. When you clear this the Zyxel Device drops packets larger than the MTU that have the "Don't Fragment" bit in the header turned on.
IPv4 / IPv6 Configuration	
Add	Click this to create a new entry.
Edit	Double-click an entry or select it and click Edit to open a screen where you can modify the entry's settings.

Table 225 Configuration > VPN > IPsec VPN > VPN Connection (continued)

LABEL	DESCRIPTION
Remove	To remove an entry, select it and click Remove . The Zyxel Device confirms you want to remove it before doing so.
Activate	To turn on an entry, select it and click Activate .
Inactivate	To turn off an entry, select it and click Inactivate .
Connect	To connect an IPsec SA, select it and click Connect .
Disconnect	To disconnect an IPsec SA, select it and click Disconnect .
Reference	Select an entry and click References to open a screen that shows which settings use the entry. See Section 10.4.4 on page 350 for an example.
#	This field is a sequential value, and it is not associated with a specific connection.
Status	The activate (light bulb) icon is lit when the entry is active and dimmed when the entry is inactive. The connect icon is lit when the interface is connected and dimmed when it is disconnected.
Name	This field displays the name of the IPsec SA.
VPN Gateway	This field displays the VPN gateway in use for this VPN connection.
Gateway IP Version	This field displays what IP version the associated VPN gateway(s) is using. An IPv4 gateway may use an IKEv1 or IKEv2 SA. An IPv6 gateway may use IKEv2 only.
Encapsulation	This field displays the type of encapsulation the VPN tunnel uses.
Algorithm	This field displays the hash algorithm that the VPN tunnel uses to authenticate packet data.
Policy	This field displays the local policy and the remote policy, respectively.
Apply	Click Apply to save your changes back to the Zyxel Device.
Reset	Click Reset to return the screen to its last-saved settings.

30.2.1 VPN Connection Add/Edit Screen

The **VPN Connection Add/Edit Gateway** screen allows you to create a new VPN connection policy or edit an existing one. To access this screen, go to the **Configuration > VPN Connection** screen (see [Section 30.2 on page 640](#)), and click either the **Add** icon or an **Edit** icon.

Figure 443 Configuration > VPN > IPsec VPN > VPN Connection > Add/Edit

Add VPN Connection ? X

Hide Advanced Settings Create new Object

General Settings

Enable

Connection Name:

Advance

Nailed-Up

Enable Replay Detection

Enable NetBIOS broadcast over IPsec

MSS Adjustment

Custom Size (200 - 1460 Bytes)

Auto

VPN Gateway

Application Scenario

Site-to-site

Site-to-site with Dynamic Peer

Remote Access (Server Role)

Remote Access (Client Role)

VPN Tunnel Interface

VPN Gateway:

Policy

Local policy:

Remote policy:

Advance

Enable GRE over IPsec

Policy Enforcement

Phase 2 Setting

SA Life Time: (180 - 3000000 Seconds)

Advance

Active Protocol:

Encapsulation:

Proposal

#	Encryption	Authentication
1	AES128	SHA1

Perfect Forward Security (PFS):

Related Settings

Zone:

Connectivity Check

Enable Connectivity Check

Check Method:

Check Period: (5-600 Seconds)

Check Timeout: (1-10 Seconds)

Check Fail Tolerance: (1-10)

Check This Address

Check the First and Last IP Address in the Remote Policy

Log

Advance

Inbound/Outbound traffic NAT

Outbound Traffic

Source NAT

Source:

Destination:

SNAT:

Inbound Traffic

Source NAT

Source:

Destination:

SNAT:

Destination NAT

#	Original IP	Mapped IP	Protocol	Original Port Start	Original Port End	Mapped Port Start	Mapped Port End
No data to display							

Page 0 of 0 | Show 50 items

Each field is described in the following table.

Table 226 Configuration > VPN > IPsec VPN > VPN Connection > Add/Edit

LABEL	DESCRIPTION
Show Advanced Settings / Hide Advanced Settings	Click this button to display a greater or lesser number of configuration fields.
Create new Object	Use to configure any new settings objects that you need to use in this screen.
General Settings	
Enable	Select this check box to activate this VPN connection.
Connection Name	Enter the name used to identify this IPsec SA. You may use 1 – 31 alphanumeric characters, underscores (_), or dashes (-), but the first character cannot be a number. This value is case-sensitive.
Nailed-Up	Select this if you want the Zyxel Device to automatically renegotiate the IPsec SA when the SA life time expires.
Enable Replay Detection	Select this check box to detect and reject old or duplicate packets to protect against Denial-of-Service attacks.
Enable NetBIOS Broadcast over IPsec	<p>Select this check box if you the Zyxel Device to send NetBIOS (Network Basic Input/Output System) packets through the IPsec SA.</p> <p>NetBIOS packets are TCP or UDP packets that enable a computer to connect to and communicate with a LAN. It may sometimes be necessary to allow NetBIOS packets to pass through IPsec SAs in order to allow local computers to find computers on the remote network and vice versa.</p>
MSS Adjustment	<p>Select Custom Size to set a specific number of bytes for the Maximum Segment Size (MSS) meaning the largest amount of data in a single TCP segment or IP datagram for this VPN connection.</p> <p>Some VPN clients may not be able to use a custom MSS size if it is set too small. In that case those VPN clients will ignore the size set here and use the minimum size that they can use.</p> <p>Select Auto to have the Zyxel Device automatically set the MSS for this VPN connection.</p>
Narrowed	<p>If the IP range on the Zyxel Device (local policy) and the local IP range on the remote IPsec router overlap in an IKEv2 SA, then you may select Narrowed to have the SA only apply to the IP addresses in common.</p> <p>Here are some examples.</p> <ul style="list-style-type: none"> • If the Zyxel Device (local policy) IP range is 192.168.20/24, the remote IPsec router local IP range is from 192.168.20.1 to 192.168.20.20, then the SA will only apply the IP addresses in common (192.168.20.1 to 192.168.20.20) after you select Narrowed. • If the Zyxel Device (local policy) IP range is from 192.168.30.50 to 192.168.30.70, the remote IPsec router local IP range is from 192.168.30.60 to 192.168.30.80, then the SA will only apply the IP addresses in common (192.168.30.60 to 192.168.30.70) after you select Narrowed.
VPN Gateway	

Table 226 Configuration > VPN > IPsec VPN > VPN Connection > Add/Edit (continued)

LABEL	DESCRIPTION
Application Scenario	<p>Select the scenario that best describes your intended VPN connection.</p> <p>Site-to-site – Choose this if the remote IPsec router has a static IP address or a domain name. This Zyxel Device can initiate the VPN tunnel.</p> <p>Site-to-site with Dynamic Peer – Choose this if the remote IPsec router has a dynamic IP address. Only the remote IPsec router can initiate the VPN tunnel.</p> <p>Remote Access (Server Role) – Choose this to allow incoming connections from IPsec VPN clients. The clients have dynamic IP addresses and are also known as dial-in users. Only the clients can initiate the VPN tunnel.</p> <p>Remote Access (Client Role) – Choose this to connect to an IPsec server. This Zyxel Device is the client (dial-in user) and can initiate the VPN tunnel.</p> <p>VPN Tunnel Interface – Choose this to set up a VPN tunnel interface to bind with a VPN connection. The Zyxel Device can use the interface to do load balancing using a specific Trunk. The remote IPsec router should have a static IP address or a domain name. See Configuration > Network > Interface > VTI.</p>
VPN Gateway	Select the VPN gateway this VPN connection is to use or select Create Object to add another VPN gateway for this VPN connection to use.
Policy	
Local Policy	Select the address corresponding to the local network. Use Create new Object if you need to configure a new one.
Remote Policy	Select the address corresponding to the remote network. Use Create new Object if you need to configure a new one.
Enable GRE over IPsec	Select this to allow traffic using the Generic Routing Encapsulation (GRE) tunneling protocol through an IPsec tunnel.
Policy Enforcement	<p>Clear this to allow traffic with source and destination IP addresses that do not match the local and remote policy to use the VPN tunnel. Leave this cleared for free access between the local and remote networks.</p> <p>Selecting this restricts who can use the VPN tunnel. The Zyxel Device drops traffic with source and destination IP addresses that do not match the local and remote policy.</p>
Mode Config	This is visible when you select Remote Access (Server Role) and a VPN Gateway .
Enable Mode Config	Select this to have the IPsec VPN client receive an IP address, DNS and WINS information from the Zyxel Device.
IP Address Pool	Select an address object from the drop-down list box.
First DNS Server (Optional)	The Domain Name System (DNS) maps a domain name to an IP address and vice versa. The Zyxel Device uses these (in the order you specify here) to resolve domain names for VPN. Enter a DNS server's IP address.
Second DNS Server (Optional)	Enter a secondary DNS server's IP address that is checked if the first one is unavailable.
First WINS Server (Optional)	Type the IP address of the WINS (Windows Internet Naming Service) server that you want to send to the DHCP clients. The WINS server keeps a mapping table of the computer names on your network and the IP addresses that they are currently using.
Second WINS Server (Optional)	Enter a secondary WINS server's IP address that is checked if the first one is unavailable.
Configuration Payload	This is only available when you have created an IKEv2 Gateway and are using Remote Access (Server Role) .
Enable Configuration Payload	Select this to have at least have the IP address pool included in the VPN setup data.
IP Address Pool:	Select an address object from the drop-down list box.

Table 226 Configuration > VPN > IPsec VPN > VPN Connection > Add/Edit (continued)

LABEL	DESCRIPTION
First DNS Server (optional)	The Domain Name System (DNS) maps a domain name to an IP address and vice versa. The Zyxel Device uses these (in the order you specify here) to resolve domain names for VPN. Enter a DNS server's IP address.
Second DNS Server (Optional)	Enter a secondary DNS server's IP address that is checked if the first one is unavailable.
First WINS Server (Optional)	Type the IP address of the WINS (Windows Internet Naming Service) server that you want to send to the DHCP clients. The WINS server keeps a mapping table of the computer names on your network and the IP addresses that they are currently using.
Second WINS Server (Optional)	Enter a secondary WINS server's IP address that is checked if the first one is unavailable.
Phase 2 Settings	
SA Life Time	Type the maximum number of seconds the IPsec SA can last. Shorter life times provide better security. The Zyxel Device automatically negotiates a new IPsec SA before the current one expires, if there are users who are accessing remote resources.
Active Protocol	<p>Select which protocol you want to use in the IPsec SA. Choices are:</p> <p>AH (RFC 2402) – provides integrity, authentication, sequence integrity (replay resistance), and non-repudiation but not encryption. If you select AH, you must select an Authentication algorithm.</p> <p>ESP (RFC 2406) – provides encryption and the same services offered by AH, but its authentication is weaker. If you select ESP, you must select an Encryption algorithm and Authentication algorithm.</p> <p>Both AH and ESP increase processing requirements and latency (delay).</p> <p>The Zyxel Device and remote IPsec router must use the same active protocol.</p>
Encapsulation	<p>Select which type of encapsulation the IPsec SA uses. Choices are</p> <p>Tunnel – this mode encrypts the IP header information and the data.</p> <p>Transport – this mode only encrypts the data.</p> <p>The Zyxel Device and remote IPsec router must use the same encapsulation.</p>
Proposal	Use this section to manage the encryption algorithm and authentication algorithm pairs the Zyxel Device accepts from the remote IPsec router for negotiating the IPsec SA.
Add	Click this to create a new entry.
Edit	Select an entry and click this to be able to modify it.
Remove	Select an entry and click this to delete it.
#	This field is a sequential value, and it is not associated with a specific proposal. The sequence of proposals should not affect performance significantly.

Table 226 Configuration > VPN > IPsec VPN > VPN Connection > Add/Edit (continued)

LABEL	DESCRIPTION
Encryption	<p>This field is applicable when the Active Protocol is ESP. Select which key size and encryption algorithm to use in the IPsec SA. Choices are:</p> <p>NULL – no encryption key or algorithm</p> <p>DES – a 56-bit key with the DES encryption algorithm</p> <p>3DES – a 168-bit key with the DES encryption algorithm</p> <p>AES128 – a 128-bit key with the AES encryption algorithm</p> <p>AES192 – a 192-bit key with the AES encryption algorithm</p> <p>AES256 – a 256-bit key with the AES encryption algorithm</p> <p>The Zyxel Device and the remote IPsec router must both have at least one proposal that uses use the same encryption and the same key.</p> <p>Longer keys are more secure, but require more processing power, resulting in increased latency and decreased throughput.</p>
Authentication	<p>Select which hash algorithm to use to authenticate packet data in the IPsec SA. Choices are SHA1, SHA256, SHA512 and MD5. SHA is generally considered stronger than MD5, but it is also slower.</p> <p>The Zyxel Device and the remote IPsec router must both have a proposal that uses the same authentication algorithm.</p>
Perfect Forward Secrecy (PFS)	<p>Select whether or not you want to enable Perfect Forward Secrecy (PFS) and, if you do, which Diffie-Hellman key group to use for encryption. Choices are:</p> <p>none – disable PFS</p> <p>DH1 – enable PFS and use a 768-bit random number</p> <p>DH2 – enable PFS and use a 1024-bit random number</p> <p>DH5 – enable PFS and use a 1536-bit random number</p> <p>DH14 – enable PFS and use a 2048 bit random number</p> <p>PFS changes the root key that is used to generate encryption keys for each IPsec SA. The longer the key, the more secure the encryption, but also the longer it takes to encrypt and decrypt information. Both routers must use the same DH key group.</p> <p>PFS is ignored in initial IKEv2 authentication but is used when re-authenticating.</p>
Related Settings	
Zone	<p>Select the security zone into which to add this VPN connection policy. Any security rules or settings configured for the selected zone apply to this VPN connection policy.</p>
Connectivity Check	<p>The Zyxel Device can regularly check the VPN connection to the gateway you specified to make sure it is still available.</p>
Enable Connectivity Check	<p>Select this to turn on the VPN connection check.</p>
Check Method	<p>Select how the Zyxel Device checks the connection. The peer must be configured to respond to the method you select.</p> <p>Select icmp to have the Zyxel Device regularly ping the address you specify to make sure traffic can still go through the connection. You may need to configure the peer to respond to pings.</p> <p>Select tcp to have the Zyxel Device regularly perform a TCP handshake with the address you specify to make sure traffic can still go through the connection. You may need to configure the peer to accept the TCP connection.</p>

Table 226 Configuration > VPN > IPsec VPN > VPN Connection > Add/Edit (continued)

LABEL	DESCRIPTION
Check Port	This field displays when you set the Check Method to tcp . Specify the port number to use for a TCP connectivity check.
Check Period	Enter the number of seconds between connection check attempts.
Check Timeout	Enter the number of seconds to wait for a response before the attempt is a failure.
Check Fail Tolerance	Enter the number of consecutive failures allowed before the Zyxel Device disconnects the VPN tunnel. The Zyxel Device resumes using the first peer gateway address when the VPN connection passes the connectivity check.
Check this Address	Select this to specify a domain name or IP address for the connectivity check. Enter that domain name or IP address in the field next to it.
Check the First and Last IP Address in the Remote Policy	Select this to have the Zyxel Device check the connection to the first and last IP addresses in the connection's remote policy. Make sure one of these is the peer gateway's LAN IP address.
Log	Select this to have the Zyxel Device generate a log every time it checks this VPN connection.
Inbound/Outbound traffic NAT	
Outbound Traffic	
Source NAT	This translation hides the source address of computers in the local network. It may also be necessary if you want the Zyxel Device to route packets from computers outside the local network through the IPsec SA.
Source	Select the address object that represents the original source address (or select Create Object to configure a new one). This is the address object for the computer or network outside the local network. The size of the original source address range (Source) must be equal to the size of the translated source address range (SNAT).
Destination	Select the address object that represents the original destination address (or select Create Object to configure a new one). This is the address object for the remote network.
SNAT	Select the address object that represents the translated source address (or select Create Object to configure a new one). This is the address object for the local network. The size of the original source address range (Source) must be equal to the size of the translated source address range (SNAT).
Inbound Traffic	
Source NAT	This translation hides the source address of computers in the remote network.
Source	Select the address object that represents the original source address (or select Create Object to configure a new one). This is the address object for the remote network. The size of the original source address range (Source) must be equal to the size of the translated source address range (SNAT).
Destination	Select the address object that represents the original destination address (or select Create Object to configure a new one). This is the address object for the local network.
SNAT	Select the address object that represents the translated source address (or select Create Object to configure a new one). This is the address that hides the original source address. The size of the original source address range (Source) must be equal to the size of the translated source address range (SNAT).
Destination NAT	This translation forwards packets (for example, mail) from the remote network to a specific computer (for example, the mail server) in the local network.
Add	Click this to create a new entry. Select an entry and click Add to create a new entry after the selected entry.
Edit	Select an entry and click this to be able to modify it.
Remove	Select an entry and click this to delete it.

Table 226 Configuration > VPN > IPsec VPN > VPN Connection > Add/Edit (continued)

LABEL	DESCRIPTION
Move	To change an entry's position in the numbered list, select it and click Move to display a field to type a number for where you want to put that entry and press [ENTER] to move the entry to the number that you typed.
#	This field is a sequential value, and it is not associated with a specific NAT record. However, the order of records is the sequence in which conditions are checked and executed.
Original IP	Select the address object that represents the original destination address. This is the address object for the remote network.
Mapped IP	Select the address object that represents the desired destination address. For example, this is the address object for the mail server.
Protocol	Select the protocol required to use this translation. Choices are: TCP , UDP , or All .
Original Port Start / Original Port End	These fields are available if the protocol is TCP or UDP . Enter the original destination port or range of original destination ports. The size of the original port range must be the same size as the size of the mapped port range.
Mapped Port Start / Mapped Port End	These fields are available if the protocol is TCP or UDP . Enter the translated destination port or range of translated destination ports. The size of the original port range must be the same size as the size of the mapped port range.
OK	Click OK to save the changes.
Cancel	Click Cancel to discard all changes and return to the main VPN screen.

30.3 VPN Gateway Screen

The **VPN Gateway** summary screen displays the IPsec VPN gateway policies in the Zyxel Device, as well as the Zyxel Device's address, remote IPsec router's address, and associated VPN connections for each one. In addition, it also lets you activate and deactivate each VPN gateway. To access this screen, click **Configuration > VPN > Network > IPsec VPN > VPN Gateway**. The following screen appears.

Figure 444 Configuration > VPN > IPsec VPN > VPN Gateway

The screenshot displays the 'VPN Gateway' configuration page. At the top, there are tabs for 'VPN Connection', 'VPN Gateway', 'Concentrator', and 'Configuration Provisioning'. Below the tabs, the 'IPv4 Configuration' section is active, showing a table of VPN gateway policies. The table has columns for '#', 'Status', 'Name', 'My Address', 'Secure Gateway', 'VPN Connection', and 'IKE V...'. There are 6 entries listed. Below the table, there are navigation controls for 'Page 1 of 1' and 'Show 50 items'. The 'IPv6 Configuration' section below it shows 'Page 0 of 0' and 'No data to display'. At the bottom of the screen, there are 'Apply' and 'Reset' buttons.

#	Status	Name	My Address	Secure Gateway	VPN Connection	IKE V...
1	🔦	WIZ_VPN	wan1	1.1.1.1	WIZ_VPN	IKEv1
2	🔦	WIZ	wan1	1.1.1.1	WIZ	IKEv1
3	🔦	WIZ_L2TP_VPN	wan1	0.0.0.0	WIZ_L2TP_VPN	IKEv1
4	🔦	WIZ_L2TP	wan1	0.0.0.0	WIZ_L2TP	IKEv1
5	🔦	WIZ_L2T	wan1	0.0.0.0	WIZ_L2T	IKEv1
6	🔦	WIZ_L2TP_VP	wan1	0.0.0.0	WIZ_L2TP_VP	IKEv1

Each field is discussed in the following table. See [Section 30.3.1 on page 650](#) for more information.

Table 227 Configuration > VPN > IPsec VPN > VPN Gateway

LABEL	DESCRIPTION
Add	Click this to create a new entry.
Edit	Double-click an entry or select it and click Edit to open a screen where you can modify the entry's settings.
Remove	To remove an entry, select it and click Remove . The Zyxel Device confirms you want to remove it before doing so.
Activate	To turn on an entry, select it and click Activate .
Inactivate	To turn off an entry, select it and click Inactivate .
References	Select an entry and click References to open a screen that shows which settings use the entry. See Section 10.4.4 on page 350 for an example.
#	This field is a sequential value, and it is not associated with a specific VPN gateway.
Status	The activate (light bulb) icon is lit when the entry is active and dimmed when the entry is inactive.
Name	This field displays the name of the VPN gateway.
My address	This field displays the interface or a domain name the Zyxel Device uses for the VPN gateway.
Secure Gateway	This field displays the IP address(es) of the remote IPsec routers.
VPN Connection	This field displays VPN connections that use this VPN gateway.
IKE Version	This field displays whether the gateway is using IKEv1 or IKEv2 . IKEv1 applies to IPv4 traffic only. IKEv2 applies to both IPv4 and IPv6 traffic. IKE (Internet Key Exchange) is a protocol used in setting up security associations that allows two parties to send data securely. See Section 30.1 on page 635 for more information on IKEv1 and IKEv2.
Apply	Click Apply to save your changes back to the Zyxel Device.
Reset	Click Reset to return the screen to its last-saved settings.

30.3.1 VPN Gateway Add/Edit Screen

The **VPN Gateway Add/Edit** screen allows you to create a new VPN gateway policy or edit an existing one. To access this screen, go to the **VPN Gateway summary** screen (see [Section 30.3 on page 649](#)), and click either the **Add** icon or an **Edit** icon.

Figure 445 Configuration > VPN > IPsec VPN > VPN Gateway > Add/Edit

Add VPN Gateway
? X

Hide Advanced Settings Create new Object

General Settings

Enable

VPN Gateway Name:

IKE Version

IKEv1

IKEv2

Gateway Settings

My Address

Interface: wan1 DHCP client -- 172.21.56.51/255.255.25

Domain Name / IPv4:

Peer Gateway Address

Static Address i

Primary:

Secondary:

Fall back to Primary Peer Gateway when possible

Fall Back Check Interval: (60-86400 seconds)

Dynamic Address i

Authentication

Pre-Shared Key:

unmasked

Certificate: Example (See [My Certificates](#))

User Based PSK: admin i

Advance

Local ID Type: IPv4

Content:

Peer ID Type: Any

Content:

Phase 1 Settings

SA Life Time: (180 - 3000000 Seconds)

Negotiation Mode: Aggressive

Advance

Proposal

#	Encryption	Authentication
1	DES	MD5

Key Group: DH1

NAT Traversal

Dead Peer Detection (DPD)

X-Auth

Enable Extended Authentication

Server Mode

AAA Method: default

Allowed User: any

Client Mode

User Name:

Password:

Retype to Confirm:

Each field is described in the following table.

Table 228 Configuration > VPN > IPsec VPN > VPN Gateway > Add/Edit

LABEL	DESCRIPTION
Show Advanced Settings / Hide Advanced Settings	Click this button to display a greater or lesser number of configuration fields.
Create New Object	Use to configure any new settings objects that you need to use in this screen.
General Settings	
Enable	Select this to activate the VPN Gateway policy.
VPN Gateway Name	Enter the name used to identify this VPN gateway. You may use 1 – 31 alphanumeric characters, underscores(_), or dashes (-), but the first character cannot be a number. This value is case-sensitive.
IKE Version	
IKEv1 / IKEv2	Select IKEv1 or IKEv2 . IKEv1 applies to IPv4 traffic only. IKEv2 applies to both IPv4 and IPv6 traffic. IKE (Internet Key Exchange) is a protocol used in setting up security associations that allows two parties to send data securely. See Section 30.1 on page 635 for more information on IKEv1 and IKEv2.
Gateway Settings	
My Address	<p>Select how the IP address of the Zyxel Device in the IKE SA is defined.</p> <p>If you select Interface, select the Ethernet interface, VLAN interface, virtual Ethernet interface, virtual VLAN interface or PPPoE/PPTP interface. The IP address of the Zyxel Device in the IKE SA is the IP address of the interface.</p> <p>If you select Domain Name / IP, enter the domain name or the IP address of the Zyxel Device. The IP address of the Zyxel Device in the IKE SA is the specified IP address or the IP address corresponding to the domain name. 0.0.0.0 is not generally recommended as it has the Zyxel Device accept IPsec requests destined for any interface address on the Zyxel Device.</p>
Peer Gateway Address	<p>Select how the IP address of the remote IPsec router in the IKE SA is defined.</p> <p>Select Static Address to enter the domain name or the IP address of the remote IPsec router. You can provide a second IP address or domain name for the Zyxel Device to try if it cannot establish an IKE SA with the first one.</p> <p>Fall back to Primary Peer Gateway when possible: When you select this, if the connection to the primary address goes down and the Zyxel Device changes to using the secondary connection, the Zyxel Device will reconnect to the primary address when it becomes available again and stop using the secondary connection. Users will lose their VPN connection briefly while the Zyxel Device changes back to the primary connection. To use this, the peer device at the secondary address cannot be set to use a nailed-up VPN connection. In the Fallback Check Interval field, set how often to check if the primary address is available.</p> <p>Select Dynamic Address if the remote IPsec router has a dynamic IP address (and does not use DDNS).</p>
Authentication	<p>Note: The Zyxel Device and remote IPsec router must use the same authentication method to establish the IKE SA.</p>

Table 228 Configuration > VPN > IPsec VPN > VPN Gateway > Add/Edit (continued)

LABEL	DESCRIPTION
Pre-Shared Key	<p>Select this to have the Zyxel Device and remote IPsec router use a pre-shared key (password) of up to 128 characters to identify each other when they negotiate the IKE SA. Type the pre-shared key in the field to the right. The pre-shared key can be:</p> <ul style="list-style-type: none"> alphanumeric characters or ;: `~!@#\$\$%^&*()_+ \{}':./<>=" pairs of hexadecimal (0-9, A-F) characters, preceded by "0x". <p>Type "0x" at the beginning of a hexadecimal key. For example, "0x0123456789ABCDEF" is in hexadecimal format; "0123456789ABCDEF" is in ASCII format. If you use hexadecimal, you must enter twice as many characters since you need to enter pairs.</p> <p>The Zyxel Device and remote IPsec router must use the same pre-shared key.</p> <p>Select unmasked to see the pre-shared key in readable plain text.</p>
Certificate	<p>Select this to have the Zyxel Device and remote IPsec router use certificates to authenticate each other when they negotiate the IKE SA. Then select the certificate the Zyxel Device uses to identify itself to the remote IPsec router.</p> <p>This certificate is one of the certificates in My Certificates. If this certificate is self-signed, import it into the remote IPsec router. If this certificate is signed by a CA, the remote IPsec router must trust that CA.</p> <p>Note: The IPsec routers must trust each other's certificates.</p> <p>The Zyxel Device uses one of its Trusted Certificates to authenticate the remote IPsec router's certificate. The trusted certificate can be a self-signed certificate or that of a trusted CA that signed the remote IPsec router's certificate.</p>
User-based PSK	<p>User-based PSK (IKEv1 only) generates and manages separate pre-shared keys for every user. This enables multiple users, each with a unique key, to access the same VPN gateway policy with one-to-one authentication and strong encryption. Access can be denied on a per-user basis thus allowing VPN SA user-based policies. Click User-Based PSK then select a user or group object who is allowed VPN SA access using this VPN gateway policy. This is for IKEv1 only.</p>
Local ID Type	<p>This field is read-only if the Zyxel Device and remote IPsec router use certificates to identify each other. Select which type of identification is used to identify the Zyxel Device during authentication. Choices are:</p> <p>IPv4 or IPv6 – the Zyxel Device is identified by an IP address</p> <p>DNS – the Zyxel Device is identified by a domain name</p> <p>E-mail – the Zyxel Device is identified by the string specified in this field</p>
Content	<p>This field is read-only if the Zyxel Device and remote IPsec router use certificates to identify each other. Type the identity of the Zyxel Device during authentication. The identity depends on the Local ID Type.</p> <p>IP – type an IP address; if you type 0.0.0.0, the Zyxel Device uses the IP address specified in the My Address field. This is not recommended in the following situations:</p> <ul style="list-style-type: none"> There is a NAT router between the Zyxel Device and remote IPsec router. You want the remote IPsec router to be able to distinguish between IPsec SA requests that come from IPsec routers with dynamic WAN IP addresses. <p>In these situations, use a different IP address, or use a different Local ID Type.</p> <p>DNS – type the fully qualified domain name (FQDN). This value is only used for identification and can be any string that matches the peer ID string.</p> <p>E-mail – the Zyxel Device is identified by the string you specify here; you can use up to 63 ASCII characters including spaces, although trailing spaces are truncated. This value is only used for identification and can be any string.</p>

Table 228 Configuration > VPN > IPsec VPN > VPN Gateway > Add/Edit (continued)

LABEL	DESCRIPTION
Peer ID Type	<p>Select which type of identification is used to identify the remote IPsec router during authentication. Choices are:</p> <p>IP – the remote IPsec router is identified by an IP address</p> <p>DNS – the remote IPsec router is identified by a domain name</p> <p>E-mail – the remote IPsec router is identified by the string specified in this field</p> <p>Any – the Zyxel Device does not check the identity of the remote IPsec router</p> <p>If the Zyxel Device and remote IPsec router use certificates, there is one more choice.</p> <p>Subject Name – the remote IPsec router is identified by the subject name in the certificate</p>
Content	<p>This field is disabled if the Peer ID Type is Any. Type the identity of the remote IPsec router during authentication. The identity depends on the Peer ID Type.</p> <p>If the Zyxel Device and remote IPsec router do not use certificates,</p> <p>IP – type an IP address; see the note at the end of this description.</p> <p>DNS – type the fully qualified domain name (FQDN). This value is only used for identification and can be any string that matches the peer ID string.</p> <p>E-mail – the remote IPsec router is identified by the string you specify here; you can use up to 31 ASCII characters including spaces, although trailing spaces are truncated. This value is only used for identification and can be any string.</p> <p>If the Zyxel Device and remote IPsec router use certificates, type the following fields from the certificate used by the remote IPsec router.</p> <p>IP – subject alternative name field; see the note at the end of this description.</p> <p>DNS – subject alternative name field</p> <p>E-mail – subject alternative name field</p> <p>Subject Name – subject name (maximum 255 ASCII characters, including spaces)</p> <p>Note: If Peer ID Type is IP, please read the rest of this section.</p> <p>If you type 0.0.0.0, the Zyxel Device uses the IP address specified in the Secure Gateway Address field. This is not recommended in the following situations:</p> <ul style="list-style-type: none"> • There is a NAT router between the Zyxel Device and remote IPsec router. • You want the remote IPsec router to be able to distinguish between IPsec SA requests that come from IPsec routers with dynamic WAN IP addresses. <p>In these situations, use a different IP address, or use a different Peer ID Type.</p>
Phase 1 Settings	
SA Life Time (Seconds)	<p>Type the maximum number of seconds the IKE SA can last. When this time has passed, the Zyxel Device and remote IPsec router have to update the encryption and authentication keys and re-negotiate the IKE SA. This does not affect any existing IPsec SAs, however.</p>
Negotiation Mode	<p>Select the negotiation mode to use to negotiate the IKE SA. Choices are</p> <p>Main – this encrypts the Zyxel Device's and remote IPsec router's identities but takes more time to establish the IKE SA</p> <p>Aggressive – this is faster but does not encrypt the identities</p> <p>The Zyxel Device and the remote IPsec router must use the same negotiation mode.</p>
Proposal	<p>Use this section to manage the encryption algorithm and authentication algorithm pairs the Zyxel Device accepts from the remote IPsec router for negotiating the IKE SA.</p>
Add	<p>Click this to create a new entry.</p>

Table 228 Configuration > VPN > IPsec VPN > VPN Gateway > Add/Edit (continued)

LABEL	DESCRIPTION
Edit	Select an entry and click this to be able to modify it.
Remove	Select an entry and click this to delete it.
#	This field is a sequential value, and it is not associated with a specific proposal. The sequence of proposals should not affect performance significantly.
Encryption	Select which key size and encryption algorithm to use in the IKE SA. Choices are: DES – a 56-bit key with the DES encryption algorithm 3DES – a 168-bit key with the DES encryption algorithm AES128 – a 128-bit key with the AES encryption algorithm AES192 – a 192-bit key with the AES encryption algorithm AES256 – a 256-bit key with the AES encryption algorithm The Zyxel Device and the remote IPsec router must use the same key size and encryption algorithm. Longer keys require more processing power, resulting in increased latency and decreased throughput.
Authentication	Select which hash algorithm to use to authenticate packet data in the IPsec SA. Choices are SHA1 , SHA256 , SHA512 and MD5 . SHA is generally considered stronger than MD5 , but it is also slower. The remote IPsec router must use the same authentication algorithm.
Key Group	Select which Diffie-Hellman key group (DHx) you want to use for encryption keys. Choices are: DH1 – use a 768-bit random number DH2 – use a 1024-bit random number DH5 – use a 1536-bit random number DH14 – use a 2048 bit random number The longer the key, the more secure the encryption, but also the longer it takes to encrypt and decrypt information. Both routers must use the same DH key group.
NAT Traversal	Select this if any of these conditions are satisfied. <ul style="list-style-type: none"> This IKE SA might be used to negotiate IPsec SAs that use ESP as the active protocol. There are one or more NAT routers between the Zyxel Device and remote IPsec router, and these routers do not support IPsec pass-thru or a similar feature. The remote IPsec router must also enable NAT traversal, and the NAT routers have to forward packets with UDP port 500 and UDP 4500 headers unchanged. This field applies for IKEv1 only. NAT Traversal is always performed when you use IKEv2.
Dead Peer Detection (DPD)	Select this check box if you want the Zyxel Device to make sure the remote IPsec router is there before it transmits data through the IKE SA. The remote IPsec router must support DPD. If there has been no traffic for at least 15 seconds, the Zyxel Device sends a message to the remote IPsec router. If the remote IPsec router responds, the Zyxel Device transmits the data. If the remote IPsec router does not respond, the Zyxel Device shuts down the IKE SA. If the remote IPsec router does not support DPD, see if you can use the VPN connection connectivity check (see Section 30.2.1 on page 642). This field applies for IKEv1 only. Dead Peer Detection (DPD) is always performed when you use IKEv2.
X Auth / Extended Authentication Protocol	This part of the screen displays X-Auth when using IKEv1 and Extended Authentication Protocol when using IKEv2 .

Table 228 Configuration > VPN > IPsec VPN > VPN Gateway > Add/Edit (continued)

LABEL	DESCRIPTION
X-Auth	This displays when using IKEv1. When different users use the same VPN tunnel to connect to the Zyxel Device (telecommuters sharing a tunnel for example), use X-auth to enforce a user name and password check. This way even though telecommuters all know the VPN tunnel's security settings, each still has to provide a unique user name and password.
Enable Extended Authentication	Select this if one of the routers (the Zyxel Device or the remote IPsec router) verifies a user name and password from the other router using the local user database and/or an external server.
Server Mode	Select this if the Zyxel Device authenticates the user name and password from the remote IPsec router. You also have to select the authentication method, which specifies how the Zyxel Device authenticates this information.
AAA Method	Select the authentication method, which specifies how the Zyxel Device authenticates this information.
Allowed User	Extended authentication now supports an allowed user. Select what users should be authenticated.
Client Mode	Select this radio button if the Zyxel Device provides a username and password to the remote IPsec router for authentication. You also have to provide the User Name and the Password .
User Name	This field is required if the Zyxel Device is in Client Mode for extended authentication. Enter the user name the Zyxel Device sends to the remote IPsec router. The user name can be 1 – 31 ASCII characters. It is case-sensitive, but spaces are not allowed.
Password	This field is required if the Zyxel Device is in Client Mode for extended authentication. Enter the password the Zyxel Device sends to the remote IPsec router. The password can be 1 – 31 ASCII characters. It is case-sensitive, but spaces are not allowed.
Retype to Confirm	Enter the exact same password again here to make sure an error was not made when typing it originally.
Extended Authentication Protocol	This displays when using IKEv2 . EAP uses a certificate for authentication.
Allowed Auth Method	This field displays the authentication method that is used to authenticate users.
Enable Extended Authentication	Select this if one of the routers (the Zyxel Device or the remote IPsec router) verifies a user name and password from the other router using the local user database and/or an external server or a certificate.
Server Mode	Select this if the Zyxel Device authenticates the user name and password from the remote IPsec router. You also have to select an AAA method, which specifies how the Zyxel Device authenticates this information and who may be authenticated (Allowed User).
Client Mode	Select this radio button if the Zyxel Device provides a username and password to the remote IPsec router for authentication. You also have to provide the User Name and the Password .
User Name	This field is required if the Zyxel Device is in Client Mode for extended authentication. Type the user name the Zyxel Device sends to the remote IPsec router. The user name can be 1 – 31 ASCII characters. It is case-sensitive, but spaces are not allowed.
Password	This field is required if the Zyxel Device is in Client Mode for extended authentication. Type the password the Zyxel Device sends to the remote IPsec router. The password can be 1 – 31 ASCII characters. It is case-sensitive, but spaces are not allowed.
Retype to Confirm	Type the exact same password again here to make sure an error was not made when typing it originally.
OK	Click OK to save your settings and exit this screen.
Cancel	Click Cancel to exit this screen without saving.

30.4 VPN Concentrator

A VPN concentrator combines several IPsec VPN connections into one secure network.

Figure 446 VPN Topologies (Fully Meshed and Hub and Spoke)

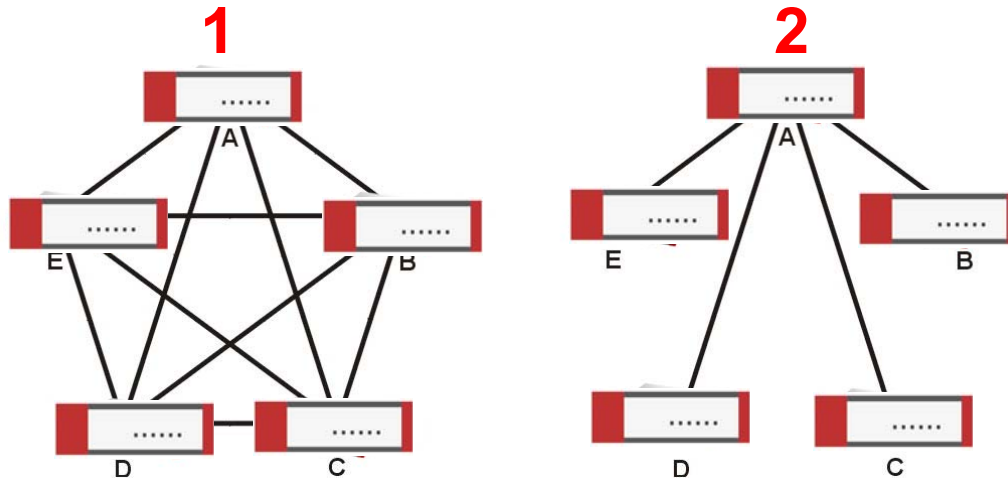

In a fully-meshed VPN topology (1 in the figure), there is a VPN connection between every pair of routers. In a hub-and-spoke VPN topology (2 in the figure), there is a VPN connection between each spoke router (B, C, D, and E) and the hub router (A), which uses the VPN concentrator. The VPN concentrator routes VPN traffic between the spoke routers and itself.

A VPN concentrator reduces the number of VPN connections that you have to set up and maintain in the network. You might also be able to consolidate the policy routes in each spoke router, depending on the IP addresses and subnets of each spoke.

However a VPN concentrator is not for every situation. The hub router is a single failure point, so a VPN concentrator is not as appropriate if the connection between spoke routers cannot be down occasionally (maintenance, for example). There is also more burden on the hub router. It receives VPN traffic from one spoke, decrypts it, inspects it to find out to which spoke to route it, encrypts it, and sends it to the appropriate spoke. Therefore, a VPN concentrator is more suitable when there is a minimum amount of traffic between spoke routers.

30.4.1 VPN Concentrator Requirements and Suggestions

Consider the following when using the VPN concentrator.

- The local IP addresses configured in the VPN rules should not overlap.
- The concentrator must have at least one separate VPN rule for each spoke. In the local policy, specify the IP addresses of the networks with which the spoke is to be able to have a VPN tunnel. This may require you to use more than one VPN rule for each spoke.
- To have all Internet access from the spoke routers go through the VPN tunnel, set the VPN rules in the spoke routers to use 0.0.0.0 (any) as the remote IP address.
- Your security policies can still block VPN packets.

30.4.2 VPN Concentrator Screen

The **VPN Concentrator** summary screen displays the VPN concentrators in the Zyxel Device. To access this screen, click **Configuration > VPN > IPsec VPN > Concentrator**.

Figure 447 Configuration > VPN > IPsec VPN > Concentrator

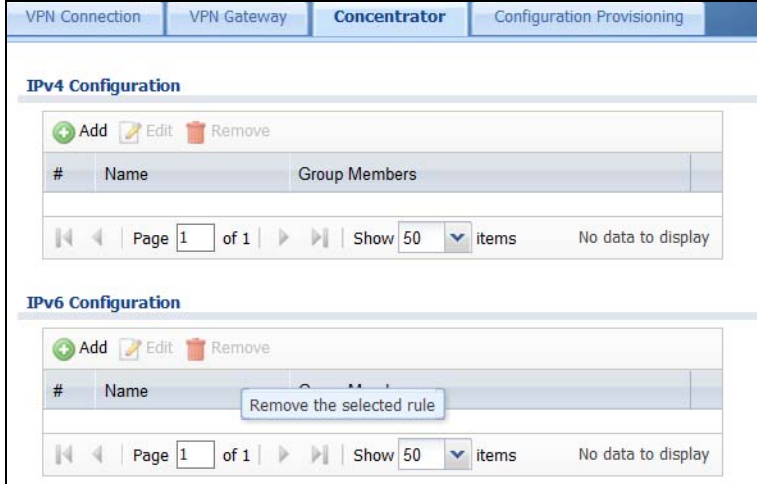

Each field is discussed in the following table. See [Section 30.4.3 on page 658](#) for more information.

Table 229 Configuration > VPN > IPsec VPN > Concentrator

LABEL	DESCRIPTION
IPv4/IPv6 Configuration	Choose to configure for IPv4 or IPv6 traffic.
Add	Click this to create a new entry.
Edit	Select an entry and click this to be able to modify it.
Remove	Select an entry and click this to delete it.
#	This field is a sequential value, and it is not associated with a specific concentrator.
Name	This field displays the name of the VPN concentrator.
Group Members	These are the VPN connection policies that are part of the VPN concentrator.

30.4.3 VPN Concentrator Add/Edit Screen

Use the **VPN Concentrator Add/Edit** screen to create or edit a VPN concentrator. To access this screen, go to the **VPN Concentrator summary** screen (see [Section 30.4 on page 657](#)), and click either the **Add** icon or an **Edit** icon.

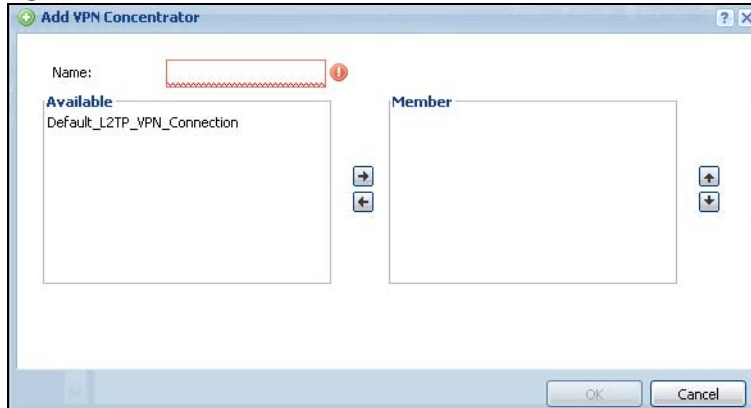
Figure 448 Configuration > VPN > IPsec VPN > Concentrator > Add/Edit

Each field is described in the following table.

Table 230 VPN > IPsec VPN > Concentrator > Add/Edit

LABEL	DESCRIPTION
Name	Enter the name of the concentrator. You may use 1-31 alphanumeric characters, underscores(_), or dashes (-), but the first character cannot be a number. This value is case-sensitive.
Member	<p>Select the concentrator's IPsec VPN connection policies.</p> <p>Note: You must disable policy enforcement in each member. See Section 30.2.1 on page 642.</p> <p>IPsec VPN connection policies that do not belong to a VPN concentrator appear under Available. Select any VPN connection policies that you want to add to the VPN concentrator and click the right arrow button to add them.</p> <p>The VPN concentrator's member VPN connections appear under Member. Select any VPN connections that you want to remove from the VPN concentrator, and click the left arrow button to remove them.</p>
OK	Click OK to save your changes in the Zyxel Device.
Cancel	Click Cancel to exit this screen without saving.

30.5 Zyxel Device IPsec VPN Client Configuration Provisioning

Use the **Configuration > VPN > IPsec VPN > Configuration Provisioning** screen to configure who can retrieve VPN rule settings from the Zyxel Device using the Zyxel Device IPsec VPN Client. In the Zyxel Device IPsec VPN Client, you just need to enter the IP address of the Zyxel Device to get all the VPN rule settings automatically. You do not need to manually configure all rule settings in the Zyxel Device IPsec VPN client.

VPN rules for the Zyxel Device IPsec VPN Client have certain restrictions. They must *not* contain the following settings:

- **AH** active protocol
- **NULL** encryption
- **SHA512** authentication

- A subnet or range remote policy

The following VPN Gateway rules configured on the Zyxel Device cannot be provisioned to the IPsec VPN Client:

- IPv4 rules with IKEv2 version
- IPv4 rules with User-based PSK authentication

Note: You must enable IPv6 in System > IPv6 to activate IPv6 VPN tunneling rules.

In the Zyxel Device **Quick Setup** wizard, you can use the **VPN Settings for Configuration Provisioning** wizard to create a VPN rule that will not violate these restrictions.

Figure 449 Configuration > VPN > IPsec VPN > Configuration Provisioning

The screenshot shows the 'Configuration Provisioning' tab in the Zyxel Device web interface. It includes sections for General Settings, Authentication, and Configuration. The 'Enable Configuration Provisioning' checkbox is checked. The 'VPN Provisioning Port' is set to 443. The 'Client Authentication Method' is set to 'RemoteAccess_Wi'. A table below shows a single configuration item with ID 1, priority 1, type 4in4, and name 'RemoteAccess_L2TP_Wiz'. The table has columns for #, St..., Priority, Type, VPN Connection, Upload Bandwid..., and Allowed User. At the bottom of the page are 'Apply' and 'Reset' buttons.

Each field is discussed in the following table.

Table 231 Configuration > VPN > IPsec VPN > Configuration Provisioning

LABEL	DESCRIPTION
Enable Configuration Provisioning	Select this for users to be able to retrieve VPN rule settings using the Zyxel Device IPsec VPN client.
VPN Provisioning Port	Change the default port that IPsec VPN clients use to retrieve VPN rule settings from the Zyxel Device. The default is 443 which is already in use for remote management by default. If you change the default IPsec VPN port on the Zyxel Device, make sure to make the same change to the Zyxel IPsec VPN client. See Section 1.5.2 on page 39 for more information. Configure a new port between 1024 to 65535 that is not in use by other services.

Table 231 Configuration > VPN > IPsec VPN > Configuration Provisioning (continued)

LABEL	DESCRIPTION
Client Authentication Method	Choose how users should be authenticated. They can be authenticated using the local database on the Zyxel Device or an external authentication database such as LDAP, Active Directory or RADIUS. default is a method you configured in Object > Auth Method . You may configure multiple methods there. If you choose the local database on the Zyxel Device, then configure users using the Object > User/Group screen. If you choose LDAP, Active Directory or RADIUS authentication servers, then configure users on the respective server.
Configuration	<p>When you add or edit a configuration provisioning entry, you are allowed to set the VPN Connection and Allowed User fields.</p> <p>Duplicate entries are not allowed. You cannot select the same VPN Connection and Allowed User pair in a new entry if the same pair exists in a previous entry.</p> <p>You can bind different rules to the same user, but the Zyxel Device will only allow VPN rule setting retrieval for the first match found.</p>
Add	<p>Click Add to bind a configured VPN rule to a user or group. Only that user or group may then retrieve the specified VPN rule settings.</p> <p>If you click Add without selecting an entry in advance then the new entry appears as the first entry. Entry order is important as the Zyxel Device searches entries in the order listed here to find a match. After a match is found, the Zyxel Device stops searching. If you want to add an entry as number three for example, then first select entry 2 and click Add. To reorder an entry, use Move.</p>
Edit	Select an existing entry and click Edit to change its settings.
Remove	To remove an entry, select it and click Remove . The Zyxel Device confirms you want to remove it before doing so.
Activate	To turn on an entry, select it and click Activate . Make sure that Enable Configuration Provisioning is also selected.
Inactivate	To turn off an entry, select it and click Inactivate .
Move	Use Move to reorder a selected entry. Select an entry, click Move , type the number where the entry should be moved, press <ENTER>, then click Apply .
Status	This icon shows if the entry is active (yellow) or not (gray). VPN rule settings can only be retrieved when the entry is activated (and Enable Configuration Provisioning is also selected).
Priority	Priority shows the order of the entry in the list. Entry order is important as the Zyxel Device searches entries in the order listed here to find a match. After a match is found the Zyxel Device stops searching.
VPN Connection	This field shows all configured VPN rules that match the rule criteria for the Zyxel Device IPsec VPN client. Select a rule to bind to the associated user or group.
Upload Bandwidth Limit	<p>Upload Bandwidth Limit is only available for Zyxel subscription-based SecuExtender IPsec VPN clients with Windows version 5.6.80.007 or later or macOS version 1.2.0.7 or later.</p> <p>Use Upload Bandwidth Limit to set the maximum bandwidth for uploading traffic from Zyxel IPsec VPN clients over IPsec VPN tunnels.</p>
Allowed User	<p>Select which user or group of users is allowed to retrieve the associated VPN rule settings using the Zyxel Device IPsec VPN client. A user may belong to a number of groups. If entries are configured for different groups, the Zyxel Device will allow VPN rule setting retrieval based on the first match found.</p> <p>Users of type admin or limited-admin are not allowed.</p>
Type	<p>This field shows how traffic is tunneled from the Zyxel Device to the Zyxel VPN client:</p> <ul style="list-style-type: none"> • 6in4 (tunnel IPv6 traffic from the Zyxel Device to the Zyxel client in an IPv4 network); • 4in6 (tunnel IPv4 traffic from the Zyxel Device to the Zyxel VPN client in an IPv6 network); • 4in4 (tunnel IPv4 traffic from the Zyxel Device to the Zyxel VPN client in an IPv4 network).
Apply	Click Apply to save your changes back to the Zyxel Device.
Reset	Click Reset to return the screen to its last-saved settings.

30.6 IPsec VPN Background Information

Here is some more detailed IPsec VPN background information.

IKE SA Overview

The IKE SA provides a secure connection between the Zyxel Device and remote IPsec router.

It takes several steps to establish an IKE SA. The negotiation mode determines how many. There are two negotiation modes – main mode and aggressive mode. Main mode provides better security, while aggressive mode is faster.

Note: Both routers must use the same negotiation mode.

These modes are discussed in more detail in [Negotiation Mode](#). Main mode is used in various examples in the rest of this section.

The Zyxel Device supports IKEv1 and IKEv2. See [Section 30.1 on page 635](#) for more information.

IP Addresses of the Zyxel Device and Remote IPsec Router

To set up an IKE SA, you have to specify the IP addresses of the Zyxel Device and remote IPsec router. You can usually enter a static IP address or a domain name for either or both IP addresses. Sometimes, your Zyxel Device might offer another alternative, such as using the IP address of a port or interface, as well.

You can also specify the IP address of the remote IPsec router as 0.0.0.0. This means that the remote IPsec router can have any IP address. In this case, only the remote IPsec router can initiate an IKE SA because the Zyxel Device does not know the IP address of the remote IPsec router. This is often used for telecommuters.

IKE SA Proposal

The IKE SA proposal is used to identify the encryption algorithm, authentication algorithm, and Diffie-Hellman (DH) key group that the Zyxel Device and remote IPsec router use in the IKE SA. In main mode, this is done in steps 1 and 2, as illustrated next.

Figure 450 IKE SA: Main Negotiation Mode, Steps 1 - 2: IKE SA Proposal

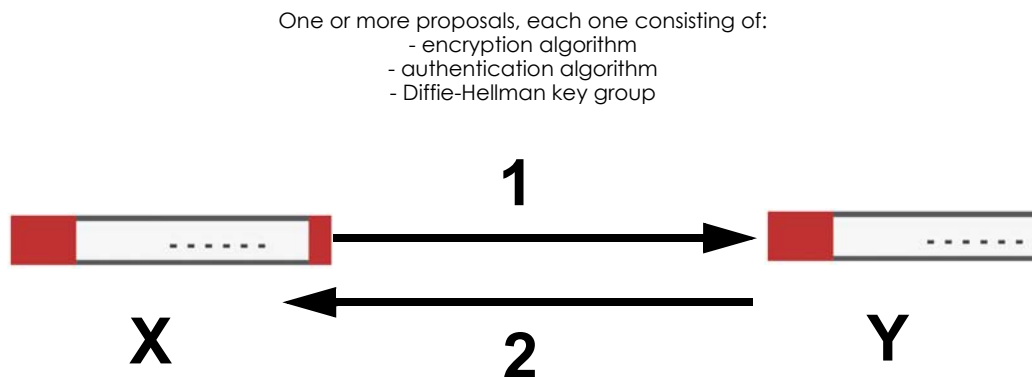

The Zyxel Device sends one or more proposals to the remote IPsec router. (In some devices, you can only set up one proposal.) Each proposal consists of an encryption algorithm, authentication algorithm, and DH key group that the Zyxel Device wants to use in the IKE SA. The remote IPsec router selects an acceptable proposal and sends the accepted proposal back to the Zyxel Device. If the remote IPsec router rejects all of the proposals, the Zyxel Device and remote IPsec router cannot establish an IKE SA.

Note: Both routers must use the same encryption algorithm, authentication algorithm, and DH key group.

In most Zyxel Devices, you can select one of the following encryption algorithms for each proposal. The algorithms are listed in order from weakest to strongest.

- Data Encryption Standard (DES) is a widely used method of data encryption. It applies a 56-bit key to each 64-bit block of data.
- Triple DES (3DES) is a variant of DES. It iterates three times with three separate keys, effectively tripling the strength of DES.
- Advanced Encryption Standard (AES) is a newer method of data encryption that also uses a secret key. AES applies a 128-bit key to 128-bit blocks of data. It is faster than 3DES.

Some Zyxel Devices also offer stronger forms of AES that apply 192-bit or 256-bit keys to 128-bit blocks of data.

In most Zyxel Devices, you can select one of the following authentication algorithms for each proposal. The algorithms are listed in order from weakest to strongest.

- MD5 (Message Digest 5) produces a 128-bit digest to authenticate packet data.
- SHA1 (Secure Hash Algorithm) produces a 160-bit digest to authenticate packet data.
- SHA256 (Secure Hash Algorithm) produces a 256-bit digest to authenticate packet data.
- SHA512 (Secure Hash Algorithm) produces a 512-bit digest to authenticate packet data.

See [Diffie-Hellman \(DH\) Key Exchange on page 663](#) for more information about DH key groups.

Diffie-Hellman (DH) Key Exchange

The Zyxel Device and the remote IPsec router use DH public-key cryptography to establish a shared secret. The shared secret is then used to generate encryption keys for the IKE SA and IPsec SA. In main mode, this is done in steps 3 and 4, as illustrated next.

Figure 451 IKE SA: Main Negotiation Mode, Steps 3 - 4: DH Key Exchange

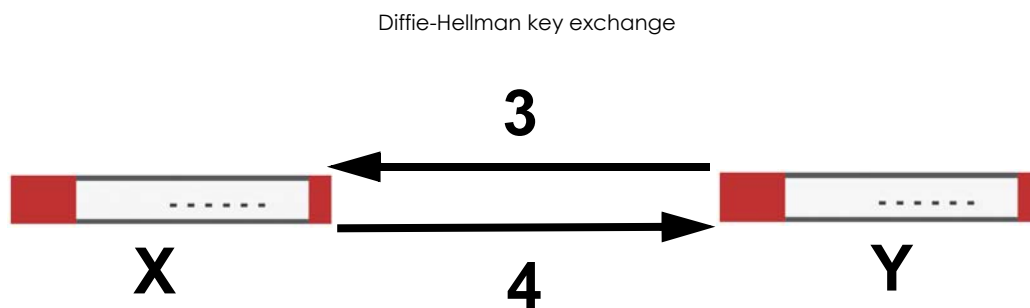

DH public-key cryptography is based on DH key groups. Each key group is a fixed number of bits long. The longer the key, the more secure the encryption, but also the longer it takes to encrypt and decrypt

information. For example, DH2 keys (1024 bits) are more secure than DH1 keys (768 bits), but DH2 keys take longer to encrypt and decrypt.

Authentication

Before the Zyxel Device and remote IPsec router establish an IKE SA, they have to verify each other's identity. This process is based on pre-shared keys and router identities.

In main mode, the Zyxel Device and remote IPsec router authenticate each other in steps 5 and 6, as illustrated below. The identities are also encrypted using the encryption algorithm and encryption key the Zyxel Device and remote IPsec router selected in previous steps.

Figure 452 IKE SA: Main Negotiation Mode, Steps 5 - 6: Authentication (continued)

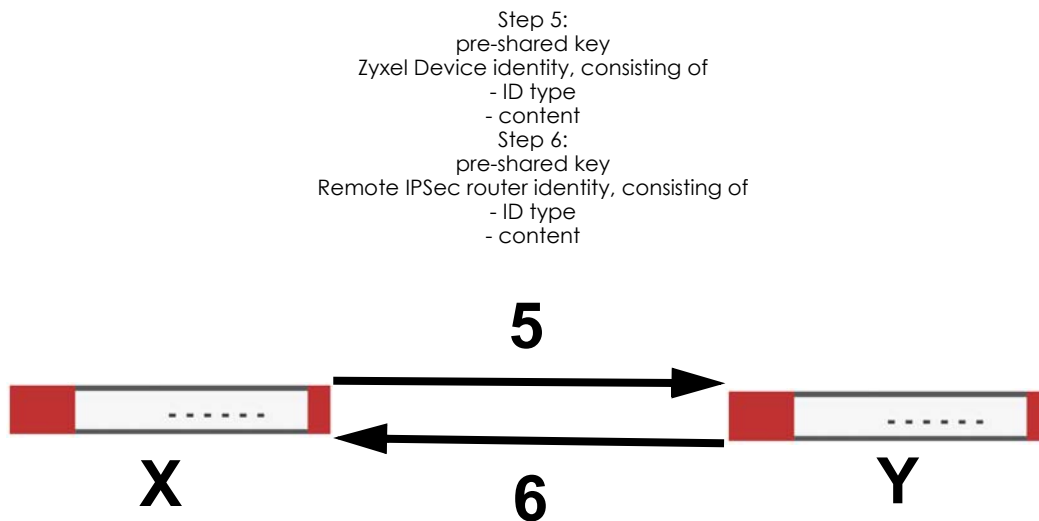

You have to create (and distribute) a pre-shared key. The Zyxel Device and remote IPsec router use it in the authentication process, though it is not actually transmitted or exchanged.

Note: The Zyxel Device and the remote IPsec router must use the same pre-shared key.

Router identity consists of ID type and content. The ID type can be domain name, IP address, or e-mail address, and the content is a (properly-formatted) domain name, IP address, or e-mail address. The content is only used for identification. Any domain name or e-mail address that you enter does not have to actually exist. Similarly, any domain name or IP address that you enter does not have to correspond to the Zyxel Device's or remote IPsec router's properties.

The Zyxel Device and the remote IPsec router have their own identities, so both of them must store two sets of information, one for themselves and one for the other router. Local ID type and content refers to the ID type and content that applies to the router itself, and peer ID type and content refers to the ID type and content that applies to the other router.

Note: The Zyxel Device's local and peer ID type and content must match the remote IPsec router's peer and local ID type and content, respectively.

For example, in the next table, the Zyxel Device and the remote IPsec router authenticate each other successfully. In contrast, in the following table, the Zyxel Device and the remote IPsec router cannot authenticate each other and, therefore, cannot establish an IKE SA.

Table 232 VPN Example: Matching ID Type and Content

ZYXEL DEVICE	REMOTE IPSEC ROUTER
Local ID type: E-mail	Local ID type: IP
Local ID content: tom@yourcompany.com	Local ID content: 1.1.1.2
Peer ID type: IP	Peer ID type: E-mail
Peer ID content: 1.1.1.2	Peer ID content: tom@yourcompany.com

Table 233 VPN Example: Mismatching ID Type and Content

ZYXEL DEVICE	REMOTE IPSEC ROUTER
Local ID type: Email	Local ID type: IP
Local ID content: tom@yourcompany.com	Local ID content: 1.1.1.2
Peer ID type: IP	Peer ID type: E-mail
Peer ID content: 1.1.1.20	Peer ID content: tom@yourcompany.com

It is also possible to configure the Zyxel Device to ignore the identity of the remote IPsec router. In this case, you usually set the peer ID type to **Any**. This is less secure, so you should only use this if your Zyxel Device provides another way to check the identity of the remote IPsec router (for example, extended authentication) or if you are troubleshooting a VPN tunnel.

Additional Topics for IKE SA

This section provides more information about IKE SA.

Negotiation Mode

There are two negotiation modes – main mode and aggressive mode. Main mode provides better security, while aggressive mode is faster.

Main mode takes six steps to establish an IKE SA.

Steps 1 – 2: The Zyxel Device sends its proposals to the remote IPsec router. The remote IPsec router selects an acceptable proposal and sends it back to the Zyxel Device.

Steps 3 – 4: The Zyxel Device and the remote IPsec router exchange pre-shared keys for authentication and participate in a Diffie-Hellman key exchange, based on the accepted DH key group, to establish a shared secret.

Steps 5 – 6: Finally, the Zyxel Device and the remote IPsec router generate an encryption key (from the shared secret), encrypt their identities, and exchange their encrypted identity information for authentication.

In contrast, aggressive mode only takes three steps to establish an IKE SA. Aggressive mode does not provide as much security because the identity of the Zyxel Device and the identity of the remote IPsec router are not encrypted. It is usually used in remote-access situations, where the address of the initiator is not known by the responder and both parties want to use pre-shared keys for authentication. For example, the remote IPsec router may be a telecommuter who does not have a static IP address.

VPN, NAT, and NAT Traversal

In the following example, there is another router (**A**) between router **X** and router **Y**.

Figure 453 VPN/NAT Example

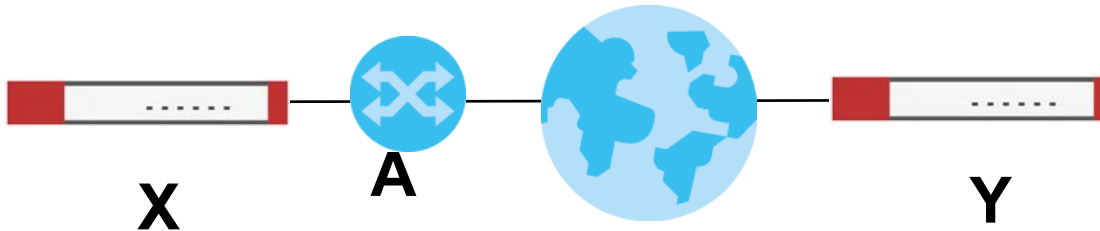

If router **A** does NAT, it might change the IP addresses, port numbers, or both. If router **X** and router **Y** try to establish a VPN tunnel, the authentication fails because it depends on this information. The routers cannot establish a VPN tunnel.

Most routers like router **A** now have an IPsec pass-thru feature. This feature helps router **A** recognize VPN packets and route them appropriately. If router **A** has this feature, router **X** and router **Y** can establish a VPN tunnel as long as the active protocol is ESP. (See [Active Protocol on page 667](#) for more information about active protocols.)

If router **A** does not have an IPsec pass-thru or if the active protocol is AH, you can solve this problem by enabling NAT traversal. In NAT traversal, router **X** and router **Y** add an extra header to the IKE SA and IPsec SA packets. If you configure router **A** to forward these packets unchanged, router **X** and router **Y** can establish a VPN tunnel.

You have to do the following things to set up NAT traversal.

- Enable NAT traversal on the Zyxel Device and remote IPsec router.
- Configure the NAT router to forward packets with the extra header unchanged. (See the field description for detailed information about the extra header.)

The extra header may be UDP port 500 or UDP port 4500, depending on the standard(s) the Zyxel Device and remote IPsec router support.

X-Auth / Extended Authentication

X-Auth / Extended authentication is often used when multiple IPsec routers use the same VPN tunnel to connect to a single IPsec router. For example, this might be used with telecommuters.

In extended authentication, one of the routers (the Zyxel Device or the remote IPsec router) provides a user name and password to the other router, which uses a local user database and/or an external server to verify the user name and password. If the user name or password is wrong, the routers do not establish an IKE SA.

You can set up the Zyxel Device to provide a user name and password to the remote IPsec router, or you can set up the Zyxel Device to check a user name and password that is provided by the remote IPsec router.

If you use extended authentication, it takes four more steps to establish an IKE SA. These steps occur at the end, regardless of the negotiation mode (steps 7-10 in main mode, steps 4-7 in aggressive mode).

Certificates

It is possible for the Zyxel Device and remote IPSec router to authenticate each other with certificates. In this case, you do not have to set up the pre-shared key, local identity, or remote identity because the certificates provide this information instead.

- Instead of using the pre-shared key, the Zyxel Device and remote IPSec router check the signatures on each other's certificates. Unlike pre-shared keys, the signatures do not have to match.
- The local and peer ID type and content come from the certificates.

Note: You must set up the certificates for the Zyxel Device and remote IPSec router first.

IPSec SA Overview

Once the Zyxel Device and remote IPSec router have established the IKE SA, they can securely negotiate an IPSec SA through which to send data between computers on the networks.

Note: The IPSec SA stays connected even if the underlying IKE SA is not available anymore.

This section introduces the key components of an IPSec SA.

Local Network and Remote Network

In an IPSec SA, the local network, the one(s) connected to the Zyxel Device, may be called the local policy. Similarly, the remote network, the one(s) connected to the remote IPSec router, may be called the remote policy.

Active Protocol

The active protocol controls the format of each packet. It also specifies how much of each packet is protected by the encryption and authentication algorithms. IPSec VPN includes two active protocols, AH (Authentication Header, RFC 2402) and ESP (Encapsulating Security Payload, RFC 2406).

Note: The Zyxel Device and remote IPSec router must use the same active protocol.

Usually, you should select ESP. AH does not support encryption, and ESP is more suitable with NAT.

Encapsulation

There are two ways to encapsulate packets. Usually, you should use tunnel mode because it is more secure. Transport mode is only used when the IPSec SA is used for communication between the Zyxel Device and remote IPSec router (for example, for remote management), not between computers on the local and remote networks.

Note: The Zyxel Device and remote IPSec router must use the same encapsulation.

These modes are illustrated below.

Figure 454 VPN: Transport and Tunnel Mode Encapsulation

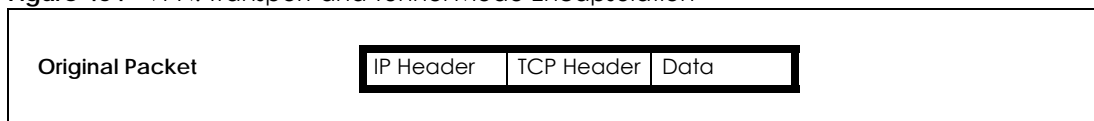
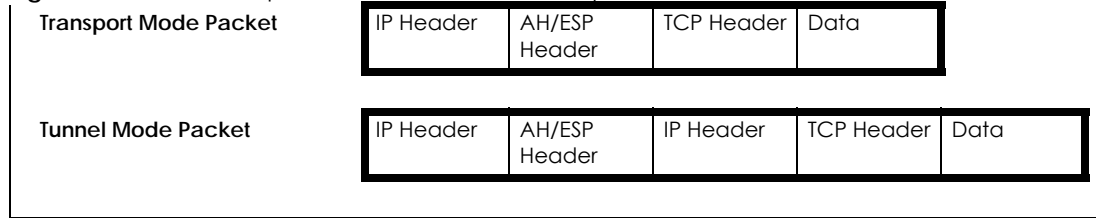

Figure 454 VPN: Transport and Tunnel Mode Encapsulation

In tunnel mode, the Zyxel Device uses the active protocol to encapsulate the entire IP packet. As a result, there are two IP headers:

- **Outside header:** The outside IP header contains the IP address of the Zyxel Device or remote IPsec router, whichever is the destination.
- **Inside header:** The inside IP header contains the IP address of the computer behind the Zyxel Device or remote IPsec router. The header for the active protocol (AH or ESP) appears between the IP headers.

In transport mode, the encapsulation depends on the active protocol. With AH, the Zyxel Device includes part of the original IP header when it encapsulates the packet. With ESP, however, the Zyxel Device does not include the IP header when it encapsulates the packet, so it is not possible to verify the integrity of the source IP address.

IPsec SA Proposal and Perfect Forward Secrecy

An IPsec SA proposal is similar to an IKE SA proposal (see [IKE SA Proposal](#)), except that you also have the choice whether or not the Zyxel Device and remote IPsec router perform a new DH key exchange every time an IPsec SA is established. This is called Perfect Forward Secrecy (PFS).

If you enable PFS, the Zyxel Device and remote IPsec router perform a DH key exchange every time an IPsec SA is established, changing the root key from which encryption keys are generated. As a result, if one encryption key is compromised, other encryption keys remain secure.

If you do not enable PFS, the Zyxel Device and remote IPsec router use the same root key that was generated when the IKE SA was established to generate encryption keys.

The DH key exchange is time-consuming and may be unnecessary for data that does not require such security.

PFS is ignored in initial IKEv2 authentication but is used when re-authenticating.

Additional Topics for IPsec SA

This section provides more information about IPsec SA in your Zyxel Device.

Authentication and the Security Parameter Index (SPI)

For authentication, the Zyxel Device and remote IPsec router use the SPI, instead of pre-shared keys, ID type and content. The SPI is an identification number.

Note: The Zyxel Device and remote IPsec router must use the same SPI.

NAT for Inbound and Outbound Traffic

The Zyxel Device can translate the following types of network addresses in IPsec SA.

- Source address in outbound packets – this translation is necessary if you want the Zyxel Device to route packets from computers outside the local network through the IPsec SA.
- Source address in inbound packets – this translation hides the source address of computers in the remote network.
- Destination address in inbound packets – this translation is used if you want to forward packets (for example, mail) from the remote network to a specific computer (like the mail server) in the local network.

Each kind of translation is explained below. The following example is used to help explain each one.

Figure 455 VPN Example: NAT for Inbound and Outbound Traffic

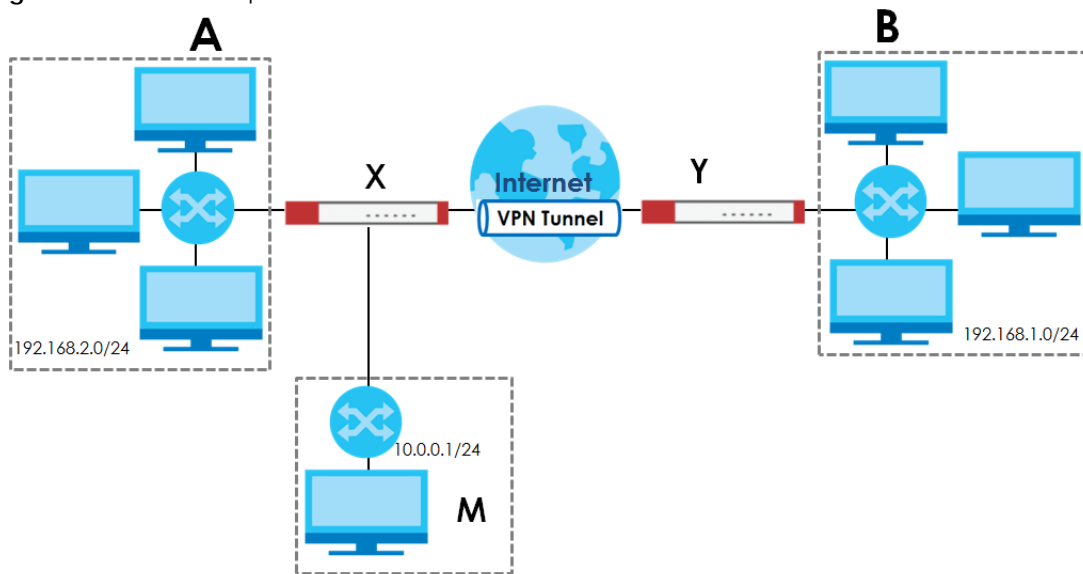

Source Address in Outbound Packets (Outbound Traffic, Source NAT)

This translation lets the Zyxel Device route packets from computers that are not part of the specified local network (local policy) through the IPsec SA. For example, in [Figure 455 on page 669](#), you have to configure this kind of translation if you want computer **M** to establish a connection with any computer in the remote network (**B**). If you do not configure it, the remote IPsec router may not route messages for computer **M** through the IPsec SA because computer **M**'s IP address is not part of its local policy.

To set up this NAT, you have to specify the following information:

- Source - the original source address; most likely, computer **M**'s network.
- Destination - the original destination address; the remote network (**B**).
- SNAT - the translated source address; the local network (**A**).

Source Address in Inbound Packets (Inbound Traffic, Source NAT)

You can set up this translation if you want to change the source address of computers in the remote network. To set up this NAT, you have to specify the following information:

- Source – the original source address; the remote network (B).
- Destination – the original destination address; the local network (A).
- SNAT – the translated source address; a different IP address (range of addresses) to hide the original source address.

Destination Address in Inbound Packets (Inbound Traffic, Destination NAT)

You can set up this translation if you want the Zyxel Device to forward some packets from the remote network to a specific computer in the local network. For example, in [Figure 455 on page 669](#), you can configure this kind of translation if you want to forward mail from the remote network to the mail server in the local network (A).

You have to specify one or more rules when you set up this kind of NAT. The Zyxel Device checks these rules similar to the way it checks rules for a security policy. The first part of these rules define the conditions in which the rule apply.

- Original IP – the original destination address; the remote network (B).
- Protocol – the protocol [TCP, UDP, or both] used by the service requesting the connection.
- Original Port – the original destination port or range of destination ports; in [Figure 455 on page 669](#), it might be port 25 for SMTP.

The second part of these rules controls the translation when the condition is satisfied.

- Mapped IP – the translated destination address; in [Figure 455 on page 669](#), the IP address of the mail server in the local network (A).
- Mapped Port – the translated destination port or range of destination ports.

The original port range and the mapped port range must be the same size.

IPsec VPN Example Scenario

Here is an example site-to-site IPsec VPN scenario.

Figure 456 Site-to-site IPsec VPN Example

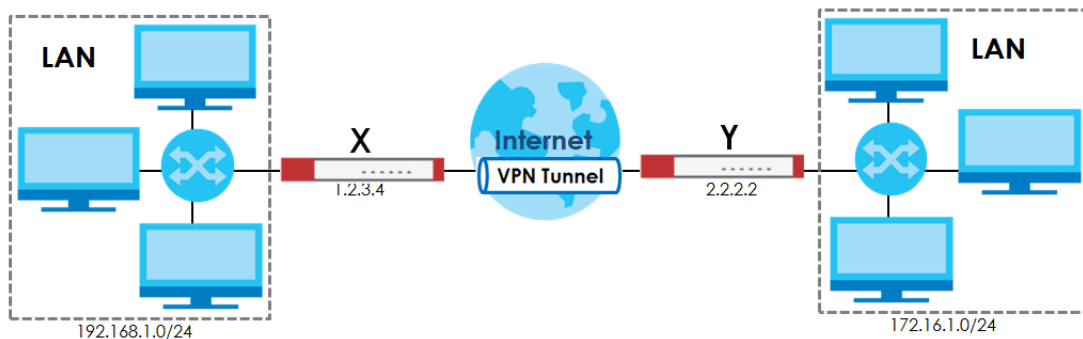

CHAPTER 31

SSL VPN

31.1 Overview

Use SSL VPN to allow users to use a web browser for secure remote user login. The remote users do not need a VPN router or VPN client software.

31.1.1 What You Can Do in this Chapter

- Use the **VPN > SSL VPN > Access Privilege** screens (see [Section 31.2 on page 672](#)) to configure SSL access policies.
- Use the **Click VPN > SSL VPN > Global Setting** screen (see [Section 31.3 on page 676](#)) to set the IP address of the Zyxel Device (or a gateway device) on your network for full tunnel mode access, enter access messages or upload a custom logo to be displayed on the remote user screen.
- Use the **VPN > SSL VPN > SecuExtender** screen (see [Section Figure 461 on page 678](#)) to update and check the current and latest version of the Security Extender.

31.1.2 What You Need to Know

Full Tunnel Mode

In full tunnel mode, a virtual connection is created for remote users with private IP addresses in the same subnet as the local network. This allows them to access network resources in the same way as if they were part of the internal network.

Figure 457 Network Access Mode: Full Tunnel Mode

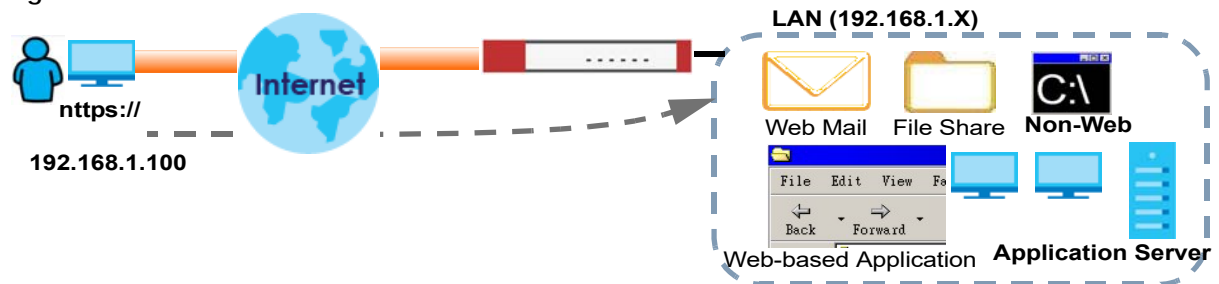

SSL Access Policy

An SSL access policy allows the Zyxel Device to perform the following tasks:

- limit user access to specific applications or file sharing server on the network.
- allow user access to specific networks.
- assign private IP addresses and provide DNS/WINS server information to remote users to access internal networks.

SSL Access Policy Objects

The SSL access policies reference the following objects. If you update this information, in response to changes, the Zykel Device automatically propagates the changes through the SSL policies that use the object(s). When you delete an SSL policy, the objects are not removed.

Table 234 Objects

OBJECT TYPE	OBJECT SCREEN	DESCRIPTION
User Accounts	User Account/ User Group	Configure a user account or user group to which you want to apply this SSL access policy.
Application	SSL Application	Configure an SSL application object to specify the type of application and the address of the local computer, server, or web site SSL users are to be able to access.
IP Pool	Address	Configure an address object that defines a range of private IP addresses to assign to user computers so they can access the internal network through a VPN connection.
Server Addresses	Address	Configure address objects for the IP addresses of the DNS and WINS servers that the Zykel Device sends to the VPN connection users.
VPN Network	Address	Configure an address object to specify which network segment users are allowed to access through a VPN connection.

You cannot delete an object that is referenced by an SSL access policy. To delete the object, you must first unassociate the object from the SSL access policy.

31.2 The SSL Access Privilege Screen

Click **VPN > SSL VPN** to open the **Access Privilege** screen. This screen lists the configured SSL access policies.

Click on the icons to go to the OneSecurity website where there is guidance on configuration walkthroughs, troubleshooting and other information.

Figure 458 VPN > SSL VPN > Access Privilege

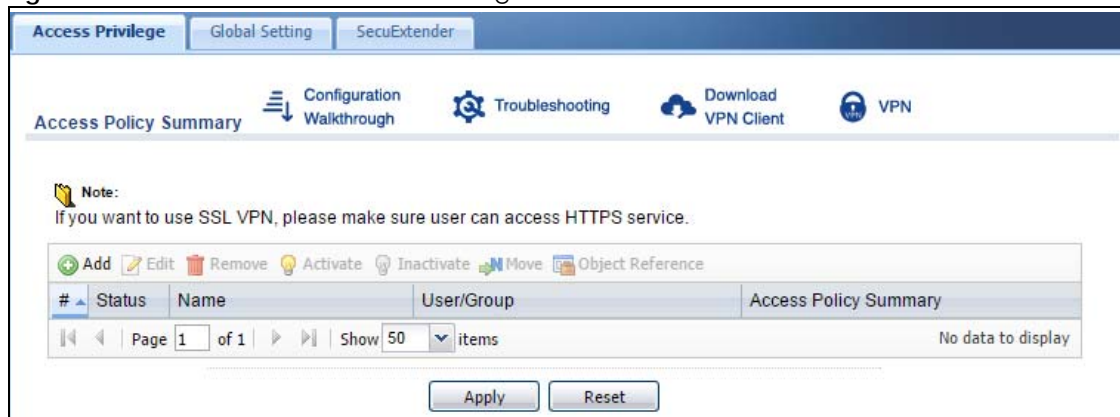

The following table describes the labels in this screen.

Table 235 VPN > SSL VPN > Access Privilege

LABEL	DESCRIPTION
Access Policy Summary	This screen shows a summary of SSL VPN policies created. Click on the VPN icon to go to the Zyxel VPN Client product page at the Zyxel website.
Add	Click this to create a new entry. Select an entry and click Add to create a new entry after the selected entry.
Edit	Double-click an entry or select it and click Edit to open a screen where you can modify the entry's settings.
Remove	To remove an entry, select it and click Remove . The Zyxel Device confirms you want to remove it before doing so.
Activate	To turn on an entry, select it and click Activate .
Inactivate	To turn off an entry, select it and click Inactivate .
Move	To move an entry to a different number in the list, click the Move icon. In the field that appears, specify the number to which you want to move the interface.
References	Select an entry and click References to open a screen that shows which settings use the entry. Click Refresh to update information on this screen.
#	This field displays the index number of the entry.
Status	This icon is lit when the entry is active and dimmed when the entry is inactive.
Name	This field displays the descriptive name of the SSL access policy for identification purposes.
User/Group	This field displays the user account or user group name(s) associated to an SSL access policy. This field displays up to three names.
Access Policy Summary	This field displays details about the SSL application object this policy uses including its name, type, and address.
Apply	Click Apply to save the settings.
Reset	Click Reset to discard all changes.

31.2.1 The SSL Access Privilege Policy Add/Edit Screen

To create a new or edit an existing SSL access policy, click the **Add** or **Edit** icon in the **Access Privilege** screen.

Figure 459 VPN > SSL VPN > Add/Edit

Add Access Policy [?] [X]

Create new Object ▾

Configuration

Enable Policy

Name:

Zone: ⓘ

Description: (Optional)

User/Group

Selectable User/Group Objects

=== Object ===

admin
ldap-users
radius-users
ad-users
lillian

➔
➜

Selected User/Group Objects

SSL Application List (Optional)

Selectable Application Objects

➔
➜

Selected Application Objects

Network Extension (Optional)

Enable Network Extension (Full Tunnel Mode)

Force all client traffic to enter SSL VPN tunnel ⓘ

NetBIOS broadcast over SSL VPN Tunnel

Assign IP Pool: ⓘ

DNS Server 1:

DNS Server 2:

WINS Server 1:

WINS Server 2:

Network List

Selectable Address Objects

DMZ1_SUBNET
DMZ2_SUBNET
IP6to4-Relay
LAN1_SUBNET
LAN2_SUBNET

➔
➜

Selected Address Objects

ⓘ Note: Address Objects are what the SSL VPN clients will have access to.

< >

OK Cancel

The following table describes the labels in this screen.

Table 236 VPN > SSL VPN > Access Privilege > Add/Edit

LABEL	DESCRIPTION
Create new Object	Use to configure any new settings objects that you need to use in this screen.
Configuration	
Enable Policy	Select this option to activate this SSL access policy.
Name	Enter a descriptive name to identify this policy. You can enter up to 31 characters ("a-z", "A-Z", "0-9") with no spaces allowed.
Zone	Select the zone to which to add this SSL access policy. You use zones to apply security settings such as security policy and remote management.
Description	Enter additional information about this SSL access policy. You can enter up to 60 characters ("0-9", "a-z", "A-Z", "-" and "_").
User/Group	<p>The Selectable User/Group Objects list displays the name(s) of the user account and/or user group(s) to which you have not applied an SSL access policy yet.</p> <p>To associate a user or user group to this SSL access policy, select a user account or user group and click the right arrow button to add to the Selected User/Group Objects list. You can select more than one name.</p> <p>To remove a user or user group, select the name(s) in the Selected User/Group Objects list and click the left arrow button.</p> <p>Note: Although you can select admin and limited-admin accounts in this screen, they are reserved for device configuration only. You cannot use them to access the SSL VPN portal.</p>
SSL Application List (Optional)	<p>The Selectable Application Objects list displays the name(s) of the SSL application(s) you can select for this SSL access policy.</p> <p>To associate an SSL application to this SSL access policy, select a name and click the right arrow button to add to the Selected Application Objects list. You can select more than one application.</p> <p>To remove an SSL application, select the name(s) in the Selected Application Objects list and click the left arrow button.</p> <p>Note: To allow access to shared files on a Windows 7 computer, within Windows 7 you must enable sharing on the folder and also go to the Network and Sharing Center's Advanced sharing settings and turn on the current network profile's file and printer sharing.</p>
Network Extension (Optional)	
Enable Network Extension	<p>Select this option to create a VPN tunnel between the authenticated users and the internal network. This allows the users to access the resources on the network as if they were on the same local network. This includes access to resources not supported by SSL application objects. For example this lets users Telnet to the internal network even though the Zyxel Device does not have SSL application objects for Telnet.</p> <p>Clear this option to disable this feature. Users can only access the applications as defined by the VPN tunnel's selected SSL application settings and the remote user computers are not made to be a part of the local network.</p>
Force all client traffic to SSL VPN tunnel	Select this to send all traffic from the SSL VPN clients through the SSL VPN tunnel. This replaces the default gateway of the SSL VPN clients with the SSL VPN gateway.
NetBIOS broadcast over SSL VPN Tunnel	Select this to search for a remote computer and access its applications as if it was in a Local Area Network. The user can find a computer not only by its IP address but also by computer name.

Table 236 VPN > SSL VPN > Access Privilege > Add/Edit (continued)

LABEL	DESCRIPTION
Assign IP Pool	Define a separate pool of IP addresses to assign to the SSL users. Select it here. The SSL VPN IP pool should not overlap with IP addresses on the Zyxel Device's local networks (LAN and DMZ for example), the SSL user's network, or the networks you specify in the SSL VPN Network List .
DNS/WINS Server 1..2	Select the name of the DNS or WINS server whose information the Zyxel Device sends to the remote users. This allows them to access devices on the local network using domain names instead of IP addresses.
Network List	To allow user access to local network(s), select a network name in the Selectable Address Objects list and click the right arrow button to add to the Selected Address Objects list. You can select more than one network. To block access to a network, select the network name in the Selected Address Objects list and click the left arrow button.
OK	Click OK to save the changes and return to the main Access Privilege screen.
Cancel	Click Cancel to discard all changes and return to the main Access Privilege screen.

31.3 The SSL Global Setting Screen

Click **VPN > SSL VPN** and click the **Global Setting** tab to display the following screen. Use this screen to set the IP address of the Zyxel Device (or a gateway device) on your network for full tunnel mode access, enter access messages or upload a custom logo to be displayed on the remote user screen.

Figure 460 VPN > SSL VPN > Global Setting

The screenshot shows the 'Global Setting' tab in the Zyxel VPN configuration interface. The page is titled 'Global Settings' and contains several sections:

- Global Settings:** A text input field for 'Network Extension Local IP' with the value '192.168.200.1'.
- SSL VPN Login Domain Name:** Two optional text input fields for 'SSL VPN Login Domain Name 1' and 'SSL VPN Login Domain Name 2'.
- Message:** Two text input fields for 'Login Message' (containing 'Welcome to SSL VPN') and 'Logout Message' (containing 'Goodbye to SSL VPN').
- Update Client Virtual Desktop Logo:** A text input field for 'File Path' (containing 'Select a file path') and buttons for 'Browse...', 'Upload', and 'Reset Logo to default'.

At the bottom of the screen, there are 'Apply' and 'Reset' buttons.

The following table describes the labels in this screen.

Table 237 VPN > SSL VPN > Global Setting

LABEL	DESCRIPTION
Global Setting	
Network Extension Local IP	Specify the IP address of the Zyxel Device (or a gateway device) for full tunnel mode SSL VPN access. Leave this field to the default settings unless it conflicts with another interface.
SSL VPN Login Domain Name	
SSL VPN Login Domain Name 1/2	Specify a full domain name for users to use for SSL VPN login. The domain name must be registered to one of the Zyxel Device's IP addresses or be one of the Zyxel Device's DDNS entries. You can specify up to two domain names so you could use one domain name for each of two WAN ports. For example, www.zyxel.com is a fully qualified domain name where "www" is the host. The Zyxel Device displays the normal login screen without the button for logging into the Web Configurator.
Message	
Login Message	Specify a message to display on the screen when a user logs in and an SSL VPN connection is established successfully. You can enter up to 60 characters (0-9, a-z, A-Z, '()+,./:=?!*#@\$_%-"') with spaces allowed.
Logout Message	Specify a message to display on the screen when a user logs out and the SSL VPN connection is terminated successfully. You can enter up to 60 characters (0-9, a-z, A-Z, '()+,./:=?!*#@\$_%-"') with spaces allowed.
Update Client Virtual Desktop Logo	You can upload a graphic logo to be displayed on the web browser on the remote user computer. The Zyxel company logo is the default logo. Specify the location and file name of the logo graphic or click Browse to locate it. Note: The logo graphic must be GIF, JPG, or PNG format. The graphic should use a resolution of 103 x 29 pixels to avoid distortion when displayed. The Zyxel Device automatically resizes a graphic of a different resolution to 103 x 29 pixels. The file size must be 100 kilobytes or less. Transparent background is recommended.
Browse	Click Browse to locate the graphic file on your computer.
Upload	Click Upload to transfer the specified graphic file from your computer to the Zyxel Device.
Reset Logo to Default	Click Reset Logo to Default to display the Zyxel company logo on the remote user's web browser.
Apply	Click Apply to save the changes and/or start the logo file upload process.
Reset	Click Reset to return the screen to its last-saved settings.

31.3.1 How to Upload a Custom Logo

Follow the steps below to upload a custom logo to display on the remote user SSL VPN screens.

- 1 Click **VPN > SSL VPN** and click the **Global Setting** tab to display the configuration screen.
- 2 Click **Browse** to locate the logo graphic. Make sure the file is in GIF, JPG, or PNG format.
- 3 Click **Apply** to start the file transfer process.
- 4 Log in as a user to verify that the new logo displays properly.

The following shows an example logo on the remote user screen.

Figure 461 Example Logo Graphic Display

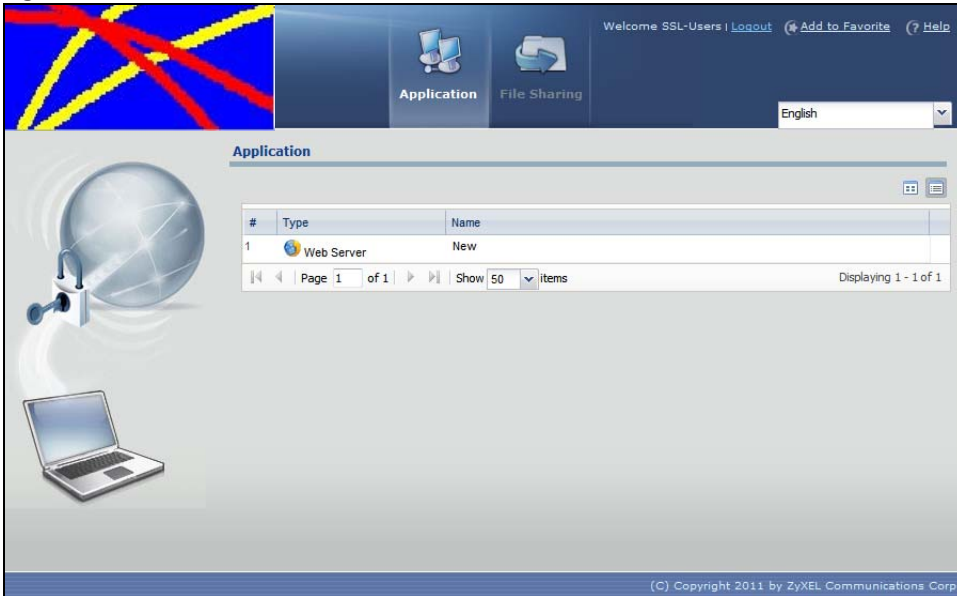

CHAPTER 32

SSL User Screens

32.1 Overview

This chapter introduces the remote user SSL VPN screens. The following figure shows a network example where a remote user (A) logs into the Zyxel Device from the Internet to access the web server (WWW) on the local network.

Figure 462 SSL User Network Example

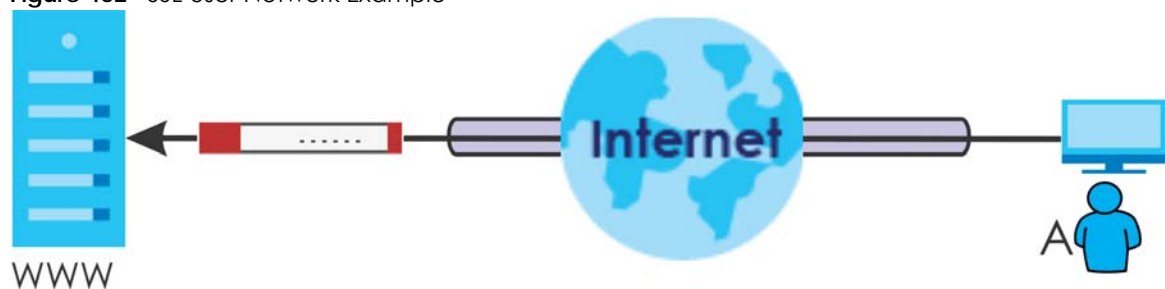

32.1.1 What You Need to Know

The Zyxel Device can use SSL VPN to provide secure connections to network resources such as applications, files, intranet sites or e-mail through a web-based interface and using Microsoft Outlook Web Access (OWA).

Network Resource Access Methods

As a remote user, you can access resources on the local network using one of the following methods.

- Using a supported web browser
Once you have successfully logged in through the Zyxel Device, you can access intranet sites, web-based applications, or web-based e-mails using one of the supported web browsers.
- Using the Zyxel Device SecuExtender client
Once you have successfully logged into the Zyxel Device, if the SSL VPN access policy has network extension enabled the Zyxel Device automatically loads the Zyxel Device SecuExtender client program to your computer. With the Zyxel Device SecuExtender, you can access network resources, remote desktops and manage files as if you were on the local network. See [Chapter 33 on page 692](#) for more on the Zyxel Device SecuExtender.

System Requirements

Here are the browser and computer system requirements for remote user access.

- Windows 7 (32 or 64-bit), Vista (32 or 64-bit), 2003 (32-bit), XP (32-bit), or 2000 (32-bit)
- Internet Explorer 7 and above or Firefox 1.5 and above

- Using RDP requires Internet Explorer
- Sun's Runtime Environment (JRE) version 1.6 or later installed and enabled.

Required Information

A remote user needs the following information from the network administrator to log in and access network resources.

- the domain name or IP address of the Zyxel Device
- the login account user name and password
- if also required, the user name and/or password to access the network resource

Certificates

The remote user's computer establishes an HTTPS connection to the Zyxel Device to access the login screen. If instructed by your network administrator, you must install or import a certificate (provided by the Zyxel Device or your network administrator).

Finding Out More

See [Chapter 31 on page 671](#) for how to configure SSL VPN on the Zyxel Device.

32.2 Remote SSL User Login

This section shows you how to access and log into the network through the Zyxel Device. Example screens for Internet Explorer are shown.

Note: You should have already installed the SecuExtender client. See [Section 32.8.1 on page 689](#).

- 1 Open a web browser and enter the web site address or IP address of the Zyxel Device. For example, "http://sslvpn.mycompany.com".

Figure 463 Enter the Address in a Web Browser

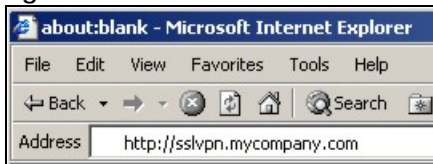

- 2 Click **OK** or **Yes** if a security screen displays.

Figure 464 Login Security Screen



- 3 A login screen displays. Enter the user name and password of your login account. If a token password is also required, enter it in the **One-Time Password** field. Click **SSL VPN** to log in and establish an SSL VPN connection to the network to access network resources.

Figure 465 Login Screen

- 4 Your computer starts establishing a secure connection to the Zyxel Device after a successful login. This may take up to two minutes. If you get a message about needing Java, download and install it and restart your browser and re-login. If a certificate warning screen displays, click **OK**, **Yes** or **Continue**.

Figure 466 Java Needed Message

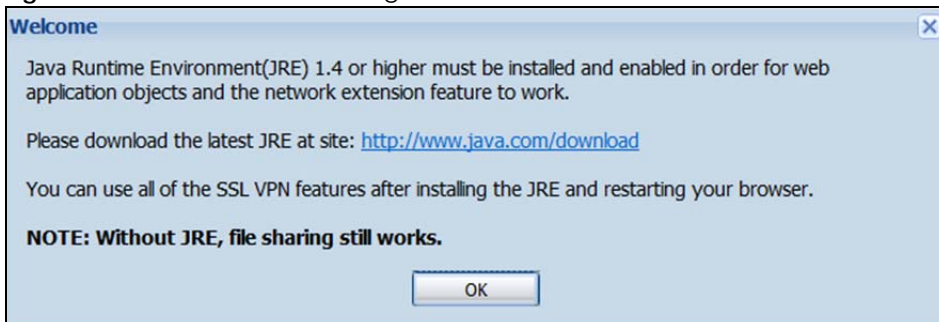

- 5 The **Application** screen displays showing the list of resources available to you. See [Figure 467 on page 682](#) for a screen example.

Note: Available resource links vary depending on the configuration your network administrator made.

32.3 The SSL VPN User Screens

This section describes the main elements in the remote user screens.

Figure 467 Remote User Screen

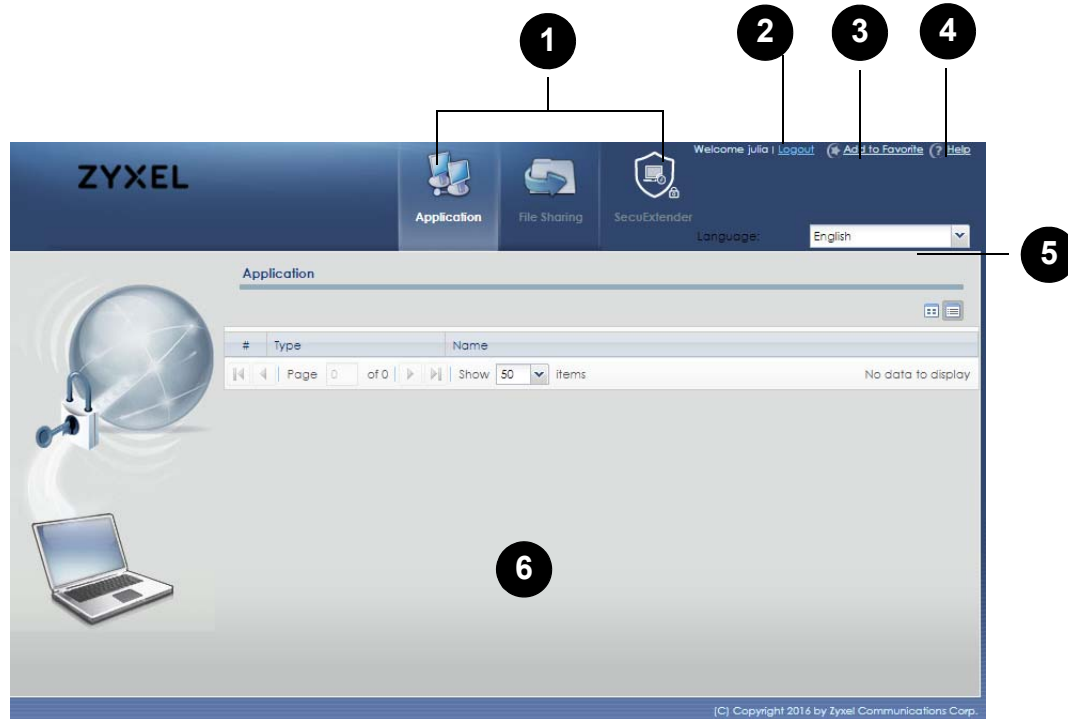

The following table describes the various parts of a remote user screen.

Table 238 Remote User Screen Overview

#	DESCRIPTION
1	Click on a menu tab to go to the corresponding screen.
2	Click this icon to log out and terminate the secure connection.
3	Click this icon to create a bookmark to the SSL VPN user screen in your web browser.
4	Click this icon to display the on-line help window.
5	Select your preferred language for the interface.
6	This part of the screen displays a list of the resources available to you. <ul style="list-style-type: none"> In the Application screen, click on a link to access or display the access method. In the File Sharing screen, click on a link to open a file or directory. In the SecuExtender screen, click on a link to download the client. You can also see the latest versions available and current version of the client that you have.

32.4 Bookmarking the Zyxel Device

You can create a bookmark of the Zyxel Device by clicking the **Add to Favorite** icon. This allows you to access the Zyxel Device using the bookmark without having to enter the address every time.

- 1 In any remote user screen, click the **Add to Favorite** icon.
- 2 A screen displays. Accept the default name in the **Name** field or enter a descriptive name to identify this link.
- 3 Click **OK** to create a bookmark in your web browser.

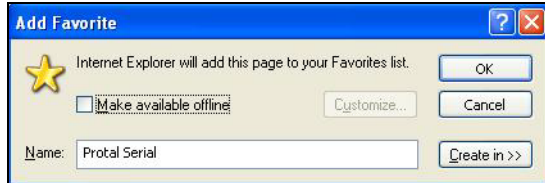
Figure 468 Add Favorite

32.5 Logging Out of the SSL VPN User Screens

To properly terminate a connection, click on the **Logout** icon in any remote user screen.

- 1 Click the **Logout** icon in any remote user screen.
- 2 A prompt window displays. Click **OK** to continue.

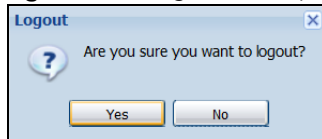
Figure 469 Logout: Prompt

32.6 SSL User Application Screen

Use the **Application** tab's screen to access web-based applications (such as web sites and e-mail) on the network through the SSL VPN connection. Which applications you can access depends on the Zyxel Device's configuration.

The **Name** field displays the descriptive name for an application. The **Type** field displays whether the application is a web site (**Web Server**) or web-based e-mail using Microsoft Outlook Web Access (**OWA**).

To access a web-based application, simply click a link in the **Application** screen to display the web screen in a separate browser window.

Figure 470 Application

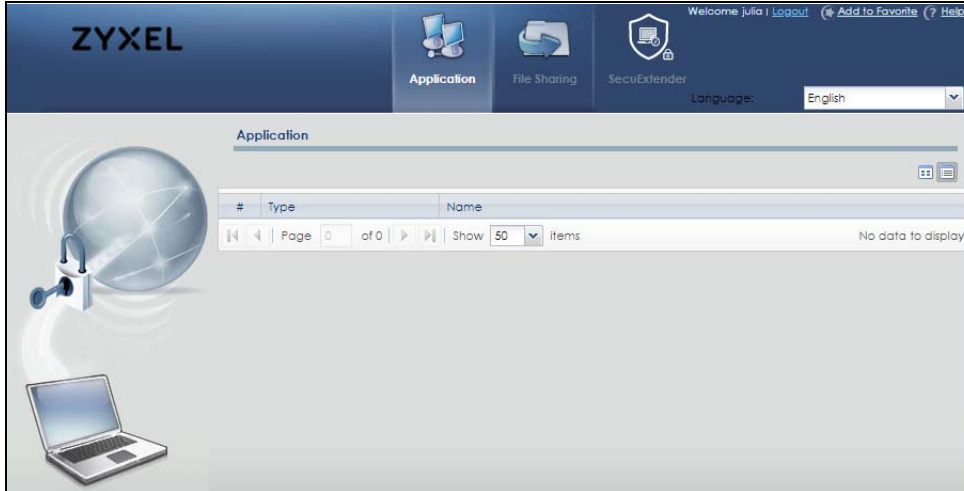

32.7 SSL User File Sharing

The **File Sharing** screen lets you access files on a file server through the SSL VPN connection. Use it to display and access shared files/folders on a file server.

You can also perform the following actions:

- Access a folder.
- Open a file (if your web browser cannot open the file, you are prompted to download it).
- Save a file to your computer.
- Create a new folder.
- Rename a file or folder.
- Delete a file or folder.
- Upload a file.

Note: Available actions you can perform in the **File Sharing** screen vary depending on the rights granted to you on the file server.

32.7.1 The Main File Sharing Screen

The first **File Sharing** screen displays the name(s) of the shared folder(s) available. The following figure shows an example with one file share.

Figure 471 File Sharing

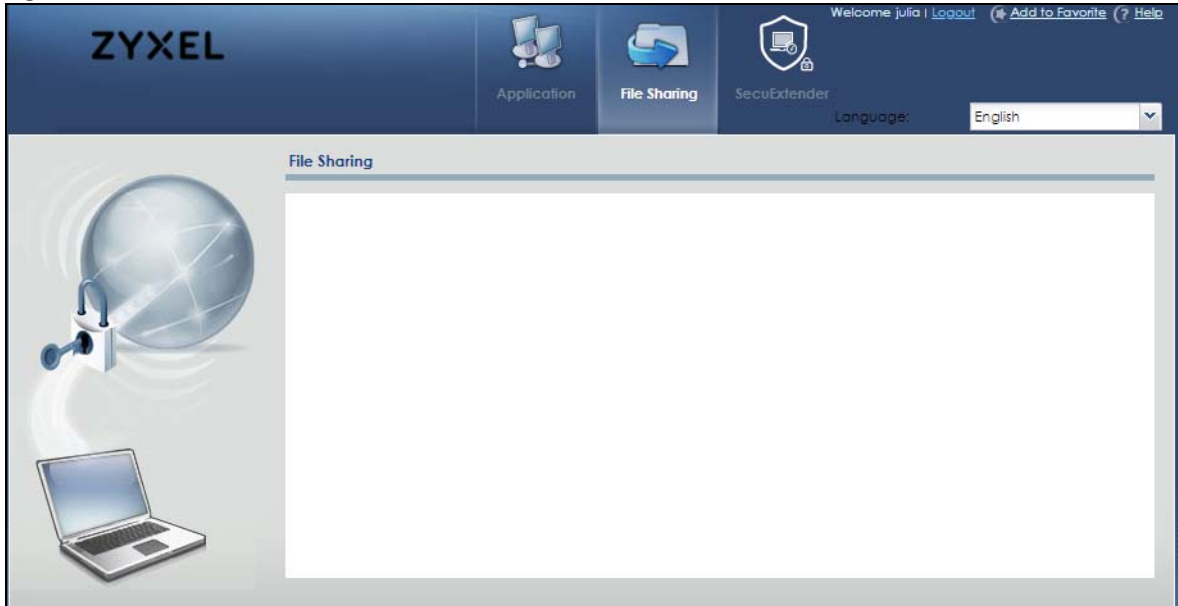

32.7.2 Opening a File or Folder

You can open a file if the file extension is recognized by the web browser and the associated application is installed on your computer.

- 1 Log in as a remote user and click the **File Sharing** tab.
- 2 Click on a file share icon.
- 3 If an access user name and password are required, a screen displays as shown in the following figure. Enter the account information and click **Login** to continue.

Figure 472 File Sharing: Enter Access User Name and Password

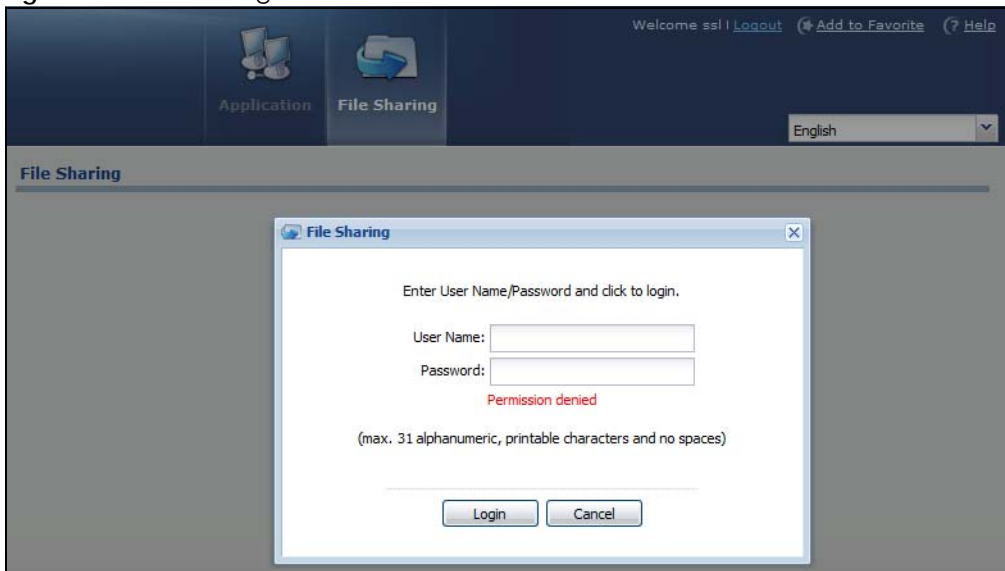

- 4 A list of files/folders displays. Double click a file to open it in a separate browser window or select a file and click **Download** to save it to your computer. You can also click a folder to access it.

For this example, click on a .doc file to open the Word document.

Figure 473 File Sharing: Open a Word File

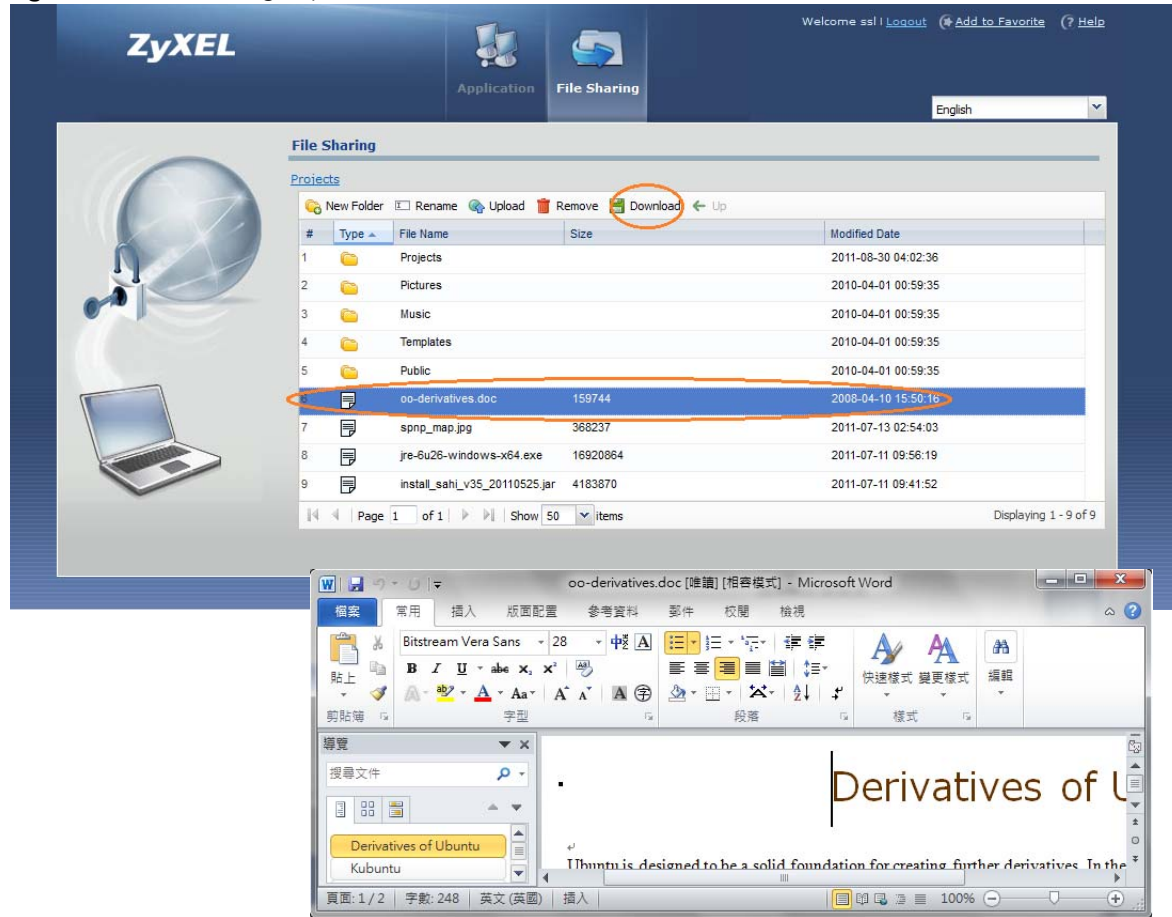

32.7.3 Downloading a File

You are prompted to download a file which cannot be opened using a web browser.

Follow the on-screen instructions to download and save the file to your computer. Then launch the associated application to open the file.

32.7.4 Saving a File

After you have opened a file in a web browser, you can save a copy of the file by clicking **File > Save As** and following the on-screen instructions.

Figure 474 File Sharing: Save a Word File

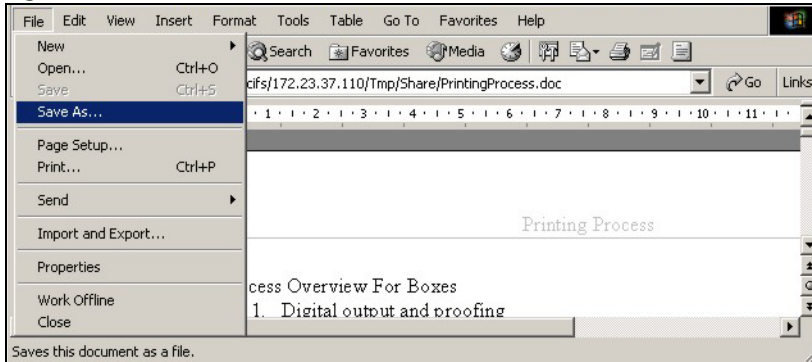

32.7.5 Creating a New Folder

To create a new folder in the file share location, click the **New Folder** icon.

Specify a descriptive name for the folder. You can enter up to 356 characters. Then click **Add**.

Note: Make sure the length of the folder name does not exceed the maximum allowed on the file server.

Figure 475 File Sharing: Create a New Folder

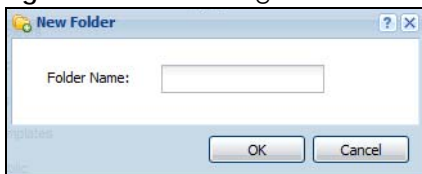

32.7.6 Renaming a File or Folder

To rename a file or folder, select a file or folder and click the **Rename** icon.

Figure 476 File Sharing: Rename

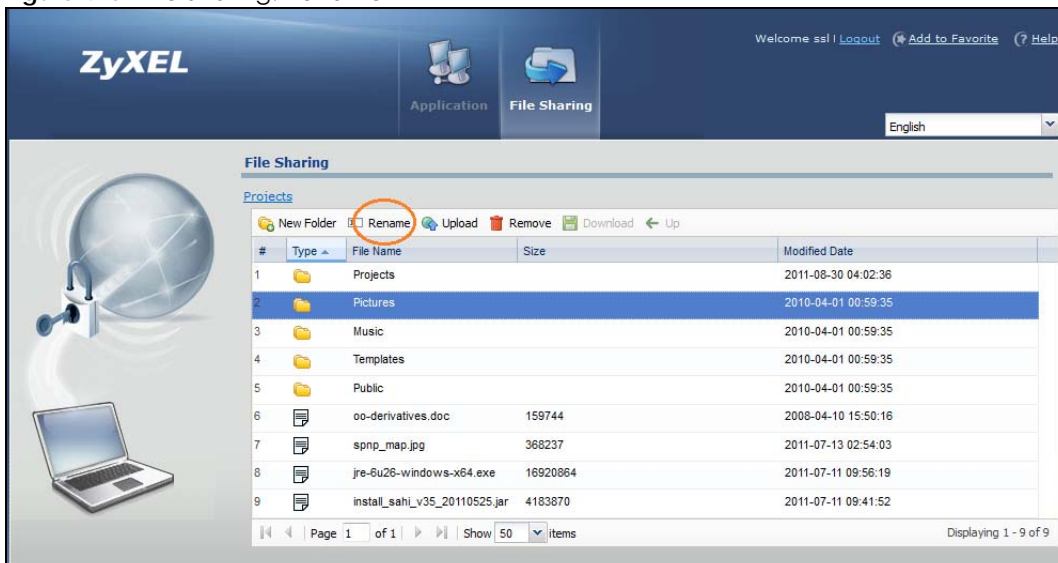

A popup window displays. Specify the new name and/or file extension in the field provided. You can enter up to 356 characters. Then click **Apply**.

Note: Make sure the length of the name does not exceed the maximum allowed on the file server.

You may not be able to open a file if you change the file extension.

Figure 477 File Sharing: Rename



32.7.7 Deleting a File or Folder

Click the **Delete** icon next to a file or folder to remove it.

32.7.8 Uploading a File

Follow the steps below to upload a file to the file server.

- 1 Log into the remote user screen and click the **File Sharing** tab.
- 2 Click **Upload** and specify the location and/or name of the file you want to upload. Or click **Browse** to locate it.
- 3 Click **OK** to send the file to the file server.
- 4 After the file is uploaded successfully, you should see the name of the file and a message in the screen.

Figure 478 File Sharing: File Upload

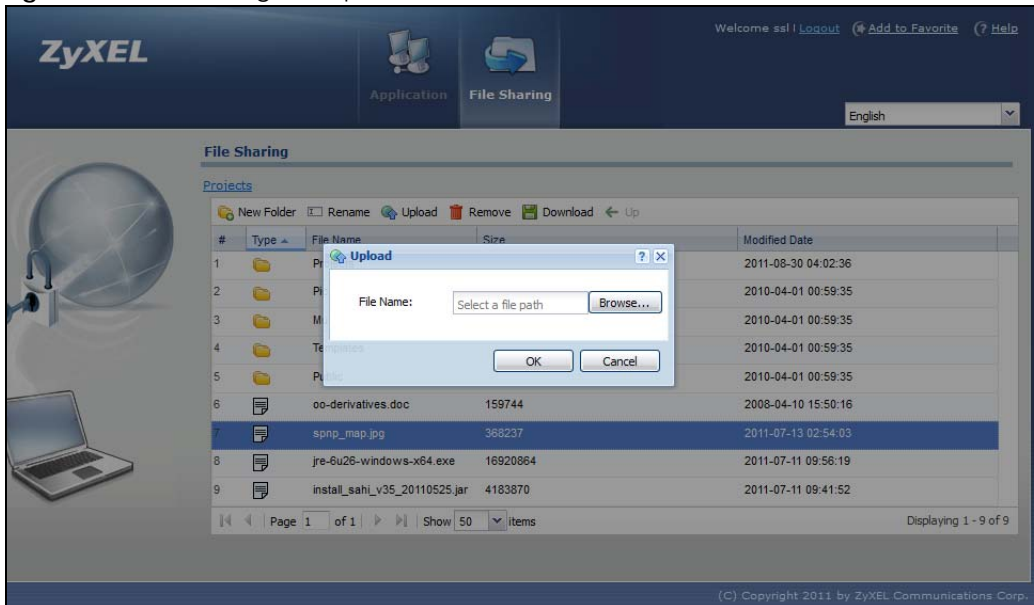

Note: Uploading a file with the same name and file extension replaces the existing file on the file server. No warning message is displayed.

32.8 SecuExtender Screen

Use the **SecuExtender** tab's screen to download the client and see the latest SecuExtender versions available for Windows (**latest version of Windows**) and Mac (**latest version of Mac**), as well as the **Current Version** of the SecuExtender client that you have. We recommend you upgrade to the latest version of the SecuExtender client for your operating system. You must first install the SecuExtender client before using SSL VPN to log into the Zyxel Device.

Figure 479 SecuExtender

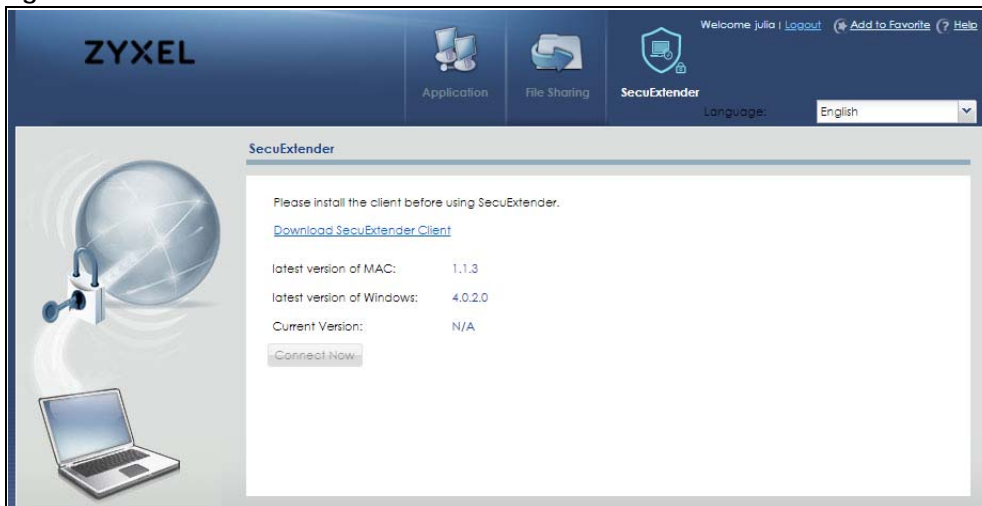

32.8.1 Installing the SecuExtender Client

- 1 Click **Download SecuExtender Client** to first go to the Download Library, click **Software**, then download the SecuExtender version for your operating system.

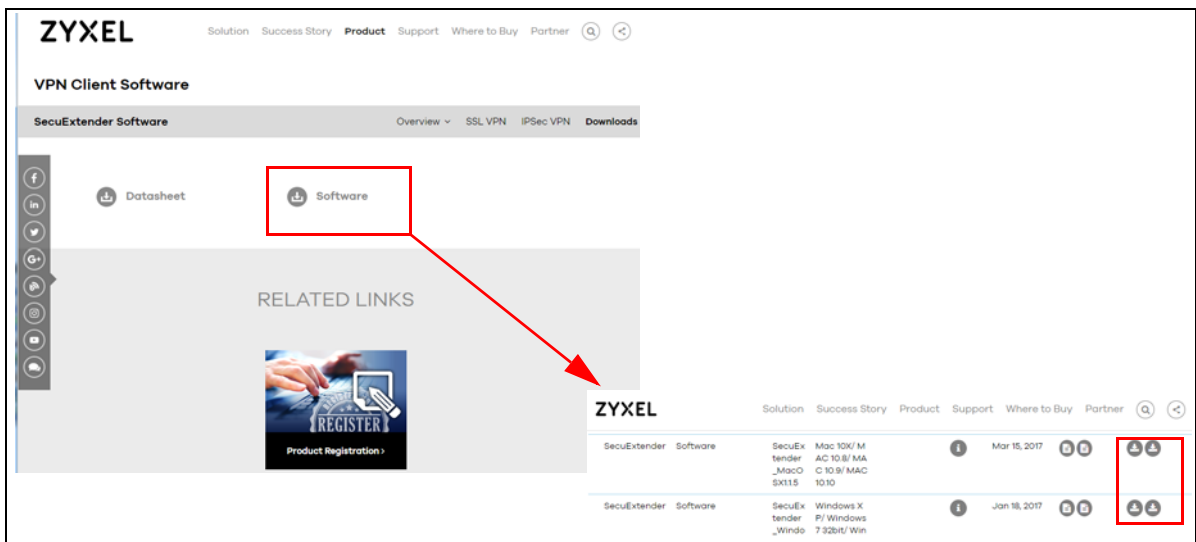

- Click **SecuExtenderSetup.exe** to begin the installation. There are some prerequisites to first install.

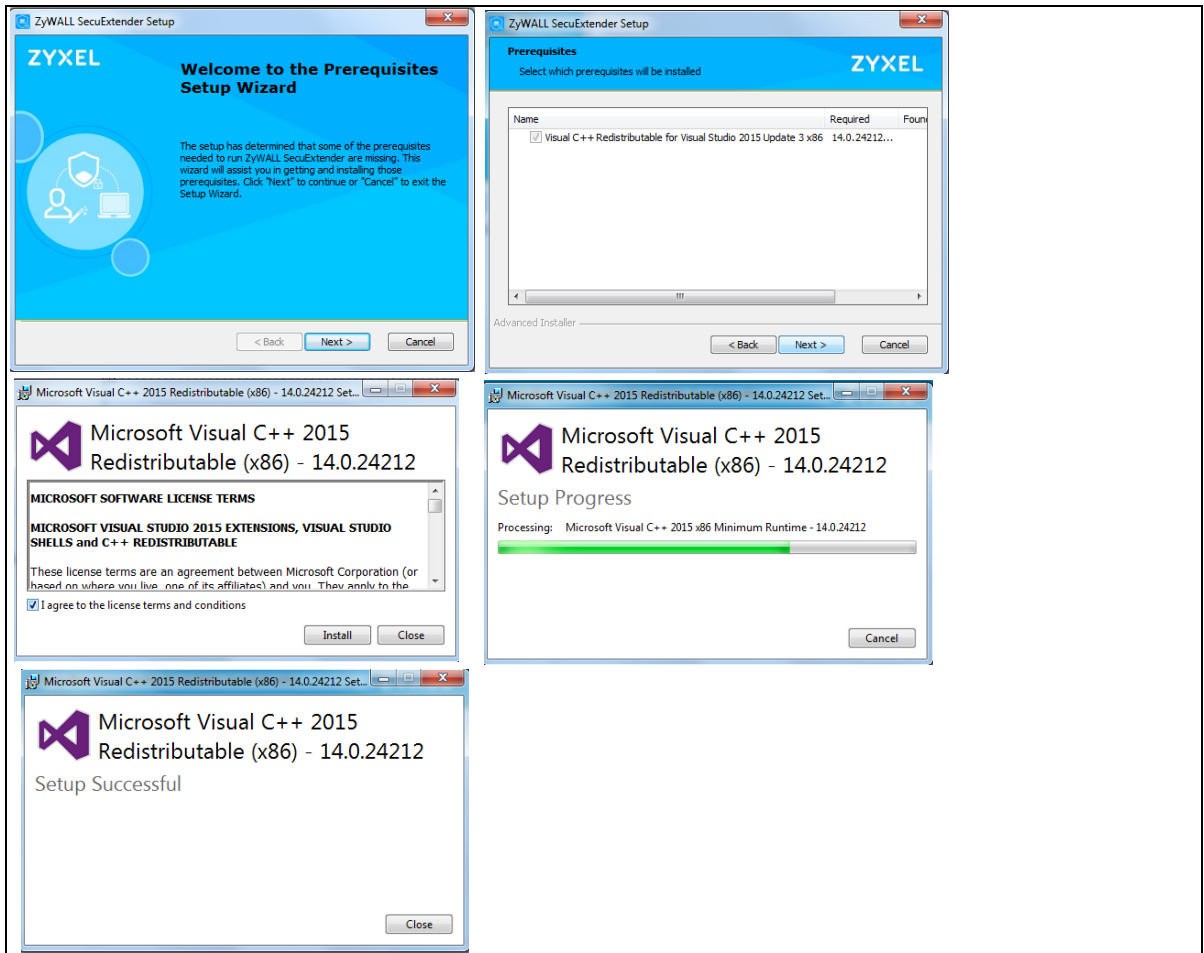

- Next install SecuExtender. Follow the wizard prompts. Click **Install** if you see a security warning.

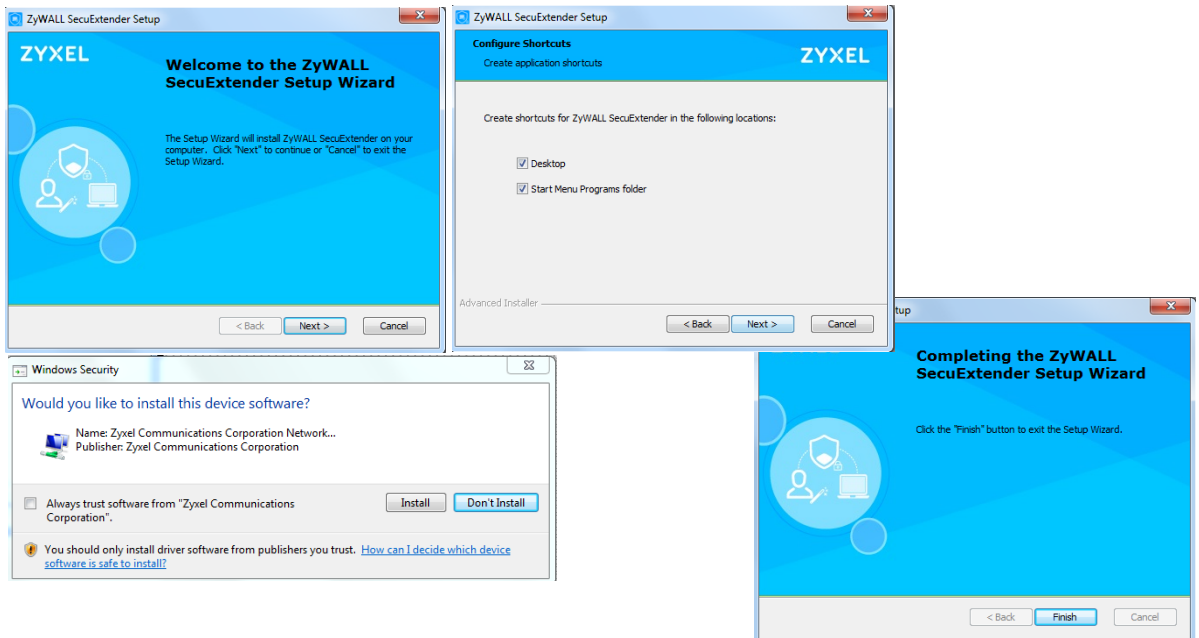

- 4 Next run and log into the SecuExtender client.

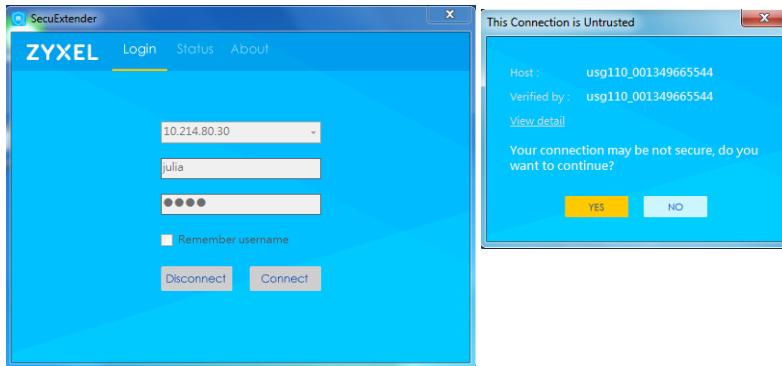

CHAPTER 33

Zyxel Device SecuExtender (Windows)

The Zyxel Device automatically loads the Zyxel Device SecuExtender for Windows client program to your computer after a successful login to an SSL VPN tunnel with network extension support enabled.

Note: For information on using the Zyxel Device SecuExtender for Mac client program, please see its User's Guide at the download library on the Zyxel website.

The Zyxel Device SecuExtender (Windows) lets you:

- Access servers, remote desktops and manage files as if you were on the local network.
- Use applications like email, file transfer, and remote desktop programs directly without using a browser. For example, you can use Outlook for email instead of the Zyxel Device's web-based email.
- Use applications, even proprietary applications, for which the Zyxel Device does not offer SSL application objects.

The applications must be installed on your computer. For example, to use the VNC remote desktop program, you must have the VNC client installed on your computer.

33.1 The Zyxel Device SecuExtender Icon

The Zyxel Device SecuExtender icon color indicates the SSL VPN tunnel's connection status.

Figure 480 Zyxel Device SecuExtender Icon



- Green: the SSL VPN tunnel is connected. You can connect to the SSL application and network resources. You can also use another application to access resources behind the Zyxel Device.
- Gray: the SSL VPN tunnel's connection is suspended. This means the SSL VPN tunnel is connected, but the Zyxel Device SecuExtender will not send any traffic through it until you right-click the icon and resume the connection.
- Red: the SSL VPN tunnel is not connected. You cannot connect to the SSL application and network resources.

33.2 Status

Right-click the Zyxel Device SecuExtender icon in the system tray and select **Status** to open the **Status** screen. Use this screen to view the Zyxel Device SecuExtender's connection status and activity statistics.

Figure 481 Zyxel Device SecuExtender Status

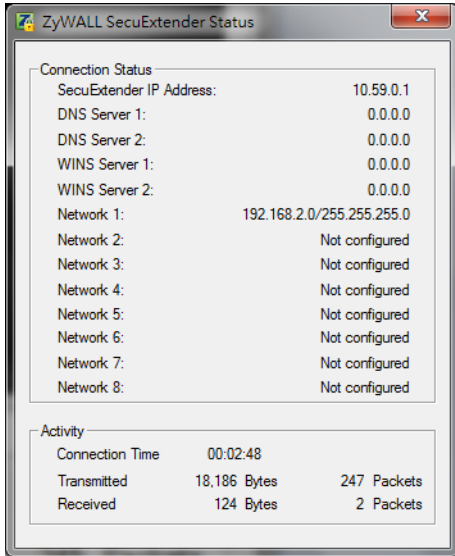

The following table describes the labels in this screen.

Table 239 Zyxel Device SecuExtender Status

LABEL	DESCRIPTION
Connection Status	
SecuExtender IP Address	This is the IP address the Zyxel Device assigned to this remote user computer for an SSL VPN connection.
DNS Server 1/2	These are the IP addresses of the DNS server and backup DNS server for the SSL VPN connection. DNS (Domain Name System) maps a domain name to its corresponding IP address and vice versa. The DNS server is extremely important because without it, you must know the IP address of a computer before you can access it. Your computer uses the DNS server specified here to resolve domain names for resources you access through the SSL VPN connection.
WINS Server 1/2	These are the IP addresses of the WINS (Windows Internet Naming Service) and backup WINS servers for the SSL VPN connection. The WINS server keeps a mapping table of the computer names on your network and the IP addresses that they are currently using.
Network 1~8	These are the networks (including netmask) that you can access through the SSL VPN connection.
Activity	
Connected Time	This is how long the computer has been connected to the SSL VPN tunnel.
Transmitted	This is how many bytes and packets the computer has sent through the SSL VPN connection.
Received	This is how many bytes and packets the computer has received through the SSL VPN connection.

33.3 View Log

If you have problems with the Zyxel Device SecuExtender, customer support may request you to provide information from the log. Right-click the Zyxel Device SecuExtender icon in the system tray and select **Log** to open a notepad file of the Zyxel Device SecuExtender's log.

Figure 482 Zyxel Device SecuExtender Log Example

```
#####
#####
[ 2009/03/12 13:35:50 ][SecuExtender Agent][DETAIL] Build Datetime: Feb 24 2009/
10:25:07
[ 2009/03/12 13:35:50 ][SecuExtender Agent][DEBUG] rasphone.pbk: C:\Documents and
Settings\11746\rasphone.pbk
[ 2009/03/12 13:35:50 ][SecuExtender Agent][DEBUG] SecuExtender.log:
C:\Documents and Settings\11746\SecuExtender.log
[ 2009/03/12 13:35:50 ][SecuExtender Agent][DETAIL] Check Parameters
[ 2009/03/12 13:35:50 ][SecuExtender Agent][DETAIL] Connect to 172.23.31.19:443/
10444
[ 2009/03/12 13:35:50 ][SecuExtender Agent][DETAIL] Parameter is OK
[ 2009/03/12 13:35:50 ][SecuExtender Agent][DETAIL] Checking System status...
[ 2009/03/12 13:35:50 ][SecuExtender Agent][DETAIL] Checking service (first) ...
[ 2009/03/12 13:35:50 ][SecuExtender Agent][DETAIL] SecuExtender Helper is running
[ 2009/03/12 13:35:50 ][SecuExtender Agent][DETAIL] System is OK
[ 2009/03/12 13:35:50 ][SecuExtender Agent][DEBUG] Connect to 2887196435/443
[ 2009/03/12 13:35:50 ][SecuExtender Agent][DETAIL] Handshake LoopCounter: 0
[ 2009/03/12 13:35:50 ][SecuExtender Agent][DETAIL] 611 bytes of handshake data
received
```

33.4 Suspend and Resume the Connection

When the Zyxel Device SecuExtender icon in the system tray is green, you can right-click the icon and select **Suspend Connection** to keep the SSL VPN tunnel connected but not send any traffic through it until you right-click the icon and resume the connection.

33.5 Stop the Connection

Right-click the icon and select **Stop Connection** to disconnect the SSL VPN tunnel.

33.6 Uninstalling the Zyxel Device SecuExtender

Do the following if you need to remove the Zyxel Device SecuExtender.

- 1 Click **start > All Programs > Zyxel > Zyxel Device SecuExtender > Uninstall ZyWALL SecuExtender**.
- 2 In the confirmation screen, click **Yes**.

Figure 483 Uninstalling the Zyxel Device SecuExtender Confirmation

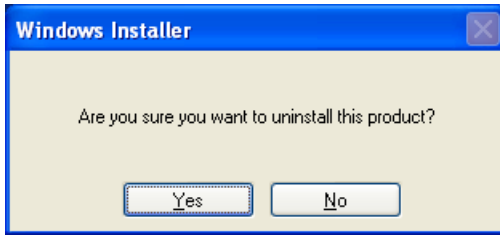

- 3 Windows uninstalls the Zyxel Device SecuExtender.

Figure 484 Zyxel Device SecuExtender Uninstallation

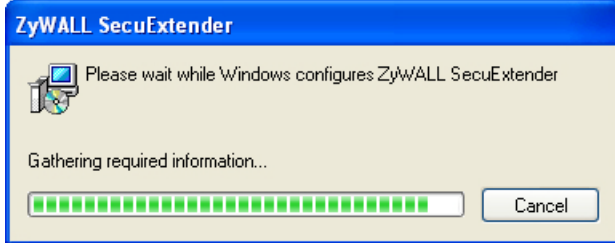

CHAPTER 34

L2TP VPN

34.1 Overview

L2TP VPN uses the L2TP and IPSec client software included in remote users' Android, iOS, Windows or Mac OS X operating systems for secure connections to the network behind the Zyxel Device. The remote users do not need their own IPSec gateways or third-party VPN client software.

Figure 485 L2TP VPN Overview

The screenshot shows the L2TP VPN configuration page. At the top, there are tabs for 'General Settings', 'Configuration Walkthrough', and 'Troubleshooting'. The 'General Settings' tab is active. Below the tabs, there is a checkbox for 'Enable L2TP Over IPSec'. Underneath, there are three dropdown menus: 'VPN Connection' (set to 'none'), 'IP Address Pool' (set to 'none'), and 'Authentication Method' (set to 'default'). To the right of the 'Authentication Method' dropdown is a 'local' label. Below these is an 'Advance' section with a dropdown for 'Authentication Server Certificate' (set to 'default'). Further down, there are several more dropdown menus and input fields: 'Allowed User' (set to 'any'), 'Keep Alive Timer' (set to '60' with a note '(1-180 seconds)'), 'First DNS Server (Optional)' (set to 'Custom Defined'), 'Second DNS Server (Optional)' (set to 'Custom Defined'), 'First WINS Server (Optional)', and 'Second WINS Server (Optional)'. At the bottom of the page, there are 'Apply' and 'Reset' buttons.

34.1.1 What You Can Do in this Chapter

- Use the **L2TP VPN** screen (see [Section 34.2 on page 697](#)) to configure the Zyxel Device's L2TP VPN settings.
- Use the **VPN Setup Wizard** screen in **Quick Setup** ([Chapter 5 on page 156](#)) to configure the Zyxel Device's L2TP VPN settings.

34.1.2 What You Need to Know

The Layer 2 Tunneling Protocol (L2TP) works at layer 2 (the data link layer) to tunnel network traffic between two peers over another network (like the Internet). In L2TP VPN, an IPSec VPN tunnel is established first and then an L2TP tunnel is built inside it. See [Chapter 30 on page 635](#) for information on IPSec VPN.

IPSec Configuration Required for L2TP VPN

You must configure an IPSec VPN connection prior to proper L2TP VPN usage (see [Chapter 34 on page 696](#) for details). The IPSec VPN connection must:

- Be enabled.
- Use transport mode.
- Use **Pre-Shared Key** authentication.
- Use a VPN gateway with the **Secure Gateway** set to **0.0.0.0** if you need to allow L2TP VPN clients to connect from more than one IP address.

Using the Quick Setup VPN Setup Wizard

The **VPN Setup Wizard** is an easy and convenient way to configure the L2TP VPN settings. Click **Configuration > Quick Setup > VPN Setup > VPN Settings for L2TP VPN Settings** to get started.

Policy Route

The Policy Route for return traffic (from LAN to L2TP clients) is automatically created when Zyxel Device adds a new L2TP connection, allowing users access the resources on a network without additional configuration. However, if some of the traffic from the L2TP clients needs to go to the Internet, you will need to create a policy route to send that traffic from the L2TP tunnels out through a WAN trunk. This task can be easily performed by clicking the Allow L2TP traffic through WAN checkbox at **Quick Setup > VPN Setup > Allow L2TP traffic through WAN**.

Figure 486 Policy Route for L2TP VPN

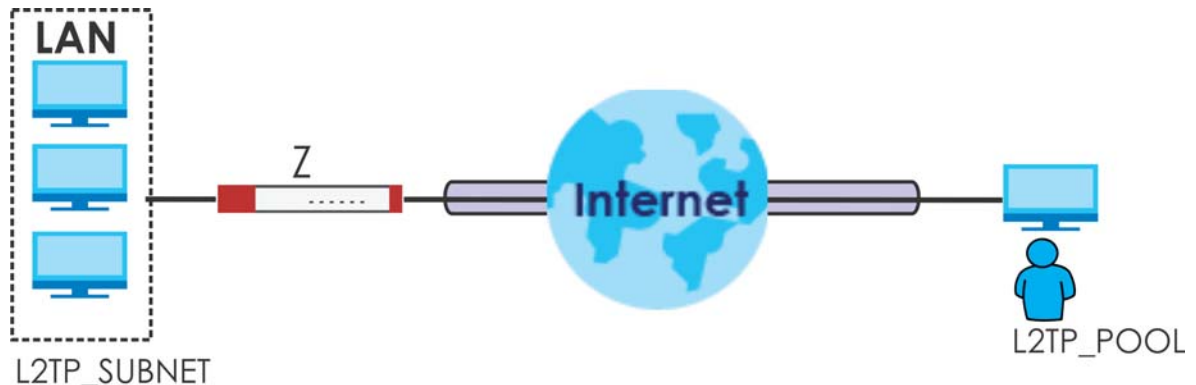

34.2 L2TP VPN Screen

Click **Configuration > VPN > L2TP VPN** to open the following screen. Use this screen to configure the Zyxel Device's L2TP VPN settings.

Note: Disconnect any existing L2TP VPN sessions before modifying L2TP VPN settings. The remote users must make any needed matching configuration changes and re-establish the sessions using the new settings.

Click on the icons to go to the OneSecurity website where there is guidance on configuration walkthroughs, troubleshooting, and other information.

Figure 487 Configuration > VPN > L2TP VPN

The following table describes the fields in this screen.

Table 240 Configuration > VPN > L2TP VPN

LABEL	DESCRIPTION
Show Advanced Settings / Hide Advanced Settings	Click this button to display a greater or lesser number of configuration fields.
Create new Object	Use to configure any new settings objects that you need to use in this screen.
Enable L2TP Over IPsec	Use this field to turn the Zyxel Device's L2TP VPN function on or off.
VPN Connection	Select the IPsec VPN connection the Zyxel Device uses for L2TP VPN. All of the configured VPN connections display here, but the one you use must meet the requirements listed in IPsec Configuration Required for L2TP VPN . Note: Modifying this VPN connection (or the VPN gateway that it uses) disconnects any existing L2TP VPN sessions.
IP Address Pool	Select the pool of IP addresses that the Zyxel Device uses to assign to the L2TP VPN clients. Use Create new Object if you need to configure a new pool of IP addresses. This should not conflict with any WAN, LAN, DMZ or WLAN subnet even if they are not in use.
Authentication Method	Select how the Zyxel Device authenticates a remote user before allowing access to the L2TP VPN tunnel. The authentication method has the Zyxel Device check a user's user name and password against the Zyxel Device's local database, a remote LDAP, RADIUS, a Active Directory server, or more than one of these.
Authentication Server Certificate	Select the certificate to use to identify the Zyxel Device for L2TP VPN connections. You must have certificates already configured in the My Certificates screen. The certificate is used with the EAP, PEAP, and MSCHAPv2 authentication protocols.

Table 240 Configuration > VPN > L2TP VPN (continued)

LABEL	DESCRIPTION
Allowed User	The remote user must log into the Zyxel Device to use the L2TP VPN tunnel. Select a user or user group that can use the L2TP VPN tunnel. Use Create new Object if you need to configure a new user account. Otherwise, select any to allow any user with a valid account and password on the Zyxel Device to log in.
Keep Alive Timer	The Zyxel Device sends a Hello message after waiting this long without receiving any traffic from the remote user. The Zyxel Device disconnects the VPN tunnel if the remote user does not respond.
First DNS Server, Second DNS Server	Specify the IP addresses of DNS servers to assign to the remote users. You can specify these IP addresses two ways. Custom Defined - enter a static IP address. From ISP - use the IP address of a DNS server that another interface received from its DHCP server.
First WINS Server, Second WINS Server	The WINS (Windows Internet Naming Service) server keeps a mapping table of the computer names on your network and the IP addresses that they are currently using. Type the IP addresses of up to two WINS servers to assign to the remote users. You can specify these IP addresses two ways.
Apply	Click Apply to save your changes in the Zyxel Device.
Reset	Click Reset to return the screen to its last-saved settings.

34.2.1 Example: L2TP and Zyxel Device Behind a NAT Router

If the Zyxel Device (Z) is behind a NAT router (N), then do the following for remote clients (C) to access the network behind the Zyxel Device (Z) using L2TP over IPv4.

Figure 488 L2TP and Zyxel Device Behind a NAT Router

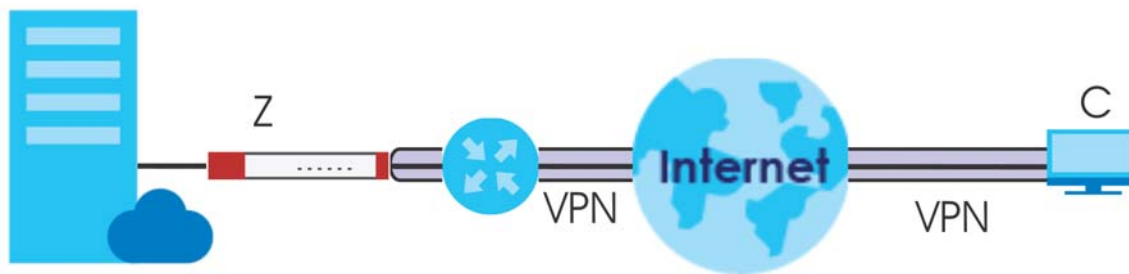

- 1 Create an address object in **Configuration > Object > Address** for the WAN IP address of the NAT router.

- 2 Go to **Configuration > VPN > IPSec VPN > VPN Connection** and click **Add** for **IPv4 Configuration** to create a new VPN connection.

- 3 Select **Remote Access (Server Role)** as the VPN scenario for the remote client.
- 4 Select the NAT router WAN IP address object as the **Local Policy**.

The screenshot shows the configuration page for a new VPN object. The 'General Settings' section has the 'Enable' checkbox checked and the 'Connection Name' set to 'L2TP-IPSec-NAT'. The 'VPN Gateway' section has 'Remote Access (Server Role)' selected as the application scenario, with 'L2TPGateway' as the gateway and 'wan1 0.0.0.0, 0.0.0.0' as the interface. The 'Policy' section has 'NATrouterIP' selected as the local policy and 'HOST, 1.1.1.1' as the host. The 'Phase 2 Setting' section has 'SA Life Time' set to '86400' seconds.

- 5 Go to **Configuration > VPN > L2TP VPN** and select the **VPN Connection** just configured.

The screenshot shows the configuration page for an existing L2TP VPN connection. The 'General Settings' section has the 'Enable L2TP Over IPSec' checkbox checked. The 'VPN Connection' is set to 'L2TP-IPSec-NAT', the 'IP Address Pool' is 'LAN1_SUBNET', and the 'Authentication Method' is 'default'. The 'Allowed User' is set to 'any' and the 'Keep Alive Timer' is '60' seconds. The 'First DNS Server (Optional)' and 'Second DNS Server (Optional)' are both set to 'Custom Defined'. The 'First WINS Server (Optional)' and 'Second WINS Server (Optional)' are both empty. The 'Apply' button is highlighted.

CHAPTER 35

BWM (Bandwidth Management)

35.1 Overview

Bandwidth management provides a convenient way to manage the use of various services on the network. It manages general protocols (for example, HTTP and FTP) and applies traffic prioritization to enhance the performance of delay-sensitive applications like voice and video.

35.1.1 What You Can Do in this Chapter

Use the **BWM** screens (see [Section 35.2 on page 705](#)) to control bandwidth for services passing through the Zyxel Device, and to identify the conditions that define the bandwidth control.

35.1.2 What You Need to Know

When you allow a service, you can restrict the bandwidth it uses. It controls TCP and UDP traffic. Use policy routes to manage other types of traffic (like ICMP).

Note: Bandwidth management in policy routes has priority over TCP and UDP traffic policies.

If you want to use a service, make sure both the security policy allow the service's packets to go through the Zyxel Device.

Note: The Zyxel Device checks security policies before it checks bandwidth management rules for traffic going through the Zyxel Device.

Bandwidth management examines every TCP and UDP connection passing through the Zyxel Device. Then, you can specify, by port, whether or not the Zyxel Device continues to route the connection.

BWM Type

The Zyxel Device supports three types of bandwidth management: **Shared**, **Per user** and **Per-Source-IP**.

The **Shared** BWM type is selected by default in a bandwidth management rule. All matched traffic shares the bandwidth configured in the rule.

If the BWM type is set to **Per user** in a rule, each user that matches the rule can use up to the configured bandwidth by his/her own.

Select the **Per-Source-IP** type when you want to set the maximum bandwidth for traffic from an individual source IP address.

In the following example, you configure a **Per user** bandwidth management rule for radius-users to limit outgoing traffic to 300 kbps. Then all radius-users (**A**, **B** and **C**) can send 300 kbps of traffic.

Figure 489 Bandwidth Management Per User Type

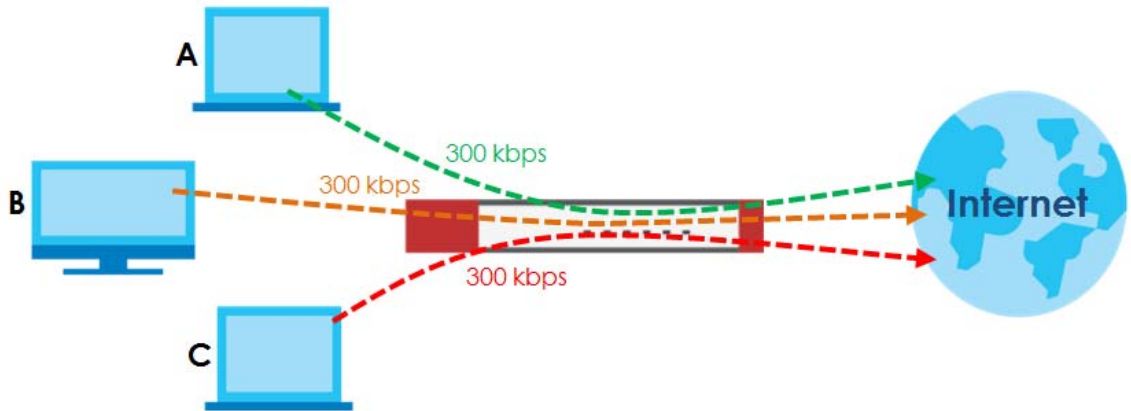

DiffServ and DSCP Marking

QoS is used to prioritize source-to-destination traffic flows. All packets in the same flow are given the same priority. CoS (class of service) is a way of managing traffic in a network by grouping similar types of traffic together and treating each type as a class. You can use CoS to give different priorities to different packet types.

DiffServ (Differentiated Services) is a class of service (CoS) model that marks packets so that they receive specific per-hop treatment at DiffServ-compliant network devices along the route based on the application types and traffic flow. Packets are marked with DiffServ Code Points (DSCPs) indicating the level of service desired. This allows the intermediary DiffServ-compliant network devices to handle the packets differently depending on the code points without the need to negotiate paths or remember state information for every flow. In addition, applications do not have to request a particular service or give advanced notice of where the traffic is going.

Connection and Packet Directions

Bandwidth management looks at the connection direction, that is, from which interface the connection was initiated and to which interface the connection is going.

A connection has outbound and inbound packet flows. The Zyxel Device controls the bandwidth of traffic of each flow as it is going out through an interface or VPN tunnel.

- The outbound traffic flows from the connection initiator to the connection responder.
- The inbound traffic flows from the connection responder to the connection initiator.

For example, a LAN1 to WAN connection is initiated from LAN1 and goes to the WAN.

- Outbound traffic goes from a LAN1 device to a WAN device. Bandwidth management is applied before sending the packets out a WAN interface on the Zyxel Device.
- Inbound traffic comes back from the WAN device to the LAN1 device. Bandwidth management is applied before sending the traffic out a LAN1 interface.

Figure 490 LAN1 to WAN Connection and Packet Directions

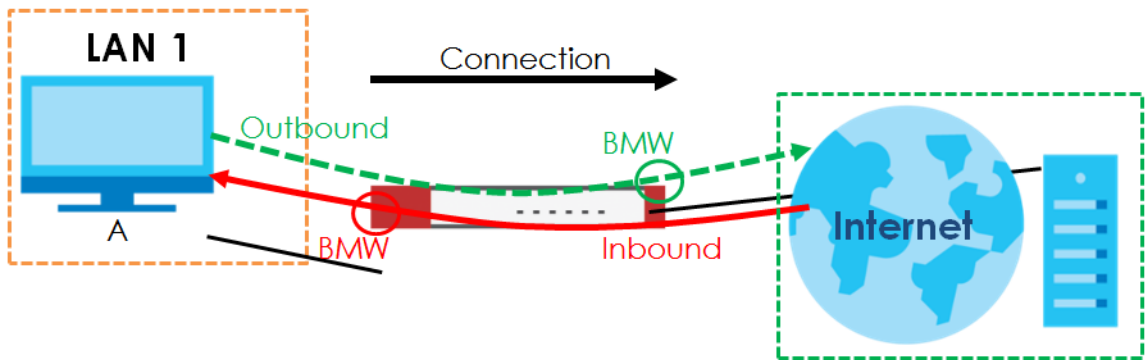

Outbound and Inbound Bandwidth Limits

You can limit an application's outbound or inbound bandwidth. This limit keeps the traffic from using up too much of the out-going interface's bandwidth. This way you can make sure there is bandwidth for other applications. When you apply a bandwidth limit to outbound or inbound traffic, each member of the out-going zone can send up to the limit. Take a LAN1 to WAN policy for example.

- Outbound traffic is limited to 200 kbps. The connection initiator is on the LAN1 so outbound means the traffic traveling from the LAN1 to the WAN. Each of the WAN zone's two interfaces can send the limit of 200 kbps of traffic.
- Inbound traffic is limited to 500 kbps. The connection initiator is on the LAN1 so inbound means the traffic traveling from the WAN to the LAN1.

Figure 491 LAN1 to WAN, Outbound 200 kbps, Inbound 500 kbps

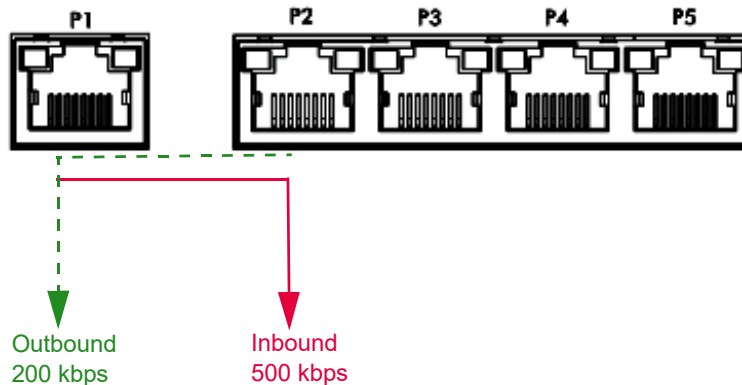

Bandwidth Management Priority

- The Zyxel Device gives bandwidth to higher-priority traffic first, until it reaches its configured bandwidth rate.
- Then lower-priority traffic gets bandwidth.
- The Zyxel Device uses a fairness-based (round-robin) scheduler to divide bandwidth among traffic flows with the same priority.
- The Zyxel Device automatically treats traffic with bandwidth management disabled as priority 7 (the lowest priority).

Maximize Bandwidth Usage

Maximize bandwidth usage allows applications with maximize bandwidth usage enabled to “borrow” any unused bandwidth on the out-going interface.

After each application gets its configured bandwidth rate, the Zyxel Device uses the fairness- based scheduler to divide any unused bandwidth on the out-going interface amongst applications that need more bandwidth and have maximize bandwidth usage enabled.

Unused bandwidth is divided equally. Higher priority traffic does not get a larger portion of the unused bandwidth.

Bandwidth Management Behavior

The following sections show how bandwidth management behaves with various settings. For example, you configure DMZ to WAN policies for FTP servers **A** and **B**. Each server tries to send 1000 kbps, but the WAN is set to a maximum outgoing speed of 1000 kbps. You configure policy A for server **A**'s traffic and policy B for server **B**'s traffic.

Figure 492 Bandwidth Management Behavior

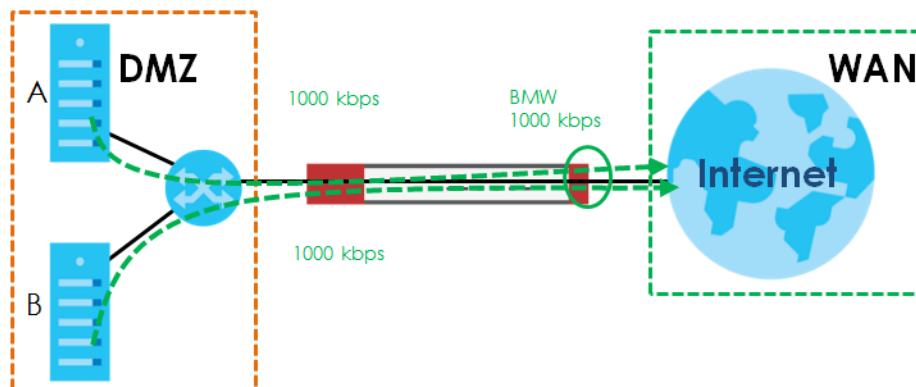

Configured Rate Effect

In the following table the configured rates total less than the available bandwidth and maximize bandwidth usage is disabled, both servers get their configured rate.

Table 241 Configured Rate Effect

POLICY	CONFIGURED RATE	MAX. B. U.	PRIORITY	ACTUAL RATE
A	300 kbps	No	1	300 kbps
B	200 kbps	No	1	200 kbps

Priority Effect

Here the configured rates total more than the available bandwidth. Because server **A** has higher priority, it gets up to its configured rate (800 kbps), leaving only 200 kbps for server **B**.

Table 242 Priority Effect

POLICY	CONFIGURED RATE	MAX. B. U.	PRIORITY	ACTUAL RATE
A	800 kbps	Yes	1	800 kbps
B	1000 kbps	Yes	2	200 kbps

Maximize Bandwidth Usage Effect

With maximize bandwidth usage enabled, after each server gets its configured rate, the rest of the available bandwidth is divided equally between the two. So server **A** gets its configured rate of 300 kbps and server **B** gets its configured rate of 200 kbps. Then the Zyxel Device divides the remaining bandwidth ($1000 - 500 = 500$) equally between the two ($500 / 2 = 250$ kbps for each). The priority has no effect on how much of the unused bandwidth each server gets.

So server **A** gets its configured rate of 300 kbps plus 250 kbps for a total of 550 kbps. Server **B** gets its configured rate of 200 kbps plus 250 kbps for a total of 450 kbps.

Table 243 Maximize Bandwidth Usage Effect

POLICY	CONFIGURED RATE	MAX. B. U.	PRIORITY	ACTUAL RATE
A	300 kbps	Yes	1	550 kbps
B	200 kbps	Yes	2	450 kbps

Priority and Over Allotment of Bandwidth Effect

Server **A** has a configured rate that equals the total amount of available bandwidth and a higher priority. You should regard extreme over allotment of traffic with different priorities (as shown here) as a configuration error. Even though the Zyxel Device still attempts to let all traffic get through and not be lost, regardless of its priority, server **B** gets almost no bandwidth with this configuration.

Table 244 Priority and Over Allotment of Bandwidth Effect

POLICY	CONFIGURED RATE	MAX. B. U.	PRIORITY	ACTUAL RATE
A	1000 kbps	Yes	1	999 kbps
B	1000 kbps	Yes	2	1 kbps

35.2 The Bandwidth Management Configuration

The Bandwidth management screens control the bandwidth allocation for TCP and UDP traffic. You can use source interface, destination interface, destination port, schedule, user, source, destination information, DSCP code and service type as criteria to create a sequence of specific conditions, similar to the sequence of rules used by firewalls, to specify how the Zyxel Device handles the DSCP value and allocate bandwidth for the matching packets.

Click **Configuration > BWM** to open the following screen. This screen allows you to enable/disable bandwidth management and add, edit, and remove user-defined bandwidth management policies.

The default bandwidth management policy is the one with the priority of "default". It is the last policy the Zyxel Device checks if traffic does not match any other bandwidth management policies you have configured. You cannot remove, activate, deactivate or move the default bandwidth management policy.

Figure 493 Configuration > Bandwidth Management

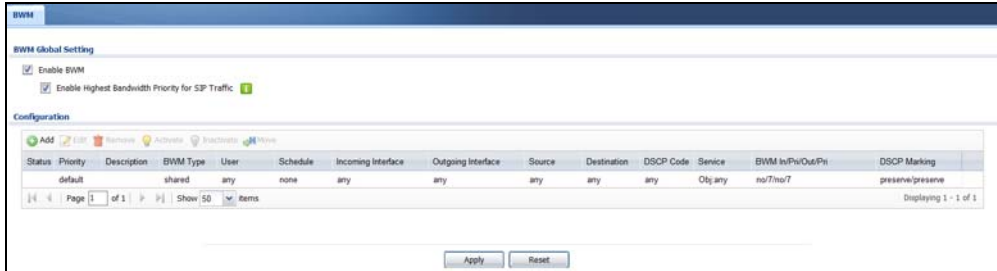

The following table describes the labels in this screen. See [Section 35.2.1 on page 708](#) for more information as well.

Table 245 Configuration > Bandwidth Management

LABEL	DESCRIPTION
Enable BWM	Select this check box to activate management bandwidth.
Enable Highest Bandwidth Priority for SIP Traffic	Select this to maximize the throughput of SIP traffic to improve SIP-based VoIP call sound quality. This has the Zyxel Device immediately send SIP traffic upon identifying it. When this option is enabled the Zyxel Device ignores any other application patrol rules for SIP traffic (so there is no bandwidth control for SIP traffic) and does not record SIP traffic bandwidth usage statistics.
Add	Click this to create a new entry. Select an entry and click Add to create a new entry after the selected entry.
Edit	Select an entry and click this to be able to modify it.
Remove	Select an entry and click this to delete it.
Activate	To turn on an entry, select it and click Activate .
Inactivate	To turn off an entry, select it and click Inactivate .
Move	To change an entry's position in the numbered list, select it and click Move to display a field to type a number for where you want to put that entry and press [ENTER] to move the entry to the number that you typed.
Status	The activate (light bulb) icon is lit when the entry is active and dimmed when the entry is inactive. The status icon is not available for the default bandwidth management policy.
Priority	This field displays a sequential value for each bandwidth management policy and it is not associated with a specific setting. This field displays default for the default bandwidth management policy.
Description	This field displays additional information about this policy.
BWM Type	This field displays the below types of BWM: <ul style="list-style-type: none"> • Shared, when the policy is set for all matched traffic • Per User, when the policy is set for an individual user or a user group • Per-Source-IP, when the policy is set for a source IP
User	This is the type of user account to which the policy applies. If any displays, the policy applies to all user accounts.
Schedule	This is the schedule that defines when the policy applies. none means the policy always applies.
Incoming Interface	This is the source interface of the traffic to which this policy applies.

Table 245 Configuration > Bandwidth Management

LABEL	DESCRIPTION
Outgoing Interface	This is the destination interface of the traffic to which this policy applies.
Source	This is the source address or address group, including geographic address and FQDN (group) objects, for whom this policy applies. If any displays, the policy is effective for every source.
Destination	This is the destination address or address group, including geographic address and FQDN (group) objects, for whom this policy applies. If any displays, the policy is effective for every destination.
DSCP Code	<p>These are the DSCP code point values of incoming and outgoing packets to which this policy applies. The lower the number the higher the priority with the exception of 0 which is usually given only best-effort treatment.</p> <p>any means all DSCP value or no DSCP marker.</p> <p>default means traffic with a DSCP value of 0. This is usually best effort traffic</p> <p>The "af" options stand for Assured Forwarding. The number following the "af" identifies one of four classes and one of three drop preferences.</p>
Service Type	<p>App and the service name displays if you selected Application Object for the service type. An Application Object is a pre-defined service.</p> <p>Obj and the service name displays if you selected Service Object for the service type. A Service Object is a customized pre-defined service or another service. Mouse over the service object name to view the corresponding IP protocol number.</p>
BWM In/Pri/Out/Pri	<p>This field shows the amount of bandwidth the traffic can use.</p> <p>In - This is how much inbound bandwidth, in kilobits per second, this policy allows the matching traffic to use. Inbound refers to the traffic the Zyxel Device sends to a connection's initiator. If no displays here, this policy does not apply bandwidth management for the inbound traffic.</p> <p>Out - This is how much outgoing bandwidth, in kilobits per second, this policy allows the matching traffic to use. Outbound refers to the traffic the Zyxel Device sends out from a connection's initiator. If no displays here, this policy does not apply bandwidth management for the outbound traffic.</p> <p>Pri - This is the priority for the incoming (the first Pri value) or outgoing (the second Pri value) traffic that matches this policy. The smaller the number, the higher the priority. Traffic with a higher priority is given bandwidth before traffic with a lower priority. The Zyxel Device ignores this number if the incoming and outgoing limits are both set to 0. In this case the traffic is automatically treated as being set to the lowest priority (7) regardless of this field's configuration.</p>
DSCP Marking	<p>This is how the Zyxel Device handles the DSCP value of the incoming and outgoing packets that match this policy.</p> <p>In - Inbound, the traffic the Zyxel Device sends to a connection's initiator.</p> <p>Out - Outbound, the traffic the Zyxel Device sends out from a connection's initiator.</p> <p>If this field displays a DSCP value, the Zyxel Device applies that DSCP value to the route's outgoing packets.</p> <p>preserve means the Zyxel Device does not modify the DSCP value of the route's outgoing packets.</p> <p>default means the Zyxel Device sets the DSCP value of the route's outgoing packets to 0.</p> <p>The "af" choices stand for Assured Forwarding. The number following the "af" identifies one of four classes and one of three drop preferences.</p>
Apply	Click Apply to save your changes back to the Zyxel Device.
Reset	Click Reset to return the screen to its last-saved settings.

35.2.1 The Bandwidth Management Add/Edit Screen

The **Configuration > Bandwidth Management Add/Edit** screen allows you to create a new condition or edit an existing one.

802.1P Marking

Use 802.1P to prioritize outgoing traffic from a VLAN interface. The **Priority Code** is a 3-bit field within a 802.1Q VLAN tag that's used to prioritize associated outgoing VLAN traffic. "0" is the lowest priority level and "7" is the highest.

Table 246 Single Tagged 802.1Q Frame Format

			DA	SA	TPID	Priority	VID	Len/Etype	Data	FCS	IEEE 802.1Q customer tagged frame
--	--	--	----	----	------	----------	-----	-----------	------	-----	-----------------------------------

Table 247 802.1Q Frame

DA	Destination Address	Priority	802.1p Priority
SA	Source Address	Len/Etype	Length and type of Ethernet frame
TPID	Tag Protocol Identifier	Data	Frame data
VID	VLAN ID	FCS	Frame Check Sequence

The following table is a guide to types of traffic for the priority code.

Table 248 Priority Code and Types of Traffic

PRIORITY	TRAFFIC TYPES
0 (lowest)	Background
1	Best Effort
2	Excellent Effort
3	Critical Applications
4	Video, less than 100 ms latency and jitter
5	Voice, less than 10 ms latency and jitter
6	Internetwork Control
7 (highest)	Network Control

To access this screen, go to the **Configuration > Bandwidth Management** screen (see [Section 35.2 on page 705](#)), and click either the **Add** icon or an **Edit** icon.

Figure 494 Configuration > Bandwidth Management > Edit (For the Default Policy)

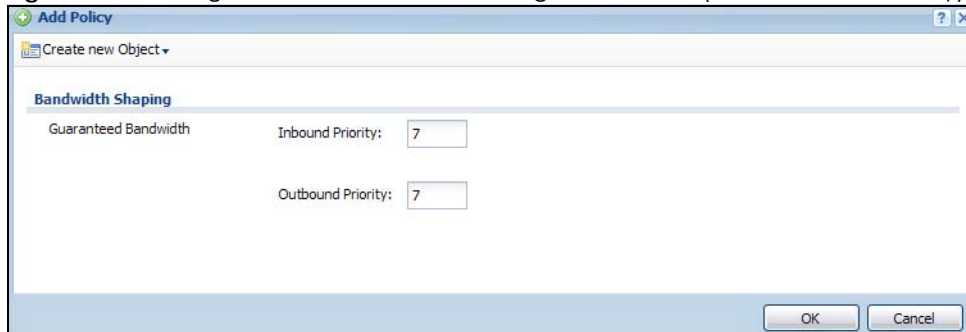

Figure 495 Configuration > Bandwidth Management > Add/Edit

The following table describes the labels in this screen.

Table 249 Configuration > Bandwidth Management > Add/Edit

LABEL	DESCRIPTION
Create new Object	Use to configure any new settings objects that you need to use in this screen.
Configuration	
Enable	Select this check box to turn on this policy.
Description	Enter a description of this policy. It is not used elsewhere. You can use alphanumeric and () + / : = ? ! * # @ \$ _ % - characters, and it can be up to 60 characters long.
Criteria	Use this section to configure the conditions of traffic to which this policy applies.

Table 249 Configuration > Bandwidth Management > Add/Edit (continued)

LABEL	DESCRIPTION
BWM Type	This field displays the below types of BWM rule: <ul style="list-style-type: none"> • Shared, when the policy is set for all users • Per User, when the policy is set for an individual user or a user group • Per Source IP, when the policy is set for a source IP
User	Select a user name or user group to which to apply the policy. Use Create new Object if you need to configure a new user account. Select any to apply the policy for every user.
Schedule	Select a schedule that defines when the policy applies or select Create Object to configure a new one. Otherwise, select none to make the policy always effective.
Incoming Interface	Select the source interface of the traffic to which this policy applies.
Outgoing Interface	Select the destination interface of the traffic to which this policy applies.
Source	Select a source address or address group, including geographic address and FQDN (group) objects, for whom this policy applies. Use Create new Object if you need to configure a new one. Select any if the policy is effective for every source.
Destination	Select a destination address or address group, including geographic address and FQDN (group) objects, for whom this policy applies. Use Create new Object if you need to configure a new one. Select any if the policy is effective for every destination.
DSCP Code	Select a DSCP code point value of incoming packets to which this policy route applies or select User Defined to specify another DSCP code point. The lower the number the higher the priority with the exception of 0 which is usually given only best-effort treatment. any means all DSCP value or no DSCP marker. default means traffic with a DSCP value of 0. This is usually best effort traffic The " af " choices stand for Assured Forwarding. The number following the " af " identifies one of four classes and one of three drop preferences.
User-Defined DSCP Code	Use this field to specify a custom DSCP code point.
Service Type	Select Service Object or Application Object if you want a specific service (defined in a service object) or application patrol service to which the policy applies.
Service Object	This field is available if you selected Service Object as the service type. Select a service or service group to identify the type of traffic to which this policy applies. any means all services.
Application Object	This field is available if you selected Application Object as the service type. Select an application patrol service to identify the specific traffic to which this policy applies.
DSCP Marking	Set how the Zyxel Device handles the DSCP value of the incoming and outgoing packets that match this policy. Inbound refers to the traffic the Zyxel Device sends to a connection's initiator. Outbound refers to the traffic the Zyxel Device sends out from a connection's initiator. Select one of the pre-defined DSCP values to apply or select User Defined to specify another DSCP value. The " af " choices stand for Assured Forwarding. The number following the " af " identifies one of four classes and one of three drop preferences. Select preserve to have the Zyxel Device keep the packets' original DSCP value. Select default to have the Zyxel Device set the DSCP value of the packets to 0.
Bandwidth Shaping	Configure these fields to set the amount of bandwidth the matching traffic can use.

Table 249 Configuration > Bandwidth Management > Add/Edit (continued)

LABEL	DESCRIPTION
Inbound kbps	<p>Type how much inbound bandwidth, in kilobits per second, this policy allows the traffic to use. Inbound refers to the traffic the Zyxel Device sends to a connection's initiator.</p> <p>If you enter 0 here, this policy does not apply bandwidth management for the matching traffic that the Zyxel Device sends to the initiator. Traffic with bandwidth management disabled (inbound and outbound are both set to 0) is automatically treated as the lowest priority (7).</p> <p>If the sum of the bandwidths for routes using the same next hop is higher than the actual transmission speed, lower priority traffic may not be sent if higher priority traffic uses all of the actual bandwidth.</p>
Outbound kbps	<p>Type how much outbound bandwidth, in kilobits per second, this policy allows the traffic to use. Outbound refers to the traffic the Zyxel Device sends out from a connection's initiator.</p> <p>If you enter 0 here, this policy does not apply bandwidth management for the matching traffic that the Zyxel Device sends out from the initiator. Traffic with bandwidth management disabled (inbound and outbound are both set to 0) is automatically treated as the lowest priority (7).</p> <p>If the sum of the bandwidths for routes using the same next hop is higher than the actual transmission speed, lower priority traffic may not be sent if higher priority traffic uses all of the actual bandwidth.</p>
Priority	<p>This field displays when the inbound or outbound bandwidth management is not set to 0. Enter a number between 1 and 7 to set the priority for traffic that matches this policy. The smaller the number, the higher the priority.</p> <p>Traffic with a higher priority is given bandwidth before traffic with a lower priority.</p> <p>The Zyxel Device uses a fairness-based (round-robin) scheduler to divide bandwidth between traffic flows with the same priority.</p> <p>The number in this field is ignored if the incoming and outgoing limits are both set to 0. In this case the traffic is automatically treated as being set to the lowest priority (7) regardless of this field's configuration.</p>
Maximize Bandwidth Usage	<p>This field displays when the inbound or outbound bandwidth management is not set to 0 and the BWM Type is set to Shared. Enable maximize bandwidth usage to let the traffic matching this policy "borrow" all unused bandwidth on the out-going interface.</p> <p>After each application or type of traffic gets its configured bandwidth rate, the Zyxel Device uses the fairness-based scheduler to divide any unused bandwidth on the out-going interface among applications and traffic types that need more bandwidth and have maximize bandwidth usage enabled.</p>
Maximum	<p>If you did not enable Maximize Bandwidth Usage, then type the maximum unused bandwidth that traffic matching this policy is allowed to "borrow" on the out-going interface (in Kbps), here.</p>
802.1P Marking	<p>Use 802.1P to prioritize outgoing traffic from a VLAN interface.</p>
Priority Code	<p>This is a 3-bit field within a 802.1Q VLAN tag that's used to prioritize associated outgoing VLAN traffic. "0" is the lowest priority level and "7" is the highest. See Table 248 on page 708. The setting configured here overwrites existing priority settings.</p>
Interface	<p>Choose a VLAN interface to which to apply the priority level for matching frames.</p>
Related Setting	
Log	<p>Select whether to have the Zyxel Device generate a log (log), log and alert (log alert) or neither (no) when any traffic matches this policy.</p>
OK	<p>Click OK to save your changes back to the Zyxel Device.</p>
Cancel	<p>Click Cancel to exit this screen without saving your changes.</p>

35.2.1.1 Adding Objects for the BWM Policy

Objects are parameters to which the Policy rules are built upon. There are three kinds of objects you can add/edit for the BWM policy, they are **User**, **Schedule** and **Address** objects. Click **Configuration > BWM > Add > Create New Object > Add User** to see the following screen.

Figure 496 Configuration >BWM > Create New Object > Add User

The following table describes the fields in the above screen.

Table 250 Configuration > BWM > Create New Object > Add User

LABEL	DESCRIPTION
User Name	Type a user or user group object name of the rule.
User Type	Select a user type from the drop down menu. The user types are Admin, Limited admin, User, Guest, Ext-user, Ext-group-user.

Table 250 Configuration > BWM > Create New Object > Add User (continued)

LABEL	DESCRIPTION
Password	Type a password for the user object. The password can consist of alphanumeric characters, the underscore, and some punctuation marks (+-/*= ; : ! @ \$ & % # ~ ' \ ()), and it can be up to eight characters long.
Retype	Retype the password to confirm.
Description	Enter a description for this user object. It is not used elsewhere. You can use alphanumeric and () + / : = ? ! * # @ \$ % _ - characters, and it can be up to 60 characters long.
Authentication Timeout Settings	Choose either Use Default setting option, which shows the default Lease Time of 1,440 minutes and Reauthentication Time of 1,440 minutes or you can enter them manually by choosing Use Manual Settings option.
Lease Time	This shows the Lease Time setting for the user, by default it is 1,440 minutes.
Reauthentication Time	This shows the Reauthentication Time for the user, by default it is 1,440 minutes.
OK	Click OK to save the setting.
Cancel	Click Cancel to abandon this screen.

Figure 497 Configuration > BWM > Create New Object > Add Schedule

The screenshot shows the 'Add Policy' configuration window. The 'Create Schedule Object' dialog is open, showing the following fields:

- Configuration:** Name (text input), Type (One Time dropdown).
- Day Time:** Start Date (calendar icon), Start Time (time icon), Stop Date (calendar icon), Stop Time (time icon).

The main window shows the following sections:

- Configuration:** Enable (checked), Description (text input), BWM Type (Shared radio selected).
- Criteria:** User (any), Schedule (none), Incoming Interface (any), Outgoing Interface (any), Source (any), Destination (any), DSCP Code (any), Service Type (Service Object radio selected), Service Object (any).
- DSCP Marking:** Inbound Marking (preserve), Outbound Marking (preserve).
- Bandwidth Shaping:** Guaranteed Bandwidth (Inbound: 0 kbps, Priority: 4, Maximize Bandwidth Usage checkbox), Outbound (0 kbps, Priority: 4, Maximize Bandwidth Usage checkbox).
- 802.1P Marking:** Priority Code (0), Interface (none).
- Related Setting:** Log (no).

The following table describes the fields in the above screen.

Table 251 Configuration > BWM > Create New Object > Add Schedule

LABEL	DESCRIPTION
Name	Enter a name for the schedule object of the rule.
Type	Select an option from the drop down menu for the schedule object. It will show One Time or Recurring .
Start Date	Click the icon menu on the right to choose a Start Date for the schedule object.
Start Time	Click the icon menu on the right to choose a Start Time for the schedule object.
Stop Date	Click the icon menu on the right to choose a Stop Date for schedule object.
Stop Time	Click the icon menu on the right to choose a Stop Time for the schedule object.

Figure 498 Configuration > BWM > Create New Object > Add Address

The screenshot shows the 'Add Policy' configuration window with the 'Create Address' dialog box open. The dialog box contains the following fields:

- Name:** A text input field with a red error icon.
- Address Type:** A dropdown menu set to 'HOST'.
- IP Address:** A text input field containing '0.0.0.0'.

The background window shows the following configuration sections:

- Configuration:** Includes 'Enable' (checked), 'Description', 'BWM Type' (Shared), and 'Service Type' (Service Object).
- Criteria:** Includes 'User', 'Schedule', 'Incoming Interface', 'Outgoing Interface', 'Source', 'Destination', 'DSCP Code', 'Service Object', and 'Service Object' dropdowns.
- DSCP Marking:** Includes 'Inbound Marking' and 'Outbound Marking' dropdowns set to 'preserve'.
- Bandwidth Shaping:** Includes 'Guaranteed Bandwidth' and 'Maximum' settings for 'Inbound' and 'Outbound' traffic.
- 802.1P Marking:** Includes 'Priority Code' (0) and 'Interface' (none).
- Related Setting:** Includes 'Log' (no).

The following table describes the fields in the above screen.

Table 252 Configuration > BWM > Create New Object > Add Address

LABEL	DESCRIPTION
Name	Enter a name for the Address object of the rule.
Address Type	Select an Address Type from the drop down menu on the right. The Address Types are Host, Range, Subnet, Interface IP, Interface Subnet, and Interface Gateway.
IP Address	Enter an IP address for the Address object.
OK	Click OK to save the setting.
Cancel	Click Cancel to abandon the setting.

CHAPTER 36

Application Patrol

36.1 Overview

Application patrol provides a convenient way to manage the use of various applications on the network. It manages general protocols (for example, HTTP and FTP) and instant messenger (IM), peer-to-peer (P2P), Voice over IP (VoIP), and streaming (RSTP) applications. You can even control the use of a particular application's individual features (like text messaging, voice, video conferencing, and file transfers). You can also configure bandwidth management with application patrol in the **Configuration > BWM** screen for traffic prioritization to enhance the performance of delay-sensitive applications like voice and video.

36.1.1 What You Can Do in this Chapter

- Use the **Profile** summary screen (see [Section 36.2 on page 717](#)) to view license registration and signature information.
- Use the **Profile Add/Edit** screens (see [Section 36.2 on page 717](#)) to set actions for application categories and for specific applications within the category.

36.1.2 What You Need to Know

If you want to use a service, make sure both the Security Policy and application patrol allow the service's packets to go through the Zyxel Device.

Note: The Zyxel Device checks secure policies before it checks application patrol rules for traffic going through the Zyxel Device.

Application patrol examines every TCP and UDP connection passing through the Zyxel Device and identifies what application is using the connection. Then, you can specify whether or not the Zyxel Device continues to route the connection. Traffic not recognized by the application patrol signatures is ignored.

Application Profiles & Policies

An application patrol profile is a group of categories of application patrol signatures. For each profile, you can specify the default action the Zyxel Device takes once a packet matches a signature (forward, drop, or reject a service's connections and/or create a log alert).

Use policies to link profiles to traffic flows based on criteria such as source zone, destination zone, source address, destination address, schedule, user.

Classification of Applications

There are two ways the Zyxel Device can identify the application. The first is called auto. The Zyxel Device looks at the IP payload (OSI level-7 inspection) and attempts to match it with known patterns for

specific applications. Usually, this occurs at the beginning of a connection, when the payload is more consistent across connections, and the Zyxel Device examines several packets to make sure the match is correct. Before confirmation, packets are forwarded by App Patrol with no action taken. The number of packets inspected before confirmation varies by signature.

Note: The Zyxel Device allows the first eight packets to go through the security policy, regardless of the application patrol policy for the application. The Zyxel Device examines these first eight packets to identify the application.

The second approach is called service ports. The Zyxel Device uses only OSI level-4 information, such as ports, to identify what application is using the connection. This approach is available in case the Zyxel Device identifies a lot of "false positives" for a particular application.

Custom Ports for SIP and the SIP ALG

Configuring application patrol to use custom port numbers for SIP traffic also configures the SIP ALG to use the same port numbers for SIP traffic. Likewise, configuring the SIP ALG to use custom port numbers for SIP traffic also configures application patrol to use the same port numbers for SIP traffic.

Finding Out More

- You must configure services in **Objects > Application**.
- See **Configuration > BWM** chapter for detailed information on bandwidth management.

36.2 Application Patrol Profile

Use the application patrol **Profile** screens to customize action and log settings for a group of application patrol signatures. You then link a profile to a policy. Use this screen to create an application patrol profile, and view signature information. It also lists the registration status and details about the signature set the Zyxel Device is using.

Note: You must register for the IDP/AppPatrol signature service (at least the trial) before you can use it.

A profile is an application object(s) or application group(s) that has customized action and log settings.

Click **Configuration > UTM Profile > App Patrol > Profile** to open the following screen.

Click on the icons to go to the OneSecurity website where there is guidance on configuration walkthroughs, troubleshooting and other information.

Figure 499 Configuration > UTM Profile > App Patrol > Profile

The screenshot shows the 'Profile' configuration page for 'App Patrol'. At the top, there are navigation tabs: 'Profile Management', 'Configuration Walkthrough', 'Troubleshooting', and 'Application Patrol'. Below these are icons for 'Add', 'Edit', 'Remove', and 'Object References'. A table lists profile entries with columns for '#', 'Name', 'Description', 'Scan Options', and 'Reference'. One entry is shown: #1, Name: mytube, Description: blah, Scan Options: test, Reference: 1. Below the table is a pagination control showing 'Page 1 of 1' and 'Show 50 items'. The 'Service' section shows 'Service Status: Activated' with a 'Renew' link, 'Service Type: Standard', and 'Expiration Date: 2018-02-19'. The 'Signature Information' section shows 'Current Version: 3.2.4.061' and 'Released Date: 2017-07-26 01:28:16 (UTC+00:00)', with an 'Update Signatures' link.

The following table describes the labels in this screen.

Table 253 Configuration > UTM Profile > App Patrol > Profile

LABEL	DESCRIPTION
Add	Click this to create a new entry. Select an entry and click Add to create a new entry after the selected entry.
Edit	Double-click an entry or select it and click Edit to open a screen where you can modify the entry's settings.
Remove	Select an entry and click Remove to delete the selected entry.
References	Select an entry and click References to open a screen that shows which settings use the entry. Click Refresh to update information on this screen.
#	This field is a sequential value showing the number of the profile. The profile order is not important.
Name	This displays the name of the profile created.
Description	This displays the description of the App Patrol Profile.
Scan Option	This field displays the scan options from the App Patrol profile.
Reference	This displays the number of times an object reference is used in a profile.
Service	You need to create an account at myZyxel, register your Zyxel Device and then subscribe for App Patrol in order to be able to download new packet inspection signatures from myZyxel. There's an initial free trial period for App Patrol after which you must pay to subscribe to the service. See the Registration chapter for details.
Service Status	This field displays whether a service license is enabled at myZyxel (Activated) or not (Not Activated) or expired (Expired). It displays the remaining Grace Period if your license has Expired . It displays Not Licensed if there isn't a license to be activated for this service. If you need a license or a trial license has expired, click Buy to buy a new one. If a Standard license has expired, click Renew to extend the license. Then, click Activate to connect with the myZyxel server to activate the new license.
Service Type	This field shows Trial , Standard or None depending on whether you subscribed to the App Patrol trial, bought an iCard for App Patrol service or neither.
Signature Information	The following fields display information on the current signature set that the Zyxel Device is using.

Table 253 Configuration > UTM Profile > App Patrol > Profile (continued)

LABEL	DESCRIPTION
Current Version	This field displays the App Patrol signature set version number. This number gets larger as the set is enhanced.
Released Date	This field displays the date and time the set was released.
Update Signatures	Click this link to go to the screen you can use to download signatures from the update server.

36.2.1 The Application Patrol Profile Add/Edit Screen

Use this screen to configure profile settings. Click **Configuration > UTM Profile > App Patrol > Profile**, then click **Add** to create a new profile rule or click an existing profile and click **Edit** (or double-click it) to open the following screen.

Figure 500 Configuration > UTM Profile > App Patrol > Profile > Add/Edit

The following table describes the labels in this screen.

Table 254 Configuration > UTM Profile > App Patrol > Profile > Add/Edit

LABEL	DESCRIPTION
General Settings	
Name	Type the name of the profile. You may use 1-31 alphanumeric characters, underscores(_), or dashes (-), but the first character cannot be a number. This value is case-sensitive. These are valid, unique profile names: <ul style="list-style-type: none"> • MyProfile • mYProfile • Mymy12_3-4 These are invalid profile names: <ul style="list-style-type: none"> • 1mYProfile • My Profile • MyProfile? • Whatalongprofilename123456789012

Table 254 Configuration > UTM Profile > App Patrol > Profile > Add/Edit (continued)

LABEL	DESCRIPTION
Description	Type a description for the profile rule to help identify the purpose of rule. You may use 1-31 alphanumeric characters, underscores (_), or dashes (-), but the first character cannot be a number. This value is case-sensitive. This field is optional.
Profile Management	
Add	Click this to create a new entry. Select an entry and click Add to create a new entry after the selected entry.
Remove	Select an entry and click Remove to delete the selected entry.
#	This field is a sequential value showing the number of the profile. The profile order is not important.
Application	This field displays the application name of the policy.
Action	Select the default action for all signatures in this category. forward - the Zyxel Device routes packets that matches these signatures. drop - the Zyxel Device silently drops packets that matches these signatures without notification. reject - the Zyxel Device drops packets that matches these signatures and sends notification.
Log	Select whether to have the Zyxel Device generate a log (log), log and alert (log alert) or neither (no) by default when traffic matches a signature in this category.
OK	A profile consists of separate category editing screens. If you want to configure just one category for a profile, click OK to save your settings to the Zyxel Device, complete the profile and return to the profile summary page.
Cancel	Click Cancel to return to the profile summary page without saving any changes.

36.2.2 The Application Patrol Profile Rule Add Application Screen

Click **Add** or **Edit** under **Profile Management** in the previous screen to display the following screen.

Figure 501 Configuration > UTM Profile > App Patrol > Profile > Profile Management > Add/Edit

The following table describes the labels in this screen.

Table 255 Configuration > UTM Profile > App Patrol > Profile > Profile Management > Add/Edit

LABEL	DESCRIPTION
General Settings	
Application	Select an application to apply the policy.

Table 255 Configuration > UTM Profile > App Patrol > Profile > Profile Management > Add/Edit

LABEL	DESCRIPTION
Action	Select the default action for all signatures in this category. forward - the Zyxel Device routes packets that matches these signatures. drop - the Zyxel Device silently drops packets that matches these signatures without notification. reject - the Zyxel Device drops packets that matches these signatures and sends notification.
Log	Select whether to have the Zyxel Device generate a log (log), log and alert (log alert) or neither (no) by default when traffic matches a signature in this category.
OK	Click OK to save your settings to the Zyxel Device.
Cancel	Click Cancel to return to the profile summary page without saving any changes.

CHAPTER 37

Content Filtering

37.1 Overview

Use the content filtering feature to control access to specific web sites or web content.

37.1.1 What You Can Do in this Chapter

- Use the **Filter Profile** screens ([Section 37.2 on page 724](#)) to set up content filtering profiles.
- Use the **Trusted Web Sites** screens ([Section 37.3 on page 744](#)) to create a common list of good (allowed) web site addresses.
- Use the **Forbidden Web Sites** screens ([Section 37.4 on page 745](#)) to create a common list of bad (blocked) web site addresses.

37.1.2 What You Need to Know

Content Filtering

Content filtering allows you to block certain web features, such as cookies, and/or block access to specific web sites. It can also block access to specific categories of web site content. You can create different content filter policies for different addresses, schedules, users or groups and content filter profiles. For example, you can configure one policy that blocks John Doe's access to arts and entertainment web pages during the workday and another policy that lets him access them after work.

Content Filtering Policies

A content filtering policy allows you to do the following.

- Use schedule objects to define when to apply a content filter profile.
- Use address and/or user/group objects to define to whose web access to apply the content filter profile.
- Apply a content filter profile that you have custom-tailored.

Content Filtering Profiles

A content filtering profile conveniently stores your custom settings for the following features.

- **Category-based Blocking**
The Zyxel Device can block access to particular categories of web site content, such as pornography or racial intolerance.

- Restrict Web Features

The Zyxel Device can disable web proxies and block web features such as ActiveX controls, Java applets and cookies.

- Customize Web Site Access

You can specify URLs to which the Zyxel Device blocks access. You can alternatively block access to all URLs except ones that you specify. You can also have the Zyxel Device block access to URLs that contain particular keywords.

Content Filtering Configuration Guidelines

When the Zyxel Device receives an HTTP request, the content filter searches for a policy that matches the source address and time (schedule). The content filter checks the policies in order (based on the policy numbers). When a matching policy is found, the content filter allows or blocks the request depending on the settings of the filtering profile specified by the policy. Some requests may not match any policy. The Zyxel Device allows the request if the default policy is not set to block. The Zyxel Device blocks the request if the default policy is set to block.

External Web Filtering Service

When you register for and enable the external web filtering service, your Zyxel Device accesses an external database that has millions of web sites categorized based on content. You can have the Zyxel Device block, block and/or log access to web sites based on these categories.

HTTPS Domain Filter

HTTPS Domain Filter works with the Content Filter category feature to identify HTTPS traffic and take appropriate action. SSL Inspection identifies HTTPS traffic for all UTM traffic and has higher priority than HTTPS Domain Filter. HTTPS Domain Filter only identifies keywords in the domain name of an URL and matches it to a category. For example, if the keyword is 'picture' and the URL is <http://www.google.com/picture/index.htm>, then HTTPS Domain Filter cannot identify 'picture' because that keyword is not in the domain name 'www.google.com'. However, SSL Inspection can identify 'picture' in the URL <http://www.google.com/picture/index.htm>.

Keyword Blocking URL Checking

The Zyxel Device checks the URL's domain name (or IP address) and file path separately when performing keyword blocking.

The URL's domain name or IP address is the characters that come before the first slash in the URL. For example, with the URL www.zyxel.com.tw/news/pressroom.php, the domain name is www.zyxel.com.tw.

The file path is the characters that come after the first slash in the URL. For example, with the URL www.zyxel.com.tw/news/pressroom.php, the file path is [news/pressroom.php](http://www.zyxel.com.tw/news/pressroom.php).

Since the Zyxel Device checks the URL's domain name (or IP address) and file path separately, it will not find items that go across the two. For example, with the URL www.zyxel.com.tw/news/pressroom.php, the Zyxel Device would find "tw" in the domain name (www.zyxel.com.tw). It would also find "news" in the file path ([news/pressroom.php](http://www.zyxel.com.tw/news/pressroom.php)) but it would not find "tw/news".

Finding Out More

- See [Section 37.5 on page 746](#) for content filtering background/technical information.

37.1.3 Before You Begin

- You must configure an address object, a schedule object and a filtering profile before you can set up a content security policy.
- You must have Content Filtering license in order to use the function.subscribe to use the external database content filtering (see the **Licensing > Registration** screens).

37.2 Content Filter Profile Screen

Click **Configuration > UTM Profile > Content Filter > Profile** to open the **Content Filter Profile** screen. Use this screen to enable content filtering, view and order your list of content filter policies, create a denial of access message or specify a redirect URL and check your external web filtering service registration status.

Click on the icons to go to the OneSecurity website where there is guidance on configuration walkthroughs, troubleshooting and other information.

Figure 502 Configuration > UTM Profile > Content Filter > Profile

The screenshot displays the 'Content Filter Profile' configuration page. At the top, there are tabs for 'Profile', 'Trusted Web Sites', and 'Forbidden Web Sites'. Below the tabs, there are navigation icons for 'Configuration Walkthrough', 'Troubleshooting', and 'Content Filter'. The 'General Settings' section includes options to 'Enable HTTPS Domain Filter for HTTPS traffic' (unchecked) and 'Drop connection when HTTPS connection with SSL V3 or previous version' (checked). A 'Content Filter Category Service Timeout' is set to 10 seconds. The 'Message to display when a site is blocked' section shows a 'Denied Access Message' and a 'Redirect URL' field. The 'Profile Management' section features a table with 4 rows of built-in profiles. The 'Content Filter Category Service Status' section shows the service is 'Activated' with an expiration date of 2021-07-15. At the bottom, there are 'Apply' and 'Reset' buttons.

#	Name	Description	Reference
1	Healthcare_profile	Built-in CF Profile	0
2	HomeOffice_profile	Built-in CF Profile	0
3	Office_profile	Built-in CF Profile	0
4	Retail_profile	Built-in CF Profile	0

The following table describes the labels in this screen.

Table 256 Configuration > UTM Profile > Content Filter > Profile

LABEL	DESCRIPTION
General Settings	
Report Server	Click this link to go to the myZyxel website.
Enable HTTPS Domain Filter for HTTPS traffic	Select this check box to have the Zyxel Device block HTTPS web pages using the cloud category service. In an HTTPS connection, the Zyxel Device can extract the Server Name Indication (SNI) from a client request, check if it matches a category in the cloud content filter and then take appropriate action. The keyword match is for the domain name only.
Drop connection when HTTPS connection with SSL V3 or previous version	Select this check box to have the Zyxel Device block HTTPS web pages using SSL V3 or a previous version.
Content Filter Category Service Timeout	Specify the allowable time period in seconds for accessing the external web filtering service's server.
Denied Access Message	Enter a message to be displayed when content filter blocks access to a web page. Use up to 127 characters (0-9a-zA-Z;/?:@&+=\$\._!~*()%,"). For example, "Access to this web page is not allowed. Please contact the network administrator". It is also possible to leave this field blank if you have a URL specified in the Redirect URL field. In this case if the content filter blocks access to a web page, the Zyxel Device just opens the web page you specified without showing a denied access message.
Redirect URL	Enter the URL of the web page to which you want to send users when their web access is blocked by content filter. The web page you specify here opens in a new frame below the denied access message. Use "http://" or "https://" followed by up to 262 characters (0-9a-zA-Z;/?:@&+=\$\._!~*()%,). For example, http://192.168.1.17/blocked access.
Profile Management	
Add	Click Add to create a new content filter rule.
Edit	Click Edit to make changes to a content filter rule.
Remove	Click Remove to delete a content filter rule.
References	Select an entry and click References to open a screen that shows which settings use the entry. Click Refresh to update information on this screen.
#	This column lists the index numbers of the content filter profile.
Name	This column lists the names of the content filter profile rule.
Description	This column lists the description of the content filter profile rule.
Reference	This displays the number of times an Object Reference is used in a rule.
Service Status	This read-only field displays the status of your content-filtering database service registration. This field displays whether a service license is enabled at myZyxel (Activated) or not (Not Activated) or expired (Expired). It displays the remaining Grace Period if your license has Expired . It displays Not Licensed if there isn't a license to be activated for this service. If you need a license or a trial license has expired, click Buy to buy a new one. If a Standard license has expired, click Renew to extend the license. Then, click Activate to connect with the myZyxel server to activate the new license. You can view content filter reports after you register the Zyxel Device and activate the subscription service in the Registration screen.

Table 256 Configuration > UTM Profile > Content Filter > Profile (continued)

LABEL	DESCRIPTION
Service Type	<p>This read-only field displays what kind of service registration you have for the content-filtering database.</p> <p>None displays if you have not successfully registered and activated the service.</p> <p>Standard displays if you have successfully registered the Zyxel Device and activated the service.</p> <p>Trial displays if you have successfully registered the Zyxel Device and activated the trial service subscription.</p>
Expiration Date	This field displays the date your service license expires.
Register Now	<p>Click the link to go to myZyxel where you can register your Zyxel Device and activate the service.</p> <p>This link is available only when the service is not activated yet.</p>
Apply	Click Apply to save your changes back to the Zyxel Device.
Reset	Click Reset to return the screen to its last-saved settings.

37.2.1 Content Filter Add Profile Category Service

Click **Configuration > UTM > Content Filter > Profile > Add or Edit** to open the **Add Filter Profile** screen.

Figure 503 Content Filter > Profile > Add Filter Profile > Category Service

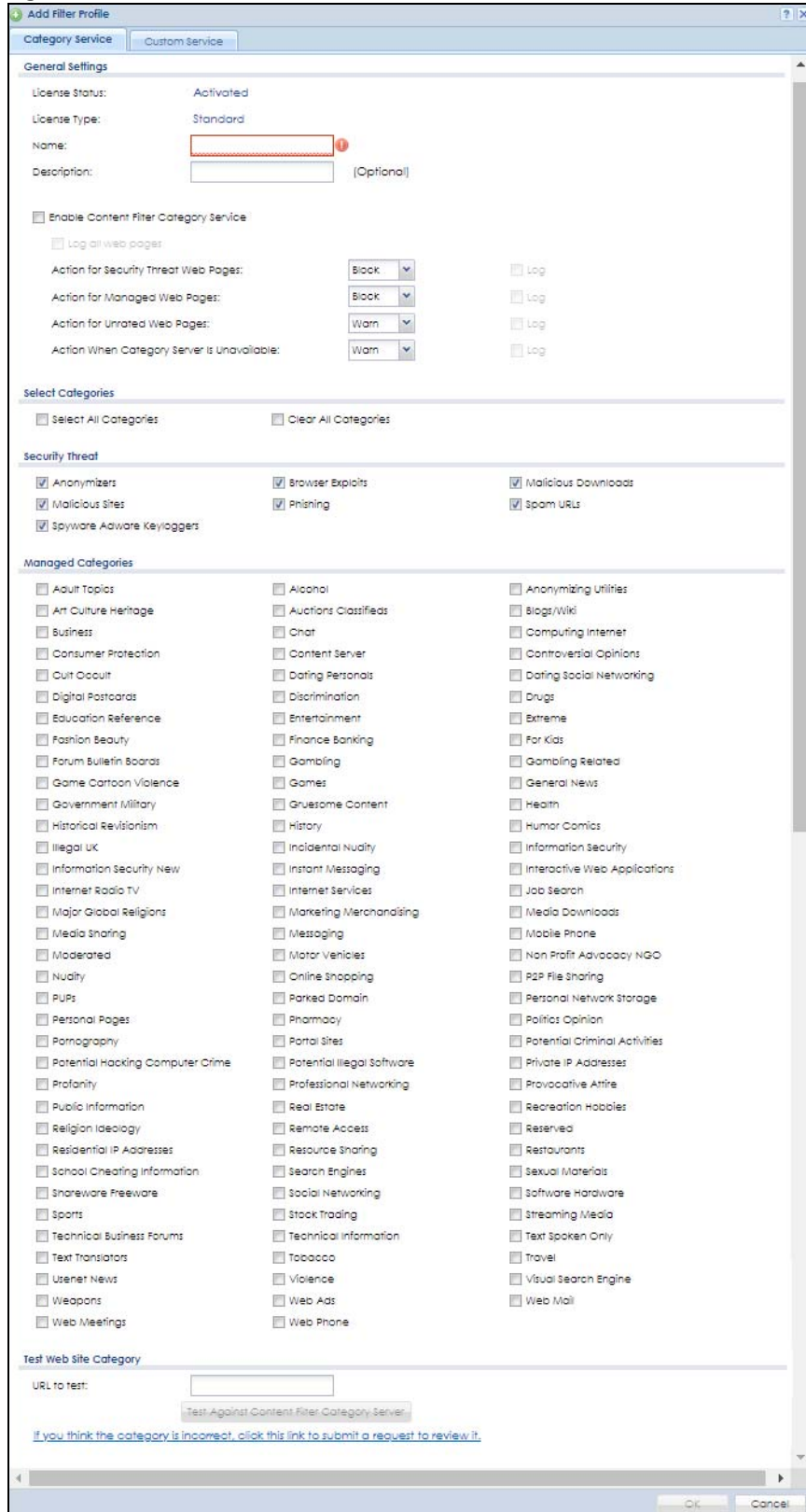

The following table describes the labels in this screen.

Table 257 Configuration > UTM Profile> Content Filter > Profile > Add > Category Service

LABEL	DESCRIPTION
Service Status	<p>This read-only field displays the status of your content-filtering database service registration.</p> <p>This field displays whether a service license is enabled at myZyxel (Activated) or not (Not Activated) or expired (Expired). It displays the remaining Grace Period if your license has Expired. It displays Not Licensed if there isn't a license to be activated for this service.</p> <p>If you need a license or a trial license has expired, click Buy to buy a new one. If a Standard license has expired, click Renew to extend the license.</p> <p>Then, click Activate to connect with the myZyxel server to activate the new license.</p> <p>You can view content filter reports after you register the Zyxel Device and activate the subscription service in the Registration screen.</p>
Service Type	<p>This read-only field displays what kind of service registration you have for the content-filtering database.</p> <p>None displays if you have not successfully registered and activated the service.</p> <p>Standard displays if you have successfully registered the Zyxel Device and activated the standard content filtering service.</p> <p>Trial displays if you have successfully registered the Zyxel Device and activated the trial service subscription.</p>
Name	<p>Enter a descriptive name for this content filtering profile name. You may use 1-31 alphanumeric characters, underscores(_), or dashes (-), but the first character cannot be a number. This value is case-sensitive.</p>
Description	<p>Enter a description for the content filtering profile rule to help identify the purpose of rule. You may use 1-31 alphanumeric characters, underscores(_), or dashes (-), but the first character cannot be a number. This value is case-sensitive.</p> <p>This field is optional.</p>
Enable SafeSearch	<p>SafeSearch is a search engine that can automatically filter sexually explicit videos and images from the search result without overloading the Zyxel Device. It does this by adding a parameter in the search URL:</p> <p>https://www.google.com.tw/?gws_rd=ssl#q=porn&safe=active.</p> <p>Supported search engines at the time of writing are:</p> <p>Yahoo, Google, MSN Live Bing, Yandex</p>
Enable Content Filter Category Service	<p>Enable external database content filtering to have the Zyxel Device check an external database to find to which category a requested web page belongs. The Zyxel Device then blocks or forwards access to the web page depending on the configuration of the rest of this page.</p>
Log all web pages	<p>Select this to record attempts to access web pages when:</p> <ul style="list-style-type: none"> • They match the other categories that you select below • They are not categorized • The external content filtering database is unavailable.

Table 257 Configuration > UTM Profile> Content Filter > Profile > Add > Category Service (continued)

LABEL	DESCRIPTION
Action for Security Threat Web Pages	<p>Select Pass to allow users to access web pages that match the Security Threat categories that you select below.</p> <p>Select Block to prevent users from accessing web pages that match the Security Threat categories that you select below. When external database content filtering blocks access to a web page, it displays the denied access message that you configured in the Content Filter General screen along with the category of the blocked web page.</p> <p>Select Warn to display a warning message before allowing users to access web pages that match the Security Threat categories that you select below.</p> <p>Select Log to record attempts to access web pages that match the Security Threat categories that you select below.</p>
Action for Managed Web Pages	<p>Select Pass to allow users to access web pages that match the other categories that you select below.</p> <p>Select Block to prevent users from accessing web pages that match the other categories that you select below. When external database content filtering blocks access to a web page, it displays the denied access message that you configured in the Content Filter General screen along with the category of the blocked web page.</p> <p>Select Log to record attempts to access web pages that match the other categories that you select below.</p>
Action for Unrated Web Pages	<p>Select Pass to allow users to access web pages that the external web filtering service has not categorized.</p> <p>Select Block to prevent users from accessing web pages that the external web filtering service has not categorized. When the external database content filtering blocks access to a web page, it displays the denied access message that you configured in the Content Filter General screen along with the category of the blocked web page.</p> <p>Select Warn to display a warning message before allowing users to access web pages that the external web filtering service has not categorized.</p> <p>Select Log to record attempts to access web pages that are not categorized.</p>
Action When Category Server Is Unavailable	<p>Select Pass to allow users to access any requested web page if the external content filtering database is unavailable.</p> <p>Select Block to block access to any requested web page if the external content filtering database is unavailable.</p> <p>Select Warn to display a warning message before allowing users to access any requested web page if the external content filtering database is unavailable.</p> <p>The following are possible causes for the external content filtering server not being available:</p> <ul style="list-style-type: none"> • There is no response from the external content filtering server within the time period specified in the Content Filter Server Unavailable Timeout field. • The Zyxel Device is not able to resolve the domain name of the external content filtering database. • There is an error response from the external content filtering database. This can be caused by an expired content filtering registration (External content filtering's license key is invalid"). <p>Select Log to record attempts to access web pages that occur when the external content filtering database is unavailable.</p>
Select Categories	
Select All Categories	Select this check box to restrict access to all site categories listed below.
Clear All Categories	Select this check box to clear the selected categories below.

Table 257 Configuration > UTM Profile> Content Filter > Profile > Add > Category Service (continued)

LABEL	DESCRIPTION
Security Threat	These are the categories of web pages that are known to pose a security threat to users or their computers.
Anonymizers	Sites and proxies that act as an intermediary for surfing to other Web sites in an anonymous fashion, whether to circumvent Web filtering or for other reasons. For example, blog.go2.tw, anonymizer.com, www.qu365.com.
Browser Exploits	Sites that contain browser exploits. A browser exploit is any content that forces a web browser to perform operations that you do not explicitly intend.
Malicious Downloads	Sites that host files containing malicious content, such as viruses, spyware, rootkits, and ransomware.
Malicious Sites	Sites that install unwanted software on a user's computer with the intent to enable third-party monitoring or make system changes without the user's consent.
Phishing	Sites that are used for deceptive or fraudulent purposes (e.g. phishing), such as stealing financial or other user account information. These sites are most often designed to appear as legitimate sites in order to mislead users into entering their credentials. For example, optimizedby.rmxads.com, 218.1.71.226/.../e3b.
Spam URLs	Sites that have been promoted through spam techniques. For example, img.tongji.linezing.com, banner.chinesegamer.net.
Spyware Adware Keyloggers	<p>Sites that contain spyware, adware, or keyloggers.</p> <p>Spyware is a program installed on your computer, usually without your explicit knowledge, that captures and transmits personal information or Internet browsing habits and details to companies. Companies use this information to analyze browsing habits, to gather marketing data, and to sell your information to others.</p> <p>Key logger programs try to capture and steal your passwords and watch and record everything you do on your computer.</p> <p>Adware programs typically display blinking advertisements or pop-up windows when you perform a certain action. Adware programs are often installed in exchange for another service, such as the right to sue a program without paying for it.</p>
Managed Categories	<p>These are categories of web pages based on their content. Select categories in this section to control access to specific types of Internet content.</p> <p>You must have the Category Service content filtering license to filter these categories. See the next table for category details.</p>
Test Web Site Category	
URL to test	<p>You can check which category a web page belongs to. Enter a web site URL in the text box.</p> <p>When the content filter is active, you should see the web page's category. The query fails if the content filter is not active.</p> <p>Content Filtering can query a category by full URL string (for example, http://www.google.com/picture/index.htm), but HTTPS Domain Filter can only query a category by domain name ('www.google.com'), so the category may be different in the query result. URL to test displays both results in the test.</p>
If you think the category is incorrect	Click this link to see the category recorded in the Zyxel Device's content filtering database for the web page you specified (if the database has an entry for it).
Test Against Content Filter Category Server	Click this button to see the category recorded in the external content filter server's database for the web page you specified.
OK	Click OK to save your changes back to the Zyxel Device.
Cancel	Click Cancel to exit this screen without saving your changes.

The following table describes the managed categories.

Table 258 Managed Category Descriptions

CATEGORY	DESCRIPTION
Adult Topics	Web pages that contain content or themes that are generally considered unsuitable for children.
Alcohol	Web pages that mainly sell, promote, or advocate the use of alcohol, such as beer, wine, and liquor. This category also includes cocktail recipes and home-brewing instructions.
Anonymizing Utilities	Web pages that result in anonymous web browsing without the explicit intent to provide such a service. This category includes URL translators, web-page caching, and other utilities that might function as anonymizers, but without the express purpose of bypassing filtering software. This category does not include text translation.
Art Culture Heritage	Web pages that contain virtual art galleries, artist sites (including sculpture and photography), museums, ethnic customs, and country customs. This category does not include online photograph albums.
Auctions Classifieds	Web pages that provide online bidding and selling of items or services. This category includes web pages that focus on bidding and sales. This category does not include classified advertisements such as real estate postings, personal ads, or companies marketing their auctions.
Blogs/Wiki	Web pages containing dynamic content, which often changes because users can post or edit content at any time. This category covers the risks with dynamic content that might range from harmless to offensive.
Business	Web pages that provide business-related information, such as corporate overviews or business planning and strategies. This category also includes information, services, or products that help other businesses plan, manage, and market their enterprises, and multi-level marketing. This category does not include personal pages and web-hosting web pages.
Chat	Web pages that provide web-based, real-time social messaging in public and private chat rooms. This category includes IRC. This category does not include instant messaging.
Computing Internet	Web pages containing reviews, information, buyer's guides of computers, computer parts and accessories, computer software and internet companies, industry news and magazines, and pay-to-surf sites.
Consumer Protection	Websites that try to rob or cheat consumers. Some examples of their activities include selling counterfeit products, selling products that were originally provided for free, or improperly using the brand of another company. This category also includes sites where many consumers reported being cheated or not receiving services. This category does not include phishing, which tries to perpetrate fraud or theft by stealing account information.

Table 258 Managed Category Descriptions (continued)

Content Server	<p>URLs for servers that host images, media files, or JavaScript for one or more sites and are intended to speed up content retrieval for existing web servers, such as Apache.</p> <p>This category includes domain-level and sub-domain-level URLs that function as content servers.</p> <p>This category does not include:</p> <ul style="list-style-type: none"> • Web pages for businesses that provide the content servers • Web pages that allow users to browse photographs. See the Media Sharing category. • URLs for servers that serve only advertisements. See the Web Ads category.
Controversial Opinions	<p>Web pages that contain opinions that are likely to offend political or social sensibilities and incite controversy. Much of this content is at the extremes of public opinion.</p> <p>This category does not include opinion or language clearly intended to promote hate or discrimination.</p>
Cult Occult	<p>Sites relating to non-traditional religious practices considered to be false, unorthodox, extremist, or coercive.</p>
Dating Personals	<p>Web pages that provide networking for online dating, matchmaking, escort services, or introductions to potential spouses.</p> <p>This category does not include sites that provide social networking that might include dating, but are not specific to dating.</p>
Dating Social Networking	<p>Web pages that focus on social interaction such as online dating, friendship, school reunions, pen-pals, escort services, or introductions to potential spouses.</p> <p>This category does not include wedding-related content, dating tips, or related marketing.</p>
Digital Postcards	<p>Web pages that allow people to send and receive digital postcards and greeting cards via the Internet.</p>
Discrimination	<p>Web pages, which provide information that explicitly encourages the oppression or discrimination of a specific group of individuals.</p> <p>This category does not include jokes and humor, unless the focus of the entire site is considered discriminatory.</p>
Drugs	<p>Websites that provide information on the purchase, manufacture, and use of illegal or recreational drugs.</p> <p>This category does not include sites with exclusive health or political themes.</p>
Education Reference	<p>Web pages devoted to academic-related content such as academic subjects (mathematics, history), school or university web pages, and education administration pages (school boards, teacher curriculum).</p>
Entertainment	<p>Web pages that provide information about cinema, theater, music, television, infotainment, entertainment industry gossip-news, and sites about celebrities such as actors and musicians.</p> <p>This category also includes sites where the content is devoted to providing entertainment on the web, such as horoscopes or fan clubs.</p>
Extreme	<p>Web pages that provide content considered gory, perverse, or horrific.</p>
Fashion Beauty	<p>Web pages that market clothing, cosmetics, jewelry, and other fashion-oriented products, accessories, or services.</p> <p>This category also includes product reviews, comparisons, and general consumer information, and services such as hair salons, tanning salons, tattoo studios, and body-piercing studios.</p> <p>This category does not include fashion-related content such as modeling or celebrity fashion unless the site focuses on marketing the product line.</p>

Table 258 Managed Category Descriptions (continued)

Finance Banking	<p>Web pages that provide financial information or access to online financial accounts.</p> <p>This category includes stock information (but not stock trading), home finance, and government-related financial information.</p>
For Kids	<p>Web pages that are family-safe, specifically for children of approximate ages ten and under.</p> <p>This category can also be used as an exception to allow web pages that do not pose a risk to children, or to access sites that have a primary educational or recreational focus for children, but are in other categories such as Games, Humor/Comics, Recreation/Hobbies, or Entertainment.</p>
Forum Bulletin Boards	<p>Web pages that provide access (http://) to Usenet newsgroups or hold discussions and post user-generated content, such as real-time message posting for an interest group. This category also includes archives of files uploaded to newsgroups.</p> <p>This category does not include message forums with a business or technical support focus.</p>
Gambling	<p>Web pages that allow users to wager or place bets online, or provide gambling software that allows online betting, such as casino games, betting pools, sports betting, and lotteries.</p> <p>This category does not include web pages related to gambling that do not allow betting online.</p>
Gambling Related	<p>Web pages that offer information about gambling, without providing the means to gamble.</p> <p>This category includes casino-related web pages that do not offer online gambling, gambling links, tips, sports picks, lottery results, and horse, car, or boat racing.</p>
Game Cartoon Violence	<p>Web pages that provide fantasy or fictitious representations of violence within the context of games, comics, cartoons, or graphic novels.</p> <p>This category includes images and textual descriptions of physical assaults or hand-to-hand combat, and grave injury and destruction caused by weapons or explosives.</p>
Games	<p>Web pages that offer online games and related information such as cheats, codes, demos, emulators, online contests or role-playing games, gaming clans, game manufacturer sites, fantasy or virtual sports leagues, and other gaming sites without chances of profit.</p> <p>This category includes gaming consoles.</p>
General News	<p>Web pages that provide online news media, such as international or regional news broadcasting and publication.</p> <p>This category includes portal sites that provide news content.</p>
Government Military	<p>Web pages that contain content maintained by governmental or military organizations, such as government branches or agencies, police departments, fire departments, civil defense, counter-terrorism organizations, or supranational organizations, such as the United Nations or the European Union.</p> <p>This category includes military and veterans' medical facilities.</p>
Gruesome Content	<p>Web pages with content that can be considered tasteless, gross, shocking, or gruesome.</p> <p>This category does not include web pages with content pertaining to physical assault.</p>

Table 258 Managed Category Descriptions (continued)

Health	<p>Web pages that cover all health-related information and health care services.</p> <p>This category does not include cosmetic surgery, marketing/selling pharmaceuticals, or animal-related medical services.</p>
Historical Revisionism	<p>Web pages that denounce, or offer different interpretations of, significant historical facts, such as holocaust denial.</p> <p>This category does not include all re-examination of historical facts, only historical events that are highly sensitive.</p>
History	<p>Web pages that provide content about historical facts.</p> <p>This category includes content suitable for higher education, but the Education category includes content for primary education. For example, a site with Holocaust photographs might be offensive, but have academic value.</p>
Humor Comics	<p>Web pages that provide comical or funny content.</p> <p>This category includes sites with jokes, sketches, comics, and satire pages. This category might also include graphic novel content, which is often associated with comics.</p>
Illegal UK	<p>Web pages that contain child sexual abuse content hosted anywhere in the world, and criminally obscene and incitement to racial hatred content hosted in the UK.</p>
Incidental Nudity	<p>Web pages that contain non-pornographic images of the bare human body like those in classic sculpture and paintings, or medical images.</p> <p>This category enables you to allow or block sites in order to address cultural or geographic differences in opinion about nudity. For example, you can use this category to block access to nudity, but allow access when nudity is not the primary focus of a site, such as news sites or major portals.</p>
Information Security	<p>Web pages that legitimately provide information about data protection. This category includes detailed information for safeguarding business or personal data, intellectual property, privacy, and infrastructure on the Internet, private networks, or in other bandwidth services such as telecommunications.</p> <p>This category does not include:</p> <ul style="list-style-type: none"> • Legitimate information security companies and security software providers, such as virus protection companies. • Sites that intend to exploit security or teach how to bypass security.
Information Security New	<p>Web pages that legitimately provide information about data protection. This category includes detailed information for safeguarding business or personal data, intellectual property, privacy, and infrastructure on the Internet, private networks, or in other bandwidth services such as telecommunications.</p> <p>This category does not include:</p> <ul style="list-style-type: none"> • Legitimate information security companies and security software providers, such as virus protection companies. • Sites that intend to exploit security or teach how to bypass security.
Instant Messaging	<p>Web pages that provide software for real-time communication over a network exclusively for users who joined a member's contact list or an instant-messaging session.</p> <p>Most instant-messaging software includes features such as file transfer, PC-to-PC phone calls, and can track when other people log on and off.</p>
Interactive Web Applications	<p>Web pages that provide access to live or interactive web applications, such as browser-based office suites and groupware. This category includes sites with business, academic, or individual focus.</p> <p>This category does not include sites providing access to interactive web applications that do not take critical user data or offer security risks, such as Google Maps.</p>

Table 258 Managed Category Descriptions (continued)

Internet Radio TV	<p>Web pages that provide software or access to continuous audio or video broadcasting, such as Internet radio, TV programming, or podcasting.</p> <p>Quick downloads and shorter streams that consume less bandwidth are in the Streaming Media or Media Downloads categories.</p>
Internet Services	<p>Web pages that provide services for publication and maintenance of Internet sites such as web design, domain registration, Internet Service Providers, and broadband and telecommunications companies that provide web services.</p> <p>This category includes web utilities such as statistics and access logs, and web graphics like clip art.</p>
Job Search	<p>Web pages related to a job search including sites concerned with resume writing, interviewing, changing careers, classified advertising, and large job databases. This category also includes corporate web pages that list job openings, salary comparison sites, temporary employment, and company job-posting sites.</p> <p>This category does not include make-money-at-home sites.</p>
Major Global Religions	<p>Web pages with content about religious topics and information related to major religions. This category includes sites that cover religious content such as discussion, beliefs, non-controversial commentary, articles, and information for local congregations such as a church or synagogue homepage.</p> <p>The religions in this category are Baha'i, Buddhism, Chinese Traditional, Christianity, Hinduism, Islam, Jainism, Judaism, Shinto, Sikhism, Tenrikyo, Zoroastrianism.</p>
Marketing Merchandising	<p>Web pages that promote individual or business products or services on the web, but do not sell their products or services online.</p> <p>This category includes websites that are generally a company overview, describing services or products that cannot be purchased directly from these sites. Examples include automobile manufacturer sites, wedding photography services, or graphic design services.</p> <p>This category does not include:</p> <ul style="list-style-type: none"> • Other categories that imply marketing such as Alcohol, Auctions/Classifieds, Drugs, Finance/Banking, Mobile Phone, Online Shopping, Real Estate, School Cheating Information, Software/Hardware, Stock Trading, Tobacco, Travel, and Weapons. • Sites that market their services only to other businesses. See the Business category. • Sites that rob or cheat consumers. See the Consumer Protection category.
Media Downloads	<p>Web pages that provide audio or video files for download such as MP3, WAV, AVI, and MPEG formats. The files are saved to, and played from, the user's computer.</p> <p>This category does not include audio or video files that are played directly through a browser window. See the Streaming Media category.</p>
Media Sharing	<p>Web pages that allow users to upload, search for, and share media files and photographs, such as online photograph albums.</p>
Messaging	<p>Examples include text messaging to mobile phones, PDAs, fax machines, and internal website user-to-user messaging or site-to-site messaging.</p> <p>This category does not include real-time chat or instant messaging, or message posts that can be viewed by anyone but the intended recipient.</p>
Mobile Phone	<p>Web pages that sell media, software, or utilities for mobile phones that can be downloaded and delivered to mobile phones.</p> <p>Examples include ringtones, logos/skins, games, screen-savers, text-based tunes, and software for SMS, MMS, WAP, and other mobile phone protocols.</p>

Table 258 Managed Category Descriptions (continued)

Moderated	<p>Bulletin boards, chat rooms, search engines, or web mail sites that are monitored by an individual or group who has the authority to block messages or content considered inappropriate.</p> <p>This category does not include sites with posted rules against offensive content. See the Forum/Bulletin Boards category.</p>
Motor Vehicles	<p>Websites for manufacturers and dealerships of consumer transportation vehicles, such as cars, vans, trucks, SUVs, motorcycles, and scooters. This category also includes sites that provide product marketing, reviews, comparisons, pricing information, auto fairs, auto expos, and general consumer information about motor vehicles.</p> <p>This category does not include automotive accessories, mechanics, auto-body shops, and recreational hobby pages. This category does not include sites that provide business-to-business-only content regarding motor vehicles.</p>
Non Profit Advocacy NGO	<p>Web pages from charitable or educational groups that fulfill a stated mission, benefiting the larger community, such as clubs, lobbies, communities, non-profit organizations, labor unions, and advocacy groups.</p> <p>Examples are Masons, Elks, Boy and Girl Scouts, or Big Brothers.</p>
Nudity	<p>Web pages that have non-pornographic images of the bare human body. This category includes classic sculpture and paintings, artistic nude photographs, some naturism pictures, and detailed medical illustrations.</p> <p>This category does not include high-profile sites where nudity is not a concern for visitors. See the Incidental Nudity category.</p>
Online Shopping	<p>Web pages that sell products or services online.</p> <p>Web pages selling a broad range of products might pose a risk to users by offering access to items that are normally in other categories such as Pornography, Weapons, Nudity, or Violence. Web pages selling such content exclusively are in their respective categories.</p>
P2P File Sharing	<p>Web pages that allow the exchange of files between computers and users for business or personal use, such as downloadable music.</p> <p>P2P clients allow users to search for and exchange files from a peer-user network. They often include spyware or real-time chat capabilities. This category includes BitTorrent web pages.</p>
Parked Domain	<p>Web pages that once served content, but their domains have been sold or abandoned and are no longer registered.</p> <p>Parked domains do not host their own content, but usually redirect users to a generic page that states the domain name is for sale, or redirect users to a generic search engine and portal page, some of which provide valid search engine results.</p>
Personal Network Storage	<p>Web pages that allow users to upload folders and files to an online network server in order to backup, share, edit, or retrieve files or folders from any web browser.</p>
Personal Pages	<p>Personal home pages that share a common domain such as those hosted by ISPs, university/education servers, or free web page hosts.</p> <p>This category also includes unique domains that contain personal information, such as a personal home page. This category does not include home pages of public figures.</p>
Pharmacy	<p>Web pages that provide reviews, descriptions, and market or sell prescription-based drugs, over-the-counter drugs, birth control, or dietary supplements.</p>
Politics Opinion	<p>Web pages covering political parties, individuals in political life, and opinion on various topics.</p> <p>This category might also cover laws and political opinion about drugs. This category includes URLs for political parties, political campaigning, and opinions on various topics, including political debates.</p>

Table 258 Managed Category Descriptions (continued)

Pornography	<p>Web pages that contain materials intended to be sexually arousing or erotic.</p> <p>This category includes fetish pages, animation, cartoons, stories, and illegal pornography.</p>
Portal Sites	<p>Web pages that serve as major gateways or directories to content on the web.</p> <p>Many portal sites also provide a variety of internal site features or services such as search engines, email, news, and entertainment. Mailing list sites with a variety of content are in this category.</p> <p>This category does not include sites with topic-specific content.</p>
Potential Criminal Activities	<p>Web pages that provide instructions to commit illegal or criminal activities.</p> <p>Instructions include committing murder or suicide, sabotage, bomb-making, lock-picking, service theft, evading law enforcement, or spoofing drug tests. This category might also include information on how to distribute illegal content, perpetrate fraud, or consumer scams.</p> <p>This category does not include computer-related fraud.</p>
Potential Hacking Computer Crime	<p>Web pages that provide instructions, or otherwise enable, fraud, crime, or malicious activity that is computer-oriented.</p> <p>This category includes web pages related to computer crime include malicious hacking information or tools that help individuals gain unauthorized access to computers and networks (root kits, kiddie scripts). This category also includes other areas of electronic fraud such as dialer scams and illegal manipulation of electronic devices.</p> <p>This category does not include illegal software.</p>
Potential Illegal Software	<p>Web pages, which the filter believes offer information to potentially 'pirated' or illegally distribute software or electronic media, such as copyrighted music or film, distribution of illegal license key generators, software cracks, and serial numbers.</p> <p>This category does not include peer-to-peer web pages.</p>
Private IP Addresses	<p>Sites that are private IP addresses as defined in RFC 1918, that is, hosts that do not require access to hosts in other enterprises (or require just limited access) and whose IP address may be ambiguous between enterprises but are well defined within a certain enterprise.</p>
Profanity	<p>Web pages that contain crude, vulgar, or obscene language or gestures.</p>
Professional Networking	<p>Web pages that provide social networking exclusively for professional or business purposes.</p> <p>This category includes sites that provide personal or group profiles, and enable their members to interact through real-time communication, message posting, public bulletins, and media sharing. This category also contains alumni sites that have a networking function.</p> <p>This category does not include social networking sites where the focus might vary, but include friendship, dating, or professional focuses.</p>
Provocative Attire	<p>Web pages with pictures that include alluring or revealing attire, lingerie and swimsuits, or supermodel or celebrity photograph collections, but do not involve nudity.</p> <p>This category does not include sites with swimwear or similar attire that is not intended to be provocative. For example, Olympic swimming sites are not in this category.</p>
Public Information	<p>Web pages that provide general reference information such as public service providers, regional information, transportation schedules, maps, or weather reports.</p>

Table 258 Managed Category Descriptions (continued)

PUPs	<p>Web pages that contain Potentially Unwanted Programs (PUPs).</p> <p>PUPs are often made for a beneficial purpose but they alter the security of a computer or the computer user's privacy. Computer users who are concerned about security or privacy might want to be informed about this software, and in some cases, they might want to remove this software from their computers.</p>
Real Estate	<p>Web pages that provide commercial or residential real estate services and information.</p> <p>Service and information includes sales and rental of living space or retail space and guides for apartments, housing, and property, and information on appraisal and brokerage. This category includes sites that allow you to browse model homes.</p> <p>This category does not include content related to personal finance, such as credit applications.</p>
Recreation Hobbies	<p>Web pages for recreational organizations and facilities that include content devoted to recreational activities and hobbies.</p> <p>This category includes information about public swimming pools, zoos, fairs, festivals, amusement parks, recreation guides, hiking, fishing, bird watching, or stamp collecting.</p> <p>This category does not include activities that need no active participation, such as watching a movie or reading celebrity gossip.</p>
Religion Ideology	<p>Web pages with content related to religious topics and beliefs in human spirituality that are not within the major religions.</p> <p>This category includes religious discussion, beliefs, articles, and information for local congregations or groups such as a church homepage, unless the site is already in the Major Global Religions category. This category also includes comparative religion, or sites that include religions and ideologies.</p> <p>This category does not include astrology and horoscope sites</p>
Remote Access	<p>Web pages that provide remote access to a program, online service, or an entire computer system.</p> <p>Although remote access is often used legitimately to run a computer from a remote location, it creates a security risk, such as backdoor access. Backdoor access, written by the original programmer, allows the system to be controlled by another party without the user's knowledge.</p>
Reserved	This category is reserved for future use.
Residential IP Addresses	<p>IP addresses (and any domains associated with them) that access the Internet by DSL modems or cable modems.</p> <p>Because this content is not generally intended for Internet access via HTTP, access to the Internet through these IP addresses can indicate suspicious behavior. This behavior might be related to malware located on the home computer or homegrown gateways set up to allow anonymous Internet access.</p>
Resource Sharing	<p>Web pages that harness idle or unused computer resources to focus on a common task.</p> <p>The task can be on a company or an international basis. Well known examples are the SETI program and the Human Genome Project, which use the idle time of thousands of volunteered computers to analyze data.</p>

Table 258 Managed Category Descriptions (continued)

Restaurants	<p>Web pages that provide information about restaurants, bars, catering, take-out and delivery, including online ordering.</p> <p>This category includes sites that provide information about location, hours, prices, menus and related dietary information. This category also includes restaurant guides and reviews, and cafes and coffee shops.</p> <p>This category does not include groceries, wholesale food, non-profit and charitable food organizations, or bars that do not focus on serving food.</p>
School Cheating Information	<p>Web pages that promote plagiarism or cheating by providing free or fee-based term papers, written essays, or exam answers.</p> <p>This category does not include sites that offer student help, discuss literature, films, or books, or other content that is often the subject of research papers.</p>
Search Engines	<p>Web pages that provide search results that enable users to find information on the Internet based on key words.</p> <p>This category does not include site-specific search engines.</p>
Sexual Materials	<p>Web pages that describe or depict sexual acts, but are not intended to be arousing or erotic.</p> <p>Examples of sexual materials include sex education, sexual innuendo, humor, or sex related merchandise.</p> <p>This category does not include web pages with content intended to arouse.</p>
Shareware Freeware	<p>Web pages that are repositories of downloadable copies of shareware and freeware.</p> <p>This category does not include subscription-based software.</p>
Social Networking	<p>Web pages that enable social networking for a variety of purposes, such as friendship, dating, professional, or topics of interest.</p> <p>These sites provide personal or group profiles and enable interaction among their members through real-time communication, message posting, public bulletins, and media sharing.</p> <p>This category does not include sites that are exclusive to dating, matchmaking, or a specific professional networking focus.</p>
Software Hardware	<p>Web pages related to computing software and hardware, including vendors, product marketing and reviews, deployment and maintenance of software and hardware, and software updates and add-ons such as scripts, plug-ins, or drivers. Hardware includes computer parts, accessories, and electronic equipment used with computers and networks.</p> <p>This category includes the marketing of software and hardware, and magazines focused on software or hardware product reviews or industry trends.</p>
Sports	<p>Web pages related to professional or organized recreational sports.</p> <p>This category includes sporting news, events, and information such as playing tips, strategies, game scores, or player trades.</p> <p>This category does not include fantasy leagues, sports centers, athletic clubs, fitness or martial arts clubs, and non-league billiards, darts, or other such activities.</p>
Stock Trading	<p>Web pages that offer purchasing, selling, or trading of shares online.</p> <p>This category also includes ticker-tape information that enables viewing of real-time stock prices and financial spread betting in the stock market. Other betting is in the Gambling category.</p> <p>This category does not include sites that offer information about stocks, but do not offer purchasing, selling, or trading of shares.</p>

Table 258 Managed Category Descriptions (continued)

Streaming Media	<p>Web pages that provide streaming media, or contain software plug-ins for displaying audio and visual data before the entire file has been transmitted.</p> <p>This category does not include audio or video files that are downloaded to a user's computer before being played.</p>
Technical Business Forums	<p>Web pages with a technical or business focus that provide online message posting or real-time chatting, such as technical support or interactive business communication.</p> <p>Although users can post any type of content, these forums tend to present less risk of containing offensive content.</p> <p>Sites that offer a variety of forums with themes, including technical and business content, are only in the categories of Forum/Bulletin Boards or Chat.</p>
Technical Information	<p>Web pages that provide computing information with an educational focus in areas such as Information Technology, computer programming, and certification.</p> <p>Examples include Linux user groups, UNIX commands, software tutorials, or dictionaries of technical terms. Most sites in this category might be subdirectories of larger domains. For example, a software site with a tutorial page is in this category only at the tutorial page URL.</p> <p>This category does not include content about information security.</p>
Text Spoken Only	<p>Content that is text or audio only, and does not contain pictures.</p> <p>This category can be used as an exception to allow explicit text and recorded material to be accessed when you want pictures blocked using the Pornography, Violence, or Sexual Materials categories. Libraries or universities can use this category to prevent the display of offensive graphics in their public facilities.</p>
Text Translators	<p>Web pages that allow users to type phrases or a block of text to translate it from one language into another.</p> <p>This category also includes language identifier web pages. URL translation is in the Anonymizing Utilities category.</p>
Tobacco	<p>Web pages that sell, promote, or advocate the use of tobacco products, tobacco paraphernalia, including cigarettes, cigars, pipes, snuff and chewing tobacco.</p>
Travel	<p>Web pages that promote personal or business travel, such as hotels, resorts, airlines, ground transportation, car rentals, travel agencies, and general tourist and travel information.</p> <p>This category also includes sites for buying tickets or accommodation.</p> <p>This category does not include personal vacation photographs.</p>
Usenet News	<p>Web pages that provide access (http://) to Usenet newsgroups and archives of files uploaded to newsgroups.</p> <p>This category also includes online groups that offer similar community-oriented content posting.</p>
Violence	<p>Web pages that contain real or lifelike images or text that portray, describe, or advocate physical assaults against people, animals, or institutions, such as depictions of war, suicide, mutilation, or dismemberment.</p>
Visual Search Engine	<p>Web pages that provide image-specific search results such as thumbnail pictures.</p> <p>This category does not include sites that offer site-specific visual search engines.</p>

Table 258 Managed Category Descriptions (continued)

Weapons	<p>Web pages that provide information about buying, making, modifying, or using weapons, such as guns, knives, swords, paintball guns, and ammunition, explosives, and weapon accessories.</p> <p>This category also includes sites that contain content for: weapons for personal or military use, homemade weapons, non-lethal weapons such as mace, pepper spray, or Taser guns, weapons facilities, such as shooting ranges, and government or military oriented weapons.</p> <p>This category does not include political action groups, such as the NRA.</p>
Web Ads	<p>Web pages that provide advertisement-hosting or programs that create advertisements.</p> <p>Examples include links, source code or applets for banners, popups, and other kinds of static or dynamically generated advertisements that appear on web pages. This category is intended to block advertisements on web pages, not the companies that provide the advertisements or advertising services.</p> <p>This category does not include aggressive advertising adware. See the Spyware/ Adware category.</p>
Web Mail	<p>Web pages that enable users to send or receive email through the Internet.</p>
Web Meetings	<p>Web pages that host live meetings, video conferences, and interactive presentations mainly for businesses.</p> <p>Web meetings generally include streaming audio and video, and allow data transfer or office-oriented application sharing, such as online presentations.</p>
Web Phone	<p>Web pages that enable users to make telephone calls via the Internet or obtain information or software for this purpose.</p> <p>Web Phone service is also called Internet Telephony, or VoIP. Web phone service includes PC-to-PC, PC-to-phone, and phone-to-phone services connecting via TCP/IP networks.</p>

37.2.2 Content Filter Add Filter Profile Custom Service

Click **Configuration > UTM Profile > Content Filter > Filter Profile > Add or Edit > Custom Service** to open the **Custom Service** screen. You can create a list of good (allowed) web site addresses and a list of bad (blocked) web site addresses. You can also block web sites based on whether the web site's address contains a keyword. Use this screen to add or remove specific sites or keywords from the filter list.

Figure 504 Configuration > UTM Profile > Content Filter > Filter Profile > Custom Service

Add Filter Profile

Category Service **Custom Service**

General Settings

Name: !

Description: (Optional)

Enable Custom Service

Allow web traffic for trusted web sites only

Check Common Trusted/Forbidden List

Restricted Web Features

Block: ActiveX Java Cookies Web Proxy

Allow Java/ActiveX/Cookies/Web proxy to trusted web sites

Trusted Web Sites

#	Trusted Web Sites
No data to display	

Page 1 of 1 Show 50 items

Forbidden Web Sites

#	Forbidden Web Sites
No data to display	

Page 1 of 1 Show 50 items

Blocked URL Keywords

#	Blocked URL Keywords
No data to display	

Page 1 of 1 Show 50 items

Note: Use "*" as a wildcard to match any string in trusted/forbidden web sites and blocked URL keywords (for example, *.zyxel*.com).

The following table describes the labels in this screen.

Table 259 Configuration > UTM Profile > Content Filter > Profile > Custom Service

LABEL	DESCRIPTION
Name	Enter a descriptive name for this content filtering profile name. You may use 1-31 alphanumeric characters, underscores (_), or dashes (-), but the first character cannot be a number. This value is case-sensitive.
Description	Enter a description for the content filtering profile rule to help identify the purpose of rule. You may use 1-31 alphanumeric characters, underscores (_), or dashes (-), but the first character cannot be a number. This value is case-sensitive. This field is optional.

Table 259 Configuration > UTM Profile > Content Filter > Profile > Custom Service (continued)

LABEL	DESCRIPTION
Enable Custom Service	Select this check box to allow trusted web sites and block forbidden web sites. Content filter list customization may be enabled and disabled without re-entering these site names.
Allow Web traffic for trusted web sites only	When this box is selected, the Zyxel Device blocks Web access to sites that are not on the Trusted Web Sites list. If they are chosen carefully, this is the most effective way to block objectionable material.
Check Common Trusted/Forbidden List	Select this check box to check the common trusted and forbidden web sites lists. See Section 37.3 on page 744 and Section 37.4 on page 745 for information on configuring these lists.
Restricted Web Features	Select the check box(es) to restrict a feature. Select the check box(es) to restrict a feature. <ul style="list-style-type: none"> When you download a page containing ActiveX or Java, that part of the web page will be blocked with an X. When you download a page coming from a Web Proxy, the whole web page will be blocked. When you download a page containing cookies, the cookies will be removed, but the page will not be blocked.
Block ActiveX	ActiveX is a tool for building dynamic and active web pages and distributed object applications. When you visit an ActiveX web site, ActiveX controls are downloaded to your browser, where they remain in case you visit the site again.
Java	Java is a programming language and development environment for building downloadable Web components or Internet and intranet business applications of all kinds.
Cookies	Cookies are files stored on a computer's hard drive. Some web servers use them to track usage and provide service based on ID.
Web Proxy	A server that acts as an intermediary between a user and the Internet to provide security, administrative control, and caching service. When a proxy server is located on the WAN it is possible for LAN users to circumvent content filtering by pointing to this proxy server.
Allow Java/ActiveX/Cookies/ Web proxy to trusted web sites	When this box is selected, the Zyxel Device will permit Java, ActiveX and Cookies from sites on the Trusted Web Sites list to the LAN. In certain cases, it may be desirable to allow Java, ActiveX or Cookies from sites that are known and trusted.
Trusted Web Sites	These are sites that you want to allow access to, regardless of their content rating, can be allowed by adding them to this list.
Add	Click this to create a new entry.
Edit	Select an entry and click this to be able to modify it.
Remove	Select an entry and click this to delete it.
#	This displays the index number of the trusted web sites.
Trusted Web Site	This column displays the trusted web sites already added. <p>Enter host names such as www.good-site.com into this text field. Do not enter the complete URL of the site – that is, do not include "http://". All subdomains are allowed. For example, entering "**zyxel.com" also allows "www.zyxel.com", "partner.zyxel.com", "press.zyxel.com", and so on. You can also enter just a top level domain. For example, enter "*.com" to allow all .com domains.</p> <p>Use up to 127 characters (0-9a-z). The casing does not matter. "*" can be used as a wildcard to match any string. The entry must contain at least one "." or it will be invalid.</p>
Forbidden Web Site List	Sites that you want to block access to, regardless of their content rating, can be allowed by adding them to this list.
Add	Click this to create a new entry.

Table 259 Configuration > UTM Profile > Content Filter > Profile > Custom Service (continued)

LABEL	DESCRIPTION
Edit	Select an entry and click this to be able to modify it.
Remove	Select an entry and click this to delete it.
#	This displays the index number of the forbidden web sites.
Forbidden Web Sites	<p>This list displays the forbidden web sites already added.</p> <p>Enter host names such as www.bad-site.com into this text field. Do not enter the complete URL of the site – that is, do not include “http://”. All subdomains are also blocked. For example, entering “*bad-site.com” also blocks “www.bad-site.com”, “partner.bad-site.com”, “press.bad-site.com”, and do on. You can also enter just a top level domain. For example, enter “*.com” to block all .com domains.</p> <p>Use up to 127 characters (0-9a-z). The casing does not matter. “*” can be used as a wildcard to match any string. The entry must contain at least one “.” or it will be invalid.</p>
Blocked URL Keywords	This section allows you to block Web sites with URLs that contain certain keywords in the domain name or IP address.
Add	Click this to create a new entry.
Edit	Select an entry and click this to be able to modify it.
Remove	Select an entry and click this to delete it.
#	This displays the index number of the blocked URL keywords.
Blocked URL Keywords	<p>This list displays the keywords already added.</p> <p>Enter a keyword or a numerical IP address to block. You can also enter a numerical IP address.</p> <p>Use up to 127 case-insensitive characters (0-9a-zA-Z;/?:@&=+\$\._!~*()%). “*” can be used as a wildcard to match any string. Use “ *” to indicate a single wildcard character.</p> <p>For example enter *Bad_Site* to block access to any web page that includes the exact phrase Bad_Site. This does not block access to web pages that only include part of the phrase (such as Bad for example).</p>
OK	Click OK to save your changes back to the Zyxel Device.
Cancel	Click Cancel to exit this screen without saving your changes.

37.3 Content Filter Trusted Web Sites Screen

Click **Configuration > UTM Profile > Content Filter > Trusted Web Sites** to open the **Trusted Web Sites** screen. You can create a common list of good (allowed) web site addresses. When you configure **Filter Profiles**, you can select the option to check the **Common Trusted Web Sites** list. Use this screen to add or remove specific sites from the filter list.

Figure 505 Configuration > UTM Profile > Content Filter > Trusted Web Sites

The following table describes the labels in this screen.

Table 260 Configuration > UTM Profile > Content Filter > Trusted Web Sites

LABEL	DESCRIPTION
Common Trusted Web Sites	These are sites that you want to allow access to, regardless of their content rating, can be allowed by adding them to this list.
Add	Click this to create a new entry.
Edit	Select an entry and click this to be able to modify it.
Remove	Select an entry and click this to delete it.
#	This displays the index number of the trusted web sites.
Trusted Web Site	This column displays the trusted web sites already added. Enter host names such as www.good-site.com into this text field. Do not enter the complete URL of the site – that is, do not include "http://". All subdomains are allowed. For example, entering "zyxel.com" also allows "www.zyxel.com", "partner.zyxel.com", "press.zyxel.com", and so on. You can also enter just a top level domain. For example, enter .com to allow all .com domains. Use up to 127 characters (0-9a-z-). The casing does not matter.
Apply	Click Apply to save your changes back to the Zyxel Device.
Reset	Click Reset to return the screen to its last-saved settings.

37.4 Content Filter Forbidden Web Sites Screen

Click **Configuration > UTM Profile > Content Filter > Forbidden Web Sites** to open the **Forbidden Web Sites** screen. You can create a common list of bad (blocked) web site addresses. When you configure **Filter Profiles**, you can select the option to check the **Common Forbidden Web Sites** list. Use this screen to add or remove specific sites from the filter list.

Figure 506 Configuration > UTM Profile > Content Filter > Forbidden Web Sites

The following table describes the labels in this screen.

Table 261 Configuration > UTM Profile > Content Filter > Forbidden Web Sites

LABEL	DESCRIPTION
Forbidden Web Site List	Sites that you want to block access to, regardless of their content rating, can be allowed by adding them to this list.
Add	Click this to create a new entry.
Edit	Select an entry and click this to be able to modify it.
Remove	Select an entry and click this to delete it.
#	This displays the index number of the forbidden web sites.
Forbidden Web Sites	This list displays the forbidden web sites already added. Enter host names such as www.bad-site.com into this text field. Do not enter the complete URL of the site – that is, do not include “http://”. All subdomains are also blocked. For example, entering “bad-site.com” also blocks “www.bad-site.com”, “partner.bad-site.com”, “press.bad-site.com”, and do on. You can also enter just a top level domain. For example, enter .com to block all .com domains. Use up to 127 characters (0-9a-z-). The casing does not matter.
Apply	Click Apply to save your changes back to the Zyxel Device.
Cancel	Click Reset to return the screen to its last-saved settings.

37.5 Content Filter Technical Reference

This section provides content filtering background information.

External Content Filter Server Lookup Procedure

The content filter lookup process is described below.

Figure 507 Content Filter Lookup Procedure

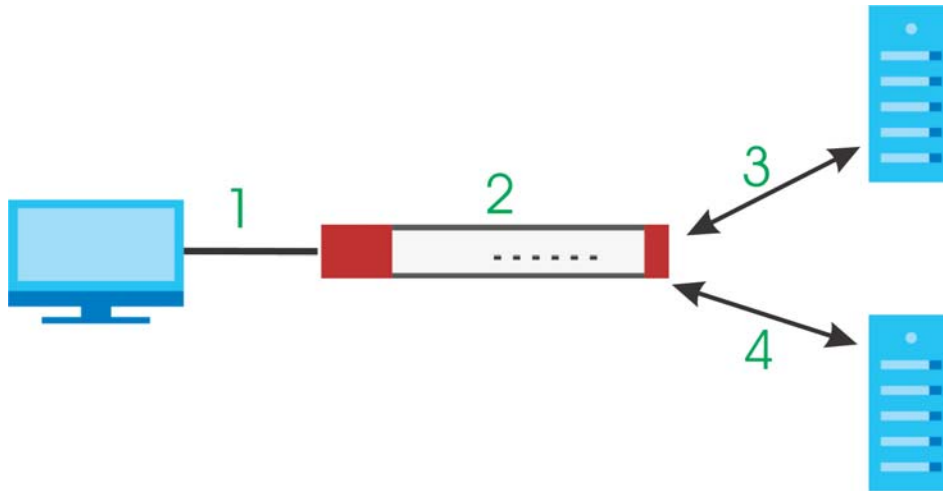

- 1 A computer behind the Zykel Device tries to access a web site.
- 2 The Zykel Device looks up the web site in its cache. If an attempt to access the web site was made in the past, a record of that web site's category will be in the Zykel Device's cache. The Zykel Device blocks, blocks and logs or just logs the request based on your configuration.
- 3 Use the **Content Filter Cache** screen to configure how long a web site address remains in the cache as well as view those web site addresses. All of the web site address records are also cleared from the local cache when the Zykel Device restarts.
- 4 If the Zykel Device has no record of the web site, it queries the external content filter database and simultaneously sends the request to the web server.
- 5 The external content filter server sends the category information back to the Zykel Device, which then blocks and/or logs access to the web site based on the settings in the content filter profile. The web site's address and category are then stored in the Zykel Device's content filter cache.

CHAPTER 38

IDP

38.1 Overview

This chapter introduces packet inspection IDP (Intrusion, Detection and Prevention), IDP profiles, binding an IDP profile to a traffic flow, custom signatures and updating signatures. An IDP system can detect malicious or suspicious packets and respond instantaneously. IDP on the Zyxel Device protects against network-based intrusions.

38.1.1 What You Can Do in this Chapter

- Use the **UTM Profile > IDP > Profile** screen ([Section 38.2 on page 749](#)) to view registration and signature information. Click the **Add** icon to create a new profile from a base IDP profile. Select an existing profile and click the **Edit** icon to change the profile, or click the **Remove** icon to delete it.
- Use the **UTM Profile > IDP > Custom Signature** screens ([Section 38.3 on page 760](#)) to create a new custom signature, edit an existing signature, delete existing signatures or save signatures to your computer.

38.1.2 What You Need To Know

Packet Inspection Signatures

A signature is a pattern of malicious or suspicious packet activity. You can specify an action to be taken if the system matches a stream of data to a malicious signature. You can change the action in the profile screens. Packet inspection examines OSI (Open System Interconnection) layer-4 to layer-7 packet contents for malicious data. Generally, packet inspection signatures are created for known attacks while anomaly detection looks for abnormal behavior.

Applying Your IDP Configuration

Changes to the Zyxel Device's IDP settings affect new sessions, but not the sessions that already existed before you applied the changed settings.

38.1.3 Before You Begin

- Register for a trial IDP subscription in the **Registration** screen. This gives you access to free signature updates. This is important as new signatures are created as new attacks evolve. When the trial subscription expires, purchase and enter a license key using the same screens to continue the subscription.

38.2 The IDP Profile Screen

An IDP profile is a set of packet inspection signatures.

Click **Configuration > UTM Profile > IDP > Profile** to open this screen. Use this screen to view registration and signature information.

Note: You must register in order to update packet inspection signatures. See the **Registration** screens.

If you try to enable IDP when the IDP service has not yet been registered, a warning screen displays and IDP is not enabled.

Click on the icons to go to the OneSecurity website where there is guidance on configuration walkthroughs, troubleshooting and other information.

Figure 508 Configuration > UTM Profile > IDP > Profile

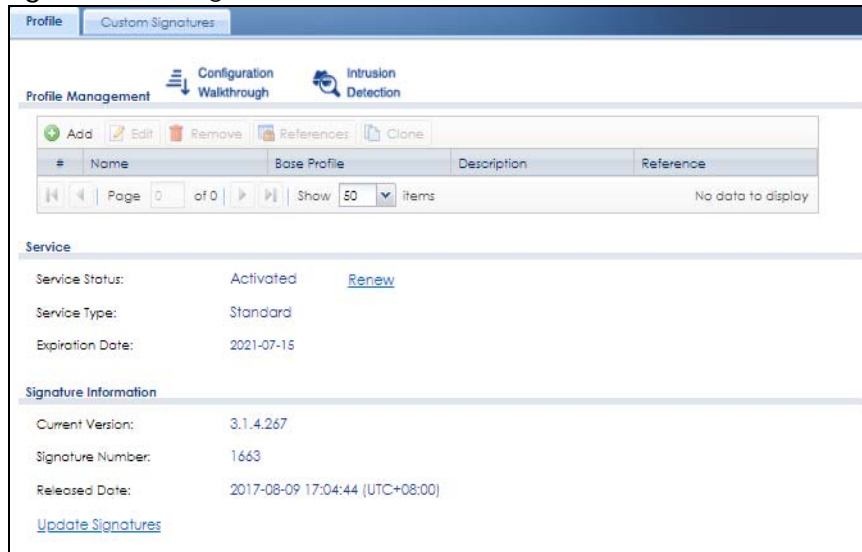

The following table describes the fields in this screen.

Table 262 Configuration > UTM Profile > IDP > Profile

LABEL	DESCRIPTION
Profile Management	
Add	Click Add to create a new profile. Select from the options in the box.
Edit	Select an entry and click this to be able to modify it.
Remove	Select an entry and click this to delete it.
References	Select an entry and click References to open a screen that shows which settings use the entry. Click Refresh to update information on this screen.
Clone	Use Clone to create a new entry by modifying an existing one. <ul style="list-style-type: none"> Select an existing entry. Click Clone. A configuration copy of the selected entry pops up. You must at least change the name as duplicate entry names are not allowed.
#	This is the entry's index number in the list.

Table 262 Configuration > UTM Profile > IDP > Profile (continued)

LABEL	DESCRIPTION
Name	This displays the name of the IDP Profile.
Base Profile	This displays the base profile used to create the IDP profile.
Description	This displays the description of the IDP Profile.
Reference	This displays the number of times an object reference is used in a profile.
Service	You need to create an account at myZyxel, register your Zyxel Device and then subscribe for IDP in order to be able to download new packet inspection signatures from myZyxel. There's an initial free trial period for IDP after which you must pay to subscribe to the service. See the Registration chapter for details.
Service Status	This field displays whether a service license is enabled at myZyxel (Activated) or not (Not Activated) or expired (Expired). It displays the remaining Grace Period if your license has Expired . It displays Not Licensed if there isn't a license to be activated for this service. If you need a license or a trial license has expired, click Buy to buy a new one. If a Standard license has expired, click Renew to extend the license. Then, click Activate to connect with the myZyxel server to activate the new license.
Service Type	This field shows Trial , Standard or None depending on whether you subscribed to the IDP trial, bought an iCard for IDP service or neither.
Signature Information	The following fields display information on the current signature set that the Zyxel Device is using.
Current Version	This field displays the IDP signature set version number. This number gets larger as the set is enhanced.
Signature Number	This field displays the number of IDP signatures in this set. This number usually gets larger as the set is enhanced. Older signatures and rules may be removed if they are no longer applicable or have been supplanted by newer ones.
Released Date	This field displays the date and time the set was released.
Update Signatures	Click this link to go to the screen you can use to download signatures from the update server.

38.2.1 Base Profiles

The Zyxel Device comes with several base profiles. You use base profiles to create new profiles. In the **Configuration > UTM > IDP > Profile** screen, click **Add** to display the following screen.

Figure 509 Base Profiles

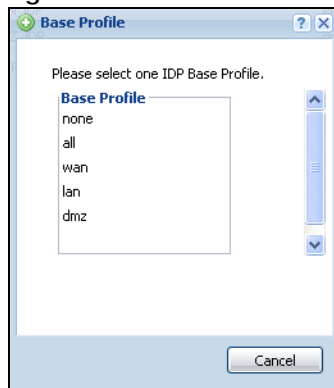

The following table describes this screen.

Table 263 Base Profiles

BASE PROFILE	DESCRIPTION
none	All signatures are disabled. No logs are generated nor actions are taken.
all	All signatures are enabled. Signatures with a high or severe severity level (greater than three) generate log alerts and cause packets that trigger them to be dropped. Signatures with a very low, low or medium severity level (less than or equal to three) generate logs (not log alerts) and no action is taken on packets that trigger them.
wan	Signatures for all services are enabled. Signatures with a medium, high or severe severity level (greater than two) generate logs (not log alerts) and no action is taken on packets that trigger them. Signatures with a very low or low severity level (less than or equal to two) are disabled.
lan	This profile is most suitable for common LAN network services. Signatures for common services such as DNS, FTP, HTTP, ICMP, IM, IMAP, MISC, NETBIOS, P2P, POP3, RPC, RSERVICE, SMTP, SNMP, SQL, TELNET, TFTP, MySQL are enabled. Signatures with a high or severe severity level (greater than three) generate logs (not log alerts) and cause packets that trigger them to be dropped. Signatures with a low or medium severity level (two or three) generate logs (not log alerts) and no action is taken on packets that trigger them. Signatures with a very low severity level (one) are disabled.
dmz	This profile is most suitable for networks containing your servers. Signatures for common services such as DNS, FTP, HTTP, ICMP, IMAP, MISC, NETBIOS, POP3, RPC, RSERVICE, SMTP, SNMP, SQL, TELNET, Oracle, MySQL are enabled. Signatures with a high or severe severity level (greater than three) generate log alerts and cause packets that trigger them to be dropped. Signatures with a low or medium severity level (two or three) generate logs (not log alerts) and no action is taken on packets that trigger them. Signatures with a very low severity level (one) are disabled.
OK	Click OK to save your changes.
Cancel	Click Cancel to exit this screen without saving your changes.

38.2.2 Adding / Editing Profiles

You may want to create a new profile if not all signatures in a base profile are applicable to your network. In this case you should disable non-applicable signatures so as to improve Zyxel Device IDP processing efficiency.

You may also find that certain signatures are triggering too many false positives or false negatives. A false positive is when valid traffic is flagged as an attack. A false negative is when invalid traffic is wrongly allowed to pass through the Zyxel Device. As each network is different, false positives and false negatives are common on initial IDP deployment.

You could create a new 'monitor profile' that creates logs but all actions are disabled. Observe the logs over time and try to eliminate the causes of the false alarms. When you're satisfied that they have been reduced to an acceptable level, you could then create an 'inline profile' whereby you configure appropriate actions to be taken when a packet matches a signature.

Packet inspection signatures examine the contents of a packet for malicious data. It operates at layer-4 to layer-7. An IDP profile is a group of IDP signatures that have the same log and action settings. In 'group view' you can configure the same log and action settings for all IDP signatures by severity level in the Add Profile screen. You may also configure signature exceptions in the same view.

38.2.3 Profile > Group View Screen

Select **Configuration > UTM Profile > IDP > Profile** and then click **Add** to create a new profile or select an existing profile, then click a group in the base profile box (or double-click the existing profile) to modify it. Group view is displayed first by default.

Figure 510 Configuration > UTM Profile > IDP > Profile > Add > Edit: Group View

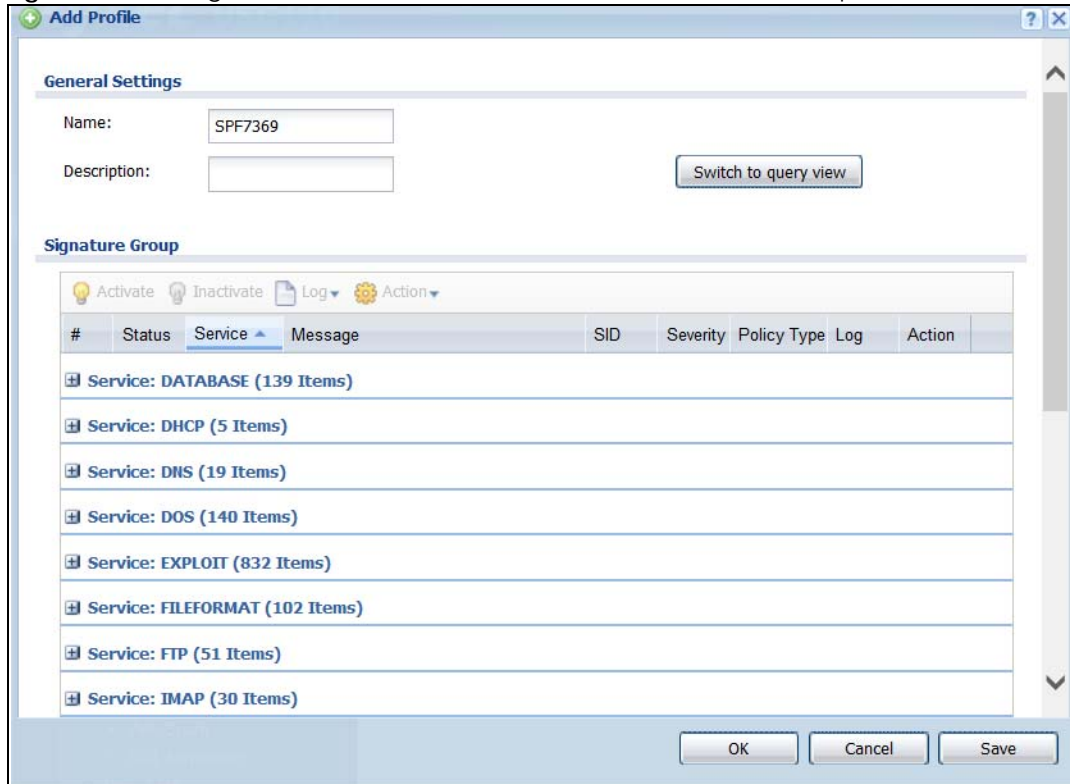

The following table describes the fields in this screen.

Table 264 Configuration > UTM Profile > IDP > Profile > Add > Group View

LABEL	DESCRIPTION
Name	<p>This is the name of the profile. You may use 1-31 alphanumeric characters, underscores(_), or dashes (-), but the first character cannot be a number. This value is case-sensitive. These are valid, unique profile names:</p> <ul style="list-style-type: none"> • MyProfile • mYProfile • Mymy12_3-4 <p>These are invalid profile names:</p> <ul style="list-style-type: none"> • 1mYProfile • My Profile • MyProfile? • Whatalongprofilename123456789012
Description	<p>Enter additional information about this IDP rule. You can enter up to 60 characters ("0-9", "a-z", "A-Z", "-" and "_").</p>

Table 264 Configuration > UTM Profile> IDP > Profile > Add > Group View (continued)

LABEL	DESCRIPTION
Switch to query view	Click this button to go to a screen where you can search for signatures by criteria such as name, ID, severity, attack type, vulnerable attack platforms, service category, log options or actions.
Severity Level	Select a severity level and these use the icons to enable/disable and configure logs and actions for all signatures of that level.
Signature Group	
Activate	To turn on an entry, select it and click Activate .
Inactivate	To turn off an entry, select it and click Inactivate .
Log	<p>To edit an item's log option, select it and use the Log icon. These are the log options:</p> <p>no: Select this option on an individual signature or a complete service group to have the Zyxel Device create no log when a packet matches a signature(s).</p> <p>log: Select this option on an individual signature or a complete service group to have the Zyxel Device create a log when a packet matches a signature(s).</p> <p>log alert: An alert is an e-mailed log for more serious events that may need more immediate attention. They also appear in red in the Monitor > Log screen. Select this option to have the Zyxel Device send an alert when a packet matches a signature(s).</p>
Action	<p>To edit what action the Zyxel Device takes when a packet matches a signature, select the signature and use the Action icon.</p> <p>none: Select this action on an individual signature or a complete service group to have the Zyxel Device take no action when a packet matches the signature(s).</p> <p>drop: Select this action on an individual signature or a complete service group to have the Zyxel Device silently drop a packet that matches the signature(s). Neither sender nor receiver are notified.</p> <p>reject-sender: Select this action on an individual signature or a complete service group to have the Zyxel Device send a reset to the sender when a packet matches the signature. If it is a TCP attack packet, the Zyxel Device will send a packet with a 'RST' flag. If it is an ICMP or UDP attack packet, the Zyxel Device will send an ICMP unreachable packet.</p> <p>reject-receiver: Select this action on an individual signature or a complete service group to have the Zyxel Device send a reset to the receiver when a packet matches the signature. If it is a TCP attack packet, the Zyxel Device will send a packet with an a 'RST' flag. If it is an ICMP or UDP attack packet, the Zyxel Device will do nothing.</p> <p>reject-both: Select this action on an individual signature or a complete service group to have the Zyxel Device send a reset to both the sender and receiver when a packet matches the signature. If it is a TCP attack packet, the Zyxel Device will send a packet with a 'RST' flag to the receiver and sender. If it is an ICMP or UDP attack packet, the Zyxel Device will send an ICMP unreachable packet.</p>
#	This is the entry's index number in the list.
Status	The activate (light bulb) icon is lit when the entry is active and dimmed when the entry is inactive.
Message	This displays the message of the violation of IDP Profile rule.
SID	This displays the Signature ID number. The SID is a numerical field in the 9000000 to 9999999 range.

Table 264 Configuration > UTM Profile> IDP > Profile > Add > Group View (continued)

LABEL	DESCRIPTION
Severity	<p>These are the severities as defined in the Zyxel Device. The number in brackets is the number you use if using commands.</p> <p>Severe (5): These denote attacks that try to run arbitrary code or gain system privileges.</p> <p>High (4): These denote known serious vulnerabilities or attacks that are probably not false alarms.</p> <p>Medium (3): These denote medium threats, access control attacks or attacks that could be false alarms.</p> <p>Low (2): These denote mild threats or attacks that could be false alarms.</p> <p>Very Low (1): These denote possible attacks caused by traffic such as Ping, trace route, ICMP queries etc.</p>
Policy Type	This displays the application of the IDP profile.
Log	These are the log options. To edit this, select an item and use the Log icon.
Action	This is the action the Zyxel Device should take when a packet matches a signature here. To edit this, select an item and use the Action icon.
Excepted Signatures	Use the icons to enable/disable and configure logs and actions for individual signatures that are different to the general settings configured for the severity level to which the signatures belong. Signatures configured in Query View will appear in Group View .
Add	Click this to configure settings to a signature that are different to the severity level to which it belongs.
Remove	Select an existing signature exception and then click this to delete the exception.
Activate	To turn on an entry, select it and click Activate .
Inactivate	To turn off an entry, select it and click Inactivate .
Log	<p>To edit an item's log option, select it and use the Log icon. These are the log options:</p> <p>no: Select this option on an individual signature or a complete service group to have the Zyxel Device create no log when a packet matches a signature(s).</p> <p>log: Select this option on an individual signature or a complete service group to have the Zyxel Device create a log when a packet matches a signature(s).</p> <p>log alert: An alert is an e-mailed log for more serious events that may need more immediate attention. Select this option to have the Zyxel Device send an alert when a packet matches a signature(s).</p>

Table 264 Configuration > UTM Profile> IDP > Profile > Add > Group View (continued)

LABEL	DESCRIPTION
Action	<p>To edit what action the Zyxel Device takes when a packet matches a signature, select the signature and use the Action icon.</p> <p>none: Select this action on an individual signature or a complete service group to have the Zyxel Device take no action when a packet matches the signature(s).</p> <p>drop: Select this action on an individual signature or a complete service group to have the Zyxel Device silently drop a packet that matches the signature(s). Neither sender nor receiver are notified.</p> <p>reject-sender: Select this action on an individual signature or a complete service group to have the Zyxel Device send a reset to the sender when a packet matches the signature. If it is a TCP attack packet, the Zyxel Device will send a packet with a 'RST' flag. If it is an ICMP or UDP attack packet, the Zyxel Device will send an ICMP unreachable packet.</p> <p>reject-receiver: Select this action on an individual signature or a complete service group to have the Zyxel Device send a reset to the receiver when a packet matches the signature. If it is a TCP attack packet, the Zyxel Device will send a packet with an a 'RST' flag. If it is an ICMP or UDP attack packet, the Zyxel Device will do nothing.</p> <p>reject-both: Select this action on an individual signature or a complete service group to have the Zyxel Device send a reset to both the sender and receiver when a packet matches the signature. If it is a TCP attack packet, the Zyxel Device will send a packet with a 'RST' flag to the receiver and sender. If it is an ICMP or UDP attack packet, the Zyxel Device will send an ICMP unreachable packet.</p>
#	This is the entry's index number in the list.
Status	The activate (light bulb) icon is lit when the entry is active and dimmed when the entry is inactive.
SID	Type the exact signature ID (identification) number that uniquely identifies a Zyxel Device IDP signature.
Log	These are the log options. To edit this, select an item and use the Log icon.
Action	This is the action the Zyxel Device should take when a packet matches a signature here. To edit this, select an item and use the Action icon.
OK	A profile consists of three separate screens. If you want to configure just one screen for an IDP profile, click OK to save your settings to the Zyxel Device, complete the profile and return to the profile summary page.
Cancel	Click Cancel to return to the profile summary page without saving any changes.
Save	If you want to configure more than one screen for an IDP profile, click Save to save the configuration to the Zyxel Device, but remain in the same page. You may then go to another profile screen (tab) in order to complete the profile. Click OK in the final profile screen to complete the profile.

38.2.4 Add Profile > Query View

In the group view screen, click **Switch to query view** to search for signatures by criteria such as Name, ID, Severity, Policy Type, Platform, Service, Platforms, or actions.

Policy Types

This table describes **Policy Types** as categorized in the Zyxel Device.

Table 265 Policy Types

POLICY TYPE	DESCRIPTION
Access Control	Access control refers to procedures and controls that limit or detect access. Access control attacks try to bypass validation checks in order to access network resources such as servers, directories, and files.
Any	Any attack includes all other kinds of attacks that are not specified in the policy such as password, spoof, hijack, phishing, and close-in.
Backdoor/Trojan Horse	<p>A backdoor (also called a trapdoor) is hidden software or a hardware mechanism that can be triggered to gain access to a program, online service or an entire computer system. A Trojan horse is a harmful program that is hidden inside apparently harmless programs or data.</p> <p>Although a virus, a worm and a Trojan are different types of attacks, they can be blended into one attack. For example, W32/Blaster and W32/Sasser are blended attacks that feature a combination of a worm and a Trojan.</p>
Buffer Overflow	<p>A buffer overflow occurs when a program or process tries to store more data in a buffer (temporary data storage area) than it was intended to hold. The excess information can overflow into adjacent buffers, corrupting or overwriting the valid data held in them.</p> <p>Intruders could run codes in the overflow buffer region to obtain control of the system, install a backdoor or use the victim to launch attacks on other devices.</p>
DoS/DDoS	<p>The goal of Denial of Service (DoS) attacks is not to steal information, but to disable a device or network on the Internet.</p> <p>A Distributed Denial of Service (DDoS) attack is one in which multiple compromised systems attack a single target, thereby causing denial of service for users of the targeted system.</p>
Instant Messenger	IM (Instant Messenger) refers to chat applications. Chat is real-time, text-based communication between two or more users via networks-connected computers. After you enter a chat (or chat room), any room member can type a message that will appear on the monitors of all the other participants.
Mail	A Mail or E-mail bombing attack involves sending several thousand identical messages to an electronic mailbox in order to overflow it, making it unusable.
Misc	Miscellaneous attacks takes advantage of vulnerable computer networks and web servers by forcing cache servers or web browsers into disclosing user-specific information that might be sensitive and confidential. The most common type of Misc. attacks are HTTP Response Smuggling, HTTP Response Splitting and JSON Hijacking.
P2P	Peer-to-peer (P2P) is where computing devices link directly to each other and can directly initiate communication with each other; they do not need an intermediary. A device can be both the client and the server. In the Zyxel Device, P2P refers to peer-to-peer applications such as e-Mule, e-Donkey, BitTorrent, iMesh, etc.
Scan	<p>A scan describes the action of searching a network for an exposed service. An attack may then occur once a vulnerability has been found. Scans occur on several network levels.</p> <p>A network scan occurs at layer-3. For example, an attacker looks for network devices such as a router or server running in an IP network.</p> <p>A scan on a protocol is commonly referred to as a layer-4 scan. For example, once an attacker has found a live end system, he looks for open ports.</p> <p>A scan on a service is commonly referred to a layer-7 scan. For example, once an attacker has found an open port, say port 80 on a server, he determines that it is a HTTP service run by some web server application. He then uses a web vulnerability scanner (for example, Nikto) to look for documented vulnerabilities.</p>

Table 265 Policy Types (continued)

POLICY TYPE	DESCRIPTION
SPAM	Spam is unsolicited "junk" e-mail sent to large numbers of people to promote products or services.
Stream Media	A Stream Media attack occurs when a malicious network node downloads an overwhelming amount of media stream data that could potentially exhaust the entire system. This method allows users to send small requests messages that result in the streaming of large media objects, providing an opportunity for malicious users to exhaust resources in the system with little effort expended on their part.
Tunnel	A Tunneling attack involves sending IPv6 traffic over IPv4, slipping viruses, worms and spyware through the network using secret tunnels. This method infiltrates standard security measures through IPv6 tunnels, passing through IPv4 undetected. An external signal then activates the malicious files to wreak havoc from inside the network.
Virus/Worm	A computer virus is a small program designed to corrupt and/or alter the operation of other legitimate programs. A worm is a program that is designed to copy itself from one computer to another on a network. A worm's uncontrolled replication consumes system resources, thus slowing or stopping other tasks.
Web Attack	Web attacks refer to attacks on web servers such as IIS (Internet Information Services).

IDP Service Groups

An IDP service group is a set of related packet inspection signatures.

Table 266 IDP Service Groups

WEB_PHP	WEB_MISC	WEB_IIS	WEB_FRONTPAGE
WEB_CGI	WEB_ATTACKS	TFTP	TELNET
SQL	SNMP	SMTP	RSERVICES
RPC	POP3	POP2	P2P
ORACLE	NNTP	NETBIOS	MYSQL
MISC_EXPLOIT	MISC_DDOS	MISC_BACKDOOR	MISC
IMAP	IM	ICMP	FTP
FINGER	DNS	n/a	

The n/a service group is for signatures that are not for a specific service.

Figure 511 Configuration > UTM Profile> IDP > Profile: Query View

The following table describes the fields specific to this screen's query view.

Table 267 Configuration > UTM Profile > IDP > Profile: Query View

LABEL	DESCRIPTION
Name	This is the name of the profile that you created in the IDP > Profiles > Group View screen.
Switch to query view	Click this button to go to the IDP profile group view screen where IDP signatures are grouped by service and you can configure activation, logs and/or actions.
Query Signatures	Select the criteria on which to perform the search.
Search all custom signatures	Select this check box to include signatures you created or imported in the Custom Signatures screen in the search. You can search for specific signatures by name or ID. If the name and ID fields are left blank, then all signatures are searched according to the criteria you select.
Name	Type the name or part of the name of the signature(s) you want to find.
Signature ID	Type the ID or part of the ID of the signature(s) you want to find.

Table 267 Configuration > UTM Profile > IDP > Profile: Query View (continued)

LABEL	DESCRIPTION
Severity	<p>Search for signatures by severity level(s). Hold down the [Ctrl] key if you want to make multiple selections.</p> <p>These are the severities as defined in the Zyxel Device. The number in brackets is the number you use if using commands.</p> <p>Severe (5): These denote attacks that try to run arbitrary code or gain system privileges.</p> <p>High (4): These denote known serious vulnerabilities or attacks that are probably not false alarms.</p> <p>Medium (3): These denote medium threats, access control attacks or attacks that could be false alarms.</p> <p>Low (2): These denote mild threats or attacks that could be false alarms.</p> <p>Very-Low (1): These denote possible attacks caused by traffic such as Ping, trace route, ICMP queries etc.</p>
Attack Type	Search for signatures by attack type(s) (see Table 265 on page 756). Attack types are known as policy types in the group view screen. Hold down the [Ctrl] key if you want to make multiple selections.
Platform	Search for signatures created to prevent intrusions targeting specific operating system(s). Hold down the [Ctrl] key if you want to make multiple selections.
Service	Search for signatures by IDP service group(s). See Table 265 on page 756 for group details. Hold down the [Ctrl] key if you want to make multiple selections.
Action	Search for signatures by the response the Zyxel Device takes when a packet matches a signature. See Table 264 on page 752 for action details. Hold down the [Ctrl] key if you want to make multiple selections.
Activation	Search for activated and/or inactivated signatures here.
Log	Search for signatures by log option here. See Table 264 on page 752 for option details.
Search	Click this button to begin the search. The results display at the bottom of the screen. Results may be spread over several pages depending on how broad the search criteria selected were. The tighter the criteria selected, the fewer the signatures returned.
Query Result	The results are displayed in a table showing the SID, Name, Severity, Attack Type, Platform, Service, Activation, Log, and Action criteria as selected in the search. Click the SID column header to sort search results by signature ID.
OK	Click OK to save your settings to the Zyxel Device, complete the profile and return to the profile summary page.
Cancel	Click Cancel to return to the profile summary page without saving any changes.
Save	Click Save to save the configuration to the Zyxel Device, but remain in the same page. You may then go to the another profile screen (tab) in order to complete the profile. Click OK in the final profile screen to complete the profile.

38.2.5 Query Example

This example shows a search with these criteria:

- Severity: high
- Policy Type: DoS
- Platform: Windows
- Service: Any
- Actions: Any

Figure 512 Query Example Search

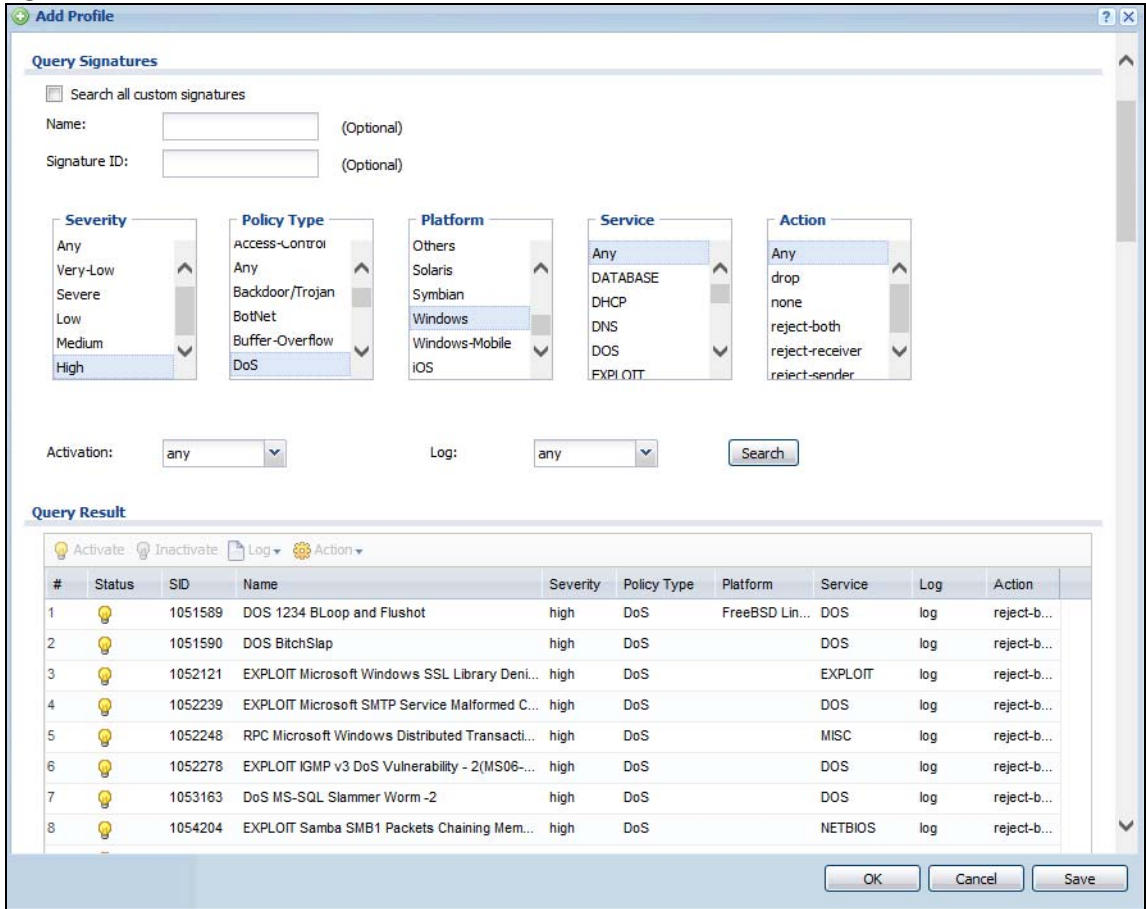

38.3 IDP Custom Signatures

Create custom signatures for new attacks or attacks peculiar to your network. Custom signatures can also be saved to/from your computer so as to share with others.

You need some knowledge of packet headers and attack types to create your own custom signatures.

IP Packet Header

These are the fields in an Internet Protocol (IP) version 4 packet header.

Figure 513 IP v4 Packet Headers

0	4	8	16	19	31
Version	IHL	Type of Service	Total Length		
Identification			Flags	Fragment Offset	
Time To Live		Protocol	Header Checksum		
Source IP Address					
Destination IP Address					
Options				Padding	

The header fields are discussed in the following table.

Table 268 IP v4 Packet Headers

HEADER	DESCRIPTION
Version	The value 4 indicates IP version 4.
IHL	IP Header Length is the number of 32 bit words forming the total length of the header (usually five).
Type of Service	The Type of Service, (also known as Differentiated Services Code Point (DSCP)) is usually set to 0, but may indicate particular quality of service needs from the network.
Total Length	This is the size of the datagram in bytes. It is the combined length of the header and the data.
Identification	This is a 16-bit number, which together with the source address, uniquely identifies this packet. It is used during reassembly of fragmented datagrams.
Flags	Flags are used to control whether routers are allowed to fragment a packet and to indicate the parts of a packet to the receiver.
Fragment Offset	This is a byte count from the start of the original sent packet.
Time To Live	This is a counter that decrements every time it passes through a router. When it reaches zero, the datagram is discarded. It is used to prevent accidental routing loops.
Protocol	The protocol indicates the type of transport packet being carried, for example, 1 = ICMP; 2= IGMP; 6 = TCP; 17= UDP.
Header Checksum	This is used to detect processing errors introduced into the packet inside a router or bridge where the packet is not protected by a link layer cyclic redundancy check. Packets with an invalid checksum are discarded by all nodes in an IP network.
Source IP Address	This is the IP address of the original sender of the packet.
Destination IP Address	This is the IP address of the final destination of the packet.
Options	IP options is a variable-length list of IP options for a datagram that define IP Security Option , IP Stream Identifier , (security and handling restrictions for the military), Record Route (have each router record its IP address), Loose Source Routing (specifies a list of IP addresses that must be traversed by the datagram), Strict Source Routing (specifies a list of IP addresses that must ONLY be traversed by the datagram), Timestamp (have each router record its IP address and time), End of IP List and No IP Options .
Padding	Padding is used as a filler to ensure that the IP packet is a multiple of 32 bits.

Select **Configuration > UTM Profile > IDP > Custom Signatures**. The first screen shows a summary of all custom signatures created. Click the **SID** or **Name** heading to sort. Click the **Add** icon to create a new

signature or click the **Edit** icon to edit an existing signature. You can also delete custom signatures here or save them to your computer.

Note: The Zyxel Device checks all signatures and continues searching even after a match is found. If two or more rules have conflicting actions for the same packet, then the Zyxel Device applies the more restrictive action (**reject-both**, **reject-receiver** or **reject-sender**, **drop**, **none** in this order). If a packet matches a rule for **reject-receiver** and it also matches a rule for **reject-sender**, then the Zyxel Device will **reject-both**.

Figure 514 Configuration > UTM Profile > IDP > Custom Signatures

The following table describes the fields in this screen.

Table 269 Configuration > UTM Profile> IDP > Custom Signatures

LABEL	DESCRIPTION
Custom Signature Rules	Use this part of the screen to create, edit, delete or export (save to your computer) custom signatures.
Add	Click this to create a new entry.
Edit	Select an entry and click this to be able to modify it.
Remove	Select an entry and click this to delete it.
Export	To save an entry or entries as a file on your computer, select them and click Export . Click Save in the file download dialog box and then select a location and name for the file. Custom signatures must end with the 'rules' file name extension, for example, MySig.rules.
#	This is the entry's index number in the list.
SID	SID is the signature ID that uniquely identifies a signature. Click the SID header to sort signatures in ascending or descending order. It is automatically created when you click the Add icon to create a new signature. You can edit the ID, but it cannot already exist and it must be in the 9000000 to 9999999 range.
Name	This is the name of your custom signature. Duplicate names can exist, but it is advisable to use unique signature names that give some hint as to intent of the signature and the type of attack it is supposed to prevent.

Table 269 Configuration > UTM Profile> IDP > Custom Signatures (continued)

LABEL	DESCRIPTION
Customer Signature Rule Importing	<p>Use this part of the screen to import custom signatures (previously saved to your computer) to the Zyxel Device.</p> <p>Note: The name of the complete custom signature file on the Zyxel Device is 'custom.rules'. If you import a file named 'custom.rules', then all custom signatures on the Zyxel Device are overwritten with the new file. If this is not your intention, make sure that the files you import are not named 'custom.rules'.</p>
File Path	<p>Type the file path and name of the custom signature file you want to import in the text box (or click Browse to find it on your computer) and then click Importing to transfer the file to the Zyxel Device.</p> <p>New signatures then display in the Zyxel Device IDP > Custom Signatures screen.</p>

38.3.1 Add / Edit Custom Signatures

Click the **Add** icon to create a new signature or click the **Edit** icon to edit an existing signature in the screen as shown in [Figure 514 on page 762](#).

A packet must match all items you configure in this screen before it matches the signature. The more specific your signature (including packet contents), then the fewer false positives the signature will trigger.

Try to write signatures that target a vulnerability, for example a certain type of traffic on certain operating systems, instead of a specific exploit.

Figure 515 Configuration > UTM Profile > IDP > Custom Signatures > Add/Edit

Add Custom Signature

Setup

Name: Cs
Signature ID: 9703924

Information

Severity: [Dropdown]
Platform: Windows Linux FreeBSD Solaris
 Other-Unix Network-Device MAC iOS
 Android Windows-Mobile Symbian Others
Policy Type: Any

Frequency

Threshold [] Packet(s)/ [] Second(s)

Header Options

Network Protocol: IPv4
 Type of Service [] []
 Identification []
 Fragmentation Reserved Bit Don't Fragment More Fragment
 Fragment Offset [] []
 Time to Live [] []
 IP Options []
 Some IP []

Transport Protocol: TCP
Port: Source Port: 0 (0:any) Destination Port: 0 (0:any)
 Flow [] [] []
 Flags SYN FIN RST PSH
 ACK URG Reserved 1 (MSB) Reserved 2
 Sequence Number []
 Ack Number []
 Window Size Equal []

Payload Options

Payload Size [] [] Bytes

+ Add Edit Remove

#	Offset	Content	Case-insensitive	Decode as URI
[Empty Table]				

OK Cancel

The following table describes the fields in this screen.

Table 270 Configuration > UTM Profile > IDP > Custom Signatures > Add/Edit

LABEL	DESCRIPTION
Name	<p>Type the name of your custom signature. You may use 1-31 alphanumeric characters, underscores(_), or dashes (-), but the first character cannot be a number. This value is case-sensitive.</p> <p>Duplicate names can exist but it is advisable to use unique signature names that give some hint as to intent of the signature and the type of attack it is supposed to prevent. Refer to (but do not copy) the packet inspection signature names for hints on creating a naming convention.</p>
Signature ID	<p>A signature ID is automatically created when you click the Add icon to create a new signature. You can edit the ID to create a new one (in the 9000000 to 9999999 range), but you cannot use one that already exists. You may want to do that if you want to order custom signatures by SID.</p>
Information	<p>Use the following fields to set general information about the signature as denoted below.</p>
Severity	<p>The severity level denotes how serious the intrusion is. Categorize the seriousness of the intrusion here. See Table 264 on page 752 as a reference.</p>
Platform	<p>Some intrusions target specific operating systems only. Select the operating systems that the intrusion targets, that is, the operating systems you want to protect from this intrusion. SGI refers to Silicon Graphics Incorporated, who manufactures multi-user Unix workstations that run the IRIX operating system (SGI's version of UNIX). A router is an example of a network device.</p>
Service	<p>Select the IDP service group that the intrusion exploits or targets. See Table 266 on page 757 for a list of IDP service groups. The custom signature then appears in that group in the IDP > Profile > Group View screen.</p>
Policy Type	<p>Categorize the attack type here. See Table 265 on page 756 as a reference.</p>
Frequency	<p>Recurring packets of the same type may indicate an attack. Use the following field to indicate how many packets per how many seconds constitute an intrusion</p>
Threshold	<p>Select Threshold and then type how many packets (that meet the criteria in this signature) per how many seconds constitute an intrusion.</p>
Header Options	
Network Protocol	<p>Configure signatures for IP version 4.</p>
Type Of Service	<p>Type of service in an IP header is used to specify levels of speed and/or reliability. Some intrusions use an invalid Type Of Service number. Select the check box, then select Equal or Not-Equal and then type in a number.</p>
Identification	<p>The identification field in a datagram uniquely identifies the datagram. If a datagram is fragmented, it contains a value that identifies the datagram to which the fragment belongs. Some intrusions use an invalid Identification number. Select the check box and then type in the invalid number that the intrusion uses.</p>
Fragmentation	<p>A fragmentation flag identifies whether the IP datagram should be fragmented, not fragmented or is a reserved bit. Some intrusions can be identified by this flag. Select the check box and then select the flag that the intrusion uses.</p>
Fragment Offset	<p>When an IP datagram is fragmented, it is reassembled at the final destination. The fragmentation offset identifies where the fragment belongs in a set of fragments. Some intrusions use an invalid Fragment Offset number. Select the check box, select Equal, Smaller or Greater and then type in a number</p>
Time to Live	<p>Time to Live is a counter that decrements every time it passes through a router. When it reaches zero, the datagram is discarded. Usually it's used to set an upper limit on the number of routers a datagram can pass through. Some intrusions can be identified by the number in this field. Select the check box, select Equal, Smaller or Greater and then type in a number.</p>

Table 270 Configuration > UTM Profile > IDP > Custom Signatures > Add/Edit (continued)

LABEL	DESCRIPTION
IP Options	IP options is a variable-length list of IP options for a datagram that define IP Security Option , IP Stream Identifier , (security and handling restrictions for the military), Record Route (have each router record its IP address), Loose Source Routing (specifies a list of IP addresses that must be traversed by the datagram), Strict Source Routing (specifies a list of IP addresses that must ONLY be traversed by the datagram), Timestamp (have each router record its IP address and time), End of IP List and No IP Options . IP Options can help identify some intrusions. Select the check box, then select an item from the list box that the intrusion uses
Same IP	Select the check box for the signature to check for packets that have the same source and destination IP addresses.
Transport Protocol	The following fields vary depending on whether you choose TCP , UDP or ICMP .
Transport Protocol: TCP	
Port	Select the check box and then enter the source and destination TCP port numbers that will trigger this signature.
Flow	The selected keyword sets the criteria as to which traffic is matched. You can match traffic based on direction or whether the connection is established or not. You can also specify whether you want to match signatures per packet or in a stream of packets. Established: Match established TCP connections. Stateless: Match packets regardless of the state of the stream processor. This is useful for packets that are designed to cause machines to crash. To Client: Match packets that flow from server to client. To Server: Match packets that flow from client to server. From Client: Match packets that flow from client to server. From Servers: Match packets that flow from server to client. No Stream: Match packets that have not been reassembled by the stream engine. It will not match packets that have been reassembled. Only Stream: Match packets that have been reassembled.
Flags	Select what TCP flag bits the signature should check.
Sequence Number	Use this field to check for a specific TCP sequence number.
Ack Number	Use this field to check for a specific TCP acknowledgment number.
Window Size	Use this field to check for a specific TCP window size.
Transport Protocol: UDP	
Port	Select the check box and then enter the source and destination UDP port numbers that will trigger this signature.
Transport Protocol: ICMP	
Type	Use this field to check for a specific ICMP type value.
Code	Use this field to check for a specific ICMP code value.
ID	Use this field to check for a specific ICMP ID value. This is useful for covert channel programs that use static ICMP fields when they communicate.
Sequence Number	Use this field to check for a specific ICMP sequence number. This is useful for covert channel programs that use static ICMP fields when they communicate.
Payload Options	The longer a payload option is, the more exact the match, the faster the signature processing. Therefore, if possible, it is recommended to have at least one payload option in your signature.

Table 270 Configuration > UTM Profile > IDP > Custom Signatures > Add/Edit (continued)

LABEL	DESCRIPTION
Payload Size	<p>This field may be used to check for abnormally sized packets or for detecting buffer overflows.</p> <p>Select the check box, then select Equal, Smaller or Greater and then type the payload size.</p> <p>Stream rebuilt packets are not checked regardless of the size of the payload.</p>
Add	Click this to create a new entry.
Edit	Select an entry and click this to be able to modify it.
Remove	Select an entry and click this to delete it.
#	This is the entry's index number in the list.
Offset	This field specifies where to start searching for a pattern within a packet. For example, an offset of 5 would start looking for the specified pattern after the first five bytes of the payload.
Content	<p>Type the content that the signature should search for in the packet payload. Hexadecimal code entered between pipes is converted to ASCII. For example, you could represent the ampersand as either <code>&</code> or <code> 26 </code> (26 is the hexadecimal code for the ampersand).</p>
Case-insensitive	Select Yes if content casing does NOT matter.
Decode as URI	<p>A Uniform Resource Identifier (URI) is a string of characters for identifying an abstract or physical resource (RFC 2396). A resource can be anything that has identity, for example, an electronic document, an image, a service ("today's weather report for Taiwan"), a collection of other resources. An identifier is an object that can act as a reference to something that has identity. Example URIs are:</p> <p><code>ftp://ftp.is.co.za/rfc/rfc1808.txt</code>; ftp scheme for File Transfer Protocol services</p> <p><code>http://www.math.uio.no/faq/compression-faq/part1.html</code>; http scheme for Hypertext Transfer Protocol services</p> <p><code>mailto:mduerst@ifi.unizh.ch</code>; mailto scheme for electronic mail addresses</p> <p><code>telnet://melvyl.ucop.edu/</code>; telnet scheme for interactive services via the TELNET Protocol</p> <p>Select Yes for the signature to search for normalized URI fields. This means that if you are writing signatures that includes normalized content, such as <code>%2</code> for directory traversals, these signatures will not be triggered because the content is normalized out of the URI buffer.</p> <p>For example, the URI:</p> <p><code>/scripts/..%c0%af../winnt/system32/cmd.exe?/c+ver</code></p> <p>will get normalized into:</p> <p><code>/winnt/system32/cmd.exe?/c+ver</code></p>
OK	Click this button to save your changes to the Zyxel Device and return to the summary screen.
Cancel	Click this button to return to the summary screen without saving any changes.

38.3.2 Custom Signature Example

Before creating a custom signature, you must first clearly understand the vulnerability.

38.3.2.1 Understand the Vulnerability

Check the Zyxel Device logs when the attack occurs. Use web sites such as Google or Security Focus to get as much information about the attack as you can. The more specific your signature, the less chance it will cause false positives.

As an example, say you want to check if your router is being overloaded with DNS queries so you create a signature to detect DNS query traffic.

38.3.2.2 Analyze Packets

Use the packet capture screen and a packet analyzer (also known as a network or protocol analyzer) such as Wireshark or Ethereal to investigate some more.

Figure 516 DNS Query Packet Details

The screenshot shows the Wireshark interface with a filter set to 'udp.port eq 53'. The packet list pane shows several packets, with the selected packet being a DNS query (No. 46363) from 192.168.1.33 to 192.168.1.1. The packet details pane shows the following information:

```

Time to first byte: 120
Protocol: UDP (0x11)
  Header checksum: 0xce07 [correct]
  Source: 192.168.1.33 (192.168.1.33)
  Destination: 192.168.1.1 (192.168.1.1)
User Datagram Protocol, Src Port: 25301 (25301), Dst Port: domain (53)
Domain Name System (query)
  Transaction ID: 0x9d13
  Flags: 0x0100 (Standard query)
    0... .. = Response: Message is a query
    .000 0... .. = opcode: standard query (0)
    .... ..0. .... = Truncated: Message is not truncated
    .... ..1 .... = Recursion desired: Do query recursively
    .... ..0.. .... = Z: reserved (0)
    .... ..0 .... = Non-authenticated data OK: Non-authenticated data is unacc
Questions: 1
Answer RRs: 0
Authority RRs: 0
Additional RRs: 0
  Queries
    www.gravatar.com: type A, class IN
0000 00 00 aa 78 57 43 00 0f 3d ec 5e c3 08 00 45 00 ...xwC.. =.A...E.
0010 00 3e e9 34 00 00 80 11 ce 07 c0 a8 01 21 c0 a8 ..>.4.... !...
0020 01 01 62 d5 00 35 00 2a 58 19 9d 13 01 00 00 01 ..b..5.* x!.....
0030 00 00 00 00 00 00 03 77 77 77 08 67 72 61 76 61 .....w ww.grava
0040 74 61 72 03 63 6f 6d 00 00 01 00 01 tar.com. ....

```

From the details about DNS query you see that the protocol is UDP and the port is 53. The type of DNS packet is standard query and the Flag is 0x0100 with an offset of 2. Therefore enter |010| as the first pattern.

The final custom signature should look like as shown in the following figure.

Figure 517 Example Custom Signature

#	Offset	Content	Case-insensitive	Decode as URI
1	2	010	no	no

38.3.3 Applying Custom Signatures

After you create your custom signature, it becomes available in an IDP profile (**Configuration > UTM Profile > IDP > Profile > Edit** screen). Custom signatures have an SID from 9000000 to 9999999.

Search for, then activate the signature, configure what action to take when a packet matches it and if it should generate a log or alert in a profile. Then bind the profile to a zone.

38.3.4 Verifying Custom Signatures

Configure the signature to create a log when traffic matches the signature. (You may also want to configure an alert if it is for a serious attack and needs immediate attention.) After you apply the signature to a zone, you can see if it works by checking the logs (**Monitor > Log**).

The **Priority** column shows **warn** for signatures that are configured to generate a log only. It shows **critical** for signatures that are configured to generate a log and alert. All IDP signatures come under the **IDP** category. The **Note** column displays **ACCESS FORWARD** when no action is configured for the signature. It displays **ACCESS DENIED** if you configure the signature action to drop the packet. The destination port is the service port (53 for DNS in this case) that the attack tries to exploit.

Figure 518 Custom Signature Log

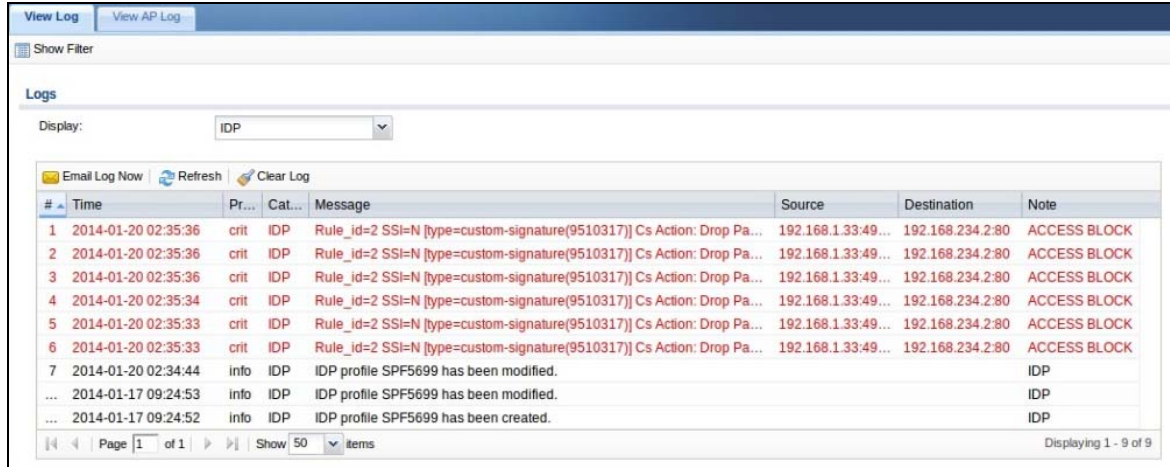

The screenshot shows a web-based interface for viewing logs. At the top, there are tabs for 'View Log' and 'View AP Log'. Below that is a 'Show Filter' button. The main section is titled 'Logs' and has a 'Display:' dropdown menu set to 'IDP'. There are buttons for 'Email Log Now', 'Refresh', and 'Clear Log'. The log entries are displayed in a table with the following columns: #, Time, Pr..., Cat..., Message, Source, Destination, and Note. The table contains several entries, including critical alerts for 'ACCESS BLOCK' and informational messages about IDP profile modifications.

#	Time	Pr...	Cat...	Message	Source	Destination	Note
1	2014-01-20 02:35:36	crit	IDP	Rule_id=2 SSI=N [type=custom-signature(9510317)] Cs Action: Drop Pa...	192.168.1.33:49...	192.168.234.2:80	ACCESS BLOCK
2	2014-01-20 02:35:36	crit	IDP	Rule_id=2 SSI=N [type=custom-signature(9510317)] Cs Action: Drop Pa...	192.168.1.33:49...	192.168.234.2:80	ACCESS BLOCK
3	2014-01-20 02:35:36	crit	IDP	Rule_id=2 SSI=N [type=custom-signature(9510317)] Cs Action: Drop Pa...	192.168.1.33:49...	192.168.234.2:80	ACCESS BLOCK
4	2014-01-20 02:35:34	crit	IDP	Rule_id=2 SSI=N [type=custom-signature(9510317)] Cs Action: Drop Pa...	192.168.1.33:49...	192.168.234.2:80	ACCESS BLOCK
5	2014-01-20 02:35:33	crit	IDP	Rule_id=2 SSI=N [type=custom-signature(9510317)] Cs Action: Drop Pa...	192.168.1.33:49...	192.168.234.2:80	ACCESS BLOCK
6	2014-01-20 02:35:33	crit	IDP	Rule_id=2 SSI=N [type=custom-signature(9510317)] Cs Action: Drop Pa...	192.168.1.33:49...	192.168.234.2:80	ACCESS BLOCK
7	2014-01-20 02:34:44	info	IDP	IDP profile SPF5699 has been modified.			IDP
...	2014-01-17 09:24:53	info	IDP	IDP profile SPF5699 has been modified.			IDP
...	2014-01-17 09:24:52	info	IDP	IDP profile SPF5699 has been created.			IDP

At the bottom of the table, there is a pagination control showing 'Page 1 of 1', 'Show 50 items', and 'Displaying 1 - 9 of 9'.

38.4 IDP Technical Reference

This section contains some background information on IDP.

Host Intrusions

The goal of host-based intrusions is to infiltrate files on an individual computer or server in with the goal of accessing confidential information or destroying information on a computer.

You must install a host IDP directly on the system being protected. It works closely with the operating system, monitoring and intercepting system calls to the kernel or APIs in order to prevent attacks as well as log them.

Disadvantages of host IDPs are that you have to install them on each device (that you want to protect) in your network and due to the necessarily tight integration with the host operating system, future operating system upgrades could cause problems.

Network Intrusions

Network-based intrusions have the goal of bringing down a network or networks by attacking computer(s), switch(es), router(s) or modem(s). If a LAN switch is compromised for example, then the whole LAN is compromised. Host-based intrusions may be used to cause network-based intrusions when the goal of the host virus is to propagate attacks on the network, or attack computer/server operating system vulnerabilities with the goal of bringing down the computer/server. Typical "network-based intrusions" are SQL slammer, Blaster, Nimda MyDoom etc.

Snort Signatures

You may want to refer to open source Snort signatures when creating custom Zyxel Device ones. Most Snort rules are written in a single line. Snort rules are divided into two logical sections, the rule header and the rule options as shown in the following example:

```
alert tcp any any -> 192.168.1.0/24 111 (content:"|00 01 a5|"; msg:"mound access");
```

The text up to the first parenthesis is the rule header and the section enclosed in parenthesis contains the rule options. The words before the colons in the rule options section are the option keywords.

The rule header contains the rule's:

- Action
- Protocol
- Source and destination IP addresses and netmasks
- Source and destination ports information.

The rule option section contains alert messages and information on which parts of the packet should be inspected to determine if the rule action should be taken.

These are some equivalent Snort terms in the Zyxel Device.

Table 271 Zyxel Device - Snort Equivalent Terms

ZYXEL DEVICE TERM	SNORT EQUIVALENT TERM
Type Of Service	tos
Identification	id
Fragmentation	fragbits
Fragmentation Offset	fragoffset
Time to Live	tll
IP Options	ipopts
Same IP	sameip
Transport Protocol	
Transport Protocol: TCP	
Port	(In Snort rule header)
Flow	flow
Flags	flags
Sequence Number	seq
Ack Number	ack
Window Size	window
Transport Protocol: UDP	(In Snort rule header)
Port	(In Snort rule header)
Transport Protocol: ICMP	
Type	itype
Code	icode
ID	icmp_id
Sequence Number	icmp_seq

Table 271 Zyxel Device - Snort Equivalent Terms (continued)

ZYXEL DEVICE TERM	SNORT EQUIVALENT TERM
Payload Options	(Snort rule options)
Payload Size	dsize
Offset (relative to start of payload)	offset
Relative to end of last match	distance
Content	content
Case-insensitive	nocase
Decode as URI	uricontent

Note: Not all Snort functionality is supported in the Zyxel Device.

CHAPTER 39

Anti-Virus

39.1 Overview

Use the Zyxel Device's anti-virus feature to protect your connected network from virus/spyware infection. The Zyxel Device checks traffic going in the direction(s) you specify for signature matches. In the following figure the Zyxel Device is set to check traffic coming from the WAN zone (which includes two interfaces) to the LAN zone.

Figure 519 Zyxel Device Anti-Virus Example

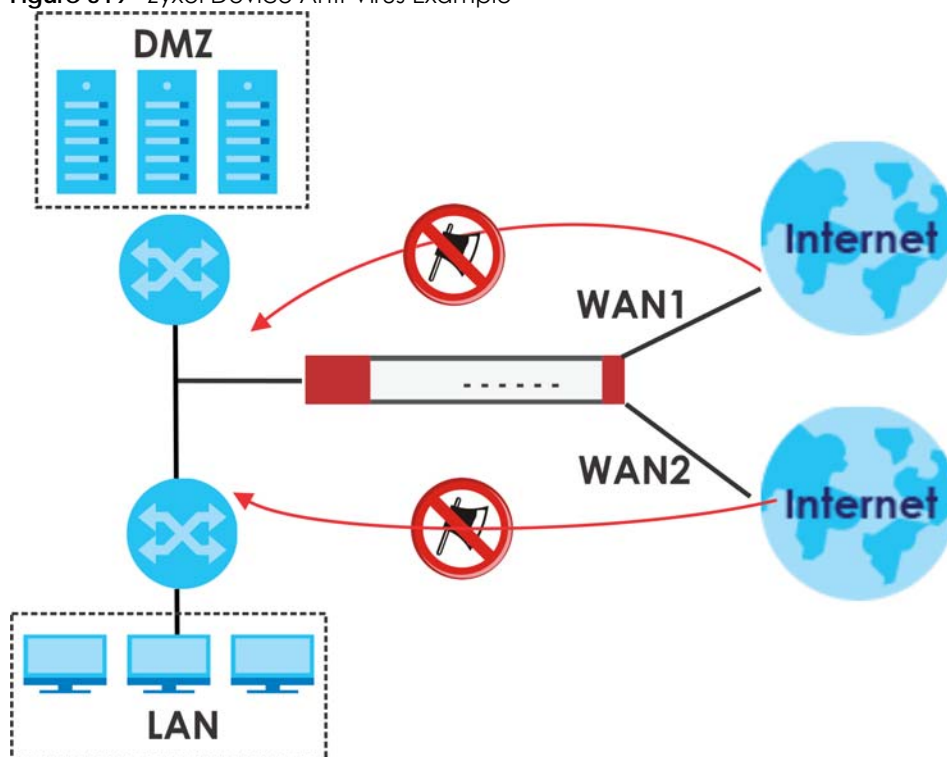

The anti-virus matches a file with those in a virus database. This is done as files go through the Zyxel Device.

Virus, Worm, and Spyware

A computer virus is a type of malicious software designed to corrupt and/or alter the operation of other legitimate programs. A worm is a self-replicating virus that resides in active memory and duplicates itself. The effect of a virus attack varies from doing so little damage that you are unaware your computer is infected to wiping out the entire contents of a hard drive to rendering your computer inoperable. Spyware infiltrate your device and secretly gathers information about you, such as your network activity, passwords, bank details, and so on.

Anti-Virus Licensing

The Zyxel Device downloads signature sets after it is registered and the anti-virus license is activated at myZyxel. A signature is a unique string of bits, or binary pattern, of a virus. A signature acts as a fingerprint that can be used to detect and identify a specific virus. These signatures are periodically updated if you have a valid license.

Having extensive, up-to-date signatures with the most common virus is critical to making the anti-virus service work effectively. [Section 8.2 on page 287](#) shows licensing information for the different signature databases that can be used by the Zyxel Device.

After the anti-virus license expires, you need to purchase an iCard to update your local signature database. Extend your license in the **Registration > Service** screen.

Anti-Virus Scan Process

- 1 Before going through the Anti-Virus file scan, the Zyxel Device first identifies the packets sent by the following four major protocols with corresponding standard ports:
 - FTP (File Transfer Protocol)
 - HTTP (Hyper Text Transfer Protocol)
 - SMTP (Simple Mail Transfer Protocol)
 - POP3 (Post Office Protocol version 3)

The Zyxel Device records the order of packets in TCP connection-oriented sessions to check for matching virus signatures. The order of non-setup packets such as SYN, ACK and FIN is ignored.

- 2 The Zyxel Device checks every packet of the file for matches with the local signature databases. If a virus pattern signature is matched, the actions you specify for identified virus will be applied. If **Destroy infected file** is enabled, the file will be modified. Logs/alerts will be sent according to your settings.

Note: The receiver is not notified if a file is modified by the Zyxel Device. If the file cannot be used, the receiver should contact the Zyxel Device administrator to confirm if the Zyxel Device modified the file by checking the logs.

Notes About the Zyxel Device Anti-Virus

The following lists important notes about the Zyxel Device's anti-virus feature:

- 1 Zyxel's anti-virus feature can detect polymorphic virus (see [Section 39.5 on page 783](#)).
- 2 When a virus is detected, a log is created or an alert message is sent to the administrator depending on your log settings.
- 3 Changes to the Zyxel Device's anti-virus settings only affect new sessions, not sessions that already existed before you applied the changed settings.
- 4 The Zyxel Device does not scan the following file/traffic types:
 - Simultaneous downloads of a file using multiple connections. For example, when you use FlashGet to download sections of a file simultaneously.

- Encrypted traffic. This could be password-protected files or VPN traffic where the Zyxel Device is not the endpoint (pass-through VPN traffic).
- Traffic through custom (non-standard) ports. The Zyxel Device scans whatever port number is specified for FTP in the ALG screen.
- All compressed files within a compressed file. Note that a single file can still be decompressed and scanned if you select **Enable file decompression (ZIP and RAR)**.
- Traffic compressed or encoded using a method the Zyxel Device does not support.

Finding Out More

- See [Section 39.5 on page 783](#) for anti-virus background information.

39.1.1 What You Can Do in this Chapter

- Use the **Profile** screens ([Section 39.2 on page 775](#)) to turn anti-virus on or off, set up anti-virus policies and custom service port rules. You can also check the anti-virus license and signature status.
- Use the **Black/White List** screen ([Section 39.3 on page 779](#)) to set up anti-virus black (blocked) and white (allowed) lists of virus file patterns.
- Use the **Signature** screen ([Section 39.4 on page 782](#)) to search for particular signatures and get more information about them.

39.2 Anti-Virus Profile Screen

Click **Configuration > UTM Profile > Anti-Virus** to display the configuration screen as shown next.

Click on the icons to go to the OneSecurity website where there is guidance on configuration walkthroughs, troubleshooting and other information.

Figure 520 Configuration > UTM Profile > Anti-Virus > Profile

The screenshot shows the configuration page for the Anti-Virus profile. It includes tabs for Profile, Black/White List, and Signature. The main content area has sections for General Settings, Scan Mode, Profile Management, Service, and Signature Information. The 'Scan and detect EICAR test virus' checkbox is checked. Under Scan Mode, 'Stream Mode' is selected. The Profile Management section shows a table with columns for #, Name, Description, and Reference, but it is currently empty. The Service section shows 'Service Status: Activated' with a 'Renew' link, 'Service Type: Standard', and 'Expiration Date: 2021-07-15'. The Signature Information section shows 'Current Version: 2.0.1.864', 'Signature Number: 684077', and 'Released Date: 2018-01-02 08:16:57 (UTC+08:00)'. There is an 'Update Signatures' link and 'Apply' and 'Reset' buttons at the bottom.

The following table describes the labels in this screen.

Table 272 Configuration > UTM Profile > Anti-Virus > Profile

LABEL	DESCRIPTION
General Setting	
Scan and detect EICAR test virus	Select this option to have the Zyxel Device check for the EICAR test file and treat it in the same way as a real virus file. The EICAR test file is a standardized test file for signature based anti-virus scanners. When the virus scanner detects the EICAR file, it responds in the same way as if it found a real virus. Besides straightforward detection, the EICAR file can also be compressed to test whether the anti-virus software can detect it in a compressed file. The test string consists of the following human-readable ASCII characters. X5O!P%#@AP[4\PZX54(P^)7CC]7}\$EICAR-STANDARD-ANTIVIRUS-TEST-FILE!\$H+H*
Scan Mode	
Express Mode	In this mode you can define which types of files are scanned using the File Type For Scan fields. The Zyxel Device then scans files by sending each file's hash value to a cloud database using cloud query. This is the fastest scan mode.
Stream Mode	In this mode the Zyxel Device scans all files for viruses using anti-malware signatures to detect known virus patterns, and Threat Intelligence Machine Learning. Threat Intelligence Machine Learning is a master cloud database containing malware patterns learned from all Zyxel Devices. This is the deepest scan mode.
Profile Management	

Table 272 Configuration > UTM Profile > Anti-Virus > Profile (continued)

LABEL	DESCRIPTION
Add	Click this to create a new entry. Select an entry and click Add to create a new entry after the selected entry.
Edit	Select an entry and click this to be able to modify it.
Remove	Select an entry and click this to delete it.
References	Select an entry and click References to open a screen that shows which settings use the entry. Click Refresh to update information in this screen.
#	This displays the index number of the rule.
Name	This displays the name for the anti-virus rule.
Description	This displays the description of the anti-virus rule.
Reference	This displays the number of times an Object Reference is used in a rule.
Service	The following fields display information about the current state of your subscription for virus signatures.
Service Status	This field displays whether a service license is enabled at myZyxel (Activated) or not (Not Activated) or expired (Expired). It displays the remaining Grace Period if your license has Expired . It displays Not Licensed if there isn't a license to be activated for this service. If you need a license or a trial license has expired, click Buy to buy a new one. If a Standard license has expired, click Renew to extend the license. Then, click Activate to connect with the myZyxel server to activate the new license.
Service Type	This field displays whether you applied for a trial application (Trial) or registered a service with your iCard's PIN number (Standard). None displays when the service is not activated.
Expiration Date	This field displays the date your service license expires.
Signature Information	The following fields display information on the current signature set that the Zyxel Device is using.
Current Version	This field displays the anti-virus signature set version number. This number gets larger as the set is enhanced.
Signature Number	This field displays the number of anti-virus signatures in this set.
Released Date	This field displays the date and time the set was released.
Update Signatures	Click this link to go to the screen you can use to download signatures from the update server.
Apply	Click Apply to save your changes.
Reset	Click Reset to return the screen to its last-saved settings.

39.2.1 Anti-Virus Profile Add or Edit

Click the **Add** or **Edit** icon in the **Configuration > UTM Profile > Anti-Virus > Profile** screen to display the configuration screen as shown next.

Note: If "Destroy infected file" is disabled and "log" is set to "no", the Zyxel Device will still perform the scan but will not do anything else. It is recommended to enable at least one of the two functions.

If "Destroy infected file" is disabled, any malicious file found can still be executed by the end user after it is forwarded. The administrator would have to inform the user if there is an infected file.

Figure 521 Configuration > UTM Profile > Anti-Virus > Profile: Profile Management > Add

The following table describes the labels in this screen.

Table 273 Configuration > UTM > Anti-Virus > Profile: Profile Management > Add

LABEL	DESCRIPTION
Configuration	
Name	Enter a descriptive name for this anti-virus rule. You may use 1-31 alphanumeric characters, underscores(_), or dashes (-), but the first character cannot be a number. This value is case-sensitive. Enter the name of the anti-virus policy.
Description	Enter a descriptive name for this anti-virus rule. You may use 1-31 alphanumeric characters, underscores(_), or dashes (-), but the first character cannot be a number. This value is case-sensitive.
Actions When Matched	
Destroy infected file	When you select this check box, if a virus signature is matched, the Zyxel Device overwrites the infected portion of the file with zeros before being forwarded to the user. The uninfected portion of the file will pass through unmodified.
Log	These are the log options: no: Do not create a log when a packet matches a signature(s). log: Create a log on the Zyxel Device when a packet matches a signature(s). log alert: An alert is an e-mailed log for more serious events that may need more immediate attention. Select this option to have the Zyxel Device send an alert when a packet matches a signature(s).
Check White List	Select this check box to check files against the white list.
Check Black List	Select this check box to check files against the black list.
File decompression	

Table 273 Configuration > UTM > Anti-Virus > Profile: Profile Management > Add (continued)

LABEL	DESCRIPTION
Enable file decompression (ZIP and RAR)	Select this check box to have the Zyxel Device scan a compressed file (the file does not need to have a "zip" or "rar" file extension). The Zyxel Device first decompresses the file and then scans the contents for malware. Note: The Zyxel Device decompresses a compressed file once. The Zyxel Device does NOT decompress any file(s) within a compressed file.
Destroy compressed files that could not be decompressed	When you select this check box, the Zyxel Device deletes compressed files that use password encryption. Select this check box to have the Zyxel Device delete any compressed files that it cannot decompress. The Zyxel Device cannot decompress password protected files or a file within another compressed file. There are also limits to the number of compressed files that the Zyxel Device can concurrently decompress. Note: The Zyxel Device's firmware package cannot go through the Zyxel Device with this check box enabled. The Zyxel Device classifies the firmware package as a file that cannot be decompressed and then deletes it. Clear this check box when you download a firmware package from the Zyxel website. It's OK to upload a firmware package to the Zyxel Device with the check box selected.
OK	Click OK to save your changes.
Cancel	Click Cancel to exit this screen without saving your changes.

39.3 Anti-Virus Black List

Click **Configuration > UTM Profile > Anti-Virus > Black/White List** to display the screen shown next. Use the **Black List** screen to set up the Anti-Virus black (blocked) list of virus file patterns. Click a column's heading cell to sort the table entries by that column's criteria. Click the heading cell again to reverse the sort order.

Figure 522 Configuration > UTM Profile > Anti-Virus > Black/White List > Black List

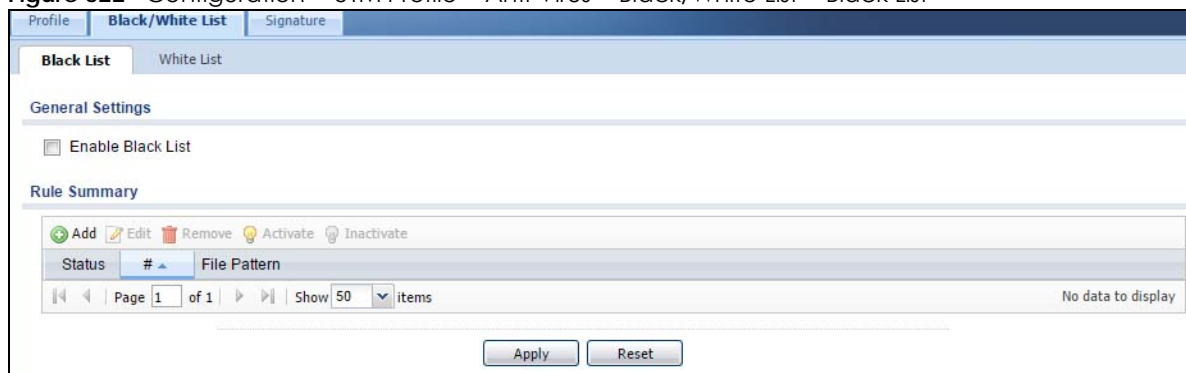

The following table describes the labels in this screen.

Table 274 Configuration > UTM Profile > Anti-Virus > Black/White List > Black List

LABEL	DESCRIPTION
Enable Black List	Select this check box to log and delete files with names that match the black list patterns. Use the black list to log and delete files with names that match the black list patterns.
Add	Click this to create a new entry.
Edit	Select an entry and click this to be able to modify it.
Remove	Select an entry and click this to delete it.
Activate	To turn on an entry, select it and click Activate .
Inactivate	To turn off an entry, select it and click Inactivate .
Status	The activate (light bulb) icon is lit when the entry is active and dimmed when the entry is inactive.
#	This is the entry's index number in the list.
File Pattern	This is the file name pattern. If a file's name that matches this pattern, the Zyxel Device logs and deletes the file.
Apply	Click Apply to save your changes.
Reset	Click Reset to return the screen to its last-saved settings.

39.3.1 Anti-Virus Black List or White List Add/Edit

From the **Configuration > UTM Profile > Anti-Virus > Black/White List > Black List** (or **White List**) screen, click the **Add** icon or an **Edit** icon to display the following screen. A black list allows you to specify signatures that you want to block. A white list allows you to specify signatures to allow in order to avoid false positives. False positives occur when a non-infected file matches a virus signature.

- For a black list entry, enter a file pattern that would cause the Zyxel Device to log and modify this file.
- For a white list entry, enter a file pattern that would cause the Zyxel Device to allow this file.

Figure 523 Configuration > UTM Profile > Anti-Virus > Black/White List > Black List (or White List) > Add

The following table describes the labels in this screen.

Table 275 Configuration > UTM Profile > Anti-Virus > Black/White List > Black List (or White List) > Add

LABEL	DESCRIPTION
Enable	<p>If this is a black list entry, select this option to have the Zyxel Device apply this entry when using the black list.</p> <p>If this is a white list entry, select this option to have the Zyxel Device apply this entry when using the white list.</p>
File Pattern	<p>For a black list entry, specify a pattern to identify the names of files that the Zyxel Device should log and delete.</p> <p>For a white list entry, specify a pattern to identify the names of files that the Zyxel Device should not scan for viruses.</p> <ul style="list-style-type: none"> • Use up to 80 characters. Alphanumeric characters, underscores (_), dashes (-), question marks (?) and asterisks (*) are allowed. • A question mark (?) lets a single character in the file name vary. For example, use "a?.zip" (without the quotation marks) to specify aa.zip, ab.zip and so on. • Wildcards (*) let multiple files match the pattern. For example, use "*a.zip" (without the quotation marks) to specify any file that ends with "a.zip". A file named "testa.zip" would match. There could be any number (of any type) of characters in front of the "a.zip" at the end and the file name would still match. A file named "test.zipa" for example would not match. • A * in the middle of a pattern has the Zyxel Device check the beginning and end of the file name and ignore the middle. For example, with "abc*.zip", any file starting with "abc" and ending in ".zip" matches, no matter how many characters are in between. • The whole file name has to match if you do not use a question mark or asterisk. • If you do not use a wildcard, the Zyxel Device checks up to the first 80 characters of a file name.
Source	<p>Select a source address or address group for whom this policy applies. You can configure a new one in the Object > Address > Add screen. Select any if the policy is effective for every source.</p>
Destination	<p>Select a destination address or address group for whom this policy applies. You can configure a new one in the Object > Address > Add screen. Select any if the policy is effective for every destination.</p>
OK	<p>Click OK to save your changes.</p>
Cancel	<p>Click Cancel to exit this screen without saving your changes.</p>

39.3.2 Anti-Virus Black/White List

Click **Configuration > UTM Profile > Anti-Virus > Black/White List > White List** to display the screen shown next. Use the **Black/White List** screen to set up Anti-Virus black (blocked) and white (allowed) lists of virus file patterns. You can set them if you are avoiding specific kinds of viruses or reducing false positives. Click a column's heading cell to sort the table entries by that column's criteria. Click the heading cell again to reverse the sort order.

Figure 524 Configuration > UTM Profile > Anti-Virus > Black/White List > White List

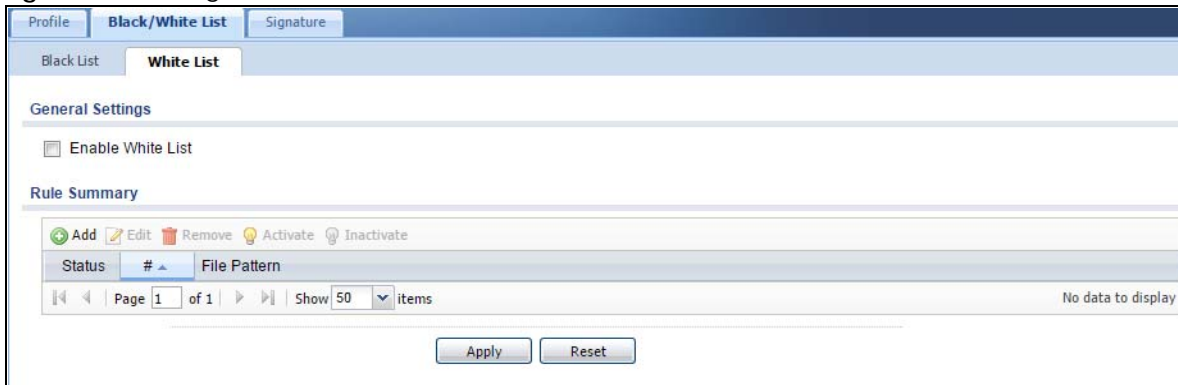

The following table describes the labels in this screen.

Table 276 Configuration > UTM Profile > Anti-Virus > Black/White List > White List

LABEL	DESCRIPTION
Enable White List	Select this check box to have the Zyxel Device not perform the anti-virus check on files with names that match the white list patterns. Use the white list to have the Zyxel Device not perform the anti-virus check on files with names that match the white list patterns.
Add	Click this to create a new entry.
Edit	Select an entry and click this to be able to modify it.
Remove	Select an entry and click this to delete it.
Activate	To turn on an entry, select it and click Activate .
Inactivate	To turn off an entry, select it and click Inactivate .
Status	The activate (light bulb) icon is lit when the entry is active and dimmed when the entry is inactive.
#	This is the entry's index number in the list.
File Pattern	This is the file name pattern. If a file's name matches this pattern, the Zyxel Device does not check the file for viruses.
Source	This is the source address or address group for whom this policy applies.
Destination	This is the destination address or address group for whom this policy applies.
Apply	Click Apply to save your changes.
Reset	Click Reset to return the screen to its last-saved settings.

39.4 AV Signature Searching

Click **Configuration > UTM Profile > Anti-Virus > Signature** to display this screen. Use this screen to locate signatures and display details about them.

If your browser opens a warning screen about a script making it run slowly and the computer unresponsive, just click **No** to continue. Click a column's heading cell to sort the table entries by that column's criteria. Click the heading cell again to reverse the sort order.

Figure 525 Configuration > UTM Profile > Anti-Virus > Signature

The screenshot shows the 'Signature' configuration page. At the top, there are tabs for 'Profile', 'Black/White List', and 'Signature'. Below the tabs is a 'Query Signatures' section with a search input field, a 'Search' button, and an 'Export' button. Below this is a 'Query Result' section with a table header showing columns for '#' and 'Name'. The table content area is empty, displaying 'No data to display'.

The following table describes the labels in this screen.

Table 277 Configuration > UTM > Anti-Virus > Signature

LABEL	DESCRIPTION
Signatures Search	Enter the name, part of the name or keyword of the signature(s) you want to find. This search is not case-sensitive and accepts numerical strings.
Query all signatures and export	Click Export to have the Zyxel Device save all of the anti-virus signatures to your computer in a .txt file.
Query Result	
#	This is the entry's index number in the list.
Name	This is the name of the anti-virus signature. Click the Name column heading to sort your search results in ascending or descending order according to the signature name. Click a signature's name to see details about the virus.

39.5 Anti-Virus Technical Reference

Types of Computer Viruses

The following table describes some of the common computer viruses.

Table 278 Common Computer Virus Types

TYPE	DESCRIPTION
File Infector	This is a small program that embeds itself in a legitimate program. A file infector is able to copy and attach itself to other programs that are executed on an infected computer.
Boot Sector Virus	This type of virus infects the area of a hard drive that a computer reads and executes during startup. The virus causes computer crashes and to some extent renders the infected computer inoperable.
Macro Virus	Macro viruses or Macros are small programs that are created to perform repetitive actions. Macros run automatically when a file to which they are attached is opened. Macros spread more rapidly than other types of viruses as data files are often shared on a network.
E-mail Virus	E-mail viruses are malicious programs that spread through e-mail.
Polymorphic Virus	A polymorphic virus (also known as a mutation virus) tries to evade detection by changing a portion of its code structure after each execution or self replication. This makes it harder for an anti-virus scanner to detect or intercept it. A polymorphic virus can also belong to any of the virus types discussed above.

Computer Virus Infection and Prevention

The following describes a simple life cycle of a computer virus.

- 1 A computer gets a copy of a virus from a source such as the Internet, e-mail, file sharing or any removable storage media. The virus is harmless until the execution of an infected program.
- 2 The virus spreads to other files and programs on the computer.
- 3 The infected files are unintentionally sent to another computer thus starting the spread of the virus.
- 4 Once the virus is spread through the network, the number of infected networked computers can grow exponentially.

Types of Anti-Virus Scanner

The section describes two types of anti-virus scanner: host-based and network-based.

A host-based anti-virus (HAV) scanner is often software installed on computers and/or servers in the network. It inspects files for virus patterns as they are moved in and out of the hard drive. However, host-based anti-virus scanners cannot eliminate all viruses for a number of reasons:

- HAV scanners are slow in stopping virus threats through real-time traffic (such as from the Internet).
- HAV scanners may reduce computing performance as they also share the resources (such as CPU time) on the computer for file inspection.
- You have to update the virus signatures and/or perform virus scans on all computers in the network regularly.

A network-based anti-virus (NAV) scanner is often deployed as a dedicated security device (such as your Zyxel Device) on the network edge. NAV scanners inspect real-time data traffic (such as E-mail messages or web) that tends to bypass HAV scanners. The following lists some of the benefits of NAV scanners.

- NAV scanners stop virus threats at the network edge before they enter or exit a network.
- NAV scanners reduce computing loading on computers as the read-time data traffic inspection is done on a dedicated security device.

CHAPTER 40

Anti-Spam

40.1 Overview

The anti-spam feature can mark or discard spam (unsolicited commercial or junk email). Use the white list to identify legitimate email. Use the black list to identify spam email. The Zyxel Device can also check email against a DNS black list (DNSBL) of IP addresses of servers that are suspected of being used by spammers.

40.1.1 What You Can Do in this Chapter

- Use the **General Profile** screens ([Section 40.3 on page 787](#)) to turn anti-spam on or off and manage anti-spam policies.
- Use the **Mail Scan** screen ([Section 40.4 on page 790](#)) to enable and configure the mail scan functions.
- Use the **Black/White List** screens ([Section 40.5 on page 791](#)) to set up a black list to identify spam and a white list to identify legitimate email.
- Use the **DNSBL** screens ([Section 40.7 on page 796](#)) to have the Zyxel Device check email against DNS Black Lists.

40.1.2 What You Need to Know

White List

Configure white list entries to identify legitimate email. The white list entries have the Zyxel Device classify any email that is from a specified sender or uses a specified header field and header value as being legitimate (see [E-mail Headers](#) for more on mail headers). The anti-spam feature checks an email against the white list entries before doing any other anti-spam checking. If the email matches a white list entry, the Zyxel Device classifies the email as legitimate and does not perform any more anti-spam checking on that individual email. A properly configured white list helps keep important email from being incorrectly classified as spam. The white list can also increase the Zyxel Device's anti-spam speed and efficiency by not having the Zyxel Device perform the full anti-spam checking process on legitimate email.

Black List

Configure black list entries to identify spam. The black list entries have the Zyxel Device classify any e-mail that is from or forwarded by a specified IP address or uses a specified header field and header value as being spam. If an e-mail does not match any of the white list entries, the Zyxel Device checks it against the black list entries. The Zyxel Device classifies an e-mail that matches a black list entry as spam and immediately takes the configured action for dealing with spam. If an e-mail matches a blacklist entry, the Zyxel Device does not perform any more anti-spam checking on that individual e-mail. A properly configured black list helps catch spam e-mail and increases the Zyxel Device's anti-spam speed and efficiency.

SMTP and POP3

Simple Mail Transfer Protocol (SMTP) is the Internet's message transport standard. It controls the sending of e-mail messages between servers. E-mail clients (also called e-mail applications) then use mail server protocols such as POP (Post Office Protocol) or IMAP (Internet Message Access Protocol) to retrieve e-mail. E-mail clients also generally use SMTP to send messages to a mail server. The older POP2 requires SMTP for sending messages while the newer POP3 can be used with or without it. This is why many e-mail applications require you to specify both the SMTP server and the POP or IMAP server (even though they may actually be the same server).

The Zyxel Device's anti-spam feature checks SMTP (TCP port 25) and POP3 (TCP port 110) e-mails by default. You can also specify custom SMTP and POP3 ports for the Zyxel Device to check.

E-mail Headers

Every email has a header and a body. The header is structured into fields and includes the addresses of the recipient and sender, the subject, and other information about the e-mail and its journey. The body is the actual message text and any attachments. You can have the Zyxel Device check for specific header fields with specific values.

E-mail programs usually only show you the To:, From:, Subject:, and Date: header fields but there are others such as Received: and Content-Type:. To see all of an e-mail's header, you can select an e-mail in your e-mail program and look at its properties or details. For example, in Microsoft's Outlook Express, select a mail and click **File > Properties > Details**. This displays the e-mail's header. Click **Message Source** to see the source for the entire mail including both the header and the body.

E-mail Header Buffer Size

The Zyxel Device has a 5 K buffer for an individual e-mail header. If an e-mail's header is longer than 5 K, the Zyxel Device only checks up to the first 5 K.

DNSBL

A DNS Black List (DNSBL) is a server that hosts a list of IP addresses known or suspected of having sent or forwarded spam. A DNSBL is also known as a DNS spam blocking list. The Zyxel Device can check the routing addresses of e-mail against DNSBLs and classify an e-mail as spam if it was sent or forwarded by a computer with an IP address in the DNSBL.

Finding Out More

See [Section 40.8 on page 798](#) for more background information on anti-spam.

40.2 Before You Begin

- Before using the Anti-Spam features (IP Reputation, Mail Content Analysis and Virus Outbreak Detection) you must activate your Anti-Spam Service license.
- Configure your zones before you configure anti-spam.

40.3 The Anti-Spam Profile Screen

Click **Configuration > UTM Profile > Anti-Spam** to open the **Anti-Spam Profile** screen. Use this screen to turn the anti-spam feature on or off and manage anti-spam policies. You can also select the action the Zyxel Device takes when the mail sessions threshold is reached.

Click on the icons to go to the OneSecurity website where there is guidance on configuration walkthroughs, troubleshooting and other information.

Figure 526 Configuration > UTM Profile > Anti-Spam > Profile

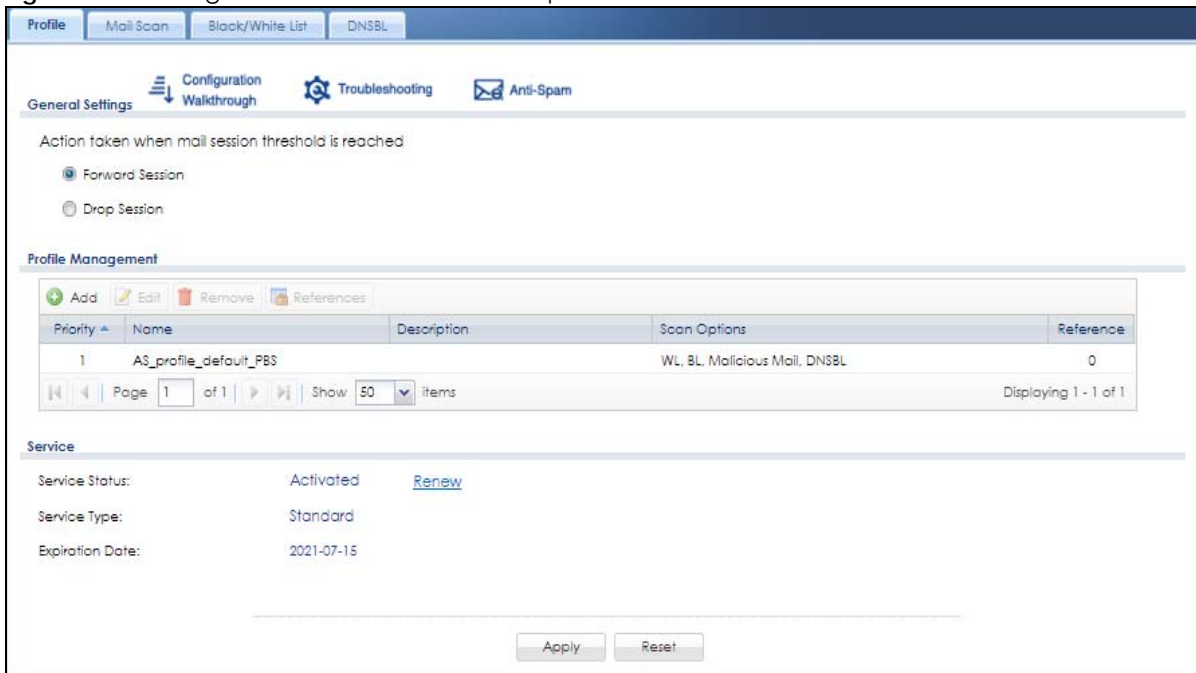

The following table describes the labels in this screen.

Table 279 Configuration > UTM Profile > Anti-Spam > Profile

LABEL	DESCRIPTION
General Settings	
Action taken when mail sessions threshold is reached	An e-mail session is when an e-mail client and e-mail server (or two e-mail servers) connect through the Zyxel Device. Select how to handle concurrent e-mail sessions that exceed the maximum number of concurrent e-mail sessions that the anti-spam feature can handle. See the chapter of product specifications for the threshold. Select Forward Session to have the Zyxel Device allow the excess e-mail sessions without any spam filtering. Select Drop Session to have the Zyxel Device drop mail connections to stop the excess e-mail sessions. The e-mail client or server will have to re-attempt to send or receive e-mail later when the number of e-mail sessions is under the threshold.
Add	Click this to create a new entry. Select an entry and click Add to create a new entry after the selected entry.
Edit	Select an entry and click this to be able to modify it.
Remove	Select an entry and click this to delete it.
References	Select an entry and click References to open a screen that shows which settings use the entry. Click Refresh to update information in this screen.

Table 279 Configuration > UTM Profile > Anti-Spam > Profile

LABEL	DESCRIPTION
Priority	This is the index number of the anti-spam rule. Anti-spam rules are applied in turn.
Name	The name identifies the anti-spam rule.
Description	This is some optional extra information on the rule.
Scan Options	This shows which types (protocols) of traffic to scan for spam.
Reference	This shows how many objects are referenced in the rule.
Service	
Service Status	This field displays whether a service license is enabled at myZyxel (Activated) or not (Not Activated) or expired (Expired). It displays the remaining Grace Period if your license has Expired . It displays Not Licensed if there isn't a license to be activated for this service. If you need a license or a trial license has expired, click Buy to buy a new one. If a Standard license has expired, click Renew to extend the license. Then, click Activate to connect with the myZyxel server to activate the new license.
Service Type	This read-only field displays what kind of service registration you have for the anti-spam scanning. None displays if you have not successfully registered and activated the service. Standard displays if you have successfully registered the Zyxel Device and activated the service with your iCard's PIN number. Trial displays if you have successfully registered the Zyxel Device and activated the trial service subscription.
Expiration Date	This field displays the date your service license expires.
Apply	Click Apply to save your changes back to the Zyxel Device.
Reset	Click Reset to return the screen to its last-saved settings.

40.3.1 The Anti-Spam Profile Add or Edit Screen

Click the **Add** or **Edit** icon in the **Configuration > UTM Profile > Anti-Spam > Profile** screen to display the configuration screen as shown next. Use this screen to configure an anti-spam policy that controls scan options, and the action to take on spam traffic.

Figure 527 Configuration > UTM Profile > Anti-Spam > Profile > Add

The following table describes the labels in this screen.

Table 280 Configuration > UTM Profile > Anti-Spam > Profile > Add

LABEL	DESCRIPTION
General Settings	
Name	Enter a descriptive name for this anti-spam rule. You may use 1-31 alphanumeric characters, underscores(_), or dashes (-), but the first character cannot be a number. This value is case-sensitive.
Description	Enter a description for the anti-spam rule to help identify the purpose of rule. You may use 1-31 alphanumeric characters, underscores(_), or dashes (-), but the first character cannot be a number. This value is case-sensitive. This field is optional.
Log	Select how the Zyxel Device is to log the event when the DNSBL times out or an e-mail matches the white list, black list, or DNSBL. no: Do not create a log. log: Create a log on the Zyxel Device. log alert: An alert is an e-mailed log for more serious events that may need more immediate attention. Select this option to have the Zyxel Device send an alert.
Scan Options	
Check White List	Select this check box to check e-mail against the white list. The Zyxel Device classifies e-mail that matches a white list entry as legitimate (not spam).
Check Black List	Select this check box to check e-mail against the black list. The Zyxel Device classifies e-mail that matches a black list entry as spam.

Table 280 Configuration > UTM Profile > Anti-Spam > Profile > Add (continued)

LABEL	DESCRIPTION
Check Malicious Mail	
Check DNSBL	Select this check box to check e-mail against the Zyxel Device's configured DNSBL domains. The Zyxel Device classifies e-mail that matches a DNS black list as spam.
Actions for Spam Mail	Use this section to set how the Zyxel Device is to handle spam mail.
SMTP	Select how the Zyxel Device is to handle spam SMTP mail. Select drop to discard spam SMTP mail. Select forward to allow spam SMTP mail to go through. Select forward with tag to add a spam tag to an SMTP spam mail's mail subject and send it on to the destination.
POP3	Select how the Zyxel Device is to handle spam POP3 mail. Select forward to allow spam POP3 mail to go through. Select forward with tag to add a spam tag to an POP3 spam mail's mail subject and send it on to the destination.
OK	Click OK to save your changes.
Cancel	Click Cancel to exit this screen without saving your changes.

40.4 The Mail Scan Screen

Click **Configuration > UTM Profile > Anti-Spam > Mail Scan** to open the **Mail Scan** screen. Use this screen to enable and configure the Mail Scan functions. You must first enable the Mail Scan functions on this screen before selecting them in the **Configuration > UTM Profile > Anti-Spam > Profile > Add/Edit** screen.

Figure 528 Configuration > UTM Profile > Anti-Spam > Mail Scan

The screenshot shows the 'Mail Scan' configuration screen. It features a navigation bar with tabs for 'Profile', 'Mail Scan', 'Black/White List', and 'DNSBL'. The 'Mail Scan' tab is active. The screen is divided into two main sections: 'General Settings' and 'Query Timeout Settings'. In the 'General Settings' section, there is a checkbox labeled 'Enable Malicious Mail Checking' which is currently unchecked. Below it is a text input field for 'Malicious Mail Tag' containing the text '[Malicious]'. In the 'Query Timeout Settings' section, there are two dropdown menus for 'SMTP' and 'POP3', both set to 'forward with tag'. Below these is a text input field for 'Timeout Value' containing the number '5', with a note '(1-10 Seconds)'. There is also a text input field for 'Timeout Tag' containing '[Timeout]'. At the bottom of the screen, there are two buttons: 'Apply' and 'Reset'.

The following table describes the labels in this screen.

Table 281 Configuration > UTM Profile > Anti-Spam > Mail Scan

LABEL	DESCRIPTION
General Settings	
Enable Malicious Mail Checking	
Query Timeout Settings	
SMTP	Select how the Zyxel Device is to handle SMTP mail query timeout. Select drop to discard SMTP mail. Select forward to allow SMTP mail to go through. Select forward with tag to add a tag to an SMTP query timeout mail's mail subject and send it on to the destination.
POP3	Select how the Zyxel Device is to handle POP3 mail query timeout. Select forward to allow POP3 mail to go through. Select forward with tag to add a tag to an POP3 query timeout mail's mail subject and send it on to the destination.
Timeout Value	Set how long the Zyxel Device waits for a reply from the mail scan server. If there is no reply before this time period expires, the Zyxel Device takes the action defined in the relevant Actions when Query Timeout field.
Timeout Tag	Enter a message or label (up to 15 ASCII characters) to add to the mail subject of e-mails that the Zyxel Device forwards if queries to the mail scan servers time out.
Timeout X-Header	Specify the name and value for the X-Header to be added when queries to the mail scan servers time out.
Apply	Click Apply to save your changes back to the Zyxel Device.
Reset	Click Reset to return the screen to its last-saved settings.

40.5 The Anti-Spam Black List Screen

Click **Configuration > UTM Profile > Anti-Spam > Black/White List** to display the **Anti-Spam Black List** screen.

Configure the black list to identify spam e-mail. You can create black list entries based on the sender's or relay server's IP address or e-mail address. You can also create entries that check for particular e-mail header fields with specific values or specific subject text. Click a column's heading cell to sort the table entries by that column's criteria. Click the heading cell again to reverse the sort order.

Figure 529 Configuration > UTM Profile > Anti-Spam > Black/White List > Black List

The following table describes the labels in this screen.

Table 282 Configuration > UTM Profile > Anti-Spam > Black/White List > Black List

LABEL	DESCRIPTION
General Settings	
Enable Black List Checking	Select this check box to have the Zyxel Device treat e-mail that matches (an active) black list entry as spam.
Black List Spam Tag	Enter a message or label (up to 15 ASCII characters) to add to the mail subject of e-mails that match the Zyxel Device's spam black list.
Black List X-Header	Specify the name and value for the X-Header to be added to e-mails that match the Zyxel Device's spam black list.
Rule Summary	
Add	Click this to create a new entry.
Edit	Select an entry and click this to be able to modify it.
Remove	Select an entry and click this to delete it.
Activate	To turn on an entry, select it and click Activate .
Inactivate	To turn off an entry, select it and click Inactivate .
Status	The activate (light bulb) icon is lit when the entry is active and dimmed when the entry is inactive.
#	This is the entry's index number in the list.
Type	This field displays whether the entry is based on the e-mail's subject, source or relay IP address, source e-mail address, or header.
Content	This field displays the subject content, source or relay IP address, source e-mail address, or header value for which the entry checks.
Apply	Click Apply to save your changes back to the Zyxel Device.
Reset	Click Reset to return the screen to its last-saved settings.

40.5.1 The Anti-Spam Black or White List Add/Edit Screen

In the anti-spam **Black List** or **White List** screen, click the **Add** icon or an **Edit** icon to display the following screen.

Use this screen to configure an anti-spam black list entry to identify spam e-mail. You can create entries based on specific subject text, or the sender's or relay's IP address or e-mail address. You can also create entries that check for particular header fields and values.

Figure 530 Configuration > UTM Profile > Anti-Spam > Black/White List > Black List (or White List) > Add

The following table describes the labels in this screen.

Table 283 Configuration > UTM Profile > Anti-Spam > Black/White List > Black/White List > Add

LABEL	DESCRIPTION
Enable Rule	Select this to have the Zyxel Device use this entry as part of the black or white list. To actually use the entry, you must also turn on the use of the list in the corresponding list screen, enable the anti-spam feature in the anti-spam general screen, and configure an anti-spam policy to use the list.
Type	Use this field to base the entry on the e-mail's subject, source or relay IP address, source e-mail address, or header. Select Subject to have the Zyxel Device check e-mail for specific content in the subject line. Select IP Address to have the Zyxel Device check e-mail for a specific source or relay IP address. Select IPv6 Address to have the Zyxel Device check e-mail for a specific source or relay IPv6 address. Select E-Mail Address to have the Zyxel Device check e-mail for a specific source e-mail address or domain name. Select Mail Header to have the Zyxel Device check e-mail for specific header fields and values. Configure black list header entries to check for e-mail from bulk mail programs or with content commonly used in spam. Configure white list header entries to allow certain header values that identify the e-mail as being from a trusted source.
Mail Subject Keyword	This field displays when you select the Subject type. Enter up to 63 ASCII characters of text to check for in e-mail headers. Spaces are not allowed, although you could substitute a question mark (?). See Section 40.5.2 on page 794 for more details.
Sender or Mail Relay IP Address	This field displays when you select the IP Address type. Enter an IP address in dotted decimal notation.
Sender or Mail Relay IPv6 Address	This field displays when you select the IPv6 Address type. Enter an IPv6 address with prefix.
Netmask	This field displays when you select the IP type. Enter the subnet mask here, if applicable.
Sender E-Mail Address	This field displays when you select the E-Mail type. Enter a keyword (up to 63 ASCII characters). See Section 40.5.2 on page 794 for more details.

Table 283 Configuration > UTM Profile > Anti-Spam > Black/White List > Black/White List > Add

LABEL	DESCRIPTION
Mail Header Field Name	This field displays when you select the Mail Header type. Type the name part of an e-mail header (the part that comes before the colon). Use up to 63 ASCII characters. For example, if you want the entry to check the "Received:" header for a specific mail server's domain, enter "Received" here.
Field Value Keyword	This field displays when you select the Mail Header type. Type the value part of an e-mail header (the part that comes after the colon). Use up to 63 ASCII characters. For example, if you want the entry to check the "Received:" header for a specific mail server's domain, enter the mail server's domain here. See Section 40.5.2 on page 794 for more details.
OK	Click OK to save your changes.
Cancel	Click Cancel to exit this screen without saving your changes.

40.5.2 Regular Expressions in Black or White List Entries

The following applies for a black or white list entry based on an e-mail subject, e-mail address, or e-mail header value.

- Use a question mark (?) to let a single character vary. For example, use "a?c" (without the quotation marks) to specify abc, acc and so on.
- You can also use a wildcard (*). For example, if you configure *def.com, any e-mail address that ends in def.com matches. So "mail.def.com" matches.
- The wildcard can be anywhere in the text string and you can use more than one wildcard. You cannot use two wildcards side by side, there must be other characters between them.
- The Zyxel Device checks the first header with the name you specified in the entry. So if the e-mail has more than one "Received" header, the Zyxel Device checks the first one.

40.6 The Anti-Spam White List Screen

Click **Configuration > UTM Profile > Anti-Spam > Black/White List** and then the **White List** tab to display the **Anti-Spam White List** screen.

Configure the white list to identify legitimate e-mail. You can create white list entries based on the sender's or relay's IP address or e-mail address. You can also create entries that check for particular header fields and values or specific subject text.

Figure 531 Configuration > UTM Profile > Anti-Spam > Black/White List > White List

The following table describes the labels in this screen.

Table 284 Configuration > UTM Profile > Anti-Spam > Black/White List > White List

LABEL	DESCRIPTION
General Settings	
Enable White List Checking	Select this check box to have the Zyxel Device forward e-mail that matches (an active) white list entry without doing any more anti-spam checking on that individual e-mail.
White List X-Header	Specify the name and value for the X-Header to be added to e-mails that match the Zyxel Device's spam white list.
Rule Summary	
Add	Click this to create a new entry. See Section 40.5.1 on page 793 for details.
Edit	Select an entry and click this to be able to modify it. See Section 40.5.1 on page 793 for details.
Remove	Select an entry and click this to delete it.
Activate	To turn on an entry, select it and click Activate .
Inactivate	To turn off an entry, select it and click Inactivate .
Status	The activate (light bulb) icon is lit when the entry is active and dimmed when the entry is inactive.
#	This is the entry's index number in the list.
Type	This field displays whether the entry is based on the e-mail's subject, source or relay IP address, source e-mail address, or a header.
Content	This field displays the subject content, source or relay IP address, source e-mail address, or header value for which the entry checks.
Apply	Click Apply to save your changes back to the Zyxel Device.
Reset	Click Reset to return the screen to its last-saved settings.

40.7 The DNSBL Screen

Click **Configuration > UTM Profile > Anti-Spam > DNSBL** to display the anti-spam **DNSBL** screen. Use this screen to configure the Zyxel Device to check the sender and relay IP addresses in e-mail headers against DNS (Domain Name Service)-based spam Black Lists (DNSBLs).

Figure 532 Configuration > UTM Profile > Anti-Spam > DNSBL

The screenshot displays the DNSBL configuration interface. At the top, there are tabs for Profile, Mail Scan, Black/White List, and DNSBL. Below the tabs is a 'Hide Advanced Settings' button. The main content is organized into three sections:

- General Settings:**
 - Enable DNS Black List (DNSBL) Checking
 - DNSBL Spam Tag: [Spam] (Optional)
 - X- [] : [] (Optional)
 - Max. IPs Checking Per Mail: 3 (1-5) ⓘ
 - IP Selection Per Mail: last N IPs
- Query Timeout Settings:**
 - SMTP: forward with tag
 - POP3: forward with tag
 - Timeout Value: 5 (1-10 Seconds)
 - Timeout Tag: [Timeout] (Optional)
 - Timeout X-Header: X- [] : [] (Optional)
- DNSBL Domain List:**
 - Buttons: Add, Edit, Remove, Activate, Inactivate
 - Table with columns: Status, #, DNSBL Domain
 - Page 1 of 1, Show 50 items, No data to display

Note: Each mail relay and sender IP in mail header (under max. number) will be checked against the DNSBL domain servers listed and enabled above.

At the bottom, there are 'Apply' and 'Reset' buttons.

The following table describes the labels in this screen.

Table 285 Configuration > UTM Profile > Anti-Spam > DNSBL

LABEL	DESCRIPTION
Show Advanced Settings / Hide Advanced Settings	Click this button to display a greater or lesser number of configuration fields.
Enable DNS Black List (DNSBL) Checking	Select this to have the Zyxel Device check the sender and relay IP addresses in e-mail headers against the DNSBL servers maintained by the DNSBL domains listed in the Zyxel Device.
DNSBL Spam Tag	Enter a message or label (up to 15 ASCII characters) to add to the beginning of the mail subject of e-mails that have a sender or relay IP address in the header that matches a black list maintained by one of the DNSBL domains listed in the Zyxel Device. This tag is only added if the anti-spam policy is configured to forward spam mail with a spam tag.
Max. IPs Checking Per Mail	Set the maximum number of sender and relay server IP addresses in the mail header to check against the DNSBL domain servers.
IP Selection Per Mail	Select first N IPs to have the Zyxel Device start checking from the first IP address in the mail header. This is the IP of the sender or the first server that forwarded the mail. Select last N IPs to have the Zyxel Device start checking from the last IP address in the mail header. This is the IP of the last server that forwarded the mail.
Query Timeout Setting	
SMTP	Select how the Zyxel Device is to handle SMTP mail (mail going to an e-mail server) if the queries to the DNSBL domains time out. Select drop to discard SMTP mail. Select forward to allow SMTP mail to go through. Select forward with tag to add a DNSBL timeout tag to the mail subject of an SMTP mail and send it.
POP3	Select how the Zyxel Device is to handle POP3 mail (mail coming to an e-mail client) if the queries to the DNSBL domains time out. Select forward to allow POP3 mail to go through. Select forward with tag to add a DNSBL timeout tag to the mail subject of an POP3 mail and send it.
Timeout Value	Set how long the Zyxel Device waits for a reply from the DNSBL domains listed below. If there is no reply before this time period expires, the Zyxel Device takes the action defined in the relevant Actions when Query Timeout field.
Timeout Tag	Enter a message or label (up to 15 ASCII characters) to add to the mail subject of e-mails that the Zyxel Device forwards if queries to the DNSBL domains time out.
Timeout X-Header	Specify the name and value for the X-Header to be added to e-mails that the Zyxel Device forwards if queries to the DNSBL domains time out.
DNSBL Domain List	
Add	Click this to create a new entry.
Edit	Select an entry and click this to be able to modify it.
Remove	Select an entry and click this to delete it.
Activate	To turn on an entry, select it and click Activate .
Inactivate	To turn off an entry, select it and click Inactivate .
Status	The activate (light bulb) icon is lit when the entry is active and dimmed when the entry is inactive.
#	This is the entry's index number in the list.

Table 285 Configuration > UTM Profile > Anti-Spam > DNSBL (continued)

LABEL	DESCRIPTION
DNSBL Domain	This is the name of a domain that maintains DNSBL servers. Enter the domain that is maintaining a DNSBL.
Apply	Click Apply to save your changes back to the Zyxel Device.
Reset	Click Reset to return the screen to its last-saved settings.

40.8 Anti-Spam Technical Reference

Here is more detailed anti-spam information.

DNSBL

- The Zyxel Device checks only public sender and relay IP addresses, it does not check private IP addresses.
- The Zyxel Device sends a separate query (DNS lookup) for each sender or relay IP address in the e-mail's header to each of the Zyxel Device's DNSBL domains at the same time.
- The DNSBL servers send replies as to whether or not each IP address matches an entry in their list. Each IP address has a separate reply.
- As long as the replies are indicating the IP addresses do not match entries on the DNSBL lists, the Zyxel Device waits until it receives at least one reply for each IP address.
- If the Zyxel Device receives a DNSBL reply that one of the IP addresses is in the DNSBL list, the Zyxel Device immediately classifies the e-mail as spam and takes the anti-spam policy's configured action for spam. The Zyxel Device does not wait for any more DNSBL replies.
- If the Zyxel Device receives at least one non-spam reply for each of an e-mail's routing IP addresses, the Zyxel Device immediately classifies the e-mail as legitimate and forwards it.
- Any further DNSBL replies that come after the Zyxel Device classifies an e-mail as spam or legitimate have no effect.
- The Zyxel Device records DNSBL responses for IP addresses in a cache for up to 72 hours. The Zyxel Device checks an e-mail's sender and relay IP addresses against the cache first and only sends DNSBL queries for IP addresses that are not in the cache.

Here is an example of an e-mail classified as spam based on DNSBL replies.

Figure 533 DNSBL Spam Detection Example

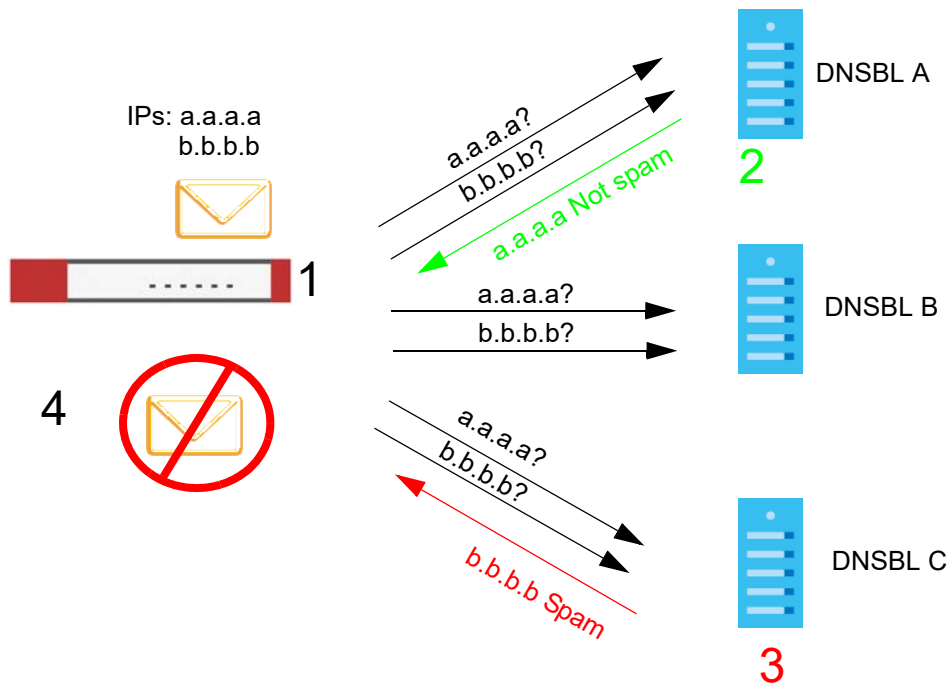

- 1 The ZyXel Device receives an e-mail that was sent from IP address a.a.a.a and relayed by an e-mail server at IP address b.b.b.b. The ZyXel Device sends a separate query to each of its DNSBL domains for IP address a.a.a.a. The ZyXel Device sends another separate query to each of its DNSBL domains for IP address b.b.b.b.
- 2 DNSBL A replies that IP address a.a.a.a does not match any entries in its list (not spam).
- 3 DNSBL C replies that IP address b.b.b.b matches an entry in its list.
- 4 The ZyXel Device immediately classifies the e-mail as spam and takes the action for spam that you defined in the anti-spam policy. In this example it was an SMTP mail and the defined action was to drop the mail. The ZyXel Device does not wait for any more DNSBL replies.

Here is an example of an e-mail classified as legitimate based on DNSBL replies.

Figure 534 DNSBL Legitimate E-mail Detection Example

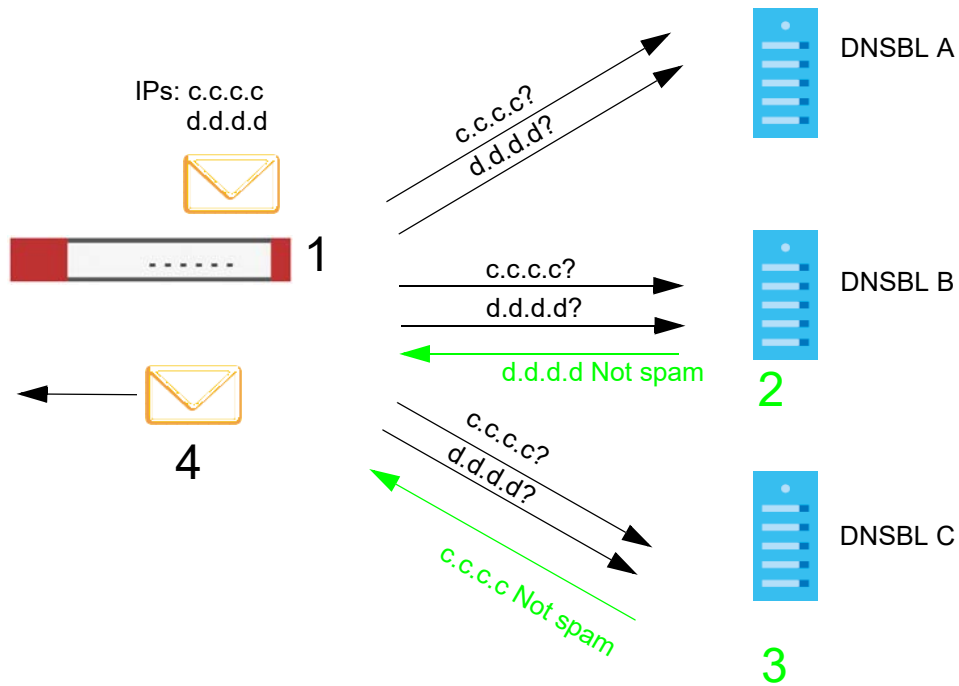

- 1 The Zyxel Device receives an e-mail that was sent from IP address c.c.c.c and relayed by an e-mail server at IP address d.d.d.d. The Zyxel Device sends a separate query to each of its DNSBL domains for IP address c.c.c.c. The Zyxel Device sends another separate query to each of its DNSBL domains for IP address d.d.d.d.
- 2 DNSBL B replies that IP address d.d.d.d does not match any entries in its list (not spam).
- 3 DNSBL C replies that IP address c.c.c.c does not match any entries in its list (not spam).
- 4 Now that the Zyxel Device has received at least one non-spam reply for each of the e-mail's routing IP addresses, the Zyxel Device immediately classifies the e-mail as legitimate and forwards it. The Zyxel Device does not wait for any more DNSBL replies.

If the Zyxel Device receives conflicting DNSBL replies for an e-mail routing IP address, the Zyxel Device classifies the e-mail as spam. Here is an example.

Figure 535 Conflicting DNSBL Replies Example

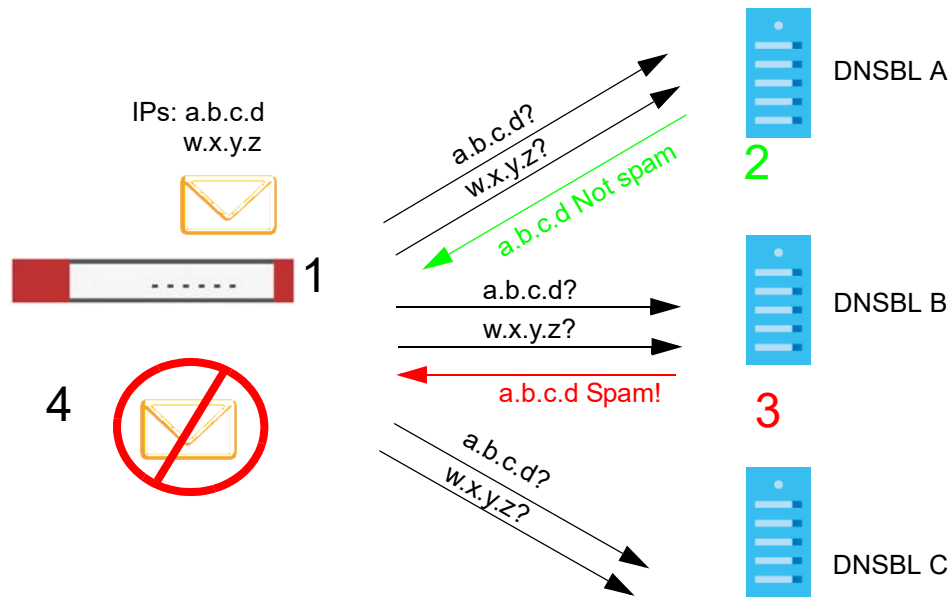

- 1 The Zyxel Device receives an e-mail that was sent from IP address a.b.c.d and relayed by an e-mail server at IP address w.x.y.z. The Zyxel Device sends a separate query to each of its DNSBL domains for IP address a.b.c.d. The Zyxel Device sends another separate query to each of its DNSBL domains for IP address w.x.y.z.
- 2 DNSBL A replies that IP address a.b.c.d does not match any entries in its list (not spam).
- 3 While waiting for a DNSBL reply about IP address w.x.y.z, the Zyxel Device receives a reply from DNSBL B saying IP address a.b.c.d is in its list.
- 4 The Zyxel Device immediately classifies the e-mail as spam and takes the action for spam that you defined in the anti-spam policy. In this example it was an SMTP mail and the defined action was to drop the mail. The Zyxel Device does not wait for any more DNSBL replies.

CHAPTER 41

SSL Inspection

41.1 Overview

Secure Socket Layer (SSL) traffic, such as <https://www.google.com>/HTTPS, FTPs, POP3s, SMTPs, etc. is encrypted, and cannot be inspected using Unified Threat Management (UTM) profiles such as App Patrol, Content Filter, Intrusion, Detection and Prevention (IDP), or Anti-Virus. The Zyxel Device uses SSL Inspection to decrypt SSL traffic, sends it to the UTM engines for inspection, then encrypts traffic that passes inspection and forwards it to the destination server, such as Google.

An example process is shown in the following figure. User **U** sends a HTTPS request (SSL) to destination server **D**, via the Zyxel Device, **Z**. The traffic matches an SSL Inspection profile in a security policy, so the Zyxel Device decrypts the traffic using SSL Inspection. The decrypted traffic is then inspected by the UTM profiles in the same security profile that matched the SSL Inspection profile. If all is OK, then the Zyxel Device re-encrypts the traffic using SSL Inspection and forwards it to the destination server **D**. SSL traffic could be in the opposite direction for other examples.

Figure 536 SSL Inspection Overview

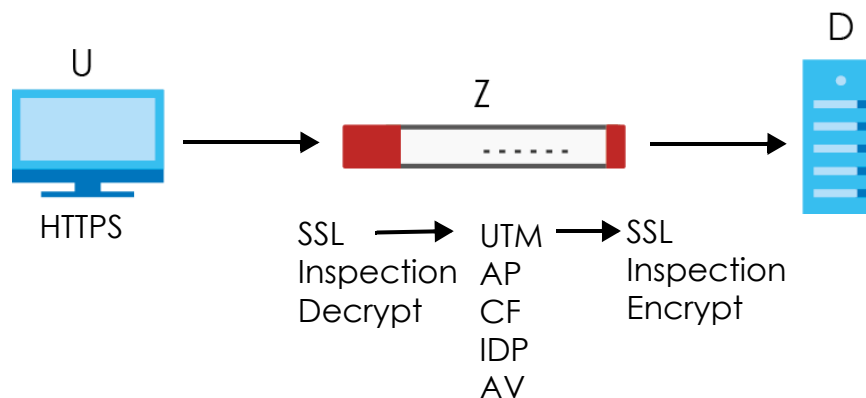

Note: Anti-Spam cannot be applied to traffic decrypted by SSL Inspection.

41.1.1 What You Can Do in this Chapter

- Use the **UTM Profile > SSL Inspection > Profile** screen ([Section 41.2 on page 803](#)) to view SSL Inspection profiles. Click the **Add** or **Edit** icon in this screen to configure the CA certificate, action and log in an SSL Inspection profile.
- Use the **UTM Profile > SSL Inspection > Exclude List** screens ([Section 41.3 on page 807](#)) to create a whitelist of destination servers to which traffic is passed through uninspected.

41.1.2 What You Need To Know

- The Zyxel Device supports the following SSL/TLS versions and cipher suites:
 - SSLv3 AES-CBC

- TLS1.0 AES-CBC
- TLS1.2 AES-CBC/AES-GCM
- TLS1.3 AES-GCM
- SSL Inspection Does not support the following:
 - Compression
 - Client Authentication
 - TLS1.3 Key updates
 - TLS1.3 Zero Round Trip Time Resumption (0-RTT)
- Traffic using TLS1.1 (Transport Layer Security) or TLS1.2 is downgraded to TLS1.0 for SSL Inspection
- No Compression Support Now
- No Client Authentication Request Support Now
- Finding Out More
 - See **Configuration > Object > Certificate > My Certificates** for information on creating certificates on the Zyxel Device.
 - See **Monitor > UTM Statistics > SSL Inspection** to get usage data and easily add a destination server to the whitelist of exclusion servers.
 - See **Configuration > Security Policy > Policy Control > Policy** to bind an SSL Inspection profile to a traffic flow(s).

41.1.3 Before You Begin

- If you don't want to use the default Zyxel Device certificate, then create a new certificate in **Object > Certificate > My Certificates**.
- Decide what destination servers to which traffic is sent directly without inspection. This may be a matter of privacy and legality regarding inspecting an individual's encrypted session, such as financial websites. This may vary by locale.

41.2 The SSL Inspection Profile Screen

An SSL Inspection profile is a template with pre-configured certificate, action and log.

Click **Configuration > UTM Profile > SSL Inspection > Profile** to open this screen.

Figure 537 Configuration > UTM Profile > SSL Inspection > Profile

#	Name	Description	CA Certificate	Reference
1	MyProfile	This is an example profile	Example	0

The following table describes the fields in this screen.

Table 286 Configuration > UTM Profile > SSL Inspection > Profile

LABEL	DESCRIPTION
Profile Management	
Add	Click Add to create a new profile.
Edit	Select an entry and click this to be able to modify it.
Remove	Select an entry and click this to delete it.
References	Select an entry and click References to open a screen that shows which settings use the entry. Click Refresh to update information on this screen.
#	This is the entry's index number in the list.
Name	This displays the name of the profile.
Description	This displays the description of the profile.
CA Certificate	This displays the CA certificate being used in this profile.
Reference	This displays the number of times an object reference is used in a profile.

41.2.1 Add / Edit SSL Inspection Profiles

Click **Configuration > UTM Profile > SSL Inspection > Profile > Add** to create a new profile or select an existing profile and click **Edit** to change its settings.

Figure 538 Configuration > UTM Profile > SSL Inspection > Profile > Add / Edit

The screenshot shows a dialog box titled "Edit Rule: MyProfile" with a "General Settings" section. The settings are as follows:

Name:	MyProfile		
Description:	This is an example profil		
CA Certificate:	Example		
Action for connection with SSL v2:	block	Log:	log alert
Action for connection with unsupported suit:	pass	Log:	no
Action for connection with untrusted cert chain:	pass	Log:	log

At the bottom right of the dialog box are "OK" and "Cancel" buttons.

The following table describes the fields in this screen.

Table 287 Configuration > UTM Profile > SSL Inspection > Profile > Add / Edit

LABEL	DESCRIPTION
Name	<p>This is the name of the profile. You may use 1-31 alphanumeric characters, underscores(_), or dashes (-), but the first character cannot be a number. This value is case-sensitive. These are valid, unique profile names:</p> <ul style="list-style-type: none"> • MyProfile • mYProfile • Mymy12_3-4 <p>These are invalid profile names:</p> <ul style="list-style-type: none"> • 1mYProfile • My Profile • MyProfile? • Whatalongprofilename123456789012
Description	Enter additional information about this SSL Inspection entry. You can enter up to 60 characters ("0-9", "a-z", "A-Z", "-" and "_").
CA Certificate	This contains the default certificate and the certificates created in Object > Certificate > My Certificates . Choose the certificate for this profile.
Severity Level	Select a severity level and these use the icons to enable/disable and configure logs and actions for all signatures of that level.
Action for connection with SSL v2	SSL Inspection supports SSLv3 and TLS1.0. Select to pass or block SSLv2 traffic that matches traffic bound to this policy here.
Log	<p>These are the log options for SSLv2 traffic that matches traffic bound to this policy:</p> <ul style="list-style-type: none"> • no: Select this option to have the Zyxel Device create no log for SSLv2 traffic that matches traffic bound to this policy. • log: Select this option to have the Zyxel Device create a log for SSLv2 traffic that matches traffic bound to this policy. • log alert: An alert is an e-mailed log for more serious events that may need more immediate attention. They also appear in red in the Monitor > Log screen. Select this option to have the Zyxel Device send an alert for SSLv2 traffic that matches traffic bound to this policy.
Action for Connection with unsupported suit	<p>SSL Inspection supports these cipher suites:</p> <ul style="list-style-type: none"> • DES • 3DES • AES <p>Select to pass or block unsupported traffic (such as other cipher suites, compressed traffic, client authentication requests, and so on) that matches traffic bound to this policy here.</p>
Log	<p>These are the log options for unsupported traffic that matches traffic bound to this policy:</p> <ul style="list-style-type: none"> • no: Select this option to have the Zyxel Device create no log for unsupported traffic that matches traffic bound to this policy. • log: Select this option to have the Zyxel Device create a log for unsupported traffic that matches traffic bound to this policy • log alert: An alert is an e-mailed log for more serious events that may need more immediate attention. They also appear in red in the Monitor > Log screen. Select this option to have the Zyxel Device send an alert for unsupported traffic that matches traffic bound to this policy.
Excepted Signatures	Use the icons to enable/disable and configure logs and actions for individual signatures that are different to the general settings configured for the severity level to which the signatures belong. Signatures configured in Query View will appear in Group View .
Add	Click this to configure settings to a signature that are different to the severity level to which it belongs.

Table 287 Configuration > UTM Profile > SSL Inspection > Profile > Add / Edit (continued)

LABEL	DESCRIPTION
Remove	Select an existing signature exception and then click this to delete the exception.
Activate	To turn on an entry, select it and click Activate .
Inactivate	To turn off an entry, select it and click Inactivate .
Log	To edit an item's log option, select it and use the Log icon. These are the log options: no : Select this option on an individual signature or a complete service group to have the Zyxel Device create no log when a packet matches a signature(s). log : Select this option on an individual signature or a complete service group to have the Zyxel Device create a log when a packet matches a signature(s). log alert : An alert is an e-mailed log for more serious events that may need more immediate attention. Select this option to have the Zyxel Device send an alert when a packet matches a signature(s).
Action	To edit what action the Zyxel Device takes when a packet matches a signature, select the signature and use the Action icon. none : Select this action on an individual signature or a complete service group to have the Zyxel Device take no action when a packet matches the signature(s). drop : Select this action on an individual signature or a complete service group to have the Zyxel Device silently drop a packet that matches the signature(s). Neither sender nor receiver are notified. reject-sender : Select this action on an individual signature or a complete service group to have the Zyxel Device send a reset to the sender when a packet matches the signature. If it is a TCP attack packet, the Zyxel Device will send a packet with a 'RST' flag. If it is an ICMP or UDP attack packet, the Zyxel Device will send an ICMP unreachable packet. reject-receiver : Select this action on an individual signature or a complete service group to have the Zyxel Device send a reset to the receiver when a packet matches the signature. If it is a TCP attack packet, the Zyxel Device will send a packet with an 'RST' flag. If it is an ICMP or UDP attack packet, the Zyxel Device will do nothing. reject-both : Select this action on an individual signature or a complete service group to have the Zyxel Device send a reset to both the sender and receiver when a packet matches the signature. If it is a TCP attack packet, the Zyxel Device will send a packet with a 'RST' flag to the receiver and sender. If it is an ICMP or UDP attack packet, the Zyxel Device will send an ICMP unreachable packet.
#	This is the entry's index number in the list.
Status	The activate (light bulb) icon is lit when the entry is active and dimmed when the entry is inactive.
SID	Type the exact signature ID (identification) number that uniquely identifies a Zyxel Device IDP signature.
Log	These are the log options. To edit this, select an item and use the Log icon.
Action	This is the action the Zyxel Device should take when a packet matches a signature here. To edit this, select an item and use the Action icon.
OK	Click OK to save your settings to the Zyxel Device, and return to the profile summary page.
Cancel	Click Cancel to return to the profile summary page without saving any changes.

41.3 Exclude List Screen

There may be privacy and legality issues regarding inspecting a user's encrypted session. The legal issues may vary by locale, so it's important to check with your legal department to make sure that it's OK to intercept SSL traffic from your Zyxel Device users.

To ensure individual privacy and meet legal requirements, you can configure an exclusion list to exclude matching sessions to destination servers. This traffic is not intercepted and is passed through uninspected.

Click **Configuration > UTM Profile > SSL Inspection > Exclude List** to display the following screen. Use **Add** to put a new item in the list or **Edit** to change an existing one or **Remove** to delete an existing entry.

Figure 539 Configuration > UTM Profile > SSL Inspection > Exclude List (> Add/Edit)

The following table describes the fields in this screen.

Table 288 Configuration > UTM Profile > SSL Inspection > Exclude List

LABEL	DESCRIPTION
General Settings	
Enable Logs for Exclude List	Click this to create a log for traffic that bypasses SSL Inspection.
Exclude List Settings	Use this part of the screen to create, edit, or delete items in the SSL Inspection exclusion list.
Add	Click this to create a new entry.
Edit	Select an entry and click this to be able to modify it.
Remove	Select an entry and click this to delete it.
#	This is the entry's index number in the list.

Table 288 Configuration > UTM Profile > SSL Inspection > Exclude List (continued)

LABEL	DESCRIPTION
Exclude List of Certificate Identity	<p>SSL traffic to a server to be excluded from SSL Inspection is identified by its certificate. Identify the certificate in one of the following ways:</p> <ul style="list-style-type: none"> The Common Name (CN) of the certificate. The common name of the certificate can be created in the Object > Certificate > My Certificates screen. Type an IPv4 or IPv6 address. For example, type 192.168.1.35, or 2001:7300:3500::1 Type an IPv4/IPv6 in CIDR notation. For example, type 192.168.1.1/24, or 2001:7300:3500::1/64 Type an IPv4/IPv6 address range. For example, type 192.168.1.1-192.168.1.35, or 2001:7300:3500::1-2001:7300:3500::35 Type an email address. For example, type abc@zyxel.com.tw Type a DNS name or a common name (wildcard char: '*', escape char: '\'). Use up to 127 case-insensitive characters (0-9a-zA-Z~!@#\$\$%^&*()-_+=+[]{} ;:~<>/?). '*' can be used as a wildcard to match any string. Use '*' to indicate a single wildcard character. <p>Alternatively, to automatically add an entry for existing SSL traffic to a destination server, go to Monitor > UTM Statistics > SSL Inspection > Certificate Cache List, select an item and then click Add to Exclude List. The item will then appear here.</p>
Apply	Click Apply to save your settings to the Zyxel Device.
Reset	Click Reset to return to the profile summary page without saving any changes.

41.4 Certificate Update Screen

Use this screen to update the latest certificates of servers using SSL connections to the Zyxel Device network. User **U** sends an SSL request to destination server **D** (1), via the Zyxel Device, **Z**. **D** replies (2); **Z** intercepts the response from **D** and checks if the certificate has been previously signed. **Z** then replies to **D** (3) and also to **U** (4). **D**'s latest certificate is stored at myZyxel (**M**) along with other server certificates and can be downloaded to the Zyxel Device.

Figure 540 SSL Inspection Certificate Update Overview

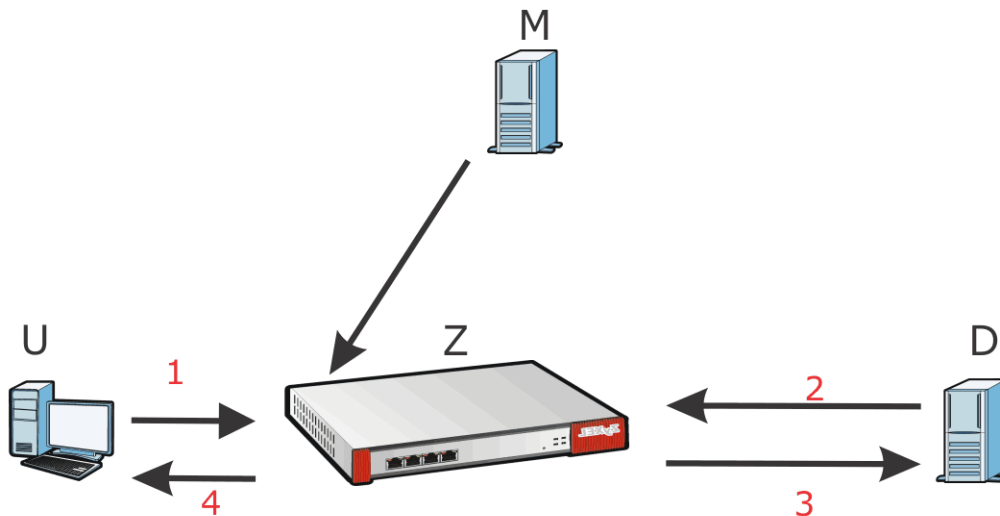

Click **Configuration > UTM Profile > SSL Inspection > Certificate Update** to display the following screen.

Figure 541 Configuration > UTM Profile > SSL Inspection > Certificate Update

The following table describes the fields in this screen.

Table 289 Configuration > UTM Profile > SSL Inspection > Certificate Update

LABEL	DESCRIPTION
Certificate Information	
Current Version	This displays the current certificate set version.
Certificate Update	You should have Internet access and have activated SSL Inspection on the Zyxel Device at myZyxel.
Update Now	Click this button to download the latest certificate set (Windows, MAC OS X, and Android) from the myZyxel and update it on the Zyxel Device.
Auto Update	Select this to automatically have the Zyxel Device update the certificate set when a new one becomes available on myZyxel.
Apply	Click Apply to save your settings to the Zyxel Device.
Reset	Click Reset to return to the profile summary page without saving any changes.

41.5 Install a CA Certificate in a Browser

Certificates used in SSL Inspection profiles should be installed in user web browsers. Do the following steps to install a certificate in a computer with a Windows operating system (PC). First, save the certificate to your computer.

- 1 Run the certificate manager using certmgr.msc.

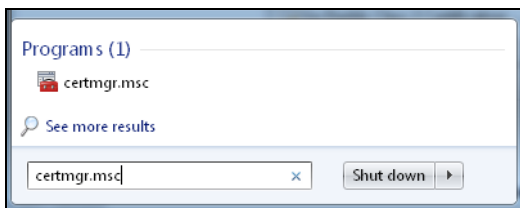

- 2 Go to Trusted Root Certification Authorities > Certificates.

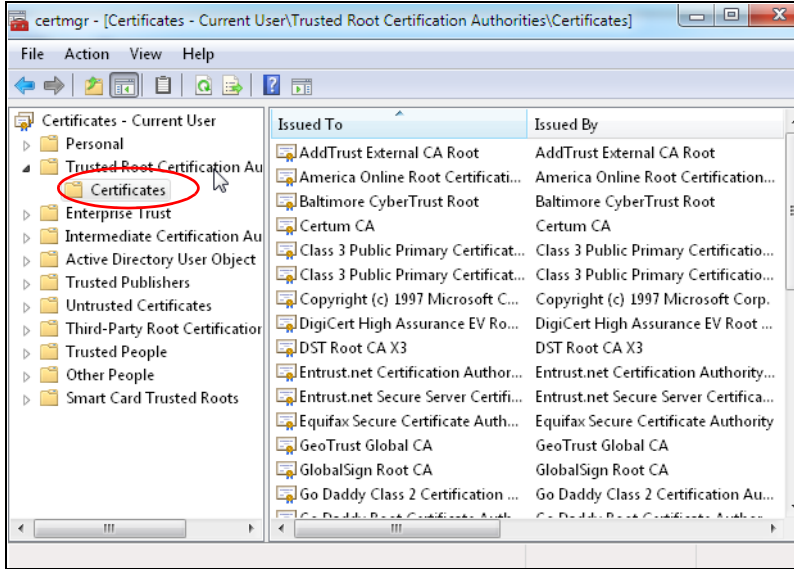

- 3 From the main menu, select **Action > All Tasks > Import** and run the **Certificate Import Wizard** to install the certificate on the PC.

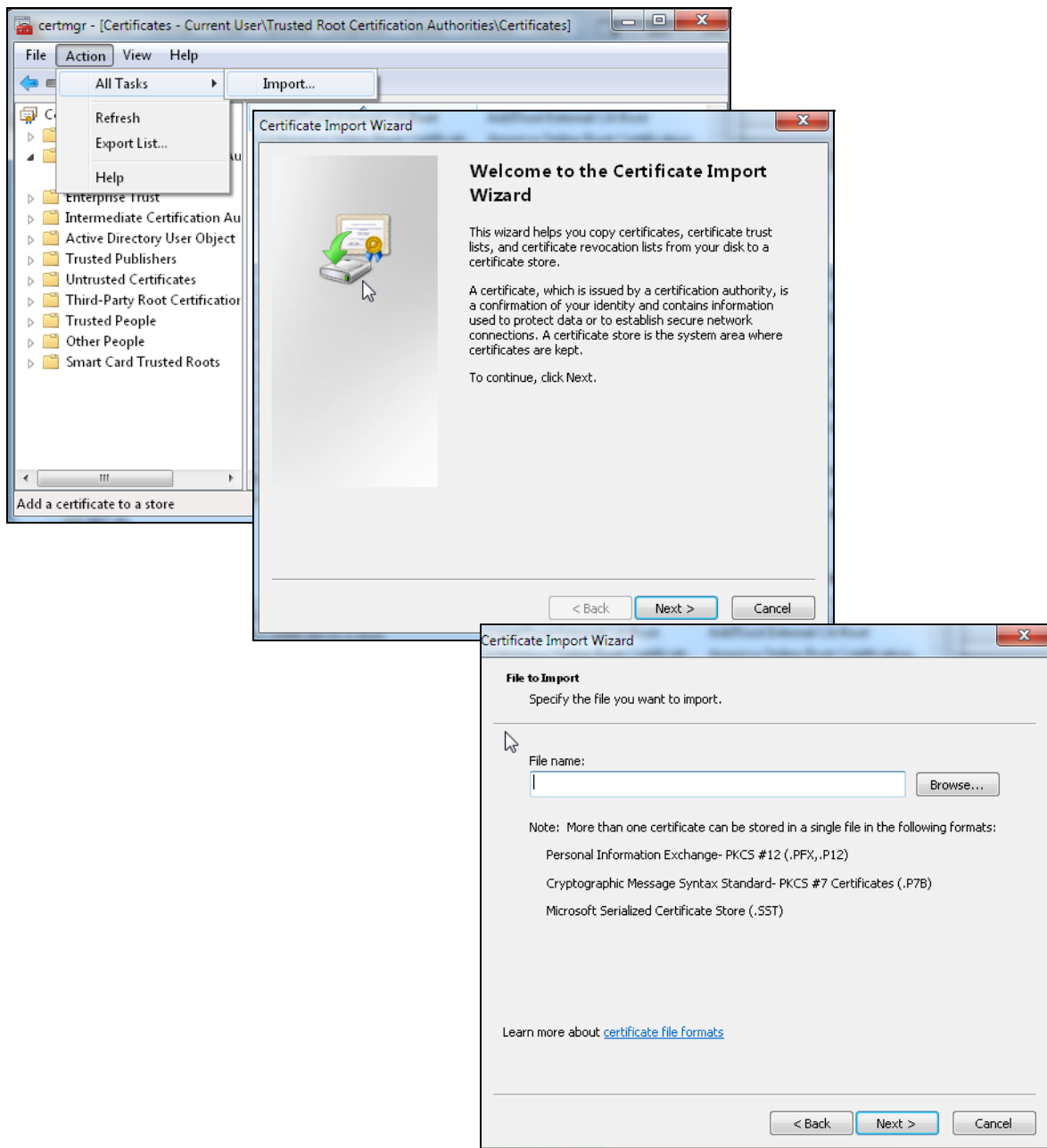

41.5.0.1 Firefox Browser

If you're using a Firefox browser, in addition to the above you need to do the following to import a certificate into the browser.

Click **Tools > Options > Advanced > Encryption > View Certificates**, click **Import** and enter the filename of the certificate you want to import. See the browser's help for further information.

CHAPTER 42

Device HA

42.1 Device HA Overview

Device HA lets a backup (or passive) Zyxel Device (B) automatically take over if the master (or active) Zyxel Device (A) fails.

Figure 542 Device HA Backup Taking Over for the Master

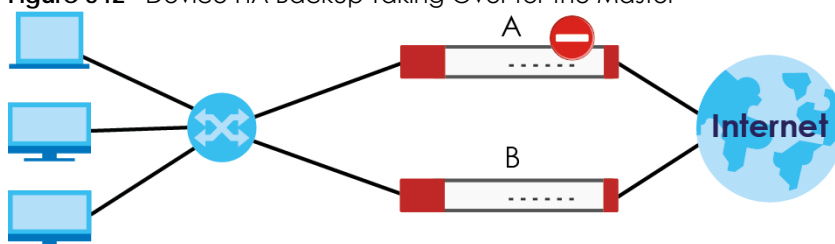

42.1.1 Device HA and Device HA Pro Differences

The following table displays the feature differences between Device HA and Device HA Pro.

Note: See [Section 1.1 on page 28](#) to see which models support Device HA and Device HA Pro.

Table 290 Device HA Vs Device HA Pro

FEATURE	DEVICE HA	DEVICE HA PRO
License	None required.	Need a license.
Role	Role of Master and Backup is configurable. Master takes over from Backup if the Master goes down and then becomes the Master again if it comes back online again (failback).	Role of active and passive is not configurable. The active model is the one whose heartbeat interface comes online first. The passive becomes active if active goes down and stays active even if the previous active comes online again.
Firmware Upgrade	Master remains Master by default when new firmware is uploaded.	If Device HA Pro is enabled, then both the active and passive Zyxel Device must be online and connected in order to upload firmware. New firmware is first uploaded to the passive device and then uploaded to the active device. By default, the passive device reboots after firmware upload making it become the active device. Don't select the Reboot prompt after uploading firmware to the passive device if you want the passive device to remain passive when new firmware is uploaded. Alternatively, disable Device HA Pro if you want to just upload firmware to the active Zyxel Device.
What is synchronized	Configuration file	Configuration file, device time, IPv4/v6 TCP sessions, IPSec VPN tunnels, user login/logout information, AV/IDP signatures, DHCP table, IP/MAC binding table.

Table 290 Device HA Vs Device HA Pro

FEATURE	DEVICE HA	DEVICE HA PRO
Maximum Failover Count	0	5 (default) to 50. Can be reset by command.
Best case Failover delay	10~30 seconds to rebuild connections.	0~1 seconds.
Monitored Interfaces	Ethernet	Ethernet, VLAN, Bridge, LAG
Dedicated monitor port	No	Heartbeat interface. Note: Remove Ethernet, VLAN, Bridge, LAG configurations from this port first.

42.1.2 What You Can Do in These Screens

- **General** screen ([Section 42.2 on page 813](#)) to configure Device HA global settings, and see the status of each interface monitored by Device HA.
- Use the **Device HA Pro** screen ([Section 42.4 on page 825](#)) to configure Device HA Pro global settings, monitored interfaces and synchronization settings.
- Use the **Device HA** screens ([Section 42.3 on page 816](#)) to use Device HA. You can configure general Device HA settings, view and manage the list of monitored interfaces, and synchronize backup Zyxel Devices.

42.2 Device HA General

Device HA

- Device HA lets a backup Zyxel Device take over if the master Zyxel Device fails.
- The Zyxel Devices must be set to use the same Device HA mode (Device HA).

Management Access

You can configure a separate management IP address for each interface. You can use it to access the Zyxel Device for management whether the Zyxel Device is the master or a backup. The management IP address should be in the same subnet as the interface IP address.

Synchronization

Use synchronization to have a backup Zyxel Device copy the master Zyxel Device's configuration, signatures (anti-virus, IDP/application patrol, and system protect), and certificates.

Note: Only Zyxel Devices of the same model and firmware version can synchronize.

Otherwise you must manually configure the master Zyxel Device's settings on the backup (by editing copies of the configuration files in a text editor for example).

Finding Out More

- See [Section 42.3.3 on page 822](#) for Device HA background/technical information.

42.2.1 Before You Begin

- Configure a static IP address for each interface that you will have Device HA monitor.

Note: Subscribe to services on the backup Zyxel Device before synchronizing it with the master Zyxel Device.

Synchronization includes updates for services to which the master and backup Zyxel Devices are both subscribed. For example, a backup subscribed to IDP/AppPatrol, but not anti-virus, gets IDP/AppPatrol updates from the master, but not anti-virus updates. It is highly recommended to subscribe the master and backup Zyxel Devices to the same services.

The **Configuration > Device HA > General** screen lets you enable or disable Device HA, and displays which Device HA mode the Zyxel Device is set to use along with a summary of the monitored interfaces.

Click on the icons to go to the OneSecurity website where there is guidance on configuration walkthroughs, troubleshooting, and other information.

Figure 543 Configuration > Device HA > General (Switch to Device HA Pro)

The screenshot shows the 'General' tab of the Device HA configuration page. The 'Enable Device HA' checkbox is checked. The 'Device HA Mode' is set to 'Device HA'. Below this is a 'Monitored Interface Summary' table with columns for #, Interface, Virtual Router IP/Netmask, Management IP / Netmask, Link Status, and HA Status. The table is currently empty with the message 'No data to display'. At the bottom, the 'Device HA Pro Service' section shows 'Service Status: Activated' with 'Apply' and 'Reset' buttons.

Figure 544 Configuration > Device HA > General (Switch to Device HA Pro)

The screenshot shows the 'General' tab of the Device HA configuration page. The 'Enable Device HA' checkbox is checked. The 'Device HA Mode' is set to 'Device HA Pro'. Below this is an 'Active Device Status' table with columns for Health Status, S/N, MAC, and Sync Status. The table shows one entry: Health Status: Off, S/N: Z34131340, MAC: (blank), Sync Status: n/a. Below that is a 'Passive Device Status' table which is empty with the message 'No data to display'. At the bottom, there are two empty boxes labeled 'Active Device' and 'Passive Device' for logs, and 'Apply' and 'Reset' buttons.

The following table describes the labels in this screen.

Table 291 Configuration > Device HA > General

LABEL	DESCRIPTION
Enable Device HA	Select this to turn the Zyxel Device's Device HA feature on. System > FTP is enabled automatically when you enable Device HA Pro. Note: With Device HA, it is not recommended to use STP (Spanning Tree Protocol) on a switch connected to the Zyxel Device.
Device HA Mode	This displays whether the Zyxel Device is currently set to use Device HA or Device HA Pro. You need a license to use Device HA Pro. Click the link to go to the screen where you can configure the Zyxel Device to use Device HA pro if it is not currently using it and you have a license.
Monitored Interface Summary	This table shows the status of the interfaces that you selected for monitoring in the other Device HA screens.
#	This is the entry's index number in the list.
Interface	These are the names of the interfaces that are monitored by Device HA.
Virtual Router IP / Netmask	This is the interface's IP address and subnet mask. Whichever Zyxel Device is the master uses this virtual router IP address and subnet mask.
Management IP / Netmask	This field displays the interface's management IP address and subnet mask. You can use this IP address and subnet mask to access the Zyxel Device whether it is in master or backup mode.
Link Status	This tells whether the monitored interface's connection is down or up.
HA Status	The text before the slash shows whether the device is configured as the master or the backup role. This text after the slash displays the monitored interface's status in the virtual router. Active - This interface is up and using the virtual IP address and subnet mask. Stand-By - This interface is a backup interface in the virtual router. It is not using the virtual IP address and subnet mask. Fault - This interface is not functioning in the virtual router right now. In Device HA if one of the master Zyxel Device's interfaces loses its connection, the master Zyxel Device forces all of its interfaces to the fault state so the backup Zyxel Device can take over all of the master Zyxel Device's functions.
Device HA Pro Service	
Service Status	This shows if Device HA Pro is licensed on the Zyxel Device. If not, click Buy to purchase a license and then click Register Now to activate it at myZyxel. These are the steps to activate a Device HA Pro license on your active and passive Zyxel Devices. 1. Buy a Device HA Pro iCard. The card contains two keys. 2. Register your active and passive Zyxel Devices at myZyxel. 3. Activate the license by entering one key on the active Zyxel Device and the other key on the passive Zyxel Device. It doesn't matter which Zyxel Device is actually active or passive as this is dynamic in Device HA Pro.
View Log	You see this section if Device HA Pro is already licensed on the Zyxel Device.
Active Device	This displays Device HA Pro logs on the active Zyxel Device.
Passive Device	This displays Device HA Pro logs on the passive Zyxel Device.

Table 291 Configuration > Device HA > General (continued)

LABEL	DESCRIPTION
Register Now	Click the link to go to myZyxel where you can register your Zyxel Device and activate the service. This link is available only when the service is not activated yet.
Apply	Click Apply to save your changes back to the Zyxel Device.
Reset	Click Reset to return the screen to its last-saved settings.

42.3 The Device HA Screen

Virtual Router

The master and backup Zyxel Device form a single 'virtual router'. In the following example, master Zyxel Device **A** and backup Zyxel Device **B** form a virtual router.

Figure 545 Virtual Router

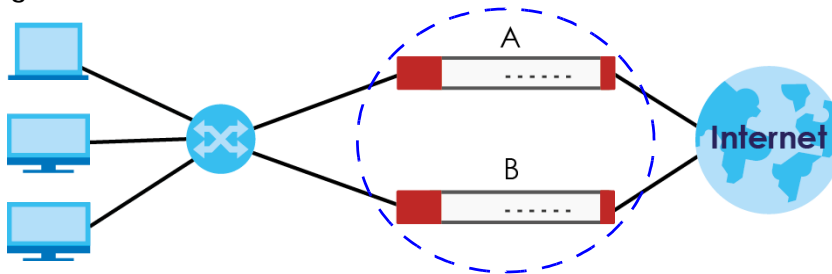

Cluster ID

You can have multiple Zyxel Device virtual routers on your network. Use a different cluster ID to identify each virtual router. In the following example, Zyxel Devices **A** and **B** form a virtual router that uses cluster ID 1. Zyxel Devices **C** and **D** form a virtual router that uses cluster ID 2.

Figure 546 Cluster IDs for Multiple Virtual Routers

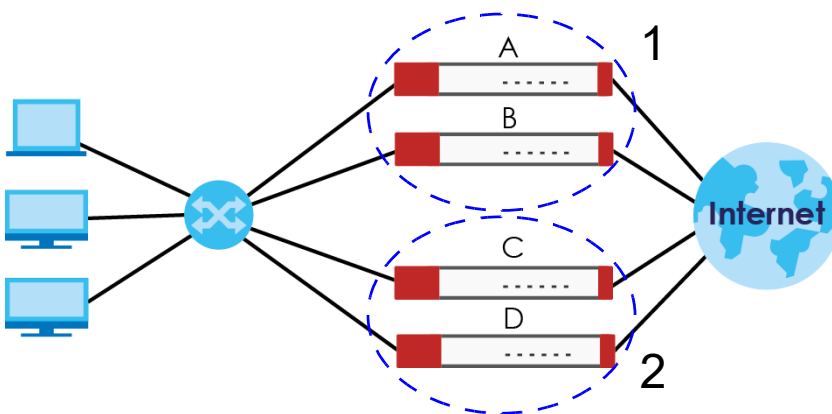

Monitored Interfaces in Device HA

You can select which interfaces Device HA monitors. If a monitored interface on the Zyxel Device loses its connection, Device HA has the backup Zyxel Device take over.

Enable monitoring for the same interfaces on the master and backup Zyxel Devices. Each monitored interface must have a static IP address and be connected to the same subnet as the corresponding interface on the backup or master Zyxel Device.

Virtual Router and Management IP Addresses

- If a backup takes over for the master, it uses the master's IP addresses. These IP addresses are known as the virtual router IP addresses.
- Each interface can also have a management IP address. You can connect to this IP address to manage the Zyxel Device regardless of whether it is the master or the backup.

For example, Zyxel Device **B** takes over **A**'s 192.168.1.1 LAN interface IP address. This is a virtual router IP address. Zyxel Device **A** keeps its LAN management IP address of 192.168.1.5 and Zyxel Device **B** has its own LAN management IP address of 192.168.1.6. These do not change when Zyxel Device **B** becomes the master.

Figure 547 Management IP Addresses

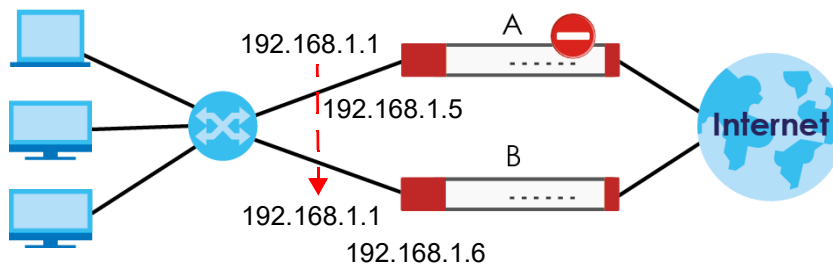

42.3.1 Configuring Device HA

The **Device HA** screen lets you configure general Device HA settings, view and manage the list of monitored interfaces, and synchronize backup Zyxel Devices. To access this screen, click **Configuration > Device HA > Device HA**.

Figure 548 Configuration > Device HA > Device HA

General
Device HA Pro
Device HA

Hide Advanced Settings

General Settings

Device Role: Master Backup

Priority: (1-254)

Enable Preemption

Cluster Settings

Cluster ID: (1-32)

Authentication: ▼

Monitored Interface Summary

#	Status	Interface	Virtual Router IP/Netmask	Management IP / Netmask	Link Status
1		wan1	/	/	Up
2		wan2	/	/	Down
3		opt	/	/	Down
4		lan1	192.168.1.1 / 255.255.255.0	/ 255.255.255.0	Down
5		lan2	192.168.2.1 / 255.255.255.0	/ 255.255.255.0	Down
6		reserved	/	/	Down
7		dmz	192.168.3.1 / 255.255.255.0	/ 255.255.255.0	Down

Page of 1
Show items
Displaying 1 - 7 of 7

Synchronization

Server Address: (IP or FQDN)

Server Port:

Password:

Retype to Confirm:

Auto Synchronize

Interval: minutes (5-1440)

Next Syno Time: N/A

Note: Backup device's configuration can synchronize with master device's.

The following table describes the labels in this screen. See [Section 42.3.2 on page 820](#) for more information as well.

Table 292 Configuration > Device HA > Device HA

LABEL	DESCRIPTION
Show Advanced Settings / Hide Advanced Settings	Click this button to display a greater or lesser number of configuration fields.
Device Role	Select the Device HA role that the Zyxel Device plays in the virtual router. Choices are: Master - This Zyxel Device is the master Zyxel Device in the virtual router. This Zyxel Device uses the virtual IP address for each monitored interface. Note: Do not set this field to Master for two or more Zyxel Devices in the same virtual router (same cluster ID). Backup - This Zyxel Device is a backup Zyxel Device in the virtual router. This Zyxel Device does not use any of the virtual IP addresses.
Priority	This field is available for a backup Zyxel Device. Type the priority of the backup Zyxel Device. The backup Zyxel Device with the highest value takes over the role of the master Zyxel Device if the master Zyxel Device becomes unavailable. The priority must be between 1 and 254. (The master interface has priority 255.)
Enable Preemption	This field is available for a backup Zyxel Device. Select this if this Zyxel Device should become the master Zyxel Device if a lower-priority Zyxel Device is the master when this one is enabled. (If the role is master, the Zyxel Device preempts by default.)
Cluster Settings	
Cluster ID	Type the cluster ID number. A virtual router consists of a master Zyxel Device and all of its backup Zyxel Devices. If you have multiple Zyxel Device virtual routers on your network, use a different cluster ID for each virtual router.
Authentication	Select the authentication method the virtual router uses. Every interface in a virtual router must use the same authentication method and password. Choices are: None - this virtual router does not use any authentication method. Text - this virtual router uses a plain text password for authentication. Type the password in the field next to the radio button. The password can consist of alphanumeric characters, the underscore, and some punctuation marks (+-/*= ; : ! @\$&%#~ ' \ ()), and it can be up to eight characters long. IP AH (MD5) - this virtual router uses an encrypted MD5 password for authentication. Type the password in the field next to the radio button. The password can consist of alphanumeric characters, the underscore, and some punctuation marks (+-/*= ; : ! @\$&%#~ ' \ ()), and it can be up to eight characters long.
Monitored Interface Summary	This table shows the status of the Device HA settings and status of the Zyxel Device's interfaces.
Edit	Select an entry and click this to be able to modify it.
Activate	To turn on an entry, select it and click Activate .
Inactivate	To turn off an entry, select it and click Inactivate .
#	This is the entry's index number in the list.
Status	The activate (light bulb) icon is lit when the entry is active and dimmed when the entry is inactive.
Interface	This field identifies the interface. At the time of writing, Ethernet and bridge interfaces can be included in the Device HA virtual router. The member interfaces of any bridge interfaces do not display separately.
Virtual Router IP / Netmask	This is the master Zyxel Device's (static) IP address and subnet mask for this interface. If a backup takes over for the master, it uses this IP address. These fields are blank if the interface is a DHCP client or has no IP settings.

Table 292 Configuration > Device HA > Device HA

LABEL	DESCRIPTION
Management IP / Netmask	This field displays the interface's management IP address and subnet mask. You can use this IP address and subnet mask to access the Zyxel Device whether it is in master or backup mode.
Link Status	This tells whether the monitored interface's connection is down or up.
Synchronization	Use synchronization to have a backup Zyxel Device copy the master Zyxel Device's configuration, certificates, AV signatures, IDP and application patrol signatures, and system protect signatures. Every interface's management IP address must be in the same subnet as the interface's IP address (the virtual router IP address).
Server Address	If this Zyxel Device is set to backup role, enter the IP address or Fully-Qualified Domain Name (FQDN) of the Zyxel Device from which to get updated configuration. Usually, you should enter the IP address or FQDN of a virtual router on a secure network. If this Zyxel Device is set to master role, this field displays the Zyxel Device's IP addresses and/or Fully-Qualified Domain Names (FQDN) through which Zyxel Devices in backup role can get updated configuration from this Zyxel Device.
Sync. Now	This displays if the Zyxel Device is set to use Device HA, the Zyxel Device is in the backup role and Device HA is enabled. Click this to copy the specified Zyxel Device's configuration.
Server Port	If this Zyxel Device is set to the backup role, enter the port number to use for Secure FTP when synchronizing with the specified master Zyxel Device. If this Zyxel Device is set to master role, this field displays the Zyxel Device's Secure FTP port number. Click the Configure link if you need to change the FTP port number. Every Zyxel Device in the virtual router must use the same port number. If the master Zyxel Device changes, you have to manually change this port number in the backups.
Password	Enter the password used for verification during synchronization. Every Zyxel Device in the virtual router must use the same password. If you leave this field blank in the master Zyxel Device, no backup Zyxel Devices can synchronize from it. If you leave this field blank in a backup Zyxel Device, it cannot synchronize from the master Zyxel Device.
Retype to Confirm	Type the password again here to confirm it.
Auto Synchronize	You see the following fields when the Zyxel Device is a Backup . Select this to get the updated configuration automatically from the specified Zyxel Device according to the specified Interval . The first synchronization begins after the specified Interval ; the Zyxel Device does not synchronize immediately.
Interval	When you select Auto Synchronize , set how often the Zyxel Device synchronizes with the master.
Next Sync Time	This appears the next time and date (in hh:mm yyyy-mm-dd format) the Zyxel Device will synchronize with the master.
Apply	This appears when the Zyxel Device is currently using Device HA. Click Apply to save your changes back to the Zyxel Device.
Reset	Click Reset to return the screen to its last-saved settings.

42.3.2 Device HA Edit Monitored Interface

The **Device HA Monitored Interface Edit** screen lets you enable or disable monitoring of an interface and set the interface's management IP address and subnet mask. To access this screen, click **Configuration > Device HA > Device HA > Edit**.

If you configure Device HA settings for an Ethernet interface and later add the Ethernet interface to a bridge, the Zyxel Device retains the interface's Device HA settings and uses them again if you later remove the interface from the bridge. If the bridge is later deleted or the interface is removed from it, Device HA will recover the interface's setting.

A bridge interface's Device HA settings are not retained if you delete the bridge interface.

Figure 549 Configuration > Device HA > Device HA > Edit

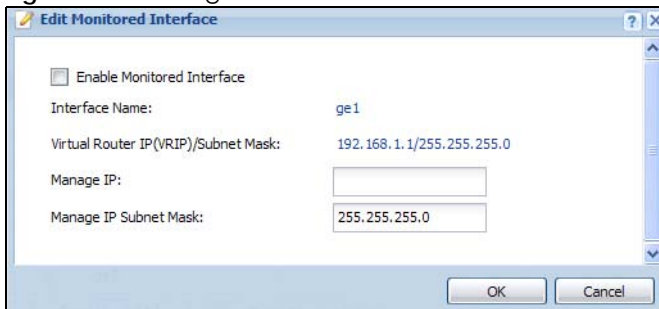
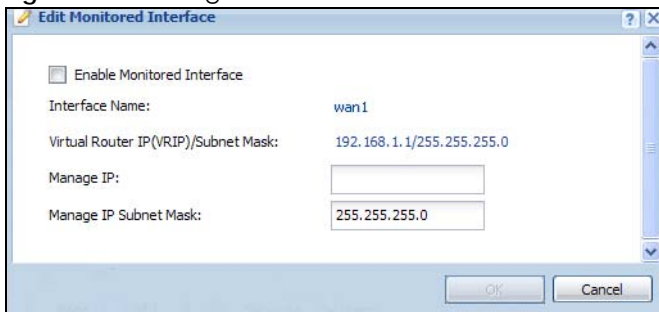

Figure 550 Configuration > Device HA > Device Ha > Edit



The following table describes the labels in this screen.

Table 293 Configuration > Device HA > Device HA > Edit

LABEL	DESCRIPTION
Enable Monitored Interface	Select this to have Device HA monitor the status of this interface's connection.
Interface Name	This identifies the interface. Note: Do not connect the bridge interfaces on two Zyxel Devices without Device HA activated on both. Doing so could cause a broadcast storm. Either activate Device HA before connecting the bridge interfaces or disable the bridge interfaces, connect the bridge interfaces, activate Device HA, and finally reactivate the bridge interfaces.
Virtual Router IP (VRIP) / Subnet Mask	This is the interface's (static) IP address and subnet mask in the virtual router. Whichever Zyxel Device is currently serving as the master uses this virtual router IP address and subnet mask. These fields are blank if the interface is a DHCP client or has no IP settings.
Manage IP	Enter the interface's IP address for management access. You can use this IP address to access the Zyxel Device whether it is the master or a backup. This management IP address should be in the same subnet as the interface IP address.
Manage IP Subnet Mask	Enter the subnet mask of the interface's management IP address.
OK	Click OK to save your changes back to the Zyxel Device.
Cancel	Click Cancel to exit this screen without saving your changes.

42.3.3 Device HA Technical Reference

Device HA with Bridge Interfaces

Here are two ways to avoid a broadcast storm when you connect the bridge interfaces on two Zyxel Devices.

First Option for Connecting the Bridge Interfaces on Two Zyxel Devices

The first way is to activate Device HA before connecting the bridge interfaces as shown in the following example.

- 1 Make sure the bridge interfaces of the master Zyxel Device (A) and the backup Zyxel Device (B) are not connected.

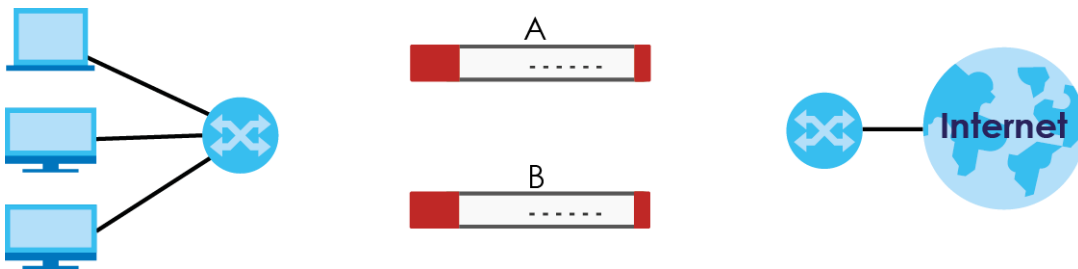

- 2 Configure the bridge interface on the master Zyxel Device, set the bridge interface as a monitored interface, and activate Device HA.

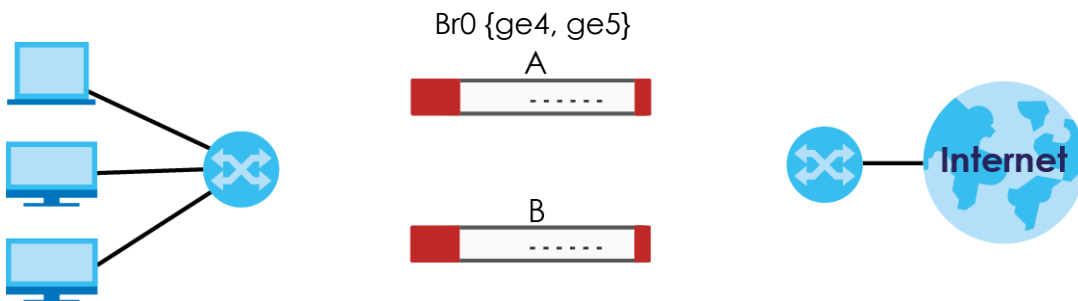

- 3 Configure the bridge interface on the backup Zyxel Device, set the bridge interface as a monitored interface, and activate Device HA.

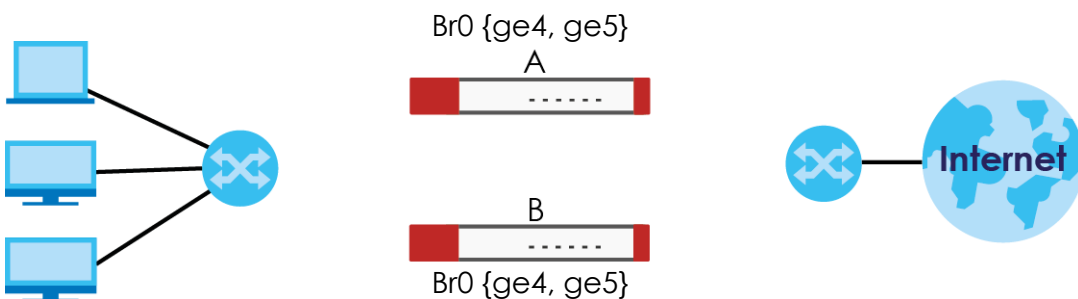

- 4 Connect the Zyxel Devices.

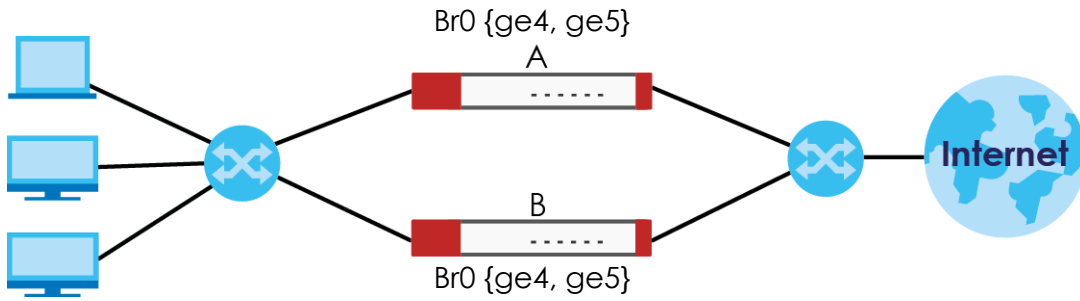

Second Option for Connecting the Bridge Interfaces on Two Zyxel Devices

Another option is to disable the bridge interfaces, connect the bridge interfaces, activate Device HA, and finally reactivate the bridge interfaces as shown in the following example.

- 1 In this case the Zyxel Devices are already connected, but the bridge faces have not been configured yet. Configure a disabled bridge interface on the master Zyxel Device but disable it. Then set the bridge interface as a monitored interface, and activate Device HA.

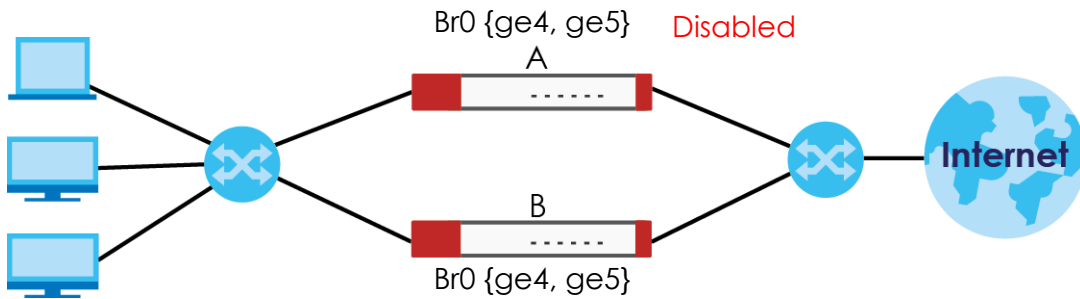

- 2 Configure a corresponding disabled bridge interface on the backup Zyxel Device. Then set the bridge interface as a monitored interface, and activate Device HA.

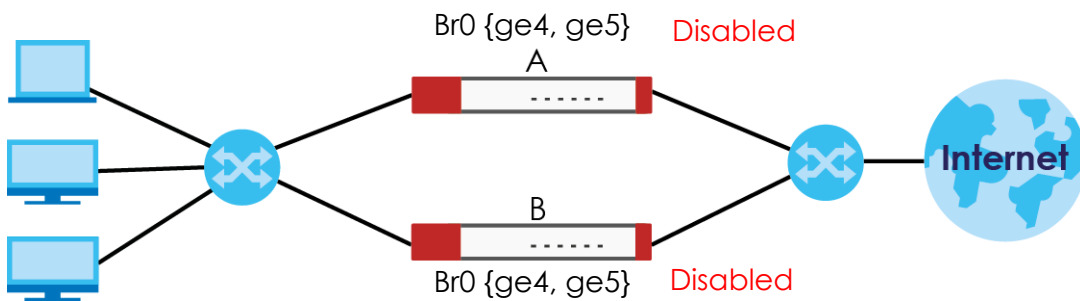

- 3 Enable the bridge interface on the master Zyxel Device and then on the backup Zyxel Device.

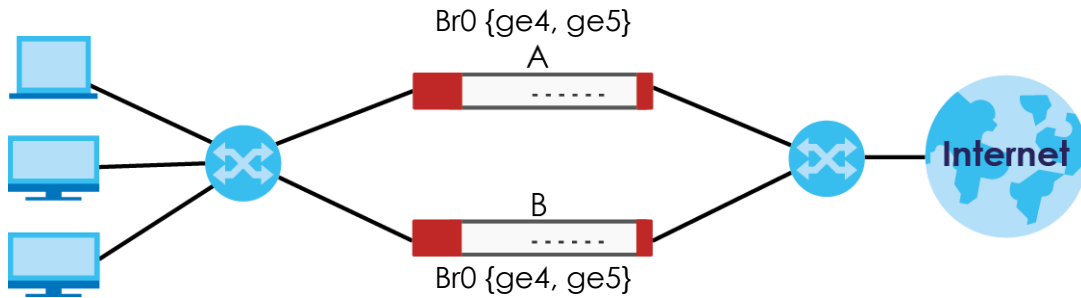

Synchronization

During synchronization, the master Zyxel Device sends the following information to the backup Zyxel Device.

- Startup configuration file (**startup-config.conf**)
- AV signatures
- IDP and application patrol signatures
- System protect signatures
- Certificates (**My Certificates**, and **Trusted Certificates**)

Synchronization does not change the Device HA settings in the backup Zyxel Device.

Synchronization affects the entire device configuration. You can only configure one set of settings for synchronization, regardless of how many VRRP groups you might configure. The Zyxel Device uses Secure FTP (on a port number you can change) to synchronize, but it is still recommended that the backup Zyxel Device synchronize with a master Zyxel Device on a secure network.

The backup Zyxel Device gets the configuration from the master Zyxel Device. The backup Zyxel Device cannot become the master or be managed while it applies the new configuration. This usually takes two or three minutes or longer depending on the configuration complexity.

The following restrictions apply with active-passive mode.

- The master Zyxel Device must have no inactive monitored interfaces.
- The backup Zyxel Device cannot be the master. This refers to the actual role at the time of synchronization, not the role setting in the configuration screen.

The backup applies the entire configuration if it is different from the backup's current configuration.

DHCP table, IP/MAC binding table and license status can also be backed up using Device HA Pro.

42.4 Device HA > Device HA Pro

Active and Passive Devices

Device HA Pro uses a dedicated heartbeat link between an active device ('master') and a passive device ('backup') for status syncing and backup to the passive device. On the passive device, all ports are disabled except for the port with the heartbeat link.

In the following example, Zyxel Device **A** is the active device that is connected to passive device Zyxel Device **B** via a dedicated link that is used for heartbeat control, configuration synchronization and troubleshooting. All links on Zyxel Device **B** are down except for the dedicated heartbeat link.

Note: The dedicated heartbeat link port must be the highest-numbered copper Ethernet port on each Zyxel Device for Device HA Pro to work.

Figure 551 Device HA Pro

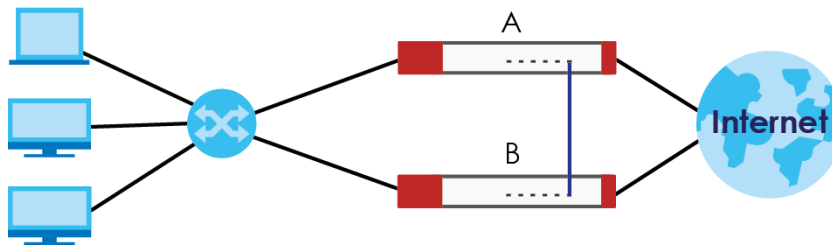

Failover from the active Zyxel Device to the passive Zyxel Device is activated when:

- A monitored interface is down.
- A monitored service (daemon) is down.
- The heartbeat link exceeds the failure tolerance.

After failover, the initial active Zyxel Device becomes the passive Zyxel Device after it recovers.

Note: After failover, the Device HA Pro license is transferred from the failing device to the passive device. Thus, the original license will always be used.

42.4.1 Deploying Device HA Pro

- 1 Register either the active or passive Zyxel Device with a Device HA Pro license at myZyxel. Check that it's properly licensed in **Licensing > Registration > Service** in the active Zyxel Device.
- 2 Make sure the passive Zyxel Device is offline, then enable Device HA in **Device HA > General** in the passive Zyxel Device.
- 3 Must make sure the FTP port in **System > FTP** (default 21) is the same on both Zyxel Devices. FTP is used for transferring files in the event of failover from active to passive Zyxel Device.
- 4 Connect the passive Zyxel Device to the active Zyxel Device using the highest-numbered copper Ethernet ports on both Zyxel Devices. This is the heartbeat interface. Make sure that this interface is not already configured for other features such as LAG, VLAN, Bridge.

Note: If both Zyxel Devices are turned on at the same time with Device HA enabled, then they may send the heartbeat at the same time. In this case, the Zyxel Device with the bigger MAC address becomes the passive Zyxel Device.

- When using Device HA Pro to synchronize firmware, the location of the running firmware must be the same in both active and passive Zyxel Devices. For example, if the running firmware is in partition 1 in the active Zyxel Device (standby firmware in partition 2), then the running firmware must also be in partition 1 in the passive Zyxel Device (standby firmware in partition 2).

42.4.2 Configuring Device HA Pro

Go to **Configuration > Device HA > Device HA Pro** and configure the following screen.

Figure 552 Configuration > Device HA > Device HA Pro

General Settings

Enable Configuration Provisioning From Active Device.

Serial Number of Licensed Device for License Synchronization: Z112233

Active Device Management IP:

Passive Device Management IP:

Subnet Mask:

Password:

Retype to Confirm:

Heartbeat Interval: 2 seconds (1-10)

Heartbeat Last Tolerance: 2 (1-10)

Monitor Interface

Available Interfaces

=== Object ===

wan1

wan2

opt

lan1

lan2

Monitor Interface

Failover Detection

Enable Failover When Interface Failure (Option)

Enable Failover When Device Service Fails (Option)

Note:

- Please transfer licenses in portal.mvzyxel.com to the device with the serial number entered in this screen.
- If you want to configure connectivity check, please go to [Ethernet](#).
- Before configure Heartbeat interface, please make sure the Heartbeat interface are not being used, such as LAG, VLAN, Bridge, and so on.

Apply & switch to Device HA Pro Apply Reset

Table 294 Configuration > Device HA > Device HA Pro

LABEL	DESCRIPTION
Enable Configuration Provisioning From Active Device.	Select this to have a passive Zyxel Device copy the active Zyxel Device's configuration, signatures (anti-virus, IDP/application patrol, and system protect), and certificates. Note: Only Zyxel Devices of the same model and firmware version can synchronize.
Serial Number of Licensed Device for License Synchronization	Type the serial number of the Zyxel Device (active or passive) with the Device HA Pro subscribed license.
Active Device Management IP	Type the IPv4 address of the highest-numbered copper Ethernet port on the active Zyxel Device (the heartbeat dedicated link port).
Passive Device Management IP	Type the IPv4 address of the highest-numbered copper Ethernet port on the passive Zyxel Device (the heartbeat dedicated link port). Note: The active and passive Zyxel Device Management IP addresses must be in the same subnet.
Subnet Mask	Type the subnet mask for the management IP addresses.
Password	Type a synchronization password of between 1 and 32 single-byte printable characters. You will be prompted for the password before synchronization takes place.
Retype to Confirm	Type the exact same synchronization password as typed above.
Heartbeat Interval	Type the number of seconds (1-10) allowed for absence of a heartbeat signal before a failure of the active Zyxel Device is recorded.
Heartbeat Lost Tolerance	Type the number of heartbeat failures allowed before failover is activated on the passive Zyxel Device.
Monitor Interface	Select an interface in Available Interfaces and click the right-arrow button to move it to Monitor Interface to become a Device HA pro monitored interface. To remove a Device HA pro monitored interface, select it in Monitor Interface and click the left-arrow button to move it to Available Interfaces .
Failover Detection	
Enable Failover When Interface Failure (Option)	Select this to have the passive Zyxel Device take over when a monitored interface fails.
Enable Failover When Device Service Fails (Option)	Select this to have the passive Zyxel Device take over when a monitored service daemon on the active Zyxel Device fails.
Apply & switch to Device HA Pro	Click Apply to save your changes back to the Zyxel Device and change the Zyxel Device to begin using Device HA Pro from Device HA (general) if it isn't already. You need a Device HA Pro license registered at myZyxel to do this.
Apply	Click Apply to save your Device HA Pro configurations back to the Zyxel Device but keep the Zyxel Device using Device HA (general).
Reset	Click Reset to return the screen to its last-saved settings.

CHAPTER 43

Object

43.1 Zones Overview

Set up zones to configure network security and network policies in the Zyxel Device. A zone is a group of interfaces and/or VPN tunnels. The Zyxel Device uses zones instead of interfaces in many security and policy settings, such as Secure Policies rules, UTM Profile, and remote management.

Zones cannot overlap. Each Ethernet interface, VLAN interface, bridge interface, PPPoE/PPTP interface and VPN tunnel can be assigned to at most one zone. Virtual interfaces are automatically assigned to the same zone as the interface on which they run.

Figure 553 Example: Zones

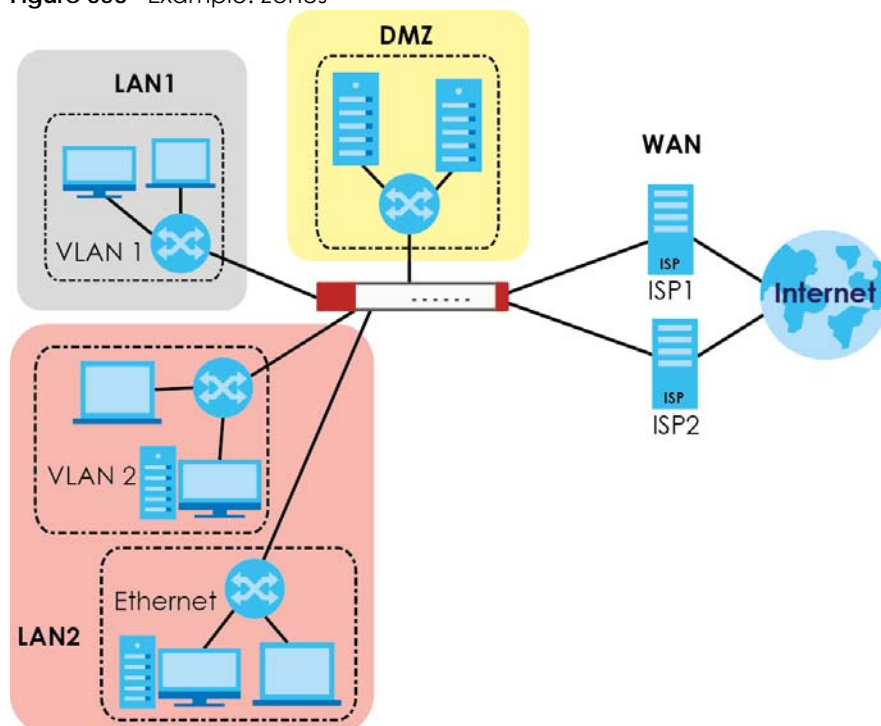

Use the **Zone** screens (see [Section 43.9.2 on page 902](#)) to manage the Zyxel Device's zones.

43.1.1 What You Need to Know

Zones effectively divide traffic into three types—intra-zone traffic, inter-zone traffic, and extra-zone traffic.

Intra-zone Traffic

- Intra-zone traffic is traffic between interfaces or VPN tunnels in the same zone. For example, in [Figure 553 on page 828](#), traffic between VLAN 2 and the Ethernet is intra-zone traffic.

Inter-zone Traffic

Inter-zone traffic is traffic between interfaces or VPN tunnels in different zones. For example, in [Figure 553 on page 828](#), traffic between VLAN 1 and the Internet is inter-zone traffic. This is the normal case when zone-based security and policy settings apply.

Extra-zone Traffic

- Extra-zone traffic is traffic to or from any interface or VPN tunnel that is not assigned to a zone. For example, in [Figure 553 on page 828](#), traffic to or from computer **C** is extra-zone traffic.
- Some zone-based security and policy settings may apply to extra-zone traffic, especially if you can set the zone attribute in them to **Any** or **All**. See the specific feature for more information.

43.1.2 The Zone Screen

The **Zone** screen provides a summary of all zones. In addition, this screen allows you to add, edit, and remove zones. To access this screen, click **Configuration > Object > Zone**.

Figure 554 Configuration > Object > Zone

The following table describes the labels in this screen.

Table 295 Configuration > Object > Zone

LABEL	DESCRIPTION
User Configuration / System Default	The Zyxel Device comes with pre-configured System Default zones that you cannot delete. You can create your own User Configuration zones
Add	Click this to create a new, user-configured zone.
Edit	Double-click an entry or select it and click Edit to open a screen where you can modify the entry's settings.
Remove	To remove a user-configured trunk, select it and click Remove . The Zyxel Device confirms you want to remove it before doing so.
References	Select an entry and click References to open a screen that shows which settings use the entry. Click Refresh to update information in this screen.
#	This field is a sequential value, and it is not associated with any interface.
Name	This field displays the name of the zone.

Table 295 Configuration > Object > Zone (continued)

LABEL	DESCRIPTION
Member	This field displays the names of the interfaces that belong to each zone.
Reference	This field displays the number of times an Object Reference is used in a policy.

43.1.2.1 Zone Edit

The **Zone Edit** screen allows you to add or edit a zone. To access this screen, go to the **Zone** screen (see [Section 43.9.2 on page 902](#)), and click the **Add** icon or an **Edit** icon.

Figure 555 Configuration > Object > Zone > Add

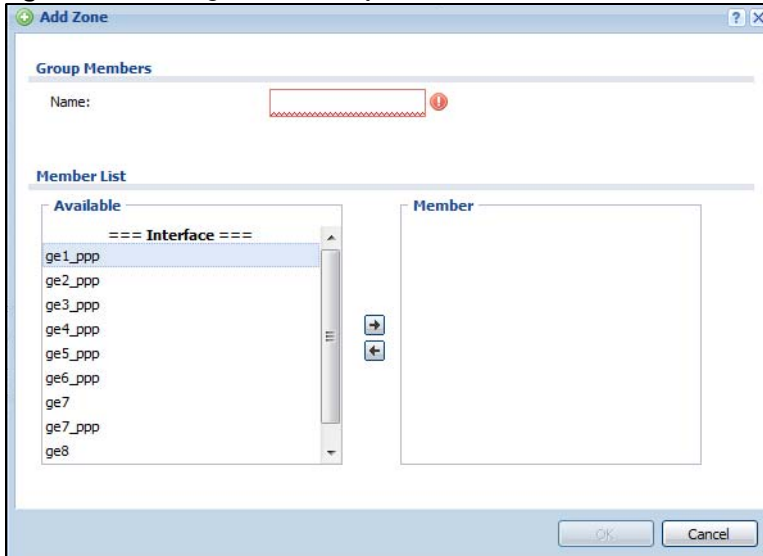

The following table describes the labels in this screen.

Table 296 Configuration > Object > Zone > Add/Edit

LABEL	DESCRIPTION
Name	For a system default zone, the name is read only. For a user-configured zone, type the name used to refer to the zone. You may use 1-31 alphanumeric characters, underscores (_), or dashes (-), but the first character cannot be a number. This value is case-sensitive.
Member List	Available lists the interfaces and VPN tunnels that do not belong to any zone. Select the interfaces and VPN tunnels that you want to add to the zone you are editing, and click the right arrow button to add them. Member lists the interfaces and VPN tunnels that belong to the zone. Select any interfaces that you want to remove from the zone, and click the left arrow button to remove them.
OK	Click OK to save your customized settings and exit this screen.
Cancel	Click Cancel to exit this screen without saving.

43.2 User/Group Overview

This section describes how to set up user accounts, user groups, and user settings for the Zyxel Device. You can also set up rules that control when users have to log in to the Zyxel Device before the Zyxel Device routes traffic for them.

- The **User** screen (see [Section 43.2.2 on page 833](#)) provides a summary of all user accounts.
- The **Group** screen (see [Section 43.2.4 on page 837](#)) provides a summary of all user groups. In addition, this screen allows you to add, edit, and remove user groups. User groups may consist of access users and other user groups. You cannot put admin users in user groups.
- The **Setting** screen (see [Section 43.2.6 on page 841](#)) controls default settings, login settings, lockout settings, and other user settings for the Zyxel Device. You can also use this screen to specify when users must log in to the Zyxel Device before it routes traffic for them.
- The **MAC Address** screen (see [Section 43.2.7 on page 845](#)) allows you to configure the MAC addresses or OUI (Organizationally Unique Identifier) of wireless clients for MAC authentication using the local user database. The OUI is the first three octets in a MAC address and uniquely identifies the manufacturer of a network device.

43.2.1 What You Need To Know

User Account

A user account defines the privileges of a user logged into the Zyxel Device. User accounts are used in security policies and application patrol, in addition to controlling access to configuration and services in the Zyxel Device.

User Types

These are the types of user accounts the Zyxel Device uses.

Table 297 Types of User Accounts

TYPE	ABILITIES	LOGIN METHOD(S)
Admin Users		
admin	Change Zyxel Device configuration (web, CLI)	WWW, TELNET, SSH, FTP, Console
limited-admin	Look at Zyxel Device configuration (web, CLI) Perform basic diagnostics (CLI)	WWW, TELNET, SSH, Console
Access Users		
user	Access network services Browse user-mode commands (CLI)	WWW, TELNET, SSH
guest	Access network services	WWW
ext-user	External user account	WWW
ext-group-user	External group user account	WWW
guest-manager	Create dynamic guest accounts	WWW
dynamic-guest	Access network services	Hotspot Portal

Note: The default **admin** account is always authenticated locally, regardless of the authentication method setting. (See [Chapter 43 on page 916](#) for more information about authentication methods.)

Ext-User Accounts

Set up an **ext-user** account if the user is authenticated by an external server and you want to set up specific policies for this user in the Zyxel Device. If you do not want to set up policies for this user, you do not have to set up an **ext-user** account.

All **ext-user** users should be authenticated by an external server, such as AD, LDAP or RADIUS. If the Zyxel Device tries to use the local database to authenticate an **ext-user**, the authentication attempt always fails. (This is related to AAA servers and authentication methods, which are discussed in those chapters in this guide.)

Note: If the Zyxel Device tries to authenticate an **ext-user** using the local database, the attempt always fails.

Once an **ext-user** user has been authenticated, the Zyxel Device tries to get the user type (see [Table 297 on page 831](#)) from the external server. If the external server does not have the information, the Zyxel Device sets the user type for this session to **User**.

For the rest of the user attributes, such as reauthentication time, the Zyxel Device checks the following places, in order.

- 1 User account in the remote server.
- 2 User account (Ext-User) in the Zyxel Device.
- 3 Default user account for AD users (**ad-users**), LDAP users (**ldap-users**) or RADIUS users (**radius-users**) in the Zyxel Device.

See [Setting up User Attributes in an External Server](#) for a list of attributes and how to set up the attributes in an external server.

Ext-Group-User Accounts

Ext-Group-User accounts work are similar to ext-user accounts but allow you to group users by the value of the group membership attribute configured for the AD or LDAP server. See [Section 43.10.5.1 on page 911](#) for more on the group membership attribute.

Dynamic-Guest Accounts

Dynamic guest accounts are guest accounts, but are created dynamically and stored in the Zyxel Device's local user database. A dynamic guest account has a dynamically-created user name and password. A dynamic guest account user can access the Zyxel Device's services only within a given period of time and will become invalid after the expiration date/time.

There are three types of dynamic guest accounts depending on how they are created or authenticated: **billing-users**, **ua-users** and **trial-users**.

billing-users are guest account created with the guest manager account or an external printer and paid by cash or created and paid via the on-line payment service. **ua-users** are users that log in from the user agreement page. **trial-users** are free guest accounts that are created with the Free Time function.

User Groups

User groups may consist of user accounts or other user groups. Use user groups when you want to create the same rule for several user accounts, instead of creating separate rules for each one.

Note: You cannot put access users and admin users in the same user group.

Note: You cannot put the default **admin** account into any user group.

The sequence of members in a user group is not important.

User Awareness

By default, users do not have to log into the Zyxel Device to use the network services it provides. The Zyxel Device automatically routes packets for everyone. If you want to restrict network services that certain users can use via the Zyxel Device, you can require them to log in to the Zyxel Device first. The Zyxel Device is then 'aware' of the user who is logged in and you can create 'user-aware policies' that define what services they can use. See [Section 43.2.8 on page 847](#) for a user-aware login example.

Finding Out More

- See [Section 43.2.8 on page 847](#) for some information on users who use an external authentication server in order to log in.
- The Zyxel Device supports TTLS using PAP so you can use the Zyxel Device's local user database to authenticate users with WPA or WPA2 instead of needing an external RADIUS server.

43.2.2 User/Group User Summary Screen

The **User** screen provides a summary of all user accounts. To access this screen, login to the Web Configurator, and click **Configuration > Object > User/Group**.

Figure 556 Configuration > Object > User/Group > User

#	User Name	User Type	Description	Refere...
1	admin	admin	Administration account	0
2	ldap-users	ext-user	External LDAP Users	0
3	radius-users	ext-user	External RADIUS Users	0
4	ad-users	ext-user	External AD Users	0
5	john	admin	Local User	0

The following table describes the labels in this screen.

Table 298 Configuration > Object > User/Group > User

LABEL	DESCRIPTION
Add	Click this to create a new entry.
Edit	Double-click an entry or select it and click Edit to open a screen where you can modify the entry's settings.

Table 298 Configuration > Object > User/Group > User (continued)

LABEL	DESCRIPTION
Remove	To remove an entry, select it and click Remove . The Zyxel Device confirms you want to remove it before doing so.
References	Select an entry and click References to open a screen that shows which settings use the entry.
#	This field is a sequential value, and it is not associated with a specific user.
User Name	This field displays the user name of each user.
User Type	This field displays the types of user accounts the Zyxel Device uses: <ul style="list-style-type: none"> • admin - this user can look at and change the configuration of the Zyxel Device • limited-admin - this user can look at the configuration of the Zyxel Device but not to change it • dynamic-guest - this user has access to the Zyxel Device's services but cannot look at the configuration. • user - this user has access to the Zyxel Device's services and can also browse user-mode commands (CLI). • guest - this user has access to the Zyxel Device's services but cannot look at the configuration • ext-user - this user account is maintained in a remote server, such as RADIUS or LDAP. See Ext-User Accounts on page 832 for more information about this type. • ext-group-user - this user account is maintained in a remote server, such as RADIUS or LDAP. See Ext-Group-User Accounts on page 832 for more information about this type. • guest-manager - this user can log in via the web configurator login screen and create dynamic guest accounts using the Account Generator screen that pops up. See Section 21.4.1 on page 553 for detailed information about the Account Generator screen.
Description	This field displays the description for each user.
Reference	This displays the number of times an object reference is used in a profile.

43.2.3 User Add/Edit General Screen

The **User Add/Edit** screen allows you to create a new user account or edit an existing one.

43.2.3.1 Rules for User Names

Enter a user name from 1 to 31 characters.

The user name can only contain the following characters:

- Alphanumeric A-z 0-9 (there is no unicode support)
- _ [underscores]
- - [dashes]

The first character must be alphabetical (A-Z a-z), an underscore (_), or a dash (-). Other limitations on user names are:

- User names are case-sensitive. If you enter a user 'bob' but use 'BOB' when connecting via CIFS or FTP, it will use the account settings used for 'BOB' not 'bob'.
- User names have to be different than user group names.
- Here are the reserved user names:

- | | | | | |
|--------------|------------------|--------|---------|----------|
| • adm | • admin | • any | • bin | • daemon |
| • debug | • devicehaecived | • ftp | • games | • halt |
| • ldap-users | • lp | • mail | • news | • nobody |

- operator
- radius-users
- root
- shutdown
- sshd
- sync
- uucp
- zyxel

To access this screen, go to the **User** screen (see [Section 43.2.2 on page 833](#)), and click either the **Add** icon or an **Edit** icon.

Figure 557 Configuration > Object > User/Group > User > Add/Edit_General

The following table describes the labels in this screen.

Table 299 Configuration > Object > User/Group > User > Add/Edit_General

LABEL	DESCRIPTION
User Name	Type the user name for this user account. You may use 1-31 alphanumeric characters, underscores(_), or dashes (-), but the first character cannot be a number. This value is case-sensitive. User names have to be different than user group names, and some words are reserved. See Section 43.2.3.1 on page 834 .
User Type	This field displays the types of user accounts the Zyxel Device uses: <ul style="list-style-type: none"> • admin - this user can look at and change the configuration of the Zyxel Device • limited-admin - this user can look at the configuration of the Zyxel Device but not to change it • user - this user has access to the Zyxel Device's services and can also browse user-mode commands (CLI). • guest - this user has access to the Zyxel Device's services but cannot look at the configuration. • ext-user - this user account is maintained in a remote server, such as RADIUS or LDAP. See Ext-User Accounts on page 832 for more information about this type. • ext-group-user - this user account is maintained in a remote server, such as RADIUS or LDAP. See Ext-Group-User Accounts on page 832 for more information about this type.

Table 299 Configuration > Object > User/Group > User > Add/Edit_General (continued)

LABEL	DESCRIPTION
Password	<p>This field is not available if you select the ext-user or ext-group-user type.</p> <p>Enter a password of from 1 to 64 characters for this user account. If you selected Enable Password Complexity in Configuration > Object > User/Group > Setting, it must consist of at least 8 characters and at most 64. At least 1 character must be a number, at least 1 a lower case letter, at least 1 an upper case letter and at least 1 a special character from the keyboard, such as !@#\$\$%^&*()_+.</p>
Retype	<p>This field is not available if you select the ext-user or ext-group-user type.</p>
Group Identifier	<p>This field is available for a ext-group-user type user account.</p> <p>Specify the value of the AD or LDAP server's Group Membership Attribute that identifies the group to which this user belongs.</p>
Associated AAA Server Object	<p>This field is available for a ext-group-user type user account. Select the AAA server to use to authenticate this account's users.</p>
Description	<p>Enter the description of each user, if any. You can use up to 60 printable ASCII characters. Default descriptions are provided.</p>
Email	<p>Type one or more valid email addresses for this user so that email messages can be sent to this user if required. A valid email address must contain the @ character. For example, this is a valid email address: abc@example.com.</p>
Mobile Number	<p>Type a valid mobile telephone number for this user so that SMS messages can be sent to this user if required. A valid mobile telephone number can be up to 20 characters in length, including the numbers 1-9 and the following characters in the square brackets [+*#()-].</p>
Send Code	<p>This button is available when the user type is admin or limited-admin.</p> <p>Click this and an authorization email or SMS message with a code of six digits will be sent to the email addresses or mobile telephone number you put in.</p> <p>Enter the verification code to verify your email addresses or mobile telephone number.</p> <p>Figure 558 Verification Code for Email</p>  <p>Figure 559 Verification Code for Mobile Telephone Number</p> 
Authentication Timeout Settings	<p>If you want the system to use default settings, select Use Default Settings. If you want to set authentication timeout to a value other than the default settings, select Use Manual Settings then fill your preferred values in the fields that follow.</p>

Table 299 Configuration > Object > User/Group > User > Add/Edit_General (continued)

LABEL	DESCRIPTION
Lease Time	<p>If you select Use Default Settings in the Authentication Timeout Settings field, the default lease time is shown.</p> <p>If you select Use Manual Settings, you need to enter the number of minutes this user has to renew the current session before the user is logged out. You can specify 1 to 1440 minutes. You can enter 0 to make the number of minutes unlimited. Admin users renew the session every time the main screen refreshes in the Web Configurator. Access users can renew the session by clicking the Renew button on their screen. If you allow access users to renew time automatically (see Section 43.2.6 on page 841), the users can select this check box on their screen as well. In this case, the session is automatically renewed before the lease time expires.</p>
Reauthentication Time	<p>If you select Use Default Settings in the Authentication Timeout Settings field, the default lease time is shown.</p> <p>If you select Use Manual Settings, you need to type the number of minutes this user can be logged into the Zyxel Device in one session before the user has to log in again. You can specify 1 to 1440 minutes. You can enter 0 to make the number of minutes unlimited. Unlike Lease Time, the user has no opportunity to renew the session without logging out.</p>
User VLAN ID	<p>This field is available for a ext-group-user type user account.</p> <p>Select this option to enable dynamic VLAN assignment on the Zyxel Device. When a user is authenticated successfully, all data traffic from this user is tagged with the VLAN ID number you specify here.</p> <p>This allows you to assign a user of the ext-group-user type to a specific VLAN based on the user credentials instead of using an AAA server.</p>
Configuration Validation	Use a user account from the group specified above to test if the configuration is correct. Enter the account's user name in the User Name field and click Test .
OK	Click OK to save your changes back to the Zyxel Device.
Cancel	Click Cancel to exit this screen without saving your changes.

43.2.4 User Add/Edit Two-factor Authentication Screen

The User Add/Edit Two-factor Authentication screen allows you to create two-factor security for VPN access or admin access for this user to the Zyxel Device.

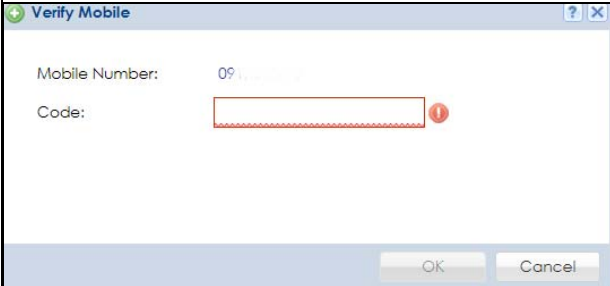
Two-factor authentication adds an extra layer of security for users logging into the Zyxel Device. When two-factor authentication is enabled, a user has to first enter their username and password, and then click on a temporary link or enter a one-time password when logging in.

You can enable two-factor authentication for users who are logging into the Zyxel Device to create a VPN tunnel (VPN access), and for administrator and limited admin users who are logging into the Web Configurator or CLI (admin access) to configure the Zyxel Device.

Table 300 Two Factor Authentication Methods

ACCESS TYPE	TWO-FACTOR AUTHENTICATION METHODS	FACTOR 2 PASSWORD
VPN	SMS	Code
VPN	Email	Link
Admin	SMS	Code
Admin	Email	Link
Admin	Google Authenticator app	Code

You must first enable two-factor authentication on the Zyxel Device in **Object > Auth. Method > Two-factor Authentication > VPN Access** and **Object > Auth. Method > Two-factor Authentication > Admin Access**. See [Section 43.11.4 on page 919](#) and [Section 43.11.5 on page 923](#) for more prerequisites and other information.

In **Object > User/Group > User**, click **Add** to create a new entry or select an entry and click **Edit** to modify the entry.

Figure 560 Configuration > Object > User/Group > User> Add/Edit_Two-factor Authentication

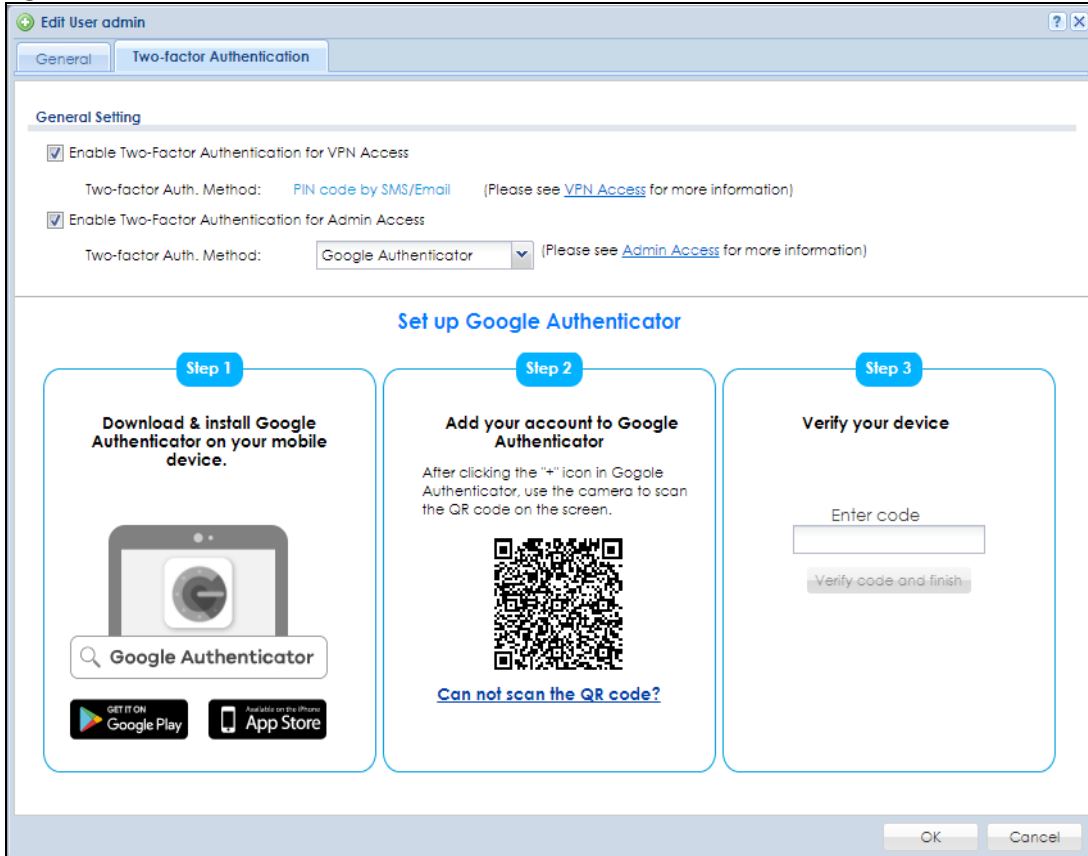

The following table describes the labels in this screen.

Table 301 Configuration > Object > User/Group> User> Add_Two -factor Authentication

LABEL	DESCRIPTION
Enable Two-factor Authentication for VPN Access	Select this to require two-actor authentication for this user to use a pre-configured VPN tunnel for secure access to a network behind the Zyxel Device. Select the types of VPN allowed in Object > Auth. Method > Two-factor Authentication > VPN Access . You may choose from: <ul style="list-style-type: none"> • SSL VPN Access • IPSec VPN Access • L2TP/ IPSec VPN Access
Enable Two-factor Authentication for Admin Access	Select this to require two-factor authentication for an admin user to access the Zyxel Device. Select the types of VPN allowed in Object > Auth. Method > Two-factor Authentication > Admin Access . You may choose from: <ul style="list-style-type: none"> • Web • SSH • TELNET

Table 301 Configuration > Object > User/Group > User > Add_Two -factor Authentication (continued)

LABEL	DESCRIPTION
Two-factor Auth. Method	Select Default or User Defined and select from PIN code by SMS/Email or Google Authenticator
Set up Google Authenticator	If you chose Google Authenticator for offline two-factor authentication, on your mobile device, go to an app store to download Google Authenticator. To add your account to Google Authenticator, press the plus (+) icon, select Scan Barcode , then use your mobile device's camera to scan the barcode. Finally enter the verification code you receive on your mobile device in Verify your device .
View your backup codes	You see this after successful Google authentication. In the event that you do not have access to email or your mobile device, click Download to create backup codes as second-factor authentication. Make sure to put them in a safe place.
Verify your device	In the event that you do not have access to email or your mobile device, enter a backup code here as second factor authentication. You can use each code only once. If you generate a new set of backup codes (Regenerate backup codes), the old set become obsolete.
Revoke	Click this to cancel Google authentication as second-factor authentication for Admin Access . You must then use a PIN code by SMS or email as second-factor authentication instead.
OK	Click OK to save your changes back to the Zyxel Device and close the screen.
Cancel	Click Cancel to exit this screen without saving your changes.

43.2.5 User/Group Group Summary Screen

User groups consist of access users and other user groups. You cannot put admin users in user groups. The **Group** screen provides a summary of all user groups. In addition, this screen allows you to add, edit, and remove user groups. To access this screen, login to the Web Configurator, and click **Configuration > Object > User/Group > Group**.

Figure 561 Configuration > Object > User/Group > Group

The following table describes the labels in this screen. See [Section 43.2.5.1 on page 840](#) for more information as well.

Table 302 Configuration > Object > User/Group > Group

LABEL	DESCRIPTION
Add	Click this to create a new entry.
Edit	Double-click an entry or select it and click Edit to open a screen where you can modify the entry's settings.
Remove	To remove an entry, select it and click Remove . The Zyxel Device confirms you want to remove it before doing so. Removing a group does not remove the user accounts in the group.
References	Select an entry and click References to open a screen that shows which settings use the entry.
#	This field is a sequential value, and it is not associated with a specific user group.
Group Name	This field displays the name of each user group.

Table 302 Configuration > Object > User/Group > Group (continued)

LABEL	DESCRIPTION
Description	This field displays the description for each user group.
Member	This field lists the members in the user group. Each member is separated by a comma.
Reference	This displays the number of times an object reference is used in a profile.

43.2.5.1 Group Add/Edit Screen

The **Group Add/Edit** screen allows you to create a new user group or edit an existing one. To access this screen, go to the **Group** screen (see [Section 43.2.4 on page 837](#)), and click either the **Add** icon or an **Edit** icon.

Figure 562 Configuration > Object > User/Group > Group > Add

The following table describes the labels in this screen.

Table 303 Configuration > Object > User/Group > Group > Add

LABEL	DESCRIPTION
Name	Type the name for this user group. You may use 1-31 alphanumeric characters, underscores(_), or dashes (-), but the first character cannot be a number. This value is case-sensitive. User group names have to be different than user names.
Description	Enter the description of the user group, if any. You can use up to 60 characters, punctuation marks, and spaces.
Member List	The Member list displays the names of the users and user groups that have been added to the user group. The order of members is not important. Select users and groups from the Available list that you want to be members of this group and move them to the Member list. You can double-click a single entry to move it or use the [Shift] or [Ctrl] key to select multiple entries and use the arrow button to move them. Move any members you do not want included to the Available list.
OK	Click OK to save your changes back to the Zyxel Device.
Cancel	Click Cancel to exit this screen without saving your changes.

43.2.6 User/Group Setting Screen

The **Setting** screen controls default settings, login settings, lockout settings, and other user settings for the Zyxel Device. You can also use this screen to specify when users must log in to the Zyxel Device before it routes traffic for them.

To access this screen, login to the Web Configurator, and click **Configuration > Object > User/Group > Setting**.

Figure 563 Configuration > Object > User/Group > Setting

User Default Setting

Default Authentication Timeout Settings

#	User Type	Lease Time	Reauthentication Time
1	admin	1440	1440
2	limited-admin	1440	1440
3	user	1440	1440
4	guest	1440	1440
5	ext-user	1440	1440
6	ext-group-user	1440	1440
7	guest-manager	1440	1440

Page 1 of 1 Show 50 items Displaying 1 - 7 of 7

Miscellaneous Settings

Allow renewing lease time automatically

Enable user idle detection

User idle timeout: (1-60 minutes)

Login Security

Password must changed every (days): (1-365 days)

Enable Password Complexity

Complexity requirement:

- Minimum password length should be of 8 characters.
- Include at least 1 Upper case alphabetic characters.
- Include at least 1 Lower case alphabetic characters.
- Include at least 1 numeric character* Include at least 1 special characters like @, \$, !, ...

User Logon Settings

Limit the number of simultaneous logons for administration account

Maximum number per administration account: (1-200)

Limit the number of simultaneous logons for access account

Maximum number per access account: (1-200)

Reach maximum number per account: Block Remove previous user and login

User Lockout Settings

Enable logon retry limit

Maximum retry count: (1-99)

Lockout period: (1-65535 minutes)

Apply Reset

The following table describes the labels in this screen.

Table 304 Configuration > Object > User/Group > Setting

LABEL	DESCRIPTION
User Authentication Timeout Settings	
Default Authentication Timeout Settings	These authentication timeout settings are used by default when you create a new user account. They also control the settings for any existing user accounts that are set to use the default settings. You can still manually configure any user account's authentication timeout settings.
Edit	Double-click an entry or select it and click Edit to open a screen where you can modify the entry's settings.
#	This field is a sequential value, and it is not associated with a specific entry.
User Type	<p>These are the kinds of user account the Zyxel Device supports.</p> <ul style="list-style-type: none"> • admin - this user can look at and change the configuration of the Zyxel Device • limited-admin - this user can look at the configuration of the Zyxel Device but not to change it • user - this user has access to the Zyxel Device's services but cannot look at the configuration • guest - this user has access to the Zyxel Device's services but cannot look at the configuration • ext-user - this user account is maintained in a remote server, such as RADIUS or LDAP. See Ext-User Accounts on page 832 for more information about this type. • ext-group-user - this user account is maintained in a remote server, such as RADIUS or LDAP. See Ext-Group-User Accounts on page 832 for more information about this type.
Lease Time	<p>This is the default lease time in minutes for each type of user account. It defines the number of minutes the user has to renew the current session before the user is logged out.</p> <p>Admin users renew the session every time the main screen refreshes in the Web Configurator. Access users can renew the session by clicking the Renew button on their screen. If you allow access users to renew time automatically (see Section 43.2.6 on page 841), the users can select this check box on their screen as well. In this case, the session is automatically renewed before the lease time expires.</p>
Reauthentication Time	This is the default reauthentication time in minutes for each type of user account. It defines the number of minutes the user can be logged into the Zyxel Device in one session before having to log in again. Unlike Lease Time , the user has no opportunity to renew the session without logging out.
Miscellaneous Settings	
Allow renewing lease time automatically	Select this check box if access users can renew lease time automatically, as well as manually, simply by selecting the Updating lease time automatically check box on their screen.
Enable user idle detection	<p>This is applicable for access users.</p> <p>Select this check box if you want the Zyxel Device to monitor how long each access user is logged in and idle (in other words, there is no traffic for this access user). The Zyxel Device automatically logs out the access user once the User idle timeout has been reached.</p>
User idle timeout	<p>This is applicable for access users.</p> <p>This field is effective when Enable user idle detection is checked. Type the number of minutes each access user can be logged in and idle before the Zyxel Device automatically logs out the access user.</p>
Login Security	

Table 304 Configuration > Object > User/Group > Setting (continued)

LABEL	DESCRIPTION
Password must changed every (days):	Enter how often users must change their password when they log into the Zyxel Device. You can choose from once a day to once a year.
Password reset link (FQDN/IP):	Associate the password expiration to a specific Zyxel Device. Default is this Zyxel Device (myrouter) or select Custom and enter the IP address or Fully Qualified Domain Name (FQDN).
Enable Password Complexity	Select this to enforce the following conditions in a user password. Requiring a strong password is good for security. The conditions are that the password must consist of at least 8 characters and at most 64. At least 1 character must be a number, at least 1 a lower case letter, at least 1 an upper case letter and at least 1 a special character from the keyboard, such as !@#%&*()_+.
User Logon Settings	
Limit the number of simultaneous logons for administration account	Select this check box if you want to set a limit on the number of simultaneous logins by admin users. If you do not select this, admin users can login as many times as they want at the same time using the same or different IP addresses.
Maximum number per administration account	This field is effective when Limit ... for administration account is checked. Type the maximum number of simultaneous logins by each admin user.
Limit the number of simultaneous logons for access account	Select this check box if you want to set a limit on the number of simultaneous logins by non-admin users. If you do not select this, access users can login as many times as they want as long as they use different IP addresses.
Maximum number per access account	This field is effective when Limit ... for access account is checked. Type the maximum number of simultaneous logins by each access user.
Reach maximum number per account:	Select Block to stop new users from logging in when the Maximum number per access account is reached. Select Remove previous user and login to disassociate the first user that logged in and allow a new user to log in when the Maximum number per access account is reached.
User Lockout Settings	
Enable logon retry limit	Select this check box to set a limit on the number of times each user can login unsuccessfully (for example, wrong password) before the IP address is locked out for a specified amount of time.
Maximum retry count	This field is effective when Enable logon retry limit is checked. Type the maximum number of times each user can login unsuccessfully before the IP address is locked out for the specified lockout period . The number must be between 1 and 99.
Lockout period	This field is effective when Enable logon retry limit is checked. Type the number of minutes the user must wait to try to login again, if logon retry limit is enabled and the maximum retry count is reached. This number must be between 1 and 65,535 (about 45.5 days).
Apply	Click Apply to save the changes.
Reset	Click Reset to return the screen to its last-saved settings.

43.2.6.1 Default User Authentication Timeout Settings Edit Screens

The **Default Authentication Timeout Settings Edit** screen allows you to set the default authentication timeout settings for the selected type of user account. These default authentication timeout settings also control the settings for any existing user accounts that are set to use the default settings. You can still manually configure any user account's authentication timeout settings.

To access this screen, go to the **Configuration > Object > User/Group > Setting** screen (see [Section 43.2.6 on page 841](#)), and click one of the **Default Authentication Timeout Settings** section's **Edit** icons.

Figure 564 Configuration > Object > User/Group > Setting > Edit

The following table describes the labels in this screen.

Table 305 Configuration > Object > User/Group > Setting > Edit

LABEL	DESCRIPTION
User Type	<p>This read-only field identifies the type of user account for which you are configuring the default settings.</p> <ul style="list-style-type: none"> admin - this user can look at and change the configuration of the Zyxel Device limited-admin - this user can look at the configuration of the Zyxel Device but not to change it. dynamic-guest - this user has access to the Zyxel Device's services but cannot look at the configuration. user - this user has access to the Zyxel Device's services but cannot look at the configuration. guest - this user has access to the Zyxel Device's services but cannot look at the configuration. ext-user - this user account is maintained in a remote server, such as RADIUS or LDAP. See Ext-User Accounts on page 832 for more information about this type. ext-group-user - this user account is maintained in a remote server, such as RADIUS or LDAP. See Ext-Group-User Accounts on page 832 for more information about this type. guest-manager - this user can log in via the web configurator login screen and create dynamic guest accounts using the Account Generator screen that pops up. See Section 21.4.1 on page 553 for detailed information about the Account Generator screen.
Lease Time	<p>Enter the number of minutes this type of user account has to renew the current session before the user is logged out. You can specify 1 to 1440 minutes. You can enter 0 to make the number of minutes unlimited.</p> <p>Admin users renew the session every time the main screen refreshes in the Web Configurator. Access users can renew the session by clicking the Renew button on their screen. If you allow access users to renew time automatically (see Section 43.2.6 on page 841), the users can select this check box on their screen as well. In this case, the session is automatically renewed before the lease time expires.</p>
Reauthentication Time	<p>Type the number of minutes this type of user account can be logged into the Zyxel Device in one session before the user has to log in again. You can specify 1 to 1440 minutes. You can enter 0 to make the number of minutes unlimited. Unlike Lease Time, the user has no opportunity to renew the session without logging out.</p>
OK	Click OK to save your changes back to the Zyxel Device.
Cancel	Click Cancel to exit this screen without saving your changes.

43.2.6.2 User Aware Login Example

Access users cannot use the Web Configurator to browse the configuration of the Zyxel Device. Instead, after access users log into the Zyxel Device, the following screen appears.

Figure 565 Web Configurator for Non-Admin Users

test, You now have logged in.

Click the logout button to terminate the access session.
You could renew your lease time by clicking the Renew button.
For security reason you must login in again after 24 hours 0 minutes.

User-defined lease time (max 1440 minutes):

Updating lease time automatically

Remaining time before lease timeout (hh:mm:ss):

Remaining time before auth. timeout (hh:mm):

The following table describes the labels in this screen.

Table 306 Web Configurator for Non-Admin Users

LABEL	DESCRIPTION
User-defined lease time (max ... minutes)	Access users can specify a lease time shorter than or equal to the one that you specified. The default value is the lease time that you specified.
Renew	Access users can click this button to reset the lease time, the amount of time remaining before the Zyxel Device automatically logs them out. The Zyxel Device sets this amount of time according to the: <ul style="list-style-type: none"> • User-defined lease time field in this screen • Lease time field in the User Add/Edit screen (see Section 43.2.3 on page 834) • Lease time field in the Setting screen (see Section 43.2.6 on page 841).
Updating lease time automatically	This box appears if you checked the Allow renewing lease time automatically box in the Setting screen. (See Section 43.2.6 on page 841 .) Access users can select this check box to reset the lease time automatically 30 seconds before it expires. Otherwise, access users have to click the Renew button to reset the lease time.
Remaining time before lease timeout	This field displays the amount of lease time that remains, though the user might be able to reset it.
Remaining time before auth. timeout	This field displays the amount of time that remains before the Zyxel Device automatically logs the access user out, regardless of the lease time.

43.2.7 User/Group MAC Address Summary Screen

This screen shows the MAC addresses of wireless clients, which can be authenticated by their MAC addresses using the local user database. Click **Configuration > Object > User/Group > MAC Address** to open this screen.

Note: You need to configure an SSID security profile's MAC authentication settings to have the AP use the Zyxel Device's local database to authenticate wireless clients by their MAC addresses.

Figure 566 Configuration > Object > User/Group > MAC Address

MAC Address / OUI	Description
12:34:56:78:90:AB	User Joe's PC
34:56:78:90:AB:CD	User Jane's Tablet
12:34:56	User Mary's IPAD

The following table describes the labels in this screen.

Table 307 Configuration > Object > User/Group > MAC Address

LABEL	DESCRIPTION
Add	Click this to create a new entry.
Edit	Double-click an entry or select it and click Edit to open a screen where you can modify the entry's settings.
Remove	To remove an entry, select it and click Remove . The Zyxel Device confirms you want to remove it before doing so.
MAC Address/ OUI	This field displays the MAC address or OUI (Organizationally Unique Identifier of computer hardware manufacturers) of wireless clients using MAC authentication with the Zyxel Device local user database.
Description	This field displays a description of the device identified by the MAC address or OUI.

43.2.7.1 MAC Address Add/Edit Screen

This screen allows you to create a new allowed device or edit an existing one. To access this screen, go to the **MAC Address** screen (see [Section 43.2.7 on page 845](#)), and click either the **Add** icon or an **Edit** icon.

Figure 567 Configuration > Object > User/Group > MAC Address > Add

The following table describes the labels in this screen.

Table 308 Configuration > Object > User/Group > MAC Address > Add

LABEL	DESCRIPTION
MAC Address/ OUI	Type the MAC address (six hexadecimal number pairs separated by colons or hyphens) or OUI (three hexadecimal number pairs separated by colons or hyphens) to identify specific wireless clients for MAC authentication using the Zyxel Device local user database. The OUI is the first three octets in a MAC address and uniquely identifies the manufacturer of a network device.
Description	Enter an optional description of the wireless device(s) identified by the MAC or OUI. You can use up to 60 characters, punctuation marks, and spaces.

Table 308 Configuration > Object > User/Group > MAC Address > Add (continued)

LABEL	DESCRIPTION
OK	Click OK to save your changes back to the Zyxel Device.
Cancel	Click Cancel to exit this screen without saving your changes.

43.2.8 User /Group Technical Reference

This section provides some information on users who use an external authentication server in order to log in.

Setting up User Attributes in an External Server

To set up user attributes, such as reauthentication time, in LDAP or RADIUS servers, use the following keywords in the user configuration file.

Table 309 LDAP/RADIUS: Keywords for User Attributes

KEYWORD	CORRESPONDING ATTRIBUTE IN WEB CONFIGURATOR
type	User Type . Possible Values: admin, limited-admin, dynamic-guest, user, guest.
leaseTime	Lease Time . Possible Values: 1-1440 (minutes).
reauthTime	Reauthentication Time . Possible Values: 1-1440 (minutes).

The following examples show you how you might set up user attributes in LDAP and RADIUS servers.

Figure 568 LDAP Example: Keywords for User Attributes

```
type: admin
leaseTime: 99
reauthTime: 199
```

Figure 569 RADIUS Example: Keywords for User Attributes

```
type=user;leaseTime=222;reauthTime=222
```

Creating a Large Number of Ext-User Accounts

If you plan to create a large number of **Ext-User** accounts, you might use CLI commands, instead of the Web Configurator, to create the accounts. Extract the user names from the LDAP or RADIUS server, and create a shell script that creates the user accounts.

43.3 AP Profile Overview

This section shows you how to configure preset profiles for the Access Points (APs) connected to your Zyxel Device's wireless network.

- The **Radio** screen ([Section 43.3.1 on page 848](#)) creates radio configurations that can be used by the APs.
- The **SSID** screen ([Section 43.3.2 on page 854](#)) configures three different types of profiles for your networked APs.

43.3.0.1 What You Need To Know

The following terms and concepts may help as you read this section.

Wireless Profiles

At the heart of all wireless AP configurations on the Zyxel Device are profiles. A profile represents a group of saved settings that you can use across any number of connected APs. You can set up the following wireless profile types:

- **Radio** - This profile type defines the properties of an AP's radio transmitter. You can have a maximum of 32 radio profiles on the Zyxel Device.
- **SSID** - This profile type defines the properties of a single wireless network signal broadcast by an AP. Each radio on a single AP can broadcast up to 8 SSIDs. You can have a maximum of 32 SSID profiles on the Zyxel Device.
- **Security** - This profile type defines the security settings used by a single SSID. It controls the encryption method required for a wireless client to associate itself with the SSID. You can have a maximum of 32 security profiles on the Zyxel Device.
- **MAC Filtering** - This profile provides an additional layer of security for an SSID, allowing you to block access or allow access to that SSID based on wireless client MAC addresses. If a client's MAC address is on the list, then it is either allowed or denied, depending on how you set up the MAC Filter profile. You can have a maximum of 32 MAC filtering profiles on the Zyxel Device.

SSID

The SSID (Service Set Identifier) is the name that identifies the Service Set with which a wireless station is associated. Wireless stations associating to the access point (AP) must have the same SSID. In other words, it is the name of the wireless network that clients use to connect to it.

WEP

WEP (Wired Equivalent Privacy) encryption scrambles all data packets transmitted between the AP and the wireless stations associated with it in order to keep network communications private. Both the wireless stations and the access points must use the same WEP key for data encryption and decryption.

WPA and WPA2

Wi-Fi Protected Access (WPA) is a subset of the IEEE 802.11i standard. WPA2 (IEEE 802.11i) is a wireless security standard that defines stronger encryption, authentication and key management than WPA. Key differences between WPA(2) and WEP are improved data encryption and user authentication.

IEEE 802.1x

The IEEE 802.1x standard outlines enhanced security methods for both the authentication of wireless stations and encryption key management. Authentication is done using an external RADIUS server.

43.3.1 Radio Screen

This screen allows you to create radio profiles for the APs on your network. A radio profile is a list of settings that a supported managed AP (NWA5121-N for example) can use to configure either one of its two radio transmitters. To access this screen click **Configuration > Object > AP Profile**.

Note: You can have a maximum of 32 radio profiles on the Zyxel Device.

Figure 570 Configuration > Object > AP Profile > Radio

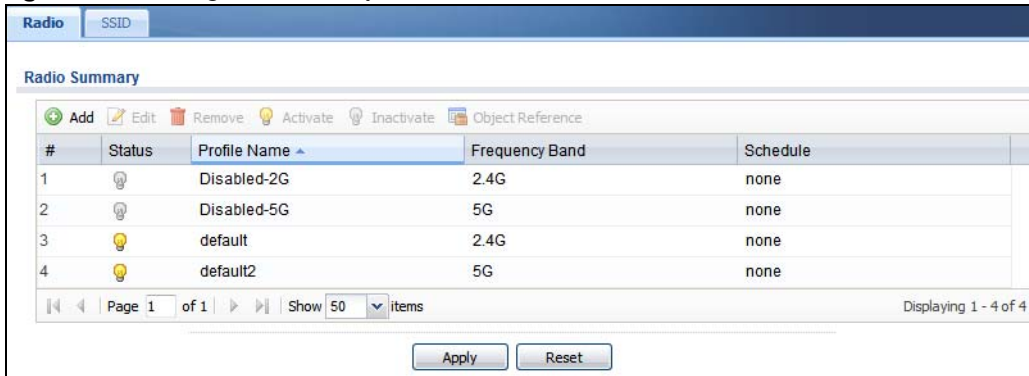

The following table describes the labels in this screen.

Table 310 Configuration > Object > AP Profile > Radio

LABEL	DESCRIPTION
Add	Click this to add a new radio profile.
Edit	Click this to edit the selected radio profile.
Remove	Click this to remove the selected radio profile.
Activate	To turn on an entry, select it and click Activate .
Inactivate	To turn off an entry, select it and click Inactivate .
References	Click this to view which other objects are linked to the selected radio profile.
#	This field is a sequential value, and it is not associated with a specific profile.
Status	This icon is lit when the entry is active and dimmed when the entry is inactive.
Profile Name	This field indicates the name assigned to the radio profile.
Frequency Band	This field indicates the frequency band which this radio profile is configured to use.
Schedule	This field displays the schedule object which defines when this radio profile can be used.
Apply	Click Apply to save your changes back to the Zyxel Device.
Reset	Click Reset to return the screen to its last-saved settings.

43.3.1.1 Add/Edit Radio Profile

This screen allows you to create a new radio profile or edit an existing one. To access this screen, click the **Add** button or select a radio profile from the list and click the **Edit** button.

WiFi6 / IEEE 802.11ax

WiFi6 is backwards compatible with IEEE 802.11a/b/g/n/ac and is most suitable in areas with a high concentration of users. WiFi6 devices support Target Wakeup Time (TWT) allowing them to automatically power down when they are inactive.

The following table displays the comparison of the different WiFi standards.

Table 311 WiFi Standards Comparison

WIFI STANDARD	MAXIMUM LINK RATE *	BAND	SIMULTANEOUS CONNECTIONS
802.11b	11 Mbps	2.4 GHz	1
802.11a/g	54 Mbps	2.4 GHz and 5 GHz	1
802.11n	600 Mbps	2.4 GHz and 5 GHz	1
802.11ac	6.93 Gbps	5 GHz	4
802.11ax	2.4 Gbps	2.4 GHz	128
	9.61 Gbps	2.4 GHz and 6 GHz	

Figure 571 Configuration > Object > AP Profile > Add/Edit Radio Profile

Edit Radio Profile default

Hide Advanced Settings Create New Object

General Settings

Activate

Profile Name: default

Schedule: none

802.11 Band: 2.4G 5G

802.11 Mode: 11ax

Channel Width: 20MHz

Channel Selection: DCS Manual s

Enable DCS Client Aware

2.4 GHz Channel Selection Method: auto

2.4 GHz Channel Deployment: Three-Channel Deployment

Time Interval

DCS Time Interval: 720 (10~1440 minutes)

Schedule

Advance

Enable A-MPDU Aggregation

A-MPDU Limit: 50000 (100~65535)

A-MPDU Subframe: 32 (2~64)

Enable A-MSDU Aggregation

A-MSDU Limit: 4096 (2290~4096)

RTS/CTS Threshold: 2347 (0~2347)

Beacon Interval: 100 (40ms~1000ms)

DTIM: 2 (1~255)

Enable Signal Threshold

Station Signal Threshold: -76 dBm (-20 ~ -105)

Disassociate Station Threshold: -105 dBm (-20 ~ -105)

Allow Station Connection after Multiple Retries

Station Retry Count: 6 (1 ~ 100)

Allow 802.11n/ac/ax stations only 1

Multicast Settings

Transmission Mode: Multicast to Unicast Fixed Multicast Rate

Multicast Rate(Mbps): 1 2 5.5 11 6 9 12 18 24 36 48 54

OK Cancel

The following table describes the labels in this screen.

Table 312 Configuration > Object > AP Profile > Add/Edit Radio Profile

LABEL	DESCRIPTION
Hide / Show Advanced Settings	Click this to hide or show the Advanced Settings in this window.
General Settings	
Activate	Select this option to make this profile active.
Profile Name	Enter up to 31 alphanumeric characters to be used as this profile's name. Spaces and underscores are allowed.
Schedule	
802.11 Band	Select whether this radio would use the .24G or 5G band.
802.11 Mode	<p>Select how to let wireless clients connect to the AP.</p> <p>If 802.11 Band is set to 2.4G:</p> <ul style="list-style-type: none"> • 11b/g: allows either IEEE 802.11b or IEEE 802.11g compliant WLAN devices to associate with the AP. The AP adjusts the transmission rate automatically according to the wireless standard supported by the wireless devices. • 11n: allows IEEE802.11b, IEEE802.11g and IEEE802.11n compliant WLAN devices to associate with the AP. <p>If 802.11 Band is set to 5G:</p> <ul style="list-style-type: none"> • 11a: allows only IEEE 802.11a compliant WLAN devices to associate with the AP. • 11a/n: allows both IEEE802.11n and IEEE802.11a compliant WLAN devices to associate with the AP. The transmission rate of your AP might be reduced. • 11ac: allows only IEEE802.11ac compliant WLAN devices to associate with the AP. • 11ax: allows IEEE802.11n, IEEE802.11a, IEEE802.11ac, and IEEE802.11ax compliant WLAN devices to associate with the AP. If the WLAN device isn't compatible with 802.11ax, the AP will communicate with the WLAN device using 802.11ac, and so on <p>Note: If you select 11ac but the WLAN devices in the network do not support IEEE 802.11ac, the Zyxel Device automatically sets the AP to use 11a/n.</p>
Channel Width	<p>Select the wireless channel bandwidth you want the AP to use.</p> <p>A standard 20 MHz channel offers transfer speeds of up to 144Mbps (2.4GHz) or 217Mbps (5GHz) whereas a 40MHz channel uses two standard channels and offers speeds of up to 300Mbps (2.4GHz) or 450Mbps (5GHz). An IEEE 802.11ac-specific 80MHz channel offers speeds of up to 1.3Gbps.</p> <p>40 MHz (channel bonding or dual channel) bonds two adjacent radio channels to increase throughput. A 80 MHz channel consists of two adjacent 40 MHz channels. The wireless clients must also support 40 MHz or 80 MHz. It is often better to use the 20 MHz setting in a location where the environment hinders the wireless signal.</p> <p>Because not all devices support 40 MHz and/or 80 MHz channels, select 20/40MHz or 20/40/80MHz to allow the AP to adjust the channel bandwidth automatically.</p> <p>Select 20MHz if you want to lessen radio interference with other wireless devices in your neighborhood or the wireless clients do not support channel bonding.</p> <p>Note: If the environment has poor signal-to-noise (SNR), the Zyxel Device will switch to a lower bandwidth.</p>

Table 312 Configuration > Object > AP Profile > Add/Edit Radio Profile (continued)

LABEL	DESCRIPTION
Channel Selection	<p>Select the wireless channel which this radio profile should use.</p> <p>It is recommended that you choose the channel least in use by other APs in the region where this profile will be implemented. This will reduce the amount of interference between wireless clients and the AP to which this profile is assigned.</p> <p>Select DCS to have the AP automatically select the radio channel upon which it broadcasts by scanning the area around it and determining what channels are currently being used by other devices.</p> <p>Note: If you change the country code later, Channel Selection is set to Manual automatically.</p> <p>Select Manual and specify the channels the AP uses.</p>
Blacklist DFS channels in presence of radar	<p>This field is available if 802.11 Band is set to 5G and Channel Selection is set to DCS.</p> <p>Enable this to temporarily blacklist the wireless channels in the Dynamic Frequency Selection (DFS) range whenever a radar signal is detected by the AP.</p>
Enable DCS Client Aware	<p>This field is available when you set Channel Selection to DCS.</p> <p>Select this to have the AP wait until all connected clients have disconnected before switching channels.</p> <p>If you disable this then the AP switches channels immediately regardless of any client connections. In this instance, clients that are connected to the AP when it switches channels are dropped.</p>
2.4 GHz Channel Selection Method	<p>This field is available when you set Channel Selection to DCS.</p> <p>Select auto to have the AP search for available channels automatically in the 2.4 GHz band. The available channels vary depending on what you select in the 2.4 GHz Channel Deployment field.</p> <p>Select manual and specify the channels the AP uses in the 2.4 GHz band.</p>
2.4 GHz Channel Deployment	<p>This field is available only when you set Channel Selection to DCS and set 2.4 GHz Channel Selection Method to auto.</p> <p>Select Three-Channel Deployment to limit channel switching to channels 1, 6, and 11, the three channels that are sufficiently attenuated to have almost no impact on one another. In other words, this allows you to minimize channel interference by limiting channel-hopping to these three "safe" channels.</p> <p>Select Four-Channel Deployment to limit channel switching to four channels. Depending on the country domain, if the only allowable channels are 1-11 then the Zyxel Device uses channels 1, 4, 7, 11 in this configuration; otherwise, the Zyxel Device uses channels 1, 5, 9, 13 in this configuration. Four channel deployment expands your pool of possible channels while keeping the channel interference to a minimum.</p>
DCS Time Interval	<p>This field is available when you set Channel Selection to DCS.</p> <p>Enter a number of minutes. This regulates how often the AP surveys the other APs within its broadcast radius. If the channel on which it is currently broadcasting suddenly comes into use by another AP, the AP will then dynamically select the next available clean channel or a channel with lower interference.</p>
Channel ID	<p>This field is available only when you set Channel Selection to DCS and set 2.4 GHz Channel Selection Method to manual.</p> <p>Select the check boxes of the channels that you want the AP to use.</p>
Schedule	<p>Select this option to have the AP survey the other APs within its broadcast radius at a specific time on selected days of the week.</p>
Start Time	<p>Specify the time of the day (in 24-hour format) to have the AP use DCS to automatically scan and find a less-used channel.</p>

Table 312 Configuration > Object > AP Profile > Add/Edit Radio Profile (continued)

LABEL	DESCRIPTION
Week Days	Select each day of the week to have the AP use DCS to automatically scan and find a less-used channel.
Enable 5 GHz DFS Aware	<p>This field is available only when you select 11a, 11a/n or 11ac in the 802.11 Band field.</p> <p>Select this if your APs are operating in an area known to have RADAR devices. This allows the device to downgrade its frequency to below 5 GHz in the event a RADAR signal is detected, thus preventing it from interfering with that signal.</p> <p>Enabling this forces the AP to select a non-DFS channel.</p>
5 GHz Channel Selection Method	This shows auto and allows the AP to search for available channels automatically in the 5 GHz band.
Advanced Settings	
Guard Interval	<p>This field is available only when the 802.11 Band is set to 5G and 802.11 Mode is set to 11n or 11ac.</p> <p>Set the guard interval for this radio profile to either Short or Long.</p> <p>The guard interval is the gap introduced between data transmission from users in order to reduce interference. Reducing the interval increases data transfer rates but also increases interference. Increasing the interval reduces data transfer rates but also reduces interference.</p>
Enable A-MPDU Aggregation	<p>Select this to enable A-MPDU aggregation.</p> <p>Message Protocol Data Unit (MPDU) aggregation collects Ethernet frames along with their 802.11n headers and wraps them in a 802.11n MAC header. This method is useful for increasing bandwidth throughput in environments that are prone to high error rates.</p>
A-MPDU Limit	Enter the maximum frame size to be aggregated.
A-MPDU Subframe	Enter the maximum number of frames to be aggregated each time.
Enable A-MSDU Aggregation	<p>Select this to enable A-MSDU aggregation.</p> <p>Mac Service Data Unit (MSDU) aggregation collects Ethernet frames without any of their 802.11n headers and wraps the header-less payload in a single 802.11n MAC header. This method is useful for increasing bandwidth throughput. It is also more efficient than A-MPDU except in environments that are prone to high error rates.</p>
A-MSDU Limit	Enter the maximum frame size to be aggregated.
RTS/CTS Threshold	<p>Use RTS/CTS to reduce data collisions on the wireless network if you have wireless clients that are associated with the same AP but out of range of one another. When enabled, a wireless client sends an RTS (Request To Send) and then waits for a CTS (Clear To Send) before it transmits. This stops wireless clients from transmitting packets at the same time (and causing data collisions).</p> <p>A wireless client sends an RTS for all packets larger than the number (of bytes) that you enter here. Set the RTS/CTS equal to or higher than the fragmentation threshold to turn RTS/CTS off.</p>
Beacon Interval	When a wirelessly networked device sends a beacon, it includes with it a beacon interval. This specifies the time period before the device sends the beacon again. The interval tells receiving devices on the network how long they can wait in low-power mode before waking up to handle the beacon. A high value helps save current consumption of the access point.
DTIM	Delivery Traffic Indication Message (DTIM) is the time period after which broadcast and multicast packets are transmitted to mobile clients in the Active Power Management mode. A high DTIM value can cause clients to lose connectivity with the network. This value can be set from 1 to 255.

Table 312 Configuration > Object > AP Profile > Add/Edit Radio Profile (continued)

LABEL	DESCRIPTION
Enable Signal Threshold	Select the check box to use the signal threshold to ensure wireless clients receive good throughput. This allows only wireless clients with a strong signal to connect to the AP. Clear the check box to not require wireless clients to have a minimum signal strength to connect to the AP.
Station Signal Threshold	Set a minimum client signal strength. A wireless client is allowed to connect to the AP only when its signal strength is stronger than the specified threshold. -20 dBm is the strongest signal you can require and -76 is the weakest.
Disassociate Station Threshold	Set a minimum kick-off signal strength. When a wireless client's signal strength is lower than the specified threshold, the Zyxel Device disconnects the wireless client from the AP. -20 dBm is the strongest signal you can require and -90 is the weakest.
Allow Station Connection after Multiple Retries	Select this option to allow a wireless client to try to associate with the AP again after it is disconnected due to weak signal strength.
Station Retry Count	Set the maximum number of times a wireless client can attempt to re-connect to the AP
Allow 802.11n/ac/ax stations only	Select this option to allow only 802.11 n/ac/ax stations to connect, and reject 802.11 a/b/g stations.
Multicast Settings	Use this section to set a transmission mode and maximum rate for multicast traffic.
Transmission Mode	Set how the AP handles multicast traffic. Select Multicast to Unicast to broadcast wireless multicast traffic to all of the wireless clients as unicast traffic. Unicast traffic dynamically changes the data rate based on the application's bandwidth requirements. The retransmit mechanism of unicast traffic provides more reliable transmission of the multicast traffic, although it also produces duplicate packets. Select Fixed Multicast Rate to send wireless multicast traffic at a single data rate. You must know the multicast application's bandwidth requirements and set it in the following field.
Multicast Rate (Mbps)	If you set the multicast transmission mode to fixed multicast rate, set the data rate for multicast traffic here. For example, to deploy 4 Mbps video, select a fixed multicast rate higher than 4 Mbps.
OK	Click OK to save your changes back to the Zyxel Device.
Cancel	Click Cancel to exit this screen without saving your changes.

43.3.2 SSID Screen

The SSID screens allow you to configure three different types of profiles for your networked APs: an SSID list, which can assign specific SSID configurations to your APs; a security list, which can assign specific encryption methods to the APs when allowing wireless clients to connect to them; and a MAC filter list, which can limit connections to an AP based on wireless clients MAC addresses.

43.3.2.1 SSID List

This screen allows you to create and manage SSID configurations that can be used by the APs. An SSID, or Service Set Identifier, is basically the name of the wireless network to which a wireless client can connect. The SSID appears as readable text to any device capable of scanning for wireless frequencies (such as the WiFi adapter in a laptop), and is displayed as the wireless network name when a person makes a connection to it.

To access this screen click **Configuration > Object > AP Profile > SSID**.

Note: You can have a maximum of 32 SSID profiles on the Zyxel Device.

Figure 572 Configuration > Object > AP Profile > SSID List

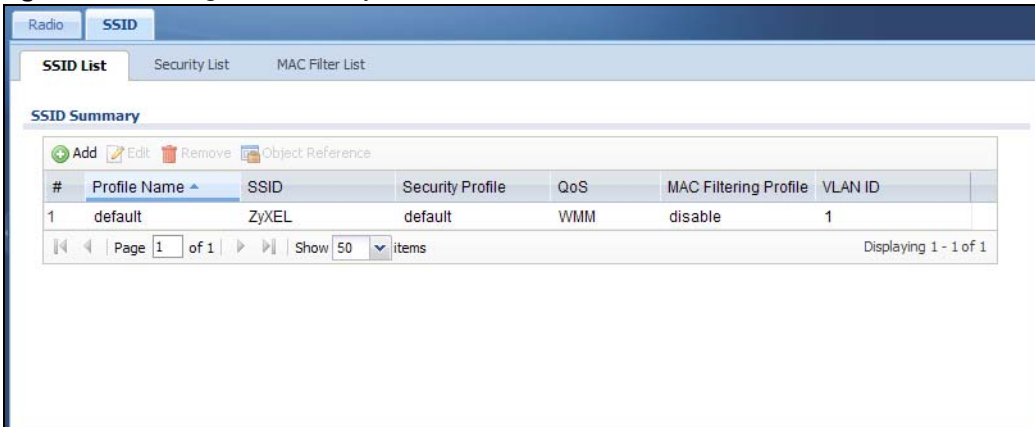

The following table describes the labels in this screen.

Table 313 Configuration > Object > AP Profile > SSID List

LABEL	DESCRIPTION
Add	Click this to add a new SSID profile.
Edit	Click this to edit the selected SSID profile.
Remove	Click this to remove the selected SSID profile.
References	Click this to view which other objects are linked to the selected SSID profile (for example, radio profile).
#	This field is a sequential value, and it is not associated with a specific profile.
Profile Name	This field indicates the name assigned to the SSID profile.
SSID	This field indicates the SSID name as it appears to wireless clients.
Security Profile	This field indicates which (if any) security profile is associated with the SSID profile.
QoS	This field indicates the QoS type associated with the SSID profile.
MAC Filtering Profile	This field indicates which (if any) MAC Filter Profile is associated with the SSID profile.
VLAN ID	This field indicates the VLAN ID associated with the SSID profile.

43.3.2.2 Add/Edit SSID Profile

This screen allows you to create a new SSID profile or edit an existing one. To access this screen, click the **Add** button or select an SSID profile from the list and click the **Edit** button.

Figure 573 Configuration > Object > AP Profile > SSID > Add/Edit SSID Profile

The following table describes the labels in this screen.

Table 314 Configuration > Object > AP Profile > SSID > Add/Edit SSID Profile

LABEL	DESCRIPTION
Create new Object	Select an object type from the list to create a new one associated with this SSID profile.
Profile Name	Enter up to 31 alphanumeric characters for the profile name. This name is only visible in the Web Configurator and is only for management purposes. Spaces and underscores are allowed.
SSID	Enter the SSID name for this profile. This is the name visible on the network to wireless clients. Enter up to 32 characters, spaces and underscores are allowed.
Security Profile	Select a security profile from this list to associate with this SSID. If none exist, you can use the Create new Object menu to create one. Note: It is highly recommended that you create security profiles for all of your SSIDs to enhance your network security.

Table 314 Configuration > Object > AP Profile > SSID > Add/Edit SSID Profile (continued)

LABEL	DESCRIPTION
MAC Filtering Profile	<p>Select a MAC filtering profile from the list to associate with this SSID. If none exist, you can use the Create new Object menu to create one.</p> <p>MAC filtering allows you to limit the wireless clients connecting to your network through a particular SSID by wireless client MAC addresses. Any clients that have MAC addresses not in the MAC filtering profile of allowed addresses are denied connections.</p> <p>The disable setting means no MAC filtering is used.</p>
QoS	<p>Select a Quality of Service (QoS) access category to associate with this SSID. Access categories minimize the delay of data packets across a wireless network. Certain categories, such as video or voice, are given a higher priority due to the time sensitive nature of their data packets.</p> <p>QoS access categories are as follows:</p> <p>disable: Turns off QoS for this SSID. All data packets are treated equally and not tagged with access categories.</p> <p>WMM: Enables automatic tagging of data packets. The Zyxel Device assigns access categories to the SSID by examining data as it passes through it and making a best guess effort. If something looks like video traffic, for instance, it is tagged as such.</p> <p>WMM_VOICE: All wireless traffic to the SSID is tagged as voice data. This is recommended if an SSID is used for activities like placing and receiving VoIP phone calls.</p> <p>WMM_VIDEO: All wireless traffic to the SSID is tagged as video data. This is recommended for activities like video conferencing.</p> <p>WMM_BEST_EFFORT: All wireless traffic to the SSID is tagged as "best effort," meaning the data travels the best route it can without displacing higher priority traffic. This is good for activities that do not require the best bandwidth throughput, such as surfing the Internet.</p> <p>WMM_BACKGROUND: All wireless traffic to the SSID is tagged as low priority or "background traffic", meaning all other access categories take precedence over this one. If traffic from an SSID does not have strict throughput requirements, then this access category is recommended. For example, an SSID that only has network printers connected to it.</p>
Rate Limiting (Per Station Traffic Rate)	Define the maximum incoming and outgoing transmission data rate per wireless station
Downlink:	Define the maximum incoming transmission data rate (either in Mbps or Kbps) on a per-station basis.
Uplink:	Define the maximum outgoing transmission data rate (either in Mbps or Kbps) on a per-station basis.
Band Select:	<p>To improve network performance and avoid interference in the 2.4 GHz frequency band, you can enable this feature to use the 5 GHz band first. You should set 2.4GHz and 5 GHz radio profiles to use the same SSID and security settings.</p> <p>Select standard to have the AP try to connect the wireless clients to the same SSID using the 5 GHz band. Connections to an SSID using the 2.4GHz band are still allowed.</p> <p>Otherwise, select disable to turn off this feature.</p>
Forwarding Mode	Select a forwarding mode (Tunnel or Local bridge) for traffic from this SSID.
VLAN ID	If you selected Local Bridge forwarding mode, enter the VLAN ID that will be used to tag all traffic originating from this SSID if the VLAN is different from the native VLAN. All the wireless station's traffic goes through the associated AP's gateway.
VLAN Interface	If you selected the Tunnel forwarding mode, select a VLAN interface. All the wireless station's traffic is forwarded to the Zyxel Device first.

Table 314 Configuration > Object > AP Profile > SSID > Add/Edit SSID Profile (continued)

LABEL	DESCRIPTION
Hidden SSID	Select this if you want to "hide" your SSID from wireless clients. This tells any wireless clients in the vicinity of the AP using this SSID profile not to display its SSID name as a potential connection. Not all wireless clients respect this flag and display it anyway. When an SSID is "hidden" and a wireless client cannot see it, the only way you can connect to the SSID is by manually entering the SSID name in your wireless connection setup screen(s) (these vary by client, client connectivity software, and operating system).
Enable Intra-BSS Traffic Blocking	Select this option to prevent crossover traffic from within the same SSID.
Enable U-APSD	Select this option to enable Unscheduled Automatic Power Save Delivery (U-APSD), which is also known as WMM-Power Save. This helps increase battery life for battery-powered wireless clients connected to the Zyxel Device using this SSID profile.
Enable ARP Proxy	The Address Resolution Protocol (ARP) is a protocol for mapping an IP address to a MAC address. An ARP broadcast is sent to all devices on the same Ethernet network to request the MAC address of a target IP address. Select this option to allow the Zyxel Device to answer ARP requests for an IP address on behalf of a client associated with this SSID. This can reduce broadcast traffic and improve network performance.
802.11 k/v Assisted Roaming	Select this option to enable IEEE 802.11k/v assisted roaming on the Zyxel Device. When the connected clients request 802.11k neighbor lists, the Zyxel Device will response with a list of neighbor APs that can be candidates for roaming.
Schedule SSID	Select this option and set whether the SSID is enabled or disabled on each day of the week. You also need to select the hour and minute (in 24-hour format) to specify the time period of each day during which the SSID is enabled/enabled.
Local VAP Setting	This part of the screen only applies to Zyxel Device models that have built-in wireless functionality (AP) - see Section 1.1 on page 28 .
VLAN Support	Select On to have the Zyxel Device assign the VLAN ID listed in the top part of the screen to the built-in AP. Select Off to have the Zyxel Device ignore the VLAN ID listed in the top part of the screen. Select an Outgoing Interface to have the Zyxel Device assign an IP address in the same subnet as the selected interface to the built-in AP.
OK	Click OK to save your changes back to the Zyxel Device.
Cancel	Click Cancel to exit this screen without saving your changes.

43.3.2.3 Security List

This screen allows you to manage wireless security configurations that can be used by your SSIDs. Wireless security is implemented strictly between the AP broadcasting the SSID and the stations that are connected to it.

To access this screen click **Configuration > Object > AP Profile > SSID > Security List**.

Note: You can have a maximum of 32 security profiles on the Zyxel Device.

Figure 574 Configuration > Object > AP Profile > SSID > Security List

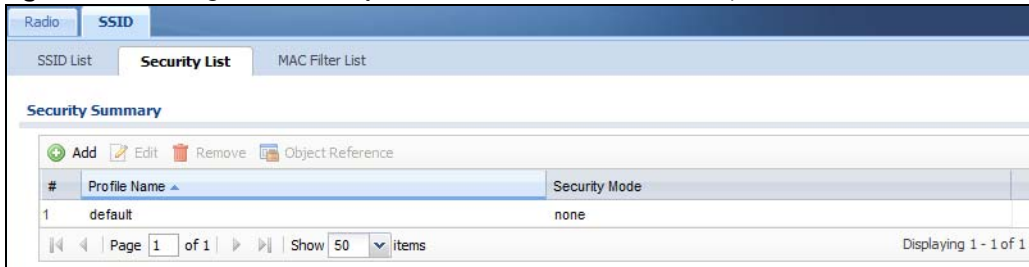

The following table describes the labels in this screen.

Table 315 Configuration > Object > AP Profile > SSID > Security List

LABEL	DESCRIPTION
Add	Click this to add a new security profile.
Edit	Click this to edit the selected security profile.
Remove	Click this to remove the selected security profile.
References	Click this to view which other objects are linked to the selected security profile (for example, SSID profile).
#	This field is a sequential value, and it is not associated with a specific profile.
Profile Name	This field indicates the name assigned to the security profile.
Security Mode	This field indicates this profile's security mode (if any).

43.3.2.4 Add/Edit Security Profile

This screen allows you to create a new security profile or edit an existing one. To access this screen, click the **Add** button or select a security profile from the list and click the **Edit** button.

Note: This screen's options change based on the **Security Mode** selected.

Figure 575 Configuration > Object > AP Profile > SSID > Security Profile > Add/Edit Security Profile > Security Mode: open

Add Security Profile

General Settings

Profile Name: ⓘ

Security Mode:

Authentication Settings

Enterprise

Reauthentication Timer: (30~30000 seconds, 0 is unlimited)

Idle timeout: (30~30000 seconds)

Radius Settings

Radius Server Type:

Radius Server IP Address:

Radius Server Port: (1~65535)

Radius Server Secret:

Secondary Radius Server Activate

Radius Server IP Address:

Radius Server Port: (1~65535)

Radius Server Secret:

Primary Accounting Server Activate

Accounting Server IP Address:

Accounting Server Port: (1~65535)

Accounting Share Secret:

Secondary Accounting Server Activate

Accounting Server IP Address:

Accounting Server Port: (1~65535)

Accounting Share Secret:

Accounting Interim Update

Interim Interval: (1~1440 minutes)

MAC Authentication Setting

MAC Authentication

Delimiter (Account):

Case (Account):

Delimiter (Calling Station ID):

Case (Calling Station ID):

OK Cancel

The following table describes the labels in this screen.

Table 316 Configuration > Object > AP Profile > SSID > Security Profile > Add/Edit Security Profile > Security Mode: open

LABEL	DESCRIPTION
Profile Name	Enter up to 31 alphanumeric characters for the profile name. This name is only visible in the Web Configurator and is only for management purposes. Spaces and underscores are allowed.
Security Mode	Select a security mode from the list: open , enhanced open , wep , wpa2 , or wpa2-mix , wpa3 .
Authentication Settings	
Enterprise	Select this to enable 802.1x secure authentication with a RADIUS server.
Reauthentication Timer	Enter the interval (in seconds) between authentication requests. Enter a 0 for unlimited time.
Idle Timeout	Enter the idle interval (in seconds) that a client can be idle before authentication is discontinued.
Radius Settings	
Primary / Secondary Radius Server Activate	Select this to have the Zyxel Device use the specified RADIUS server.
Radius Server IP Address	Enter the IP address of the RADIUS server to be used for authentication.
Radius Server Port	Enter the port number of the RADIUS server to be used for authentication.
Radius Server Secret	Enter the shared secret password of the RADIUS server to be used for authentication.
Primary / Secondary Accounting Server Activate	Select the check box to enable user accounting through an external authentication server.
Accounting Server IP Address	Enter the IP address of the external accounting server in dotted decimal notation.
Accounting Server Port	Enter the port number of the external accounting server. The default port number is 1813. You need not change this value unless your network administrator instructs you to do so with additional information.
Accounting Share Secret	Enter a password (up to 128 alphanumeric characters) as the key to be shared between the external accounting server and the Zyxel Device. The key must be the same on the external accounting server and your Zyxel Device. The key is not sent over the network.
Accounting Interim Update	This field is available only when you enable user accounting through an external authentication server. Select this to have the Zyxel Device send subscriber status updates to the accounting server at the interval you specify.
Interim Update Interval	Specify the time interval for how often the Zyxel Device is to send a subscriber status update to the accounting server.
MAC Authentication	Select this to use an external server or the Zyxel Device's local database to authenticate wireless clients by their MAC addresses. Users cannot get an IP address if the MAC authentication fails. An external server can use the wireless client's account (username/password) or Calling Station ID for MAC authentication. Configure the ones the external server uses.
Delimiter (Account)	Select the separator the external server uses for the two-character pairs within account MAC addresses.
Case (Account)	Select the case (upper or lower) the external server requires for letters in the account MAC addresses.

Table 316 Configuration > Object > AP Profile > SSID > Security Profile > Add/Edit Security Profile> Security Mode: open (continued)

LABEL	DESCRIPTION
Delimiter (Calling Station ID)	RADIUS servers can require the MAC address in the Calling Station ID RADIUS attribute. Select the separator the external server uses for the pairs in calling station MAC addresses.
Case (Calling Station ID)	Select the case (upper or lower) the external server requires for letters in the calling station MAC addresses.
OK	Click OK to save your changes back to the Zyxel Device.
Cancel	Click Cancel to exit this screen without saving your changes.

Figure 576 Configuration > Object > AP Profile > SSID > Security Profile > Add/Edit Security Profile> Security Mode: enhanced-open

The following table describes the labels in this screen.

Table 317 Configuration > Object > AP Profile > SSID > Security Profile > Add/Edit Security Profile > Security Mode: enhanced-open

LABEL	DESCRIPTION
Profile Name	Enter up to 31 alphanumeric characters for the profile name. This name is only visible in the Web Configurator and is only for management purposes. Spaces and underscores are allowed.
Security Mode	Select a security mode from the list: open , enhanced open , wep , wpa2 , or wpa2-mix , wpa3 .
Authentication Settings	
Transition Mode	Enable this for backwards compatibility. This option is only available if the Security Mode is wpa3 or enhanced-open . This creates two virtual APs (VAPs) with a primary (wpa3 or enhanced-open) and fallback (wpa2 or none) security method. If the Security Mode is wpa3 , enabling this will force Management Frame Protection to be set to Optional . If this is disabled or if the Security Mode is enhanced-open , Management Frame Protection will be set to Required .
Idle Timeout	Enter the idle interval (in seconds) that a client can be idle before authentication is discontinued.
Radius Settings	
Primary / Secondary Radius Server Activate	Select this to have the Zyxel Device use the specified RADIUS server.
Radius Server IP Address	Enter the IP address of the RADIUS server to be used for authentication.
Radius Server Port	Enter the port number of the RADIUS server to be used for authentication.
Radius Server Secret	Enter the shared secret password of the RADIUS server to be used for authentication.
Primary / Secondary Accounting Server Activate	Select the check box to enable user accounting through an external authentication server.
Accounting Server IP Address	Enter the IP address of the external accounting server in dotted decimal notation.
Accounting Server Port	Enter the port number of the external accounting server. The default port number is 1813. You need not change this value unless your network administrator instructs you to do so with additional information.
Accounting Share Secret	Enter a password (up to 128 alphanumeric characters) as the key to be shared between the external accounting server and the Zyxel Device. The key must be the same on the external accounting server and your Zyxel Device. The key is not sent over the network.
Accounting Interim Update	This field is available only when you enable user accounting through an external authentication server. Select this to have the Zyxel Device send subscriber status updates to the accounting server at the interval you specify.
Interim Update Interval	Specify the time interval for how often the Zyxel Device is to send a subscriber status update to the accounting server.
MAC Authentication	Select this to use an external server or the Zyxel Device's local database to authenticate wireless clients by their MAC addresses. Users cannot get an IP address if the MAC authentication fails. An external server can use the wireless client's account (username/password) or Calling Station ID for MAC authentication. Configure the ones the external server uses.
Delimiter (Account)	Select the separator the external server uses for the two-character pairs within account MAC addresses.

Table 317 Configuration > Object > AP Profile > SSID > Security Profile > Add/Edit Security Profile> Security Mode: enhanced-open (continued)

LABEL	DESCRIPTION
Case (Account)	Select the case (upper or lower) the external server requires for letters in the account MAC addresses.
Delimiter (Calling Station ID)	RADIUS servers can require the MAC address in the Calling Station ID RADIUS attribute. Select the separator the external server uses for the pairs in calling station MAC addresses.
Case (Calling Station ID)	Select the case (upper or lower) the external server requires for letters in the calling station MAC addresses.
OK	Click OK to save your changes back to the Zyxel Device.
Cancel	Click Cancel to exit this screen without saving your changes.

Figure 577 Configuration > Object > AP Profile > SSID > Security Profile > Add/Edit Security Profile> Security Mode: wep

Add Security Profile

General Settings

Profile Name:

Security Mode: **wep**

Authentication Settings

Enterprise

Reauthentication Timer: (30~30000 seconds, 0 is unlimited)

Idle timeout: (30~30000 seconds)

Authentication Type: **open**

Key Length: **WEP-64**

64-bit: Enter 5 ASCII characters or 10 hexadecimal characters (0-F, a-f, A-F) for each Key (1-4).
128-bit: Enter 13 ASCII characters or 26 hexadecimal characters (0-F, a-f, A-F) for each Key (1-4).

Key 1

Key 2

Key 3

Key 4

Radius Settings

Radius Server Type: **External**

Radius Server IP Address:

Radius Server Port: [1~65535]

Radius Server Secret:

Secondary Radius Server Activate

Radius Server IP Address:

Radius Server Port: [1~65535]

Radius Server Secret:

Primary Accounting Server Activate

Accounting Server IP Address:

Accounting Server Port: [1~65535]

Accounting Share Secret:

Secondary Accounting Server Activate

Accounting Server IP Address:

Accounting Server Port: [1~65535]

Accounting Share Secret:

Accounting Interim Update

Interim Interval: [1~1440 minutes]

MAC Authentication Setting

MAC Authentication

Delimiter (Account): **colon (:)**

Case (Account): **upper**

Delimiter (Calling Station ID): **colon (:)**

Case (Calling Station ID): **upper**

OK Cancel

The following table describes the labels in this screen.

Table 318 Configuration > Object > AP Profile > SSID > Security Profile > Add/Edit Security Profile > Security Mode: wep

LABEL	DESCRIPTION
Profile Name	Enter up to 31 alphanumeric characters for the profile name. This name is only visible in the Web Configurator and is only for management purposes. Spaces and underscores are allowed.
Security Mode	Select a security mode from the list: open , enhanced open , wep , wpa2 , or wpa2-mix , wpa3 .
Authentication Settings	
Enterprise	Select this to enable 802.1x secure authentication with a RADIUS server.
Reauthentication Timer	Enter the interval (in seconds) between authentication requests. Enter a 0 for unlimited time.
Idle Timeout	Enter the idle interval (in seconds) that a client can be idle before authentication is discontinued.
Authentication Type	Select a WEP authentication method. Choices are Open or Share key.
Key Length	Select the bit-length of the encryption key to be used in WEP connections. If you select WEP-64 : <ul style="list-style-type: none"> Enter 10 hexadecimal digits in the range of "A-F", "a-f" and "0-9" (for example, 0x11AA22BB33) for each Key used. or <ul style="list-style-type: none"> Enter 5 ASCII characters (case sensitive) ranging from "a-z", "A-Z" and "0-9" (for example, MyKey) for each Key used. If you select WEP-128 : <ul style="list-style-type: none"> Enter 26 hexadecimal digits in the range of "A-F", "a-f" and "0-9" (for example, 0x00112233445566778899AABBCC) for each Key used. or <ul style="list-style-type: none"> Enter 13 ASCII characters (case sensitive) ranging from "a-z", "A-Z" and "0-9" (for example, MyKey12345678) for each Key used.
Key 1~4	Based on your Key Length selection, enter the appropriate length hexadecimal or ASCII key.
Radius Settings	
Primary / Secondary Radius Server Activate	Select this to have the Zyxel Device use the specified RADIUS server.
Radius Server IP Address	Enter the IP address of the RADIUS server to be used for authentication.
Radius Server Port	Enter the port number of the RADIUS server to be used for authentication.
Radius Server Secret	Enter the shared secret password of the RADIUS server to be used for authentication.
Primary / Secondary Accounting Server Activate	Select the check box to enable user accounting through an external authentication server.
Accounting Server IP Address	Enter the IP address of the external accounting server in dotted decimal notation.
Accounting Server Port	Enter the port number of the external accounting server. The default port number is 1813. You need not change this value unless your network administrator instructs you to do so with additional information.
Accounting Share Secret	Enter a password (up to 128 alphanumeric characters) as the key to be shared between the external accounting server and the Zyxel Device. The key must be the same on the external accounting server and your Zyxel Device. The key is not sent over the network.

Table 318 Configuration > Object > AP Profile > SSID > Security Profile > Add/Edit Security Profile > Security Mode: wep (continued)

LABEL	DESCRIPTION
Accounting Interim Update	<p>This field is available only when you enable user accounting through an external authentication server.</p> <p>Select this to have the Zyxel Device send subscriber status updates to the accounting server at the interval you specify.</p>
Interim Update Interval	Specify the time interval for how often the Zyxel Device is to send a subscriber status update to the accounting server.
MAC Authentication	<p>Select this to use an external server or the Zyxel Device's local database to authenticate wireless clients by their MAC addresses. Users cannot get an IP address if the MAC authentication fails.</p> <p>An external server can use the wireless client's account (username/password) or Calling Station ID for MAC authentication. Configure the ones the external server uses.</p>
Delimiter (Account)	Select the separator the external server uses for the two-character pairs within account MAC addresses.
Case (Account)	Select the case (upper or lower) the external server requires for letters in the account MAC addresses.
Delimiter (Calling Station ID)	<p>RADIUS servers can require the MAC address in the Calling Station ID RADIUS attribute.</p> <p>Select the separator the external server uses for the pairs in calling station MAC addresses.</p>
Case (Calling Station ID)	Select the case (upper or lower) the external server requires for letters in the calling station MAC addresses.
OK	Click OK to save your changes back to the Zyxel Device.
Cancel	Click Cancel to exit this screen without saving your changes.

Figure 578 Configuration > Object > AP Profile > SSID > Security Profile > Add/Edit Security Profile > Security Mode: wpa2/ wpa2-mix

Add Security Profile

General Settings

Profile Name: !

Security Mode:

Authentication Settings

Enterprise

Reauthentication Timer: (30~30000 seconds, 0 is unlimited)

Personal

Pre-Shared Key:

Cipher Type:

Idle Timeout: (30~30000 seconds)

Group Key Update Timer: (30~30000 seconds)

Pre-Authentication:

Management Frame Protection Optional Required

Fast Roaming Settings

802.11r

Radius Settings

Radius Server Type:

Radius Server IP Address:

Radius Server Port: (1~65535)

Radius Server Secret:

Secondary Radius Server Activate

Radius Server IP Address:

Radius Server Port: (1~65535)

Radius Server Secret:

Primary Accounting Server Activate

Accounting Server IP Address:

Accounting Server Port: (1~65535)

Accounting Share Secret:

Secondary Accounting Server Activate

Accounting Server IP Address:

Accounting Server Port: (1~65535)

Accounting Share Secret:

Accounting Interim Update

Interim Interval: (1~1440 minutes)

MAC Authentication Setting

MAC Authentication

Delimiter (Account):

Case (Account):

Delimiter (Calling Station ID):

Case (Calling Station ID):

OK Cancel

The following table describes the labels in this screen.

Table 319 Configuration > Object > AP Profile > SSID > Security Profile > Add/Edit Security Profile > Security Mode: wpa2/ wpa2-mix

LABEL	DESCRIPTION
Profile Name	Enter up to 31 alphanumeric characters for the profile name. This name is only visible in the Web Configurator and is only for management purposes. Spaces and underscores are allowed.
Security Mode	Select a security mode from the list: open , enhanced open , wep , wpa2 , or wpa2-mix , wpa3 .
Authentication Settings	
Enterprise	Select this to enable 802.1x secure authentication with a RADIUS server.
Reauthentication Timer	Enter the interval (in seconds) between authentication requests. Enter a 0 for unlimited time.
Personal	This field is available when you select the wpa2 , wpa2-mix or wpa3 security mode. Select this option to use a Pre-Shared Key (PSK) with WPA2 encryption or Simultaneous Authentication of Equals (SAE) with WPA3 encryption.
Pre-Shared Key	Enter a pre-shared key of between 8 and 63 case-sensitive ASCII characters (including spaces and symbols) or 64 hexadecimal characters.
Cipher Type	Select an encryption cipher type from the list. <ul style="list-style-type: none"> auto - This automatically chooses the best available cipher based on the cipher in use by the wireless client that is attempting to make a connection. aes - This is the Advanced Encryption Standard encryption method. It is a more recent development over TKIP and considerably more robust. Not all wireless clients may support this.
Idle Timeout	Enter the idle interval (in seconds) that a client can be idle before authentication is discontinued.
Group Key Update Timer	Enter the interval (in seconds) at which the AP updates the group WPA2 encryption key.
Management Frame Protection	This field is available only when you select wpa2 in the Security Mode field and set Cipher Type to aes . Data frames in 802.11 WLANs can be encrypted and authenticated with WEP, WPA or WPA2. But 802.11 management frames, such as beacon/probe response, association request, association response, de-authentication and disassociation are always unauthenticated and unencrypted. IEEE 802.11w Protected Management Frames allows APs to use the existing security mechanisms (encryption and authentication methods defined in IEEE 802.11i WPA/WPA2) to protect management frames. This helps prevent wireless DoS attacks. Select the check box to enable management frame protection (MFP) to add security to 802.11 management frames. Select Optional if you do not require the wireless clients to support MFP. Management frames will be encrypted if the clients support MFP. Select Required and wireless clients must support MFP in order to join the Zyxel Device's wireless network.
Fast Roaming Settings	IEEE 802.11r fast roaming, which is also known as Fast BSS Transition (FT), allows wireless clients to quickly move from one AP to another in a WiFi network that uses WPA2 with 802.1x authentication. Information from the original association is passed to the target AP when the client roams. The client doesn't need to perform the whole 802.1x authentication process. Messages exchanged between the target AP and client are reduced and performed using one of the two methods: <ul style="list-style-type: none"> Over-the-DS: The wireless client communicates with the target AP via the current AP. The communication is sent to the target AP through the wired Ethernet connection. Over-the-Air: The wireless client communicates directly with the target AP.

Table 319 Configuration > Object > AP Profile > SSID > Security Profile > Add/Edit Security Profile > Security Mode: wpa2/ wpa2-mix (continued)

LABEL	DESCRIPTION
802.11r	Select this to turn on IEEE 802.11r fast roaming on the AP (Zyxel Device). This is good for wireless clients that transport a lot of real-time interactive traffic, such as voice and video. Wireless clients should also support WPA2 and fast roaming to associate with the AP (Zyxel Device) and roam seamlessly.
Radius Settings	
Primary / Secondary Radius Server Activate	Select this to have the Zyxel Device use the specified RADIUS server.
Radius Server IP Address	Enter the IP address of the RADIUS server to be used for authentication.
Radius Server Port	Enter the port number of the RADIUS server to be used for authentication.
Radius Server Secret	Enter the shared secret password of the RADIUS server to be used for authentication.
Primary / Secondary Accounting Server Activate	Select the check box to enable user accounting through an external authentication server.
Accounting Server IP Address	Enter the IP address of the external accounting server in dotted decimal notation.
Accounting Server Port	Enter the port number of the external accounting server. The default port number is 1813. You need not change this value unless your network administrator instructs you to do so with additional information.
Accounting Share Secret	Enter a password (up to 128 alphanumeric characters) as the key to be shared between the external accounting server and the Zyxel Device. The key must be the same on the external accounting server and your Zyxel Device. The key is not sent over the network.
Accounting Interim Update	This field is available only when you enable user accounting through an external authentication server. Select this to have the Zyxel Device send subscriber status updates to the accounting server at the interval you specify.
Interim Update Interval	Specify the time interval for how often the Zyxel Device is to send a subscriber status update to the accounting server.
MAC Authentication	Select this to use an external server or the Zyxel Device's local database to authenticate wireless clients by their MAC addresses. Users cannot get an IP address if the MAC authentication fails. An external server can use the wireless client's account (username/password) or Calling Station ID for MAC authentication. Configure the ones the external server uses.
Delimiter (Account)	Select the separator the external server uses for the two-character pairs within account MAC addresses.
Case (Account)	Select the case (upper or lower) the external server requires for letters in the account MAC addresses.
Delimiter (Calling Station ID)	RADIUS servers can require the MAC address in the Calling Station ID RADIUS attribute. Select the separator the external server uses for the pairs in calling station MAC addresses.
Case (Calling Station ID)	Select the case (upper or lower) the external server requires for letters in the calling station MAC addresses.
OK	Click OK to save your changes back to the Zyxel Device.
Cancel	Click Cancel to exit this screen without saving your changes.

Figure 579 Configuration > Object > AP Profile > SSID > Security Profile > Add/Edit Security Profile > Security Mode: wpa3

The following table describes the labels in this screen.

Table 320 Configuration > Object > AP Profile > SSID > Security Profile > Add/Edit Security Profile > Security Mode: wpa3

LABEL	DESCRIPTION
Profile Name	Enter up to 31 alphanumeric characters for the profile name. This name is only visible in the Web Configurator and is only for management purposes. Spaces and underscores are allowed.
Security Mode	Select a security mode from the list: open , enhanced open , wep , wpa2 , or wpa2-mix , wpa3 .
Authentication Settings	
Enterprise	Select this to enable 802.1x secure authentication with a RADIUS server.

Table 320 Configuration > Object > AP Profile > SSID > Security Profile > Add/Edit Security Profile > Security Mode: wpa3 (continued)

LABEL	DESCRIPTION
Reauthentication Timer	Enter the interval (in seconds) between authentication requests. Enter a 0 for unlimited time.
Personal	This field is available when you select the wpa2 , wpa2-mix or wpa3 security mode. Select this option to use a Pre-Shared Key (PSK) with WPA2 encryption or Simultaneous Authentication of Equals (SAE) with WPA3 encryption.
Pre-Shared Key	Enter a pre-shared key of between 8 and 63 case-sensitive ASCII characters (including spaces and symbols) or 64 hexadecimal characters.
Transition Mode	Enable this for backwards compatibility. This option is only available if the Security Mode is wpa3 or enhanced-open . This creates two virtual APs (VAPs) with a primary (wpa3 or enhanced-open) and fallback (wpa2 or none) security method. If the Security Mode is wpa3 , enabling this will force Management Frame Protection to be set to Optional . If this is disabled or if the Security Mode is enhanced-open , Management Frame Protection will be set to Required .
Idle Timeout	Enter the idle interval (in seconds) that a client can be idle before authentication is discontinued.
Group Key Update Timer	Enter the interval (in seconds) at which the AP updates the group WPA2 encryption key.
Management Frame Protection	This field is available only when you select wpa2 in the Security Mode field and set Cipher Type to aes . Data frames in 802.11 WLANs can be encrypted and authenticated with WEP, WPA or WPA2. But 802.11 management frames, such as beacon/probe response, association request, association response, de-authentication and disassociation are always unauthenticated and unencrypted. IEEE 802.11w Protected Management Frames allows APs to use the existing security mechanisms (encryption and authentication methods defined in IEEE 802.11i WPA/WPA2) to protect management frames. This helps prevent wireless DoS attacks. Select the check box to enable management frame protection (MFP) to add security to 802.11 management frames. Select Optional if you do not require the wireless clients to support MFP. Management frames will be encrypted if the clients support MFP. Select Required and wireless clients must support MFP in order to join the Zyxel Device's wireless network.
Radius Settings	
Primary / Secondary Radius Server Activate	Select this to have the Zyxel Device use the specified RADIUS server.
Radius Server IP Address	Enter the IP address of the RADIUS server to be used for authentication.
Radius Server Port	Enter the port number of the RADIUS server to be used for authentication.
Radius Server Secret	Enter the shared secret password of the RADIUS server to be used for authentication.
Primary / Secondary Accounting Server Activate	Select the check box to enable user accounting through an external authentication server.
Accounting Server IP Address	Enter the IP address of the external accounting server in dotted decimal notation.
Accounting Server Port	Enter the port number of the external accounting server. The default port number is 1813. You need not change this value unless your network administrator instructs you to do so with additional information.

Table 320 Configuration > Object > AP Profile > SSID > Security Profile > Add/Edit Security Profile> Security Mode: wpa3 (continued)

LABEL	DESCRIPTION
Accounting Share Secret	Enter a password (up to 128 alphanumeric characters) as the key to be shared between the external accounting server and the Zyxel Device. The key must be the same on the external accounting server and your Zyxel Device. The key is not sent over the network.
Accounting Interim Update	This field is available only when you enable user accounting through an external authentication server. Select this to have the Zyxel Device send subscriber status updates to the accounting server at the interval you specify.
Interim Update Interval	Specify the time interval for how often the Zyxel Device is to send a subscriber status update to the accounting server.
MAC Authentication	Select this to use an external server or the Zyxel Device's local database to authenticate wireless clients by their MAC addresses. Users cannot get an IP address if the MAC authentication fails. An external server can use the wireless client's account (username/password) or Calling Station ID for MAC authentication. Configure the ones the external server uses.
Delimiter (Account)	Select the separator the external server uses for the two-character pairs within account MAC addresses.
Case (Account)	Select the case (upper or lower) the external server requires for letters in the account MAC addresses.
Delimiter (Calling Station ID)	RADIUS servers can require the MAC address in the Calling Station ID RADIUS attribute. Select the separator the external server uses for the pairs in calling station MAC addresses.
Case (Calling Station ID)	Select the case (upper or lower) the external server requires for letters in the calling station MAC addresses.
OK	Click OK to save your changes back to the Zyxel Device.
Cancel	Click Cancel to exit this screen without saving your changes.

43.3.2.5 MAC Filter List

This screen allows you to create and manage security configurations that can be used by your SSIDs. To access this screen click **Configuration > Object > AP Profile > SSID > MAC Filter List**.

Note: You can have a maximum of 32 MAC filtering profiles on the Zyxel Device.

Figure 580 Configuration > Object > AP Profile > SSID > MAC Filter List

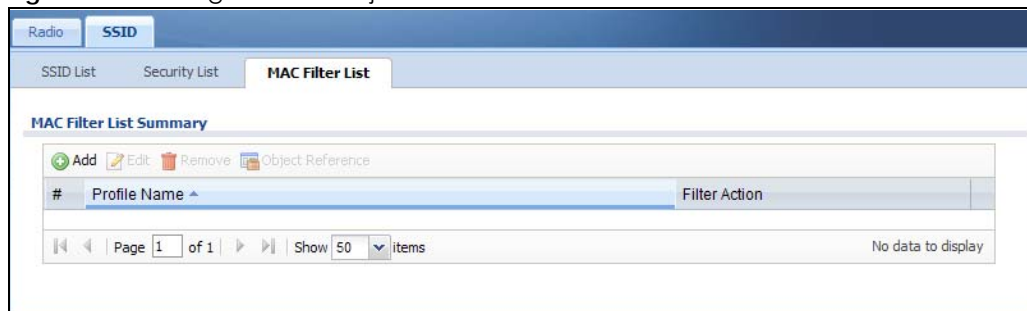

The following table describes the labels in this screen.

Table 321 Configuration > Object > AP Profile > SSID > MAC Filter List

LABEL	DESCRIPTION
Add	Click this to add a new MAC filtering profile.
Edit	Click this to edit the selected MAC filtering profile.
Remove	Click this to remove the selected MAC filtering profile.
References	Click this to view which other objects are linked to the selected MAC filtering profile (for example, SSID profile).
#	This field is a sequential value, and it is not associated with a specific profile.
Profile Name	This field indicates the name assigned to the MAC filtering profile.
Filter Action	This field indicates this profile's filter action (if any).

43.3.2.6 Add/Edit MAC Filter Profile

This screen allows you to create a new MAC filtering profile or edit an existing one. To access this screen, click the **Add** button or select a MAC filter profile from the list and click the **Edit** button.

Figure 581 SSID > MAC Filter List > Add/Edit MAC Filter Profile

The following table describes the labels in this screen.

Table 322 SSID > MAC Filter List > Add/Edit MAC Filter Profile

LABEL	DESCRIPTION
Profile Name	Enter up to 31 alphanumeric characters for the profile name. This name is only visible in the Web Configurator and is only for management purposes. Spaces and underscores are allowed.
Filter Action	Select allow to permit the wireless client with the MAC addresses in this profile to connect to the network through the associated SSID; select deny to block the wireless clients with the specified MAC addresses.
Add	Click this to add a MAC address to the profile's list.
Edit	Click this to edit the selected MAC address in the profile's list.
Remove	Click this to remove the selected MAC address from the profile's list.
#	This field is a sequential value, and it is not associated with a specific profile.
MAC Address	This field specifies a MAC address associated with this profile.

Table 322 SSID > MAC Filter List > Add/Edit MAC Filter Profile (continued)

LABEL	DESCRIPTION
Description	This field displays a description for the MAC address associated with this profile. You can click the description to make it editable. Enter up to 60 characters, spaces and underscores allowed.
OK	Click OK to save your changes back to the Zyxel Device.
Cancel	Click Cancel to exit this screen without saving your changes.

43.4 MON Profile

43.4.1 Overview

This screen allows you to set up monitor mode configurations that allow your connected APs to scan for other wireless devices in the vicinity. Once detected, you can use the **Rogue AP** screen ([Section 9.4 on page 311](#)) to classify them as either rogue or friendly and then manage them accordingly.

The **MON Profile** screen ([Section 43.4.2 on page 874](#)) creates preset monitor mode configurations that can be used by the APs.

43.4.1.1 What You Need To Know

The following terms and concepts may help as you read this chapter.

Active Scan

An active scan is performed when an 802.11-compatible wireless monitoring device is explicitly triggered to scan a specified channel or number of channels for other wireless devices broadcasting on the 802.11 frequencies by sending probe request frames.

Passive Scan

A passive scan is performed when an 802.11-compatible monitoring device is set to periodically listen to a specified channel or number of channels for other wireless devices broadcasting on the 802.11 frequencies.

43.4.2 Configuring MON Profile

This screen allows you to create monitor mode configurations that can be used by the APs. To access this screen, login to the Web Configurator, and click **Configuration > Object > MON Profile**.

Figure 582 Configuration > Object > MON Profile

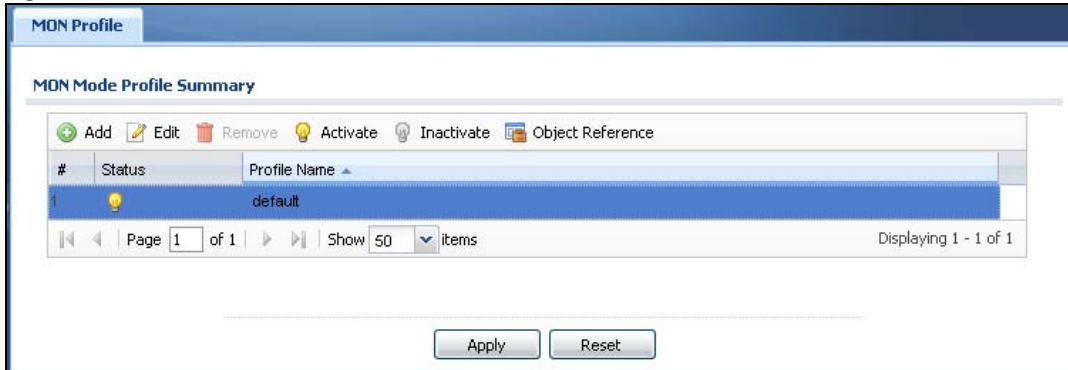

The following table describes the labels in this screen.

Table 323 Configuration > Object > MON Profile

LABEL	DESCRIPTION
Add	Click this to add a new monitor mode profile.
Edit	Click this to edit the selected monitor mode profile.
Remove	Click this to remove the selected monitor mode profile.
Activate	To turn on an entry, select it and click Activate .
Inactivate	To turn off an entry, select it and click Inactivate .
References	Click this to view which other objects are linked to the selected monitor mode profile (for example, an AP management profile).
#	This field is a sequential value, and it is not associated with a specific user.
Status	This icon is lit when the entry is active and dimmed when the entry is inactive.
Profile Name	This field indicates the name assigned to the monitor profile.
Apply	Click Apply to save your changes back to the Zyxel Device.
Reset	Click Reset to return the screen to its last-saved settings.

43.4.3 Add/Edit MON Profile

This screen allows you to create a new monitor mode profile or edit an existing one. To access this screen, click the **Add** button or select an existing monitor mode profile and click the **Edit** button.

Figure 583 Configuration > Object > MON Profile > Add/Edit MON Profile

Add MON Profile

General Settings

Activate

Profile Name:

Channel dwell time: (100ms~1000ms)

Scan Channel Mode:

Country Code:

Set Scan Channel List (2.4 GHz)

Channel ID
<input type="checkbox"/> 1
<input type="checkbox"/> 2
<input type="checkbox"/> 3
<input type="checkbox"/> 4
<input type="checkbox"/> 5
<input type="checkbox"/> 6
<input type="checkbox"/> 7
<input type="checkbox"/> 8

Set Scan Channel List (5 GHz)

Channel ID
<input type="checkbox"/> 36
<input type="checkbox"/> 40
<input type="checkbox"/> 44
<input type="checkbox"/> 48
<input type="checkbox"/> 56
<input type="checkbox"/> 60
<input type="checkbox"/> 64
<input type="checkbox"/> 100

OK Cancel

The following table describes the labels in this screen.

Table 324 Configuration > Object > MON Profile > Add/Edit MON Profile

LABEL	DESCRIPTION
Activate	Select this to activate this monitor mode profile.
Profile Name	This field indicates the name assigned to the monitor mode profile.
Channel dwell time	Enter the interval (in milliseconds) before the AP switches to another channel for monitoring.
Scan Channel Mode	Select auto to have the AP switch to the next sequential channel once the Channel dwell time expires. Select manual to set specific channels through which to cycle sequentially when the Channel dwell time expires. Selecting this options makes the Scan Channel List options available.

Table 324 Configuration > Object > MON Profile > Add/Edit MON Profile (continued)

LABEL	DESCRIPTION
Country Code	<p>Select the country code of APs that are connected to the Zyxel Device to be the same as where the Zyxel Device is located/installed.</p> <p>The available channels vary depending on the country you selected. Be sure to select the correct/same country for both radios on an AP and all connected APs, in order to prevent roaming failure and interference to other systems.</p> <p>After changing the country code, the AP channel setting will be reset if your manually selected channel(s) are not valid in the new country code setting.</p>
Set Scan Channel List (2.4 GHz)	<p>Move a channel from the Available channels column to the Channels selected column to have the APs using this profile scan that channel when Scan Channel Mode is set to manual.</p> <p>These channels are limited to the 2 GHz range (802.11 b/g/n).</p>
Set Scan Channel List (5 GHz)	<p>Move a channel from the Available channels column to the Channels selected column to have the APs using this profile scan that channel when Scan Channel Mode is set to manual.</p> <p>These channels are limited to the 5 GHz range (802.11 a/n).</p>
OK	Click OK to save your changes back to the Zyxel Device.
Cancel	Click Cancel to exit this screen without saving your changes.

43.4.4 Technical Reference

The following section contains additional technical information about the features described in this chapter.

Rogue APs

Rogue APs are wireless access points operating in a network's coverage area that are not under the control of the network's administrators, and can open up holes in a network's security. Attackers can take advantage of a rogue AP's weaker (or non-existent) security to gain access to the network, or set up their own rogue APs in order to capture information from wireless clients. If a scan reveals a rogue AP, you can use commercially-available software to physically locate it.

Figure 584 Rogue AP Example

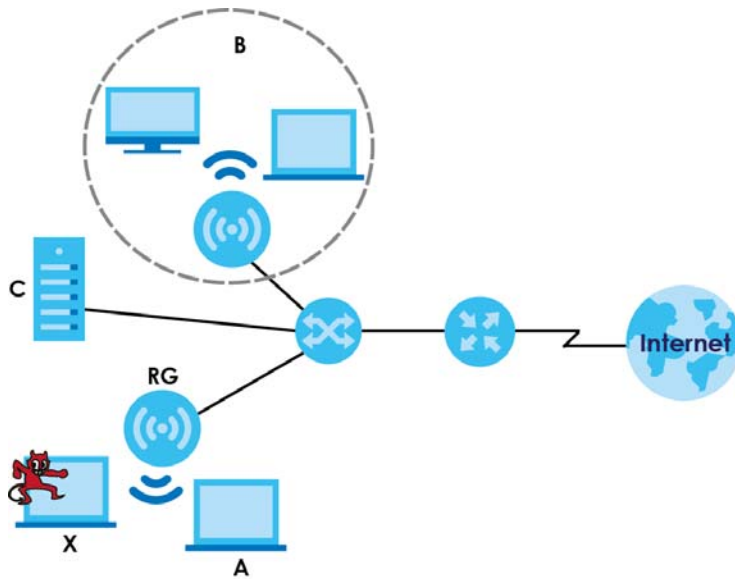

In the example above, a corporate network's security is compromised by a rogue AP (**RG**) set up by an employee at his workstation in order to allow him to connect his notebook computer wirelessly (**A**). The company's legitimate wireless network (the dashed ellipse **B**) is well-secured, but the rogue AP uses inferior security that is easily broken by an attacker (**X**) running readily available encryption-cracking software. In this example, the attacker now has access to the company network, including sensitive data stored on the file server (**C**).

Friendly APs

If you have more than one AP in your wireless network, you should also configure a list of "friendly" APs. Friendly APs are other wireless access points that are detected in your network, as well as any others that you know are not a threat (those from recognized networks, for example). It is recommended that you export (save) your list of friendly APs often, especially if you have a network with a large number of access points.

43.5 ZyMesh Overview

This section shows you how to configure ZyMesh profiles for the Zyxel Device to apply to the managed APs.

ZyMesh is a Zyxel proprietary protocol that creates wireless mesh links between managed APs to expand the wireless network. Managed APs can provide services or forward traffic between the Zyxel Device and wireless clients. ZyMesh also allows the Zyxel Device to use CAPWAP to automatically update the configuration settings on the managed APs (in repeater mode) through wireless connections. The managed APs (in repeater mode) are provisioned hop by hop.

The managed APs in a ZyMesh must use the same SSID, channel number and pre-shared key. A managed AP can be either a root AP or repeater in a ZyMesh.

Note: All managed APs should be connected to the Zyxel Device directly to get the configuration file before being deployed to build a ZyMesh. Ensure you restart the managed AP after you change its operating mode using the **Configuration > Wireless > AP Management** screen (see [Section 9.3 on page 293](#)).

- Root AP: a managed AP that can transmit and receive data from the Zyxel Device via a wired Ethernet connection.
- Repeater: a managed AP that transmits and/or receives data from the Zyxel Device via a wireless connection through a root AP.

Note: When managed APs are deployed to form a ZyMesh for the first time, the root AP must be connected to an AP controller (the Zyxel Device).

In the following example, managed APs 1 and 2 act as a root AP and managed APs A, B and C are repeaters.

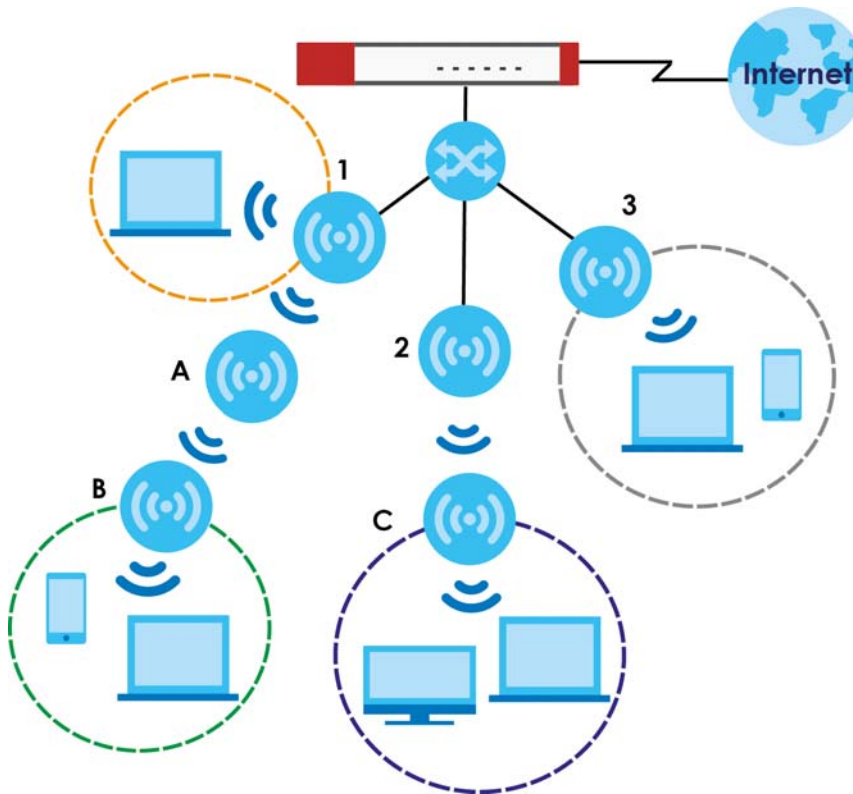

The maximum number of hops (the repeaters between a wireless client and the root AP) you can have in a ZyMesh varies according to how many wireless clients a managed AP can support.

Note: A ZyMesh link with more hops has lower throughput.

Note: When the wireless connection between the root AP and the repeater is up, in order to prevent bridge loops, the repeater would not be able to transmit data through its Ethernet port(s). The repeater then could only receive power from a PoE device if you use PoE to provide power to the managed AP via an 8-ping Ethernet cable.

43.5.1 ZyMesh Profile

This screen allows you to manage and create ZyMesh profiles that can be used by the APs. To access this screen, click **Configuration > Object > ZyMesh Profile**.

Figure 585 Configuration > Object > ZyMesh Profile

The following table describes the labels in this screen.

Table 325 Configuration > Object > ZyMesh Profile

LABEL	DESCRIPTION
Hide / Show Advanced Settings	Click this to display a greater or lesser number of configuration fields.
ZyMesh Provision Group	<p>By default, this shows the MAC address used by the Zyxel Device's first Ethernet port.</p> <p>Say you have two AP controllers (Zyxel Devices) in your network and the primary AP controller is not reachable. You may want to deploy the second/backup AP controller in your network to replace the primary AP controller. In this case, it is recommended that you enter the primary AP controller's ZyMesh Provision Group MAC address in the second AP controller's ZyMesh Provision Group field.</p> <p>If you didn't change the second AP controller's MAC address, managed APs in an existing ZyMesh can still access the networks through the second AP controller and communicate with each other. But new managed APs will not be able to communicate with the managed APs in the existing ZyMesh, which is set up with the primary AP controller's MAC address.</p> <p>To allow all managed APs to communicate in the same ZyMesh, you can just set the second AP controller to use the primary AP controller's MAC address. Otherwise, reset all managed APs to the factory defaults and set up a new ZyMesh with the second AP controller's MAC address.</p>
Next	Click this button and follow the on-screen instructions to update the AP controller's MAC address.
Add	Click this to add a new profile.
Edit	Click this to edit the selected profile.
Remove	Click this to remove the selected profile.
#	This field is a sequential value, and it is not associated with a specific profile.

Table 325 Configuration > Object > ZyMesh Profile (continued)

LABEL	DESCRIPTION
Profile Name	This field indicates the name assigned to the profile.
ZyMesh SSID	This field shows the SSID specified in this ZyMesh profile.

43.5.2 Add/Edit ZyMesh Profile

This screen allows you to create a new ZyMesh profile or edit an existing one. To access this screen, click the **Add** button or select an existing profile and click the **Edit** button.

Figure 586 Configuration > Object > ZyMesh Profile > Add/Edit ZyMesh Profile

The following table describes the labels in this screen.

Table 326 Configuration > Object > ZyMesh Profile > Add/Edit ZyMesh Profile

LABEL	DESCRIPTION
Profile Name	Enter up to 31 alphanumeric characters for the profile name.
ZyMesh SSID	Enter the SSID with which you want the managed AP to connect to a root AP or repeater to build a ZyMesh link. Note: The ZyMesh SSID is hidden in the outgoing beacon frame so a wireless device cannot obtain the SSID through scanning using a site survey tool.
Pre-Shared Key	Enter a pre-shared key of between 8 and 63 case-sensitive ASCII characters (including spaces and symbols) or 64 hexadecimal characters. The key is used to encrypt the wireless traffic between the APs.
OK	Click OK to save your changes back to the Zyxel Device.
Cancel	Click Cancel to exit this screen without saving your changes.

43.6 Application

Go to **Configuration > Licensing > Signature Update > IDP/AppPatrol** to check that you have the latest IDP and App Patrol signatures. These signatures are available to create application objects in **Configuration > Object > Application > Application**. Categories of applications include (at the time of writing):

Table 327 Categories of Applications

• Instant Messaging	• P2P	• File Transfer
• Streaming Media	• Mail and Collaboration	• Voice over IP

Table 327 Categories of Applications

• Database	• Games	• Network Management
• Remote Access Terminals	• Bypass Proxies and Tunnels	• Web
• Security Update	• Web IM	• TCP/UDP traffic
• Business	• Network Protocols	• Mobile
• Private Protocol	• Social Network	•

The following table shows the types of categories currently supported (A) and the associated signatures for each category (B).

Figure 587 Application Categories and Associated Signatures

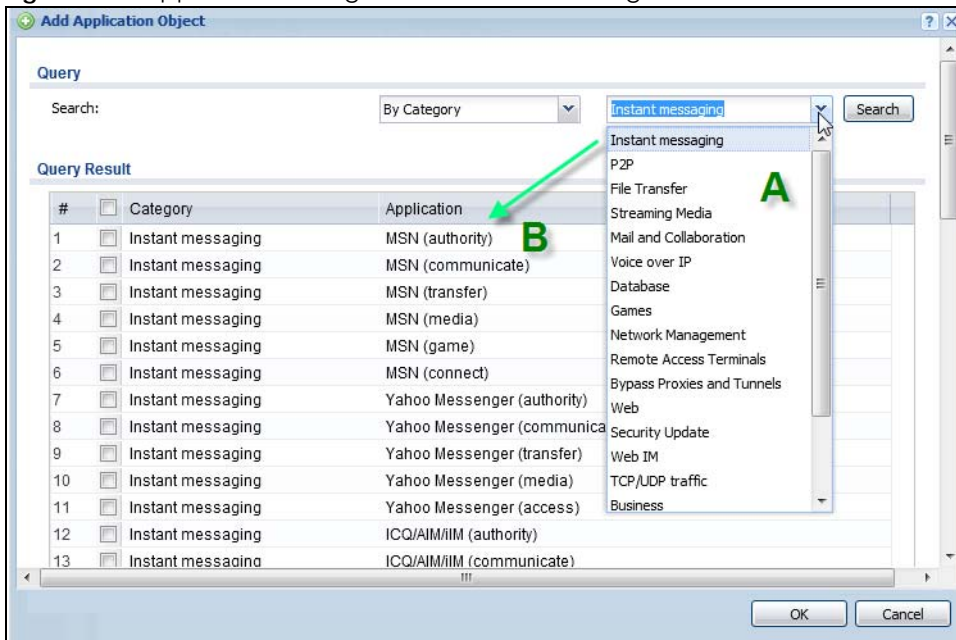

- Use the **Application** screen (Section on page 883) to create application objects that can be used in App Patrol profiles.
- Use the **Application Group** screen (Section 43.6.2 on page 886) to group application objects as an individual object that can be used in App Patrol profiles.

The Application screen allows you to create application objects consisting of service signatures as well as view license and signature information. To access this screen click **Configuration > Object > Application > Application**.

Figure 588 Configuration > Object > Application > Application

The screenshot displays the 'Application' configuration screen. At the top, there are tabs for 'Application' and 'Application Group'. Below the tabs is a 'Configuration' section with a toolbar containing 'Add', 'Edit', 'Remove', 'Object Reference', and 'Clone' icons. A table lists application objects with columns for '#', 'Name', 'Description', 'Content', and 'Ref...'. The table contains one entry: #1, Name: test, Description: New entry, Content: MSN (authority), Ref...: 0. Below the table is a 'License' section showing 'License Status: Licensed' and 'License Type: Standard'. The 'Signature Information' section shows 'Current Version: 3.1.4.049' and 'Released Date: 2013-12-05 10:09:51 (G)'. There is also a link for 'Update Signatures'.

The following table describes the labels in this screen.

Table 328 Configuration > Object > Application > Application

LABEL	DESCRIPTION
Configuration	
Add	Click this to add a new application object.
Edit	Click this to edit the selected application object.
Remove	Click this to remove the selected application object.
References	Click this to view which other objects are linked to the selected application object.
Clone	Use Clone to create a new entry by modifying an existing one. <ul style="list-style-type: none"> Select an existing entry. Click Clone. A configuration copy of the selected entry pops up. You must at least change the name as duplicate entry names are not allowed.
#	This field is a sequential value associated with an application object.
Name	This field indicates the name assigned to the application object.
Description	This field shows some extra information on the application object.
Content	This field shows the application signature(s) in this application object.
Reference	This displays the number of times an object reference is used in a profile.
License	You need to buy a license or use a trial license in order to use IDP/AppPatrol signatures. These fields show license-related information.
License Status	This field shows whether you have activated an IDP/AppPatrol signatures license
License Type	This field shows the type of IDP/AppPatrol signatures license you have activated
Signature Information	An activated license allows you to download signatures to the Zyxel Device from myZyxel. These fields show details on the signatures downloaded.
Current Version	The version number increments when signatures are updated at myZyxel. This field shows the current version downloaded to the Zyxel Device.

Table 328 Configuration > Object > Application > Application (continued)

LABEL	DESCRIPTION
Released Date	This field shows the date (YYYY-MM-DD) and time the current signature version was released.
Update Signatures	If your signature set is not the most recent, click this to go to Configuration > Licensing > Signature Update > IDP / AppPatrol to update your signatures.

43.6.1 Add Application Rule

Click **Add** in **Configuration > Object > Application > Application** to create a new application rule. In the first screen you type a name to identify this application object and write an optional brief description of it.

You then click **Add** again to choose the signatures that should go into this object.

Figure 589 Configuration > Object > Application > Application > Add Application Rule

The following table describes the labels in this screen.

Table 329 Configuration > Object > Application > Application > Add Application Rule

LABEL	DESCRIPTION
Name	Type a name to identify this application rule. You may use 1-31 alphanumeric characters, underscores(_), or dashes (-), but the first character cannot be a number. This value is case-sensitive.
Description	You may type some extra information on the application object here.
Add	Click this to create a new application rule.
Remove	Click this to remove the selected application rule.
#	This field is a sequential value associated with this application rule.
Category	This field shows the category to which the signature belongs in this application rule.
Application	This displays the name of the application signature used in this application rule.
OK	Click OK to save your changes back to the Zyxel Device.
Cancel	Click Cancel to exit this screen without saving your changes.

43.6.1.1 Add Application Object by Category or Service

Click **Add** in **Configuration > Object > Application > Application > Add Application Rule** to choose the signatures that should go into this object.

Figure 590 Configuration > Object > Application > Application > Add Application Rule > Add By Category

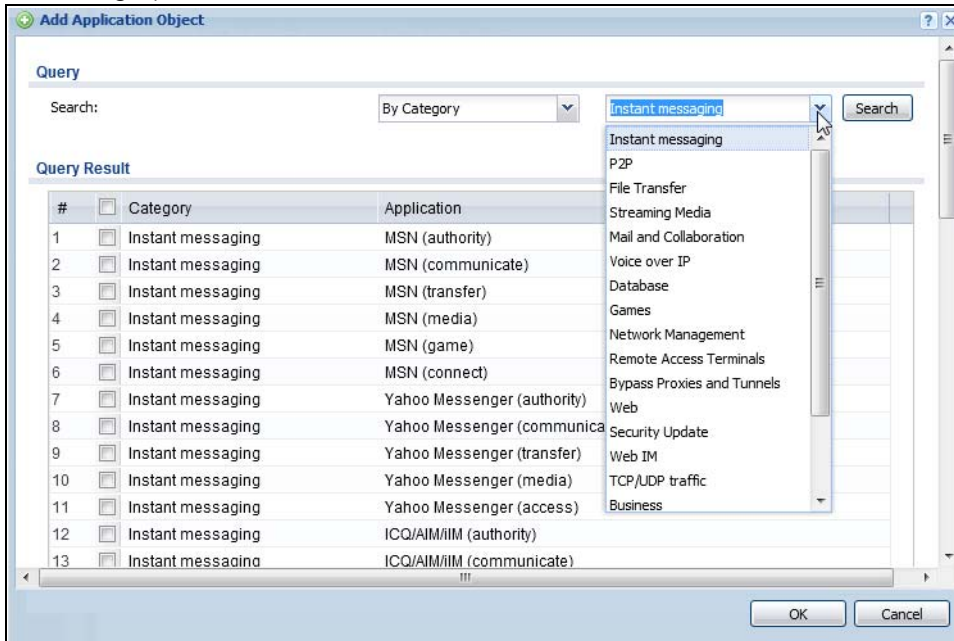
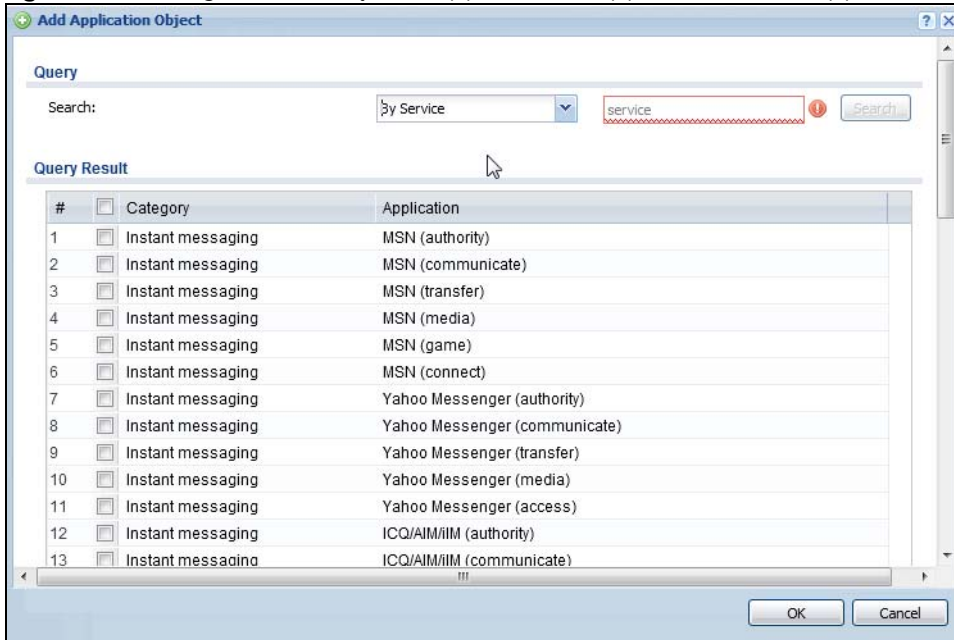

Figure 591 Configuration > Object > Application > Application > Add Application Rule > Add By Service



The following table describes the labels in this screen.

Table 330 Configuration > Object > Application > Application > Add Application Rule > Add Application Object

LABEL	DESCRIPTION
Query	
Search	Choose signatures in one of the following ways: <ul style="list-style-type: none"> Select By Category then select a category in the adjacent drop-down list box to display all signatures of that category Select By Service, type a keyword and click Search to display all signatures containing that keyword.
Query Result	The results of the search are displayed here.
#	This field is a sequential value associated with this signature
Category	This field shows the category to which the signature belongs. Select the checkbox to add this signature to the application object.
Application	This displays the name of the application signature.
OK	Click OK to save your changes back to the Zyxel Device.
Cancel	Click Cancel to exit this screen without saving your changes.

43.6.2 Application Group Screen

This screen allows you to group individual application objects to be treated as a single application object. To access this screen click **Configuration > Object > Application > Application Group**.

Figure 592 Configuration > Object > Application > Application Group



The following table describes the labels in this screen.

Table 331 Configuration > Object > Application > Application Group

LABEL	DESCRIPTION
Add	Click this to add a new application group.
Edit	Click this to edit the selected application group.
Remove	Click this to remove the selected application group.
References	Click this to view which other objects are linked to the selected application group.
#	This field is a sequential value associated with an application group.

Table 331 Configuration > Object > Application > Application Group (continued)

LABEL	DESCRIPTION
Name	This field indicates the name assigned to the application group.
Description	You may type some extra information on the application group here.
Member	This field shows the application objects in this application group.
Reference	This displays the number of times an object reference is used in a profile.
License	You need to buy a license or use a trial license in order to use IDP/AppPatrol signatures. These fields show license-related information.
License Status	This field shows whether you have activated an IDP/AppPatrol signatures license
License Type	This field shows the type of IDP/AppPatrol signatures license you have activated
Signature Information	An activated license allows you to download signatures to the Zykel Device from myZykel. These fields show details on the signatures downloaded.
Current Version	The version number increments when signatures are updated at myZykel. This field shows the current version downloaded to the Zykel Device.
Released Date	This field shows the date (YYYY-MM-DD) and time the current signature version was released.
Update Signatures	If your signature set is not the most recent, click this to go to Configuration > Licensing > Signature Update > IDP / AppPatrol to update your signatures.

43.6.2.1 Add Application Group Rule

Click **Add** in **Configuration > Object > Application > Application Group** to select already created application rules and combine them as a single new rule.

Figure 593 Configuration > Object > Application > Application > Add Application Group Rule

The following table describes the labels in this screen.

Table 332 Configuration > Object > Application > Application > Add Application Group Rule

LABEL	DESCRIPTION
Name	Enter a name for the group. You may use 1-31 alphanumeric characters, underscores(_), or dashes (-), but the first character cannot be a number. This value is case-sensitive.
Description	This field displays the description of each group, if any. You can use up to 60 characters, punctuation marks, and spaces.

Table 332 Configuration > Object > Application > Application > Add Application Group Rule

LABEL	DESCRIPTION
Member List	<p>The Member list displays the names of the application and application group objects that have been added to the application group. The order of members is not important.</p> <p>Select items from the Available list that you want to be members and move them to the Member list. You can double-click a single entry to move it or use the [Shift] or [Ctrl] key to select multiple entries and use the arrow button to move them.</p> <p>Move any members you do not want included to the Available list.</p>
OK	Click OK to save your changes back to the Zyxel Device.
Cancel	Click Cancel to exit this screen without saving your changes.

43.7 Address/Geo IP Overview

Address objects can represent a single IP address or a range of IP addresses. Address groups are composed of address objects and other address groups.

- The **Address** screen ([Section 43.7.2 on page 888](#)) provides a summary of all addresses in the Zyxel Device. Use the **Address Add/Edit** screen to create a new address or edit an existing one.
- Use the **Address Group** summary screen ([Section 43.7.3 on page 892](#)) and the **Address Group Add/Edit** screen, to maintain address groups in the Zyxel Device.
- Use the **Geo IP** screen ([Section 43.7.4 on page 894](#)) to update the database of country-to-IP address mappings and to manually configure country-to-IP address mappings.

43.7.1 What You Need To Know

Address objects and address groups are used in dynamic routes, security policies, application patrol, content filtering, and VPN connection policies. For example, addresses are used to specify where content restrictions apply in content filtering. Please see the respective sections for more information about how address objects and address groups are used in each one.

Address groups are composed of address objects and address groups. The sequence of members in the address group is not important.

43.7.2 Address Summary Screen

The address screens are used to create, maintain, and remove addresses. There are the types of address objects:

- **HOST** - the object uses an **IP Address** to define a host address
- **RANGE** - the object uses a range address defined by a **Starting IP Address** and an **Ending IP Address**
- **SUBNET** - the object uses a network address defined by a **Network IP address** and **Netmask** subnet mask
- **INTERFACE IP** - the object uses the IP address of one of the Zyxel Device's interfaces
- **INTERFACE SUBNET** - the object uses the subnet mask of one of the Zyxel Device's interfaces
- **INTERFACE GATEWAY** - the object uses the gateway IP address of one of the Zyxel Device's interfaces
- **GEOGRAPHY** - the object uses the IP addresses of a country to represent a country

FQDN - the object uses a FQDN (Fully Qualified Domain Name). An FQDN consists of a host and domain name. For example, `www.zyxel.com` is a fully qualified domain name, where "www" is the host, "zyxel" is the second-level domain, and "com" is the top level domain. `mail.myZyxel.com.tw` is also an FQDN, where "mail" is the host, "myZyxel" is the third-level domain, "com" is the second-level domain, and "tw" is the top level domain.

Table 333 FQDN Example

HTTP://	WWW.	ZYXEL.	COM
	host name	second-level domain name	top-level domain name
FQDN			
Uniform Resource Locator (URL)			

In an address FQDN object, you can also use one wildcard. For example, `*.zyxel.com`. An FQDN is resolved to its IP address using the DNS server configured on the Zyxel Device.

The **Address** screen provides a summary of all addresses in the Zyxel Device. To access this screen, click **Configuration > Object > Address > Address**. Click a column's heading cell to sort the table entries by that column's criteria. Click the heading cell again to reverse the sort order.

Figure 594 Configuration > Object > Address/Geo IP > Address

The screenshot displays the 'Address' configuration page, which is divided into two sections: 'IPv4 Address Configuration' and 'IPv6 Address Configuration'. Each section contains a table of address objects with columns for ID, Name, Type, IP Address, and Reference. The IPv4 section lists 8 objects, including subnets and hosts. The IPv6 section lists 9 objects, all of which are interface subnets for DHCPv6, SLAAC, and STATIC configurations.

IPv4 Address Configuration				
#	Name	Type	IPv4 Address	Reference
1	DMZ_SUBNET	INTERFACE SUBNET	dmz-192.168.3.0/24	0
2	IP6to4-Relay	HOST	192.88.99.1	0
3	LAN1_SUBNET	INTERFACE SUBNET	lan1-192.168.1.0/24	0
4	LAN2_SUBNET	INTERFACE SUBNET	lan2-192.168.2.0/24	0
5	RFC1918_1	SUBNET	10.0.0.0/8	1
6	RFC1918_2	SUBNET	172.16.0.0/12	1
7	RFC1918_3	SUBNET	192.168.0.0/16	1
8	WIZ_LAN_SUBNET	INTERFACE SUBNET	wan1-172.21.56.0/24	0

IPv6 Address Configuration				
#	Name	Type	IPv6 Address	Reference
1	DMZ_SUBNET_DHCPv6	INTERFACE SUBNET	dmz-::/0 (DHCPv6)	0
2	DMZ_SUBNET_SLAAC	INTERFACE SUBNET	dmz-::/0 (SLAAC)	0
3	DMZ_SUBNET_STATIC	INTERFACE SUBNET	dmz-::/0 (STATIC)	0
4	LAN1_SUBNET_DHCPv6	INTERFACE SUBNET	lan1-::/0 (DHCPv6)	0
5	LAN1_SUBNET_SLAAC	INTERFACE SUBNET	lan1-::/0 (SLAAC)	0
6	LAN1_SUBNET_STATIC	INTERFACE SUBNET	lan1-::/0 (STATIC)	0
7	LAN2_SUBNET_DHCPv6	INTERFACE SUBNET	lan2-::/0 (DHCPv6)	0
8	LAN2_SUBNET_SLAAC	INTERFACE SUBNET	lan2-::/0 (SLAAC)	0
9	LAN2_SUBNET_STATIC	INTERFACE SUBNET	lan2-::/0 (STATIC)	0

The following table describes the labels in this screen. See [Section 43.7.2.1 on page 890](#) for more information as well.

Table 334 Configuration > Object > Address/Geo IP > Address

LABEL	DESCRIPTION
IPv4 Address Configuration	
Add	Click this to create a new entry.
Edit	Double-click an entry or select it and click Edit to be able to modify the entry's settings.
Remove	To remove an entry, select it and click Remove . The Zyxel Device confirms you want to remove it before doing so.
References	Select an entry and click References to open a screen that shows which settings use the entry.
#	This field is a sequential value, and it is not associated with a specific address.
Name	This field displays the configured name of each address object.
Type	This field displays the type of each address object. " INTERFACE " means the object uses the settings of one of the Zyxel Device's interfaces.
IPv4 Address	This field displays the IPv4 addresses represented by each address object. If the object's settings are based on one of the Zyxel Device's interfaces, the name of the interface displays first followed by the object's current address settings.
Reference	This displays the number of times an object reference is used in a profile.
IPv6 Address Configuration	
Add	Click this to create a new entry.
Edit	Double-click an entry or select it and click Edit to be able to modify the entry's settings.
Remove	To remove an entry, select it and click Remove . The Zyxel Device confirms you want to remove it before doing so.
References	Select an entry and click References to open a screen that shows which settings use the entry.
#	This field is a sequential value, and it is not associated with a specific address.
Name	This field displays the configured name of each address object.
Type	This field displays the type of each address object. " INTERFACE " means the object uses the settings of one of the Zyxel Device's interfaces.
IPv6 Address	This field displays the IPv6 addresses represented by each address object. If the object's settings are based on one of the Zyxel Device's interfaces, the name of the interface displays first followed by the object's current address settings.

43.7.2.1 IPv4 Address Add/Edit Screen

The **Configuration > Object > Address/GeoIP > Address > Add/Edit** screen allows you to create a new address or edit an existing one. To access this screen, go to the **Address** screen (see [Section 43.7.2 on page 888](#)), and click either the **Add** icon or an **Edit** icon in the **IPv4 Address Configuration** section.

Figure 595 Configuration > Object > Address/GeoIP > Address > Add/Edit (IPv4)t

The screenshot shows a dialog box titled "Add Address Rule". It has a title bar with a green plus icon and a question mark icon. The dialog contains three input fields: "Name" with a red dashed border and a red warning icon, "Address Type" with a dropdown menu showing "HOST", and "IP Address" with the value "0.0.0.0". At the bottom are "OK" and "Cancel" buttons.

The following table describes the labels in this screen.

Table 335 Configuration > Object > Address/GeoIP > Address > Add/Edit (IPv4)

LABEL	DESCRIPTION
Name	Type the name used to refer to the address. You may use 1-31 alphanumeric characters, underscores(_), or dashes (-), but the first character cannot be a number. This value is case-sensitive.
Address Type	Select the type of address you want to create. Note: The Zyxel Device automatically updates address objects that are based on an interface's IP address, subnet, or gateway if the interface's IP address settings change. For example, if you change 1's IP address, the Zyxel Device automatically updates the corresponding interface-based, LAN subnet address object.
IP Address	This field is only available if the Address Type is HOST . This field cannot be blank. Enter the IP address that this address object represents.
Starting IP Address	This field is only available if the Address Type is RANGE . This field cannot be blank. Enter the beginning of the range of IP addresses that this address object represents.
Ending IP Address	This field is only available if the Address Type is RANGE . This field cannot be blank. Enter the end of the range of IP address that this address object represents.
Network	This field is only available if the Address Type is SUBNET , in which case this field cannot be blank. Enter the IP address of the network that this address object represents.
Netmask	This field is only available if the Address Type is SUBNET , in which case this field cannot be blank. Enter the subnet mask of the network that this address object represents. Use dotted decimal format.
Interface	If you selected INTERFACE IP , INTERFACE SUBNET , or INTERFACE GATEWAY as the Address Type , use this field to select the interface of the network that this address object represents.
Region	If you selected GEOGRAPHY as the Address Type , use this field to select a country or continent. A GEOGRAPHY object uses the data from the country-to-IP/continent-to-IP address database. Go to the Configuration > Object > Address/Geo IP > Geo IP screen to configure the custom country-to-IP/continent-to-IP address mappings for a GEOGRAPHY object.
FQDN	If you selected FQDN as the Address Type , use this field to enter a fully qualified domain name.
OK	Click OK to save your changes back to the Zyxel Device.
Cancel	Click Cancel to exit this screen without saving your changes.

43.7.2.2 IPv6 Address Add/Edit Screen

The **Configuration > Object > Address/GeoIP > Address > Add/Edit** screen allows you to create a new address or edit an existing one. To access this screen, go to the **Address** screen (see [Section 43.7.2 on page 888](#)), and click either the **Add** icon or an **Edit** icon in the **IPv6 Address Configuration** section.

Figure 596 Configuration > Object > Address/GeoIP > Address > Add/Edit (IPv6)

The following table describes the labels in this screen.

Table 336 Configuration > Object > Address/GeoIP > Address > Add/Edit (IPv6)

LABEL	DESCRIPTION
Name	Type the name used to refer to the address. You may use 1-31 alphanumeric characters, underscores(_), or dashes (-), but the first character cannot be a number. This value is case-sensitive.
Object Type	Select the type of address you want to create. Note: The Zyxel Device automatically updates address objects that are based on an interface's IP address, subnet, or gateway if the interface's IP address settings change. For example, if you change 1's IP address, the Zyxel Device automatically updates the corresponding interface-based, LAN subnet address object.
IPv6 Address	This field is only available if the Address Type is HOST . This field cannot be blank. Enter the IP address that this address object represents.
IPv6 Starting Address	This field is only available if the Address Type is RANGE . This field cannot be blank. Enter the beginning of the range of IP addresses that this address object represents.
IPv6 Ending Address	This field is only available if the Address Type is RANGE . This field cannot be blank. Enter the end of the range of IP address that this address object represents.
IPv6 Address Prefix	This field is only available if the Address Type is SUBNET . This field cannot be blank. Enter the IPv6 address prefix that the Zyxel Device uses for the LAN IPv6 address.
Interface	If you selected INTERFACE IP , INTERFACE SUBNET , or INTERFACE GATEWAY as the Address Type , use this field to select the interface of the network that this address object represents.
IPv6 Address Type	Select whether the IPv6 address is a link-local IP address (LINK LOCAL), static IP address (STATIC), an IPv6 Stateless Address Auto Configuration IP address (SLAAC), or is obtained from a DHCPv6 server (DHCPv6).
Region	If you selected Geography as the Address Type , use this field to select a country or continent.
FQDN	If you selected FQDN as the Address Type , use this field to enter a fully qualified domain name.
OK	Click OK to save your changes back to the Zyxel Device.
Cancel	Click Cancel to exit this screen without saving your changes.

43.7.3 Address Group Summary Screen

The **Address Group** screen provides a summary of all address groups. To access this screen, click **Configuration > Object > Address/Geo IP > Address Group**. Click a column's heading cell to sort the table entries by that column's criteria. Click the heading cell again to reverse the sort order.

Figure 597 Configuration > Object > Address/Geo IP > Address Group

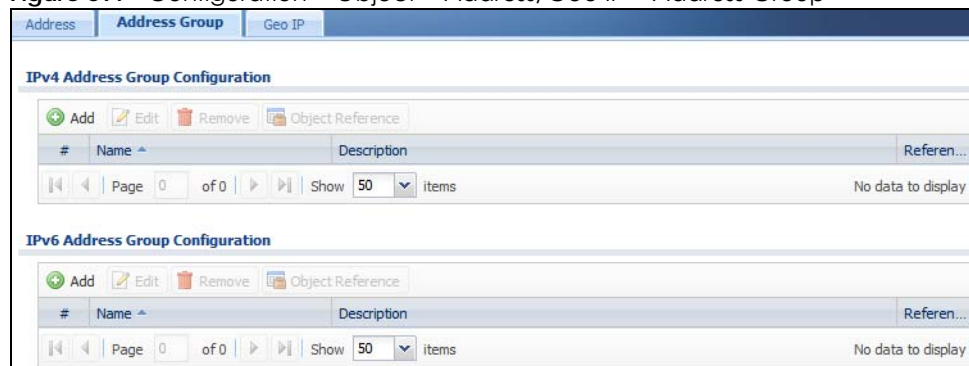

The following table describes the labels in this screen. See [Section 43.7.3.1 on page 893](#) for more information as well.

Table 337 Configuration > Object > Address/Geo IP > Address Group

LABEL	DESCRIPTION
IPv4 Address Group Configuration	
Add	Click this to create a new entry.
Edit	Double-click an entry or select it and click Edit to be able to modify the entry's settings.
Remove	To remove an entry, select it and click Remove . The Zyxel Device confirms you want to remove it before doing so.
References	Select an entry and click References to open a screen that shows which settings use the entry.
#	This field is a sequential value, and it is not associated with a specific address group.
Name	This field displays the name of each address group.
Description	This field displays the description of each address group, if any.
Reference	This displays the number of times an object reference is used in a profile.
IPv6 Address Group Configuration	
Add	Click this to create a new entry.
Edit	Double-click an entry or select it and click Edit to be able to modify the entry's settings.
Remove	To remove an entry, select it and click Remove . The Zyxel Device confirms you want to remove it before doing so.
References	Select an entry and click References to open a screen that shows which settings use the entry.
#	This field is a sequential value, and it is not associated with a specific address group.
Name	This field displays the name of each address group.
Description	This field displays the description of each address group, if any.

43.7.3.1 Address Group Add/Edit Screen

The **Address Group Add/Edit** screen allows you to create a new address group or edit an existing one. To access this screen, go to the **Address Group** screen (see [Section 43.7.3 on page 892](#)), and click either the **Add** icon or an **Edit** icon in the **IPv4 Address Group Configuration** or **IPv6 Address Group Configuration** section.

Figure 598 IPv4/IPv6 Address Group Configuration > Add

The following table describes the labels in this screen.

Table 338 IPv4/IPv6 Address Group Configuration > Add

LABEL	DESCRIPTION
Name	Enter a name for the address group. You may use 1-31 alphanumeric characters, underscores(_), or dashes (-), but the first character cannot be a number. This value is case-sensitive.
Description	This field displays the description of each address group, if any. You can use up to 60 characters, punctuation marks, and spaces.
Address Type	Select the type of address (Address , GEOGRAPHY , and FQDN) you want to create. Note: The Zyxel Device automatically updates address objects that are based on an interface's IP address, subnet, or gateway if the interface's IP address settings change. For example, if you change 1's IP address, the Zyxel Device automatically updates the corresponding interface-based, LAN subnet address object.
Member List	The Member list displays the names of the address and address group objects that have been added to the address group. The order of members is not important. Select items from the Available list that you want to be members and move them to the Member list. You can double-click a single entry to move it or use the [Shift] or [Ctrl] key to select multiple entries and use the arrow button to move them. Move any members you do not want included to the Available list. Note: Only objects of the same address type can be added to a address group.
OK	Click OK to save your changes back to the Zyxel Device.
Cancel	Click Cancel to exit this screen without saving your changes.

43.7.4 Geo IP Summary Screen

Use this screen to update the database of country-to-IP and continent-to-IP address mappings and manually configure custom country-to-IP and continent-to-IP address mappings in geographic address

objects. You can then use geographic address objects in security policies to forward or deny traffic to whole countries or regions.

Click a column's heading cell to sort the table entries by that column's criteria. Click the heading cell again to reverse the sort order.

Figure 599 Configuration > Object > Address/Geo IP > Geo IP

The screenshot displays the configuration page for Geo IP objects. At the top, there are tabs for 'Address', 'Address Group', and 'Geo IP'. The main content is organized into several sections:

- Country Database Update:** Shows 'Latest Version: 20190205' and 'Current Version: 20190205'. A note indicates that a Content Filter license must be enabled at portal.myzyxel.com for updates. There is an 'Update Now' button and an 'Auto Update' checkbox. The auto-update schedule is set to 'Wednesday' every '14' hours.
- Custom IPv4 to Geography Rules:** Contains a text input field with '0.0.0.0' and a 'Country to Geography' button. Below is a table with columns: '#', 'Geolocation', 'Type', and 'IPv4 Address'. The table is currently empty, showing 'Page 0 of 0' and 'No data to display'.
- Custom IPv6 to Geography Rules:** Similar to the IPv4 section, but for IPv6 addresses. It also shows an empty table with 'No data to display'.
- Region vs. Continent:** Features a 'Region' text input field, a 'Continent' dropdown menu (currently set to 'Africa'), and a 'Country List' button. A large empty box is provided for the country list.

At the bottom of the page, there are 'Apply' and 'Reset' buttons.

The following table describes the labels in this screen.

Table 339 Configuration > Object > Address/Geo IP > Geo IP

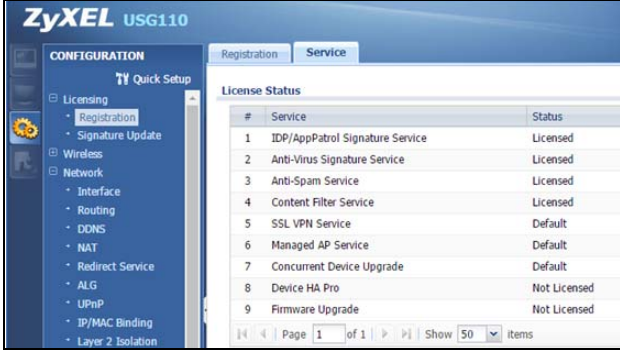
LABEL	DESCRIPTION
Country Database Update	
Latest Version	This is the latest country-to-IP address database version on myZyxel. You need to have a registered Content Filter Service license. 
Current Version	This is the country-to-IP address database version currently on the Zyxel Device.
Update Now	Click this to check for the latest country-to-IP address database version on myZyxel. The latest version is downloaded to the Zyxel Device and replaces the current version if it is newer. There are logs to show the update status. You need to have a registered Content Filter Service license.
Auto Update	If you want the Zyxel Device to check weekly for the latest country-to-IP address database version on myZyxel, select the checkbox, choose a day and time each week and then click Apply . The default day and time displayed is the Zyxel Device current day and time.
Custom IPv4/IPv6 to Geography Rules	
Add	Click this to create a new entry.
IPv4/v6 to Geography	Enter an IP address, then click this button to query which country this IP address belongs to.
Remove	To remove an entry, select it and click Remove . The Zyxel Device confirms you want to remove it before doing so.
#	This field is a sequential value, and it is not associated with a specific entry.
Geolocation	This field displays the name of the country or region that is associated with this IP address.
Type	This field displays whether this address object is HOST , RANGE or SUBNET .
IPv4/IPv6 Address	This field displays the IPv4/IPv6 addresses represented by the type of address object.
Region vs. Continent	
Region	Enter a country name, then click the Region to Continent button to query which continent this country belongs to.
Continent	Select a continent, then click the Region List button to query which countries belong to the continent.
Apply	Click Apply to save the changes.
Reset	Click Reset to return the screen to its last-saved settings.

43.7.4.1 Add Custom IPv4/IPv6 Address to Geography Screen

This screen allows you to create a new geography-to-IP address mapping. To access this screen, go to the **Geo IP** screen (see [Section 43.7.4 on page 894](#)), and click the **Add** icon in the **Custom IPv4 to Geography Rules** or **Custom IPv6 to Geography Rules** section.

Figure 600 Geo IP > Add

The following table describes the labels in this screen.

Table 340 Geo IP > Add

LABEL	DESCRIPTION
Region	Select the country or continent that maps to this IP address.
Address Type	Select the type of address you want to create. Choices are: HOST , RANGE , SUBNET .
IP Address	This field is only available if the Address Type is HOST . This field cannot be blank. Enter the IP address that this address object represents.
IP Starting Address	This field is only available if the Address Type is RANGE . This field cannot be blank. Enter the beginning of the range of IP addresses that this address object represents.
IP Ending Address	This field is only available if the Address Type is RANGE . This field cannot be blank. Enter the end of the range of IP address that this address object represents.
Network / Netmask	These fields are only available if the IPv4 Address Type is SUBNET . They cannot be blank. Enter the network IP and subnet mask that defines the IPv4 subnet.
IPv6 Address Prefix	This field is only available if the IPv6 Address Type is SUBNET . This field cannot be blank. Enter the IPv6 address prefix that the Zyxel Device uses for the LAN IPv6 address.
OK	Click OK to save your changes back to the Zyxel Device.
Cancel	Click Cancel to exit this screen without saving your changes.

43.8 Service Overview

Use service objects to define TCP applications, UDP applications, and ICMP messages. You can also create service groups to refer to multiple service objects in other features.

- Use the **Service** screens ([Section 43.8.2 on page 898](#)) to view and configure the Zyxel Device's list of services and their definitions.
- Use the **Service Group** screens ([Section 43.8.2 on page 898](#)) to view and configure the Zyxel Device's list of service groups.

43.8.1 What You Need to Know

IP Protocols

IP protocols are based on the eight-bit protocol field in the IP header. This field represents the next-level protocol that is sent in this packet. This section discusses three of the most common IP protocols.

Computers use Transmission Control Protocol (TCP, IP protocol 6) and User Datagram Protocol (UDP, IP protocol 17) to exchange data with each other. TCP guarantees reliable delivery but is slower and more complex. Some uses are FTP, HTTP, SMTP, and TELNET. UDP is simpler and faster but is less reliable. Some uses are DHCP, DNS, RIP, and SNMP.

TCP creates connections between computers to exchange data. Once the connection is established, the computers exchange data. If data arrives out of sequence or is missing, TCP puts it in sequence or waits for the data to be re-transmitted. Then, the connection is terminated.

In contrast, computers use UDP to send short messages to each other. There is no guarantee that the messages arrive in sequence or that the messages arrive at all.

Both TCP and UDP use ports to identify the source and destination. Each port is a 16-bit number. Some port numbers have been standardized and are used by low-level system processes; many others have no particular meaning.

Unlike TCP and UDP, Internet Control Message Protocol (ICMP, IP protocol 1) is mainly used to send error messages or to investigate problems. For example, ICMP is used to send the response if a computer cannot be reached. Another use is ping. ICMP does not guarantee delivery, but networks often treat ICMP messages differently, sometimes looking at the message itself to decide where to send it.

Service Objects and Service Groups

Use service objects to define IP protocols.

- TCP applications
- UDP applications
- ICMP messages
- user-defined services (for other types of IP protocols)

These objects are used in policy routes, security policies, and IDP profiles.

Use service groups when you want to create the same rule for several services, instead of creating separate rules for each service. Service groups may consist of services and other service groups. The sequence of members in the service group is not important.

43.8.2 The Service Summary Screen

The **Service** summary screen provides a summary of all services and their definitions. In addition, this screen allows you to add, edit, and remove services.

To access this screen, log in to the Web Configurator, and click **Configuration > Object > Service > Service**. Click a column's heading cell to sort the table entries by that column's criteria. Click the heading cell again to reverse the sort order.

Figure 601 Configuration > Object > Service > Service

#	Name	Content	Reference
1	AH	Protocol=51	2
2	AIM	TCP=5190	0
3	AUTH	TCP=113	0
4	Any_TCP	TCP/1-65535	0
5	Any_UDP	UDP/1-65535	0
6	BGP	TCP=179	0
7	BONJOUR	UDP=5353	0
8	BOOTP_CLIENT	UDP=68	0

The following table describes the labels in this screen.

Table 341 Configuration > Object > Service > Service

LABEL	DESCRIPTION
Add	Click this to create a new entry.
Edit	Double-click an entry or select it and click Edit to be able to modify the entry's settings.
Remove	To remove an entry, select it and click Remove . The Zyxel Device confirms you want to remove it before doing so.
References	Select an entry and click References to open a screen that shows which settings use the entry.
#	This field is a sequential value, and it is not associated with a specific service.
Name	This field displays the name of each service.
Content	This field displays a description of each service.
Reference	This displays the number of times an object reference is used in a profile.

43.8.2.1 The Service Add/Edit Screen

The **Service Add/Edit** screen allows you to create a new service or edit an existing one. To access this screen, go to the **Service** screen (see [Section 43.8.2 on page 898](#)), and click either the **Add** icon or an **Edit** icon.

Figure 602 Configuration > Object > Service > Service > Edit

Add Service Rule

Name:

IP Protocol:

Starting Port: (1..65535)

Ending Port: (1..65535)

OK Cancel

The following table describes the labels in this screen.

Table 342 Configuration > Object > Service > Service > Edit

LABEL	DESCRIPTION
Name	Type the name used to refer to the service. You may use 1-31 alphanumeric characters, underscores(_), or dashes (-), but the first character cannot be a number. This value is case-sensitive.
IP Protocol	Select the protocol the service uses. Choices are: TCP , UDP , ICMP , ICMPv6 , and User Defined .

Table 342 Configuration > Object > Service > Service > Edit (continued)

LABEL	DESCRIPTION
Starting Port Ending Port	This field appears if the IP Protocol is TCP or UDP . Specify the port number(s) used by this service. If you fill in one of these fields, the service uses that port. If you fill in both fields, the service uses the range of ports.
ICMP Type	This field appears if the IP Protocol is ICMP or ICMPv6 . Select the ICMP message used by this service. This field displays the message text, not the message number.
IP Protocol Number	This field appears if the IP Protocol is User Defined . Enter the number of the next-level protocol (IP protocol). Allowed values are 1 - 255.
OK	Click OK to save your changes back to the Zyxel Device.
Cancel	Click Cancel to exit this screen without saving your changes.

43.8.3 The Service Group Summary Screen

The **Service Group** summary screen provides a summary of all service groups. In addition, this screen allows you to add, edit, and remove service groups.

To access this screen, log in to the Web Configurator, and click **Configuration > Object > Service > Service Group**.

Figure 603 Configuration > Object > Service > Service Group



#	Family	Name	Description	Reference
1		CU-SEEME		0
2		DHCPv6		0
3		DNS		3
4		Default_Allow_DMZ_To_ZyWALL	System Default Allow From DMZ To ZyWALL	1
5		Default_Allow_ICMPv6_Group	Default Allow icmpv6 to ZyWALL	1
6		Default_Allow_WAN_To_ZyWALL	System Default Allow From WAN To ZyWALL	1
7		Default_Allow_v6_DMZ_To_ZyWALL	System Default Allow IPv6 From DMZ to ZyWALL	1
8		Default_Allow_v6_WAN_To_ZyWALL	System Default Allow IPv6 Form WAN To ZyWALL	1
9		Default_Allow_v6_any_to_ZyWALL	System Default Allow IPv6 From any To ZyWALL	1
10		IRC		0

The following table describes the labels in this screen. See [Section 43.8.3.1 on page 901](#) for more information as well.

Table 343 Configuration > Object > Service > Service Group

LABEL	DESCRIPTION
Add	Click this to create a new entry.
Edit	Double-click an entry or select it and click Edit to be able to modify the entry's settings.
Remove	To remove an entry, select it and click Remove . The Zyxel Device confirms you want to remove it before doing so.
References	Select an entry and click References to open a screen that shows which settings use the entry.
#	This field is a sequential value, and it is not associated with a specific service group.

Table 343 Configuration > Object > Service > Service Group (continued)

LABEL	DESCRIPTION
Family	This field displays the Server Group supported type, which is according to your configurations in the Service Group Add/Edit screen. There are 3 types of families: <ul style="list-style-type: none">  : Supports IPv4 only  : Supports IPv6 only  : Supports both IPv4 and IPv6
Name	This field displays the name of each service group. By default, the Zyxel Device uses services starting with "Default_Allow_" in the security policies to allow certain services to connect to the Zyxel Device.
Description	This field displays the description of each service group, if any.
Reference	This displays the number of times an object reference is used in a profile.

43.8.3.1 The Service Group Add/Edit Screen

The **Service Group Add/Edit** screen allows you to create a new service group or edit an existing one. To access this screen, go to the **Service Group** screen (see [Section 43.8.3 on page 900](#)), and click either the **Add** icon or an **Edit** icon.

Figure 604 Configuration > Object > Service > Service Group > Edit

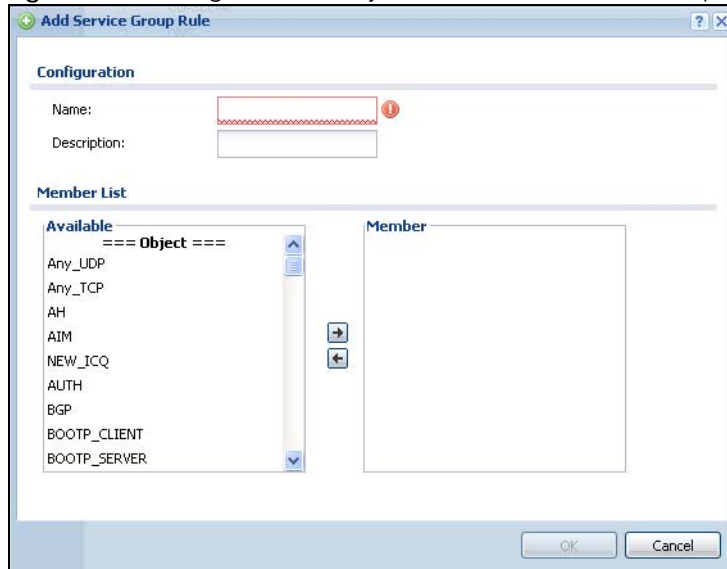

The following table describes the labels in this screen.

Table 344 Configuration > Object > Service > Service Group > Edit

LABEL	DESCRIPTION
Name	Enter the name of the service group. You may use 1-31 alphanumeric characters, underscores(_), or dashes (-), but the first character cannot be a number. This value is case-sensitive.
Description	Enter a description of the service group, if any. You can use up to 60 printable ASCII characters.

Table 344 Configuration > Object > Service > Service Group > Edit (continued)

LABEL	DESCRIPTION
Member List	<p>The Member list displays the names of the service and service group objects that have been added to the service group. The order of members is not important.</p> <p>Select items from the Available list that you want to be members and move them to the Member list. You can double-click a single entry to move it or use the [Shift] or [Ctrl] key to select multiple entries and use the arrow button to move them.</p> <p>Move any members you do not want included to the Available list.</p>
OK	Click OK to save your changes back to the Zyxel Device.
Cancel	Click Cancel to exit this screen without saving your changes.

43.9 Schedule Overview

Use schedules to set up one-time and recurring schedules for policy routes, security policies, application patrol, and content filtering. The Zyxel Device supports one-time and recurring schedules. One-time schedules are effective only once, while recurring schedules usually repeat. Both types of schedules are based on the current date and time in the Zyxel Device.

Note: Schedules are based on the Zyxel Device's current date and time.

- Use the **Schedule** summary screen ([Section 43.9.2 on page 902](#)) to see a list of all schedules in the Zyxel Device.
- Use the **One-Time Schedule Add/Edit** screen ([Section 43.9.2.1 on page 903](#)) to create or edit a one-time schedule.
- Use the **Recurring Schedule Add/Edit** screen ([Section 43.9.2.2 on page 904](#)) to create or edit a recurring schedule.
- Use the **Schedule Group** screen ([Section 43.9.3 on page 905](#)) to merge individual schedule objects as one object.

43.9.1 What You Need to Know

One-time Schedules

One-time schedules begin on a specific start date and time and end on a specific stop date and time. One-time schedules are useful for long holidays and vacation periods.

Recurring Schedules

Recurring schedules begin at a specific start time and end at a specific stop time on selected days of the week (Sunday, Monday, Tuesday, Wednesday, Thursday, Friday, and Saturday). Recurring schedules always begin and end in the same day. Recurring schedules are useful for defining the workday and off-work hours.

43.9.2 The Schedule Screen

The **Schedule** screen provides a summary of all schedules in the Zyxel Device. To access this screen, click **Configuration > Object > Schedule**.

Figure 605 Configuration > Object > Schedule

The following table describes the labels in this screen. See [Section 43.9.2.1 on page 903](#) and [Section 43.9.2.2 on page 904](#) for more information as well.

Table 345 Configuration > Object > Schedule

LABEL	DESCRIPTION
One Time	
Add	Click this to create a new entry.
Edit	Double-click an entry or select it and click Edit to be able to modify the entry's settings.
Remove	To remove an entry, select it and click Remove . The Zyxel Device confirms you want to remove it before doing so.
References	Select an entry and click References to open a screen that shows which settings use the entry.
#	This field is a sequential value, and it is not associated with a specific schedule.
Name	This field displays the name of the schedule, which is used to refer to the schedule.
Start Day / Time	This field displays the date and time at which the schedule begins.
Stop Day / Time	This field displays the date and time at which the schedule ends.
Reference	This displays the number of times an object reference is used in a profile.
Recurring	
Add	Click this to create a new entry.
Edit	Double-click an entry or select it and click Edit to be able to modify the entry's settings.
Remove	To remove an entry, select it and click Remove . The Zyxel Device confirms you want to remove it before doing so.
References	Select an entry and click References to open a screen that shows which settings use the entry.
#	This field is a sequential value, and it is not associated with a specific schedule.
Name	This field displays the name of the schedule, which is used to refer to the schedule.
Start Time	This field displays the time at which the schedule begins.
Stop Time	This field displays the time at which the schedule ends.
Reference	This displays the number of times an object reference is used in a profile.

43.9.2.1 The One-Time Schedule Add/Edit Screen

The **One-Time Schedule Add/Edit** screen allows you to define a one-time schedule or edit an existing one. To access this screen, go to the **Schedule** screen (see [Section 43.9.2 on page 902](#)), and click either the **Add** icon or an **Edit** icon in the **One Time** section.

Figure 606 Configuration > Object > Schedule > Edit (One Time)

The following table describes the labels in this screen.

Table 346 Configuration > Object > Schedule > Edit (One Time)

LABEL	DESCRIPTION
Configuration	
Name	Type the name used to refer to the one-time schedule. You may use 1-31 alphanumeric characters, underscores(_), or dashes (-), but the first character cannot be a number. This value is case-sensitive.
Date Time	
StartDate	Specify the year, month, and day when the schedule begins. <ul style="list-style-type: none"> • Year - 1900 - 2999 • Month - 1 - 12 • Day - 1 - 31 (it is not possible to specify illegal dates, such as February 31.)
StartTime	Specify the hour and minute when the schedule begins. <ul style="list-style-type: none"> • Hour - 0 - 23 • Minute - 0 - 59
StopDate	Specify the year, month, and day when the schedule ends. <ul style="list-style-type: none"> • Year - 1900 - 2999 • Month - 1 - 12 • Day - 1 - 31 (it is not possible to specify illegal dates, such as February 31.)
StopTime	Specify the hour and minute when the schedule ends. <ul style="list-style-type: none"> • Hour - 0 - 23 • Minute - 0 - 59
OK	Click OK to save your changes back to the Zyxel Device.
Cancel	Click Cancel to exit this screen without saving your changes.

43.9.2.2 The Recurring Schedule Add/Edit Screen

The **Recurring Schedule Add/Edit** screen allows you to define a recurring schedule or edit an existing one. To access this screen, go to the **Schedule** screen (see [Section 43.9.2 on page 902](#)), and click either the **Add** icon or an **Edit** icon in the **Recurring** section.

Figure 607 Configuration > Object > Schedule > Edit (Recurring)

The **Year**, **Month**, and **Day** columns are not used in recurring schedules and are disabled in this screen. The following table describes the remaining labels in this screen.

Table 347 Configuration > Object > Schedule > Edit (Recurring)

LABEL	DESCRIPTION
Configuration	
Name	Type the name used to refer to the recurring schedule. You may use 1-31 alphanumeric characters, underscores(_), or dashes (-), but the first character cannot be a number. This value is case-sensitive.
Date Time	
StartTime	Specify the hour and minute when the schedule begins each day. <ul style="list-style-type: none"> • Hour - 0 - 23 • Minute - 0 - 59
StopTime	Specify the hour and minute when the schedule ends each day. <ul style="list-style-type: none"> • Hour - 0 - 23 • Minute - 0 - 59
Weekly	
Week Days	Select each day of the week the recurring schedule is effective.
OK	Click OK to save your changes back to the Zyxel Device.
Cancel	Click Cancel to exit this screen without saving your changes.

43.9.3 The Schedule Group Screen

The **Schedule Group** screen provides a summary of all groups of schedules in the Zyxel Device. To access this screen, click **Configuration > Object > Schedule > Group**.

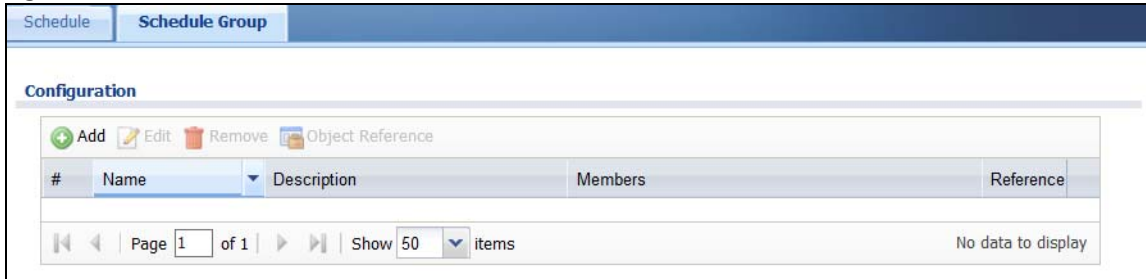
Figure 608 Configuration > Object > Schedule > Schedule Group

The following table describes the fields in the above screen.

Table 348 Configuration > Object > Schedule > Schedule Group

LABEL	DESCRIPTION
Configuration	
Add	Click this to create a new entry.
Edit	Double-click an entry or select it and click Edit to be able to modify the entry's settings.
Remove	To remove an entry, select it and click Remove . The Zyxel Device confirms you want to remove it before doing so.
References	Select an entry and click References to open a screen that shows which settings use the entry.
#	This field is a sequential value, and it is not associated with a specific schedule.
Name	This field displays the name of the schedule group, which is used to refer to the schedule.
Description	This field displays the description of the schedule group.
Members	This field lists the members in the schedule group. Each member is separated by a comma.
Reference	This displays the number of times an object reference is used in a profile.

43.9.3.1 The Schedule Group Add/Edit Screen

The **Schedule Group Add/Edit** screen allows you to define a schedule group or edit an existing one. To access this screen, go to the **Schedule** screen (see), and click either the **Add** icon or an **Edit** icon in the **Schedule Group** section.

Figure 609 Configuration > Schedule > Schedule Group > Add

The following table describes the fields in the above screen.

Table 349 Configuration > Schedule > Schedule Group > Add

LABEL	DESCRIPTION
Group Members	
Name	Type the name used to refer to the recurring schedule. You may use 1-31 alphanumeric characters, underscores(_), or dashes (-), but the first character cannot be a number. This value is case-sensitive.
Description	Enter a description of the service group, if any. You can use up to 60 printable ASCII characters.
Member List	The Member list displays the names of the service and service group objects that have been added to the service group. The order of members is not important. Select items from the Available list that you want to be members and move them to the Member list. You can double-click a single entry to move it or use the [Shift] or [Ctrl] key to select multiple entries and use the arrow button to move them. Move any members you do not want included to the Available list.
OK	Click OK to save your changes back to the Zyxel Device.
Cancel	Click Cancel to exit this screen without saving your changes.

43.10 AAA Server Overview

You can use a AAA (Authentication, Authorization, Accounting) server to provide access control to your network. The AAA server can be a Active Directory, LDAP, or RADIUS server. Use the **AAA Server** screens to create and manage objects that contain settings for using AAA servers. You use AAA server objects in

configuring ext-group-user user objects and authentication method objects (see [Chapter 43 on page 916](#)).

43.10.1 Directory Service (AD/LDAP)

LDAP/AD allows a client (the Zyxel Device) to connect to a server to retrieve information from a directory. A network example is shown next.

Figure 610 Example: Directory Service Client and Server

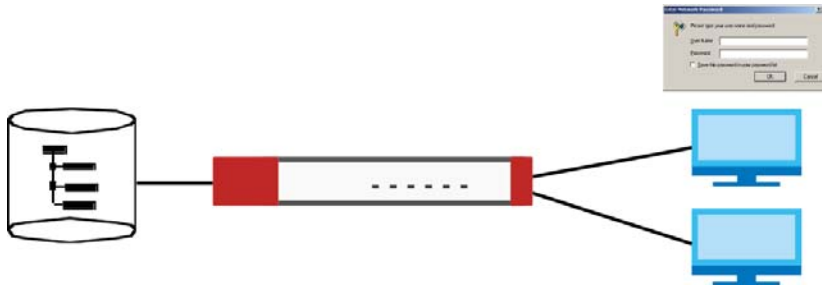

The following describes the user authentication procedure via an LDAP/AD server.

- 1 A user logs in with a user name and password pair.
- 2 The Zyxel Device tries to bind (or log in) to the LDAP/AD server.
- 3 When the binding process is successful, the Zyxel Device checks the user information in the directory against the user name and password pair.
- 4 If it matches, the user is allowed access. Otherwise, access is blocked.

43.10.2 RADIUS Server

RADIUS (Remote Authentication Dial-In User Service) authentication is a popular protocol used to authenticate users by means of an external server instead of (or in addition to) an internal device user database that is limited to the memory capacity of the device. In essence, RADIUS authentication allows you to validate a large number of users from a central location.

Figure 611 RADIUS Server Network Example

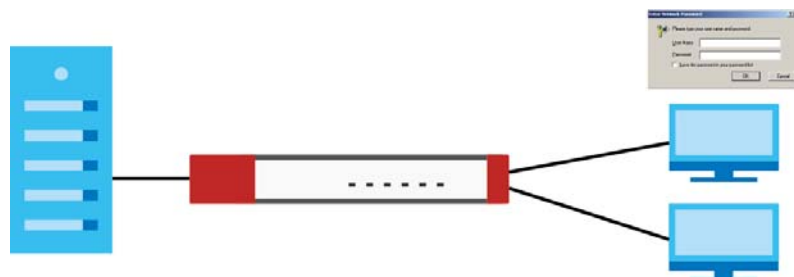

43.10.3 ASAS

ASAS (Authenex Strong Authentication System) is a RADIUS server that works with the One-Time Password (OTP) feature. Purchase a Zyxel Device OTP package in order to use this feature. The package contains

server software and physical OTP tokens (PIN generators). Do the following to use OTP. See the documentation included on the ASAS' CD for details.

- 1 Install the ASAS server software on a computer.
- 2 Create user accounts on the Zyxel Device and in the ASAS server.
- 3 Import each token's database file (located on the included CD) into the server.
- 4 Assign users to OTP tokens (on the ASAS server).
- 5 Configure the ASAS as a RADIUS server in the Zyxel Device's **Configuration > Object > AAA Server** screens.
- 6 Give the OTP tokens to (local or remote) users.
 - Use the **Configuration > Object > AAA Server > Active Directory** (or **LDAP**) screens ([Section 43.10.5 on page 910](#)) to configure Active Directory or LDAP server objects.
 - Use the **Configuration > Object > AAA Server > RADIUS** screen ([Section 43.10.2 on page 908](#)) to configure the default external RADIUS server to use for user authentication.

43.10.4 What You Need To Know

AAA Servers Supported by the Zyxel Device

The following lists the types of authentication server the Zyxel Device supports.

- Local user database

The Zyxel Device uses the built-in local user database to authenticate administrative users logging into the Zyxel Device's Web Configurator or network access users logging into the network through the Zyxel Device. You can also use the local user database to authenticate VPN users.
- Directory Service (LDAP/AD)

LDAP (Lightweight Directory Access Protocol)/AD (Active Directory) is a directory service that is both a directory and a protocol for controlling access to a network. The directory consists of a database specialized for fast information retrieval and filtering activities. You create and store user profile and login information on the external server.
- RADIUS

RADIUS (Remote Authentication Dial-In User Service) authentication is a popular protocol used to authenticate users by means of an external or built-in RADIUS server. RADIUS authentication allows you to validate a large number of users from a central location.

Directory Structure

The directory entries are arranged in a hierarchical order much like a tree structure. Normally, the directory structure reflects the geographical or organizational boundaries. The following figure shows a basic directory structure branching from countries to organizations to organizational units to individuals.

Figure 612 Basic Directory Structure

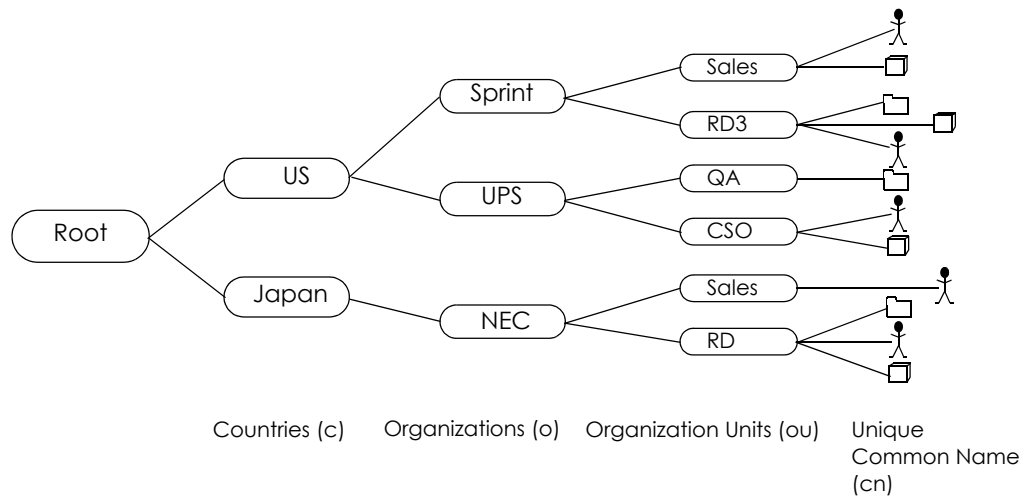

Distinguished Name (DN)

A DN uniquely identifies an entry in a directory. A DN consists of attribute-value pairs separated by commas. The leftmost attribute is the Relative Distinguished Name (RDN). This provides a unique name for entries that have the same "parent DN" ("cn=domain1.com, ou=Sales, o=MyCompany" in the following examples).

```
cn=domain1.com, ou = Sales, o=MyCompany, c=US
cn=domain1.com, ou = Sales, o=MyCompany, c=JP
```

Base DN

A base DN specifies a directory. A base DN usually contains information such as the name of an organization, a domain name and/or country. For example, o=MyCompany, c=UK where o means organization and c means country.

Bind DN

A bind DN is used to authenticate with an LDAP/AD server. For example a bind DN of cn=zywallAdmin allows the Zyxel Device to log into the LDAP/AD server using the user name of zywallAdmin. The bind DN is used in conjunction with a bind password. When a bind DN is not specified, the Zyxel Device will try to log in as an anonymous user. If the bind password is incorrect, the login will fail.

43.10.5 Active Directory or LDAP Server Summary

Use the **Active Directory** or **LDAP** screen to manage the list of AD or LDAP servers the Zyxel Device can use in authenticating users.

Click **Configuration > Object > AAA Server > Active Directory (or LDAP)** to display the **Active Directory (or LDAP)** screen.

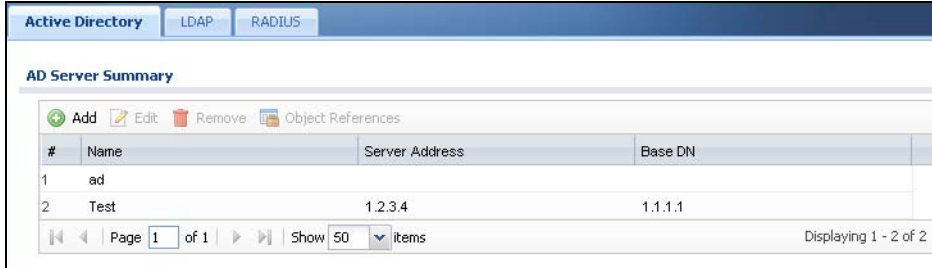
Figure 613 Configuration > Object > AAA Server > Active Directory (or LDAP)

The following table describes the labels in this screen.

Table 350 Configuration > Object > AAA Server > Active Directory (or LDAP)

LABEL	DESCRIPTION
Add	Click this to create a new entry.
Edit	Double-click an entry or select it and click Edit to open a screen where you can modify the entry's settings.
Remove	To remove an entry, select it and click Remove . The Zyxel Device confirms you want to remove it before doing so.
References	Select an entry and click References to open a screen that shows which settings use the entry.
#	This field is a sequential value, and it is not associated with a specific AD or LDAP server.
Name	This field displays the name of the Active Directory.
Server Address	This is the address of the AD or LDAP server.
Base DN	This specifies a directory. For example, <code>o=Zyxel, c=US</code> .

43.10.5.1 Adding an Active Directory or LDAP Server

Click **Object > AAA Server > Active Directory (or LDAP)** to display the **Active Directory (or LDAP)** screen. Click the **Add** icon or an **Edit** icon to display the following screen. Use this screen to create a new AD or LDAP entry or edit an existing one.

Figure 614 Configuration > Object > AAA Server > Active Directory (or LDAP) > Add

Add Active Directory

General Settings

Name:

Description: (Optional)

Server Settings

Server Address: (IP or FQDN)

Backup Server Address: (IP or FQDN)(Optional)

Port: (1-65535)

Base DN: (1-300 seconds)

Use SSL

Search time limit: (1-300 seconds)

Case-sensitive User Names

Server Authentication

Bind DN:

Password:

Retype to Confirm:

User Login Settings

Login Name Attribute:

Alternative Login Name Attribute: (Optional)

Group Membership Attribute:

Domain Authentication for MSChap

Enable

User Name: Must be a user who has rights to add a machine to the domain.

User Password:

Retype to Confirm:

Realm:

NetBIOS Name: (Optional)

Configuration Validation

Please enter an existing user account in this server to validate the above settings.

Username:

The following table describes the labels in this screen.

Table 351 Configuration > Object > AAA Server > Active Directory (or LDAP) > Add

LABEL	DESCRIPTION
Name	Enter a descriptive name (up to 63 alphanumeric characters) for identification purposes.
Description	Enter the description of each server, if any. You can use up to 60 printable ASCII characters.
Server Address	Enter the address of the AD or LDAP server.
Backup Server Address	If the AD or LDAP server has a backup server, enter its address here.
Port	Specify the port number on the AD or LDAP server to which the Zyxel Device sends authentication requests. Enter a number between 1 and 65535. This port number should be the same on all AD or LDAP server(s) in this group.
Base DN	Specify the directory (up to 127 alphanumeric characters). For example, o=Zyxe1 , c=US. This is only for LDAP .
Use SSL	Select Use SSL to establish a secure connection to the AD or LDAP server(s).
Search time limit	Specify the timeout period (between 1 and 300 seconds) before the Zyxel Device disconnects from the AD or LDAP server. In this case, user authentication fails. Search timeout occurs when either the user information is not in the AD or LDAP server(s) or the AD or LDAP server(s) is down.
Case-sensitive User Names	Select this if the server checks the case of the usernames.
Bind DN	Specify the bind DN for logging into the AD or LDAP server. Enter up to 127 alphanumeric characters. For example, cn=zywallAdmin specifies zywallAdmin as the user name.
Password	If required, enter the password (up to 15 alphanumeric characters) for the Zyxel Device to bind (or log in) to the AD or LDAP server.
Retype to Confirm	Retype your new password for confirmation.
Login Name Attribute	Enter the type of identifier the users are to use to log in. For example "name" or "e-mail address".
Alternative Login Name Attribute	If there is a second type of identifier that the users can use to log in, enter it here. For example "name" or "e-mail address".
Group Membership Attribute	An AD or LDAP server defines attributes for its accounts. Enter the name of the attribute that the Zyxel Device is to check to determine to which group a user belongs. The value for this attribute is called a group identifier; it determines to which group a user belongs. You can add ext-group-user user objects to identify groups based on these group identifier values. For example you could have an attribute named "memberOf" with values like "sales", "RD", and "management". Then you could also create a ext-group-user user object for each group. One with "sales" as the group identifier, another for "RD" and a third for "management".
Domain Authentication for MSChap	Select the Enable checkbox to enable domain authentication for MSChap. This is only for Active Directory .
User Name	Enter the user name for the user who has rights to add a machine to the domain. This is only for Active Directory .
User Password	Enter the password for the associated user name. This is only for Active Directory .
Retype to Confirm	Retype your new password for confirmation. This is only for Active Directory .

Table 351 Configuration > Object > AAA Server > Active Directory (or LDAP) > Add (continued)

LABEL	DESCRIPTION
Realm	Enter the realm FQDN. This is only for Active Directory .
NetBIOS Name	Type the NetBIOS name. This field is optional. NetBIOS packets are TCP or UDP packets that enable a computer to connect to and communicate with a LAN which allows local computers to find computers on the remote network and vice versa.
Configuration Validation	Use a user account from the server specified above to test if the configuration is correct. Enter the account's user name in the Username field and click Test .
OK	Click OK to save the changes.
Cancel	Click Cancel to discard the changes.

43.10.6 RADIUS Server Summary

Use the **RADIUS** screen to manage the list of RADIUS servers the Zyxel Device can use in authenticating users.

Click **Configuration > Object > AAA Server > RADIUS** to display the **RADIUS** screen.

Figure 615 Configuration > Object > AAA Server > RADIUS

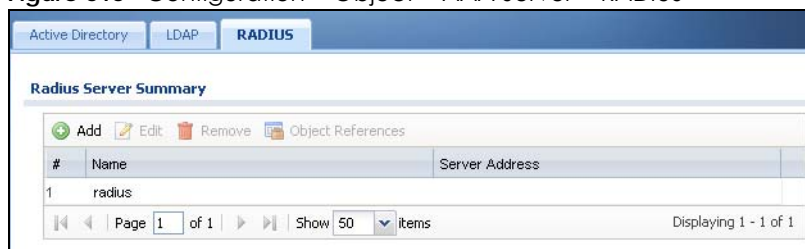

The following table describes the labels in this screen.

Table 352 Configuration > Object > AAA Server > RADIUS

LABEL	DESCRIPTION
Add	Click this to create a new entry.
Edit	Double-click an entry or select it and click Edit to open a screen where you can modify the entry's settings.
Remove	To remove an entry, select it and click Remove . The Zyxel Device confirms you want to remove it before doing so.
References	Select an entry and click References to open a screen that shows which settings use the entry.
#	This field displays the index number.
Name	This is the name of the RADIUS server entry.
Server Address	This is the address of the AD or LDAP server.

43.10.6.1 Adding a RADIUS Server

Click **Configuration > Object > AAA Server > RADIUS** to display the **RADIUS** screen. Click the **Add** icon or an **Edit** icon to display the following screen. Use this screen to create a new AD or LDAP entry or edit an existing one.

Figure 616 Configuration > Object > AAA Server > RADIUS > Add

The following table describes the labels in this screen.

Table 353 Configuration > Object > AAA Server > RADIUS > Add

LABEL	DESCRIPTION
Name	Enter a descriptive name (up to 63 alphanumeric characters) for identification purposes.
Description	Enter the description of each server, if any. You can use up to 60 printable ASCII characters.
Server Address	Enter the address of the RADIUS server.
Authentication Port	Specify the port number on the RADIUS server to which the Zyxel Device sends authentication requests. Enter a number between 1 and 65535.
Backup Server Address	If the RADIUS server has a backup server, enter its address here.
Backup Authentication Port	Specify the port number on the RADIUS server to which the Zyxel Device sends authentication requests. Enter a number between 1 and 65535.
Timeout	Specify the timeout period (between 1 and 300 seconds) before the Zyxel Device disconnects from the RADIUS server. In this case, user authentication fails. Search timeout occurs when either the user information is not in the RADIUS server or the RADIUS server is down.
NAS IP Address	Type the IP address of the NAS (Network Access Server).
Case-sensitive User Names	Select this if you want configure your username as case-sensitive.

Table 353 Configuration > Object > AAA Server > RADIUS > Add (continued)

LABEL	DESCRIPTION
Key	<p>Enter a password (up to 15 alphanumeric characters) as the key to be shared between the external authentication server and the Zyxel Device.</p> <p>The key is not sent over the network. This key must be the same on the external authentication server and the Zyxel Device.</p>
Group Membership Attribute	<p>A RADIUS server defines attributes for its accounts. Select the name and number of the attribute that the Zyxel Device is to check to determine to which group a user belongs. If it does not display, select user-defined and specify the attribute's number.</p> <p>This attribute's value is called a group identifier; it determines to which group a user belongs. You can add ext-group-user user objects to identify groups based on these group identifier values.</p> <p>For example you could have an attribute named "memberOf" with values like "sales", "RD", and "management". Then you could also create a ext-group-user user object for each group. One with "sales" as the group identifier, another for "RD" and a third for "management".</p>
OK	Click OK to save the changes.
Cancel	Click Cancel to discard the changes.

43.11 Auth. Method Overview

Authentication method objects set how the Zyxel Device authenticates wireless, HTTP/HTTPS clients, and peer IPSec routers (extended authentication) clients. Configure authentication method objects to have the Zyxel Device use the local user database, and/or the authentication servers and authentication server groups specified by AAA server objects. By default, user accounts created and stored on the Zyxel Device are authenticated locally.

- Use the **Configuration > Object > Auth. Method** screens ([Section 43.11.3 on page 917](#)) to create and manage authentication method objects.
- Use the **Configuration > Object > Auth. Method > Two-Factor Authentication** screen ([Section 43.11.4 on page 919](#)) to configure double-layer security to access a secured network behind the Zyxel Device via a VPN tunnel, Web Configurator, SSH, or Telnet.

43.11.1 Before You Begin

Configure AAA server objects before you configure authentication method objects.

43.11.2 Example: Selecting a VPN Authentication Method

After you set up an authentication method object in the **Auth. Method** screens, you can use it in the **VPN Gateway** screen to authenticate VPN users for establishing a VPN connection. Refer to the chapter on VPN for more information.

Follow the steps below to specify the authentication method for a VPN connection.

- 1 Access the **Configuration > VPN > IPSec VPN > VPN Gateway > Edit** screen.
- 2 Click **Show Advance Setting** and select **Enable Extended Authentication**.

- 3 Select **Server Mode** and select an authentication method object from the drop-down list box.
- 4 Click **OK** to save the settings.

Figure 617 Example: Using Authentication Method in VPN

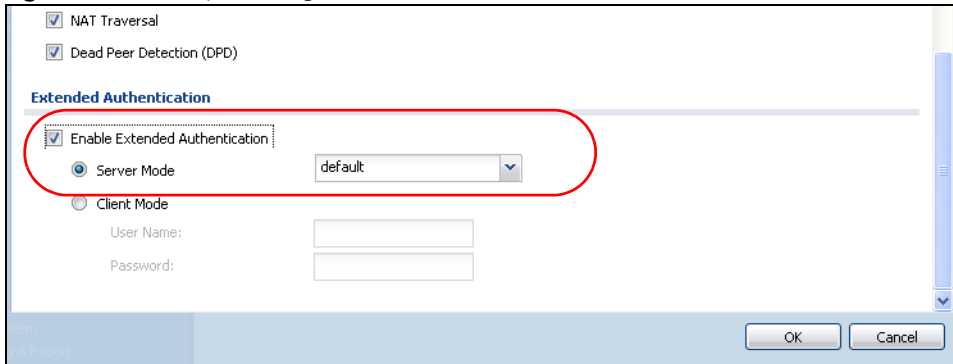

43.11.3 Authentication Method Objects

Click **Configuration > Object > Auth. Method** to display the screen as shown.

Note: You can create up to 16 authentication method objects.

Figure 618 Configuration > Object > Auth. Method

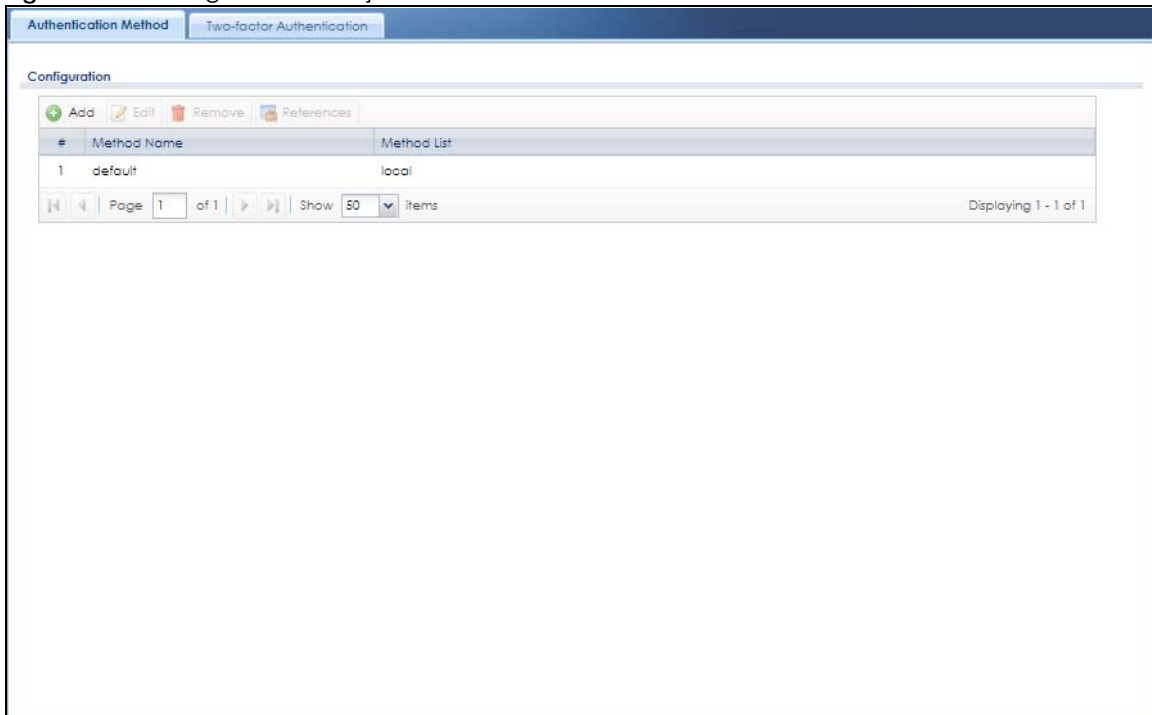

The following table describes the labels in this screen.

Table 354 Configuration > Object > Auth. Method

LABEL	DESCRIPTION
Add	Click this to create a new entry.
Edit	Double-click an entry or select it and click Edit to open a screen where you can modify the entry's settings.
Remove	To remove an entry, select it and click Remove . The Zyxel Device confirms you want to remove it before doing so.
References	Select an entry and click References to open a screen that shows which settings use the entry.
#	This field displays the index number.
Method Name	This field displays a descriptive name for identification purposes.
Method List	This field displays the authentication method(s) for this entry.

43.11.3.1 Creating an Authentication Method Object

Follow the steps below to create an authentication method object.

- 1 Click **Configuration > Object > Auth. Method**.
- 2 Click **Add**.
- 3 Specify a descriptive name for identification purposes in the **Name** field. You may use 1-31 alphanumeric characters, underscores(_), or dashes (-), but the first character cannot be a number. This value is case-sensitive. For example, "My_Device".
- 4 Click **Add** to insert an authentication method in the table.
- 5 Select a server object from the **Method List** drop-down list box.
- 6 You can add up to four server objects to the table. The ordering of the **Method List** column is important. The Zyxel Device authenticates the users using the databases (in the local user database or the external authentication server) in the order they appear in this screen.

If two accounts with the same username exist on two authentication servers you specify, the Zyxel Device does not continue the search on the second authentication server when you enter the username and password that doesn't match the one on the first authentication server.

Note: You can NOT select two server objects of the same type.

- 7 Click **OK** to save the settings or click **Cancel** to discard all changes and return to the previous screen.

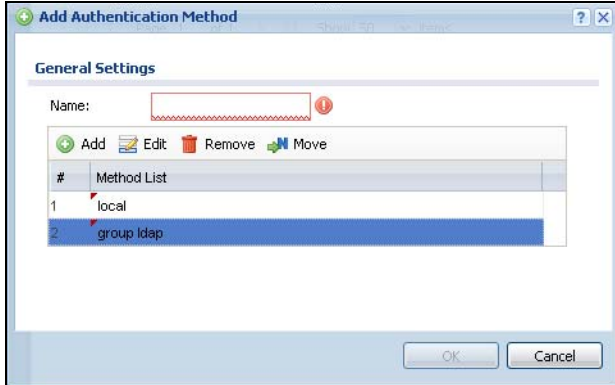
Figure 619 Configuration > Object > Auth. Method > Add

The following table describes the labels in this screen.

Table 355 Configuration > Object > Auth. Method > Add

LABEL	DESCRIPTION
Name	Specify a descriptive name for identification purposes. You may use 1-31 alphanumeric characters, underscores(_), or dashes (-), but the first character cannot be a number. This value is case-sensitive. For example, "My_Device".
Add	Click this to create a new entry. Select an entry and click Add to create a new entry after the selected entry.
Edit	Double-click an entry or select it and click Edit to open a screen where you can modify the entry's settings.
Remove	To remove an entry, select it and click Remove . The Zyxel Device confirms you want to remove it before doing so.
Move	To change a method's position in the numbered list, select the method and click Move to display a field to type a number for where you want to put it and press [ENTER] to move the rule to the number that you typed. The ordering of your methods is important as Zyxel Device authenticates the users using the authentication methods in the order they appear in this screen.
#	This field displays the index number.
Method List	Select a server object from the drop-down list box. You can create a server object in the AAA Server screen. The Zyxel Device authenticates the users using the databases (in the local user database or the external authentication server) in the order they appear in this screen. If two accounts with the same username exist on two authentication servers you specify, the Zyxel Device does not continue the search on the second authentication server when you enter the username and password that doesn't match the one on the first authentication server.
OK	Click OK to save the changes.
Cancel	Click Cancel to discard the changes.

43.11.4 Two-Factor Authentication

Use two-factor authentication to have double-layer security to access a secured network behind the Zyxel Device via a VPN tunnel, Web Configurator, SSH, or Telnet.

The first layer is the VPN client/Zyxel Device's login user name / password and the second layer is an authorized SMS (via mobile phone number) or email address.

43.11.4.1 Overview

This section introduces how two-factor authentication works.

Figure 620 Two-Factor Authentication

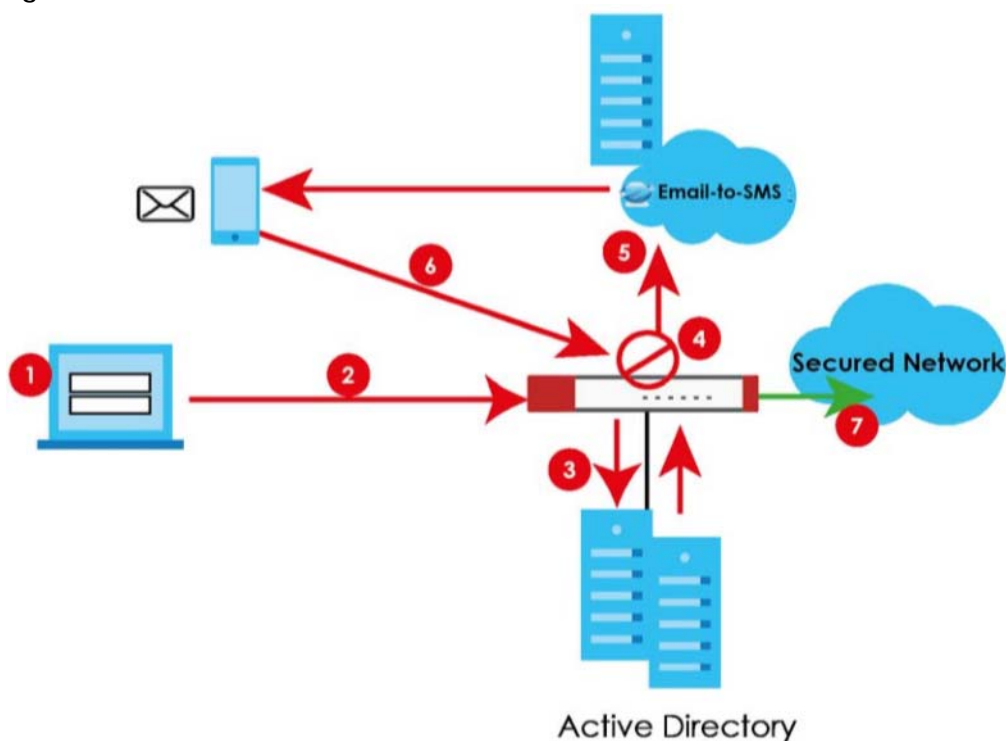

VPN Access Via a VPN tunnel

- 1 A user runs a VPN client and logs in with the user name and password for this VPN tunnel.
- 2 The VPN tunnel is created from the VPN client device to the Zyxel Device.
- 3 The Zyxel Device requests the user's user-name, password and mobile phone number or email address from the Active Directory, RADIUS server or local Zyxel Device database in order to authenticate this user's use of the VPN tunnel (factor 1). If they are not found, then the Zyxel Device terminates the VPN tunnel.
- 4 If all correct credentials are found, then the Zyxel Device will request the Cloud SMS system to send an authorization SMS or email to the client requesting VPN access (factor 2).
- 5 The client should access the authorization link sent via SMS or email by the Cloud SMS system within a specified deadline (**Valid Time**).
- 6 If the authorization is correct and received on time, then the client can have VPN access to the secured network. If the authorization deadline has expired, then the client will have to run the VPN client again. If authorization credentials are incorrect or if the SMS/email was not received, then the client must check with the network administrator.

Admin Access Via the Web Configurator, SSH, or Telnet

- 1 An admin user is trying to log into the Zyxel Device using the Web Configurator, SSH, or Telnet.
- 2 The Zyxel Device requests the admin user's user-name, password and mobile phone number or email address from the Active Directory, RADIUS server or local Zyxel Device database in order to authenticate this admin user.
- 3 If all correct credentials are found, then the Zyxel Device will request the Cloud SMS system to send an authorization SMS or email to the admin user.
- 4 The admin user should access the authorization link sent via SMS or email by the Cloud SMS system within a specified deadline (**Valid Time**).
- 5 If the authorization is correct and received on time, then the client can access to the secured network. If the authorization deadline has expired, then the admin user will have to try again. If authorization credentials are incorrect or if the SMS/email was not received, then the admin user must check with the network administrator.

43.11.4.2 Pre-configuration

Before configuration, you must:

- Set up the user's user-name, password and email address or mobile number in the Active Directory, RADIUS server or local Zyxel Device database
- Enable Two-factor Authentication in **Object > User/Group > User > Edit > Two-factor Authentication** for a specific user
- Enable Two-factor Authentication in **Object > User/Group > User > Edit > Two-factor Authentication** for the Zyxel Device
- Enable **HTTP** and/or **HTTPS** in **System > WWW > Service Control**
- Enable **SSH** and/or **Telnet** in **System > SSH** and/or **System > TELNET**
- Add **HTTP, HTTPS, SSH, and/or, TELNET** in the **Object > Service > Service Group > Default_Allow_WAN_To_ZyWALL** service group. This service group defines the default services allowed in the **WAN_to_Device** security policy.
- For VPN access, configure the VPN tunnel for this user on the Zyxel Device

Email Authentication

- Configure **Mail Server** in **System > Notification > Mail Server**.

SMS Authentication

- Configure **Mail Server** in **System > Notification > Mail Server**.
- Configure **SMS** in **System > Notification > SMS**.
- Have an account with an Email-to-SMS cloud provider to be able to send SMS authorization requests

Google Authentication

- Install Google Authenticator

Two-Factor authentication may fail if one of the above is not configured or one of the below occurred.

- You omit any of the pre-configuration items. Make sure to perform all pre-configuration items.
- The user cannot receive the authorization SMS or email. Check if the mobile telephone number or email address of the user in the Active Directory, RADIUS Server or local Zyxel Device database is configured correctly.
- Email-to-SMS cloud system authentication fails. Make sure that SMS is enabled and credentials are correct in **System > Notification > SMS**.
- Mail server authentication failed. Check if the **System > Notification > Mail Server** settings are correct.
- Authorization timed out. Extend the **Valid Time** in **Configuration > Object > Auth. Method > Two-factor Authentication > VPN Access**.
- You are unable to access Google Authenticator (you lost your phone or uninstalled the app). Log in using one of the backup codes.
- You get a Google Authenticator verification error. You must enter the code within the time displayed in Google Authenticator. The time on your cellphone and the time on the Zyxel Device must be the same.

Use this screen to select the users and VPN service(s) that requires two-factor authentication.

Go to **Configuration > Object > Auth. Method > Two-factor Authentication > VPN Access** and configure the following screen as shown.

Figure 621 Configuration > Object > Auth. Method > Two-factor Authentication > VPN Access

The screenshot shows the configuration page for Two-factor Authentication > VPN Access. It includes the following details:

- Authentication Method:** Two-factor Authentication
- VPN Access:** Admin Access
- General Settings:**
 - Enable
 - Valid Time: 3 (1-15 minutes)
 - Two-factor Authentication for Services:
 - SSL VPN Access
 - IPsec VPN Access
 - L2TP/IPsec VPN Access
- User/Group:**
 - Selectable User/Group Objects:** ldap-users, radius-users, ad-users, admin
 - Selected User/Group Objects:** any
- Delivery Settings:**
 - Deliver Authorize Link Method: SMS, Email
 - Authorize Link URL Address: https, From Interface, wan1
 - Message: Use Default Message, Use Multilingual file
 - File Name: 2FA-msg.txt (Download button)
 - File Path: Select a File Path (Browse... Upload buttons)
 - Restore Customized File to Default: Restore button
 - Link: [Download the default 2FA-msg.txt example.](#)
- Note:**
 - The Default Message must use alphanumeric characters.
 - The Multilingual file must be in UTF-8 format and named '2FA-msg.txt'.
 - The Default Message and the Multilingual file must contain a <url> tag. You can also use <user>/<host>/<time> variables to display dynamic information.
 - The Default Message and the Multilingual file do not support HTML tags such as
, <i>, and so on.

Buttons at the bottom: Apply, Reset

The following table describes the labels in this screen.

Table 356 Configuration > Object > Auth. Method > Two-factor Authentication > VPN Access

LABEL	DESCRIPTION
General Settings	
Enable	Select the check box to require double-layer security to access a secured network behind the Zyxel Device via a VPN tunnel.
Valid Time	Enter the maximum time (in minutes) that the user must click or tap the authorization link in the SMS or email in order to get authorization for the VPN connection.
Two-factor Authentication for Services:	Select which kinds of VPN tunnels require Two-Factor Authentication. You should have configured the VPN tunnel first. <ul style="list-style-type: none"> • SSL VPN Access • IPSec VPN Access • L2TP/IPSec VPN Access
User/Group	This list displays the names of the users and user groups that can be selected for two-factor authentication. The order of members is not important. Select users and groups from the Selectable User/Group Objects list that require two-factor authentication for VPN access to a secured network behind the Zyxel Device and move them to the Selected User/Group Objects list. You can double-click a single entry to move it or use the [Shift] or [Ctrl] key to select multiple entries and use the arrow button to move them. Similarly, move user/groups that do not you do not require two-factor authentication back to the Selectable User/Group Objects list.
Delivery Settings	Use this section to configure how to send an SMS or email for authorization.
Deliver Authorize Link Method:	Select one or both methods: <ul style="list-style-type: none"> • SMS: Object > User/Group > User must contain a valid mobile telephone number. A valid mobile telephone number can be up to 20 characters in length, including the numbers 1~9 and the following characters in the square brackets [+*#(-)]. • Email: Object > User/Group > User must contain a valid email address. A valid email address must contain the @ character. For example, this is a valid email address: abc@example.com
Authorize Link URL Address:	Allows access to the link that the user will receive in the SMS or email. The user must be able to access the link. <ul style="list-style-type: none"> • http/https: you must enable HTTP or HTTPS in System > WWW > Service Control • From Interface/User-Defined: select the Zyxel Device WAN interface (wan1/2) or select User-Defined and then enter an IP address.
Message	You can either create a default message in the text box or upload a message file (Use Multilingual file) from your computer. The message file must be named '2FA-msg.txt' and be in UTF-8 format. To create the file, click Download the default 2FA-msg.txt example and edit the file for your needs. (If you make a mistake, use Restore Customized File to Default to restore your customized file to the default.) Use Select a File Path to locate the final file on your computer and then click Upload to transfer it to the Zyxel Device. The message in either the text box or the file must contain the <url> variable within angle brackets, while the <user>, <host>, and <time> variables are optional.
Apply	Click Apply to save the changes.
Reset	Click Reset to return the screen to its last-saved settings.

43.11.5 Two-Factor Authentication Admin Access

Use this screen to select the service (**Web, SSH, and TELNET**) that requires two-factor authentication for the admin user.

Go to **Configuration > Object > Auth. Method > Two-factor Authentication > Admin Access** and configure the following screen as shown.

Figure 622 Configuration > Object > Auth. Method > Two-factor Authentication > Admin Access

The screenshot shows the configuration page for Two-factor Authentication Admin Access. It is divided into two main sections: General Settings and Delivery Settings. In the General Settings section, the 'Enable' checkbox is checked. The 'Valid Time' is set to 3 minutes. Under 'Two-factor Authentication for Services', the checkboxes for 'Web', 'SSH', and 'TELNET' are all checked. In the Delivery Settings section, the 'Verification Code Delivery Method' is set to 'Email'. At the bottom of the page, there are 'Apply' and 'Reset' buttons.

The following table describes the labels in this screen.

Table 357 Configuration > Object > Auth. Method > Two-factor Authentication > Admin Access

LABEL	DESCRIPTION
General Settings	
Enable	Select the check box to require double-layer security to access a secured network behind the Zyxel Device via the Web Configurator, SSH, or Telnet.
Valid Time	Enter the maximum time (in minutes) that the user must click or tap the authorization link in the SMS or email in order to get authorization for logins via the Web Configurator, SSH, or Telnet.
Two-factor Authentication for Services:	Select which services require Two-Factor Authentication for the admin user. <ul style="list-style-type: none"> • Web • SSH • TELNET
Delivery Settings	Use this section to configure how to send an SMS or email for authorization.
Verification Code Delivery Method	Select one or both methods: <ul style="list-style-type: none"> • SMS: Object > User/Group > User must contain a valid mobile telephone number. A valid mobile telephone number can be up to 20 characters in length, including the numbers 1-9 and the following characters in the square brackets [+*#()-]. • Email: Object > User/Group > User must contain a valid email address. A valid email address must contain the @ character. For example, this is a valid email address: abc@example.com • All: You will receive both SMS and email for authorization.
Apply	Click Apply to save the changes.
Reset	Click Reset to return the screen to its last-saved settings.

43.12 Certificate Overview

The Zyxel Device can use certificates (also called digital IDs) to authenticate users. Certificates are based on public-private key pairs. A certificate contains the certificate owner's identity and public key. Certificates provide a way to exchange public keys for use in authentication.

- Use the **My Certificates** screens (see [Section 43.12.3 on page 927](#) to [Section 43.12.3.3 on page 935](#)) to generate and export self-signed certificates or certification requests and import the CA-signed certificates.
- Use the **Trusted Certificates** screens (see [Section 43.12.4 on page 936](#) to [Section 43.12.4.2 on page 940](#)) to save CA certificates and trusted remote host certificates to the Zyxel Device. The Zyxel Device trusts any valid certificate that you have imported as a trusted certificate. It also trusts any valid certificate signed by any of the certificates that you have imported as a trusted certificate.

43.12.1 What You Need to Know

When using public-key cryptology for authentication, each host has two keys. One key is public and can be made openly available. The other key is private and must be kept secure.

These keys work like a handwritten signature (in fact, certificates are often referred to as "digital signatures"). Only you can write your signature exactly as it should look. When people know what your signature looks like, they can verify whether something was signed by you, or by someone else. In the same way, your private key "writes" your digital signature and your public key allows people to verify whether data was signed by you, or by someone else. This process works as follows.

- 1 Tim wants to send a message to Jenny. He needs her to be sure that it comes from him, and that the message content has not been altered by anyone else along the way. Tim generates a public key pair (one public key and one private key).
- 2 Tim keeps the private key and makes the public key openly available. This means that anyone who receives a message seeming to come from Tim can read it and verify whether it is really from him or not.
- 3 Tim uses his private key to sign the message and sends it to Jenny.
- 4 Jenny receives the message and uses Tim's public key to verify it. Jenny knows that the message is from Tim, and that although other people may have been able to read the message, no-one can have altered it (because they cannot re-sign the message with Tim's private key).
- 5 Additionally, Jenny uses her own private key to sign a message and Tim uses Jenny's public key to verify the message.

The Zyxel Device uses certificates based on public-key cryptology to authenticate users attempting to establish a connection, not to encrypt the data that you send after establishing a connection. The method used to secure the data that you send through an established connection depends on the type of connection. For example, a VPN tunnel might use the triple DES encryption algorithm.

The certification authority uses its private key to sign certificates. Anyone can then use the certification authority's public key to verify the certificates.

A certification path is the hierarchy of certification authority certificates that validate a certificate. The Zyxel Device does not trust a certificate if any certificate on its path has expired or been revoked.

Certification authorities maintain directory servers with databases of valid and revoked certificates. A directory of certificates that have been revoked before the scheduled expiration is called a CRL (Certificate Revocation List). The Zyxel Device can check a peer's certificate against a directory server's list of revoked certificates. The framework of servers, software, procedures and policies that handles keys is called PKI (public-key infrastructure).

Advantages of Certificates

Certificates offer the following benefits.

- The Zyxel Device only has to store the certificates of the certification authorities that you decide to trust, no matter how many devices you need to authenticate.
- Key distribution is simple and very secure since you can freely distribute public keys and you never need to transmit private keys.

Self-signed Certificates

You can have the Zyxel Device act as a certification authority and sign its own certificates.

Factory Default Certificate

The Zyxel Device generates its own unique self-signed certificate when you first turn it on. This certificate is referred to in the GUI as the factory default certificate.

Certificate File Formats

Any certificate that you want to import has to be in one of these file formats:

- Binary X.509: This is an ITU-T recommendation that defines the formats for X.509 certificates.
- PEM (Base-64) encoded X.509: This Privacy Enhanced Mail format uses lowercase letters, uppercase letters and numerals to convert a binary X.509 certificate into a printable form.
- Binary PKCS#7: This is a standard that defines the general syntax for data (including digital signatures) that may be encrypted. A PKCS #7 file is used to transfer a public key certificate. The private key is not included. The Zyxel Device currently allows the importation of a PKCS#7 file that contains a single certificate.
- PEM (Base-64) encoded PKCS#7: This Privacy Enhanced Mail (PEM) format uses lowercase letters, uppercase letters and numerals to convert a binary PKCS#7 certificate into a printable form.
- Binary PKCS#12: This is a format for transferring public key and private key certificates. The private key in a PKCS #12 file is within a password-encrypted envelope. The file's password is not connected to your certificate's public or private passwords. Exporting a PKCS #12 file creates this and you must provide it to decrypt the contents when you import the file into the Zyxel Device.

Note: Be careful not to convert a binary file to text during the transfer process. It is easy for this to occur since many programs use text files by default.

43.12.2 Verifying a Certificate

Before you import a trusted certificate into the Zyxel Device, you should verify that you have the correct certificate. You can do this using the certificate's fingerprint. A certificate's fingerprint is a message digest calculated using the MD5 or SHA1 algorithm. The following procedure describes how to check a certificate's fingerprint to verify that you have the actual certificate.

- 1 Browse to where you have the certificate saved on your computer.
- 2 Make sure that the certificate has a ".cer" or ".crt" file name extension.

Figure 623 Remote Host Certificates



- 3 Double-click the certificate's icon to open the **Certificate** window. Click the **Details** tab and scroll down to the **Thumbprint Algorithm** and **Thumbprint** fields.

Figure 624 Certificate Details

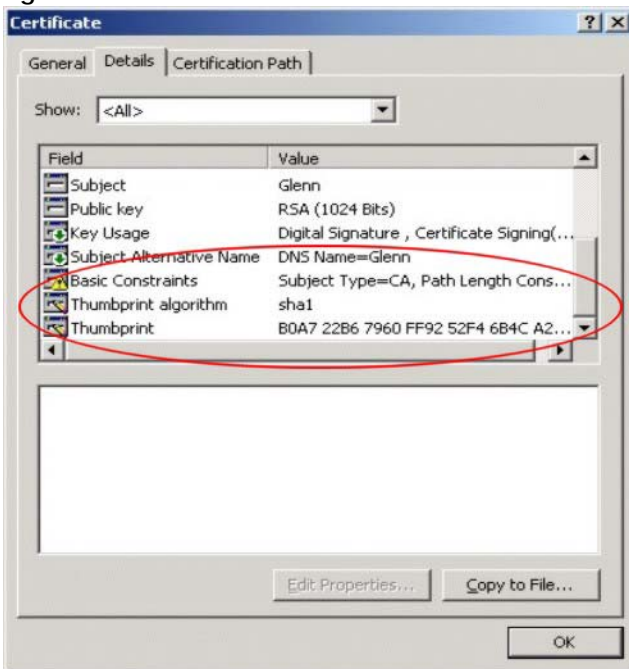

- 4 Use a secure method to verify that the certificate owner has the same information in the **Thumbprint Algorithm** and **Thumbprint** fields. The secure method may vary based on your situation. Possible examples would be over the telephone or through an HTTPS connection.

43.12.3 The My Certificates Screen

Click **Configuration > Object > Certificate > My Certificates** to open the **My Certificates** screen. This is the Zyxel Device's summary list of certificates and certification requests.

Figure 625 Configuration > Object > Certificate > My Certificates

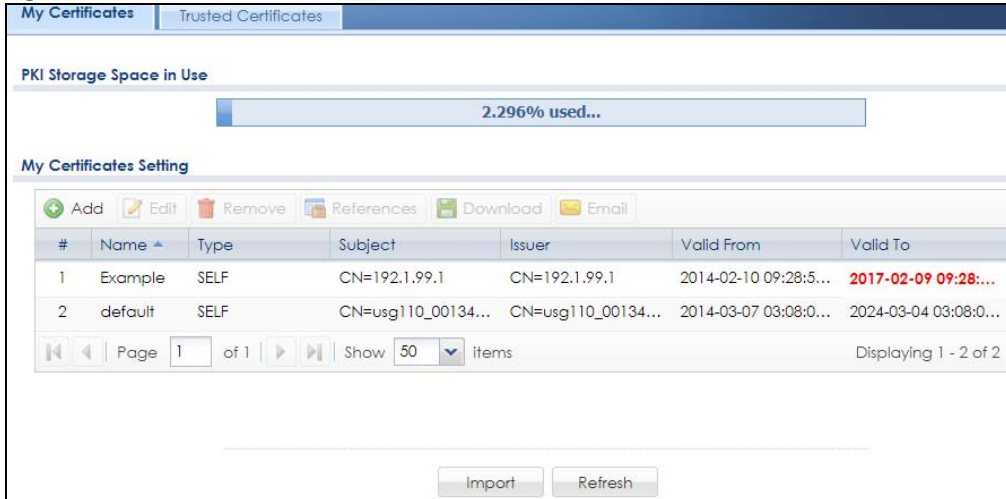

The following table describes the labels in this screen.

Table 358 Configuration > Object > Certificate > My Certificates

LABEL	DESCRIPTION
PKI Storage Space in Use	This bar displays the percentage of the Zykel Device's PKI storage space that is currently in use. When the storage space is almost full, you should consider deleting expired or unnecessary certificates before adding more certificates.
Add	Click this to go to the screen where you can have the Zykel Device generate a certificate or a certification request.
Edit	Double-click an entry or select it and click Edit to open a screen with an in-depth list of information about the certificate.
Remove	The Zykel Device keeps all of your certificates unless you specifically delete them. Uploading a new firmware or default configuration file does not delete your certificates. To remove an entry, select it and click Remove . The Zykel Device confirms you want to remove it before doing so. Subsequent certificates move up by one when you take this action.
References	You cannot delete certificates that any of the Zykel Device's features are configured to use. Select an entry and click References to open a screen that shows which settings use the entry.
Download	Click this and the following screen will appear. Type the selected certificate's password and save the selected certificate to your computer. Figure 626 Download a Certificate

Table 358 Configuration > Object > Certificate > My Certificates (continued)

LABEL	DESCRIPTION
Email	<p>Click this to email the selected certificate to the configured email address(es) for SSL connection establishment. This enables you to establish an SSL connection on your laptops, tablets, or smartphones.</p> <p>Click this and the following screen will appear.</p> <p>Here are the field descriptions:</p> <ul style="list-style-type: none"> • Mail Subject: Type the subject line for outgoing email from the Zyxel Device. • Mail To: Type the email address (or addresses) to which the outgoing email is delivered. • Send Certificate with Private Key: Select the check box to send the selected certificate with a private key. • Password: Enter a private key of up to 31 keyboard characters for the certificate. The special characters listed in the brackets [;\ `~!@#\$\$%^&*()_+\\ \'}:./<>=-"] are allowed. • E-mail Content: Create the email content in English, and use up to 250 keyboard characters. The special characters listed in the brackets [;\ `~!@#\$\$%^&*()_+\\ \'}:./<>=-"] are allowed. • Compress as a ZIP File: Select the check box to compress the selected certificate. Make sure the endpoint devices can decompress ZIP files before sending the compressed certificate. It's recommended to compress the certificate with a private key. Some email servers block PKCS #12 files. • Send Email: Click this to send the selected certificate. • Cancel: Click this to return to the previous screen without saving your changes. <p>Figure 627 Email My Certificate</p> 
#	This field displays the certificate index number. The certificates are listed in alphabetical order.
Name	This field displays the name used to identify this certificate. It is recommended that you give each certificate a unique name.

Table 358 Configuration > Object > Certificate > My Certificates (continued)

LABEL	DESCRIPTION
Type	<p>This field displays what kind of certificate this is.</p> <p>REQ represents a certification request and is not yet a valid certificate. Send a certification request to a certification authority, which then issues a certificate. Use the My Certificate Import screen to import the certificate and replace the request.</p> <p>SELF represents a self-signed certificate.</p> <p>CERT represents a certificate issued by a certification authority.</p>
Subject	<p>This field displays identifying information about the certificate's owner, such as CN (Common Name), OU (Organizational Unit or department), O (Organization or company) and C (Country). It is recommended that each certificate have unique subject information.</p>
Issuer	<p>This field displays identifying information about the certificate's issuing certification authority, such as a common name, organizational unit or department, organization or company and country. With self-signed certificates, this is the same information as in the Subject field.</p>
Valid From	<p>This field displays the date that the certificate becomes applicable.</p>
Valid To	<p>This field displays the date that the certificate expires. The text displays in red and includes an Expired! message if the certificate has expired.</p>
Import	<p>Click Import to open a screen where you can save a certificate to the Zyxel Device.</p>
Refresh	<p>Click Refresh to display the current validity status of the certificates.</p>

43.12.3.1 The My Certificates Add Screen

Click **Configuration > Object > Certificate > My Certificates** and then the **Add** icon to open the **My Certificates Add** screen. Use this screen to have the Zyxel Device create a self-signed certificate, enroll a certificate with a certification authority or generate a certification request.

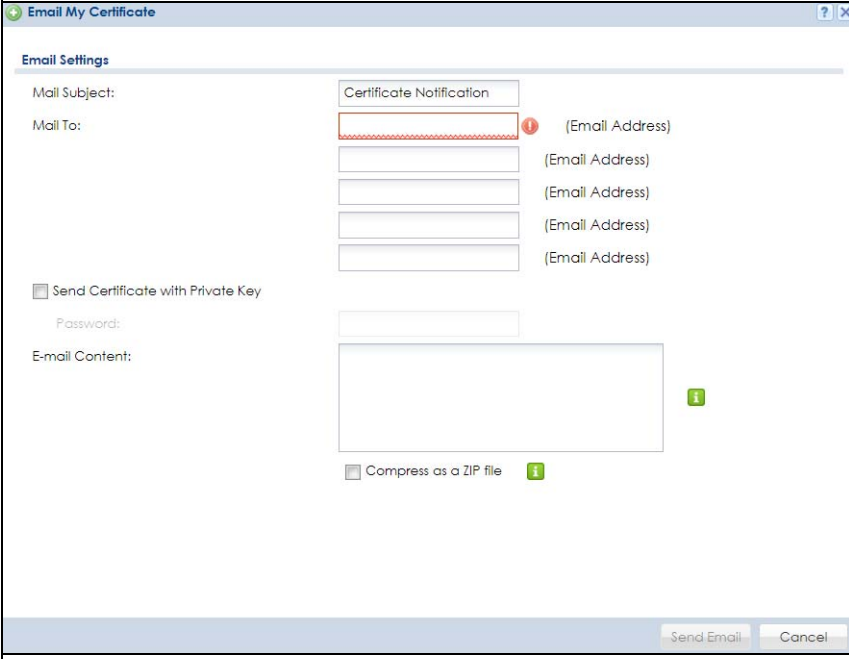
Figure 628 Configuration > Object > Certificate > My Certificates > Add

The following table describes the labels in this screen.

Table 359 Configuration > Object > Certificate > My Certificates > Add

LABEL	DESCRIPTION
Name	Type a name to identify this certificate. You can use up to 31 alphanumeric and ;'~!@#\$\$%^&()_+[]}'',.- characters.
Subject Information	<p>Use these fields to record information that identifies the owner of the certificate. You do not have to fill in every field, although you must specify a Host IP Address, Host IPv6 Address, Host Domain Name, or E-Mail. The certification authority may add fields (such as a serial number) to the subject information when it issues a certificate. It is recommended that each certificate have unique subject information.</p> <p>Select a radio button to identify the certificate's owner by IP address, domain name or e-mail address. Type the IP address (in dotted decimal notation), domain name or e-mail address in the field provided. The domain name or e-mail address is for identification purposes only and can be any string.</p> <p>A domain name can be up to 255 characters. You can use alphanumeric characters, the hyphen and periods.</p> <p>An e-mail address can be up to 63 characters. You can use alphanumeric characters, the hyphen, the @ symbol, periods and the underscore.</p>
Organizational Unit	Identify the organizational unit or department to which the certificate owner belongs. You can use up to 31 characters. You can use alphanumeric characters, the hyphen and the underscore.
Organization	Identify the company or group to which the certificate owner belongs. You can use up to 31 characters. You can use alphanumeric characters, the hyphen and the underscore.

Table 359 Configuration > Object > Certificate > My Certificates > Add (continued)

LABEL	DESCRIPTION
Town (City)	Identify the town or city where the certificate owner is located. You can use up to 31 characters. You can use alphanumeric characters, the hyphen and the underscore.
State, (Province)	Identify the state or province where the certificate owner is located. You can use up to 31 characters. You can use alphanumeric characters, the hyphen and the underscore.
Country	Identify the nation where the certificate owner is located. You can use up to 31 characters. You can use alphanumeric characters, the hyphen and the underscore.
Key Type	Select RSA to use the Rivest, Shamir and Adleman public-key algorithm. Select DSA to use the Digital Signature Algorithm public-key algorithm.
Key Length	Select a number from the drop-down list box to determine how many bits the key should use (512 to 2048). The longer the key, the more secure it is. A longer key also uses more PKI storage space.
Extended Key Usage	This field displays how the Zyxel Device generates and stores a request for server authentication, client authentication, and/or IKE Intermediate authentication certificate.
Server Authentication	Select this to have Zyxel Device generate and store a request for server authentication certificate.
Client Authentication	Select this to have Zyxel Device generate and store a request for client authentication certificate.
IKE Intermediate	Select this to have Zyxel Device generate and store a request for IKE Intermediate authentication certificate.
Create a self-signed certificate	Select this to have the Zyxel Device generate the certificate and act as the Certification Authority (CA) itself. This way you do not need to apply to a certification authority for certificates.
Create a certification request and save it locally for later manual enrollment	Select this to have the Zyxel Device generate and store a request for a certificate. Use the My Certificate Details screen to view the certification request and copy it to send to the certification authority. Copy the certification request from the My Certificate Details screen (see Section 43.12.3.2 on page 932) and then send it to the certification authority.
OK	Click OK to begin certificate or certification request generation.
Cancel	Click Cancel to quit and return to the My Certificates screen.

If you configured the **My Certificate Create** screen to have the Zyxel Device enroll a certificate and the certificate enrollment is not successful, you see a screen with a **Return** button that takes you back to the **My Certificate Create** screen. Click **Return** and check your information in the **My Certificate Create** screen. Make sure that the certification authority information is correct and that your Internet connection is working properly if you want the Zyxel Device to enroll a certificate online.

43.12.3.2 The My Certificates Edit Screen

Click **Configuration > Object > Certificate > My Certificates** and then the **Edit** icon to open the **My Certificate Edit** screen. You can use this screen to view in-depth certificate information and change the certificate's name.

Figure 629 Configuration > Object > Certificate > My Certificates > Edit

The following table describes the labels in this screen.

Table 360 Configuration > Object > Certificate > My Certificates > Edit

LABEL	DESCRIPTION
Name	This field displays the identifying name of this certificate. You can use up to 31 alphanumeric and ;'~!@#\$%^&()_+[]{}'.,=- characters.
Certification Path	This field displays for a certificate, not a certification request. Click the Refresh button to have this read-only text box display the hierarchy of certification authorities that validate the certificate (and the certificate itself). If the issuing certification authority is one that you have imported as a trusted certification authority, it may be the only certification authority in the list (along with the certificate itself). If the certificate is a self-signed certificate, the certificate itself is the only one in the list. The Zyxel Device does not trust the certificate and displays "Not trusted" in this field if any certificate on the path has expired or been revoked.
Refresh	Click Refresh to display the certification path.

Table 360 Configuration > Object > Certificate > My Certificates > Edit (continued)

LABEL	DESCRIPTION
Certificate Information	These read-only fields display detailed information about the certificate.
Type	This field displays general information about the certificate. CA-signed means that a Certification Authority signed the certificate. Self-signed means that the certificate's owner signed the certificate (not a certification authority). "X.509" means that this certificate was created and signed according to the ITU-T X.509 recommendation that defines the formats for public-key certificates.
Version	This field displays the X.509 version number.
Serial Number	This field displays the certificate's identification number given by the certification authority or generated by the Zyxel Device.
Subject	This field displays information that identifies the owner of the certificate, such as Common Name (CN), Organizational Unit (OU), Organization (O), State (ST), and Country (C).
Issuer	This field displays identifying information about the certificate's issuing certification authority, such as Common Name, Organizational Unit, Organization and Country. With self-signed certificates, this is the same as the Subject Name field. "none" displays for a certification request.
Signature Algorithm	This field displays the type of algorithm that was used to sign the certificate. The Zyxel Device uses rsa-pkcs1-sha1 (RSA public-private key encryption algorithm and the SHA1 hash algorithm). Some certification authorities may use rsa-pkcs1-md5 (RSA public-private key encryption algorithm and the MD5 hash algorithm).
Valid From	This field displays the date that the certificate becomes applicable. "none" displays for a certification request.
Valid To	This field displays the date that the certificate expires. The text displays in red and includes an Expired! message if the certificate has expired. "none" displays for a certification request.
Key Algorithm	This field displays the type of algorithm that was used to generate the certificate's key pair (the Zyxel Device uses RSA encryption) and the length of the key set in bits (1024 bits for example).
Subject Alternative Name	This field displays the certificate owner's IP address (IP), domain name (DNS) or e-mail address (EMAIL).
Key Usage	This field displays for what functions the certificate's key can be used. For example, "DigitalSignature" means that the key can be used to sign certificates and "KeyEncipherment" means that the key can be used to encrypt text.
Basic Constraint	This field displays general information about the certificate. For example, Subject Type=CA means that this is a certification authority's certificate and "Path Length Constraint=1" means that there can only be one certification authority in the certificate's path. This field does not display for a certification request.
MD5 Fingerprint	This is the certificate's message digest that the Zyxel Device calculated using the MD5 algorithm.
SHA1 Fingerprint	This is the certificate's message digest that the Zyxel Device calculated using the SHA1 algorithm.
Certificate in PEM (Base-64) Encoded Format	This read-only text box displays the certificate or certification request in Privacy Enhanced Mail (PEM) format. PEM uses lowercase letters, uppercase letters and numerals to convert a binary certificate into a printable form. You can copy and paste a certification request into a certification authority's web page, an e-mail that you send to the certification authority or a text editor and save the file on a management computer for later manual enrollment. You can copy and paste a certificate into an e-mail to send to friends or colleagues or you can copy and paste a certificate into a text editor and save the file on a management computer for later distribution (via floppy disk for example).

Table 360 Configuration > Object > Certificate > My Certificates > Edit (continued)

LABEL	DESCRIPTION
Export Certificate Only	Use this button to save a copy of the certificate without its private key. Click this button and then Save in the File Download screen. The Save As screen opens, browse to the location that you want to use and click Save .
Password	If you want to export the certificate with its private key, create a password and type it here. Make sure you keep this password in a safe place. You will need to use it if you import the certificate to another device.
Export Certificate with Private Key	Use this button to save a copy of the certificate with its private key. Type the certificate's password and click this button. Click Save in the File Download screen. The Save As screen opens, browse to the location that you want to use and click Save .
OK	Click OK to save your changes back to the Zyxel Device. You can only change the name.
Cancel	Click Cancel to quit and return to the My Certificates screen.

43.12.3.3 The My Certificates Import Screen

Click **Configuration > Object > Certificate > My Certificates > Import** to open the **My Certificate Import** screen. Follow the instructions in this screen to save an existing certificate to the Zyxel Device.

Note: You can import a certificate that matches a corresponding certification request that was generated by the Zyxel Device. You can also import a certificate in PKCS#12 format, including the certificate's public and private keys.

The certificate you import replaces the corresponding request in the **My Certificates** screen.

You must remove any spaces from the certificate's filename before you can import it.

Figure 630 Configuration > Object > Certificate > My Certificates > Import

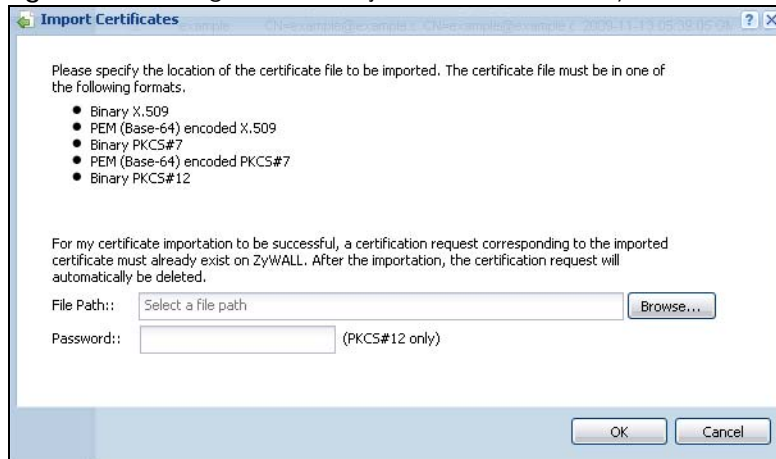

The following table describes the labels in this screen.

Table 361 Configuration > Object > Certificate > My Certificates > Import

LABEL	DESCRIPTION
File Path	Type in the location of the file you want to upload in this field or click Browse to find it. You cannot import a certificate with the same name as a certificate that is already in the Zyxel Device.
Browse	Click Browse to find the certificate file you want to upload.

Table 361 Configuration > Object > Certificate > My Certificates > Import (continued)

LABEL	DESCRIPTION
Password	This field only applies when you import a binary PKCS#12 format file. Type the file's password that was created when the PKCS #12 file was exported.
OK	Click OK to save the certificate on the Zyxel Device.
Cancel	Click Cancel to quit and return to the My Certificates screen.

43.12.4 The Trusted Certificates Screen

Click **Configuration > Object > Certificate > Trusted Certificates** to open the **Trusted Certificates** screen. This screen displays a summary list of certificates that you have set the Zyxel Device to accept as trusted. The Zyxel Device also accepts any valid certificate signed by a certificate on this list as being trustworthy; thus you do not need to import any certificate that is signed by one of these certificates.

Figure 631 Configuration > Object > Certificate > Trusted Certificates

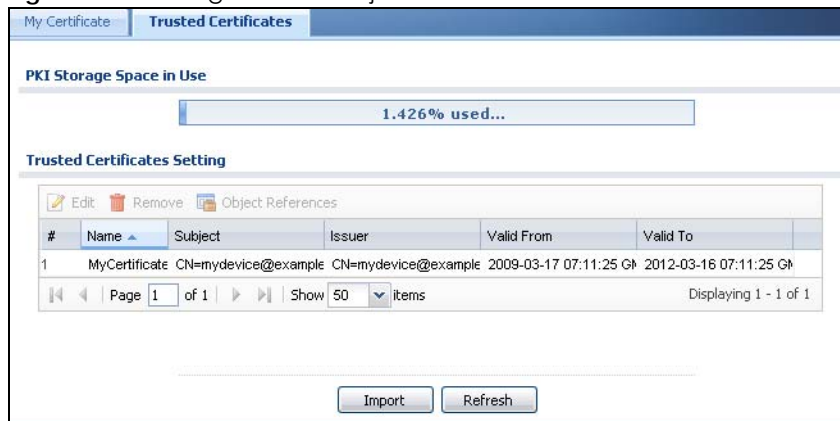

The following table describes the labels in this screen.

Table 362 Configuration > Object > Certificate > Trusted Certificates

LABEL	DESCRIPTION
PKI Storage Space in Use	This bar displays the percentage of the Zyxel Device's PKI storage space that is currently in use. When the storage space is almost full, you should consider deleting expired or unnecessary certificates before adding more certificates.
Edit	Double-click an entry or select it and click Edit to open a screen with an in-depth list of information about the certificate.
Remove	The Zyxel Device keeps all of your certificates unless you specifically delete them. Uploading a new firmware or default configuration file does not delete your certificates. To remove an entry, select it and click Remove . The Zyxel Device confirms you want to remove it before doing so. Subsequent certificates move up by one when you take this action.
References	You cannot delete certificates that any of the Zyxel Device's features are configured to use. Select an entry and click References to open a screen that shows which settings use the entry.
#	This field displays the certificate index number. The certificates are listed in alphabetical order.
Name	This field displays the name used to identify this certificate.
Subject	This field displays identifying information about the certificate's owner, such as CN (Common Name), OU (Organizational Unit or department), O (Organization or company) and C (Country). It is recommended that each certificate have unique subject information.
Issuer	This field displays identifying information about the certificate's issuing certification authority, such as a common name, organizational unit or department, organization or company and country. With self-signed certificates, this is the same information as in the Subject field.

Table 362 Configuration > Object > Certificate > Trusted Certificates (continued)

LABEL	DESCRIPTION
Valid From	This field displays the date that the certificate becomes applicable.
Valid To	This field displays the date that the certificate expires. The text displays in red and includes an Expired! message if the certificate has expired.
Import	Click Import to open a screen where you can save the certificate of a certification authority that you trust, from your computer to the Zyxel Device.
Refresh	Click this button to display the current validity status of the certificates.

43.12.4.1 The Trusted Certificates Edit Screen

Click **Configuration > Object > Certificate > Trusted Certificates** and then a certificate's **Edit** icon to open the **Trusted Certificates Edit** screen. Use this screen to view in-depth information about the certificate, change the certificate's name and set whether or not you want the Zyxel Device to check a certification authority's list of revoked certificates before trusting a certificate issued by the certification authority.

Figure 632 Configuration > Object > Certificate > Trusted Certificates > Edit

Edit Trusted Certificates ? X

Configuration

Name:

Certification Path

Certificate Validation

Enable X.509v3 CRL Distribution Points and OCSP checking

OCSP Server

URL:

ID:

Password:

LDAP Server

Address: Port:

ID:

Password:

Certificate Information

Type:	Self-signed X.509 Certificate
Version:	V3
Serial Number:	1237273885
Subject:	CN=mydevice@example.com
Issuer:	CN=mydevice@example.com
Signature Algorithm:	rsa-pkcs1-sha1
Valid From:	2009-03-17 07:11:25 GMT
Valid To:	2012-03-16 07:11:25 GMT
Key Algorithm:	rsaEncryption (512 bits)
Subject Alternative Name:	mydevice@example.com
Key Usage:	DigitalSignature, KeyEncipherment, KeyCertSign
Basic Constraint:	Subject Type=CA, Path Length Constraint=1
MDS Fingerprint:	78:34:e2:25:e3:79:92:e2:b6:33:5f:a9:17:be:72:4f
SHA1 Fingerprint:	ef:07:15:b5:e7:22:93:8b:1e:a7:e9:8f:cb:06:4c:04:f4:68:9c:e2

Certificate

```
-----BEGIN X509 CERTIFICATE-----
MIIBeTCCASOgAwIBAgIIESb9NHTANBgkqhkiG9w0BAQUFADAfMR0wGwYDVQQDDBRl
eWRldmJjZUBleGFtZXplcm9udG91b3R5b3R5b3R5b3R5b3R5b3R5b3R5b3R5b3R5
b3R5b3R5b3R5b3R5b3R5b3R5b3R5b3R5b3R5b3R5b3R5b3R5b3R5b3R5b3R5b3R5
MjVhM8xHTAbGnVBAMMFG15ZGV2aWNIQGV4YyW1wbGUuY291MFwwDQYJKoZIhvcN
-----
```

The following table describes the labels in this screen.

Table 363 Configuration > Object > Certificate > Trusted Certificates > Edit

LABEL	DESCRIPTION
Name	This field displays the identifying name of this certificate. You can change the name. You can use up to 31 alphanumeric and ;'~!@#%&()_+[]{}',.- characters.
Certification Path	Click the Refresh button to have this read-only text box display the end entity's certificate and a list of certification authority certificates that shows the hierarchy of certification authorities that validate the end entity's certificate. If the issuing certification authority is one that you have imported as a trusted certificate, it may be the only certification authority in the list (along with the end entity's own certificate). The Zyxel Device does not trust the end entity's certificate and displays "Not trusted" in this field if any certificate on the path has expired or been revoked.
Refresh	Click Refresh to display the certification path.
Enable X.509v3 CRL Distribution Points and OCSP checking	Select this check box to turn on/off certificate revocation. When it is turned on, the Zyxel Device validates a certificate by getting Certificate Revocation List (CRL) through HTTP or LDAP (can be configured after selecting the LDAP Server check box) and online responder (can be configured after selecting the OCSP Server check box).
OCSP Server	Select this check box if the directory server uses OCSP (Online Certificate Status Protocol).
URL	Type the protocol, IP address and path name of the OCSP server.
ID	The Zyxel Device may need to authenticate itself in order to assess the OCSP server. Type the login name (up to 31 ASCII characters) from the entity maintaining the server (usually a certification authority).
Password	Type the password (up to 31 ASCII characters) from the entity maintaining the OCSP server (usually a certification authority).
LDAP Server	Select this check box if the directory server uses LDAP (Lightweight Directory Access Protocol). LDAP is a protocol over TCP that specifies how clients access directories of certificates and lists of revoked certificates.
Address	Type the IP address (in dotted decimal notation) of the directory server.
Port	Use this field to specify the LDAP server port number. You must use the same server port number that the directory server uses. 389 is the default server port number for LDAP.
ID	The Zyxel Device may need to authenticate itself in order to assess the CRL directory server. Type the login name (up to 31 ASCII characters) from the entity maintaining the server (usually a certification authority).
Password	Type the password (up to 31 ASCII characters) from the entity maintaining the CRL directory server (usually a certification authority).
Certificate Information	These read-only fields display detailed information about the certificate.
Type	This field displays general information about the certificate. CA-signed means that a Certification Authority signed the certificate. Self-signed means that the certificate's owner signed the certificate (not a certification authority). X.509 means that this certificate was created and signed according to the ITU-T X.509 recommendation that defines the formats for public-key certificates.
Version	This field displays the X.509 version number.
Serial Number	This field displays the certificate's identification number given by the certification authority.
Subject	This field displays information that identifies the owner of the certificate, such as Common Name (CN), Organizational Unit (OU), Organization (O) and Country (C).
Issuer	This field displays identifying information about the certificate's issuing certification authority, such as Common Name, Organizational Unit, Organization and Country. With self-signed certificates, this is the same information as in the Subject Name field.

Table 363 Configuration > Object > Certificate > Trusted Certificates > Edit (continued)

LABEL	DESCRIPTION
Signature Algorithm	This field displays the type of algorithm that was used to sign the certificate. Some certification authorities use rsa-pkcs1-sha1 (RSA public-private key encryption algorithm and the SHA1 hash algorithm). Other certification authorities may use rsa-pkcs1-md5 (RSA public-private key encryption algorithm and the MD5 hash algorithm).
Valid From	This field displays the date that the certificate becomes applicable. The text displays in red and includes a Not Yet Valid! message if the certificate has not yet become applicable.
Valid To	This field displays the date that the certificate expires. The text displays in red and includes an Expiring! or Expired! message if the certificate is about to expire or has already expired.
Key Algorithm	This field displays the type of algorithm that was used to generate the certificate's key pair (the Zyxel Device uses RSA encryption) and the length of the key set in bits (1024 bits for example).
Subject Alternative Name	This field displays the certificate's owner's IP address (IP), domain name (DNS) or e-mail address (EMAIL).
Key Usage	This field displays for what functions the certificate's key can be used. For example, "DigitalSignature" means that the key can be used to sign certificates and "KeyEncipherment" means that the key can be used to encrypt text.
Basic Constraint	This field displays general information about the certificate. For example, Subject Type=CA means that this is a certification authority's certificate and "Path Length Constraint=1" means that there can only be one certification authority in the certificate's path.
MD5 Fingerprint	This is the certificate's message digest that the Zyxel Device calculated using the MD5 algorithm. You can use this value to verify with the certification authority (over the phone for example) that this is actually their certificate.
SHA1 Fingerprint	This is the certificate's message digest that the Zyxel Device calculated using the SHA1 algorithm. You can use this value to verify with the certification authority (over the phone for example) that this is actually their certificate.
Certificate	This read-only text box displays the certificate or certification request in Privacy Enhanced Mail (PEM) format. PEM uses lowercase letters, uppercase letters and numerals to convert a binary certificate into a printable form. You can copy and paste the certificate into an e-mail to send to friends or colleagues or you can copy and paste the certificate into a text editor and save the file on a management computer for later distribution (via floppy disk for example).
Export Certificate	Click this button and then Save in the File Download screen. The Save As screen opens, browse to the location that you want to use and click Save .
OK	Click OK to save your changes back to the Zyxel Device. You can only change the name.
Cancel	Click Cancel to quit and return to the Trusted Certificates screen.

43.12.4.2 The Trusted Certificates Import Screen

Click **Configuration > Object > Certificate > Trusted Certificates > Import** to open the **Trusted Certificates Import** screen. Follow the instructions in this screen to save a trusted certificate to the Zyxel Device.

Note: You must remove any spaces from the certificate's filename before you can import the certificate.

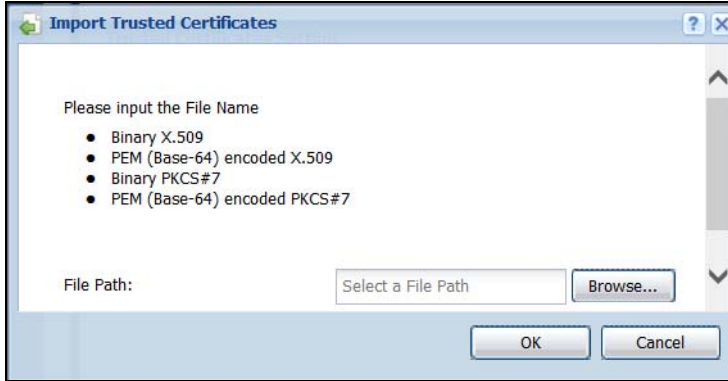
Figure 633 Configuration > Object > Certificate > Trusted Certificates > Import

The following table describes the labels in this screen.

Table 364 Configuration > Object > Certificate > Trusted Certificates > Import

LABEL	DESCRIPTION
File Path	Type in the location of the file you want to upload in this field or click Browse to find it. You cannot import a certificate with the same name as a certificate that is already in the Zyxel Device.
Browse	Click Browse to find the certificate file you want to upload.
OK	Click OK to save the certificate on the Zyxel Device.
Cancel	Click Cancel to quit and return to the previous screen.

43.12.5 Certificates Technical Reference

OCSP

OCSP (Online Certificate Status Protocol) allows an application or device to check whether a certificate is valid. With OCSP the Zyxel Device checks the status of individual certificates instead of downloading a Certificate Revocation List (CRL). OCSP has two main advantages over a CRL. The first is real-time status information. The second is a reduction in network traffic since the Zyxel Device only gets information on the certificates that it needs to verify, not a huge list. When the Zyxel Device requests certificate status information, the OCSP server returns a “expired”, “current” or “unknown” response.

43.13 ISP Account Overview

Use ISP accounts to manage Internet Service Provider (ISP) account information for PPPoE/PPTP/L2TP interfaces. An ISP account is a profile of settings for Internet access using PPPoE, PPTP or L2TP.

Use the **Object > ISP Account** screens ([Section 43.13.1 on page 941](#)) to create and manage ISP accounts in the Zyxel Device.

43.13.1 ISP Account Summary

This screen provides a summary of ISP accounts in the Zyxel Device. To access this screen, click **Configuration > Object > ISP Account**.

Figure 634 Configuration > Object > ISP Account

#	Profile Name	Protocol	Authentication Type	User Name
1	OPT_PPPOE_ACCOUNT	pppoe	chap-pap	
2	OPT_PPTP_ACCOUNT	pptp	chap-pap	
3	WAN1_PPPOE_ACCOUNT	pppoe	chap-pap	
4	WAN1_PPTP_ACCOUNT	pptp	chap-pap	
5	WAN2_PPPOE_ACCOUNT	pppoe	chap-pap	
6	WAN2_PPTP_ACCOUNT	pptp	chap-pap	
7	l2tp-eg	l2tp	chap-pap	ann

The following table describes the labels in this screen. See [the ISP Account Add/Edit section](#) below for more information as well.

Table 365 Configuration > Object > ISP Account

LABEL	DESCRIPTION
Add	Click this to create a new entry.
Edit	Double-click an entry or select it and click Edit to be able to modify the entry's settings.
Remove	To remove an entry, select it and click Remove . The Zyxel Device confirms you want to remove it before doing so.
References	Select an entry and click References to open a screen that shows which settings use the entry.
#	This field is a sequential value, and it is not associated with a specific entry.
Profile Name	This field displays the profile name of the ISP account. This name is used to identify the ISP account.
Protocol	This field displays the protocol used by the ISP account.
Authentication Type	This field displays the authentication type used by the ISP account.
User Name	This field displays the user name of the ISP account.

43.13.1.1 ISP Account Add/Edit

The **ISP Account Add/Edit** screen lets you add information about new accounts and edit information about existing accounts. To open this window, open the **ISP Account** screen. (See [Section 43.13.1 on page 941](#).) Then, click on an **Add** icon or **Edit** icon to open the **ISP Account Edit** screen below.

Figure 635 Configuration > Object > ISP Account > Edit

The following table describes the labels in this screen.

Table 366 Configuration > Object > ISP Account > Edit

LABEL	DESCRIPTION
Profile Name	This field is read-only if you are editing an existing account. Type in the profile name of the ISP account. The profile name is used to refer to the ISP account. You may use 1-31 alphanumeric characters, underscores(_), or dashes (-), but the first character cannot be a number. This value is case-sensitive.
Protocol	This field is read-only if you are editing an existing account. Select the protocol used by the ISP account. Your ISP will provide you with a related username, password and IP (server) information. Options are: pppoe - This ISP account uses the PPPoE protocol. pptp - This ISP account uses the PPTP protocol. l2tp - This ISP account uses the L2TP protocol.
Authentication Type	Use the drop-down list box to select an authentication protocol for outgoing calls. Options are: CHAP/PAP - Your Zyxel Device accepts either CHAP or PAP when requested by this remote node. Chap - Your Zyxel Device accepts CHAP only. PAP - Your Zyxel Device accepts PAP only. MSCHAP - Your Zyxel Device accepts MSCHAP only. MSCHAP-V2 - Your Zyxel Device accepts MSCHAP-V2 only.
Encryption Method	This field is available if this ISP account uses the PPTP protocol. Use the drop-down list box to select the type of Microsoft Point-to-Point Encryption (MPPE). Options are: nomppe - This ISP account does not use MPPE. mppe-40 - This ISP account uses 40-bit MPPE. mppe-128 - This ISP account uses 128-bit MMPE.
User Name	Type the user name given to you by your ISP.
Password	Type the password associated with the user name above. The password can only consist of alphanumeric characters (A-Z, a-z, 0-9). This field can be blank.
Retype to Confirm	Type your password again to make sure that you have entered is correctly.
IP Address/FQDN	Enter the IP address or Fully-Qualified Domain Name (FQDN) of the PPTP or L2TP server.

Table 366 Configuration > Object > ISP Account > Edit (continued)

LABEL	DESCRIPTION
Server IP	If this ISP account uses the PPPoE protocol, this field is not displayed. If this ISP account uses the PPTP protocol, type the IP address of the PPTP server.
Connection ID	This field is available if this ISP account uses the PPTP protocol. Type your identification name for the PPTP server. This field can be blank.
Service Name	If this ISP account uses the PPPoE protocol, type the PPPoE service name to access. PPPoE uses the specified service name to identify and reach the PPPoE server. This field can be blank. If this ISP account uses the PPTP protocol, this field is not displayed.
Compression	Select On button to turn on stac compression, and select Off to turn off stac compression. Stac compression is a data compression technique capable of compressing data by a factor of about four.
Idle Timeout	This value specifies the number of seconds that must elapse without outbound traffic before the Zyxel Device automatically disconnects from the PPPoE/PPTP server. This value must be an integer between 0 and 360. If this value is zero, this timeout is disabled.
OK	Click OK to save your changes back to the Zyxel Device. If there are no errors, the program returns to the ISP Account screen. If there are errors, a message box explains the error, and the program stays in the ISP Account Edit screen.
Cancel	Click Cancel to return to the ISP Account screen without creating the profile (if it is new) or saving any changes to the profile (if it already exists).

43.14 SSL Application Overview

You use SSL application objects in SSL VPN. Configure an SSL application object to specify the type of application and the address of the local computer, server, or web site SSL users are to be able to access. You can apply one or more SSL application objects in the **VPN > SSL VPN** screen for a user account/user group.

The ZyWALL VPN models do not support SSL Application.

- Use the **SSL Application** screen ([Section 43.14.2 on page 946](#)) to view the Zyxel Device's configured SSL application objects.
- Use the **SSL Application Edit** screen to create or edit web-based application objects to allow remote users to access an application via standard web browsers ([Section 43.14.2.1 on page 947](#)).
- You can also use the **SSL Application Edit** screen to specify the name of a folder on a Linux or Windows file server which remote users can access using a standard web browser ([Section 43.14.2.1 on page 947](#)).

43.14.1 What You Need to Know

Application Types

You can configure the following SSL application on the Zyxel Device.

- **Web-based**
A web-based application allows remote users to access an intranet site using standard web browsers.

Remote User Screen Links

Available SSL application names are displayed as links in remote user screens. Depending on the application type, remote users can simply click the links or follow the steps in the pop-up dialog box to access.

Remote Desktop Connections

Use SSL VPN to allow remote users to manage LAN computers. Depending on the functions supported by the remote desktop software, they can install or remove software, run programs, change settings, and open, copy, create, and delete files. This is useful for troubleshooting, support, administration, and remote access to files and programs.

The LAN computer to be managed must have VNC (Virtual Network Computing) or RDP (Remote Desktop Protocol) server software installed. The remote user's computer does not use VNC or RDP client software. The Zyxel Device works with the following remote desktop connection software:

RDP

- Windows Remote Desktop (supported in Internet Explorer)

VNC

- RealVNC
- TightVNC
- UltraVNC

For example, user **A** uses an SSL VPN connection to log into the Zyxel Device. Then he manages LAN computer **B** which has RealVNC server software installed.

Figure 636 SSL-protected Remote Management



Weblinks

You can configure weblink SSL applications to allow remote users to access web sites.

43.14.1.1 Example: Specifying a Web Site for Access

This example shows you how to create a web-based application for an internal web site. The address of the web site is `http://info` with web page encryption.

- 1 Click **Configuration > Object > SSL Application** in the navigation panel.

- Click the **Add** button and select **Web Application** in the **Type** field.

In the **Server Type** field, select **Web Server**.

Enter a descriptive name in the **Display Name** field. For example, "CompanyIntranet".

In the **URL Address** field, enter "http://my-info".

Select **Web Page Encryption** to prevent users from saving the web content.

Click **OK** to save the settings.

The configuration screen should look similar to the following figure.

Figure 637 Example: SSL Application: Specifying a Web Site for Access

The screenshot shows a dialog box titled "Add SSL Application". It has a "Create new Object" dropdown at the top. Under the "Object" section, the "Type" is set to "Web Application". Under the "Web Application" section, the "Server Type" is "Web Server", the "Name" is "WebExample", the "URL" is "http://info", and the "Entry Point" is empty with "(Optional)" next to it. The "Web Page Encryption" checkbox is checked. "OK" and "Cancel" buttons are at the bottom right.

43.14.2 The SSL Application Screen

The main **SSL Application** screen displays a list of the configured SSL application objects. Click **Configuration > Object > SSL Application** in the navigation panel.

Figure 638 Configuration > Object > SSL Application

The screenshot shows the "SSL Application" configuration screen. It has a "Configuration" section with a table of SSL application objects. The table has columns for "#", "Name", "Address", and "Type". Below the table are navigation controls for page and items.

#	Name	Address	Type
1	FileSharing_1	\example\example_1	file-sharing
2	OWA-example	http://mail.example	owa
3	VNC_Server1	DMZ2_SUBNET:5900-5900	vnc
4	WebExample	http://info	web-server
5	WebLink-Example	http://example.com	weblink

Navigation controls: Page 1 of 1, Show 50 items, Displaying 1 - 5 of 5

The following table describes the labels in this screen.

Table 367 Configuration > Object > SSL Application

LABEL	DESCRIPTION
Add	Click this to create a new entry.
Edit	Double-click an entry or select it and click Edit to be able to modify the entry's settings.
Remove	To remove an entry, select it and click Remove . The Zyxel Device confirms you want to remove it before doing so.
References	Select an entry and click References to open a screen that shows which settings use the entry.
#	This field displays the index number.
Name	This field displays the name of the object.
Address	This field displays the IP address/URL of the application server or the location of a file share.
Type	This field shows whether the object is a file-sharing, web-server, Outlook Web Access, Virtual Network Computing, or Remote Desktop Protocol SSL application.

43.14.2.1 Creating/Editing an SSL Application Object

You can create a web-based application that allows remote users to access an application via standard web browsers. You can also create a file sharing application that specify the name of a folder on a file server (Linux or Windows) which remote users can access. Remote users can access files using a standard web browser and files are displayed as links on the screen.

To configure an SSL application, click the **Add** or **Edit** button in the **SSL Application** screen and select **Web Application** or **File Sharing** in the **Type** field. The screen differs depending on what object type you choose.

Note: If you are creating a file sharing SSL application, you must also configure the shared folder on the file server for remote access. Refer to the document that comes with your file server.

Figure 639 Configuration > Object > SSL Application > Add/Edit: Web Application

Figure 640 Configuration > Object > SSL Application > Add/Edit: File Sharing

The following table describes the labels in this screen.

Table 368 Configuration > Object > SSL Application > Add/Edit: Web Application/File Sharing

LABEL	DESCRIPTION
Create new Object	Use this to configure any new settings objects that you need to use in this screen.
Object	
Type	Select Web Application or File Sharing from the drop-down list box.
Web Application	
Server Type	<p>This field only appears when you choose Web Application as the object type.</p> <p>Specify the type of service for this SSL application.</p> <p>Select Web Server to allow access to the specified web site hosted on the local network.</p> <p>Select OWA (Outlook Web Access) to allow users to access e-mails, contacts, calendars via Microsoft Outlook-like interface using supported web browsers. The Zyxel Device supports one OWA object.</p> <p>Select VNC to allow users to manage LAN computers that have Virtual Network Computing remote desktop server software installed.</p> <p>Select RDP to allow users to manage LAN computers that have Remote Desktop Protocol remote desktop server software installed.</p> <p>Select Weblink to create a link to a web site that you expect the SSL VPN users to commonly use.</p>
Name	Enter a descriptive name to identify this object. You can enter up to 31 characters ("0-9", "a-z", "A-Z", "-", and "_"). Spaces are not allowed.
URL	<p>This field only appears when you choose Web Application as the object type.</p> <p>This field displays if the Server Type is set to Web Server, OWA, or Weblink.</p> <p>Enter the Fully-Qualified Domain Name (FQDN) or IP address of the application server.</p> <p>Note: You must enter the "http://" or "https://" prefix.</p> <p>Remote users are restricted to access only files in this directory. For example, if you enter "\remote\" in this field, remote users can only access files in the "remote" directory.</p> <p>If a link contains a file that is not within this domain, then remote users cannot access it.</p>

Table 368 Configuration > Object > SSL Application > Add/Edit: Web Application/File Sharing

LABEL	DESCRIPTION
Preview	<p>This field only appears when you choose Web Application or File Sharing as the object type.</p> <p>This field displays if the Server Type is set to Web Server, OWA or Weblink.</p> <p>Note: If your Internet Explorer or other browser screen doesn't show a preview, it may be due to your web browser security settings. You need to add the Zyxel Device's IP address in the trusted sites of your web browser. For example, in Internet Explorer, click Tools > Internet Options > Security > Trusted Sites > Sites and type the Zyxel Device's IP address, then click Add. For other web browsers, please check the browser help.</p> <p>Click Preview to access the URL you specified in a new web browser screen.</p>
Entry Point	<p>This field only appears when you choose Web Application as the object type.</p> <p>This field displays if the Server Type is set to Web Server or OWA.</p> <p>This field is optional. You only need to configure this field if you need to specify the name of the directory or file on the local server as the home page or home directory on the user screen.</p>
Web Page Encryption	<p>This field only appears when you choose Web Application as the object type.</p> <p>Select this option to prevent users from saving the web content.</p>
Shared Path	<p>This field only appears when you choose File Sharing as the object type.</p> <p>Specify the IP address, domain name or NetBIOS name (computer name) of the file server and the name of the share to which you want to allow user access. Enter the path in one of the following formats.</p> <p>"\\<IP address>\<share name>"</p> <p>"\\<domain name>\<share name>"</p> <p>"\\<computer name>\<share name>"</p> <p>For example, if you enter "\\my-server\Tmp", this allows remote users to access all files and/or folders in the "\\Tmp" share on the "my-server" computer.</p>
OK	Click OK to save the changes and return to the main SSL Application Configuration screen.
Cancel	Click Cancel to discard the changes and return to the main SSL Application Configuration screen.

43.15 DHCPv6 Overview

This section describes how to configure DHCPv6 request type and lease type objects.

- The **Request** screen (see [Section 43.2.2 on page 833](#)) allows you to configure DHCPv6 request type objects.
- The **Lease** screen (see [Section 43.2.4 on page 837](#)) allows you to configure DHCPv6 lease type objects.

43.15.1 The DHCPv6 Request Screen

The **Request** screen allows you to add, edit, and remove DHCPv6 request type objects. To access this screen, login to the Web Configurator, and click **Configuration > Object > DHCPv6 > Request**.

Figure 641 Configuration > Object > DHCPv6 > Request

The following table describes the labels in this screen.

Table 369 Configuration > Object > DHCPv6 > Request

LABEL	DESCRIPTION
Configuration	
Add	Click this to create a new entry.
Edit	Double-click an entry or select it and click Edit to open a screen where you can modify the entry's settings.
Remove	To remove an entry, select it and click Remove . The Zyxel Device confirms you want to remove it before doing so.
References	Select an entry and click References to open a screen that shows which settings use the entry.
#	This field is a sequential value, and it is not associated with a specific object.
Name	This field displays the name of each request object.
Type	This field displays the request type of each request object.
Interface	This field displays the interface used for each request object.
Value	This field displays the value for each request object.

43.15.1.1 DHCPv6 Request Add/Edit Screen

The **Request Add/Edit** screen allows you to create a new request object or edit an existing one.

To access this screen, go to the **Request** screen (see [Section 43.2.2 on page 833](#)), and click either the **Add** icon or an **Edit** icon.

Figure 642 Configuration > DHCPv6 > Request > Add

The following table describes the labels in this screen.

Table 370 Configuration > DHCPv6 > Request > Add

LABEL	DESCRIPTION
Name	Type the name for this request object. You may use 1-31 alphanumeric characters, underscores(_), or dashes (-), but the first character cannot be a number. This value is case-sensitive.
Request Type	Select the request type for this request object. You can choose from Prefix Delegation , DNS Server , NTP Server , or SIP Server .

Table 370 Configuration > DHCPv6 > Request > Add (continued)

LABEL	DESCRIPTION
Interface	Select the interface for this request object.
OK	Click OK to save your changes back to the Zyxel Device.
Cancel	Click Cancel to exit this screen without saving your changes.

43.15.2 The DHCPv6 Lease Screen

The **Lease** screen allows you to add, edit, and remove DHCPv6 lease type objects. To access this screen, login to the Web Configurator, and click **Configuration > Object > DHCPv6 > Lease**.

Figure 643 Configuration > Object > DHCPv6 > Lease

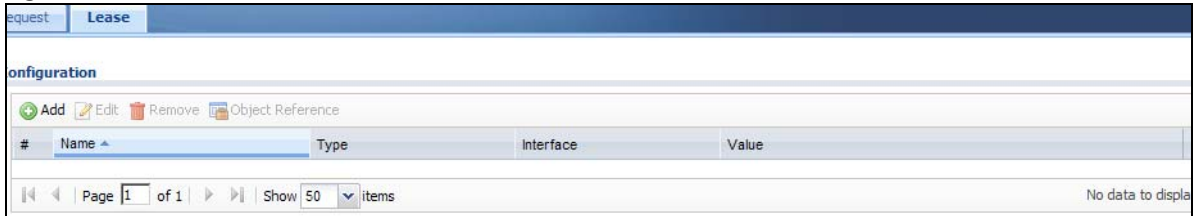

The following table describes the labels in this screen.

Table 371 Configuration > Object > DHCPv6 > Lease

LABEL	DESCRIPTION
Configuration	
Add	Click this to create a new entry.
Edit	Double-click an entry or select it and click Edit to open a screen where you can modify the entry's settings.
Remove	To remove an entry, select it and click Remove . The Zyxel Device confirms you want to remove it before doing so.
References	Select an entry and click References to open a screen that shows which settings use the entry.
#	This field is a sequential value, and it is not associated with a specific object.
Name	This field displays the name of each lease object.
Type	This field displays the request type of each lease object.
Interface	This field displays the interface used for each lease object.
Value	This field displays the value for each lease object.

43.15.2.1 DHCPv6 Lease Add/Edit Screen

The **Lease Add/Edit** screen allows you to create a new lease object or edit an existing one.

To access this screen, go to the **Lease** screen (see [Section 43.15.2 on page 951](#)), and click either the **Add** icon or an **Edit** icon.

Figure 644 Configuration > DHCPv6 > Lease > Add

The following table describes the labels in this screen.

Table 372 Configuration > DHCPv6 > Lease > Add/Edit

LABEL	DESCRIPTION
Name	Type the name for this lease object. You may use 1-31 alphanumeric characters, underscores(_), or dashes (-), but the first character cannot be a number. This value is case-sensitive.
Lease Type	Select the lease type for this lease object. You can choose from Prefix Delegation , DNS Server , Address , Address Pool , NTP Server , or SIP Server .
Interface	Select the interface for this lease object.
DUID	If you select Prefix Delegation or Address in the Lease Type field, enter the DUID of the interface.
Prefix	If you select Prefix Delegation or Address in the Lease Type field, enter the IPv6 prefix of the interface.
DNS Server	If you select DNS Server in the Lease Type field, select a request object or User Defined in the DNS Server field and enter the IP address of the DNS server in the User Defined Address field below.
Starting IP Address	If you select Address Pool in the Lease Type field, enter the first of the contiguous addresses in the IP address pool.
End IP Address	If you select Address Pool in the Lease Type field, enter the last of the contiguous addresses in the IP address pool.
NTP Server	If you select NTP Server in the Lease Type field, select a request object or User Defined in the NTP Server field and enter the IP address of the NTP server in the User Defined Address field below.
SIP Server	If you select SIP Server in the Lease Type field, select a request object or User Defined in the SIP field and enter the IP address of the SIP server in the User Defined Address field below.
User Defined Address	If you select DNS Server , NTP Server , or SIP Server as your lease type, you must enter the IP address of the server you selected.
OK	Click OK to save your changes back to the Zyxel Device.
Cancel	Click Cancel to exit this screen without saving your changes.

CHAPTER 44

System

44.1 Overview

Use the system screens to configure general Zyxel Device settings.

44.1.1 What You Can Do in this Chapter

- Use the **System > Host Name** screen (see [Section 44.2 on page 954](#)) to configure a unique name for the Zyxel Device in your network.
- Use the **System > USB Storage** screen (see [Section 44.3 on page 954](#)) to configure the settings for the connected USB devices.
- Use the **System > Date/Time** screen (see [Section 44.4 on page 955](#)) to configure the date and time for the Zyxel Device.
- Use the **System > Console Speed** screen (see [Section 44.5 on page 959](#)) to configure the console port speed when you connect to the Zyxel Device via the console port using a terminal emulation program.
- Use the **System > DNS** screen (see [Section 44.6 on page 960](#)) to configure the DNS (Domain Name System) server used for mapping a domain name to its corresponding IP address and vice versa.
- Use the **System > WWW** screens (see [Section 44.7 on page 969](#)) to configure settings for HTTP or HTTPS access to the Zyxel Device and how the login and access user screens look.
- Use the **System > SSH** screen (see [Section 44.8 on page 987](#)) to configure SSH (Secure SHell) used to securely access the Zyxel Device's command line interface. You can specify which zones allow SSH access and from which IP address the access can come.
- Use the **System > TELNET** screen (see [Section 44.9 on page 992](#)) to configure Telnet to access the Zyxel Device's command line interface. Specify which zones allow Telnet access and from which IP address the access can come.
- Use the **System > FTP** screen (see [Section 44.10 on page 993](#)) to specify from which zones FTP can be used to access the Zyxel Device. You can also specify from which IP addresses the access can come. You can upload and download the Zyxel Device's firmware and configuration files using FTP.
- Your Zyxel Device can act as an SNMP agent, which allows a manager station to manage and monitor the Zyxel Device through the network. Use the **System > SNMP** screen (see [Section 44.11 on page 994](#)) to configure SNMP settings, including from which zones SNMP can be used to access the Zyxel Device. You can also specify from which IP addresses the access can come.
- Use the **Auth. Server** screen ([Section 44.12 on page 999](#)) to configure the Zyxel Device to operate as a RADIUS server.
- Use the **Notification > Mail Server** screen ([Section 44.13 on page 1001](#)) to configure the Zyxel Device to operate as a RADIUS server.
- Use the **Notification > SMS** screen ([Section 44.14 on page 1003](#)) to turn on the SMS service on the Zyxel Device in order to send dynamic guest account information in text messages and authorization for VPN tunnel access to a secured network.
- Use the **System > Language** screen (see [Section 44.16 on page 1006](#)) to set a language for the Zyxel Device's Web Configurator screens.

- Use the **System > IPv6** screen (see [Section 44.17 on page 1006](#)) to enable or disable IPv6 support on the Zyxel Device.
- Use the **System > ZON** screen (see [Section 44.18 on page 1007](#)) to enable or disable the Zyxel One Network (ZON) utility that uses Zyxel Discovery Protocol (ZDP) for discovering and configuring ZDP-aware Zyxel devices in the same network as the computer on which ZON is installed.
- Use the **System > Advanced** screen (see [Section 44.19 on page 1012](#)) to enable or disable the Fast Forwarding feature for your Zyxel Device.

Note: See each section for related background information and term definitions.

44.2 Host Name

A host name is the unique name by which a device is known on a network. Click **Configuration > System > Host Name** to open the **Host Name** screen.

Figure 645 Configuration > System > Host Name

The following table describes the labels in this screen.

Table 373 Configuration > System > Host Name

LABEL	DESCRIPTION
System Name	Enter a descriptive name to identify your Zyxel Device device. This name can be up to 64 alphanumeric characters long. Spaces are not allowed, but dashes (-) underscores (_) and periods (.) are accepted.
Domain Name	Enter the domain name (if you know it) here. This name is propagated to DHCP clients connected to interfaces with the DHCP server enabled. This name can be up to 254 alphanumeric characters long. Spaces are not allowed, but dashes "-" are accepted.
Apply	Click Apply to save your changes back to the Zyxel Device.
Reset	Click Reset to return the screen to its last-saved settings.

44.3 USB Storage

The Zyxel Device can use a connected USB device to store the system log and other diagnostic information. Use this screen to turn on this feature and set a disk full warning limit.

Note: Only connect one USB device. It must allow writing (it cannot be read-only) and use the FAT16, FAT32, EXT2, or EXT3 file system.

Click **Configuration > System > USB Storage** to open the screen as shown next.

Figure 646 Configuration > System > USB Storage

The following table describes the labels in this screen.

Table 374 Configuration > System > USB Storage

LABEL	DESCRIPTION
Activate USB storage service	Select this if you want to use the connected USB device(s).
Disk full warning when remaining space is less than	Set a number and select a unit (MB or %) to have the Zyxel Device send a warning message when the remaining USB storage space is less than the value you set here.
Apply	Click Apply to save your changes back to the Zyxel Device.
Reset	Click Reset to return the screen to its last-saved settings.

44.4 Date and Time

For effective scheduling and logging, the Zyxel Device system time must be accurate. The Zyxel Device's Real Time Chip (RTC) keeps track of the time and date. There is also a software mechanism to set the time manually or get the current time and date from an external server.

To change your Zyxel Device's time based on your local time zone and date, click **Configuration > System > Date/Time**. The screen displays as shown. You can manually set the Zyxel Device's time and date or have the Zyxel Device get the date and time from a time server.

Figure 647 Configuration > System > Date and Time

The following table describes the labels in this screen.

Table 375 Configuration > System > Date and Time

LABEL	DESCRIPTION
Current Time and Date	
Current Time	This field displays the present time of your Zyxel Device.
Current Date	This field displays the present date of your Zyxel Device.
Time and Date Setup	
Manual	Select this radio button to enter the time and date manually. If you configure a new time and date, time zone and daylight saving at the same time, the time zone and daylight saving will affect the new time and date you entered. When you enter the time settings manually, the Zyxel Device uses the new setting once you click Apply .
New Time (hh-mm-ss)	This field displays the last updated time from the time server or the last time configured manually. When you set Time and Date Setup to Manual , enter the new time in this field and then click Apply .
New Date (yyyy-mm-dd)	This field displays the last updated date from the time server or the last date configured manually. When you set Time and Date Setup to Manual , enter the new date in this field and then click Apply .

Table 375 Configuration > System > Date and Time (continued)

LABEL	DESCRIPTION
Get from Time Server	<p>Select this radio button to have the Zyxel Device get the time and date from the time server you specify below. The Zyxel Device requests time and date settings from the time server under the following circumstances.</p> <ul style="list-style-type: none"> • When the Zyxel Device starts up. • When you click Apply or Synchronize Now in this screen. • 24-hour intervals after starting up.
Time Server Address	Enter the IP address or URL of your time server. Check with your ISP/network administrator if you are unsure of this information.
Sync. Now	Click this button to have the Zyxel Device get the time and date from a time server (see the Time Server Address field). This also saves your changes (except the daylight saving settings).
Time Zone Setup	
Time Zone	Choose the time zone of your location. This will set the time difference between your time zone and Greenwich Mean Time (GMT).
Automatically Sync Time Zone	Select this for the Zyxel Device to automatically get its time zone.
Daylight Saving	
Enable Daylight Savings	<p>Daylight savings is a period from late spring to early fall when many countries set their clocks ahead of normal local time by one hour to give more daytime light in the evening.</p> <p>Select this option if you use Daylight Saving Time.</p>
Automatically adjust clock for Daylight Saving Time	Select this for the Zyxel Device to automatically adjust the time if daylight savings is implemented in its time zone.
Start Date	<p>Configure the day and time when Daylight Saving Time starts if you selected Enable Daylight Saving. The at field uses the 24 hour format. Here are a couple of examples:</p> <p>Daylight Saving Time starts in most parts of the United States on the second Sunday of March. Each time zone in the United States starts using Daylight Saving Time at 2 A.M. local time. So in the United States you would select Second, Sunday, March and type 2 in the at field.</p> <p>Daylight Saving Time starts in the European Union on the last Sunday of March. All of the time zones in the European Union start using Daylight Saving Time at the same moment (1 A.M. GMT or UTC). So in the European Union you would select Last, Sunday, March. The time you type in the at field depends on your time zone. In Germany for instance, you would type 2 because Germany's time zone is one hour ahead of GMT or UTC (GMT+1).</p>
End Date	<p>Configure the day and time when Daylight Saving Time ends if you selected Enable Daylight Saving. The at field uses the 24 hour format. Here are a couple of examples:</p> <p>Daylight Saving Time ends in the United States on the first Sunday of November. Each time zone in the United States stops using Daylight Saving Time at 2 A.M. local time. So in the United States you would select First, Sunday, November and type 2 in the at field.</p> <p>Daylight Saving Time ends in the European Union on the last Sunday of October. All of the time zones in the European Union stop using Daylight Saving Time at the same moment (1 A.M. GMT or UTC). So in the European Union you would select Last, Sunday, October. The time you type in the at field depends on your time zone. In Germany for instance, you would type 2 because Germany's time zone is one hour ahead of GMT or UTC (GMT+1).</p>
Offset	<p>Specify how much the clock changes when daylight saving begins and ends.</p> <p>Enter a number from 1 to 5.5 (by 0.5 increments).</p> <p>For example, if you set this field to 3.5, a log occurred at 6 P.M. in local official time will appear as if it had occurred at 10:30 P.M.</p>

Table 375 Configuration > System > Date and Time (continued)

LABEL	DESCRIPTION
Apply	Click Apply to save your changes back to the Zyxel Device.
Reset	Click Reset to return the screen to its last-saved settings.

44.4.1 Pre-defined NTP Time Servers List

When you turn on the Zyxel Device for the first time, the date and time start at 2003-01-01 00:00:00. The Zyxel Device then attempts to synchronize with one of the following pre-defined list of Network Time Protocol (NTP) time servers.

The Zyxel Device continues to use the following pre-defined list of NTP time servers if you do not specify a time server or it cannot synchronize with the time server you specified.

Table 376 Default Time Servers

0.pool.ntp.org
1.pool.ntp.org
2.pool.ntp.org

When the Zyxel Device uses the pre-defined list of NTP time servers, it randomly selects one server and tries to synchronize with it. If the synchronization fails, then the Zyxel Device goes through the rest of the list in order from the first one tried until either it is successful or all the pre-defined NTP time servers have been tried.

44.4.2 Time Server Synchronization

Click the **Synchronize Now** button to get the time and date from the time server you specified in the **Time Server Address** field.

When the **Please Wait...** screen appears, you may have to wait up to one minute.

Figure 648 Synchronization in Process



The **Current Time** and **Current Date** fields will display the appropriate settings if the synchronization is successful.

If the synchronization was not successful, a log displays in the **View Log** screen. Try re-configuring the **Date/Time** screen.

To manually set the Zyxel Device date and time.

- 1 Click **System > Date/Time**.
- 2 Select **Manual** under **Time and Date Setup**.
- 3 Enter the Zyxel Device's time in the **New Time** field.

- 4 Enter the Zyxel Device's date in the **New Date** field.
- 5 Under **Time Zone Setup**, select your **Time Zone** from the list.
- 6 As an option you can select the **Enable Daylight Saving** check box to adjust the Zyxel Device clock for daylight savings.
- 7 Click **Apply**.

To get the Zyxel Device date and time from a time server

- 1 Click **System > Date/Time**.
- 2 Select **Get from Time Server** under **Time and Date Setup**.
- 3 Under **Time Zone Setup**, select your **Time Zone** from the list.
- 4 As an option you can select the **Enable Daylight Saving** check box to adjust the Zyxel Device clock for daylight savings.
- 5 Under **Time and Date Setup**, enter a **Time Server Address** ([Table 376 on page 958](#)).
- 6 Click **Apply**.

44.5 Console Port Speed

This section shows you how to set the console port speed when you connect to the Zyxel Device via the console port using a terminal emulation program.

Click **Configuration > System > Console Speed** to open the **Console Speed** screen.

Figure 649 Configuration > System > Console Speed

The following table describes the labels in this screen.

Table 377 Configuration > System > Console Speed

LABEL	DESCRIPTION
Console Port Speed	Use the drop-down list box to change the speed of the console port. Your Zyxel Device supports 9600, 19200, 38400, 57600, and 115200 bps (default) for the console port. The Console Port Speed applies to a console port connection using terminal emulation software and NOT the Console in the Zyxel Device Web Configurator Status screen.
Apply	Click Apply to save your changes back to the Zyxel Device.
Reset	Click Reset to return the screen to its last-saved settings.

44.6 DNS Overview

DNS (Domain Name System) is for mapping a domain name to its corresponding IP address and vice versa. The DNS server is extremely important because without it, you must know the IP address of a machine before you can access it.

44.6.1 DNS Server Address Assignment

The Zyxel Device can get the DNS server addresses in the following ways.

- The ISP tells you the DNS server addresses, usually in the form of an information sheet, when you sign up. If your ISP gives you DNS server addresses, manually enter them in the DNS server fields.
- If your ISP dynamically assigns the DNS server IP addresses (along with the Zyxel Device's WAN IP address), set the DNS server fields to get the DNS server address from the ISP.
- You can manually enter the IP addresses of other DNS servers.

44.6.2 Configuring the DNS Screen

Click **Configuration > System > DNS** to change your Zyxel Device's DNS settings. Use the **DNS** screen to configure the Zyxel Device to use a DNS server to resolve domain names for Zyxel Device system features like VPN, DDNS and the time server. You can also configure the Zyxel Device to accept or discard DNS queries. Use the **Network > Interface** screens to configure the DNS server information that the Zyxel Device sends to the specified DHCP client devices.

A name query begins at a client computer and is passed to a resolver, a DNS client service, for resolution. The Zyxel Device can be a DNS client service. The Zyxel Device can resolve a DNS query locally using cached Resource Records (RR) obtained from a previous query (and kept for a period of time). If the Zyxel Device does not have the requested information, it can forward the request to DNS servers. This is known as recursion.

The Zyxel Device can ask a DNS server to use recursion to resolve its DNS client requests. If recursion on the Zyxel Device or a DNS server is disabled, they cannot forward DNS requests for resolution.

A Domain Name Server (DNS) amplification attack is a kind of Distributed Denial of Service (DDoS) attack that uses publicly accessible open DNS servers to flood a victim with DNS response traffic. An open DNS server is a DNS server which is willing to resolve recursive DNS queries from anyone on the Internet.

In a DNS amplification attack, an attacker sends a DNS name lookup request to an open DNS server with the source address spoofed as the victim's address. When the DNS server sends the DNS record response, it is sent to the victim. Attackers can request as much information as possible to maximize the amplification effect.

Configure the **Security Option Control** section in the **Configuration > System > DNS** screen (click **Show Advanced Settings** to display it) if you suspect the Zyxel Device is being used (either by hackers or by a corrupted open DNS server) in a DNS amplification attack.

Figure 650 Configuration > System > DNS

The screenshot shows the DNS configuration interface. It includes sections for Address/PTR Record, IPv6 Address/PTR Record, CNAME Record, Domain Zone Forwarder, MX Record (for My FQDN), Security Option Control, and Service Control. Each section contains a table with columns for various fields and actions like 'Add', 'Edit', and 'Remove'.

The following table describes the labels in this screen.

Table 378 Configuration > System > DNS

LABEL	DESCRIPTION
Address/PTR Record	This record specifies the mapping of a Fully-Qualified Domain Name (FQDN) to an IP address. An FQDN consists of a host and domain name. For example, www.zyxel.com.tw is a fully qualified domain name, where "www" is the host, "zyxel" is the third-level domain, "com" is the second-level domain, and "tw" is the top level domain.
Add	Click this to create a new entry.
Edit	Double-click an entry or select it and click Edit to be able to modify the entry's settings.
Remove	To remove an entry, select it and click Remove . The Zyxel Device confirms you want to remove it before doing so. Note that subsequent entries move up by one when you take this action.
#	This is the index number of the address/PTR record.

Table 378 Configuration > System > DNS (continued)

LABEL	DESCRIPTION
FQDN	This is a host's fully qualified domain name.
IP Address	This is the IP address of a host.
CNAME Record	This record specifies an alias for a FQDN. Use this record to bind all subdomains with the same IP address as the FQDN without having to update each one individually, which increases chance for errors. See CNAME Record (Section 44.6.6 on page 964) for more details.
Add	Click this to create a new entry.
Edit	Double-click an entry or select it and click Edit to be able to modify the entry's settings.
Remove	To remove an entry, select it and click Remove. The Zyxel Device confirms you want to remove it before doing so. Note that subsequent entries move up by one when you take this action.
#	This is the index number of the domain zone forwarder record. The ordering of your rules is important as rules are applied in sequence. A hyphen (-) displays for the default domain zone forwarder record. The default record is not configurable. The Zyxel Device uses this default record if the domain zone that needs to be resolved does not match any of the other domain zone forwarder records.
Alias Name	Enter an Alias name. Use "*" as prefix for a wildcard domain name. For example, *.example.com.
FQDN	Enter the Fully Qualified Domain Name (FQDN).
Domain Zone Forwarder	This specifies a DNS server's IP address. The Zyxel Device can query the DNS server to resolve domain zones for features like VPN, DDNS and the time server. When the Zyxel Device needs to resolve a domain zone, it checks it against the domain zone forwarder entries in the order that they appear in this list.
Add	Click this to create a new entry. Select an entry and click Add to create a new entry after the selected entry.
Edit	Double-click an entry or select it and click Edit to be able to modify the entry's settings.
Remove	To remove an entry, select it and click Remove . The Zyxel Device confirms you want to remove it before doing so. Note that subsequent entries move up by one when you take this action.
Move	To change an entry's position in the numbered list, select the method and click Move to display a field to type a number for where you want to put it and press [ENTER] to move the rule to the number that you typed.
#	This is the index number of the domain zone forwarder record. The ordering of your rules is important as rules are applied in sequence. A hyphen (-) displays for the default domain zone forwarder record. The default record is not configurable. The Zyxel Device uses this default record if the domain zone that needs to be resolved does not match any of the other domain zone forwarder records.
Domain Zone	A domain zone is a fully qualified domain name without the host. For example, zyxel.com.tw is the domain zone for the www.zyxel.com.tw fully qualified domain name. A "*" means all domain zones.
Type	This displays whether the DNS server IP address is assigned by the ISP dynamically through a specified interface or configured manually (User-Defined).
DNS Server	This is the IP address of a DNS server. This field displays N/A if you have the Zyxel Device get a DNS server IP address from the ISP dynamically but the specified interface is not active.
Query Via	This is the interface through which the Zyxel Device sends DNS queries to the entry's DNS server. If the Zyxel Device connects through a VPN tunnel, tunnel displays.
MX Record (for My FQDN)	A MX (Mail eXchange) record identifies a mail server that handles the mail for a particular domain.
Add	Click this to create a new entry.

Table 378 Configuration > System > DNS (continued)

LABEL	DESCRIPTION
Edit	Double-click an entry or select it and click Edit to be able to modify the entry's settings.
Remove	To remove an entry, select it and click Remove . The Zyxel Device confirms you want to remove it before doing so. Note that subsequent entries move up by one when you take this action.
#	This is the index number of the MX record.
Domain Name	This is the domain name where the mail is destined for.
IP/FQDN	This is the IP address or Fully-Qualified Domain Name (FQDN) of a mail server that handles the mail for the domain specified in the field above.
Security Option Control	Click Show Advanced Settings to display this part of the screen. There are two control policies: Default and Customize .
Edit	Click either control policy and then click this button to change allow or deny actions for Query Recursion and Additional Info from Cache .
Priority	The Customize control policy is checked first and if an address object match is not found, the Default control policy is checked.
Name	You may change the name of the Customize control policy.
Address	These are the object addresses used in the control policy. RFC1918 refers to private IP address ranges. It can be modified in Object > Address .
Additional Info from Cache	This displays if the Zyxel Device is allowed or denied to cache Resource Records (RR) obtained from previous DNS queries.
Query Recursion	This displays if the Zyxel Device is allowed or denied to forward DNS client requests to DNS servers for resolution.
Service Control	This specifies from which computers and zones you can send DNS queries to the Zyxel Device.
Add	Click this to create a new entry. Select an entry and click Add to create a new entry after the selected entry.
Edit	Double-click an entry or select it and click Edit to be able to modify the entry's settings.
Remove	To remove an entry, select it and click Remove . The Zyxel Device confirms you want to remove it before doing so. Note that subsequent entries move up by one when you take this action.
Move	To change an entry's position in the numbered list, select the method and click Move to display a field to type a number for where you want to put it and press [ENTER] to move the rule to the number that you typed.
#	This the index number of the service control rule. The ordering of your rules is important as rules are applied in sequence. The entry with a hyphen (-) instead of a number is the Zyxel Device's (non-configurable) default policy. The Zyxel Device applies this to traffic that does not match any other configured rule. It is not an editable rule. To apply other behavior, configure a rule that traffic will match so the Zyxel Device will not have to use the default policy.
Zone	This is the zone on the Zyxel Device the user is allowed or denied to access.
Address	This is the object name of the IP address(es) with which the computer is allowed or denied to send DNS queries.
Action	This displays whether the Zyxel Device accepts DNS queries from the computer with the IP address specified above through the specified zone (Accept) or discards them (Deny).

44.6.3 (IPv6) Address Record

An address record contains the mapping of a Fully-Qualified Domain Name (FQDN) to an IP address.

The Zyxel Device allows you to configure address records about the Zyxel Device itself or another device. This way you can keep a record of DNS names and addresses that people on your network may use frequently. If the Zyxel Device receives a DNS query for an FQDN for which the Zyxel Device has an address record, the Zyxel Device can send the IP address in a DNS response without having to query a DNS name server.

44.6.4 PTR Record

A PTR (pointer) record is also called a reverse record or a reverse lookup record. It is a mapping of an IP address to a domain name.

44.6.5 Adding an (IPv6) Address/PTR Record

Click the **Add** icon in the **Address/PTR Record** or **IPv6 Address/PTR Record** table to add an IPv4 or IPv6 address/PTR record.

Figure 651 Configuration > System > DNS > Address/PTR Record Edit

The following table describes the labels in this screen.

Table 379 Configuration > System > DNS > (IPv6) Address/PTR Record Edit

LABEL	DESCRIPTION
FQDN	Type a Fully-Qualified Domain Name (FQDN) of a server. An FQDN starts with a host name and continues all the way up to the top-level domain name. For example, www.zyxel.com.tw is a fully qualified domain name, where "www" is the host, "zyxel" is the third-level domain, "com" is the second-level domain, and "tw" is the top level domain. Underscores are not allowed. Use ".*" as a prefix in the FQDN for a wildcard domain name (for example, *.example.com).
IP Address	Enter the IP address of the host in dotted decimal notation.
OK	Click OK to save your customized settings and exit this screen.
Cancel	Click Cancel to exit this screen without saving.

44.6.6 CNAME Record

A Canonical Name Record or CNAME record is a type of resource record in the Domain Name System (DNS) that specifies that the domain name is an alias of another, canonical domain name. This allows users to set up a record for a domain name which translates to an IP address, in other words, the domain name is an alias of another. This record also binds all the subdomains to the same IP address without having to create a record for each, so when the IP address is changed, all subdomain's IP address is updated as well, with one edit to the record.

For example, the domain name `zyxel.com` is hooked up to a record named `A` which translates it to `11.22.33.44`. You also have several subdomains, like `mail.zyxel.com`, `ftp.zyxel.com` and you want this subdomain to point to your main domain `zyxel.com`. Edit the IP Address in record `A` and all subdomains will follow automatically. This eliminates chances for errors and increases efficiency in DNS management.

44.6.7 Adding a CNAME Record

Click the **Add** icon in the CNAME Record table to add a record. Use `**.` as a prefix for a wildcard domain name. For example `*.zyxel.com`.

Figure 652 Configuration > System > DNS > CNAME Record > Add

The following table describes the labels in this screen.

Table 380 Configuration > System > DNS > CNAME Record > Add

LABEL	DESCRIPTION
Alias name	Enter an Alias Name. Use <code>**.</code> as a prefix in the Alias name for a wildcard domain name (for example, <code>*.example.com</code>).
FQDN	Type a Fully-Qualified Domain Name (FQDN) of a server. An FQDN starts with a host name and continues all the way up to the top-level domain name. For example, <code>www.zyxel.com.tw</code> is a fully qualified domain name, where <code>www</code> is the host, <code>zyxel</code> is the third-level domain, <code>com</code> is the second-level domain, and <code>tw</code> is the top level domain. Underscores are not allowed. Use <code>**.</code> as a prefix in the FQDN for a wildcard domain name (for example, <code>*.example.com</code>).
OK	Click OK to save your customized settings and exit this screen.
Cancel	Click Cancel to exit this screen without saving.

44.6.8 Domain Zone Forwarder

A domain zone forwarder contains a DNS server's IP address. The Zyxel Device can query the DNS server to resolve domain zones for features like VPN, DDNS and the time server. A domain zone is a fully qualified domain name without the host. For example, `zyxel.com.tw` is the domain zone for the `www.zyxel.com.tw` fully qualified domain name.

44.6.9 Adding a Domain Zone Forwarder

Click the **Add** icon in the **Domain Zone Forwarder** table to add a domain zone forwarder record.

Figure 653 Configuration > System > DNS > Domain Zone Forwarder Add

The following table describes the labels in this screen.

Table 381 Configuration > System > DNS > Domain Zone Forwarder Add

LABEL	DESCRIPTION
Domain Zone	A domain zone is a fully qualified domain name without the host. For example, zyxel.com.tw is the domain zone for the www.zyxel.com.tw fully qualified domain name. For example, whenever the Zyxel Device receives needs to resolve a zyxel.com.tw domain name, it can send a query to the recorded name server IP address. Enter * if all domain zones are served by the specified DNS server(s).
DNS Server	Select DNS Server(s) from ISP if your ISP dynamically assigns DNS server information. You also need to select an interface through which the ISP provides the DNS server IP address(es). The interface should be activated and set to be a DHCP client. The fields below display the (read-only) DNS server IP address(es) that the ISP assigns. N/A displays for any DNS server IP address fields for which the ISP does not assign an IP address. Select Public DNS Server if you have the IP address of a DNS server. Enter the DNS server's IP address in the field to the right. The Zyxel Device must be able to connect to the DNS server without using a VPN tunnel. The DNS server could be on the Internet or one of the Zyxel Device's local networks. You cannot use 0.0.0.0. Use the Query via field to select the interface through which the Zyxel Device sends DNS queries to a DNS server. Select Private DNS Server if you have the IP address of a DNS server to which the Zyxel Device connects through a VPN tunnel. Enter the DNS server's IP address in the field to the right. You cannot use 0.0.0.0.
OK	Click OK to save your customized settings and exit this screen.
Cancel	Click Cancel to exit this screen without saving.

44.6.10 MX Record

A MX (Mail eXchange) record indicates which host is responsible for the mail for a particular domain, that is, controls where mail is sent for that domain. If you do not configure proper MX records for your domain or other domain, external e-mail from other mail servers will not be able to be delivered to your mail server and vice versa. Each host or domain can have only one MX record, that is, one domain is mapping to one host.

44.6.11 Adding a MX Record

Click the **Add** icon in the **MX Record** table to add a MX record.

Figure 654 Configuration > System > DNS > MX Record Add

The following table describes the labels in this screen.

Table 382 Configuration > System > DNS > MX Record Add

LABEL	DESCRIPTION
Domain Name	Enter the domain name where the mail is destined for.
IP Address/FQDN	Enter the IP address or Fully-Qualified Domain Name (FQDN) of a mail server that handles the mail for the domain specified in the field above.
OK	Click OK to save your customized settings and exit this screen.
Cancel	Click Cancel to exit this screen without saving.

44.6.12 Security Option Control

Configure the **Security Option Control** section in the **Configuration > System > DNS** screen (click **Show Advanced Settings** to display it) if you suspect the Zyxel Device is being used by hackers in a DNS amplification attack.

One possible strategy would be to deny **Query Recursion** and **Additional Info from Cache** in the default policy and allow **Query Recursion** and **Additional Info from Cache** only from trusted DNS servers identified by address objects and added as members in the customized policy.

44.6.13 Editing a Security Option Control

Click a control policy and then click **Edit** to change **allow** or **deny** actions for **Query Recursion** and **Additional Info from Cache**.

Figure 655 Configuration > System > DNS > Security Option Control Edit (Customize)

The following table describes the labels in this screen.

Table 383 Configuration > System > DNS > Security Option Control Edit (Customize)

LABEL	DESCRIPTION
Name	You may change the name for the customized security option control policy. The customized security option control policy is checked first and if an address object match is not found, the Default control policy is checked.
Query Recursion	Choose if the ZyWALL/USG is allowed or denied to forward DNS client requests to DNS servers for resolution. This can apply to specific open DNS servers using the address objects in a customized rule.
Additional Info from Cache	Choose if the ZyWALL/USG is allowed or denied to cache Resource Records (RR) obtained from previous DNS queries.
Address List	Specifying address objects is not available in the default policy as all addresses are included.
Available	This box displays address objects created in Object > Address . Select one (or more), and click the > arrow to have it (them) join the Member list of address objects that will apply to this rule. For example, you could specify an open DNS server suspect of sending compromised resource records by adding an address object for that server to the member list.
Member	This box displays address objects that will apply to this rule.
OK	Click OK to save your customized settings and exit this screen.
Cancel	Click Cancel to exit this screen without saving.

44.6.14 Adding a DNS Service Control Rule

Click the **Add** icon in the **Service Control** table to add a service control rule.

Figure 656 Configuration > System > DNS > Service Control Rule Add

The following table describes the labels in this screen.

Table 384 Configuration > System > DNS > Service Control Rule Add

LABEL	DESCRIPTION
Create new Object	Use this to configure any new settings objects that you need to use in this screen.
Address Object	Select ALL to allow or deny any computer to send DNS queries to the Zyxel Device. Select a predefined address object to just allow or deny the computer with the IP address that you specified to send DNS queries to the Zyxel Device.
Zone	Select ALL to allow or prevent DNS queries through any zones. Select a predefined zone on which a DNS query to the Zyxel Device is allowed or denied.
Action	Select Accept to have the Zyxel Device allow the DNS queries from the specified computer. Select Deny to have the Zyxel Device reject the DNS queries from the specified computer.
OK	Click OK to save your customized settings and exit this screen.
Cancel	Click Cancel to exit this screen without saving.

44.7 WWW Overview

The following figure shows secure and insecure management of the Zyxel Device coming in from the WAN. HTTPS and SSH access are secure. HTTP and Telnet access are not secure.

Note: To allow the Zyxel Device to be accessed from a specified computer using a service, make sure you do not have a service control rule or to-Zyxel Device security policy rule to block that traffic.

To stop a service from accessing the Zyxel Device, clear **Enable** in the corresponding service screen.

44.7.1 Service Access Limitations

A service cannot be used to access the Zyxel Device when:

- 1 You have disabled that service in the corresponding screen.
- 2 The allowed IP address (address object) in the **Service Control** table does not match the client IP address (the Zyxel Device disallows the session).

- 3 The IP address (address object) in the **Service Control** table is not in the allowed zone or the action is set to **Deny**.
- 4 There is a security policy rule that blocks it.

44.7.2 System Timeout

There is a lease timeout for administrators. The Zyxel Device automatically logs you out if the management session remains idle for longer than this timeout period. The management session does not time out when a statistics screen is polling.

Each user is also forced to log in the Zyxel Device for authentication again when the reauthentication time expires.

You can change the timeout settings in the **User/Group** screens.

44.7.3 HTTPS

You can set the Zyxel Device to use HTTP or HTTPS (HTTPS adds security) for Web Configurator sessions. Specify which zones allow Web Configurator access and from which IP address the access can come.

HTTPS (HyperText Transfer Protocol over Secure Socket Layer, or HTTP over SSL) is a web protocol that encrypts and decrypts web pages. Secure Socket Layer (SSL) is an application-level protocol that enables secure transactions of data by ensuring confidentiality (an unauthorized party cannot read the transferred data), authentication (one party can identify the other party) and data integrity (you know if data has been changed).

It relies upon certificates, public keys, and private keys.

HTTPS on the Zyxel Device is used so that you can securely access the Zyxel Device using the Web Configurator. The SSL protocol specifies that the HTTPS server (the Zyxel Device) must always authenticate itself to the HTTPS client (the computer which requests the HTTPS connection with the Zyxel Device), whereas the HTTPS client only should authenticate itself when the HTTPS server requires it to do so (select **Authenticate Client Certificates** in the **WWW** screen). **Authenticate Client Certificates** is optional and if selected means the HTTPS client must send the Zyxel Device a certificate. You must apply for a certificate for the browser from a CA that is a trusted CA on the Zyxel Device.

Please refer to the following figure.

- 1 HTTPS connection requests from an SSL-aware web browser go to port 443 (by default) on the Zyxel Device's web server.
- 2 HTTP connection requests from a web browser go to port 80 (by default) on the Zyxel Device's web server.

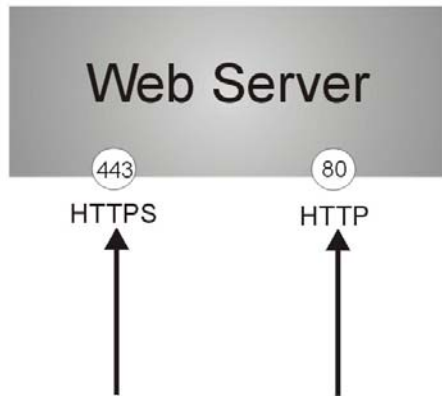
Figure 657 HTTP/HTTPS Implementation

Note: If you disable **HTTP** in the **WWW** screen, then the Zyxel Device blocks all HTTP connection attempts.

44.7.4 Configuring WWW Service Control

Click **Configuration > System > WWW** to open the **WWW** screen. Use this screen to specify from which zones you can access the Zyxel Device using HTTP or HTTPS. You can also specify which IP addresses the access can come from.

Note: **Admin Service Control** deals with management access (to the Web Configurator).
User Service Control deals with user access to the Zyxel Device (logging into SSL VPN for example).

Figure 658 Configuration > System > WWW > Service Control

The screenshot shows the 'Service Control' configuration page. It is organized into several sections:

- HTTPS:** Includes an 'Enable' checkbox, a 'Server Port' field (443), an 'Authenticate Client Certificates' checkbox (with a link to 'Trusted CAs'), a 'Server Certificate' dropdown menu (set to 'default'), and a 'Redirect HTTP to HTTPS' checkbox.
- Admin Service Control:** A table with columns for '#', 'Zone', 'Address', and 'Action'. It contains one entry: Zone: ALL, Address: ALL, Action: accept. Below the table are navigation controls: Page 1 of 1, Show 50 items, and 'Displaying 1 - 1 of 1'.
- User Service Control:** A table with columns for '#', 'Zone', 'Address', and 'Action'. It contains one entry: Zone: ALL, Address: ALL, Action: accept. Below the table are navigation controls: Page 1 of 1, Show 50 items, and 'Displaying 1 - 1 of 1'.
- HTTP:** Includes an 'Enable' checkbox and a 'Server Port' field (80).
- Authentication:** Includes a 'Client Authentication Method' dropdown menu (set to 'default').
- Other:** Includes an 'Enable Content Filter HTTPS Domain Filter Block/Warn Page' checkbox and a 'Block/Warn Page Port' field (54088).

At the bottom of the page are 'Apply' and 'Reset' buttons.

The following table describes the labels in this screen.

Table 385 Configuration > System > WWW > Service Control

LABEL	DESCRIPTION
HTTPS	
Enable	Select the check box to allow or disallow the computer with the IP address that matches the IP address(es) in the Service Control table to access the Zyxel Device Web Configurator using secure HTTPS connections.
Server Port	The HTTPS server listens on port 443 by default. If you change the HTTPS server port to a different number on the Zyxel Device, for example 8443, then you must notify people who need to access the Zyxel Device Web Configurator to use "https://Zyxel Device IP Address:8443" as the URL.
Authenticate Client Certificates	Select Authenticate Client Certificates (optional) to require the SSL client to authenticate itself to the Zyxel Device by sending the Zyxel Device a certificate. To do that the SSL client must have a CA-signed certificate from a CA that has been imported as a trusted CA on the Zyxel Device (see Section 44.7.7.5 on page 982 on importing certificates for details).
Server Certificate	Select a certificate the HTTPS server (the Zyxel Device) uses to authenticate itself to the HTTPS client. You must have certificates already configured in the My Certificates screen.

Table 385 Configuration > System > WWW > Service Control (continued)

LABEL	DESCRIPTION
Redirect HTTP to HTTPS	To allow only secure Web Configurator access, select this to redirect all HTTP connection requests to the HTTPS server.
Admin/User Service Control	Admin Service Control specifies from which zones an administrator can use HTTPS to manage the Zyxel Device (using the Web Configurator). You can also specify the IP addresses from which the administrators can manage the Zyxel Device. User Service Control specifies from which zones a user can use HTTPS to log into the Zyxel Device (to log into SSL VPN for example). You can also specify the IP addresses from which the users can access the Zyxel Device.
Add	Click this to create a new entry. Select an entry and click Add to create a new entry after the selected entry.
Edit	Double-click an entry or select it and click Edit to be able to modify the entry's settings.
Remove	To remove an entry, select it and click Remove . The Zyxel Device confirms you want to remove it before doing so. Note that subsequent entries move up by one when you take this action.
Move	To change an entry's position in the numbered list, select the method and click Move to display a field to type a number for where you want to put it and press [ENTER] to move the rule to the number that you typed.
#	This is the index number of the service control rule. The entry with a hyphen (-) instead of a number is the Zyxel Device's (non-configurable) default policy. The Zyxel Device applies this to traffic that does not match any other configured rule. It is not an editable rule. To apply other behavior, configure a rule that traffic will match so the Zyxel Device will not have to use the default policy.
Zone	This is the zone on the Zyxel Device the user is allowed or denied to access.
Address	This is the object name of the IP address(es) with which the computer is allowed or denied to access.
Action	This displays whether the computer with the IP address specified above can access the Zyxel Device zone(s) configured in the Zone field (Accept) or not (Deny).
HTTP	
Enable	Select the check box to allow or disallow the computer with the IP address that matches the IP address(es) in the Service Control table to access the Zyxel Device Web Configurator using HTTP connections.
Server Port	You may change the server port number for a service if needed, however you must use the same port number in order to use that service to access the Zyxel Device.
Admin/User Service Control	Admin Service Control specifies from which zones an administrator can use HTTP to manage the Zyxel Device (using the Web Configurator). You can also specify the IP addresses from which the administrators can manage the Zyxel Device. User Service Control specifies from which zones a user can use HTTP to log into the Zyxel Device (to log into SSL VPN for example). You can also specify the IP addresses from which the users can access the Zyxel Device.
Add	Click this to create a new entry. Select an entry and click Add to create a new entry after the selected entry.
Edit	Double-click an entry or select it and click Edit to be able to modify the entry's settings.
Remove	To remove an entry, select it and click Remove . The Zyxel Device confirms you want to remove it before doing so. Note that subsequent entries move up by one when you take this action.
Move	To change an entry's position in the numbered list, select the method and click Move to display a field to type a number for where you want to put it and press [ENTER] to move the rule to the number that you typed.

Table 385 Configuration > System > WWW > Service Control (continued)

LABEL	DESCRIPTION
#	This is the index number of the service control rule. The entry with a hyphen (-) instead of a number is the Zyxel Device's (non-configurable) default policy. The Zyxel Device applies this to traffic that does not match any other configured rule. It is not an editable rule. To apply other behavior, configure a rule that traffic will match so the Zyxel Device will not have to use the default policy.
Zone	This is the zone on the Zyxel Device the user is allowed or denied to access.
Address	This is the object name of the IP address(es) with which the computer is allowed or denied to access.
Action	This displays whether the computer with the IP address specified above can access the Zyxel Device zone(s) configured in the Zone field (Accept) or not (Deny).
Authentication	
Client Authentication Method	Select a method the HTTPS or HTTP server uses to authenticate a client. You must have configured the authentication methods in the Auth. method screen.
Other	When HTTPS Domain Filter blocks a page, the connection is redirected to a local web server to display the blocking message. HSTS (HTTP Strict Transport Security) may be activated in some browsers as the browser cached certificate is different to the one displayed by the local server. In this case, you cannot see a blocking warning message. Accessing a web page may require multiple connections to different sites to get all the information in the web page. When there is a connection to a HTTPS website that belongs to a blocked category, it is filtered, but you don't receive a warning page with the option to continue. For example, you want to block www.google.com and issue a Warn action. When you connect to www.google.com another connection to pic.google.com is created to get the pictures on the Google page. www.google.com can display a warning page in your browser (and you can click 'Continue' to forward the connection) but the connection to pic.google.com cannot display a 'Continue' dialog, so parts of the Google page will appear blank and will not display the related picture content.
Enable Content Filter HTTPS Domain Filter Block/Warn Page	Use this field to have the Zyxel Device display a warning page instead of a blank page when an HTTPS connection is redirected.
Block/Warn Page Port	Use the default port number as displayed for the warning page. If you change it, the new port number should be unique.
Apply	Click Apply to save your changes back to the Zyxel Device.
Reset	Click Reset to return the screen to its last-saved settings.

44.7.5 Service Control Rules

Click **Add** or **Edit** in the **Service Control** table in a **WWW**, **SSH**, **Telnet**, **FTP** or **SNMP** screen to add a service control rule.

Figure 659 Configuration > System > Service Control Rule > Edit

The screenshot shows a dialog box titled "Create new Object". It contains three dropdown menus: "Address Object" with "ALL" selected, "Zone" with "ALL" selected, and "Action" with "Accept" selected. At the bottom of the dialog, there is a text field containing "ALL" and two buttons labeled "OK" and "Cancel".

The following table describes the labels in this screen.

Table 386 Configuration > System > Service Control Rule > Edit

LABEL	DESCRIPTION
Create new Object	Use this to configure any new settings objects that you need to use in this screen.
Address Object	<p>Select ALL to allow or deny any computer to communicate with the Zyxel Device using this service.</p> <p>Select a predefined address object to just allow or deny the computer with the IP address that you specified to access the Zyxel Device using this service.</p>
Zone	<p>Select ALL to allow or prevent any Zyxel Device zones from being accessed using this service.</p> <p>Select a predefined Zyxel Device zone on which a incoming service is allowed or denied.</p>
Action	<p>Select Accept to allow the user to access the Zyxel Device from the specified computers.</p> <p>Select Deny to block the user's access to the Zyxel Device from the specified computers.</p>
OK	Click OK to save your customized settings and exit this screen.
Cancel	Click Cancel to exit this screen without saving.

44.7.6 Customizing the WWW Login Page

Click **Configuration > System > WWW > Login Page** to open the **Login Page** screen. Use this screen to customize the Web Configurator login screen. You can also customize the page that displays after an access user logs into the Web Configurator to access network services like the Internet.

Figure 660 Configuration > System > WWW > Login Page (Desktop View)

The screenshot displays the configuration interface for the Login Page in Desktop View. The interface is divided into a configuration panel on the left and a preview area on the right.

Configuration Panel:

- Select Type:**
 - Use Default Login Page
 - Use Customized Login Page
- Logo File:**
 - To upload a logo file (* .gif/png/jpg), browse to the location of the file and then click Upload. (support format: * .gif/png/jpg, maximum size: 100K, suggest pixel size: 103*29)
 - File Path:
- Customized Login Page:**
 - Title:
 - Titlecolor: (CSS color code)
 - Message Color: (CSS color code)
 - Note Message:
 - Background (support format: * .gif/png/jpg, maximum size: 100K)
 - Picture
 - Color (CSS color code)
- Customized Access Page:**
 - Title:
 - Message Color: (CSS color code)
 - Note Message:
 - Background (support format: * .gif/png/jpg, maximum size: 100K)
 - Picture
 - Color (CSS color code)

Preview Area:

The preview area shows two versions of the login page:

- Top Preview:** Shows the login form with the title "USG60W". The form includes fields for "User Name", "Password", and "One-Time Password (Optional)". Below the fields is a note: "(max. 63 alphanumeric, printable characters and no spaces)". There is a red "Error Message" label and "Login" and "SSL VPN" buttons.
- Bottom Preview:** Shows the "You now have logged in." message. It includes instructions: "Click the logout button to terminate the access session. You could renew your lease time by clicking the Renew button. For security reason you must login in again after". It also displays session management options: "User-defined lease time (max)", "Remaining time before lease timeout (hh:mm:ss): 23:03:39", and "Remaining time before auth. timeout (hh:mm:ss): none". There are "Renew" and "Logout" buttons.

At the bottom of the configuration panel, there are "Apply" and "Reset" buttons.

Figure 661 Configuration > System > WWW > Login Page (Mobile View)

Service Control | **Login Page**

Desktop View | **Mobile View**

Select Type

Use Default Login Page

Use Customized Login Page

General

Logo File

To upload a logo file (*.gif/png/jpg), browse to the location of the file and then click Upload.
(support format: *.gif/png/jpg, maximum size: 100K, suggest pixel size: 70*20)

File Path:

Banner Color: (CSS color code)

Customized Login Page

Title:

Titlecolor: (CSS color code)

Customized Access Page

Title:

Message Color: (CSS color code)

Preview 1: Login Page

inn

Login

User Name

Password

Login

[View Desktop Version](#)

Preview 2: Session Page

inn Logout

admin, you now have logged in.

Session

-Remaining time before lease timeout (hh:mm:ss)

The following figures identify the parts you can customize in the login and access pages.

Figure 662 Login Page Customization

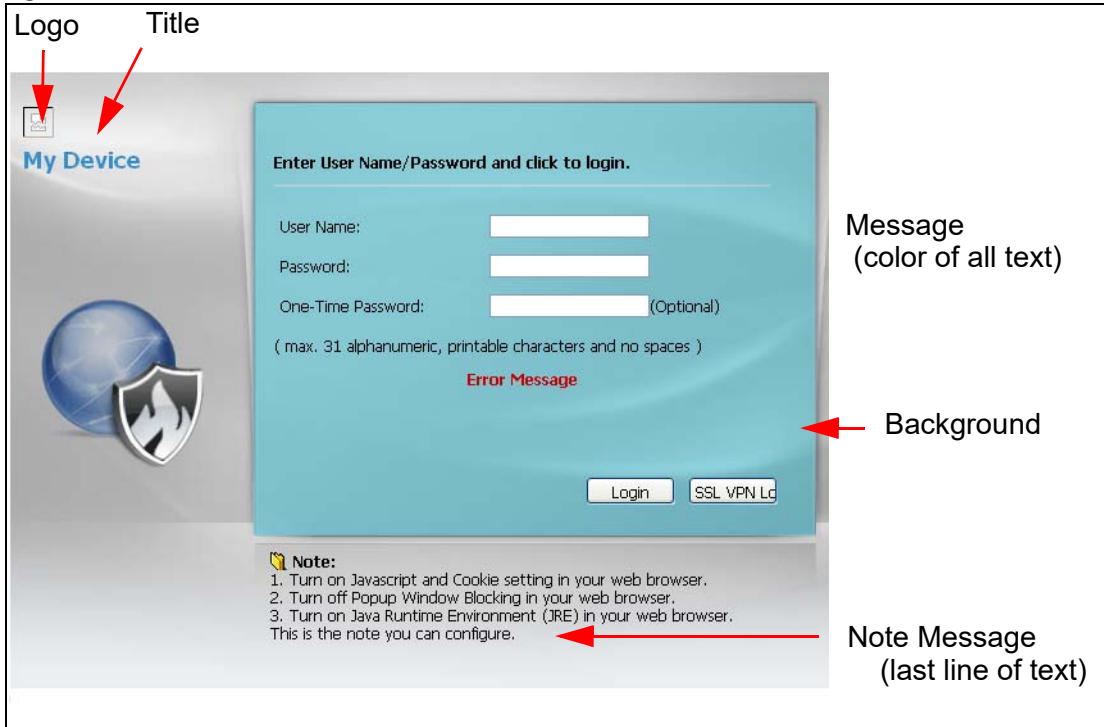
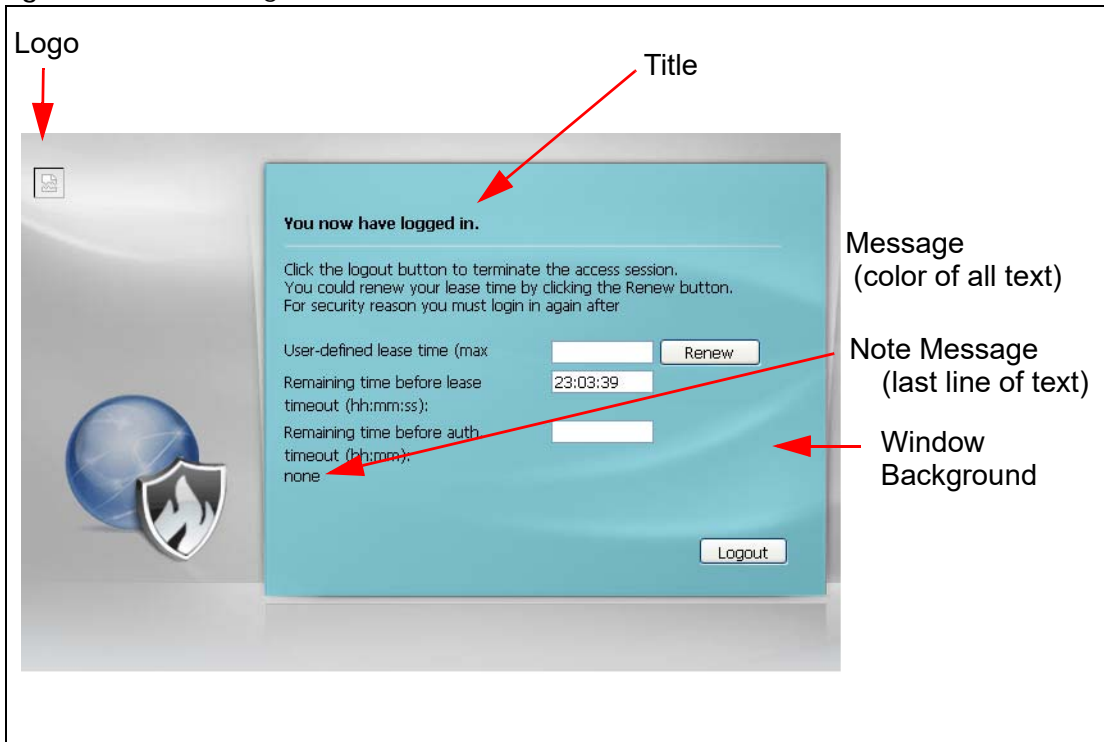

Figure 663 Access Page Customization



You can specify colors in one of the following ways:

- Click **Color** to display a screen of web-safe colors from which to choose.
- Enter the name of the desired color.

- Enter a pound sign (#) followed by the six-digit hexadecimal number that represents the desired color. For example, use "#000000" for black.
- Enter "rgb" followed by red, green, and blue values in parenthesis and separate by commas. For example, use "rgb(0,0,0)" for black.

Your desired color should display in the preview screen on the right after you click in another field, click **Apply**, or press [ENTER]. If your desired color does not display, your browser may not support it. Try selecting another color.

The following table describes the labels in the screen.

Table 387 Configuration > System > WWW > Login Page

LABEL	DESCRIPTION
Select Type	Select whether the Web Configurator uses the default login screen or one that you customize in the rest of this screen.
Logo File	You can upload a graphic logo to be displayed on the upper left corner of the Web Configurator login screen and access page. Specify the location and file name of the logo graphic or click Browse to locate it. Note: Use a GIF, JPG, or PNG of 100 kilobytes or less. Click Upload to transfer the specified graphic file from your computer to the Zyxel Device.
Customized Login Page	Use this section to set how the Web Configurator login screen looks.
Title	Enter the title for the top of the screen. Use up to 64 printable ASCII characters. Spaces are allowed.
Title Color	Specify the color of the screen's title text.
Message Color	Specify the color of the screen's text.
Note Message	Enter a note to display at the bottom of the screen. Use up to 64 printable ASCII characters. Spaces are allowed.
Background	Set how the screen background looks. To use a graphic, select Picture and upload a graphic. Specify the location and file name of the logo graphic or click Browse to locate it. The picture's size cannot be over 438 x 337 pixels. Note: Use a GIF, JPG, or PNG of 100 kilobytes or less. To use a color, select Color and specify the color.
Customized Access Page	Use this section to customize the page that displays after an access user logs into the Web Configurator to access network services like the Internet.
Title	Enter the title for the top of the screen. Use up to 64 printable ASCII characters. Spaces are allowed.
Message Color	Specify the color of the screen's text.
Note Message	Enter a note to display below the title. Use up to 64 printable ASCII characters. Spaces are allowed.
Background	Set how the window's background looks. To use a graphic, select Picture and upload a graphic. Specify the location and file name of the logo graphic or click Browse to locate it. The picture's size cannot be over 438 x 337 pixels. Note: Use a GIF, JPG, or PNG of 100 kilobytes or less. To use a color, select Color and specify the color.

Table 387 Configuration > System > WWW > Login Page (continued)

LABEL	DESCRIPTION
Apply	Click Apply to save your changes back to the Zyxel Device.
Reset	Click Reset to return the screen to its last-saved settings.

44.7.7 HTTPS Example

If you haven't changed the default HTTPS port on the Zyxel Device, then in your browser enter "https://Zyxel Device IP Address/" as the web site address where "Zyxel Device IP Address" is the IP address or domain name of the Zyxel Device you wish to access.

44.7.7.1 Internet Explorer Warning Messages

When you attempt to access the Zyxel Device HTTPS server, you will see the error message shown in the following screen.

Figure 664 Security Alert Dialog Box (Internet Explorer)

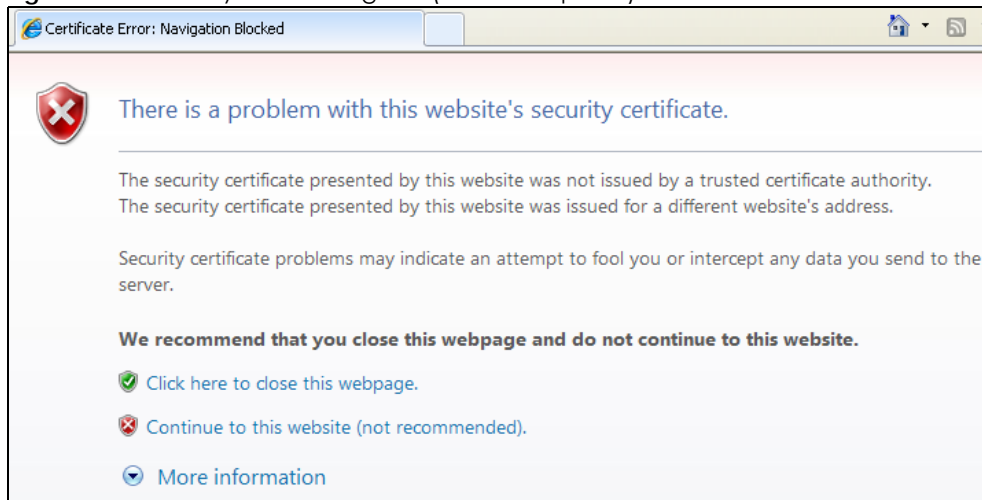

Select **Continue to this website** to proceed to the Web Configurator login screen. Otherwise, select **Click here to close this web page** to block the access.

44.7.7.2 Mozilla Firefox Warning Messages

When you attempt to access the Zyxel Device HTTPS server, a **The Connection is Untrusted** screen appears as shown in the following screen. Click **Technical Details** if you want to verify more information about the certificate from the Zyxel Device.

Select **I Understand the Risks** and then click **Add Exception** to add the Zyxel Device to the security exception list. Click **Confirm Security Exception**.

Figure 665 Security Certificate 1 (Firefox)

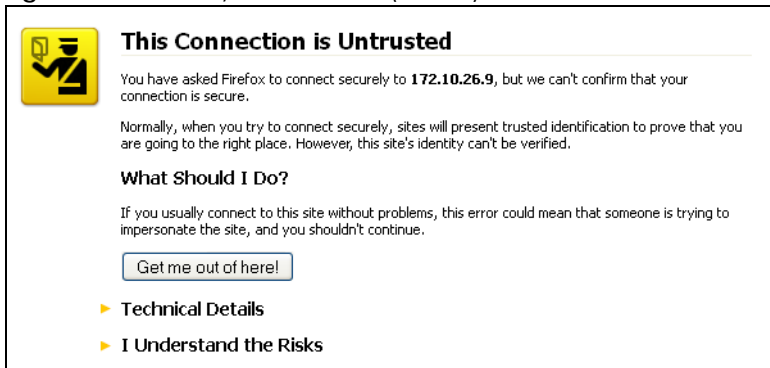
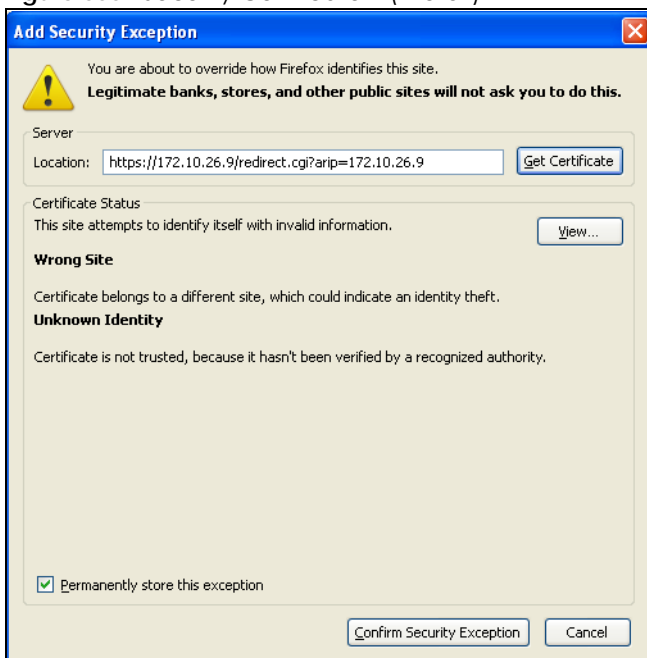

Figure 666 Security Certificate 2 (Firefox)



44.7.7.3 Avoiding Browser Warning Messages

Here are the main reasons your browser displays warnings about the Zyxel Device's HTTPS server certificate and what you can do to avoid seeing the warnings:

- The issuing certificate authority of the Zyxel Device's HTTPS server certificate is not one of the browser's trusted certificate authorities. The issuing certificate authority of the Zyxel Device's factory default certificate is the Zyxel Device itself since the certificate is a self-signed certificate.
- For the browser to trust a self-signed certificate, import the self-signed certificate into your operating system as a trusted certificate.
- To have the browser trust the certificates issued by a certificate authority, import the certificate authority's certificate into your operating system as a trusted certificate.

44.7.7.4 Login Screen

After you accept the certificate, the Zyxel Device login screen appears. The lock displayed in the bottom of the browser status bar denotes a secure connection.

Figure 667 Login Screen (Internet Explorer)

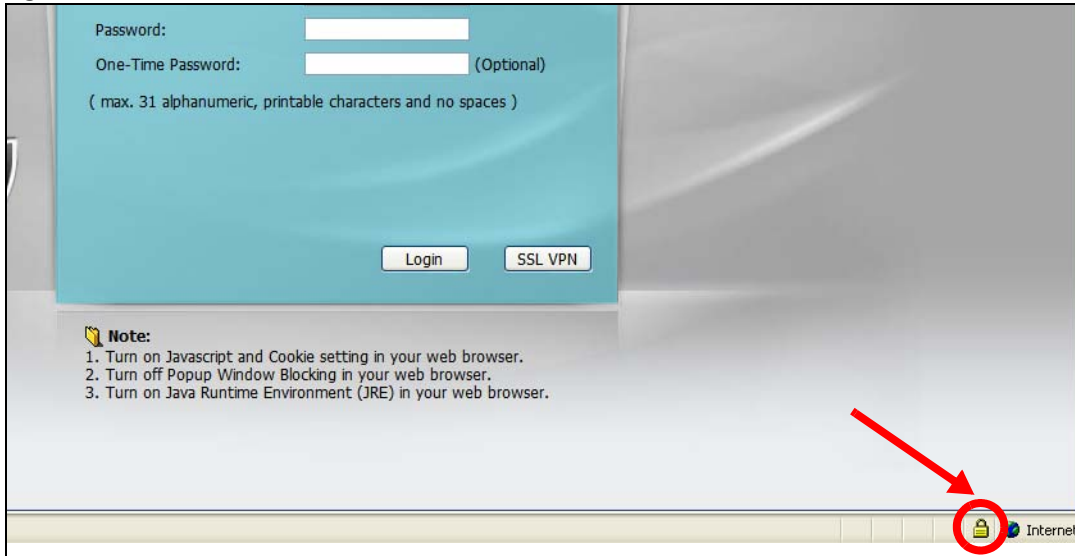

44.7.7.5 Enrolling and Importing SSL Client Certificates

The SSL client needs a certificate if **Authenticate Client Certificates** is selected on the Zyxel Device.

You must have imported at least one trusted CA to the Zyxel Device in order for the **Authenticate Client Certificates** to be active (see the Certificates chapter for details).

Apply for a certificate from a Certification Authority (CA) that is trusted by the Zyxel Device (see the Zyxel Device's **Trusted CA Web Configurator** screen).

Figure 668 Zyxel Device Trusted CA Screen

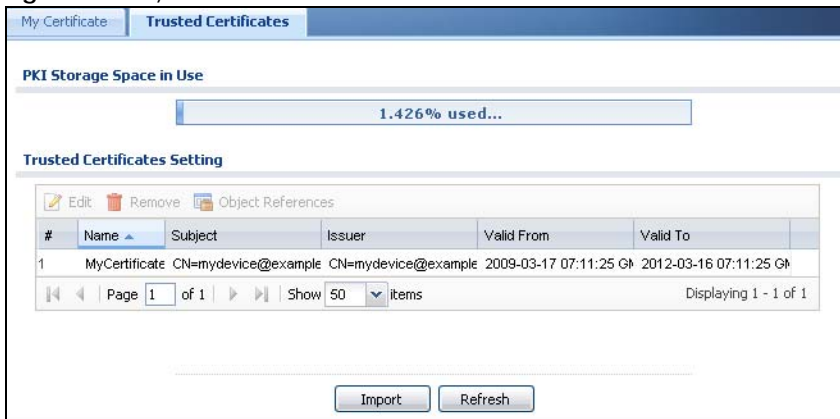

The CA sends you a package containing the CA's trusted certificate(s), your personal certificate(s) and a password to install the personal certificate(s).

44.7.7.5.1 Installing the CA's Certificate

- 1 Double click the CA's trusted certificate to produce a screen similar to the one shown next.

Figure 669 CA Certificate Example

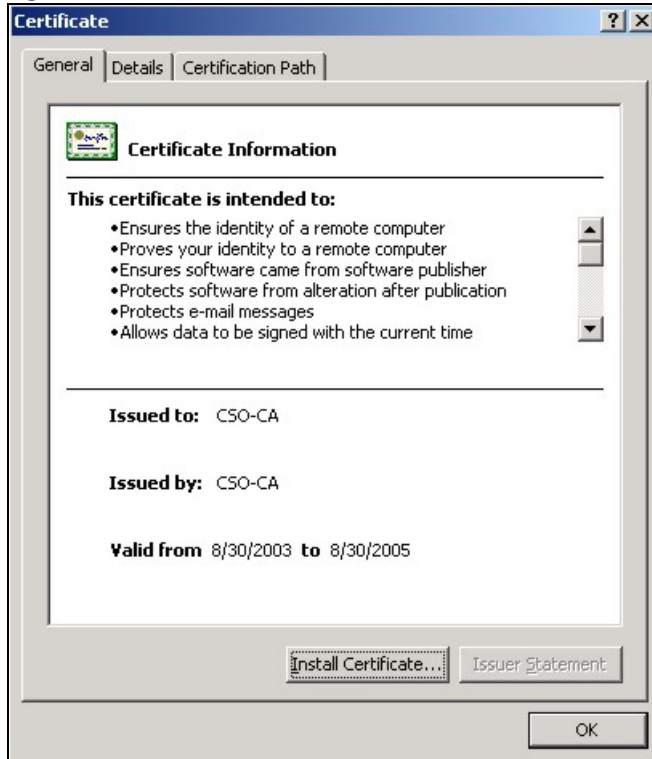

- 2 Click **Install Certificate** and follow the wizard as shown earlier in this appendix.

44.7.7.5.2 Installing Your Personal Certificate(s)

You need a password in advance. The CA may issue the password or you may have to specify it during the enrollment. Double-click the personal certificate given to you by the CA to produce a screen similar to the one shown next

- 1 Click **Next** to begin the wizard.

Figure 670 Personal Certificate Import Wizard 1



- 2 The file name and path of the certificate you double-clicked should automatically appear in the **File name** text box. Click **Browse** if you wish to import a different certificate.

Figure 671 Personal Certificate Import Wizard 2



- 3 Enter the password given to you by the CA.

Figure 672 Personal Certificate Import Wizard 3



The screenshot shows the 'Certificate Import Wizard' dialog box, step 3, titled 'Password'. The window has a blue title bar with the text 'Certificate Import Wizard' and a close button (X). The main content area is light gray. At the top, the title 'Password' is bolded, followed by the text 'To maintain security, the private key was protected with a password.' Below this is a horizontal line. The text 'Type the password for the private key.' is followed by a 'Password:' label and a white text input field. Below the input field are two unchecked checkboxes: 'Enable strong private key protection. You will be prompted every time the private key is used by an application if you enable this option.' and 'Mark the private key as exportable'. At the bottom right, there are three buttons: '< Back', 'Next >', and 'Cancel'.

- 4 Have the wizard determine where the certificate should be saved on your computer or select **Place all certificates in the following store** and choose a different location.

Figure 673 Personal Certificate Import Wizard 4

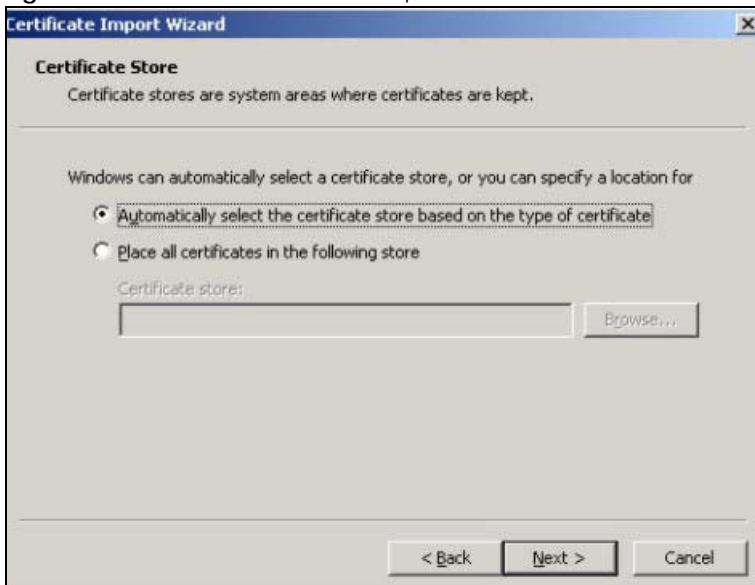

The screenshot shows the 'Certificate Import Wizard' dialog box, step 4, titled 'Certificate Store'. The window has a blue title bar with the text 'Certificate Import Wizard' and a close button (X). The main content area is light gray. At the top, the title 'Certificate Store' is bolded, followed by the text 'Certificate stores are system areas where certificates are kept.' Below this is a horizontal line. The text 'Windows can automatically select a certificate store, or you can specify a location for' is followed by two radio button options: 'Automatically select the certificate store based on the type of certificate' (which is selected) and 'Place all certificates in the following store'. Below the second option is a 'Certificate store:' label and a white text input field with a 'Browse...' button to its right. At the bottom right, there are three buttons: '< Back', 'Next >', and 'Cancel'.

- 5 Click **Finish** to complete the wizard and begin the import process.

Figure 674 Personal Certificate Import Wizard 5



- 6 You should see the following screen when the certificate is correctly installed on your computer.

Figure 675 Personal Certificate Import Wizard 6



44.7.7.6 Using a Certificate When Accessing the Zyxel Device Example

Use the following procedure to access the Zyxel Device via HTTPS.

- 1 Enter 'https://Zyxel Device IP Address/' in your browser's web address field.

Figure 676 Access the Zyxel Device Via HTTPS



- 2 When **Authenticate Client Certificates** is selected on the Zyxel Device, the following screen asks you to select a personal certificate to send to the Zyxel Device. This screen displays even if you only have a single certificate as in the example.

Figure 677 SSL Client Authentication

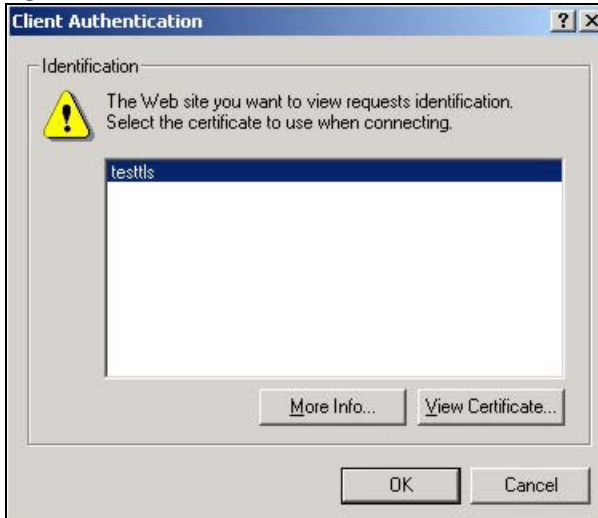

- 3 You next see the Web Configurator login screen.

Figure 678 Secure Web Configurator Login Screen

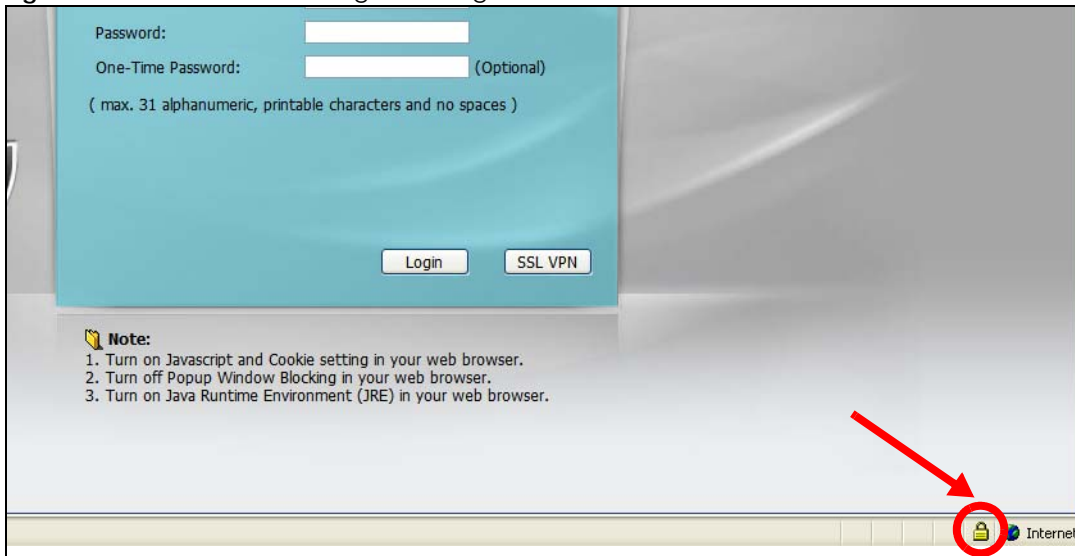

44.8 SSH

You can use SSH (Secure SHell) to securely access the Zyxel Device's command line interface. Specify which zones allow SSH access and from which IP address the access can come.

SSH is a secure communication protocol that combines authentication and data encryption to provide secure encrypted communication between two hosts over an unsecured network. In the following figure, computer **A** on the Internet uses SSH to securely connect to the WAN port of the Zyxel Device for a management session.

Figure 679 SSH Communication Over the WAN Example



44.8.1 How SSH Works

The following figure is an example of how a secure connection is established between two remote hosts using SSH v1.

Figure 680 How SSH v1 Works Example

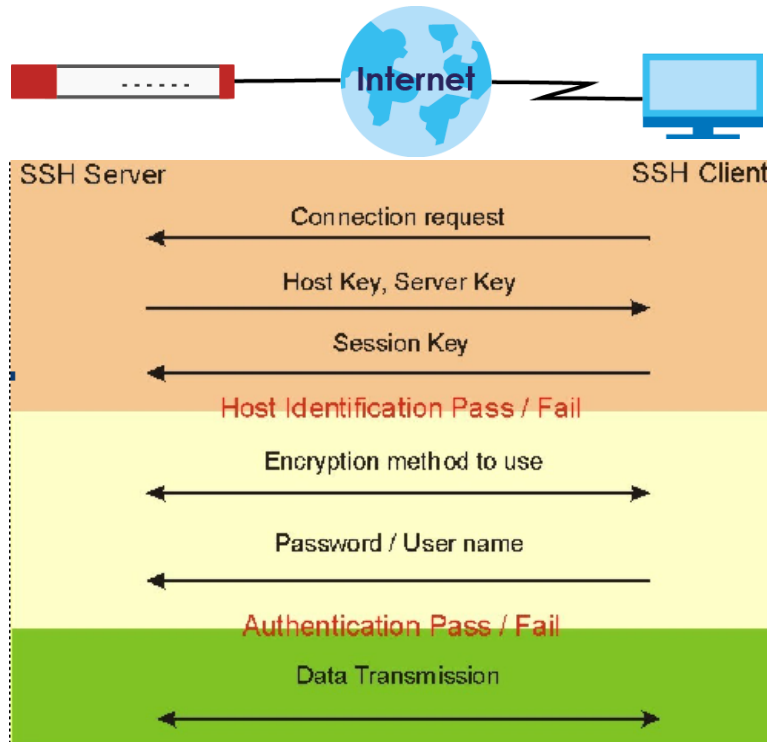

1 Host Identification

The SSH client sends a connection request to the SSH server. The server identifies itself with a host key. The client encrypts a randomly generated session key with the host key and server key and sends the result back to the server.

The client automatically saves any new server public keys. In subsequent connections, the server public key is checked against the saved version on the client computer.

2 Encryption Method

Once the identification is verified, both the client and server must agree on the type of encryption method to use.

3 Authentication and Data Transmission

After the identification is verified and data encryption activated, a secure tunnel is established between the client and the server. The client then sends its authentication information (user name and password) to the server to log in to the server.

44.8.2 SSH Implementation on the Zyxel Device

Your Zyxel Device supports SSH version 2 using RSA authentication and four encryption methods (AES, 3DES, Archfour, and Blowfish). The SSH server is implemented on the Zyxel Device for management using port 22 (by default).

44.8.3 Requirements for Using SSH

You must install an SSH client program on a client computer (Windows or Linux operating system) that is used to connect to the Zyxel Device over SSH.

44.8.4 Configuring SSH

Click **Configuration > System > SSH** to change your Zyxel Device's Secure Shell settings. Use this screen to specify from which zones SSH can be used to manage the Zyxel Device. You can also specify from which IP addresses the access can come.

Figure 681 Configuration > System > SSH

The following table describes the labels in this screen.

Table 388 Configuration > System > SSH

LABEL	DESCRIPTION
Enable	Select the check box to allow or disallow the computer with the IP address that matches the IP address(es) in the Service Control table to access the Zyxel Device CLI using this service.
Server Port	You may change the server port number for a service if needed, however you must use the same port number in order to use that service for remote management.

Table 388 Configuration > System > SSH (continued)

LABEL	DESCRIPTION
Server Certificate	Select the certificate whose corresponding private key is to be used to identify the Zyxel Device for SSH connections. You must have certificates already configured in the My Certificates screen.
Service Control	This specifies from which computers you can access which Zyxel Device zones.
Add	Click this to create a new entry. Select an entry and click Add to create a new entry after the selected entry. Refer to Table 386 on page 975 for details on the screen that opens.
Edit	Double-click an entry or select it and click Edit to be able to modify the entry's settings.
Remove	To remove an entry, select it and click Remove . The Zyxel Device confirms you want to remove it before doing so. Note that subsequent entries move up by one when you take this action.
Move	To change an entry's position in the numbered list, select the method and click Move to display a field to type a number for where you want to put it and press [ENTER] to move the rule to the number that you typed.
#	This the index number of the service control rule.
Zone	This is the zone on the Zyxel Device the user is allowed or denied to access.
Address	This is the object name of the IP address(es) with which the computer is allowed or denied to access.
Action	This displays whether the computer with the IP address specified above can access the Zyxel Device zone(s) configured in the Zone field (Accept) or not (Deny).
Apply	Click Apply to save your changes back to the Zyxel Device.
Reset	Click Reset to return the screen to its last-saved settings.

44.8.5 Secure Telnet Using SSH Examples

This section shows two examples using a command interface and a graphical interface SSH client program to remotely access the Zyxel Device. The configuration and connection steps are similar for most SSH client programs. Refer to your SSH client program user's guide.

44.8.5.1 Example 1: Microsoft Windows

This section describes how to access the Zyxel Device using the Secure Shell Client program.

- 1 Launch the SSH client and specify the connection information (IP address, port number) for the Zyxel Device.
- 2 Configure the SSH client to accept connection using SSH version 2.
- 3 A window displays prompting you to store the host key in you computer. Click **Yes** to continue.

Figure 682 SSH Example 1: Store Host Key



Enter the password to log in to the Zyxel Device. The CLI screen displays next.

44.8.5.2 Example 2: Linux

This section describes how to access the Zyxel Device using the OpenSSH client program that comes with most Linux distributions.

- 1 Test whether the SSH service is available on the Zyxel Device.

Enter "telnet 192.168.1.1 22" at a terminal prompt and press [ENTER]. The computer attempts to connect to port 22 on the Zyxel Device (using the default IP address of 192.168.1.1).

A message displays indicating the SSH protocol version supported by the Zyxel Device.

Figure 683 SSH Example 2: Test

```
$ telnet 192.168.1.1 22
Trying 192.168.1.1...
Connected to 192.168.1.1.
Escape character is '^]'.
SSH-1.5-1.0.0
```

- 2 Enter "ssh -1 192.168.1.1". This command forces your computer to connect to the Zyxel Device using SSH version 2. If this is the first time you are connecting to the Zyxel Device using SSH, a message displays prompting you to save the host information of the Zyxel Device. Type "yes" and press [ENTER].

Then enter the password to log in to the Zyxel Device.

Figure 684 SSH Example 2: Log in

```
$ ssh -1 192.168.1.1
The authenticity of host '192.168.1.1 (192.168.1.1)' can't be established.
RSA1 key fingerprint is 21:6c:07:25:7e:f4:75:80:ec:af:bd:d4:3d:80:53:d1.
Are you sure you want to continue connecting (yes/no)? yes
Warning: Permanently added '192.168.1.1' (RSA1) to the list of known hosts.
Administrator@192.168.1.1's password:
```

- 3 The CLI screen displays next.

44.9 Telnet

You can use Telnet to access the Zyxel Device's command line interface. Specify which zones allow Telnet access and from which IP address the access can come.

44.9.1 Configuring Telnet

Click **Configuration > System > TELNET** to configure your Zyxel Device for remote Telnet access. Use this screen to specify from which zones Telnet can be used to manage the Zyxel Device. You can also specify from which IP addresses the access can come.

Figure 685 Configuration > System > TELNET

The following table describes the labels in this screen.

Table 389 Configuration > System > TELNET

LABEL	DESCRIPTION
Enable	Select the check box to allow or disallow the computer with the IP address that matches the IP address(es) in the Service Control table to access the Zyxel Device CLI using this service.
Server Port	You may change the server port number for a service if needed, however you must use the same port number in order to use that service for remote management.
Service Control	This specifies from which computers you can access which Zyxel Device zones.
Add	Click this to create a new entry. Select an entry and click Add to create a new entry after the selected entry. Refer to Table 386 on page 975 for details on the screen that opens.
Edit	Double-click an entry or select it and click Edit to be able to modify the entry's settings.
Remove	To remove an entry, select it and click Remove . The Zyxel Device confirms you want to remove it before doing so. Note that subsequent entries move up by one when you take this action.
Move	To change an entry's position in the numbered list, select the method and click Move to display a field to type a number for where you want to put it and press [ENTER] to move the rule to the number that you typed.

Table 389 Configuration > System > TELNET (continued)

LABEL	DESCRIPTION
#	This the index number of the service control rule. The entry with a hyphen (-) instead of a number is the Zyxel Device's (non-configurable) default policy. The Zyxel Device applies this to traffic that does not match any other configured rule. It is not an editable rule. To apply other behavior, configure a rule that traffic will match so the Zyxel Device will not have to use the default policy.
Zone	This is the zone on the Zyxel Device the user is allowed or denied to access.
Address	This is the object name of the IP address(es) with which the computer is allowed or denied to access.
Action	This displays whether the computer with the IP address specified above can access the Zyxel Device zone(s) configured in the Zone field (Accept) or not (Deny).
Apply	Click Apply to save your changes back to the Zyxel Device.
Reset	Click Reset to return the screen to its last-saved settings.

44.10 FTP

You can upload and download the Zyxel Device's firmware and configuration files using FTP. To use this feature, your computer must have an FTP client.

44.10.1 Configuring FTP

To change your Zyxel Device's FTP settings, click **Configuration > System > FTP** tab. The screen appears as shown. Use this screen to specify from which zones FTP can be used to access the Zyxel Device. You can also specify from which IP addresses the access can come.

Figure 686 Configuration > System > FTP

The screenshot shows the FTP configuration interface. Under 'General Settings', the 'Enable' checkbox is checked, 'TLS required' is unchecked, 'Server Port' is 21, and 'Server Certificate' is 'default'. The 'Service Control' section contains a table with one entry:

#	Zone	Address	Action
-	ALL	ALL	Accept

At the bottom of the page are 'Apply' and 'Reset' buttons.

The following table describes the labels in this screen.

Table 390 Configuration > System > FTP

LABEL	DESCRIPTION
Enable	Select the check box to allow or disallow the computer with the IP address that matches the IP address(es) in the Service Control table to access the Zyxel Device using this service.
TLS required	Select the check box to use FTP over TLS (Transport Layer Security) to encrypt communication. This implements TLS as a security mechanism to secure FTP clients and/or servers.
Server Port	You may change the server port number for a service if needed, however you must use the same port number in order to use that service for remote management.
Server Certificate	Select the certificate whose corresponding private key is to be used to identify the Zyxel Device for FTP connections. You must have certificates already configured in the My Certificates screen.
Service Control	This specifies from which computers you can access which Zyxel Device zones.
Add	Click this to create a new entry. Select an entry and click Add to create a new entry after the selected entry. Refer to Table 386 on page 975 for details on the screen that opens.
Edit	Double-click an entry or select it and click Edit to be able to modify the entry's settings.
Remove	To remove an entry, select it and click Remove . The Zyxel Device confirms you want to remove it before doing so. Note that subsequent entries move up by one when you take this action.
Move	To change an entry's position in the numbered list, select the method and click Move to display a field to type a number for where you want to put it and press [ENTER] to move the rule to the number that you typed.
#	This the index number of the service control rule. The entry with a hyphen (-) instead of a number is the Zyxel Device's (non-configurable) default policy. The Zyxel Device applies this to traffic that does not match any other configured rule. It is not an editable rule. To apply other behavior, configure a rule that traffic will match so the Zyxel Device will not have to use the default policy.
Zone	This is the zone on the Zyxel Device the user is allowed or denied to access.
Address	This is the object name of the IP address(es) with which the computer is allowed or denied to access.
Action	This displays whether the computer with the IP address specified above can access the Zyxel Device zone(s) configured in the Zone field (Accept) or not (Deny).
Apply	Click Apply to save your changes back to the Zyxel Device.
Reset	Click Reset to return the screen to its last-saved settings.

44.11 SNMP

Simple Network Management Protocol is a protocol used for exchanging management information between network devices. Your Zyxel Device supports SNMP agent functionality, which allows a manager station to manage and monitor the Zyxel Device through the network. The Zyxel Device supports SNMP version one (SNMPv1), version two (SNMPv2c) and version 3 (SNMPv3). The next figure illustrates an SNMP management operation.

Figure 687 SNMP Management Model

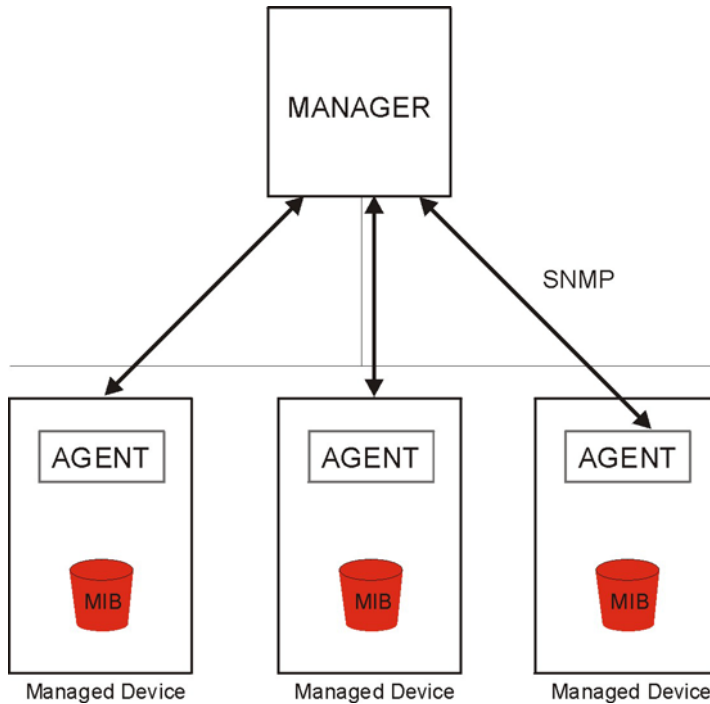

An SNMP managed network consists of two main types of component: agents and a manager.

An agent is a management software module that resides in a managed device (the Zyxel Device). An agent translates the local management information from the managed device into a form compatible with SNMP. The manager is the console through which network administrators perform network management functions. It executes applications that control and monitor managed devices.

The managed devices contain object variables/managed objects that define each piece of information to be collected about a device. Examples of variables include such as number of packets received, node port status etc. A Management Information Base (MIB) is a collection of managed objects. SNMP allows a manager and agents to communicate for the purpose of accessing these objects.

SNMP itself is a simple request/response protocol based on the manager/agent model. The manager issues a request and the agent returns responses using the following protocol operations:

- Get - Allows the manager to retrieve an object variable from the agent.
- GetNext - Allows the manager to retrieve the next object variable from a table or list within an agent. In SNMPv1, when a manager wants to retrieve all elements of a table from an agent, it initiates a Get operation, followed by a series of GetNext operations.
- Set - Allows the manager to set values for object variables within an agent.
- Trap - Used by the agent to inform the manager of some events.

44.11.1 SNMPv3 and Security

SNMPv3 enhances security for SNMP management using authentication and encryption. SNMP managers can be required to authenticate with agents before conducting SNMP management sessions.

Security can be further enhanced by encrypting the SNMP messages sent from the managers. Encryption protects the contents of the SNMP messages. When the contents of the SNMP messages are encrypted, only the intended recipients can read them.

44.11.2 Supported MIBs

The Zyxel Device supports MIB II that is defined in RFC-1213 and RFC-1215. The Zyxel Device also supports private MIBs (zywall.mib and zyxel-zywall-ZLD-Common.mib) to collect information about CPU and memory usage and VPN total throughput. The focus of the MIBs is to let administrators collect statistical data and monitor status and performance. You can download the Zyxel Device's MIBs from www.zyxel.com.

44.11.3 SNMP Traps

The Zyxel Device will send traps to the SNMP manager when any one of the following events occurs.

Table 391 SNMP Traps

OBJECT LABEL	OBJECT ID	DESCRIPTION
Cold Start	1.3.6.1.6.3.1.1.5.1	This trap is sent when the Zyxel Device is turned on or an agent restarts.
linkDown	1.3.6.1.6.3.1.1.5.3	This trap is sent when the Ethernet link is down.
linkUp	1.3.6.1.6.3.1.1.5.4	This trap is sent when the Ethernet link is up.
authenticationFailure	1.3.6.1.6.3.1.1.5.5	This trap is sent when an SNMP request comes from non-authenticated hosts.
vpnTunnelDisconnected	1.3.6.1.4.1.890.1.6.22.2.3	This trap is sent when an IPSec VPN tunnel is disconnected.
vpnTunnelName	1.3.6.1.4.1.890.1.6.22.2.2.1.1	This trap is sent along with the vpnTunnelDisconnected trap. This trap carries the disconnected tunnel's IPSec SA name.
vpnIKEName	1.3.6.1.4.1.890.1.6.22.2.2.1.2	This trap is sent along with the vpnTunnelDisconnected trap. This trap carries the disconnected tunnel's IKE SA name.
vpnTunnelSPI	1.3.6.1.4.1.890.1.6.22.2.2.1.3	This trap is sent along with the vpnTunnelDisconnected trap. This trap carries the security parameter index (SPI) of the disconnected VPN tunnel.

44.11.4 Configuring SNMP

To change your Zyxel Device's SNMP settings, click **Configuration > System > SNMP** tab. The screen appears as shown. Use this screen to configure your SNMP settings, including from which zones SNMP can be used to access the Zyxel Device. You can also specify from which IP addresses the access can come.

Figure 688 Configuration > System > SNMP

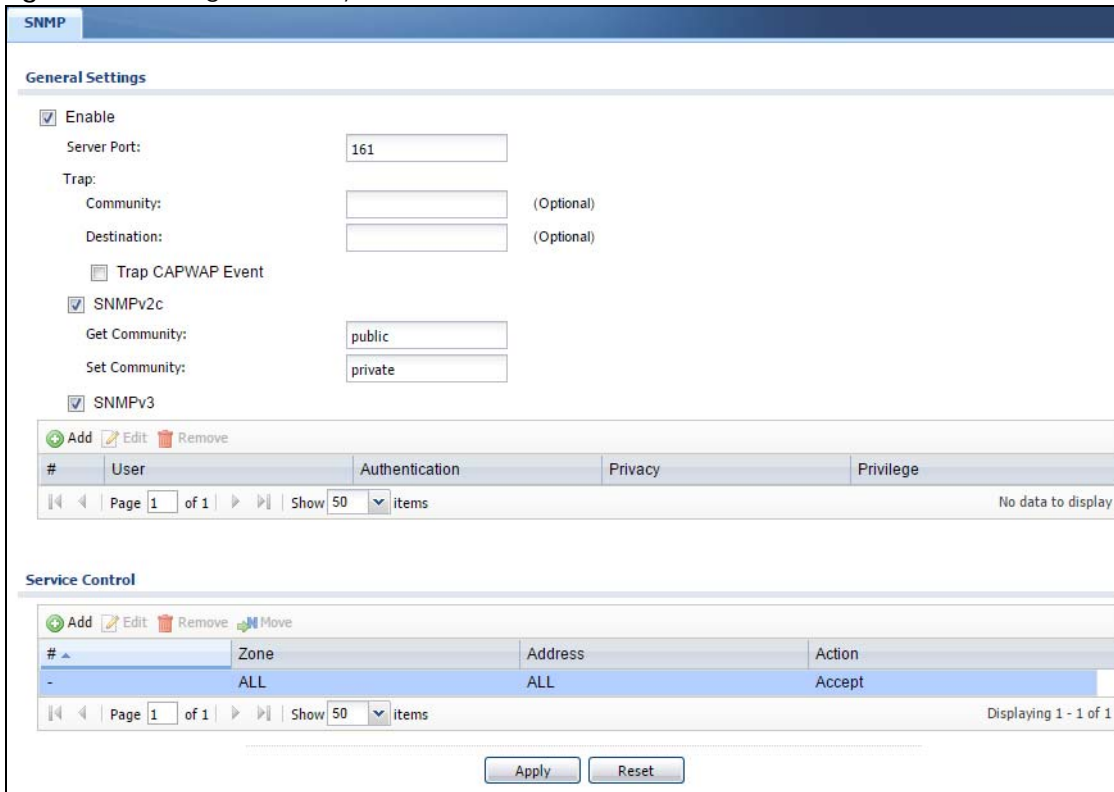

The following table describes the labels in this screen.

Table 392 Configuration > System > SNMP

LABEL	DESCRIPTION
Enable	Select the check box to allow or disallow the computer with the IP address that matches the IP address(es) in the Service Control table to access the Zyxel Device using this service.
Server Port	You may change the server port number for a service if needed, however you must use the same port number in order to use that service for remote management.
Trap	
Community	Type the trap community, which is the password sent with each trap to the SNMP manager. The default is public and allows all requests.
Destination	Type the IP address of the station to send your SNMP traps to.
SNMPv2c	Select the SNMP version for the Zyxel Device. The SNMP version on the Zyxel Device must match the version on the SNMP manager.
Get Community	Enter the Get Community , which is the password for the incoming Get and GetNext requests from the management station. The default is public and allows all requests.
Set Community	Enter the Set community , which is the password for incoming Set requests from the management station. The default is private and allows all requests.
SNMPv3	Select the SNMP version for the Zyxel Device. The SNMP version on the Zyxel Device must match the version on the SNMP manager. SNMPv3 (RFCs 3413 to 3415) provides secure access by authenticating and encrypting data packets over the network. The Zyxel Device uses your login password as the SNMPv3 authentication and encryption passphrase. Note: Your login password must consist of at least 8 printable characters for SNMPv3. An error message will display if your login password has fewer characters.

Table 392 Configuration > System > SNMP (continued)

LABEL	DESCRIPTION
Add	Click this to create a new entry. Select an entry and click Add to create a new entry after the selected entry.
Edit	Double-click an entry or select it and click Edit to be able to modify the entry's settings.
Remove	To remove an entry, select it and click Remove . The Zyxel Device confirms you want to remove it before doing so. Note that subsequent entries move up by one when you take this action.
#	This is the index number of the entry.
User	This displays the name of the user object to be sent to the SNMP manager along with the SNMP v3 trap.
Authentication	This displays the authentication algorithm used for this entry. MD5 (Message Digest 5) and SHA (Secure Hash Algorithm) are hash algorithms used to authenticate SNMP data. SHA authentication is generally considered stronger than MD5, but is slower.
Privacy	This displays the encryption method for SNMP communication from this user. Methods available are: <ul style="list-style-type: none"> DES - Data Encryption Standard is a widely used (but breakable) method of data encryption. It applies a 56-bit key to each 64-bit block of data. AES - Advanced Encryption Standard is another method for data encryption that also uses a secret key. AES applies a 128-bit key to 128-bit blocks of data.
Privilege	This displays the access rights to MIBs. <ul style="list-style-type: none"> Read-Write - The associated user can create and edit the MIBs on the Zyxel Device, except the user account. Read-Only - The associated user can only collect information from the Zyxel Device MIBs.
Service Control	This specifies from which computers you can access which Zyxel Device zones.
Add	Click this to create a new entry. Select an entry and click Add to create a new entry after the selected entry. Refer to Table 386 on page 975 for details on the screen that opens.
Edit	Double-click an entry or select it and click Edit to be able to modify the entry's settings.
Remove	To remove an entry, select it and click Remove . The Zyxel Device confirms you want to remove it before doing so. Note that subsequent entries move up by one when you take this action.
Move	To change an entry's position in the numbered list, select the method and click Move to display a field to type a number for where you want to put it and press [ENTER] to move the rule to the number that you typed.
#	This the index number of the service control rule. The entry with a hyphen (-) instead of a number is the Zyxel Device's (non-configurable) default policy. The Zyxel Device applies this to traffic that does not match any other configured rule. It is not an editable rule. To apply other behavior, configure a rule that traffic will match so the Zyxel Device will not have to use the default policy.
Zone	This is the zone on the Zyxel Device the user is allowed or denied to access.
Address	This is the object name of the IP address(es) with which the computer is allowed or denied to access.
Action	This displays whether the computer with the IP address specified above can access the Zyxel Device zone(s) configured in the Zone field (Accept) or not (Deny).
Apply	Click Apply to save your changes back to the Zyxel Device.
Reset	Click Reset to return the screen to its last-saved settings.

44.11.5 Add SNMPv3 User

Click **Add** under SNMPv3 in **Configuration > System > SNMP** to create an SNMPv3 user for authentication with managers using SNMP v3. Use the username and password of the login accounts you specify in this screen to create accounts on the SNMP v3 manager.

Figure 689 Configuration > System > SNMP(v3) > Add

The following table describes the labels in this screen.

Table 393 Configuration > System > SNMP(v3) > Add

LABEL	DESCRIPTION
User	Specify the username of a login account on the Zyxel Device. The associated password is used in authentication algorithms and encryption methods.
Authentication	Select an authentication algorithm. MD5 (Message Digest 5) and SHA (Secure Hash Algorithm) are hash algorithms used to authenticate SNMP data. SHA authentication is generally considered stronger than MD5, but is slower.
Privacy	Specify the encryption method for SNMP communication from this user. You can choose one of the following: <ul style="list-style-type: none"> DES - Data Encryption Standard is a widely used (but breakable) method of data encryption. It applies a 56-bit key to each 64-bit block of data. AES - Advanced Encryption Standard is another method for data encryption that also uses a secret key. AES applies a 128-bit key to 128-bit blocks of data.
Privilege	Select the access rights to MIBs. <ul style="list-style-type: none"> Read-Write - The associated user can create and edit the MIBs on the Zyxel Device, except the user account. Read-Only - The associated user can only collect information from the Zyxel Device MIBs.
OK	Click OK to save the changes.
Cancel	Click Cancel to begin configuring this screen afresh.

44.12 Authentication Server

You can set the Zyxel Device to work as a RADIUS server to exchange messages with a RADIUS client, such as an AP for user authentication and authorization. Click **Configuration > System > Auth. Server** tab. The screen appears as shown. Use this screen to enable the authentication server feature of the Zyxel Device and specify the RADIUS client's IP address.

Figure 690 Configuration > System > Auth. Server

Auth. Server

General Settings

Enable Authentication Server

Authentication Server Certificate: default

Authentication Method: default

Trusted Client

Add Edit Remove Activate Inactivate

#	Status	Profile Name	IP Address	Mask	Description
1		test	172.16.1.11	255.255.255.0	

Page 1 of 1 Show 50 items Displaying 1 - 1 of 1

Apply Reset

The following table describes the labels in this screen.

Table 394 Configuration > System > Auth. Server

LABEL	DESCRIPTION
Enable Authentication Server	Select the check box to have the Zyxel Device act as a RADIUS server.
Authentication Server Certificate	Select the certificate whose corresponding private key is to be used to identify the Zyxel Device to the RADIUS client. You must have certificates already configured in the My Certificates screen.
Authentication Method	Select an authentication method if you have created any in the Configuration > Object > Auth. Method screen.
Trusted Client	Use this section to configure trusted clients in the Zyxel Device RADIUS server database.
Add	Click this to create a new entry. Select an entry and click Add to create a new entry after the selected entry.
Edit	Double-click an entry or select it and click Edit to be able to modify the entry's settings.
Remove	To remove an entry, select it and click Remove . The Zyxel Device confirms you want to remove it before doing so. Note that subsequent entries move up by one when you take this action.
Activate	To turn on an entry, select it and click Activate .
Inactivate	To turn off an entry, select it and click Inactivate .
#	This is the index number of the entry.
Status	This icon is lit when the entry is active and dimmed when the entry is inactive.
Profile Name	This field indicates the name assigned to the profile.
IP Address	This is the IP address of the RADIUS client that is allowed to exchange messages with the Zyxel Device.
Mask	This is the subnet mask of the RADIUS client.
Description	This is the description of the RADIUS client.
Apply	Click Apply to save your changes back to the Zyxel Device.
Reset	Click Reset to return the screen to its last-saved settings.

44.12.1 Add/Edit Trusted RADIUS Client

Click **Configuration > System > Auth. Server** to display the **Auth. Server** screen. Click the **Add** icon or an **Edit** icon to display the following screen. Use this screen to create a new entry or edit an existing one.

Figure 691 Configuration > System > Auth. Server > Add/Edit

The following table describes the labels in this screen.

Table 395 Configuration > System > Auth. Server > Add/Edit

LABEL	DESCRIPTION
Activate	Select this check box to make this profile active.
Profile Name	Enter a descriptive name (up to 31 alphanumeric characters) for identification purposes.
IP Address	Enter the IP address of the RADIUS client that is allowed to exchange messages with the Zyxel Device.
Netmask	Enter the subnet mask of the RADIUS client.
Secret	Enter a password (up to 64 alphanumeric characters) as the key to be shared between the Zyxel Device and the RADIUS client. The key is not sent over the network. This key must be the same on the external authentication server and the Zyxel Device.
Description	Enter the description of each server, if any. You can use up to 60 printable ASCII characters.
OK	Click OK to save the changes.
Cancel	Click Cancel to discard the changes.

44.13 Notification > Mail Server

Use this screen to configure a mail server so you can receive reports and notification emails such as when your password is about to expire. After you configure the screen, you can test the settings in **Maintenance > Diagnostics > Network Tool** and then select **Test Email Server**. See **Configuration > Log & Report > Email Daily Report** to configure what reports to send and to whom.

Click **Configuration > System > Notification** to display the **Mail Server** screen.

Figure 692 Configuration > System > Notification > Mail Server

The following table describes the labels in this screen.

Table 396 Configuration > System > Notification > Mail Server

LABEL	DESCRIPTION
Mail Server	Type the name or IP address of the outgoing SMTP server.
Mail Subject	Go to Configuration > Log & Report > Email Daily Report to type a subject line for outgoing e-mail from the Zyxel Device.
Append system name	Select Append system name to add the Zyxel Device's system name to the subject.
Append date time	Select Append date time to add the Zyxel Device's system date and time to the subject.
Mail Server Port	Enter the same port number here as is on the mail server for mail traffic.
TLS Security	Select this option if the mail server uses Transport Layer Security (TLS) for encrypted communications between the mail server and the Zyxel Device.
STARTTLS	Select this option if the mail server uses SSL or TLS for encrypted communications between the mail server and the Zyxel Device.
Authenticate Server	Select this if the Zyxel Device authenticates the mail server in the TLS handshake.
Mail From	Type the e-mail address from which the outgoing e-mail is delivered. This address is used in replies.
SMTP Authentication	Select this check box if it is necessary to provide a user name and password to the SMTP server.
User Name	This box is effective when you select the SMTP Authentication check box. Type the user name to provide to the SMTP server when the log is e-mailed.
Password	This box is effective when you select the SMTP Authentication check box. Type a password of up to 63 characters to provide to the SMTP server when the log is e-mailed.
Retype to Confirm	Type the password again to make sure that you have entered is correctly.
Time for sending report	Select the time of day (hours and minutes) when the log is e-mailed. Use 24-hour notation.

Table 396 Configuration > System > Notification > Mail Server (continued)

LABEL	DESCRIPTION
Apply	Click Apply to save your changes back to the Zyxel Device.
Reset	Click Reset to return the screen to its last-saved settings.

44.14 Notification > SMS

The Zyxel Device supports Short Message Service (SMS) to send short text messages to mobile phone devices. At the time of writing, the Zyxel Device uses ViaNett as the SMS gateway to help forward SMS messages. You must already have a ViaNett account in order to use the SMS service.

Click **Configuration > System > System > Notification > SMS** to open the following screen.

Configure the settings according to your SMS service provider's format. Different SMS service providers may have different format.

Figure 693 Configuration > System > Notification > SMS

The screenshot shows the 'SMS' configuration page. At the top, there are tabs for 'Mail Server', 'SMS', and 'Response Message'. The 'SMS' tab is active. Under 'General Settings', there is a checkbox for 'Enable SMS'. Below it is a text field for 'Default country code for phone number' with the value '0' and a '(1-4) digit' label. The 'SMS Provider' is set to 'Email-to-SMS Provider'. There is a text field for 'Provider Domain' with a red error icon. A checkbox for 'auto append to Mail to' is checked. Below are text fields for 'Mail Subject', 'Mail From', and 'Mail To', with '(Optional)' labels. At the bottom, there are 'Apply' and 'Reset' buttons. A 'Note' section contains the following text:

1. If you select to use an Email-to-SMS provider, configure a mail server before you enable SMS.
2. If you leave the Mail From field blank here, the system automatically uses the mail address configured in the Mail Server screen.
3. "Mail To" default format is "\$mobile_number\$@provider domain" and some Service Providers might require prefix symbol like "+" added before \$mobile_number\$.
4. ViaNett Service is about to end of support, please stop purchase new ViaNett credits.

The following table describes the labels in this screen.

Table 397 Configuration > System > Notification > SMS

LABEL	DESCRIPTION
General Settings	
Enable SMS	Select the check box to turn on the SMS service.
Default country code for phone number	Enter the default country code for the mobile phone number to which you want to send SMS messages.

Table 397 Configuration > System > Notification > SMS (continued)

LABEL	DESCRIPTION
SMS Provider	<p>The Zyxel Device uses Email-to-SMS Provider to forward SM S messages.</p> <p>Note: Go to the Configuration> System> Notification> Mail Server screen to configure a mail server to allow the Zyxel Device to send SMS messages to the SMS service provider using emails.</p>
Provider Domain	<p>Enter the domain name of your SMS service provider. The domain name can be of up to 252 characters.</p> <p>Select auto append to "Mail to" to add the domain name of your SMS service provider after the mobile phone number in the Mail To field.</p>
Mail Subject	<p>Type the subject line of up to 128 characters for outgoing e-mail from the Zyxel Device.</p>
Mail From	<p>Enter the sender's email address of up to 64 characters. This email address needs to be in your SMS provider's allowed sender address list.</p> <p>If you leave this field blank, the Zyxel Device will use the IP address or domain name of the Mail Server field in the Configuration > System > Notification > Mail Server screen.</p>
Mail To	<p>Enter the mobile phone number of up to 80 characters. You can only have one receiver.</p> <p>Use this variable in brackets [\$mobile_number\$], and the Zyxel Device will use the mobile phone number of the user logging in. Go to the Configuration > Object > User/Group > User screen to add a valid mobile telephone number for a user.</p>
Apply	<p>Click this button to save your changes to the Zyxel Device.</p>
Reset	<p>Click this button to return the screen to its last-saved settings.</p>

44.15 Notification > Response Message

Use this screen to create a web page when access to a website is restricted due to a security service.

Click **Configuration > System > Notification** to display the **Response Message** screen.

Figure 694 Configuration > System > Notification > Response Message

The following table describes the labels in this screen.

Table 398 Configuration > System > Notification > Response Message

LABEL	DESCRIPTION
Message	Use this part of the screen to create a message to display when access to a website is blocked due to a security service.
Edit	Double-click an entry or select it and click Edit to be able to modify the entry's settings.
#	This is the index number of the entry.
Service	This is the security service that may restrict access to a website.
Denied Access Message	Type a message to display when access to a website is blocked due to this security service. You may type up to 127 characters.
Page Layout	Use this part of the screen to create a web page to display when access to a website is blocked due to a security service.
Use Customized	Select this if you want to specify a logo and colors in the access blocked web page. You cannot change the banner message.
Preview Web Page	Use this to see how the colors look in your customized access blocked web page. The below example also shows the location of the access blocked message, the logo and banner. <div data-bbox="500 1465 1227 1644" data-label="Image"> </div>
File Path	Type the path to the access blocked web page file or use Browse to find it on your computer. After, click Upload to send the file to the Zyxel Device.
Message Color	Specify the font color of the message. You can use the Color palette chooser, or enter a CSS hex color code. For example, the CSS hex color code for blue is #0000FF .
Background Color	Specify the color of the access blocked web page background. You can use the Color palette chooser, or enter a CSS hex color code. For example, the CSS hex color code for blue is #0000FF .

Table 398 Configuration > System > Notification > Response Message (continued)

LABEL	DESCRIPTION
Banner Color	Specify the color of the access blocked web page banner. You can use the Color palette chooser, or enter a CSS hex color code. For example, the CSS hex color code for blue is #0000FF.
Banner Message Color	Specify the color of the access blocked web page banner text. You can use the Color palette chooser, or enter a CSS hex color code. For example, the CSS hex color code for blue is #0000FF.
Apply	Click this button to save your changes to the Zyxel Device.
Reset	Click this button to return the screen to its last-saved settings.

44.16 Language Screen

Click **Configuration > System > Language** to open the following screen. Use this screen to select a display language for the Zyxel Device's Web Configurator screens.

Figure 695 Configuration > System > Language

The following table describes the labels in this screen.

Table 399 Configuration > System > Language

LABEL	DESCRIPTION
Language Setting	Select a display language for the Zyxel Device's Web Configurator screens. You also need to open a new browser session to display the screens in the new language.
Apply	Click Apply to save your changes back to the Zyxel Device.
Reset	Click Reset to return the screen to its last-saved settings.

44.17 IPv6 Screen

Click **Configuration > System > IPv6** to open the following screen. Use this screen to enable IPv6 support for the Zyxel Device's Web Configurator screens.

Figure 696 Configuration > System > IPv6

The following table describes the labels in this screen.

Table 400 Configuration > System > IPv6

LABEL	DESCRIPTION
Enable IPv6	Select this to have the Zyxel Device support IPv6 and make IPv6 settings be available on the screens that the functions support, such as the Configuration > Network > Interface > Ethernet, VLAN, and Bridge screens. The Zyxel Device discards all IPv6 packets if you clear this check box.
Apply	Click Apply to save your changes back to the Zyxel Device.
Reset	Click Reset to return the screen to its last-saved settings.

44.18 Zyxel One Network (ZON) Utility

The Zyxel One Network (ZON) utility uses the Zyxel Discovery Protocol (ZDP) for discovering and configuring ZDP-aware Zyxel devices in the same broadcast domain as the computer on which ZON is installed.

The ZON Utility issues requests via ZDP and in response to the query, the Zyxel Device responds with basic information including IP address, firmware version, location, system and model name. The information is then displayed in the ZON Utility screen and you can perform tasks like basic configuration of the devices and batch firmware upgrade in it. You can download the ZON Utility at www.zyxel.com and install it on a computer.

44.18.1 Requirements

Before installing the ZON Utility on your computer, please make sure it meets the requirements listed below.

Operating System

At the time of writing, the ZON Utility is compatible with:

- Windows 7 (both 32-bit / 64-bit versions)
- Windows 8 (both 32-bit / 64-bit versions)
- Windows 8.1 (both 32-bit / 64-bit versions)
- Window 10 (both 32-bit / 64-bit versions)

Note: To check for your Windows operating system version, right-click on **My Computer > Properties**. You should see this information in the **General** tab.

Hardware

Here are the minimum hardware requirements to use the ZON Utility on your computer.

- Core i3 processor
- 2GB RAM
- 100MB free hard disk
- WXGA (Wide XGA 1280x800)

44.18.2 Run the ZON Utility

- 1 Double-click the ZON Utility to run it.
- 2 The first time you run the ZON Utility you will see if your Zyxel Device and firmware version support the ZON Utility. Click the **OK** button to close this screen.

Figure 697 Supported Devices and Versions

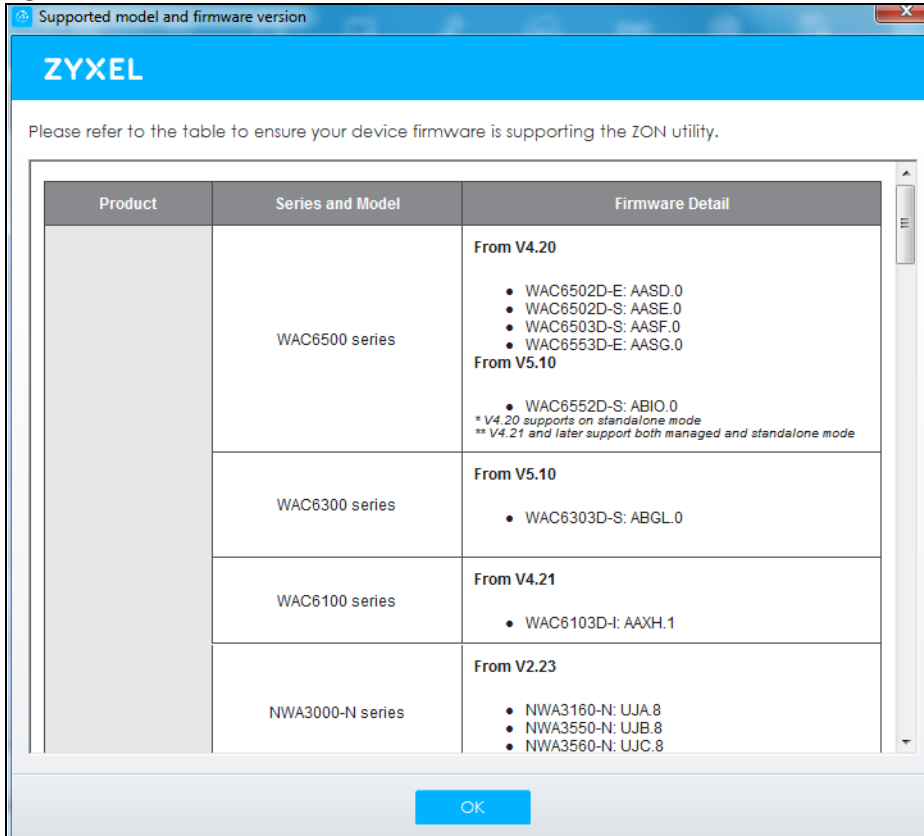

If you want to check the supported models and firmware versions later, you can click the **Show information about ZON** icon in the upper right hand corner of the screen. Then select the **Supported model and firmware version** link.

- 3 Select the network adapter to which your supported devices are connected.

Figure 698 Network Adapter



- 4 Click the **Go** button for the ZON Utility to discover all supported devices in your network.

Figure 699 Discovering Devices

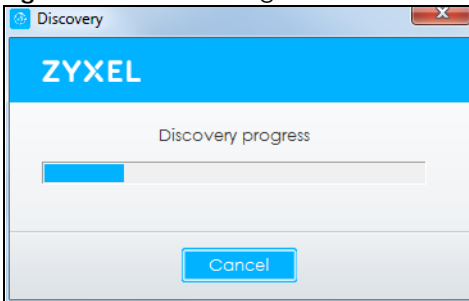

- 5 The ZON Utility screen shows the devices discovered.

Figure 700 ZON Utility Screen

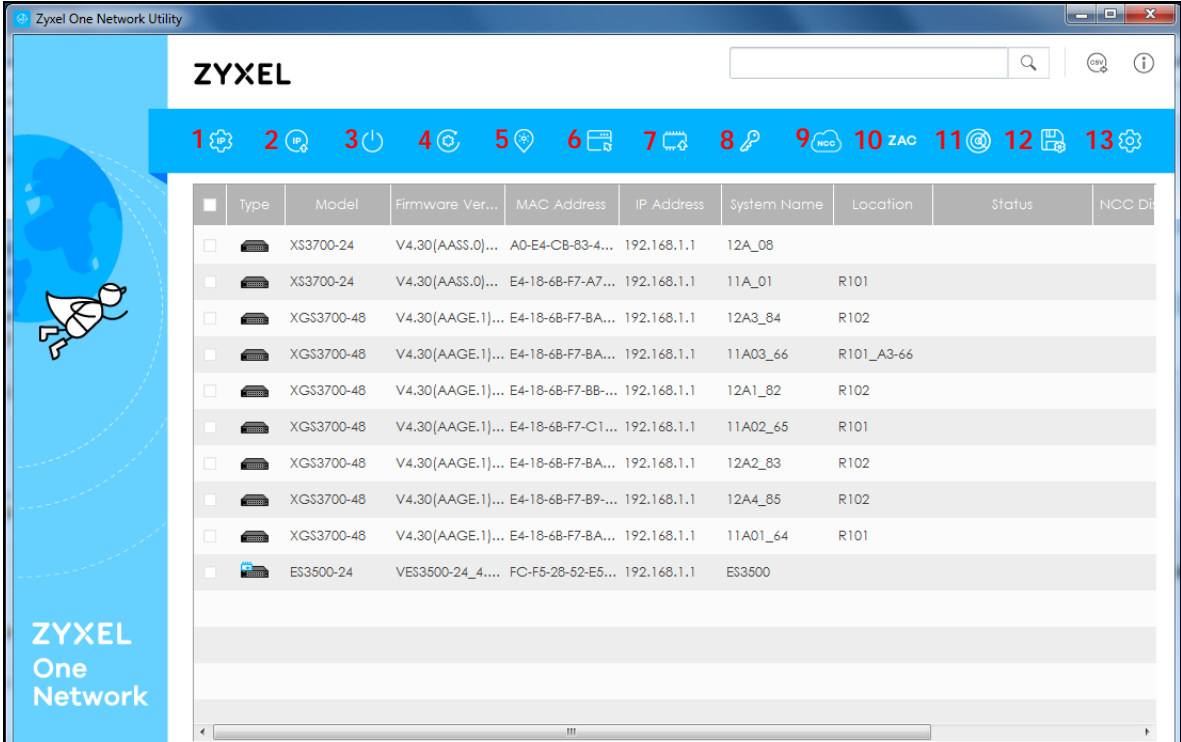

- 6 Select a device and then use the icons to perform actions.

Note: Some functions may not be available for your devices.

The following table describes the icons numbered from left to right in the ZON Utility screen.

Table 401 ZON Utility Icons

ICON	DESCRIPTION
1 IP configuration	Change the selected device's IP address.
2 Renew IP Address	Update a DHCP-assigned dynamic IP address.
3 Reboot Device	Use this icon to restart the selected device(s). This may be useful when troubleshooting or upgrading new firmware.
4 Reset Configuration to Default	If you forget your password or cannot access the Web Configurator, you can use this icon to reload the factory-default configuration file. This means that you will lose all configurations that you had previously.
5 Locator LED	Use this icon to locate the selected device by causing its Locator LED to blink.
6 Web GUI	Use this to access the selected device web configurator from your browser. You will need a username and password to log in.
7 Firmware Upgrade	Use this icon to upgrade new firmware to selected device(s) of the same model. Make sure you have downloaded the firmware from the Zyxel website to your computer and unzipped it in advance. If your Zyxel Device supports dual firmware images, the standby image will be upgraded. After the new firmware is uploaded, you Zyxel Device will reboot, and the new firmware will be the running firmware.
8 Change Password	Use this icon to change the admin password of the selected device. You must know the current admin password before changing to a new one.

Table 401 ZON Utility Icons

ICON	DESCRIPTION
9 Configure NCC Discovery	You must have Internet access to use this feature. Use this icon to enable or disable Nebula Control Center (NCC) discovery on the selected device. If it's enabled, the selected device will try to connect to the NCC. Once the selected device is connected to and has registered in the NCC, it'll go into the cloud management mode.
10 ZAC	Use this icon to run the Zyxel AP Configurator of the selected AP.
11 Clear and Rescan	Use this icon to clear the list and discover all devices on the connected network again.
12 Save Configuration	Use this icon to save configuration changes to permanent memory on a selected device.
13 Settings	Use this icon to select a network adaptor for the computer on which the ZON utility is installed, and the utility language.

The following table describes the fields in the ZON Utility main screen.

Table 402 ZON Utility Fields

LABEL	DESCRIPTION
Type	This field displays an icon of the kind of device discovered.
Model	This field displays the model name of the discovered device.
Firmware Version	This field displays the firmware version of the discovered device.
MAC Address	This field displays the MAC address of the discovered device.
IP Address	This field displays the IP address of an internal interface on the discovered device that first received an ZDP discovery request from the ZON utility.
System Name	This field displays the system name of the discovered device.
Location	This field displays where the discovered device is.
Status	This field displays whether changes to the discovered device have been done successfully. As the Zyxel Device does not support IP Configuration , Renew IP address and Flash Locator LED , this field displays "Update failed", "Not support Renew IP address" and "Not support Flash Locator LED" respectively.
NCC Discovery	This field displays if the discovered device supports the Nebula Control Center (NCC) discovery feature. If it's enabled, the selected device will try to connect to the NCC. Once the selected device is connected to and has registered in the NCC, it'll go into the cloud management mode.
Serial Number	Enter the admin password of the discovered device to display its serial number.
Hardware Version	This field displays the hardware version of the discovered device.

44.18.3 Zyxel One Network (ZON) System Screen

Enable **ZDP (ZON)** and **Smart Connect** (Ethernet Neighbor) in the **System > ZON** screen.

See **Monitor > System Status > Ethernet Neighbor** for information on using **Smart Connect** (Link Layer Discovery Protocol (LLDP)) for discovering and configuring LLDP-aware devices in the same broadcast domain as the Zyxel Device that you're logged into using the web configurator.

The following figure shows the **System > ZON** screen.

Figure 701 Configuration > System > ZON

The following table describes the labels in this screen.

Table 403 Configuration > System > ZON

LABEL	DESCRIPTION
ZDP	Zyxel Discovery Protocol (ZDP) is the protocol that the Zyxel One Network (ZON) utility uses for discovering and configuring ZDP-aware Zyxel devices in the same broadcast domain as the computer on which ZON is installed.
Enable	Select to activate ZDP discovery on the Zyxel Device.
Smart Connect	Smart Connect uses Link Layer Discovery Protocol (LLDP) for discovering and configuring LLDP-aware devices in the same broadcast domain as the Zyxel Device that you're logged into using the web configurator.
Enable	Select to activate LLDP discovery on the Zyxel Device. See also Monitor > System Status > Ethernet Discovery .
Apply	Click Apply to save your changes back to the Zyxel Device.
Reset	Click Reset to return the screen to its last-saved settings.

44.19 Advanced Screen

Use this screen to maximize the network performance of the Zyxel Device.

Fast Forwarding maximizes the network performance of the Zyxel Device by enabling a faster packet switching method which uses a trie (prefix tree).

When Fast Forwarding is enabled, essential network services such as NAT, routing, firewall, and VPN work as expected. However, security and logging services such as UTM, web authentication, MAC address binding, BWM, and traffic statistics are bypassed. This means traffic passes through the Zyxel Device unchecked and unlogged.

Note: Enabling Fast Forwarding might expose your network to security threat. We recommend enabling Fast Forwarding temporarily and only when it is needed.

44.19.1 Fast Forwarding Technical Reference

When switching a packet, a network device examines the packet's destination and then searches its local route cache to determine the output interface and then next hop to the destination. The route cached must be periodically cleared of old and invalid entries, to prevent the cached from consuming too much memory.

Fast Forwarding improves route cached performance by using a trie (prefix tree). A trie is a 256-way binary tree that does not store any data. Instead, each leaf in the tree contains a pointer to data in a separate adjacency table. The routing cached stores destination information in the search tree, and information about how to reach each destination in the adjacency table. Separating the routing cached into two data structures offers several advantages:

- The search tree and adjacency table can be created and recreated separately
- Modifying entries in the adjacency table does not invalidate entries in the search tree
- Entries in the adjacency table can point to each other, speeding up recursive routing. Recursive routing is where a device looks up a packet's next hop in the routing cached but does not know how to reach the next hop, requiring another lookup
- The adjacency table can be updated directly from the device's ARP cache and routing table. This eliminates the need to periodically clear old and invalid entries from the cache

Click **System > Advanced** to open the following screen.

Figure 702 Configuration > System > Advanced

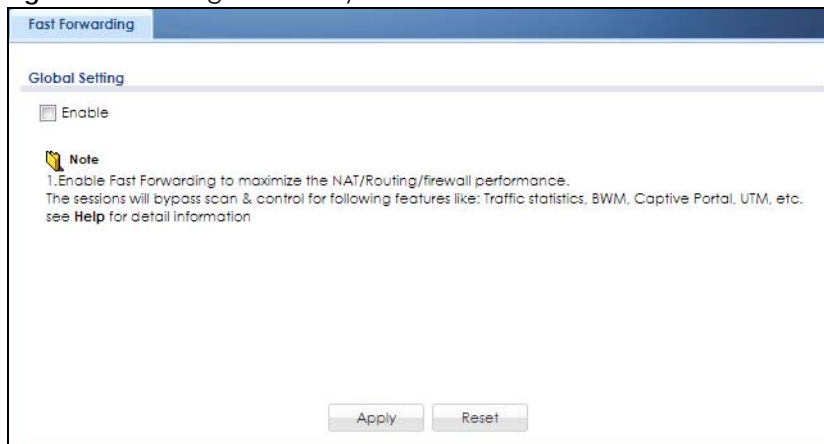

The following table describes the labels in this screen.

Table 404 Configuration > System > ZON

LABEL	DESCRIPTION
Enable	Select to activate fast forwarding on the Zyxel Device.
Apply	Click Apply to save your changes back to the Zyxel Device.
Reset	Click Reset to return the screen to its last-saved settings.

A warning message will pop out when you select **Enable**.

Figure 703 Fast Forwarding Warning Message

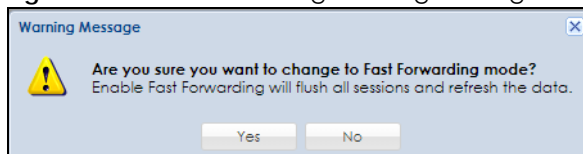

An icon will show at the Title Bar when Fast Forwarding is enabled.

Figure 704 Fast Forwarding Icon



CHAPTER 45

Log and Report

45.1 Overview

Use these screens to configure daily reporting and log settings.

45.1.1 What You Can Do In this Chapter

- Use the **Email Daily Report** screen ([Section 45.2 on page 1014](#)) to configure where and how to send daily reports and what reports to send.
- Use the **Log Setting** screens ([Section 45.3 on page 1016](#)) to specify settings for recording log messages and alerts, emailing them, storing them on a connected USB storage device, and sending them to remote syslog servers.

45.2 Email Daily Report

Use the **Email Daily Report** screen to start or stop data collection and view various statistics about traffic passing through your Zyxel Device. See **Configuration > System > Notification** to set up the mail server.

Note: Data collection may decrease the Zyxel Device's traffic throughput rate.

Click **Configuration > Log & Report > Email Daily Report** to display the following screen. Configure this screen to have the Zyxel Device e-mail you system statistics every day.

Figure 705 Configuration > Log & Report > Email Daily Report

The following table describes the labels in this screen.

Table 405 Configuration > Log & Report > Email Daily Report

LABEL	DESCRIPTION
Enable Email Daily Report	Select this to send reports by e-mail every day.
Mail Subject	Type the subject line for outgoing e-mail from the Zyxel Device.
Mail To	Type the e-mail address (or addresses) to which the outgoing e-mail is delivered.
Send Report Now	Click this button to have the Zyxel Device send the daily e-mail report immediately.
Report Items	Select the information to include in the report. Types of information include System Resource Usage , Wireless Report , Interface Traffic Statistics and DHCP Table . Select Reset counters after sending report successfully if you only want to see statistics for a 24 hour period.

Table 405 Configuration > Log & Report > Email Daily Report (continued)

LABEL	DESCRIPTION
Reset All Counters	Click this to discard all report data and start all of the counters over at zero.
Apply	Click Apply to save your changes back to the Zyxel Device.
Reset	Click Reset to return the screen to its last-saved settings.

45.3 Log Setting Screens

The **Log Setting** screens control log messages and alerts. A log message stores the information for viewing or regular e-mailing later, and an alert is e-mailed immediately. Usually, alerts are used for events that require more serious attention, such as system errors and attacks.

The Zyxel Device provides a system log and supports e-mail profiles and remote syslog servers. View the system log in the **MONITOR > Log** screen. Use the e-mail profiles to mail log messages to the specific destinations. You can also have the Zyxel Device store system logs on a connected USB storage device. The other four logs are stored on specified syslog servers.

The **Log Setting** screens control what information the Zyxel Device saves in each log. You can also specify which log messages to e-mail for the system log, and where and how often to e-mail them. These screens also set for which events to generate alerts and where to email the alerts.

The first **Log Setting** screen provides a settings summary. Use the **Edit** screens to configure settings such as log categories, e-mail addresses, and server names for any log. Use the **Log Category Settings** screen to edit what information is included in the system log, USB storage, e-mail profiles, and remote servers.

45.3.1 Log Setting Summary

To access this screen, click **Configuration > Log & Report > Log Setting**.

Figure 706 Configuration > Log & Report > Log Setting

#	Status	Name	Log Format	Summary
1		System Log	Internal	E-mail Server 1 Mail Server: Mail Subject: Send From: Send Log to: Send Alert to: Schedule: Send log when full.
2		System Log	Internal	E-mail Server 2 Mail Server: Mail Subject: Send From: Send Log to: Send Alert to: Schedule: Send log when full.
3		USB Storage	Internal	USB Status: none
4		Remote Server 1	VRPT/Syslog	Server Address: Log Facility: Local 1
5		Remote Server 2	VRPT/Syslog	Server Address: Log Facility: Local 1
6		Remote Server 3	VRPT/Syslog	Server Address: Log Facility: Local 1
7		Remote Server 4	VRPT/Syslog	Server Address: Log Facility: Local 1

The following table describes the labels in this screen.

Table 406 Configuration > Log & Report > Log Setting

LABEL	DESCRIPTION
Edit	Double-click an entry or select it and click Edit to open a screen where you can modify it.
Activate	To turn on an entry, select it and click Activate .
Inactivate	To turn off an entry, select it and click Inactivate .
#	This field is a sequential value, and it is not associated with a specific log.
Name	This field displays the type of log setting entry (system log, logs stored on a USB storage device connected to the Zyxel Device, or one of the remote servers).
Log Format	This field displays the format of the log. Internal - system log; you can view the log on the View Log tab. VRPT/Syslog - Zyxel's Vantage Report, syslog-compatible format. CEF/Syslog - Common Event Format, syslog-compatible format.
Summary	This field is a summary of the settings for each log. Please see Section 45.3.2 on page 1017 for more information.
Log Category Settings	Click this button to open the Log Category Settings Edit screen.
Apply	Click this button to save your changes (activate and deactivate logs) and make them take effect.

45.3.2 Edit System Log Settings

The **Log Settings Edit** screen controls the detailed settings for each log in the system log (which includes the e-mail profiles). Go to the **Log Settings Summary** screen (see [Section 45.3.1 on page 1016](#)), and click the system log **Edit** icon.

Figure 707 Configuration > Log & Report > Log Setting > Edit (System Log - E-mail Servers)

Edit Log Setting

E-mail Server 1

Active

Mail Server: (Outgoing SMTP Server Name or IP Address)

Mail Server Port: TLS Security Authenticate Server

Mail Subject:

Send From: (E-Mail Address)

Send Log to: (E-Mail Address)

Send Alerts to: (E-Mail Address)

Sending Log:

Day for Sending Log:

Time for Sending Log:

SMTP Authentication

User Name:

Password:

Retype to Confirm:

E-mail Server 2

Active

Mail Server: (Outgoing SMTP Server Name or IP Address)

Mail Server Port: TLS Security Authenticate Server

Mail Subject:

Send From: (E-Mail Address)

Send Log to: (E-Mail Address)

Send Alerts to: (E-Mail Address)

Sending Log:

Day for Sending Log:

Time for Sending Log:

SMTP Authentication

User Name:

Password:

Retype to Confirm:

Figure 708 Configuration > Log & Report > Log Setting > Edit (System Log - AC)

Edit Log Setting					
Active Log and Alert (AC)					
System Log - E-mail Server 1 - E-mail Server 2					
#	Log Category	System Log	Email Server 1	Email Server 2	
1	Account	<input type="checkbox"/> <input checked="" type="checkbox"/> <input type="checkbox"/>	<input checked="" type="checkbox"/> <input type="checkbox"/>	<input checked="" type="checkbox"/> <input type="checkbox"/>	
2	ADP	<input type="checkbox"/> <input checked="" type="checkbox"/> <input type="checkbox"/>	<input checked="" type="checkbox"/> <input type="checkbox"/>	<input checked="" type="checkbox"/> <input type="checkbox"/>	
3	Anti-Spam	<input type="checkbox"/> <input checked="" type="checkbox"/> <input type="checkbox"/>	<input checked="" type="checkbox"/> <input type="checkbox"/>	<input checked="" type="checkbox"/> <input type="checkbox"/>	
4	Anti-Virus	<input type="checkbox"/> <input checked="" type="checkbox"/> <input type="checkbox"/>	<input checked="" type="checkbox"/> <input type="checkbox"/>	<input checked="" type="checkbox"/> <input type="checkbox"/>	
5	Application Patrol	<input type="checkbox"/> <input checked="" type="checkbox"/> <input type="checkbox"/>	<input checked="" type="checkbox"/> <input type="checkbox"/>	<input checked="" type="checkbox"/> <input type="checkbox"/>	
6	Auth. Policy	<input type="checkbox"/> <input checked="" type="checkbox"/> <input type="checkbox"/>	<input checked="" type="checkbox"/> <input type="checkbox"/>	<input checked="" type="checkbox"/> <input type="checkbox"/>	
7	Authentication Server	<input type="checkbox"/> <input checked="" type="checkbox"/> <input type="checkbox"/>	<input checked="" type="checkbox"/> <input type="checkbox"/>	<input checked="" type="checkbox"/> <input type="checkbox"/>	
8	Blocked web sites	<input type="checkbox"/> <input checked="" type="checkbox"/> <input type="checkbox"/>	<input checked="" type="checkbox"/> <input type="checkbox"/>	<input checked="" type="checkbox"/> <input type="checkbox"/>	
9	Built-in Service	<input type="checkbox"/> <input checked="" type="checkbox"/> <input type="checkbox"/>	<input checked="" type="checkbox"/> <input type="checkbox"/>	<input checked="" type="checkbox"/> <input type="checkbox"/>	
10	BWM	<input type="checkbox"/> <input checked="" type="checkbox"/> <input type="checkbox"/>	<input checked="" type="checkbox"/> <input type="checkbox"/>	<input checked="" type="checkbox"/> <input type="checkbox"/>	
11	CAPWAP	<input type="checkbox"/> <input checked="" type="checkbox"/> <input type="checkbox"/>	<input checked="" type="checkbox"/> <input type="checkbox"/>	<input checked="" type="checkbox"/> <input type="checkbox"/>	
12	Cellular	<input type="checkbox"/> <input checked="" type="checkbox"/> <input type="checkbox"/>	<input checked="" type="checkbox"/> <input type="checkbox"/>	<input checked="" type="checkbox"/> <input type="checkbox"/>	
13	Connectivity Check	<input type="checkbox"/> <input checked="" type="checkbox"/> <input type="checkbox"/>	<input checked="" type="checkbox"/> <input type="checkbox"/>	<input checked="" type="checkbox"/> <input type="checkbox"/>	
14	Content Filter	<input type="checkbox"/> <input checked="" type="checkbox"/> <input type="checkbox"/>	<input checked="" type="checkbox"/> <input type="checkbox"/>	<input checked="" type="checkbox"/> <input type="checkbox"/>	
15	Daily Report	<input type="checkbox"/> <input checked="" type="checkbox"/> <input type="checkbox"/>	<input checked="" type="checkbox"/> <input type="checkbox"/>	<input checked="" type="checkbox"/> <input type="checkbox"/>	
16	Default	<input type="checkbox"/> <input type="checkbox"/> <input checked="" type="checkbox"/>	<input checked="" type="checkbox"/> <input type="checkbox"/>	<input checked="" type="checkbox"/> <input type="checkbox"/>	
17	Device HA	<input type="checkbox"/> <input checked="" type="checkbox"/> <input type="checkbox"/>	<input checked="" type="checkbox"/> <input type="checkbox"/>	<input checked="" type="checkbox"/> <input type="checkbox"/>	
18	DHCP	<input type="checkbox"/> <input checked="" type="checkbox"/> <input type="checkbox"/>	<input checked="" type="checkbox"/> <input type="checkbox"/>	<input checked="" type="checkbox"/> <input type="checkbox"/>	
19	DNS Query	<input type="checkbox"/> <input checked="" type="checkbox"/> <input type="checkbox"/>	<input checked="" type="checkbox"/> <input type="checkbox"/>	<input checked="" type="checkbox"/> <input type="checkbox"/>	
20	File Manager	<input type="checkbox"/> <input checked="" type="checkbox"/> <input type="checkbox"/>	<input checked="" type="checkbox"/> <input type="checkbox"/>	<input checked="" type="checkbox"/> <input type="checkbox"/>	
21	Forward Clear Mails	<input type="checkbox"/> <input checked="" type="checkbox"/> <input type="checkbox"/>	<input checked="" type="checkbox"/> <input type="checkbox"/>	<input checked="" type="checkbox"/> <input type="checkbox"/>	
22	Forward web sites	<input type="checkbox"/> <input checked="" type="checkbox"/> <input type="checkbox"/>	<input checked="" type="checkbox"/> <input type="checkbox"/>	<input checked="" type="checkbox"/> <input type="checkbox"/>	
23	IDP	<input type="checkbox"/> <input checked="" type="checkbox"/> <input type="checkbox"/>	<input checked="" type="checkbox"/> <input type="checkbox"/>	<input checked="" type="checkbox"/> <input type="checkbox"/>	
24	IKE	<input type="checkbox"/> <input checked="" type="checkbox"/> <input type="checkbox"/>	<input checked="" type="checkbox"/> <input type="checkbox"/>	<input checked="" type="checkbox"/> <input type="checkbox"/>	
25	Inbound Load Balancing	<input type="checkbox"/> <input checked="" type="checkbox"/> <input type="checkbox"/>	<input checked="" type="checkbox"/> <input type="checkbox"/>	<input checked="" type="checkbox"/> <input type="checkbox"/>	
26	Interface	<input type="checkbox"/> <input checked="" type="checkbox"/> <input type="checkbox"/>	<input checked="" type="checkbox"/> <input type="checkbox"/>	<input checked="" type="checkbox"/> <input type="checkbox"/>	
27	IP-MAC Binding	<input type="checkbox"/> <input checked="" type="checkbox"/> <input type="checkbox"/>	<input checked="" type="checkbox"/> <input type="checkbox"/>	<input checked="" type="checkbox"/> <input type="checkbox"/>	
28	IPSec	<input type="checkbox"/> <input checked="" type="checkbox"/> <input type="checkbox"/>	<input checked="" type="checkbox"/> <input type="checkbox"/>	<input checked="" type="checkbox"/> <input type="checkbox"/>	
29	L2TP Over IPSec	<input type="checkbox"/> <input checked="" type="checkbox"/> <input type="checkbox"/>	<input checked="" type="checkbox"/> <input type="checkbox"/>	<input checked="" type="checkbox"/> <input type="checkbox"/>	
30	my.ZyXEL.com	<input type="checkbox"/> <input checked="" type="checkbox"/> <input type="checkbox"/>	<input checked="" type="checkbox"/> <input type="checkbox"/>	<input checked="" type="checkbox"/> <input type="checkbox"/>	
31	NAT	<input type="checkbox"/> <input checked="" type="checkbox"/> <input type="checkbox"/>	<input checked="" type="checkbox"/> <input type="checkbox"/>	<input checked="" type="checkbox"/> <input type="checkbox"/>	
32	PKI	<input type="checkbox"/> <input checked="" type="checkbox"/> <input type="checkbox"/>	<input checked="" type="checkbox"/> <input type="checkbox"/>	<input checked="" type="checkbox"/> <input type="checkbox"/>	
33	Policy Route	<input type="checkbox"/> <input checked="" type="checkbox"/> <input type="checkbox"/>	<input checked="" type="checkbox"/> <input type="checkbox"/>	<input checked="" type="checkbox"/> <input type="checkbox"/>	
34	Port Grouping	<input type="checkbox"/> <input checked="" type="checkbox"/> <input type="checkbox"/>	<input checked="" type="checkbox"/> <input type="checkbox"/>	<input checked="" type="checkbox"/> <input type="checkbox"/>	
35	Routing Protocol	<input type="checkbox"/> <input checked="" type="checkbox"/> <input type="checkbox"/>	<input checked="" type="checkbox"/> <input type="checkbox"/>	<input checked="" type="checkbox"/> <input type="checkbox"/>	
36	Secure-Policy	<input type="checkbox"/> <input checked="" type="checkbox"/> <input type="checkbox"/>	<input checked="" type="checkbox"/> <input type="checkbox"/>	<input checked="" type="checkbox"/> <input type="checkbox"/>	
37	Sessions Limit	<input type="checkbox"/> <input checked="" type="checkbox"/> <input type="checkbox"/>	<input checked="" type="checkbox"/> <input type="checkbox"/>	<input checked="" type="checkbox"/> <input type="checkbox"/>	
38	SSL Inspection	<input type="checkbox"/> <input checked="" type="checkbox"/> <input type="checkbox"/>	<input checked="" type="checkbox"/> <input type="checkbox"/>	<input checked="" type="checkbox"/> <input type="checkbox"/>	
39	SSL VPN	<input type="checkbox"/> <input checked="" type="checkbox"/> <input type="checkbox"/>	<input checked="" type="checkbox"/> <input type="checkbox"/>	<input checked="" type="checkbox"/> <input type="checkbox"/>	
40	SSD	<input type="checkbox"/> <input checked="" type="checkbox"/> <input type="checkbox"/>	<input checked="" type="checkbox"/> <input type="checkbox"/>	<input checked="" type="checkbox"/> <input type="checkbox"/>	
41	System	<input type="checkbox"/> <input checked="" type="checkbox"/> <input type="checkbox"/>	<input checked="" type="checkbox"/> <input type="checkbox"/>	<input checked="" type="checkbox"/> <input type="checkbox"/>	
42	USB Storage	<input type="checkbox"/> <input checked="" type="checkbox"/> <input type="checkbox"/>	<input checked="" type="checkbox"/> <input type="checkbox"/>	<input checked="" type="checkbox"/> <input type="checkbox"/>	
43	User	<input type="checkbox"/> <input checked="" type="checkbox"/> <input type="checkbox"/>	<input checked="" type="checkbox"/> <input type="checkbox"/>	<input checked="" type="checkbox"/> <input type="checkbox"/>	
44	Warning web sites	<input type="checkbox"/> <input checked="" type="checkbox"/> <input type="checkbox"/>	<input checked="" type="checkbox"/> <input type="checkbox"/>	<input checked="" type="checkbox"/> <input type="checkbox"/>	
45	Web Authentication	<input type="checkbox"/> <input checked="" type="checkbox"/> <input type="checkbox"/>	<input checked="" type="checkbox"/> <input type="checkbox"/>	<input checked="" type="checkbox"/> <input type="checkbox"/>	
46	Wlan Station Info	<input type="checkbox"/> <input checked="" type="checkbox"/> <input type="checkbox"/>	<input checked="" type="checkbox"/> <input type="checkbox"/>	<input checked="" type="checkbox"/> <input type="checkbox"/>	
47	ZySH	<input type="checkbox"/> <input checked="" type="checkbox"/> <input type="checkbox"/>	<input checked="" type="checkbox"/> <input type="checkbox"/>	<input checked="" type="checkbox"/> <input type="checkbox"/>	

Page 1 of 1 Show 50 items Displaying 1 - 47 of 47

Figure 709 Configuration > Log & Report > Log Setting > Edit (System Log - AP)

Active Log and Alert (AP)

System Log | E-mail Server 1 | E-mail Server 2

#	Log Category	System Log	Email Server 1	Email Server 2
1	Account	<input type="radio"/> <input checked="" type="radio"/> <input type="radio"/>	<input checked="" type="checkbox"/> <input type="checkbox"/>	<input checked="" type="checkbox"/> <input type="checkbox"/>
2	Built-in Service	<input type="radio"/> <input checked="" type="radio"/> <input type="radio"/>	<input checked="" type="checkbox"/> <input type="checkbox"/>	<input checked="" type="checkbox"/> <input type="checkbox"/>
3	CAPWAP	<input type="radio"/> <input checked="" type="radio"/> <input type="radio"/>	<input checked="" type="checkbox"/> <input type="checkbox"/>	<input checked="" type="checkbox"/> <input type="checkbox"/>
4	Daily Report	<input type="radio"/> <input checked="" type="radio"/> <input type="radio"/>	<input checked="" type="checkbox"/> <input type="checkbox"/>	<input checked="" type="checkbox"/> <input type="checkbox"/>
5	Default	<input type="radio"/> <input type="radio"/> <input checked="" type="radio"/>	<input checked="" type="checkbox"/> <input type="checkbox"/>	<input checked="" type="checkbox"/> <input type="checkbox"/>
6	DHCP	<input type="radio"/> <input checked="" type="radio"/> <input type="radio"/>	<input checked="" type="checkbox"/> <input type="checkbox"/>	<input checked="" type="checkbox"/> <input type="checkbox"/>
7	File Manager	<input type="radio"/> <input checked="" type="radio"/> <input type="radio"/>	<input checked="" type="checkbox"/> <input type="checkbox"/>	<input checked="" type="checkbox"/> <input type="checkbox"/>
8	Force Authentication	<input type="radio"/> <input checked="" type="radio"/> <input type="radio"/>	<input checked="" type="checkbox"/> <input type="checkbox"/>	<input checked="" type="checkbox"/> <input type="checkbox"/>
9	Interface	<input type="radio"/> <input checked="" type="radio"/> <input type="radio"/>	<input checked="" type="checkbox"/> <input type="checkbox"/>	<input checked="" type="checkbox"/> <input type="checkbox"/>
10	PKI	<input type="radio"/> <input checked="" type="radio"/> <input type="radio"/>	<input checked="" type="checkbox"/> <input type="checkbox"/>	<input checked="" type="checkbox"/> <input type="checkbox"/>
11	Routing Protocol	<input type="radio"/> <input checked="" type="radio"/> <input type="radio"/>	<input checked="" type="checkbox"/> <input type="checkbox"/>	<input checked="" type="checkbox"/> <input type="checkbox"/>
12	System	<input type="radio"/> <input checked="" type="radio"/> <input type="radio"/>	<input checked="" type="checkbox"/> <input type="checkbox"/>	<input checked="" type="checkbox"/> <input type="checkbox"/>
13	User	<input type="radio"/> <input checked="" type="radio"/> <input type="radio"/>	<input checked="" type="checkbox"/> <input type="checkbox"/>	<input checked="" type="checkbox"/> <input type="checkbox"/>
14	Wireless LAN	<input type="radio"/> <input checked="" type="radio"/> <input type="radio"/>	<input checked="" type="checkbox"/> <input type="checkbox"/>	<input checked="" type="checkbox"/> <input type="checkbox"/>
15	Wlan Station Info	<input type="radio"/> <input checked="" type="radio"/> <input type="radio"/>	<input checked="" type="checkbox"/> <input type="checkbox"/>	<input checked="" type="checkbox"/> <input type="checkbox"/>
16	ZySH	<input type="radio"/> <input checked="" type="radio"/> <input type="radio"/>	<input checked="" type="checkbox"/> <input type="checkbox"/>	<input checked="" type="checkbox"/> <input type="checkbox"/>

Page 1 of 1 | Show 50 items | Displaying 1 - 16 of 16

Log Consolidation

Active

Log Consolidation Interval (seconds): (10 - 600)

OK Cancel

The following table describes the labels in this screen.

Table 407 Configuration > Log & Report > Log Setting > Edit (System Log)

LABEL	DESCRIPTION
E-Mail Server 1/2	
Active	Select this to send log messages and alerts according to the information in this section. You specify what kinds of log messages are included in log information and what kinds of log messages are included in alerts in the Active Log and Alert section.
Mail Server	Type the name or IP address of the outgoing SMTP server.
Mail Subject	Type the subject line for the outgoing e-mail.
Send From	Type the e-mail address from which the outgoing e-mail is delivered. This address is used in replies.
Send Log To	Type the e-mail address to which the outgoing e-mail is delivered.
Send Alerts To	Type the e-mail address to which alerts are delivered.
Sending Log	Select how often log information is e-mailed. Choices are: When Full, Hourly and When Full, Daily and When Full, and Weekly and When Full.
Day for Sending Log	This field is available if the log is e-mailed weekly. Select the day of the week the log is e-mailed.
Time for Sending Log	This field is available if the log is e-mailed weekly or daily. Select the time of day (hours and minutes) when the log is e-mailed. Use 24-hour notation.

Table 407 Configuration > Log & Report > Log Setting > Edit (System Log) (continued)

LABEL	DESCRIPTION
SMTP Authentication	Select this check box if it is necessary to provide a user name and password to the SMTP server.
User Name	This box is effective when you select the SMTP Authentication check box. Type the user name to provide to the SMTP server when the log is e-mailed.
Password	This box is effective when you select the SMTP Authentication check box. Type the password of up to 63 characters to provide to the SMTP server when the log is e-mailed.
Retype to Confirm	Type the password again to make sure that you have entered is correctly.
Active Log and Alert	
System Log	<p>Use the System Log drop-down list to change the log settings for all of the log categories.</p> <p>disable all logs (red X) - do not log any information for any category for the system log or e-mail any logs to e-mail server 1 or 2.</p> <p>enable normal logs (green check mark) - create log messages and alerts for all categories for the system log. If e-mail server 1 or 2 also has normal logs enabled, the Zyxel Device will e-mail logs to them.</p> <p>enable normal logs and debug logs (yellow check mark) - create log messages, alerts, and debugging information for all categories. The Zyxel Device does not e-mail debugging information, even if this setting is selected.</p>
E-mail Server 1	<p>Use the E-Mail Server 1 drop-down list to change the settings for e-mailing logs to e-mail server 1 for all log categories.</p> <p>Using the System Log drop-down list to disable all logs overrides your e-mail server 1 settings.</p> <p>enable normal logs (green check mark) - e-mail log messages for all categories to e-mail server 1.</p> <p>enable alert logs (red exclamation point) - e-mail alerts for all categories to e-mail server 1.</p>
E-mail Server 2	<p>Use the E-Mail Server 2 drop-down list to change the settings for e-mailing logs to e-mail server 2 for all log categories.</p> <p>Using the System Log drop-down list to disable all logs overrides your e-mail server 2 settings.</p> <p>enable normal logs (green check mark) - e-mail log messages for all categories to e-mail server 2.</p> <p>enable alert logs (red exclamation point) - e-mail alerts for all categories to e-mail server 2.</p>
#	This field is a sequential value, and it is not associated with a specific address.
Log Category	This field displays each category of messages. It is the same value used in the Display and Category fields in the View Log tab. The Default category includes debugging messages generated by open source software.
System log	<p>Select which events you want to log by Log Category. There are three choices:</p> <p>disable all logs (red X) - do not log any information from this category</p> <p>enable normal logs (green check mark) - create log messages and alerts from this category</p> <p>enable normal logs and debug logs (yellow check mark) - create log messages, alerts, and debugging information from this category; the Zyxel Device does not e-mail debugging information, however, even if this setting is selected.</p>

Table 407 Configuration > Log & Report > Log Setting > Edit (System Log) (continued)

LABEL	DESCRIPTION
E-mail Server 1	Select whether each category of events should be included in the log messages when it is e-mailed (green check mark) and/or in alerts (red exclamation point) for the e-mail settings specified in E-Mail Server 1 . The Zyxel Device does not e-mail debugging information, even if it is recorded in the System log .
E-mail Server 2	Select whether each category of events should be included in log messages when it is e-mailed (green check mark) and/or in alerts (red exclamation point) for the e-mail settings specified in E-Mail Server 2 . The Zyxel Device does not e-mail debugging information, even if it is recorded in the System log .
Log Consolidation	
Active	Select this to activate log consolidation. Log consolidation aggregates multiple log messages that arrive within the specified Log Consolidation Interval . In the View Log tab, the text "[count=x]", where <i>x</i> is the number of original log messages, is appended at the end of the Message field, when multiple log messages were aggregated.
Log Consolidation Interval	Type how often, in seconds, to consolidate log information. If the same log message appears multiple times, it is aggregated into one log message with the text "[count=x]", where <i>x</i> is the number of original log messages, appended at the end of the Message field.
OK	Click this to save your changes and return to the previous screen.
Cancel	Click this to return to the previous screen without saving your changes.

45.3.3 Edit Log on USB Storage Setting

The **Edit Log on USB Storage Setting** screen controls the detailed settings for saving logs to a connected USB storage device. Go to the **Log Setting Summary** screen (see [Section 45.3.1 on page 1016](#)), and click the USB storage **Edit** icon.

Figure 710 Configuration > Log & Report > Log Setting > Edit (USB Storage)

The following table describes the labels in this screen.

Table 408 Configuration > Log & Report > Log Setting > Edit (USB Storage)

LABEL	DESCRIPTION
Duplicate logs to USB storage (if ready)	Select this to have the Zyxel Device save a copy of its system logs to a connected USB storage device. Use the Active Log section to specify what kinds of messages to include.
Enable log keep duration:	Select this checkbox to enter a value in the Keep Duration field.
Keep duration:	Enter a number of days that the Zyxel Device keeps this log.
Active Log	
Selection	Use the Selection drop-down list to change the log settings for all of the log categories. disable all logs (red X) - do not send the remote server logs for any log category. enable normal logs (green check mark) - send the remote server log messages and alerts for all log categories. enable normal logs and debug logs (yellow check mark) - send the remote server log messages, alerts, and debugging information for all log categories.
#	This field is a sequential value, and it is not associated with a specific entry.
Log Category	This field displays each category of messages. The Default category includes debugging messages generated by open source software.

Table 408 Configuration > Log & Report > Log Setting > Edit (USB Storage) (continued)

LABEL	DESCRIPTION
Selection	Select what information you want to log from each Log Category (except All Logs ; see below). Choices are: disable all logs (red X) - do not log any information from this category enable normal logs (green check mark) - log regular information and alerts from this category enable normal logs and debug logs (yellow check mark) - log regular information, alerts, and debugging information from this category
OK	Click this to save your changes and return to the previous screen.
Cancel	Click this to return to the previous screen without saving your changes.

45.3.4 Edit Remote Server Log Settings

The **Log Settings Edit** screen controls the detailed settings for each log in the remote server (syslog). Go to the **Log Settings Summary** screen (see [Section 45.3.1 on page 1016](#)), and click a remote server **Edit** icon.

Figure 711 Configuration > Log & Report > Log Setting > Edit (Remote Server - AC)

Edit Remote Server 1
Log Settings for Remote Server

Active

Log Format:

Server Address: (Server Name or IP Address)

Server Port:

Log Facility:

Active Log (AC)

#	Log Category	Selection
1	Account	<input checked="" type="checkbox"/> <input type="checkbox"/> <input type="checkbox"/>
2	ADP	<input type="checkbox"/> <input type="checkbox"/> <input type="checkbox"/>
3	Anti-Spam	<input type="checkbox"/> <input type="checkbox"/> <input type="checkbox"/>
4	Anti-Virus	<input type="checkbox"/> <input type="checkbox"/> <input type="checkbox"/>
5	Application Patrol	<input type="checkbox"/> <input type="checkbox"/> <input type="checkbox"/>
6	Auth. Policy	<input type="checkbox"/> <input type="checkbox"/> <input type="checkbox"/>
7	Authentication Server	<input type="checkbox"/> <input type="checkbox"/> <input type="checkbox"/>
8	Blocked web sites	<input type="checkbox"/> <input type="checkbox"/> <input type="checkbox"/>
9	Built-in Service	<input type="checkbox"/> <input type="checkbox"/> <input type="checkbox"/>
10	BWM	<input type="checkbox"/> <input type="checkbox"/> <input type="checkbox"/>
11	CAPWAP	<input type="checkbox"/> <input type="checkbox"/> <input type="checkbox"/>
12	Cellular	<input type="checkbox"/> <input type="checkbox"/> <input type="checkbox"/>
13	Connectivity Check	<input type="checkbox"/> <input type="checkbox"/> <input type="checkbox"/>
14	Content Filter	<input type="checkbox"/> <input type="checkbox"/> <input type="checkbox"/>
15	Daily Report	<input type="checkbox"/> <input type="checkbox"/> <input type="checkbox"/>
16	Default	<input type="checkbox"/> <input type="checkbox"/> <input type="checkbox"/>
17	Device HA	<input type="checkbox"/> <input type="checkbox"/> <input type="checkbox"/>
18	DHCP	<input type="checkbox"/> <input type="checkbox"/> <input type="checkbox"/>
19	DNS Query	<input type="checkbox"/> <input type="checkbox"/> <input type="checkbox"/>
20	File Manager	<input type="checkbox"/> <input type="checkbox"/> <input type="checkbox"/>
21	Forward Clear Mails	<input type="checkbox"/> <input type="checkbox"/> <input type="checkbox"/>
22	Forward web sites	<input type="checkbox"/> <input type="checkbox"/> <input type="checkbox"/>
23	IDP	<input type="checkbox"/> <input type="checkbox"/> <input type="checkbox"/>
24	IKE	<input type="checkbox"/> <input type="checkbox"/> <input type="checkbox"/>
25	Inbound Load Balancing	<input type="checkbox"/> <input type="checkbox"/> <input type="checkbox"/>
26	Interface	<input type="checkbox"/> <input type="checkbox"/> <input type="checkbox"/>
27	Interface Statistics	<input type="checkbox"/> <input type="checkbox"/> <input type="checkbox"/>
28	IP-MAC Binding	<input type="checkbox"/> <input type="checkbox"/> <input type="checkbox"/>
29	IPSec	<input type="checkbox"/> <input type="checkbox"/> <input type="checkbox"/>
30	L2TP Over IPSec	<input type="checkbox"/> <input type="checkbox"/> <input type="checkbox"/>
31	myZyXEL.com	<input type="checkbox"/> <input type="checkbox"/> <input type="checkbox"/>
32	NAT	<input type="checkbox"/> <input type="checkbox"/> <input type="checkbox"/>
33	PKI	<input type="checkbox"/> <input type="checkbox"/> <input type="checkbox"/>
34	Policy Route	<input type="checkbox"/> <input type="checkbox"/> <input type="checkbox"/>
35	Port Grouping	<input type="checkbox"/> <input type="checkbox"/> <input type="checkbox"/>
36	Routing Protocol	<input type="checkbox"/> <input type="checkbox"/> <input type="checkbox"/>
37	Secure-Policy	<input type="checkbox"/> <input type="checkbox"/> <input type="checkbox"/>
38	Sessions Limit	<input type="checkbox"/> <input type="checkbox"/> <input type="checkbox"/>
39	SSL Inspection	<input type="checkbox"/> <input type="checkbox"/> <input type="checkbox"/>
40	SSL VPN	<input type="checkbox"/> <input type="checkbox"/> <input type="checkbox"/>
41	SSO	<input type="checkbox"/> <input type="checkbox"/> <input type="checkbox"/>
42	System	<input type="checkbox"/> <input type="checkbox"/> <input type="checkbox"/>
43	System Monitoring	<input type="checkbox"/> <input type="checkbox"/> <input type="checkbox"/>
44	Traffic Log	<input type="checkbox"/> <input type="checkbox"/> <input type="checkbox"/>
45	USB Storage	<input type="checkbox"/> <input type="checkbox"/> <input type="checkbox"/>
46	User	<input type="checkbox"/> <input type="checkbox"/> <input type="checkbox"/>
47	Warning web sites	<input type="checkbox"/> <input type="checkbox"/> <input type="checkbox"/>
48	Web Authentication	<input type="checkbox"/> <input type="checkbox"/> <input type="checkbox"/>
49	Wlan Station Info	<input type="checkbox"/> <input type="checkbox"/> <input type="checkbox"/>
50	ZySH	<input type="checkbox"/> <input type="checkbox"/> <input type="checkbox"/>

Page 1 of 1 | Show 50 items | Displaying 1 - 50 of 50

Configuration > Log & Report > Log Setting > Edit (Remote Server - AP)

#	Log Category	Selection
1	Account	<input type="checkbox"/> <input checked="" type="checkbox"/> <input type="checkbox"/>
2	Built-in Service	<input type="checkbox"/> <input type="checkbox"/> <input type="checkbox"/>
3	CAPWAP	<input type="checkbox"/> <input type="checkbox"/> <input type="checkbox"/>
4	Daily Report	<input type="checkbox"/> <input type="checkbox"/> <input type="checkbox"/>
5	Default	<input type="checkbox"/> <input checked="" type="checkbox"/> <input type="checkbox"/>
6	DHCP	<input type="checkbox"/> <input type="checkbox"/> <input type="checkbox"/>
7	File Manager	<input type="checkbox"/> <input type="checkbox"/> <input type="checkbox"/>
8	Force Authentication	<input type="checkbox"/> <input type="checkbox"/> <input type="checkbox"/>
9	Interface	<input type="checkbox"/> <input type="checkbox"/> <input type="checkbox"/>
10	Interface Statistics	<input type="checkbox"/> <input type="checkbox"/> <input type="checkbox"/>
11	PKI	<input type="checkbox"/> <input type="checkbox"/> <input type="checkbox"/>
12	Routing Protocol	<input type="checkbox"/> <input type="checkbox"/> <input type="checkbox"/>
13	System	<input type="checkbox"/> <input type="checkbox"/> <input type="checkbox"/>
14	System Monitoring	<input type="checkbox"/> <input type="checkbox"/> <input type="checkbox"/>
15	Traffic Log	<input type="checkbox"/> <input type="checkbox"/> <input type="checkbox"/>
16	User	<input type="checkbox"/> <input type="checkbox"/> <input type="checkbox"/>
17	Wireless LAN	<input type="checkbox"/> <input type="checkbox"/> <input type="checkbox"/>
18	Wlan Station Info	<input type="checkbox"/> <input type="checkbox"/> <input type="checkbox"/>
19	ZySH	<input type="checkbox"/> <input type="checkbox"/> <input type="checkbox"/>

The following table describes the labels in this screen.

Table 409 Configuration > Log & Report > Log Setting > Edit (Remote Server)

LABEL	DESCRIPTION
Log Settings for Remote Server	
Active	Select this check box to send log information according to the information in this section. You specify what kinds of messages are included in log information in the Active Log section.
Log Format	This field displays the format of the log information. It is read-only. VRPT/Syslog - Zyxel's Vantage Report, syslog-compatible format. CEF/Syslog - Common Event Format, syslog-compatible format.
Server Address	Type the server name or the IP address of the syslog server to which to send log information.
Server Port	Type the service port number used by the remote server. See Appendix B on page 1099 for information on commonly used port numbers.
Log Facility	Select a log facility. The log facility allows you to log the messages to different files in the syslog server. Please see the documentation for your syslog program for more information.
Active Log	

Table 409 Configuration > Log & Report > Log Setting > Edit (Remote Server) (continued)

LABEL	DESCRIPTION
Selection	Use the Selection drop-down list to change the log settings for all of the log categories. disable all logs (red X) - do not send the remote server logs for any log category. enable normal logs (green check mark) - send the remote server log messages and alerts for all log categories. enable normal logs and debug logs (yellow check mark) - send the remote server log messages, alerts, and debugging information for all log categories.
#	This field is a sequential value, and it is not associated with a specific address.
Log Category	This field displays each category of messages. It is the same value used in the Display and Category fields in the View Log tab. The Default category includes debugging messages generated by open source software.
Selection	Select what information you want to log from each Log Category (except All Logs ; see below). Choices are: disable all logs (red X) - do not log any information from this category enable normal logs (green check mark) - log regular information and alerts from this category enable normal logs and debug logs (yellow check mark) - log regular information, alerts, and debugging information from this category
OK	Click this to save your changes and return to the previous screen.
Cancel	Click this to return to the previous screen without saving your changes.

45.3.5 Log Category Settings Screen

The **Log Category Settings** screen allows you to view and to edit what information is included in the system log, USB storage, e-mail profiles, and remote servers at the same time. It does not let you change other log settings (for example, where and how often log information is e-mailed or remote server names). To access this screen, go to the **Log Settings Summary** screen (see [Section 45.3.1 on page 1016](#)), and click the **Log Category Settings** button.

Figure 712 Log Category Settings AC

The screenshot displays the 'Log Category Settings (AC)' window. At the top, there are tabs for 'System Log', 'USB Storage', 'E-mail Server 1', 'E-mail Server 2', and four 'Remote Server' tabs (1-4). Below the tabs is a table with 50 rows, each representing a log category. The columns are: '#', 'Log Category', 'System Log', 'USB Storage', 'E-mail Server 1', 'E-mail Server 2', 'Remote Server 1', 'Remote Server 2', 'Remote Server 3', and 'Remote Server 4'. Each cell in the table contains a set of three radio buttons (one selected) and a checkbox. The 'Account' category (row 1) has status icons (green checkmarks and a red X) in the first two columns. The 'System Monitoring' category (row 43) has checkboxes in the last two columns. At the bottom, there is a navigation bar with 'Page 1 of 1', 'Show 50 items', and 'Displaying 1 - 50 of 50'.

#	Log Category	System Log	USB Storage	E-mail Server 1	E-mail Server 2	Remote Server 1	Remote Server 2	Remote Server 3	Remote Server 4
1	Account	<input checked="" type="radio"/> <input type="radio"/> <input type="radio"/>	<input checked="" type="radio"/> <input type="radio"/> <input type="radio"/>	<input checked="" type="checkbox"/> <input type="checkbox"/>	<input checked="" type="checkbox"/> <input type="checkbox"/>	<input type="radio"/> <input type="radio"/> <input type="radio"/>	<input type="radio"/> <input type="radio"/> <input type="radio"/>	<input type="radio"/> <input type="radio"/> <input type="radio"/>	<input type="radio"/> <input type="radio"/> <input type="radio"/>
2	ADP	<input type="radio"/> <input type="radio"/> <input type="radio"/>	<input type="radio"/> <input type="radio"/> <input type="radio"/>	<input checked="" type="checkbox"/> <input type="checkbox"/>	<input checked="" type="checkbox"/> <input type="checkbox"/>	<input type="radio"/> <input type="radio"/> <input type="radio"/>	<input type="radio"/> <input type="radio"/> <input type="radio"/>	<input type="radio"/> <input type="radio"/> <input type="radio"/>	<input type="radio"/> <input type="radio"/> <input type="radio"/>
3	Anti-Spam	<input type="radio"/> <input type="radio"/> <input type="radio"/>	<input type="radio"/> <input type="radio"/> <input type="radio"/>	<input checked="" type="checkbox"/> <input type="checkbox"/>	<input checked="" type="checkbox"/> <input type="checkbox"/>	<input type="radio"/> <input type="radio"/> <input type="radio"/>	<input type="radio"/> <input type="radio"/> <input type="radio"/>	<input type="radio"/> <input type="radio"/> <input type="radio"/>	<input type="radio"/> <input type="radio"/> <input type="radio"/>
4	Anti-Virus	<input type="radio"/> <input type="radio"/> <input type="radio"/>	<input type="radio"/> <input type="radio"/> <input type="radio"/>	<input checked="" type="checkbox"/> <input type="checkbox"/>	<input checked="" type="checkbox"/> <input type="checkbox"/>	<input type="radio"/> <input type="radio"/> <input type="radio"/>	<input type="radio"/> <input type="radio"/> <input type="radio"/>	<input type="radio"/> <input type="radio"/> <input type="radio"/>	<input type="radio"/> <input type="radio"/> <input type="radio"/>
5	Application Patrol	<input type="radio"/> <input type="radio"/> <input type="radio"/>	<input type="radio"/> <input type="radio"/> <input type="radio"/>	<input checked="" type="checkbox"/> <input type="checkbox"/>	<input checked="" type="checkbox"/> <input type="checkbox"/>	<input type="radio"/> <input type="radio"/> <input type="radio"/>	<input type="radio"/> <input type="radio"/> <input type="radio"/>	<input type="radio"/> <input type="radio"/> <input type="radio"/>	<input type="radio"/> <input type="radio"/> <input type="radio"/>
6	Auth. Policy	<input type="radio"/> <input type="radio"/> <input type="radio"/>	<input type="radio"/> <input type="radio"/> <input type="radio"/>	<input checked="" type="checkbox"/> <input type="checkbox"/>	<input checked="" type="checkbox"/> <input type="checkbox"/>	<input type="radio"/> <input type="radio"/> <input type="radio"/>	<input type="radio"/> <input type="radio"/> <input type="radio"/>	<input type="radio"/> <input type="radio"/> <input type="radio"/>	<input type="radio"/> <input type="radio"/> <input type="radio"/>
7	Authentication S...	<input type="radio"/> <input type="radio"/> <input type="radio"/>	<input type="radio"/> <input type="radio"/> <input type="radio"/>	<input checked="" type="checkbox"/> <input type="checkbox"/>	<input checked="" type="checkbox"/> <input type="checkbox"/>	<input type="radio"/> <input type="radio"/> <input type="radio"/>	<input type="radio"/> <input type="radio"/> <input type="radio"/>	<input type="radio"/> <input type="radio"/> <input type="radio"/>	<input type="radio"/> <input type="radio"/> <input type="radio"/>
8	Blocked web sites	<input type="radio"/> <input type="radio"/> <input type="radio"/>	<input type="radio"/> <input type="radio"/> <input type="radio"/>	<input checked="" type="checkbox"/> <input type="checkbox"/>	<input checked="" type="checkbox"/> <input type="checkbox"/>	<input type="radio"/> <input type="radio"/> <input type="radio"/>	<input type="radio"/> <input type="radio"/> <input type="radio"/>	<input type="radio"/> <input type="radio"/> <input type="radio"/>	<input type="radio"/> <input type="radio"/> <input type="radio"/>
9	Built-in Service	<input type="radio"/> <input type="radio"/> <input type="radio"/>	<input type="radio"/> <input type="radio"/> <input type="radio"/>	<input checked="" type="checkbox"/> <input type="checkbox"/>	<input checked="" type="checkbox"/> <input type="checkbox"/>	<input type="radio"/> <input type="radio"/> <input type="radio"/>	<input type="radio"/> <input type="radio"/> <input type="radio"/>	<input type="radio"/> <input type="radio"/> <input type="radio"/>	<input type="radio"/> <input type="radio"/> <input type="radio"/>
10	BWM	<input type="radio"/> <input type="radio"/> <input type="radio"/>	<input type="radio"/> <input type="radio"/> <input type="radio"/>	<input checked="" type="checkbox"/> <input type="checkbox"/>	<input checked="" type="checkbox"/> <input type="checkbox"/>	<input type="radio"/> <input type="radio"/> <input type="radio"/>	<input type="radio"/> <input type="radio"/> <input type="radio"/>	<input type="radio"/> <input type="radio"/> <input type="radio"/>	<input type="radio"/> <input type="radio"/> <input type="radio"/>
11	CAPWAP	<input type="radio"/> <input type="radio"/> <input type="radio"/>	<input type="radio"/> <input type="radio"/> <input type="radio"/>	<input checked="" type="checkbox"/> <input type="checkbox"/>	<input checked="" type="checkbox"/> <input type="checkbox"/>	<input type="radio"/> <input type="radio"/> <input type="radio"/>	<input type="radio"/> <input type="radio"/> <input type="radio"/>	<input type="radio"/> <input type="radio"/> <input type="radio"/>	<input type="radio"/> <input type="radio"/> <input type="radio"/>
12	Cellular	<input type="radio"/> <input type="radio"/> <input type="radio"/>	<input type="radio"/> <input type="radio"/> <input type="radio"/>	<input checked="" type="checkbox"/> <input type="checkbox"/>	<input checked="" type="checkbox"/> <input type="checkbox"/>	<input type="radio"/> <input type="radio"/> <input type="radio"/>	<input type="radio"/> <input type="radio"/> <input type="radio"/>	<input type="radio"/> <input type="radio"/> <input type="radio"/>	<input type="radio"/> <input type="radio"/> <input type="radio"/>
13	Connectivity Check	<input type="radio"/> <input type="radio"/> <input type="radio"/>	<input type="radio"/> <input type="radio"/> <input type="radio"/>	<input checked="" type="checkbox"/> <input type="checkbox"/>	<input checked="" type="checkbox"/> <input type="checkbox"/>	<input type="radio"/> <input type="radio"/> <input type="radio"/>	<input type="radio"/> <input type="radio"/> <input type="radio"/>	<input type="radio"/> <input type="radio"/> <input type="radio"/>	<input type="radio"/> <input type="radio"/> <input type="radio"/>
14	Content Filter	<input type="radio"/> <input type="radio"/> <input type="radio"/>	<input type="radio"/> <input type="radio"/> <input type="radio"/>	<input checked="" type="checkbox"/> <input type="checkbox"/>	<input checked="" type="checkbox"/> <input type="checkbox"/>	<input type="radio"/> <input type="radio"/> <input type="radio"/>	<input type="radio"/> <input type="radio"/> <input type="radio"/>	<input type="radio"/> <input type="radio"/> <input type="radio"/>	<input type="radio"/> <input type="radio"/> <input type="radio"/>
15	Daily Report	<input type="radio"/> <input type="radio"/> <input type="radio"/>	<input type="radio"/> <input type="radio"/> <input type="radio"/>	<input checked="" type="checkbox"/> <input type="checkbox"/>	<input checked="" type="checkbox"/> <input type="checkbox"/>	<input type="radio"/> <input type="radio"/> <input type="radio"/>	<input type="radio"/> <input type="radio"/> <input type="radio"/>	<input type="radio"/> <input type="radio"/> <input type="radio"/>	<input type="radio"/> <input type="radio"/> <input type="radio"/>
16	Default	<input type="radio"/> <input type="radio"/> <input type="radio"/>	<input type="radio"/> <input type="radio"/> <input type="radio"/>	<input checked="" type="checkbox"/> <input type="checkbox"/>	<input checked="" type="checkbox"/> <input type="checkbox"/>	<input type="radio"/> <input type="radio"/> <input type="radio"/>	<input type="radio"/> <input type="radio"/> <input type="radio"/>	<input type="radio"/> <input type="radio"/> <input type="radio"/>	<input type="radio"/> <input type="radio"/> <input type="radio"/>
17	Device HA	<input type="radio"/> <input type="radio"/> <input type="radio"/>	<input type="radio"/> <input type="radio"/> <input type="radio"/>	<input checked="" type="checkbox"/> <input type="checkbox"/>	<input checked="" type="checkbox"/> <input type="checkbox"/>	<input type="radio"/> <input type="radio"/> <input type="radio"/>	<input type="radio"/> <input type="radio"/> <input type="radio"/>	<input type="radio"/> <input type="radio"/> <input type="radio"/>	<input type="radio"/> <input type="radio"/> <input type="radio"/>
18	DHCP	<input type="radio"/> <input type="radio"/> <input type="radio"/>	<input type="radio"/> <input type="radio"/> <input type="radio"/>	<input checked="" type="checkbox"/> <input type="checkbox"/>	<input checked="" type="checkbox"/> <input type="checkbox"/>	<input type="radio"/> <input type="radio"/> <input type="radio"/>	<input type="radio"/> <input type="radio"/> <input type="radio"/>	<input type="radio"/> <input type="radio"/> <input type="radio"/>	<input type="radio"/> <input type="radio"/> <input type="radio"/>
19	DNS Query	<input type="radio"/> <input type="radio"/> <input type="radio"/>	<input type="radio"/> <input type="radio"/> <input type="radio"/>	<input checked="" type="checkbox"/> <input type="checkbox"/>	<input checked="" type="checkbox"/> <input type="checkbox"/>	<input type="radio"/> <input type="radio"/> <input type="radio"/>	<input type="radio"/> <input type="radio"/> <input type="radio"/>	<input type="radio"/> <input type="radio"/> <input type="radio"/>	<input type="radio"/> <input type="radio"/> <input type="radio"/>
20	File Manager	<input type="radio"/> <input type="radio"/> <input type="radio"/>	<input type="radio"/> <input type="radio"/> <input type="radio"/>	<input checked="" type="checkbox"/> <input type="checkbox"/>	<input checked="" type="checkbox"/> <input type="checkbox"/>	<input type="radio"/> <input type="radio"/> <input type="radio"/>	<input type="radio"/> <input type="radio"/> <input type="radio"/>	<input type="radio"/> <input type="radio"/> <input type="radio"/>	<input type="radio"/> <input type="radio"/> <input type="radio"/>
21	Forward Clear M...	<input type="radio"/> <input type="radio"/> <input type="radio"/>	<input type="radio"/> <input type="radio"/> <input type="radio"/>	<input checked="" type="checkbox"/> <input type="checkbox"/>	<input checked="" type="checkbox"/> <input type="checkbox"/>	<input type="radio"/> <input type="radio"/> <input type="radio"/>	<input type="radio"/> <input type="radio"/> <input type="radio"/>	<input type="radio"/> <input type="radio"/> <input type="radio"/>	<input type="radio"/> <input type="radio"/> <input type="radio"/>
22	Forward web sites	<input type="radio"/> <input type="radio"/> <input type="radio"/>	<input type="radio"/> <input type="radio"/> <input type="radio"/>	<input checked="" type="checkbox"/> <input type="checkbox"/>	<input checked="" type="checkbox"/> <input type="checkbox"/>	<input type="radio"/> <input type="radio"/> <input type="radio"/>	<input type="radio"/> <input type="radio"/> <input type="radio"/>	<input type="radio"/> <input type="radio"/> <input type="radio"/>	<input type="radio"/> <input type="radio"/> <input type="radio"/>
23	IDP	<input type="radio"/> <input type="radio"/> <input type="radio"/>	<input type="radio"/> <input type="radio"/> <input type="radio"/>	<input checked="" type="checkbox"/> <input type="checkbox"/>	<input checked="" type="checkbox"/> <input type="checkbox"/>	<input type="radio"/> <input type="radio"/> <input type="radio"/>	<input type="radio"/> <input type="radio"/> <input type="radio"/>	<input type="radio"/> <input type="radio"/> <input type="radio"/>	<input type="radio"/> <input type="radio"/> <input type="radio"/>
24	IKE	<input type="radio"/> <input type="radio"/> <input type="radio"/>	<input type="radio"/> <input type="radio"/> <input type="radio"/>	<input checked="" type="checkbox"/> <input type="checkbox"/>	<input checked="" type="checkbox"/> <input type="checkbox"/>	<input type="radio"/> <input type="radio"/> <input type="radio"/>	<input type="radio"/> <input type="radio"/> <input type="radio"/>	<input type="radio"/> <input type="radio"/> <input type="radio"/>	<input type="radio"/> <input type="radio"/> <input type="radio"/>
25	Inbound Load Bal...	<input type="radio"/> <input type="radio"/> <input type="radio"/>	<input type="radio"/> <input type="radio"/> <input type="radio"/>	<input checked="" type="checkbox"/> <input type="checkbox"/>	<input checked="" type="checkbox"/> <input type="checkbox"/>	<input type="radio"/> <input type="radio"/> <input type="radio"/>	<input type="radio"/> <input type="radio"/> <input type="radio"/>	<input type="radio"/> <input type="radio"/> <input type="radio"/>	<input type="radio"/> <input type="radio"/> <input type="radio"/>
26	Interface	<input type="radio"/> <input type="radio"/> <input type="radio"/>	<input type="radio"/> <input type="radio"/> <input type="radio"/>	<input checked="" type="checkbox"/> <input type="checkbox"/>	<input checked="" type="checkbox"/> <input type="checkbox"/>	<input type="radio"/> <input type="radio"/> <input type="radio"/>	<input type="radio"/> <input type="radio"/> <input type="radio"/>	<input type="radio"/> <input type="radio"/> <input type="radio"/>	<input type="radio"/> <input type="radio"/> <input type="radio"/>
27	Interface Statistics	<input type="radio"/> <input type="radio"/> <input type="radio"/>	<input type="radio"/> <input type="radio"/> <input type="radio"/>	<input type="checkbox"/> <input type="checkbox"/>	<input type="checkbox"/> <input type="checkbox"/>	<input type="radio"/> <input type="radio"/> <input type="radio"/>	<input type="radio"/> <input type="radio"/> <input type="radio"/>	<input type="radio"/> <input type="radio"/> <input type="radio"/>	<input type="radio"/> <input type="radio"/> <input type="radio"/>
28	IP-MAC Binding	<input type="radio"/> <input type="radio"/> <input type="radio"/>	<input type="radio"/> <input type="radio"/> <input type="radio"/>	<input checked="" type="checkbox"/> <input type="checkbox"/>	<input checked="" type="checkbox"/> <input type="checkbox"/>	<input type="radio"/> <input type="radio"/> <input type="radio"/>	<input type="radio"/> <input type="radio"/> <input type="radio"/>	<input type="radio"/> <input type="radio"/> <input type="radio"/>	<input type="radio"/> <input type="radio"/> <input type="radio"/>
29	IPSec	<input type="radio"/> <input type="radio"/> <input type="radio"/>	<input type="radio"/> <input type="radio"/> <input type="radio"/>	<input checked="" type="checkbox"/> <input type="checkbox"/>	<input checked="" type="checkbox"/> <input type="checkbox"/>	<input type="radio"/> <input type="radio"/> <input type="radio"/>	<input type="radio"/> <input type="radio"/> <input type="radio"/>	<input type="radio"/> <input type="radio"/> <input type="radio"/>	<input type="radio"/> <input type="radio"/> <input type="radio"/>
30	L2TP Over IPSec	<input type="radio"/> <input type="radio"/> <input type="radio"/>	<input type="radio"/> <input type="radio"/> <input type="radio"/>	<input checked="" type="checkbox"/> <input type="checkbox"/>	<input checked="" type="checkbox"/> <input type="checkbox"/>	<input type="radio"/> <input type="radio"/> <input type="radio"/>	<input type="radio"/> <input type="radio"/> <input type="radio"/>	<input type="radio"/> <input type="radio"/> <input type="radio"/>	<input type="radio"/> <input type="radio"/> <input type="radio"/>
31	myZYXEL.com	<input type="radio"/> <input type="radio"/> <input type="radio"/>	<input type="radio"/> <input type="radio"/> <input type="radio"/>	<input checked="" type="checkbox"/> <input type="checkbox"/>	<input checked="" type="checkbox"/> <input type="checkbox"/>	<input type="radio"/> <input type="radio"/> <input type="radio"/>	<input type="radio"/> <input type="radio"/> <input type="radio"/>	<input type="radio"/> <input type="radio"/> <input type="radio"/>	<input type="radio"/> <input type="radio"/> <input type="radio"/>
32	NAT	<input type="radio"/> <input type="radio"/> <input type="radio"/>	<input type="radio"/> <input type="radio"/> <input type="radio"/>	<input checked="" type="checkbox"/> <input type="checkbox"/>	<input checked="" type="checkbox"/> <input type="checkbox"/>	<input type="radio"/> <input type="radio"/> <input type="radio"/>	<input type="radio"/> <input type="radio"/> <input type="radio"/>	<input type="radio"/> <input type="radio"/> <input type="radio"/>	<input type="radio"/> <input type="radio"/> <input type="radio"/>
33	PKI	<input type="radio"/> <input type="radio"/> <input type="radio"/>	<input type="radio"/> <input type="radio"/> <input type="radio"/>	<input checked="" type="checkbox"/> <input type="checkbox"/>	<input checked="" type="checkbox"/> <input type="checkbox"/>	<input type="radio"/> <input type="radio"/> <input type="radio"/>	<input type="radio"/> <input type="radio"/> <input type="radio"/>	<input type="radio"/> <input type="radio"/> <input type="radio"/>	<input type="radio"/> <input type="radio"/> <input type="radio"/>
34	Policy Route	<input type="radio"/> <input type="radio"/> <input type="radio"/>	<input type="radio"/> <input type="radio"/> <input type="radio"/>	<input checked="" type="checkbox"/> <input type="checkbox"/>	<input checked="" type="checkbox"/> <input type="checkbox"/>	<input type="radio"/> <input type="radio"/> <input type="radio"/>	<input type="radio"/> <input type="radio"/> <input type="radio"/>	<input type="radio"/> <input type="radio"/> <input type="radio"/>	<input type="radio"/> <input type="radio"/> <input type="radio"/>
35	Port Grouping	<input type="radio"/> <input type="radio"/> <input type="radio"/>	<input type="radio"/> <input type="radio"/> <input type="radio"/>	<input checked="" type="checkbox"/> <input type="checkbox"/>	<input checked="" type="checkbox"/> <input type="checkbox"/>	<input type="radio"/> <input type="radio"/> <input type="radio"/>	<input type="radio"/> <input type="radio"/> <input type="radio"/>	<input type="radio"/> <input type="radio"/> <input type="radio"/>	<input type="radio"/> <input type="radio"/> <input type="radio"/>
36	Routing Protocol	<input type="radio"/> <input type="radio"/> <input type="radio"/>	<input type="radio"/> <input type="radio"/> <input type="radio"/>	<input checked="" type="checkbox"/> <input type="checkbox"/>	<input checked="" type="checkbox"/> <input type="checkbox"/>	<input type="radio"/> <input type="radio"/> <input type="radio"/>	<input type="radio"/> <input type="radio"/> <input type="radio"/>	<input type="radio"/> <input type="radio"/> <input type="radio"/>	<input type="radio"/> <input type="radio"/> <input type="radio"/>
37	Secure-Policy	<input type="radio"/> <input type="radio"/> <input type="radio"/>	<input type="radio"/> <input type="radio"/> <input type="radio"/>	<input checked="" type="checkbox"/> <input type="checkbox"/>	<input checked="" type="checkbox"/> <input type="checkbox"/>	<input type="radio"/> <input type="radio"/> <input type="radio"/>	<input type="radio"/> <input type="radio"/> <input type="radio"/>	<input type="radio"/> <input type="radio"/> <input type="radio"/>	<input type="radio"/> <input type="radio"/> <input type="radio"/>
38	Sessions Limit	<input type="radio"/> <input type="radio"/> <input type="radio"/>	<input type="radio"/> <input type="radio"/> <input type="radio"/>	<input checked="" type="checkbox"/> <input type="checkbox"/>	<input checked="" type="checkbox"/> <input type="checkbox"/>	<input type="radio"/> <input type="radio"/> <input type="radio"/>	<input type="radio"/> <input type="radio"/> <input type="radio"/>	<input type="radio"/> <input type="radio"/> <input type="radio"/>	<input type="radio"/> <input type="radio"/> <input type="radio"/>
39	SSL Inspection	<input type="radio"/> <input type="radio"/> <input type="radio"/>	<input type="radio"/> <input type="radio"/> <input type="radio"/>	<input checked="" type="checkbox"/> <input type="checkbox"/>	<input checked="" type="checkbox"/> <input type="checkbox"/>	<input type="radio"/> <input type="radio"/> <input type="radio"/>	<input type="radio"/> <input type="radio"/> <input type="radio"/>	<input type="radio"/> <input type="radio"/> <input type="radio"/>	<input type="radio"/> <input type="radio"/> <input type="radio"/>
40	SSL VPN	<input type="radio"/> <input type="radio"/> <input type="radio"/>	<input type="radio"/> <input type="radio"/> <input type="radio"/>	<input checked="" type="checkbox"/> <input type="checkbox"/>	<input checked="" type="checkbox"/> <input type="checkbox"/>	<input type="radio"/> <input type="radio"/> <input type="radio"/>	<input type="radio"/> <input type="radio"/> <input type="radio"/>	<input type="radio"/> <input type="radio"/> <input type="radio"/>	<input type="radio"/> <input type="radio"/> <input type="radio"/>
41	SSO	<input type="radio"/> <input type="radio"/> <input type="radio"/>	<input type="radio"/> <input type="radio"/> <input type="radio"/>	<input checked="" type="checkbox"/> <input type="checkbox"/>	<input checked="" type="checkbox"/> <input type="checkbox"/>	<input type="radio"/> <input type="radio"/> <input type="radio"/>	<input type="radio"/> <input type="radio"/> <input type="radio"/>	<input type="radio"/> <input type="radio"/> <input type="radio"/>	<input type="radio"/> <input type="radio"/> <input type="radio"/>
42	System	<input type="radio"/> <input type="radio"/> <input type="radio"/>	<input type="radio"/> <input type="radio"/> <input type="radio"/>	<input checked="" type="checkbox"/> <input type="checkbox"/>	<input checked="" type="checkbox"/> <input type="checkbox"/>	<input type="radio"/> <input type="radio"/> <input type="radio"/>	<input type="radio"/> <input type="radio"/> <input type="radio"/>	<input type="radio"/> <input type="radio"/> <input type="radio"/>	<input type="radio"/> <input type="radio"/> <input type="radio"/>
43	System Monitoring	<input type="radio"/> <input type="radio"/> <input type="radio"/>	<input type="radio"/> <input type="radio"/> <input type="radio"/>	<input type="checkbox"/> <input type="checkbox"/>	<input type="checkbox"/> <input type="checkbox"/>	<input type="radio"/> <input type="radio"/> <input type="radio"/>	<input type="radio"/> <input type="radio"/> <input type="radio"/>	<input type="radio"/> <input type="radio"/> <input type="radio"/>	<input type="radio"/> <input type="radio"/> <input type="radio"/>
44	Traffic Log	<input type="radio"/> <input type="radio"/> <input type="radio"/>	<input type="radio"/> <input type="radio"/> <input type="radio"/>	<input type="checkbox"/> <input type="checkbox"/>	<input type="checkbox"/> <input type="checkbox"/>	<input type="radio"/> <input type="radio"/> <input type="radio"/>	<input type="radio"/> <input type="radio"/> <input type="radio"/>	<input type="radio"/> <input type="radio"/> <input type="radio"/>	<input type="radio"/> <input type="radio"/> <input type="radio"/>
45	USB Storage	<input type="radio"/> <input type="radio"/> <input type="radio"/>	<input type="radio"/> <input type="radio"/> <input type="radio"/>	<input checked="" type="checkbox"/> <input type="checkbox"/>	<input checked="" type="checkbox"/> <input type="checkbox"/>	<input type="radio"/> <input type="radio"/> <input type="radio"/>	<input type="radio"/> <input type="radio"/> <input type="radio"/>	<input type="radio"/> <input type="radio"/> <input type="radio"/>	<input type="radio"/> <input type="radio"/> <input type="radio"/>
46	User	<input type="radio"/> <input type="radio"/> <input type="radio"/>	<input type="radio"/> <input type="radio"/> <input type="radio"/>	<input checked="" type="checkbox"/> <input type="checkbox"/>	<input checked="" type="checkbox"/> <input type="checkbox"/>	<input type="radio"/> <input type="radio"/> <input type="radio"/>	<input type="radio"/> <input type="radio"/> <input type="radio"/>	<input type="radio"/> <input type="radio"/> <input type="radio"/>	<input type="radio"/> <input type="radio"/> <input type="radio"/>
47	Warning web sites	<input type="radio"/> <input type="radio"/> <input type="radio"/>	<input type="radio"/> <input type="radio"/> <input type="radio"/>	<input checked="" type="checkbox"/> <input type="checkbox"/>	<input checked="" type="checkbox"/> <input type="checkbox"/>	<input type="radio"/> <input type="radio"/> <input type="radio"/>	<input type="radio"/> <input type="radio"/> <input type="radio"/>	<input type="radio"/> <input type="radio"/> <input type="radio"/>	<input type="radio"/> <input type="radio"/> <input type="radio"/>
48	Web Authenticati...	<input type="radio"/> <input type="radio"/> <input type="radio"/>	<input type="radio"/> <input type="radio"/> <input type="radio"/>	<input checked="" type="checkbox"/> <input type="checkbox"/>	<input checked="" type="checkbox"/> <input type="checkbox"/>	<input type="radio"/> <input type="radio"/> <input type="radio"/>	<input type="radio"/> <input type="radio"/> <input type="radio"/>	<input type="radio"/> <input type="radio"/> <input type="radio"/>	<input type="radio"/> <input type="radio"/> <input type="radio"/>
49	WMan Station Info	<input type="radio"/> <input type="radio"/> <input type="radio"/>	<input type="radio"/> <input type="radio"/> <input type="radio"/>	<input checked="" type="checkbox"/> <input type="checkbox"/>	<input checked="" type="checkbox"/> <input type="checkbox"/>	<input type="radio"/> <input type="radio"/> <input type="radio"/>	<input type="radio"/> <input type="radio"/> <input type="radio"/>	<input type="radio"/> <input type="radio"/> <input type="radio"/>	<input type="radio"/> <input type="radio"/> <input type="radio"/>
50	ZySH	<input type="radio"/> <input type="radio"/> <input type="radio"/>	<input type="radio"/> <input type="radio"/> <input type="radio"/>	<input checked="" type="checkbox"/> <input type="checkbox"/>	<input checked="" type="checkbox"/> <input type="checkbox"/>	<input type="radio"/> <input type="radio"/> <input type="radio"/>	<input type="radio"/> <input type="radio"/> <input type="radio"/>	<input type="radio"/> <input type="radio"/> <input type="radio"/>	<input type="radio"/> <input type="radio"/> <input type="radio"/>

Figure 713 Log Category Settings AP

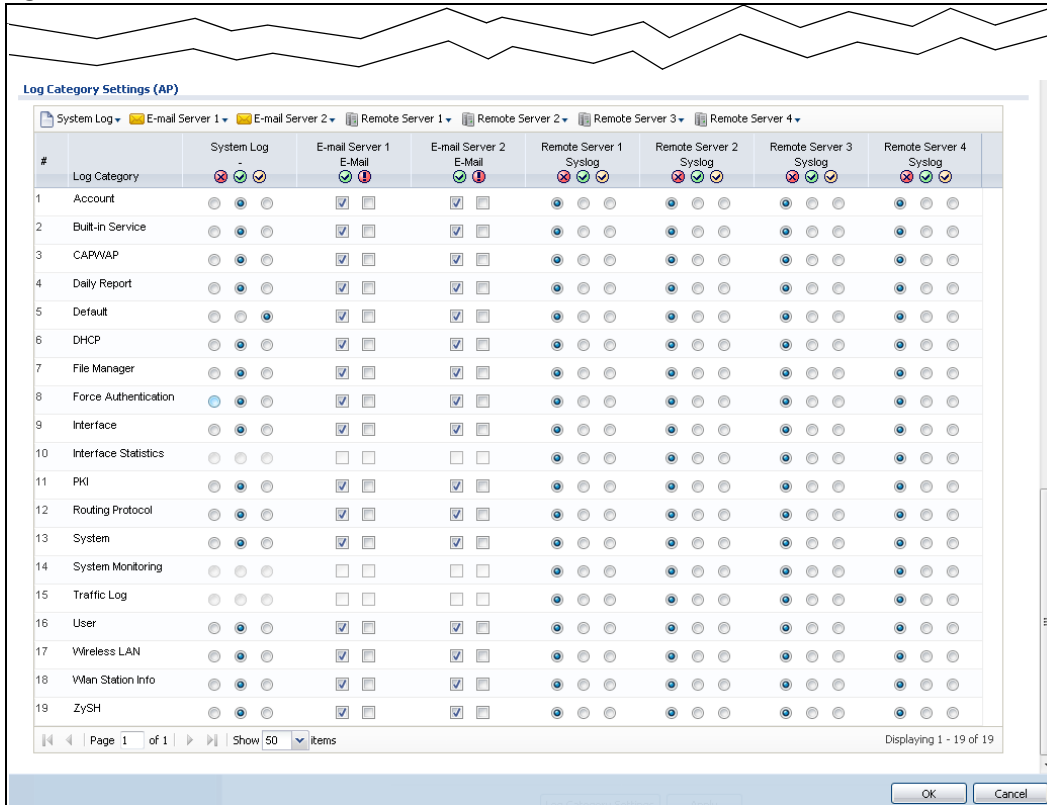

This screen provides a different view and a different way of indicating which messages are included in each log and each alert. Please see [Section 45.3.2 on page 1017](#), where this process is discussed. (The **Default** category includes debugging messages generated by open source software).

The following table describes the fields in this screen.

Table 410 Configuration > Log & Report > Log Setting > Log Category Settings

LABEL	DESCRIPTION
System Log	<p>Use the System Log drop-down list to change the log settings for all of the log categories.</p> <p>disable all logs (red X) - do not log any information for any category for the system log or e-mail any logs to e-mail server 1 or 2.</p> <p>enable normal logs (green check mark) - create log messages and alerts for all categories for the system log. If e-mail server 1 or 2 also has normal logs enabled, the Zyxel Device will e-mail logs to them.</p> <p>enable normal logs and debug logs (yellow check mark) - create log messages, alerts, and debugging information for all categories. The Zyxel Device does not e-mail debugging information, even if this setting is selected.</p>
USB Storage	<p>Use the USB Storage drop-down list to change the log settings for saving logs to a connected USB storage device.</p> <p>disable all logs (red X) - do not log any information for any category to a connected USB storage device.</p> <p>enable normal logs (green check mark) - create log messages and alerts for all categories and save them to a connected USB storage device.</p> <p>enable normal logs and debug logs (yellow check mark) - create log messages, alerts, and debugging information for all categories and save them to a connected USB storage device.</p>

Table 410 Configuration > Log & Report > Log Setting > Log Category Settings (continued)

LABEL	DESCRIPTION
E-mail Server 1	<p>Use the E-Mail Server 1 drop-down list to change the settings for e-mailing logs to e-mail server 1 for all log categories.</p> <p>Using the System Log drop-down list to disable all logs overrides your e-mail server 1 settings.</p> <p>enable normal logs (green check mark) - e-mail log messages for all categories to e-mail server 1.</p> <p>enable alert logs (red exclamation point) - e-mail alerts for all categories to e-mail server 1.</p>
E-mail Server 2	<p>Use the E-Mail Server 2 drop-down list to change the settings for e-mailing logs to e-mail server 2 for all log categories.</p> <p>Using the System Log drop-down list to disable all logs overrides your e-mail server 2 settings.</p> <p>enable normal logs (green check mark) - e-mail log messages for all categories to e-mail server 2.</p> <p>enable alert logs (red exclamation point) - e-mail alerts for all categories to e-mail server 2.</p>
Remote Server 1~4	<p>For each remote server, use the Selection drop-down list to change the log settings for all of the log categories.</p> <p>disable all logs (red X) - do not send the remote server logs for any log category.</p> <p>enable normal logs (green check mark) - send the remote server log messages and alerts for all log categories.</p> <p>enable normal logs and debug logs (yellow check mark) - send the remote server log messages, alerts, and debugging information for all log categories.</p>
#	This field is a sequential value, and it is not associated with a specific address.
Log Category	This field displays each category of messages. It is the same value used in the Display and Category fields in the View Log tab. The Default category includes debugging messages generated by open source software.
System Log	<p>Select which events you want to log by Log Category. There are three choices:</p> <p>disable all logs (red X) - do not log any information from this category</p> <p>enable normal logs (green check mark) - create log messages and alerts from this category</p> <p>enable normal logs and debug logs (yellow check mark) - create log messages, alerts, and debugging information from this category; the Zyxel Device does not e-mail debugging information, however, even if this setting is selected.</p>
USB Storage	<p>Select which event log categories to save to a connected USB storage device. There are three choices:</p> <p>disable all logs (red X) - do not log any information from this category</p> <p>enable normal logs (green check mark) - save log messages and alerts from this category</p> <p>enable normal logs and debug logs (yellow check mark) - save log messages, alerts, and debugging information from this category.</p>
E-mail Server 1 E-mail	Select whether each category of events should be included in the log messages when it is e-mailed (green check mark) and/or in alerts (red exclamation point) for the e-mail settings specified in E-Mail Server 1 . The Zyxel Device does not e-mail debugging information, even if it is recorded in the System log .
E-mail Server 2 E-mail	Select whether each category of events should be included in log messages when it is e-mailed (green check mark) and/or in alerts (red exclamation point) for the e-mail settings specified in E-Mail Server 2 . The Zyxel Device does not e-mail debugging information, even if it is recorded in the System log .

Table 410 Configuration > Log & Report > Log Setting > Log Category Settings (continued)

LABEL	DESCRIPTION
Remote Server 1~4	For each remote server, select what information you want to log from each Log Category (except All Logs ; see below). Choices are: disable all logs (red X) - do not log any information from this category enable normal logs (green check mark) - log regular information and alerts from this category enable normal logs and debug logs (yellow check mark) - log regular information, alerts, and debugging information from this category
OK	Click this to save your changes and return to the previous screen.
Cancel	Click this to return to the previous screen without saving your changes.

CHAPTER 46

File Manager

46.1 Overview

Configuration files define the Zyxel Device's settings. Shell scripts are files of commands that you can store on the Zyxel Device and run when you need them. You can apply a configuration file or run a shell script without the Zyxel Device restarting. You can store multiple configuration files and shell script files on the Zyxel Device. You can edit configuration files or shell scripts in a text editor and upload them to the Zyxel Device. Configuration files use a .conf extension and shell scripts use a .zysh extension.

46.1.1 What You Can Do in this Chapter

- Use the **Configuration File** screen (see [Section 46.2 on page 1034](#)) to store and name configuration files. You can also download configuration files from the Zyxel Device to your computer and upload configuration files from your computer to the Zyxel Device.
- Use the **Firmware Package** screen (see [Section 46.3 on page 1040](#)) to check your current firmware version and upload firmware to the Zyxel Device.
- Use the **Shell Script** screen (see [Section 46.4 on page 1045](#)) to store, name, download, upload and run shell script files.

46.1.2 What you Need to Know

Configuration Files and Shell Scripts

When you apply a configuration file, the Zyxel Device uses the factory default settings for any features that the configuration file does not include. When you run a shell script, the Zyxel Device only applies the commands that it contains. Other settings do not change.

These files have the same syntax, which is also identical to the way you run CLI commands manually. An example is shown below.

Figure 714 Configuration File / Shell Script: Example

```
# enter configuration mode
configure terminal
# change administrator password
username admin password 4321 user-type admin
# configure ge3
interface ge3
ip address 172.23.37.240 255.255.255.0
ip gateway 172.23.37.254 metric 1
exit
# create address objects for remote management / to-ZyWALL firewall rules
# use the address group in case we want to open up remote management later
address-object TW_SUBNET 172.23.37.0/24
object-group address TW_TEAM
address-object TW_SUBNET
exit
# enable Telnet access (not enabled by default, unlike other services)
ip telnet server
# open WAN-to-ZyWALL firewall for TW_TEAM for remote management
firewall WAN ZyWALL insert 4
sourceip TW_TEAM
service TELNET
action allow
exit
write
```

While configuration files and shell scripts have the same syntax, the Zyxel Device applies configuration files differently than it runs shell scripts. This is explained below.

Table 411 Configuration Files and Shell Scripts in the Zyxel Device

Configuration Files (.conf)	Shell Scripts (.zys)
<ul style="list-style-type: none"> Resets to default configuration. Goes into CLI Configuration mode. Runs the commands in the configuration file. 	<ul style="list-style-type: none"> Goes into CLI Privilege mode. Runs the commands in the shell script.

You have to run the example in [Figure 714 on page 1033](#) as a shell script because the first command is run in **Privilege** mode. If you remove the first command, you have to run the example as a configuration file because the rest of the commands are executed in **Configuration** mode.

Comments in Configuration Files or Shell Scripts

In a configuration file or shell script, use “#” or “!” as the first character of a command line to have the Zyxel Device treat the line as a comment.

Your configuration files or shell scripts can use “exit” or a command line consisting of a single “!” to have the Zyxel Device exit sub command mode.

Note: “exit” or “!” must follow sub commands if it is to make the Zyxel Device exit sub command mode.

Line 3 in the following example exits sub command mode.

```
interface ge1
ip address dhcp
!
```

Lines 1 and 3 in the following example are comments and line 4 exits sub command mode.

```
!
interface ge1
# this interface is a DHCP client
!
```

Lines 1 and 2 are comments. Line 5 exits sub command mode.

```
! this is from Joe
# on 2008/04/05
interface ge1
ip address dhcp
!
```

Errors in Configuration Files or Shell Scripts

When you apply a configuration file or run a shell script, the Zyxel Device processes the file line-by-line. The Zyxel Device checks the first line and applies the line if no errors are detected. Then it continues with the next line. If the Zyxel Device finds an error, it stops applying the configuration file or shell script and generates a log.

You can change the way a configuration file or shell script is applied. Include `setenv stop-on-error off` in the configuration file or shell script. The Zyxel Device ignores any errors in the configuration file or shell script and applies all of the valid commands. The Zyxel Device still generates a log for any errors.

46.2 The Configuration Screen

Click **Maintenance > File Manager > Configuration File** to open the **Configuration File** screen. Use the **Configuration File** screen to store, run, and name configuration files. You can also download configuration files from the Zyxel Device to your computer and upload configuration files from your computer to the Zyxel Device.

Once your Zyxel Device is configured and functioning properly, it is highly recommended that you back up your configuration file before making further configuration changes. The backup configuration file will be useful in case you need to return to your previous settings.

Filenames beginning with `autoback` are automatic configuration files created when new firmware is uploaded. `backup-yyyy-mm-dd-hh-mm-ss.conf` is the name of the automatic backup when a secure policy is added or changed. Select a configuration file, then click **Apply** to apply the file to the Zyxel Device.

Configuration File Flow at Restart

- If there is not a **startup-config.conf** when you restart the Zyxel Device (whether through a management interface or by physically turning the power off and back on), the Zyxel Device uses the **system-default.conf** configuration file with the Zyxel Device's default settings.
- If there is a **startup-config.conf**, the Zyxel Device checks it for errors and applies it. If there are no errors, the Zyxel Device uses it and copies it to the **lastgood.conf** configuration file as a back up file. If there is an error, the Zyxel Device generates a log and copies the **startup-config.conf** configuration file to the **startup-config-bad.conf** configuration file and tries the existing **lastgood.conf** configuration file. If there isn't a **lastgood.conf** configuration file or it also has an error, the Zyxel Device applies the **system-default.conf** configuration file.
- You can change the way the **startup-config.conf** file is applied. Include the `setenv-startup stop-on-error off` command. The Zyxel Device ignores any errors in the **startup-config.conf** file and applies all of the valid commands. The Zyxel Device still generates a log for any errors.

Figure 715 Maintenance > File Manager > Configuration File > Configuration

The screenshot displays the 'Configuration File' section of the File Manager. It features a table with the following columns: #, File Name, Size, and Last Modified. Below the table is a pagination control showing 'Page 1 of 1' and 'Show 80 Items'. At the bottom, there is an 'Upload Configuration File' section with a text input for 'File Path:' and 'Browse...' and 'Upload' buttons.

#	File Name	Size	Last Modified
1	system-default.conf	70334	2020-06-29 10:07:16
2	startup-config.conf	77540	2020-08-04 10:18:46
3	lastgood.conf	76673	2020-06-29 10:09:59
4	autobackup-0.00.conf	82123	2017-08-02 14:58:51
5	410AAKZ0433-2014-04-18-08-47-56.conf	14386	2014-04-18 16:47:56
6	410AAKZ0Phec1-r62818-2015-08-21-09-23-31.conf	23220	2015-08-21 17:23:31
7	startup-config-bad.conf	82123	2017-08-02 15:52:46
8	410AAKZ0Phec1-r63448-2015-10-07-02-24-42.conf	21198	2015-10-07 10:24:42
9	ezmode-config.conf	75442	2019-03-18 10:29:23
10	415AAKZ0a1-2016-02-19-11-12-08.conf	74012	2016-02-19 19:12:08
11	420AAKZ0b2-2016-03-16-22-43-57.conf	75844	2016-03-16 22:43:57
12	420AAKZ0a2r2-2016-05-24-00-05-04.conf	76586	2016-05-24 00:05:04
13	420AAKZ0b3r2-2016-07-05-13-58-00.conf	76560	2016-07-05 13:58:00
14	420AAKZ0a4r2-2016-12-29-11-10-25.conf	77381	2016-12-29 11:10:25
15	425AAKZ0b2-2017-05-22-14-51-08.conf	80365	2017-05-22 14:51:08
16	autobackup-4.25.conf	69668	2017-12-20 10:27:38
17	430AAKZ0a1-2017-05-22-17-50-34.conf	81458	2017-05-22 17:50:34
18	430AAKZ0a1s1-2017-08-02-14-55-59.conf	82123	2017-08-02 14:55:59
19	425AAKZ1-2017-12-20-10-24-24.conf	69668	2017-12-20 10:24:24
20	secudeployer-autobackup-2017-12-20-10-32-04.conf	70481	2017-12-20 10:32:04
21	secudeployer-autobackup-2018-01-19-13-47-39.conf	69965	2018-01-19 13:47:39
22	secudeployer-autobackup-2018-02-02-10-12-51.conf	73800	2018-02-02 10:12:51
23	432AAKZ0b3-2018-06-25-13-32-01.conf	73296	2018-06-25 13:32:01
24	autobackup-4.32.conf	73296	2018-11-22 14:00:56
25	432AAKZ0b4-2018-11-22-13-57-55.conf	73296	2018-11-22 13:57:55
26	433AAKZ0a2-2018-11-23-09-18-11.conf	73296	2018-11-23 09:18:11
27	autobackup-4.33.conf	73296	2018-11-23 09:21:12
28	435AAKZ0a1-2020-06-24-14-25-59.conf	77803	2020-06-24 14:25:59
29	autobackup-4.35.conf	77803	2020-06-24 14:29:56

Do not turn off the Zyxel Device while configuration file upload is in progress.

The following table describes the labels in this screen.

Table 412 Maintenance > File Manager > Configuration File

LABEL	DESCRIPTION
Rename	<p>Use this button to change the label of a configuration file on the Zyxel Device. You can only rename manually saved configuration files. You cannot rename the lastgood.conf, system-default.conf and startup-config.conf files.</p> <p>You cannot rename a configuration file to the name of another configuration file in the Zyxel Device.</p> <p>Click a configuration file's row to select it and click Rename to open the Rename File screen.</p> <p>Figure 716 Maintenance > File Manager > Configuration File > Rename</p>  <p>Specify the new name for the configuration file. Use up to 63 characters (including a-zA-Z0-9;~!@#%&()_+[]{}'.,=-).</p> <p>Click OK to save the duplicate or click Cancel to close the screen without saving a duplicate of the configuration file.</p>
Remove	<p>Click a configuration file's row to select it and click Remove to delete it from the Zyxel Device. You can only delete manually saved configuration files. You cannot delete the system-default.conf, startup-config.conf and lastgood.conf files.</p> <p>A pop-up window asks you to confirm that you want to delete the configuration file. Click OK to delete the configuration file or click Cancel to close the screen without deleting the configuration file.</p>
Download	<p>Click a configuration file's row to select it and click Download to save the configuration to your computer. Select Encryption if you want to add an encryption password to the downloaded zipped configuration file. Enter a password consists of 1 to 31 single-byte characters, with the following special characters !"#%&'()*+,-./:;<=>@\^_`{ }~</p> <p>This field is case sensitive. []?and spaces are not allowed. You or another admin must use the same password to unzip the file.</p> <p>Figure 717 Configuration File > Download > Encryption</p>  <p>Figure 718 Unzip the Configuration File Password</p> 

Table 412 Maintenance > File Manager > Configuration File (continued)

LABEL	DESCRIPTION
Copy	<p>Use this button to save a duplicate of a configuration file on the Zyxel Device.</p> <p>Click a configuration file's row to select it and click Copy to open the Copy File screen.</p> <p>Figure 719 Maintenance > File Manager > Configuration File > Copy</p>  <p>Specify a name for the duplicate configuration file. Use up to 63 characters (including a-zA-Z0-9;~!@#\$\$%^&()_+[]{}',.-).</p> <p>Click OK to save the duplicate or click Cancel to close the screen without saving a duplicate of the configuration file.</p>
Apply	<p>Use this button to have the Zyxel Device use a specific configuration file.</p> <p>Click a configuration file's row to select it and click Apply to have the Zyxel Device use that configuration file. The Zyxel Device does not have to restart in order to use a different configuration file, although you will need to wait for a few minutes while the system reconfigures.</p> <p>The following screen gives you options for what the Zyxel Device is to do if it encounters an error in the configuration file.</p> <p>Figure 720 Maintenance > File Manager > Configuration File > Apply</p>  <p>Immediately stop applying the configuration file - this is not recommended because it would leave the rest of the configuration blank. If the interfaces were not configured before the first error, the console port may be the only way to access the device.</p> <p>Immediately stop applying the configuration file and roll back to the previous configuration - this gets the Zyxel Device started with a fully valid configuration file as quickly as possible.</p> <p>Ignore errors and finish applying the configuration file - this applies the valid parts of the configuration file and generates error logs for all of the configuration file's errors. This lets the Zyxel Device apply most of your configuration and you can refer to the logs for what to fix.</p> <p>Ignore errors and finish applying the configuration file and then roll back to the previous configuration - this applies the valid parts of the configuration file, generates error logs for all of the configuration file's errors, and starts the Zyxel Device with a fully valid configuration file.</p> <p>Click OK to have the Zyxel Device start applying the configuration file or click Cancel to close the screen</p>

Table 412 Maintenance > File Manager > Configuration File (continued)

LABEL	DESCRIPTION
Email	<p>Use this button to send the configuration file to the configured email addresses.</p> <p>Click a configuration file's row to select it and click Email to open the Email Configuration File screen.</p> <p>Figure 721 Maintenance > File Manager > Configuration File > Email</p>  <p>Mail Subject- Enter a email subject text with 1-60 characters. It may consist of letters, numbers, and the following special characters: '()+,./:;=?;!*#@\$%-</p> <p>Mail To- Enter the receiving email address. You and send the configuration file to a maximum of five email addresses.</p> <p>Encryption password- Enter a password consists of 1-31 ASCII characters to add an encryption password to the configuration file in the email.</p> <p>Email Content- Enter the backup email body text consists of 1-250 ASCII characters.</p>
#	<p>This column displays the number for each configuration file entry. This field is a sequential value, and it is not associated with a specific address. The total number of configuration files that you can save depends on the sizes of the configuration files and the available flash storage space.</p>
File Name	<p>This column displays the label that identifies a configuration file.</p> <p>You cannot delete the following configuration files or change their file names.</p> <p>The system-default.conf file contains the Zyxel Device's default settings. Select this file and click Apply to reset all of the Zyxel Device settings to the factory defaults. This configuration file is included when you upload a firmware package.</p> <p>The startup-config.conf file is the configuration file that the Zyxel Device is currently using. If you make and save changes during your management session, the changes are applied to this configuration file. The Zyxel Device applies configuration changes made in the Web Configurator to the configuration file when you click Apply or OK. It applies configuration changes made via commands when you use the <code>write</code> command.</p> <p>The lastgood.conf is the most recently used (valid) configuration file that was saved when the device last restarted. If you upload and apply a configuration file with an error, you can apply <code>lastgood.conf</code> to return to a valid configuration.</p>
Size	<p>This column displays the size (in KB) of a configuration file.</p>
Last Modified	<p>This column displays the date and time that the individual configuration files were last changed or saved.</p>

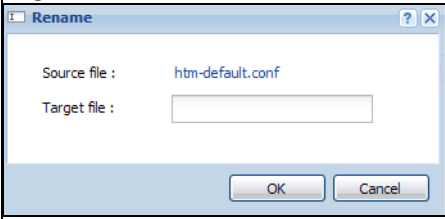
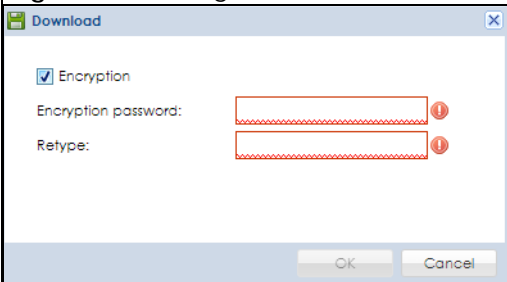
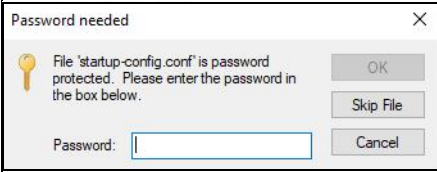
Table 412 Maintenance > File Manager > Configuration File (continued)

LABEL	DESCRIPTION
Upload Configuration File	The bottom part of the screen allows you to upload a new or previously saved configuration file from your computer to your Zyxel Device You cannot upload a configuration file named system-default.conf or lastgood.conf . If you upload startup-config.conf , it will replace the current configuration and immediately apply the new settings.
File Path	Type in the location of the file you want to upload in this field or click Browse ... to find it.
Browse...	Click Browse... to find the .conf file you want to upload. The configuration file must use a ".conf" filename extension. You will receive an error message if you try to upload a file of a different format. Remember that you must decompress compressed (.zip) files before you can upload them.
Upload	Click Upload to begin the upload process. This process may take up to two minutes.

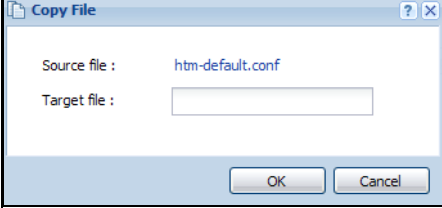
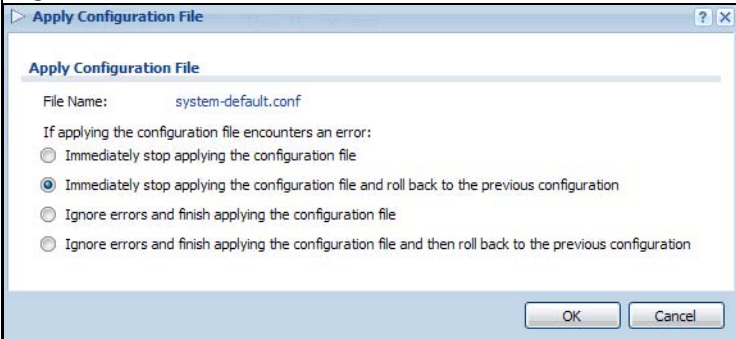
46.2.1 The Configuration Schedule Backup Screen

Use the Schedule Backup screen to automatically backup the current Zyxel Device configuration file according to a schedule, and then send it to the configured email addresses.

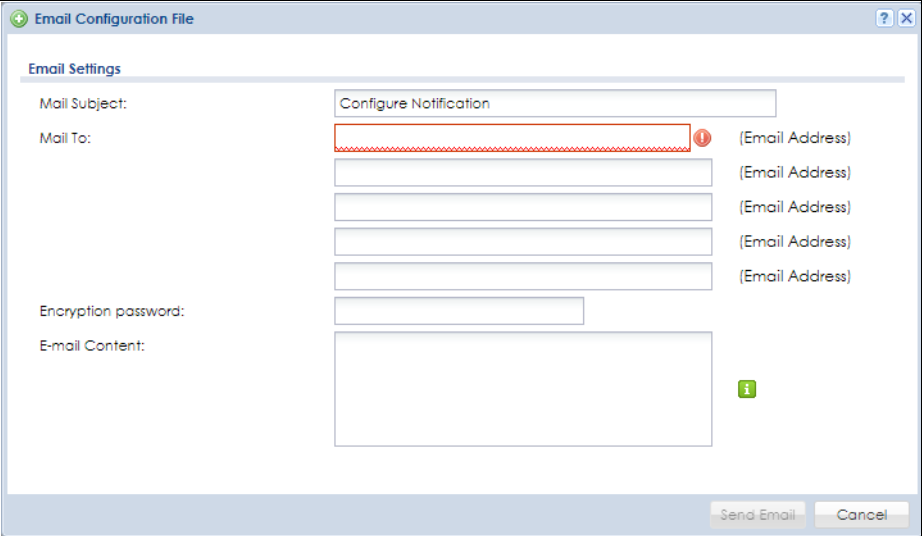
Figure 722 Maintenance > File Manager > Configuration File > Schedule Backup

The screenshot displays the 'Schedule Backup' configuration page. At the top, there are tabs for 'Configuration File', 'Firmware Management', and 'Shell Script'. Below these are sub-tabs for 'Configuration' and 'Schedule Backup'. The main section is titled 'Configure Backup Schedule'. It contains the following elements:

- Mail Subject:** A text field containing 'Configuration File Backup Notification'.
- Mail To:** A list of five email address input fields. The first field has a red error icon and '(Email Address)' text to its right.
- Email Content:** A large text area for composing the email body, with a green information icon to its right.
- Enable Auto Backup:** A checked checkbox with a green information icon.
- Frequency:** Radio buttons for 'Daily', 'Weekly' (selected), and 'Monthly'.
- Time Settings:**
 - Daily:** Dropdown for Day, and dropdowns for Hour and Minute.
 - Weekly:** Dropdown for Day (set to 'Monday'), and dropdowns for Hour and Minute. The Hour and Minute dropdowns have red error icons.
 - Monthly:** Dropdown for Day, and dropdowns for Hour and Minute.
- Send Email:** A checked checkbox.
- Encryption password:** A text field and a checkbox labeled 'unmasked'.
- Buttons:** 'Apply' and 'Reset' buttons at the bottom center.

The following table describes the labels in this screen.

Table 413 Maintenance > File Manager > Configuration File> Schedule Backup

LABEL	DESCRIPTION
Configure Backup Schedule	
Mail Subject	Enter a email subject text with 1-60 characters. It may consist of letters, numbers, and the following special characters: '()+,./:=?;!*#@%-
Mail To	Enter the receiving email address. You can send the configuration file to a maximum of five email addresses.
E-mail Content	Enter the backup email body text using 1 to 251 single-byte characters, including 0-9a-zA-Z!"#\$%&'()*+,-./:;<=>@\^_`{ } and spaces are allowed. ? is not allowed
Enable Auto Backup	Select the check box to have the Zyxel Device backup the configuration file at a user defined schedule. Note: After the first backup, the back up only occurs if the configuration file is different from the previous backed up configuration file.
Daily	Set the Zyxel Device to backup its configuration file once a day at the specified hour and minute.
Weekly	Set the Zyxel Device to backup its configuration file once a week on the specified day, at the specified hour and minute.
Monthly	Set the Zyxel Device to backup its configuration file once a month on the specified day, at the specified hour and minute. Note: If the date you select is greater than the number of days in a month, the Zyxel Device automatically backs up its configuration on the last day of the month. For example, if you select 31 and the month is February, the Zyxel Device backs up its configuration file on day 28 or 29.
Send Email	Select the check box to have the Zyxel Device sends the current configuration file to the configured email addresses.
Encryption password	Enter a password consists of 1 to 31 single-byte characters, with the following special characters !"#\$\$%&'()*+,-./:;<=>@\^_`{ }~ This field is case sensitive. []?and spaces are not allowed.
Apply	Click Apply to save your changes back to the Zyxel Device.
Reset	Click Reset to return the screen to its last-saved settings.

46.3 Firmware Management

Use the **Firmware Management** screen to check your current firmware version and upload firmware to the Zyxel Device. You can upload firmware to be the **Running** firmware or **Standby** firmware.

Note: The Web Configurator is the recommended method for uploading firmware. You only need to use the command line interface if you need to recover the firmware. See the CLI Reference Guide for how to determine if you need to recover the firmware and how to recover it.

Find the firmware file in a folder that (usually) uses the system model name with the model code and a bin extension. For example, a firmware for ZyWALL VPN100 is "430ABFV0b2s1.bin".

The Zyxel Device's firmware package cannot go through the Zyxel Device when you enable the anti-virus **Destroy compressed files that could not be decompressed** option. The Zyxel Device classifies the firmware package as not being able to be decompressed and deletes it. You can upload the firmware package to the Zyxel Device with the option enabled, so you only need to clear the **Destroy compressed files that could not be decompressed** option while you download the firmware package. See [Section 39.2.1 on page 777](#) for more on the anti-virus **Destroy compressed files that could not be decompressed** option.

The firmware update can take up to five minutes. Do not turn off or reset the Zyxel Device while the firmware update is in progress!

If your Zyxel Device has two firmware images installed, and one fails to boot (kernel crash, kernel panic, out-of-memory etc.), then the Zyxel Device will automatically use the (good) backup image to boot.

46.3.1 Firmware Upload and Device HA Pro

If Device HA Pro is enabled, then both the active and passive Zyxel Device must be online and connected in order to upload firmware. New firmware is first uploaded to the passive device and then uploaded to the active device. By default, the passive device reboots after firmware upload making it become the active device. Don't select the **Reboot** prompt after uploading firmware to the passive device if you want the passive device to remain passive when new firmware is uploaded. Alternatively, disable Device HA Pro if you want to just upload firmware to the active Zyxel Device.

46.3.2 Cloud Helper

Cloud Helper lets you know if there is a later firmware available on the Cloud Helper server and lets you download it if there is.

Note: You can download up to firmware version 4.20, directly from the Zyxel website. To download firmware version 4.25 and later, go to myZyxel, create an account and register your Zyxel Device first. Then you will be able to see links to and get notifications on new firmware available.

At the time of writing, the Firmware Upgrade license providing Cloud Helper new firmware notifications is free when you register your Zyxel Device. The license expires on 2020/12/31 if you have firmware version 4.20 or 4.25, and does not expire if you have firmware version 4.25 patch 1 and later.

The following table explains the **Upgrade** icons in the web configurator.

Table 414 Cloud Helper Firmware Icons

<p>Cloud Helper New</p> 	<p>A later firmware is available on the Cloud Helper Server. Click this icon to display a What's New pop-up screen. You need a Firmware Upgrade license to upgrade the firmware. If you do not have a license, Upgrade Now is grayed out. If you have a license, click Upgrade Now to directly upgrade firmware to the standby partition and have the Zyxel Device reboot automatically so that the new standby firmware becomes the running firmware. The previous running firmware becomes the standby firmware.</p> 
<p>Cloud Helper Flag</p> 	<p>Cloud firmware is being downloaded from the Cloud Helper Server. If you select another partition or the local firmware upgrade icon, you will see the following warning message.</p>  <p>When firmware is downloading, you can pause, resume, stop or retry the firmware download.</p> 
<p>Local Firmware</p> 	<p>Use this if you have already downloaded the latest firmware from the Zyxel website to your computer and unzipped it. Click the icon and then browse to the location of the unzipped files.</p>

46.3.3 The Firmware Management Screen

Click **Maintenance > File Manager > Firmware Management** to open the **Firmware Management** screen.

Figure 723 Maintenance > File Manager > Firmware Management

The following table describes the labels in this screen.

Table 415 Maintenance > File Manager > Firmware Management

LABEL	DESCRIPTION
Firmware Status	
Reboot	<p>Click the Reboot icon to restart the Zyxel Device. If you applied changes in the Web configurator, these were saved automatically and do not change when you reboot. If you made changes in the CLI, however, you have to use the <code>write</code> command to save the configuration before you reboot. Otherwise, the changes are lost when you reboot.</p> <p>If you want the Standby firmware to be the Running firmware, then select the Standby firmware row and click Reboot. Wait a few minutes until the login screen appears. If the login screen does not appear, clear your browser cache and refresh the screen or type the IP address of the Zyxel Device in your Web browser again.</p> <p>You can also use the CLI command <code>reboot</code> to restart the Zyxel Device.</p>
#	This displays the system space (partition) index number where the firmware is located. The firmware can be either Standby or Running ; only one firmware can be running at any one time.
Status	This indicates whether the firmware is Running , or not running but already uploaded to the Zyxel Device and is on Standby . It displays N/A if there is no firmware uploaded to that system space.
Model	This is the model name of the device which the firmware is running on.

Table 415 Maintenance > File Manager > Firmware Management (continued)

LABEL	DESCRIPTION
Version	This is the firmware version and the date created.
Released Date	This is the date that the version of the firmware was created.
Upgrade	A cloud helper icon displays if there is a later firmware on the Cloud Server than the firmware in the partition. Click the cloud helper icon to download a later firmware from the Cloud Helper Server. Use the local firmware icon if you have already downloaded the latest firmware from the Zyxel website to your computer and unzipped it.
Cloud Firmware Information	You must register your Zyxel Device at myZyxel first to use cloud firmware.
Latest Version	This displays the latest firmware version at the Cloud Helper Server. Click Check Now to see if there is a later firmware at the Cloud Server.
Release Date	This displays the date the latest firmware version was made available.
Release Note	The release note contains details of latest firmware version such as new features and bug fixes.
Auto Update	Select this check box to have the Zyxel Device automatically check for and download new firmware to the standby partition at the time and day specified. You should select a time when your network is not busy for minimal interruption. Note: You cannot enable Auto Update in File Manager> Firmware Management and Schedule Reboot in Maintenance> Shutdown-Reboot at the same time.
Daily	Select this option to have the Zyxel Device check for new firmware every day at the specified time. The time format is the 24 hour clock, so '0' means midnight for example.
Weekly	Select this option to have the Zyxel Device check for new firmware once a week on the day and at the time specified.
Auto Reboot	Select this to have the newly downloaded firmware in the standby partition become the running firmware after the Zyxel Device automatically restarts.
Firmware Upgrade Service Status	
Service Status	This field displays whether the firmware license service is activated at myZyxel (Activated) or not (Not Activated).

After you see the **Firmware Upload in Process** screen, wait a few minutes before logging into the Zyxel Device again.

Figure 724 Firmware Upload In Process

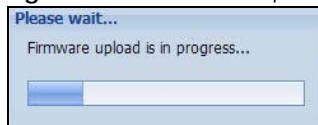

Note: The Zyxel Device automatically reboots after a successful upload.

The Zyxel Device automatically restarts causing a temporary network disconnect. In some operating systems, you may see the following icon on your desktop.

Figure 725 Network



After five minutes, log in again and check your new firmware version in the **Dashboard** screen.

If the upload was not successful, the following message appears in the status bar at the bottom of the screen.

Figure 726 Firmware Upload Error

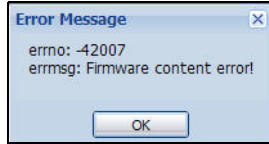

46.3.4 Firmware Upgrade via USB Stick

In addition to uploading firmware via the web configurator or console port (see the CLI Reference Guide), you can also upload firmware directly from a USB stick connected to the Zyxel Device.

- 1 Create a folder on the USB stick called '/[ProductName_dir]/firmware'. For example, if your Zyxel Device is USG110, then create a '/usg110_dir/firmware/' folder on the stick.
- 2 Put one firmware 'bin' file into the firmware folder. Make sure the firmware ID and version number are correct for your model (the firmware ID is in brackets after the firmware version number - for USG100 it is AAPH).

Note: Do not put more than one firmware 'bin' file into the firmware folder.

The firmware version in the USB stick must be different to the currently running firmware. If the firmware on the USB stick is older, then the Zyxel Device will 'upgrade' to the older version. It is recommended that the firmware on the USB stick be the latest firmware version.

- 3 Insert the USB stick into the Zyxel Device. The firmware uploads to the standby system space.
- 4 The **SYS** LED blinks when the Zyxel Device automatically reboots making the upgraded firmware in standby become the running firmware.

Note: If the **startup-config.conf** configuration file has problems and you are upgrading to 4.25 or later firmware, then the Zyxel Device will revert (failover) to the previously running firmware.

If the **startup-config.conf** configuration file has problems and you are upgrading to earlier than 4.25 firmware, then the Zyxel Device uses the new earlier firmware, but generates a log and tries the existing **lastgood.conf** configuration file. If there isn't a **lastgood.conf** configuration file or it also has an error, the Zyxel Device applies the **system-default.conf** configuration file.

46.4 The Shell Script Screen

Use shell script files to have the Zyxel Device execute commands that you specify. Use a text editor to create the shell script files. They must use a ".zysh" filename extension.

Click **Maintenance > File Manager > Shell Script** to open the **Shell Script** screen. Use the **Shell Script** screen to store, name, download, upload and run shell script files. You can store multiple shell script files on the Zyxel Device at the same time.

Note: You should include `write` commands in your scripts. If you do not use the `write` command, the changes will be lost when the Zyxel Device restarts. You could use multiple `write` commands in a long script.

Figure 727 Maintenance > File Manager > Shell Script

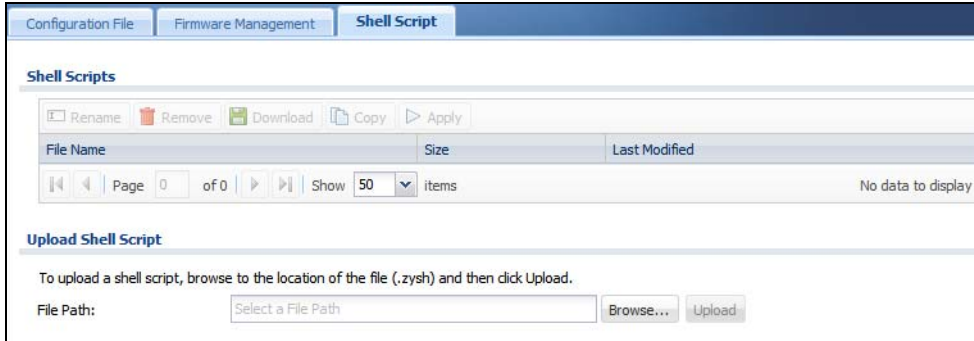

Each field is described in the following table.

Table 416 Maintenance > File Manager > Shell Script

LABEL	DESCRIPTION
Rename	<p>Use this button to change the label of a shell script file on the Zyxel Device.</p> <p>You cannot rename a shell script to the name of another shell script in the Zyxel Device.</p> <p>Click a shell script's row to select it and click Rename to open the Rename File screen.</p> <p>Figure 728 Maintenance > File Manager > Shell Script > Rename</p>  <p>Specify the new name for the shell script file. Use up to 63 characters (including a-zA-Z0-9;~!@#\$\$%^&()_+[]{}',.-).</p> <p>Click OK to save the duplicate or click Cancel to close the screen without saving a duplicate of the configuration file.</p>
Remove	<p>Click a shell script file's row to select it and click Remove to delete the shell script file from the Zyxel Device.</p> <p>A pop-up window asks you to confirm that you want to delete the shell script file. Click OK to delete the shell script file or click Cancel to close the screen without deleting the shell script file.</p>
Download	<p>Click a shell script file's row to select it and click Download to save the configuration to your computer.</p>

Table 416 Maintenance > File Manager > Shell Script (continued)

LABEL	DESCRIPTION
Copy	<p>Use this button to save a duplicate of a shell script file on the Zyxel Device.</p> <p>Click a shell script file's row to select it and click Copy to open the Copy File screen.</p> <p>Figure 729 Maintenance > File Manager > Shell Script > Copy</p>  <p>Specify a name for the duplicate file. Use up to 63 characters (including a-zA-Z0-9;~!@#%&()_+[]{}',.-).</p> <p>Click OK to save the duplicate or click Cancel to close the screen without saving a duplicate of the configuration file.</p>
Apply	<p>Use this button to have the Zyxel Device use a specific shell script file.</p> <p>Click a shell script file's row to select it and click Apply to have the Zyxel Device use that shell script file. You may need to wait awhile for the Zyxel Device to finish applying the commands.</p>
#	This column displays the number for each shell script file entry.
File Name	This column displays the label that identifies a shell script file.
Size	This column displays the size (in KB) of a shell script file.
Last Modified	This column displays the date and time that the individual shell script files were last changed or saved.
Upload Shell Script	The bottom part of the screen allows you to upload a new or previously saved shell script file from your computer to your Zyxel Device.
File Path	Type in the location of the file you want to upload in this field or click Browse ... to find it.
Browse...	Click Browse... to find the .zysh file you want to upload.
Upload	Click Upload to begin the upload process. This process may take up to several minutes.

CHAPTER 47

Diagnostics

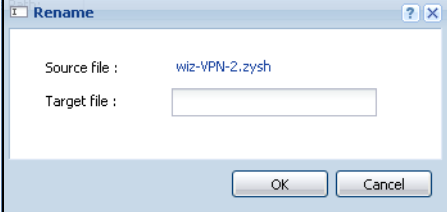
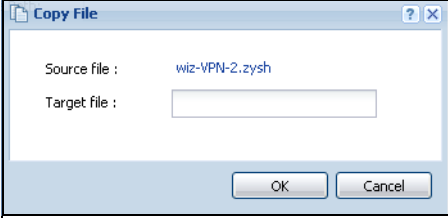
47.1 Overview

Use the diagnostics screens for troubleshooting.

47.1.1 What You Can Do in this Chapter

- Use the **Diagnostics** screens (see [Section 45.9 on page 1041](#)) to generate a file containing the Zyxel Device's configuration and diagnostic information if you need to provide it to customer support during troubleshooting.
- Use the **Packet Capture** screens (see [Section 45.9 on page 1044](#)) to capture packets going through the Zyxel Device.
- Use the **CPU / Memory Status** screens (see [Section 45.10 on page 1049](#)) to view the CPU and memory performance of various applications on the Zyxel Device.
- Use the **System Logs** screen (see [Section 45.11 on page 1050](#)) to see system logs stored on a connected USB storage device on the Zyxel Device.
- Use the **Network Tool** screen (see [Section 45.12 on page 1050](#)) to ping an IP address or trace the route packets take to a host.
- Use the **Routing Traces** screens (see [Section 45.13 on page 1051](#)) to configure traceroute to identify where packets are dropped for troubleshooting.
- Use the **Wireless Frame Capture** screens (see [Section 45.14 on page 1052](#)) to capture network traffic going through the AP interfaces connected to your Zyxel Device.

47.2 The Diagnostics Screens

The **Diagnostics** screens provide an easy way for you to generate a file containing the Zyxel Device's configuration and diagnostic information. You may need to send this file to customer support for troubleshooting.

Click **Maintenance > Diagnostics** to open the **Diagnostics** screens.

47.2.1 Scripts

Use scripts to gather information on the Zyxel Device or on external APs connected to the Zyxel Device.

Use a notepad editor that supports Unicode, such as Notepad to create a script. Each command in a script must be on its own line and the file must end with an empty line. The script must be saved in Unicode format (UTF-8).

This is an example of a script to display information about the Zyxel Device.

```
show service-register status all
show myzyxel-service get-cloud-timezone
show cloud-helper firmware
show cloud-helper remind
```

This is an example of a default script with interface diagnostic commands.

```
debug interface ifconfig
debug interface show event_sink
debug interface show interface_obj
debug switch table
debug switch port_grouping
show ping-check status
debug system netstat interface
show interface all
show port status
```

Script Name

The script name must use a ".zysh" filename extension with a file name of up to 25 characters (including a-z, A-Z, 0-9 and ;'~!@#\$\$%^&()_+[]{}',.-). Spaces are allowed.

Script Uploads to the Zyxel Device

You can upload the scripts in **File Manager**> **Shell Script** to run command on the Zyxel Device. You can also copy, and download scripts here.

Upload a script in **Diagnostics**> **Controller** to generate information about the Zyxel Device own configuration and diagnostics.

Upload a script in **Diagnostics**> **AP** to generate information about the selected managed AP in **Diagnostics**> **AP**.

Script Output

The results of generating a script are shown in **Diagnostics**> **Files** in bz2 format. You need to decompress the bz2 file to tar, and then unwrap the tar file to display a debug folder that contains other folders containing debug dbg text files. Customer support may request the bz2 file for troubleshooting.

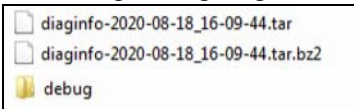

47.2.2 The Diagnostics Controller Screen

Click **Maintenance**> **Diagnostics**> **Controller** to open the following screen. When you click **Collect Now**, A series of commands are run to display information about the Zyxel Device.

Figure 730 Maintenance > Diagnostics > Controller

The screenshot shows the 'Diagnostics' tab selected in the top navigation bar. Below it, the 'Controller' sub-tab is active. The main content area is divided into several sections:

- Diagnostics Collect Status:** Shows 'Status: Standby'.
- General Setting:** Displays 'Filename: diaginfo-2017-05-23_16-08-12.tar.bz2', 'Last Modified: 2017-05-23 16:11:07', and 'Size: 201 KB'. There is a checkbox for 'Copy the diagnostic file to USB storage (if ready)' which is currently unchecked.
- Diagnostic Collect by Script files:** Features a 'Script File:' dropdown menu set to 'none' and an 'Optional' label with an information icon.
- Upload Shell Script:** Includes instructions to upload a shell script (.zsh) and a file selection interface with a 'File:' label, a 'Select a file' input field, a 'Browse...' button, and an 'Upload' button.

At the bottom of the screen, there is a 'Collect Now' button.

The following table describes the labels in this screen.

Table 417 Maintenance > Diagnostics > Collect

LABEL	DESCRIPTION
Diagnostic Collect Status	
Status	This field displays the following states the Zyxel Device is in when collecting diagnostic data. <ul style="list-style-type: none"> Standby: The Zyxel Device is ready to generate a diagnostic file or has just finished generating a diagnostic file. Busy on Ap: The Zyxel Device is generating a diagnostic file for the selected managed AP in Diagnostics > AP. Busy on ZyWall: The Zyxel Device is generating a diagnostic file containing its own configuration and diagnostic information.
General Setting	
Filename	This is the name of the most recently created diagnostic file.
Last modified	This is the date and time that the last diagnostic file was created. The format is yyyy-mm-dd hh:mm:ss.
Size	This is the size of the most recently created diagnostic file.
Copy the diagnostic file to USB storage (if ready)	Select this to have the Zyxel Device create an extra copy of the diagnostic file to a connected USB storage device.
Diagnostic Collect by Script files	
Script File	Select a script here to generate information about configuration and diagnostics of managed APs. See Section 47.2.1 on page 1048 for more information on scripts.
Upload Shell Script	

Table 417 Maintenance > Diagnostics > Collect (continued)

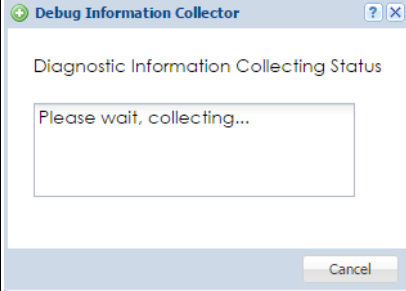
LABEL	DESCRIPTION
File Path	Click Browse to find the location of the file you want to upload in this field. Click Upload to begin the upload process. This process may take a few minutes.
Collect Now	Click this to have the Zyxel Device create a new diagnostic file. Wait while information is collected. 

47.2.3 The Diagnostics AP Screen

This screen provides an easy way for you to generate a file containing the selected managed AP's configuration and diagnostic information. You may need to generate this file and send it to customer support during troubleshooting. Click **Maintenance > Diagnostics > AP** to open the **AP** screen.

Figure 731 Maintenance > Diagnostics > AP

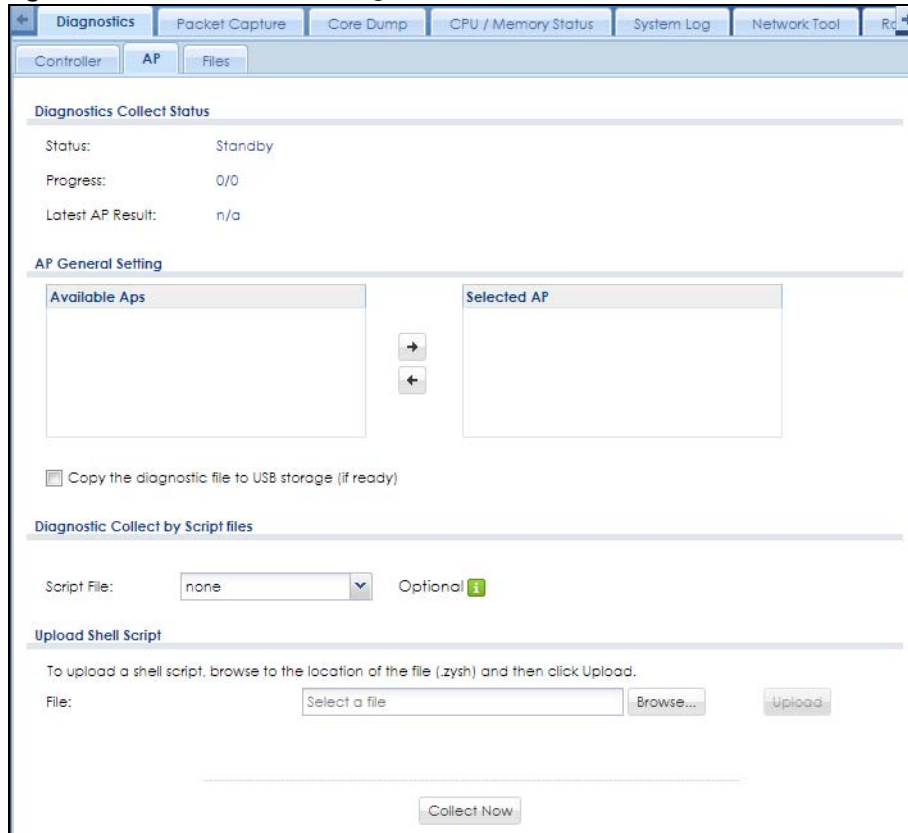

The following table describes the labels in this screen.

Table 418 Maintenance > Diagnostics > Collect on AP

LABEL	DESCRIPTION
Diagnostic Collect Status	
Status	This field displays the following states the Zyxel Device is in when collecting diagnostic data. <ul style="list-style-type: none"> • Standby: The Zyxel Device is ready to generate a diagnostic file or has just finished generating a diagnostic file. • Busy on Ap: The Zyxel Device is generating a diagnostic file for the selected managed AP in Diagnostics > AP. • Busy on ZyWall: The Zyxel Device is generating a diagnostic file containing its own configuration and diagnostic information.
Progress	This field displays the number of APs processed compared to the number of APs selected for processing.
Latest AP Result	This field displays the latest AP description and status.
AP General Setting	
Available APs	This text box lists the managed APs that are connected and available. Select the managed APs that you want the Zyxel Device to generate a diagnostic file containing their configuration, and click the right arrow button to add them.
Collected APs	This text box lists the managed APs that you allow the Zyxel Device to generate a diagnostic file containing their configuration. Select any managed APs that you want to prevent the Zyxel Device from generating a diagnostic file for them, and click the left arrow button to remove them.
Copy the diagnostic file to USB storage (if ready)	Select this to have the Zyxel Device create an extra copy of the diagnostic file to a connected USB storage device.
Diagnostic Collect by Script files	
Script File	Select a script here to generate information about configuration and diagnostics of managed APs. See Section 47.2.1 on page 1048 for more information on scripts.
Upload Shell Script	
File Path	Click Browse to find the location of the file you want to upload in this field. Click Upload to begin the upload process. This process may take a few minutes.
Apply	Click Apply to save your changes.
Collect Now	Click this to have the Zyxel Device create a new diagnostic file.

47.2.4 The Diagnostics Files Screen

Click **Maintenance > Diagnostics > Files** to open the diagnostic files screen. This screen lists the files of diagnostic information the Zyxel Device has collected and stored on the Zyxel Device or in a connected USB storage device. You may need to send these files to customer support for troubleshooting.

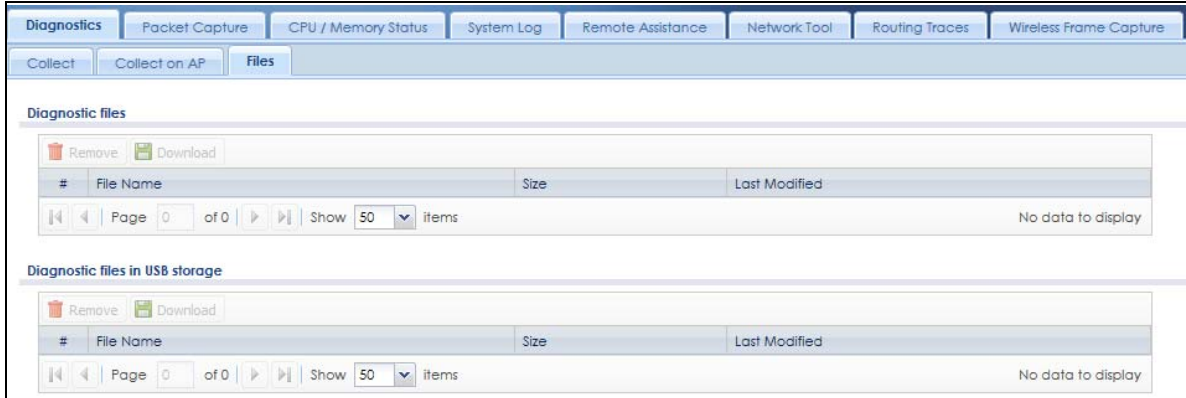
Figure 732 Maintenance > Diagnostics > Files

The following table describes the labels in this screen.

Table 419 Maintenance > Diagnostics > Files

LABEL	DESCRIPTION
Diagnostic files	This lists the files of diagnostic information stored on the Zyxel Device.
Diagnostic files in USB storage	This lists the files of diagnostic information stored in a connected USB storage device.
Remove	Select files and click Remove to delete them from the Zyxel Device or the USB storage device. Use the [Shift] and/or [Ctrl] key to select multiple files. A pop-up window asks you to confirm that you want to delete.
Download	Click a file to select it and click Download to save it to your computer.
#	This column displays the number for each file entry. The total number of files that you can save depends on the file sizes and the available storage space.
File Name	This column displays the label that identifies the file.
Size	This column displays the size (in bytes) of a file.
Last Modified	This column displays the date and time that the individual files were saved.

47.3 The Packet Capture Screen

Use this screen to capture network traffic going through the ZyXel Device's interfaces. Studying these packet captures may help you identify network problems. Click **Maintenance > Diagnostics > Packet Capture** to open the packet capture screen.

Note: New capture files overwrite existing files of the same name. Change the **File Suffix** field's setting to avoid this.

Figure 733 Maintenance > Diagnostics > Packet Capture

The following table describes the labels in this screen.

Table 420 Maintenance > Diagnostics > Packet Capture

LABEL	DESCRIPTION
Interfaces	Enabled interfaces (except for virtual interfaces) appear under Available Interfaces . Select interfaces for which to capture packets and click the right arrow button to move them to the Capture Interfaces list. Use the [Shift] and/or [Ctrl] key to select multiple objects.
IP Version	Select the version of IP for which to capture packets. Select any to capture packets for all IP versions.
Protocol Type	Select the protocol of traffic for which to capture packets. Select any to capture packets for all types of traffic.
Host IP	Select a host IP address object for which to capture packets. Select any to capture packets for all hosts. Select User Defined to be able to enter an IP address.
Host Port	This field is configurable when you set the IP Type to any , tcp , or udp . Specify the port number of traffic to capture.

Table 420 Maintenance > Diagnostics > Packet Capture (continued)

LABEL	DESCRIPTION
Continuously capture and overwrite old ones	Select this to have the Zyxel Device keep capturing traffic and overwriting old packet capture entries when the available storage space runs out.
Save data to onboard storage only	Select this to have the Zyxel Device only store packet capture entries on the Zyxel Device. The available storage size is displayed as well. Note: The Zyxel Device reserves some on board storage space as a buffer.
Save data to USB storage	Select this to have the Zyxel Device store packet capture entries only on a USB storage device connected to the Zyxel Device if the Zyxel Device allows this. Status: Unused - the connected USB storage device was manually unmounted by using the Remove Now button or for some reason the Zyxel Device cannot mount it. none - no USB storage device is connected. service deactivated - USB storage feature is disabled (in Configuration > System > USB Storage), so the Zyxel Device cannot use a connected USB device to store system logs and other diagnostic information. available - you can have the Zyxel Device use the USB storage device. The available storage capacity also displays. Note: The Zyxel Device reserves some USB storage space as a buffer.
Captured Packet Files	When saving packet captures only to the Zyxel Device's on board storage, specify a maximum limit in megabytes for the total combined size of all the capture files on the Zyxel Device. When saving packet captures to a connected USB storage device, specify a maximum limit in megabytes for each capture file. Note: If you have existing capture files and have not selected the Continuously capture and overwrite old ones option, you may need to set this size larger or delete existing capture files. The valid range depends on the available on board/USB storage size. The Zyxel Device stops the capture and generates the capture file when either the file reaches this size or the time period specified in the Duration field expires.
Split threshold	Specify a maximum size limit in megabytes for individual packet capture files. After a packet capture file reaches this size, the Zyxel Device starts another packet capture file.
Duration	Set a time limit in seconds for the capture. The Zyxel Device stops the capture and generates the capture file when either this period of time has passed or the file reaches the size specified in the File Size field. 0 means there is no time limit.
File Suffix	Specify text to add to the end of the file name (before the dot and filename extension) to help you identify the packet capture files. Modifying the file suffix also avoids making new capture files that overwrite existing files of the same name. The file name format is "interface name-file suffix.cap", for example "vlan2-packet-capture.cap".
Number Of Bytes To Capture (Per Packet)	Specify the maximum number of bytes to capture per packet. The Zyxel Device automatically truncates packets that exceed this size. As a result, when you view the packet capture files in a packet analyzer, the actual size of the packets may be larger than the size of captured packets.
Save data to ftp server (available: xx MB)	Select this to have the Zyxel Device store packet capture entries on the defined FTP site. The available storage size is displayed as well.
Server Address	Type the IP address of the FTP server.
Server Port	Type the port this server uses for FTP traffic. The default FTP port is 21.
Name	Type the login username to access the FTP server.
Password	Type the associated login password to access the FTP server.

Table 420 Maintenance > Diagnostics > Packet Capture (continued)

LABEL	DESCRIPTION
Capture	<p>Click this button to have the Zyxel Device capture packets according to the settings configured in this screen.</p> <p>You can configure the Zyxel Device while a packet capture is in progress although you cannot modify the packet capture settings.</p> <p>The Zyxel Device's throughput or performance may be affected while a packet capture is in progress.</p> <p>After the Zyxel Device finishes the capture it saves a separate capture file for each selected interface. The total number of packet capture files that you can save depends on the file sizes and the available flash storage space. Once the flash storage space is full, adding more packet captures will fail.</p>
Stop	Click this button to stop a currently running packet capture and generate a separate capture file for each selected interface.
Reset	Click this button to return the screen to its last-saved settings.

47.3.1 The Packet Capture on AP Screen

Use this screen to capture network traffic going through the connected APs' interfaces. Studying these packet captures may help you identify network problems. Click **Maintenance > Diagnostics > Packet Capture > Capture on AP** to open the packet capture screen.

Note: New capture files overwrite existing files of the same name. Change the **File Suffix** field's setting to avoid this.

Figure 734 Maintenance > Diagnostics > Packet Capture > Capture on AP

The screenshot shows the 'Capture on AP' configuration interface. At the top, there are navigation tabs: 'Diagnostics', 'Packet Capture', 'CPU / Memory Status', 'System Log', 'Remote Assistance', 'Network Tool', and 'Routing Traces'. Below these are sub-tabs: 'Capture', 'Capture on AP', and 'Files'. The main content area is divided into four sections:

- AP General Setting:** Contains a 'Select on AP' dropdown menu and a 'Query' button. Below it, the 'Capture Status' is shown as 'Standby'.
- Interfaces:** Features two empty list boxes, 'Available Interfaces' and 'Capture Interfaces', with '+' and '-' arrows between them for moving items.
- Filter:** Includes dropdown menus for 'IP Version' (set to 'any'), 'Protocol Type' (set to 'any'), and 'Host IP' (set to 'any'). There is also a text input for 'Host Port' (set to '0') with '(0: any)' next to it.
- Misc setting:** Contains radio buttons for 'Save data to onboard storage only (Available: 11 MB)' (selected) and 'Save data to USB storage (service deactivated)'. Below are text inputs for 'Captured Packet Files' (0 MB), 'Duration' (0), and 'File Suffix' (-packet-capture). A note indicates '(0: unlimited)' for the duration.

At the bottom of the page, there are 'Capture' and 'Stop' buttons.

The following table describes the labels in this screen.

Table 421 Maintenance > Diagnostics > Packet Capture > Capture on AP

LABEL	DESCRIPTION
Select on AP	This lists the managed APs that are connected and available. Select the managed AP that you want the Zyxel Device to capture network traffic going through it.
Query	After you select an AP, click this button to update and display the interfaces, filter configuration and storage size available for the selected AP in the screen. Note: You need to use the Query button before packet capturing on an AP if the AP has rebooted or the applied AP profile settings have been changed.
Capture Status	This shows Standby when the Zyxel Device is ready to or have finished capturing network traffic going through the selected AP's interface(s). This shows Preparing when the Zyxel Device is sending the capture command to the AP's interface(s). This shows Capturing when the AP is capturing network traffic going through the selected AP's interface(s). This shows File Receiving when the Zyxel Device starts to receive capture files from the AP's interface(s) after you press the Stop button.

Table 421 Maintenance > Diagnostics > Packet Capture > Capture on AP (continued)

LABEL	DESCRIPTION
Interfaces	Enabled interfaces (except for virtual interfaces) appear under Available Interfaces . Select interfaces for which to capture packets and click the right arrow button to move them to the Capture Interfaces list. Use the [Shift] and/or [Ctrl] key to select multiple objects.
IP Version	Select the version of IP for which to capture packets. Select any to capture packets for all IP versions.
Protocol Type	Select the protocol of traffic for which to capture packets. Select any to capture packets for all types of traffic.
Host IP	Select a host IP address object for which to capture packets. Select any to capture packets for all hosts. Select User Defined to be able to enter an IP address.
Host Port	This field is configurable when you set the IP Type to any , tcp , or udp . Specify the port number of traffic to capture.
Continuously capture and overwrite old ones	Select this to have the Zyxel Device keep capturing traffic and overwriting old packet capture entries when the available storage space runs out.
Captured Packet Files	<p>When saving packet captures only to the Zyxel Device's on board storage, specify a maximum limit in megabytes for the total combined size of all the capture files on the Zyxel Device.</p> <p>When saving packet captures to a connected USB storage device, specify a maximum limit in megabytes for each capture file.</p> <p>Note: If you have existing capture files and have not selected the Continuously capture and overwrite old ones option, you may need to set this size larger or delete existing capture files.</p> <p>The valid range depends on the available on board/USB storage size. The Zyxel Device stops the capture and generates the capture file when either the file reaches this size or the time period specified in the Duration field expires.</p>
Split threshold	Specify a maximum size limit in megabytes for individual packet capture files. After a packet capture file reaches this size, the Zyxel Device starts another packet capture file.
Duration	Set a time limit in seconds for the capture. The Zyxel Device stops the capture and generates the capture file when either this period of time has passed or the file reaches the size specified in the File Size field. 0 means there is no time limit.
File Suffix	<p>Specify text to add to the end of the file name (before the dot and filename extension) to help you identify the packet capture files. Modifying the file suffix also avoids making new capture files that overwrite existing files of the same name.</p> <p>The file name format is "interface name-file suffix.cap", for example "vlan2-packet-capture.cap".</p>
Number Of Bytes To Capture (Per Packet)	Specify the maximum number of bytes to capture per packet. The Zyxel Device automatically truncates packets that exceed this size. As a result, when you view the packet capture files in a packet analyzer, the actual size of the packets may be larger than the size of captured packets.
Save data to onboard storage only	<p>Select this to have the Zyxel Device only store packet capture entries on the Zyxel Device. The available storage size is displayed as well.</p> <p>Note: The Zyxel Device reserves some on board storage space as a buffer.</p>

Table 421 Maintenance > Diagnostics > Packet Capture > Capture on AP (continued)

LABEL	DESCRIPTION
Save data to USB storage	<p>Select this to have the Zyxel Device store packet capture entries only on a USB storage device connected to the Zyxel Device if the Zyxel Device allows this.</p> <p>Status:</p> <p>Unused - the connected USB storage device was manually unmounted by using the Remove Now button or for some reason the Zyxel Device cannot mount it.</p> <p>none - no USB storage device is connected.</p> <p>service deactivated - USB storage feature is disabled (in Configuration > System > USB Storage), so the Zyxel Device cannot use a connected USB device to store system logs and other diagnostic information.</p> <p>available - you can have the Zyxel Device use the USB storage device. The available storage capacity also displays.</p> <p>Note: The Zyxel Device reserves some USB storage space as a buffer.</p>
Save data to ftp server (available: xx MB)	Select this to have the Zyxel Device store packet capture entries on the defined FTP site. The available storage size is displayed as well.
Server Address	Type the IP address of the FTP server.
Server Port	Type the port this server uses for FTP traffic. The default FTP port is 21.
Name	Type the login username to access the FTP server.
Password	Type the associated login password to access the FTP server.
Capture	<p>Click this button to have the Zyxel Device capture packets according to the settings configured in this screen.</p> <p>You can configure the Zyxel Device while a packet capture is in progress although you cannot modify the packet capture settings.</p> <p>The Zyxel Device's throughput or performance may be affected while a packet capture is in progress.</p> <p>After the Zyxel Device finishes the capture it saves a separate capture file for each selected interface. The total number of packet capture files that you can save depends on the file sizes and the available flash storage space. Once the flash storage space is full, adding more packet captures will fail.</p>
Stop	Click this button to stop a currently running packet capture and generate a separate capture file for each selected interface.
Reset	Click this button to return the screen to its last-saved settings.

47.3.2 The Packet Capture Files Screen

Click **Maintenance > Diagnostics > Packet Capture > Files** to open the packet capture files screen. This screen lists the files of packet captures stored on the Zyxel Device or a connected USB storage device. You can download the files to your computer where you can study them using a packet analyzer (also known as a network or protocol analyzer) such as Wireshark.

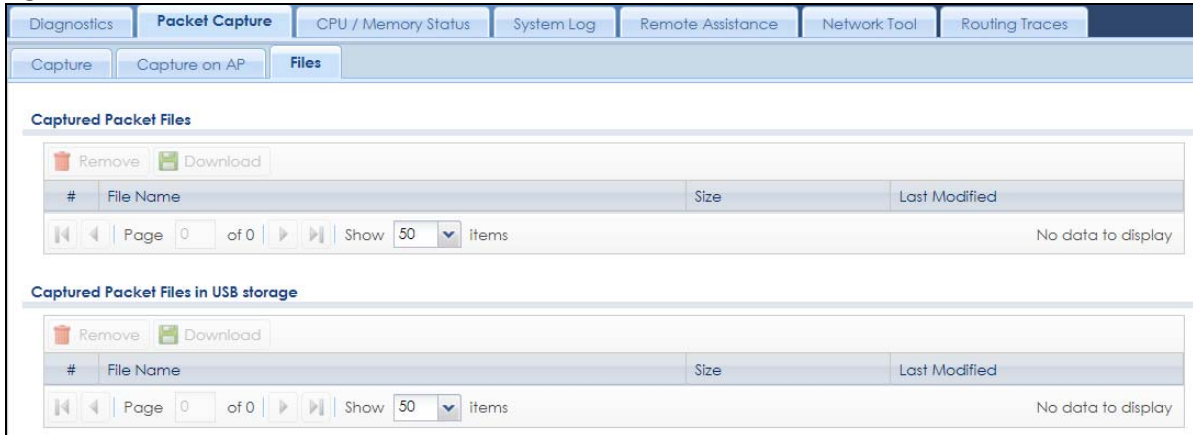
Figure 735 Maintenance > Diagnostics > Packet Capture > Files

The following table describes the labels in this screen.

Table 422 Maintenance > Diagnostics > Packet Capture > Files

LABEL	DESCRIPTION
Remove	Select files and click Remove to delete them from the Zyxel Device or the connected USB storage device. Use the [Shift] and/or [Ctrl] key to select multiple files. A pop-up window asks you to confirm that you want to delete.
Download	Click a file to select it and click Download to save it to your computer.
#	This column displays the number for each packet capture file entry. The total number of packet capture files that you can save depends on the file sizes and the available flash storage space.
File Name	This column displays the label that identifies the file. The file name format is interface name-file suffix.cap.
Size	This column displays the size (in bytes) of a configuration file.
Last Modified	This column displays the date and time that the individual files were saved.

47.4 The CPU / Memory Status Screen

Click **Maintenance > Diagnostics > CPU / Memory Status** to open the **CPU/Memory Status** screen. Use this screen to view the CPU and memory performance of various applications on the Zyxel Device.

Figure 736 Maintenance > Diagnostics > CPU / Memory Status

CPU Status

CPU0 Usage: 0 %
 CPU1 Usage: 0 %
 CPU2 Usage: 0 %
 CPU3 Usage: 0 %

Network Traffic: 0 % (Please see [Traffic Statistics](#) for more information)

#	CPU	Application	Memory	Time
1	0.2	DNS server	0.2	00:25:17
2	0.2	System statistics	0.0	00:24:50
3	0.1	SSLVPN application	0.2	00:18:55
4	0.1	wacd	0.1	00:16:24
5	0.0	IPsec VPN	1.3	00:03:46
6	0.0	Zyxel Service	1.2	00:06:00
7	0.0	HTTP/HTTPS server	0.9	00:00:17
8	0.0	HTTP/HTTPS server	0.6	00:00:09
9	0.0	HTTP/HTTPS server	0.6	00:00:09

Page 1 of 1 | Show 50 items | Displaying 1 - 9 of 9

Memory Status

Memory Usage: 52%

#	Memory	Application	CPU	Time
1	1.3	IPsec VPN	0.0	00:03:46
2	1.2	Zyxel Service	0.0	00:06:00
3	0.9	HTTP/HTTPS server	0.0	00:00:17
4	0.6	HTTP/HTTPS server	0.0	00:00:09
5	0.6	HTTP/HTTPS server	0.0	00:00:09
6	0.5	HTTP/HTTPS server	0.0	00:00:07
7	0.5	HTTP/HTTPS server	0.0	00:00:06
8	0.5	HTTP/HTTPS server	0.0	00:00:06

Refresh

The following table describes the labels in this screen.

Table 423 Maintenance > Diagnostics > CPU / Memory Status

LABEL	DESCRIPTION
CPU Status	This table displays the applications that use the most Zyxel Device CPU processing.
CPU _n Usage	CPU usage shows how much processing power the Zyxel Device is using. This field displays the current percentage usage of a CPU (where n is the number of the CPU) as a percentage of total processing power.
Network Traffic	This field displays the current percentage of network traffic through the Zyxel Device.
#	This field is a sequential value, and it is not associated with any entry.
CPU	This field displays the current CPU utilization percentage for each application used on the Zyxel Device.
Application	This field displays the name of the application consuming the related processing power on the Zyxel Device.
Memory	This field displays the current DRAM memory utilization percentage for each application used on the Zyxel Device.
Time	This field displays each application's running time in hours - minutes - seconds.

Table 423 Maintenance > Diagnostics > CPU / Memory Status

LABEL	DESCRIPTION
Memory Status	This table displays the applications that use the most Zyxel Device DRAM memory.
Memory Usage	Memory usage shows how much DRAM memory the Zyxel Device is using. This field displays the current percentage of memory utilization.
#	This field is a sequential value, and it is not associated with any entry.
Memory	This field displays the current DRAM memory utilization percentage for each application used on the Zyxel Device.
Application	This field displays the name of the application consuming the related memory on the Zyxel Device.
CPU	This field displays the current CPU utilization percentage for each application used on the Zyxel Device.
Time	This field displays each application's running time.
Refresh	Click this to update the information in this screen.

47.5 The System Log Screen

Click **Maintenance > Diagnostics > System Log** to open the **System Log** screen. This screen lists the files of Zyxel Device system logs stored on a connected USB storage device. The files are in comma separated value (csv) format. You can download them to your computer and open them in a tool like Microsoft's Excel.

Figure 737 Maintenance > Diagnostics > System Log

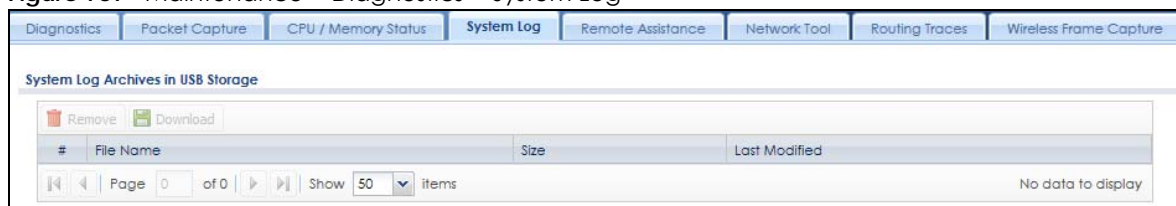

The following table describes the labels in this screen.

Table 424 Maintenance > Diagnostics > System Log

LABEL	DESCRIPTION
Remove	Select files and click Remove to delete them from the Zyxel Device. Use the [Shift] and/or [Ctrl] key to select multiple files. A pop-up window asks you to confirm that you want to delete.
Download	Click a file to select it and click Download to save it to your computer.
#	This column displays the number for each file entry. The total number of files that you can save depends on the file sizes and the available storage space.
File Name	This column displays the label that identifies the file.
Size	This column displays the size (in bytes) of a file.
Last Modified	This column displays the date and time that the individual files were saved.

47.6 The Network Tool Screen

Use this screen to perform various network tests.

Click **Maintenance > Diagnostics > Network Tool** to display this screen.

Figure 738 Maintenance > Diagnostics > Network Tool

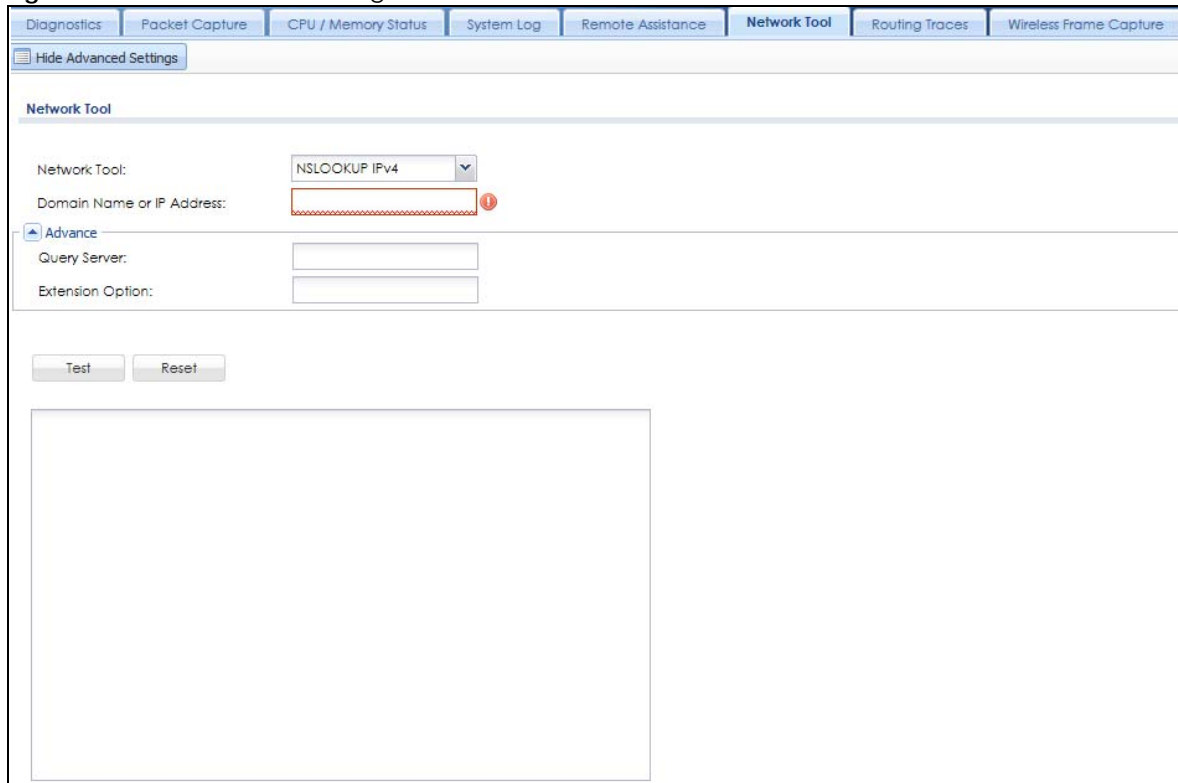

The screenshot shows a web interface for the Network Tool. At the top, there is a navigation bar with tabs: Diagnostics, Packet Capture, CPU / Memory Status, System Log, Remote Assistance, Network Tool (selected), Routing Traces, and Wireless Frame Capture. Below the navigation bar is a "Hide Advanced Settings" button. The main content area is titled "Network Tool" and contains the following elements:

- Network Tool:** A dropdown menu currently set to "NSLOOKUP IPv4".
- Domain Name or IP Address:** A text input field with a red dashed border and a red warning icon to its right.
- Advance:** A collapsed section containing:
 - Query Server:** A text input field.
 - Extension Option:** A text input field.
- Buttons:** "Test" and "Reset" buttons.
- Output Area:** A large empty rectangular box for displaying test results.

Figure 739 Maintenance > Diagnostics > Network Tool - Test Email Server

The following table describes the labels in this screen.

Table 425 Maintenance > Diagnostics > Network Tool

LABEL	DESCRIPTION
Network Tool	Select a network tool: <ul style="list-style-type: none"> Select NSLOOKUP IPv4 or NSLOOKUP IPv6 to perform name server lookup for querying the Domain Name System (DNS) to get the domain name or IP address mapping. Select PING IPv4 or PING IPv6 to ping the IP address that you entered. Select TRACEROUTE IPv4 or TRACEROUTE IPv6 to run the traceroute function. This determines the path a packet takes to the specified computer. Select Test Email Server to test access to an SMTP email server.
Domain Name or IP Address	Type the IP address that you want to use to for the selected network tool.
Advance	Click this to display the following fields.
Query Server	Enter the IP address of a server to which the Zyxel Device sends queries for NSLOOKUP.
Interface	Select the interface through which the Zyxel Device sends queries for PING or TRACEROUTE.
Extension Option	Enter the extended option if you want to use an extended ping or traceroute command. For example, enter " -c count " (where <i>count</i> is the number of ping requests) to set how many times the Zyxel Device pings the destination IP address, or enter " -w waittime " (where <i>waittime</i> is a time period in seconds) to set how long the Zyxel Device waits for a response to a probe before running another traceroute.

Table 425 Maintenance > Diagnostics > Network Tool (continued)

LABEL	DESCRIPTION
The following fields display when you select Test Email Server in Network Tool .	
Mail Server	Type the name or IP address of the outgoing SMTP server.
Mail Subject	Type the subject line for the outgoing e-mail. <ul style="list-style-type: none"> Select Append system name to add the Zyxel Device system name to the subject. Select Append date time to add the Zyxel Device date and time to the subject.
Mail Server Port	Enter the same port number here as is on the mail server for mail traffic.
TLS Security	Select this option if the mail server uses Transport Layer Security (TLS) for encrypted communications between the mail server and the Zyxel Device.
STARTTLS	Select this option if the mail server uses SSL or TLS for encrypted communications between the mail server and the Zyxel Device.
Authenticate Server	Select this if the Zyxel Device authenticates the mail server in the TLS handshake.
Mail From	Type the e-mail address from which the outgoing e-mail is delivered. This address is used in replies.
Mail To	Type the e-mail address to which the outgoing e-mail is delivered.
SMTP Authentication	Select this check box if it is necessary to provide a user name and password to the SMTP server.
User Name	This box is effective when you select the SMTP Authentication check box. Type the user name to provide to the SMTP server when the log is e-mailed.
Password	This box is effective when you select the SMTP Authentication check box. Type a password of up to 63 characters to provide to the SMTP server when the log is e-mailed.
Retype to Confirm	Retype your new password for confirmation.
Test	Click this button to start the test.
Stop	Click this button to stop the test.
Reset	Click this button to return the screen to its last-saved settings.

47.7 The Routing Traces Screen

Click **Maintenance > Diagnostics > Routing Traces** to display this screen. Use this screen to configure a traceroute to identify where packets are dropped for troubleshooting.

Figure 740 Maintenance > Diagnostics > Routing Traces

The screenshot displays the 'Routing Traces' configuration interface. At the top, there are navigation tabs: Diagnostics, Packet Capture, CPU / Memory Status, System Log, Remote Assistance, Network Tool, Routing Traces (selected), and Wireless Frame Capture. The main content area is titled 'General Setting' and includes the following fields:

- IP Address:** Radio buttons for 'Source', 'Destination', and 'Host'. The 'Source' and 'Destination' fields are highlighted with red dashed boxes and have red error icons. The 'Host' field is empty.
- Port:** Three empty input fields corresponding to Source, Destination, and Host.
- Protocol:** A dropdown menu set to 'any'.
- Interval:** A text input field set to '5' with '(1-120 seconds)' next to it.

Below the settings are two buttons: 'Capture' and 'Flush Data'. At the bottom, there is a table header with columns: Session, ID, Protocol, from V..., to VPN ID, Incoming Interface, and Message. The table body is empty, and the status at the bottom indicates 'Page 0 of 0' and 'No data to display'.

The following table describes the labels in this screen.

Table 426 Maintenance > Diagnostics > Routing Traces

LABEL	DESCRIPTION
IP Address	You can trace traffic through the Zyxel Device from a specific source-to-destination stream or just from/to a specific host (source or destination).
Source	Enter the source IP address of traffic that you want to trace.
Port	Enter the source port number of traffic that you want to trace.
Destination	Enter the destination IP address of traffic that you want to trace.
Port	Enter the destination port number of traffic that you want to trace.
Host	Enter the IP address of a specific source or destination host whose traffic you want to trace.
Port	Enter the port number for particular source traffic on the host that you want to trace.
Protocol	Select the protocol of traffic that you want to trace. any means any protocol.
Interval	Enter a time interval in seconds for renewing a route trace. The default time interval is 5 seconds.
Capture	Click this button to have the Zyxel Device capture frames according to the settings configured in this screen. You can configure the Zyxel Device while a frame capture is in progress although you cannot modify the frame capture settings.
Flush Data	Click this to clear all data on the screen.
Session	This field displays established sessions that passed through the Zyxel Device which matched the capture criteria.
ID	This field displays the packet ID for each active session.
Protocol	This field displays the protocol used in each active session.
from VPN ID	This field displays the tagged VLAN ID in ingress packets coming into the Zyxel Device.
to VPN ID	This field displays the tagged VLAN ID in egress packets going out from the Zyxel Device.
Incoming Interface	This is the source interface of packets to which this active session applies.
Message	This field displays traceroute information.

47.8 The Wireless Frame Capture Screen

Use this screen to capture wireless network traffic going through the AP interfaces connected to your Zyxel Device. Studying these frame captures may help you identify network problems.

Click **Maintenance > Diagnostics > Wireless Frame Capture** to display this screen.

Note: New capture files overwrite existing files of the same name. Change the **File Prefix** field's setting to avoid this.

Figure 741 Maintenance > Diagnostics > Wireless Frame Capture > Capture

The following table describes the labels in this screen.

Table 427 Maintenance > Diagnostics > Wireless Frame Capture > Capture

LABEL	DESCRIPTION
MON Mode APs	
Configure AP to MON Mode	Click this to go the Configuration > Wireless > AP Management screen, where you can set one or more APs to monitor mode.
Available MON Mode APs	This column displays which APs on your wireless network are currently configured for monitor mode. Use the arrow buttons to move APs off this list and onto the Captured MON Mode APs list.
Capture MON Mode APs	This column displays the monitor-mode configured APs selected to for wireless frame capture.
Misc Setting	
File Size	Specify a maximum size limit in kilobytes for the total combined size of all the capture files on the Zyxel Device, including any existing capture files and any new capture files you generate. Note: If you have existing capture files you may need to set this size larger or delete existing capture files. The valid range is 1 to 50000. The Zyxel Device stops the capture and generates the capture file when either the file reaches this size.
File Prefix	Specify text to add to the front of the file name in order to help you identify frame capture files. You can modify the prefix to also create new frame capture files each time you perform a frame capture operation. Doing this does no overwrite existing frame capture files. The file format is: [file prefix].cap. For example, "monitor.cap".

Table 427 Maintenance > Diagnostics > Wireless Frame Capture > Capture (continued)

LABEL	DESCRIPTION
Capture	<p>Click this button to have the Zyxel Device capture frames according to the settings configured in this screen.</p> <p>You can configure the Zyxel Device while a frame capture is in progress although you cannot modify the frame capture settings.</p> <p>The Zyxel Device's throughput or performance may be affected while a frame capture is in progress.</p> <p>After the Zyxel Device finishes the capture it saves a combined capture file for all APs. The total number of frame capture files that you can save depends on the file sizes and the available flash storage space. Once the flash storage space is full, adding more frame captures will fail.</p>
Stop	Click this button to stop a currently running frame capture and generate a combined capture file for all APs.
Reset	Click this button to return the screen to its last-saved settings.

47.8.1 The Wireless Frame Capture Files Screen

Click **Maintenance > Diagnostics > Wireless Frame Capture > Files** to open this screen. This screen lists the files of wireless frame captures the Zyxel Device has performed. You can download the files to your computer where you can study them using a packet analyzer (also known as a network or protocol analyzer) such as Wireshark.

Figure 742 Maintenance > Diagnostics > Wireless Frame Capture > Files

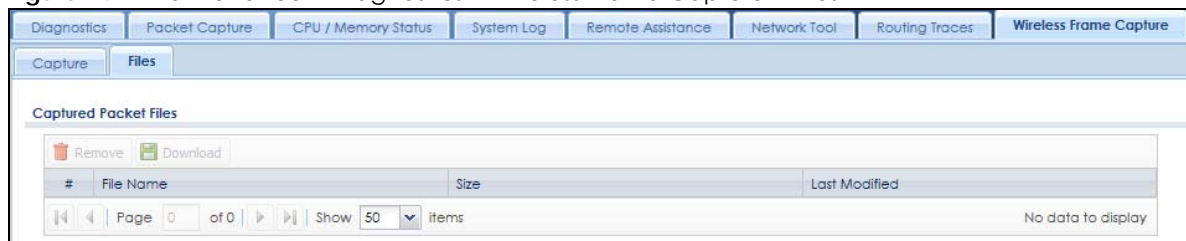

The following table describes the labels in this screen.

Table 428 Maintenance > Diagnostics > Wireless Frame Capture > Files

LABEL	DESCRIPTION
Remove	Select files and click Remove to delete them from the Zyxel Device. Use the [Shift] and/or [Ctrl] key to select multiple files. A pop-up window asks you to confirm that you want to delete.
Download	Click a file to select it and click Download to save it to your computer.
#	This column displays the number for each packet capture file entry. The total number of packet capture files that you can save depends on the file sizes and the available flash storage space.
File Name	This column displays the label that identifies the file. The file name format is interface name-file suffix.cap.
Size	This column displays the size (in bytes) of a configuration file.
Last Modified	This column displays the date and time that the individual files were saved.

CHAPTER 48

Packet Flow Explore

48.1 Overview

Use this to get a clear picture on how the Zyxel Device determines where to forward a packet and how to change the source IP address of the packet according to your current settings. This function provides you a summary of all your routing and SNAT settings and helps troubleshoot any related problems.

48.1.1 What You Can Do in this Chapter

- Use the **Routing Status** screen (see [Section 48.2 on page 1069](#)) to view the overall routing flow and each routing function's settings.
- Use the **SNAT Status** screen (see [Section 48.3 on page 1074](#)) to view the overall source IP address conversion (SNAT) flow and each SNAT function's settings.

48.2 The Routing Status Screen

The **Routing Status** screen allows you to view the current routing flow and quickly link to specific routing settings. Click a function box in the **Routing Flow** section, the related routes (activated) will display in the **Routing Table** section. To access this screen, click **Maintenance > Packet Flow Explore > Routing Status**.

The order of the routing flow may vary depending on whether you:

- Select **use policy route to override direct route** in the **CONFIGURATION > Network > Routing > Policy Route** screen.
- Use policy routes to control 1-1 NAT by using the `policy control-virtual-server-rules activate` command.
- Select **use policy routes to control dynamic IPSec rules** in the **CONFIGURATION > VPN > IPSec VPN > VPN Connection** screen.

Note: Once a packet matches the criteria of a routing rule, the Zyxel Device takes the corresponding action and does not perform any further flow checking.

Figure 743 Maintenance > Packet Flow Explore > Routing Status (Direct Route)

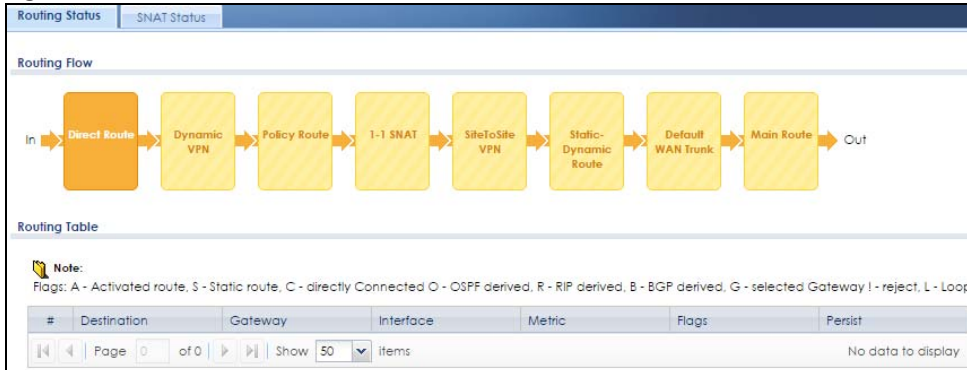

Figure 744 Maintenance > Packet Flow Explore > Routing Status (Dynamic VPN)

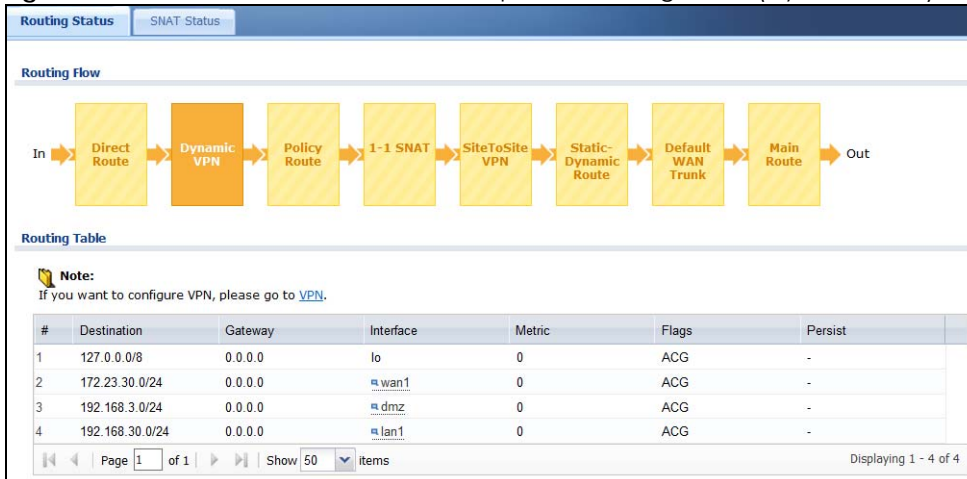

Figure 745 Maintenance > Packet Flow Explore > Routing Status (Policy Route)

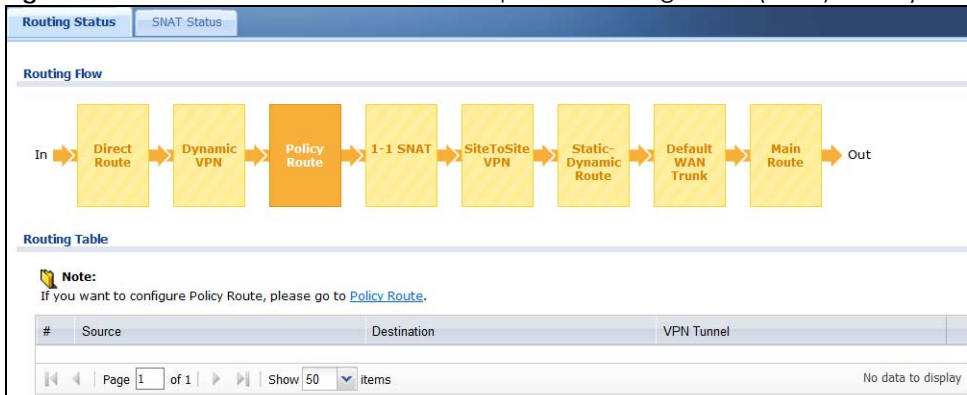

Figure 746 Maintenance > Packet Flow Explore > Routing Status (1-1 SNAT)

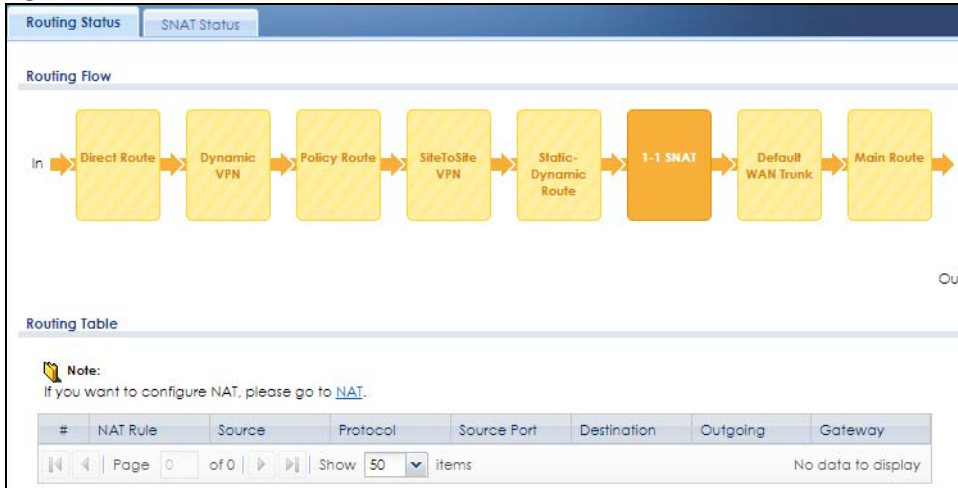

Figure 747 Maintenance > Packet Flow Explore > Routing Status (SiteToSite VPN)

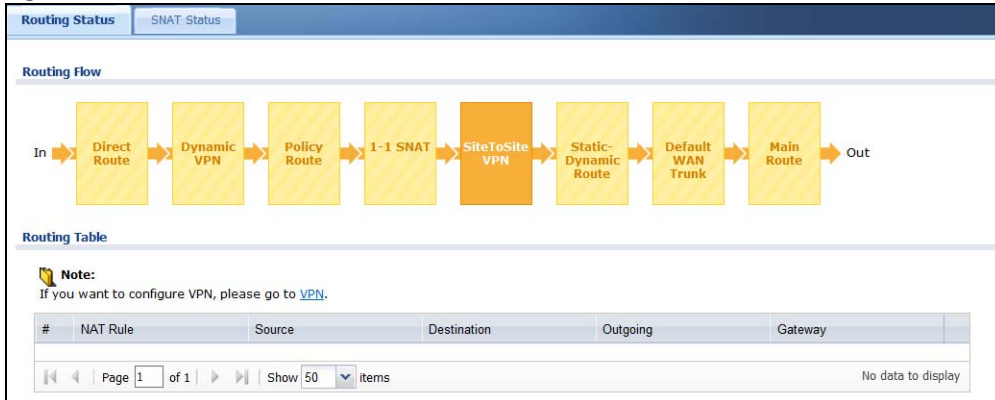

Figure 748 Maintenance > Packet Flow Explore > Routing Status (Static-Dynamic Route)

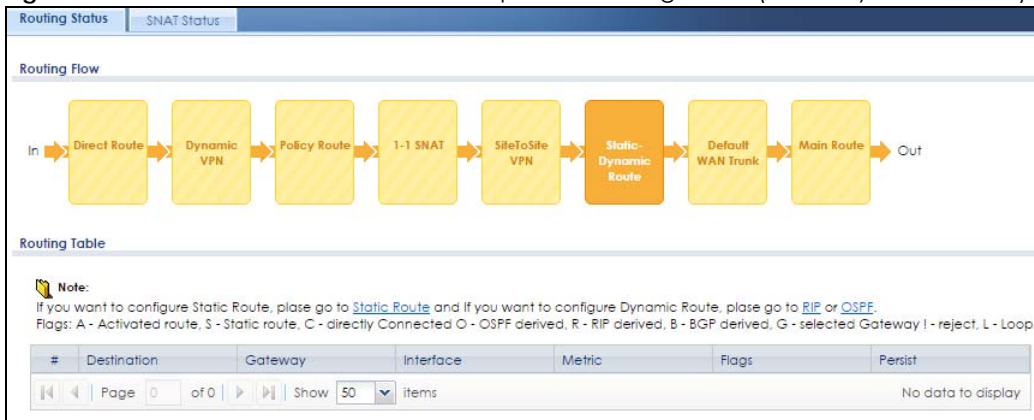

Figure 749 Maintenance > Packet Flow Explore > Routing Status (Default WAN Trunk)

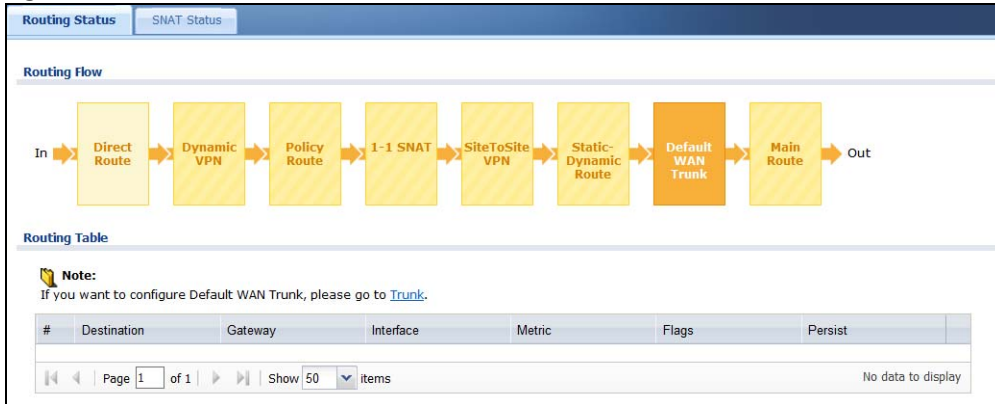
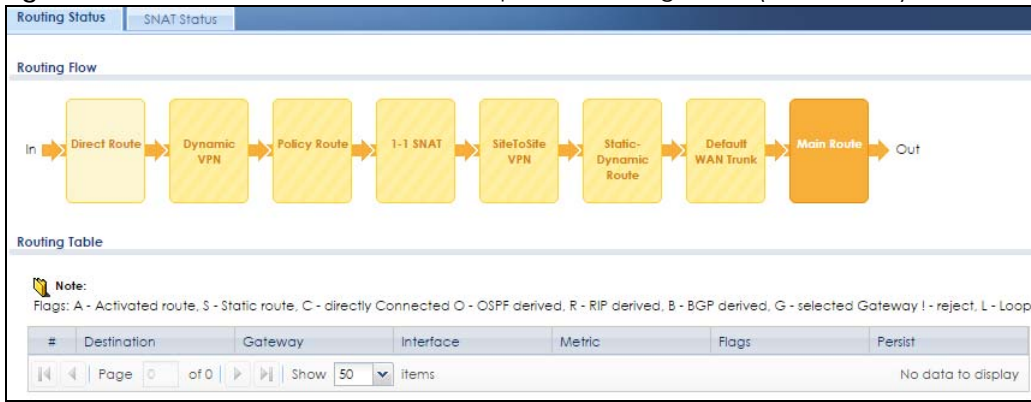

Figure 750 Maintenance > Packet Flow Explore > Routing Status (Main Route)



The following table describes the labels in this screen.

Table 429 Maintenance > Packet Flow Explore > Routing Status

LABEL	DESCRIPTION
Routing Flow	This section shows you the flow of how the Zyxel Device determines where to route a packet. Click a function box to display the related settings in the Routing Table section.
Routing Table	This section shows the corresponding settings according to the function box you click in the Routing Flow section.
The following fields are available if you click Direct Route , Static-Dynamic Route , or Main Route in the Routing Flow section.	
#	This field is a sequential value, and it is not associated with any entry.
Destination	This is the destination IP address of a route.
Gateway	This is the IP address of the next-hop gateway or the interface through which the traffic is routed.
Interface	This is the name of an interface associated with the route.
Metric	This is the route's priority among the displayed routes.

Table 429 Maintenance > Packet Flow Explore > Routing Status (continued)

LABEL	DESCRIPTION
Flags	This indicates additional information for the route. The possible flags are: <ul style="list-style-type: none"> • A - this route is currently activated. • S - this is a static route. • C - this is a direct connected route. • O - this is a dynamic route learned through OSPF. • R - this is a dynamic route learned through RIP. • B - this is a dynamic route learned through BGP. • G - the route is to a gateway (router) in the same network. • ! - this is a route which forces a route lookup to fail. • B - this is a route which discards packets. • L - this is a recursive route.
Persist	This is the remaining time of a dynamically learned route. The Zyxel Device removes the route after this time period is counted down to zero.
The following fields are available if you click Policy Route in the Routing Flow section.	
#	This field is a sequential value, and it is not associated with any entry.
Incoming	This is the interface on which the packets are received.
Source	This is the source IP address(es) from which the packets are sent.
Destination	This is the destination IP address(es) to which the packets are transmitted.
Service	This is the name of the service object. any means all services.
Source Port	This is the source port(s) from which the packets are sent.
DSCP Code	This is the DSCP value of incoming packets to which this policy route applies. See Section 11.2 on page 431 for more information.
Next Hop Type	This is the type of the next hop to which packets are directed.
Next Hop Info	<ul style="list-style-type: none"> • This is the main route if the next hop type is Auto. • This is the interface name and gateway IP address if the next hop type is Interface /GW. • This is the tunnel name if the next hop type is VPN Tunnel. • This is the trunk name if the next hop type is Trunk.
The following fields are available if you click 1-1 SNAT in the Routing Flow section.	
#	This field is a sequential value, and it is not associated with any entry.
NAT Rule	This is the name of an activated 1:1 or Many 1:1 NAT rule in the NAT table.
Source	This is the external source IP address(es).
Protocol	This is the transport layer protocol.
Source Port	This is the source port number.
Destination	This is the external destination IP address(es).
Outgoing	This is the outgoing interface that the SNAT rule uses to transmit packets.
Gateway	This is the IP address of the gateway in the same network of the outgoing interface.
The following fields are available if you click Dynamic VPN or SiteToSite VPN in the Routing Flow section.	
#	This field is a sequential value, and it is not associated with any entry.
Source	This is the IP address(es) of the local VPN network.
Destination	This is the IP address(es) for the remote VPN network.
VPN Tunnel	This is the name of the VPN tunnel.
The following fields are available if you click Default WAN Trunk in the Routing Flow section.	
#	This field is a sequential value, and it is not associated with any entry.
Source	This is the source IP address(es) from which the packets are sent. any means any IP address.

Table 429 Maintenance > Packet Flow Explore > Routing Status (continued)

LABEL	DESCRIPTION
Destination	This is the destination IP address(es) to which the packets are transmitted. any means any IP address.
Trunk	This is the name of the WAN trunk through which the matched packets are transmitted.

48.3 The SNAT Status Screen

The **SNAT Status** screen allows you to view and quickly link to specific source NAT (SNAT) settings. Click a function box in the **SNAT Flow** section, the related SNAT rules (activated) will display in the **SNAT Table** section. To access this screen, click **Maintenance > Packet Flow Explore > SNAT Status**.

The order of the SNAT flow may vary depending on whether you:

- select **use default SNAT** in the **CONFIGURATION > Network > Interface > Trunk** screen.
- use policy routes to control 1-1 NAT by using the `policy control-virtual-server-rules activate` command.

Note: Once a packet matches the criteria of an SNAT rule, the Zyxel Device takes the corresponding action and does not perform any further flow checking.

Figure 751 Maintenance > Packet Flow Explore > SNAT Status (Policy Route SNAT)

SNAT Flow

In → Policy Route SNAT → 1-1 SNAT → Loopback SNAT → Default SNAT → Out

SNAT Table

Note:
If you want to configure Policy Route SNAT, please go to [Policy Route](#).

#	PR #	Outgoing	SNAT
No data to display			

Page 1 of 1 | Show 50 items

Figure 752 Maintenance > Packet Flow Explore > SNAT Status (1-1 SNAT)

Routing Status | **SNAT Status**

SNAT Flow

In → Policy Route SNAT → 1-1 SNAT → Loopback SNAT → Default SNAT → Out

SNAT Table

Note:
If you want to configure 1-1 SNAT, please go to [NAT](#).

#	NAT Rule	Source	Protocol	Source Port	Destination	Outgoing	SNAT
No data to display							

Page 0 of 0 | Show 50 items

Figure 753 Maintenance > Packet Flow Explore > SNAT Status (Loopback SNAT)

SNAT Flow

In → Policy Route SNAT → 1-1 SNAT → Loopback SNAT → Default SNAT → Out

SNAT Table

Note:
If you want to configure loopback SNAT, please go to [NAT](#).
Loopback SNAT will be only applied only when the initiator is located at the network which the server locates at.

#	NAT Rule	Source	Destination	SNAT
No data to display				

Page 1 of 1 | Show 50 items

Figure 754 Maintenance > Packet Flow Explore > SNAT Status (Default SNAT)

SNAT Flow

In → Policy Route SNAT → 1-1 SNAT → Loopback SNAT → Default SNAT → Out

SNAT Table

Note:
If you want to configure Default SNAT, please go to [Trunk](#).

#	Incoming	Outgoing	SNAT
1	Internal Interface	External Interface	Outgoing Interface IP

Page 1 of 1 | Show 50 items | Displaying 1 - 1 of 1

The following table describes the labels in this screen.

Table 430 Maintenance > Packet Flow Explore > SNAT Status

LABEL	DESCRIPTION
SNAT Flow	This section shows you the flow of how the Zyxel Device changes the source IP address for a packet according to the rules you have configured in the Zyxel Device. Click a function box to display the related settings in the SNAT Table section.
SNAT Table	The table fields in this section vary depending on the function box you select in the SNAT Flow section.
The following fields are available if you click Policy Route SNAT in the SNAT Flow section.	
#	This field is a sequential value, and it is not associated with any entry.
PR #	This is the number of an activated policy route which uses SNAT.
Outgoing	This is the outgoing interface that the route uses to transmit packets.
SNAT	This is the source IP address(es) that the SNAT rule uses finally.
The following fields are available if you click 1-1 SNAT in the SNAT Flow section.	
#	This field is a sequential value, and it is not associated with any entry.
NAT Rule	This is the name of an activated NAT rule which uses SNAT.
Source	This is the external source IP address(es).
Protocol	This is the transport layer protocol.
Source Port	This is the source port number.
Destination	This is the external destination IP address(es).
Outgoing	This is the outgoing interface that the SNAT rule uses to transmit packets.
SNAT	This is the source IP address(es) that the SNAT rule uses finally.
The following fields are available if you click Loopback SNAT in the SNAT Flow section.	
#	This field is a sequential value, and it is not associated with any entry.

Table 430 Maintenance > Packet Flow Explore > SNAT Status (continued)

LABEL	DESCRIPTION
NAT Rule	This is the name of an activated NAT rule which uses SNAT and enables NAT loopback.
Source	This is the external source IP address(es). any means any IP address.
Destination	This is the external destination IP address(es). any means any IP address.
SNAT	This indicates which source IP address the SNAT rule uses finally. For example, Outgoing Interface IP means that the Zyxel Device uses the IP address of the outgoing interface as the source IP address for the matched packets it sends out through this rule.
The following fields are available if you click Default SNAT in the SNAT Flow section.	
#	This field is a sequential value, and it is not associated with any entry.
Incoming	This indicates internal interface(s) on which the packets are received.
Outgoing	This indicates external interface(s) from which the packets are transmitted.
SNAT	This indicates which source IP address the SNAT rule uses finally. For example, Outgoing Interface IP means that the Zyxel Device uses the IP address of the outgoing interface as the source IP address for the matched packets it sends out through this rule.

CHAPTER 49

Shutdown/Reboot

49.1 Overview

Use this to shutdown the device in preparation for disconnecting the power.

Always use the Maintenance > Shutdown > Shutdown screen or the “shutdown” command before you turn off the Zyxel Device or remove the power. Not doing so can cause the firmware to become corrupt.

49.1.1 What You Need To Know

Shutdown writes all cached data to the local storage and stops the system processes.

49.2 The Shutdown Screen

To access this screen, click **Maintenance > Shutdown**.

Figure 755 Maintenance > Shutdown

The screenshot shows the 'Shutdown/Reboot' configuration page. It is divided into two main sections: 'Shutdown' and 'Reboot'.

- Shutdown Section:** Contains a 'Shutdown' button and the instruction: 'Click the Shutdown button to turn off the device.'
- Reboot Section:** Contains a 'Reboot' button and the instruction: 'Click the Reboot button to reboot the device. Please wait a minute until the login screen appears. If the login screen does not appear, type the IP address of the device in your Web browser.'
- Schedule Reboot:** A checkbox labeled 'Schedule Reboot' is checked. Below it are three radio button options: 'Daily', 'Weekly', and 'Monthly'. Each option has associated dropdown menus for scheduling: 'Daily' has (Hour) and (Minute); 'Weekly' has (Day), (Hour), and (Minute); 'Monthly' has (Day), (Hour), and (Minute). A green information icon is next to the 'Monthly' (Day) dropdown.
- Note:** A yellow note icon is followed by the text: 'Schedule Reboot and Auto Firmware Update functions are mutually exclusive. If Auto Firmware Update enabled, then you cannot set Schedule Reboot and vice versa.'
- Buttons:** 'Apply' and 'Reset' buttons are located at the bottom of the page.

The following table describes the labels in this screen.

Table 431 Maintenance> Shutdown/ Reboot

LABEL	DESCRIPTION
Shutdown	Click the Shutdown button to shut down the Zyxel Device. Wait for the device to shut down before you manually turn off or remove the power. It does not turn off the power.
Reboot	Click Reboot to reboot the Zyxel Device immediately without turning the power off.
Schedule Reboot	<p>Select this check box to schedule a periodic reboot of the Zyxel Device.</p> <p>You should select a time when your network is not busy for minimal interruption.</p> <p>Note: You cannot enable Auto Update in File Manager> Firmware Management and Schedule Reboot in Maintenance> Shutdown-Reboot at the same time.</p>
Daily	Set the Zyxel Device to reboot every day at the specified time. The time format is the 24 hour clock, so '0' means midnight for example.
Weekly	Set the Zyxel Device to reboot once a week on the day and at the time specified.
Monthly	<p>Set the Zyxel Device to reboot once a month on the specified day, at the specified hour and minute.</p> <p>Note: If the date you select is greater than the number of days in a month, the Zyxel Device automatically backs up its configuration on the last day of the month. For example, if you select 31 and the month is February, the Zyxel Device backs up its configuration file on day 28 or 29.</p>
Apply	Click Apply to save you change back to the Zyxel Device.
Reset	Click <i>Reset</i> to return the screen to its last-saved settings.

You can also use the CLI command `shut down` to close down the Zyxel Device.

PART III

Appendices and Troubleshooting

CHAPTER 50

Troubleshooting

This chapter offers some suggestions to solve problems you might encounter.

- You can also refer to the logs (see [Section 7.36 on page 278](#)).
- For the order in which the Zyxel Device applies its features and checks, see [Chapter on page 1053](#).

None of the LEDs turn on.

Make sure that you have the power cord connected to the Zyxel Device and plugged in to an appropriate power source. Make sure you have the Zyxel Device turned on. Check all cable connections.

If the LEDs still do not turn on, you may have a hardware problem. In this case, you should contact your local vendor.

Cannot access the Zyxel Device from the LAN.

- Check the cable connection between the Zyxel Device and your computer or switch.
- Ping the Zyxel Device from a LAN computer. Make sure your computer's Ethernet card is installed and functioning properly. Also make sure that its IP address is in the same subnet as the Zyxel Device's.
- In the computer, click **Start, (All) Programs, Accessories** and then **Command Prompt**. In the **Command Prompt** window, type "ping" followed by the Zyxel Device's LAN IP address (192.168.1.1 is the default) and then press [ENTER]. The Zyxel Device should reply.
- If you've forgotten the Zyxel Device's password, use the **RESET** button. Press the button in for about 5 seconds (or until the **SYS** LED starts to blink), then release it. It returns the Zyxel Device to the factory defaults (password is 1234, LAN IP address 192.168.1.1 etc).
- If you've forgotten the Zyxel Device's IP address, you can use the commands through the **CONSOLE** port to check it. Connect your computer to the **CONSOLE** port using a console cable. Your computer should have a terminal emulation communications program (such as HyperTerminal) set to VT100 terminal emulation, no parity, 8 data bits, 1 stop bit, no flow control and 115200 bps port speed.

I cannot access the Internet.

- Check the Zyxel Device's connection to the Ethernet jack with Internet access. Make sure the Internet gateway device (such as a DSL modem) is working properly.
- Check the WAN interface's status in the **Dashboard**. Use the installation setup wizard again and make sure that you enter the correct settings. Use the same case as provided by your ISP.

I cannot update the anti-virus/IDP/application patrol signatures.

- Make sure your Zyxel Device has the anti-virus/IDP/application patrol service registered and that the license is not expired. Purchase a new license if the license is expired.
- Make sure your Zyxel Device is connected to the Internet.

I downloaded updated anti-virus or IDP/application patrol signatures. Why has the Zyxel Device not re-booted yet?

The Zyxel Device does not have to reboot when you upload new signatures.

The content filter category service is not working.

- Make sure your Zyxel Device has the content filter category service registered and that the license is not expired. Purchase a new license if the license is expired.
- Make sure your Zyxel Device is connected to the Internet.
- Make sure you select **Enable Content Filter Category Service** when you add a filter profile in the **Content Filter > Profile > Add Filter Profile > Category Service** screen.

I configured security settings but the Zyxel Device is not applying them for certain interfaces.

Many security settings are usually applied to zones. Make sure you assign the interfaces to the appropriate zones. When you create an interface, there is no security applied on it until you assign it to a zone.

The Zyxel Device is not applying the custom policy route I configured.

The Zyxel Device checks the policy routes in the order that they are listed. So make sure that your custom policy route comes before any other routes that the traffic would also match.

The Zyxel Device is not applying the custom security policy I configured.

The Zyxel Device checks the security policies in the order that they are listed. So make sure that your custom security policy comes before any other rules that the traffic would also match.

I cannot enter the interface name I want.

The format of interface names other than the Ethernet interface names is very strict. Each name consists of 2-4 letters (interface type), followed by a number (x, limited by the maximum number of each type of interface). For example, VLAN interfaces are vlan0, vlan1, vlan2,...; and so on.

- The names of virtual interfaces are derived from the interfaces on which they are created. For example, virtual interfaces created on Ethernet interface wan1 are called wan1:1, wan1:2, and so on. Virtual interfaces created on VLAN interface vlan2 are called vlan2:1, vlan2:2, and so on. You cannot specify the number after the colon(:) in the Web Configurator; it is a sequential number. You can specify the number after the colon if you use the CLI to set up a virtual interface.

I cannot set up a PPP interface, virtual Ethernet interface or virtual VLAN interface on an Ethernet interface.

You cannot set up a PPP interface, virtual Ethernet interface or virtual VLAN interface if the underlying interface is a member of a bridge. You also cannot add an Ethernet interface or VLAN interface to a bridge if the member interface has a virtual interface or PPP interface on top of it.

My rules and settings that apply to a particular interface no longer work.

The interface's IP address may have changed. To avoid this create an IP address object based on the interface. This way the Zyxel Device automatically updates every rule or setting that uses the object whenever the interface's IP address settings change. For example, if you change LAN1's IP address, the Zyxel Device automatically updates the corresponding interface-based, LAN1 subnet address object.

I cannot set up a PPP interface.

You have to set up an ISP account before you create a PPPoE or PPTP interface.

The data rates through my cellular connection are no-where near the rates I expected.

The actual cellular data rate you obtain varies depending on the cellular device you use, the signal strength to the service provider's base station, and so on.

I created a cellular interface but cannot connect through it.

- Make sure you have a compatible mobile broadband device installed or connected. See www.zyxel.com for details.
- Make sure you have the cellular interface enabled.
- Make sure the cellular interface has the correct user name, password, and PIN code configured with the correct casing.
- If the Zyxel Device has multiple WAN interfaces, make sure their IP addresses are on different subnets.

[Hackers have accessed my WEP-encrypted wireless LAN.](#)

WEP is extremely insecure. Its encryption can be broken by an attacker, using widely-available software. It is strongly recommended that you use a more effective security mechanism. Use the strongest security mechanism that all the wireless devices in your network support. WPA2 or WPA2-PSK is recommended.

[The wireless security is not following the re-authentication timer setting I specified.](#)

If a RADIUS server authenticates wireless stations, the re-authentication timer on the RADIUS server has priority. Change the RADIUS server's configuration if you need to use a different re-authentication timer setting.

[I cannot configure a particular VLAN interface on top of an Ethernet interface even though I have it configured it on top of another Ethernet interface.](#)

Each VLAN interface is created on top of only one Ethernet interface.

[The Zyxel Device is not applying an interface's configured ingress bandwidth limit.](#)

At the time of writing, the Zyxel Device does not support ingress bandwidth management.

[The Zyxel Device is not applying my application patrol bandwidth management settings.](#)

Bandwidth management in policy routes has priority over application patrol bandwidth management.

[The Zyxel Device's performance slowed down after I configured many new application patrol entries.](#)

The Zyxel Device checks the ports and conditions configured in application patrol entries in the order they appear in the list. While this sequence does not affect the functionality, you might improve the performance of the Zyxel Device by putting more commonly used ports at the top of the list.

The Zyxel Device's anti-virus scanner cleaned an infected file but now I cannot use the file.

The scanning engine checks the contents of the packets for malware. If a malware pattern is matched, the Zyxel Device removes a portion of the file, while the rest goes through. Since the Zyxel Device erases a portion of the file before sending it, you may not be able to open the file.

The Zyxel Device sent an alert that a virus-infected file has been found, but the file was still forwarded to the user and could still be executed.

Make sure you enable **Destroy Infected File** in the **Configuration > UTM Profile > Anti-Virus > Profile: Profile Management > Add** screen to modify infected files before forwarding to the user, preventing them from being executed.

I added a file pattern in the anti-virus white list, but the Zyxel Device still checks and modifies files that match this pattern.

Make sure you select the **Check White List** check box above the white list table. If it is already selected, make sure that the white list entry corresponding to this file pattern is activated.

The Zyxel Device is not scanning some zipped files.

The Zyxel Device cannot unzip password protected ZIP files or a ZIP file within another ZIP file. There are also limits to the number of ZIP files that the Zyxel Device can concurrently unzip.

The Zyxel Device is deleting some zipped files.

The anti-virus policy may be set to delete zipped files that the Zyxel Device cannot unzip. The Zyxel Device cannot unzip password protected ZIP files or a ZIP file within another ZIP file. There are also limits to the number of ZIP files that the Zyxel Device can concurrently unzip.

The Zyxel Device's performance seems slower after configuring IDP.

Depending on your network topology and traffic load, binding every packet direction to an IDP profile may affect the Zyxel Device's performance. You may want to focus IDP scanning on certain traffic directions such as incoming traffic.

[IDP is dropping traffic that matches a rule that says no action should be taken.](#)

The Zyxel Device checks all signatures and continues searching even after a match is found. If two or more rules have conflicting actions for the same packet, then the Zyxel Device applies the more restrictive action (**reject-both**, **reject-receiver** or **reject-sender**, **drop**, **none** in this order). If a packet matches a rule for **reject-receiver** and it also matches a rule for **reject-sender**, then the Zyxel Device will reject-both.

[I uploaded a custom signature file and now all of my earlier custom signatures are gone.](#)

The name of the complete custom signature file on the Zyxel Device is 'custom.rules'. If you import a file named 'custom.rules', then all custom signatures on the Zyxel Device are overwritten with the new file. If this is not your intention, make sure that the files you import are not named 'custom.rules'.

[I cannot configure some items in IDP that I can configure in Snort.](#)

Not all Snort functionality is supported in the Zyxel Device.

[The Zyxel Device's performance seems slower after configuring ADP.](#)

Depending on your network topology and traffic load, applying an anomaly profile to each and every packet direction may affect the Zyxel Device's performance.

[The Zyxel Device destroyed/dropped a file/email without notifying me.](#)

Make sure you enable logs for your security settings, such as in the following screens:

- **Configuration > UTM Profile > IDP > Profile > Add**
- **Configuration > UTM Profile > Anti-Virus > Profile: Profile Management > Add**
- **Configuration > UTM Profile > Anti-Spam > Profile > Add**

[The Zyxel Device routes and applies SNAT for traffic from some interfaces but not from others.](#)

The Zyxel Device automatically uses SNAT for traffic it routes from internal interfaces to external interfaces. For example LAN to WAN traffic. You must manually configure a policy route to add routing and SNAT settings for an interface with the **Interface Type** set to **General**. You can also configure a policy route to override the default routing and SNAT behavior for an interface with the **Interface Type** set to **Internal** or **External**.

I cannot get Dynamic DNS to work.

- You must have a public WAN IP address to use Dynamic DNS.
- Make sure you recorded your DDNS account's user name, password, and domain name and have entered them properly in the Zyxel Device.
- You may need to configure the DDNS entry's IP Address setting to **Auto** if the interface has a dynamic IP address or there are one or more NAT routers between the Zyxel Device and the DDNS server.
- The Zyxel Device may not determine the proper IP address if there is an HTTP proxy server between the Zyxel Device and the DDNS server.

I cannot create a second HTTP redirect rule for an incoming interface.

You can configure up to one HTTP redirect rule for each (incoming) interface.

I cannot get the application patrol to manage SIP traffic.

Make sure you have the SIP ALG enabled.

I cannot get the application patrol to manage H.323 traffic.

Make sure you have the H.323 ALG enabled.

I cannot get the application patrol to manage FTP traffic.

Make sure you have the FTP ALG enabled.

The Zyxel Device keeps resetting the connection.

If an alternate gateway on the LAN has an IP address in the same subnet as the Zyxel Device's LAN IP address, return traffic may not go through the Zyxel Device. This is called an asymmetrical or "triangle"

route. This causes the Zyxel Device to reset the connection, as the connection has not been acknowledged.

You can set the Zyxel Device's security policy to permit the use of asymmetrical route topology on the network (so it does not reset the connection) although this is not recommended since allowing asymmetrical routes may let traffic from the WAN go directly to the LAN without passing through the Zyxel Device. A better solution is to use virtual interfaces to put the Zyxel Device and the backup gateway on separate subnets. See [Asymmetrical Routes on page 602](#) and the chapter about interfaces for more information.

I cannot set up an IPSec VPN tunnel to another device.

If the IPSec tunnel does not build properly, the problem is likely a configuration error at one of the IPSec routers. Log into both Zyxel IPSec routers and check the settings in each field methodically and slowly. Make sure both the Zyxel Device and remote IPSec router have the same security settings for the VPN tunnel. It may help to display the settings for both routers side-by-side.

Here are some general suggestions. See also [Chapter 30 on page 635](#).

- The system log can often help to identify a configuration problem.
- If you enable NAT traversal, the remote IPSec device must also have NAT traversal enabled.
- The Zyxel Device and remote IPSec router must use the same authentication method to establish the IKE SA.
- Both routers must use the same negotiation mode.
- Both routers must use the same encryption algorithm, authentication algorithm, and DH key group.
- When using pre-shared keys, the Zyxel Device and the remote IPSec router must use the same pre-shared key.
- The Zyxel Device's local and peer ID type and content must match the remote IPSec router's peer and local ID type and content, respectively.
- The Zyxel Device and remote IPSec router must use the same active protocol.
- The Zyxel Device and remote IPSec router must use the same encapsulation.
- The Zyxel Device and remote IPSec router must use the same SPI.
- If the sites are/were previously connected using a leased line or ISDN router, physically disconnect these devices from the network before testing your new VPN connection. The old route may have been learned by RIP and would take priority over the new VPN connection.
- To test whether or not a tunnel is working, ping from a computer at one site to a computer at the other.
Before doing so, ensure that both computers have Internet access (via the IPSec routers).
- It is also helpful to have a way to look at the packets that are being sent and received by the Zyxel Device and remote IPSec router (for example, by using a packet sniffer).

Check the configuration for the following Zyxel Device features.

- The Zyxel Device does not put IPSec SAs in the routing table. You must create a policy route for each VPN tunnel. See [Chapter 11 on page 429](#).
- Make sure the To-Zyxel Device security policies allow IPSec VPN traffic to the Zyxel Device. IKE uses UDP port 500, AH uses IP protocol 51, and ESP uses IP protocol 50.

- The Zyxel Device supports UDP port 500 and UDP port 4500 for NAT traversal. If you enable this, make sure the To-Zyxel Device security policies allow UDP port 4500 too.
- Make sure regular security policies allow traffic between the VPN tunnel and the rest of the network. Regular security policies check packets the Zyxel Device sends before the Zyxel Device encrypts them and check packets the Zyxel Device receives after the Zyxel Device decrypts them. This depends on the zone to which you assign the VPN tunnel and the zone from which and to which traffic may be routed.
- If you set up a VPN tunnel across the Internet, make sure your ISP supports AH or ESP (whichever you are using).
- If you have the Zyxel Device and remote IPSec router use certificates to authenticate each other, You must set up the certificates for the Zyxel Device and remote IPSec router first and make sure they trust each other's certificates. If the Zyxel Device's certificate is self-signed, import it into the remote IPSec router. If it is signed by a CA, make sure the remote IPSec router trusts that CA. The Zyxel Device uses one of its **Trusted Certificates** to authenticate the remote IPSec router's certificate. The trusted certificate can be the remote IPSec router's self-signed certificate or that of a trusted CA that signed the remote IPSec router's certificate.
- Multiple SAs connecting through a secure gateway must have the same negotiation mode.

The VPN connection is up but VPN traffic cannot be transmitted through the VPN tunnel.

If you have the **Configuration > VPN > IPSec VPN > VPN Connection** screen's **Use Policy Route to control dynamic IPSec rules option** enabled, check the routing policies to see if they are sending traffic elsewhere instead of through the VPN tunnels.

I uploaded a logo to show in the SSL VPN user screens but it does not display properly.

The logo graphic must be GIF, JPG, or PNG format. The graphic should use a resolution of 103 x 29 pixels to avoid distortion when displayed. The Zyxel Device automatically resizes a graphic of a different resolution to 103 x 29 pixels. The file size must be 100 kilobytes or less. Transparent background is recommended.

I logged into the SSL VPN but cannot see some of the resource links.

Available resource links vary depending on the SSL application object's configuration.

I cannot download the Zyxel Device's firmware package.

The Zyxel Device's firmware package cannot go through the Zyxel Device when you enable the anti-virus **Destroy compressed files that could not be decompressed** option. The Zyxel Device classifies the firmware package as not being able to be decompressed and deletes it.

You can upload the firmware package to the Zyxel Device with the option enabled, so you only need to clear the **Destroy compressed files that could not be decompressed** option while you download the firmware package. See [Section 39.2.1 on page 777](#) for more on the anti-virus **Destroy compressed files that could not be decompressed** option.

[I changed the LAN IP address and can no longer access the Internet.](#)

The Zyxel Device automatically updates address objects based on an interface's IP address, subnet, or gateway if the interface's IP address settings change. However, you need to manually edit any address objects for your LAN that are not based on the interface.

[I configured application patrol to allow and manage access to a specific service but access is blocked.](#)

- If you want to use a service, make sure the security policy allows UTM application patrol to go through the Zyxel Device.

[I configured policy routes to manage the bandwidth of TCP and UDP traffic but the bandwidth management is not being applied properly.](#)

It is recommended to use application patrol instead of policy routes to manage the bandwidth of TCP and UDP traffic.

[I cannot get the RADIUS server to authenticate the Zyxel Device's default admin account.](#)

The default **admin** account is always authenticated locally, regardless of the authentication method setting.

[The Zyxel Device fails to authentication the ext-user user accounts I configured.](#)

An external server such as AD, LDAP or RADIUS must authenticate the ext-user accounts. If the Zyxel Device tries to use the local database to authenticate an **ext-user**, the authentication attempt will always fail. (This is related to AAA servers and authentication methods, which are discussed in other chapters in this guide.)

[I cannot add the admin users to a user group with access users.](#)

You cannot put access users and admin users in the same user group.

I cannot add the default admin account to a user group.

You cannot put the default **admin** account into any user group.

The schedule I configured is not being applied at the configured times.

Make sure the Zyxel Device's current date and time are correct.

I cannot get a certificate to import into the Zyxel Device.

- 1 For **My Certificates**, you can import a certificate that matches a corresponding certification request that was generated by the Zyxel Device. You can also import a certificate in PKCS#12 format, including the certificate's public and private keys.
- 2 You must remove any spaces from the certificate's filename before you can import the certificate.
- 3 Any certificate that you want to import has to be in one of these file formats:
 - Binary X.509: This is an ITU-T recommendation that defines the formats for X.509 certificates.
 - PEM (Base-64) encoded X.509: This Privacy Enhanced Mail format uses lowercase letters, uppercase letters and numerals to convert a binary X.509 certificate into a printable form.
 - Binary PKCS#7: This is a standard that defines the general syntax for data (including digital signatures) that may be encrypted. A PKCS #7 file is used to transfer a public key certificate. The private key is not included. The Zyxel Device currently allows the importation of a PKCS#7 file that contains a single certificate.
 - PEM (Base-64) encoded PKCS#7: This Privacy Enhanced Mail (PEM) format uses lowercase letters, uppercase letters and numerals to convert a binary PKCS#7 certificate into a printable form.
 - Binary PKCS#12: This is a format for transferring public key and private key certificates. The private key in a PKCS #12 file is within a password-encrypted envelope. The file's password is not connected to your certificate's public or private passwords. Exporting a PKCS #12 file creates this and you must provide it to decrypt the contents when you import the file into the Zyxel Device.

Note: Be careful not to convert a binary file to text during the transfer process. It is easy for this to occur since many programs use text files by default.

I cannot access the Zyxel Device from a computer connected to the Internet.

Check the service control rules and to-Zyxel Device security policies.

I uploaded a logo to display on the upper left corner of the Web Configurator login screen and access page but it does not display properly.

Make sure the logo file is a GIF, JPG, or PNG of 100 kilobytes or less.

I uploaded a logo to use as the screen or window background but it does not display properly.

Make sure the logo file is a GIF, JPG, or PNG of 100 kilobytes or less.

The Zyxel Device's traffic throughput rate decreased after I started collecting traffic statistics.

Data collection may decrease the Zyxel Device's traffic throughput rate.

I can only see newer logs. Older logs are missing.

When a log reaches the maximum number of log messages, new log messages automatically overwrite existing log messages, starting with the oldest existing log message first.

The commands in my configuration file or shell script are not working properly.

- In a configuration file or shell script, use “#” or “!” as the first character of a command line to have the Zyxel Device treat the line as a comment.
- Your configuration files or shell scripts can use “exit” or a command line consisting of a single “!” to have the Zyxel Device exit sub command mode.
- Include `write` commands in your scripts. Otherwise the changes will be lost when the Zyxel Device restarts. You could use multiple `write` commands in a long script.

Note: “exit” or “!” must follow sub commands if it is to make the Zyxel Device exit sub command mode.

See [Chapter on page 1032](#) for more on configuration files and shell scripts.

I cannot get the firmware uploaded using the commands.

The Web Configurator is the recommended method for uploading firmware. You only need to use the command line interface if you need to recover the firmware. See the CLI Reference Guide for how to determine if you need to recover the firmware and how to recover it.

My packet capture captured less than I wanted or failed.

The packet capture screen's **File Size** sets a maximum size limit for the total combined size of all the capture files on the Zyxel Device, including any existing capture files and any new capture files you generate. If you have existing capture files you may need to set this size larger or delete existing capture files.

The Zyxel Device stops the capture and generates the capture file when either the capture files reach the **File Size** or the time period specified in the **Duration** field expires.

My earlier packet capture files are missing.

New capture files overwrite existing files of the same name. Change the **File Suffix** field's setting to avoid this.

The SecuReporter banner keeps showing up.

See [Configuration > Cloud CNM > SecuReporter > set Org/Network site on page 631](#) for more information.

50.1 Resetting the Zyxel Device

If you cannot access the Zyxel Device by any method, try restarting it by turning the power off and then on again. If you still cannot access the Zyxel Device by any method or you forget the administrator password(s), you can reset the Zyxel Device to its factory-default settings. Any configuration files or shell scripts that you saved on the Zyxel Device should still be available afterwards.

Use the following procedure to reset the Zyxel Device to its factory-default settings. This overwrites the settings in the startup-config.conf file with the settings in the system-default.conf file.

Note: This procedure removes the current configuration.

- 1 Make sure the **SYS** LED is on and not blinking.
- 2 Press the **RESET** button and hold it until the **SYS** LED begins to blink. (This usually takes about five seconds.)
- 3 Release the **RESET** button, and wait for the Zyxel Device to restart.

You should be able to access the Zyxel Device using the default settings.

50.2 Getting More Troubleshooting Help

Search for support information for your model at www.zyxel.com for more troubleshooting suggestions.

APPENDIX A

Customer Support

In the event of problems that cannot be solved by using this manual, you should contact your vendor. If you cannot contact your vendor, then contact a Zyxel office for the region in which you bought the device.

For Zyxel Communication offices, see <https://service-provider.zyxel.com/global/en/contact-us> for the latest information.

For Zyxel Network offices, see <https://www.zyxel.com/index.shtml> for the latest information.

Please have the following information ready when you contact an office.

Required Information

- Product model and serial number.
- Warranty Information.
- Date that you received your device.
- Brief description of the problem and the steps you took to solve it.

Corporate Headquarters (Worldwide)

Taiwan

- Zyxel Communications Corporation
- <https://www.zyxel.com>

Asia

China

- Zyxel Communications (Shanghai) Corp.
- Zyxel Communications (Beijing) Corp.
- Zyxel Communications (Tianjin) Corp.
- <https://www.zyxel.com/cn/zh/>

India

- Zyxel Technology India Pvt Ltd.
- <https://www.zyxel.com/in/en/>

Kazakhstan

- Zyxel Kazakhstan
- <https://www.zyxel.kz>

Korea

- Zyxel Korea Corp.
- <http://www.zyxel.kr>

Malaysia

- Zyxel Malaysia Sdn Bhd.
- <http://www.zyxel.com.my>

Pakistan

- Zyxel Pakistan (Pvt.) Ltd.
- <http://www.zyxel.com.pk>

Philippines

- Zyxel Philippines
- <http://www.zyxel.com.ph>

Singapore

- Zyxel Singapore Pte Ltd.
- <http://www.zyxel.com.sg>

Taiwan

- Zyxel Communications Corporation
- <https://www.zyxel.com/tw/zh/>

Thailand

- Zyxel Thailand Co., Ltd.
- <https://www.zyxel.com/th/th/>

Vietnam

- Zyxel Communications Corporation-Vietnam Office
- <https://www.zyxel.com/vn/vi>

Europe

Belarus

- Zyxel BY
- <https://www.zyxel.by>

Bulgaria

- Zyxel България
- <https://www.zyxel.com/bg/bg/>

Czech Republic

- Zyxel Communications Czech s.r.o
- <https://www.zyxel.com/cz/cs/>

Denmark

- Zyxel Communications A/S
- <https://www.zyxel.com/dk/da/>

Finland

- Zyxel Communications
- <https://www.zyxel.com/fi/fi/>

France

- Zyxel France
- <https://www.zyxel.fr>

Germany

- Zyxel Deutschland GmbH
- <https://www.zyxel.com/de/de/>

Hungary

- Zyxel Hungary & SEE
- <https://www.zyxel.com/hu/hu/>

Italy

- Zyxel Communications Italy
- <https://www.zyxel.com/it/it/>

Netherlands

- Zyxel Benelux
- <https://www.zyxel.com/nl/nl/>

Norway

- Zyxel Communications
- <https://www.zyxel.com/no/no/>

Poland

- Zyxel Communications Poland
- <https://www.zyxel.com/pl/pl/>

Romania

- Zyxel Romania

- <https://www.zyxel.com/ro/ro>

Russia

- Zyxel Russia
- <https://www.zyxel.com/ru/ru/>

Slovakia

- Zyxel Communications Czech s.r.o. organizacna zlozka
- <https://www.zyxel.com/sk/sk/>

Spain

- Zyxel Communications ES Ltd.
- <https://www.zyxel.com/es/es/>

Sweden

- Zyxel Communications
- <https://www.zyxel.com/se/sv/>

Switzerland

- Studerus AG
- <https://www.zyxel.ch/de>
- <https://www.zyxel.ch/fr>

Turkey

- Zyxel Turkey A.S.
- <https://www.zyxel.com/tr/tr/>

UK

- Zyxel Communications UK Ltd.
- <https://www.zyxel.com/uk/en/>

Ukraine

- Zyxel Ukraine
- <http://www.ua.zyxel.com>

South America

Argentina

- Zyxel Communications Corporation
- <https://www.zyxel.com/co/es/>

Brazil

- Zyxel Communications Brasil Ltda.
- <https://www.zyxel.com/br/pt/>

Colombia

- Zyxel Communications Corporation
- <https://www.zyxel.com/co/es/>

Ecuador

- Zyxel Communications Corporation
- <https://www.zyxel.com/co/es/>

South America

- Zyxel Communications Corporation
- <https://www.zyxel.com/co/es/>

Middle East

Israel

- Zyxel Communications Corporation
- <http://il.zyxel.com/>

North America

USA

- Zyxel Communications, Inc. – North America Headquarters
- <https://www.zyxel.com/us/en/>

APPENDIX B

Common Services

The following table lists some commonly-used services and their associated protocols and port numbers. For a comprehensive list of port numbers, ICMP type/code numbers and services, visit the IANA (Internet Assigned Number Authority) web site.

- **Name:** This is a short, descriptive name for the service. You can use this one or create a different one, if you like.
- **Protocol:** This is the type of IP protocol used by the service. If this is **TCP/UDP**, then the service uses the same port number with TCP and UDP. If this is **User-Defined**, the **Port(s)** is the IP protocol number, not the port number.
- **Port(s):** This value depends on the **Protocol**. Please refer to RFC 1700 for further information about port numbers.
 - If the **Protocol** is **TCP, UDP, or TCP/UDP**, this is the IP port number.
 - If the **Protocol** is **USER**, this is the IP protocol number.
- **Description:** This is a brief explanation of the applications that use this service or the situations in which this service is used.

Table 432 Commonly Used Services

NAME	PROTOCOL	PORT(S)	DESCRIPTION
AH (IPSEC_TUNNEL)	User-Defined	51	The IPSEC AH (Authentication Header) tunneling protocol uses this service.
AIM/New-ICQ	TCP	5190	AOL's Internet Messenger service. It is also used as a listening port by ICQ.
AUTH	TCP	113	Authentication protocol used by some servers.
BGP	TCP	179	Border Gateway Protocol.
BOOTP_CLIENT	UDP	68	DHCP Client.
BOOTP_SERVER	UDP	67	DHCP Server.
CU-SEEME	TCP UDP	7648 24032	A popular videoconferencing solution from White Pines Software.
DNS	TCP/UDP	53	Domain Name Server, a service that matches web names (for example www.zyxel.com) to IP numbers.
ESP (IPSEC_TUNNEL)	User-Defined	50	The IPSEC ESP (Encapsulation Security Protocol) tunneling protocol uses this service.
FINGER	TCP	79	Finger is a UNIX or Internet related command that can be used to find out if a user is logged on.
FTP	TCP TCP	20 21	File Transfer Program, a program to enable fast transfer of files, including large files that may not be possible by e-mail.
H.323	TCP	1720	NetMeeting uses this protocol.
HTTP	TCP	80	Hyper Text Transfer Protocol - a client/server protocol for the world wide web.

Table 432 Commonly Used Services (continued)

NAME	PROTOCOL	PORT(S)	DESCRIPTION
HTTPS	TCP	443	HTTPS is a secured http session often used in e-commerce.
ICMP	User-Defined	1	Internet Control Message Protocol is often used for diagnostic or routing purposes.
ICQ	UDP	4000	This is a popular Internet chat program.
IGMP (MULTICAST)	User-Defined	2	Internet Group Multicast Protocol is used when sending packets to a specific group of hosts.
IKE	UDP	500	The Internet Key Exchange algorithm is used for key distribution and management.
IRC	TCP/UDP	6667	This is another popular Internet chat program.
MSN Messenger	TCP	1863	Microsoft Networks' messenger service uses this protocol.
NEW-ICQ	TCP	5190	An Internet chat program.
NEWS	TCP	144	A protocol for news groups.
NFS	UDP	2049	Network File System - NFS is a client/server distributed file service that provides transparent file sharing for network environments.
NNTP	TCP	119	Network News Transport Protocol is the delivery mechanism for the USENET newsgroup service.
PING	User-Defined	1	Packet Internet Groper is a protocol that sends out ICMP echo requests to test whether or not a remote host is reachable.
POP3	TCP	110	Post Office Protocol version 3 lets a client computer get e-mail from a POP3 server through a temporary connection (TCP/IP or other).
PPTP	TCP	1723	Point-to-Point Tunneling Protocol enables secure transfer of data over public networks. This is the control channel.
PPTP_TUNNEL (GRE)	User-Defined	47	PPTP (Point-to-Point Tunneling Protocol) enables secure transfer of data over public networks. This is the data channel.
RCMD	TCP	512	Remote Command Service.
REAL_AUDIO	TCP	7070	A streaming audio service that enables real time sound over the web.
REXEC	TCP	514	Remote Execution Daemon.
RLOGIN	TCP	513	Remote Login.
RTELNET	TCP	107	Remote Telnet.
RTSP	TCP/UDP	554	The Real Time Streaming (media control) Protocol (RTSP) is a remote control for multimedia on the Internet.
SFTP	TCP	115	Simple File Transfer Protocol.
SMTP	TCP	25	Simple Mail Transfer Protocol is the message-exchange standard for the Internet. SMTP enables you to move messages from one e-mail server to another.
SNMP	TCP/UDP	161	Simple Network Management Program.
SNMP-TRAPS	TCP/UDP	162	Traps for use with the SNMP (RFC:1215).

Table 432 Commonly Used Services (continued)

NAME	PROTOCOL	PORT(S)	DESCRIPTION
SQL-NET	TCP	1521	Structured Query Language is an interface to access data on many different types of database systems, including mainframes, midrange systems, UNIX systems and network servers.
SSH	TCP/UDP	22	Secure Shell Remote Login Program.
STRM WORKS	UDP	1558	Stream Works Protocol.
SYSLOG	UDP	514	Syslog allows you to send system logs to a UNIX server.
TACACS	UDP	49	Login Host Protocol used for (Terminal Access Controller Access Control System).
TELNET	TCP	23	Telnet is the login and terminal emulation protocol common on the Internet and in UNIX environments. It operates over TCP/IP networks. Its primary function is to allow users to log into remote host systems.
TFTP	UDP	69	Trivial File Transfer Protocol is an Internet file transfer protocol similar to FTP, but uses the UDP (User Datagram Protocol) rather than TCP (Transmission Control Protocol).
VDOLIVE	TCP	7000	Another videoconferencing solution.

APPENDIX C

Product Features

Please refer to the product datasheet for the latest product features.

Version	4.70	4.70	4.70	4.70	4.70	4.70	4.70	4.70	4.70	4.70	4.70	4.70
Model Name	USG40	USG40W	USG60	USG60W	ZyWALL 110	USG110	USG210	ZyWALL 310	USG310	ZyWALL 1100	USG1100	USG1900
# of MAC Addresses	5	6	6	8	7	7	7	8	8	8	8	8
Interface												
VLAN	8	8	16	16	16	16	32	64	64	128	128	128
Virtual(alias) per interface	4	4	4	4	4	4	4	4	4	4	4	4
PPP (System Default)	2	2	2	2	3	3	3	8	8	8	8	8
PPP (User Created)	2	2	4	4	4	4	8	16	16	32	32	32
Bridge	2	2	4	4	8	8	8	16	16	16	16	16
Tunnel (GRE/IPV6 Transition)	4	4	4	4	4	4	4	4	4	4	4	4
Routing												
Static Route	64	64	128	128	128	128	256	256	256	512	512	512
Policy Route	100	100	200	200	500	500	500	1000	1000	1000	1000	2000
Reserved Sessions for Managed Devices	500	500	500	500	500	500	500	500	500	500	500	500
Max OSPF areas	10	10	10	10	10	10	10	10	10	10	10	10
Max. BGP Neighbor	5	5	5	5	5	5	5	5	5	5	5	5
BGP Max. Network	16	16	16	16	16	16	16	16	16	16	16	16
Sessions												
Max. TCP Concurrent Sessions (Forwarding, NAT/Firewall)	50,000	50,000	100,000	100,000	150,000	150,000	200,000	500,000	500,000	1,000,000	1,000,000	1,000,000
Session Rate	2,000	2,000	3,000	3,000	3,500	3,500	3,500	10,000	10,000	15,000	15,000	20,000
NAT												
Max. Virtual Server Number	128	128	256	256	256	256	512	1024	1024	1024	1024	1024
Firewall (Secure policy)												
Max Firewall ACL Rule Number = Secure Policy Number	500	500	500	500	500	500	500	2,000	2,000	5000	5000	10000
Max Session Limit per Host Rules	1000	1000	1000	1000	1000	1000	1000	1,000	1,000	1000	1000	1000
ADP												
Max. ADP Profile Number	8	8	8	8	8	8	8	16	16	16	16	32
Max. ADP Rule Number	32	32	32	32	32	32	32	32	32	32	32	32
Application Patrol												
Max. AppPatrol Profile	32	32	32	32	32	32	32	64	64	64	64	64
Max Application Object in Each Orofile (object + object group)	32	32	32	32	32	32	32	32	32	32	32	32
User Profile												
Max. Local User	64	64	128	128	128	128	128	256	256	512	512	1024
Max. Admin User	5	5	5	5	5	5	5	5	5	10	10	10
Max. User Group	16	16	32	32	32	32	32	64	64	128	128	256
Max user in one user group	64	64	128	128	128	128	128	256	256	512	512	1024
Default Concurrent Device Login	64	64	200	200	200	200	200	500	500	800	800	1500
Max. Concurrent Device Upgrade (License)	64	64	200	200	300 (Extend by license)	300 (Extend by license)	300 (Extend by license)	800 (Extend by license)	800 (Extend by license)	1500 (Extend by license)	1500 (Extend by license)	2000 (Extend by license)
HTTPd												
Max HTTPd number	128	128	128	128	256	256	256	512	512	512	512	1024
Objects												
Address Object	300	300	300	300	300	300	500	1,000	1,000	2000	2000	2000
Address Group	25	25	50	50	50	50	100	200	200	400	400	400
Max. Address Object in One Group	64	64	128	128	128	128	128	128	128	256	256	256
Service Object	200	200	200	200	500	500	500	1,000	1,000	1,000	1,000	1,000
Service Group	50	50	50	50	100	100	100	200	200	200	200	200
Max. Service Object in One Group	64	64	128	128	128	128	128	128	128	256	256	256
Schedule Object	32	32	32	32	32	32	32	32	32	32	32	32
Schedule Group	16	16	16	16	16	16	16	16	16	16	16	16

Appendix C Product Features

Max. Schedule Object in One Group	24	24	24	24	24	24	24	24	24	24	24	24
Application Object	500	500	500	500	500	500	500	1,000	1,000	1,000	1,000	1,000
Application Group	100	100	100	100	100	100	100	200	200	200	200	200
Max. Application Object in One Group	128	128	128	128	128	128	128	128	128	256	256	256
SP Account	16	16	16	16	16	16	16	32	32	32	64	64
Max. LDAP Server Object #	2	2	2	2	8	8	8	16	16	16	16	16
Max. RADIUS Server Object #	2	2	2	2	8	8	8	16	16	16	16	16
Max. Ad Server Object #	4	4	4	4	8	8	8	16	16	16	16	16
Max. Zone Number (System Default)	8	8	8	8	8	8	8	8	8	8	8	8
Max. Zone Number (User Defined)	8	8	16	16	16	16	16	32	32	32	32	32
Trunk												
Max. Trunk Number (System Default)	1	1	1	1	1	1	1	1	1	1	1	1
Max. Trunk Number (User Defined)	4	4	4	4	8	8	8	16	16	32	32	32
Max. Member Number per Trunk	2+8	2+8	4+8	4+8	4+8	4+8	8+8	16+8	16+8	32+8	32+8	32+8
IPSec VPN												
Max. VPN Tunnels number	20	20	40	40	100	100	200	300	300	1000	1000	2000
Max. VPN Concentrator Number	2	2	2	2	2	2	2	16	16	32	32	64
Max. VPN Configuration Provision Rule Number	20	20	40	40	100	100	200	300	300	1000	1000	2000
Certificate												
Certificate Buffer Size	128k	128k	128k	128k	256k	256k	256k	512k	512k	512k	512k	1024k
Built-in service												
A Record	32	32	64	64	64	64	64	128	128	128	128	128
NS Record (DNS Domain Zone Forward)	8	8	8	8	16	16	16	16	16	16	16	16
MX Record	4	4	8	8	8	8	8	16	16	16	16	16
Max Service Control Entries	16 per service	16 per service	16 per service	16 per service	16 per service	16 per service	16 per service	32 per service	32 per service	32 per service	32 per service	32 per service
Max. DHCP Network Pool)	14	14	24	24	29	29	45	88	88	152	152	152
Max. DHCP Host Pool (Static DHCP)	64	64	96	96	256	256	256	512	512	1024	1024	1024
Max. DHCP Extended Options	10	10	10	10	15	15	15	30	30	30	30	30
Max DDNS Profiles	5	5	10	10	10	10	10	10	10	10	10	10
DHCP Relay	2 per interface	2 per interface	2 per interface	2 per interface	2 per interface	2 per interface	2 per interface	2 per interface	2 per interface	2 per interface	2 per interface	2 per interface
USB Storage												
Device Number	1	1	1	1	1	1	1	1	1	1	1	1
Centralized Log												
Log Entries	512	512	512	512	1024	1024	1024	1024	1024	2048	2048	2048
Debug Log Entries	1024	1024	1024	1024	1024	1024	1024	1024	1024	1024	1024	1024
Admin E-mail Address	2	2	2	2	2	2	2	2	2	2	2	2
Syslog Server	4	4	4	4	4	4	4	4	4	4	4	4
IDP												
Max. IDP Profile Number	8	8	8	8	8	8	8	16	16	16	16	32
Max. Custom Signatures	32	32	32	32	32	32	32	256	256	512	512	512
SSL Inspection												
Max. SSL Inspection Profile	n/a	n/a	n/a	n/a	16	16	16	16	16	16	16	16
Max. Exclude List	n/a	n/a	n/a	n/a	256	256	256	256	256	256	256	256
Content Filtering												
Max. Number Of Content Filter Policies	16	16	16	16	16	16	16	32	32	64	64	128
Forbidden Domain Entry Number	256 per profile	256 per profile	256 per profile	256 per profile	256 per profile	256 per profile	256 per profile	512 per profile	512 per profile	512 per profile	512 per profile	512 per profile
Trusted Domain Entry Number	256 per profile	256 per profile	256 per profile	256 per profile	256 per profile	256 per profile	256 per profile	512 per profile	512 per profile	512 per profile	512 per profile	512 per profile
Keyword Blocking Number	128 per profile	128 per profile	128 per profile	128 per profile	128 per profile	128 per profile	128 per profile	256 per profile	256 per profile	256 per profile	256 per profile	256 per profile
Common Forbidden Domain Entry Number	1024	1024	1024	1024	1024	1024	1024	1024	1024	1024	1024	1024
Common Trusted Domain Entry Number	1024	1024	1024	1024	1024	1024	1024	1024	1024	1024	1024	1024
Anti-Spam												
Maximum AS Rule Number (Profile)	16	16	16	16	32	32	32	64	64	64	64	64

Appendix C Product Features

Maximum White List Rule Support	128	128	128	128	128	128	128	256	256	256	256	256
Maximum Black List Rule Support	128	128	128	128	128	128	128	256	256	256	256	256
Maximum DNSBL Domain Support	5	5	5	5	5	5	5	10	10	10	10	10
Concurrent Mail Session Scanning	200	200	200	200	200	200	200	1000	1000	1000	1000	1000
Max. Statistics Number	500	500	500	500	500	500	500	500	500	500	500	500
Max. Statistics Ranking	10	10	10	10	10	10	10	10	10	10	10	10
Anti-Virus												
Max. AV Rule (Profile)	16	16	16	16	16	16	16	32	32	32	32	32
Max. Statistics Number	500	500	500	500	500	500	500	500	500	500	500	500
Max. Statistics Ranking	10	10	10	10	10	10	10	10	10	10	10	10
SSL VPN												
Default SSL VPN Connections	20	20	20	20	50	50	50	50	50	250	250	250
Maximum SSL VPN Connections	30	30	60	60	150	150	150	150	150	500	500	750
Max. SSL VPN Network List	8	8	8	8	8	8	8	8	8	8	8	8
SSL VPN Max Policy	32	32	32	32	64	64	64	128	128	128	128	128
AP Controller												
Default # Of Control AP	8	8	8	8	8	8	8	8	8	8	8	8
Max. # Of Control AP	24	24	24	24	40	40	40	72	72	136	136	520
AP Group	8	8	8	8	8	8	8	8	8	16	16	16
Max Radio Profile	32	32	32	32	64	64	64	64	64	256	256	256
Max SSID Profile	32	32	32	32	128	128	128	1024	1024	1024	1024	1024
Max Security Profile	32	32	32	32	128	128	128	1024	1024	1024	1024	1024
Max MAC Filter Profile	32	32	32	32	32	32	32	32	32	32	32	32
Max MAC Entry Per MAC Filter Profile	512	512	512	512	512	512	512	512	512	512	512	512
Zymesh	32	32	32	32	32	32	32	32	32	32	32	32
BWM												
Maximum BWM Rule Number	128	128	128	128	256	256	256	512	512	1024	1024	1024
BWM Per Source IP (Max.)	256	256	256	256	1024	1024	1024	1024	1024	2048	2048	2048
SIP												
Maximum SIP Concurrent Call	50	50	50	50	100	100	100	100	100	200	200	200
Custom Web Portal Page												
Max Internal Web Portal Customize File	4	4	4	4	4	4	4	4	4	4	4	4
Upload Zip File Size	Up to 2MB	Up to 2MB	Up to 2MB	Up to 2MB	Up to 2MB	Up to 2MB	Up to 2MB	Up to 2MB	Up to 2MB	Up to 2MB	Up to 2MB	Up to 2MB
Unzip File Size	Up to 5MB	Up to 5MB	Up to 5MB	Up to 5MB	Up to 5MB	Up to 5MB	Up to 5MB	Up to 5MB	Up to 5MB	Up to 5MB	Up to 5MB	Up to 5MB
Hotspot Management												
Max Dynamic Account List	n/a	n/a	1000	1000	2000	2000	2000	4000	4000	4000	4000	4000
Max Free Time Account Limit	n/a	n/a	800	800	1600	1600	1600	3200	3200	3200	3200	3200
Hotspot Support	n/a	n/a	Yes	Yes	Yes	Yes	Yes	Yes	Yes	Yes	Yes	Yes
Walled Garden - URL Base	n/a	n/a	50	50	50	50	50	50	50	50	50	50
Walled Garden - Domain/IP Base	n/a	n/a	50	50	50	50	50	50	50	50	50	50
Advertisement	n/a	n/a	20	20	20	20	20	20	20	20	20	20
Ticket Printer Support / Max.#	n/a	n/a	SP350E (Ethernet) Up to 10	SP350E (Ethernet) Up to 10	Yes (SP350E)/ 10	Yes (SP350E)/ 10	Yes (SP350E)/ 10	Yes (SP350E)/ 10	Yes (SP350E)/ 10	Yes (SP350E)/ 10	Yes (SP350E)/ 10	Yes (SP350E)/ 10

The following table shows the USG2200 model.

Version	4.70
Model Name	USG2200
# of MAC Addresses	18
Interface	
VLAN	256
Virtual(alias) per interface	4
PPP (System Default)	8
PPP (User Created)	32
Bridge	16
Tunnel (GRE/IPV6 Transition)	4
Routing	
Static Route	1024
Policy Route	4000

Reserved Sessions For Managed Devices	500
Max OSPF areas	10
Max. BGP Neighbor	5
BGP Max. Network	16
Sessions	
Max. TCP Concurrent Sessions (Forwarding, NAT/Firewall)	1,500,000
Session Rate	30,000
NAT	
Max. Virtual Server Number	1024
Firewall (Secure Policy)	
Max Firewall ACL Rule Number = Secure Policy Number	10000
Max Session Limit per Host Rules	1000
ADP	
Max. ADP Profile Number	32
Max. ADP Rule Number	32
Application Patrol	
Max. App Patrol Profile	128
Max. Application Object In Each Profile (Object + Object Group)	32
User Profile	
Max. Local User	2048
Max. Admin User	10
Max. User Group	256
Max User In One User Group	1024
Default Concurrent Device Login	2000
Max. Concurrent Device Upgrade (License)	5000 (Extend by license)
HTTPd	
Max HTTPd Number	2048
Objects	
Address Object	4000
Address Group	400
Max. Address Object In One Group	512
Service Object	1,500
Service Group	300
Max. Service Object In One Group	256
Schedule Object	32
Schedule Group	16
Max. Schedule Object In One Group	24
Application Object	1,500
Application Group	300
Max. Application Object In One Group	512
SP Account	64
Max. LDAP Server Object #	16
Max. RADIUS Server Object #	16
Max. Ad Server Object #	16
Max. Zone Number (System Default)	8
Max. Zone Number (User Defined)	32
Trunk	
Max. Trunk Number (System Default)	1
Max. Trunk Number (User Defined)	32

Max. Member Number Per Trunk	32+8
IPSec VPN	
Max. VPN Tunnels Number	3000
Max. VPN Concentrator Number	128
Max. VPN Configuration Provision Rule Number	3000
Certificate	
Certificate Buffer Size	1024k
Built-In Service	
A Record	128
NS Record (DNS Domain Zone Forward)	16
MX Record	16
Max Service Control Entries	32 per service
Max. DHCP Network Pool	290
Max. DHCP Host Pool (Static DHCP)	2048
Max. DHCP Extended Options	30
Max DDNS Profiles	10
DHCP Relay	2 per interface
USB Storage	
Device Number	1
Centralized Log	
Log Entries	2048
Debug Log Entries	1024
Admin E-Mail Address	2
Syslog Server	4
IDP	
Max. IDP Profile Number	32
Max. Custom Signatures	512
SSL Inspection	
Max. SSL Inspection Profile	16
Max. Exclude List	256
Content Filtering	
Max. Number Of Content Filter Policies	256
Forbidden Domain Entry Number	512 per profile
Trusted Domain Entry Number	512 per profile
Keyword Blocking Number	256 per profile
Common Forbidden Domain Entry Number	1024
Common Trusted Domain Entry Number	1024
Anti-Spam	
Maximum AS Rule Number (Profile)	64
Maximum White List Rule Support	256
Maximum Black List Rule Support	256
Maximum DNSBL Domain Support	10
Concurrent Mail Session Scanning	1000
Max. Statistics Number	500
Max. Statistics Ranking	10
Anti-Virus	
Max. AV Rule (Profile)	32
Max. Statistics Number	500
Max. Statistics Ranking	10
SSL VPN	
Default SSL VPN Connections	250

Maximum SSL VPN Connections	1000
Max. SSL VPN Network List	8
SSL VPN Max Policy	128
AP Controller	
Default # Of Control AP	8
Max. # Of Control AP	1032
AP Group	64
Max Radio Profile	1024
Max SSID Profile	1024
Max Security Profile	1024
Max MAC Filter Profile	64
MAX MAC Entry Per MAC Filter Profile	2048
Zymesh	32
BWM	
Maximum BWM Rule Number	2048
BWM Per Source IP (Max.)	2048
SIP	
Maximum SIP Concurrent Call	200
Custom Web Portal Page	
Max Internal Web Portal Customize File	4
Upload Zip File Size	Up to 2MB
Unzip File Size	Up to 5MB
Hotspot Management	
Max Dynamic Account List	6000
Max Free Time Account Limit	4,800
Hotspot Support	Yes
Walled Garden - URL Base	50
Walled Garden - Domain/IP Base	50
Advertisement	20
Ticket Printer Support	Yes (SP350E)/10

APPENDIX D

Legal Information

Copyright

Copyright © 2022 by Zyxel and/or its affiliates.

The contents of this publication may not be reproduced in any part or as a whole, transcribed, stored in a retrieval system, translated into any language, or transmitted in any form or by any means, electronic, mechanical, magnetic, optical, chemical, photocopying, manual, or otherwise, without the prior written permission of Zyxel and/or its affiliates.

Published by Zyxel and/or its affiliates. All rights reserved.

Disclaimer

Zyxel does not assume any liability arising out of the application or use of any products, or software described herein. Neither does it convey any license under its patent rights nor the patent rights of others. Zyxel further reserves the right to make changes in any products described herein without notice. This publication is subject to change without notice.

Regulatory Notice and Statement (Class A)

Model List: ZyWALL 110, ZyWALL 310, ZyWALL 1100, USG40W, USG60W, USG110, USG210, USG310, USG1100, USG1900, USG2200

United States of America



The following information applies if you use the product within USA area.

US Importer: Zyxel Communications, Inc, 1130 North Miller Street Anaheim, CA92806-2001, <https://www.zyxel.com/us/en/>

FCC EMC Statement

- This device complies with part 15 of the FCC Rules. Operation is subject to the following two conditions:
 - (1) This device may not cause harmful interference, and
 - (2) This device must accept any interference received, including interference that may cause undesired operation.
- Changes or modifications not expressly approved by the party responsible for compliance could void the user's authority to operate the equipment.
- This device has been tested and found to comply with the limits for a Class A digital device, pursuant to part 15 of the FCC Rules. These limits are designed to provide reasonable protection against harmful interference when the equipment is operated in a commercial environment. This equipment generates, uses, and can radiate radio frequency energy and, if not installed and used in accordance with the instruction manual, may cause harmful interference to radio communications. Operation of this equipment in a residential area is likely to cause harmful interference in which case the user will be required to correct the interference at his own expense.

The following information applies if you use the product with RF function within USA area.

FCC Radiation Exposure Statement

This device complies with FCC RF radiation exposure limits set forth for an uncontrolled environment.

This transmitter must be at least 20 cm from the user and must not be co-located or operating in conjunction with any other antenna or transmitter.

Operation of this device is restricted to indoor use only, except for relevant user's manual mention that this device can be installed into the external environment.

Canada

The following information applies if you use the product within Canada area

Innovation, Science and Economic Development Canada ICES Statement

CAN ICES-3 (A)/NMB-3(A)

Innovation, Science and Economic Development Canada RSS-GEN & RSS-247 Statement

- This device contains licence-exempt transmitter(s)/receiver(s) that comply with Innovation, Science and Economic Development Canada's licence-exempt RSS(s). Operation is subject to the following two conditions: (1) this device may not cause interference, and (2) this device must accept any interference, including interference that may cause undesired operation of the device.

- This radio transmitter (USG40W: 2468C-Z2FPM9582; USG60W: 2468C-Z2FPM9582, 2468C-Z5SPM9382) has been approved by Industry Canada to operate with the antenna types listed below with the maximum permissible gain and required antenna impedance for each antenna type indicated. Antenna types not included in this list, having a gain greater than the maximum gain indicated for that type, are strictly prohibited for use with this device.

Antenna Information

Type	Manufacturer	Gain	Connector
Dipole	LYNwave (USG40W, USG60W)	3dBi	Reverse SMA
Dipole	Master Wave (USG40W, USG60W)	3dBi	Reverse SMA

If the product with 5G wireless function operating in 5150 – 5250 MHz and 5725 – 5850 MHz, the following attention must be paid.

- The device for operation in the band 5150 – 5250 MHz is only for indoor use to reduce the potential for harmful interference to co-channel mobile satellite systems.
- For devices with detachable antenna(s), the maximum antenna gain permitted for devices in the band 5725 – 5850 MHz shall be such that the equipment still complies with the e.i.r.p. limits specified for point-to-point and non-point-to-point operation as appropriate; and
- The worst-case tilt angle(s) necessary to remain compliant with the e.i.r.p. elevation mask requirement set forth in Section 6.2.2(3) of RSS 247 shall be clearly indicated.

If the product with 5G wireless function operating in 5250 – 5350 MHz and 5470 – 5725 MHz, the following attention must be paid.

- For devices with detachable antenna(s), the maximum antenna gain permitted for devices in the bands 5250 – 5350 MHz and 5470 – 5725 MHz shall be such that the equipment still complies with the e.i.r.p. limit
- L'émetteur/récepteur exempt de licence contenu dans le présent appareil est conforme aux CNR d'Innovation, Sciences et Développement économique Canada applicables aux appareils radio exempts de licence. L'exploitation est autorisée aux deux conditions suivantes : (1) l'appareil ne doit pas produire de brouillage; (2) L'appareil doit accepter tout brouillage radioélectrique subi, même si le brouillage est susceptible d'en compromettre le fonctionnement.
- Le présent émetteur radio (USG40W: 2468C-Z2FPM9582; USG60W: 2468C-Z2FPM9582, 2468C-Z5SPM9382) de modèle s'il fait partie du matériel de catégorie) a été approuvé par Industrie Canada pour fonctionner avec les types d'antenne énumérés ci-dessous et ayant un gain admissible maximal et l'impédance requise pour chaque type d'antenne. Les types d'antenne non inclus dans cette liste, ou dont le gain est supérieur au gain maximal indiqué, sont strictement interdits pour l'exploitation de l'émetteur.

Informations Antenne

Type	Fabricant	Gain	Connecteur
Dipole	LYNwave (USG40W, USG60W)	3dBi	Reverse SMA
Dipole	Master Wave (USG40W, USG60W)	3dBi	Reverse SMA

Lorsque la fonction sans fil 5G fonctionnant en 5150 – 5250 MHz and 5725 – 5850 MHz est activée pour ce produit , il est nécessaire de porter une attention particulière aux choses suivantes

- Les dispositifs fonctionnant dans la bande de 5 150 à 5 250 MHz sont réservés uniquement pour une utilisation à l'intérieur afin de réduire les risques de brouillage préjudiciable aux systèmes de satellites mobiles utilisant les mêmes canaux;
- Pour les dispositifs munis d'antennes amovibles, le gain maximal d'antenne permis (pour les dispositifs utilisant la bande de 5 725 à 5 850 MHz) doit être conforme à la limite de la p.i.r.e. spécifiée, selon le cas;
- Lorsqu'il y a lieu, les types d'antennes (s'il y en a plusieurs), les numéros de modèle de l'antenne et les pires angles d'inclinaison nécessaires pour rester conforme à l'exigence de la p.i.r.e. applicable au masque d'élévation, énoncée à la section 6.2.2.3 du CNR-247, doivent être clairement indiqués.

Lorsque la fonction sans fil 5G fonctionnant en 5250 – 5350 MHz et 5470 –5725 MHz est activée pour ce produit , il est nécessaire de porter une attention particulière aux choses suivantes.

- Pour les dispositifs munis d'antennes amovibles, le gain maximal d'antenne permis pour les dispositifs utilisant les bandes de 5 250 à 5 350 MHz et de 5 470 à 5 725 MHz doit être conforme à la limite de la p.i.r.e.

Industry Canada radiation exposure statement

This equipment complies with ISED radiation exposure limits set forth for an uncontrolled environment. This equipment should be installed and operated with a minimum distance of 25 cm between the radiator and your body.

Déclaration d'exposition aux radiations:

Cet équipement est conforme aux limites d'exposition aux rayonnements ISED établies pour un environnement non contrôlé. Cet équipement doit être installé et utilisé avec un minimum de 25 cm de distance entre la source de rayonnement et votre corps.

European Union and United Kingdom



The following information applies if you use the product within the European Union and United Kingdom.

CE EMC statement

WARNING: This equipment is compliant with Class A of EN55032. In a residential environment this equipment may cause radio interference.

Declaration of Conformity with Regard to EU Directive 2014/53/EU (Radio Equipment Directive, RED) and UK Regulation

- Compliance information for 2.4 GHz and/or 5 GHz wireless products relevant to the EU, UK and other Countries following the EU Directive 2014/53/EU (RED) and UK regulation. And this product may be used in all EU countries (and other countries following the EU Directive 2014/53/EU) and United Kingdom without any limitation except for the countries mentioned below table:
- In the majority of the EU and other European countries, the 5 GHz bands have been made available for the use of wireless local area networks (LANs). Later in this document you will find an overview of countries in which additional restrictions or requirements or both are applicable. The requirements for any country may evolve. Zyxel recommends that you check with the local authorities for the latest status of their national regulations for the 5 GHz wireless LANs.
- If this device for operation in the band 5150 – 5350 MHz, it is for indoor use only.
- This equipment should be installed and operated with a minimum distance of 20 cm between the radio equipment and your body.
- The maximum RF power operating for each band as follows:
 - USG40W
 - The band 2,400 to 2,483.5 MHz is 91.201 mW
 - USG60W
 - The band 2,400 to 2,483.5 MHz is 72.277 mW
 - The band 5,150 MHz to 5,350 MHz is 143.549 mW
 - The band 5,470 MHz to 5,725 MHz is 690.240 mW

Български (Bulgarian)	<p>С настоящото Zyxel декларира, че това оборудване е в съответствие със съществените изисквания и другите приложими разпоредбите на Директива 2014/53/ЕС.</p> <p>National Restrictions</p> <ul style="list-style-type: none"> • The Belgian Institute for Postal Services and Telecommunications (BIPT) must be notified of any outdoor wireless link having a range exceeding 300 meters. Please check http://www.bipt.be for more details. • Draadloze verbindingen voor buitengebruik en met een reikwijdte van meer dan 300 meter dienen aangemeld te worden bij het Belgisch Instituut voor postdiensten en telecommunicatie (BIPT). Zie http://www.bipt.be voor meer gegevens. • Les liaisons sans fil pour une utilisation en extérieur d'une distance supérieure à 300 mètres doivent être notifiées à l'Institut Belge des services Postaux et des Télécommunications (IBPT). Visitez http://www.ibpt.be pour de plus amples détails.
Español (Spanish)	Por medio de la presente Zyxel declara que el equipo cumple con los requisitos esenciales y cualesquiera otras disposiciones aplicables o exigibles de la Directiva 2014/53/UE.
Čeština (Czech)	Zyxel tímto prohlašuje, že tento zařízení je ve shodě se základními požadavky a dalšími příslušnými ustanoveními směrnice 2014/53/EU.
Dansk (Danish)	<p>Undertegnede Zyxel erklærer herved, at følgende udstyr overholder de væsentlige krav og øvrige relevante krav i direktiv 2014/53/EU.</p> <p>National Restrictions</p> <ul style="list-style-type: none"> • In Denmark, the band 5150 – 5350 MHz is also allowed for outdoor usage. • I Danmark må frekvensbåndet 5150 – 5350 også anvendes udendørs.
Deutsch (German)	Hiermit erklärt Zyxel, dass sich das Gerät Ausstattung in Übereinstimmung mit den grundlegenden Anforderungen und den übrigen einschlägigen Bestimmungen der Richtlinie 2014/53/EU befindet.
Eesti keel (Estonian)	Käesolevaga kinnitab Zyxel seadme seadme vastavust direktiivi 2014/53/EU põhinõuetele ja nimetatud direktiivist tulenevatele teistele asjakohastele sätetele.
Ελληνικά (Greek)	ΜΕ ΤΗΝ ΠΑΡΟΥΣΑ Zyxel ΔΗΛΩΝΕΙ ΟΤΙ ΕΞΟΤΙΣΜΟΣ ΣΥΜΜΟΡΦΩΝΕΤΑΙ ΠΡΟΣ ΤΙΣ ΟΥΣΙΩΔΕΙΣ ΑΠΑΙΤΗΣΕΙΣ ΚΑΙ ΤΙΣ ΛΟΙΠΕΣ ΣΧΕΤΙΚΕΣ ΔΙΑΤΑΞΕΙΣ ΤΗΣ ΟΔΗΓΙΑΣ 2014/53/EU.
English	Hereby, Zyxel declares that this device is in compliance with the essential requirements and other relevant provisions of Directive 2014/53/EU.
Français (French)	Par la présente Zyxel déclare que l'appareil équipements est conforme aux exigences essentielles et aux autres dispositions pertinentes de la directive 2014/53/EU.
Hrvatski (Croatian)	Zyxel ovime izjavljuje da je radijska oprema tipa u skladu s Direktivom 2014/53/EU.
Íslenska (Icelandic)	Hér með lýsir, Zyxel því yfir að þessi búnaður er í samræmi við grunnkröfur og önnur viðeigandi ákvæði tilskipunar 2014/53/EU.
Italiano (Italian)	<p>Con la presente Zyxel dichiara che questo attrezzatura è conforme ai requisiti essenziali ed alle altre disposizioni pertinenti stabilite dalla direttiva 2014/53/EU.</p> <p>National Restrictions</p> <ul style="list-style-type: none"> • This product meets the National Radio Interface and the requirements specified in the National Frequency Allocation Table for Italy. Unless this wireless LAN product is operating within the boundaries of the owner's property, its use requires a "general authorization." Please check http://www.sviluppoeconomico.gov.it/ for more details. • Questo prodotto è conforme alla specifiche di Interfaccia Radio Nazionali e rispetta il Piano Nazionale di ripartizione delle frequenze in Italia. Se non viene installato all'interno del proprio fondo, l'utilizzo di prodotti Wireless LAN richiede una "Autorizzazione Generale". Consultare http://www.sviluppoeconomico.gov.it/ per maggiori dettagli.

Latviešu valoda (Latvian)	Ar šo Zyxel deklarē, ka iekārtas atbilst Direktīvas 2014/53/EU būtiskajām prasībām un citiem ar to saistītajiem noteikumiem. National Restrictions <ul style="list-style-type: none"> The outdoor usage of the 2.4 GHz band requires an authorization from the Electronic Communications Office. Please check http://www.esd.lv for more details. 2.4 GHz frekvenču joslas izmantošanai ārpus telpām nepieciešama atļauja no Elektronisko sakaru direkcijas. Vairāk informācijas: http://www.esd.lv.
Lietuvių kalba (Lithuanian)	Šiuo Zyxel deklaruoją, kad šis įranga atitinka esminius reikalavimus ir kitas 2014/53/EU Direktyvos nuostatas.
Magyar (Hungarian)	Alulírott, Zyxel nyilatkozom, hogy a berendezés megfelel a vonatkozó alapvető követelményeknek és az 2014/53/EU irányelv egyéb előírásainak.
Malti (Maltese)	Hawnhekk, Zyxel, jiddikjara li dan tagħmir jikkonforma mal-htigijiet essenzjali u ma provvedimenti oħrajn rilevanti li hemm fid-Direttiva 2014/53/EU.
Nederlands (Dutch)	Hierbij verklaart Zyxel dat het toestel uitrusting in overeenstemming is met de essentiële eisen en de andere relevante bepalingen van richtlijn 2014/53/EU.
Polski (Polish)	Niniejszym Zyxel oświadcza, że sprzęt jest zgodny z zasadniczymi wymogami oraz pozostałymi stosownymi postanowieniami Dyrektywy 2014/53/EU.
Português (Portuguese)	Zyxel declara que este equipamento está conforme com os requisitos essenciais e outras disposições da Directiva 2014/53/EU.
Română (Romanian)	Prin prezenta, Zyxel declară că acest echipament este în conformitate cu cerințele esențiale și alte prevederi relevante ale Directivei 2014/53/EU.
Slovenčina (Slovak)	Zyxel týmto vyhlasuje, že zariadenia spĺňa základné požiadavky a všetky príslušné ustanovenia Smernice 2014/53/EU.
Slovenščina (Slovene)	Zyxel izjavlja, da je ta oprema v skladu z bistvenimi zahtevami in ostalimi relevantnimi določili direktive 2014/53/EU.
Suomi (Finnish)	Zyxel vakuuttaa täten että laitteet tyyppinen laite on direktiivin 2014/53/EU oleellisten vaatimusten ja sitä koskevien direktiivin muiden ehtojen mukainen.
Svenska (Swedish)	Härmed intygar Zyxel att denna utrustning står i överensstämmelse med de väsentliga egenskapskrav och övriga relevanta bestämmelser som framgår av direktiv 2014/53/EU.
Norsk (Norwegian)	Erklærer herved Zyxel at dette utstyret er i samsvar med de grunnleggende kravene og andre relevante bestemmelser i direktiv 2014/53/EU.

Notes:

1. Although Norway, Switzerland and Liechtenstein are not EU member states, the EU Directive 2014/53/EU has also been implemented in those countries.

2. The regulatory limits for maximum output power are specified in EIRP. The EIRP level (in dBm) of a device can be calculated by adding the gain of the antenna used (specified in dBi) to the output power available at the connector (specified in dBm).

List of National Codes

COUNTRY	ISO 3166 2 LETTER CODE	COUNTRY	ISO 3166 2 LETTER CODE
Austria	AT	Liechtenstein	LI
Belgium	BE	Lithuania	LT
Bulgaria	BG	Luxembourg	LU
Croatia	HR	Malta	MT
Cyprus	CY	Netherlands	NL
Czech Republic	CR	Norway	NO
Denmark	DK	Poland	PL
Estonia	EE	Portugal	PT
Finland	FI	Romania	RO
France	FR	Serbia	RS
Germany	DE	Slovakia	SK
Greece	GR	Slovenia	SI
Hungary	HU	Spain	ES
Iceland	IS	Sweden	SE
Ireland	IE	Switzerland	CH
Italy	IT	Turkey	TR
Latvia	LV	United Kingdom	GB

Safety Warnings

- Do not use this product near water, for example, in a wet basement or near a swimming pool.
- Do not expose your device to dampness, dust or corrosive liquids.
- Do not store things on the device.
- Do not obstruct the device ventilation slots as insufficient airflow may harm your device. For example, do not place the device in an enclosed space such as a box or on a very soft surface such as a bed or sofa.
- Do not install, use, or service this device during a thunderstorm. There is a remote risk of electric shock from lightning.
- Connect ONLY suitable accessories to the device.
- Do not open the device or unit. Opening or removing covers can expose you to dangerous high voltage points or other risks. Only qualified service personnel should service or disassemble this device. Please contact your vendor for further information.
- Make sure to connect the cables to the correct ports.
- Place connecting cables carefully so that no one will step on them or stumble over them.
- Always disconnect all cables from this device before servicing or disassembling.
- Do not remove the plug and connect it to a power outlet by itself; always attach the plug to the power adaptor first before connecting it to a power outlet.
- Do not allow anything to rest on the power adaptor or cord and do NOT place the product where anyone can walk on the power adaptor or cord.
- Please use the provided or designated connection cables/power cables/ adaptors. Connect it to the right supply voltage (for example, 110 V AC in North America or 230 V AC in Europe). If the power adaptor or cord is damaged, it might cause electrocution. Remove it from the device and the power source, repairing the power adapter or cord is prohibited. Contact your local vendor to order a new one.
- Do not use the device outside, and make sure all the connections are indoors. There is a remote risk of electric shock from lightning.
- Caution: Risk of explosion if battery is replaced by an incorrect type, dispose of used batteries according to the instruction. Dispose them at the applicable collection point for the recycling of electrical and electronic device. For detailed information about recycling of this product, please contact your local city office, your household waste disposal service or the store where you purchased the product.
- Use ONLY power wires of the appropriate wire gauge for your device. Connect it to a power supply of the correct voltage.
- Fuse Warning! Replace a fuse only with a fuse of the same type and rating.
- The POE (Power over Ethernet) devices that supply or receive power and their connected Ethernet cables must all be completely indoors.
- The following warning statements apply, where the disconnect device is not incorporated in the device or where the plug on the power supply cord is intended to serve as the disconnect device.
 - For permanently connected devices, a readily accessible disconnect device shall be incorporated external to the device;
 - For pluggable devices, the socket-outlet shall be installed near the device and shall be easily accessible.
- For model list: ZyWALL 310, ZyWALL 1100, USG310, USG1100, USG1900, USG2200. This device must be grounded by qualified service personnel. Never defeat the ground conductor or operate the device in the absence of a suitably installed ground conductor. Contact the appropriate electrical inspection authority or an electrician if you are uncertain that suitable grounding is available. If your device has an earthing screw (frame ground), connect the screw to a ground terminal using an appropriate AWG ground wire. Do this before you make other connections. If your device has no earthing screw, but has a 3-prong power plug, make sure to connect the plug to a 3-hole earthed socket.
- WARNING: USG2200 is not suitable for use in locations where children are likely to be present.
- When connecting or disconnecting power to hot-pluggable power supplies, if offered with your system, observe the following guidelines:
 - Install the power supply before connecting the power cable to the power supply.
 - Unplug the power cable before removing the power supply.
 - If the system has multiple sources of power, disconnect power from the system by unplugging all power cables from the power supply.
- CLASS 1 LASER PRODUCT
- APPAREIL À LASER DE CLASS 1
- PRODUCT COMPLIES WITH 21 CFR 1040.10 AND 1040.11.
- PRODUIT CONFORME SELON 21 CFR 1040.10 ET 1040.11.

Environment Statement

Disposal and Recycling Information

The symbol below means that according to local regulations your product and/or its battery shall be disposed of separately from domestic waste. If this product is end of life, take it to a recycling station designated by local authorities. At the time of disposal, the separate collection of your product and/or its battery will help save natural resources and ensure that the environment is sustainable development.

Die folgende Symbol bedeutet, dass Ihr Produkt und/oder seine Batterie gemäß den örtlichen Bestimmungen getrennt vom Hausmüll entsorgt werden muss. Wenden Sie sich an eine Recyclingstation, wenn dieses Produkt das Ende seiner Lebensdauer erreicht hat. Zum Zeitpunkt der Entsorgung wird die getrennte Sammlung von Produkt und/oder seiner Batterie dazu beitragen, natürliche Ressourcen zu sparen und die Umwelt und die menschliche Gesundheit zu schützen.

El símbolo de abajo indica que según las regulaciones locales, su producto y/o su batería deberán depositarse como basura separada de la doméstica. Cuando este producto alcance el final de su vida útil, llévelo a un punto limpio. Cuando llegue el momento de desechar el producto, la recogida por separado éste y/o su batería ayudará a salvar los recursos naturales y a proteger la salud humana y medioambiental.

Le symbole ci-dessous signifie que selon les réglementations locales votre produit et/ou sa batterie doivent être éliminés séparément des ordures ménagères. Lorsque ce produit atteint sa fin de vie, amenez-le à un centre de recyclage. Au moment de la mise au rebut, la collecte séparée de votre produit et/ou de sa batterie aidera à économiser les ressources naturelles et protéger l'environnement et la santé humaine.

Il simbolo sotto significa che secondo i regolamenti locali il vostro prodotto e/o batteria deve essere smaltito separatamente dai rifiuti domestici. Quando questo prodotto raggiunge la fine della vita di servizio portarlo a una stazione di riciclaggio. Al momento dello smaltimento, la raccolta separata del vostro prodotto e/o della sua batteria aiuta a risparmiare risorse naturali e a proteggere l'ambiente e la salute umana.

Symbolen innebär att enligt lokal lagstiftning ska produkten och/eller dess batteri kastas separat från hushållsavfallet. När den här produkten når slutet av sin livslängd ska du ta den till en återvinningsstation. Vid tiden för kasseringen bidrar du till en bättre miljö och mänsklig hälsa genom att göra dig av med den på ett återvinningsställe.



台灣

警告使用者

• 這是甲類的資訊產品，在居住的環境中使用時，可能會造成射頻干擾，在這種情況下，使用者會被要求採取某些適當的對策。





安全警告 - 為了您的安全，請先閱讀以下警告及指示：

- 請勿將此產品接近水、火焰或放置在高溫的環境。
- 避免設備接觸：
 - 任何液體 - 切勿讓設備接觸水、雨水、高濕度、污水腐蝕性的液體或其他水份。
 - 灰塵及污物 - 切勿接觸灰塵、污物、沙土、食物或其他不合適的材料。
- 雷雨天氣時，不要安裝、使用或維修此設備。有遭受電擊的風險。
- 切勿重摔或撞擊設備，並勿使用不正確的電源變壓器。
- 若接上不正確的電源變壓器會有爆炸的風險。
- 請勿隨意更換產品內的電池。
- 如果更換不正確之電池型式，會有爆炸的風險，請依製造商說明書處理使用過之電池。
- 請將廢電池丟棄在適當的電器或電子設備回收處。
- 請勿將設備解體。
- 請勿阻礙設備的散熱孔，空氣對流不足將會造成設備損害。
- 請插在正確的電壓供給插座（如：北美 / 台灣電壓 110V AC，歐洲是 230V AC）。
- 假若電源變壓器或電源變壓器的纜線損壞，請從插座拔除，若您繼續插電使用，會有觸電死亡的風險。
- 請勿試圖修理電源變壓器或電源變壓器的纜線，若有毀損，請直接聯絡您購買的店家，購買一個新的電源變壓器。
- 請勿將此設備安裝於室外，此設備僅適合放置於室內。
- 請勿隨一般垃圾丟棄。
- 請參閱產品背貼上的設備額定功率。
- 請參考產品型錄或是彩盒上的作業溫度。
- 產品沒有斷電裝置或者採用電源線的插頭視為斷電裝置的一部分，以下警語將適用：
 - 對永久連接之設備，在設備外部須安裝可觸及之斷電裝置；
 - 對插接式之設備，插座必須接近安裝之地點而且是易於觸及的。

About the Symbols

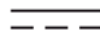
Various symbols are used in this product to ensure correct usage, to prevent danger to the user and others, and to prevent property damage. The meaning of these symbols are described below. It is important that you read these descriptions thoroughly and fully understand the contents.

Explanation of the Symbols

SYMBOL	EXPLANATION
	Alternating current (AC): AC is an electric current in which the flow of electric charge periodically reverses direction.
	Direct current (DC): DC is the unidirectional flow or movement of electric charge carriers.
	Earth; ground: A wiring terminal intended for connection of a Protective Earthing Conductor.
	Class II equipment: The method of protection against electric shock in the case of class II equipment is either double insulation or reinforced insulation.
	Caution: Shock Hazard
	Disconnect all power sources

Viewing Certifications

Go to <http://www.zyxel.com> to view this product's documentation and certifications.

Zyxel Limited Warranty

Zyxel warrants to the original end user (purchaser) that this product is free from any defects in material or workmanship for a specific period (the Warranty Period) from the date of purchase. The Warranty Period varies by region. Check with your vendor and/or the authorized Zyxel local distributor for details about the Warranty Period of this product. During the warranty period, and upon proof of purchase, should the product have indications of failure due to faulty workmanship and/or materials, Zyxel will, at its discretion, repair or replace the defective products or components without charge for either parts or labor, and to whatever extent it shall deem necessary to restore the product or components to proper operating condition. Any replacement will consist of a new or re-manufactured functionally equivalent product of equal or higher value, and will be solely at the discretion of Zyxel. This warranty shall not apply if the product has been modified, misused, tampered with, damaged by an act of God, or subjected to abnormal working conditions.

Note

Repair or replacement, as provided under this warranty, is the exclusive remedy of the purchaser. This warranty is in lieu of all other warranties, express or implied, including any implied warranty of merchantability or fitness for a particular use or purpose. Zyxel shall in no event be held liable for indirect or consequential damages of any kind to the purchaser.

To obtain the services of this warranty, contact your vendor. You may also refer to the warranty policy for the region in which you bought the device at http://www.zyxel.com/web/support_warranty_info.php.

Registration

Register your product online at www.zyxel.com to receive email notices of firmware upgrades and related information.

Trademarks

ZYNOS (Zyxel Network Operating System) and ZON (Zyxel One Network) are registered trademarks of Zyxel Communications, Inc. Other trademarks mentioned in this publication are used for identification purposes only and may be properties of their respective owners.

Open Source Licenses

This product may contain in part some free software distributed under GPL license terms and/or GPL-like licenses.

To request the source code covered under these licenses, please go to: https://www.zyxel.com/form/gpl_oss_software_notice.shtml

Regulatory Notice and Statement (Class B)

Model List: USG40, USG60

UNITED STATES of AMERICA



The following information applies if you use the product within USA area.

US Importer: Zyxel Communications, Inc, 1130 North Miller Street Anaheim, CA92806-2001, <https://www.zyxel.com/us/en/>

FCC EMC Statement

- The device complies with Part 15 of FCC rules. Operation is subject to the following two conditions:
 - (1) This device may not cause harmful interference, and
 - (2) This device must accept any interference received, including interference that may cause undesired operation.
- Changes or modifications not expressly approved by the party responsible for compliance could void the user's authority to operate the device.
- This product has been tested and complies with the specifications for a Class B digital device, pursuant to Part 15 of the FCC Rules. These limits are designed to provide reasonable protection against harmful interference in a residential installation. This device generates, uses, and can radiate radio frequency energy and, if not installed and used according to the instructions, may cause harmful interference to radio communications. However, there is no guarantee that interference will not occur in a particular installation.
- If this device does cause harmful interference to radio or television reception, which is found by turning the device off and on, the user is encouraged to try to correct the interference by one or more of the following measures:
 - Reorient or relocate the receiving antenna
 - Increase the separation between the devices
 - Connect the equipment to an outlet other than the receiver's
 - Consult a dealer or an experienced radio/TV technician for assistance

The following information applies if you use the product with RF function within USA area.

FCC Radiation Exposure Statement

- This device complies with FCC RF radiation exposure limits set forth for an uncontrolled environment.
- This transmitter must be at least 20 cm from the user and must not be co-located or operating in conjunction with any other antenna or transmitter.
- Operation of this device is restricted to indoor use only, except for relevant user's manual mention that this device can be installed into the external environment.

CANADA

The following information applies if you use the product within Canada area.

Innovation, Science and Economic Development Canada ICES Statement

CAN ICES-3 (B)/NMB-3(B)

Innovation, Science and Economic Development Canada RSS-GEN & RSS-247 Statement

- This device contains licence-exempt transmitter(s)/receiver(s) that comply with Innovation, Science and Economic Development Canada's licence-exempt RSS(s). Operation is subject to the following two conditions: (1) this device may not cause interference, and (2) this device must accept any interference, including interference that may cause undesired operation of the device.

If the product with 5G wireless function operating in 5150 – 5250 MHz and 5725 – 5850 MHz, the following attention must be paid,

- The device for operation in the band 5150 – 5250 MHz is only for indoor use to reduce the potential for harmful interference to co-channel mobile satellite systems.
- For devices with detachable antenna(s), the maximum antenna gain permitted for devices in the band 5725 – 5850 MHz shall be such that the equipment still complies with the e.i.r.p. limits specified for point-to-point and non-point-to-point operation as appropriate; and
- The worst-case tilt angle(s) necessary to remain compliant with the e.i.r.p. elevation mask requirement set forth in Section 6.2.2(3) of RSS 247 shall be clearly indicated.

If the product with 5G wireless function operating in 5250 – 5350 MHz and 5470 – 5725 MHz, the following attention must be paid.

- For devices with detachable antenna(s), the maximum antenna gain permitted for devices in the bands 5250 – 5350 MHz and 5470-5725 MHz shall be such that the equipment still complies with the e.i.r.p. limit
- L'émetteur/récepteur exempt de licence contenu dans le présent appareil est conforme aux CNR d'Innovation, Sciences et Développement économique Canada applicables aux appareils radio exempts de licence. L'exploitation est autorisée aux deux conditions suivantes : (1) l'appareil ne doit pas produire de brouillage; (2) l'appareil doit accepter tout brouillage radioélectrique subi, même si le brouillage est susceptible d'en compromettre le fonctionnement.
- Le présent émetteur radio de modèle s'il fait partie du matériel de catégorie I) a été approuvé par Industrie Canada pour fonctionner avec les types d'antenne énumérés ci-dessous et ayant un gain admissible maximal et l'impédance requise pour chaque type d'antenne. Les types d'antenne non inclus dans cette liste, ou dont le gain est supérieur au gain maximal indiqué, sont strictement interdits pour l'exploitation de l'émetteur.

Lorsque la fonction sans fil 5G fonctionnant en 5150 – 5250 MHz and 5725 – 5850 MHz est activée pour ce produit , il est nécessaire de porter une attention particulière aux choses suivantes

- Les dispositifs fonctionnant dans la bande 5150 – 5250 MHz sont réservés uniquement pour une utilisation à l'intérieur afin de réduire les risques de brouillage préjudiciable aux systèmes de satellites mobiles utilisant les mêmes canaux;
- Pour les dispositifs munis d'antennes amovibles, le gain maximal d'antenne permis (pour les dispositifs utilisant la bande de 5 725 à 5 850 MHz) doit être conforme à la limite de la p.i.r.e. spécifiée pour l'exploitation point à point et l'exploitation non point à point, selon le cas;
- Les pires angles d'inclinaison nécessaires pour rester conforme à l'exigence de la p.i.r.e. applicable au masque d'élévation, et énoncée à la section 6.2.2.3) du CNR-247, doivent être clairement indiqués.

Lorsque la fonction sans fil 5G fonctionnant en 5250-5350 MHz et 5470 – 5725 MHz est activée pour ce produit , il est nécessaire de porter une attention particulière aux choses suivantes.

- Pour les dispositifs munis d'antennes amovibles, le gain maximal d'antenne permis pour les dispositifs utilisant les bandes de 5 250 à 5 350 MHz et de 5 470 à 5 725 MHz doit être conforme à la limite de la p.i.r.e.

Industry Canada radiation exposure statement

This equipment complies with ISED radiation exposure limits set forth for an uncontrolled environment. This equipment should be installed and operated with a minimum distance of 25 cm between the radiator and your body.

Déclaration d'exposition aux radiations:

Cet équipement est conforme aux limites d'exposition aux rayonnements ISED établies pour un environnement non contrôlé. Cet équipement doit être installé et utilisé avec un minimum de 25 cm de distance entre la source de rayonnement et votre corps.

EUROPEAN UNION and UNITED KINGDOM



The following information applies if you use the product within the European Union and United Kingdom.

Declaration of Conformity with Regard to EU Directive 2014/53/EU (Radio Equipment Directive, RED) and UK Regulation

- Compliance information for 2.4 GHz and/or 5 GHz wireless products relevant to the EU, UK and other Countries following the EU Directive 2014/53/EU (RED) and UK regulation. And this product may be used in all EU countries (and other countries following the EU Directive 2014/53/EU) and United Kingdom without any limitation except for the countries mentioned below table:
- In the majority of the EU and other European countries, the 5 GHz bands have been made available for the use of wireless local area networks (LANs). Later in this document you will find an overview of countries in which additional restrictions or requirements or both are applicable. The requirements for any country may evolve. Zyxel recommends that you check with the local authorities for the latest status of their national regulations for the 5 GHz wireless LANs.
- If this device for operation in the band 5150 – 5350 MHz, it is for indoor use only.
- This equipment should be installed and operated with a minimum distance of 20cm between the radio equipment and your body.
- The maximum RF power operating for each band as follows:

Български (Bulgarian)	С настоящото Zyxel декларира, че това оборудване е в съответствие със съществените изисквания и другите приложими разпоредбите на Директива 2014/53/ЕС. National Restrictions <ul style="list-style-type: none"> • The Belgian Institute for Postal Services and Telecommunications (BIPT) must be notified of any outdoor wireless link having a range exceeding 300 meters. Please check http://www.bipt.be for more details. • Draadloze verbindingen voor buitengebruik en met een reikwijdte van meer dan 300 meter dienen aangemeld te worden bij het Belgisch Instituut voor postdiensten en telecommunicatie (BIPT). Zie http://www.bipt.be voor meer gegevens. • Les liaisons sans fil pour une utilisation en extérieur d'une distance supérieure à 300 mètres doivent être notifiées à l'Institut Belge des services Postaux et des Télécommunications (IBPT). Visitez http://www.ibpt.be pour de plus amples détails.
Español (Spanish)	Por medio de la presente Zyxel declara que el equipo cumple con los requisitos esenciales y cualesquiera otras disposiciones aplicables o exigibles de la Directiva 2014/53/UE..
Čeština (Czech)	Zyxel tímto prohlašuje, že tento zařízení je ve shodě se základními požadavky a dalšími příslušnými ustanoveními směrnice 2014/53/EU.
Dansk (Danish)	Undertegnede Zyxel erklærer herved, at følgende udstyr overholder de væsentlige krav og øvrige relevante krav i direktiv 2014/53/EU. National Restrictions <ul style="list-style-type: none"> • In Denmark, the band 5150 - 5350 MHz is also allowed for outdoor usage. • I Danmark må frekvensbåndet 5150 - 5350 også anvendes udendørs.
Deutsch (German)	Hiermit erklärt Zyxel, dass sich das Gerät Ausstattung in Übereinstimmung mit den grundlegenden Anforderungen und den übrigen einschlägigen Bestimmungen der Richtlinie 2014/53/EU befindet.
Eesti keel (Estonian)	Käesolevaga kinnitab Zyxel seadme seadmed vastavust direktiivi 2014/53/EU põhinõuetele ja nimetatud direktiivist tulenevatele teistele asjakohastele sätetele.
Ελληνικά (Greek)	ΜΕ ΤΗΝ ΠΑΡΟΥΣΑ Zyxel ΔΗΛΩΝΕΙ ΟΤΙ ΕΞΟΠΛΙΣΜΟΣ ΣΥΜΜΟΡΦΩΝΕΤΑΙ ΠΡΟΣ ΤΙΣ ΟΥΣΙΩΔΕΙΣ ΑΠΑΙΤΗΣΕΙΣ ΚΑΙ ΤΙΣ ΛΟΙΠΕΣ ΣΧΕΤΙΚΕΣ ΔΙΑΤΑΞΕΙΣ ΤΗΣ ΟΔΗΓΙΑΣ 2014/53/EU.

English	Hereby, Zyxel declares that this device is in compliance with the essential requirements and other relevant provisions of Directive 2014/53/EU.
Français (French)	Par la présente Zyxel déclare que l'appareil équipements est conforme aux exigences essentielles et aux autres dispositions pertinentes de la directive 2014/53/EU.
Hrvatski (Croatian)	Zyxel ovime izjavljuje da je radijska oprema tipa u skladu s Direktivom 2014/53/EU.
Íslenska (Icelandic)	Hér með lýsir, Zyxel því yfir að þessi búnaður er í samræmi við grunnkröfur og önnur viðeigandi ákvæði tilskipunar 2014/53/EU.
Italiano (Italian)	Con la presente Zyxel dichiara che questo attrezzatura è conforme ai requisiti essenziali ed alle altre disposizioni pertinenti stabilite dalla direttiva 2014/53/EU. National Restrictions <ul style="list-style-type: none"> This product meets the National Radio Interface and the requirements specified in the National Frequency Allocation Table for Italy. Unless this wireless LAN product is operating within the boundaries of the owner's property, its use requires a "general authorization." Please check http://www.sviluppoeconomico.gov.it/ for more details. Questo prodotto è conforme alla specifiche di Interfaccia Radio Nazionali e rispetta il Piano Nazionale di ripartizione delle frequenze in Italia. Se non viene installato all'interno del proprio fondo, l'utilizzo di prodotti Wireless LAN richiede una "Autorizzazione Generale". Consultare http://www.sviluppoeconomico.gov.it/ per maggiori dettagli.
Latviešu valoda (Latvian)	Ar šo Zyxel deklarē, ka iekārtas atbilst Direktīvas 2014/53/EU būtiskajām prasībām un citiem ar to saistītajiem noteikumiem. National Restrictions <ul style="list-style-type: none"> The outdoor usage of the 2.4 GHz band requires an authorization from the Electronic Communications Office. Please check http://www.esd.lv for more details. 2.4 GHz frekvenču joslas izmantošanai ārpus telpām nepieciešama atļauja no Elektronisko sakaru direkcijas. Vairāk informācijas: http://www.esd.lv.
Lietuvių kalba (Lithuanian)	Šiuo Zyxel deklaruoja, kad šis įranga atitinka esminius reikalavimus ir kitas 2014/53/EU Direktyvos nuostatas.
Magyar (Hungarian)	Alulírott, Zyxel nyilatkozom, hogy a berendezés megfelel a vonatkozó alapvető követelményeknek és az 2014/53/EU irányelv egyéb előírásainak.
Malti (Maltese)	Hawnhekk, Zyxel, jiddikjara li dan tagħmir jikkonforma mal-htigijiet essenzjali u ma provvedimenti oħrajn rilevanti li hemm fid-Direttiva 2014/53/EU.
Nederlands (Dutch)	Hierbij verklaart Zyxel dat het toestel uitrusting in overeenstemming is met de essentiële eisen en de andere relevante bepalingen van richtlijn 2014/53/EU.
Polski (Polish)	Niniejszym Zyxel oświadcza, że sprzęt jest zgodny z zasadniczymi wymogami oraz pozostałymi stosownymi postanowieniami Dyrektywy 2014/53/EU.
Português (Portuguese)	Zyxel declara que este equipamento está conforme com os requisitos essenciais e outras disposições da Directiva 2014/53/EU.
Română (Romanian)	Prin prezenta, Zyxel declară că acest echipament este în conformitate cu cerințele esențiale și alte prevederi relevante ale Directivei 2014/53/EU.
Slovenčina (Slovak)	Zyxel týmto vyhlasuje, že zariadenia spĺňa základné požiadavky a všetky príslušné ustanovenia Smernice 2014/53/EU.
Slovenščina (Slovene)	Zyxel izjavlja, da je ta oprema v skladu z bistvenimi zahtevami in ostalimi relevantnimi določili direktive 2014/53/EU.
Suomi (Finnish)	Zyxel vakuuttaa täten että laitteet tyyppinen laite on direktiivin 2014/53/EU oleellisten vaatimusten ja sitä koskevien direktiivin muiden ehtojen mukainen.
Svenska (Swedish)	Härmed intygar Zyxel att denna utrustning står i överensstämmelse med de väsentliga egenskapskrav och övriga relevanta bestämmelser som framgår av direktiv 2014/53/EU.
Norsk (Norwegian)	Erklærer herved Zyxel at dette utstyret er i samsvar med de grunnleggende kravene og andre relevante bestemmelser i direktiv 2014/53/EU.

Notes:

- Although Norway, Switzerland and Liechtenstein are not EU member states, the EU Directive 2014/53/EU has also been implemented in those countries.
- The regulatory limits for maximum output power are specified in EIRP. The EIRP level (in dBm) of a device can be calculated by adding the gain of the antenna used (specified in dBi) to the output power available at the connector (specified in dBm).

List of national codes

COUNTRY	ISO 3166 2 LETTER CODE	COUNTRY	ISO 3166 2 LETTER CODE
Austria	AT	Liechtenstein	LI
Belgium	BE	Lithuania	LT
Bulgaria	BG	Luxembourg	LU
Croatia	HR	Malta	MT
Cyprus	CY	Netherlands	NL
Czech Republic	CZ	Norway	NO
Denmark	DK	Poland	PL
Estonia	EE	Portugal	PT
Finland	FI	Romania	RO
France	FR	Serbia	RS
Germany	DE	Slovakia	SK
Greece	GR	Slovenia	SI
Hungary	HU	Spain	ES
Iceland	IS	Switzerland	CH
Ireland	IE	Sweden	SE
Italy	IT	Turkey	TR
Latvia	LV	United Kingdom	GB

Safety Warnings

- Do not use this product near water, for example, in a wet basement or near a swimming pool.
- Do not expose your device to dampness, dust or corrosive liquids.
- Do not store things on the device.
- Do not obstruct the device ventilation slots as insufficient airflow may harm your device. For example, do not place the device in an enclosed space such as a box or on a very soft surface such as a bed or sofa.
- Do not install, use, or service this device during a thunderstorm. There is a remote risk of electric shock from lightning.
- Connect ONLY suitable accessories to the device.
- Do not open the device or unit. Opening or removing covers can expose you to dangerous high voltage points or other risks. ONLY qualified service personnel should service or disassemble this device. Please contact your vendor for further information.
- Make sure to connect the cables to the correct ports.
- Place connecting cables carefully so that no one will step on them or stumble over them.
- Always disconnect all cables from this device before servicing or disassembling.
- Do not remove the plug and connect it to a power outlet by itself; always attach the plug to the power adaptor first before connecting it to a power outlet.
- Do not allow anything to rest on the power adaptor or cord and do NOT place the product where anyone can walk on the power adaptor or cord.
- Please use the provided or designated connection cables/power cables/ adaptors. Connect it to the right supply voltage (for example, 110 V AC in North America or 230 V AC in Europe). If the power adaptor or cord is damaged, it might cause electrocution. Remove it from the device and the power source, repairing the power adapter or cord is prohibited. Contact your local vendor to order a new one.
- Do not use the device outside, and make sure all the connections are indoors. There is a remote risk of electric shock from lightning.
- CAUTION: Risk of explosion if battery is replaced by an incorrect type, dispose of used batteries according to the instruction. Dispose them at the applicable collection point for the recycling of electrical and electronic devices. For detailed information about recycling of this product, please contact your local city office, your household waste disposal service or the store where you purchased the product.
- The following warning statements apply, where the disconnect device is not incorporated in the device or where the plug on the power supply cord is intended to serve as the disconnect device,
 - For permanently connected devices, a readily accessible disconnect device shall be incorporated external to the device;
 - For pluggable devices, the socket-outlet shall be installed near the device and shall be easily accessible.
- CLASS 1 LASER PRODUCT
- APPAREIL À LASER DE CLASS 1
- PRODUCT COMPLIES WITH 21 CFR 1040.10 AND 1040.11.
- PRODUIT CONFORME SELON 21 CFR 1040.10 ET 1040.11.

Environment Statement

ErP (Energy-related Products)

Zyxel products put on the EU and United Kingdom market in compliance with the requirement of the European Parliament and the Council published Directive 2009/125/EC and UK regulation establishing a framework for the setting of ecodesign requirements for energy-related products (recast), so called as "ErP Directive (Energy-related Products directive) as well as ecodesign requirement laid down in applicable implementing measures, power consumption has satisfied regulation requirements which are:

- Network standby power consumption < 8W, and/or
- Off mode power consumption < 0.5W, and/or
- Standby mode power consumption < 0.5W.

(Wireless setting, please refer to "Wireless" chapter for more detail.)

Disposal and Recycling Information

The symbol below means that according to local regulations your product and/or its battery shall be disposed of separately from domestic waste. If this product is end of life, take it to a recycling station designated by local authorities. At the time of disposal, the separate collection of your product and/or its battery will help save natural resources and ensure that the environment is sustainable development.

Die folgende Symbol bedeutet, dass Ihr Produkt und/oder seine Batterie gemäß den örtlichen Bestimmungen getrennt vom Hausmüll entsorgt werden muss. Wenden Sie sich an eine Recyclingstation, wenn dieses Produkt das Ende seiner Lebensdauer erreicht hat. Zum Zeitpunkt der Entsorgung wird die getrennte Sammlung von Produkt und/oder seiner Batterie dazu beitragen, natürliche Ressourcen zu sparen und die Umwelt und die menschliche Gesundheit zu schützen.

El símbolo de abajo indica que según las regulaciones locales, su producto y/o su batería deberán depositarse como basura separada de la doméstica. Cuando este producto alcance el final de su vida útil, llévelo a un punto limpio. Cuando llegue el momento de desechar el producto, la recogida por separado éste y/o su batería ayudará a salvar los recursos naturales y a proteger la salud humana y medioambiental.

Le symbole ci-dessous signifie que selon les réglementations locales votre produit et/ou sa batterie doivent être éliminés séparément des ordures ménagères. Lorsque ce produit atteint sa fin de vie, amenez-le à un centre de recyclage. Au moment de la mise au rebut, la collecte séparée de votre produit et/ou de sa batterie aidera à économiser les ressources naturelles et protéger l'environnement et la santé humaine.

Il simbolo sotto significa che secondo i regolamenti locali il vostro prodotto e/o batteria deve essere smaltito separatamente dai rifiuti domestici. Quando questo prodotto raggiunge la fine della vita di servizio portarlo a una stazione di riciclaggio. Al momento dello smaltimento, la raccolta separata del vostro prodotto e/o della sua batteria aiuta a risparmiare risorse naturali e a proteggere l'ambiente e la salute umana.

Symbolen innebär att enligt lokal lagstiftning ska produkten och/eller dess batteri kastas separat från hushållsavfallet. När den här produkten når slutet av sin livslängd ska du ta den till en återvinningsstation. Vid tiden för kasseringen bidrar du till en bättre miljö och mänsklig hälsa genom att göra dig av med den på ett återvinningsställe.



台灣



以下訊息僅適用於產品具有無線功能且銷售至台灣地區

- 取得審驗證明之低功率射頻器材，非經許可，公司、商號或使用者均不得擅自變更頻率、加大功率或變更原設計之特性及功能。
- 低功率射頻器材之使用不得影響飛航安全及干擾合法通信；經發現有干擾現象時，應立即停用，並改善至無干擾時方得繼續使用。前述合法通信，指依電信管理法規定作業之無線電通信。低功率射頻器材須忍受合法通信或工業、科學及醫療用電波輻射性電機設備之干擾。
- 使用無線產品時，應避免影響附近雷達系統之操作。
- 高增益指向性天線只得應用於固定式點對點系統。

以下訊息僅適用於產品屬於專業安裝並銷售至台灣地區

- 本器材須經專業工程人員安裝及設定，始得設置使用，且不得直接販售給一般消費者。

安全警告 - 為了您的安全，請先閱讀以下警告及指示：





- 請勿將此產品接近水、火焰或放置在高溫的環境。
- 避免設備接觸：
 - 任何液體 - 切勿讓設備接觸水、雨水、高濕度、污水腐蝕性的液體或其他水份。
 - 灰塵及污物 - 切勿接觸灰塵、污物、沙土、食物或其他不適合的材料。
- 雷雨天氣時，不要安裝、使用或維修此設備。有遭受電擊的風險。
- 切勿重摔或撞擊設備，並勿使用不正確的電源變壓器。
- 若接上不正確的電源變壓器會有爆炸的風險。
- 請勿隨意更換產品內的電池。
- 如果更換不正確之電池型式，會有爆炸的風險，請依製造商說明書處理使用過之電池。
- 請將廢電池丟棄在適當的電器或電子設備回收處。
- 請勿將設備解體。
- 請勿阻礙設備的散熱孔，空氣對流不足將會造成設備損害。

- 請插在正確的電壓供給插座 (如：北美 / 台灣電壓 110V AC，歐洲是 230V AC)。
- 假若電源變壓器或電源變壓器的纜線損壞，請從插座拔除，若您繼續插電使用，會有觸電死亡的風險。
- 請勿試圖修理電源變壓器或電源變壓器的纜線，若有毀損，請直接聯絡您購買的店家，購買一個新的電源變壓器。
- 請勿將此設備安裝於室外，此設備僅適合放置於室內。
- 請勿隨一般垃圾丟棄。
- 請參閱產品背貼上的設備額定功率。
- 請參考產品型錄或是彩盒上的作業溫度。
- 產品沒有斷電裝置或者採用電源線的插頭視為斷電裝置的一部分，以下警語將適用：
 - 對永久連接之設備，在設備外部須安裝可觸及之斷電裝置；
 - 對插接式之設備，插座必須接近安裝之地點而且是易於觸及的。

About the Symbols

Various symbols are used in this product to ensure correct usage, to prevent danger to the user and others, and to prevent property damage. The meaning of these symbols are described below. It is important that you read these descriptions thoroughly and fully understand the contents.

Explanation of the Symbols

SYMBOL	EXPLANATION
	Alternating current (AC): AC is an electric current in which the flow of electric charge periodically reverses direction.
	Direct current (DC): DC is the unidirectional flow or movement of electric charge carriers.
	Earth; ground: A wiring terminal intended for connection of a Protective Earthing Conductor.
	Class II equipment: The method of protection against electric shock in the case of class II equipment is either double insulation or reinforced insulation.

Viewing Certifications

Go to <http://www.zyxel.com> to view this product's documentation and certifications.

Zyxel Limited Warranty

Zyxel warrants to the original end user (purchaser) that this product is free from any defects in material or workmanship for a specific period (the Warranty Period) from the date of purchase. The Warranty Period varies by region. Check with your vendor and/or the authorized Zyxel local distributor for details about the Warranty Period of this product. During the warranty period, and upon proof of purchase, should the product have indications of failure due to faulty workmanship and/or materials, Zyxel will, at its discretion, repair or replace the defective products or components without charge for either parts or labor, and to whatever extent it shall deem necessary to restore the product or components to proper operating condition. Any replacement will consist of a new or re-manufactured functionally equivalent product of equal or higher value, and will be solely at the discretion of Zyxel. This warranty shall not apply if the product has been modified, misused, tampered with, damaged by an act of God, or subjected to abnormal working conditions.

Note

Repair or replacement, as provided under this warranty, is the exclusive remedy of the purchaser. This warranty is in lieu of all other warranties, express or implied, including any implied warranty of merchantability or fitness for a particular use or purpose. Zyxel shall in no event be held liable for indirect or consequential damages of any kind to the purchaser.

To obtain the services of this warranty, contact your vendor. You may also refer to the warranty policy for the region in which you bought the device at http://www.zyxel.com/web/support_warranty_info.php.

Registration

Register your product online at www.zyxel.com to receive email notices of firmware upgrades and related information.

Trademarks

ZyNOS (Zyxel Network Operating System) and ZON (Zyxel One Network) are registered trademarks of Zyxel Communications, Inc. Other trademarks mentioned in this publication are used for identification purposes only and may be properties of their respective owners.

Open Source Licenses

This product may contain in part some free software distributed under GPL license terms and/or GPL-like licenses.

To request the source code covered under these licenses, please go to: https://www.zyxel.com/form/gpl_oss_software_notice.shtml

Symbols

Numbers

- 3322 Dynamic DNS [456](#)
- 3DES [663](#)
- 6in4 tunneling [370](#)
- 6to4 tunneling [370](#)

A

AAA

- Base DN [910](#)
- Bind DN [910, 913](#)
- directory structure [909](#)
- Distinguished Name, see DN
- DN [910, 911, 913](#)
- password [913](#)
- port [913, 915](#)
- search time limit [913](#)
- SSL [913](#)

AAA server [907](#)

- AD [909](#)
- and users [832](#)
- directory service [908](#)
- LDAP [908, 909](#)
- local user database [909](#)
- RADIUS [908, 909, 914](#)
- RADIUS group [914](#)
- see also RADIUS

access [36](#)

access control attacks [756](#)

Access Point Name, see APN

access users [831, 833](#)

- custom page [975](#)
- forcing login [516](#)
- idle timeout [842](#)

logging in [516](#)

- multiple logins [843](#)
- see also users [831](#)
- Web Configurator [844](#)

access users, see also force user authentication policies

account

- user [831, 949](#)

accounting server [907](#)

Active Directory, see AD

active protocol [667](#)

- AH [667](#)
- and encapsulation [667](#)
- ESP [667](#)

active sessions [206, 225](#)

ActiveX [743](#)

AD [908, 910, 911, 913](#)

- directory structure [909](#)
- Distinguished Name, see DN
- password [913](#)
- port [913, 915](#)
- search time limit [913](#)
- SSL [913](#)

address groups [888](#)

- and content filtering [722, 723](#)
- and FTP [994](#)
- and security policy [520](#)
- and SNMP [998](#)
- and SSH [990](#)
- and Telnet [993](#)
- and WWW [975](#)

address objects [888](#)

- and content filtering [722, 723](#)
- and FTP [994](#)
- and NAT [437, 467](#)
- and policy routes [436](#)
- and security policy [520](#)
- and SNMP [998](#)
- and SSH [990](#)
- and Telnet [993](#)
- and VPN connections [640](#)
- and WWW [975](#)
- HOST [888](#)

- RANGE [888](#)
- SUBNET [888](#)
- types of [888](#), [894](#)
- address record [963](#)
- admin user
 - troubleshooting [1089](#), [1090](#)
- admin users [831](#)
 - multiple logins [843](#)
 - see also users [831](#)
- ADP [610](#)
 - false negatives [612](#)
 - false positives [612](#)
 - inline profile [612](#)
 - monitor profile [612](#)
- Advanced Encryption Standard, see AES
- AES [663](#)
- AF [440](#)
- AH [646](#), [667](#)
 - and transport mode [668](#)
- alerts [1020](#), [1021](#), [1023](#), [1027](#), [1029](#), [1030](#)
 - anti-spam [789](#)
 - anti-virus [778](#)
 - IDP [753](#), [754](#), [805](#), [806](#)
- ALG [477](#), [483](#)
 - and NAT [477](#), [479](#)
 - and policy routes [479](#), [483](#)
 - and security policy [477](#), [479](#)
 - and trunks [483](#)
 - FTP [477](#), [478](#)
 - H.323 [477](#), [478](#), [483](#)
 - peer-to-peer calls [479](#)
 - RTP [484](#)
 - see also VoIP pass through [477](#)
 - SIP [477](#), [478](#)
- Anomaly Detection and Prevention, see ADP
- anti-malware [773](#)
 - firmware package blocking [779](#)
 - packet scan [773](#)
 - packet types [774](#)
 - virus [773](#)
 - worm [773](#)
- anti-spam [785](#), [789](#), [791](#)
 - action for spam mails [790](#)
 - alerts [789](#)
 - black list [785](#), [789](#), [791](#)
 - concurrent e-mail sessions [274](#), [787](#)
 - DNSBL [786](#), [790](#), [796](#)
 - e-mail header buffer [786](#)
 - e-mail headers [786](#)
 - excess e-mail sessions [787](#)
 - general settings [787](#)
 - identifying legitimate e-mail [785](#)
 - identifying spam [785](#)
 - log options [789](#)
 - mail scan [790](#)
 - mail sessions threshold [787](#)
 - POP2 [786](#)
 - POP3 [786](#)
 - regular expressions [794](#)
 - SMTP [786](#)
 - status [274](#)
 - white list [785](#), [789](#), [793](#), [794](#)
- anti-virus [152](#), [773](#)
 - alerts [778](#)
 - black list [778](#), [780](#)
 - boot sector virus [783](#)
 - EICAR [776](#)
 - e-mail virus [783](#)
 - file decompression [779](#)
 - file infector virus [783](#)
 - log options [778](#)
 - macro virus [783](#)
 - polymorphic virus [783](#)
 - scanner types [784](#)
 - signatures [782](#)
 - statistics [270](#)
 - troubleshooting [1081](#), [1084](#)
 - troubleshooting signatures update [1081](#)
 - updating signatures [287](#)
 - virus [152](#)
 - virus types [783](#)
 - white list [782](#)
 - worm [152](#)
- AP group [248](#), [298](#), [303](#)
- APN [365](#)
- Application Layer Gateway, see ALG
- application patrol [716](#)
 - actions [716](#)
 - and HTTP redirect [472](#)
 - and security policy [716](#)
 - classification [716](#)
 - exceptions [716](#)
 - port-less [716](#)
 - ports [717](#)
 - service ports [717](#)
 - troubleshooting [1081](#), [1086](#), [1089](#)
 - troubleshooting signatures update [1081](#)

- updating signatures [288](#)
 - AppPatrol, see application patrol [288](#)
 - ASAS (Authenex Strong Authentication System) [908](#)
 - asymmetrical routes [602](#)
 - allowing through the security policy [605](#)
 - vs virtual interfaces [602](#)
 - attacks
 - access control [756](#)
 - backdoor [756](#)
 - buffer overflow [756](#)
 - Denial of Service (DoS) [644](#)
 - DoS/DDoS [756](#)
 - false negatives [751](#)
 - false positives [751](#)
 - IM [756](#)
 - P2P [756](#)
 - scan [756](#)
 - severity of [754](#)
 - spam [757](#)
 - trapdoor [756](#)
 - trojan [756](#)
 - virus [152, 757, 773](#)
 - worm [757](#)
 - Authenex Strong Authentication System (ASAS) [908](#)
 - authentication
 - in IPsec [647](#)
 - LDAP/AD [909](#)
 - server [907](#)
 - authentication algorithms [662, 663](#)
 - and active protocol [663](#)
 - MD5 [663](#)
 - SHA1 [663](#)
 - Authentication Header, see AH
 - authentication method objects [916](#)
 - and users [832](#)
 - and WWW [974](#)
 - create [918](#)
 - example [916](#)
 - authentication policy
 - exceptional services [518](#)
 - Authentication server
 - RADIUS client [1001](#)
 - authentication server [999, 1001, 1004](#)
 - authentication type [162, 943](#)
 - Authentication, Authorization, Accounting servers, see AAA server
 - authorization server [907](#)
 - Autonomous Systems (AS) [450](#)
 - auxiliary interfaces [320](#)
- ## B
- backdoor attacks [756](#)
 - backing up configuration files [1034](#)
 - bandwidth
 - egress [366, 375](#)
 - ingress [366, 375](#)
 - bandwidth limit
 - troubleshooting [1083](#)
 - bandwidth management [716](#)
 - maximize bandwidth usage [440, 705](#)
 - see also application patrol [716](#)
 - troubleshooting [1083](#)
 - Base DN [910](#)
 - base profiles
 - in IDP [750](#)
 - Batch import [625](#)
 - BGP [455](#)
 - Bind DN [910, 913](#)
 - BitTorrent [756](#)
 - black list [789, 791](#)
 - anti-spam [785](#)
 - Blaster [770](#)
 - bookmarks [682](#)
 - boot sector virus [783](#)
 - bridge interfaces [320, 392](#)
 - and virtual interfaces of members [393](#)
 - basic characteristics [320](#)
 - effect on routing table [392](#)
 - member interfaces [392](#)
 - virtual [349](#)
 - bridges [391](#)
 - buffer overflow [756](#)
 - buffer overflow attacks [756](#)
- ## C
- CA
 - and certificates [926](#)
 - CA (Certificate Authority), see certificates

- Calling Station ID [862, 864, 866, 869, 872](#)
- capturing packets [1053, 1056](#)
- card SIM [366](#)
- CEF (Common Event Format) [1017, 1026](#)
- cellular [359](#)
 - APN [365](#)
 - interfaces [320](#)
 - signal quality [234, 235](#)
 - SIM card [366](#)
 - status [236](#)
 - system [234](#)
 - troubleshooting [1082](#)
- certificate
 - troubleshooting [1090](#)
- Certificate Authority (CA)
 - see certificates
- Certificate Revocation List (CRL) [926](#)
 - vs OCSP [941](#)
- certificates [925](#)
 - advantages of [926](#)
 - and CA [926](#)
 - and FTP [994](#)
 - and HTTPS [970](#)
 - and IKE SA [667](#)
 - and SSH [990](#)
 - and synchronization (Device HA) [824](#)
 - and VPN gateways [640](#)
 - and WWW [972](#)
 - certification path [925, 933, 939](#)
 - expired [925](#)
 - factory-default [926](#)
 - file formats [926](#)
 - fingerprints [934, 940](#)
 - importing [930](#)
 - in IPsec [653](#)
 - not used for encryption [925](#)
 - revoked [925](#)
 - self-signed [926, 932](#)
 - serial number [934, 939](#)
 - storage space [928, 936](#)
 - thumbprint algorithms [927](#)
 - thumbprints [927](#)
 - used for authentication [925](#)
 - verifying fingerprints [926](#)
- certification requests [932](#)
- certifications [1118](#)
 - viewing [1114, 1120](#)
- Challenge Handshake Authentication Protocol (CHAP) [943](#)
- CHAP (Challenge Handshake Authentication Protocol) [943](#)
- CHAP/PAP [943](#)
- CLI [34, 44](#)
 - button [44](#)
 - messages [44](#)
 - popup window [44](#)
 - Reference Guide [2](#)
- client [692](#)
- cluster ID [816](#)
- CNM
 - ID [626](#)
- commands [34](#)
 - sent by Web Configurator [44](#)
- Common Event Format (CEF) [1017, 1026](#)
- compression (stac) [944](#)
- computer names [344, 388, 402, 410, 427, 699](#)
- computer virus [152, 773](#)
 - infection and prevention [784](#)
 - see also virus
- concurrent e-mail sessions [274, 787](#)
- configuration
 - information [1048](#)
 - web-based SSL application example [945](#)
- configuration file
 - troubleshooting [1091](#)
- configuration files [1032](#)
 - at restart [1035](#)
 - backing up [1034](#)
 - downloading [1036, 1068](#)
 - downloading with FTP [993](#)
 - editing [1032](#)
 - how applied [1033](#)
 - lastgood.conf [1035, 1038](#)
 - managing [1034](#)
 - startup-config.conf [1038](#)
 - startup-config-bad.conf [1035](#)
 - syntax [1033](#)
 - system-default.conf [1038](#)
 - uploading [1039](#)
 - uploading with FTP [993](#)
 - use without restart [1032](#)
- connection
 - troubleshooting [1086](#)
- connection monitor (in SSL) [264](#)

connectivity check [343](#), [359](#), [366](#), [375](#), [387](#), [404](#), [411](#), [415](#), [647](#)

console port
speed [959](#)

contact information [1094](#), [1102](#)

content (pattern) [767](#)

content filter
troubleshooting [1081](#)

content filtering [722](#), [723](#)
and address groups [722](#), [723](#)
and address objects [722](#), [723](#)
and schedules [722](#), [723](#)
and user groups [722](#)
and users [722](#)
by category [722](#), [723](#), [729](#)
by keyword (in URL) [723](#), [744](#)
by URL [723](#), [743](#), [745](#), [746](#)
by web feature [723](#), [743](#)
cache [747](#)
categories [729](#)
category service [728](#)
default policy [723](#)
external web filtering service [728](#), [747](#)
filter list [723](#)
managed web pages [729](#)
policies [722](#), [723](#)
registration status [286](#)
Security Threat web pages [729](#)
statistics [267](#)
testing [730](#)
uncategorized pages [729](#)
URL for blocked access [725](#)

cookies [743](#)

copyright [1108](#)

CPU usage [205](#)

CSV [625](#)

current date/time [202](#), [955](#)
and schedules [902](#)
daylight savings [957](#)
setting manually [958](#)
time server [959](#)

current user list [264](#)

custom
access user page [975](#)
login page [975](#)

custom signatures [760](#), [763](#), [1085](#)
applying [769](#)
example [767](#)

verifying [769](#)

custom.rules file [763](#), [1085](#)

customer support [1094](#), [1102](#)

D

Data Encryption Standard, see DES

date [955](#)

daylight savings [957](#)

DDNS [456](#)
backup mail exchanger [461](#)
mail exchanger [461](#)
service providers [456](#)
troubleshooting [1086](#)

DDoS attacks [756](#)

Dead Peer Detection, see DPD

decompression of files (in anti-virus) [779](#)

default
security policy behavior [601](#)

Default_L2TP_VPN_GW [697](#)

Denial of Service (DoS) attacks [756](#)

Denial of Service (Dos) attacks [644](#)

DES [663](#)

device access
troubleshooting [1080](#)

Device HA [812](#)
management access [813](#)
management IP address [813](#)
monitored interfaces [820](#)

device HA [813](#)
cluster ID [816](#)
copying configuration [813](#)
device role [819](#)
HA status [815](#)
modes [813](#)
monitored interfaces [817](#)
password [820](#)
synchronization [813](#), [824](#)
synchronization password [820](#)
synchronization port number [820](#)
virtual router [816](#), [825](#)
virtual router and management IP addresses [817](#)

device High Availability see Device HA [812](#)

DHCP [426](#), [954](#)
and DNS servers [427](#)

- and domain name [954](#)
 - and interfaces [426](#)
 - pool [427](#)
 - static DHCP [427](#)
 - DHCP Unique Identifier [324](#)
 - DHCPv6 [949](#)
 - DHCP Unique Identifier [324](#)
 - DHCPv6 Request [949](#)
 - diagnostice
 - controller [1049](#)
 - diagnostics [1048](#)
 - diagnostics controller
 - busy on ap [1050](#)
 - busy on ZyWall [1050](#)
 - standby [1050](#)
 - diagnosticsL AP [1051](#)
 - Differentiated Services Code Point (DSCP) [761](#)
 - Diffie-Hellman key group [663](#)
 - DiffServ [440](#)
 - Digital Signature Algorithm public-key algorithm, see DSA
 - direct routes [432](#)
 - directory [908](#)
 - directory service [908](#)
 - file structure [909](#)
 - disclaimer [1108](#)
 - Distinguished Name (DN) [910, 911, 913](#)
 - Distributed Denial of Service (DDoS) attacks [756](#)
 - DN [910, 911, 913](#)
 - DNS [960](#)
 - address records [963](#)
 - domain name forwarders [965](#)
 - domain name to IP address [963](#)
 - IP address to domain name [964](#)
 - L2TP VPN [699](#)
 - Mail eXchange (MX) records [966](#)
 - pointer (PTR) records [964](#)
 - DNS Blacklist see DNSBL [786](#)
 - DNS inbound LB [509](#)
 - DNS servers [162, 960, 965](#)
 - and interfaces [427](#)
 - DNSBL [786, 790, 796](#)
 - see also anti-spam [786](#)
 - domain name [954](#)
 - Domain Name System, see DNS
 - DoS (Denial of Service) attacks [756](#)
 - DPD [655](#)
 - DSA [932](#)
 - DSCP [433, 436, 707, 1073](#)
 - DUID [324](#)
 - Dynamic Domain Name System, see DDNS
 - dynamic guest [230](#)
 - dynamic guest account [230, 832](#)
 - Dynamic Host Configuration Protocol, see DHCP.
 - dynamic peers in IPSec [645](#)
 - dynamic users log [282](#)
 - DynDNS [456](#)
 - DynDNS see also DDNS [456](#)
 - Dynu [456](#)
- ## E
- eBGP (exterior Border Gate Protocol) [450](#)
 - e-Donkey [756](#)
 - egress bandwidth [366, 375](#)
 - EICAR [776](#)
 - Ekahau RTLS [315](#)
 - e-mail [785](#)
 - daily statistics report [1014](#)
 - header buffer [786](#)
 - headers [786](#)
 - virus [783](#)
 - e-Mule [756](#)
 - Encapsulating Security Payload, see ESP
 - encapsulation
 - and active protocol [667](#)
 - IPSec [646](#)
 - transport mode [667](#)
 - tunnel mode [667](#)
 - VPN [667](#)
 - encryption
 - and anti-malware [779](#)
 - IPSec [647](#)
 - RSA [934](#)
 - encryption algorithms [663](#)
 - 3DES [663](#)
 - AES [663](#)
 - and active protocol [663](#)
 - DES [663](#)
 - encryption method [943](#)

- end of IP list [761](#)
 - enforcing policies in IPSec [645](#)
 - ESP [646](#), [667](#)
 - and transport mode [668](#)
 - Ethernet interfaces [320](#)
 - and OSPF [328](#)
 - and RIP [328](#)
 - and routing protocols [326](#)
 - basic characteristics [320](#)
 - virtual [349](#)
 - exceptional services [518](#)
 - extended authentication
 - and VPN gateways [640](#)
 - IKE SA [666](#)
 - Extended Service Set IDentification [848](#)
 - ext-group-user [835](#)
 - ext-user [835](#)
 - troubleshooting [1089](#)
- ## F
- false negatives [612](#), [751](#)
 - false positives [612](#), [615](#), [751](#)
 - fast forwarding [1012](#)
 - file decompression (in anti-virus) [779](#)
 - file extensions
 - configuration files [1032](#)
 - shell scripts [1032](#)
 - file infector [783](#)
 - file manager [1032](#)
 - file sharing SSL application
 - create [947](#)
 - firewall
 - and SMTP redirect [473](#)
 - firmware
 - and restart [1040](#)
 - current version [202](#), [1044](#)
 - getting updated [1040](#)
 - uploading [1043](#)
 - uploading with FTP [993](#)
 - firmware package
 - troubleshooting [1088](#)
 - firmware upload
 - troubleshooting [1091](#)
 - flags [761](#)
 - flash usage [205](#)
 - forcing login [516](#)
 - FQDN [963](#)
 - fragmentation flag [765](#)
 - fragmentation offset [765](#)
 - free guest account [579](#)
 - free time [579](#)
 - configuration [579](#)
 - enable [579](#)
 - FTP [993](#)
 - additional signaling port [482](#)
 - ALG [477](#)
 - and address groups [994](#)
 - and address objects [994](#)
 - and certificates [994](#)
 - and zones [994](#)
 - signaling port [482](#)
 - troubleshooting [1086](#)
 - with Transport Layer Security (TLS) [994](#)
 - full tunnel mode [671](#), [675](#)
 - Fully-Qualified Domain Name, see FQDN
- ## G
- Generic Routing Encapsulation, see GRE.
 - global SSL setting [676](#)
 - user portal logo [677](#)
 - Grace Period [30](#)
 - GRE [428](#)
 - GSM [366](#)
 - Guide
 - CLI Reference [2](#)
 - Quick Start [2](#)
- ## H
- H.323 [483](#)
 - additional signaling port [482](#)
 - ALG [477](#), [483](#)
 - and RTP [484](#)
 - and security policy [478](#)
 - signaling port [482](#)
 - troubleshooting [1086](#)
 - HA status see device HA [815](#)

- header checksum [761](#)
 - host-based intrusions [770](#)
 - HSDPA [366](#)
 - HTTP
 - over SSL, see HTTPS
 - redirect to HTTPS [973](#)
 - vs HTTPS [970](#)
 - HTTP redirect
 - and application patrol [472](#)
 - and interfaces [476](#)
 - and policy routes [472](#), [473](#)
 - and security policy [472](#)
 - packet flow [472](#)
 - troubleshooting [1086](#)
 - HTTPS [970](#)
 - and certificates [970](#)
 - authenticating clients [970](#)
 - avoiding warning messages [981](#)
 - example [980](#)
 - vs HTTP [970](#)
 - with Internet Explorer [980](#)
 - with Netscape Navigator [980](#)
 - hub-and-spoke VPN, see VPN concentrator
 - HyperText Transfer Protocol over Secure Socket Layer, see HTTPS
- I**
- ICMP [898](#)
 - code [766](#)
 - sequence number [766](#)
 - type [766](#)
 - identification (IP) [765](#)
 - identifying
 - legitimate e-mail [785](#)
 - spam [785](#)
 - IDP [748](#)
 - action [618](#), [753](#), [755](#), [806](#)
 - alerts [753](#), [754](#), [805](#), [806](#)
 - applying custom signatures [769](#)
 - base profiles [750](#)
 - custom signature example [767](#)
 - custom signatures [760](#)
 - false negatives [751](#)
 - false positives [751](#)
 - inline profile [751](#)
 - log options [615](#), [619](#), [753](#), [754](#), [755](#), [805](#), [806](#)
 - monitor profile [751](#)
 - packet inspection profiles [751](#)
 - packet inspection signatures [751](#)
 - query view [753](#), [755](#)
 - reject sender [618](#), [753](#), [755](#), [806](#)
 - reject-both [618](#), [753](#), [755](#), [806](#)
 - reject-receiver [618](#), [753](#), [755](#), [806](#)
 - service group [757](#)
 - severity [754](#)
 - signature ID [755](#), [806](#)
 - signatures [748](#)
 - signatures and synchronization (Device HA) [824](#)
 - Snort signatures [771](#)
 - statistics [268](#)
 - troubleshooting [1081](#), [1085](#)
 - troubleshooting signatures update [1081](#)
 - updating signatures [288](#)
 - verifying custom signatures [769](#)
 - IEEE 802.1q VLAN
 - IEEE 802.1q. See VLAN.
 - IEEE 802.1x [848](#)
 - IHL (IP Header Length) [761](#)
 - IKE SA
 - aggressive mode [662](#), [665](#)
 - and certificates [667](#)
 - and RADIUS [666](#)
 - and to-ZyWALL security policy [1087](#)
 - authentication algorithms [662](#), [663](#)
 - content [664](#)
 - Dead Peer Detection (DPD) [655](#)
 - Diffie-Hellman key group [663](#)
 - encryption algorithms [663](#)
 - extended authentication [666](#)
 - ID type [664](#)
 - IP address, remote IPSec router [662](#)
 - IP address, Zyxel device [662](#)
 - local identity [664](#)
 - main mode [662](#), [665](#)
 - NAT traversal [666](#)
 - negotiation mode [662](#)
 - password [666](#)
 - peer identity [664](#)
 - pre-shared key [664](#)
 - proposal [662](#)
 - see also VPN
 - user name [666](#)
 - IM (Instant Messenger) [756](#)
 - IMAP [786](#)

- iMesh **756**
- inbound LB algorithm
 - least connection **511**
 - least load **511**
 - weighted round robin **511**
- inbound load balancing **509**
 - time to live **512**
- incoming bandwidth **366, 375**
- ingress bandwidth **366, 375**
- inline profile **612, 751**
- installation
 - precautions **84**
- Instant Messenger (IM) **716, 756**
 - managing **716**
- interface
 - status **219**
 - troubleshooting **1082**
- interfaces **319**
 - and DNS servers **427**
 - and HTTP redirect **476**
 - and layer-3 virtualization **320**
 - and NAT **467**
 - and physical ports **320**
 - and policy routes **436**
 - and static routes **439**
 - and VPN gateways **640**
 - and zones **320**
 - as DHCP relays **426**
 - as DHCP servers **426, 954**
 - auxiliary, see also auxiliary interfaces.
 - backup, see trunks
 - bandwidth management **423, 424, 426**
 - bridge, see also bridge interfaces.
 - cellular **320**
 - DHCP clients **425**
 - Ethernet, see also Ethernet interfaces.
 - gateway **425**
 - general characteristics **320**
 - IP address **425**
 - metric **425**
 - MTU **426**
 - overlapping IP address and subnet mask **425**
 - port groups, see also port groups.
 - PPPoE/PPTP, see also PPPoE/PPTP interfaces.
 - prerequisites **321**
 - relationships between **321**
 - static DHCP **427**
 - subnet mask **425**
 - trunks, see also trunks.
 - Tunnel, see also Tunnel interfaces.
 - types **320**
 - virtual, see also virtual interfaces.
 - VLAN, see also VLAN interfaces.
 - WLAN, see also WLAN interfaces.
- Internet access
 - troubleshooting **1080, 1089**
- Internet Control Message Protocol, see ICMP
- Internet Message Access Protocol, see IMAP **786**
- Internet Protocol (IP) **760**
- Internet Protocol Security, see IPSec
- Internet Protocol version 6, see IPv6
- Intrusion, Detection and Prevention see IDP **748**
- intrusions
 - host **770**
 - network **770**
- IP (Internet Protocol) **760**
- IP options **761, 766**
- IP policy routing, see policy routes
- IP pool **676**
- IP protocols **897**
 - and service objects **898**
 - ICMP, see ICMP
 - TCP, see TCP
 - UDP, see UDP
- IP security option **761**
- IP static routes, see static routes
- IP stream identifier **761**
- IP v4 packet headers **761**
- IP/MAC binding **500**
 - exempt list **503**
 - monitor **228**
 - static DHCP **503**
- IPSec **155, 600, 635**
 - active protocol **646**
 - AH **646**
 - and certificates **640**
 - authentication **647**
 - basic troubleshooting **1087**
 - certificates **653**
 - connections **640**
 - connectivity check **647**
 - Default_L2TP_VPN_GW **697**
 - encapsulation **646**
 - encryption **647**
 - ESP **646**

- established in two phases [637](#)
 - L2TP VPN [697](#)
 - local network [635](#)
 - local policy [645](#)
 - NetBIOS [644](#)
 - peer [635](#)
 - Perfect Forward Secrecy [647](#)
 - PFS [647](#)
 - phase 2 settings [646](#)
 - policy enforcement [645](#)
 - remote access [645](#)
 - remote IPSec router [635](#)
 - remote network [635](#)
 - remote policy [645](#)
 - replay detection [644](#)
 - SA life time [646](#)
 - SA monitor [263](#)
 - SA see also IPSec SA [667](#)
 - see also VPN
 - site-to-site with dynamic peer [645](#)
 - static site-to-site [645](#)
 - transport encapsulation [646](#)
 - tunnel encapsulation [646](#)
 - VPN gateway [640](#)
- IPSec SA
- active protocol [667](#)
 - and security policy [1088](#)
 - and to-ZyWALL security policy [1087](#)
 - authentication algorithms [662](#), [663](#)
 - destination NAT for inbound traffic [670](#)
 - encapsulation [667](#)
 - encryption algorithms [663](#)
 - local policy [667](#)
 - NAT for inbound traffic [669](#)
 - NAT for outbound traffic [669](#)
 - Perfect Forward Secrecy (PFS) [668](#)
 - proposal [668](#)
 - remote policy [667](#)
 - search by name [263](#)
 - search by policy [263](#)
 - Security Parameter Index (SPI) (manual keys) [668](#)
 - see also IPSec
 - see also VPN
 - source NAT for inbound traffic [669](#)
 - source NAT for outbound traffic [669](#)
 - status [263](#)
 - transport mode [667](#)
 - tunnel mode [667](#)
 - when IKE SA is disconnected [667](#)
- IPSec VPN
- troubleshooting [1087](#)
- IPv6 [322](#)
- link-local address [323](#)
 - prefix [322](#)
 - prefix delegation [323](#)
 - prefix length [322](#)
 - stateless autoconfiguration [323](#)
- IPv6 tunnelings
- 6in4 tunneling [370](#)
 - 6to4 tunneling [370](#)
- IPv6-in-IPv4 tunneling [370](#)
- ISP account
- CHAP [943](#)
 - CHAP/PAP [943](#)
 - MPPE [943](#)
 - MSCHAP [943](#)
 - MSCHAP-V2 [943](#)
 - PAP [943](#)
- ISP accounts [941](#)
- and PPPoE/PPTP interfaces [353](#), [941](#)
 - authentication type [943](#)
 - encryption method [943](#)
 - stac compression [944](#)

J

Java [743](#)

K

key pairs [925](#)

L

L2TP VPN [696](#)

- Default_L2TP_VPN_GW [697](#)
- DNS [699](#)
- IPSec configuration [697](#)
- policy routes [697](#)
- session monitor [265](#)
- WINS [699](#)

lastgood.conf [1035](#), [1038](#)

- Layer 2 Tunneling Protocol Virtual Private Network, see L2TP VPN [696](#)
 - layer-2 isolation [505](#)
 - example [505](#)
 - IP [506](#)
 - LDAP [908](#)
 - and users [832](#)
 - Base DN [910](#)
 - Bind DN [910](#), [913](#)
 - directory [908](#)
 - directory structure [909](#)
 - Distinguished Name, see DN
 - DN [910](#), [911](#), [913](#)
 - password [913](#)
 - port [913](#), [915](#)
 - search time limit [913](#)
 - SSL [913](#)
 - user attributes [847](#)
 - least connection algorithm [511](#)
 - least load algorithm [511](#)
 - least load first load balancing [418](#)
 - LED troubleshooting [1080](#)
 - legitimate e-mail [785](#)
 - level-4 inspection [717](#)
 - level-7 inspection [716](#)
 - licensing [284](#)
 - Lightweight Directory Access Protocol, see LDAP
 - limited-admin [835](#)
 - Link Layer Discovery Protocol (LLDP) [237](#)
 - LLDP (Link Layer Discovery Protocol) [237](#)
 - load balancing [308](#), [417](#)
 - algorithms [418](#), [422](#), [424](#)
 - DNS inbound [509](#)
 - least load first [418](#)
 - round robin [418](#)
 - see also trunks [417](#)
 - session-oriented [418](#)
 - spillover [419](#)
 - weighted round robin [419](#)
 - local user database [909](#)
 - log
 - troubleshooting [1091](#)
 - log messages
 - categories [1021](#), [1023](#), [1027](#), [1029](#), [1030](#)
 - debugging [278](#)
 - regular [278](#)
 - types of [278](#)
 - log options [778](#), [789](#)
 - (IDP) [615](#), [619](#), [753](#), [754](#), [755](#), [805](#), [806](#)
 - login
 - custom page [975](#)
 - SSL user [680](#)
 - logo
 - troubleshooting [1091](#)
 - logo in SSL [677](#)
 - logout
 - SSL user [683](#)
 - Web Configurator [44](#)
 - logs
 - and security policy [610](#)
 - e-mail profiles [1016](#)
 - e-mailing log messages [1020](#)
 - formats [1017](#)
 - log consolidation [1022](#)
 - settings [1016](#)
 - syslog servers [1016](#)
 - system [1016](#)
 - types of [1016](#)
 - loose source routing [761](#)
- ## M
- MAC address [845](#)
 - and VLAN [376](#)
 - Ethernet interface [339](#)
 - range [202](#)
 - MAC authentication [861](#), [863](#), [866](#), [869](#), [872](#)
 - Calling Station ID [862](#), [864](#), [866](#), [869](#), [872](#)
 - case [861](#), [862](#), [864](#), [866](#), [869](#), [872](#)
 - delimiter [861](#), [862](#), [863](#), [864](#), [866](#), [869](#), [872](#)
 - mac role [845](#)
 - macro virus [783](#)
 - mail sessions threshold [787](#)
 - managed web pages [729](#)
 - management access
 - troubleshooting [1090](#)
 - management access and Device HA [813](#)
 - Management Information Base (MIB) [995](#), [996](#)
 - managing the device
 - using SNMP. See SNMP.
 - MD5 [663](#)
 - memory usage [205](#)

- Message Digest 5, see MD5
- messages
CLI [44](#)
- metrics, see reports
- Microsoft
Challenge-Handshake Authentication Protocol (MSCHAP) [943](#)
Challenge-Handshake Authentication Protocol Version 2 (MSCHAP-V2) [943](#)
Point-to-Point Encryption (MPPE) [943](#)
- mobile broadband see also cellular [359](#)
- model name [202](#)
- Monitor [625](#)
- monitor [264](#)
Google Authenticator [839](#)
SA [263](#)
- monitor profile
ADP [612](#)
IDP [751](#)
- monitored interfaces [817](#)
Device HA [820](#)
- mounting
rack [33, 79](#)
wall [85](#)
- MPPE (Microsoft Point-to-Point Encryption) [943](#)
- MSCHAP (Microsoft Challenge-Handshake Authentication Protocol) [943](#)
- MSCHAP-V2 (Microsoft Challenge-Handshake Authentication Protocol Version 2) [943](#)
- MTU [366, 375](#)
- multicast [854](#)
- multicast rate [854](#)
- mutation virus [783](#)
- My Certificates, see also certificates [927](#)
- MyDoom [770](#)
- myZyxel [30, 289](#)
accounts, creating [30](#)
and IDP [718, 750](#)
- myZyxel.com
accounts, creating [153](#)
- N**
- NAT [440, 462](#)
ALG, see ALG
and address objects [437](#)
and address objects (HOST) [467](#)
and ALG [477, 479](#)
and interfaces [467](#)
and policy routes [430, 437](#)
and security policy [603](#)
and to-ZyWALL security policy [468](#)
and VoIP pass through [479](#)
and VPN [666](#)
loopback [468](#)
port forwarding, see NAT
port translation, see NAT
traversal [666](#)
- NAT Port Mapping Protocol [485](#)
- NAT Traversal [485](#)
- NAT-PMP [485](#)
- NBNS [344, 388, 402, 410, 427, 676](#)
- NetBIOS
Broadcast over IPsec [644](#)
Name Server, see NBNS
- NetBIOS Name Server, see NBNS
- NetMeeting [483](#)
see also H.323
- network access mode [32](#)
full tunnel [671](#)
- Network Address Translation, see NAT
- network list, see SSL [676](#)
- Network Time Protocol (NTP) [958](#)
- network-based intrusions [770](#)
- Nimda [770](#)
- no IP options [761](#)
- No-IP [456](#)
- notification
response message [1004](#)
- NSSA [443](#)
- O**
- objects [672](#)
AAA server [907](#)
addresses and address groups [888](#)
authentication method [916](#)
certificates [925](#)
schedules [902](#)
services and service groups [897](#)

SSL application **944**
 users, user groups **831, 949**
 offset (patterns) **767**
 One-Time Password (OTP) **908**
 Online Certificate Status Protocol (OCSP) **941**
 vs CRL **941**
 Open Shortest Path First, see OSPF
 operating mode **306**
 OSI (Open System Interconnection) **748**
 OSI level-4 **717**
 OSI level-7 **716**
 OSPF **443**
 and Ethernet interfaces **328**
 and RIP **444**
 and static routes **444**
 and to-ZyWALL security policy **443**
 area 0 **444**
 areas, see OSPF areas
 authentication method **328**
 autonomous system (AS) **443**
 backbone **444**
 configuration steps **445**
 direction **328**
 link cost **328**
 priority **328**
 redistribute **444**
 redistribute type (cost) **447**
 routers, see OSPF routers
 virtual links **445**
 vs RIP **441, 443**
 OSPF areas **443**
 and Ethernet interfaces **328**
 backbone **443**
 Not So Stubby Area (NSSA) **443**
 stub areas **443**
 types of **443**
 OSPF routers **444**
 area border (ABR) **444**
 autonomous system boundary (ASBR) **444**
 backbone (BR) **444**
 backup designated (BDR) **445**
 designated (DR) **445**
 internal (IR) **444**
 link state advertisements
 priority **445**
 types of **444**
 OTP (One-Time Password) **908**
 outgoing bandwidth **366, 375**

P

P2P (Peer-to-peer) **756**
 attacks **756**
 see also Peer-to-peer
 packet
 inspection signatures **749, 751**
 scan **773**
 statistics **216, 217**
 packet capture **1053, 1056**
 files **1052, 1059, 1060, 1062**
 troubleshooting **1092**
 packet captures
 downloading files **1053, 1060, 1062**
 padding **761**
 PAP (Password Authentication Protocol) **943**
 Password Authentication Protocol (PAP) **943**
 payload
 option **766**
 size **767**
 Peanut Hull **456**
 Peer-to-peer (P2P) **756**
 calls **479**
 managing **716**
 Perfect Forward Secrecy (PFS) **647**
 Diffie-Hellman key group **668**
 performance
 troubleshooting **1083, 1084, 1085**
 Personal Identification Number code, see PIN code
 PFS (Perfect Forward Secrecy) **647, 668**
 physical ports
 packet statistics **216, 217**
 PIN code **366**
 PIN generator **908**
 pointer record **964**
 Point-to-Point Protocol over Ethernet, see PPPoE.
 Point-to-Point Tunneling Protocol, see PPTP
 policy enforcement in IPsec **645**
 policy route
 troubleshooting **1081, 1089**
 policy routes **430**
 actions **431**
 and address objects **436**
 and ALG **479, 483**
 and HTTP redirect **472, 473**
 and interfaces **436**

- and NAT [430](#)
 - and schedules [436, 706, 710](#)
 - and service objects [898](#)
 - and SMTP redirect [473](#)
 - and trunks [417, 436](#)
 - and user groups [435, 706, 710](#)
 - and users [435, 706, 710](#)
 - and VoIP pass through [479](#)
 - and VPN connections [436, 1087](#)
 - benefits [430](#)
 - BWM [432](#)
 - criteria [431](#)
 - L2TP VPN [697](#)
 - overriding direct routes [432](#)
- polymorphic virus [783](#)
- POP
- POP2 [786](#)
 - POP3 [786](#)
- port forwarding, see NAT
- port groups [320, 325](#)
- port roles [324](#)
- and Ethernet interfaces [324](#)
 - and physical ports [324](#)
- port translation, see NAT
- Post Office Protocol, see POP [786](#)
- power off [1077](#)
- PPP [427](#)
- troubleshooting [1082](#)
- PPP interfaces
- subnet mask [425](#)
- PPPoE [427](#)
- and RADIUS [427](#)
 - TCP port 1723 [428](#)
- PPPoE/PPTP interfaces [320, 353](#)
- and ISP accounts [353, 941](#)
 - basic characteristics [320](#)
 - gateway [353](#)
 - subnet mask [353](#)
- PPTP [427](#)
- and GRE [428](#)
 - as VPN [428](#)
- prefix delegation [323](#)
- printer
- status [262](#)
- printer firmware [567](#)
- printer list [567](#)
- printer management [567](#)
- problems [1080](#)
- profiles
- packet inspection [751](#)
- proxy servers [472](#)
- web, see web proxy servers
- PTR record [964](#)
- Public-Key Infrastructure (PKI) [926](#)
- public-private key pairs [925](#)

Q

- QoS [430, 702](#)
- query view (IDP) [753, 755](#)
- Quick Start Guide [2](#)

R

- rack-mounting [33, 79](#)
- RADIUS [908, 909](#)

 - advantages [908](#)
 - and IKE SA [666](#)
 - and PPPoE [427](#)
 - and users [832](#)
 - user attributes [847](#)

- RADIUS server [999, 1001, 1004](#)

 - troubleshooting [1089](#)

- RDP [945](#)
- Real-time Transport Protocol, see RTP
- RealVNC [945](#)
- record route [761](#)
- Reference Guide, CLI [2](#)
- registration [284](#)
- reject (IDP)

 - both [618, 753, 755, 806](#)
 - receiver [618, 753, 755, 806](#)
 - sender [618, 753, 755, 806](#)

- Relative Distinguished Name (RDN) [910, 911, 913](#)
- remote access IPsec [645](#)
- Remote Authentication Dial-In User Service, see RADIUS
- remote desktop connections [945](#)
- Remote Desktop Protocol

 - see RDP

- remote management
 - FTP, see FTP
 - see also service control **969**
 - Telnet **992**
 - to-Device security policy **601**
 - WWW, see WWW
 - remote network **635**
 - remote user screen links **945**
 - replay detection **644**
 - reports
 - anti-virus **270**
 - collecting data **222**
 - content filtering **267**
 - daily **1014**
 - daily e-mail **1014**
 - IDP **268**
 - specifications **224**
 - traffic statistics **222**
 - reset **1092**
 - RESET button **1092**
 - RFC
 - 1058 (RIP) **441**
 - 1389 (RIP) **441**
 - 1587 (OSPF areas) **443**
 - 1631 (NAT) **440**
 - 1889 (RTP) **484**
 - 2131 (DHCP) **426**
 - 2132 (DHCP) **426**
 - 2328 (OSPF) **443**
 - 2402 (AH) **646, 667**
 - 2406 (ESP) **646, 667**
 - 2516 (PPPoE) **427**
 - 2637 (PPTP) **427**
 - 2890 (GRE) **428**
 - 3261 (SIP) **483**
 - RIP **441**
 - and Ethernet interfaces **328**
 - and OSPF **441**
 - and static routes **441**
 - and to-ZyWALL security policy **441**
 - authentication **441**
 - direction **328**
 - redistribute **441**
 - RIP-2 broadcasting methods **328**
 - versions **328**
 - vs OSPF **441**
 - Rivest, Shamir and Adleman public-key algorithm (RSA) **932**
 - round robin **418**
 - routing
 - troubleshooting **1085**
 - Routing Information Protocol, see RIP
 - routing protocols **440**
 - and Ethernet interfaces **326**
 - RSA **932, 934, 940**
 - RSSI threshold **854**
 - RTLS **315**
 - RTP **484**
 - see also ALG **484**
- ## S
- same IP **766**
 - scan attacks **756**
 - scanner types **784**
 - schedule
 - troubleshooting **1090**
 - schedule backup **1039**
 - schedules **902**
 - and content filtering **722, 723**
 - and current date/time **902**
 - and policy routes **436, 706, 710**
 - and security policy **520, 610, 706, 710**
 - one-time **902**
 - recurring **902**
 - types of **902**
 - SecuExtender **692**
 - SecuManager
 - Example Network Topology **625**
 - Secure Hash Algorithm, see SHA1
 - Secure Socket Layer, see SSL
 - SecuReporter
 - Application Scenario **628**
 - security associations, see IPSec
 - security policy **601**
 - actions **610**
 - and address groups **520**
 - and address objects **520**
 - and ALG **477, 479**
 - and application patrol **716**
 - and H.323 (ALG) **478**
 - and HTTP redirect **472**
 - and IPSec VPN **1088**

- and logs [610](#)
- and NAT [603](#)
- and schedules [520](#), [610](#), [706](#), [710](#)
- and service groups [609](#)
- and service objects [898](#)
- and services [609](#)
- and SIP (ALG) [478](#)
- and user groups [610](#), [621](#)
- and users [610](#), [621](#)
- and VoIP pass through [479](#)
- and zones [601](#), [606](#)
- asymmetrical routes [602](#), [605](#)
- global rules [602](#)
- priority [605](#)
- rule criteria [602](#)
- see also to-Device security policy [601](#)
- session limits [602](#), [619](#)
- triangle routes [602](#), [605](#)
- troubleshooting [1081](#)
- security settings
 - troubleshooting [1081](#)
- Security Threat web pages [729](#)
- sensitivity level [615](#)
- serial number [202](#)
- service control [969](#)
 - and to-ZyWALL security policy [969](#)
 - and users [970](#)
 - limitations [969](#)
 - timeouts [970](#)
- service groups [898](#)
 - and security policy [609](#)
 - in IDP [757](#)
- service objects [897](#)
 - and IP protocols [898](#)
 - and policy routes [898](#)
 - and security policy [898](#)
- Service Set [848](#)
- service subscription status [286](#)
- services [897](#)
 - and Device HA [814](#)
 - and security policy [609](#)
- Session Initiation Protocol, see SIP
- session limits [602](#), [619](#)
- session monitor (L2TP VPN) [265](#)
- sessions [225](#)
- sessions usage [206](#)
- severity (IDP) [751](#), [754](#)
- SHA1 [663](#)
- shell script
 - troubleshooting [1091](#)
- shell scripts [1032](#)
 - and users [847](#)
 - downloading [1046](#)
 - editing [1045](#)
 - how applied [1033](#)
 - managing [1046](#)
 - syntax [1033](#)
 - uploading [1047](#)
- Short Message Service [1003](#)
- shutdown [1077](#)
- signal quality [234](#), [235](#)
- signature categories
 - access control [756](#)
 - backdoor/Trojan [756](#)
 - buffer overflow [756](#)
 - DoS/DDoS [756](#)
 - IM [756](#)
 - P2P [756](#)
 - scan [756](#)
 - spam [757](#)
 - virus/worm [757](#)
 - Web attack [757](#)
- signature ID [755](#), [762](#), [765](#), [806](#)
- signatures
 - anti-virus [782](#)
 - IDP [748](#)
 - packet inspection [751](#)
 - updating [287](#)
- SIM card [366](#)
- Simple Mail Transfer Protocol, see SMTP [786](#)
- Simple Network Management Protocol, see SNMP
- Simple Traversal of UDP through NAT, see STUN
- SIP [478](#), [483](#)
 - ALG [477](#)
 - and RTP [484](#)
 - and security policy [478](#)
 - media inactivity timeout [481](#)
 - signaling inactivity timeout [482](#)
 - signaling port [482](#)
 - troubleshooting [1086](#)
- SMS [1003](#)
 - send account information [1003](#)
 - ViaNett account [1003](#)
- SMS gateway [1003](#)

- SMTP [786](#)
- SMTP redirect
 - and firewall [473](#)
 - and policy routes [473](#)
 - packet flow [473](#)
- SNAT [440](#)
 - troubleshooting [1085](#)
- SNMP [35](#), [994](#), [995](#)
 - agents [995](#)
 - and address groups [998](#)
 - and address objects [998](#)
 - and zones [998](#)
 - authentication [999](#)
 - Get [995](#)
 - GetNext [995](#)
 - Manager [995](#)
 - managers [995](#)
 - MIB [995](#), [996](#)
 - network components [995](#)
 - Set [995](#)
 - Trap [995](#)
 - traps [996](#)
 - version 3 and security [995](#)
 - versions [994](#)
- Snort
 - equivalent terms [771](#)
 - rule header [771](#)
 - rule options [771](#)
 - signatures [771](#)
- Source Network Address Translation, see SNAT
- spam [155](#), [600](#), [757](#), [785](#)
- spillover (for load balancing) [419](#)
- SQL slammer [770](#)
- SSH [987](#)
 - and address groups [990](#)
 - and address objects [990](#)
 - and certificates [990](#)
 - and zones [990](#)
 - client requirements [989](#)
 - encryption methods [989](#)
 - for secure Telnet [990](#)
 - how connection is established [988](#)
 - versions [989](#)
 - with Linux [991](#)
 - with Microsoft Windows [990](#)
- SSL [671](#), [676](#), [970](#)
 - access policy [671](#)
 - and AAA [913](#)
 - and AD [913](#)
 - and LDAP [913](#)
 - certificates [680](#)
 - client [692](#)
 - client virtual desktop logo [677](#)
 - computer names [676](#)
 - connection monitor [264](#)
 - full tunnel mode [675](#)
 - global setting [676](#)
 - IP pool [676](#)
 - network list [676](#)
 - remote user login [680](#)
 - remote user logout [683](#)
 - SecuExtender [692](#)
 - see also SSL VPN [671](#)
 - troubleshooting [1088](#)
 - user application screens [683](#), [689](#)
 - user file sharing [684](#)
 - user screen bookmarks [682](#)
 - user screens [679](#), [682](#)
 - user screens access methods [679](#)
 - user screens certificates [680](#)
 - user screens login [680](#)
 - user screens logout [683](#)
 - user screens required information [680](#)
 - user screens system requirements [679](#)
 - WINS [676](#)
- SSL application object [944](#)
 - file sharing application [947](#)
 - remote user screen links [945](#)
 - summary [946](#)
 - types [944](#)
 - web-based [944](#), [947](#)
 - web-based example [945](#)
- SSL policy
 - add [673](#)
 - edit [673](#)
 - objects used [672](#)
- SSL VPN [671](#)
 - access policy [671](#)
 - full tunnel mode [671](#)
 - network access mode [32](#)
 - remote desktop connections [945](#)
 - see also SSL [671](#)
 - troubleshooting [1088](#)
 - weblink [945](#)
- stac compression [944](#)
- startup-config.conf [1038](#)
 - and synchronization (Device HA) [824](#)

- if errors [1035](#)
- missing at restart [1035](#)
- present at restart [1035](#)
- startup-config-bad.conf [1035](#)
- static DHCP [503](#)
- static routes [430](#)
 - and interfaces [439](#)
 - and OSPF [444](#)
 - and RIP [441](#)
 - metric [439](#)
- statistics
 - anti-virus [270](#)
 - content filtering [267](#)
 - daily e-mail report [1014](#)
 - IDP [268](#)
 - traffic [222](#)
- status [199](#)
- streaming protocols management [716](#)
- strict source routing [761](#)
- stub area [443](#)
- STUN [479](#)
 - and ALG [479](#)
- subscription services
 - and synchronization (Device HA) [814](#)
 - SSL VPN [153, 284](#)
 - SSL VPN, see also SSL VPN
 - status [286](#)
- SWM [432](#)
- synchronization [813](#)
 - and subscription services [814](#)
 - information synchronized [824](#)
 - password [820](#)
 - port number [820](#)
 - restrictions [824](#)
- syslog [1017, 1026](#)
- syslog servers, see also logs
- system log, see logs
- system name [202, 954](#)
- system reports, see reports
- system uptime [202](#)
- system-default.conf [1038](#)
- ACK number [766](#)
- attack packet [618, 753, 755, 806](#)
- connections [898](#)
- flag bits [766](#)
- port numbers [898](#)
- window size [766](#)
- Telnet [992](#)
 - and address groups [993](#)
 - and address objects [993](#)
 - and zones [993](#)
 - with SSH [990](#)
- throughput rate
 - troubleshooting [1091](#)
- TightVNC [945](#)
- time [955](#)
- time servers (default) [958](#)
- time to live [761](#)
- timestamp [761](#)
- to-Device security policy
 - and remote management [601](#)
 - global rules [601](#)
 - see also security policy [601](#)
- token [908](#)
- to-ZyWALL security policy
 - and NAT [468](#)
 - and NAT traversal (VPN) [1088](#)
 - and OSPF [443](#)
 - and RIP [441](#)
 - and service control [969](#)
 - and VPN [1087](#)
- TR-069 protocol [624](#)
- traffic statistics [222](#)
- Transmission Control Protocol, see TCP
- transport encapsulation [646](#)
- Transport Layer Security (TLS) [994](#)
- trapdoor attacks [756](#)
- triangle routes [602](#)
 - allowing through the security policy [605](#)
 - vs virtual interfaces [602](#)
- Triple Data Encryption Standard, see 3DES
- trojan attacks [756](#)
- troubleshooting [1048, 1080](#)
 - admin user [1089, 1090](#)
 - anti-virus [1081, 1084](#)
 - anti-virus signatures update [1081](#)
 - application patrol [1081, 1086, 1089](#)
 - application patrol signatures update [1081](#)

T

TCP [898](#)

- bandwidth limit [1083](#)
 - bandwidth management [1083](#)
 - cellular [1082](#)
 - certificate [1090](#)
 - configuration file [1091](#)
 - connection resets [1086](#)
 - content filter [1081](#)
 - DDNS [1086](#)
 - device access [1080](#)
 - ext-user [1089](#)
 - firmware package [1088](#)
 - firmware upload [1091](#)
 - FTP [1086](#)
 - H.323 [1086](#)
 - HTTP redirect [1086](#)
 - IDP [1081](#), [1085](#)
 - IDP signatures update [1081](#)
 - interface [1082](#)
 - Internet access [1080](#), [1089](#)
 - IPSec VPN [1087](#)
 - LEDs [1080](#)
 - logo [1091](#)
 - logs [1091](#)
 - management access [1090](#)
 - packet capture [1092](#)
 - performance [1083](#), [1084](#), [1085](#)
 - policy route [1081](#), [1089](#)
 - PPP [1082](#)
 - RADIUS server [1089](#)
 - routing [1085](#)
 - schedules [1090](#)
 - security policy [1081](#)
 - security settings [1081](#)
 - shell scripts [1091](#)
 - SIP [1086](#)
 - SNAT [1085](#)
 - SSL [1088](#)
 - SSL VPN [1088](#)
 - throughput rate [1091](#)
 - VLAN [1083](#)
 - VPN [1088](#)
 - WLAN [1083](#)
 - zipped files [1084](#)
- trunks [320](#), [417](#)
- and ALG [483](#)
 - and policy routes [417](#), [436](#)
 - member interface mode [422](#), [424](#)
 - member interfaces [422](#), [424](#)
 - see also load balancing [417](#)
- Trusted Certificates, see also certificates [936](#)
- tunnel encapsulation [646](#)
- Tunnel interfaces [320](#)
- two-factor authentication [837](#)
- two-factor authentication methods [837](#)

U

- UDP [898](#)
- attack packet [618](#), [753](#), [755](#), [806](#)
 - messages [898](#)
 - port numbers [898](#)
- UltraVNC [945](#)
- Universal Plug and Play [141](#), [485](#)
- Application [485](#)
 - security issues [486](#)
- unsolicited commercial e-mail [155](#), [600](#), [785](#)
- updating
- anti-virus signatures [287](#)
 - IDP and application patrol signatures [288](#)
 - signatures [287](#)
- upgrading
- firmware [1043](#)
- uploading
- configuration files [1039](#)
 - firmware [1043](#)
 - shell scripts [1045](#)
- UPnP [485](#)
- UPnP-enabled Network Device
- auto-discover [493](#)
- URI (Uniform Resource Identifier) [767](#)
- URL [626](#)
- usage
- CPU [205](#)
 - flash [205](#)
 - memory [205](#)
 - onboard flash [205](#)
 - sessions [206](#)
- user accounts
- for WLAN [833](#)
- user authentication [831](#)
- external [832](#)
 - local user database [909](#)
- user awareness [833](#)
- User Datagram Protocol, see UDP

user group objects **831, 949**
 user groups **831, 833, 949**
 and content filtering **722**
 and policy routes **435, 706, 710**
 and security policy **610, 621**
 user name
 rules **834**
 user objects **831, 949**
 user portal
 links **945**
 logo **677**
 see SSL user screens **679, 682**
 user sessions, see sessions
 user SSL screens **679, 682**
 access methods **679**
 bookmarks **682**
 certificates **680**
 login **680**
 logout **683**
 required information **680**
 system requirements **679**
 user/group **833**
 user-aware **521**
 users **831, 949**
 access, see also access users
 admin (type) **831**
 admin, see also admin users
 and AAA servers **832**
 and authentication method objects **832**
 and content filtering **722**
 and LDAP **832**
 and policy routes **435, 706, 710**
 and RADIUS **832**
 and security policy **610, 621**
 and service control **970**
 and shell scripts **847**
 attributes for Ext-User **832**
 attributes for LDAP **847**
 attributes for RADIUS **847**
 attributes in AAA servers **847**
 currently logged in **203**
 default lease time **842, 844**
 default reauthentication time **842, 844**
 default type for Ext-User **832**
 ext-group-user (type) **831**
 Ext-User (type) **832**
 ext-user (type) **831**
 groups, see user groups

Guest (type) **831**
 guest-manager (type) **831**
 lease time **837**
 limited-admin (type) **831**
 lockout **843**
 reauthentication time **837**
 types of **831**
 user (type) **831**
 user names **834**
 verification code **836**

V

Vantage Report (VRPT) **1017, 1026**
 virtual interfaces **320, 349**
 basic characteristics **320**
 not DHCP clients **425**
 types of **349**
 vs asymmetrical routes **602**
 vs triangle routes **602**
 Virtual Local Area Network, see VLAN.
 Virtual Local Area Network. See VLAN.
 Virtual Network Computing
 see VNC
 Virtual Private Network, see VPN
 virtual router **816, 825**
 virus **757**
 attack **152, 757, 773**
 boot sector **783**
 e-mail **783**
 file infector **783**
 life cycle **784**
 macro **783**
 mutation **783**
 polymorphic **783**
 VLAN **369, 376**
 advantages **376**
 and MAC address **376**
 ID **376**
 troubleshooting **1083**
 VLAN interfaces **320, 377**
 and Ethernet interfaces **377, 1083**
 basic characteristics **320**
 virtual **349**
 VoIP pass through **483**
 and NAT **479**

- and policy routes [479](#)
 - and security policy [479](#)
 - see also ALG [477](#)
 - VPN [635](#)
 - active protocol [667](#)
 - and NAT [666](#)
 - basic troubleshooting [1087](#)
 - hub-and-spoke, see VPN concentrator
 - IKE SA, see IKE SA
 - IPSec [155](#), [600](#), [635](#)
 - IPSec SA
 - proposal [663](#)
 - security associations (SA) [637](#)
 - see also IKE SA
 - see also IPSec [155](#), [600](#), [635](#)
 - see also IPSec SA
 - status [211](#)
 - troubleshooting [1088](#)
 - VPN concentrator [657](#)
 - advantages [657](#)
 - and IPSec SA policy enforcement [659](#)
 - disadvantages [657](#)
 - VPN connections
 - and address objects [640](#)
 - and policy routes [436](#), [1087](#)
 - VPN gateways
 - and certificates [640](#)
 - and extended authentication [640](#)
 - and interfaces [640](#)
 - and to-ZyWALL security policy [1088](#)
 - VRPT (Vantage Report) [1017](#), [1026](#)
- ## W
- wall-mounting [85](#)
 - warranty [1114](#), [1120](#)
 - note [1114](#), [1120](#)
 - Web attack [757](#)
 - Web Configurator [34](#)
 - access [36](#)
 - access users [844](#)
 - web features
 - ActiveX [743](#)
 - cookies [743](#)
 - Java [743](#)
 - web proxy servers [743](#)
 - web proxy servers [472](#), [743](#)
 - web-based SSL application [944](#)
 - configuration example [945](#)
 - create [947](#)
 - weblink [945](#)
 - weighted round robin (for load balancing) [419](#)
 - weighted round robin algorithm [511](#)
 - WEP (Wired Equivalent Privacy) [848](#)
 - white list (anti-spam) [785](#), [789](#), [793](#), [794](#)
 - Wi-Fi Protected Access [848](#)
 - Windows Internet Naming Service, see WINS
 - Windows Internet Naming Service, see WINS.
 - Windows Remote Desktop [945](#)
 - WINS [344](#), [388](#), [402](#), [410](#), [427](#), [676](#)
 - in L2TP VPN [699](#)
 - WINS server [344](#), [699](#)
 - Wireshark [768](#)
 - Wizard Setup [156](#)
 - WLAN
 - troubleshooting [1083](#)
 - user accounts [833](#)
 - WLAN interfaces [320](#)
 - worm [152](#), [757](#), [773](#)
 - attacks [757](#)
 - WPA [848](#)
 - WPA2 [848](#)
 - WWW [971](#)
 - and address groups [975](#)
 - and address objects [975](#)
 - and authentication method objects [974](#)
 - and certificates [972](#)
 - and zones [975](#)
 - see also HTTP, HTTPS [971](#)
- ## Z
- zipped files
 - troubleshooting [1084](#)
 - ZON Utility [1007](#)
 - zones [828](#)
 - and FTP [994](#)
 - and interfaces [828](#)
 - and security policy [601](#), [606](#)
 - and SNMP [998](#)

- and SSH [990](#)
- and Telnet [993](#)
- and VPN [828](#)
- and WWW [975](#)
- extra-zone traffic [829](#)
- inter-zone traffic [829](#)
- intra-zone traffic [829](#)
- types of traffic [828](#)
- ZyMesh [878](#)
 - auto provision [878](#)
 - bridge loops [879](#)
 - hop [879](#)
 - profile [880](#)
 - Repeater [879](#)
 - repeater [878](#)
 - Root AP [879](#)
 - root AP [878](#)
 - security [881](#)
 - SSID [881](#)
 - WDS [878](#)
- ZyMesh profiles [880](#)