

A

NAMEK

S412-REG2D

A	B	C	D
1	S412-0008	584	446 2/2
2	S412-0009	584,	446, 2/2
3	S412-1008	1088	377 1/2
4	S412-1009	1088	377 1/2
5	S412-1010	1024	355, 1/2
6	S412-2005	950	380 1/2
7	S412-3012	901	374, 1/2
8	S412-3013	442,5	355, 2/2
9	S412-3014	442	348 2/2
10	S412-4001	901	60 1/2
11	S412-5702	330,	50, 2/2
12	S412-9003	1048	460 1/2

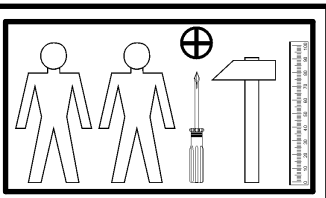
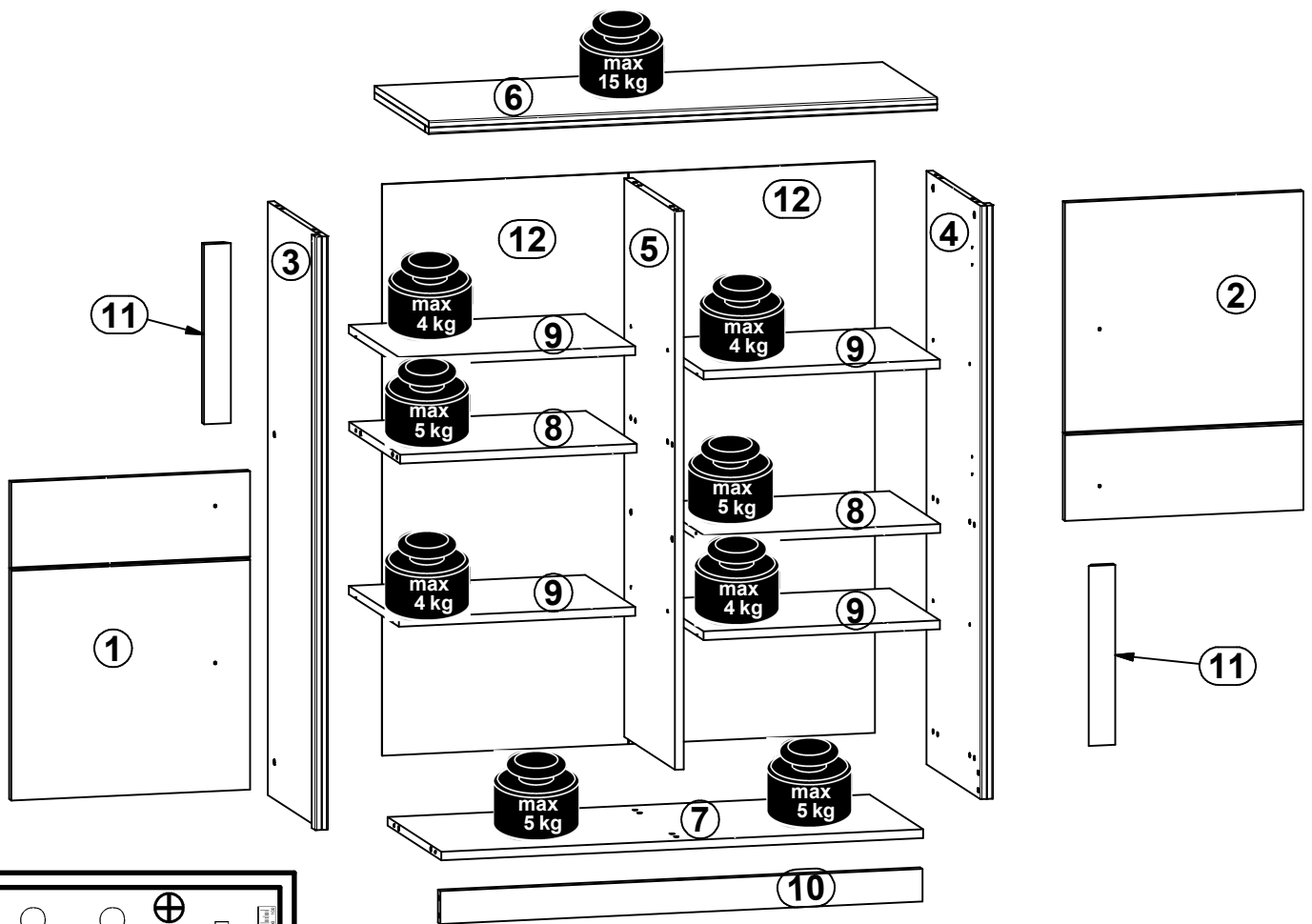
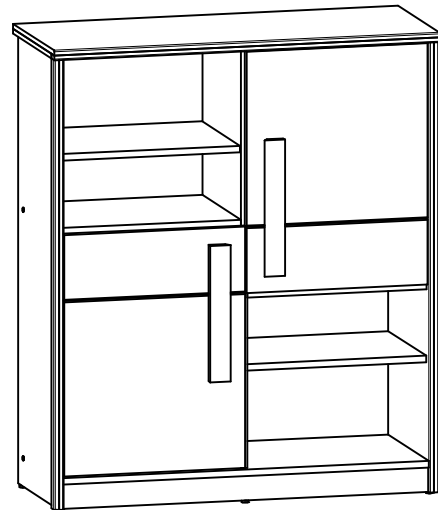

4x K16 a43	4x D5 b60	16x Ø5x17 mm d1	14x Ø7x50 mm e1	8x Ø5x12 mm e41	25x Ø8x30 mm f1	5x k1	70x 1.4x20 mm l1	4x silikon o21
8x Ø3.5x15 mm p51	4x Ø4x28 mm p94	2x Ø15x12 mm #16 r1	4x Ø12x10.5 mm #12 r15	6x 20/9 r16	12x s1	2x Ø16 s2	4x Ø12 s34	1x 4 mm z1
1x Ø3.5x16 mm p38	1x n26							

1 

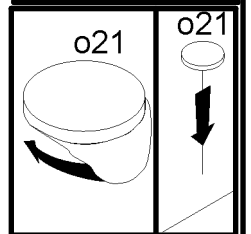
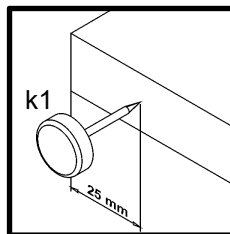
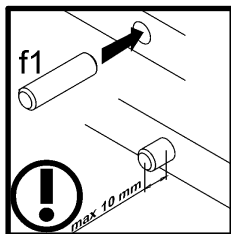
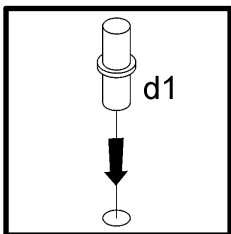
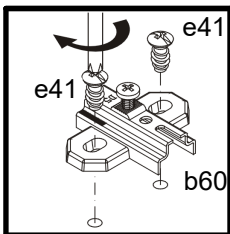
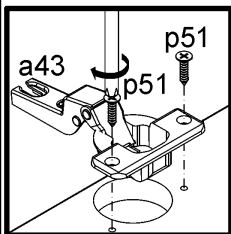
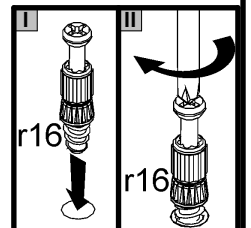
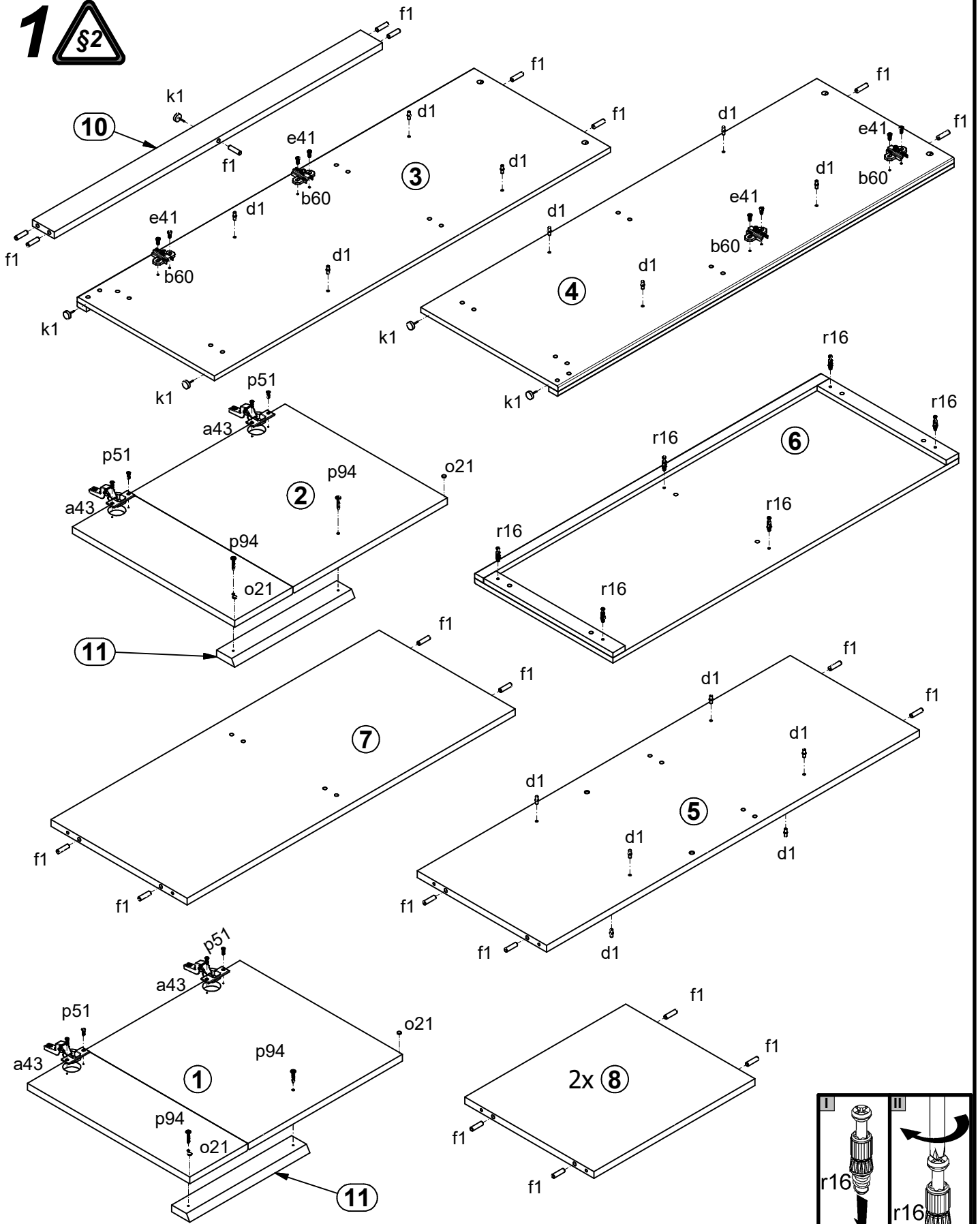

2

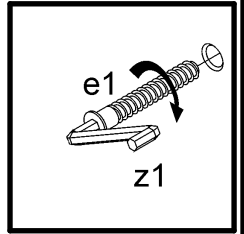
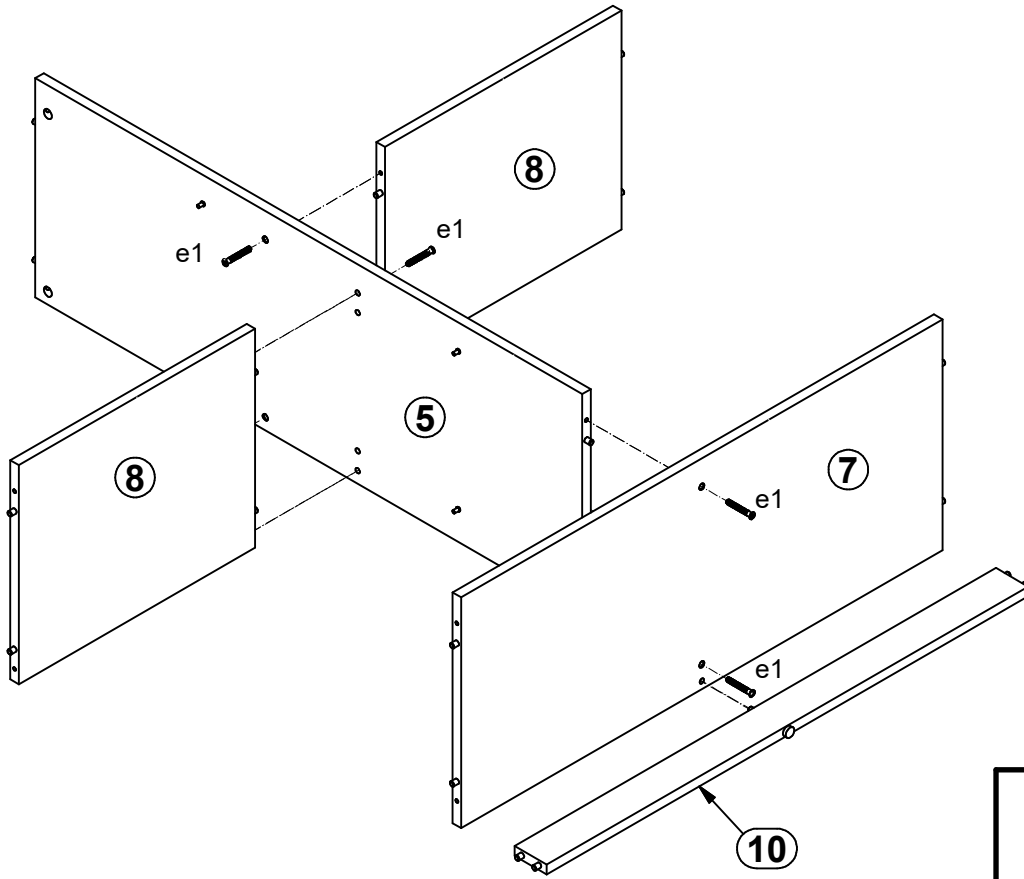

3

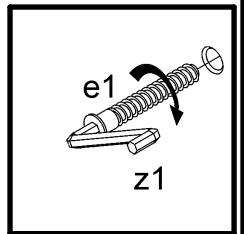
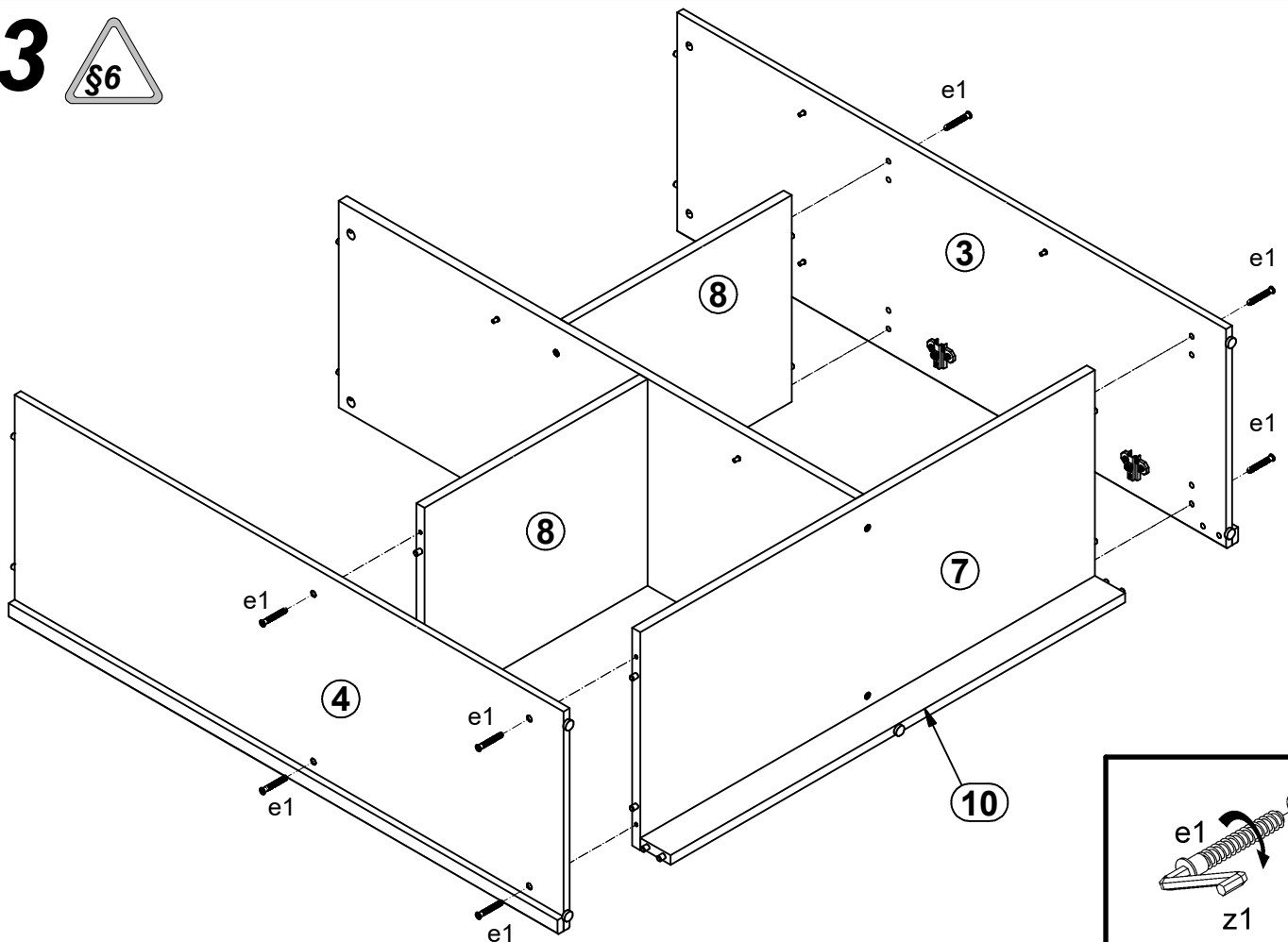

4

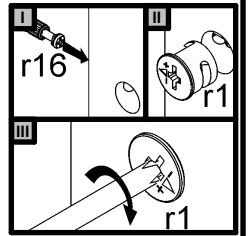
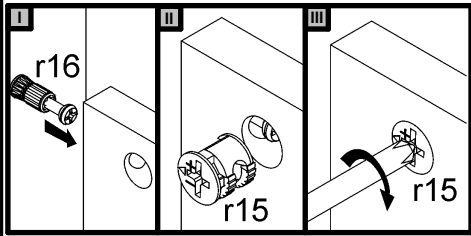
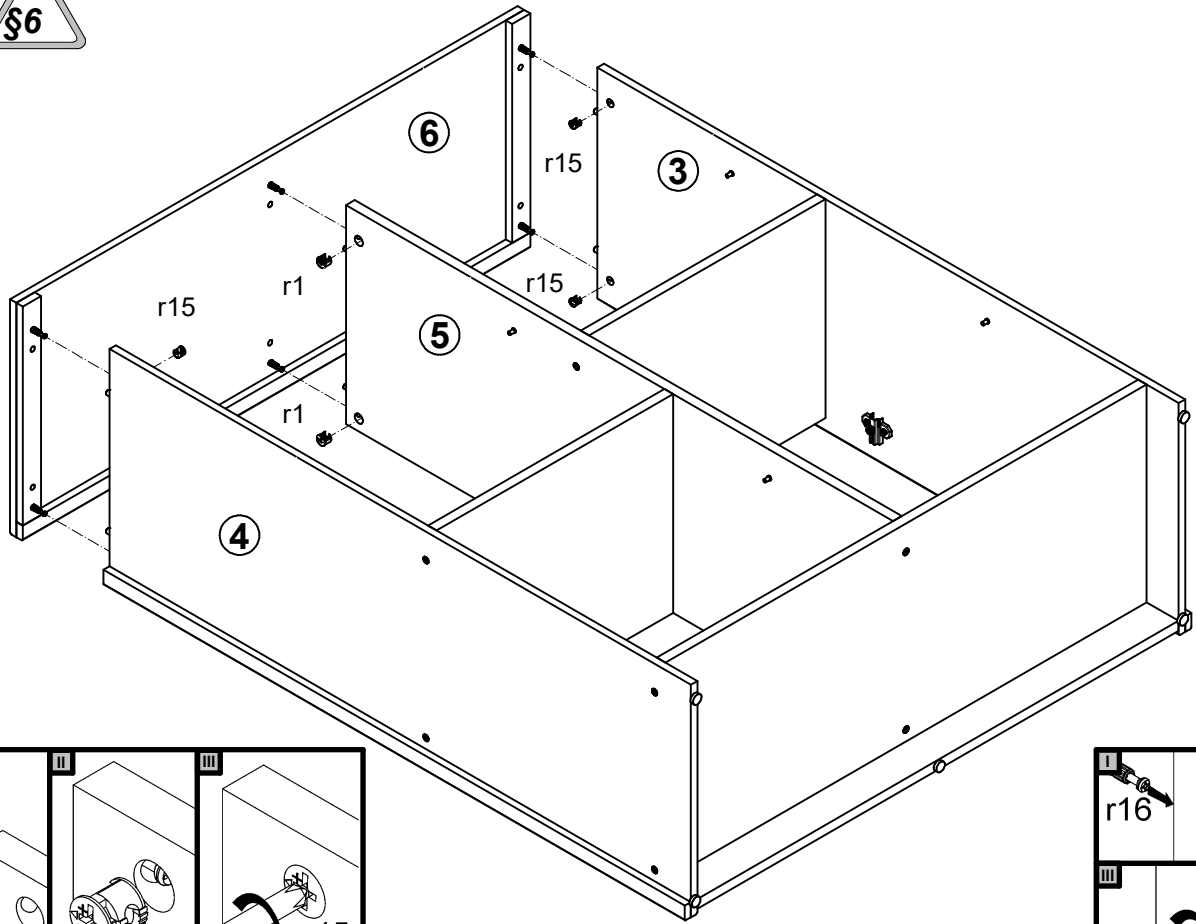

5

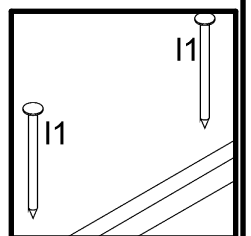
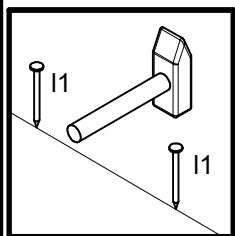
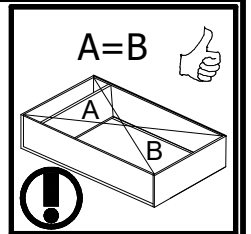
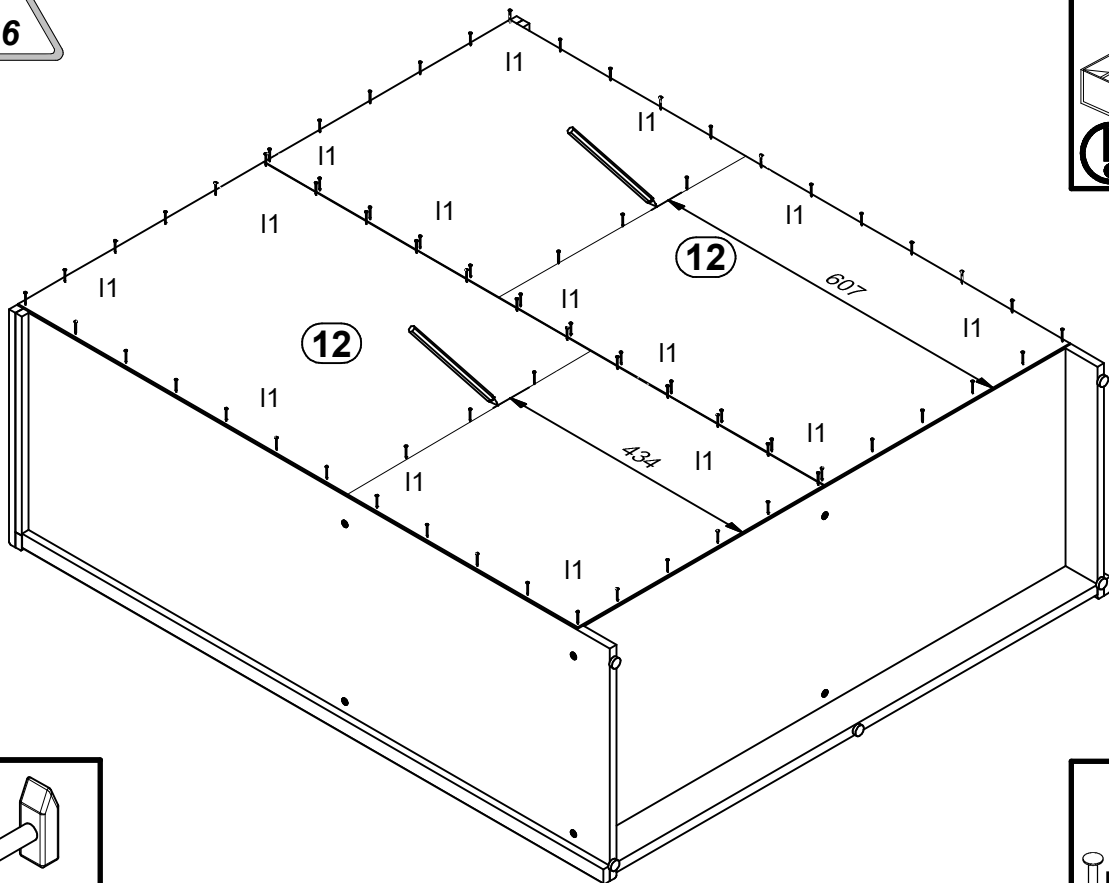

6

