



Digital Projector User Manual

Warranty and Copyright information

Limited warranty

BenQ warrants this product against any defects in material and workmanship, under normal usage and storage.

Proof of purchase date will be required with any warranty claim. In the event this product is found to be defective within the warranty period, BenQ's only obligation and your exclusive remedy shall be replacement of any defective parts (labor included). To obtain warranty service, immediately notify the dealer from which you purchased the product of any defects.

Important: The above warranty shall be void if the customer fails to operate the product in accordance with BenQ's written instructions, especially the ambient humidity must be in-between 10% and 90%, temperature in-between 0°C and 35°C, altitude lower than 4920 feet, and avoiding to operate the projector in a dusty environment. This warranty gives you specific legal rights, and you may have other rights which vary from country to country.

For other information, please visit www.BenQ.com.

Copyright

Copyright © 2021 by BenQ Corporation. All rights reserved. No part of this publication may be reproduced, transmitted, transcribed, stored in a retrieval system or translated into any language or computer language, in any form or by any means, electronic, mechanical, magnetic, optical, chemical, manual or otherwise, without the prior written permission of BenQ Corporation.

Disclaimer

BenQ Corporation makes no representations or warranties, either expressed or implied, with respect to the contents hereof and specifically disclaims any warranties, merchantability or fitness for any particular purpose. Further, BenQ Corporation reserves the right to revise this publication and to make changes from time to time in the contents hereof without obligation to notify any person of such revision or changes.

*DLP, Digital Micromirror Device and DMD are trademarks of Texas Instruments. Others are copyrights of their respective companies or organizations.

Patents

Please go to <http://patmarking.benq.com/> for the details on BenQ projector patent coverage.

Table of Contents

| | |
|---|-----------|
| Warranty and Copyright information | 2 |
| Important safety instructions | 4 |
| Introduction | 7 |
| Shipping contents | 7 |
| Projector exterior view | 8 |
| Controls and functions..... | 9 |
| Positioning your projector | 11 |
| Choosing a location | 11 |
| Obtaining a preferred projected image size..... | 12 |
| Mounting the projector | 13 |
| Adjusting the projected image | 14 |
| Connection | 16 |
| Operation | 18 |
| Installing the QS01 HDMI Media Streaming (Optional) | 18 |
| Starting up the projector | 18 |
| Setting up the QS01 HDMI Media Streaming (Optional)..... | 21 |
| Using the menus | 23 |
| Securing the projector | 24 |
| Switching input signal | 25 |
| Shutting down the projector | 26 |
| Menu operation | 27 |
| Menu System | 27 |
| Maintenance | 44 |
| Care of the projector | 44 |
| Light source information | 45 |
| Troubleshooting | 49 |
| Specifications | 50 |
| Projector specifications | 50 |
| Dimensions | 51 |
| Timing chart..... | 52 |
| RS232 command..... | 54 |

Important safety instructions

Your projector is designed and tested to meet the latest standards for safety of information technology equipment. However, to ensure safe use of this product, it is important that you follow the instructions mentioned in this manual and marked on the product.

1. **Please read this manual before you operate your projector.** Save it for future reference.

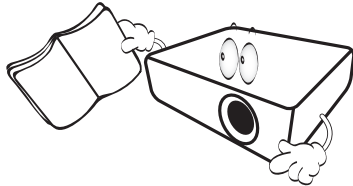

2. **Do not look straight at the projector lens during operation.** The intense light beam may damage your eyes.

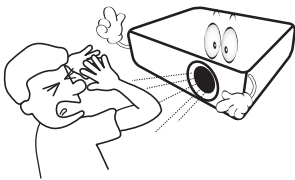

3. **Refer servicing to qualified service personnel.**

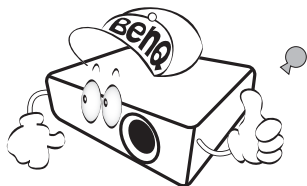

4. **Always open the lens shutter (if any) or remove the lens cap (if any) when the projector light source is on.**

5. The light source becomes extremely hot during operation. Allow the projector to cool for approximately 45 minutes prior to removing the light source assembly for replacement.

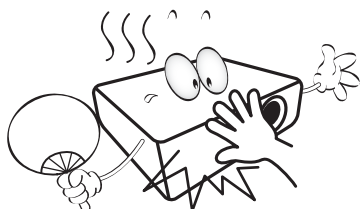

6. In some countries, the line voltage is NOT stable. This projector is designed to operate safely within a mains voltage between 100 to 240 volts AC, but could fail if power cuts or surges of ± 10 volts occur. **In areas where the mains voltage may fluctuate or cut out, it is recommended that you connect your projector through a power stabilizer, surge protector or uninterruptible power supply (UPS).**

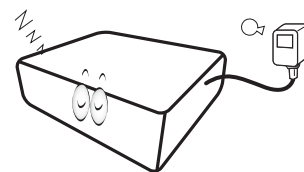

7. Do not block the projection lens with any objects when the projector is under operation as this could cause the objects to become heated and deformed or even cause a fire. To temporarily turn off the light source, press the **ECO BLANK** button.

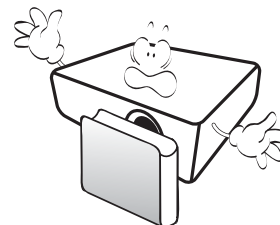

8. Do not operate light sources beyond the rated life. Excessive operation of light sources beyond the rated life could cause them to break on rare occasions.

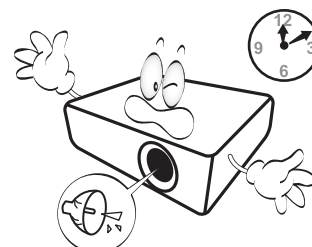

9. Never replace the light source assembly or any electronic components unless the projector is unplugged.

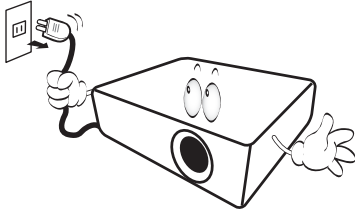

10. Do not place this product on an unstable cart, stand, or table. The product may fall, sustaining serious damage.

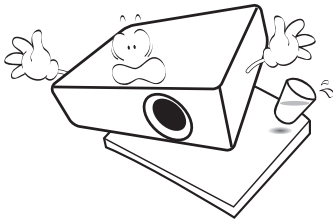

11. Do not attempt to disassemble this projector. There are dangerous high voltages inside which may cause death if you should come into contact with live parts. The only user serviceable part is the lamp which has its own removable cover.

Under no circumstances should you ever undo or remove any other covers. Refer servicing only to suitably qualified professional service personnel.

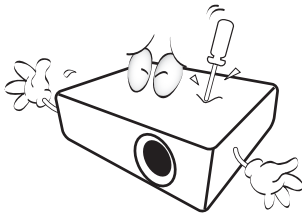

12. Do not block the ventilation holes.

- Do not place this projector on a blanket, bedding or any other soft surface.
- Do not cover this projector with a cloth or any other item.
- Do not place inflammables near the projector.

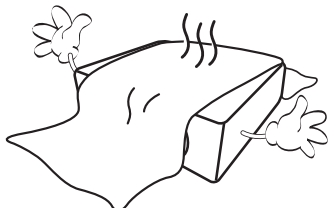

If the ventilation holes are seriously obstructed, overheating inside the projector may result in a fire.

13. Always place the projector on a level, horizontal surface during operation.

- Do not use if tilted at an angle of more than 10 degrees left to right, nor at angle of more than 15 degrees front to back. Using the projector when it is not fully horizontal may cause a malfunction of, or damage to, the light source.

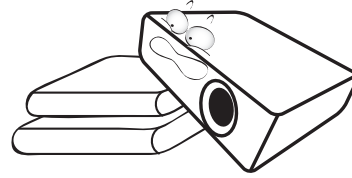

14. Do not stand the projector on end vertically. Doing so may cause the projector to fall over, causing injury or resulting in damage to the projector.



15. Do not step on the projector or place any objects upon it. Besides probable physical damage to the projector, doing so may result in accidents and possible injury.

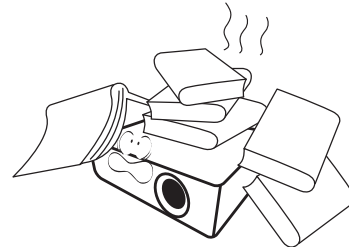

16. When the projector is under operation, you may sense some heated air and odor from its ventilation grill. It is a normal phenomenon and not a product defect.

17. Do not place liquids near or on the projector. Liquids spilled into the projector may cause it to fail. If the projector does become wet, disconnect it from the power supply's power outlet and call BenQ to have the projector serviced.

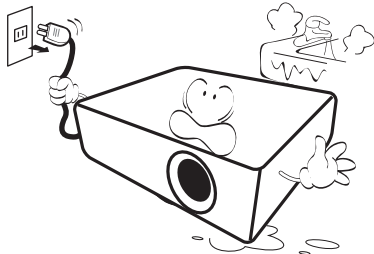

18. This product is capable of displaying inverted images for ceiling/wall mount installation.

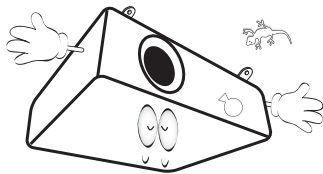

19. This apparatus must be earthed.

20. Do not place this projector in any of the following environments.

- Space that is poorly ventilated or confined. Allow at least 50 cm clearance from walls and free flow of air around the projector.
- Locations where temperatures may become excessively high, such as the inside of a car with all windows rolled up.
- Locations where excessive humidity, dust, or cigarette smoke may contaminate optical components, shorten the projector's life span and darken the image.

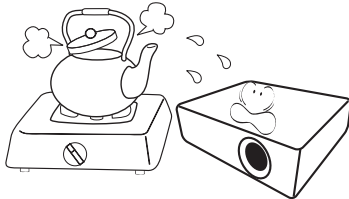

- Locations near fire alarms
- Locations with an ambient temperature above 40°C / 104°F
- Locations where the altitudes are higher than 3000 m (10000 feet).

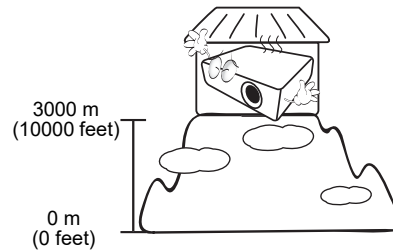

Risk Group 2

1. According to the classification of photobiological safety of light sources and light source systems, this product is Risk Group 2, IEC 62471-5:2015.
2. Possibly hazardous optical radiation emitted from this product.
3. Do not stare at operating light source. May be harmful to the eyes.
4. As with any bright source, do not stare into the direct beam.



! Hg - Lamp contains mercury. Manage in accordance with local disposal laws. See www.lamprecycle.org.

! To avoid damaging the DLP chips, never aim a high-power laser beam into the projection lens.

Introduction

Shipping contents

Carefully unpack and verify that you have all of the items shown below. If any of these items are missing, please contact your place of purchase.

Standard accessories

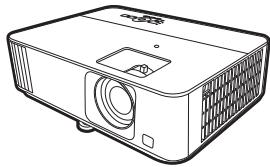

Projector

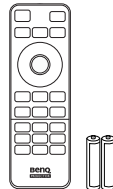

Remote control with batteries

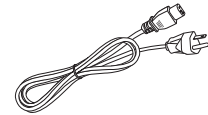

Power cord



Quick start guide

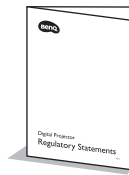

Regulatory statements



Warranty card*



- The supplied accessories will be suitable for your region, and may differ from those illustrated.
- *The warranty card is only supplied in some specific regions. Please consult your dealer for detailed information.

Optional accessories

1. Spare lamp kit
2. 3D glasses
3. QS01 HDMI Media Streaming

Replacing the remote control batteries

1. Press and slide off the battery cover, as illustrated.
2. Remove the old batteries (if applicable) and install two AAA batteries. Make sure that the positive and negative ends are positioned correctly, as illustrated.
3. Slide the battery cover in until it clicks into place.

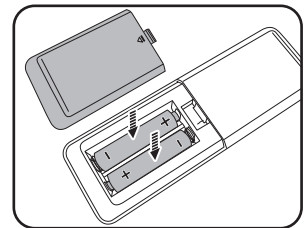
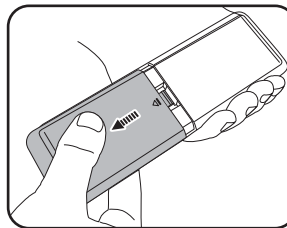

- Avoid leaving the remote control and batteries in an excessive heat or humid environment like the kitchen, bathroom, sauna, sunroom or in a closed car.
- Replace only with the same or equivalent type recommended by the battery manufacturer.
- Dispose of the used batteries according to the manufacturer's instructions and local environment regulations for your region.
- Never throw the batteries into a fire. There may be danger of an explosion.
- If the batteries are dead or if you will not be using the remote control for an extended period of time, remove the batteries to avoid damage to the remote control from possible battery leakage.

Projector exterior view

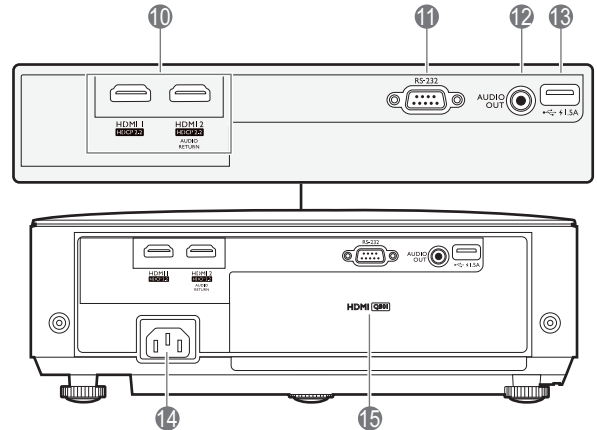
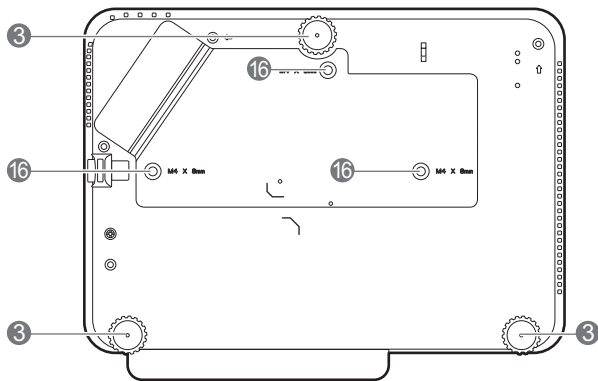
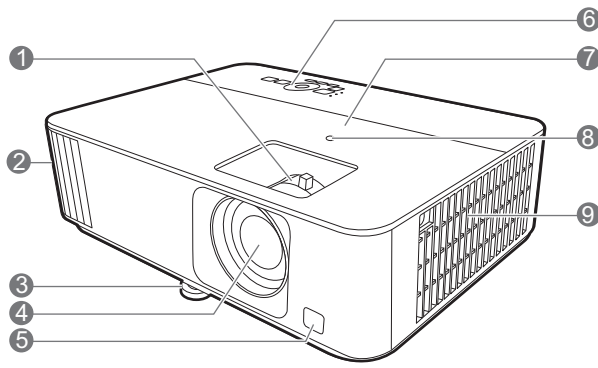

- 1. Focus ring and Zoom ring
- 2. Vent (air exhaust)
- 3. Adjuster feet
- 4. Projection lens
- 5. IR remote sensor
- 6. External control panel
(See [Controls and functions on page 9.](#))
- 7. Lamp cover
- 8. Ambient Light Sensor (ALS)
- 9. Vent (air inlet)
- 10. HDMI 1/HDMI 2 input port
- 11. RS-232 control port
- 12. Audio output jack
- 13. USB Type A port (Power supply 1.5 A)
- 14. AC power jack
- 15. QS01 HDMI Media Streaming port
(QS01 is an optional accessory.)
- 16. Ceiling mount holes

Controls and functions

Projector & Remote control



All the key presses described in this document are available on the remote control or projector.

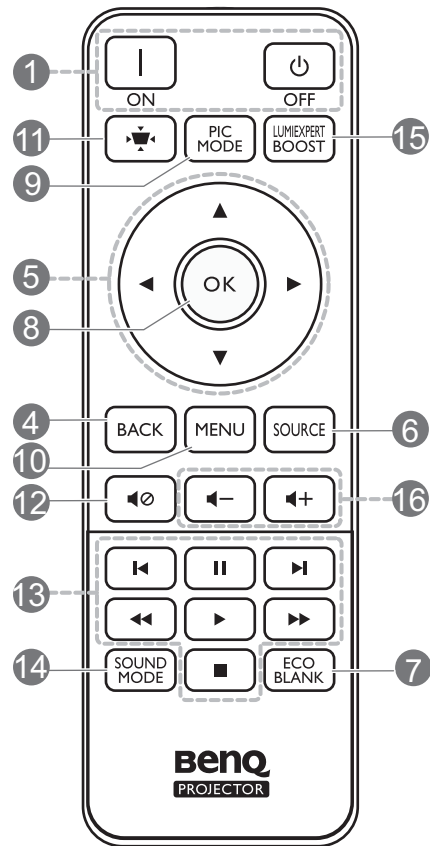
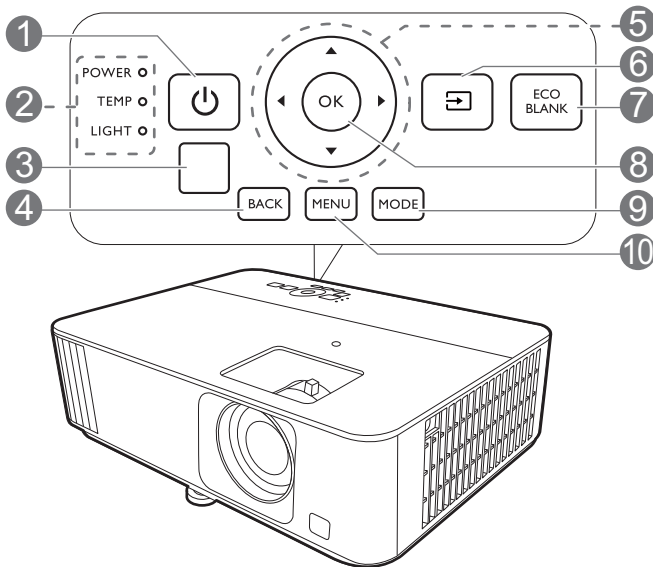

1. **POWER**

Toggles the projector between standby mode and on.

 **ON** /  **OFF**

Toggles the projector between standby mode and on.

2. **POWER indicator light/TEMPerature warning light/LIGHT indicator light** (See [Indicators on page 48.](#))

3. IR remote sensor

4. **BACK**

Goes back to previous OSD menu, exits and saves menu settings.

5. Arrow keys (, , ,)

When the On-Screen Display (OSD) or the ATV menu is activated, these keys are used as directional arrows to select the desired menu items and to make adjustments.

When OSD and ATV menu is inactive, workable under CEC-capable sources only.

6. / **SOURCE**

Displays the source selection bar.

7. **ECO BLANK**

Used to hide the screen picture.



Do not block the projection lens from projecting as this could cause the blocking object to become heated and deformed or even cause a fire.

8. **OK**

- Confirms the selected ATV or On-Screen Display (OSD) menu item.
- Under ATV media playback, plays or pauses a video or audio file.

9. **MODE/PIC MODE**

Selects an available picture mode.

10. **MENU**

Turns on/off the On-Screen Display (OSD) menu.

11. **KEYSTONE**

Displays the keystone menu. See [Correcting keystone on page 15](#) for details.

12. **MUTE**

Toggles projector audio between on and off.

13. HDMI CEC-compatible device control keys (Backward, Pause, Forward, Rewind, Play, Fast forward, Stop)

Controls video or audio playback for the CEC-compatible device.

14. **SOUND MODE**

Selects an available sound mode.

15. **LUMIEXPERT BOOST**

Displays the **LumiExpert** menu.

16. / Volume keys

Decreases or increases the projector volume.

Remote control effective range

The remote control must be held at an angle within 30 degrees perpendicular to the projector's IR remote control sensor(s) to function correctly. The distance between the remote control and the sensor(s) should not exceed 8 meters (~ 26 feet).

Make sure that there are no obstacles between the remote control and the IR sensor(s) on the projector that might obstruct the infra-red beam.

- Operating the projector from the front

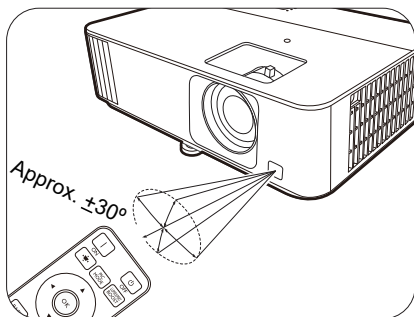

- Operating the projector from the top

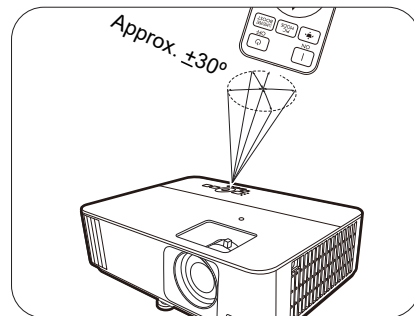

Positioning your projector

Choosing a location

Before choosing an installation location for your projector, take the following factors into consideration:

- Size and position of your screen
- Electrical outlet location
- Location and distance between the projector and the rest of your equipment

You can install your projector in the following ways.

1. Front

Select this location with the projector placed on the table in front of the screen. This is the most common way to position the projector for quick setup and portability.

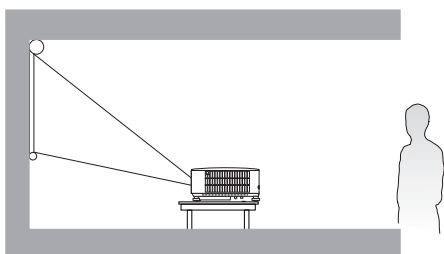

2. Rear

Select this location with the projector placed on the table behind the screen. Note that a special rear projection screen is required.

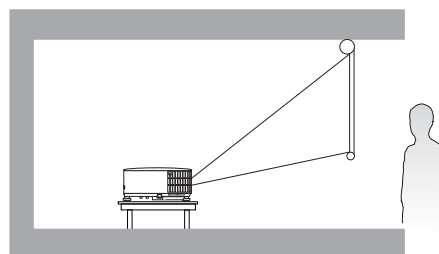

3. Front Ceiling

Select this location with the projector suspended upside-down from the ceiling in front of the screen. Purchase the BenQ Projector Ceiling Mount Kit from your dealer to mount your projector on the ceiling.

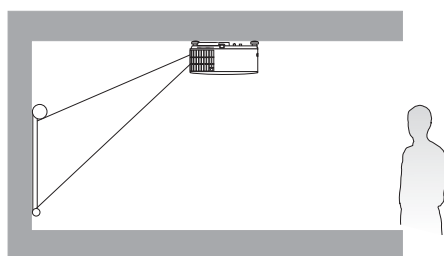

4. Rear Ceiling

Select this location with the projector suspended upside-down from the ceiling behind the screen. Note that a special rear projection screen and the BenQ Projector Ceiling Mount Kit are required for this installation location.

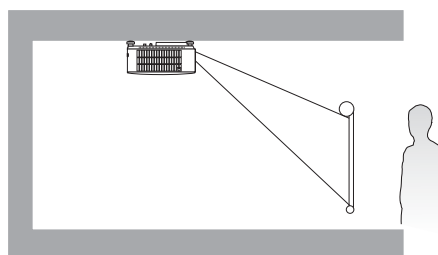

After turning on the projector, go to **Advanced** menu - **Installation** > **Projector Position**, press **OK** and press **◀/▶** to select a setting.

Obtaining a preferred projected image size

The distance from the projector lens to the screen, the zoom setting (if available), and the video format each factors in the projected image size.

Projection dimensions

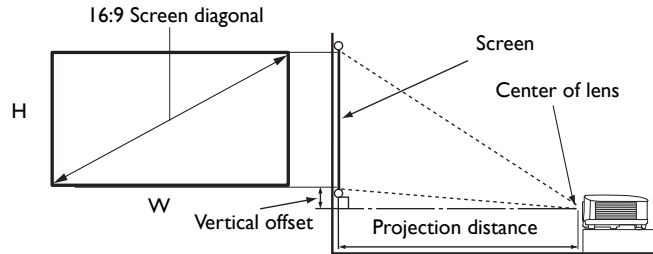

- The screen aspect ratio is 16:9 and the projected picture is in a 16:9 aspect ratio

| Screen size | | | Projection distance (mm) | | | Vertical offset (mm) | |
|-------------|------|--------|--------------------------|------------------------------|---------|----------------------|------------------------------|
| Diagonal | | H (mm) | W (mm) | Min distance (with max zoom) | Average | | Max distance (with min zoom) |
| Inch | mm | | | | | | |
| 30 | 762 | 374 | 664 | 748 | 859 | 970 | 37 |
| 40 | 1016 | 498 | 886 | 998 | 1145 | 1293 | 50 |
| 50 | 1270 | 623 | 1107 | 1247 | 1432 | 1616 | 62 |
| 60 | 1524 | 747 | 1328 | 1497 | 1718 | 1939 | 75 |
| 70 | 1778 | 872 | 1550 | 1746 | 2004 | 2263 | 87 |
| 80 | 2032 | 996 | 1771 | 1996 | 2291 | 2586 | 100 |
| 90 | 2286 | 1121 | 1992 | 2245 | 2577 | 2909 | 112 |
| 100 | 2540 | 1245 | 2214 | 2495 | 2864 | 3232 | 125 |
| 110 | 2794 | 1370 | 2435 | 2744 | 3150 | 3555 | 137 |
| 120 | 3048 | 1494 | 2657 | 2994 | 3436 | 3879 | 149 |
| 130 | 3302 | 1619 | 2878 | 3243 | 3723 | 4202 | 162 |
| 140 | 3556 | 1743 | 3099 | 3493 | 4009 | 4525 | 174 |
| 150 | 3810 | 1868 | 3321 | 3742 | 4295 | 4848 | 187 |
| 160 | 4064 | 1992 | 3542 | 3992 | 4582 | 5171 | 199 |
| 170 | 4318 | 2117 | 3763 | 4241 | 4868 | 5495 | 212 |
| 180 | 4572 | 2241 | 3985 | 4491 | 5154 | 5818 | 224 |
| 190 | 4826 | 2366 | 4206 | 4740 | 5441 | 6141 | 237 |
| 200 | 5080 | 2491 | 4428 | 4990 | 5727 | 6464 | 249 |
| 210 | 5334 | 2615 | 4649 | 5239 | 6013 | 6788 | 262 |
| 220 | 5588 | 2740 | 4870 | 5489 | 6300 | 7111 | 274 |
| 230 | 5842 | 2864 | 5092 | 5738 | 6586 | 7434 | 286 |
| 240 | 6096 | 2989 | 5313 | 5988 | 6873 | 7757 | 299 |
| 250 | 6350 | 3113 | 5535 | 6237 | 7159 | 8080 | 311 |
| 260 | 6604 | 3238 | 5756 | 6487 | 7445 | 8404 | 324 |
| 270 | 6858 | 3362 | 5977 | 6736 | 7732 | 8727 | 336 |
| 280 | 7112 | 3487 | 6199 | 6986 | 8018 | 9050 | 349 |
| 290 | 7366 | 3611 | 6420 | 7235 | 8304 | 9373 | 361 |
| 300 | 7620 | 3736 | 6641 | 7485 | 8591 | 9696 | 374 |

For example, if you are using a 120-inch screen, the recommended projection distance in the "Average" column is 3436 mm.

If your measured projection distance is 3700 mm, the closest match in the "Average" column is 3723 mm. Looking across this row shows that a 130" (about 3.3 m) screen is required.



To optimize your projection quality, we suggest doing the projection by referring to the values listed in the non-gray rows.



All measurements are approximate and may vary from the actual sizes.

BenQ recommends that if you intend to permanently install the projector, you should physically test the projection size and distance using the actual projector in situ before you permanently install it, so as to make allowance for this projector's optical characteristics. This will help you determine the exact mounting position so that it best suits your installation location.

Mounting the projector

If you intend to mount your projector, we strongly recommend that you use a proper fitting BenQ projector mounting kit and that you ensure it is securely and safely installed.

If you use a non-BenQ brand projector mounting kit, there is a safety risk that the projector may fall down due to an improper attachment through the use of the wrong gauge or length screws.

Before mounting the projector

- Purchase a BenQ projector mounting kit from the place you purchased your BenQ projector.
- Ask your dealer to install the projector for you. Installing the projector on your own may cause it to fall and result in injury.
- Take necessary procedures to prevent the projector from falling off such as during an earthquake.
- The warranty doesn't cover any product damage caused by mounting the projector with a non-BenQ brand projector mounting kit.
- Consider the surrounding temperature where the projector is ceiling/wall mounted. If a heater is used, the temperature around the ceiling may be higher than expected.
- Read the user manual for the mounting kit about the range of torque. Tightening with torque exceeding the recommended range may cause damage to the projector and subsequently falling off.
- Make sure the power outlet is at an accessible height so that you can easily shut down the projector.

Ceiling/Wall mount installation diagram

Ceiling/Wall mount screw hole: M4 x 8 mm

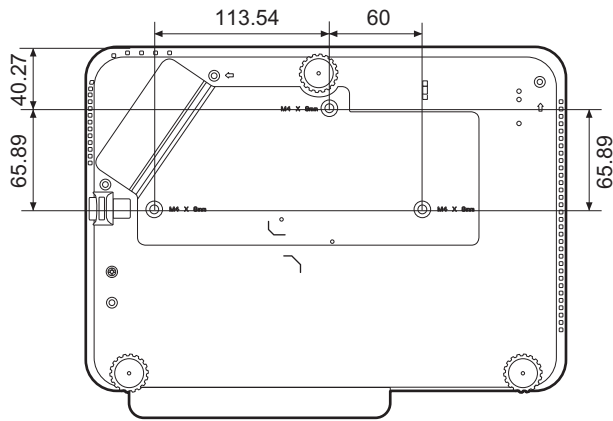

Unit: mm

Adjusting the projected image

Adjusting the projection angle

If the projector is not placed on a flat surface or the screen and the projector are not perpendicular to each other, the projected image becomes trapezoidal. You can adjust the adjuster feet to fine-tune the horizontal angle.

To retract the feet, screw the adjuster feet in a reverse direction.

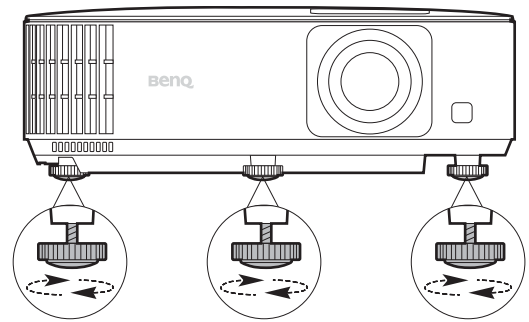

Do not look into the lens while the light source is on. The strong light from the light source may cause damage to your eyes.

Fine-tuning the image size and clarity

- Adjust the projected image to the size that you need using the zoom ring.
- Sharpen the image by rotating the focus ring.

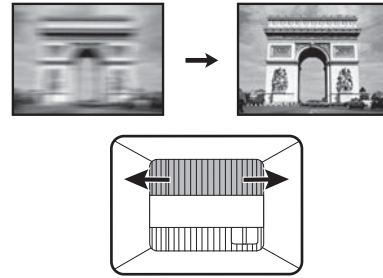
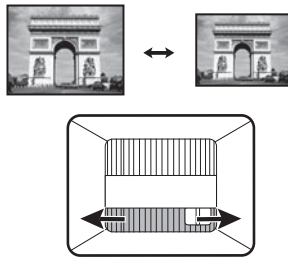

Correcting keystone

Keystoning refers to the situation where the projected image becomes a trapezoid due to angled projection.

To correct the distorted image:

1. Display the **2D Keystone** correction from the following menus.
 - The setup wizard during the projector initial setup
 - The **Basic** menu system
 - The **Installation** menu of the **Advanced** menu system
2. After the **2D Keystone** correction page appears:
 - To correct keystoning at the top of the image, use ▼.
 - To correct keystoning at the bottom of the image, use ▲.
 - To correct keystoning at the right side of the image, use ◀.
 - To correct keystoning at the left side of the image, use ▶.
 - To automatically correct the vertical sides of the distorted image, press **OK** for 2 seconds, or enable **Auto Vertical Keystone** in the **Advanced** menu - **Installation** menu.
3. When done, press ⏪ to save your changes and exit.

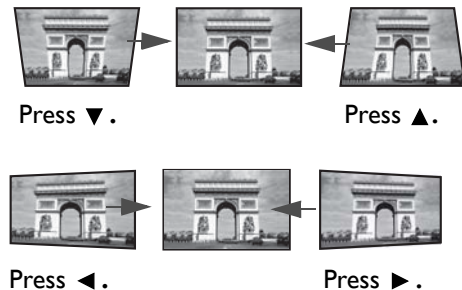

Connection

When connecting a signal source to the projector, be sure to:

1. Turn all equipment off before making any connections.
2. Use the correct signal cables for each source.
3. Ensure the cables are firmly inserted.

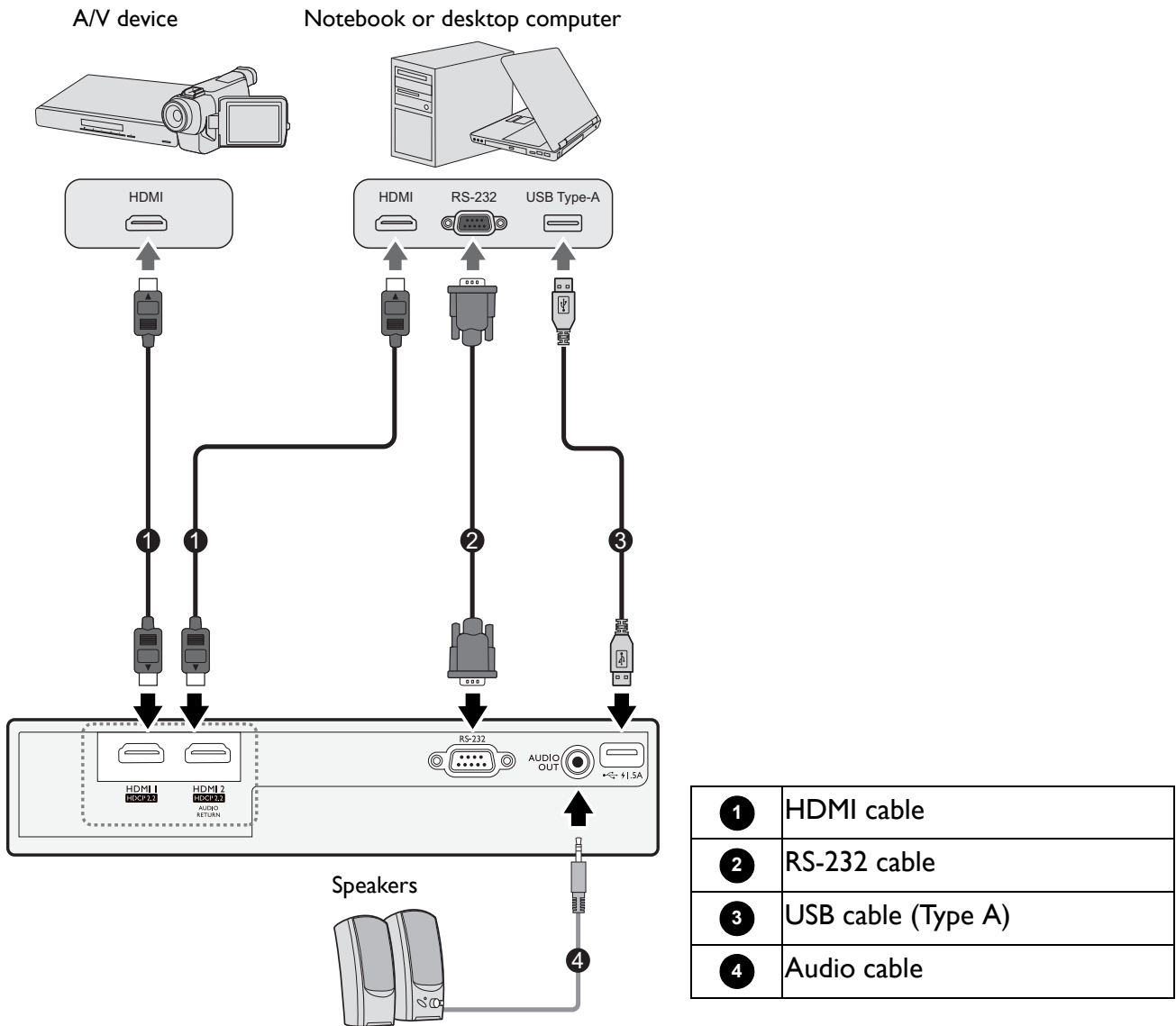

- In the connections above, some cables may not be included with the projector (see [Shipping contents on page 7](#)). They are commercially available from electronics stores.
- The connection illustrations are for reference only. The rear connecting jacks available on the projector vary with each projector model.
- Many notebooks do not turn on their external video ports when connected to a projector. Usually a key combo like FN + function key with a monitor symbol turns the external display on/off. Press FN and the labeled function key simultaneously. Refer to your notebook's documentation to find your notebook's key combination.
- If the selected video image is not displayed after the projector is turned on and the correct video source has been selected, check that the video source device is turned on and operating correctly. Also check that the signal cables have been connected correctly.

Connecting audio

The projector has built-in mono speaker(s) which are designed to provide basic audio functionality accompanying data presentations for business purposes only. They are not designed for, nor intended for stereo audio reproduction use as might be expected in home theater or home cinema applications. Any stereo audio input (if provided), is mixed into a common mono audio output through the projector speaker(s).

The built-in speaker(s) will be muted when the **AUDIO OUT** jack is connected.



- The projector is only capable of playing mixed mono audio, even if a stereo audio input is connected.

Operation



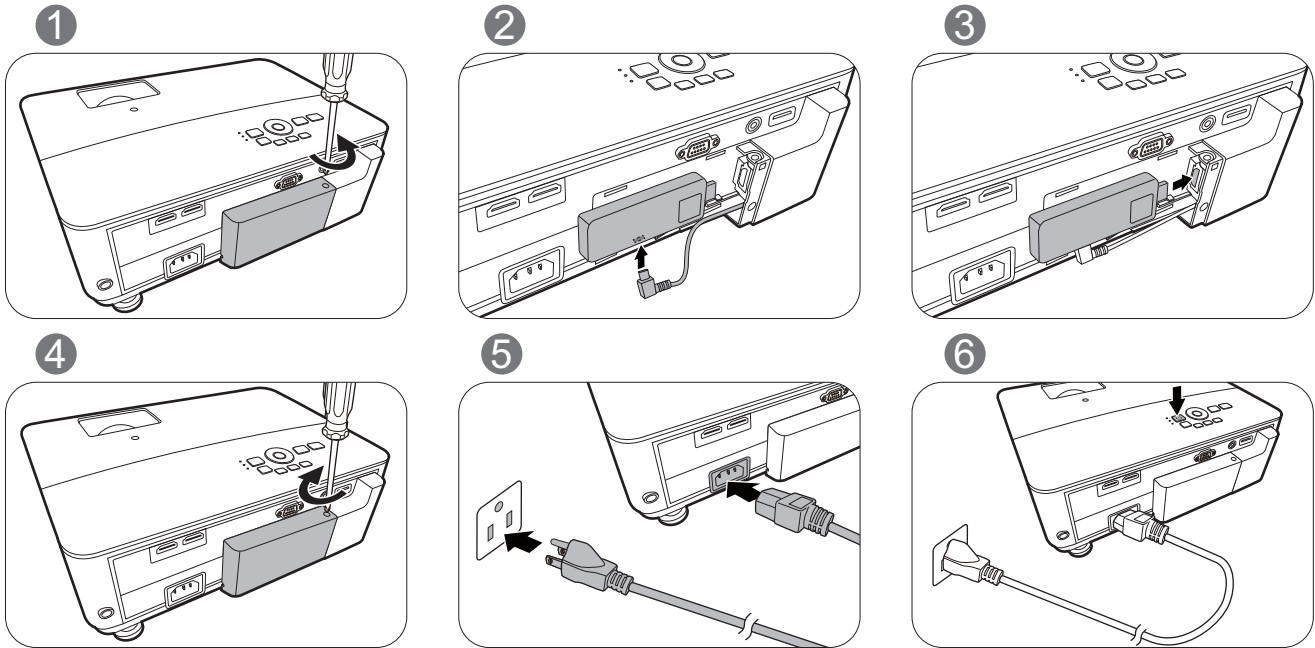

Installing the QS01 HDMI Media Streaming (Optional)

The QS01 HDMI Media Streaming is an Android TV (ATV) dongle to be used with the projector. For more information about this dongle, please contact the place you purchased this projector.

If you already have the dongle, see the illustrations below to install the dongle. Make sure that the dongle cover is installed back correctly after the dongle is plugged. Do not turn the power on with the dongle cover open.



Starting up the projector

1. Plug the power cord. Turn on the power outlet switch (where fitted). The power indicator on the projector lights orange after power has been applied.
2. Press  to start the projector. The power indicator flashes green and stays green when the projector is on. The start up procedure takes about 30 seconds. In the later stage of start up, a startup logo is projected. (If necessary) Rotate the focus ring to adjust the image clearness.
3. If this is the first time you turn on the projector, the setup wizard appears to guide you through setting up the projector. If you have already done this, skip this step and move on to the next step.
 - Use the arrow keys (/ / / ) on the projector or remote control to move through the menu items.
 - Use **OK** to confirm the selected menu item.

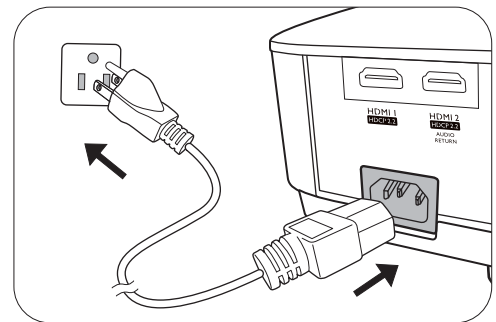

 The Setup Wizard screenshots below are for reference only and may differ from the actual design.

Step 1:

Specify **Projector Position**.

For more information about projector position, see [Choosing a location on page 11](#).

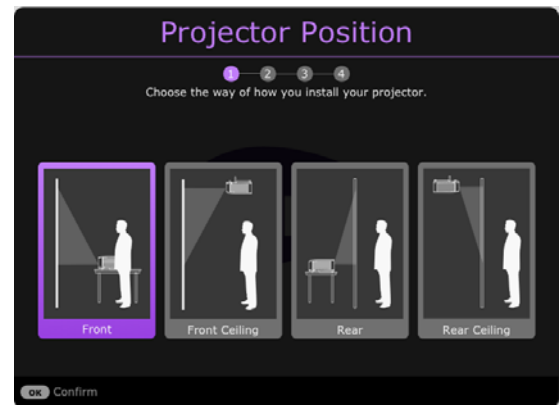

Step 2:

Specify OSD **Language**.

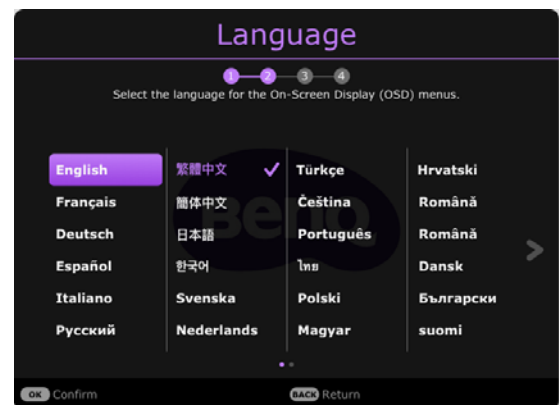

Step 3:

Specify **2D Keystone**, and choose to activate **Auto Vertical Keystone**.

For more information about keystone, see [Correcting keystone on page 15](#).

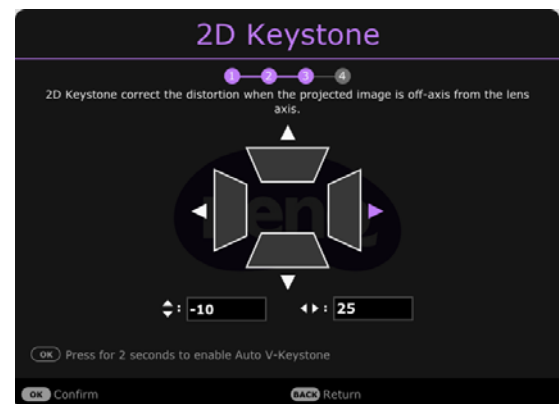

Step 4:

Specify **Game Settings**.

You can turn on the **FPS Game Mode**, and **Fast Mode** in this menu.

See [Game Settings on page 30](#) for details.

Now you've completed the initial setup.

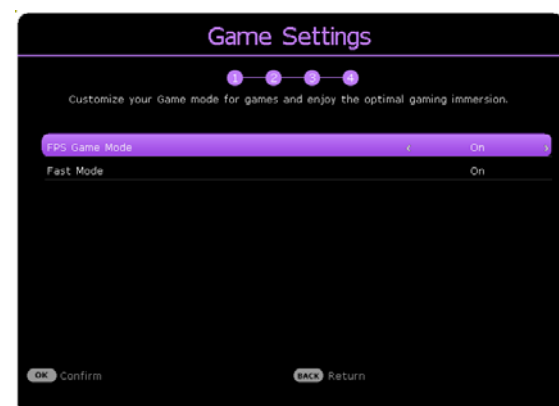

4. If you are prompted for a password, press the arrow keys to enter a 6-digit password. See [Utilizing the password function on page 24](#).

5. Switch all of the connected equipment on.

The projector will search for input signals. The current input signal being scanned appears. If the projector does not detect a valid signal, the message “No Signal” will continue displaying until an input signal is found.

You can also press /**SOURCE** to select your desired input signal. See [Switching input signal on page 25](#).



- Please use the original accessories (e.g. power cord) to avoid possible dangers such as electric shock and fire.
- If the projector is still hot from previous activity, it will run the cooling fan for approximately 90 seconds before energizing the lamp.



-
- The Setup Wizard screenshots are for reference only and may differ from the actual design.
 - If the frequency/resolution of the input signal exceeds the projector's operating range, you will see the message “Out of Range” displayed on the background screen. Please change to an input signal which is compatible with the projector's resolution or set the input signal to a lower setting. See [Timing chart on page 52](#).
 - If no signal is detected for 3 minutes, the projector automatically enters saving mode.
 - If “Reset All Settings” is selected, setup wizard will appear after reboot, and Auto Source will be reset to default value.

Setting up the QS01 HDMI Media Streaming (Optional)

Before you start

Check that you have:

- A Wi-Fi Internet connection
- A Google Account

Step 1:

Press and hold **OK** for 5 seconds to pair your remote control.

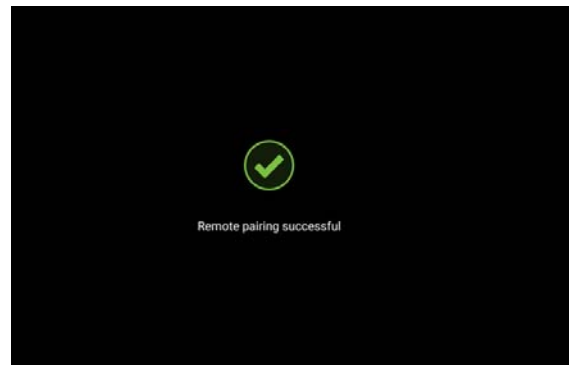
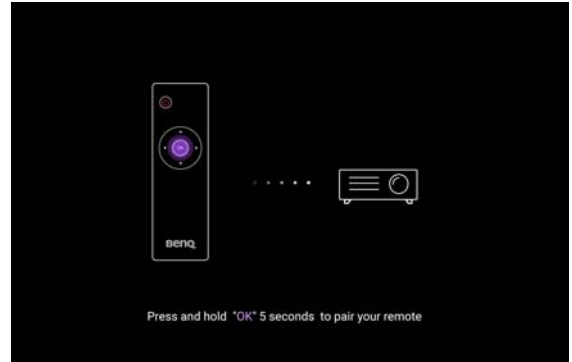

Step 2:

Set up your device.

There are 3 options to set up your device:

- Quick Setup using an Android phone

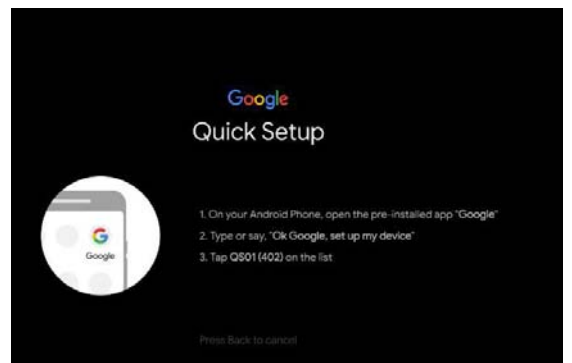

- Using your phone or computer

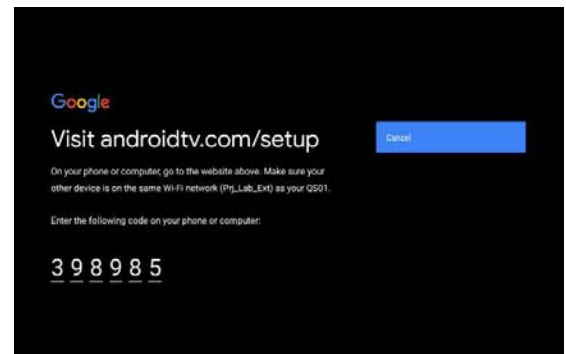

- Using your remote control

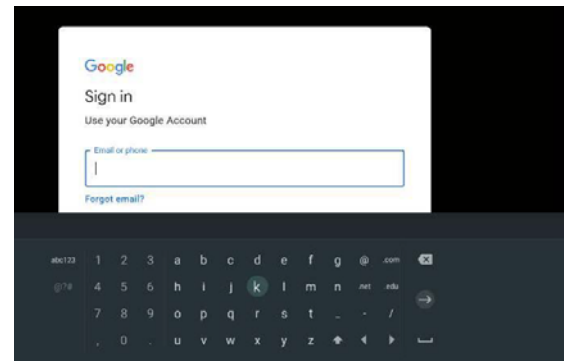

Step 3:
Display Android TV home screen.

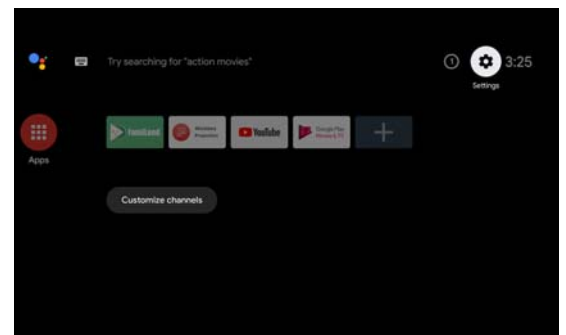

 For more information, visit <https://support.google.com/androidtv/>.

Using the menus

The projector is equipped with 2 types of On-Screen Display (OSD) menus for making various adjustments and settings.

- **Basic** OSD menu: provides primary menu functions. (See [Basic Menu on page 27](#))
- **Advanced** OSD menu: provides full menu functions. (See [Advanced Menu on page 28](#))

To access the OSD menu, press **MENU** on the projector or remote control.

- Use the arrow keys (**▲/▼/◀/▶**) on the projector or remote control to move through the menu items.
- Use **OK** on the projector or remote control to confirm the selected menu item.

The first time you use the projector (after finishing the initial setup), press **MENU**, and the **Basic** OSD menu will be displayed.



The OSD screenshots below are for reference only, and may differ from the actual design.

Below is the overview of the **Basic** OSD menu.

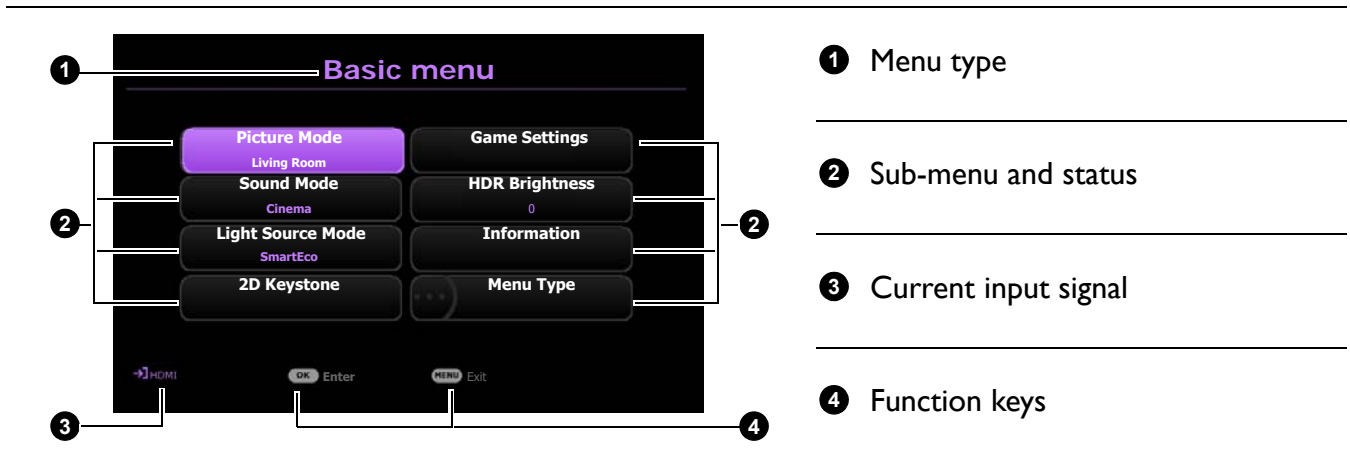

If you intend to switch from the **Basic** OSD menu to the **Advanced** OSD menu, follow the instructions below:

1. Go to **Menu Type** and press **OK**.
2. Press **▲/▼** to select **Advanced** and press **OK**. Your projector will switch to **Advanced** OSD menu.

Below is the overview of the **Advanced** OSD menu.

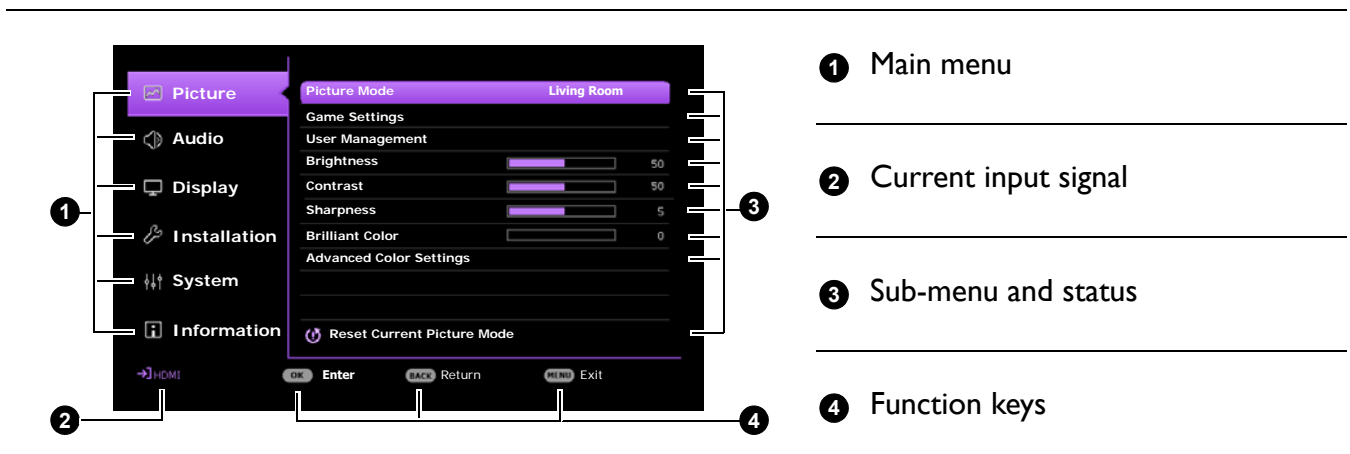

Likewise, when you wish to switch from the **Advanced** OSD menu to the **Basic** OSD menu, follow the instructions below:

1. Go to **System > Menu Settings > Menu Type** and press **OK**.
2. Press **▲/▼** to select **Basic**. Your projector will switch to the **Basic** OSD menu.

Securing the projector

Utilizing the password function

Setting a password

1. Go to **Advanced** menu - **System > Security Settings**. Press **OK**. The **Security Settings** page appears.
2. Highlight **Change Password** and press **OK**.
3. The four arrow keys (**▲, ►, ▼, ◀**) respectively represent 4 digits (1, 2, 3, 4). According to the password you desire to set, press the arrow keys to enter six digits for the password.
4. Confirm the new password by re-entering the new password.
5. To activate the **Power On Lock** function, go to **System > Security Settings > Power On Lock**, press **OK** and **◀/►** to select **On**. Input the password again.

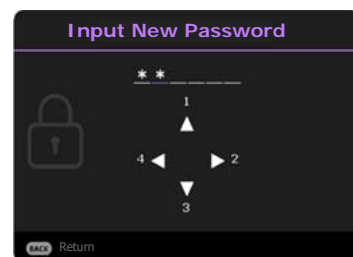

- The digits being input will display as asterisks on-screen. Make a note of your selected password and keep it in a safe place in advance or right after the password is entered so that it is available to you should you ever forget it.
- Once a password has been set and the **Power On Lock** is activated, the projector cannot be used unless the correct password is entered every time the projector is started.

If you forget the password

If you enter the wrong password, the password error message will appear, and the **Input Password** message follows. If you absolutely do not remember the password, you can use the password recall procedure. See [Entering the password recall procedure on page 24](#).

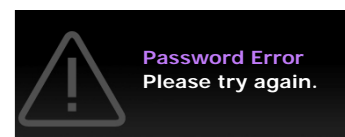

If you enter an incorrect password 5 times in succession, the projector will automatically shut down in a short time.

Entering the password recall procedure

1. Press and hold **OK** for 3 seconds. The projector will display a coded number on the screen.
2. Write down the number and turn off your projector.
3. Seek help from the local BenQ service center to decode the number. You may be required to provide proof of purchase documentation to verify that you are an authorized user of the projector.

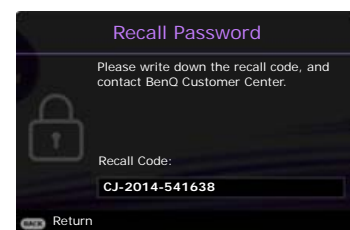

Changing the password

1. Go to **Advanced** menu - **System** > **Security Settings**. Press **OK**. The **Security Settings** page appears.
2. Highlight **Change Password** and press **OK**.
3. Enter the old password.
 - If the password is correct, another message **Input New Password** appears.
 - If the password is incorrect, the password error message will appear, and the message **Input Current Password** appears for your retry. You can press **BACK** to cancel the change or try another password.
4. Enter a new password.
5. Confirm the new password by re-entering the new password.

Disabling the password function

To disable password protection, go to **Advanced** menu - **System** > **Security Settings** > **Power On Lock** and press **OK** and **◀/▶** to select **Off**. The message **Input Password** appears. Enter the current password.

- If the password is correct, the OSD menu returns to the **Security Settings** page. You will not have to enter the password next time turning on the projector.
- If the password is incorrect, the password error message will appear, and the message **Input Current Password** appears for your retry. You can press **BACK** to cancel the change or try another password.



Though the password function is disabled, you need to keep the old password in hand should you ever need to re-activate the password function by entering the old password.

Switching input signal

The projector can be connected to multiple devices at the same time. However, it can only display one full screen at a time. When starting up, the projector automatically searches for the available signals.

Be sure the **Advanced** menu - **Display** > **Auto Source Search** menu is **On** if you want the projector to automatically search for the signals.

To manually select the source:

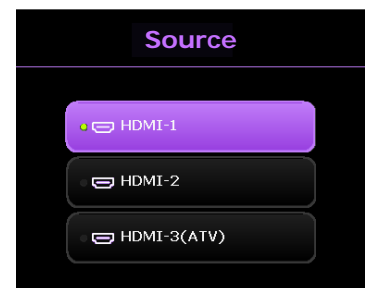

1. Press **→**/**SOURCE**. A source selection bar appears.
2. Press **▲/▼** until your desired signal is selected and press **OK**.

Once detected, the selected source information will appear at the corner of the screen for seconds. If there is multiple equipment connected to the projector, repeat steps 1-2 to search for another signal.



- The brightness level of the projected image will change accordingly when you switch between different input signals.
- For best display picture results, you should select and use an input signal which outputs at the projector's native resolution. Any other resolutions will be scaled by the projector depending upon the "aspect ratio" setting, which may cause some image distortion or loss of picture clarity. See [Aspect Ratio on page 35](#).

Shutting down the projector

1. Press  and a confirmation message will appear prompting you. If you don't respond in a few seconds, the message will disappear.
2. Press  a second time. The power indicator flashes orange, the projection light source shuts down, and the fans will continue to run for approximately 90 seconds to cool down the projector.
3. Once the cooling process finishes, the power indicator becomes a steady orange and fans stop. Disconnect the power cord from the power outlet.

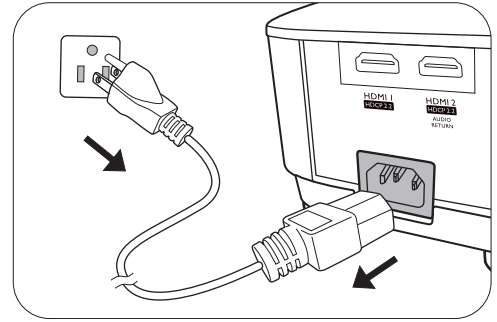

- To protect the light source, the projector will not respond to any commands during the cooling process.
- Avoid turning on the projector immediately after turning it off as excessive heat may shorten lamp life.
- Lamp life results will vary depending on environmental conditions and usage.

Menu operation

Please note that the on-screen display (OSD) menus vary according to the signal type selected and the projector model you are using.

The menu items are available when the projector detects at least one valid signal. If there is no equipment connected to the projector or no signal detected, limited menu items are accessible.

Menu System

Basic Menu

| Menu (Ref. Page) | Options |
|------------------------|--|
| Picture Mode (29) | Bright/Living Room/Game/Sports/Cinema/(3D)/(HDR10)/(HDR Game)/(HLG)/User |
| Sound Mode (34) | Cinema/Music/Game/Sports/User |
| Light Source Mode (46) | Normal/ECO/SmartEco/LampSave |
| 2D Keystone (15) | H: -30 – +30 V: -30 – +30 |
| Game Settings (30) | Fast Mode Off/On |
| HDR Brightness (32) | -2/-1/0/1/2 |
| Information (43) | Detected Resolution |
| | Source |
| | Picture Mode |
| | Light Source Mode |
| | 3D Format |
| | Color System |
| | Dynamic Range |
| | Light Source Usage Time |
| | Firmware Version |
| | Service Code |
| Menu Type (41) | Basic/Advanced |

Advanced Menu

I. Main menu: **Picture**

Structure

| Menu | | Options | |
|-------------------------|----------------------------|--|--------------------------------------|
| Picture Mode | | Bright/Living Room/Game/Sports/Cinema/3D/HDR10/HDR Game/HLG/User | |
| Game Settings | Fast Mode | Off/On | |
| User Management | Load Settings From | Bright/Living Room/Game/Sports/Cinema | |
| | Rename User Mode | | |
| Brightness | | 0-100 | |
| Contrast | | 0-100 | |
| Sharpness | | 0-10 | |
| Brilliant Color | | 0-10 | |
| Advanced Color Settings | Gamma Selection | | 1.8/2.0/2.1/2.2/2.3/2.4/2.5/2.6/BenQ |
| | Color Temperature Tuning | Color Temperature | Normal/Cool/Native/Warm |
| | | R Gain/ G Gain/ B Gain | 0-200 |
| | | R Offset/ G Offset/ B Offset | 0-511 |
| | | R/G/B/C/M/Y | Hue/Saturation/Gain |
| | Color Management | W | R Gain/G Gain/B Gain |
| | | Reset | |
| | Light Source Mode | | Normal/ECO/SmartEco/LampSave |
| | HDR Brightness | | -2/-1/0/1/2 |
| | Reset Current Picture Mode | | Reset/Cancel |

Function descriptions

| Menu | Descriptions |
|---------------------|--|
| Picture Mode | <p>The projector is preset with several predefined picture modes so that you can choose one to suit your operating environment and input signal picture type.</p> <ul style="list-style-type: none">• Bright Maximizes the brightness of the projected image. This mode is suitable for environments where extra-high brightness is required, such as using the projector in well lit rooms.• Living Room With well-saturated color, fine-tuned sharpness, and a higher brightness level, this mode is suitable for TV streaming in rooms where there is a small amount of ambient light, e.g. your living room.• Game This mode is best for playing video games, and you can select an optimal Audio-Visual preset for 3 types of games in Game Settings menu: First-Person shooting (FPS), Role-Playing game (RPG), Sports game (SPG) to have a perfect game-play experience in well-lit rooms.• Sports With well-saturated colors and higher brightness level, this mode is best for watching sporting events in a bright room.• Cinema This mode is best for watching movies with accurate color and deepest contrast at lower brightness level in rooms with a bit of ambient light, as if in a commercial cinema.• 3D Optimized to bring up 3D effects when watching 3D contents.  This mode is only available when 3D function is enabled.• HDR10/HDR Game Delivers High Dynamic Range effects with higher contrasts of brightness and colors for HDR Blu-ray movies or HDR games. After auto-detecting metadata or EOTF info from HDR contents, HDR10 and HDR Game are available for selection. HDR10 is best for displaying Blu-ray movies, while HDR Game is used to activate Game Settings menu for HDR gameplay.• HLG Delivers High Dynamic Range effects with higher contrasts of brightness and colors. Picture Mode will be switched to HLG automatically while detecting metadata or EOTF info from HLG streaming contents.• User Recalls the settings customized based on the current available picture modes. See User Management on page 28. |

| | |
|-------------------------------|--|
| <p>Game Settings</p> | <ul style="list-style-type: none"> • Fast Mode <p>Minimizes the response time between the input source and the displayed image. For the optimized latency, when Fast Mode is activated, 2D Keystone/Aspect Ratio will return to the default settings, and Auto Vertical Keystone will be turned off automatically.</p> <p>*Fast Mode can only be enabled for below input timing adopted by most of popular games:</p> <ul style="list-style-type: none"> - 1080p 60Hz/120Hz/240Hz - 4K 60Hz |
| <p>User Management</p> | <p>There is one user-definable mode if the current available picture modes are not suitable for your need. You can use one of the picture modes (except the User) as a starting point and customize the settings.</p> <ul style="list-style-type: none"> • Load Settings From <ol style="list-style-type: none"> 1. Go to Picture > Picture Mode. 2. Press ◀/▶ to select User. 3. Press ▼ to highlight User Management, and press OK. The User Management page is displayed. 4. Select Load Settings From and press OK. 5. Press ▼/▲ to select a picture mode that is closest to your need. 6. Press OK and BACK to return to the Picture menu. 7. Press ▼ to select the sub-menu items you want to change and adjust the values with ◀/▶. The adjustments define the selected user mode. <ul style="list-style-type: none"> • Rename User Mode <p>Select to rename the customized picture mode (User). The new name can be up to 9 characters including English letters (A-Z, a-z), digits (0-9), and space ().</p> <ol style="list-style-type: none"> 1. Go to Picture > Picture Mode. 2. Press ◀/▶ to select User. 3. Press ▼ to highlight User Management, and press OK. The User Management page is displayed. 4. Press ▼ to highlight Rename User Mode and press OK. The Rename User Mode page is displayed. 5. Use ▲/▶/▼/◀, and OK to set desired characters. 6. When done, press BACK to save the changes and exit. |
| <p>Brightness</p> | <p>The higher the value, the brighter the image. Adjust this control so the black areas of the image appear just as black and that detail in the dark areas is visible.</p> |
| <p>Contrast</p> | <p>The higher the value, the greater the contrast. Use this to set the peak white level after you have previously adjusted the Brightness setting to suit your selected input and viewing environment.</p> |
| <p>Sharpness</p> | <p>The higher the value, the sharper the picture becomes.</p> |
| <p>Brilliant Color</p> | <p>This function utilizes a new color-processing algorithm and system level enhancements to enable higher brightness while providing truer, more vibrant colors in picture. It enables a greater than 50% brightness increase in mid-tone images, which are common in video and natural scenes, so the projector reproduces images in realistic and true colors.</p> |

• Gamma Selection

Gamma refers to the relationship between input source and picture brightness.

- **1.8/2.0/2.1/BenQ**: Select these values according to your preference.
- **2.2/2.3**: Increases the average brightness of the picture. Best for a lit environment, meeting room or family room.
- **2.4/2.5**: Best for viewing movies in a dark environment.
- **2.6**: Best for viewing movies which are mostly composed of dark scenes.

High Brightness
Low Contrast

Low Brightness
High Contrast

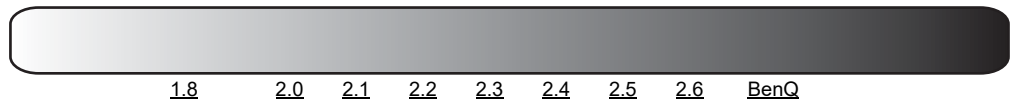

Advanced Color Settings

• Color Temperature Tuning

There are several preset color temperature settings available. The available settings may vary according to the signal type selected.

- **Normal**: Maintains normal colorings for white.
- **Cool**: Makes images appear bluish white.
- **Native**: With the light source's original color temperature and higher brightness. This setting is suitable for environments where high brightness is required, such as projecting pictures in well lit rooms.
- **Warm**: Makes images appear reddish white.

You can also set a preferred color temperature by adjusting the following options.

- **R Gain/G Gain/B Gain**: Adjusts the contrast levels of Red, Green, and Blue.
 - **R Offset/G Offset/B Offset**: Adjusts the brightness levels of Red, Green, and Blue.
-

• Color Management

The Color Management provides six sets (RGBCMY) of colors to be adjusted. When you select each color, you can independently adjust its range and saturation according to your preference.

To make adjustments, press the ▲/▼ arrows to highlight an independent color from among Red (R), Green (G), Blue (B), Cyan (C), Magenta (M), or Yellow (Y), and press **OK**. The following menu items are displayed for your choice.

- **Hue:** Increase in the range will include colors consisted of more proportions of its two adjacent colors. Please refer to the illustration for how the colors relate to each other.

For example, if you select Red and set its range at 0, only pure red in the projected picture will be selected. Increasing its range will include red close to yellow and red close to magenta.

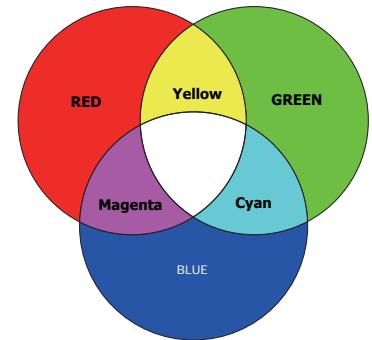

- **Saturation:** Adjusts the values to your preference. Every adjustment made will reflect to the image immediately. For example, if you select Red and set its value at 0, only the saturation of pure red will be affected.
- **Gain:** Adjusts the values to your preference. The contrast level of the primary color you select will be affected. Every adjustment made will reflect to the image immediately.

Advanced Color Settings (Continued)

If you selected **W**, you can adjust the contrast levels of Red, Green, and Blue by selecting **R Gain**, **G Gain**, and **B Gain**.

To return all the settings to the factory default values, highlight **Reset**, and press **OK**.



Saturation is the amount of that color in a video picture. Lower settings produce less saturated colors; a setting of “0” removes that color from the image entirely. If the saturation is too high, that color will be overpowering and unrealistic.

• Light Source Mode

Selects a suitable light source power from among the provided modes. See [Extending light source life on page 46](#).

• HDR Brightness

The projector can automatically adjust the brightness levels of your image according to the input source. You can also manually select a brightness level to display better picture quality. When the value is higher, the image becomes brighter; when the value is lower, the image becomes darker.

Reset Current Picture Mode

Returns all of the adjustments you've made for the selected **Picture Mode** (including the preset mode, **User**) to the factory preset values.

1. Press **OK**. The confirmation message is displayed.
2. Use **◀/▶** to select **Reset** and press **OK**. The current picture mode returns to the factory preset settings.



The following settings will still remain: **Picture Mode**.

2. Main menu: **Audio**

Structure

| Menu | Options |
|---------------------------|---|
| Sound Mode | Cinema/Music/Game/Sports/User |
| User Sound EQ | 100Hz/300Hz/ 1kHz/3kHz/10kHz -10 – +10 |
| Mute | Off/On |
| Volume | 0 – 20 |
| Power On/Off Ring Tone | Off/On |
| Reset Audio | Reset/Cancel |

Function descriptions



| Menu | Descriptions |
|-----------------------------------|--|
| Sound Mode | <p>This function utilizes treVolo and Bongiovi DPS (Digital Power Station) Technology, which incorporates its patented algorithms with 120 calibration points that optimizes any audio signal in real time to add depth, clarity, definition, presence and enhanced stereo field imaging for more immersive audio experience. The following preset sounds are available: Cinema, Music, Game, Sports, and User.</p> <p>The User mode allows you to personalize the sound settings. When selecting the User mode, you may make manual adjustments with the User Sound EQ function.</p> <p>If the Mute function is activated, adjusting Sound Mode will turn off the Mute function.</p> |
| User Sound EQ | <p>Select desired frequency bands (100 Hz, 300 Hz, 1k Hz, 3k Hz, and 10k Hz) to adjust the levels according to your preference. The settings made here define the User mode.</p> |
| Mute | <p>Select On to temporarily turn off the projector's internal speaker or the volume being output from the audio output jack.</p> <p>To restore the audio, select Off.</p> |
| Volume | <p>Adjusts the volume level of the projector's internal speaker or the volume being output from the audio output jack.</p> <p>If the Mute function is activated, adjusting Volume will turn off the Mute function.</p> |
| Power On/Off Ring Tone | <p>Sets the ring tone for the projector On or Off.</p> <p>The Power On/Off Ring Tone can only be adjusted here. Setting the sound mute or adjusting the sound level do not affect the Power On/Off Ring Tone.</p> |
| Reset Audio | <p>Returns all of the adjustments you've done under the Audio menu to the factory preset values.</p> |

3. Main menu: **Display**

Structure

| Menu | | Options |
|---------------------------|----------------------------------|----------------------------------|
| Aspect Ratio | | Auto/4:3/16:9 |
| Auto Source Search | | Off/On |
| Source Rename | | HDMI-1/HDMI-2 |
| 3D | 3D Mode | Auto/Frame Sequential/Off |
| | 3D Sync Invert | Disable/Invert |
| HDMI Format | | Auto/Limited/Full |
| HDMI Equalizer | HDMI-1/HDMI-2 | Auto/1/2/3/4/5 |
| HDMI EDID | HDMI-1/HDMI-2/ HDMI-3 | Enhanced/Standard |
| HDMI Settings | Electronics Control | Off/On |
| | Audio Return + (HDMI-2) | Off/LPCM/RAW |
| | Power On Link | Off/From Device |
| | Power Off Link | Off/From Projector |
| Reset Display | | Reset/Cancel |

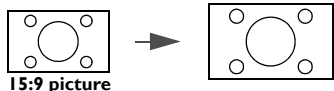
Function descriptions

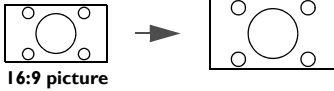
| Menu | Descriptions |
|---------------------------|---|
| Aspect Ratio | <p>There are several options to set the image's aspect ratio depending on your input signal source.</p> <p>This image adjustment might impact latency in Game Mode. We suggest setting Aspect Ratio to Auto to enjoy low latency gaming. Selecting other options will turn Fast Mode off.</p> <ul style="list-style-type: none"> • Auto: Scales an image proportionally to fit the projector's native resolution in its horizontal or vertical width. |
| | <ul style="list-style-type: none"> • 4:3: Scales an image so that it is displayed in the center of the screen with a 4:3 aspect ratio. |
| | <ul style="list-style-type: none"> • 16:9: Scales an image so that it is displayed in the center of the screen with a 16:9 aspect ratio. |
| |  <p>The diagram shows a 15:9 picture (a wide rectangle) on the left, which is scaled to fit the projector's screen (a square) on the right. The text '15:9 picture' is written below the first image.</p> |
| |  <p>The diagram shows a 4:3 picture (a square) on the left, which is scaled to fit the projector's screen (a square) on the right. Black bars are shown on the left and right sides of the screen. The text '4:3 picture' is written below the first image.</p> |
| |  <p>The diagram shows a 16:9 picture (a wide rectangle) on the left, which is scaled to fit the projector's screen (a square) on the right. The text '16:9 picture' is written below the first image.</p> |
| Auto Source Search | Allows the projector to automatically search for a signal. |

Renames the current input source to your desired name.

On the **Source Rename** page:

Source Rename

1. Press **OK** to display the on-screen keyboard.
2. Press **▲/▼/◀/▶** to select each desired digit/letter, and press **OK** to confirm each input.
3. Repeat the step above and when done, press **BACK** and **▼** to highlight **Commit**.
4. Press **OK** and the source name changes.

This projector supports playing three-dimensional (3D) content transferred through your 3D-compatible video devices and contents, such as PlayStation consoles (with 3D game discs), 3D Blu-ray players (with 3D Blu-ray discs), and so on. After you have connected the 3D video devices to the projector, wear the BenQ 3D glasses and make sure the power is on to view 3D contents.

When watching 3D contents:

- The image may seem misplaced; however, this is not a product malfunction.
- Take appropriate breaks when watching 3D contents.
- Stop watching 3D contents if you feel fatigue or discomfort.
- Keep a distance from the screen of about three times the effective height of the screen.
- Children and people with a history of oversensitivity to light, heart problems, or any other existing medical conditions should be refrained from watching 3D contents.
- The image may seem reddish, greenish, or bluish without wearing 3D glasses. However, you will not notice any color bias when watching 3D contents with 3D glasses.
- The 4K source will not be displayed.

3D

• 3D Mode

The default setting is **Auto** and the projector automatically chooses an appropriate 3D format when detecting 3D contents. If the projector cannot recognize the 3D format, you can choose **Frame Sequential** for it.

When **3D Mode** is enabled:

- The brightness level of the projected image decreases.
- The **Picture Mode** cannot be adjusted.
- The **2D Keystone** can only be adjusted within limited degrees.

• 3D Sync Invert

When your 3D image is distorted, enable this function to switch between the image for the left eye and the right eye for more comfortable 3D viewing experience.

HDMI Settings

• HDMI Format

Selects a suitable RGB color range to correct the color accuracy.

- **Auto:** Automatically selects a suitable color range for the incoming HDMI signal.
- **Limited:** Utilizes the Limited range RGB 16-235.
- **Full:** Utilizes the Full range RGB 0-255.

• HDMI Equalizer

Sets a suitable value to maintain the HDMI picture quality in long distance data transmission.

• HDMI EDID

Switches between **Enhanced** for HDMI 2.0 EDID and **Standard** for HDMI 1.4 EDID. Selecting **Standard** which supports up to 1080p 60Hz may solve abnormal display issues with some old players.

• Electronics Control

When you enable this function and connect an HDMI CEC-compatible device to your projector with an HDMI cable, turning on the HDMI CEC compatible device automatically turns on the projector, while turning off the projector automatically turns off the HDMI CEC compatible device.

• Audio Return + (HDMI-2)

When connecting to eARC compatible speaker to the projector with HDMI cables, the audio can be returned to these speakers from the projector HDMI 2 port.

HDMI-1 audio can output audio to external speakers via eARC function (**HDMI-2**).

• Power On Link/Power Off Link

When you connect an HDMI CEC-compatible device to your projector with an HDMI cable, you can set the behavior of powering on/off between the device and the projector.

| | |
|---|--|
| Power On Link > From Device | When the connected device is turned on, the projector will be activated, too. |
| Power Off Link > From Projector | When the projector is turned off, the connected device will be shut down, too. |

Reset Display

Returns all the settings on the **Display** main menu to the factory default values.

4. Main menu: Installation

Structure

| Menu | Options |
|------------------------|--|
| Projector Position | Front/Front Ceiling/Rear/Rear Ceiling |
| 2D Keystone | H: -30 – +30 |
| | V: -30 – +30 |
| Auto Vertical Keystone | Off/On |
| LumiExpert | LumiExpert Off/On |
| | LumiExpert Level -1 – 0 – 1 |
| | Manual Calibration |
| | Manual Calibration Status Calibrate Reset Manual Calibration |
| Test Pattern | Off/On |
| High Altitude Mode | Off/On |
| Baud Rate | 9600/14400/19200/38400/57600/115200 |

Function descriptions

| Menu | Descriptions |
|-------------------------------|---|
| Projector Position | The projector can be installed on a ceiling or behind a screen, or with one or more mirrors. See Choosing a location on page 11 for details. |
| 2D Keystone | See Correcting keystone on page 15 for details. This image adjustment might impact latency in Game Mode . We suggest setting the 2D Keystone values to 0 to enjoy low latency gaming. Setting the 2D Keystone to other values will turn Fast Mode off. |
| Auto Vertical Keystone | Automatically corrects the keystone at the vertical side of the projected image. This image adjustment might impact latency in Game Mode . We suggest turning Auto Vertical Keystone off to enjoy low latency gaming. Turning Auto Vertical Keystone on will turn Fast Mode off. |
| LumiExpert | <ul style="list-style-type: none"> • LumiExpert <p>When this function is enabled, the projector actively detects the ambient light conditions and automatically adjusts balanced visual brightness to create an optimum viewing experience.</p>  <p>This function is not available when the Picture Mode is Bright, 3D, or HDR10/HLG.</p> <ul style="list-style-type: none"> • LumiExpert Level: Adjusts the gamma offset. • Manual Calibration: According to the ambient brightness, you can do the calibration manually. <ul style="list-style-type: none"> • Manual Calibration Status: Shows the status of manual calibration. • Calibrate: Enact this item to start the calibration process. • Reset Manual Calibration: Resets the gamma offset to factory preset values. |

Test Pattern

Adjusts the image size and focus and check that the projected image is free from distortion.

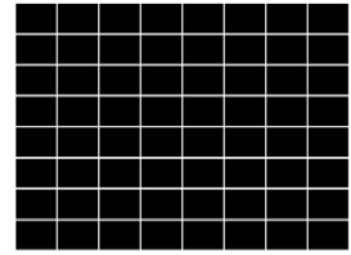

High Altitude Mode

We recommend you use the **High Altitude Mode** when your environment is between 1500 m–3000 m above sea level, and ambient temperature is between 0°C–30°C.

Operation under "**High Altitude Mode**" may cause a higher decibel operating noise level because of increased fan speed necessary to improve overall system cooling and performance.

If you use this projector under other extreme conditions excluding the above, it may display auto shut-down symptoms, which is designed to protect your projector from over-heating. In cases like this, you should switch to High Altitude mode to solve these symptoms. However, this is not to state that this projector can operate under any and all harsh or extreme conditions.



Do not use the **High Altitude Mode** if your altitude is between 0 m and 1500 m and ambient temperature is between 0°C and 35°C. The projector will be over cooled, if you turn the mode on under such a condition.

Baud Rate

Select a baud rate that is identical with your computer's so that you can connect the projector with a suitable RS-232 cable and update or download the projector's firmware. This function is intended for qualified service personnel.

5. Main menu: **System**

Structure

| Menu | | Options | |
|---------------------------------|---|--|---|
| Language | | English/Français/Deutsch/Italiano/Español/ Русский/繁體中文/简体中文/日本語/한국어/ Svenska/Nederlands/Türkçe/Čeština/ Português/ไทย/Polski/Magyar/Hrvatski/ Română/Norsk/Dansk/Български/Suomi/ Indonesian/Ελληνικά/العربية/हिन्दी | |
| Background Settings | Splash Screen | BenQ/Black/Blue | |
| Menu Settings | Menu Type | Basic/Advanced | |
| | Menu Display Time | 5 sec/10 sec/20 sec/30 sec/Always | |
| | Menu Position | Center/Top-Left/Top-Right/Bottom-Right/Bottom-Left | |
| Light Source Information | Light Source Usage Time | | |
| | Normal Mode | | |
| | ECO Mode | | |
| | SmartEco Mode | | |
| | LampSave | | |
| | Equivalent Light Hours | | |
| | Refer to UM for detailed formula | | |
| | Reset Light Timer | Reset/Cancel | |
| Operation Settings | Reminder Message | Off/On | |
| | LED Indicator | Off/On | |
| | Power On/Off Settings | Direct Power On | Off/On |
| | | Auto Power Off | Disable/3 min/10 min/15 min/20 min/25 min/30 min |
| | BenQ HDMI Media Streaming (QS01) | Off/On | Yes/Cancel |
| Security Settings | Panel Key Lock | Off/On | Yes/No |
| | Change Password | | |
| | Power On Lock | | |
| Factory Default | | Reset/Cancel | |
| Reset System | | Reset/Cancel | |

Function descriptions

| Menu | Descriptions |
|----------------------------|--|
| Language | Sets the language for the On-Screen Display (OSD) menus. |
| Background Settings | <ul style="list-style-type: none"> • Splash Screen Allows you to select which logo screen will be displayed during projector start-up. |

Menu Settings

- **Menu Type**

Sets the OSD menu type according to your needs.

- **Menu Display Time**

Sets the length of time the OSD will remain active after your last key press.

- **Menu Position**

Sets the On-Screen Display (OSD) menu position.

Light Source Information

This menu page displays the following information:

- **Light Source Usage Time**

- Light hours used under **Normal Mode, ECO Mode, SmartEco Mode, LampSave.**

- And the **Equivalent Light Hours.**

For details about how to calculate the hours, see [Getting to know the light hour on page 45.](#)

When a new lamp is installed, and you need to reset the timer, highlight **Reset Light Timer** and select **Reset**.

Operation Settings

- **Reminder Message**

Sets the reminder messages on or off.

- **LED Indicator**

You can turn off the LED warning lights. This is to avoid any light disturbance when viewing images in a dark room.

- **Power On/Off Settings**

- **Direct Power On:** Allows the projector to turn on automatically once the power is fed through the power cord.

- **Auto Power Off:** Allows the projector to turn off automatically if no input signal is detected after a set period of time to prevent unnecessary waste of light source life.

- **BenQ HDMI Media Streaming (QS01)**

With the optional QS01 installed on your projector (see [Installing the QS01 HDMI Media Streaming \(Optional\) on page 18](#)), you can select **On** to enable functions related to the Android TV dongle (QS01), including:

- the reminder for plugging in ATV dongle.

- the handshaking mechanism between the Android TV dongle and projector after power-on.

• Panel Key Lock

With the control keys on the projector and remote control locked, you can prevent your projector settings from being changed accidentally (by children, for example). When the **Panel Key Lock** is on, no control keys on the projector and remote control will operate except  **POWER**.

Security Settings

To release panel key lock, press and hold  (the right key) on the projector or remote control for 3 seconds.



If you turn off the projector without disabling panel key lock, the projector will still be in locked status the next time it is turned on.

• Change Password/Power On Lock

See [Utilizing the password function on page 24](#).

Returns all settings to the factory preset values.

Factory Default



The following settings will still remain: **Projector Position, 2D Keystone, Auto Vertical Keystone, High Altitude Mode, Baud Rate, Light Source Information, BenQ HDMI Media Streaming (QS01), Security Settings.**

Returns all the settings on the **System** main menu to the factory default values.

Reset System



The following settings will still remain: **Light Source Information, BenQ HDMI Media Streaming (QS01), Security Settings.**

6. Main menu: Information

Structure

| Menu | Options |
|-------------------------|---------|
| Detected Resolution | |
| Source | |
| Picture Mode | |
| Light Source Mode | |
| 3D Format | |
| Color System | |
| Dynamic Range | |
| Light Source Usage Time | |
| Firmware Version | |
| Service Code | |

Function descriptions

| Menu | Descriptions |
|-------------------------|---|
| Detected Resolution | Shows the native resolution of the input signal. |
| Source | Shows the current signal source. |
| Picture Mode | Shows the selected mode on the Picture menu. |
| Light Source Mode | Shows the used light source mode. |
| | Displays the current 3D mode. |
| 3D Format |  3D Format is only available when 3D is enabled. |
| Color System | Shows the input system format. |
| Dynamic Range | Shows the picture dynamic range, e.g. SDR, HDR10, HLG, etc. |
| Light Source Usage Time | Shows the number of hours the light has been used. |
| Firmware Version | Shows the firmware version of your projector. |
| Service Code | Shows the projector's serial number. |

Maintenance

Care of the projector

Cleaning the lens

Clean the lens whenever you notice dirt or dust on the surface. Please be sure to turn off the projector and let it cool down completely before cleaning the lens.

- Use a canister of compressed air to remove dust.
- If there is dirt or smears, use lens-cleaning paper or moisten a soft cloth with lens cleaner and gently wipe the lens surface.
- Never use any type of abrasive pad, alkaline/acid cleaner, scouring powder, or volatile solvent, such as alcohol, benzene, thinner or insecticide. Using such materials or maintaining prolonged contact with rubber or vinyl materials may result in damage to the projector surface and cabinet material.

Cleaning the projector case

Before you clean the case, turn the projector off using the proper shutdown procedure as described in [Shutting down the projector on page 26](#) and unplug the power cord.

- To remove dirt or dust, wipe the case with a soft, lint-free cloth.
- To remove stubborn dirt or stains, moisten a soft cloth with water and a neutral pH detergent. Then wipe the case.



Never use wax, alcohol, benzene, thinner or other chemical detergents. These can damage the case.

Storing the projector

If you need to store the projector for an extended time, please follow the instructions below:

- Make sure the temperature and humidity of the storage area are within the recommended range for the projector. Please refer to [Specifications on page 50](#) or consult your dealer about the range.
- Retract the adjuster feet.
- Remove the battery from the remote control.
- Pack the projector in its original packing or equivalent.

Transporting the projector

It is recommended that you ship the projector with its original packing or equivalent.

Light source information

Getting to know the light hour

When the projector is in operation, the duration (in hours) of light source usage is automatically calculated by the built-in timer. The method of calculating the equivalent light hour is as follows:

1. Light Usage Time = $(x+y+z+a)$ hours, if:
Time used in **Normal** mode = x hours
Time used in **ECO** mode = y hours
Time used in **SmartEco** mode = z hours
Time used in **LampSave** mode = a hours

2. Equivalent Light Hour = α hours

$$\alpha = \frac{A'}{X} \times x + \frac{A'}{Y} \times y + \frac{A'}{Z} \times z + \frac{A'}{A} \times a, \text{ if}$$

X= light source life spec of **Normal** mode

Y= light source life spec of **ECO** mode

Z= light source life spec of **SmartEco** mode

A= light source life spec of **LampSave** mode

A' is the longest light life spec among X, Y, Z, A



For time used in each light mode shown in OSD menu:

- Time used is accumulated and rounded down to an integer in **hours**.
- When time used is less than 1 hour, it shows 0 hours.



When you calculate **Equivalent Light Hours** manually, it will probably have deviation from the value shown in OSD menu since projector system calculates time used for each light mode in "Minutes" then rounds down to an integer in hours shown in OSD.

To obtain the light hour information:

Go to **Advanced** menu - **System** > **Light Source Information** and press **OK**. The **Light Source Information** page appears.

You can also get the light hour information on the **Information** menu.

Extending light source life

• Setting the **Light Source Mode**

Go to **Advanced** menu - **Picture** > **Advanced Color Settings** > **Light Source Mode**, press **OK**. The **Light Source Mode** page appears.

Setting the projector in **ECO**, **SmartEco** or **LampSave** mode extends lamp life.

| Light Mode | Description |
|-----------------|--|
| Normal | Provides full light brightness |
| ECO | Lowers brightness to extend the light life and decreases the fan noise |
| SmartEco | Adjusts the light power automatically depending on the content brightness level while optimizing display quality |
| LampSave | Adjusts the light power automatically depending on the content brightness level while offering a longer light life |

• Setting **Auto Power Off**

This function allows the projector to turn off automatically if no input signal is detected after a set period of time to prevent unnecessary waste of light source life.

To set **Auto Power Off**, go to **Advanced** menu - **System** > **Operation Settings** > **Power On/Off Settings** > **Auto Power Off** and press **◀/▶** to set a period of time.

Timing of replacing the lamp (FOR SERVICE PERSONNEL ONLY)



When the **LIGHT indicator** lights up or a message appears suggesting it is time to replace the lamp, please consult your dealer or go to <http://www.BenQ.com> before installing a new lamp. An old lamp may cause a malfunction in the projector and in some instances the light may explode.



- The apparent brightness of the projected image will vary depending on the ambient lighting conditions, selected input signal contrast/brightness settings, and is directly proportional to projection distance.
- The lamp brightness will decline over time and may vary within the lamp manufacturers specifications. This is normal and expected behavior.
- The **LIGHT indicator light** and **TEMPerature warning light** will light up if the lamp becomes too hot. Turn the power off and let the projector cool for 45 minutes. If the Light or Temp indicator still lights up after turning the power back on, please contact your dealer. See [Indicators on page 48](#).

The following Lamp warning displays will remind you to change the lamp.

















































| | |
|--|---|
| <p>Notice</p> <p>Order a replacement lamp Equivalent lamp hour > XXXX hours Order a new lamp at www.BenQ.com</p> <p>OK</p> | <p>Install a new lamp for optimal performance. Press OK to dismiss the message.</p> |
| <p>Notice</p> <p>Replace lamp soon Equivalent lamp hour > XXXX hours Order a new lamp at www.BenQ.com</p> <p>OK</p> | <p>It is strongly recommended that you replace the lamp at this age. The lamp is a consumable item. The lamp brightness diminishes with use. This is normal lamp behavior. You can replace the lamp whenever you notice that the brightness level has significantly diminished. Press OK to dismiss the message.</p> |









| | |
|--|---|
| <p>Notice</p> <hr/> <p>Replace lamp now Equivalent lamp hour > XXXX hours</p>  <p>Order a new lamp at www.BenQ.com</p> <p>OK</p> | <p>The lamp MUST be replaced before the projector will operate normally. Press OK to dismiss the message.</p> |
| <p>Notice</p> <hr/> <p>Out of lamp usage time Replace lamp (Refer to user manual) then reset the lamp timer</p>  <p>Order a new lamp at www.BenQ.com</p> <p>OK</p> | |



"XXXX" shown in the above messages are numbers that vary depending on different models.

Indicators

| Indicator | | | Status & Description |
|---|---|---|---|
| POWER ○ | TEMP ○ | LIGHT ○ | |
| Power events | | | |
|  |  |  | Stand-by mode |
|  |  |  | Powering up |
|  |  |  | Normal operation |
|  |  |  | Normal power-down cooling |
|  |  |  | Download |
|  |  |  | CW start fail |
|  |  |  | Light source life exhausted |
|  |  |  | Case open |
| Burn-In events | | | |
|  |  |  | Burn-in ON |
|  |  |  | Burn-in OFF |
| Light source events | | | |
|  |  |  | Light source error in normal operation |
|  |  |  | Light source is not lit up |
| Thermal events | | | |
|  |  |  | Fan 1 error (the actual fan speed is outside the desired speed) |
|  |  |  | Fan 2 error (the actual fan speed is outside the desired speed) |
|  |  |  | Fan 3 error (the actual fan speed is outside the desired speed) |
|  |  |  | Temperature 1 error (over limited temperature) |
|  |  |  | Thermal IC #1 I2C connection error |

| | | | | |
|---|--|---|--|--|
|  |  : Off |  : Orange On |  : Green On |  : Red On |
| | |  : Orange Flashing |  : Green Flashing |  : Red Flashing |

Troubleshooting

? The projector does not turn on.

| Cause | Remedy |
|---|---|
| There is no power from the power cord. | Plug the power cord into the AC power jack on the projector, and plug the power cord into the power outlet. If the power outlet has a switch, make sure that it is switched on. |
| Attempting to turn the projector on again during the cooling process. | Wait until the cooling down process has completed. |

? No picture

| Cause | Remedy |
|--|---|
| The video source is not turned on or connected correctly. | Turn the video source on and check that the signal cable is connected correctly. |
| The projector is not correctly connected to the input signal device. | Check the connection. |
| The input signal has not been correctly selected. | Select the correct input signal with the  /SOURCE key. |

? Blurred image

| Cause | Remedy |
|--|--|
| The projection lens is not correctly focused. | Adjust the focus of the lens using the focus ring. |
| The projector and the screen are not aligned properly. | Adjust the projection angle and direction as well as the height of the projector if necessary. |

? Remote control does not work.

| Cause | Remedy |
|--|---|
| The batteries are out of power. | Replace both of the batteries with new ones. |
| There is an obstacle between the remote control and the projector. | Remove the obstacle. |
| You are too far away from the projector. | Stand within 8 meters (26 feet) of the projector. |

? The password is incorrect.

| Cause | Remedy |
|-----------------------------------|--|
| You do not remember the password. | See Entering the password recall procedure on page 24. |

Specifications

Projector specifications



All specifications are subject to change without notice.

Optical

Resolution

3840 x 2160

Display system

1-CHIP DMD

Lens

F = 1.94 ~ 2.12, f = 11.9 ~ 15.5 mm

Light source

240 W lamp

Electrical

Power supply

AC100–240V, 3.8 A, 50–60 Hz (Automatic)

Power consumption

380 W (Max); < 0.5 W (Standby)

Mechanical

Weight

3.1 Kg (6.8 lbs)

Output terminals

Speaker

5 watt x 1

Audio signal output

PC audio jack x 1

Control

USB

Type-A power supply 5V / 1.5 A x 1

RS-232 serial control

9 pin x 1

IR receiver x 2

Input terminals

Video signal input

Digital - HDMI 2.0 x 2

Digital - QS01 HDMI Media Streaming port

(ATV dongle) x 1

Environmental Requirements

Operating temperature

0°C–40°C at sea level

Operating relative humidity

10%–90% (without condensation)

Operating altitude

0–1499 m at 0°C–35°C

1500–3000 m at 0°C–30°C (with

High Altitude Mode on)

Storage temperature

-20°C–60°C at sea level

Storage humidity

10%–90% RH (without condensation)

Storage altitude

30°C@ 0~12,200m above sea level

Transporting

Original packing or equivalent is recommended

Repairing

Please visit below website and choose your country to find your service contact window.

<http://www.benq.com/welcome>

Timing chart

Supported timing for HDMI (HDCP) input

• PC timings

| Resolution | Mode | Vertical Frequency (Hz) | Horizontal Frequency (kHz) | Pixel Frequency (MHz) | Supported 3D format |
|-------------------|-----------------------------------|-------------------------|----------------------------|-----------------------|---------------------|
| | | | | | Frame Sequential |
| 640 x 480 | VGA_60 | 59.940 | 31.469 | 25.175 | V |
| | VGA_72 | 72.809 | 37.861 | 31.500 | |
| | VGA_75 | 75.000 | 37.500 | 31.500 | |
| | VGA_85 | 85.008 | 43.269 | 36.000 | |
| 720 x 400 | 720 x 400_70 | 70.087 | 31.469 | 28.3221 | |
| 800 x 600 | SVGA_60 | 60.317 | 37.879 | 40.000 | V |
| | SVGA_72 | 72.188 | 48.077 | 50.000 | |
| | SVGA_75 | 75.000 | 46.875 | 49.500 | |
| | SVGA_85 | 85.061 | 53.674 | 56.250 | |
| | SVGA_120 (Reduce Blanking) | 119.854 | 77.425 | 83.000 | V |
| 1024 x 768 | XGA_60 | 60.004 | 48.363 | 65.000 | V |
| | XGA_70 | 70.069 | 56.476 | 75.000 | |
| | XGA_75 | 75.029 | 60.023 | 78.750 | |
| | XGA_85 | 84.997 | 68.667 | 94.500 | |
| | XGA_120 (Reduce Blanking) | 119.989 | 97.551 | 115.500 | V |
| 1152 x 864 | 1152 x 864_75 | 75.00 | 67.500 | 108.000 | |
| 1024 x 576 | BenQ Notebook Timing | 60.00 | 35.820 | 46.996 | |
| 1024 x 600 | BenQ Notebook Timing | 64.995 | 41.467 | 51.419 | |
| 1280 x 720 | 1280 x 720_60 | 60 | 45.000 | 74.250 | V |
| 1280 x 768 | 1280 x 768_60 | 59.870 | 47.776 | 79.5 | V |
| 1280 x 800 | WXGA_60 | 59.810 | 49.702 | 83.500 | V |
| | WXGA_75 | 74.934 | 62.795 | 106.500 | |
| | WXGA_85 | 84.880 | 71.554 | 122.500 | |
| | WXGA_120 (Reduce Blanking) | 119.909 | 101.563 | 146.25 | V |
| 1280 x 1024 | SXGA_60 | 60.020 | 63.981 | 108.000 | |
| | SXGA_75 | 75.025 | 79.976 | 135.000 | |
| | SXGA_85 | 85.024 | 91.146 | 157.500 | |
| 1280 x 960 | 1280 x 960_60 | 60.000 | 60.000 | 108 | |
| | 1280 x 960_85 | 85.002 | 85.938 | 148.500 | |
| 1360 x 768 | 1360 x 768_60 | 60.015 | 47.712 | 85.500 | |
| 1440 x 900 | WXGA+_60 | 59.887 | 55.935 | 106.500 | |
| 1400 x 1050 | SXGA+_60 | 59.978 | 65.317 | 121.750 | |
| 1600 x 1200 | UXGA | 60.000 | 75.000 | 162.000 | |
| 1680 x 1050 | 1680 x 1050_60 | 59.954 | 65.290 | 146.250 | |
| 640 x 480@67Hz | MAC13 | 66.667 | 35.000 | 30.240 | |
| 832 x 624@75Hz | MAC16 | 74.546 | 49.722 | 57.280 | |
| 1024 x 768@75Hz | MAC19 | 75.020 | 60.241 | 80.000 | |
| 1152 x 870@75Hz | MAC21 | 75.06 | 68.68 | 100.00 | |
| 1920 x 1080@60Hz | 1920 x 1080_60 | 60 | 67.5 | 148.5 | V |
| 1920 x 1200@60Hz | 1920 x 1200_60 (Reduce Blanking) | 59.95 | 74.038 | 154 | V |
| 1920 x 1080@120Hz | 1920 x 1080_120 | 120.000 | 135.000 | 297 | V |
| 1920 x 1080@240Hz | 1920 x 1080_240 | 239.76 | 291.309 | 582.617 | |
| 1920 x 1200@120Hz | 1920 x 1200_120 (Reduce Blanking) | 119.909 | 152.404 | 317.00 | V |
| 3840 x 2160 | 3840 x 2160_30 For 4K2K model | 30 | 67.5 | 297 | |
| 3840 x 2160 | 3840 x 2160_60 For 4K2K model | 60 | 135 | 594 | |



The timings showing above may not be supported due to EDID file and VGA graphics card limitations. It is possible that some timings cannot be chosen.

• Video timings

| Timing | Resolution | Vertical Frequency (Hz) | Horizontal Frequency (kHz) | Pixel Frequency (MHz) | Supported 3D format |
|-----------|-----------------|-------------------------|----------------------------|-----------------------|---------------------|
| | | | | | Frame Sequential |
| 480i | 720(1440) x 480 | 59.94 | 15.73 | 27 | |
| 480p | 720 x 480 | 59.94 | 31.47 | 27 | V |
| 576i | 720(1440) x 576 | 50 | 15.63 | 27 | |
| 576p | 720 x 576 | 50 | 31.25 | 27 | |
| 720/50p | 1280 x 720 | 50 | 37.5 | 74.25 | |
| 720/60p | 1280 x 720 | 60 | 45.00 | 74.25 | V |
| 1080/24P | 1920 x 1080 | 24 | 27 | 74.25 | |
| 1080/25P | 1920 x 1080 | 25 | 28.13 | 74.25 | |
| 1080/30P | 1920 x 1080 | 30 | 33.75 | 74.25 | |
| 1080/50i | 1920 x 1080 | 50 | 28.13 | 74.25 | |
| 1080/60i | 1920 x 1080 | 60 | 33.75 | 74.25 | |
| 1080/50P | 1920 x 1080 | 50 | 56.25 | 148.5 | |
| 1080/60P | 1920 x 1080 | 60 | 67.5 | 148.5 | V |
| 1080/120P | 1920 x 1080 | 120 | 135 | 297 | V |
| 1080/240P | 1920 x 1080 | 240 | 135 | 594 | |
| 2160/24P | 3840 x 2160 | 24 | 54 | 297 | |
| 2160/25P | 3840 x 2160 | 25 | 56.25 | 297 | |
| 2160/30P | 3840 x 2160 | 30 | 67.5 | 297 | |
| 2160/50P | 3840 x 2160 | 50 | 112.5 | 594 | |
| 2160/60P | 3840 x 2160 | 60 | 135 | 594 | |
| 2160/24P | 4096 x 2160 | 24 | 54 | 297 | |
| 2160/25P | 4096 x 2160 | 25 | 56.25 | 297 | |
| 2160/30P | 4096 x 2160 | 30 | 67.5 | 297 | |
| 2160/50P | 4096 x 2160 | 50 | 112.5 | 594 | |
| 2160/60P | 4096 x 2160 | 60 | 135 | 594 | |

RS232 command

RS232 pin assignment

| No. | Serial |
|-----|--------|
| 1 | NC |
| 2 | RX |
| 3 | TX |
| 4 | NC |
| 5 | GND |

| No. | Serial |
|-----|--------|
| 6 | NC |
| 7 | RTSZ |
| 8 | CTSZ |
| 9 | NC |

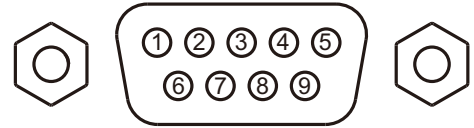

| Function | Type | Operation | ASCII |
|------------------|---------------------|-------------------------------|-----------------------------|
| Power | Write | Power On | <CR>*pow=on#<CR> |
| | Write | Power Off | <CR>*pow=off#<CR> |
| | Read | Power Status | <CR>*pow=?#<CR> |
| Source Selection | Write | HDMI(MHL) | <CR>*sour=hdmi#<CR> |
| | Write | HDMI 2(MHL2) | <CR>*sour=hdmi2#<CR> |
| | Write | HDMI 3 | <CR>*sour=hdmi3#<CR> |
| | Read | Current source | <CR>*sour=?#<CR> |
| Audio Control | Write | Mute On | <CR>*mute=on#<CR> |
| | Write | Mute Off | <CR>*mute=off#<CR> |
| | Read | Mute Status | <CR>*mute=?#<CR> |
| | Write | Volume + | <CR>*vol=+#<CR> |
| | Write | Volume - | <CR>*vol=-#<CR> |
| | Write | Volume level for customer | <CR>*vol=value#<CR> |
| Picture Mode | Read | Volume Status | <CR>*vol=?#<CR> |
| | Write | Bright | <CR>*appmod=bright#<CR> |
| | Write | Living Room | <CR>*appmod=livingroom#<CR> |
| | Write | Game | <CR>*appmod=game#<CR> |
| | Write | Cinema | <CR>*appmod=cine#<CR> |
| | Write | User1 | <CR>*appmod=user1#<CR> |
| | Write | Sport | <CR>*appmod=sport#<CR> |
| Picture Setting | Read | Picture Mode | <CR>*appmod=?#<CR> |
| | Write | Set Contrast value | <CR>*con=value#<CR> |
| | Read | Contrast value | <CR>*con=?#<CR> |
| | Write | Brightness + | <CR>*bri=+#<CR> |
| | Write | Brightness - | <CR>*bri=-#<CR> |
| | Write | Set Brightness value | <CR>*bri=value#<CR> |
| | Read | Brightness value | <CR>*bri=?#<CR> |
| | Write | Set Color value | <CR>*color=value#<CR> |
| | Read | Color value | <CR>*color=?#<CR> |
| | Write | Set Sharpness value | <CR>*sharp=value#<CR> |
| | Read | Sharpness value | <CR>*sharp=?#<CR> |
| | Write | Color Temperature-Warm | <CR>*ct=warm#<CR> |
| | Write | Color Temperature-Normal | <CR>*ct=normal#<CR> |
| | Write | Color Temperature-Cool | <CR>*ct=cool#<CR> |
| | Write | Color Temperature-lamp native | <CR>*ct=ative#<CR> |
| | Read | Color Temperature Status | <CR>*ct=?#<CR> |
| | Write | Aspect 4:3 | <CR>*asp=4:3#<CR> |
| | Write | Aspect 16:9 | <CR>*asp=16:9#<CR> |
| | Write | Aspect Auto | <CR>*asp=AUTO#<CR> |
| | Read | Aspect Status | <CR>*asp=?#<CR> |
| Write | Vertical Keystone + | <CR>*vkeystone=+#<CR> | |
| Write | Vertical Keystone - | <CR>*vkeystone=-#<CR> | |

| | | | |
|--------------------------------|------------------------|----------------------------------|-------------------------------|
| Picture Setting (Continued) | Read | Vertical Keystone value | <CR>*vkeystone=?#<CR> |
| | Write | Horizontal Keystone + | <CR>*hkeystone=+#<CR> |
| | Write | Horizontal Keystone - | <CR>*hkeystone=-#<CR> |
| | Read | Horizontal Keystone value | <CR>*hkeystone=?#<CR> |
| | Write | Brilliant color on | <CR>*BC=on#<CR> |
| | Write | Brilliant color off | <CR>*BC=off#<CR> |
| | Read | Brilliant color status | <CR>*BC=?#<CR> |
| | Write | Reset current picture settings | <CR>*rstcurpicsetting#<CR> |
| | Write | Reset all picture settings | <CR>*rstallpicsetting#<CR> |
| Operation Settings | Write | Projector Position-Front Table | <CR>*pp=FT#<CR> |
| | Write | Projector Position-Rear Table | <CR>*pp=RE#<CR> |
| | Write | Projector Position-Rear Ceiling | <CR>*pp=RC#<CR> |
| | Write | Projector Position-Front Ceiling | <CR>*pp=FC#<CR> |
| | Read | Projector Position Status | <CR>*pp=?#<CR> |
| | Write | Menu Position - Center | <CR>*menuposition=center#<CR> |
| | Write | Menu Position - Top-Left | <CR>*menuposition=tl#<CR> |
| | Write | Menu Position - Top-Right | <CR>*menuposition=tr#<CR> |
| | Write | Menu Position - Bottom-Right | <CR>*menuposition=br#<CR> |
| | Write | Menu Position - Bottom-Left | <CR>*menuposition=bl#<CR> |
| | Read | Menu Position Status | <CR>*menuposition=?#<CR> |
| | Write | Direct Power On-on | <CR>*directpower=on#<CR> |
| | Write | Direct Power On-off | <CR>*directpower=off#<CR> |
| Read | Direct Power On-Status | <CR>*directpower=?#<CR> | |
| Baud Rate | Write | 9600 | <CR>*baud=9600#<CR> |
| | Write | 14400 | <CR>*baud=14400#<CR> |
| | Write | 19200 | <CR>*baud=19200#<CR> |
| | Write | 38400 | <CR>*baud=38400#<CR> |
| | Write | 57600 | <CR>*baud=57600#<CR> |
| | Write | 115200 | <CR>*baud=115200#<CR> |
| | Read | Current Baud Rate | <CR>*baud=?#<CR> |
| Lamp Control | Read | Lamp | <CR>*ltim=?#<CR> |
| | Write | Normal mode | <CR>*lampm=lnor#<CR> |
| | Write | Eco mode | <CR>*lampm=eco#<CR> |
| | Write | SmartEco mode | <CR>*lampm=seco#<CR> |
| | Write | SmartEco mode 2 | <CR>*lampm= seco2#<CR> |
| Read | Lamp Mode Status | <CR>*lampm=?#<CR> | |
| Miscellaneous | Read | Model Name | <CR>*modelname=?#<CR> |
| | Read | System F/W Version | <CR>*sysfwversion=?#<CR> |
| | Read | Scaler F/W Version | <CR>*scalerfwversion=?#<CR> |
| | Read | MCU F/W Version | <CR>*mcutfwversion=?#<CR> |
| | Write | Blank On | <CR>*blank=on#<CR> |
| | Write | Blank Off | <CR>*blank=off#<CR> |
| | Read | Blank Status | <CR>*blank=?#<CR> |
| | Write | Freeze On | <CR>*freeze=on#<CR> |
| | Write | Freeze Off | <CR>*freeze=off#<CR> |
| | Read | Freeze Status | <CR>*freeze=?#<CR> |
| | Write | Menu On | <CR>*menu=on#<CR> |
| | Write | Menu Off | <CR>*menu=off#<CR> |
| | Read | Menu Status | <CR>*menu=?#<CR> |
| | Write | Up | <CR>*up#<CR> |
| | Write | Down | <CR>*down#<CR> |
| | Write | Right | <CR>*right#<CR> |
| | Write | Left | <CR>*left#<CR> |
| | Write | Enter | <CR>*enter#<CR> |
| | Write | Back | <CR>*back#<CR> |
| | Write | Source Menu On | <CR>*sourmenu=on#<CR> |
| Write | Source Menu Off | <CR>*sourmenu=off#<CR> | |

| | | | |
|---|----------------------|--------------------------------------|-----------------------------|
| Miscellaneous (Continued) | Read | Source Menu Status | <CR>*sourmenu=?#<CR> |
| | Write | 3D Sync Off | <CR>*3d=off#<CR> |
| | Write | 3D Sync Frame Sequential | <CR>*3d=fs#<CR> |
| | Read | 3D Sync Status | <CR>*3d=?#<CR> |
| | Write | High Altitude mode on | <CR>*Highaltitude=on#<CR> |
| | Write | High Altitude mode off | <CR>*Highaltitude=off#<CR> |
| | Read | High Altitude mode status | <CR>*Highaltitude=?#<CR> |
| Color Calibration (only for service) | Write | Set BenQ gamma value | <CR>*gamma=value#<CR> |
| | Read | Gamma value status | <CR>*gamma=?#<CR> |
| | Write | Set HDR Brightness value | <CR>*hdrbri=value#<CR> |
| | Read | Get HDR Brightness value | <CR>*hdibri=?#<CR> |
| | Write | Set Red Gain value | <CR>*RGain=value#<CR> |
| | Read | Get Red Gain value | <CR>*RGain=?#<CR> |
| | Write | Set Green Gain value | <CR>*GGain=value#<CR> |
| | Read | Get Green Gain value | <CR>*GGain=?#<CR> |
| | Write | Set Blue Gain value | <CR>*BGain=value#<CR> |
| | Read | Get Blue Gain value | <CR>*BGain=?#<CR> |
| | Write | Set Red Offset value | <CR>*ROffset=value#<CR> |
| | Read | Get Red Offset value | <CR>*ROffset=?#<CR> |
| | Write | Set Green Offset value | <CR>*GOffset=value#<CR> |
| | Read | Get Green Offset value | <CR>*GOffset=?#<CR> |
| | Write | Set Blue Offset value | <CR>*BOffset=value#<CR> |
| | Read | Get Blue Offset value | <CR>*BOffset=?#<CR> |
| | Write | Primary Color | <CR>*primcr=value#<CR> |
| | Read | Primary Color Status | <CR>*primcr=?#<CR> |
| | Write | Set Hue value | <CR>*hue=value#<CR> |
| | Read | Get Hue value | <CR>*hue=?#<CR> |
| | Write | Set Saturation value | <CR>*saturation =value#<CR> |
| Read | Get Saturation value | <CR>*saturation =?#<CR> | |
| Write | Set Gain value | <CR>*gain=value#<CR> | |
| Read | Get Gain value | <CR>*gain=?#<CR> | |
| Service (Only for service) | Write | Service mode enable for error report | <CR>*error=enable#<CR> |
| | Read | Error code report | <CR>*error=report#<CR> |
| | Read | FAN 1 speed | <CR>*fan1=?#<CR> |
| | Read | FAN 2 speed | <CR>*fan2=?#<CR> |
| | Read | FAN 3 speed | <CR>*fan3=?#<CR> |
| | Read | Temperature 1 | <CR>*tmp1=?#<CR> |
| | Read | LED indicator | <CR>*led=?#<CR> |