

Index

OPERATIONAL PRINCIPLE

APPLINK

AUDIO

AUDIO SETTINGS

BEZEL DIAGNOSTICS

BLUETOOTH PHONE

BUTTONS

CAMERA

CLIMATE CONTROL

CLOCK

ELECTRIFICATION

EMERGENCY ASSIST

MEDIA PLAYER

MESSAGE CENTER

MULTI CONTOURED SEATS

MYKEY

NAVIGATION

POWER MANAGEMENT

RADIO

SETTINGS

TRAVEL LINK

VOICE COMMANDS

VOLUME

WI-FI

OPERATIONAL PRINCIPLE

The Ford Sync FA-170-BCAR-HS is defined as a HMI module with an attached external faceplate. All display and keypad inputs are done via remote modules. The Sync Module is capable of receiving and playing or displaying USB (x2), Microphone Inputs (x2), Bluetooth 2.1+EDR, WLAN (Wi-Fi: 2.4GHZ and 5GHz), line level stereo audio and a mono line level outputs.

Communication to remote keypads, head unit and other cluster modules is accomplished via system buses

- 1) HS CAN: Vehicle High Speed Communications Bus (500Kb/s)
- 2) I CAN Bus: Vehicle Infotainment CAN Bus (500Kb/s)
- 3) SD Link: Sirius Data Link – A UART communication from AHU's Sirius module to the Sync via a differential CAN interface (115Kb/s)

The Sync Module is comprised of two boards, main and multi-media

Main Board - Controls the interface to the external busses (CAN interface), responsible for digitization of all analog audio/video signals, power moding and primary power generation of for Sync Module.

Main Board Components:

CPU – (IC603) Bolero, SPC5644CF0VLU8, utilizes Freescale's dual 32-bit Core Power Architecture running at 80MHz. The CPU has utilizes a 16MHz crystal for generation of all internal PLL loops used during normal operation of the processor. An additional 32K.768KHz crystal is used for the real time clock and watchdog generation. IC603 is mainly used for bus interface to the vehicles LAN busses (HS CAN and ICAN). The processor is the power master for the module and controls the powering sequences for the radio.

Power Supplies: The main board has 5 SMPS used for generation of power to the system. The MAX16932 is a dual synchronous switch mode power supply running at 2.1MHz. The output rail for the 3.3VSW is capable of delivering 6A to the main and multimedia boards. The 3.3VSW rail is sent to the MMB for generation of the power rails needed on the MMB. The 3.3VBatt rail is the second SMPS on the MAX16932 switcher, it is capable of 1.5A of output current and it output is fed to the Bolero CPU and WiLink Module. There are 2 USB connectors on the main board, each VBUS rail is supplied power by a Maxim MAX16984 USB Smart Switch Supply. The MAX16984 power supplies are capable of delivering 2.1A of current with voltage compensation based on current requirement for the USB port.. The MAX16904 is 800mA, 2.1MHz used to power the +5V_SW rail, which supplies current to the Audio CODEC and GNSS antenna

Audio CODEC – CS4234 has 4 Channels of Differential audio data input (4 ADC Channels) and 5 channels of Differential Analog Audio Output (DACs). The Sync module is currently using 2 analog channel inputs

for microphone digitalization and 3 DAC channels for a stereo and mono signal output. All data communicated over the I2S buses is at a 48KHz.

Video ADC: (IC803) Analog Devices ADV7281WBCPZ-M-RL converts the analog rear view camera video (NTSC or PAL Video) into a MIPI data stream. The MIPI video output is sent to the OMAP5432 using differential data and clock lines. The ADV7281WBCPZ-M-RL uses a 28.6363 MHz crystal for generation of the video data.

CPLD: IC120 (LCMXO2-640HC-4TG100ITR) is Lattice's MachX02 CPLD device used for level translation between the Main Board's CPU (3.3V Logic) and the multi-media board's CPU (1.8V logic). It also is used as an I/O expansion for the OMAP5 data to the main board

SERDES : (IC802) Texas Instrument's DS90UB925QSQX/NOPB converts the OMAP5432's 24 Bit RGB data into a video LVDS signals. The RGB data coming from the OMAP5432 is clocking at approximately 33MHz and has an output data rate of approximately 1GHz. The backchannel capabilities of the SERDES IC uses an I2C bus to control the remotes display and read the touchscreen inputs from the user. The I2C bus communicates to the OMAP processor at 100KHz to 400KHz data rates.

WiLink8 Module: (E502) WiLink8 Module is a module built by Panasonic using the WL1873 chipset from Texas Instruments. The device is capable of Bluetooth 2.1+EDR, Wi-Fi 2.4 and 5 GHz operations (SISO) as well receptions of GNSS (GPS and Glonass) satellite data. The module has a built in 26MHz TCXO for clock generations within the module. Bluetooth Audio uses the HCI (UART) for A2DP Bluetooth audio streaming and BT Hands free phone audio is communicated to the OMAP processor via the I2S bus. Wi-Fi interface is via the SDIO bus and GNSS data shares the HCI UART bus with the Bluetooth A2DP.

3 Axis Accelerometer: (IC410) ADXL312WACPZ-RL send 3 axis acceleration rates to the OMAP processor via the I2C bus that operates at 100-400KHz. The accelerometer data is used by the GPS dead reckoning engine for improved navigation functions

Multi-Media Board: Does HMI, audio & video decoding, USB interface, Wi-Fi and Bluetooth interface to WiLink module on Main Board, GNSS navigational functions including dead reckoning and route generation and navigation. Video input from rear view camera is received via main boards VADC via MIPI bus and Video output to the main board SERDES IC is by 24 bit RGB data.

CPU – IC100 – OMAP5432 contains dual core A15 processor with an operational frequency of 1GHz. The processor is used as the media processor for the Sync Module. A 19.2MHz crystal and the processors internal PLLs generate most clock necessary for operation of the system. An additional 12.288MHz TXO is used for generation of the master clock for the Audio data (8, 16, and 48KHz). The processor is responsible for:

- 1) 24 bit RGB Outputs
- 2) USB Host and Interface to external modules (USB2.0)

- 3) Audio Interface for:
 - a. USB Decodes
 - b. AEC/Voice Recognition
 - c. Video Decode for Rear View Camera display
 - d. Bluetooth Audio Decode of HCI data
 - e. Text to Speech for Voice prompts
- 4) HMI generation for viewing on remote display
- 5) Wi-Fi interface through SDIO Bus
- 6) GNSS-Route generation, map rendering, dead reckoning and point of interest generations

DDR3 Memory – (IC200-IC203) MT41K256M16HA-125AAT:E is Micron 4Gbit DDR3 memory that is clocked at 533MHz. The 4 memory devices are combined for a total bus width of 64bits and memory depth of 2 Giga bytes,

eMMC Flash: (IC204) The eMMC device from SanDisk is used to store the executable code, voice recognition data base, startup animations, user data, and maps for the navigation system. The eMMC components are SanDisk's 19nm 153pin BGA devices in 8GB, 32GB, and 64GB memory depths. The memory size is dependent on the functionality requirements and region of the world the module is used in. All devices will communicate using the 48Mz DDR mode on the SDIO bus

External USB Phy; (IC500) TUSB1210BRHBRQ1 is a standalone USB transceiver IC that converts USB Data (DP+/-) into a 8 but ULPI data stream to the OMAP processor. The data ULPI data rate to the OMAP processor is at 60MHz. The IC receives an additional 19.2MHz clock from the OMAP processor . IC500 is only used when communication occurs on USB Port 2.

PMIC : (IC700) O9038A352IZWSRQ1 is manufactured by Texas instruments. It is the power management IC that is comprised of 9 SMPS and 11 LDOs. The power supplies are used to supply the needed voltage rails for the devices on the multimedia board. The PMIC is clocked by its own 16.384MHz crystal.

Apple iPod Authentication: (IC102) MFI337S3959, Apple Rev C IC communicates to the OMAA processor over the Audio and Video I2C Bus. When an Apple device is connected to the module via USB port, it issues a challenge to the Sync Module. The Sync module uses the Apple IC to get the proper response to the challenge and also issues a counter challenge to the remote device.

3 Axis Rae Gyro: (E500) A3G4250DTR supplies the OMAP processor with a 3 axis Rate data in degrees per second. The MEMS gyro communicates to the OMAP processor via an I2C bus operating at 100-400KHz data rate. Data from the rate gyro is used to aid the accuracy of the dead reckoning algorithm in the navigation function

APPLINK

What is AppLink?

AppLink enables vehicle occupants to use the applications (“apps”) present on their mobile devices through the head-unit thereby reducing driver distractions. SYNC AppLink uses voice-activated (voice recognition (VR)) technology to build a hands-free bridge between the head-unit and the smartphone applications (through Bluetooth (BT)). Through voice commands occupants can stream Internet radio, listen to tweets, and more without fumbling through phone menus.

SYNC AppLink-compatible mobile applications are available for Android™, BlackBerry®, and iPhone® smartphone platforms, and new applications are being added regularly. Applications can be purchased and downloaded through Google Play, iTunes® App Store, and Blackberry® App World™.43

Some of the AppLink enabled applications include: Pandora, Stitcher, iHeartRadio, OpenBeak, NPR News, SYNC Destinations, Scout by Telenav.

How does it work (End-User Perspective)?

1. User installs an AppLink enabled app onto mobile phone.
2. User connects mobile phone with SYNC
 - a. For iPhone: Connection is through USB using cable
 - b. For Android/Blackberry: Connection is through Bluetooth
3. User starts the App on mobile phone
4. User accesses App from SYNC
 - a. Apps can be accessed through the SYNC HMI/SWC
 - b. Apps can be accessed through voice prompts

Examples:

Pandora

Action	Voice Command	Radio or Steering Wheel Control
Pause the audio	Pause	Play/Pause (▶) or OK
Resume play of paused audio	Resume	Play/Pause (▶) or OK
Skip the current track	Skip	SEEK forward button (▶)
Display and read the current track information	Track Info	-----
List all of your saved stations	List My Stations	-----
'Thumb Up' the current track	Thumb Up	Hold SEEK forward (▶)
'Thumb Down' the current track	Thumb Down	Hold SEEK backward (◀)
Bookmark the current track	Bookmark	-----
Create a new station from the current track	Create Station from Track	-----
Create a new station from the current artist	Create Station from Artist	-----
Play a particular saved station	Play Station <Station Name>	-----
Play a station assigned to a preset	-----	Press the preset
Receive help with all available commands	Help	-----

APPLINK

How does it work (Technical Perspective)?

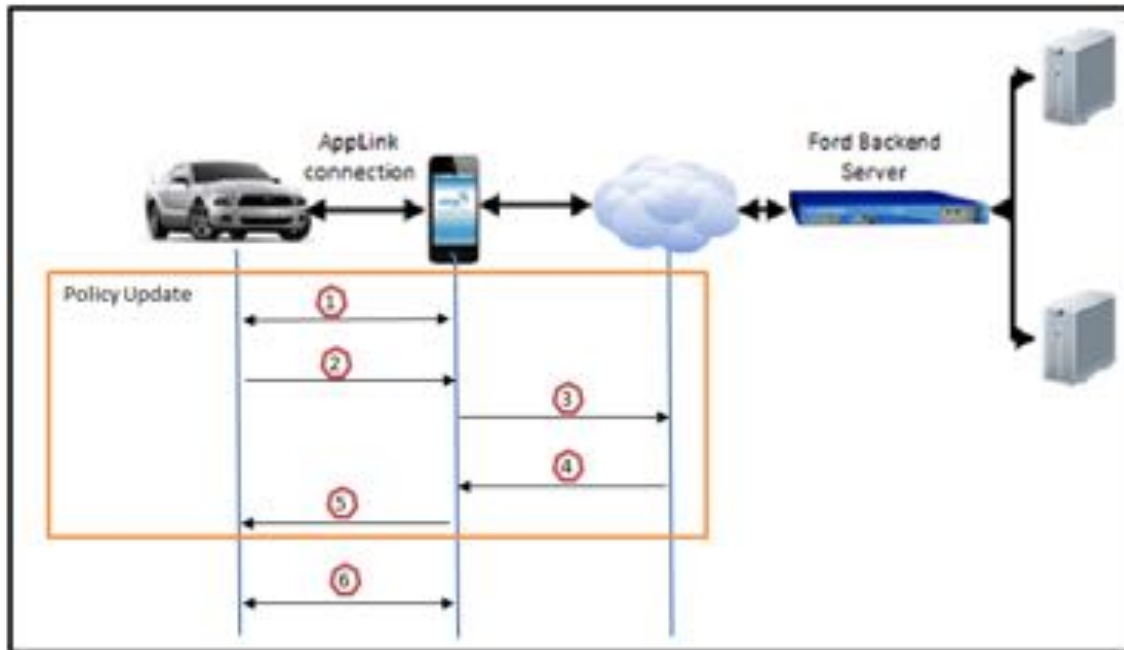

A. Policy Update:

1. The mobile phone and SYNC are connected (either through Bluetooth or through USB)

Panasonic ideas for life

**Panasonic Automotive Systems Company
of America**
Division of Panasonic Corporation of North America

2. SYNC-AppLink requests update to local policy table and sends this request to mobile device.
 3. Proxy code within mobile device forwards the request to Ford Backend Server via cloud using the phone's mobile connection.
 4. Ford Backend Server provides updated policy table back to mobile phone.
 5. Mobile phone passes on the updated policy table to SYNC-AppLink where the local policy table gets updated.
- B. Application Interaction
6. Mobile phone and SYNC AppLink pass messages to/forth in response to user requests.

AppLink Ford Video: <http://support.ford.com/sync-technology/access-applink-mobile-applications-sync>

AUDIO

Management

Audio sources are typically activated /deactivated due to event which causes an audio source to be either requested for playback or released from playback. Since multiple clients may request access to the audio system for playback, mixing, etc. the Audio Resource Server must have a method in place to track the requests for sources and track the current sources.

Priority Type	Priority Level	May Interrupt up to Level No.	May enter stack below granted entry	Stackable	Collapses Stack
Priority Service	9	8	No	No	No
Auto Answer ¹	9	8	No	No	No
Telephony Service	8	7	No	Yes	No
Mobile NAV and Tel Mute	7	6	No	Yes	No
PTT Mute & Voice	6	8	No	No	No
Alarm	5	4	Yes	No	No
TA	4	3	Yes	No	No
PTY/NEWS	3	2	Yes	No	No
Manual Audio Mute	2	4	No	Yes	No
Radio	1	7	No	Yes	Yes
Disc	1	7	No	Yes	Yes
Aux ExtSource	1	7	No	Yes	Yes
Nav. User Voice Cmd ²	N/A	9 (mix) ³	N/A	N/A	N/A
Nav. System Voice Cmd ²	N/A	7 (mix) ⁴	N/A	N/A	N/A
Not Requested ⁵	N/A	N/A	N/A	N/A	N/A

AUDIO SETTINGS

Tonal Settings Control
Bass, Treble, Midrange, Balance, Fade

These controls are available in the Sound section of the Settings.

Sound Settings

Treble

▲

Reset

Midrange

▲

Reset

Bass

▲

Reset

Balance and Fade
▶

Speed Adjusted Volume

Off ▼

Status/Interaction

Depending on vehicle configuration and components, The following options may be available.

Occupancy Mode (no external amp present), DSP Program Mode (Sound Mode)
 QuantumLogic Surround (Revel Present)
 Play THX Deepnote available if configured as Lincoln and DSP on.
 Play Revel Experience available if configured as Revel on.

Occupancy Mode	Driver ▼	
Sound Mode	Surround ▼	
QuantumLogic Surround	Audience ▼	
Play THX Deep Note™		
Play Revel Experience™		

AUDIO SETTINGS

Balance & Fade

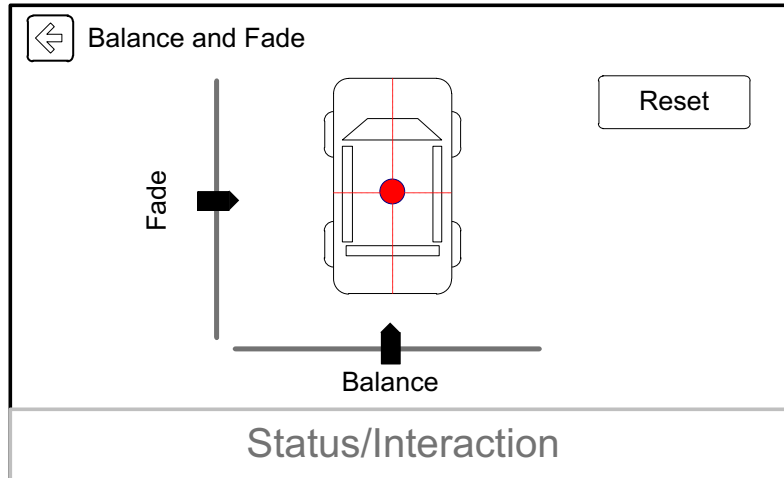

Speed Compensated Volume

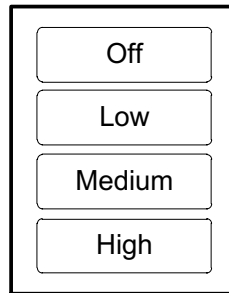

Occupancy Mode (No DSP)



Sound Mode (DSP)



QuantumLogic Surround (Revel)

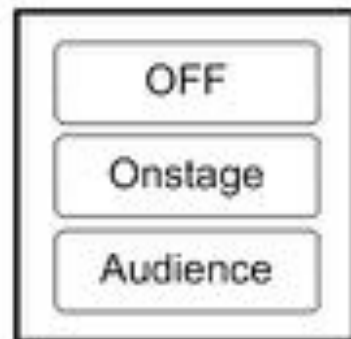

BEZEL DIAGNOSTICS

Upon system start-up the Bezel Diagnostic Client shall set the signal `_Bezel_Diagnostic.Rq` :
`Diagnostic_Operation.Rq == "Get All Background Diagnostic Request"` and request from the Bezel Diagnostic Servers the following information:

1. Software Part Number
2. Hardware Part Number
3. Calibration Part Number
4. SDARS ESN Number (applicable only to SDARS server)

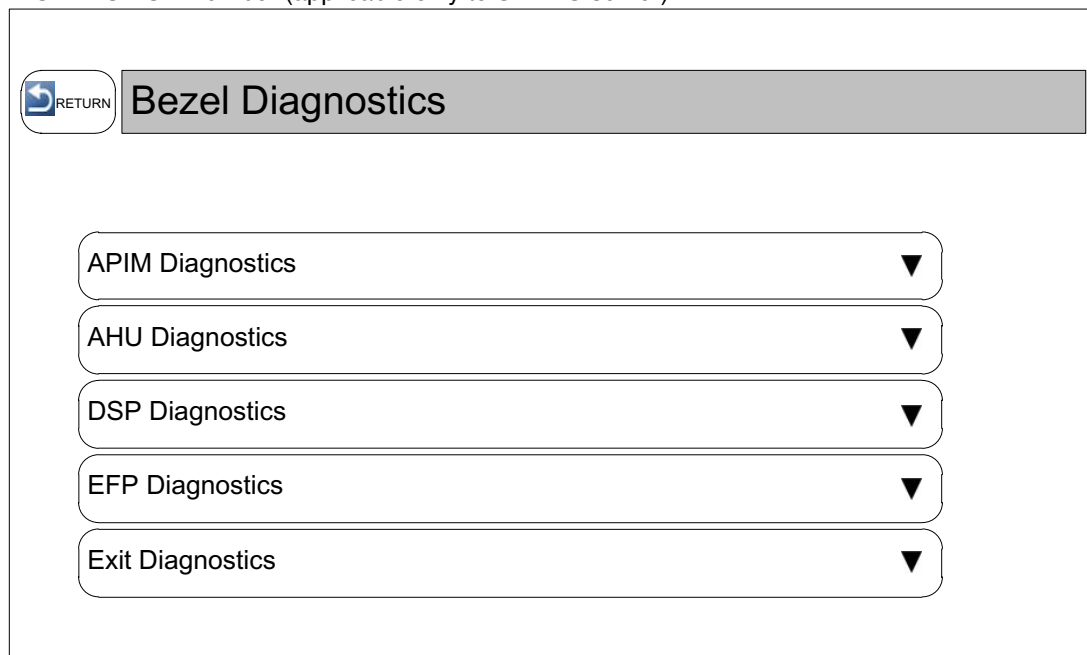

Information specific to APIM will be available through this menu.

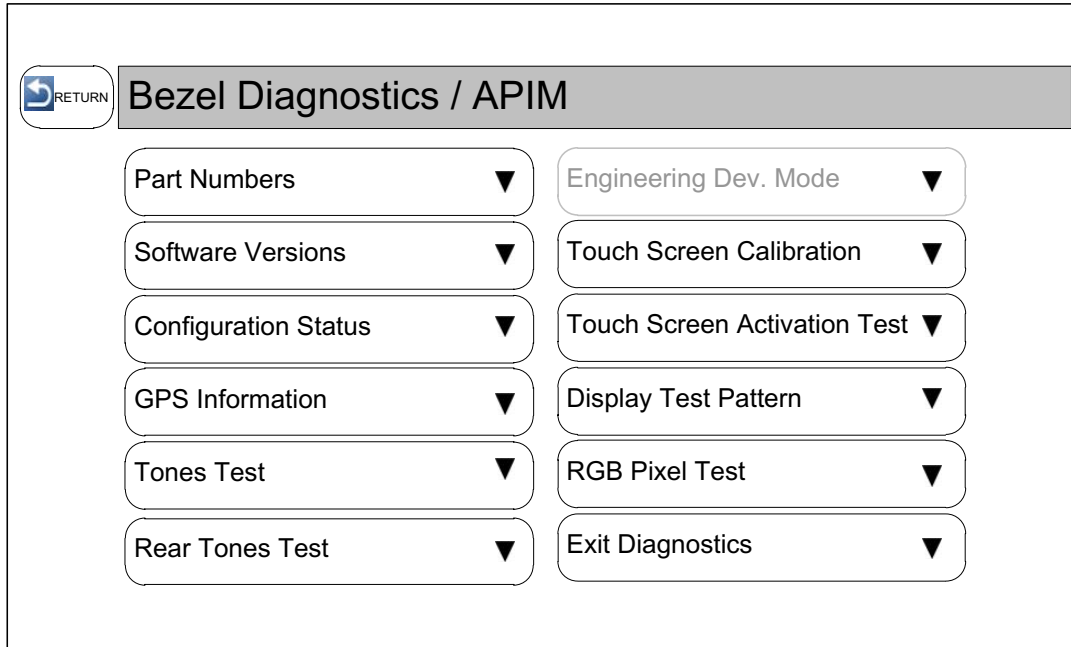

BLUETOOTH PHONE

Handsfree Phone User guide

Jim Fulner, Panasonic Automotive Systems Company of America, Inc.

The Handsfree phone feature allows the Sync system to act as an extension of your phone via wireless technology called *Bluetooth*[®]. *Bluetooth*[®] is like an invisible cable that connects one device to one other device. It is important to remember that the features of Sync available to the user are dependent on the *Bluetooth*[®] functionality of the user's phone. **NOTE: Some phones may have features that work on the handset but are not necessarily extended via *Bluetooth*[®], this may include, but is not limited to, features like Text Messaging's (SMS), photo caller ID, personalized ringtones, etc.** For more information on your particular phone's *Bluetooth*[®] capabilities, please contact your cell phone provider's technical support team.

In order to use the Handsfree phone capability you must pair the cell phone with sync. (Pairing is the establishment of the initial connection of the two devices, telling each other that they exist and they trust each other). You'll find the option in SETTINGS

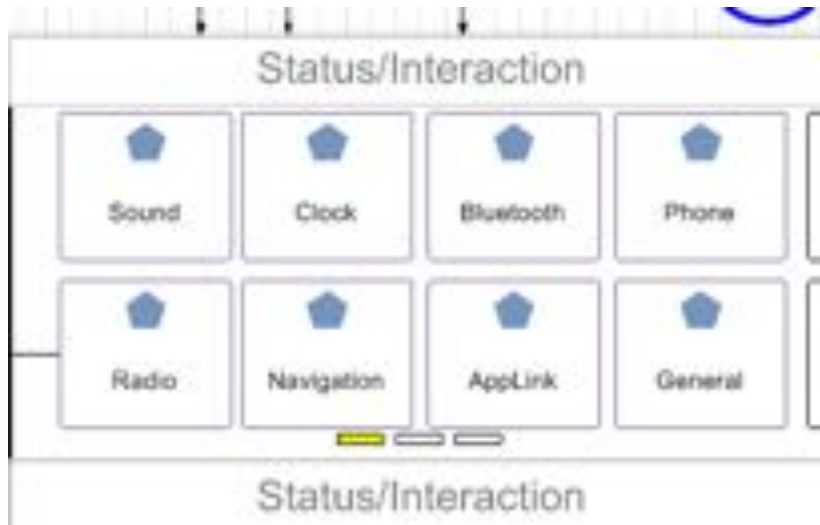

Choose BLUETOOTH Choose
BLUETOOTH DEVICE

ADD A

BLUETOOTH PHONE



Then search for new devices from your cell phone. This is normally done via your phone's SETTINGS or TOOLS menu. For specific instructions regarding pairing your phone please see your phone's users'

manual or contact your cell phone carriers technical support team. You should be able to select SYNC from a search option. You will then need to confirm the PIN. Your phone should prompt you to either enter the PIN as shown on SYNC or it will automatically show a PIN and you need to confirm on both your phone and SYNC that the PIN matches. It is recommend that, if given the option on your phone, you set SYNC as TRUSTED (sometimes this will be called AUTOMATIC, AUTHORIZED, ALLOW ACCESS TO PHONEBOOK or similar wording).

Once pairing is successful your phone and SYNC trust each other. Automatic connection should begin. Pairing should only need to be performed once. Subsequent connections should occur automatically when you get in the car and your phone's *Bluetooth*® feature is turned on. SYNC can pair (store in memory) up to 12 devices, however only one phone can be connected at a time.

If your phone supports phonebook synchronization via *Bluetooth*® this synchronization will begin automatically (you may need to authorize the first download from your phone). Once authorized, initial phonebook download may take more than two minutes for your phonebook to download and become available. Subsequent connections the phonebook should be available almost immediately upon connection.

If your phone received an incoming phone call the caller ID will be displayed and a ringtone will be played in the speakers. This can be answered via the touch screen, or your steering wheel controls. The call can be heard via the vehicle speakers and you can talk handsfree, your vehicle's microphone will pick up your voice. Remember to keep your eyes on the road and hands on the wheel.

To make an outgoing call you can tap the voice button on your steering wheel control and say a number "Call 512-646-6400" or a contact in the sync phonebook "Call Alex Jones at work." The same options can be access via SYNC's PHONE menu on the touch screen.

BLUETOOTH PHONE

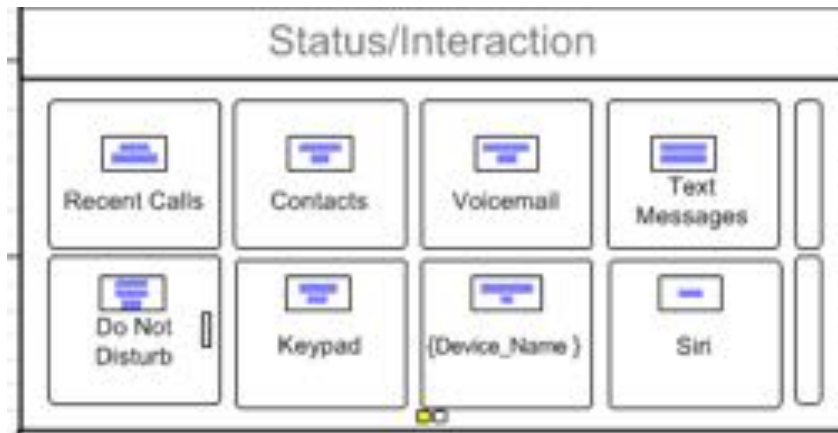

If your phone supports Text Messaging over *Bluetooth*® and you receive an incoming text message an alert will show on the display, and a tone will play through the speakers. You can then choose to have the message read to you.



If your device supports replying to SMS over *Bluetooth*®, you will be given a list of predefined messages to choose from to reply with such as “Can’t talk right now, I’m Driving.” Note, many devices do not fully support *Bluetooth*® text messaging, most notably the Apple iPhone.

Handsfree phone is a convenience feature, not a safety feature. Even when using handsfree it is recommended that the vehicle be parked in a safe location while calling or texting. No significant difference has been shown in regards to driver distraction between holding your phone and using a handsfree system like SYNC.

Troubleshooting tips: If at any time Handsfree phone is not functioning as expected, it is recommended to perform a soft reset on your phone. This is normally done by removing the battery for a short time. If problems still occur you may choose to delete the pairing from both device and pair them again. For phone specific information contact your carrier’s tech support. For additional SYNC support contact 1-877-xxx-xxxx

BUTTONS

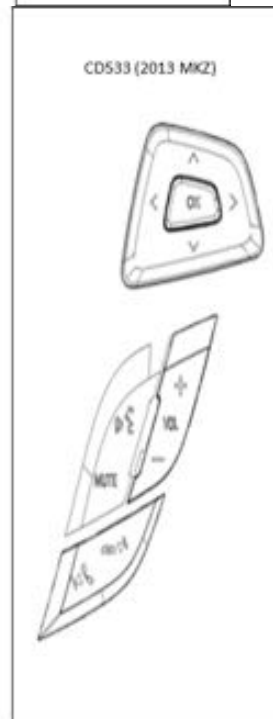
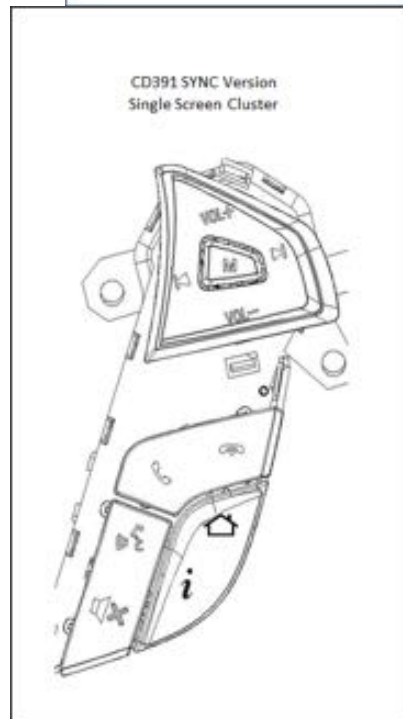
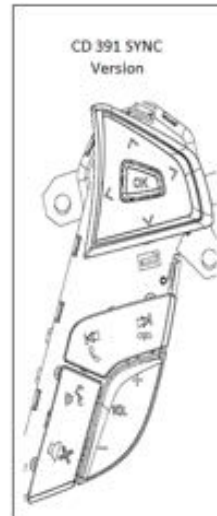
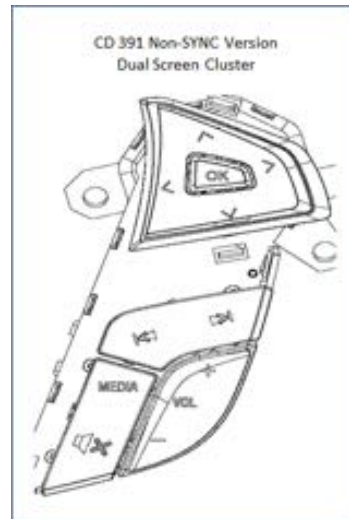

Panasonic
ideas for life

**Panasonic Automotive Systems Company
of America**
Division of Panasonic Corporation of North America

BUTTONS

Control Panel, Mechanical Definition							
Right hand side steering wheel controls							
Control	Type of Control	Input	Behavior	Output (P/S/SA)	Feedback	Symbol	Button Label (See Next Transition Table)
3 Press control (up, down, left, right, etc)	Push-button	Press	Shows L/R Recording & selection	Shows P/S/SA	Does not function, until second car change	Button press	R1, R2, R3
Seek Right	Rocker	Press	<p>Audio System OFF (no action)</p> <p>AR, FR: Tune to next stored preset (SEE TABLE BELOW)</p> <p>SAT: Tune to next stored preset (SEE TABLE BELOW)</p> <p>SAT Ready: Go forward in time to beginning of next next recorded segment</p> <p>CD: Play next song</p> <p>DYNIC Mode: Play next song</p> <p>AppLin: Send Seek Right</p> <p>"Search/Quick" button press events to enable later (open-release and Top button press event)</p>	<p>AR/FR: Radio Frequency Update</p> <p>DYNIC Mode: Display updates to next track</p>	<p>AR/FR: Radio Frequency updated</p> <p>DYNIC Mode: next track selection heard</p>	Button press	R2
		Press and hold	<p>AR, FR: Fast seek up</p> <p>SAT: Fast seek up</p> <p>CD: FFWD current song</p> <p>SAT: FFWD current song</p> <p>SAT Ready: Fast forward through recorded content</p> <p>AppLin: Send Seek Right</p> <p>"Search/Quick" button press events to enable later (open-release and Top button press event)</p>	<p>DYNIC Mode: Display updates to next track</p>	<p>DYNIC Mode: next track selection heard</p>		
Seek Left	Rocker	Press	<p>Audio System OFF (no action)</p> <p>AR, FR: Tune to previous stored preset (SEE TABLE BELOW)</p> <p>SAT: Tune to previous stored preset (SEE TABLE BELOW)</p> <p>SAT Ready: Go backward in time to beginning of next stored recorded segment</p> <p>CD: A single press shall re-start current song, an immediate second press shall begin playing the previous song</p> <p>DYNIC Mode: A single press shall re-emp-current song, an immediate second press shall begin playing the previous song</p> <p>AppLin: Send Seek Left</p> <p>"Search/Quick" button press events to enable later (open-release and Top button press event)</p>	<p>AR/FR: Radio Frequency Update</p> <p>DYNIC Mode: Display updates to previous track</p>	<p>AR/FR: Radio Frequency updated</p> <p>DYNIC Mode: previous track selection heard</p>	Button press	R3
		Press and hold	<p>AR, FR: Fast seek down</p> <p>SAT: Fast seek down</p> <p>CD: Fast-reverse current song</p> <p>DYNIC Mode: Fast-reverse current song</p> <p>SAT Ready: Fast-reverse through recorded content</p> <p>AppLin: Send Seek Left</p> <p>"Search/Quick" button press events to enable later (open-release and Top button press event)</p>	<p>DYNIC Mode: Display updates to previous track</p>	<p>DYNIC Mode: previous track selection heard</p>		
Seek Right - Press End	Rocker	Press	<p>Audio System OFF (no action)</p> <p>AR, FR: Tune to next stored preset (SEE TABLE BELOW)</p> <p>SAT: Tune to next stored preset (SEE TABLE BELOW)</p> <p>SAT Ready: Go forward in time to beginning of next next recorded segment</p> <p>SAT Ready: Fast forward through recorded content</p> <p>CD: Play next song</p> <p>DYNIC Mode: Play next song</p> <p>DYNIC Phone: Refer to table "Common Phone/END" button action</p> <p>AppLin: Send Seek Right</p>	<p>AR/FR: Radio Frequency Update</p> <p>DYNIC Mode: Display updates to next track</p> <p>DYNIC Phone: Phone Call ready</p>	<p>AR/FR: Radio Frequency updated</p> <p>DYNIC Mode: next track selection heard</p> <p>DYNIC Phone: End Phone Call</p>	Button press	R4, R5
		Press and hold	<p>AR, FR: Fast seek up</p> <p>SAT: Fast seek up</p> <p>CD: FFWD current media played</p> <p>DYNIC Mode: Next track selection</p> <p>AppLin: Send Seek Right</p> <p>"Search/Quick" button press events to enable later (open-release and Top button press event)</p>	<p>DYNIC Mode: Display updates to previous track</p>	<p>DYNIC Mode: previous track selection heard</p>		
Seek Left - Press "END"	Rocker	Press	<p>Audio System OFF (no action)</p> <p>AR, FR: Tune to previous stored preset (SEE TABLE BELOW)</p> <p>SAT: Tune to previous stored preset (SEE TABLE BELOW)</p> <p>SAT Ready: Go backward in time to beginning of next stored recorded segment</p> <p>CD: A single press shall re-start current song, an immediate second press shall begin playing the previous song</p> <p>DYNIC Mode: A single press shall re-start current song, an immediate second press shall begin playing the previous song</p> <p>DYNIC Phone: Refer to table "Common Phone/END" button action</p> <p>AppLin: Send Seek Left</p> <p>"Search/Quick" button press events to enable later (open-release and Top button press event)</p>	<p>Radio Frequency Update</p> <p>DYNIC Mode: Display updates to previous track</p> <p>DYNIC Phone: Update Phone Call</p>	<p>Radio Frequency updated</p> <p>DYNIC Mode: previous track selection heard</p> <p>DYNIC Phone: Send Phone Call</p>	Button press	R4, R5
		Push and hold	<p>AR, FR: Fast seek down</p> <p>SAT: Fast seek down</p> <p>CD: Fast-reverse current song</p> <p>DYNIC Mode: Fast-reverse current song</p> <p>SAT Ready: Fast-reverse through recorded content</p> <p>AppLin: Send Seek Left</p> <p>"Search/Quick" button press events to enable later (open-release and Top button press event)</p>	<p>DYNIC Mode: Display updates to previous track</p>	<p>DYNIC Mode: previous track selection heard</p>		

CAMERA

Brief description of Camera and features.

The SYNC Gen3 Camera feature includes multiple functions; Rear Video Camera (RVC) with zoom, Front Video Camera (FVC) with zoom, Park Distance Control (PDC), Flank Guard, Active Park Assist (APA), Park Out Assist (POA), Parallel Park Assist, Perpendicular Park Assist (left and right side), Trailer Backup Assist (TBA), and 360 degree view.

RVC:

RVC is activate by shifting the vehicle to reverse and will maintain until the user switches out of reverse or exceeds a speed of 10kph.



PDC:

PDC is the ability for the user to have a visual representation for how close they are to an object while reversing their vehicle. The four bottom sectors of the car image below represent PDC. They will turn from transparent to green to yellow to red depending on how close the object is to the appropriate sensor. There will also be an audio tone accompanied with the visual representation that will beep more frequently the close the vehicle comes to the object, ending in a solid tone when the driver is becoming too close to the object.

CAMERA



Flank Guard:

Flank Guard is the ability for the user to have a visual representation for how close they are to an object while driving in forward or reverse. The four middle sectors on each side of the car image above represent Flank Guard. They will turn from transparent to green to yellow to red depending on how close the object is to the appropriate sensor. There will also be an audio tone accompanied with the visual representation that will beep more frequently the closer the vehicle comes to the object, ending in a solid tone when the driver is becoming too close to the object.

RVC Settings:

RVC settings shall consist of the ability to turn Enhanced Park Aids ON/Off, as well as RVC delay.

CAMERA

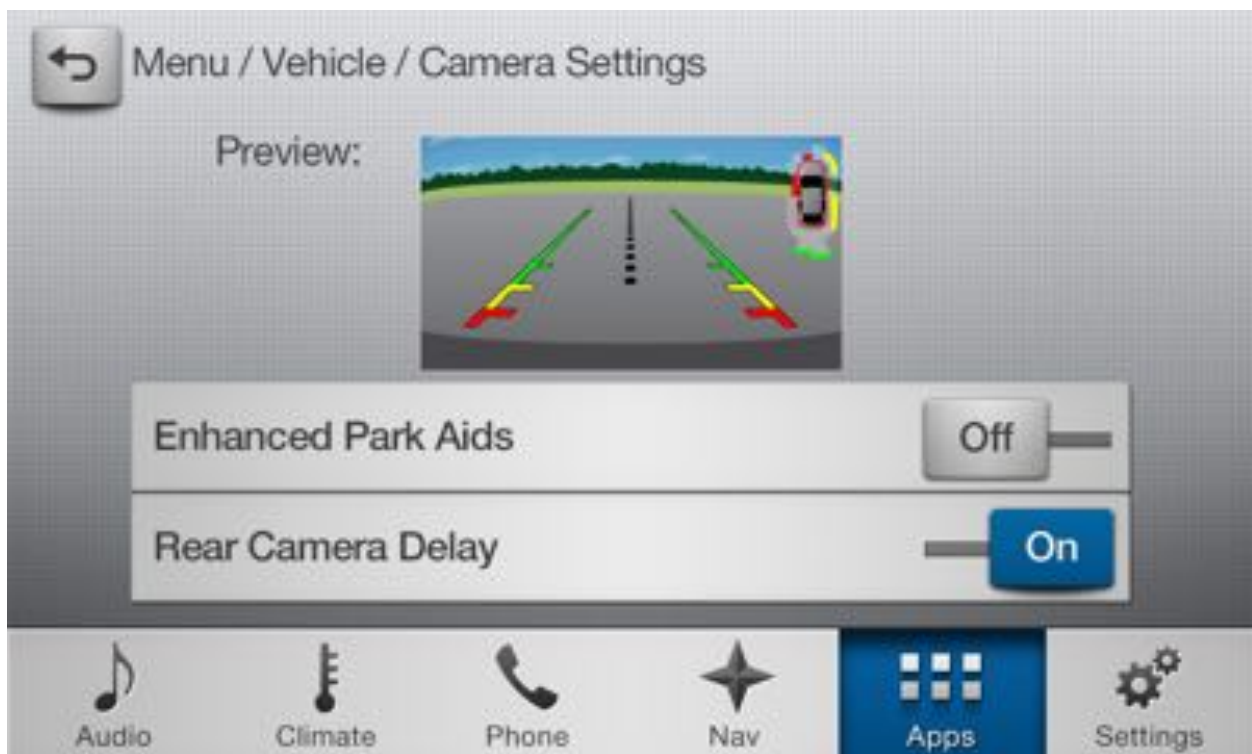

APA:

APA is a feature that assists in the user with finding an available parking spot and to maneuver into the spot by way of controlling the steering wheel. The driver is responsible for controlling gas and brake as well as shifting. Commands and warnings in the form of text will be presented on the HMI screen as well as different icons associated with the instruction – pull forward, back up, searching left, searching right, stop, and reverse.

CAMERA



POA:

POA assists the driver in pulling out of a tight parking spot. When the camera is used with the feature it looks and acts very similar to APA with two exceptions; 1) PDC can be active as well, 2) There are different icons – pull forward, back up, caution, finish, and stop. When the camera is not used or is unavailable the view will look like the below

CAMERA



Perpendicular Parking:

Perpendicular parking is a feature that will assist the driver in finding a suitable parking spot to backup into and will actually park the car for the driver. When camera is available the HMI will look similar to APA and POA with the following icons – pull forward, back up, caution, finish, stop, PDC, and steering wheel. When camera is not used or unavailable the HMI will look like the below.

CAMERA





CAMERA

Parallel Parking:

Parallel parking is a feature that assists the driver in finding a parking a parallel parking spot such as that next to a curb on a street and will actually park the vehicle for the driver. When camera is available the HMI will look similar to APA, POA, and Perpendicular Parking with the same icons as Perpendicular Parking. When camera is not used or unavailable the HMI will look like the below.



CAMERA



FVC:

FVC assists the driver in pulling the vehicle forward. It allows the driver to maneuver objects that they would normally not be able to see, as well as pull as close to an object as possible.

CAMERA



TBA:

TBA is a feature that helps the driver position the ball mount from the trailer hitch into the receptacle from the trailer. This feature also helps the driver to backup while the trailer is attached, as well as providing PDC.

CAMERA





CAMERA



Multi-Camera:

Multi-camera is a feature that enables the driver with multiple camera views, such as RVC, FVC, split RVC, and 360 degree view.

CAMERA

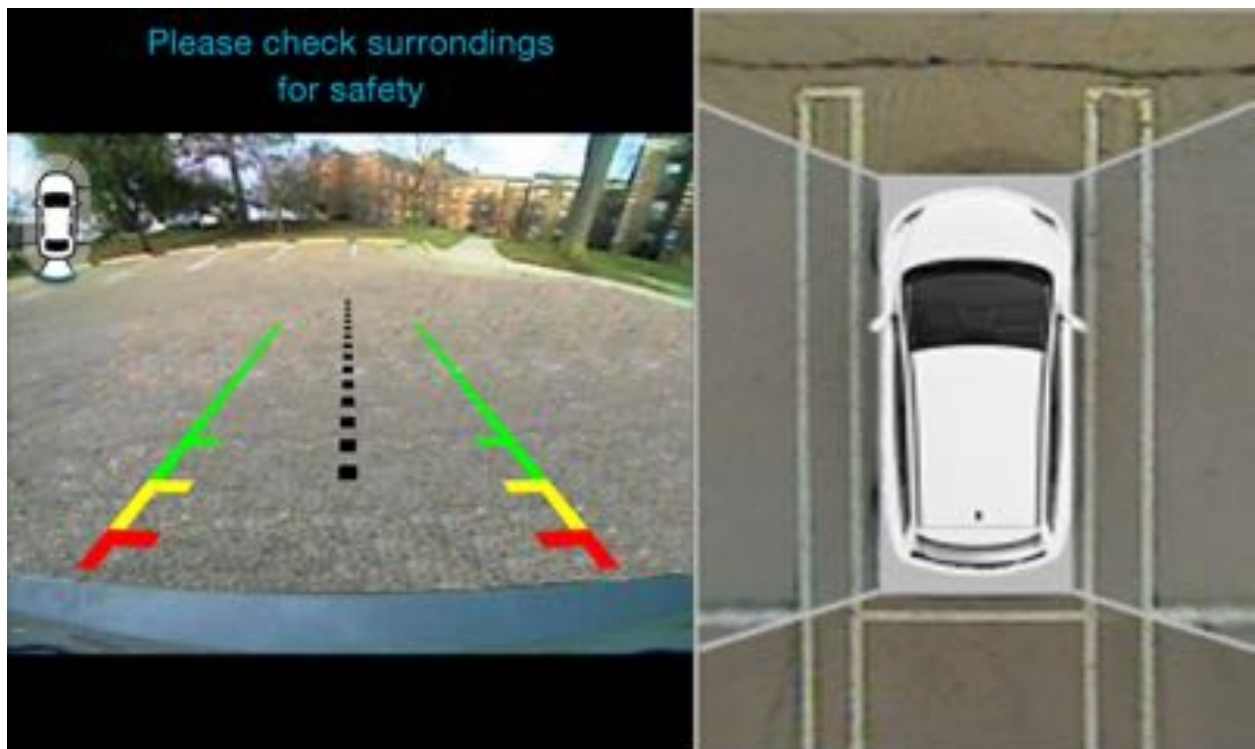

CLIMATE CONTROL

Brief description of Climate Control for North American Market.

The SYNC Gen3 Climate Control feature gives the customer access to all of the climate features, including rear climate, with the ease of touch control via the center stack. The user is able to adjust such things as driver and passenger temperature, A/C, fan speed, air outlet, heated & cooled seat intensity, heated steering wheel, front and rear defrost, and rear temp and fan speed.



CLIMATE CONTROL





CLIMATE CONTROL



Panasonic ideas for life

Panasonic Automotive Systems Company
of America
Division of Panasonic Corporation of North America

Clock is used to tell the user what time it is. The User will see the clock on the status bar.

Below: Clock is pictured in the status bar with a time of 12:07.

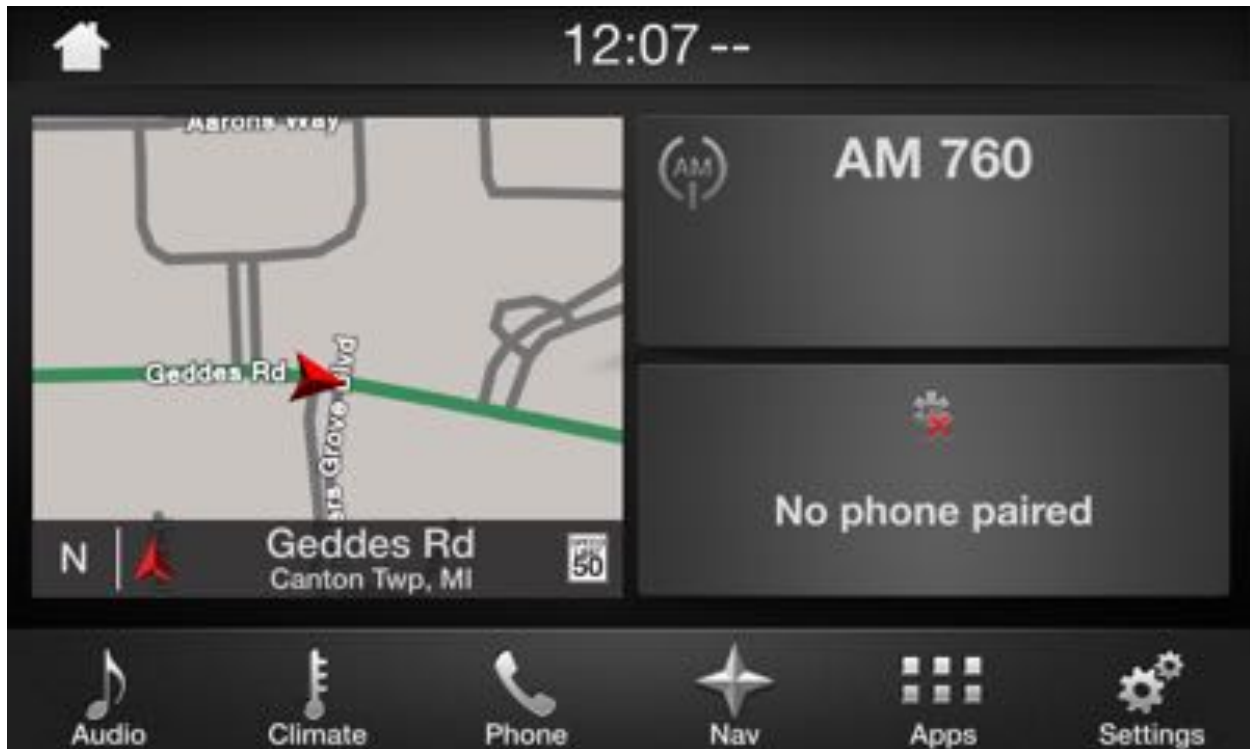

CLOCK

If the user presses the time displayed in the status bar they will see this:



From here the user can select 12 or 24 hour formats, select Auto time Zone update, select to sync the clock with GPS time (when satellite signal is available)

CLOCK

Notice the 'settings' status interface button is highlighted. The clock settings screen can be accessed from this area as well.

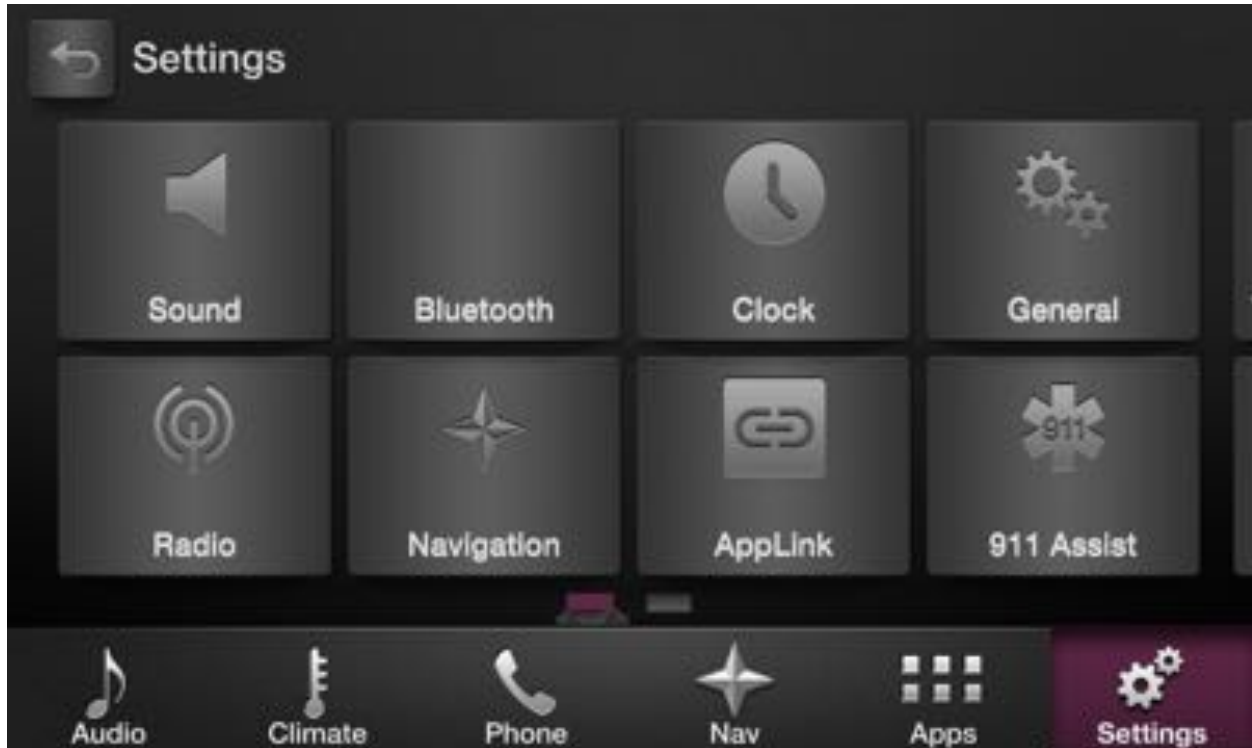

ELECTRIFICATION

Brief description of Electrification.

The SYNC Gen3 Electrification feature allows a user with a Hybrid Electric Vehicle (HEV), Battery Electric Vehicle (BEV) or at Plug-in Hybrid Electric Vehicle (PHEV) to set various parameters of how they would like their vehicle to charge while plugged in. This feature can be entered by pressing the Settings button, then pressing the EV tile button, and then selecting either Settings of Powerflow. The user can set different times, durations, intensities, as well as different start/stop times and seasonal conditions. The user can also view the Powerflow of electricity to see how they are using their battery life. Various HMI screens will look like the following:



ELECTRIFICATION

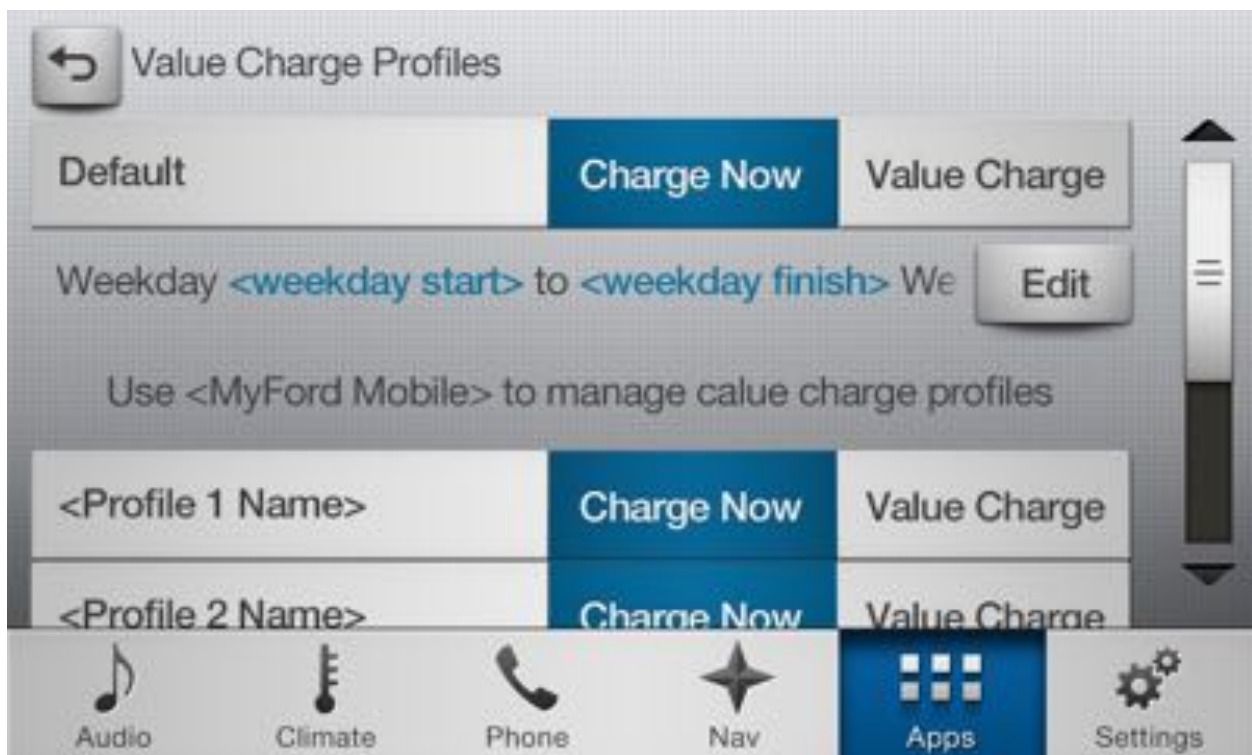

Panasonic ideas for life

Panasonic Automotive Systems Company
of America
Division of Panasonic Corporation of North America



ELECTRIFICATION

Panasonic ideas for life

Panasonic Automotive Systems Company
of America
Division of Panasonic Corporation of North America

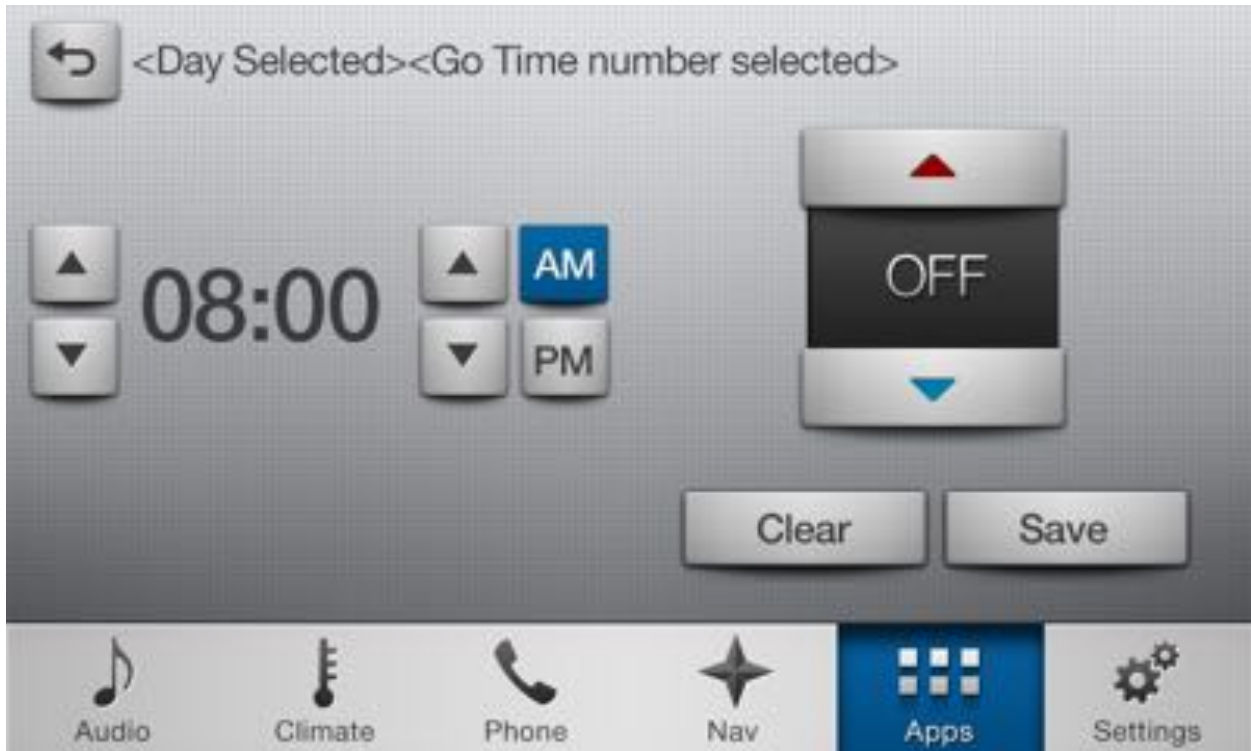

EMERGENCY ASSIST

Description of Emergency Assistance (EA) or 911 Assist® (for North America Market) Feature

The SYNC Global Emergency Assistance feature provides direct access to local emergency authorities or localized call centers in the case of a qualified vehicle accident (RCM message: airbags deployed and/or fuel-pump shut-off). The EA feature utilizes the driver's Bluetooth enabled device to place an emergency call (ie. 112, 999, 911, etc) to a local Public Safety Answering Point (PSAP). Before the emergency call is connected, SYNC delivers a message to the vehicle occupants in their set language that an emergency call is being placed. Once the emergency call is connected, SYNC provides an introduction audio message to the PSAP operator in the most appropriate language determined by SYNC. The PSAP audio messages will be rendered to the operator based on GPS location or information from the occupant's handset as appropriate. In some cases, GPS or handset information will not be required to determine the localized PSAP language but a pre-defined PSAP language will be used based on the country configuration of the module at end-of-line (EOL). After relaying details of the accident and your vehicle's location, EA will open the line so that occupants can speak directly with the PSAP. Once the PSAP call is complete, the occupant may choose to auto-dial previously enabled Emergency Contacts.

Global Emergency Assistance Block Diagram / System Architecture

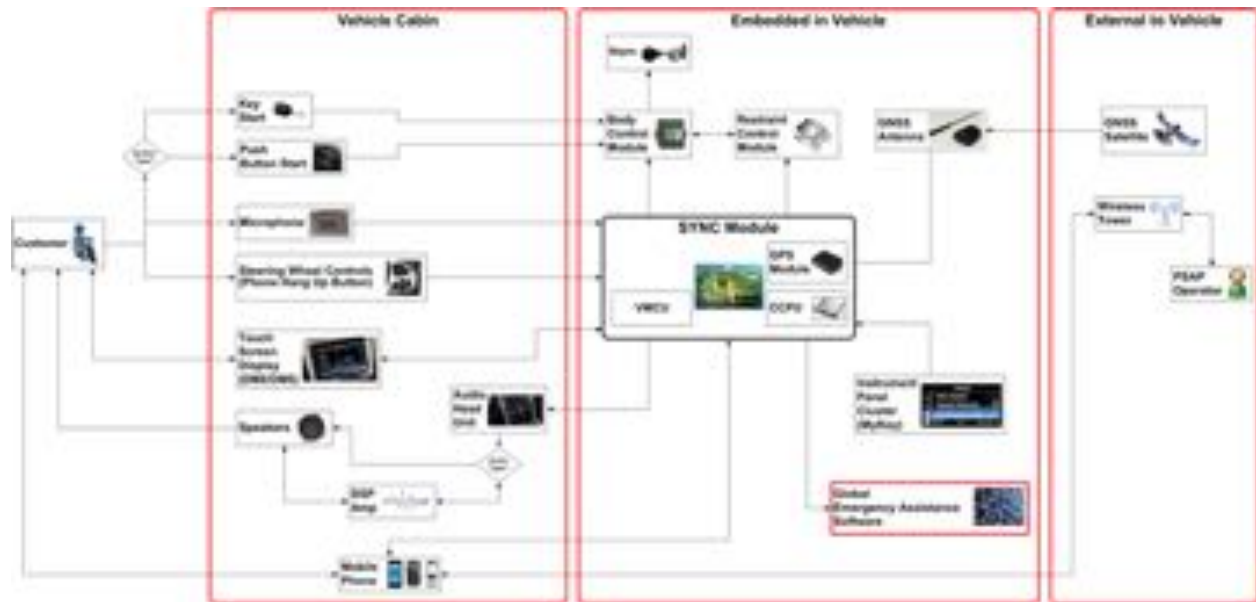

Directions to enable Emergency Assistance: (Reference Flows – H28c, H31a and H35)

911 Assist is set to Off by default, so you must initially enable the feature > After successfully pairing your mobile phone > SYNC will notify occupants that <Device name> was connected successfully > Pop-up will show [1] {Feature Name} ON/OFF > select ON > [2] state "Set as Primary Phone > select Yes > [3] state "Auto-Download Contacts" > select ON > Set and Select up to two Emergency Contacts (per phone)

Previous SYNC GEN Videos highlights EA functionality: <http://www.911assist.ford.com/USA/Overview>

MEDIA PLAYER

When a user connects their device, the inserted media device becomes the active audio source. The system begins to index the content on the device if inserted for the first time, and the system begins to play the now playing playlist of the media source.

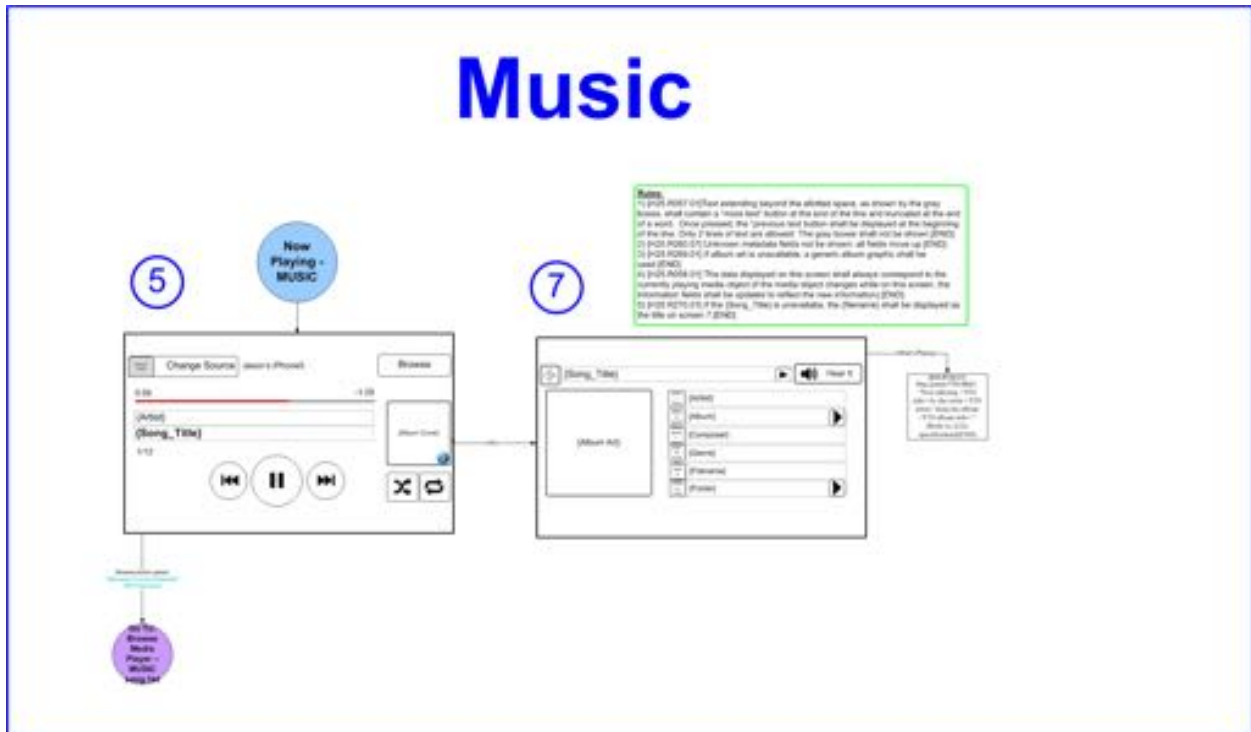

MEDIA PLAYER

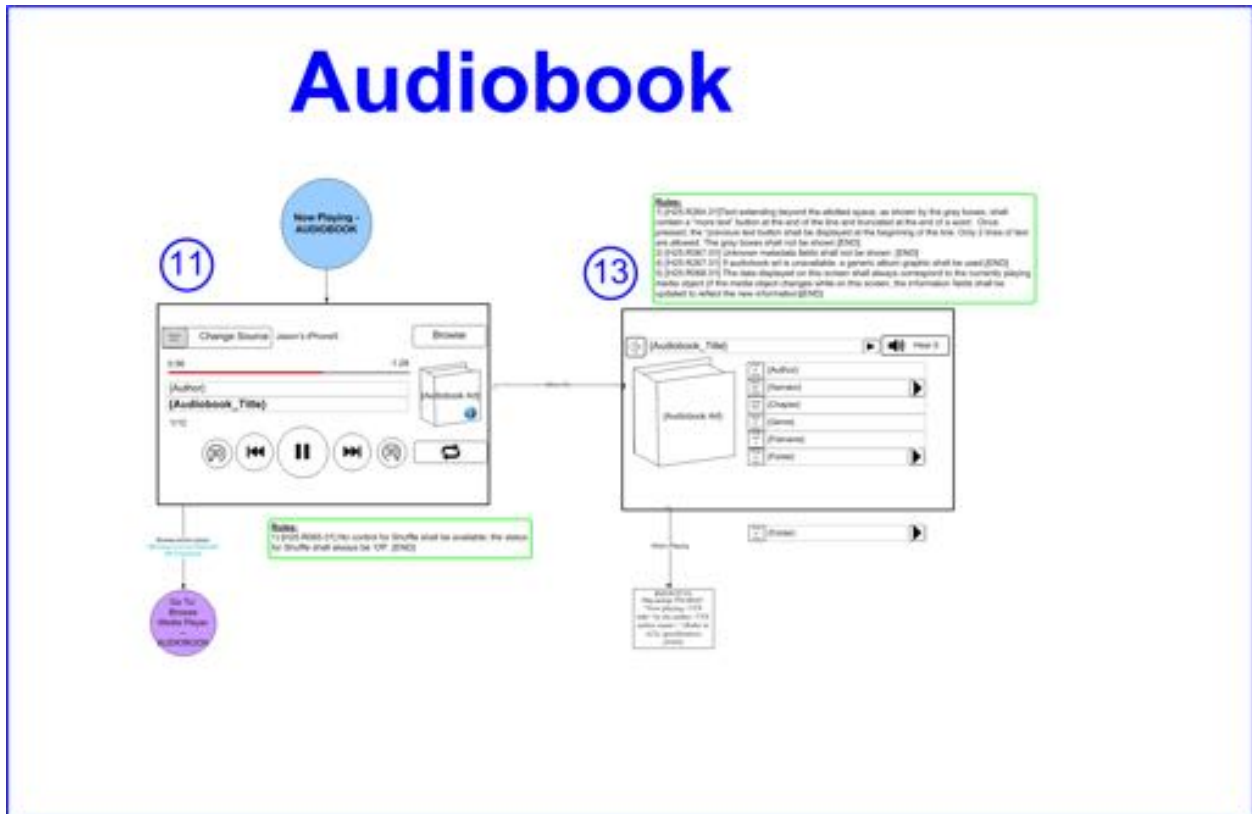

MEDIA PLAYER

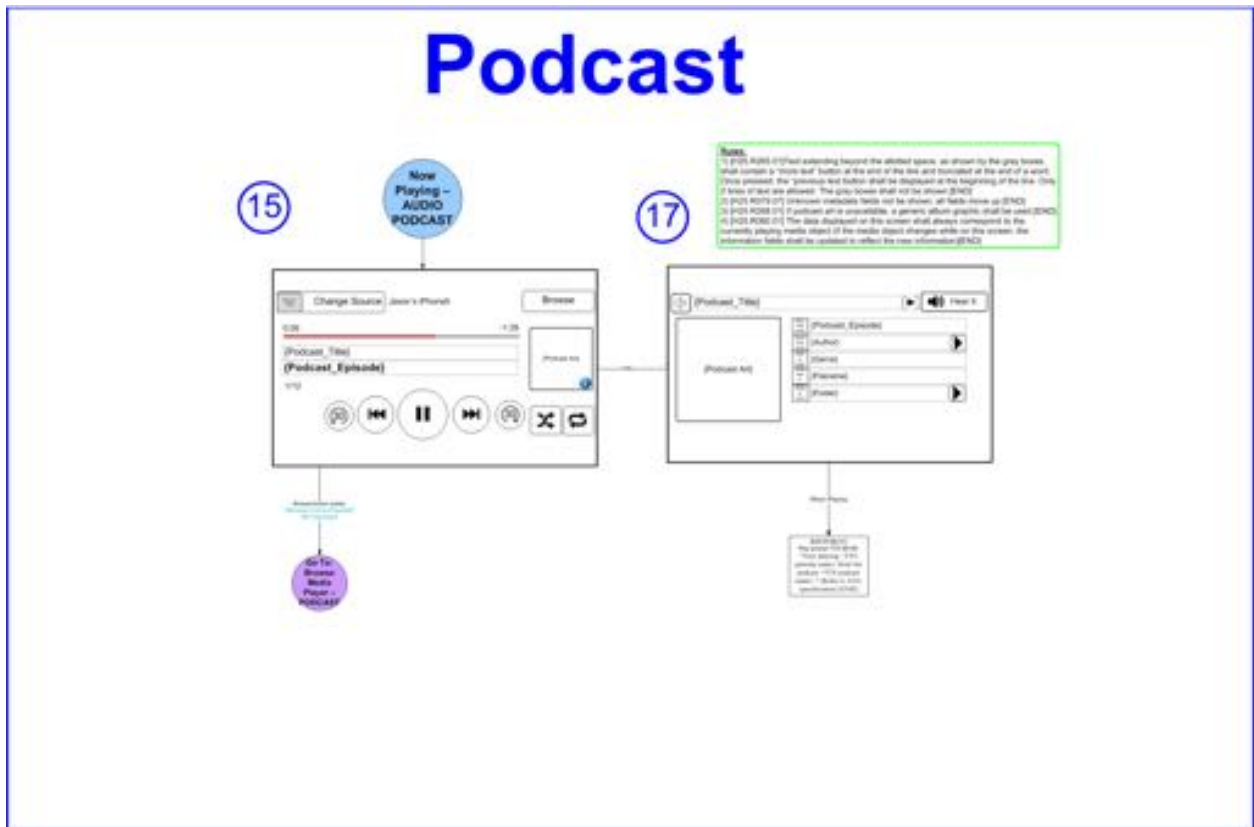

Selecting the “Browse” softkey allows the user to browse the connected device as shown below.



MESSAGE CENTER

Notifications include any set DTC's in the system.

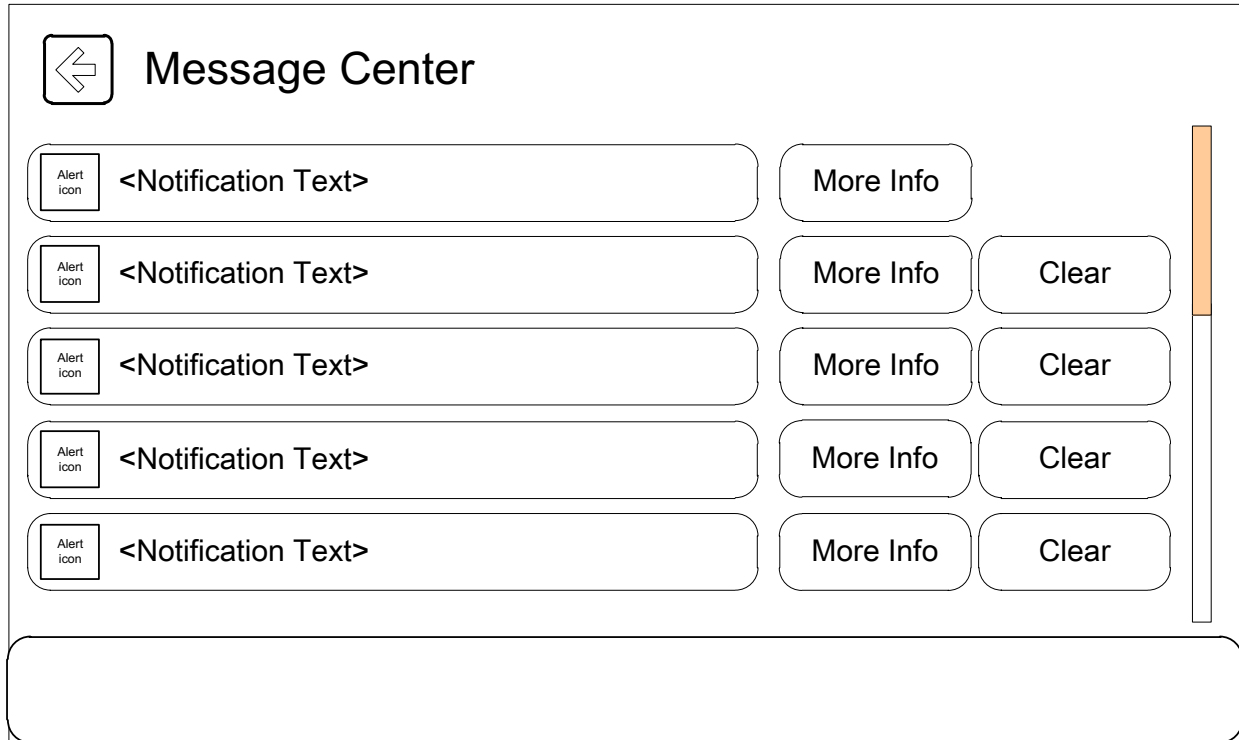

Some DTC's can be cleared, while others will remain present in the system.

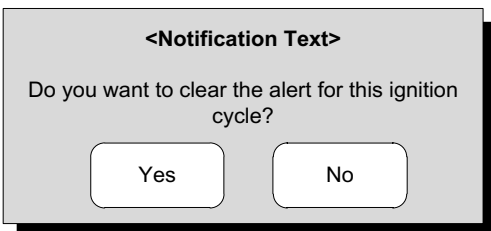
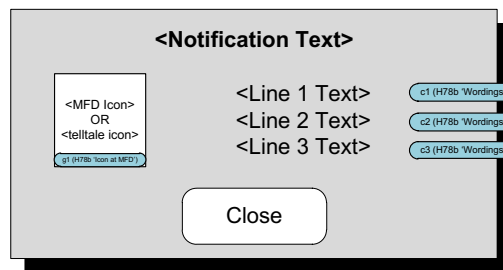
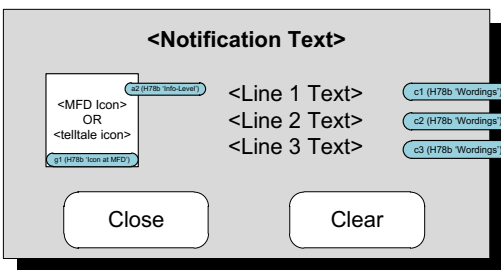

Notification Text available in **H78b_DM6_MasterMessageCenterList_Released**

MULTI CONTOURED SEATS

The Multi Contoured Seats Client shall remember Lumbar bladder fill percentages, and Bolster bladder fill percentages upon powering down of current key cycle. The Client will use these values during initialization of the next key cycle, until it receives an updated actual value from the Multi Contoured Seats Server.

This screen covers controls to adjust bladder pressures. There will be 5 ranges in the 11 bladder configuration, 4 ranges in the 9 bladder configuration, and 3 ranges in both the 3 bladder and 7 bladder configuration.

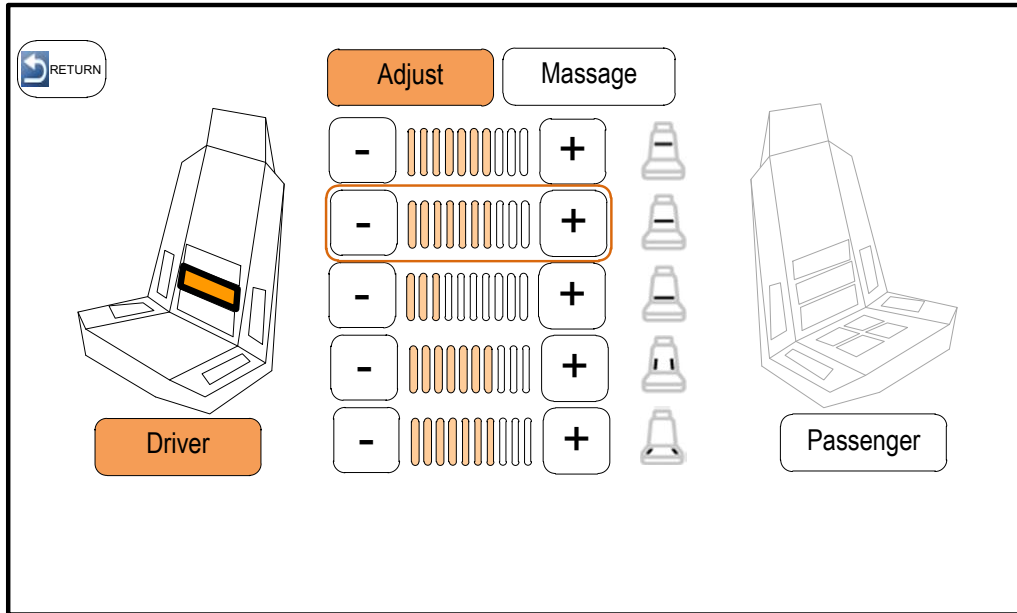

This screen covers controls to select massage intensity for leg and back massage.

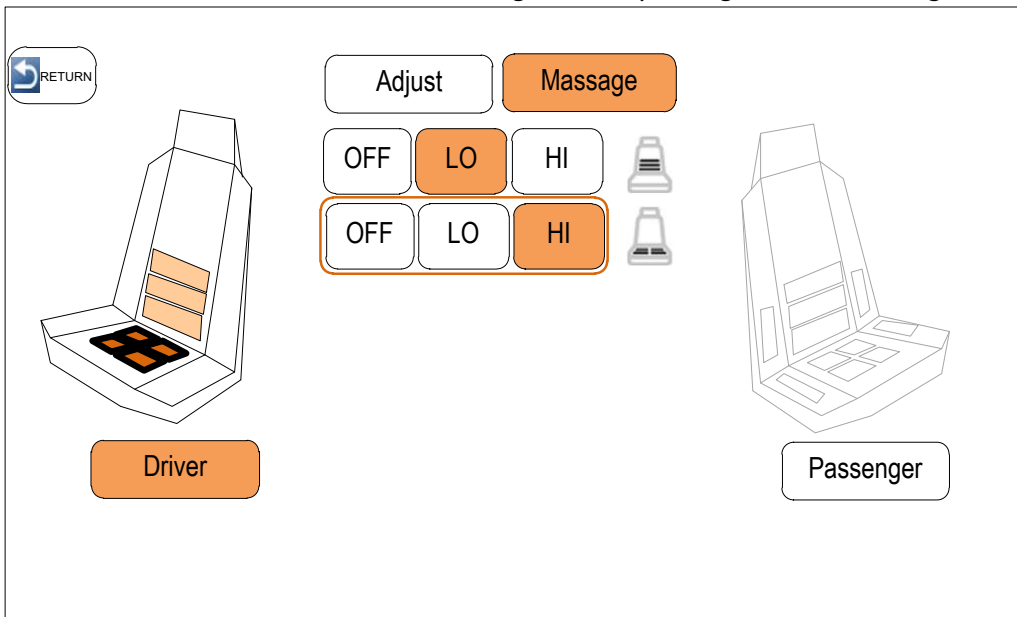

MYKEY

The APIM interfaces with the My Key Server and My Key Server2 to implement the My Key functions, Report Card, Volume Limit, Beltminder Audio Mute, Do Not Disturb and e911 Assist Override.

MyKey

MyKey Information		
Create MyKey		
911 Assist	Selectable ▼	
Emergency Assistance	Selectable ▼	
Do Not Disturb	Selectable ▼	
Traction Control	Selectable ▼	

Status/Interaction

Traction Control	Selectable ▼	
Speed Limit	No Limit ▼	
Speed Minder	None ▼	
Volume Limit	No Limit ▼	
Clear All MyKeys		

911 Assist, Emergency Assistance, Do Not Disturb, Traction Control. When available, can be toggled between:

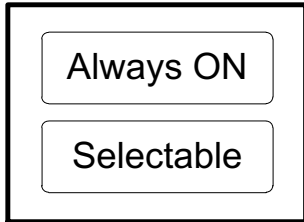

MYKEY

Speed Limit

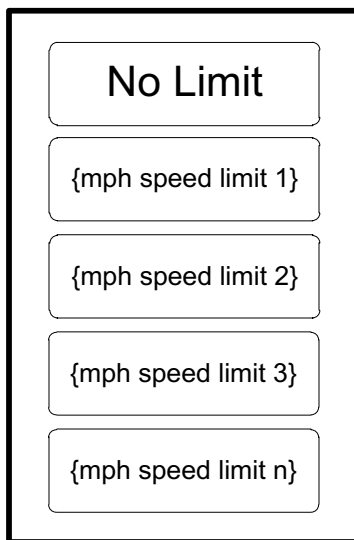

or

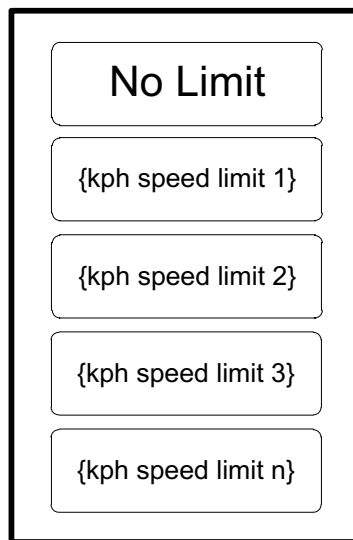

Speed Minder

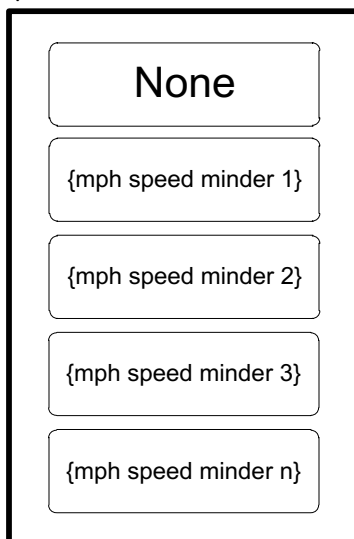

or

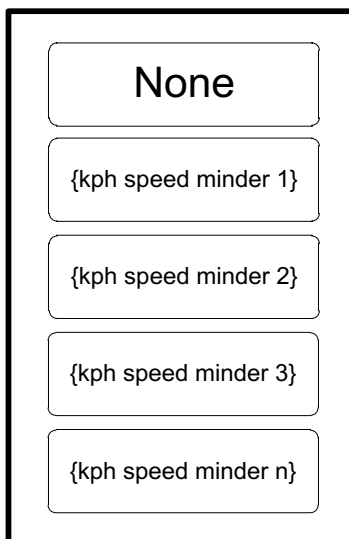

MYKEY

My Keys can be cleared:

Are you sure you want to clear
all MyKeys for this vehicle?

Yes

No

Successfully cleared all MyKeys.

Close

MYKEY

My Keys can be created:

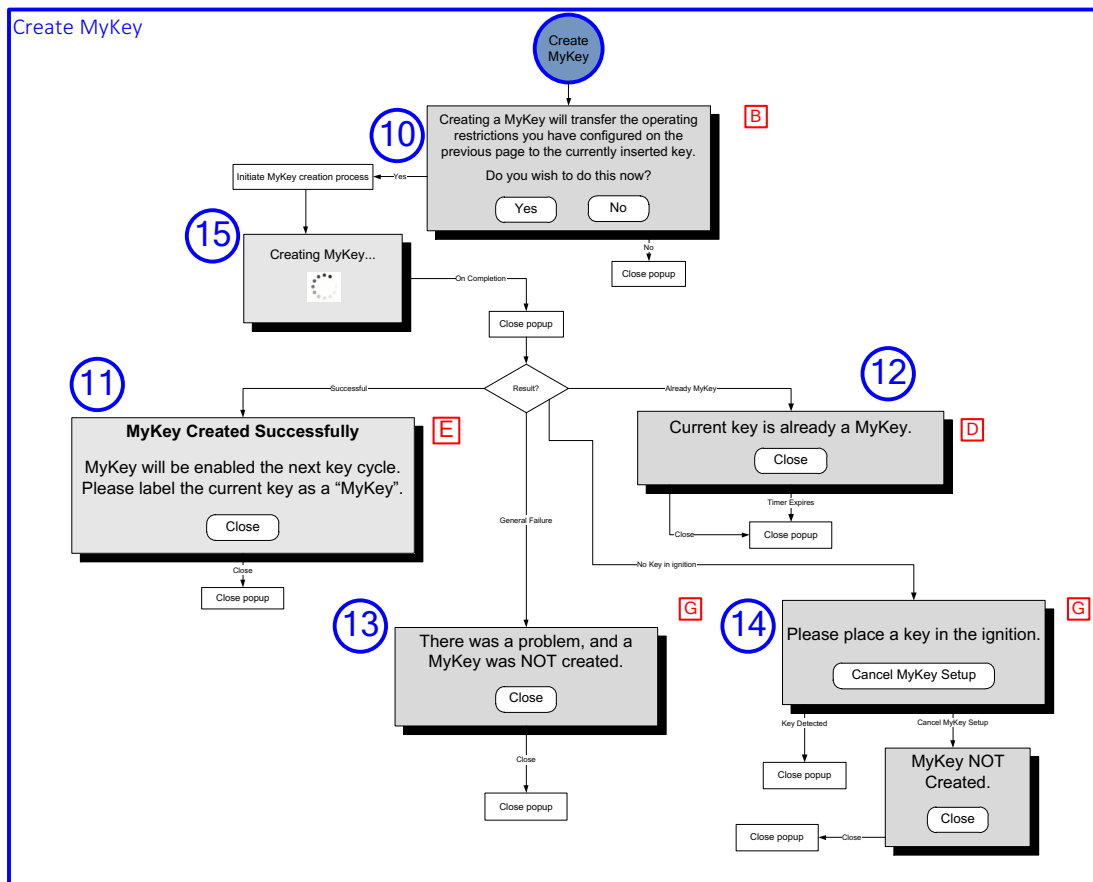

MyKey info



or



NAVIGATION

Navigation provides information about the surroundings to make driving easier including 'turn by turn navigation'. It is available on the left hand side of the home screen and has a status interface button titled 'Nav'

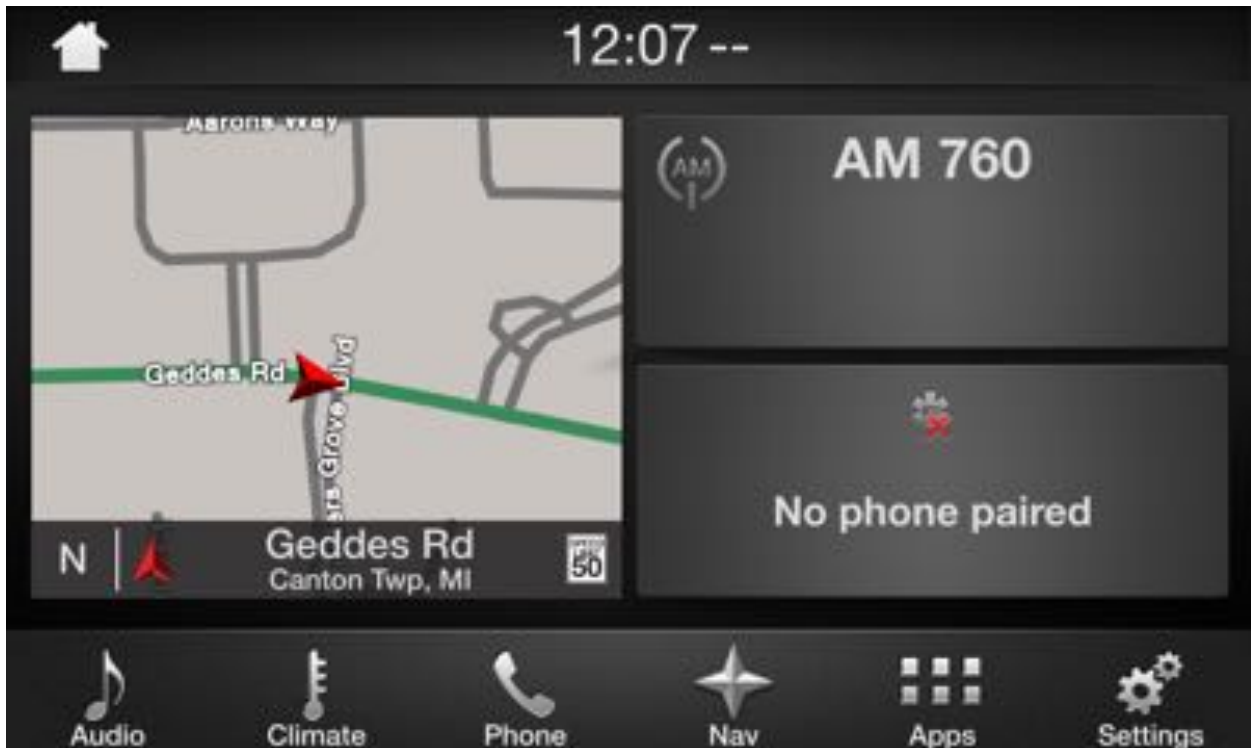

NAVIGATION

When either is pressed the user is taken to the nav home screen:



NAVIGATION

From here if the user selects 'Destination' the user sees the below screen. The user can see a list of previous destinations, set an address as Work or Home or select other locations as favorites. Address are found and added to the system using the 'One Box' search feature titled 'Search' on this screen. There is also a list of common 'Points of Interest' (POI) categories such as 'food' and 'Fuel'.

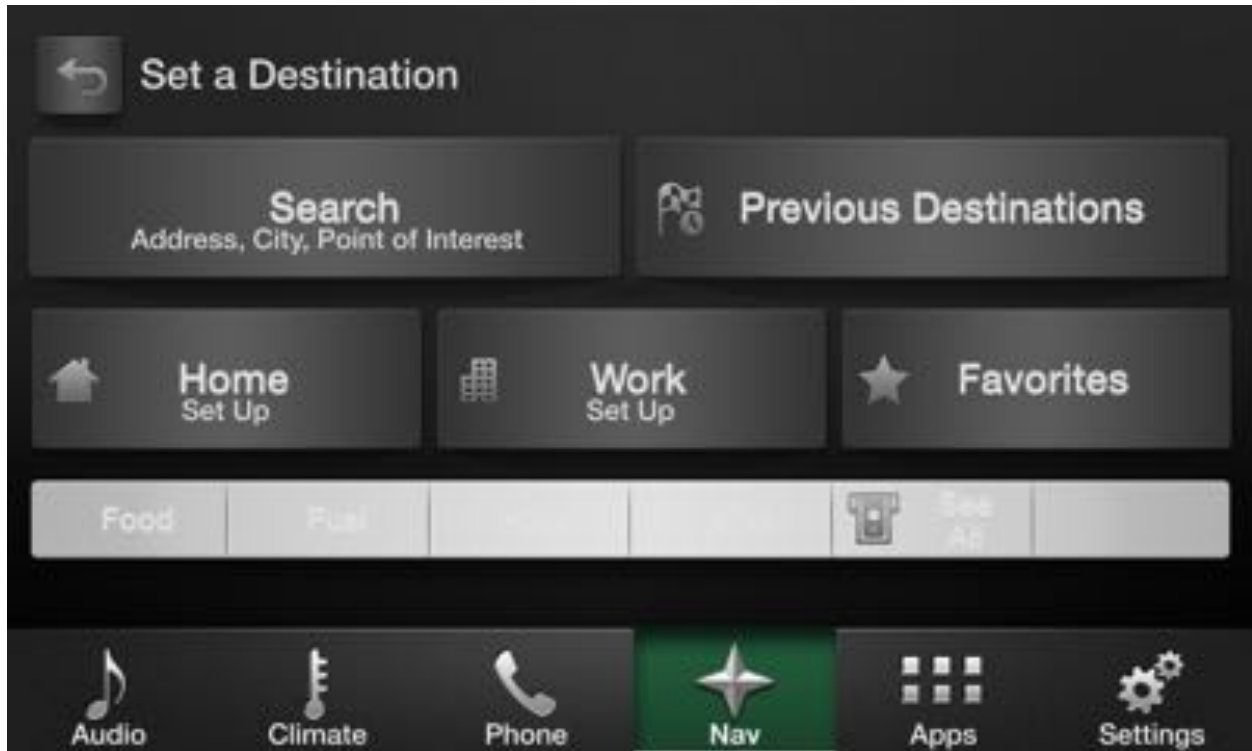

NAVIGATION

The 'One Box' search screen looks like this:



Panasonic ideas for life

Panasonic Automotive Systems Company
of America
Division of Panasonic Corporation of North America

When the user begins to type the examples in the above image are replaced with predictive text, which can be selected rather than finishing the text entry:



NAVIGATION

Regardless of which entry method is ultimately selected the user will be informed a search is in progress followed by a list detailing any findings:



NAVIGATION

If the user selects an item from the list they will be presented with a informational screen that includes the location on a map, address (where applicable), and the ability to start turn by turn navigation to that location.

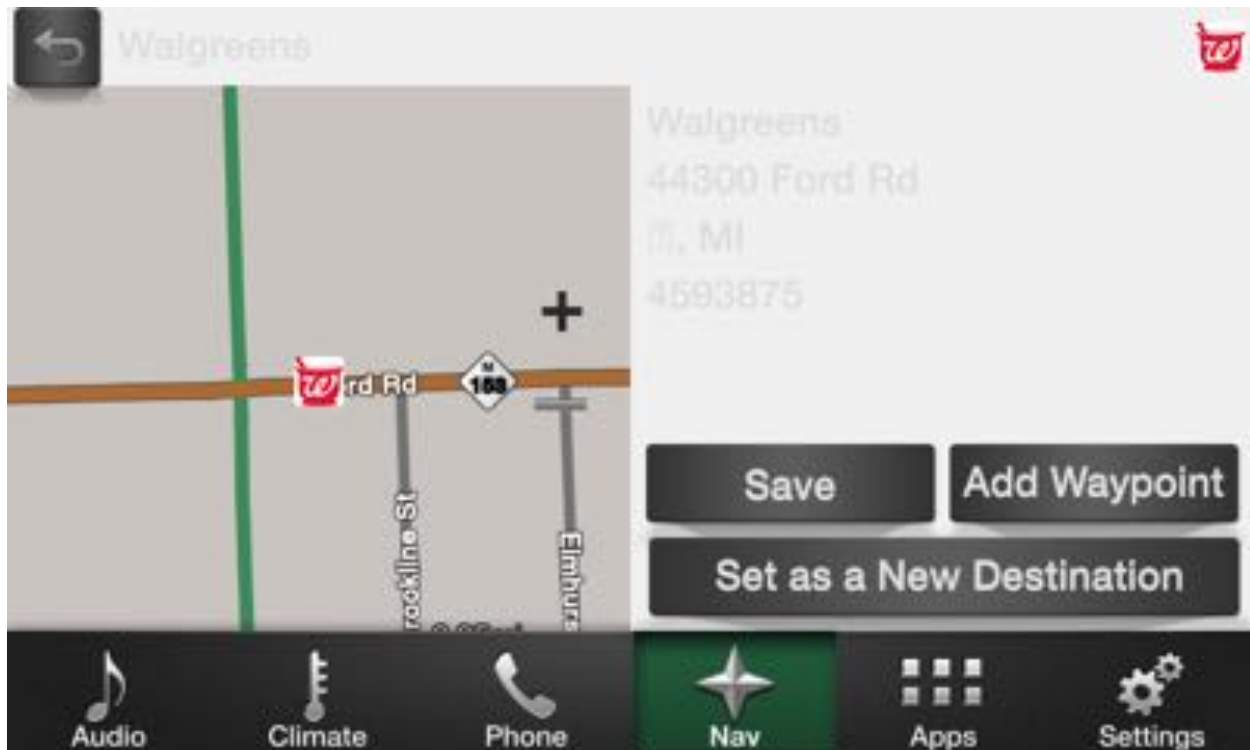

NAVIGATION

In the picture below 'Fastest' is selected but 'shortest' and 'Economical' routes are also options (if configured in settings). The user can cancel a route from here or press 'Go'. If the user holds 'Go' for 10 seconds a simulation will begin from vehicle location to the final destination complete with 'Turn by Turn' voice (if configured in settings).

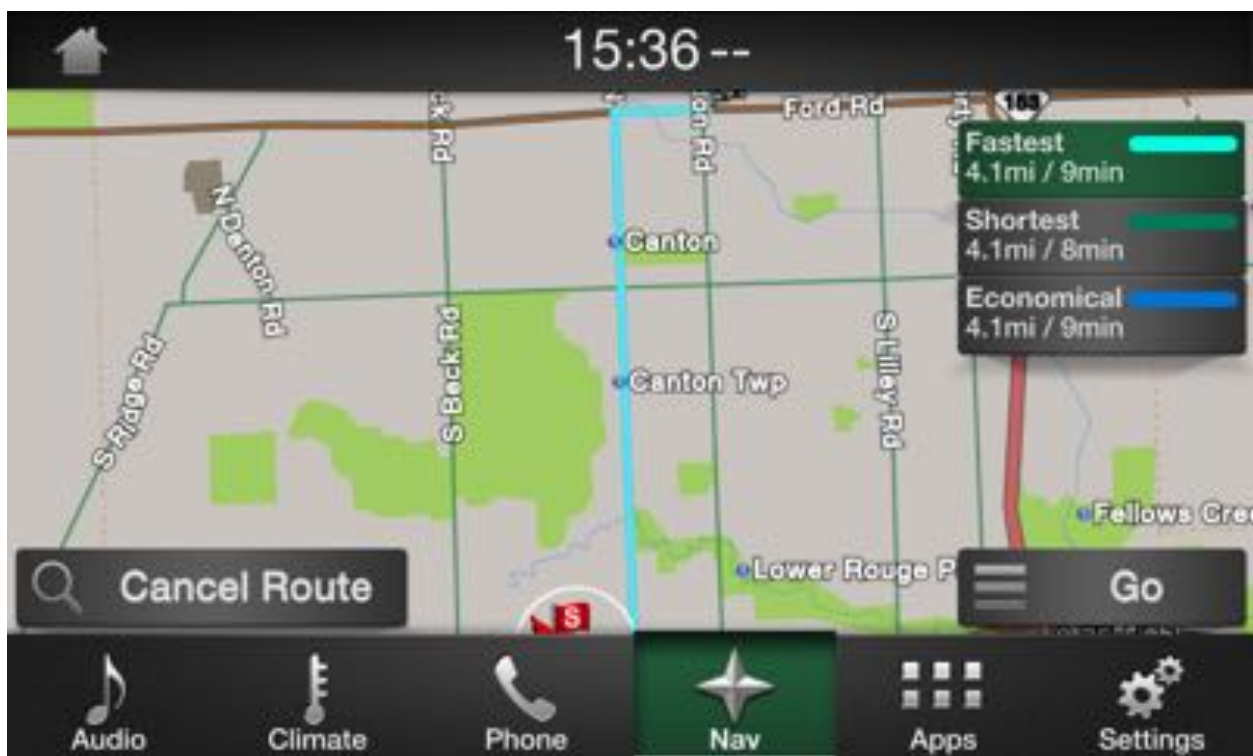

NAVIGATION

There is also a menu button on the main nav screen that if pressed shows the following user options.



POWER MANAGEMENT

The CCPU power modes are implemented by the SYNC BSP. The CCPU power manager acts as a slave to the VMCU; that is, all power mode transitions are commanded by the VMCU. Upon system power on, the VMCU will come out of reset and enable the on-board and CAN power supplies. The VMCU will then enable the CCPU main voltage rail to bring up the CCPU subsystem.

The system power is implemented via a combination of VMCU actions, CCPU power modes, and SYNC application specific behavior.

CCPU Power Mode	Description	Applicable	SYNC Function
Unpowered	No power applied to system	Unpowered	N/A
Wait-On	Minimal CPU peripherals are powered, CPU is running (transitional state only)	N/A	N/A
Infotainment	SYNC is fully operational, Infotainment components are ON	1. MMActive/ Extended Play Mode (turn power on when IGN is off and Delay ACC is off) 2. Phone Mode	1a. HMI active 1b. Audio available 1c. Infotainment features normal operation (i.e. AM/FM, SDARS/DAB, CD, VR, Bluetooth Phone, APIM, BT Audio, Prompts, USB, iPod...) 2a. Phone call active through audio system. 3. Emergency Call (911)
DisplayOnly	SYNC is partially operational, display/HMI available, Infotainment components are OFF	1. 10-Minute Clock Mode (IGN off + Door open) 2. MMInactive	“Welcome/Farewell” Screen Transport Mode CD Load/Eject with ignition off Load Shed notification Infotainment audio sources inactive Non-Infotainment Standby Features can be supported (i.e. Chimes, Climate Control)
VHM (Vehicle Health Monitor)	SYNC is partially operational, display/HMI unavailable, Infotainment components are OFF	MMInactive	Background tasks
Wait-Shutdown	CCPU is running, but transitioning to Unpowered	N/A	N/A

	mode. E-Shutdown process is started		
--	-------------------------------------	--	--

RADIO

Radio features allow the user interact with the AM, FM, FM HD, Sirius radio bands. The Accessory Protocol Interface Module (APIM) does NOT have antennas for receiving these signals or process them. Those functions are performed by the Audio Head Unit (AHU). The User will see the selected radio band on the home screen (if one is selected).

Below: the AM band is shown on the home screen.

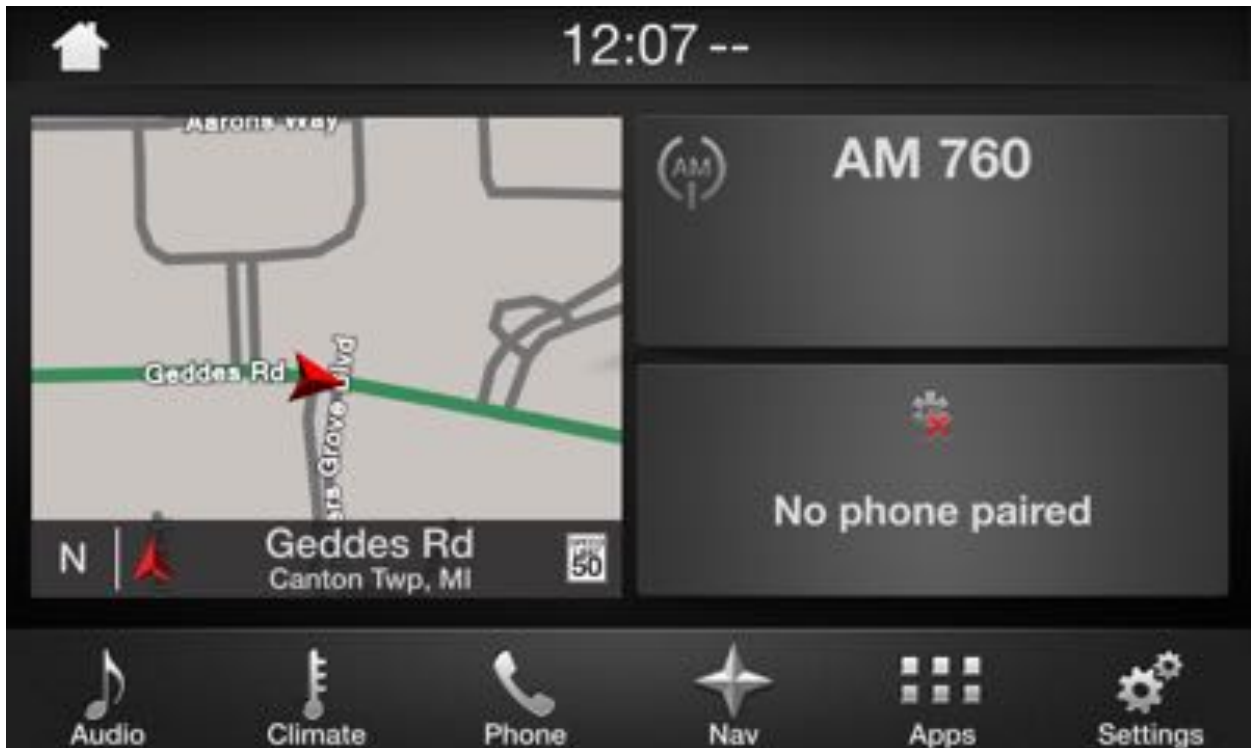

RADIO

If the user presses 'Audio' status button or the radio portion of the home screen they will see this:

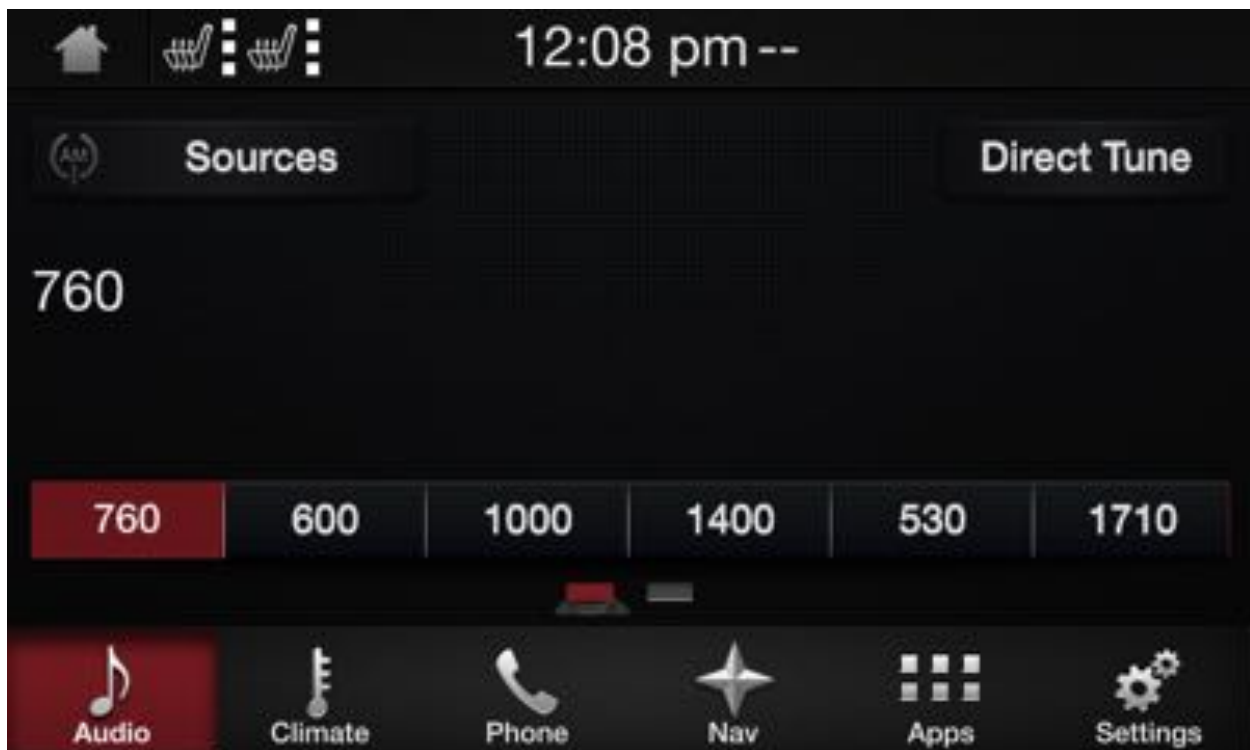

Presets are displayed on this screen in banks of 6. The user may swipe the preset bank to advance to the next preset bank. The rectangle below the preset bank indicates which bank is selected. First AM bank is selected in the picture above.

To set a preset, direct tune to a station or use hardware seek or tune buttons then press and hold the preset bank item that you wish to have this information until it is so.

RADIO

If the user presses 'Direct Tune' they can enter any valid station in the band and press enter to go there.



RADIO

If the user presses 'Sources' they will see options available with that APIM configuration:



RADIO

If the user selects FM any HD or Radio Data System (RDS) information will be displayed:



RADIO

This information is also displayed on the home screen:



Panasonic
ideas for life

**Panasonic Automotive Systems Company
of America**
Division of Panasonic Corporation of North America

RADIO

Similarly Sirius Radio information will be displayed including channel art.

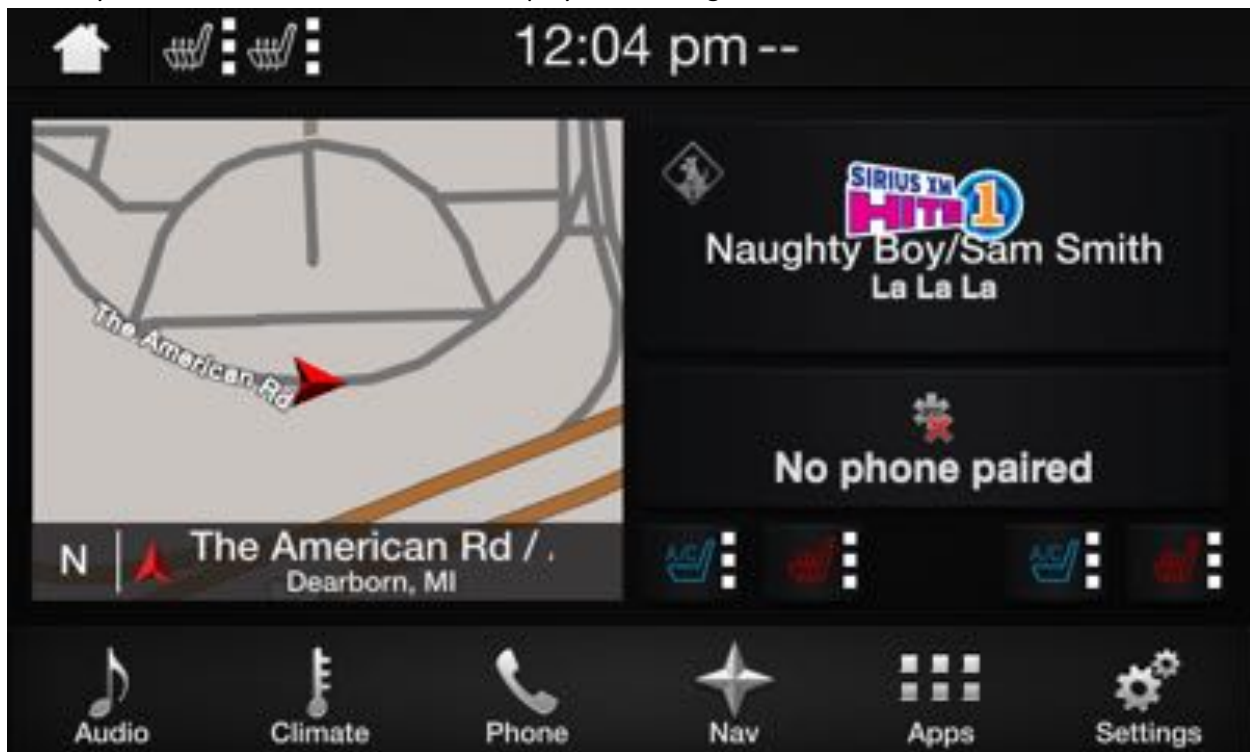

Note: Sirius must be subscribed and configured properly in the DEXX configuration block for this to be displayed and work.

RADIO

If the user presses the 'Settings' status interface button there is radio settings but this is covered in another document.

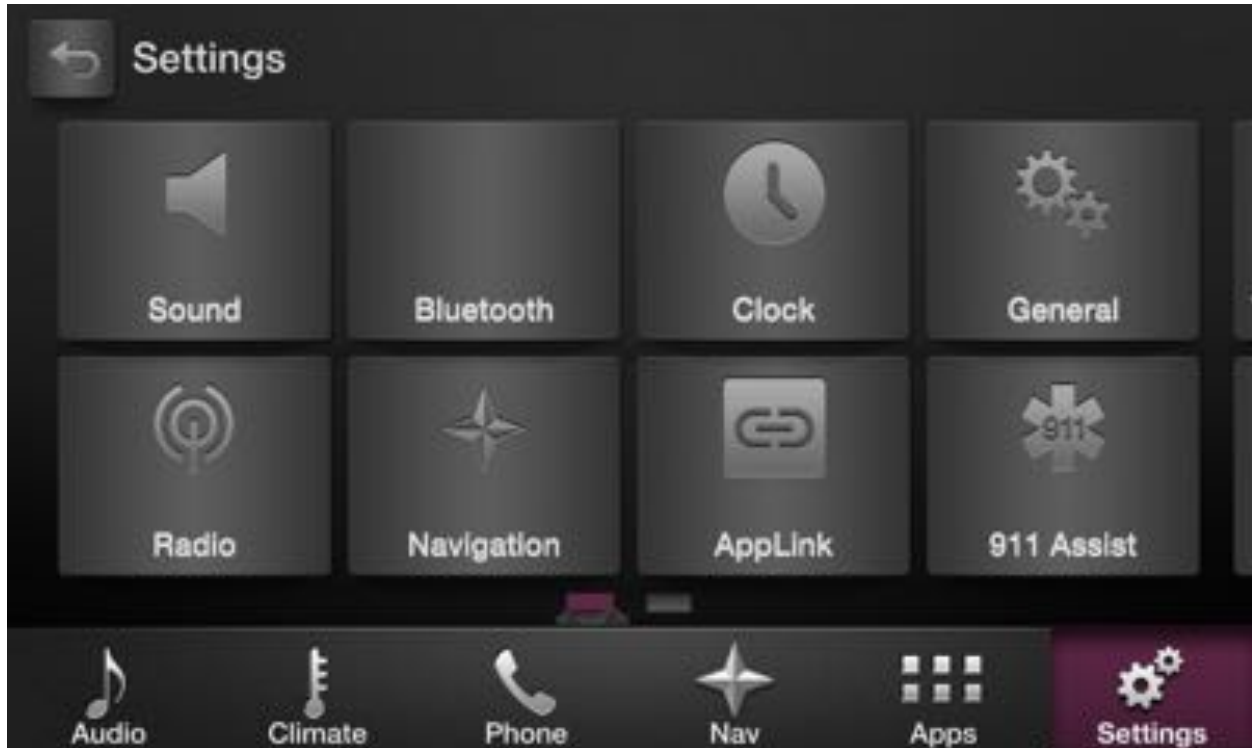

Settings

After the “Settings” button at the lower right corner of the touchscreen is pressed:

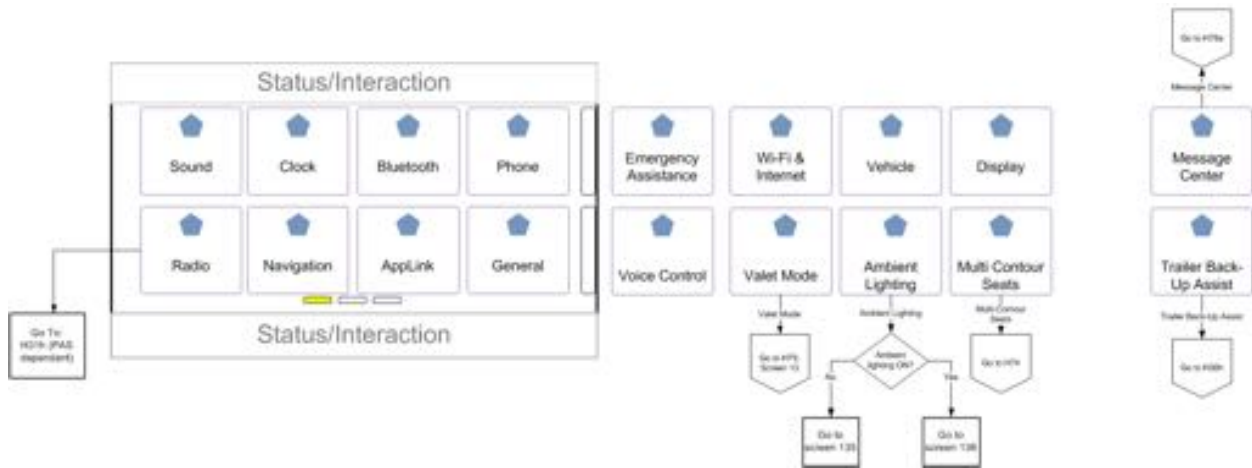

Phone list item only shown when a phone is paired and connected.

The button label for “Radio” shall be variable, dependent on the primary audio source (PAS):

- If PAS=AM/FM/DAB: It should read “Radio”
- If PAS=Sirius: “Sirius”
- If PAS=CD/CD-MP3 & WMA: No button
- If PAS=Bluetooth Non-AVRCP A2DP Device or Bluetooth AVRCP 1.0 A2DP Device: No Button Shown
- If PAS=Line In or A/V In: No Button Shown
- If PAS=Media Player (Music, Podcast, Audiobook, Bluetooth AVRCP 1.3+ Music, Bluetooth AVRCP 1.3+ Podcast, Bluetooth AVRCP 1.3+ Audiobook): “Media Player”

The button shown labeled “Radio” above should be disabled in while in a phone call

The button shown as “Emergency Assist” above:

- The feature name (Emergency Assitance vs. 911 Assist) is market dependent.
- If a phone is not paired and connected, this line item is not shown.

TRAVEL LINK

Travel Link is used to tell the user local fuel prices, movie listings, sports info, weather, and Ski conditions. The User can access Travel Link by the 'Apps' status interface button:

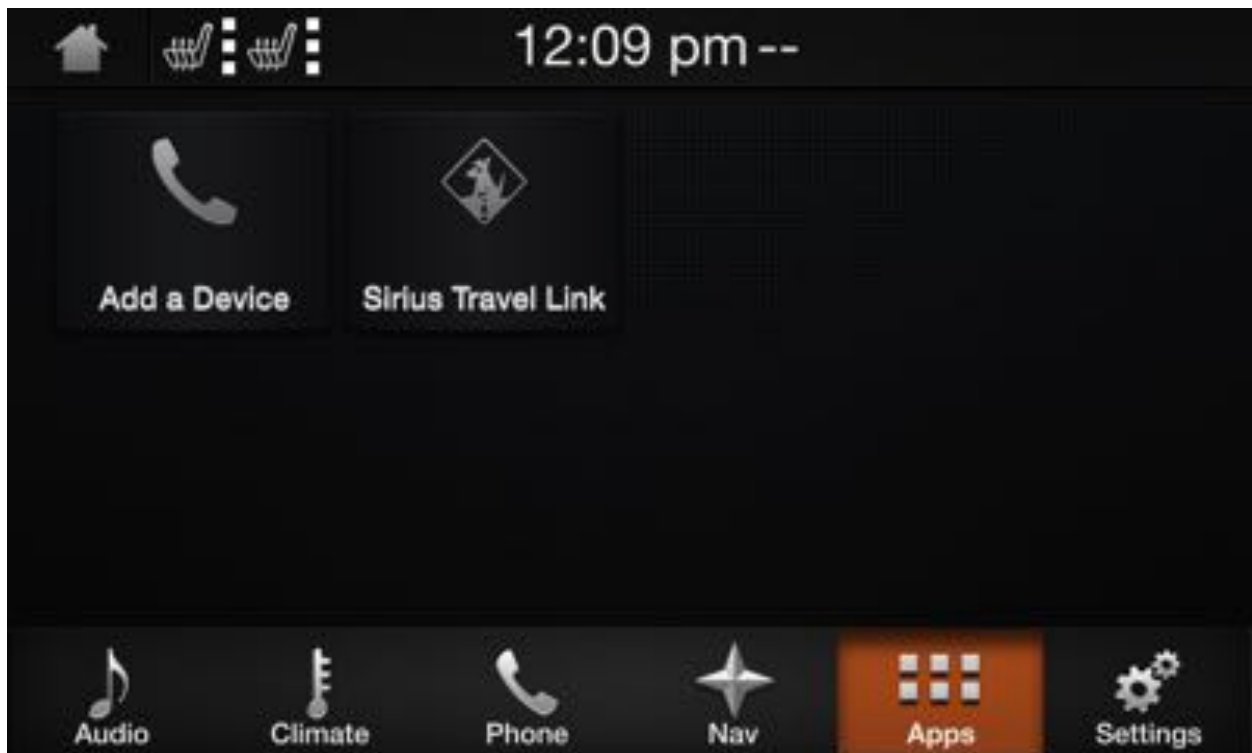

TRAVEL LINK

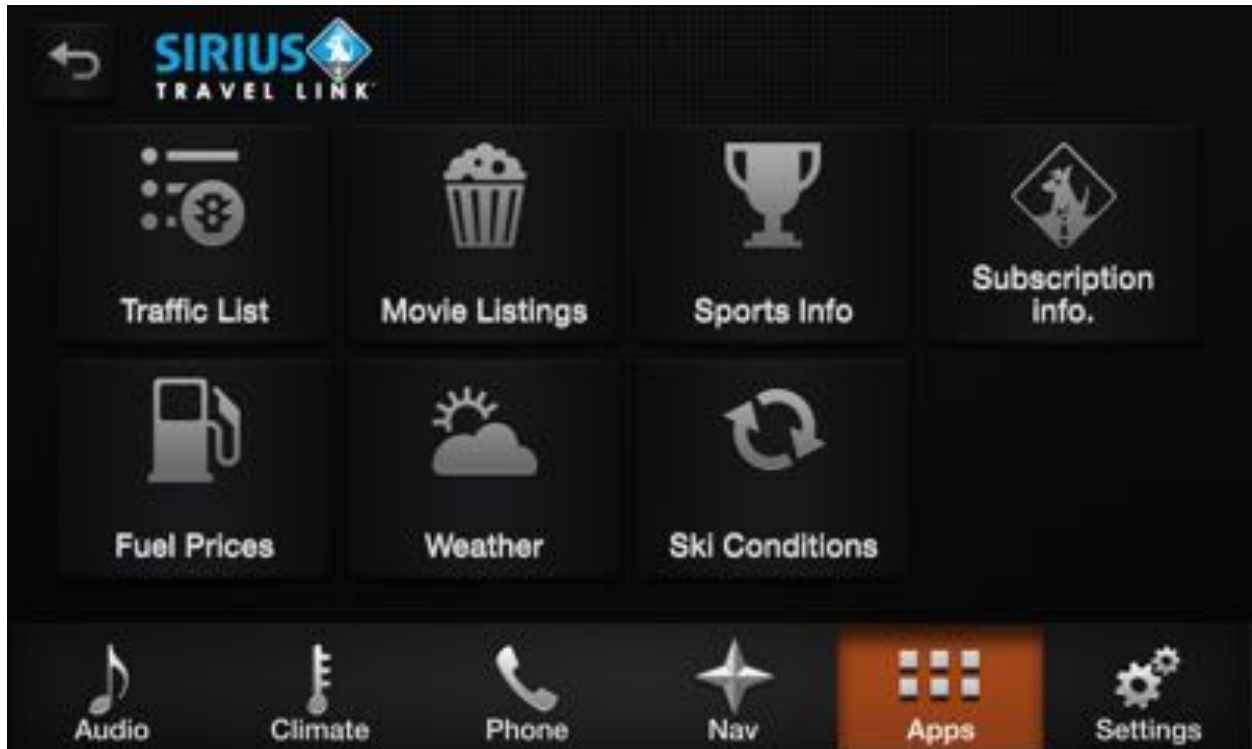

If the user presses 'traffic list' they will see traffic incidents close by.

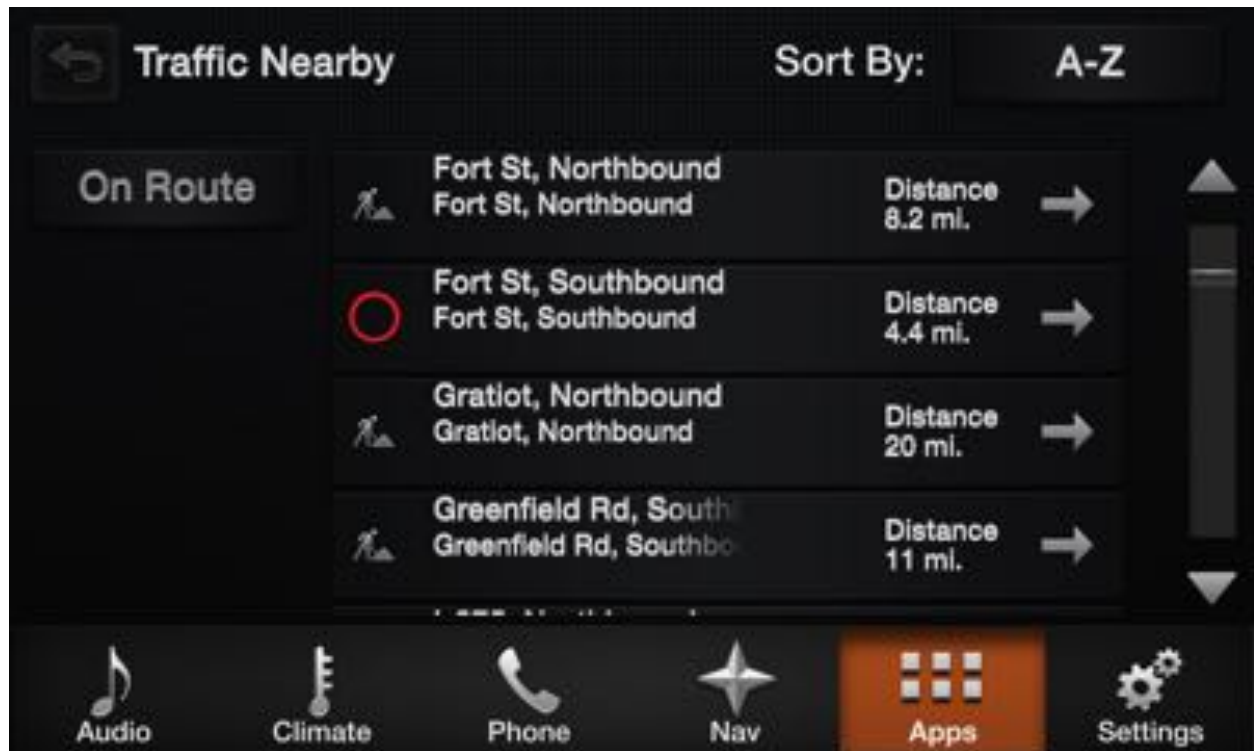

TRAVEL LINK

If the user presses Sports they have further selection options for the league.

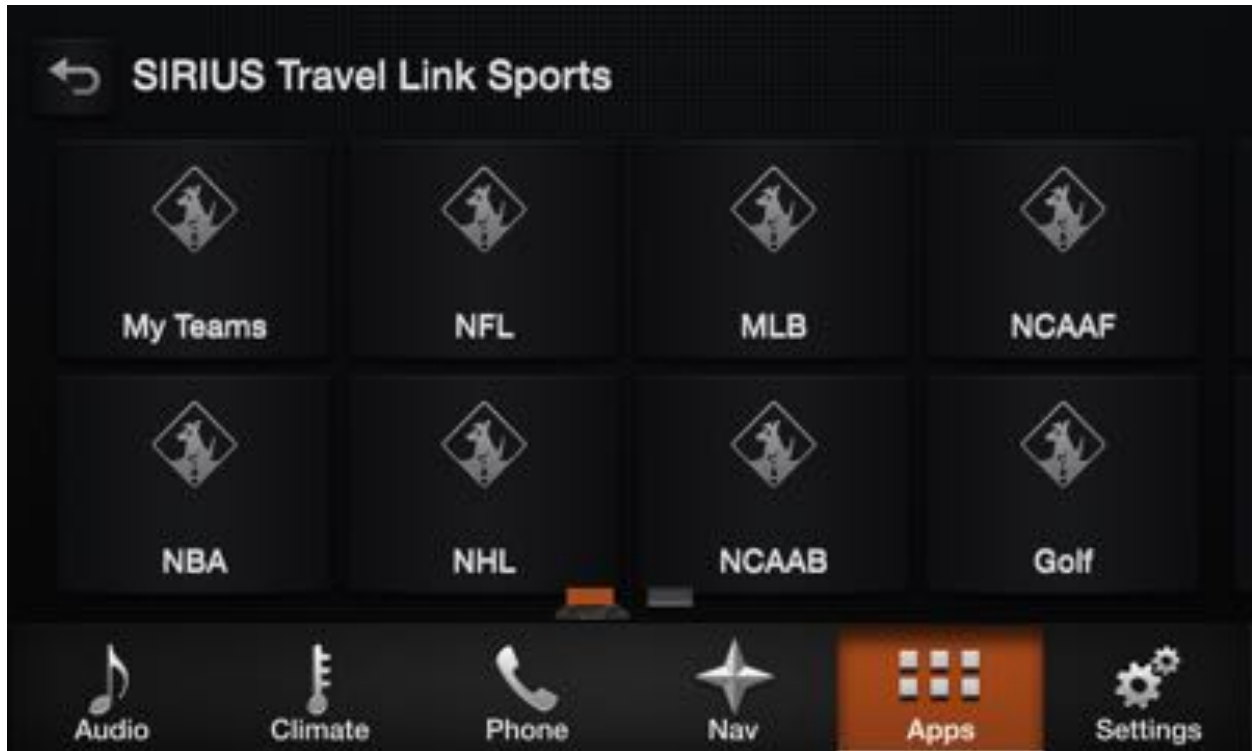

Panasonic ideas for life

Panasonic Automotive Systems Company
of America
Division of Panasonic Corporation of North America

If the user presses 'Weather'



If the user presses 'Movie Listings'

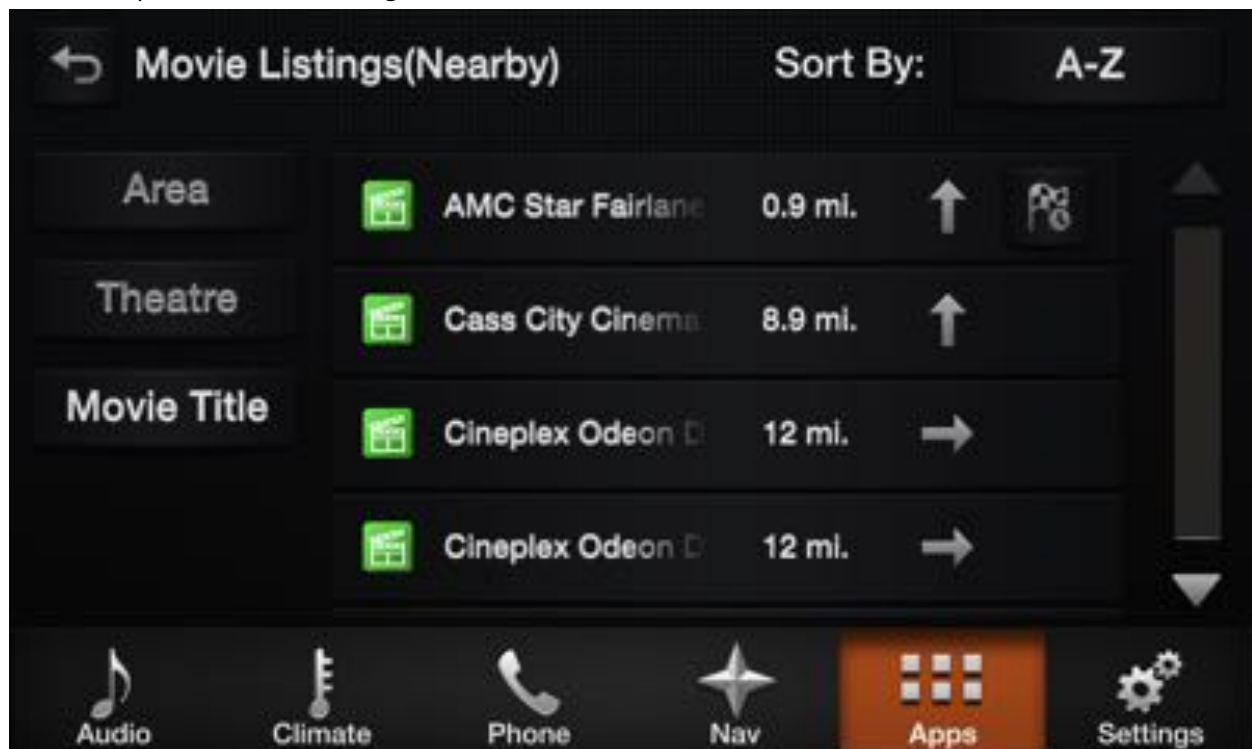

TRAVEL LINK

If the user selects a theater from the list of entries, the user is shown the location of this theater on a map. If desired this can be set as a navigation destination or a favorite:

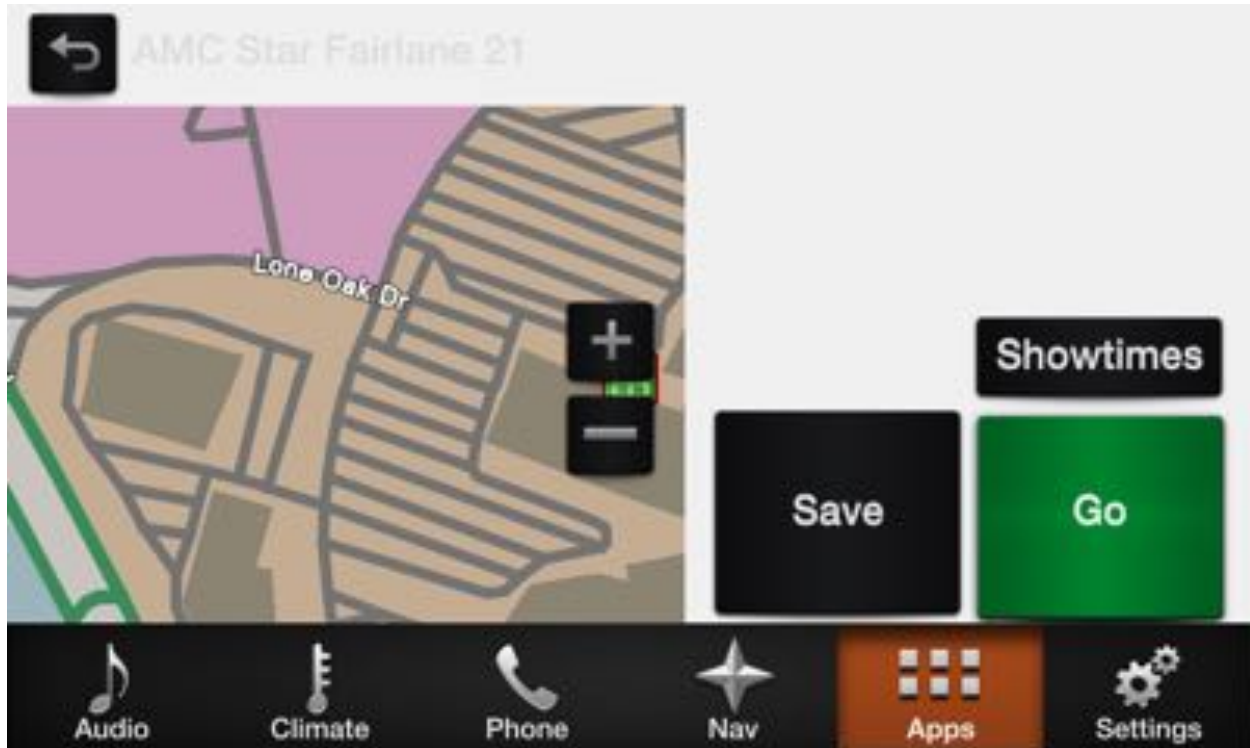

Other features not listed here explicitly work similarly.



Note: Sirius Travel Link must be subscribed and configured properly in the DEXX configuration block for this to be displayed and work.

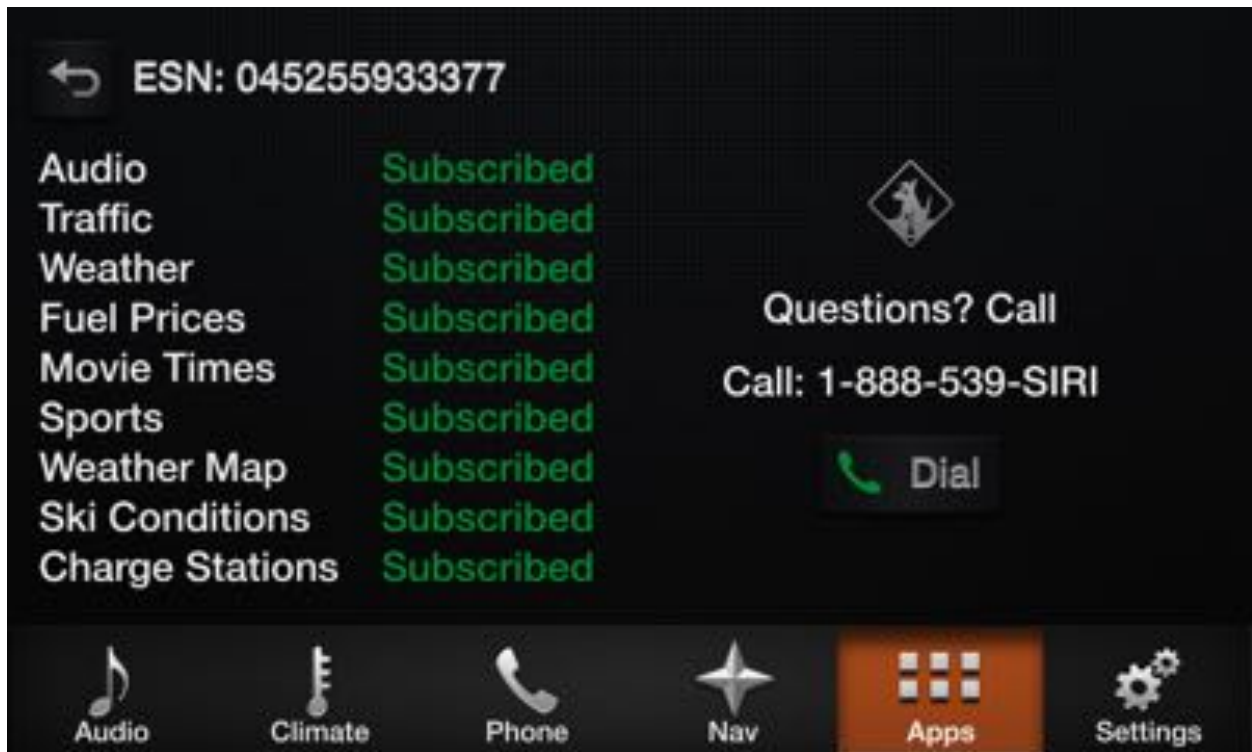

TRAVEL LINK

If the user presses 'subscription info.' They will be shown a screen that contains the Electronic Serial Number (ESN) of the Sirius module inside the Audio Head Unit (AHU) as well as current subscription status for all available Sirius Radio/Sirius Travel Link features.





VOICE COMMANDS

Voice Commands User Guide			
#	VR commands	Expected Behavior	Display Screen
1	Press PTT	System shall prompt 'Please say a command'.	
2	Press PTT, then Long press PTT	System shall prompt 'Cancelling' and VR session shall be cancelled	Go back to previous screen
3	a) Insert Empty USB b) Press PTT and say USB	System shall prompt "USB device is empty"	No change in display. Continue staying on current screen
4	a) Insert USB with Songs. Ensure song list contains - Multiple track 01, track 02, track 03 with different artists b) Say 'Play song track 01' c) Check for Disambiguation list d) Select line number by Voice	System shall play a selected song	

5	<p>a) PTT -> Say "Tune to AM 875" b) Press PTT</p>	<p>System shall tune to AM875</p>	
6	<p>a) PTT -> Say "FM" b) Press PTT</p>	<p>System shall tune to FM 107.9</p>	
7	<p>Pre: USB music playback is in progress a) Press PTT -> "Say FM 107.9"</p>	<p>System shall tune to FM 107.9</p>	



Panasonic ideas for life

Panasonic Automotive Systems Company
of America
Division of Panasonic Corporation of North America

8	<p>Pre: FM audio station playback is in progress</p> <p>a) PTT -> Say "USB"</p>	<p>System shall switch to USB mode and continue playing songs from where it was switched</p>	
9	<p>a) Pair a Phone</p> <p>b) Wait till Grammar build is done.</p> <p>c) PTT -> say "Call <Contact name>"</p>	<p>System shall place a call</p>	
10	<p>a) Press PTT</p> <p>b) Say 'Show Map'</p>	<p>System shall show a 'map' screen</p>	

Panasonic ideas for life

Panasonic Automotive Systems Company
of America
Division of Panasonic Corporation of North America

11	<p>a) Press PTT b) Say 'Show 3D'</p>	<p>System shall show a 'Map 3D' screen</p>	
12	<p>a) Press PTT b) Say 'Zoom In'</p>	<p>System shall 'Zoom in' map screen</p>	
13	<p>a) Press PTT -> Say 'Navigation' b) when prompted, Say 'Destination street address' c) when prompted, Say '37101 Corporate drive, Farmington Hills' d) when prompted to set destination, -> Press PTT & say 'Set as destination'</p>	<p>System shall switch to split map screen and ask user 'when ready, hit PTT and say 'Set as destination'</p>	

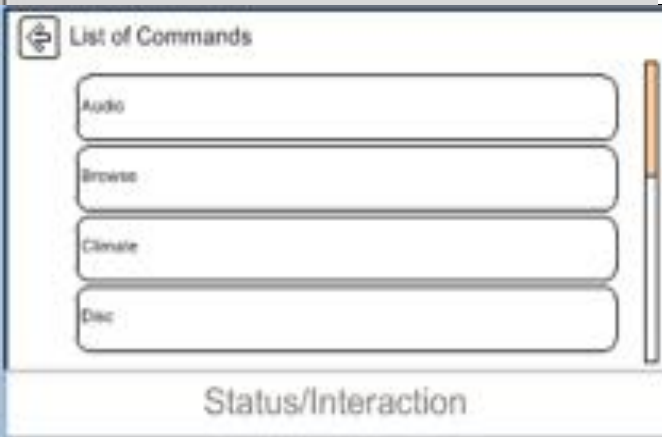
14	<p>a) Press PTT b) Say 'What Can I say'</p>	<p>System shall show 'what can I say' popup</p>	
15	<p>a) Press PTT b) Say 'List of Commands'</p>	<p>System shall show 'list of commands' screen</p>	

VOLUME

The Volume Settings Client is the interface of the Volume Settings function as called out in the SPSS and as the interface for the volume HMI Output.

The APIM shall send a single SetVolume increment / decrement to the Volume Settings Server when the volume button press the MFD / APIM receives is initially pressed.

When the volume button is held longer than Tvolume_button_held then the MFD / APIM shall increment / decrement the SetVolume signal to the Volume Settings Server every 100 milliseconds the until the button is released.

Rotary Volume

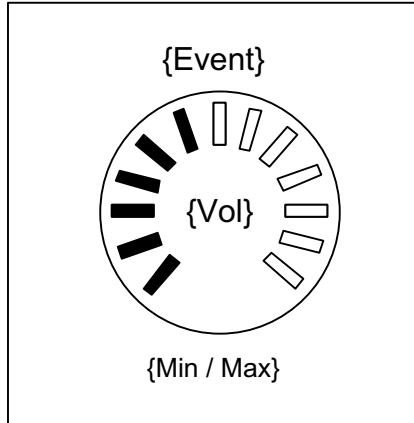

Horizontal Volume

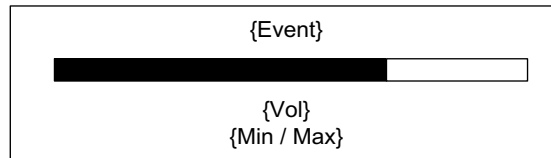

Table H22e.01. Volume event text detail

Volume Event	Text display on {Event}
Audio volume adjustment	Audio Volume
Voice recognition feedback vol. adjustment	Voice Volume
Phone call volume adjustment	Phone Volume
Voice prompt vol. adjustment	Prompt Volume
Traffic prompt volume adjustment	TA Volume
MyKey volume limit	MyKey Volume

Volume Event	Text display on {Min / Max}
Minimum volume reached	Minimum
Maximum volume reached	Maximum
MyKey volume limit	Buckle up to unmute

WI-FI

Wi-Fi is used to perform automatic software updates. You can connect to a network from the settings menu. Software updates will take place in the background when you are connected to Wi-Fi.

Below: Wifi and Internet options on settings screen

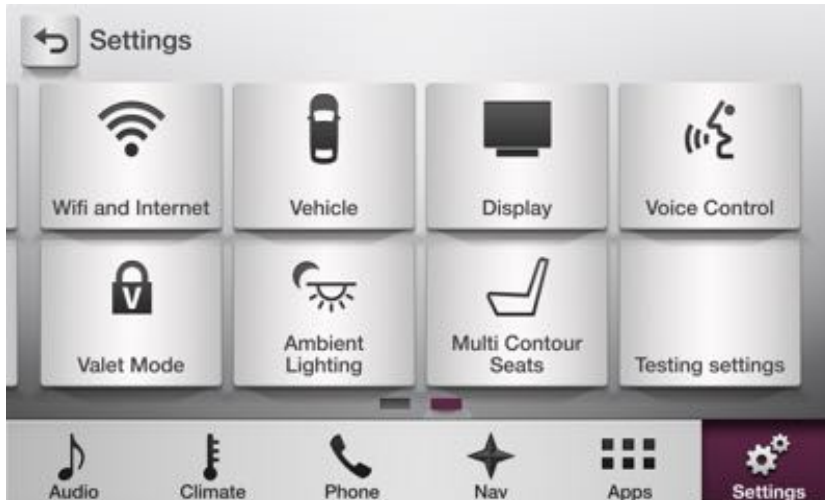

Wi-Fi and Internet settings screen:



WI-FI

Available Wifi Networks screen:

Panasonic

ideas for life

**Panasonic Automotive Systems Company
of America**
Division of Panasonic Corporation of North America



Federal Communications Commission (FCC) Statement

15.21

You are cautioned that changes or modifications not expressly approved by the part responsible for compliance could void the user's authority to operate the equipment.

15.105(b)

This equipment has been tested and found to comply with the limits for a Class B digital device, pursuant to part 15 of the FCC rules. These limits are designed to provide reasonable protection against harmful interference in a residential installation. This equipment generates, uses and can radiate radio frequency energy and, if not installed and used in accordance with the instructions, may cause harmful interference to radio communications. However, there is no guarantee that interference will not occur in a particular installation. If this equipment does cause harmful interference to radio or television reception, which can be determined by turning the equipment off and on, the user is encouraged to try to correct the interference by one or more of the following measures:

- Reorient or relocate the receiving antenna.
- Increase the separation between the equipment and receiver.
- Connect the equipment into an outlet on a circuit different from that to which the receiver is connected.
- Consult the dealer or an experienced radio/TV technician for help.

This device complies with Part 15 of the FCC Rules. Operation is subject to the following two conditions:

- 1) this device may not cause harmful interference and
- 2) this device must accept any interference received, including interference that may cause undesired operation of the device.

Radio Frequency Radiation Exposure

- This transmitter must not be co-located or operating in conjunction with any other antenna or transmitter.
- This transmitter complies with FCC RF radiation exposure limits set forth for an

uncontrolled environment. The transmitter should be installed and operated with a minimum distance of 20 cm between the radiator and your body.

Industry Canada Compliance

IC Statement:

This device complies with Industry Canada licence-exempt RSS standard(s).
Operation is subject to the following two conditions: (1) This device may not cause interference, and (2) This device must accept any interference, including interference that may cause undesired operation of the device.

This Class B digital apparatus complies with Canadian ICES-003.

Cet appareil numérique de classe B est conforme à la norme NMB-003.

Le présent appareil est conforme aux CNR d'Industrie Canada applicables aux appareils radio exempts de licence. L'exploitation est autorisée aux deux conditions suivantes:

- (1) l'appareil ne doit pas produire de brouillage, et
- (2) l'utilisateur de l'appareil doit accepter tout brouillage radioélectrique subi, même si le brouillage est susceptible d'en compromettre le fonctionnement.

Operation in the band 5150 - 5250 MHz is only for indoor use to reduce the potential for harmful interference to co-channel

mobile satellite systems.

bande 5150 - 5250 MHz est réservés uniquement pour une utilisation à l'intérieur afin de réduire les risques de

brouillage préjudiciable aux systèmes de satellites mobiles utilisant les mêmes canaux.

Caution: Exposure to Radio Frequency Radiation.

To comply with RSS 102 RF exposure compliance requirements, a separation distance of at least 20 cm must be maintained between the antenna of this device and all persons.

Pour se conformer aux exigences de conformité CNR 102 RF exposition, une distance de séparation d'au moins 20 cm doit être maintenue entre l'antenne de cet appareil et toutes les personnes.

European Union regulatory notices

Declaration of Conformity

Products bearing the CE marking comply with one or more of the following EU Directives as may be applicable:

R&TTE Directive 1999/5/EC; Low Voltage Directive 2006/95/EC; EMC Directive 2004/108/EC; Ecodesign Directive 2009/125/EC; RoHS Directive 2011/65/EU

Compliance with these directives is assessed using applicable European Harmonised Standards.