



# Maintenance and Service Guide

## **SUMMARY**

This guide provides maintenance information about such topics as spare parts, removal and replacement of parts, security, and backing up.

## Legal information

© Copyright 2023 HP Development Company, L.P.

AMD is a trademark of Advanced Micro Devices, Inc. Bluetooth is a trademark owned by its proprietor and used by HP Inc. under license. Intel, Core, Thunderbolt, and vPro are trademarks of Intel Corporation or its subsidiaries in the U.S. and/or other countries. Microsoft and Windows are either registered trademarks or trademarks of Microsoft Corporation in the United States and/or other countries. USB Type-C and USB-C are registered trademarks of USB Implementers Forum. DisplayPort™ and the DisplayPort™ logo are trademarks owned by the Video Electronics Standards Association (VESA®) in the United States and other countries. Wi-Fi is a registered trademark of the Wi-Fi Alliance®.

The information contained herein is subject to change without notice. The only warranties for HP products and services are set forth in the express warranty statements accompanying such products and services. Nothing herein should be construed as constituting an additional warranty. HP shall not be liable for technical or editorial errors or omissions contained herein.

First Edition: March 2023

Document Part Number: N41962-001

### Product notice

This guide describes features that are common to most models. Some features may not be available on your computer.

Not all features are available in all editions or versions of Windows. Systems may require upgraded and/or separately purchased hardware, drivers, software or BIOS update to take full advantage of Windows functionality. Windows is automatically updated, which is always enabled. High-speed internet and Microsoft account required. ISP fees may apply and additional requirements may apply over time for updates. See <http://www.microsoft.com>.

#### **If your product ships with Windows in S**

**Mode:** Windows in S Mode works exclusively with apps from the Microsoft Store within Windows. Certain default settings, features, and apps cannot be changed. Some accessories and apps that are compatible with Windows may not work (including some antivirus, PDF writers, driver utilities, and accessibility apps), and performance may vary, even if you switch out of S Mode. If you switch to Windows, you cannot switch back to S Mode. Learn more at [Windows.com/SmodeFAQ](https://www.windows.com/SmodeFAQ).

To access the latest user guides, go to <http://www.hp.com/support>, and follow the instructions to find your product. Then select **Manuals**.

### Software terms

By installing, copying, downloading, or otherwise using any software product preinstalled on this computer, you agree to be bound by the terms of the HP End User License Agreement (EULA). If you do not accept these license terms, your sole remedy is to return the entire unused product (hardware and software) within 14 days for a full refund subject to the refund policy of your seller.

For any further information or to request a full refund of the price of the computer, please contact your seller.

---

# Table of contents

<b>1 Product description</b> .....	<b>1</b>
<b>2 Components</b> .....	<b>6</b>
Right.....	6
Left.....	7
Display .....	8
Low blue light mode (select products only).....	8
Keyboard area.....	10
Touchpad .....	10
Touchpad settings .....	10
Adjusting touchpad settings.....	10
Turning on the touchpad .....	10
Touchpad components .....	10
Lights .....	11
Button and fingerprint reader .....	12
Special keys.....	13
Bottom .....	15
Rear .....	15
Labels .....	16
Using a SIM card (select products only).....	17
Determining the correct SIM card size for your computer .....	17
Inserting a nano SIM card .....	18
<b>3 Illustrated parts catalog</b> .....	<b>19</b>
Computer major components.....	19
Display assembly subcomponents.....	22
Cables.....	24
Miscellaneous parts.....	25
<b>4 Removal and replacement procedures preliminary requirements</b> .....	<b>30</b>
Tools required .....	30
Service considerations.....	30
Plastic parts.....	30
Cables and connectors.....	30
Drive handling .....	30
Electrostatic discharge information.....	31
Generating static electricity.....	31
Preventing electrostatic damage to equipment.....	32
Personal grounding methods and equipment.....	32
Grounding the work area.....	33

Recommended materials and equipment.....	33
Cleaning your computer .....	34
Enabling HP Easy Clean (select products only).....	34
Removing dirt and debris from your computer.....	34
Cleaning your computer with a disinfectant.....	35
Caring for wood veneer (select products only).....	36
Packaging and transporting guidelines.....	36
Accessing support information.....	37
<b>5 Removal and replacement procedures for authorized service provider parts.....</b>	<b>39</b>
Component replacement procedures .....	39
Preparation for disassembly.....	39
Bottom cover .....	39
Battery.....	41
WWAN module.....	42
WLAN module.....	44
Speakers.....	45
Memory modules.....	46
Solid-state drive.....	48
RTC battery .....	50
Fingerprint reader.....	51
NFC module .....	52
Touchpad.....	53
Card reader.....	54
Audio jack.....	55
Connector board.....	56
Fan.....	57
Heat sink .....	58
System board.....	59
Display assembly.....	62
Keyboard with top cover.....	72
<b>6 Backing up, restoring, and recovering.....</b>	<b>74</b>
Backing up information and creating recovery media.....	74
Using Windows tools for backing up.....	74
Using the HP Cloud Recovery Download Tool to create recovery media (select products only).....	74
Restoring and recovering your system.....	74
Creating a system restore .....	75
Restoring and recovery methods.....	75
Recovering using HP Recovery media.....	75
Changing the computer boot order .....	76
Using HP Sure Recover (select products only).....	76
<b>7 Computer Setup (BIOS), TPM, and HP Sure Start.....</b>	<b>77</b>
Using Computer Setup.....	77
Navigating and selecting in Computer Setup .....	77
Restoring factory settings in Computer Setup.....	77
Updating the BIOS.....	78

Determining the BIOS version .....	78
Preparing for a BIOS update .....	78
Downloading a BIOS update .....	79
Installing a BIOS update .....	79
Changing the boot order using the f9 prompt .....	79
TPM BIOS settings (select products only) .....	80
Using HP Sure Start (select products only).....	80
<b>8 Using HP PC Hardware Diagnostics .....</b>	<b>81</b>
Using HP PC Hardware Diagnostics Windows (select products only).....	81
Using an HP PC Hardware Diagnostics Windows hardware failure ID code.....	81
Accessing HP PC Hardware Diagnostics Windows.....	81
Accessing HP PC Hardware Diagnostics Windows from HP Support Assistant.....	81
Accessing HP PC Hardware Diagnostics Windows from the Start menu (select products only).....	82
Downloading HP PC Hardware Diagnostics Windows.....	82
Downloading the latest HP PC Hardware Diagnostics Windows version from HP.....	82
Downloading the HP PC Hardware Diagnostics Windows from the Microsoft Store.....	82
Downloading HP Hardware Diagnostics Windows by product name or number (select products only) .....	82
Installing HP PC Hardware Diagnostics Windows.....	83
Using HP PC Hardware Diagnostics UEFI .....	83
Using an HP PC Hardware Diagnostics UEFI hardware failure ID code.....	83
Starting HP PC Hardware Diagnostics UEFI.....	83
Starting HP PC Hardware Diagnostics UEFI through HP Hotkey Support software (select products only).....	84
Downloading HP PC Hardware Diagnostics UEFI to a USB flash drive.....	84
Downloading the latest HP PC Hardware Diagnostics UEFI version .....	84
Downloading HP PC Hardware Diagnostics UEFI by product name or number (select products only) .....	85
Using Remote HP PC Hardware Diagnostics UEFI settings (select products only).....	85
Downloading Remote HP PC Hardware Diagnostics UEFI.....	85
Downloading the latest Remote HP PC Hardware Diagnostics UEFI version.....	85
Downloading Remote HP PC Hardware Diagnostics UEFI by product name or number.....	85
Customizing Remote HP PC Hardware Diagnostics UEFI settings.....	86
<b>9 Specifications .....</b>	<b>87</b>
Computer specifications.....	87
Display specifications.....	87
Solid-state drive specifications .....	88
<b>10 Statement of memory volatility.....</b>	<b>89</b>
Current BIOS steps .....	89
Nonvolatile memory usage .....	91
Questions and answers.....	91
Using HP Sure Start (select products only).....	93
<b>11 Power cord set requirements.....</b>	<b>94</b>

Requirements for all countries .....	94
Requirements for specific countries and regions .....	94
<b>12 Recycling .....</b>	<b>96</b>
<b>Index.....</b>	<b>97</b>

# 1 Product description

This table provides detailed product information.

**Table 1-1 Product components and their descriptions**

Category	Description
<b>Product Name</b>	HP EliteBook 840 14 inch G10 Notebook PC
<b>Processors</b>	<p>Intel® Core® i7-1370P processor (5.2 GHz, 14 cores, 24 MB Intel Smart Cache, 28 W)</p> <p>Intel Core i7 1360P processor (5.0 GHz, 12 cores, 18 MB Intel Smart Cache, 28 W)</p> <p>Intel Core i5 1350P processor (4.7 GHz, 12 cores, 12 MB Intel Smart Cache, 28 W)</p> <p>Intel Core i5 1340P processor (4.6 GHz, 12 cores, 12 MB Intel Smart Cache, 28 W)</p> <p>Intel Core i7-1365U processor (1.8 GHz, 10 cores, 12 MB Intel Smart Cache, 15 W)</p> <p>Intel Core i7-1355U processor (1.7 GHz, 10 cores, 12 MB Intel Smart Cache, 15 W)</p> <p>Intel Core i5-1345U processor (4.7 GHz, 10 cores, 12 MB Intel Smart Cache, 15 W)</p> <p>Intel Core i5-1335U processor (1.3 GHz, 10 cores, 12 MB Intel Smart Cache, 15 W)</p>
<b>Display</b>	<p><b>35.6 cm (14.0 in), liquid crystal display (LCD) wide ultra extended graphics array (WUXGA, 1920 × 1200), antiglare, ultrawide viewing angle (UWVA), bent display panel</b></p> <p>White light-emitting diode + low blue light (WLED + LBL), 100% sRGB, embedded DisplayPort™ + panel self refresh (eDP 1.3 + PSR), LP, ambient light sensor + adaptive color sensor (ALS + ACS), SureView Reflect, 5 MP camera; typical brightness: 1000 nits</p> <p>WLED + LBL, 100% sRGB, eDP 1.3 + PSR, 5 MP infrared camera, ALS + ACS, SureView Reflect, WWAN; typical brightness: 1000 nits</p> <p>WLED + LBL, 100% sRGB, eDP 1.3 + PSR, 5 MP camera, ALS + ACS, SureView Reflect; typical brightness: 1000 nits</p> <p>WLED + LBL, 100% sRGB, eDP 1.3 + PSR, NB2Y, generation 4 plus privacy filter; typical brightness: 1000 nits</p> <p>WLED + LBL, 100% sRGB, eDP + PSR, LP, ALS + ACS, 5 MP infrared camera; typical brightness: 400 nits</p> <p>WLED + LBL, 100% sRGB, eDP 1.4 + PSR2, LP, NB2X, ALS + ACS, 5 MP infrared camera; typical brightness: 400 nits</p> <p>WLED + LBL, 100% sRGB, eDP + PSR, LP, ALS, 5 MP camera; typical brightness: 400 nits</p> <p>WLED + LBL, 100% sRGB, eDP + PSR, LP, ALS + ACS, 5 MP infrared camera, WWAN; typical brightness: 400 nits</p> <p>Light-emitting diode (LED), 45% CG, eDP 1.2 with PSR, LP, NB2X, TOP display panel with 5 MP infrared camera; typical brightness: 250 nits</p> <p>LED, 45% CG, eDP 1.2 without PSR, NB2X; typical brightness: 250 nits</p> <p>LED, 45% CG, eDP 1.2 without PSR, NB2X, touch-on panel (TOP); typical brightness: 250 nits</p> <p>LED, 45% CG, 5 MP camera; typical brightness: 250 nits</p> <p>LED, 45% CG, 5 MP camera, WWAN; typical brightness: 250 nits</p>

**Table 1-1 Product components and their descriptions (continued)**

Category	Description
<b>Display</b>	LED, 45% CG, 5 MP infrared camera; typical brightness: 250 nits
	LED, 45% CG, WWAN; typical brightness: 250 nits
	LED, 45% CG, 5 MP infrared camera, touch-on panel (TOP); typical brightness: 250 nits
	LED, 45% CG, 5 MP infrared camera, WWAN, touch-on panel (TOP); typical brightness: 250 nits
	LED, 45% CG, WWAN; typical brightness: 250 nits
	<b>35.6 cm (14.0 in), liquid crystal display (LCD) wide quad graphics array (WQXGA, 2560 × 1600), antiglare, ultrawide viewing angle (UWVA), bent display panel</b>
	DCI-P3, eDP 1.4 + PSR, NB2X, 5 MP infrared camera, 120 Hz; typical brightness: 500 nits
	DCI-P3, eDP 1.4 + PSR, NB2X, 120 Hz; typical brightness: 500 nits
	DCI-P3, eDP 1.4 + PSR, NB2X, WWAN, 5 MP infrared camera, 120 Hz; typical brightness: 500 nits
	DRM, DCI-P3, eDP 1.4 + PSR, NB2X, 120 Hz; typical brightness: 500 nits
<b>Memory</b>	Double data rate (DDR5)-4800 or DDR5-5200, Non Error-Correcting Code (NECC) support
	Two customer-accessible memory module slots (small outline dual in-line memory modules (SODIMMs) supporting up to 64 GB of RAM in the following configurations:
	<ul style="list-style-type: none"> <li>• 64 GB (32 × 2)</li> <li>• 48 GB (32 + 16)</li> <li>• 32 GB (32 × 1)</li> <li>• 32 GB (16 × 2)</li> <li>• 24 GB (16 + 8)</li> <li>• 16 GB (16 × 1)</li> <li>• 16 GB (8 × 2)</li> <li>• 8 GB (8 × 1)</li> </ul>
<b>eMMC</b>	<b>On-board embedded MultiMedia Controller (eMMC v5.0)</b>
	32 GB



**Table 1-1 Product components and their descriptions (continued)**

Category	Description
<b>Primary storage</b>	<b>M.2 2280, PCIe, NVMe, solid-state drive</b>
	Support for the following configurations:
	<ul style="list-style-type: none"> <li>• 2 TB, Peripheral Component Interconnect Express (PCIe)-4×4, Non-Volatile Memory Express (NVMe) solid-state drive with three-layer cell (TLC)</li> </ul>
	<ul style="list-style-type: none"> <li>• 1 TB, PCIe-4×4, TLC</li> </ul>
	<ul style="list-style-type: none"> <li>• 1 TB, PCIe-4×4, self-encrypted (SED), OPAL2, TLC</li> </ul>
	<ul style="list-style-type: none"> <li>• 512 GB, PCIe-4×4, TLC</li> </ul>
	<ul style="list-style-type: none"> <li>• 512 GB</li> </ul>
	<ul style="list-style-type: none"> <li>• 512 GB, PCIe-4×4, SED, OPAL2, TLC</li> <li>• 256 GB</li> <li>• 256 GB, PCIe-4×4, SED, OPAL2, TLC</li> </ul>
<b>Audio and video</b>	<b>Audio brand:</b> BANG and OLUFSEN
	Dual speakers
	<b>Camera</b> (select products only)
	5 MP, wide field-of-view (WFOV), fixed, infrared (IR)
	5 MP, WFOV, fixed
	Dual-array digital microphone with appropriate software: beam forming, echo cancellation, noise suppression
<b>Wireless</b>	<b>Wireless Local Area Network (WLAN) module</b>
	Intel AX211 Wi-Fi® 6e + Bluetooth® 5.3
	Intel AX211 Wi-Fi 6E + Bluetooth 5.3 vPro®
	<b>Near field communication (NFC) Mirage WNC XRAV-1</b> (select products only)
	<b>Wireless Wide Area Network (WWAN) module (select products only)</b>
	Intel 5000 5G WWAN module
	Intel XMM 7560 R+ long-term evolution (LTE)-Advanced Pro (Cat 16) WWAN module
<b>Ports</b>	Hot plug/unplug and autodetect for correct output to wide-aspect vs. standard aspect video
	Audio-out (headphone)/Audio-in (microphone) combo jack
	HDMI 2.0 port
	SIM card slot (select products only)
	USB 3.1 Gen 1 ports (2)
	USB 3.1 Type-C® ports (2)

**Table 1-1 Product components and their descriptions (continued)**

Category	Description
<b>Keyboard/pointing devices</b>	<b>Keyboard</b> (spill resistant)
	Backlit
	Not backlit
	Backlit, privacy
	<b>Touchpad</b>
	Microsoft precision touchpad default
	Gestures support
	Firmware PTP with filter driver
	Taps enabled as default
<b>Power requirements</b>	<b>Battery</b> (polymer, HP Long Life)
	3 cell, 38 Whr
	3 cell, 51 Whr
	HP Fast Charge Technology
	<b>Smart AC adapter</b>
	65 W, non-Power Factor Correction (nPFC), USB-C, standard, straight barrel, 1.8 m (6.0 ft)
	65 W, nPFC, USB-C, slim, straight barrel, 1.8 m (6.0 ft)
	<b>Power cord</b>
	C5, 1.0 m (3.3 ft), conventional, high frequency (HF), with straight connector and sticker
	C5, 1.0 m (3.3 ft), conventional with sticker
C5, 1.0 m (3.3 ft), premium with sticker	
<b>Security</b>	Active SmartCard
	Fingerprint sensor
	Kensington Nano Security Lock
	Privacy camera shutter door
<b>Sensors</b>	Adaptive color sensor (ACS)
	Ambient light sensor (ALS)
	Hall sensor (integrated)
	HP Sure Platform
	Motion AI
	Thermal sensor

**Table 1-1 Product components and their descriptions (continued)**

<b>Category</b>	<b>Description</b>
<b>Operating system</b>	Windows® 11 Pro
	Windows 11 Pro Education
	Windows 11 Home - HP recommends Windows 11 Pro for Business
	Windows 11 Home Single Language - HP recommends Windows 11 Pro for Business
	Windows 11 Pro (Windows 11 Enterprise or Windows 10 Enterprise available with a Volume Licensing Agreement)
	Windows 11 Pro (preinstalled with Windows 10 Pro Downgrade)
	FreeDOS
<b>Serviceability</b>	<b>End user replaceable part:</b> AC adapter

## 2 Components

Your computer features top-rated components. This chapter provides details about your components, where they are located, and how they work.

### Right

Use the illustration and table to identify the components on the right side of the computer.

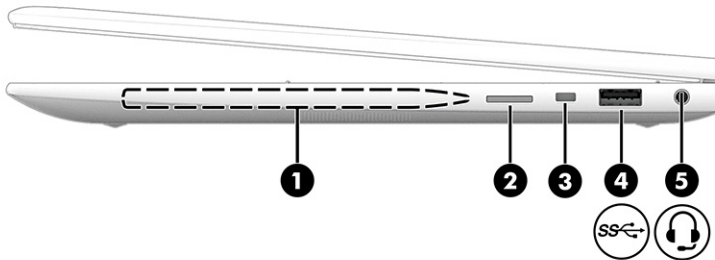

**Table 2-1** Right-side components and their descriptions

Component	Description
(1)	Magnetic pen attachment area (select products only) Holds an optional pen.
(2)	SIM card slot (select products only) Supports a wireless subscriber identity module (SIM) card.
(3)	Security cable slot Attaches an optional security cable to the computer. <b>NOTE:</b> The security cable is designed to act as a deterrent, but it might not prevent the computer from being mishandled or stolen.
(4)	USB SuperSpeed port Connects a USB device, provides high-speed data transfer, and (for select products) charges small devices (such as a smartphone) when the computer is on or in Sleep mode. <b>NOTE:</b> Use a standard USB Type-A charging cable or cable adapter (purchased separately) when charging a small external device.

**Table 2-1** Right-side components and their descriptions (continued)



Component	Description
(5)  Audio-out (headphone)/Audio-in (microphone) combo jack	<p>Connects optional powered stereo speakers, headphones, earbuds, a headset, or a television audio cable. This jack does not support optional standalone microphones.</p> <p><b>WARNING!</b> To reduce the risk of personal injury, adjust the volume before putting on headphones, earbuds, or a headset. For additional safety information, see the <i>Regulatory, Safety, and Environmental Notices</i>.</p> <p>To access this guide:</p> <ul style="list-style-type: none"> <li>Select the <b>Search</b> icon in the taskbar, type <b>HP Documentation</b> in the search box, and then select <b>HP Documentation</b>.</li> </ul> <p><b>NOTE:</b> When a device is connected to the jack, the computer speakers are disabled.</p>

## Left

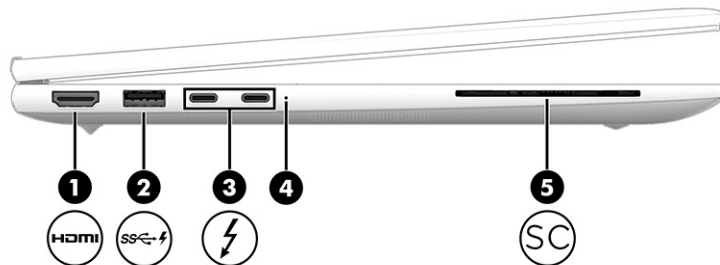

Use the illustration and table to identify the components on the left side of the computer.



**Table 2-2** Left-side components and their descriptions

Component	Description
(1)  HDMI® port	<p>Connects an optional video or audio device, such as a high-definition television, any compatible digital or audio component, or a high-speed High Definition Multimedia Interface® (HDMI) device.</p>
(2)  USB SuperSpeed port with HP Sleep and Charge	<p>Connects a USB device, provides high-speed data transfer, and charges small devices (such as a smartphone), even when the computer is off.</p> <p><b>NOTE:</b> Use a standard USB Type-A charging cable or cable adapter (purchased separately) when charging a small external device.</p>

**Table 2-2 Left-side components and their descriptions (continued)**

Component	Description
<p>(3)  USB Type-C® power connector and Thunderbolt™ ports with HP Sleep and Charge and DisplayPort™ output (2)</p>	<p>Connect an AC adapter that has a USB Type-C connector, supplying power to the computer and, if needed, charging the computer battery.</p> <p>- and -</p> <p>Connect USB devices, provide high-speed data transfer, and charge small devices (such as a smartphone), even when the computer is off.</p> <p><b>NOTE:</b> Use a standard USB Type-C charging cable or cable adapter (purchased separately) when charging a small external device.</p> <p>- and -</p> <p>Connect display devices that have a USB Type-C connector, providing DisplayPort output.</p> <p><b>NOTE:</b> Your computer might also support a Thunderbolt docking station.</p>
(4) Battery light	<p>When AC power is connected:</p> <ul style="list-style-type: none"> <li>• White: The battery charge is greater than 90 percent.</li> <li>• Amber: The battery charge is from 0 to 90 percent.</li> <li>• Off: The battery is not charging.</li> </ul> <p>When AC power is disconnected (battery not charging):</p> <ul style="list-style-type: none"> <li>• Blinking amber: The battery has reached a low battery level. When the battery has reached a critical battery level, the battery light begins blinking rapidly.</li> <li>• Off: The battery is not charging.</li> </ul>
<p>(5)  Smart card reader (select products only)</p>	Supports optional smart cards.

## Display

Use the illustration and table to identify the display components.

### Low blue light mode (select products only)

Your computer display is shipped from the factory in low blue light mode for improved eye comfort and safety. Also, blue light mode automatically adjusts blue light emissions when you are using the computer at night or for reading.

 **WARNING!** To reduce the risk of serious injury, read the *Safety & Comfort Guide*. It describes proper workstation setup and proper posture, health, and work habits for computer users. The *Safety & Comfort Guide* also provides important electrical and mechanical safety information. The *Safety & Comfort Guide* is available on the web at <http://www.hp.com/ergo>.

 **NOTE:** Refer to the illustration that most closely matches your computer.

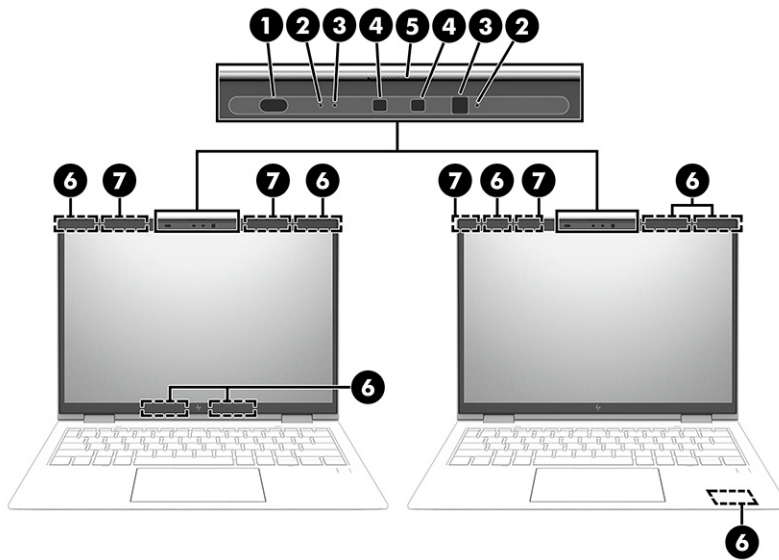

**Table 2-3** Display components and their descriptions

Component	Description
(1) Ambient light and color sensor	Adjusts the brightness of the display, depending on the ambient light, and manages and controls the color temperature. Color temperature enables you to measure and adjust the warmth or coolness of the light source.
(2) Internal microphones (2) (select products only)	Record sound.
(3) Camera lights (2) (select products only)	On: One or more cameras are in use.
(4) Cameras (2) (select products only)	Allow you to video chat, record video, and record still images. Some cameras also allow a facial recognition logon to Windows, instead of a password logon.  <b>NOTE:</b> Camera functions vary depending on the camera hardware and software installed on your product.
(5) Camera privacy cover (select products only)	By default, the camera lens is uncovered, but you can slide the camera privacy cover to block the camera's view. To use the camera, slide the camera privacy cover in the opposite direction to reveal the lens.  <b>NOTE:</b> If you have both front-facing and rear-facing cameras, when one camera lens is revealed and ready to use, the other is concealed.
(6) WWAN antennas* (4) (select products only)	Send and receive wireless signals to communicate with wireless wide area networks (WWANs).
(7) WLAN antennas* (2) (select products only)	Send and receive wireless signals to communicate with wireless local area networks (WLANs).

\*The antennas are not visible from the outside of the computer. For optimal transmission, keep the areas immediately around the antennas free from obstructions.

For wireless regulatory notices, see the section of the *Regulatory, Safety, and Environmental Notices* that applies to your country or region.

To access this guide:

- Select the **Search** icon in the taskbar, type `HP Documentation` in the search box, and then select **HP Documentation**.

# Keyboard area

Keyboards can vary by language.



---

**NOTE:** The keyboard, including the function keys and power key (select products only), is disabled in stand, tent, and tablet modes. To enable the keyboard, including the power key, change to the clamshell mode.

---

## Touchpad

The touchpad settings and components are described here.

### Touchpad settings

You learn how to adjust the touchpad settings and components here.

#### Adjusting touchpad settings

Use these steps to adjust touchpad settings and gestures.

1. Select the **Search** icon in the taskbar, type `touchpad settings` in the search box, and then press `enter`.
2. Choose a setting.

#### Turning on the touchpad

Follow these steps to turn on the touchpad.

1. Select the **Search** icon in the taskbar, type `touchpad settings` in the search box, and then press `enter`.
2. Using an external mouse, click the **Touchpad** button.

If you are not using an external mouse, press the `Tab` key repeatedly until the pointer rests on the **touchpad** button. Then press the `spacebar` to select the button.

### Touchpad components

Use the illustration and table to identify the touchpad components.



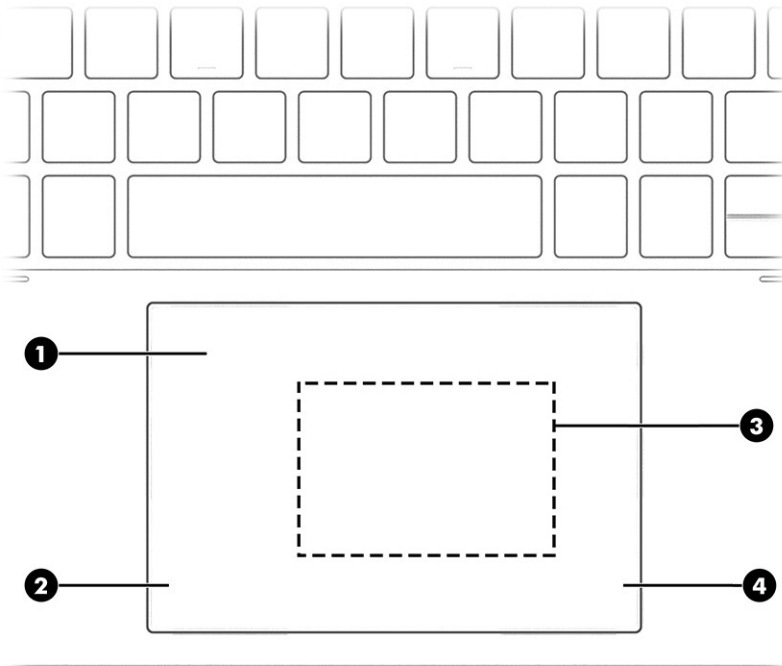

**Table 2-4** Touchpad components and their descriptions

Component	Description
(1) Touchpad zone	Reads your finger gestures to move the pointer or activate items on the screen.
(2) Left touchpad button	Functions like the left button on an external mouse.
(3) Near Field Communications (NFC) tapping area and antenna (select products only)	Allows you to wirelessly share information when you tap it with an NFC-enabled device.
(4) Right touchpad button	Functions like the right button on an external mouse.



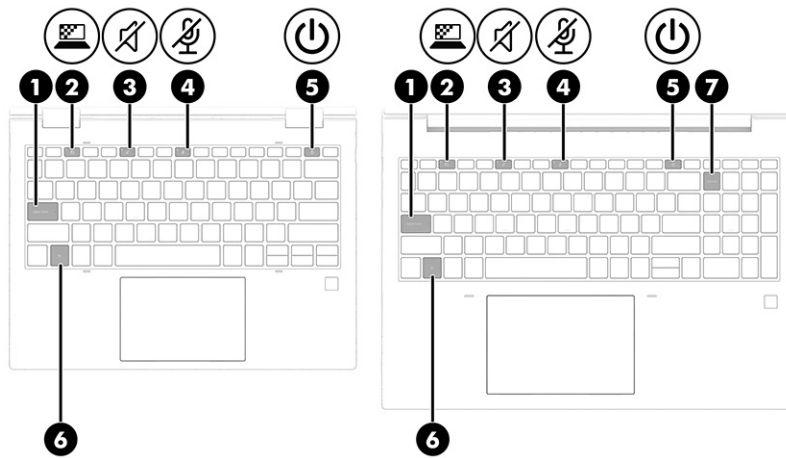

## Lights

Use the illustration and table to identify the lights on the computer.

 **NOTE:** Refer to the illustration that most closely matches your computer.





**Table 2-5** Lights and their descriptions

Component	Description
(1) Caps lock light	On: Caps lock is on, which switches the key input to all capital letters.
(2)  Privacy key light (select products only)	On: Privacy screen is on, which helps prevent side-angle viewing.
(3)  Mute light	<ul style="list-style-type: none"> <li>On: Computer sound is off.</li> <li>Off: Computer sound is on.</li> </ul>
(4)  Microphone mute light	<ul style="list-style-type: none"> <li>On: Microphone is off.</li> <li>Off: Microphone is on.</li> </ul>
(5)  Power light	<ul style="list-style-type: none"> <li>On: The computer is on.</li> <li>Blinking (select products only): The computer is in the Sleep state, a power-saving state. The computer shuts off power to the display and other unnecessary components.</li> <li>Off: Depending on your computer model, the computer is off, in Hibernation, or in Sleep. Hibernation is the power-saving state that uses the least amount of power.</li> </ul>
(6) Fn lock light	On: The <b>fn</b> key is locked.
(7) Num Lk light (select products only)	On: Num Lk is on.

## Button and fingerprint reader



Fingerprint readers can be located on the touchpad, on a side panel of the computer, or on the top cover below the keyboard.

 **IMPORTANT:** To verify that your computer supports fingerprint reader sign-in, select the **Search** icon in the taskbar, type *Sign-in options* in the search box, and then select the **Sign-on options** app. If **Fingerprint recognition** is not listed as an option, then your notebook does not include a fingerprint reader.

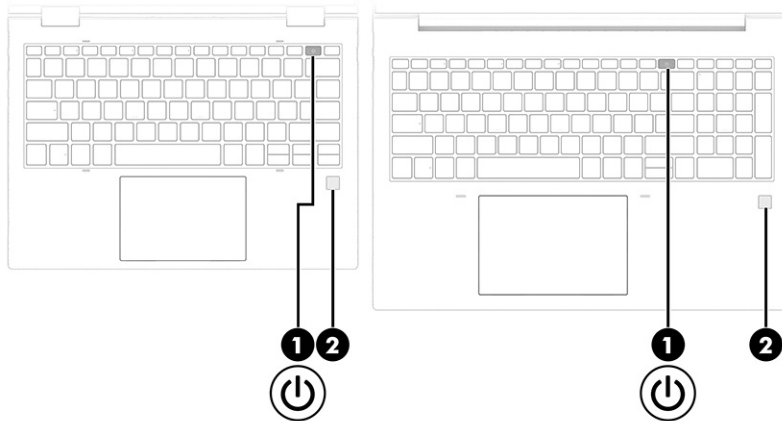
 **NOTE:** Refer to the illustration that most closely matches your computer.



**Table 2-6** Button and fingerprint reader and their descriptions

Component	Description
<p>(1)  Power button</p>	<ul style="list-style-type: none"> <li>When the computer is off, press the button briefly to turn on the computer.</li> <li>When the computer is on, press the button briefly to initiate Sleep.</li> <li>When the computer is in the Sleep state, press the button briefly to exit Sleep (select products only).</li> <li>When the computer is in Hibernation, press the button briefly to exit Hibernation.</li> </ul> <p><b>IMPORTANT:</b> Pressing and holding down the power button results in the loss of unsaved information.</p> <p>If the computer has stopped responding and shutdown procedures are ineffective, press and hold the power button for at least 4 seconds to turn off the computer.</p> <p>To learn more about your power settings, use the Power icon.</p> <ul style="list-style-type: none"> <li>Right-click the <b>Power</b> icon  and then select <b>Power and sleep settings</b>.</li> </ul>
<p>(2) Fingerprint reader (select products only)</p>	<p>Allows a fingerprint logon to Windows, instead of a password logon.</p> <ul style="list-style-type: none"> <li>Touch your finger to the fingerprint reader.</li> </ul> <p><b>IMPORTANT:</b> To prevent fingerprint logon issues, make sure when you register your fingerprint that all sides of your finger are registered by the fingerprint reader.</p>



## Special keys

Use the illustration and table to identify the special keys.

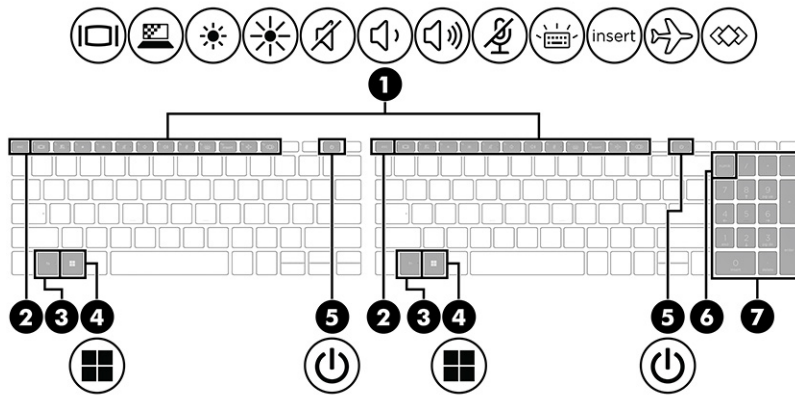
 **NOTE:** Refer to the illustration that most closely matches your computer.



**Table 2-7** Special keys and their descriptions

Component	Description
(1) Action keys	Execute frequently used system functions.
(2) <code>esc</code> key	Displays system information when pressed in combination with the <code>fn</code> key.
(3) <code>fn</code> key	Executes frequently used system functions when pressed in combination with another key. Such key combinations are called <i>hot keys</i> .
(4)  Windows key	Opens the Start menu.  <b>NOTE:</b> Pressing the Windows key again closes the Start menu.
(5)  Power button	<ul style="list-style-type: none"> <li>When the computer is off, press the button briefly to turn on the computer.</li> <li>When the computer is on, press the button briefly to initiate Sleep.</li> <li>When the computer is in the Sleep state, press the button briefly to exit Sleep (select products only).</li> <li>When the computer is in Hibernation, press the button briefly to exit Hibernation.</li> </ul> <p><b>IMPORTANT:</b> Pressing and holding down the power button results in the loss of unsaved information.</p> <p>If the computer has stopped responding and shutdown procedures are ineffective, press and hold the power button for at least 4 seconds to turn off the computer.</p> <p>To learn more about your power settings, use the Power icon.</p> <ul style="list-style-type: none"> <li>Right-click the <b>Power</b> icon , and then select <b>Power and sleep settings</b>.</li> </ul>
(6) <code>num lk</code> key (select products only)	Alternates between the navigational and numeric functions on the integrated numeric keypad.

**Table 2-7** Special keys and their descriptions (continued)

Component	Description
(7) Integrated numeric keypad (select products only)	<p>A separate keypad to the right of the alphabet keyboard. When you press <b>num lk</b>, you can use the integrated keypad like an external numeric keypad.</p> <p><b>NOTE:</b> If the keypad function is active when the computer is turned off, that function is reinstated when the computer is turned back on.</p>

## Bottom

Use the illustration and table to identify the bottom components.

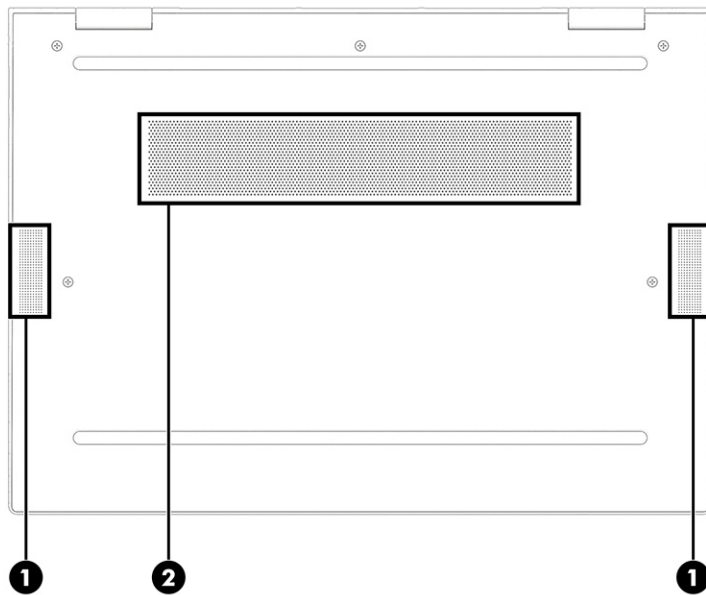

**Table 2-8** Bottom components and their descriptions

Component	Description
(1) Speakers (2)	Produce sound.
(2) Vent	<p>Enables airflow to cool internal components.</p> <p><b>NOTE:</b> The computer fan starts up automatically to cool internal components and prevent overheating. It is normal for the internal fan to cycle on and off during routine operation.</p>

## Rear

Use the illustration and table to identify the rear component.



**Table 2-9** Rear component and its descriptions

Component	Description
Vent (select products only)	Enables airflow to cool internal components.  <b>NOTE:</b> The computer fan starts up automatically to cool internal components and prevent overheating. It is normal for the internal fan to cycle on and off during routine operation.

## Labels

The labels affixed to the computer provide information you might need when you troubleshoot system problems or travel internationally with the computer. Labels might be in paper form or imprinted on the product.

 **IMPORTANT:** Check the following locations for the labels described in this section: the bottom of the computer, inside the battery bay, under the service door, on the back of the display, or on the bottom of a tablet kickstand.

- Service label—Provides important information to identify your computer. When contacting support, you might be asked for the serial number, the product number, or the model number. Locate this information before you contact support.

Your service label will resemble one of the examples shown below. Refer to the illustration that most closely matches the service label on your computer.

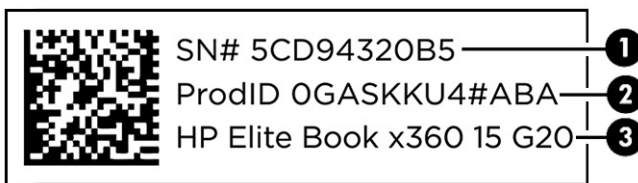

**Table 2-10** Service label components

Component
(1) Serial number
(2) Product ID
(3) HP product name

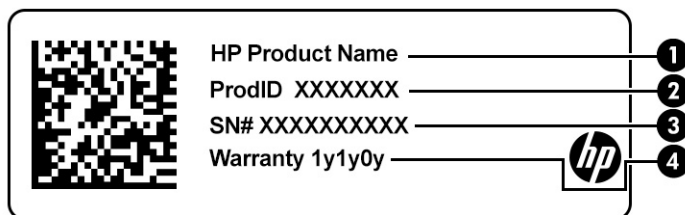

**Table 2-11 Service label components**

Component	
(1)	HP product name
(2)	Product ID
(3)	Serial number
(4)	Warranty period

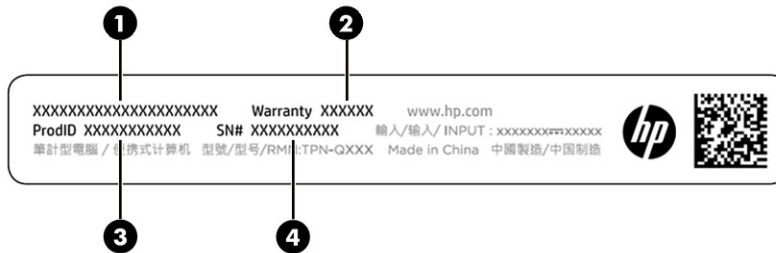

**Table 2-12 Service label components**

Component	
(1)	HP product name
(2)	Warranty period
(3)	Product ID
(4)	Serial number

- Regulatory labels—Provide regulatory information about the computer.
- Wireless certification labels—Provide information about optional wireless devices and the approval markings for the countries or regions in which the devices have been approved for use.

## Using a SIM card (select products only)

Use these instructions to insert a SIM card.

**IMPORTANT:** You can damage the SIM card if you insert the wrong size card or insert it or the SIM card tray in the wrong direction. The card might also become stuck in the slot. Do not use SIM card adapters. To prevent damage to the SIM card or connectors, use minimal force when inserting or removing a SIM card.

### Determining the correct SIM card size for your computer

Before purchasing a SIM card, follow these instructions to determine the correct SIM card size for your computer.

1. Go to <http://www.hp.com/support>, and then search for your computer by product name or number.
2. Select **Product Information**.
3. Refer to the listed options to determine which card to purchase.

## Inserting a nano SIM card

To insert a nano SIM card, follow these steps.

1. Turn off the computer by using the **Shut down** command.
2. Position the computer display-side up on a flat surface.
3. Press in gently on the SIM card access tray to disengage the SIM lock, and the tray pops out of the slot (**1**).
4. Remove the tray (**2**) from the computer and insert the card (**3**).
5. Replace the tray in the computer. Press in gently on the tray (**4**) until it is firmly seated.

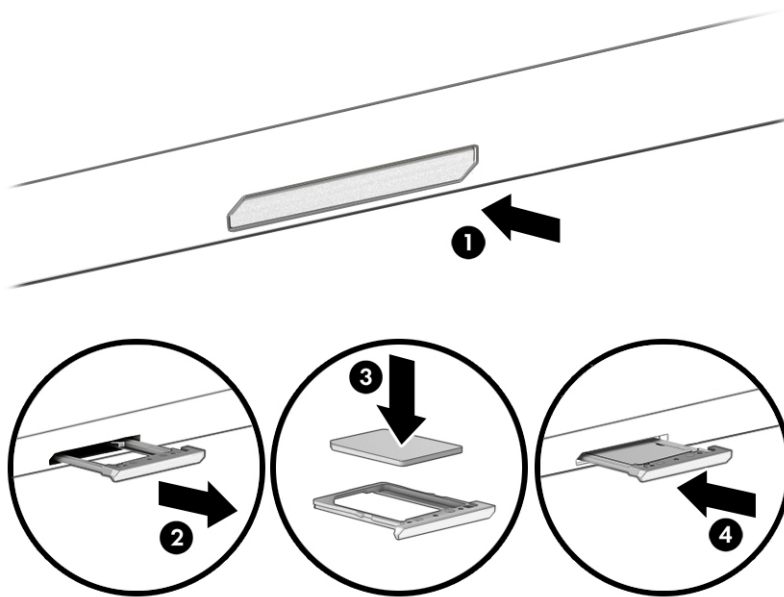

To remove the SIM card, press in gently on the SIM card access tray to disengage the SIM lock, and the tray pops out of the slot. Remove the SIM card. Replace the tray in the computer and press in gently on the tray until it is firmly seated.



# 3 Illustrated parts catalog

Use this chapter to determine the spare parts that are available for the computer.

## Computer major components

To identify the computer major components, use this illustration and table.

**NOTE:** HP continually improves and changes product parts. For complete and current information about supported parts for your computer, go to <http://partsurfer.hp.com>, select your country or region, and then follow the on-screen instructions.

**NOTE:** Details about your computer, including model, serial number, product key, and length of warranty, are on the service tag at the bottom of your computer.

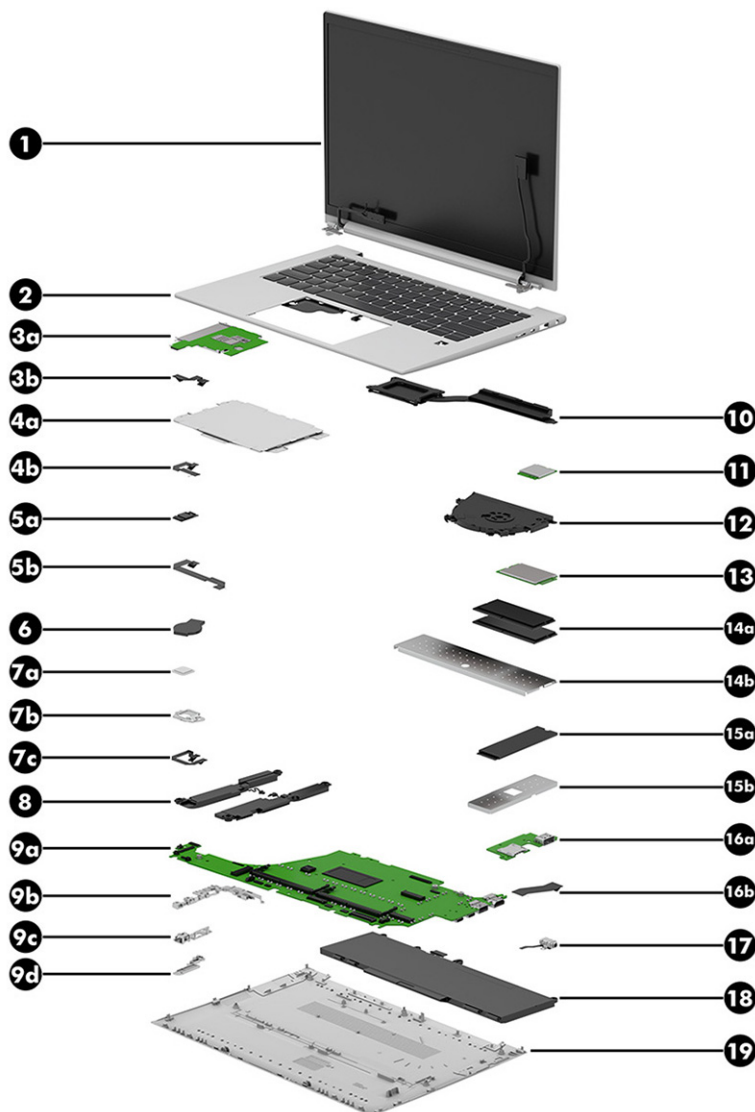

**Table 3-1 Computer major component descriptions and part numbers**

Item	Component	Spare part number
(1)	<b>Display assembly:</b> WUXGA display spare parts are available only as subcomponents. WQXGA display assemblies are available only as whole units. For display spare part information, see <a href="#">Display assembly subcomponents on page 22</a> .	N50660-001
(2)	<b>Top cover with keyboard</b> (includes backlight cable and keyboard cable)  <b>NOTE:</b> For a detailed list of country codes, see <a href="#">Keyboard with top cover on page 72</a> .	
	Backlit	N45442-xxx
	Backlit, privacy	N45443-xxx
	Not backlit	N45444-xxx
(3a)	<b>Card reader</b>	N02323-001
(3b)	<b>Card reader cable:</b> Included in the Cable Kit, spare part number N09040-001.	
(4a)	<b>Touchpad</b>	
	Touchpad with NFC module antenna	N15436-001
	Touchpad without NFC module antenna	N09033-001
(4b)	<b>Touchpad cable:</b> Included in the Cable Kit, spare part number N09040-001.	
(5a)	<b>NFC module</b>	M08706-001
(5b)	<b>NFC module cable:</b> Included in the Cable Kit, spare part number N09040-001.	
(6)	<b>RTC battery</b> (includes cable and double-sided adhesive)	N15765-001
(7a)	<b>Fingerprint reader</b>	N02325-001
(7b)	<b>Fingerprint reader bracket:</b> Included in the Bracket Kit, spare part number N53566-001.	
(7c)	<b>Fingerprint reader cable:</b> Included in the Cable Kit, spare part number N09040-001.	
(8)	<b>Speakers</b> (include cables, left and right speakers, and 4 rubber isolators)	N09034-001
(9a)	<b>System board</b> (includes integrated processor, UMA graphics subsystem, and replacement thermal material)  All system boards use the following part numbers:  xxxxxx-001: Non-Windows operating systems  xxxxxx-601: Windows operating system	
	Intel Core i7-1370P	N43988-xx1
	Intel Core i7-1370P, OSR	N43989-xx1
	Intel Core i7-1360P	N43987-xx1
	Intel Core i5-1350P	N43986-xx1
	Intel Core i5-1350P, OSR	N43985-xx1
	Intel Core i5-1340P	N43984-xx1
	Intel Core i7-1365U	N45155-xx1
	Intel Core i7-1365U, OSR	N45156-xx1
	Intel Core i7-1355U	N45154-xx1
	Intel Core i7-1345U	N45153-xx1

**Table 3-1 Computer major component descriptions and part numbers (continued)**

Item	Component	Spare part number
	Intel Core i7-1345U, OSR	N45152-xx1
	Intel Core i5-1335U	N45151-xx1
<b>(9b - 9d)</b>	<b>I/O brackets:</b> Included in the Bracket Kit, spare part number N53566-001.	
<b>(10)</b>	<b>Heat sink</b> (includes replacement thermal material)	
	For use with models with a 28 W processor	N07345-001
	For use with models with a 15 W processor	N07344-001
<b>(11)</b>	<b>WLAN module</b>	
	Intel AX211 Wi-Fi® 6e + Bluetooth® 5.3	M53366-001
	Intel AX211 Wi-Fi 6E + Bluetooth 5.3 vPro®	M53363-001
<b>(12)</b>	<b>Fan</b> (includes cable and captive screws)	
	For use on computer models equipped with a 28 W processor	N09036-001
	For use on computer models equipped with a 15 W processor	N09035-001
<b>(13)</b>	<b>WWAN module</b>	
	Intel XMM 7560 R+ LTE-Advanced Pro (Cat 16) WWAN module	N00182-001
	Intel 5000 5G Solution WWAN	N00181-001
<b>(14a)</b>	<b>Memory module</b> (SODIMM, DDR5-4800, 1.1v, NECC)	
	32 GB	N05331-001
	16 GB	M97596-001
	8 GB	M97595-001
<b>(14b)</b>	<b>Memory module shield:</b> Included in the Bracket Kit, spare part number N53566-001.	
<b>(15a)</b>	<b>Solid-state drive</b>	
	2 TB, PCIe-4×4, ZTurbo, TLC	M52027-001
	1 TB, PCIe-4×4, TLC	M16560-001
	1 TB, PCIe-4×4, SED, TLC	N23415-001
	512 GB, PCIe-4×4, TLC	M17436-001
	512 GB, PCIe-4×4, SED, TLC	M52031-001
	512 GB, PCIe-4×4	N04490-001
	256 GB, PCIe-4×4, SED, TLC	N35225-001
	256 GB, PCIe-4×4	N45477-001
<b>(15b)</b>	<b>Solid-state drive shield:</b> Included in the Bracket Kit, spare part number N53566-001.	
<b>(16a)</b>	<b>Connector board</b> (includes USB port and SIM card slot)	
		N09042-001
	<b>NOTE:</b> The I/O bracket is included in the Bracket Kit, spare part number N53566-001.	
<b>(16b)</b>	<b>Connector board cable:</b> Included in the Cable Kit, spare part number N09040-001.	

**Table 3-1 Computer major component descriptions and part numbers (continued)**

<b>Item</b>	<b>Component</b>	<b>Spare part number</b>
<b>(17)</b>	<b>Audio jack</b> (included in the Cable Kit)	N9040-001
<b>(18)</b>	<b>Battery</b> (includes cable)	
	3 cell, 51 Whr, 4.68 Ahr	M73466-005
	3 cell, 38 Whr, 3.525 Ahr	M73468-005
	3 cell, 38 Whr, 3.535 Ahr	N22347-005
<b>(19)</b>	<b>Bottom cover</b>	
	For use on models with WWAN	N55375-001
	For use on models without WWAN	N09026-001

## Display assembly subcomponents

To identify the display assembly subcomponents, use this illustration and table.

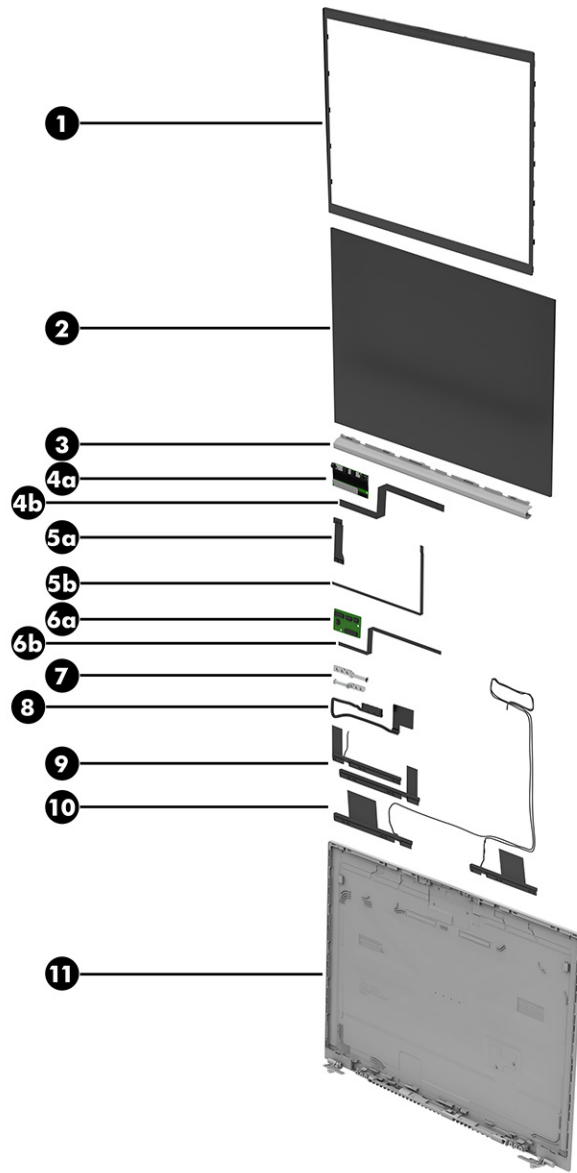

**Table 3-2** Display component descriptions and part numbers

Item	Component	Spare part number
(1)	<b>Display bezel</b>	
	For use on display assemblies with infrared	N09021-001
	For use on display assemblies with infrared and ACS	N09024-001
	For use on display assemblies with a microphone	N09023-001
	For use on display assemblies with RGB	N09022-001
	For use on display assemblies with RGB and ACS	N09025-001
(2)	<b>Display panel</b>	
	WUXGA, nontouch; typical brightness: 250 nits	N22325-001

**Table 3-2 Display component descriptions and part numbers (continued)**

<b>Item</b>	<b>Component</b>	<b>Spare part number</b>
	WUXGA, nontouch; typical brightness: 250 nits	N22326-001
	WUXGA, touch; typical brightness: 250 nits	N22327-001
	WUXGA, nontouch, privacy; typical brightness: 1000 nits	N22328-001
	WQXGA, nontouch; typical brightness: 500 nits	N50660-001
<b>(3)</b>	<b>Display hinge cover</b> (available in the Hinge Kit)	N50659-001
<b>(4a)</b>	<b>Webcam module</b>	
	Infrared	N48855-001
	HD	N48854-001
<b>(4b)</b>	<b>Webcam module cable:</b> Included in the Panel Cable Kit, spare part number N09039-001.	
<b>(5a)</b>	<b>Microphone module</b>	N15440-001
<b>(5b)</b>	<b>Microphone module cable:</b> Included in the Panel Cable Kit, spare part number N09039-001.	
<b>(6a)</b>	<b>Display transfer board</b>	
	For use on computer models equipped with a display assembly with infrared	N08541-001
	For use on computer models equipped with a display assembly with RGB	N08542-001
<b>(6b)</b>	<b>Transfer board cable:</b> Included in the Panel Cable Kit, spare part number N09039-001.	
<b>(7)</b>	<b>Display hinges</b> (includes left and right hinges)	N50659-001
<b>(8)</b>	<b>Display panel cable:</b> Included in the Display Cable Kit, spare part number N55374-001.	
<b>(9)</b>	<b>WWAN antenna:</b> Included in display back cover spare part kit.	
<b>(10)</b>	<b>WLAN antenna:</b> Included in display back cover spare part kit.	
<b>(11)</b>	<b>Display back cover</b> (includes wireless antennas)	
	For use in models with WLAN and WWAN and panel brightness of 1000 or 400 nits	N09020-001
	For use in models with WLAN and WWAN and panel brightness of 250 nits	N09019-001
	For use in models with WLAN and without WWAN and panel brightness of 1000 or 400 nits	N49585-001
	For use in models with WLAN and without WWAN and panel brightness of 250 nits	N49584-001
*	<b>Display Cable Kit</b> (includes display cable and IR hub board)	N55374-001
*	<b>Panel Cable Kit</b> (includes cables for ACS, ALS, ALS panel, microphone, RGB webcam, IR webcam, hub board)	N09039-001
*	<b>LCD Support Kit</b> (includes fixture, tape, and rubber bumper)	N19298-001
*	<b>ACS board</b>	N08540-001
	* not illustrated	

## Cables

To identify the cables, use this illustration and table.

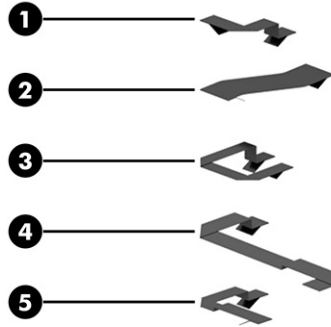

**Table 3-3** Cable descriptions and part numbers

Item	Component	Spare part number
The cables listed below are included in the Cable Kit, spare part number N09040-001.		
(1)	Card reader cable	
(2)	Connector board cable	
(3)	Fingerprint reader cable	
(4)	NFC module cable	
(5)	Touchpad cable	

## Miscellaneous parts

To identify the miscellaneous parts, use this table.

**Table 3-4** Miscellaneous part descriptions and part numbers

Component	Spare part number
<b>AC adapter</b>	
280 W AC adapter (PFC, slim, 3P 7.4 mm)	M52952-001
120 W HP Smart Adapter (PFC, slim, 7.4 mm)	L89695-001
120 W HP Smart Adapter (PFC, RC, 4.5 mm)	M95377-001
65 W AC adapter (USB Type-C, nPFC, 1.8 m (6.0 ft))	L67440-001
65 W AC adapter (USB Type-C, nPFC, slim, 1.8 m (6.0 ft))	M54350-001
65 W AC adapter (USB Type-C)	N05175-001
45 W AC adapter (USB Type-C, nPFC, 1.8 m (6.0 ft))	L43407-001
<b>Adapter</b>	
HP HDMI-to-VGA adapter	701943-001
HP USB 3.0-to-Gigabit RJ-45 adapter	M95984-001
HP USB Type-C-to-DisplayPort adapter	831753-001
HP USB Type-C-to-RJ-45 adapter	M95985-001

**Table 3-4 Miscellaneous part descriptions and part numbers (continued)**

<b>Component</b>	<b>Spare part number</b>
HP USB Type-C-to-VGA adapter	831751-001
USB Type-C-to-USB Type-A adapter connector	L65254-001
USB-C-to-HDMI 2.0 adapter	935325-001
USB-C-to-USB 3.0 adapter	814618-001
<b>Thermal pad</b>	N15920-001
<b>HP Sure Key Cable Lock</b>	L65088-001
<b>HP Nano Lock</b>	918431-001
<b>HP 128 Laser Wired Mouse</b>	M27885-001
<b>HP 435 Wireless Mouse</b>	M62277-001
<b>Bracket Kit</b> (includes connector board I/O bracket, fingerprint reader bracket, memory module shield, SIM bracket, and solid-state drive shield)	N53566-001
<b>Screw Kit</b>	N15474-001
<b>Cable</b>	
USB Type-C male-to-USB Type-C male cable (1.0 m [3.0 ft])	L65253-001
HP Thunderbolt 4 120 W cable (0.8m [2.7 ft])	M88058-001
HP Thunderbolt 4 280 W cable (0.8m [2.7 ft])	M88059-001
<b>Dock</b>	
HP Thunderbolt 280 W G4 dock with combination cable	M97106-001
HP Thunderbolt 280 W G4 dock with combination cable, TAA	N17491-001
HP Thunderbolt 120 W G4 with cable	M97105-001
HP Thunderbolt 120 W G4 with cable, TAA	N17490-001
HP 120 W Thunderbolt dock with cable	L15809-001
HP USB Type-A/C universal dock with cable	L64087-001
HP USB Type-C dock with cable	L64086-001
HP Universal USB-C Multiport Hub	M96882-001
<b>Bottom case, USB-C/A Universal Dock</b>	L64088-001
<b>Bottom case, USB-C Dock</b>	L65256-001
<b>Screw Kit for USB-C/A Universal Dock</b>	L64089-001
<b>HP Elite USB-C Multi Port Hub</b>	L39572-001
<b>HP USB External DVD+-RW Drive</b>	747080-001
<b>HP USB Type-C-to-USB Type-A hub</b>	916838-001
<b>HP USB keyboard for use in the United States</b>	L95712-001
<b>HP USB slim smart card keyboard</b>	911725-001
<b>Mouse</b>	
HP Bluetooth travel mouse	L62043-001



**Table 3-4 Miscellaneous part descriptions and part numbers (continued)**

<b>Component</b>	<b>Spare part number</b>
HP USB mouse	L95713-001
<b>Plastics Kit</b> (includes card reader space holder, fingerprint reader space holder, left and right I/O space holders, and SIM space holder)	N09031-001
<b>HP Business 14.1 Laptop bag</b>	M55007-001
<b>HP 14.1 Business Slim Top Load case</b>	L05333-001
<b>Power cord, duck head</b>	
For use in Japan	L33157-001
<b>Power cord</b> (C13, 1.0 m [3.3 ft], premium with tag)	
For use in Argentina	L32029-001
For use in Brazil	L32030-001
For use in Italy	L32031-001
<b>Power cord</b> (C13, 1.0 m [3.3 ft], LW, premium with tag)	
For use in Australia	N24670-001
For use in Denmark	N24672-001
For use in Europe	N24669-001
For use in India	N24679-001
For use in Israel	N24678-001
For use in Japan	N24680-001
For use in North America	N24671-001
For use in the People's Republic of China	N24676-001
For use in South Africa	N24674-001
For use in South Korea	N24675-001
For use in Switzerland	N24673-001
For use in Taiwan	N24677-001
For use in the United Kingdom	N24668-001
<b>Power cord</b> (C5, 1.0 m [3.3 ft], conventional with sticker)	
For use in Argentina	L19357-001
For use in Australia	L19358-001
For use in Brazil	L19359-001
For use in Denmark	L19360-001
For use in Denmark, HF	M79264-001
For use in Europe	L19361-001
For use in Europe; HF	M79266-001
For use in India	L19363-001
For use in Israel	L19362-001

**Table 3-4 Miscellaneous part descriptions and part numbers (continued)**

<b>Component</b>	<b>Spare part number</b>
For use in Italy	L19364-001
For use in Japan	L19365-001
For use in North America	L19367-001
For use in the People's Republic of China	L19368-001
For use in South Africa	L19369-001
For use in South Korea	L19366-001
For use in Switzerland	L19370-001
For use in Switzerland, HF	M79265-001
For use in Taiwan	L19372-001
For use in Thailand	L19371-001
For use in Thailand (bundle)	M85418-001
For use in the United Kingdom	L19373-001
<b>Power cord (C5, 1.0 m [3.3 ft], premium with sticker)</b>	
For use in Argentina	L30811-001
For use in Australia	L22327-001
For use in Brazil	L30812-001
For use in Denmark	L22322-001
For use in Europe	L22321-001
For use in India	L22624-001
For use in Israel	L22323-001
For use in Italy	L30813-001
For use in Japan	L22330-001
For use in North America	L22319-001
For use in the People's Republic of China	L21930-001
For use in South Africa	L22325-001
For use in South Korea	L22328-001
For use in Switzerland	L22324-001
For use in Taiwan	L22329-001
For use in Thailand	L22326-001
For use in the United Kingdom	L22320-001
<b>Power cord (C5, 1.8 m [6.0 ft], conventional with sticker)</b>	
For use in Argentina	L19357-002
For use in Australia	L19358-002
For use in Brazil	L19359-002

**Table 3-4** Miscellaneous part descriptions and part numbers (continued)

<b>Component</b>	<b>Spare part number</b>
For use in Brazil	L19341-002
For use in Denmark	L19360-002
For use in Europe	L19361-002
For use in India	L19363-002
For use in Israel	L19362-002
For use in Italy	L19364-002
For use in Japan	L19365-002
For use in North America	L19367-002
For use in the People's Republic of China	L19368-002
For use in South Africa	L19369-002
For use in South Korea	L19366-002
For use in Switzerland	L19370-002
For use in Taiwan	L19372-002
For use in Thailand	L19371-002
For use in the United Kingdom	L19373-002

---

# 4 Removal and replacement procedures preliminary requirements

Use this information to properly prepare to disassemble and reassemble the computer.

## Tools required

You need the following tools to complete the removal and replacement procedures:

- Tweezers
- Nonconductive, nonmarking pry tool
- Magnetic Phillips P1 screwdriver

## Service considerations

The following sections include some of the considerations that you must keep in mind during disassembly and assembly procedures.

---

 **NOTE:** As you remove each subassembly from the computer, place the subassembly (and all accompanying screws) away from the work area to prevent damage.

---

## Plastic parts

Using excessive force during disassembly and reassembly can damage plastic parts.

## Cables and connectors

Handle cables with extreme care to avoid damage.

---

 **IMPORTANT:** When servicing the computer, be sure that cables are placed in their proper locations during the reassembly process. Improper cable placement can damage the computer.

---

Apply only the tension required to unseat or seat the cables during removal and insertion. Handle cables by the connector whenever possible. In all cases, avoid bending, twisting, or tearing cables. Be sure that cables are routed so that they cannot be caught or snagged as you remove or replace parts. Handle flex cables with extreme care; these cables tear easily.

## Drive handling

Note the following guidelines when handling drives.

---

 **IMPORTANT:** Drives are fragile components. Handle them with care. To prevent damage to the computer, damage to a drive, or loss of information, observe these precautions:

- Before removing or inserting a hard drive, shut down the computer. If you are unsure whether the computer is off or in Hibernation, turn the computer on, and then shut it down through the operating system.

- Before handling a drive, be sure that you are discharged of static electricity. While handling a drive, avoid touching the connector.
  - Before removing an optical drive, be sure that a disc is not in the drive, and be sure that the optical drive tray is closed.
  - Handle drives on surfaces covered with at least 2.54 cm (1 inch) of shock-proof foam.
  - Avoid dropping drives from any height onto any surface.
  - After removing a hard drive or an optical drive, place it in a static-proof bag.
  - Avoid exposing an internal hard drive to products that have magnetic fields, such as monitors or speakers.
  - Avoid exposing a drive to temperature extremes or liquids.
  - If a drive must be mailed, place the drive in a bubble pack mailer or other suitable form of protective packaging, and label the package "FRAGILE."
- 

## Electrostatic discharge information

A sudden discharge of static electricity from your finger or other conductor can destroy static-sensitive devices or microcircuitry. Often the spark is neither felt nor heard, but damage occurs. An electronic device exposed to electrostatic discharge (ESD) might not appear to be affected at all and can work perfectly throughout a normal cycle. The device might function normally for a while, but it has been degraded in the internal layers, reducing its life expectancy.

Networks built into many integrated circuits provide some protection, but in many cases, the discharge contains enough power to alter device parameters or melt silicon junctions.

---

 **IMPORTANT:** To prevent damage to the device when you remove or install internal components, observe these precautions:

- Keep components in their electrostatic-safe containers until you are ready to install them.
  - Before touching an electronic component, discharge static electricity by using the guidelines described in [Personal grounding methods and equipment on page 32](#).
  - Avoid touching pins, leads, and circuitry. Handle electronic components as little as possible.
  - If you remove a component, place it in an electrostatic-safe container.
- 

## Generating static electricity

Follow these static electricity guidelines:

- Different activities generate different amounts of static electricity.
- Static electricity increases as humidity decreases.

**Table 4-1 Static electricity occurrence based on activity and humidity**

Event	Relative humidity		
	55%	40%	10%
Walking across carpet	7,500 V	15,000 V	35,000 V
Walking across vinyl floor	3,000 V	5,000 V	12,000 V
Motions of bench worker	400 V	800 V	6,000 V
Removing dual in-line packages (DIPs) from plastic tube	400 V	700 V	2,000 V
Removing DIPs from vinyl tray	2,000 V	4,000 V	11,500 V
Removing DIPs from polystyrene foam	3,500 V	5,000 V	14,500 V
Removing bubble pack from PCB (printed circuit board)	7,000 V	20,000 V	26,500 V
Packing PCBs in foam-lined box	5,000 V	11,000 V	21,000 V
Multiple electric components can be packaged together in plastic tubes, trays, or polystyrene foam.			



**NOTE:** As little as 700 V of static electricity can degrade a product.

## Preventing electrostatic damage to equipment

Many electronic components are sensitive to ESD. Circuitry design and structure determine the degree of sensitivity.

The following packaging and grounding precautions are necessary to prevent static electricity damage to electronic components:

- To avoid hand contact, transport products in static-safe containers such as tubes, bags, or boxes.
- Protect all electrostatic parts and assemblies with conductive or approved containers or packaging.
- Keep electrostatic-sensitive parts in their containers until they arrive at static-free stations.
- Place items on a grounded surface before removing them from their container.
- Always be properly grounded when touching a sensitive component or assembly.
- Avoid contact with pins, leads, or circuitry.
- Place reusable electrostatic-sensitive parts from assemblies in protective packaging or conductive foam.

## Personal grounding methods and equipment

Using certain equipment can prevent static electricity damage to electronic components.

- **Wrist straps** are flexible straps with a maximum of  $1\text{ M}\Omega \pm 10\%$  resistance in the ground cords. To provide proper ground, a strap must be worn snug against bare skin. The ground cord must be connected and fit snugly into the banana plug connector on the grounding mat or workstation.
- You can use **heel straps, toe straps, and boot straps** at standing workstations. These straps are compatible with most types of shoes or boots. On conductive floors or dissipative floor mats, use them on both feet with a maximum of  $1\text{ M}\Omega \pm 10\%$  resistance between the operator and ground.

**Table 4-2 Static shielding protection levels**

Static shielding protection levels	
Method	Voltage
Antistatic plastic	1,500
Carbon-loaded plastic	7,500
Metallized laminate	15,000

## Grounding the work area

To prevent static damage at the work area, follow these precautions:

- Cover the work surface with approved static-dissipative material.
- Use a wrist strap connected to a properly grounded work surface and use properly grounded tools and equipment.
- Use static-dissipative mats, foot straps, or air ionizers to give added protection.
- Handle electrostatic sensitive components, parts, and assemblies by the case or PCB laminate. Handle them only at static-free work areas.
- Turn off power and input signals before inserting and removing connectors or test equipment.
- Use fixtures made of static-safe materials when fixtures must directly contact dissipative surfaces.
- Keep the work area free of nonconductive materials, such as ordinary plastic assembly aids and polystyrene foam.
- Use conductive field service tools, such as cutters, screwdrivers, and vacuums.
- Avoid contact with pins, leads, or circuitry.

## Recommended materials and equipment

HP recommends certain materials and equipment to prevent static electricity:

- Antistatic tape
- Antistatic smocks, aprons, or sleeve protectors
- Conductive bins and other assembly or soldering aids
- Conductive foam
- Conductive tabletop workstations with ground cord of  $1\text{ M}\Omega \pm 10\%$  resistance
- Static-dissipative table or floor mats with hard tie to ground
- Field service kits
- Static awareness labels
- Wrist straps and footwear straps providing  $1\text{ M}\Omega \pm 10\%$  resistance
- Material handling packages

- Conductive plastic bags
- Conductive plastic tubes
- Conductive tote boxes
- Opaque shielding bags
- Transparent metallized shielding bags
- Transparent shielding tubes

## Cleaning your computer

Cleaning your computer regularly removes dirt and debris so that your device continues to operate at its best. Use the following information to safely clean the external surfaces of your computer.

### Enabling HP Easy Clean (select products only)

HP Easy Clean helps you to avoid accidental input while you clean the computer surfaces. This software disables devices such as the keyboard, touch screen, and touchpad for a preset amount of time so that you can clean all computer surfaces.

1. Start HP Easy Clean in one of the following ways:
  - Select the **Start** menu, and then select **HP Easy Clean**.
  - or -
  - Select the **HP Easy Clean** icon in the taskbar.
  - or -
  - Select **Start**, and then select the **HP Easy Clean** tile.
2. Now that your device is disabled for a short period, see [Removing dirt and debris from your computer on page 34](#) for the recommended steps to clean the high-touch, external surfaces on your computer. After you remove the dirt and debris, you can also clean the surfaces with a disinfectant. See [Cleaning your computer with a disinfectant on page 35](#) for guidelines to help prevent the spread of harmful bacteria and viruses.

### Removing dirt and debris from your computer

Here are the recommended steps to clean dirt and debris from your computer.

For computers with wood veneer, see [Caring for wood veneer \(select products only\) on page 36](#).

1. Wear disposable gloves made of latex (or nitrile gloves, if you are latex-sensitive) when cleaning the surfaces.
2. Turn off your device and unplug the power cord and other connected external devices. Remove any installed batteries from items such as wireless keyboards.

---

 **CAUTION:** To prevent electric shock or damage to components, never clean a product while it is turned on or plugged in.

---



3. Moisten a microfiber cloth with water. The cloth should be moist, but not dripping wet.

---

 **IMPORTANT:** To avoid damaging the surface, avoid abrasive cloths, towels, and paper towels.

---

4. Wipe the exterior of the product gently with the moistened cloth.

---

 **IMPORTANT:** Keep liquids away from the product. Avoid getting moisture in any openings. If liquid makes its way inside your HP product, it can cause damage to the product. Do not spray liquids directly on the product. Do not use aerosol sprays, solvents, abrasives, or cleaners containing hydrogen peroxide or bleach that might damage the finish.

---

5. Start with the display (if applicable). Wipe carefully in one direction, and move from the top of the display to the bottom. Finish with any flexible cables, like power cord, keyboard cable, and USB cables.
6. Be sure that surfaces have completely air-dried before turning the device on after cleaning.
7. Discard the gloves after each cleaning. Clean your hands immediately after you remove the gloves.

See [Cleaning your computer with a disinfectant on page 35](#) for recommended steps to clean the high-touch, external surfaces on your computer to help prevent the spread of harmful bacteria and viruses.

## Cleaning your computer with a disinfectant

The World Health Organization (WHO) recommends cleaning surfaces, followed by disinfection, as a best practice for preventing the spread of viral respiratory illnesses and harmful bacteria.

After cleaning the external surfaces of your computer using the steps in [Removing dirt and debris from your computer on page 34](#), [Caring for wood veneer \(select products only\) on page 36](#), or both, you might also choose to clean the surfaces with a disinfectant. A disinfectant that is within HP's cleaning guidelines is an alcohol solution consisting of 70% isopropyl alcohol and 30% water. This solution is also known as rubbing alcohol and is sold in most stores.

Follow these steps when disinfecting high-touch, external surfaces on your computer:

1. Wear disposable gloves made of latex (or nitrile gloves, if you are latex-sensitive) when cleaning the surfaces.
2. Turn off your device and unplug the power cord and other connected external devices. Remove any installed batteries from items such as wireless keyboards.

---

 **CAUTION:** To prevent electric shock or damage to components, never clean a product while it is turned on or plugged in.

---

3. Moisten a microfiber cloth with a mixture of 70% isopropyl alcohol and 30% water. The cloth should be moist, but not dripping wet.

---

 **CAUTION:** Do not use any of the following chemicals or any solutions that contain them, including spray-based surface cleaners: bleach, peroxides (including hydrogen peroxide), acetone, ammonia, ethyl alcohol, methylene chloride, or any petroleum-based materials, such as gasoline, paint thinner, benzene, or toluene.

---

 **IMPORTANT:** To avoid damaging the surface, avoid abrasive cloths, towels, and paper towels.

---

4. Wipe the exterior of the product gently with the moistened cloth.



**IMPORTANT:** Keep liquids away from the product. Avoid getting moisture in any openings. If liquid makes its way inside your HP product, it can cause damage to the product. Do not spray liquids directly on the product. Do not use aerosol sprays, solvents, abrasives, or cleaners containing hydrogen peroxide or bleach that might damage the finish.

5. Start with the display (if applicable). Wipe carefully in one direction, and move from the top of the display to the bottom. Finish with any flexible cables, like power cord, keyboard cable, and USB cables.
6. Be sure that surfaces have completely air-dried before turning the device on after cleaning.
7. Discard the gloves after each cleaning. Clean your hands immediately after you remove the gloves.

## Caring for wood veneer (select products only)

Your product might feature high-quality wood veneer. As with all natural wood products, proper care is important for best results over the life of the product. Because of the nature of natural wood, you might see unique variations in the grain pattern or subtle variations in color, which are normal.

- Clean the wood with a dry, static-free microfiber cloth or chamois.
- Avoid cleaning products containing substances such as ammonia, methylene chloride, acetone, turpentine, or other petroleum-based solvents.
- Do not expose the wood to sun or moisture for long periods of time.
- If the wood becomes wet, dry it by dabbing with an absorbent, lint-free cloth.
- Avoid contact with any substance that might dye or discolor the wood.
- Avoid contact with sharp objects or rough surfaces that might scratch the wood.

See [Removing dirt and debris from your computer on page 34](#) for the recommended steps to clean the high-touch, external surfaces on your computer. After you remove the dirt and debris, you can also clean the surfaces with a disinfectant. See [Cleaning your computer with a disinfectant on page 35](#) for sanitizing guidelines to help prevent the spread of harmful bacteria and viruses.

## Packaging and transporting guidelines

Follow these grounding guidelines when packaging and transporting equipment:

- To avoid hand contact, transport products in static-safe tubes, bags, or boxes.
- Protect ESD-sensitive parts and assemblies with conductive or approved containers or packaging.
- Keep ESD-sensitive parts in their containers until the parts arrive at static-free workstations.
- Place items on a grounded surface before removing items from their containers.
- Always be properly grounded when touching a component or assembly.
- Store reusable ESD-sensitive parts from assemblies in protective packaging or nonconductive foam.

- Use transporters and conveyors made of antistatic belts and roller bushings. Be sure that mechanized equipment used for moving materials is wired to ground and that proper materials are selected to avoid static charging. When grounding is not possible, use an ionizer to dissipate electric charges.

## Accessing support information

To find the HP support that you need, use this information.

**Table 4-3** Support information locations

Service consideration	Path to access information
Records of reported failure incidents stored on the computer	<p><b>Windows®:</b></p> <p>Preoperating system failures are logged in the BIOS Event Log. To view the BIOS Event Log:</p> <ol style="list-style-type: none"> <li>1. Press the power button.</li> <li>2. Immediately and repeatedly press <b>esc</b> when the power button light turns white.</li> </ol> <p><b>NOTE:</b> If you do not press <b>esc</b> at the appropriate time, you must restart the computer and again repeatedly press <b>esc</b> when the power button light turns white to access the utility.</p> <ol style="list-style-type: none"> <li>3. Press <b>f10</b> to enter the BIOS setup.</li> <li>4. (On commercial products) Under the <b>Main</b> tab, select <b>BIOS event log</b>, and then select <b>View BIOS Event Log</b>.</li> </ol> <p>- or -</p> <p>(On consumer products) Under the <b>Main</b> tab, select <b>System Log</b>.</p> <p>Post-operating system failures are logged in the Event Viewer.</p> <ol style="list-style-type: none"> <li>1. Turn on the computer and allow the operating system to open.</li> <li>2. Select the search icon  in the taskbar.</li> <li>3. Type <code>Event Viewer</code>, and then press <b>enter</b>.</li> <li>4. Select the log from the left panel. Details display in the right panel.</li> </ol> <p><b>Chrome™:</b></p> <ol style="list-style-type: none"> <li>1. Go to <a href="https://support.google.com/chrome">support.google.com/chrome</a>.</li> <li>2. Search <code>collect Chrome device logs</code>.</li> </ol>
Technical bulletins	<p>To locate technical bulletins:</p> <ol style="list-style-type: none"> <li>1. Go to <a href="https://www.hp.com">www.hp.com</a>.</li> <li>2. Place the cursor over <b>Problem solving</b> to display more options.</li> <li>3. Select <b>Support &amp; Troubleshooting</b>.</li> <li>4. Type the serial number, product number, or product name to go to the product support page.</li> <li>5. Select <b>Advisories</b> to view technical bulletins.</li> </ol>

**Table 4-3 Support information locations (continued)**

Service consideration	Path to access information
Repair professionals	To locate repair professionals: <ol style="list-style-type: none"><li data-bbox="676 310 1437 338">1. Go to <a href="http://www.hp.com">www.hp.com</a>.</li><li data-bbox="676 359 1437 386">2. Place the cursor over <b>Support resources</b> to display more options.</li><li data-bbox="676 407 1437 434">3. Select <b>Authorized service providers</b>.</li></ol>
Component and diagnosis information, failure detection, and required action	To locate diagnosis information and actions: <ol style="list-style-type: none"><li data-bbox="676 510 1437 537">1. Go to <a href="http://www.hp.com/go/techcenter/pcdiags">http://www.hp.com/go/techcenter/pcdiags</a>.</li><li data-bbox="676 558 1437 585">2. Select <b>Get Support</b>.</li><li data-bbox="676 606 1437 653">3. Near the bottom of the window, select <b>Notebook PCs</b>, and then select your location.</li></ol>

---

# 5 Removal and replacement procedures for authorized service provider parts

This chapter provides removal and replacement procedures for authorized service provider parts.

 **IMPORTANT:** Only an authorized service provider should access the components described in this chapter. Accessing these parts can damage the computer or void the warranty.

 **NOTE:** Details about your computer, including model, serial number, product key, and length of warranty, are on the service tag at the bottom of your computer.

---

## Component replacement procedures

To remove and replace computer components, use the procedures described in this section.

 **NOTE:** HP continually improves and changes product parts. For complete and current information about supported parts for your computer, go to <http://partsurfer.hp.com>, select your country or region, and then follow the on-screen instructions.

---

Make special note of each screw size and location during removal and replacement.

## Preparation for disassembly

To remove and replace computer components, use these procedures:

For initial safety procedures, see [Removal and replacement procedures preliminary requirements on page 30](#).

1. Turn off the computer. If you are unsure whether the computer is off or in Hibernation, turn the computer on, and then shut it down through the operating system.
2. Disconnect the power from the computer by unplugging the power cord from the computer.
3. Disconnect all external devices from the computer.

## Bottom cover

To remove the bottom cover, use this procedure and illustration.

**Table 5-1** Bottom cover description and part numbers

Description	Spare part number
Bottom cover for use on models with WWAN	N55375-001
Bottom cover for use on models without WWAN	N09026-001

Before removing the bottom cover, prepare the computer for disassembly (see [Preparation for disassembly on page 39](#)).

Remove the bottom cover:

1. Loosen the five Phillips captive screws that secure the bottom cover to the computer.

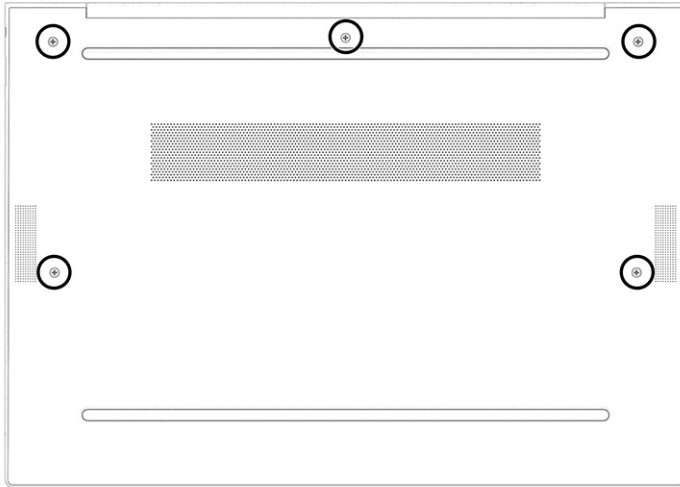

2. Use a nonmarking, nonconductive tool (1) to separate the rear edge of the bottom cover (2) from the computer.
3. Remove the bottom cover (3) from the computer.

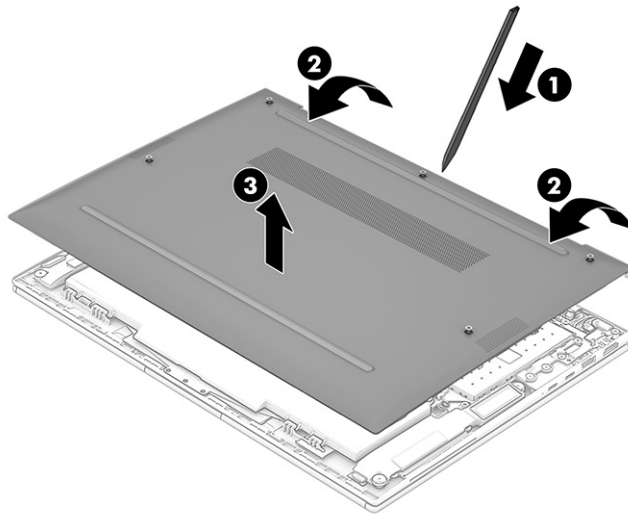

4. Thoroughly clean the thermal material from the surfaces of the WWAN module and the bottom cover each time the bottom cover is removed. Replacement thermal material is included with the bottom cover spare part kit. The following illustration shows the replacement thermal material locations.

A thermal pad is used on the WWAN module (1) and on the bottom cover area (2) that services it. The thermal pad is available as spare part number N15920-001.

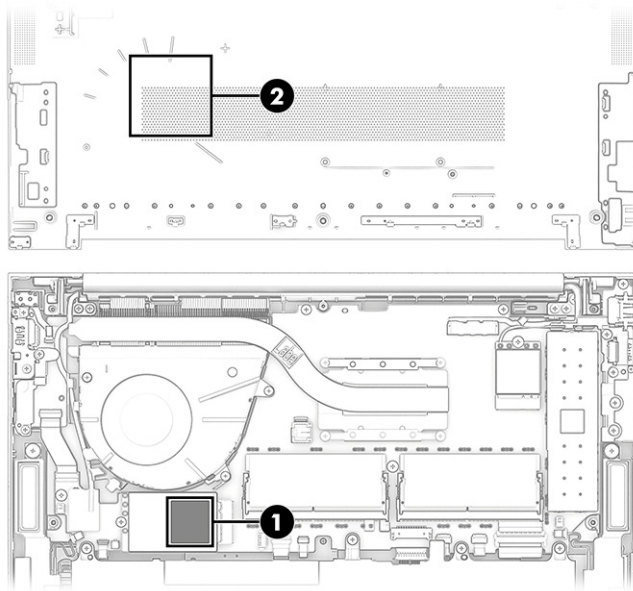

To replace the bottom cover, reverse the removal procedures.

## Battery

To remove the battery, use this procedure and illustration.

**Table 5-2 Battery description and part numbers**

Description	Spare part number
3 cell, 51 Whr, 4.68 Ahr	M73466-005
3 cell, 38 Whr, 3.525 Ahr	M73468-005
3 cell, 38 Whr, 3.535 Ahr	N22347-005

**⚠ WARNING!** To avoid personal injury and damage to the product:

- Do *not* puncture, twist, or crack the battery.
- Do *not* cause an external puncture or rupture to the battery. They can cause a short inside the battery, which can result in battery thermal runaway.
- Do *not* handle or touch the battery enclosure with sharp objects such as tweezers or pliers, which might puncture the battery.
- Do *not* compress or squeeze the battery case with tools or heavy objects stacked on top of the case. These actions can apply undue force on the battery.
- Do *not* touch the connectors with any metallic surface or object, such as metal tools, screws, or coins, which can cause shorting across the connectors.

Before removing the battery, follow these steps:

1. Prepare the computer for disassembly (see [Preparation for disassembly on page 39](#)).
2. Remove the bottom cover (see [Bottom cover on page 39](#)).

- ⚠ WARNING!** To reduce potential safety issues, use only the user-replaceable battery provided with the computer, a replacement battery provided by HP, or a compatible battery purchased from HP.
- 📄 IMPORTANT:** Removing a battery that is the sole power source for the computer can cause loss of information. To prevent loss of information, save your work or shut down the computer through Windows before you remove the battery.

Remove the battery:

1. Disconnect the battery cable (1) from the system board.
2. Remove the four Phillips M2.0 × 4.5 screws (2) that secure the battery to the computer.
3. Swing the rear edge of the battery (3) up and forward until it rests at an angle.
4. Remove the battery (4) by sliding it up and back at an angle.

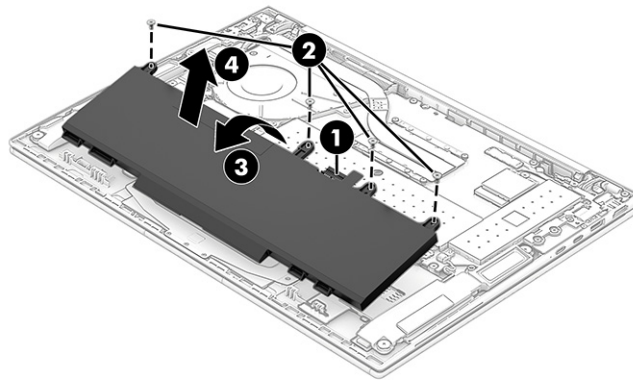

To insert the battery, reverse the removal procedures.

## WWAN module

To remove the WWAN module, use this procedure and illustration.

**Table 5-3 WWAN module description and part numbers**

Description	Spare part number
Intel XMM 7560 R+ LTE-Advanced Pro (Cat 16) WWAN module	N00182-001
Intel 5000 5G Solution WWAN	N00181-001

- 📄 IMPORTANT:** To prevent an unresponsive system, replace the wireless module only with a wireless module authorized for use in the computer by the governmental agency that regulates wireless devices in your country or region. If you replace the module and then receive a warning message, remove the module to restore device functionality, and then contact technical support.

Before removing the WWAN module, follow these steps:

1. Prepare the computer for disassembly (see [Preparation for disassembly on page 39](#)).
2. Remove the bottom cover (see [Bottom cover on page 39](#)).
3. Disconnect the battery cable from the system board (see [Battery on page 41](#)).



Remove the WWAN module:

1. Carefully disconnect the WWAN module antenna cables **(1)** from the WWAN module.

 **NOTE:** Computer models have one to four WWAN module antenna cables. The antenna cables have tags that identify them with a number that corresponds to a terminal on the WWAN module. Connect the antenna cable to the corresponding WWAN module terminal.

2. Remove the Phillips M2.0 × 2.5 screw **(2)**, and then remove the WWAN module **(3)**.

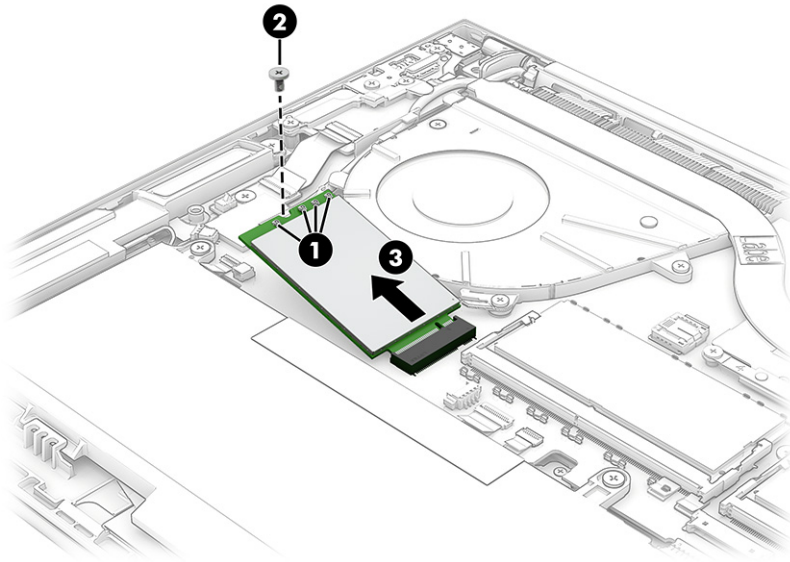

3. If the WWAN module antenna is not connected to the terminal on the WWAN module, install a protective sleeve on the antenna connector, as shown in the following illustration.

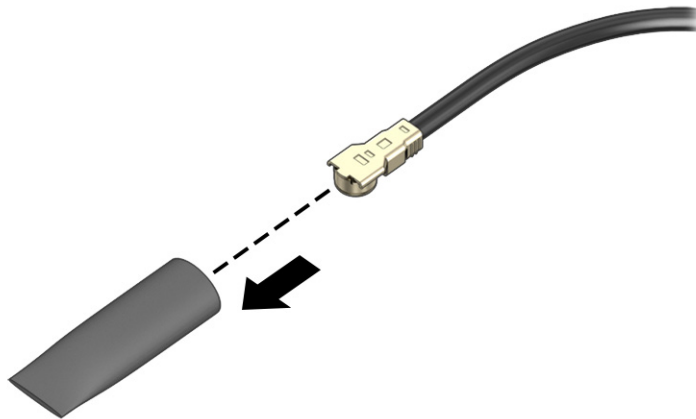

The install a WWAN module, reverse this procedure.

## WLAN module

To remove the WLAN module, use this procedure and illustration.

**Table 5-4 WLAN module descriptions and part numbers**

Description	Spare part number
Intel AX211 Wi-Fi 6e + Bluetooth 5.2 M.2 2230 160 MHz CNVi WW WLAN module	M53366-001
Intel AX211 Wi-Fi 6e + Bluetooth 5.2 M.2 2230 vPro 160 MHz CNVi WW WLAN module	M53363-001

 **IMPORTANT:** To prevent an unresponsive system, replace the wireless module only with a wireless module authorized for use in the computer by the governmental agency that regulates wireless devices in your country or region. If you replace the module and then receive a warning message, remove the module to restore device functionality, and then contact technical support.

Before removing the WLAN module, follow these steps:

1. Prepare the computer for disassembly (see [Preparation for disassembly on page 39](#)).
2. Remove the bottom cover (see [Bottom cover on page 39](#)).
3. Disconnect the battery cable from the system board (see [Battery on page 41](#)).

Remove the WLAN module:

1. Carefully disconnect the WLAN module antenna cables from the WLAN module (1).

 **NOTE:** Computer models have either one or two WLAN module antennas. On models with two antennas, the #1 white WLAN module antenna cable connects to the WLAN module #1 Main terminal. The #2 black WLAN module antenna cable connects to the WLAN module #1 Aux terminal.

2. Remove the Phillips M2.0 × 2.5 screw (2), and then remove the WLAN module (3).

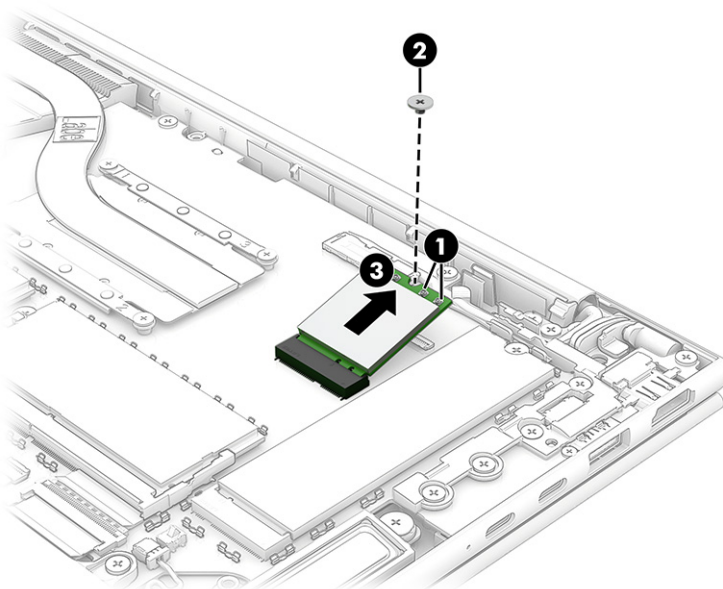

3. If the WLAN module antenna is not connected to the terminal on the WLAN module, install a protective sleeve on the antenna connector, as shown in the following illustration.

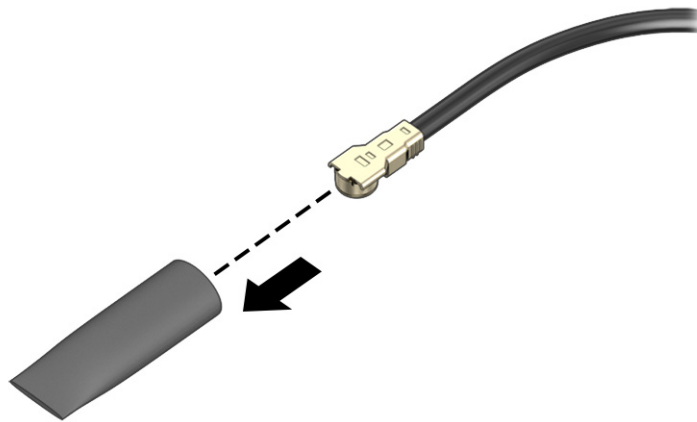

To install a WLAN module, reverse this procedure.

## Speakers

To remove the speakers, use this procedure and illustration.

**Table 5-5** Speakers description and part number

Description	Spare part number
Speakers (include cables, left and right speakers, and 4 rubber isolators)	N15439-001

Before removing the speakers, follow these steps:

1. Prepare the computer for disassembly (see [Preparation for disassembly on page 39](#)).
2. Remove the bottom cover (see [Bottom cover on page 39](#)).
3. Disconnect the battery cable from the system board (see [Battery on page 41](#)).

Remove the speakers:

1. Disconnect the speaker cables **(1)** from the system board.
2. Remove the four Phillips M2.0 × 2.4 broad head screws **(2)** that secure the speakers to the computer.
3. Remove the speakers from the computer **(3)**.

When removing the speakers, make note of the location of the four rubber isolator locations **(4)**. The absence of or damage to these isolators can result in degraded speaker performance.

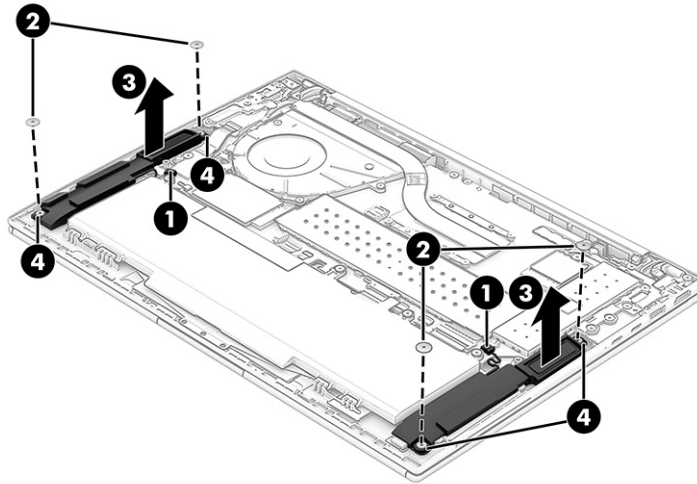

To install the speakers, reverse this procedure.

## Memory modules

To remove the memory modules, use this procedure and illustration.

**Table 5-6** Memory module descriptions and part numbers

Description	Spare part number
32 GB (SODIMM, DDR5-4800, 1.1v, NECC)	N05331-001
16 GB (SODIMM, DDR5-4800, 1.1v, NECC)	M97596-001
8 GB (SODIMM, DDR5-4800, 1.1v, NECC)	M97595-001
Memory module shield: Included in the Bracket Kit, spare part number N53566-001.	

Before removing the memory, follow these steps:

1. Prepare the computer for disassembly (see [Preparation for disassembly on page 39](#)).
2. Remove the bottom cover (see [Bottom cover on page 39](#)).
3. Disconnect the battery cable from the system board (see [Battery on page 41](#)).

If you are replacing a memory module, remove the existing memory module:

1. Remove the memory module shield.

The memory shield is included in the Bracket Kit, spare part number N53566-001.

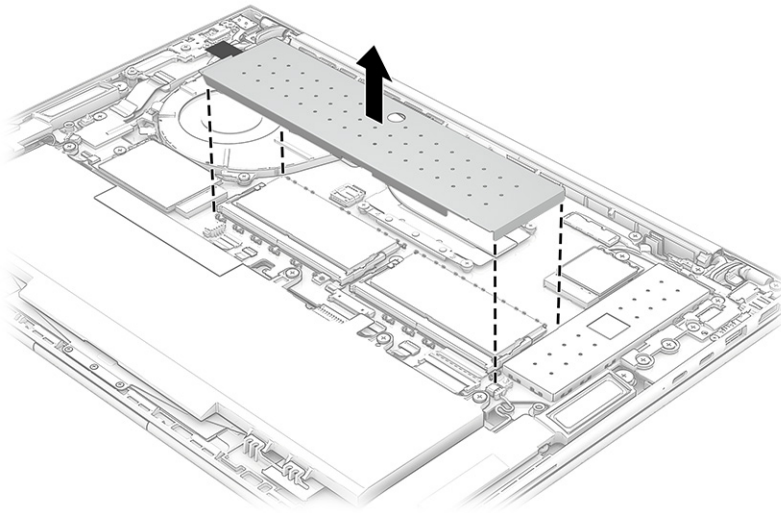

2. Spread the two retention clips outward **(1)** until the memory module tilts up at a 45° angle, and then remove the module **(2)**. Use the same procedure to remove all memory modules.

 **IMPORTANT:** To prevent damage to the memory module, hold the memory module by the edges only. Do not touch the components on the memory module.

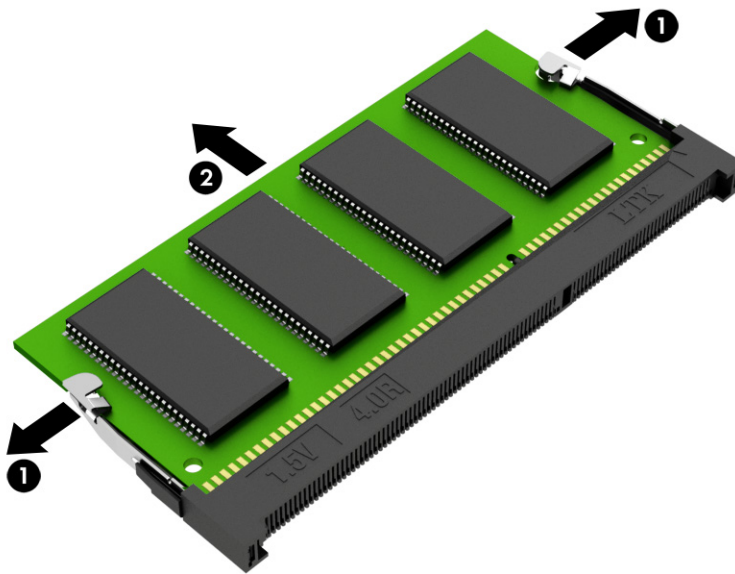

To protect a memory module after removal, place it in an electrostatic-safe container.

To install a memory module:

1. Align the notched edge of the module with the tab in the slot **(1)**, and then press the module into the slot at an angle until it is seated **(2)**.

2. Press down on the module until the side retention clips snap into place (3).

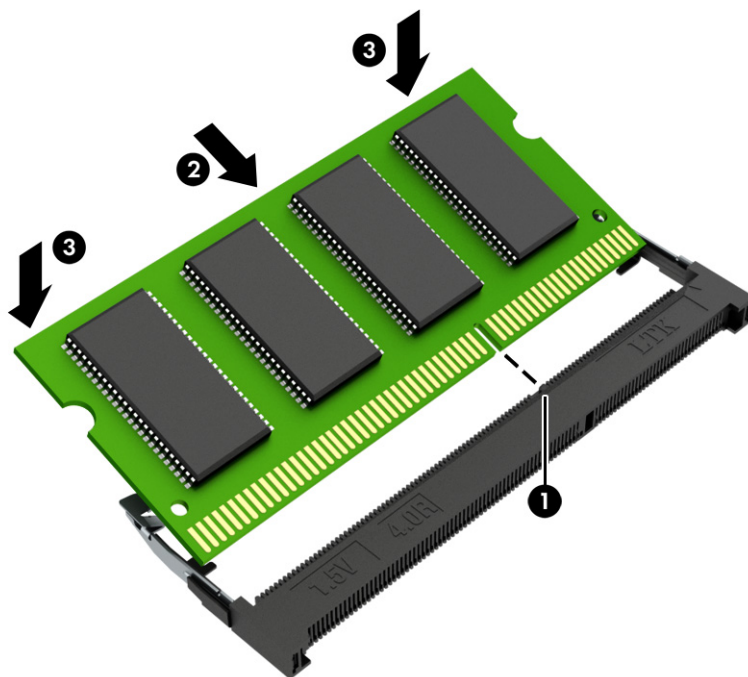

## Solid-state drive

To remove the M.2 solid-state drive, use this procedure and illustration.

**Table 5-7 Solid-state drive descriptions and part numbers**

Description	Spare part number
2 TB, PCIe-4x4, ZTurbo, TLC	M52027-001
1 TB, PCIe-4x4, TLC	M16560-001
1 TB, PCIe-4x4, SED, TLC	N23415-001
512 GB, PCIe-4x4, TLC	M17436-001
512 GB, PCIe-4x4, SED, TLC	M52031-001
512 GB, PCIe-4x4	N04490-001
256 GB, PCIe-4x4, SED, TLC	N35225-001
256 GB, PCIe-4x4	N45477-001
Solid-state drive shield (included in the Bracket Kit)	N53566-001

Before removing the solid-state drive, follow these steps:

1. Prepare the computer for disassembly (see [Preparation for disassembly on page 39](#)).
2. Remove the bottom cover (see [Bottom cover on page 39](#)).
3. Disconnect the battery cable from the system board (see [Battery on page 41](#)).

Remove the solid-state drive:

1. Remove the solid-state drive shield.

The solid-state drive shield is included in the Bracket Kit, spare part number N53566-001.

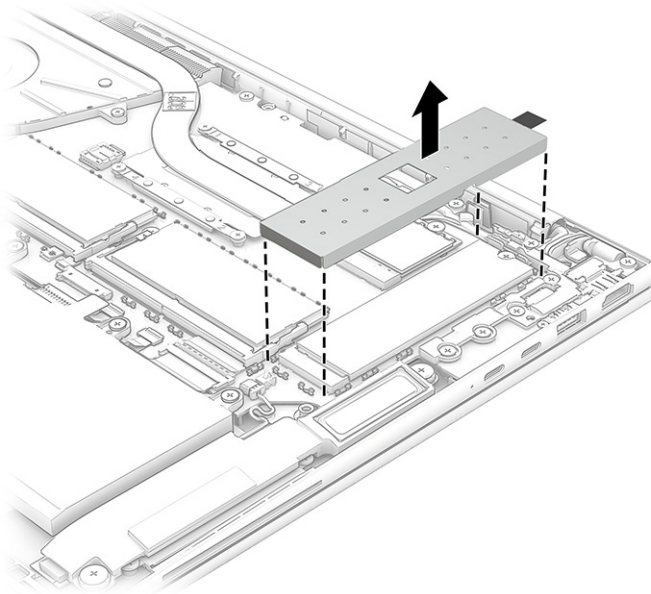

2. Thoroughly clean the thermal material from the surfaces of the solid-state drive and the solid-state drive shield each time the solid-state drive shield is removed. Replacement thermal material is included with the solid-state drive shield spare part kit. The following illustration shows the replacement thermal material locations.

A thermal pad is used on the solid-state drive **(1)** and on the solid-state drive shield area **(2)** that services it.

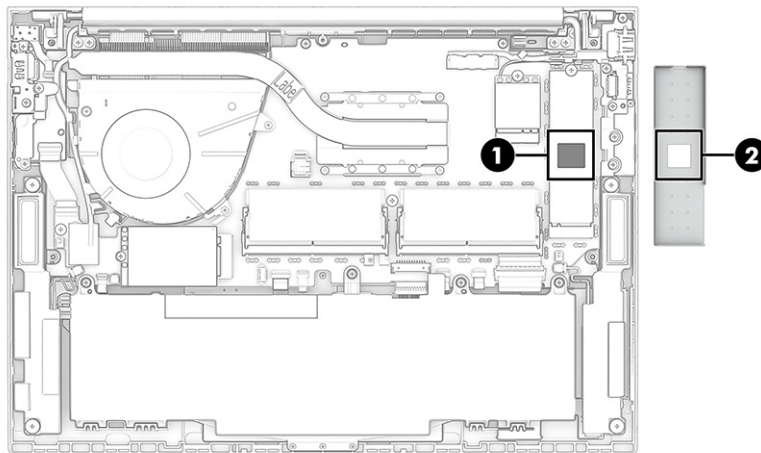

3. Remove the Phillips M2.0 × 2.5 screw (1), and then pull the drive away from the socket to remove it (2).

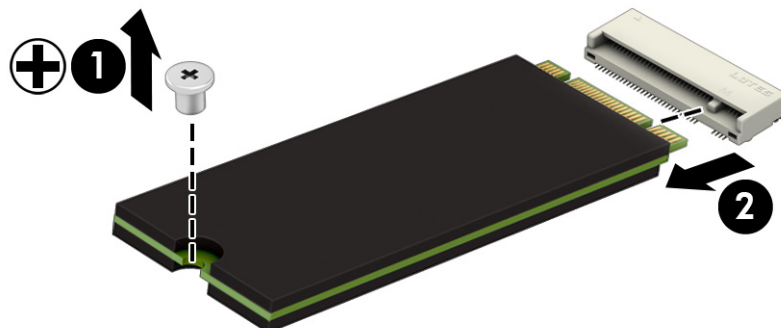

To install a solid-state drive, reverse the removal procedures.

 **NOTE:** Solid-state drives are designed with a notch to prevent incorrect insertion.

## RTC battery

To remove the RTC battery, use this procedure and illustration.

**Table 5-8** RTC battery description and part number

Description	Spare part number
RTC battery (includes cable and double-sided adhesive)	N15765-001

Before removing the RTC battery, follow these steps:

1. Prepare the computer for disassembly (see [Preparation for disassembly on page 39](#)).
2. Remove the bottom cover (see [Bottom cover on page 39](#)).
3. Remove the battery (see [Battery on page 41](#)).

Remove the RTC battery:

1. Disconnect the RTC battery cable (1) from the system board.



2. Detach the RTC battery (2) from the computer (The RTC battery is attached with double-sided adhesive.)

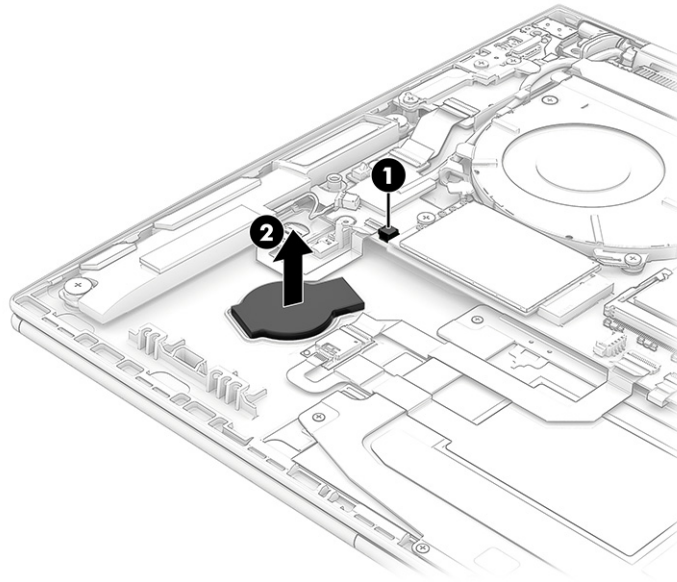

3. Remove the RTC battery.

To install the RTC battery, reverse this procedure.

## Fingerprint reader

To remove the fingerprint reader, use this procedure and illustration.

**Table 5-9** Fingerprint reader description and part number

Description	Spare part number
Fingerprint reader	N08532-001

**NOTE:** The fingerprint reader spare part kit does not include the fingerprint reader bracket or fingerprint reader cable. The fingerprint reader bracket is included in the Bracket Kit, spare part number N53566-001. The fingerprint reader cable is included in the Cable Kit, spare part number N09040-001.

Before removing the fingerprint reader, follow these steps:

1. Prepare the computer for disassembly (see [Preparation for disassembly on page 39](#)).
2. Remove the bottom cover (see [Bottom cover on page 39](#)).
3. Remove the battery (see [Battery on page 41](#)).
4. Remove the right speaker (see [Speakers on page 45](#)).

Remove the fingerprint reader:

1. Remove the Phillips M2.0 × 2.5 broad head screw (1) that secures the fingerprint reader and bracket to the computer.

2. Remove the fingerprint reader bracket (2).

The fingerprint reader bracket is included in the Bracket Kit, spare part number N53566-001.

3. Disconnect the cable from the ZIF connector on the fingerprint reader (3).
4. Detach the fingerprint reader cable (4) from the computer. The fingerprint reader cable is attached with double-sided adhesive.
5. Remove the fingerprint reader (5) and cable.

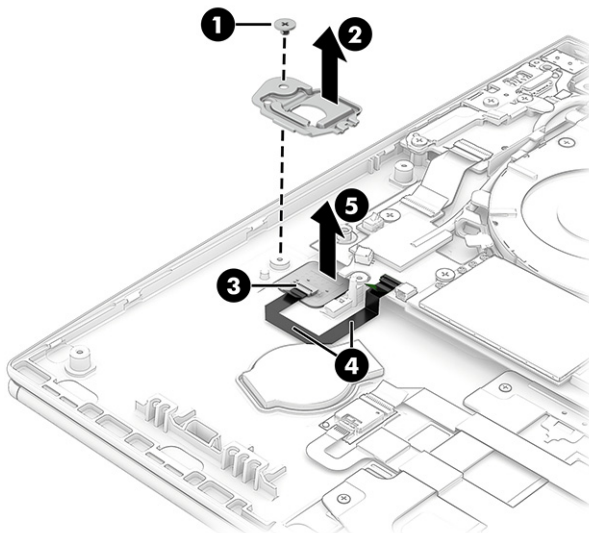

To install the fingerprint reader, reverse this procedure.

## NFC module

To remove the NFC module, use this procedure and illustration.

**Table 5-10** NFC module description and part number

Description	Spare part number
NFC module	M08706-001

**NOTE:** The NFC module spare part kit does not include the NFC module cable. The NFC module cable is included in the Cable Kit, spare part number N09040-001.

Before removing the NFC module, follow these steps:

1. Prepare the computer for disassembly (see [Preparation for disassembly on page 39](#)).
2. Remove the bottom cover (see [Bottom cover on page 39](#)).
3. Remove the battery (see [Battery on page 41](#)).

Remove the NFC module:

1. Disconnect the cable from the ZIF connector on the NFC module (1).

2. Detach the NFC module (2) from the computer. The NFC module is attached with double-sided adhesive.

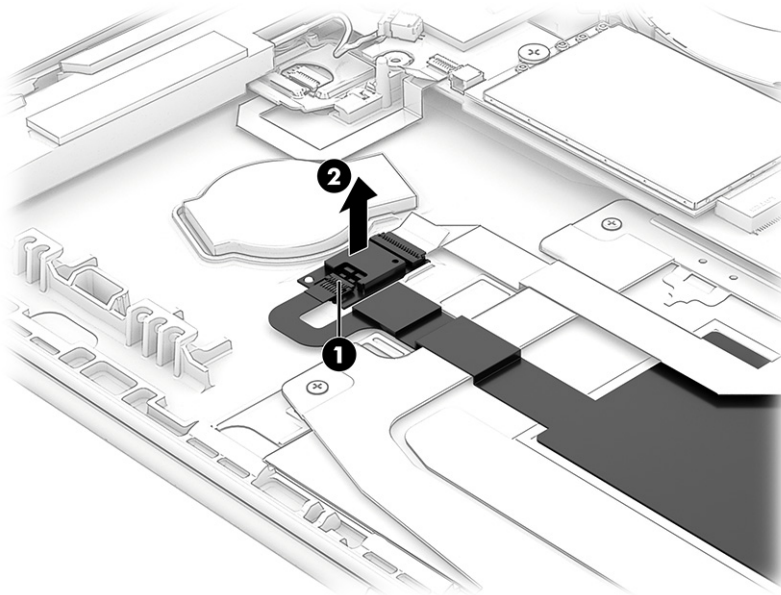

To install the NFC module, reverse this procedure.

## Touchpad

To remove the touchpad, use this procedure and illustration.

**Table 5-11 Touchpad descriptions and part numbers**

Description	Spare part number
Touchpad with NFC module antenna	N15436-001
Touchpad without NFC module antenna	N09033-001

**NOTE:** The touchpad spare part kit does not include the touchpad cable. The touchpad cable is included in the Cable Kit, spare part number N09040-001.

Before removing the touchpad, follow these steps:

1. Prepare the computer for disassembly (see [Preparation for disassembly on page 39](#)).
2. Remove the bottom cover (see [Bottom cover on page 39](#)).
3. Remove the battery (see [Battery on page 41](#)).

Remove the touchpad:

1. Disconnect the NFC cable from the reverse ZIF connector on the NFC module (1).
2. Disconnect the touchpad cable from the ZIF connector on the system board (2).
3. Remove the seven Phillips M2.0 × 3.0 screws (3) that secure the touchpad bracket to the computer.

4. Remove the touchpad from the computer (4).

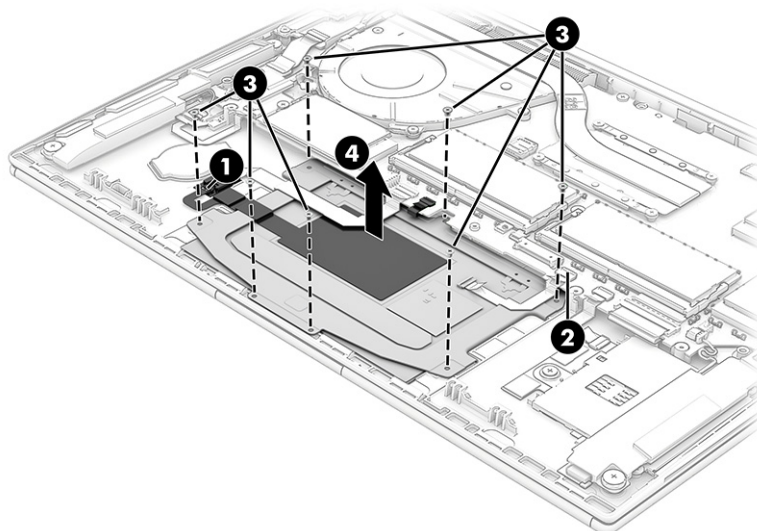

To install the touchpad, reverse this procedure.

## Card reader

To remove the card reader, use this procedure and illustration.

**Table 5-12** Card reader description and part number

Description	Spare part number
Card reader	N02323-001

**NOTE:** The card reader spare part kit does not include the card reader cable. The card reader cable is included in the Cable Kit, spare part number N09040-001.

Before removing the card reader, follow these steps:

1. Prepare the computer for disassembly (see [Preparation for disassembly on page 39](#)).
2. Remove the bottom cover (see [Bottom cover on page 39](#)).
3. Remove the battery (see [Battery on page 41](#)).

Remove the card reader:

1. Disconnect the cable that secures the card reader board to the system board (1), and remove it (2).

2. Remove the three Phillips M.2.0 x 2.0 screws **(3)** that secure the card reader to the computer, and then lift out the card reader **(4)**.

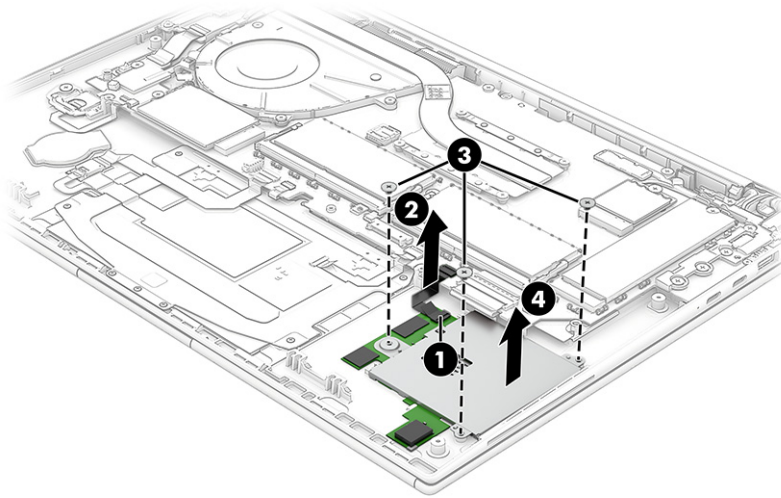

To install the card reader, reverse this procedure.

## Audio jack

To remove the audio jack, use this procedure and illustration.

**Table 5-13** Audio jack description and part number

Description	Spare part number
Audio jack (included in the Cable Kit)	N09040-001

Before removing the audio jack, follow these steps:

1. Prepare the computer for disassembly (see [Preparation for disassembly on page 39](#)).
2. Remove the bottom cover (see [Bottom cover on page 39](#)).
3. Disconnect the battery cable from the system board (see [Battery on page 41](#)).

Remove the audio jack:

1. Disconnect the audio jack cable from the ZIF connector **(1)** on the system board.
2. Remove the Phillips M2.0 x 2.5 screw **(2)** that secures the audio jack to the computer.

3. Remove the audio jack (3) from the computer.

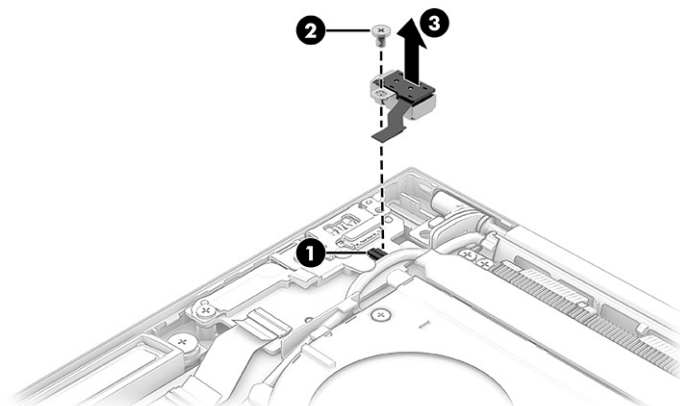

To install the audio jack, reverse this procedure.

## Connector board

To remove the connector board, use this procedure and illustration.

**Table 5-14** Connector board description and part number

Description	Spare part number
Connector board (includes USB port and SIM card slot)	N09042-001

**NOTE:** The connector board spare part kit does not include the connector board cable. The connector board cable is included in the Cable Kit, spare part number N09040-001.

Before removing the connector board, follow these steps:

1. Prepare the computer for disassembly (see [Preparation for disassembly on page 39](#)).
2. Remove the bottom cover (see [Bottom cover on page 39](#)).
3. Disconnect the battery cable from the system board (see [Battery on page 41](#)).
4. Remove the audio jack (see [Audio jack on page 55](#)).
5. Remove the connector board cable (see [Connector board on page 56](#)).

Remove the connector board:

1. Remove the three Phillips M2.0 × 2.5 screws (1) that secure the cable retainer and I/O bracket to the computer.
2. Remove the cable retainer (2) and I/O bracket (3) from the computer.

The cable retainer and I/O bracket are included in the Bracket Kit, spare part number N53566-001.

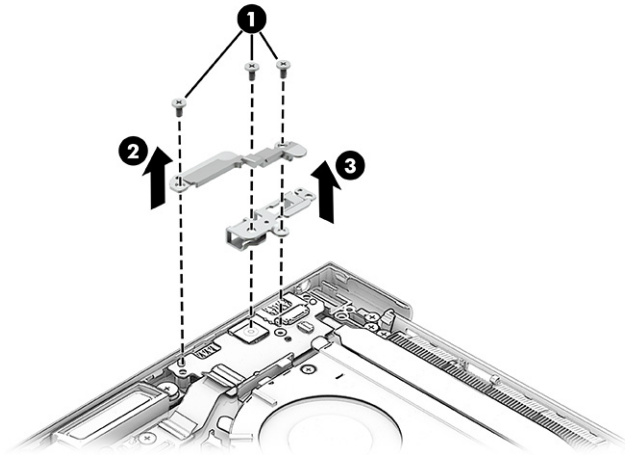

3. Remove the SIM card blank insert **(1)** from the SIM card card slot.
4. Remove the connector board **(2)** from the computer.

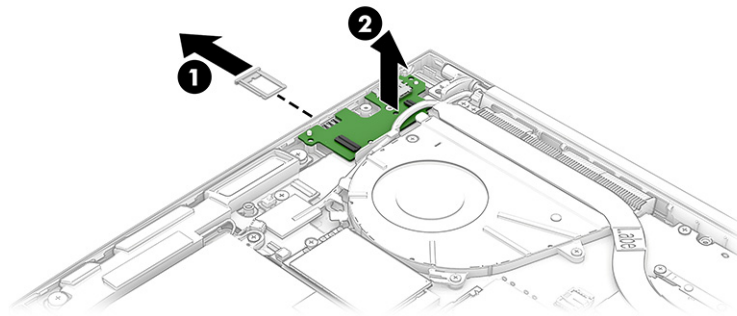

To install the connector board, reverse this procedure.

## Fan

To remove the fan, use this procedure and illustration.

**Table 5-15 Fan description and part numbers**

Description	Spare part number
Fan for use on computer models equipped with a 28 W processor	N09036-001
Fan for use on computer models equipped with a 15 W processor	N09035-001

Before removing the fan, follow these steps:

1. Prepare the computer for disassembly (see [Preparation for disassembly on page 39](#)).
2. Remove the bottom cover (see [Bottom cover on page 39](#)).
3. Disconnect the battery cable from the system board (see [Battery on page 41](#)).

Remove the fan assembly:

1. Disconnect the fan cable **(1)** from the system board.

2. Release the webcam cable and WWAN module antenna cables from the retention clips **(2)** that are built into the fan.
3. Loosen the three Phillips captive screws **(3)** that secure the fan to the computer.
4. Remove the fan **(4)** from the computer.

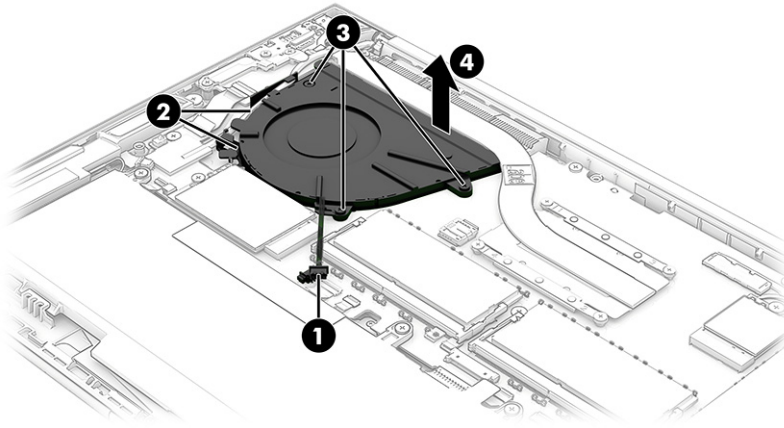

To install the fan, reverse this procedure.

## Heat sink

To remove the heat sink, use these procedures and illustrations.

**Table 5-16** Heat sink descriptions and part numbers

Description	Spare part number
Heat sink for use with models with a 28 W processor	N07345-001
Heat sink for use with models with a 15 W processor	N07344-001

Before removing the heat sink, follow these steps:

1. Prepare the computer for disassembly (see [Preparation for disassembly on page 39](#)).
2. Remove the bottom cover (see [Bottom cover on page 39](#)).
3. Remove the battery (see [Battery on page 41](#)).
4. Remove the fan (see [Fan on page 57](#)).

Remove the heat sink:

1. In the order indicated on the heat sink, loosen the four Phillips captive screws **(1)** that secure the heat sink to the system board.



2. Remove the heat sink from the system board (2).

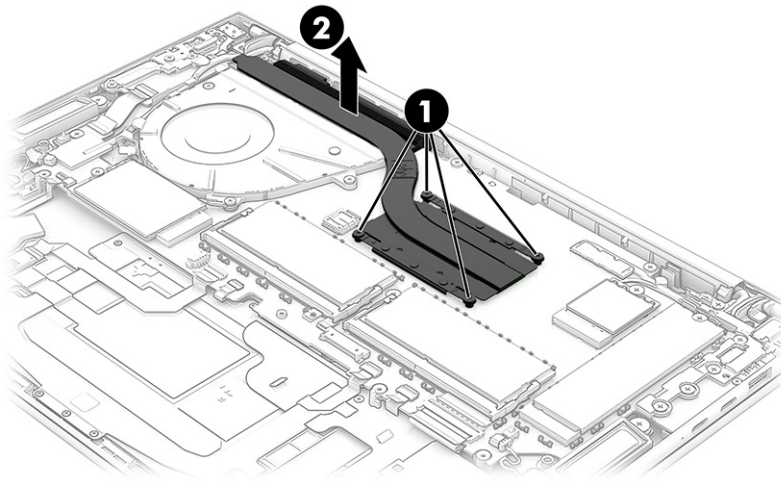

3. Thoroughly clean the thermal material from the surfaces of the heat sink and the system board components each time the heat sink is removed. Replacement thermal material is included with the heat sink and system board spare part kits. The following illustration shows the replacement thermal material locations.

Thermal paste is used on the system board processor (1) and on the heat sink area (2) that service it.

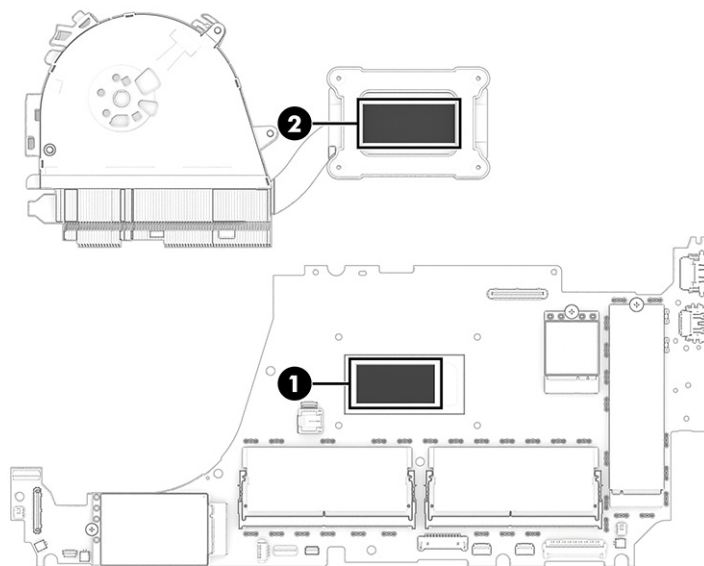

To install the heat sink, reverse this procedure.

## System board

To remove the system board, use these procedures and illustrations.

**Table 5-17 System board descriptions and part numbers**

Description	Spare part number
<b>System board</b> (includes integrated processor)	
All system boards use the following part numbers:	
xxxxxx-001: Non-Windows operating systems	
xxxxxx-601: Windows operating system	
Intel Core i7-1370P	N43988-xx1
Intel Core i7-1370P, OSR	N43989-xx1
Intel Core i7-1360P	N43987-xx1
Intel Core i5-1350P	N43986-xx1
Intel Core i5-1350P, OSR	N43985-xx1
Intel Core i5-1340P	N43984-xx1
Intel Core i7-1365U	N45155-xx1
Intel Core i7-1365U, OSR	N45156-xx1
Intel Core i7-1355U	N45154-xx1
Intel Core i7-1345U	N45153-xx1
Intel Core i7-1345U, OSR	N45152-xx1
Intel Core i5-1335U	N45151-xx1

Before removing the system board, follow these steps:

1. Prepare the computer for disassembly (see [Preparation for disassembly on page 39](#)).
2. Remove the bottom cover (see [Bottom cover on page 39](#)).
3. Remove the battery (see [Battery on page 41](#)).
4. Remove the fan (see [Fan on page 57](#)).

When you replace the system board, be sure to remove the following components from the defective system board and install them on the replacement system board:

- WWAN module (see [WWAN module on page 42](#)).
- WLAN module (see [WLAN module on page 44](#)).
- Memory modules (see [Memory modules on page 46](#)).
- Solid-state drive (see [Solid-state drive on page 48](#)).
- Heat sink (see [Heat sink on page 58](#)).
- RTC battery (see [RTC battery on page 50](#)).

Remove the system board:

1. Disconnect the connector board cable from the ZIF connector on the system board (1).

2. Disconnect the webcam cable (2) from the system board.
3. Carefully disconnect the WWAN module antenna cables (3) from the WWAN module.

 **NOTE:** Computer models have one to four WWAN module antenna cables. The antenna cables have tags that identify them with a number that corresponds to a terminal on the WWAN module. Connect the antenna cable to the corresponding WWAN module terminal.

4. Disconnect the display panel cable (4) from the system board.
5. Release the display panel cable from the retention clips (5) that are built into the computer.
6. Carefully disconnect the WLAN module antenna cables (6) from the WLAN module.

 **NOTE:** Computer models have either one or two WLAN module antennas. On models with two antennas, the #1 white WLAN module antenna cable connects to the WLAN module #1 Main terminal. The #2 black WLAN module antenna cable connects to the WLAN module #1 Aux terminal.

7. Release the WLAN module antenna cables from the retention clips (7) that are built into the computer.
8. Disconnect the following cables from the system board:
  - Speaker cables (8)
  - Keyboard ZIF cable (9)
  - Card reader ZIF cable (10)
  - Touchpad ZIF cable (11)
  - Backlight ZIF cable (12)
  - NFC module ZIF cable (13)
  - RTC battery cable (14)
  - Fingerprint reader ZIF cable (15)

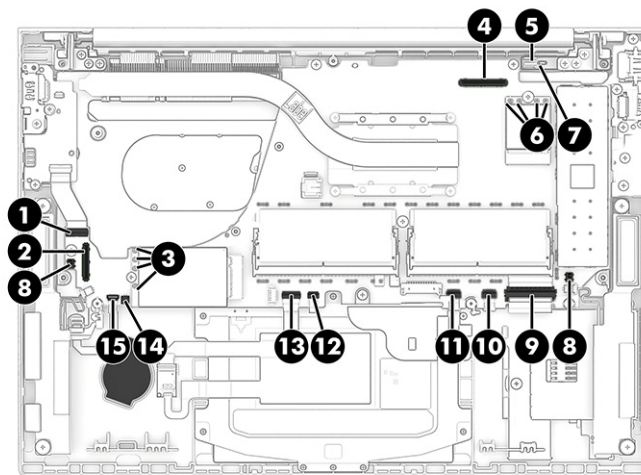

9. Remove the following screws that secure the system board and I/O bracket to the computer:
  - Two Phillips M2.0 × 2.5 broad head screws (1)
  - Three Phillips M2.0 × 4.5 screws (2)
  - One Phillips M2.0 × 4.4 screw (3)
  - Four Phillips M2.0 × 4.5 screws (4)
10. Remove the system board I/O bracket (5).

The system board I/O bracket is included in the Bracket Kit, spare part number N53566-001.

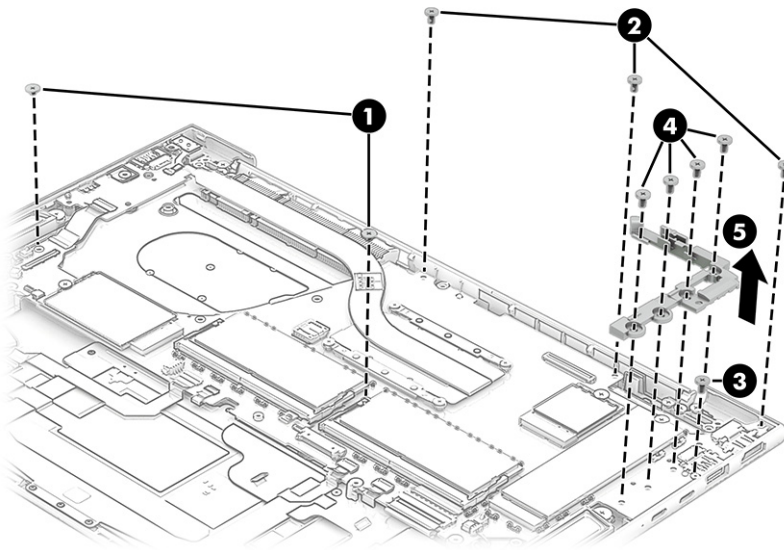

11. Lift the left side of the system board (1) until it rests at an angle.
12. Slide the system board (2) up and to the left at an angle to remove it.

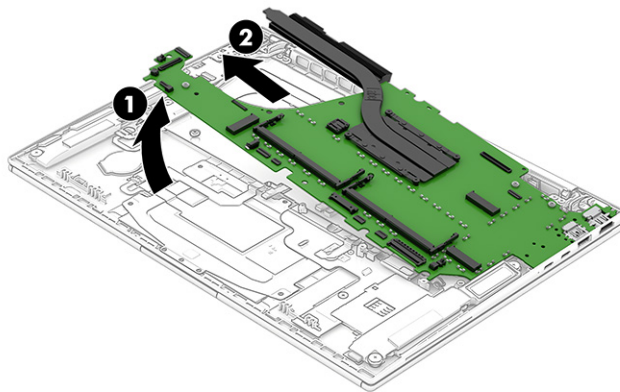

To install the system board, reverse this procedure.

## Display assembly

To remove and disassemble the display assembly, use these procedures and illustrations.

**Table 5-18 Display assembly description and part numbers**

Description	Spare part number
Display assembly, WQXGA, models without WWAN (entire assembly)	N50660-001

Before removing the display panel, follow these steps:

1. Prepare the computer for disassembly (see [Preparation for disassembly on page 39](#)).
2. Remove the bottom cover (see [Bottom cover on page 39](#)).
3. Disconnect the battery cable from the system board (see [Battery on page 41](#)).

Remove the display assembly:

1. Disconnect the webcam cable (1) from the system board.
2. Carefully disconnect the WWAN module antenna cables (2) from the WWAN module.

 **NOTE:** Computer models have one to four WWAN module antenna cables. The antenna cables have tags that identify them with a number that corresponds to a terminal on the WWAN module. Connect the antenna cable to the corresponding WWAN module terminal.

3. Release the webcam cable and WWAN module antenna cables from the retention clips (3) that are built into the fan.

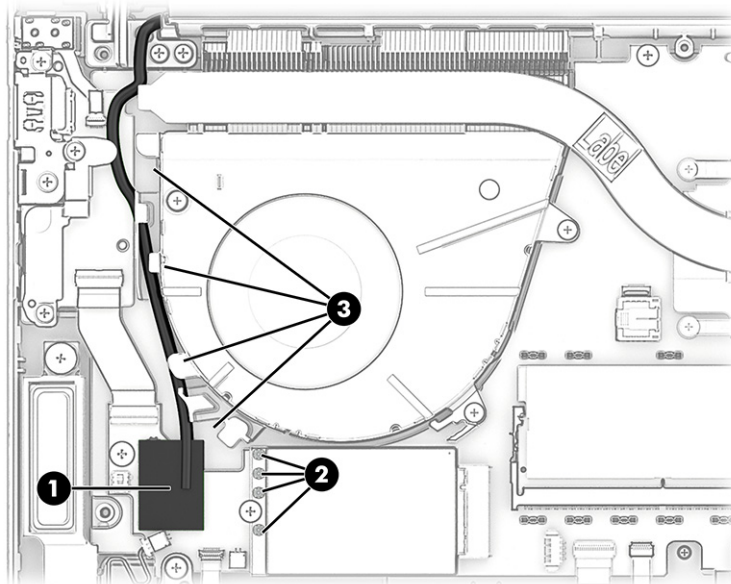

4. Disconnect the display panel cable (1) from the system board.
5. Carefully disconnect the WLAN module antenna cables from the WLAN module (2).

 **NOTE:** Computer models have either one or two WLAN module antennas. On models with two antennas, the #1 white WLAN module antenna cable connects to the WLAN module #1 Main terminal. The #2 black WLAN module antenna cable connects to the WLAN module #1 Aux terminal.

6. Release the display panel cable from the retention clips (3) that are built into the computer.

7. Release the WLAN module antenna cables from the retention clips **(4)** that are built into the computer.

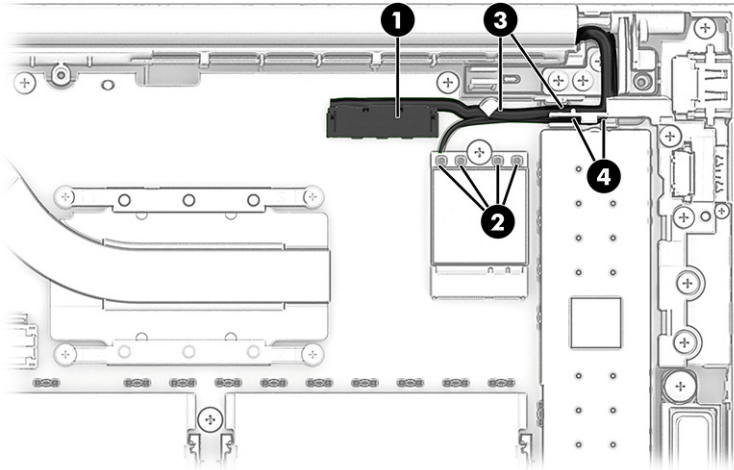

8. Remove the six Phillips M2.5 × 4.9 screws that secure the display assembly to the computer.

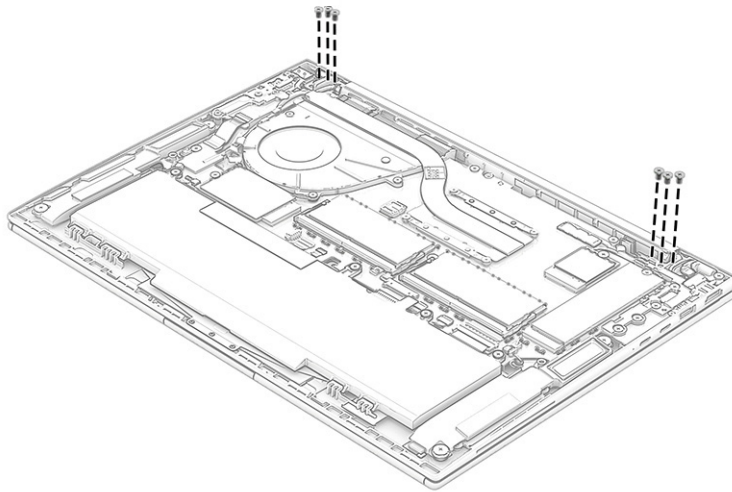

9. Swing the display hinges **(1)** up and back as far as they will go.
10. Open the display assembly **(2)** as far as it will open.

11. Separate the computer (3) from the display assembly.

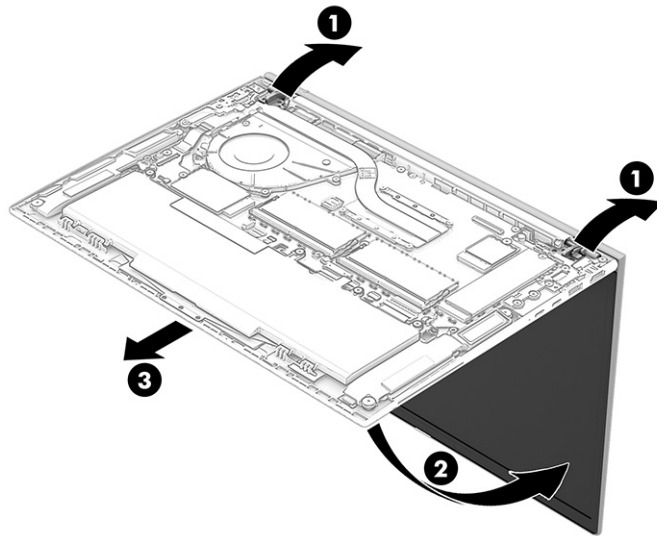

12. To replace the display bezel or the internal display assembly subcomponents:
  - a. Flex the bottom inside edge (1) of the bezel to release it from the display back cover.
  - b. Flex the left (2) and right inside edges of the bezel to release it.
  - c. Flex the top inside edge (3) of the bezel to release it.
  - d. Remove the bezel (4) from the display back cover.

The bezel is available using the following spare part numbers:

- N09021-001: For use on displays with infrared
- N09024-001: For use on displays with infrared and ACS
- N09023-001: For use on displays with a microphone
- N09022-001: For use on displays with RGB
- N09025-001: For use on displays with RGB and ACS

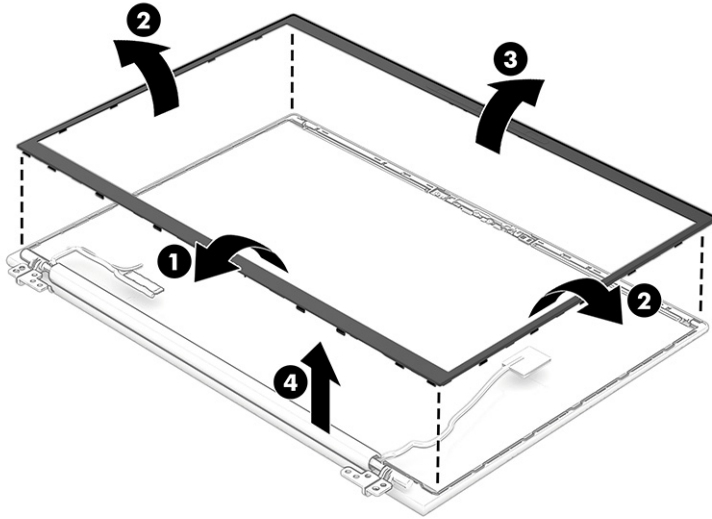

13. To remove the display panel:

- a. The display panel is secured to the display back cover with tape that is installed under the left (1) and right sides of the panel. To remove the panel, use tweezers to grasp the end of the tape (2). While turning the tweezers, wrap the tape around the tweezers as you continue to pull the tape out (3) from behind the display panel. You must pull the tape multiple times before it is completely removed.

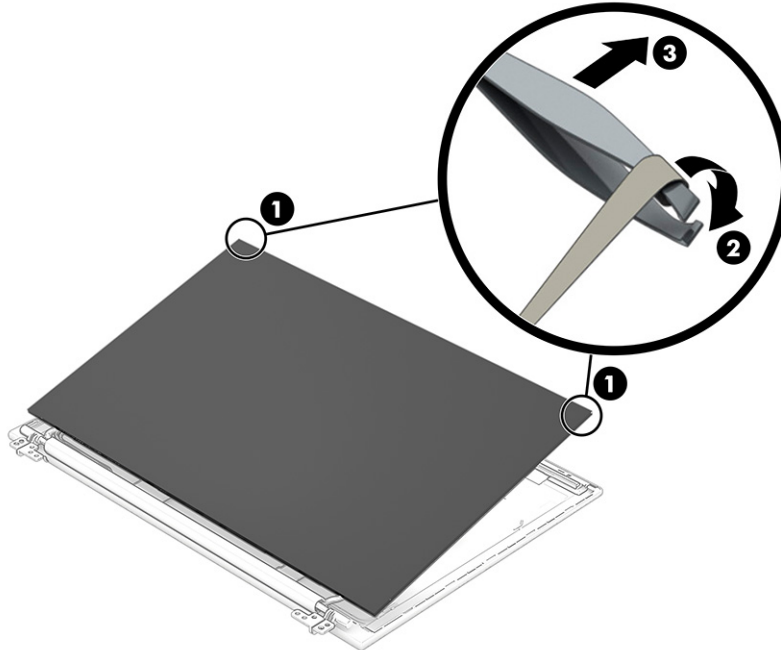

- b. Lift the top edge of the display panel (1) and swing it up and forward until it rests upside down in front of the display back cover.



- c. Release the adhesive support strip **(2)** that secures the display panel cable to the back of the display panel.
- d. Release the retention bar **(3)** that secures the display panel cable to the back of the display panel.
- e. Disconnect the display panel cable **(4)** from the display panel.

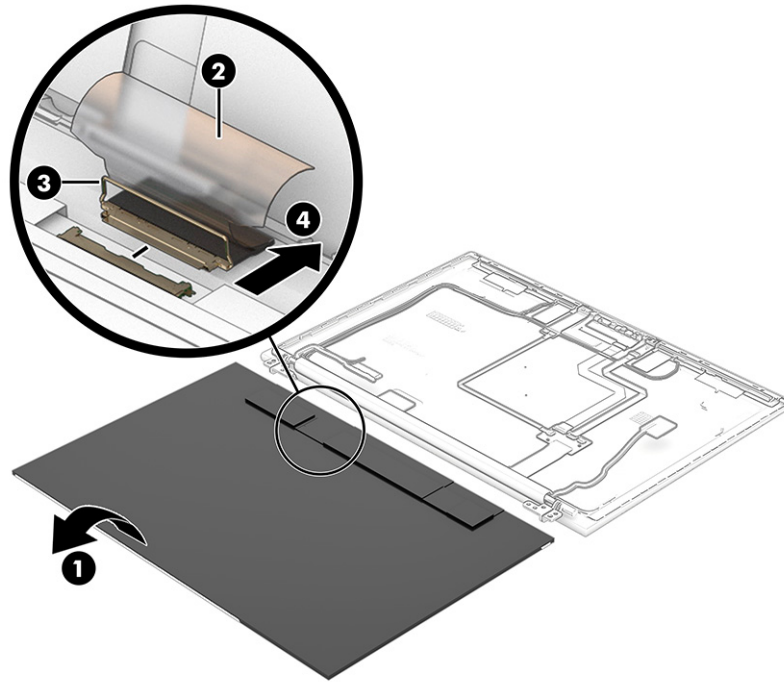

- f. Remove the display panel.

The LCD Support Kit is available using spare part number N19298-001.

The display panel is available using the following spare part numbers:

- N22325-001: WUXGA, nontouch; typical brightness: 250 nits
- N22326-001: WUXGA, nontouch; typical brightness: 250 nits
- N22327-001: WUXGA, touch; typical brightness: 250 nits
- N22328-001: WUXGA, nontouch, privacy; typical brightness: 1000 nits
- N50660-001: WQXGA, nontouch, privacy; typical brightness: 500 nits

**14.** To remove the hinge cover:

- a. Remove the Phillips M1.3 × 2.5 screw **(1)** that secures the hinge cover to the display back cover.
- b. Slide the hinge cover **(2)** to the right as far as it will go.
- c. Swing the top edge of the hinge cover **(3)** up and forward, and then remove it **(4)** from the display back cover.

The hinge cover is available in the Hinge Kit as spare part number N50659-001.

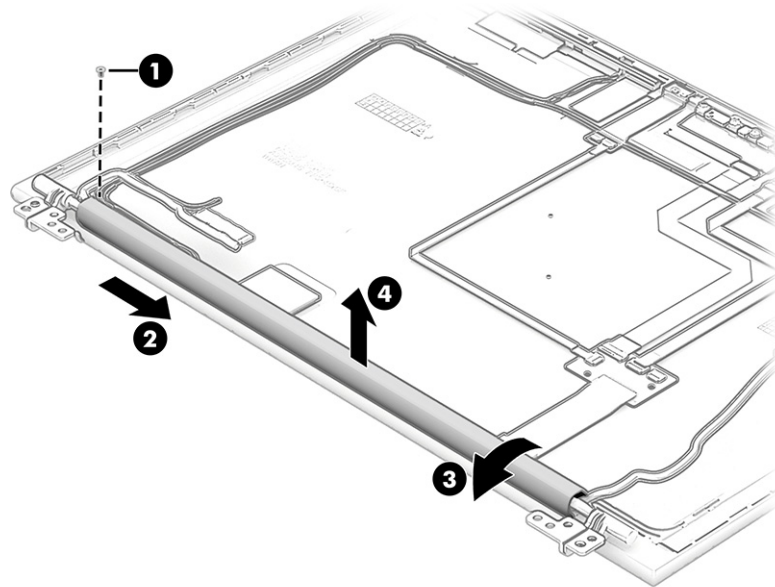

15. To remove the display panel cable:

- a. Release the display panel cable from the retention clips (1) that are built into the left hinge area.
- b. Remove the display panel cable (2).

The display panel cable is included in the Display Cable Kit, spare part number N55374-001.

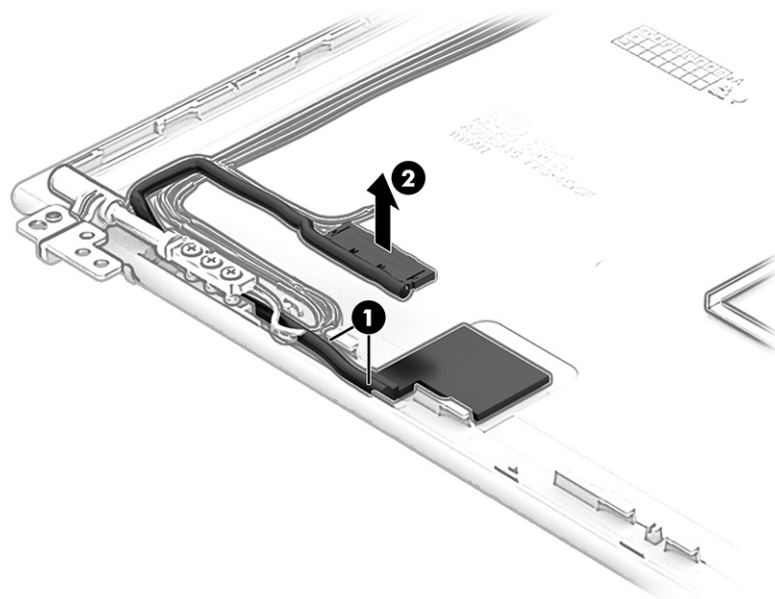

16. To remove the hinges:

- a. Remove the six Phillips M2.5 × 10.5 screws (1) that secure the hinges to the display back cover.
- b. Remove the hinges (2).

The hinges are available using spare part number N50659-001.

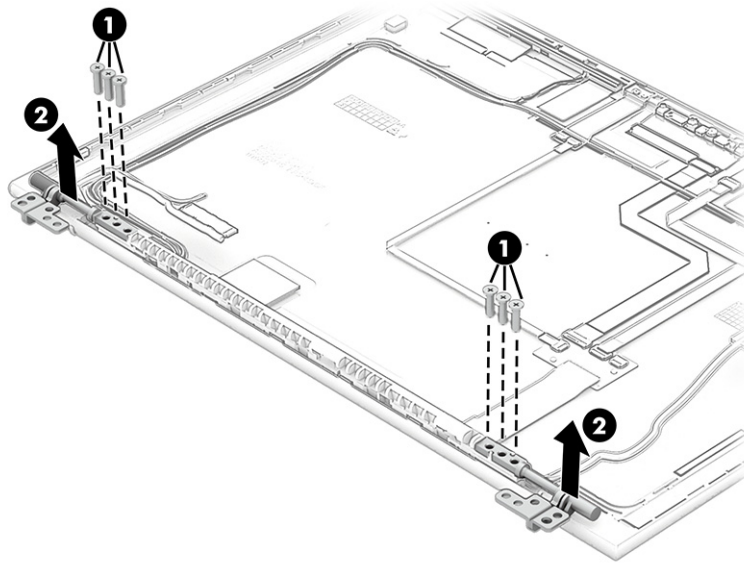

17. To remove the display transfer board cable:
  - a. Disconnect the display transfer board cable (1) from the display transfer board.
  - b. Release the display transfer board cable from the right hinge area (2).
  - c. Remove the display transfer board cable (3).

The display transfer board cable is included in the Panel Cable Kit, spare part number N09039-001.

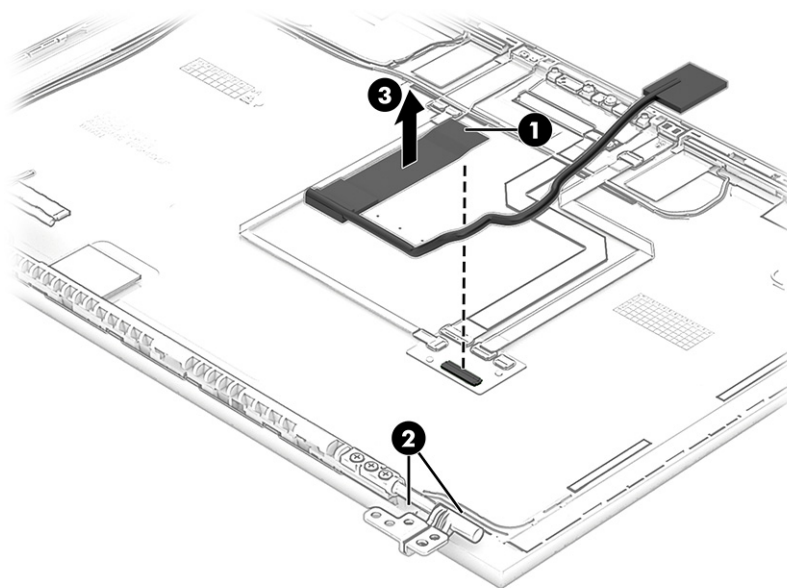

18. To remove the display transfer board:
  - a. Disconnect the transfer board cable from the ZIF connector on the transfer board (1).
  - b. Disconnect the webcam cable from the ZIF connector on the transfer board (2).

- c. Disconnect the microphone module cable from the ZIF connector on the transfer board **(3)**.
- d. Detach the display transfer board **(4)** from the display back cover. The display transfer board is attached to the display back cover with double-sided adhesive.

The display transfer board is available using the following spare part numbers:

- N08541-001: For use on computers with a display assembly with an IR camera.
- N08542-001: For use on computers with a display assembly with an RGB camera.

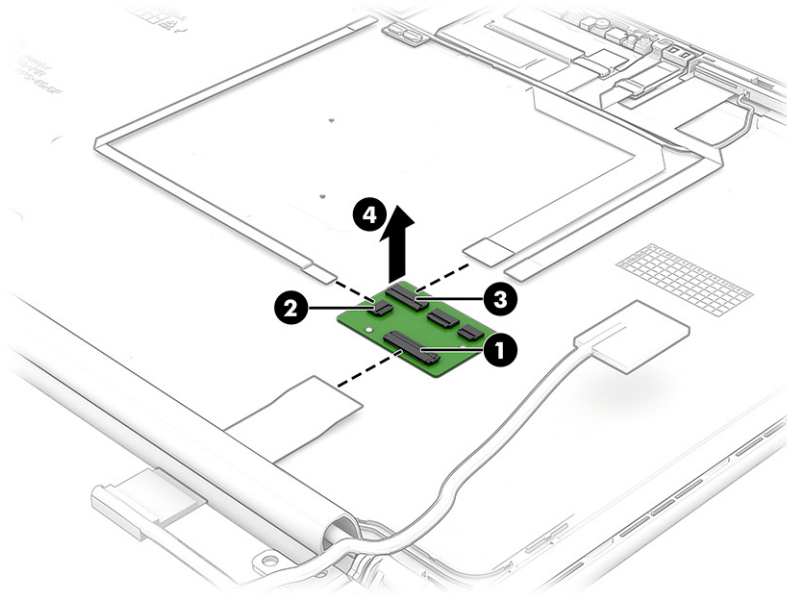

**19.** To remove the webcam module cable:

- a. Disconnect the webcam cable from the ZIF connector **(1)** on the transfer board.
- b. Disconnect the webcam cable from the ZIF connector **(2)** on the webcam module.
- c. Detach the webcam module cable **(3)** from the display back cover. The webcam module cable is attached to the display back cover with double-sided adhesive.

The webcam module cable is included in the Panel Cable Kit, spare part number N09039-001.

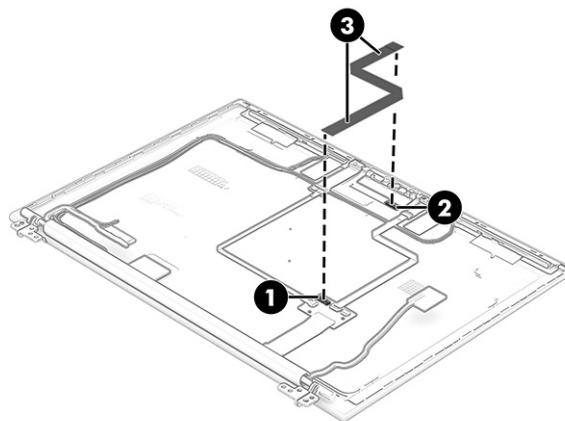

**20.** To remove the webcam module:

- Detach the webcam module from the display back cover. The webcam module is attached to the display back cover with double-sided adhesive.

The webcam module is available using spare part numbers N09061-001 (infrared) and N09060-001 (RGB).

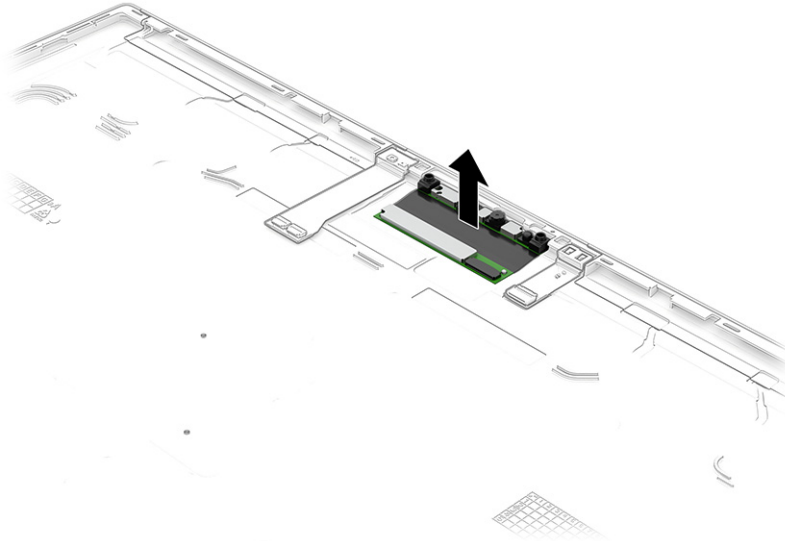

**21.** To remove the microphone module cable:

- a. Disconnect the microphone module cable from the ZIF connector **(1)** on the transfer board.
- b. Disconnect the microphone module cable from the ZIF connector **(2)** on the microphone module.
- c. Detach the microphone module cable **(3)** from the display back cover. The microphone module cable is attached to the display back cover with double-sided adhesive.

The microphone module cable is included in the Panel Cable Kit, spare part number N09039-001.

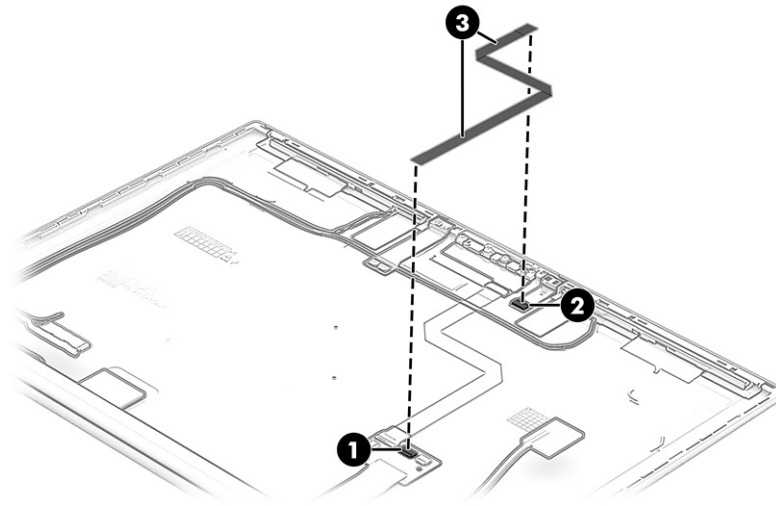

22. To remove the microphone module:

- Detach the microphone module from the display back cover. The microphone module is attached to the display back cover with double-sided adhesive.

The microphone module is available using spare part number N15440-001.

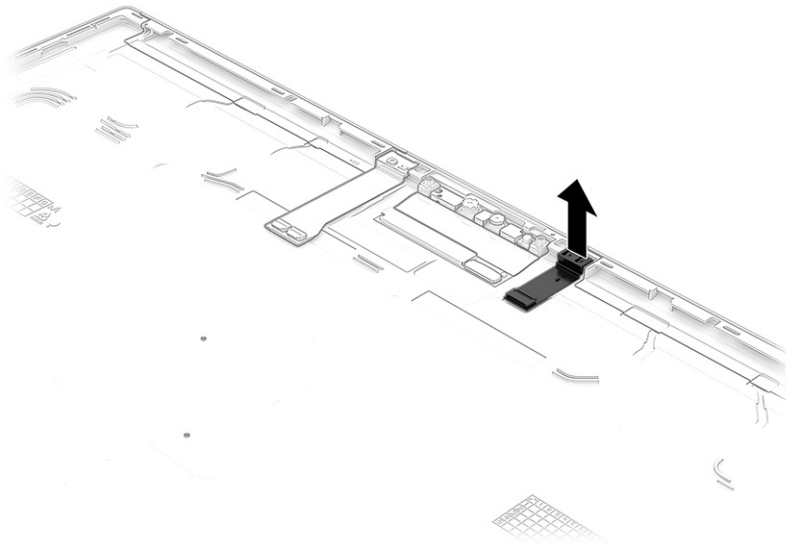

To reassemble and replace the display assembly, reverse this procedure.

## Keyboard with top cover

The top cover with keyboard remains after removing all other spare parts from the computer. In this section, the first table provides the main spare part number for the top cover with keyboards. The second table provides the country codes.

**Table 5-19 Top cover with keyboard descriptions and part numbers**

Description	Spare part number
Top cover with keyboard, backlit	N45442-xxx
Top cover with keyboard, backlit privacy	N45443-xxx
Top cover with keyboard, not backlit	N45444-xxx

**Table 5-20 Spare part country codes**

For use in country or region	Spare part number	For use in country or region	Spare part number	For use in country or region	Spare part number
Belgium	-A41	Israel	-BB1	Slovenia	-BA1
Brazil	-201	Italy	-061	South Korea	-AD1
Bulgaria	-261	Japan	-291	Spain	-071
Czech Republic and Slovakia	-FL1	Kazakhstan	-DF1	Sweden and Finland	-B71
Denmark, Finland, and Norway	-DH1	Latin America	-161	Switzerland	-BG1
France	-051	The Netherlands	-B31	Taiwan	-AB1
French Canada	-DB1	Northern Africa	-FP1	Thailand	-281
Germany	-041	Norway	-091	Turkey	-141
Greece	-151	Portugal	-131	Turkey-F	-541
Hungary	-211	Romania	-271	Ukraine	-BD1
Iceland	-DD1	Russia	-251	United Kingdom	-031
India	-D61	Saudi Arabia	-171	United States	-001

---

## 6 Backing up, restoring, and recovering

You can use Windows tools or HP software to back up your information, create a restore point, reset your computer, create recovery media, or restore your computer to its factory state. Performing these standard procedures can return your computer to a working state faster.

 **IMPORTANT:** If you are performing recovery procedures on a tablet, the tablet battery must be at least 70% charged before you start the recovery process.

 **IMPORTANT:** For a tablet with a detachable keyboard, connect the tablet to the keyboard base before beginning any recovery process.

---

### Backing up information and creating recovery media

These methods of creating recovery media and backups are available on select products only.

#### Using Windows tools for backing up

HP recommends that you back up your information immediately after initial setup. You can do this task either using Windows Backup locally with an external USB flash drive or using online tools.

 **NOTE:** If computer storage is 32 GB or less, Microsoft® System Restore is disabled by default.

---

#### Using the HP Cloud Recovery Download Tool to create recovery media (select products only)

You can use the HP Cloud Recovery Download Tool to create HP Recovery media on a bootable USB flash drive.

For details:

- Go to <http://www.hp.com>, search for HP Cloud Recovery, and then select the result that matches the type of computer that you have.

 **NOTE:** If you cannot create recovery media yourself, contact support to obtain recovery discs. Go to <http://www.hp.com/support>, select your country or region, and then follow the on-screen instructions.

 **IMPORTANT:** HP recommends that you follow the [Restoring and recovery methods on page 75](#) to restore your computer before you obtain and use the HP recovery discs. Using a recent backup can return your machine to a working state sooner than using the HP recovery discs. After the system is restored, reinstalling all the operating system software released since your initial purchase can be a lengthy process.

---

### Restoring and recovering your system

You have several tools available to recover your system both within and outside of Windows if the desktop cannot load.



HP recommends that you attempt to restore your system using the [Restoring and recovery methods on page 75](#).

## Creating a system restore

System Restore is available in Windows. The System Restore software can automatically or manually create restore points, or snapshots, of the system files and settings on the computer at a particular point.

When you use System Restore, it returns your computer to its state at the time you made the restore point. Your personal files and documents should not be affected.

## Restoring and recovery methods

After you run the first method, test to see whether the issue still exists before you proceed to the next method, which might now be unnecessary.

1. Run a Microsoft System Restore.
2. Run Reset this PC.

---

 **NOTE:** The options **Remove everything** and then **Fully clean the drive** can take several hours to complete and leave no information on your computer. It is the safest way to reset your computer before you recycle it.

---

3. Recover using HP Recovery media. For more information, see [Recovering using HP Recovery media on page 75](#).

For more information about the first two methods, see the Get Help app:

- Select the **Start** button, select **All apps**, select the **Get Help** app, and then enter the task you want to perform.

---

 **NOTE:** You must be connected to the internet to access the Get Help app.

---

## Recovering using HP Recovery media

You can use HP Recovery media to recover the operating system and drivers that were installed at the factory. On select products, you can create recovery media on a bootable USB flash drive using the HP Cloud Recovery Download Tool.

For details, see [Using the HP Cloud Recovery Download Tool to create recovery media \(select products only\) on page 74](#).

---

 **NOTE:** If you cannot create recovery media yourself, contact support to obtain recovery discs. Go to <http://www.hp.com/support>, select your country or region, and then follow the on-screen instructions.

---

To recover your system:

- Insert the HP Recovery media, and then restart the computer.

---

 **NOTE:** HP recommends that you follow the [Restoring and recovery methods on page 75](#) to restore your computer before you obtain and use the HP recovery discs. Using a recent backup can return your machine to a working state sooner than using the HP recovery discs. After the system is restored, reinstalling all the operating system software released since your initial purchase can be a lengthy process.

---

## Changing the computer boot order

If your computer does not restart using the HP Recovery media, you can change the computer boot order, which is the order of devices listed in BIOS for startup information. You can select an optical drive or a USB flash drive, depending on the location of your HP Recovery media.

---

 **IMPORTANT:** For a tablet with a detachable keyboard, connect the tablet to the keyboard base before beginning these steps.

---

To change the boot order:

1. Insert the HP Recovery media.
2. Access the system **Startup** menu.
  - For computers or tablets with keyboards attached, turn on or restart the computer or tablet, quickly press **esc**, and then press **f9** for boot options.
  - For tablets without keyboards, turn on or restart the tablet, quickly press and hold the volume up button, and then select **f9**.

– or –

Turn on or restart the tablet, quickly press and hold the volume down button, and then select **f9**.
3. Select the optical drive or USB flash drive from which you want to boot, and then follow the on-screen instructions.

## Using HP Sure Recover (select products only)

Select computer models are configured with HP Sure Recover, a PC operating system (OS) recovery solution built into the hardware and software. HP Sure Recover can fully restore the HP OS image without installed recovery software.

Using HP Sure Recover, an administrator or user can restore the system and install:

- Latest version of the operating system
- Platform-specific device drivers
- Software applications, in the case of a custom image

To access the latest documentation for HP Sure Recover, go to <http://www.hp.com/support>. Follow the on-screen instructions to find your product and locate your documentation.

---

# 7 Computer Setup (BIOS), TPM, and HP Sure Start

HP provides several tools to help set up and protect your computer.

## Using Computer Setup

Computer Setup, or Basic Input/Output System (BIOS), controls communication between all the input and output devices on the system (such as hard drives, display, keyboard, mouse, and printer). Computer Setup includes settings for types of devices installed, the startup sequence of the computer, and amount of system and extended memory.

---

 **NOTE:** Use extreme care when making changes in Computer Setup. Errors can prevent the computer from operating properly.

---

To start Computer Setup, turn on or restart the computer, and when the HP logo appears, press **F10** to enter Computer Setup.

## Navigating and selecting in Computer Setup

You can navigate and select in Computer Setup using one or more methods.

- To select a menu or a menu item, use the **tab** key and the keyboard arrow keys and then press **enter**, or use a pointing device to select the item.
- To scroll up and down, select the up arrow or the down arrow in the upper-right corner of the screen, or use the up arrow key or the down arrow key on the keyboard.
- To close open dialog boxes and return to the main Computer Setup screen, press **esc**, and then follow the on-screen instructions.

To exit Computer Setup, choose one of the following methods:

- To exit Computer Setup menus without saving your changes, select **Main**, select **Ignore Changes and Exit**, and then select **Yes**.

---

 **NOTE:** If you are using arrow keys to highlight your choice, you must then press **enter**.

---

- To save your changes and exit Computer Setup menus, select **Main**, select **Save Changes and Exit**, and then select **Yes**.

---

 **NOTE:** If you are using arrow keys to highlight your choice, you must then press **enter**.

---

Your changes go into effect when the computer restarts.

## Restoring factory settings in Computer Setup

To return all settings in Computer Setup to the values that were set at the factory, follow these steps.

---

 **NOTE:** Restoring defaults will not change the hard drive mode.

---

1. Start Computer Setup. See [Using Computer Setup on page 77](#).
2. Select **Main**, select **Apply Factory Defaults and Exit**, and then select **Yes**.

---

 **NOTE:** If you are using arrow keys to highlight your choice, you must then press **enter**.

 **NOTE:** On select products, the selections might display **Restore Defaults** instead of **Apply Factory Defaults and Exit**.

---

Your changes go into effect when the computer restarts.

---

 **NOTE:** Your password settings and security settings are not changed when you restore the factory settings.

---

## Updating the BIOS

Updated versions of the BIOS might be available on the HP website. Most BIOS updates on the HP website are packaged in compressed files called *SoftPaqs*.

Some download packages contain a file named Readme.txt, which contains information regarding installing and troubleshooting the file.

### Determining the BIOS version

To decide whether you need to update Computer Setup (BIOS), first determine the BIOS version on your computer.

If you are already in Windows, you can access BIOS version information (also known as *ROM date* and *System BIOS*) by pressing **fn+esc** (select products only). Or you can use Computer Setup.

1. Start Computer Setup. See [Using Computer Setup on page 77](#).
2. Select **Main**, and then select **System Information**.
3. To exit Computer Setup menus without saving your changes, select **Main**, select **Ignore Changes and Exit**, and then select **Yes**.

---

 **NOTE:** If you are using arrow keys to highlight your choice, you must then press **enter**.

---

To check for later BIOS versions, see [Preparing for a BIOS update on page 78](#).

### Preparing for a BIOS update

Be sure to follow all prerequisites before downloading and installing a BIOS update.

---

 **IMPORTANT:** To reduce the risk of damage to the computer or an unsuccessful installation, download and install a BIOS update only when the computer is connected to reliable external power using the AC adapter. Do not download or install a BIOS update while the computer is running on battery power, docked in an optional docking device, or connected to an optional power source. During the download and installation, follow these instructions:

Do not disconnect power on the computer by unplugging the power cord from the AC outlet.

Do not shut down the computer or initiate Sleep.

Do not insert, remove, connect, or disconnect any device, cable, or cord.

---

## Downloading a BIOS update

After you review the prerequisites, you can check for and download BIOS updates.

1. Select the **Search** icon in the taskbar, type `support` in the search box, and then select the **HP Support Assistant** app.  
  
- or -  
Select the question mark icon (select products only) in the taskbar.
2. Select **Updates**, and then select **Check for updates and messages**.
3. Follow the on-screen instructions.
4. At the download area, follow these steps:
  - a. Identify the most recent BIOS update and compare it to the BIOS version currently installed on your computer. Make a note of the date, name, or other identifier. You might need this information to locate the update later, after it has been downloaded to your hard drive.
  - b. Follow the on-screen instructions to download your selection to the hard drive.  
  
Make a note of the path to the location on your hard drive where the BIOS update is downloaded. You will need to access this path when you are ready to install the update.



---

**NOTE:** If you connect your computer to a network, consult the network administrator before installing any software updates, especially system BIOS updates.

---

## Installing a BIOS update

BIOS installation procedures vary. Follow any instructions that are displayed on the screen after the download is complete. If no instructions are displayed, follow these steps.

1. Select the **Search** icon in the taskbar, type `file` in the search box, and then select **File Explorer**.
2. Select your hard drive designation. The hard drive designation is typically Local Disk (C:).
3. Using the hard drive path you recorded earlier, open the folder that contains the update.
4. Double-click the file that has an `.exe` extension (for example, `filename.exe`).  
  
The BIOS installation begins.
5. Complete the installation by following the on-screen instructions.



---

**NOTE:** After a message on the screen reports a successful installation, you can delete the downloaded file from your hard drive.

---

## Changing the boot order using the f9 prompt

To dynamically choose a boot device for the current startup sequence, follow these steps.

1. Access the Boot Device Options menu:
  - Turn on or restart the computer, and when the HP logo appears, press **f9** to enter the Boot Device Options menu.
2. Select a boot device, press **enter**, and then follow the on-screen instructions.

## TPM BIOS settings (select products only)

TPM provides additional security for your computer. You can modify the TPM settings in Computer Setup (BIOS).

---

 **IMPORTANT:** Before enabling Trusted Platform Module (TPM) functionality on this system, you must ensure that your intended use of TPM complies with relevant local laws, regulations and policies, and approvals or licenses must be obtained if applicable. For any compliance issues arising from your operation or usage of TPM that violates the previously mentioned requirement, you shall bear all the liabilities wholly and solely. HP will not be responsible for any related liabilities.

 **NOTE:** If you change the TPM setting to Hidden, TPM is not visible in the operating system.

---

To access TPM settings in Computer Setup:

1. Start Computer Setup. See [Using Computer Setup on page 77](#).
2. Select **Security**, select **TPM Embedded Security**, and then follow the on-screen instructions.

## Using HP Sure Start (select products only)

Select computer models are configured with HP Sure Start, a technology that monitors the computer's BIOS for attacks or corruption. If the BIOS becomes corrupted or is attacked, HP Sure Start automatically restores the BIOS to its previously safe state, without user intervention.

HP Sure Start is configured and already enabled so that most users can use the HP Sure Start default configuration. Advanced users can customize the default configuration.

To access the latest documentation on HP Sure Start, go to <http://www.hp.com/support>. Select **Find your product**, and then follow the on-screen instructions.

---

# 8 Using HP PC Hardware Diagnostics

You can use the HP PC Hardware Diagnostics utility to determine whether your computer hardware is running properly. The three versions are HP PC Hardware Diagnostics Windows, HP PC Hardware Diagnostics UEFI (Unified Extensible Firmware Interface), and (for select products only) Remote HP PC Hardware Diagnostics UEFI, a firmware feature.

## Using HP PC Hardware Diagnostics Windows (select products only)

HP PC Hardware Diagnostics Windows is a Windows-based utility that allows you to run diagnostic tests to determine whether the computer hardware is functioning properly. The tool runs within the Windows operating system to diagnose hardware failures.

If HP PC Hardware Diagnostics Windows is not installed on your computer, you must download and install it. To download HP PC Hardware Diagnostics Windows, see [Downloading HP PC Hardware Diagnostics Windows on page 82](#).

## Using an HP PC Hardware Diagnostics Windows hardware failure ID code

When HP PC Hardware Diagnostics Windows detects a failure that requires hardware replacement, a 24-digit failure ID code is generated for select component tests. For interactive tests, such as keyboard, mouse, or audio and video palette, you must perform troubleshooting steps before you can receive a failure ID.

- You have several options after you receive a failure ID:
  - Select **Next** to open the Event Automation Service (EAS) page, where you can log the case.
  - Scan the QR code with your mobile device, which takes you to the EAS page, where you can log the case.
  - Select the box next to the 24-digit failure ID to copy your failure code and send it to support.

## Accessing HP PC Hardware Diagnostics Windows

After HP PC Hardware Diagnostics Windows is installed, you can access it from HP Support Assistant or the Start menu.

### Accessing HP PC Hardware Diagnostics Windows from HP Support Assistant

After HP PC Hardware Diagnostics Windows is installed, follow these steps to access it from HP Support Assistant:

1. Complete one of the following tasks:
  - Select the **Search** icon in the taskbar, type `support` in the search box, and then select the **HP Support Assistant** app.
  - Select the question mark icon in the taskbar.
2. Select **Fixes & Diagnostics**.

3. Select **Run hardware diagnostics**, and then select **Launch**.
4. When the tool opens, select the type of diagnostic test that you want to run, and then follow the on-screen instructions.

---

 **NOTE:** To stop a diagnostic test, select **Cancel**.

---

## Accessing HP PC Hardware Diagnostics Windows from the Start menu (select products only)

After HP PC Hardware Diagnostics Windows is installed, follow these steps to access it from the Start menu:

1. Select the **Start** button, and then select **All apps**.
2. Select **HP PC Hardware Diagnostics Windows**.
3. When the tool opens, select the type of diagnostic test that you want to run, and then follow the on-screen instructions.

---

 **NOTE:** To stop a diagnostic test, select **Cancel**.

---

## Downloading HP PC Hardware Diagnostics Windows

The HP PC Hardware Diagnostics Windows downloading instructions are provided in English only. You must use a Windows computer to download this tool because only .exe files are provided.

### Downloading the latest HP PC Hardware Diagnostics Windows version from HP

To download HP PC Hardware Diagnostics Windows from HP, follow these steps:

1. Go to <http://www.hp.com/go/techcenter/pcdiags>. The HP PC Diagnostics home page is displayed.
2. Select **Download HP Diagnostics Windows**, and then select the specific Windows diagnostics version to download to your computer or a USB flash drive.

The tool downloads to the selected location.

### Downloading the HP PC Hardware Diagnostics Windows from the Microsoft Store

You can download the HP PC Hardware Diagnostics Windows from the Microsoft Store:

1. Select the Microsoft Store app on your desktop or select the **Search** icon in the taskbar, and then type `Microsoft Store` in the search box.
2. Type `HP PC Hardware Diagnostics Windows` in the **Microsoft Store** search box.
3. Follow the on-screen directions.

The tool downloads to the selected location.

### Downloading HP Hardware Diagnostics Windows by product name or number (select products only)

You can download HP PC Hardware Diagnostics Windows by product name or number.

---

 **NOTE:** For some products, you might have to download the software to a USB flash drive by using the product name or number.

---



1. Go to <http://www.hp.com/support>.
2. Select **Software and Drivers**, select your type of product, and then enter the product name or number in the search box that is displayed.
3. In the **Diagnostics** section, select **Download**, and then follow the on-screen instructions to select the specific Windows diagnostics version to be downloaded to your computer or USB flash drive.

The tool downloads to the selected location.

## Installing HP PC Hardware Diagnostics Windows

To install HP PC Hardware Diagnostics Windows, navigate to the folder on your computer or the USB flash drive where the .exe file downloaded, double-click the .exe file, and then follow the on-screen instructions.

## Using HP PC Hardware Diagnostics UEFI

HP PC Hardware Diagnostics Unified Extensible Firmware Interface (UEFI) allows you to run diagnostic tests to determine whether the computer hardware is functioning properly. The tool runs outside the operating system so that it can isolate hardware failures from issues that are caused by the operating system or other software components.



**NOTE:** For some products, you must use a Windows computer and a USB flash drive to download and create the HP UEFI support environment because only .exe files are provided. For more information, see [Downloading HP PC Hardware Diagnostics UEFI to a USB flash drive on page 84](#).

If your PC does not start in Windows, you can use HP PC Hardware Diagnostics UEFI to diagnose hardware issues.

## Using an HP PC Hardware Diagnostics UEFI hardware failure ID code

When HP PC Hardware Diagnostics UEFI detects a failure that requires hardware replacement, a 24-digit failure ID code is generated.

For assistance in solving the problem, complete one of these tasks:

- Select **Contact HP**, accept the HP privacy disclaimer, and then use a mobile device to scan the failure ID code that appears on the next screen. The HP Customer Support - Service Center page appears with your failure ID and product number automatically filled in. Follow the on-screen instructions.
- Contact support, and provide the failure ID code.

## Starting HP PC Hardware Diagnostics UEFI

To start HP PC Hardware Diagnostics UEFI, follow this procedure.

1. Turn on or restart the computer, and quickly press **esc**.
2. Press **f2**.

The BIOS searches three places for the diagnostic tools, in the following order:

- a. Connected USB flash drive



---

**NOTE:** To download the HP PC Hardware Diagnostics UEFI tool to a USB flash drive, see [Downloading the latest HP PC Hardware Diagnostics UEFI version on page 84](#).

---

- b. Hard drive
  - c. BIOS
3. When the diagnostic tool opens, select the type of diagnostic test that you want to run, and then follow the on-screen instructions.

## Starting HP PC Hardware Diagnostics UEFI through HP Hotkey Support software (select products only)

This section describes how to start HP PC Hardware Diagnostics UEFI through HP Hotkey Support software.



---

**NOTE:** You must disable fast boot to access HP PC Hardware Diagnostics UEFI from the HP System Information application. To disable fast boot:

1. Turn on or restart the computer, and when the HP logo appears, press **f10** to enter Computer Setup.
2. Select **Advanced**, and then select **Boot Options**.
3. Clear **Fast Boot**.
4. Select **Save Changes and Exit**, and then select **Yes**.

- 
1. From the **Start** menu, open the HP System Information Application or enter **fn+esc**.
  2. In HP System Information screen, select **Run System Diagnostics**, select **Yes** to run the application, and then select **Restart**.



---

**IMPORTANT:** To prevent loss of data, save your work in all open apps before restarting your computer.



---

**NOTE:** When the restart is complete, the computer will boot to HP PC Hardware Diagnostics UEFI Application. Proceed with the troubleshooting tests.

---

## Downloading HP PC Hardware Diagnostics UEFI to a USB flash drive

Downloading HP PC Hardware Diagnostics UEFI to a USB flash drive can be useful in some situations.

- HP PC Hardware Diagnostics UEFI is not included in the preinstallation image.
- HP PC Hardware Diagnostics UEFI is not included in the HP Tool partition.
- The hard drive is damaged.



---

**NOTE:** The HP PC Hardware Diagnostics UEFI downloading instructions are provided in English only, and you must use a Windows computer to download and create the HP UEFI support environment because only .exe files are provided.

---

## Downloading the latest HP PC Hardware Diagnostics UEFI version

To download the latest HP PC Hardware Diagnostics UEFI version to a USB flash drive, follow this procedure:

1. Go to <http://www.hp.com/go/techcenter/pcdiags>. The HP PC Diagnostics home page is displayed.
2. Select **Download HP Diagnostics UEFI**, and then select **Run**.

## Downloading HP PC Hardware Diagnostics UEFI by product name or number (select products only)

You can download HP PC Hardware Diagnostics UEFI by product name or number (select products only) to a USB flash drive.



**NOTE:** For some products, you might have to download the software to a USB flash drive by using the product name or number.

1. Go to <http://www.hp.com/support>.
2. Enter the product name or number, select your computer, and then select your operating system.
3. In the **Diagnostics** section, follow the on-screen instructions to select and download the specific UEFI Diagnostics version for your computer.

## Using Remote HP PC Hardware Diagnostics UEFI settings (select products only)

Remote HP PC Hardware Diagnostics UEFI is a firmware (BIOS) feature that downloads HP PC Hardware Diagnostics UEFI to your computer. It can then run the diagnostics on your computer, and it might upload results to a preconfigured server.

For more information about Remote HP PC Hardware Diagnostics UEFI, go to <http://www.hp.com/go/techcenter/pcdiags>, and then select **Find out more**.

## Downloading Remote HP PC Hardware Diagnostics UEFI

Remote HP PC Hardware Diagnostics UEFI is also available as a SoftPaq that you can download to a server.

## Downloading the latest Remote HP PC Hardware Diagnostics UEFI version

You can download the latest Remote HP PC Hardware Diagnostics UEFI version to a USB flash drive.

1. Go to <http://www.hp.com/go/techcenter/pcdiags>. The HP PC Diagnostics home page is displayed.
2. Select **Download Remote Diagnostics**, and then select **Run**.

## Downloading Remote HP PC Hardware Diagnostics UEFI by product name or number

You can download Remote HP PC Hardware Diagnostics UEFI by product name or number.



**NOTE:** For some products, you might have to download the software by using the product name or number.

1. Go to <http://www.hp.com/support>.
2. Select **Software and Drivers**, select your type of product, enter the product name or number in the search box that is displayed, select your computer, and then select your operating system.

3. In the **Diagnostics** section, follow the on-screen instructions to select and download the **Remote UEFI** version for the product.

## Customizing Remote HP PC Hardware Diagnostics UEFI settings

Using the Remote HP PC Hardware Diagnostics setting in Computer Setup (BIOS), you can perform several customizations.

- Set a schedule for running diagnostics unattended. You can also start diagnostics immediately in interactive mode by selecting **Execute Remote HP PC Hardware Diagnostics UEFI**.
- Set the location for downloading the diagnostic tools. This feature provides access to the tools from the HP website or from a server that has been preconfigured for use. Your computer does not require the traditional local storage (such as a hard drive or USB flash drive) to run remote diagnostics.
- Set a location for storing the test results. You can also set the user name and password that you use for uploads.
- Display status information about the diagnostics runs previously.

To customize Remote HP PC Hardware Diagnostics UEFI settings, follow these steps:

1. Turn on or restart the computer, and when the HP logo appears, press **f10** to enter Computer Setup.
2. Select **Advanced**, and then select **Settings**.
3. Make your customization selections.
4. Select **Exit**, then select **Save Changes and Exit** to save your settings.

Your changes take effect when the computer restarts.

# 9 Specifications

This chapter provides specifications for your computer system.

## Computer specifications

This section provides specifications for your computer. When you travel with your computer, the computer dimensions and weights, as well as input power ratings and operating specifications, provide helpful information.

**Table 9-1 Computer specifications**

	Metric	U.S.
<b>Dimensions</b>		
Width	315.6 mm	12.4 in
Depth	224.1 mm	8.8 in
Height (front to back)	19.2 mm	0.8 in
<b>Weight</b>		
	1.2 kg	2.6 lb
<b>Input power</b>		
Operating voltage and current	19.5 V DC @ 2.31 A - 45 W	
	19.5 V DC @ 3.33 A - 65 W	
<b>Temperature</b>		
Operating	5°C to 35°C	41°F to 95°F
Nonoperating	-20°C to 60°C	-4°F to 140°F
<b>Relative humidity (noncondensing)</b>		
Operating	10% to 90%	
Nonoperating	5% to 95%	
<b>Maximum altitude (unpressurized)</b>		
Operating	-15 m to 3,048 m	-50 ft to 10,000 ft
Nonoperating	-15 m to 12,192 m	-50 ft to 40,000 ft
<b>NOTE:</b> Applicable product safety standards specify thermal limits for plastic surfaces. The device operates well within this range of temperatures.		

## Display specifications

This section provides specifications for your display.

**Table 9-2 Display specifications**

	<b>Metric</b>	<b>U.S.</b>
Active diagonal size	<b>35.6 cm</b>	14.0 in
Resolution	1920 × 1200 (WUXGA) 2560 × 1600 (WQXGA)	
Surface treatment	Antiglare	
Brightness	1000 nits 400 nits 250 nits	
Viewing angle	UWVA	
Backlight	WLED	
Display panel interface	eDP	

## Solid-state drive specifications

This section provides specifications for your solid-state drives.

**Table 9-3 Solid-state drive specifications**

	<b>256 GB*</b>	<b>512 GB*</b>	<b>1 TB*</b>
<b>Dimensions</b>			
Height	1.0 mm	1.0 mm	1.0 mm
Length	50.8 mm	50.8 mm	50.8 mm
Width	28.9 mm	28.9 mm	28.9 mm
Weight	< 10 g	< 10 g	< 10 g
<b>Interface type</b>			
Ready time, maximum (to not busy)	1.0 ms	< 1.0 ms	1.0 ms
Access times, logical	0.1 ms	0.1 ms	0.1 ms
<b>Transfer rate</b>			
Sequential read	up to 2150 MBps	up to 2150 MBps	up to 2150 MBps
Random read	Up to 300,000 IOPs	Up to 300,000 IOPs	Up to 300,000 IOPs
Sequential write	up to 1550 MBps	up to 1550 MBps	up to 1550 MBps
Random write	Up to 100,000 IOPs	Up to 100,000 IOPs	Up to 100,000 IOPs
<b>Total logical sectors</b>	468,883,296	1,000,215,216	1,500,336,388
<b>Operating temperature</b>	<b>0°C to 70°C (32°F to 158°F)</b>		

\*1 GB = 1 billion bytes when referring to hard drive storage capacity. Actual accessible capacity is less. Actual drive specifications might differ slightly.

**NOTE:** Certain restrictions and exclusions apply. Contact support for details.

---

# 10 Statement of memory volatility

For general information regarding nonvolatile memory in HP business computers, and to restore nonvolatile memory that can contain personal data after the system has been turned off and the hard drive has been removed, use these instructions.

HP business computer products that use Intel®-based or AMD®-based system boards contain volatile DDR memory. The amount of nonvolatile memory present in the system depends upon the system configuration. Intel-based and AMD-based system boards contain nonvolatile memory subcomponents as originally shipped from HP, with the following assumptions:

- No subsequent modifications were made to the system.
- No applications, features, or functionality were added to or installed on the system.

Following system shutdown and removal of all power sources from an HP business computer system, personal data can remain on volatile system memory (DIMMs) for a finite period of time and also remains in nonvolatile memory. Use the following steps to remove personal data from the computer, including the nonvolatile memory found in Intel-based and AMD-based system boards.

---

 **NOTE:** If your tablet has a keyboard base, connect to the keyboard base before beginning steps in this chapter.

---

## Current BIOS steps

Use these instructions to restore nonvolatile memory.

1. Follow these steps to restore the nonvolatile memory that can contain personal data. Restoring or reprogramming nonvolatile memory that does not store personal data is neither necessary nor recommended.
  - a. Turn on or restart the computer, and then quickly press **esc**.

---

 **NOTE:** If the system has a BIOS administrator password, type the password at the prompt.

---

- b. Select **Main**, select **Apply Factory Defaults and Exit**, and then select **Yes** to load defaults. The computer restarts.
- c. During the restart, press **esc** while the "Press the ESC key for Startup Menu" message is displayed at the bottom of the screen.

---

 **NOTE:** If the system has a BIOS administrator password, type the password at the prompt.

---

- d. Select the **Security** menu, select **Restore Security Settings to Factory Defaults**, and then select **Yes** to restore security level defaults. The computer restarts.
- e. During the restart, press **esc** while the "Press the ESC key for Startup Menu" message is displayed at the bottom of the screen.

---

 **NOTE:** If the system has a BIOS administrator password, type the password at the prompt.

---

- f. If an asset or ownership tag is set, select the **Security** menu and scroll down to the **Utilities** menu. Select **System IDs**, and then select **Asset Tracking Number**. Clear the tag, and then make the selection to return to the prior menu.
- g. If a DriveLock password is set, select the **Security** menu, and scroll down to **Hard Drive Utilities** under the **Utilities** menu. Select **Hard Drive Utilities**, select **DriveLock**, and then clear the check box for **DriveLock password on restart**. Select **OK** to proceed.
- h. Select the **Main** menu, and then select **Reset BIOS Security to factory default**. Select **Yes** at the warning message. The computer restarts.
- i. During the restart, press **esc** while the "Press the ESC key for Startup Menu" message is displayed at the bottom of the screen.



---

**NOTE:** If the system has a BIOS administrator password, type the password at the prompt.

---

- j. Select the **Main** menu, select **Apply Factory Defaults and Exit**, select **Yes** to save changes and exit, and then select **Shutdown**.
  - k. Restart the system. If the system has a Trusted Platform Module (TPM), fingerprint reader, or both, one or two prompts will appear—one to clear the TPM and the other to Reset Fingerprint Sensor. Press or tap **f1** to accept or **f2** to reject.
  - l. Remove all power and system batteries for at least 24 hours.
2. Complete one of the following:
- Remove and retain the storage drive.  
- or -
  - Clear the drive contents by using a third-party utility designed to erase data from an SSD.  
- or -
  - Clear the contents of the drive by using the following BIOS Setup Secure Erase command option steps:



---

**NOTE:** If you clear data using Secure Erase, you cannot recover it.

---

- a. Turn on or restart the computer, and then quickly press **esc**.
- b. Select the **Security** menu and scroll down to the **esc** menu.
- c. Select **Hard Drive Utilities**.
- d. Under **Utilities**, select **Secure Erase**, select the hard drive storing the data you want to clear, and then follow the on-screen instructions to continue.  
- or -  
Clear the contents of the drive using the following Disk Sanitizer commands steps:
  - i. Turn on or restart the computer, and then quickly press **esc**.
  - ii. Select the **Security** menu and scroll down to the **Utilities** menu.
  - iii. Select **Hard Drive Utilities**.



- iv. Under **Utilities**, select **Disk Sanitizer**, select the hard drive with the data that you want to clear, and then follow the on-screen instructions to continue.

 **NOTE:** The amount of time it takes for Disk Sanitizer to run can take several hours. Plug the computer into an AC outlet before starting.

## Nonvolatile memory usage

Use this table to troubleshoot nonvolatile memory usage.

**Table 10-1** Troubleshooting steps for nonvolatile memory usage

Description	Volatility description	Storage user data	How to erase
Primary storage device, holds the OS, applications, and application settings	Non-volatile, 8-256 GB of eMMC or NVMe SSD storage, removable	Yes <sup>1</sup>	Follow instructions below under "Erase the Primary Storage Device"
System memory (RAM), holds transient data during system operation	Volatile, SODIMM socket. Removable (4 GB/8 GB/16 GB)	Yes	Unplug unit from power
Permanent system BIOS settings	Non-volatile; 16 KB; stored	No <sup>2</sup>	Follow instructions below under "Clearing BIOS Settings"
System boot ROM (BIOS)	Non-volatile memory, 128 Mbit (16 MB) socketed, removable	No	Download the latest BIOS for your model from the HP website and follow the instructions to flash the BIOS that are on the website
RTC (CMOS) RAM	Volatile memory, 256 bytes located in AMD embedded System on Chip (SoC)	No	Unplug unit from main power, remove top cover and press <b>Clear CMOS</b> button
Keyboard/mouse (ROM)	Non-volatile, 2 KB embedded in the super I/O controller (SIO2)	Yes	N/A
Keyboard/mouse (RAM)	Volatile, 256 bytes embedded in the super I/O controller (SIO2)	No	Unplug unit from main power
LOM EEPROM	Non-volatile, 2 MB embedded in LAN controller	No	N/A
Trusted Platform Module (TPM)	Non-volatile; 51 KB ROM for firmware and 38 KB system parametric data	No <sup>3</sup>	Follow instructions below under "Clearing TPM"

<sup>1</sup> Under typical operation, the only user data stored on the primary storage device are preferences for device configuration and settings for connections. However, the administrator can configure the system to allow users to store data locally.

<sup>2</sup> Only user data potentially stored in BIOS Settings are the ownership and asset tags, administrator password, and startup password.

<sup>3</sup> The Trusted Platform Module may contain encrypted passwords or certificates generated from user or administrator input.

## Questions and answers

Use this section to answer your questions about nonvolatile memory.

## 1. How can the BIOS settings be restored (returned to factory settings)?



**IMPORTANT:** The restore defaults feature does not securely erase any information on your hard drive. See question and answer 6 for steps to securely erase information.

The restore defaults feature does not reset the Custom Secure Boot keys. See question and answer 7 for information about resetting the keys.

- a. Turn on or restart the computer, and then quickly press **esc**.
- b. Select **Main**, and then select **Apply Factory Defaults and Exit**.
- c. Follow the on-screen instructions.
- d. Select **Main**, select **Save Changes and Exit**, and then follow the on-screen instructions.

## 2. What is a UEFI BIOS, and how is it different from a legacy BIOS?

The Unified Extensible Firmware Interface (UEFI) BIOS is an industry-standard software interface between the platform firmware and an operating system (OS). It replaces the older BIOS architecture but supports much of the legacy BIOS functionality.

Like the legacy BIOS, the UEFI BIOS provides an interface to display the system information and configuration settings and to change the configuration of your computer before an OS is loaded. BIOS provides a secure runtime environment that supports a Graphic User Interface (GUI). In this environment, you can use either a pointing device (touch screen, touchpad, pointing stick, or USB mouse) or the keyboard to navigate and make menu and configuration selections. The UEFI BIOS also contains basic system diagnostics.

The UEFI BIOS provides functionality beyond that of the legacy BIOS. In addition, the UEFI BIOS works to initialize the computer's hardware before loading and executing the OS; the runtime environment allows the loading and execution of software programs from storage devices to provide more functionality, such as advanced hardware diagnostics (with the ability to display more detailed system information) and advanced firmware management and recovery software.

HP has provided options in Computer Setup (BIOS) to allow you to run in legacy BIOS, if required by the operating system. Examples of this requirement would be if you upgrade or downgrade the OS.

## 3. Where is the UEFI BIOS located?

The UEFI BIOS is located on a flash memory chip. You must use a utility to write to the chip.

## 4. What kind of configuration data is stored on the DIMM Serial Presence Detect (SPD) memory module? How would this data be written?

The DIMM SPD memory contains information about the memory module, such as size, serial number, data width, speed and timing, voltage, and thermal information. This information is written by the module manufacturer and stored on an EEPROM. You cannot write to this EEPROM when the memory module is installed in a computer. Third-party tools do exist that can write to the EEPROM when the memory module is not installed in a computer. Various third-party tools are available to read SPD memory.

## 5. What is meant by "Restore the nonvolatile memory found in Intel-based system boards"?

This message relates to clearing the Real Time Clock (RTC) CMOS memory that contains computer configuration data.

## 6. How can the BIOS security be reset to factory defaults and erase the data?



**IMPORTANT:** Resetting results in the loss of information.

These steps do not reset Custom Secure Boot Keys. See question and answer 7 for information about resetting the keys.

- a. Turn on or restart the computer, and then quickly press **esc**.
- b. Select **Main**, and then select **Reset Security to Factory Defaults**.
- c. Follow the on-screen instructions.
- d. Select **Main**, select **Save Changes and Exit**, and then follow the on-screen instructions.

## 7. How can the Custom Secure Boot Keys be reset?

Secure Boot is a feature to ensure that only authenticated code can start on a platform. If you enabled Secure Boot and created Custom Secure Boot Keys, disabling Secure Boot does not clear the keys. You must also select to clear the Custom Secure Boot Keys. Use the same Secure Boot access procedure that you used to create the Custom Secure Boot Keys, but select to clear or delete all Secure Boot Keys.

- a. Turn on or restart the computer, and then quickly press **esc**.
- b. Select the **Security** menu, select **Secure Boot Configuration**, and then follow the on-screen instructions.
- c. At the **Secure Boot Configuration** window, select **Secure Boot**, select **Clear Secure Boot Keys**, and then follow the on-screen instructions to continue.

## Using HP Sure Start (select products only)

Select computer models are configured with HP Sure Start, a technology that continuously monitors your computer's BIOS for attacks or corruption.

If the BIOS becomes corrupted or is attacked, HP Sure Start restores the BIOS to its previously safe state, without user intervention. Those select computer models ship with HP Sure Start configured and enabled. HP Sure Start is configured and already enabled so that most users can use the HP Sure Start default configuration. Advanced users can customize the default configuration.

To access the latest documentation on HP Sure Start, go to <http://www.hp.com/support>.

# 11 Power cord set requirements

This chapter provides power cord requirements for countries and regions.

The wide-range input feature of the computer permits it to operate from any line voltage from 100 V AC to 120 V AC, or from 220 V AC to 240 V AC.

The three-conductor power cord set included with the computer meets the requirements for use in the country or region where the equipment is purchased.

Power cord sets for use in other countries or regions must meet the requirements of the country and region where the computer is used.

## Requirements for all countries

These power cord requirements are applicable to all countries and regions.

- The length of the power cord set must be at least **1.0 m** (3.3 ft) and no more than **2.0 m** (6.5 ft).
- All power cord sets must be approved by an acceptable accredited agency responsible for evaluation in the country or region where the power cord set will be used.
- The power cord sets must have a minimum current capacity of 10 A and a nominal voltage rating of 125 V AC or 250 V AC, as required by the power system of each country or region.
- The appliance coupler must meet the mechanical configuration of an EN 60 320/IEC 320 Standard Sheet C13 connector for mating with the appliance inlet on the back of the computer.

## Requirements for specific countries and regions

To determine power cord requirements for specific countries and regions, use this table.

**Table 11-1** Power cord requirements for specific countries and regions

Country/region	Accredited agency	Applicable note number
Argentina	IRAM	1
Australia	SAA	1
Austria	OVE	1
Belgium	CEBEC	1
Brazil	ABNT	1
Canada	CSA	2
Chile	IMQ	1
Denmark	DEMKO	1
Finland	FIMKO	1
France	UTE	1

**Table 11-1 Power cord requirements for specific countries and regions (continued)**

Country/region	Accredited agency	Applicable note number
Germany	VDE	1
India	BIS	1
Israel	SII	1
Italy	IMQ	1
Japan	JIS	3
Netherlands	KEMA	1
New Zealand	SANZ	1
Norway	NEMKO	1
People's Republic of China	CCC	4
Saudi Arabia	SASO	7
Singapore	PSB	1
South Africa	SABS	1
South Korea	KTL	5
Sweden	SEMKO	1
Switzerland	SEV	1
Taiwan	BSMI	6
Thailand	TISI	1
United Kingdom	ASTA	1
United States	UL	2

1. The flexible cord must be Type H05VV-F, three-conductor, 0.75 mm<sup>2</sup> conductor size. Power cord set fittings (appliance coupler and wall plug) must bear the certification mark of the agency responsible for evaluation in the country or region where it will be used.
2. The flexible cord must be Type SVT/SJT or equivalent, No. 18 AWG, three-conductor. The wall plug must be a two-pole grounding type with a NEMA 5-15P (15 A, 125 V AC) or NEMA 6-15P (15 A, 250 V AC) configuration. CSA or C-UL mark. UL file number must be on each element.
3. The appliance coupler, flexible cord, and wall plug must bear a T mark and registration number in accordance with the Japanese Dentori Law. The flexible cord must be Type VCTF, three-conductor, 0.75 mm<sup>2</sup> or 1.25 mm<sup>2</sup> conductor size. The wall plug must be a two-pole grounding type with a Japanese Industrial Standard C8303 (7 A, 125 V AC) configuration.
4. The flexible cord must be Type RVV, three-conductor, 0.75 mm<sup>2</sup> conductor size. Power cord set fittings (appliance coupler and wall plug) must bear the CCC certification mark.
5. The flexible cord must be Type H05VV-F three-conductor, 0.75 mm<sup>2</sup> conductor size. KTL logo and individual approval number must be on each element. Approval number and logo must be printed on a flag label.
6. The flexible cord must be Type HVCTF three-conductor, 1.25 mm<sup>2</sup> conductor size. Power cord set fittings (appliance coupler, cable, and wall plug) must bear the BSMI certification mark.
7. For 127 V AC, the flexible cord must be Type SVT or SJT 3-conductor, 18 AWG, with plug NEMA 5-15P (15 A, 125 V AC), with UL and CSA or C-UL marks. For 240 V AC, the flexible cord must be Type H05VV-F three-conductor, 0.75 mm<sup>2</sup> or 1.00 mm<sup>2</sup> conductor size, with plug BS 1363/A with BSI or ASTA marks.

---

## 12 Recycling

When a nonrechargeable or rechargeable battery has reached the end of its useful life, do not dispose of the battery in general household waste. Follow the local laws and regulations in your area for battery disposal.

HP encourages customers to recycle used electronic hardware, HP original print cartridges, and rechargeable batteries. For more information about recycling programs, see the HP website at <http://www.hp.com/recycle>.

# Index

## A

AC adapter  
  spare part numbers 25  
adapter  
  spare part numbers 25  
ambient light and color sensor,  
  identifying 9  
audio jack  
  illustrated 22  
  removal 55  
  spare part number 22, 55  
audio-out (headphone)/audio-in  
  (microphone) combo jack,  
  identifying 7  
audio, product description 3

## B

backup, creating 74  
backups 74  
battery  
  illustrated 22  
  removal 41  
  spare part numbers 22, 41  
battery light 8  
BIOS  
  determining version 78  
  downloading an update 78, 79  
  updating 78  
Bluetooth label 16  
boot order  
  changing using the f9  
  prompt 79  
boot order, changing 76  
bottom cover  
  illustrated 22  
  removal 39  
  spare part numbers 22, 39  
Bracket Kit, spare part  
  number 26  
buttons  
  left touchpad 11  
  power 13, 14  
  right touchpad 11

## C

cable retainer  
  removal 56

  spare part number 56  
cable, spare part numbers 26  
cables  
  spare part numbers 24  
camera 9  
  identifying 9  
camera light, identifying 9  
camera privacy cover,  
  identifying 9  
caps lock light, identifying 12  
card reader  
  illustrated 20  
  removal 54  
  spare part number 20, 54  
card reader cable  
  illustrated 20, 24  
  spare part number 20, 24  
caring for your computer 34  
cautions  
  electrostatic discharge 30, 31  
cleaning your computer 34  
  caring for wood veneer 36  
  disinfecting 35  
  HP Easy Clean 34  
  removing dirt and debris 34  
components  
  bottom 15  
  display 8  
  keyboard area 10  
  left side 7  
  rear 15  
  right side 6  
Computer Setup  
  navigating and selecting 77  
  restoring factory settings 77  
  starting 77  
computer specifications 87  
connector board  
  removal 56  
  spare part number 56  
connector board cable  
  illustrated 21, 24  
  spare part number 21, 24  
connector, power 8

## D

display  
  specifications 87

display assembly  
  removal 62  
  subcomponents 22  
display back cover  
  illustrated 22  
  spare part numbers 22  
display bezel  
  illustrated 22  
  removal 65  
  spare part numbers 22, 65  
display components 8  
display panel  
  illustrated 22  
  product description 1, 2  
  removal 66  
  spare part numbers 22, 67  
display panel cable  
  illustrated 22  
  removal 68  
  spare part number 22, 68  
display transfer board  
  illustrated 22  
  removal 69  
  spare part numbers 22, 70  
display transfer board cable  
  illustrated 22  
  removal 69  
  spare part number 22, 69  
dock, spare part numbers 26

## E

electrostatic discharge (ESD) 30,  
  31  
  preventing damage 30-32  
eMMC  
  product description 2  
esc key, identifying 14

## F

fan  
  illustrated 21  
  removal 57  
  spare part numbers 21, 57  
fingerprint reader  
  illustrated 20  
  removal 51  
  spare part number 20

- spare part numbers 51
- fingerprint reader bracket
  - illustrated 20
  - removal 51
  - spare part number 20, 52
- fingerprint reader cable
  - illustrated 20, 24
  - spare part number 20, 24
- fingerprint reader, identifying 13
- fn key, identifying 14
- fn lock light, identifying 12

## G

- grounding methods 30-32
- guidelines
  - packaging 30, 36
  - transporting 30, 36
  - workstation 30

## H

- hard drive
  - specifications 87
- HDMI port, identifying 7
- heat sink
  - illustrated 21
  - removal 58
  - spare part numbers 21, 58
- hinge
  - illustrated 22
  - removal 68
  - spare part number 22, 68
- hinge cover
  - illustrated 22
  - removal 67
  - spare part number 22, 67
- HP PC Hardware Diagnostics UEFI
  - downloading 84
  - failure ID code 83
  - HP Hotkey Support
    - software 84
  - starting 83, 84
  - using 83
- HP PC Hardware Diagnostics Windows
  - accessing 81, 82
  - downloading 82
  - failure ID code 81
  - installing 83
  - using 81
- HP Recovery media
  - recovery 75
- HP Sure Recover 76
- HP Sure Start 89, 93
- hub, spare part numbers 26

## I

- I/O bracket
  - illustrated 21
  - removal 56, 62
  - spare part number 21, 56, 62
- illustrated parts catalog 19
- integrated numeric keypad, identifying 15
- internal microphones, identifying 9

## J

- jacks
  - audio-out (headphone)/audio-in (microphone) combo 7

## K

- keyboard
  - product description 4
- keyboard, spare part number 26
- keypad
  - integrated numeric 15
- keys
  - esc 14
  - fn 14
  - num lk 14
  - Windows 14

## L

- labels
  - Bluetooth 16
  - regulatory 16
  - serial number 16
  - service 16
  - wireless certification 16
  - WLAN 16
- left side components 7
- lights
  - AC adapter and battery 8
  - battery 8
  - camera 9
  - caps lock 12
  - fn lock 12
  - microphone mute 12
  - num lk 12
  - power 12
  - privacy key 12
- lights, mute 12
- lights, num lk 12
- low blue light mode 8

## M

- magnetic pen attachment area, identifying 6
- memory
  - nonvolatile 89
  - volatile 89
- memory module
  - illustrated 21
  - product description 2
  - spare part numbers 21
- memory module shield
  - illustrated 21
  - removal 46
  - spare part number 21, 46
- memory modules
  - removal 46
  - spare part numbers 46
- microphone
  - product description 3
- microphone module
  - illustrated 22
  - removal 72
  - spare part number 22, 72
- microphone module cable
  - illustrated 22
  - removal 71
  - spare part number 22, 71
- microphone mute light, identifying 12
- model name 1
- mouse, spare part numbers 26
- mute light, identifying 12

## N

- nano SIM card, inserting 18
- Near Field Communications (NFC)
  - tapping area and antenna, identifying 11
- NFC module
  - illustrated 20
  - removal 52
  - spare part number 20, 52
- NFC module cable
  - illustrated 20, 24
  - spare part number 20, 24
- nonvolatile memory 89
- num lk light 12
- num lk light, identifying 12

## O

- operating system, product description 5



optical drive, spare part  
number 26

## P

packaging guidelines 30, 36  
pen, magnetic attachment area 6  
Plastics Kit, spare part  
number 27  
pointing device, product  
description 4  
ports  
HDMI 7  
product description 3  
USB SuperSpeed 6  
USB SuperSpeed port with HP  
Sleep and Charge 7  
USB Type-C power connector  
and Thunderbolt port with  
HP Sleep and Charge 8  
power button, identifying 13, 14  
power connector  
identifying USB Type-C 8  
power cord  
requirements for all  
countries 94  
requirements for specific  
countries and regions 94  
set requirements 94  
spare part numbers 27, 28  
power lights 12  
power requirements, product  
description 4  
privacy key light 12  
processor  
product description 1  
product description  
audio 3  
display panel 1, 2  
eMMC 2  
keyboard 4  
memory module 2  
microphone 3  
operating system 5  
pointing device 4  
ports 3  
power requirements 4  
processors 1  
product name 1  
security 4  
sensors 4  
serviceability 5  
storage 3  
video 3  
wireless 3

product name 1  
product name and number,  
computer 16

## R

recovery 74  
discs 75  
media 75  
USB flash drive 75  
recovery media 74  
creating using HP Cloud  
Recovery Download Tool 74  
creating using Windows  
tools 74  
regulatory information  
regulatory label 16  
wireless certification labels 16  
Remote HP PC Hardware  
Diagnostics UEFI settings  
customizing 86  
using 85  
removal and replacement  
procedures 39  
removing personal data from  
volatile system memory 89  
restoring 74  
restoring and recovery  
methods 75  
right side components 6  
RTC battery  
illustrated 20  
spare part number 20

## S

Screw Kit, spare part number 26  
security cable slot, identifying 6  
security, product description 4  
sensors, product description 4  
serial number, computer 16  
service labels, locating 16  
serviceability, product  
description 5  
setup utility  
navigating and selecting 77  
restoring factory settings 77  
SIM card slot, identifying 6  
SIM card, correct size 17  
SIM card, inserting 17  
slots  
security cable 6  
SIM card 6  
smart card 8  
smart card slot, identifying 8

solid-state drive  
illustrated 21  
removal 48  
spare part numbers 21, 48  
specifications 88  
solid-state drive shield  
illustrated 21  
removal 49  
spare part number 21, 48, 49  
spare part country codes 72  
speaker  
removal 45  
spare part number 45  
speakers  
illustrated 20  
spare part number 20  
speakers, identifying 15  
special keys, using 13  
specifications  
computer 87  
display 87  
hard drive 87  
solid-state drive 88  
static electricity 30, 31  
storage  
product description 3  
support information 37  
Sure Start  
using 80  
system board  
illustrated 20  
removal 59  
spare part numbers 20, 59  
system memory, removing  
personal data from volatile 89  
system restore 75  
system restore point, creating 74

## T

top cover with keyboard  
illustrated 20  
spare part numbers 20, 72  
touchpad  
illustrated 20, 21  
removal 53  
settings 10  
spare part numbers 20, 21, 53  
touchpad buttons  
identifying 11  
touchpad cable  
illustrated 20, 24  
spare part number 20, 24  
touchpad zone, identifying 11  
TPM settings 80

transporting guidelines 30, 36  
traveling with the computer 16

removal 42  
spare part numbers 21, 42

## U

USB SuperSpeed port with HP  
Sleep and Charge,  
identifying 7  
USB SuperSpeed port,  
identifying 6  
USB Type-C power connector and  
Thunderbolt port with HP Sleep  
and Charge, identifying 8

## V

vents, identifying 15, 16  
video, product description 3

## W

webcam module  
illustrated 22  
removal 71  
spare part number 22  
spare part numbers 71  
webcam module cable  
illustrated 22  
removal 70  
spare part number 22, 70  
Windows  
backup 74  
recovery media 74  
system restore point 74  
Windows key, identifying 14  
Windows tools, using 74  
wireless antennas, identifying 9  
wireless certification label 16  
wireless, product description 3  
WLAN antenna  
illustrated 22  
spare part number 22  
WLAN antennas, identifying 9  
WLAN device 16  
WLAN label 16  
WLAN module  
illustrated 21  
removal 44  
spare part numbers 21, 44  
workstation guidelines 30  
WWAN antenna  
illustrated 22  
spare part number 22  
WWAN antennas, identifying 9  
WWAN module  
illustrated 21