

Service Manual



Colour LCD Television

TX-32LX600F

TX-32LX600P

TX-26LX600F

TX-26LX600P

LH50 Chassis

Specifications

(Informations in brackets [] refers to models 26'')

Power Source:	220-240V AC, 50/60Hz	
Power Consumption	136W TX-32LX600F 169W TX-32LX600P 82W TX-26LX600F 118W TX-26LX600P	
Stand-by Power Consumption:	0,4W	
Aerial Impedance:	75Ω unbalanced, Coaxial Type	
Receiving System:	PAL-I, B/G, H, D/K, SECAM B/G, D/K, L/L' PAL-525/60, M.NTSC, NTSC (AV only)	
Receiving Channels:	VHF E2-E12 VHF A-H (ITALY) VHF R3-R5 UHF E21-E69 CATV S1-S10 (M1-M10) CATV S21-S41 (Hyperband)	VHF H1-H2 (ITALY) VHF R1-R2 VHF R6-R12 CATV (S01-S05) CATV S11-S20 (U1-U10)
Operating Conditions:	Temperature: 0°C ÷ 35°C	
Scanning format:	480i(60Hz), 480p(60Hz), 576i(50Hz), 576p(50Hz), 720p(60Hz), 720p(50Hz), 1.080i(60Hz), 1.080i(50Hz)	
PC signals:	VGA, SVGA, XGA SXGA(compressed)	Horizontal scanning frequency 31 – 69 kHz Vertical scanning frequency 59 – 86 Hz
Intermediate Frequency:		
Video/Audio		
Video	38,9MHz, 33,9MHz	
Audio	33,4MHz (B/G), 33,16MHz (A2) 33,05MHz (NICAM B/G, D/K, L) 32,4MHz (D/K), 32,66MHz (CZ STEREO) 40,4MHz (L'), 39,75Mhz (L'NICAM),	
Colour	34,47MHz (PAL) 34,5MHz, 34,65MHz (SECAM) 38,3MHz, 38,15MHz (SECAM L')	
Terminals:		
AV1 IN	Video (21 pin) 1V p-p 75Ω Audio (21 pin) 500mV rms 10kΩ RGB (21 pin) 0,7V p-p 75Ω	

AV1 OUT	Video (21 pin) 1V p-p 75Ω Audio (21 pin) 500mV rms 1kΩ
AV2 IN	Video (21 pin) 1V p-p 75Ω Audio (21 pin) 500mV rms 10kΩ S-video IN (21-pin)Y: 1V p-p 75Ω C:0,3V p-p 75Ω
AV2 OUT	Video (21 pin) 1V p-p 75Ω Audio (21 pin) 500mV rms 1kΩ
AV3 IN	Video (21 pin) 1V p-p 75Ω Audio (21 pin) 500mV rms 10kΩ RGB (21 pin) 0,7V p-p 75Ω S-video IN (21-pin)Y: 1V p-p 75Ω C:0,3V p-p 75Ω
AV3 OUT	Video (21 pin) 1V p-p 75Ω Audio (21 pin) 500mV rms 1kΩ
AV4 IN	S-Video IN (4-pin)Y: 1V p-p 75Ω C:0,3V p-p 75Ω Audio (RCAX2) 500mV rms 10kΩ Video (RCAX1) 1V p-p 75Ω
HDMI1, HDMI2	Type A Connector
COMPONENT YUV	Video (RCAX3) Y:1V p-p 75Ω Pb, Pr: 0,7V p-p 75Ω
AUDIO IN	Audio (RCAX2) 500mV rms 10kΩ
AUDIO OUT	Audio (RCAX2) 500mV rms 1kΩ
PC	HIGH-DENSITY D_SUB 15PIN
CARD SLOT	SD CARD slot x1
LCD screen:	L5EDD8Q00025 [L5EDD6Q00019] 1366 x 768 XGA, 16:9 Visible Diagonal 800mm [660mm]
Audio Output:	20W (5W + 5W, 5W + 5W)
Headphones:	3,5mm, 8Ω Impedance
Accessories supplied :	Remote Control 2 x R6 (UM3) Batteries
Dimensions:	
Including TV stand	Height: Width: Depth: 624mm 857mm 300mm [549mm] [724mm] [300mm]
TV set only	563mm 857mm 141mm [487mm] [724mm] [141mm]
Net weight:	22,5kg [19,5kg]

Specifications are subject to change without notice.
Weights and dimensions shown are approximate.

Warning

This service information is designed for experienced repair technicians only and is not designed for use by the general public. It does not contain warnings or cautions to advise non-technical individuals of potential dangers in attempting to service a product. Products powered by electricity should be serviced or repaired only by experienced professional technicians. Any attempt to service or repair the product or products deal within this service information by anyone else could result in serious injury or death.

CONTENTS

SAFETY PRECAUTIONS	4	REPLACEMENT PARTS LIST	24
GENERAL QUIDE LINES.....	4	SCHEMATIC DIAGRAMS.....	49
TOUCH – CURRENT CHECK.....	4	AP-BOARD (1 OF 3) SCHEMATIC DIAGRAM....	50
PREVENTION OF ELECTROSTATIC DISCHARGE (ESD) TO ELECTROSTATICALLY SENSITIVE (ES) DEVICES	5	AP-BOARD (2 OF 3) SCHEMATIC DIAGRAM....	51
ABOUT LEAD FREE SOLDER (PBF).....	6	AP-BOARD (3 OF 3) SCHEMATIC DIAGRAM....	52
SUGGESTED PB FREE SOLDER.....	6	DG-BOARD (1 OF 8) SCHEMATIC DIAGRAM ...	53
APPLICABLE SIGNALS.....	7	DG-BOARD (2 OF 8) SCHEMATIC DIAGRAM ...	54
SERVICE HINTS	8	DG-BOARD (3 OF 8) SCHEMATIC DIAGRAM ...	55
CHASSIS BOARD LAYOUT	9	DG-BOARD (4 OF 8) SCHEMATIC DIAGRAM ...	56
SETTING INSPECTION.....	9	DG-BOARD (5 OF 8) SCHEMATIC DIAGRAM ...	57
SELF-CHECK	10	DG-BOARD (6 OF 8) SCHEMATIC DIAGRAM ...	58
POWER LED BLINKING TIMING CHART	11	DG-BOARD (7 OF 8) SCHEMATIC DIAGRAM ...	59
SERVICE MODE FUNCTION.....	12	DG-BOARD (8 OF 8) SCHEMATIC DIAGRAM ...	60
SERVICE 1	13	G-BOARD SCHEMATIC DIAGRAM	61
SERVICE 2	14	GS-BOARD SCHEMATIC DIAGRAM.....	62
OPTION DESCRIPTION.....	15	H-BOARD (1 OF 4) SCHEMATIC DIAGRAM.....	63
ADJUSTMENT METHOD	17	H-BOARD (2 OF 4) SCHEMATIC DIAGRAM.....	64
WIRING DIAGRAM	18	H-BOARD (3 OF 4) SCHEMATIC DIAGRAM.....	65
BLOCK DIAGRAMS.....	19	H-BOARD (4 OF 4) SCHEMATIC DIAGRAM.....	66
PARTS LOCATION.....	22	V ,K-BOARD SCHEMATIC DIAGRAM.....	67
		CONDUCTOR VIEWS.....	68

Safety Precautions

General Guide Lines

1. When servicing, observe the original lead dress. If a short circuit is found, replace all parts which have been overheated or damaged by the short circuit.
2. After servicing, see to it that all the protective devices such as insulation barriers, insulation papers shields are properly installed.
3. After servicing, make the following touch current checks to prevent the customer from being exposed to shock hazards.
4. Always ensure panel TKKL5290 is correctly replaced before returning to customer (see Fig.1).

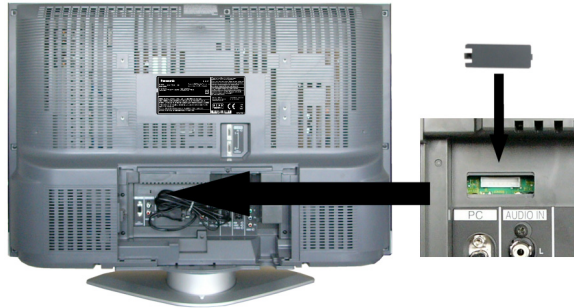

Fig. 1

Touch-Current Check

1. Plug the AC cord directly into the AC outlet. Do not use an isolation transformer for this check.
2. Connect a measuring network for touch currents between each exposed metallic part on the set and a good earth ground such as a water pipe, as shown in Fig. 2.
3. Use Leakage Current Tester (Simpson 228 or equivalent) to measure the potential across the measuring network.
4. Check each exposed metallic part, and measure the voltage at each point.
5. Reserve the AC plug in the AC outlet and repeat each of the above measure.
6. The potential at any point (TOUCH CURRENT) expressed as voltage U_1 and U_2 , does not exceed the following values:
For a. c.: $U_1 = 35 \text{ V}$ (peak) and $U_2 = 0.35 \text{ V}$ (peak);
For d. c.: $U_1 = 1.0 \text{ V}$,

Note:

The limit value of $U_2 = 0.35 \text{ V}$ (peak) for a. c. and $U_1 = 1.0 \text{ V}$ for d. c. correspond to the values 0.7 mA (peak) a. c. and 2.0 mA d. c.

The limit value $U_1 = 35 \text{ V}$ (peak) for a. c. correspond to the value 70 mA (peak) a. c. for frequencies greater than 100 kHz .

7. In case a measurement is out of the limits specified, there is a possibility of a shock hazard, and the equipment should be repaired and rechecked before it is returned to the customer.

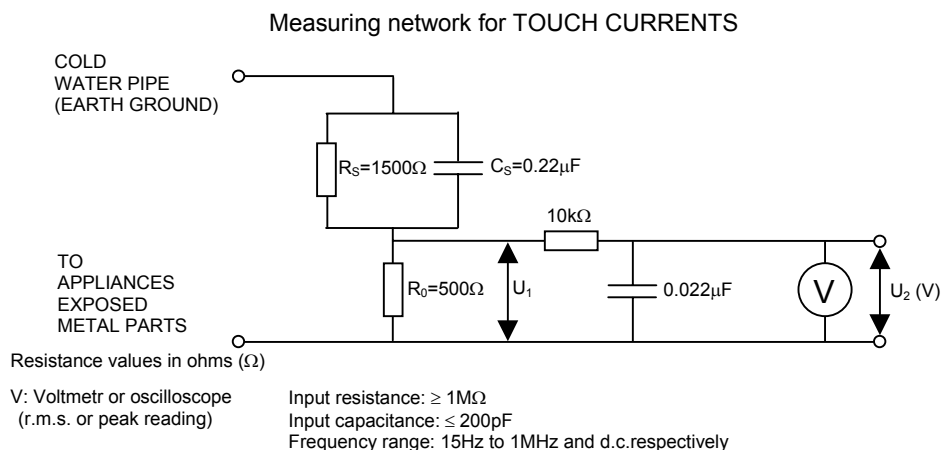

NOTE – Appropriate measures should be taken to obtain the correct value in case of non-sinusoidal waveforms

Fig. 2

Prevention of Electrostatic Discharge (ESD) to Electrostatically Sensitive (ES) Devices

Some semiconductor (solid state) devices can be damaged easily by static electricity. Such components commonly are called Electrostatically Sensitive (ES) Devices. Examples of typical ES devices are integrated circuits and some field-effect transistors and semiconductor "chip" components. The following techniques should be used to help reduce the incidence of component damage caused by electrostatic discharge (ESD).

1. Immediately before handling any semiconductor component or semiconductor-equipped assembly, drain off any ESD on your body by touching a known earth ground. Alternatively, obtain and wear a commercially available discharging ESD wrist strap, which should be removed for potential shock reasons prior to applying power to the unit under test.
2. After removing an electrical assembly equipped with ES devices, place the assembly on a conductive surface such as aluminum foil, to prevent electrostatic charge build up or exposure of the assembly.
3. Use only a grounded-tip soldering iron to solder or unsolder ES devices.
4. Use only an anti-static solder removal device. Some solder removal devices not classified as "anti-static (ESD protected)" can generate electrical charge sufficient to damage ES devices.
5. Do not use freon-propelled chemicals. These can generate electrical charges sufficient to damage ES devices.
6. Do not remove a replacement ES device from its protective package until immediately before you are ready to install it. (Most replacement ES devices are packaged with leads electrically shorted together by conductive foam, aluminum foil or comparable conductive material).
7. Immediately before removing the protective material from the leads of a replacement ES device, touch the protective material to the chassis or circuit assembly into which the device will be installed.

Caution

Be sure no power is applied to the chassis or circuit, and observe all other safety precautions.

8. Minimize bodily motions when handling unpackaged replacement ES devices. (Otherwise harmless motion such as the brushing together of your clothes fabric or the lifting of your foot from a carpeted floor can generate static electricity (ESD) sufficient to damage an ES device).

IMPORTANT SAFETY NOTICE

There are special components used in this equipment which are important for safety. These parts are marked by  in schematic diagrams, exploded views and replacement parts list. It is essential that these critical parts should be replaced with manufacturer's specified parts to prevent shock, fire, or other hazards. Do not modify the original design without permission of manufacturer.

About lead free solder (PbF)

Note: Lead is listed as (Pb) in the periodic table of elements.

In the information below, Pb will refer to Lead solder, and PbF will refer to Lead Free Solder.

The Lead Free Solder used in our manufacturing process and discussed below is (Sn+Ag+Cu).

That is Tin (Sn), Silver (Ag) and Copper (Cu) although other types are available.

This model uses Pb Free solder in it's manufacture due to environmental conservation issues. For service and repair work, we'd suggest the use of Pb free solder as well, although Pb solder may be used.

PCBs manufactured using lead free solder will have the PbF within a leaf Symbol

 stamped on the back of PCB.

Caution

- Pb free solder has a higher melting point than standard solder. Typically the melting point is 50 ~ 70 °F (30~40°C) higher. Please use a high temperature soldering iron and set it to 700 ± 20 °F (370 ± 10 °C).
- Pb free solder will tend to splash when heated too high (about 1100 °F or 600 °C).
If you must use Pb solder, please completely remove all of the Pb free solder on the pins or solder area before applying Pb solder. If this is not practical, be sure to heat the Pb free solder until it melts, before applying Pb solder.
- After applying PbF solder to double layered boards, please check the component side for excess solder which may flow onto the opposite side. (see Fig.3)

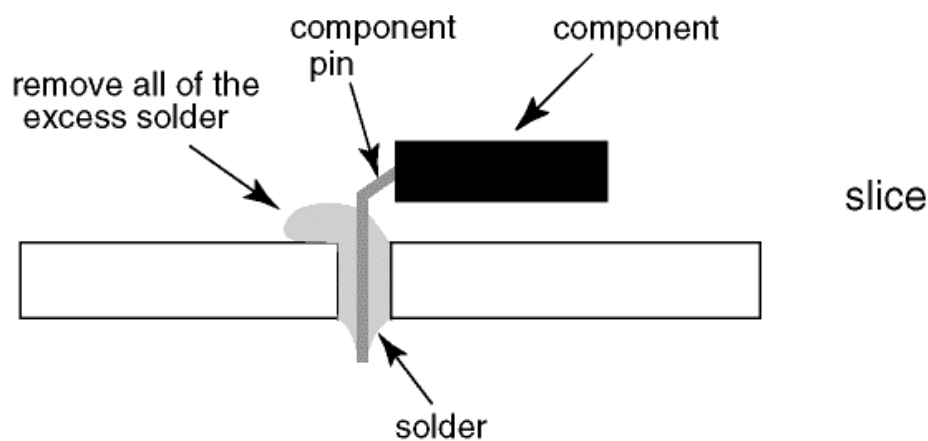

Fig.3

Suggested Pb free solder

There are several kinds of Pb free solder available for purchase. This product uses Sn+Ag+Cu (tin, silver, copper) solder. However, Sn+Cu (tin, copper), Sn+Zn+Bi (tin, zinc, bismuth) solder can also be used. (see Fig.4)

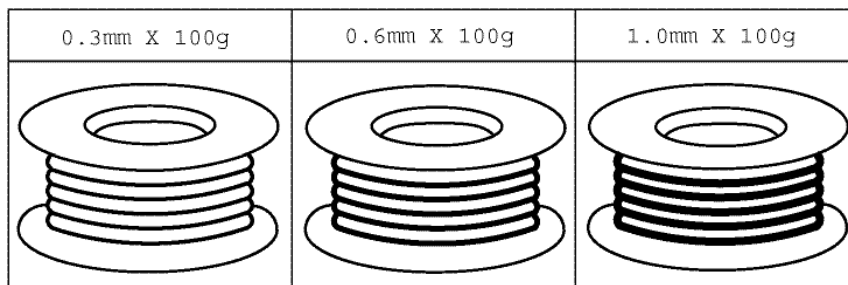

Fig.4

Applicable signals

Signal name	Horizontal frequency (kHz)	Vertical frequency (Hz)	Component	HDMI	PC
525 (480)/60i	15,73	59,94	*	*	
525 (480)/60p	31,47	59,94	*	*	
625 (576)/50i	15,63	50,00	*	*	
625 (576)/50p	31,25	50,00	*	*	
750 (720)/60p	45,00	60,00	*	*	
750 (720)/50p	37,50	50,00	*	*	
1.125 (1.080)/60i	33,75	60,00	*	*	
1.125 (1.080)/50i	28,13	50,00	*	*	
640 x 400 @70 Hz	31,46	70,07			*
640 x 480 @60 Hz	31,47	59,94			*
640 x 480 @75 Hz	37,50	75,00			*
852 x 480 @60 Hz	31,47	59,94			*
800 x 600 @60 Hz	37,88	60,32			*
800 x 600 @75 Hz	46,88	75,00			*
800 x 600 @85 Hz	53,67	85,06			*
1.024 x 768 @60 Hz	48,36	60,00			*
1.024 x 768 @70 Hz	56,48	70,07			*
1.024 x 768 @75 Hz	60,02	75,03			*
1.024 x 768 @85 Hz	68,68	85,00			*
1.280 x 1024 @60 Hz	63,98	60,02			*
1.366 x 768 @60 Hz	48,36	60,00			*
Macintosh 13" (640 x 480)	35,00	66,67			*
Macintosh 16" (832 x 624)	49,72	74,54			*
Macintosh 21" (1.152 x 870)	68,68	75,06			*

Note:

- Signals other than above may not be displayed properly.
- Applicable input signal for PC is basically compatible to VESA standard timing.
- PC signal is magnified or compressed for display, so that it may not be possible to show fine detail.

Service Hints

How to remove the Pedestal assembly

Lay the main unit face down. (see Fig.5)



Fig.5

Remove the cable cover. (see Fig.6)

Remove the 4 fixing screws and the pedestal assembly. (see Fig.7)

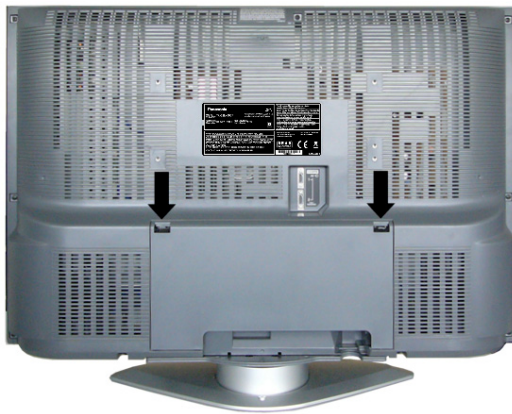

Fig.6

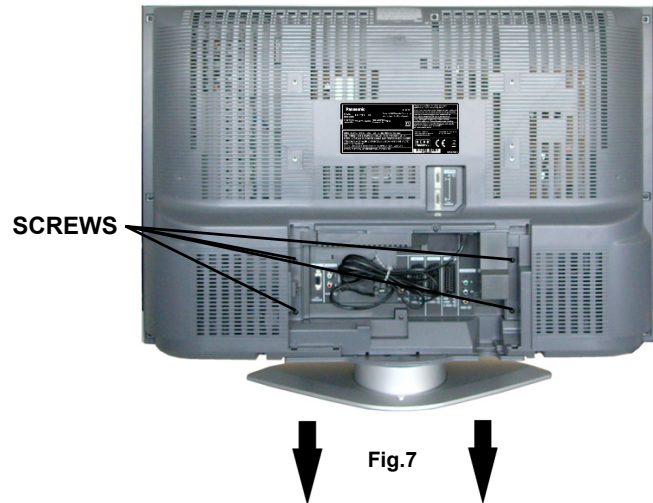

Fig.7

How to remove the backcover

Remove the cable cover. (see Fig.6)

Remove the 15 fixing screws. (see Fig.8)

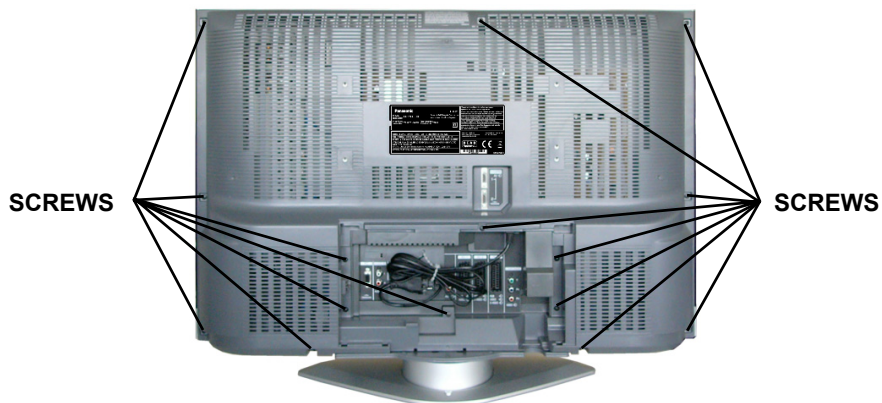
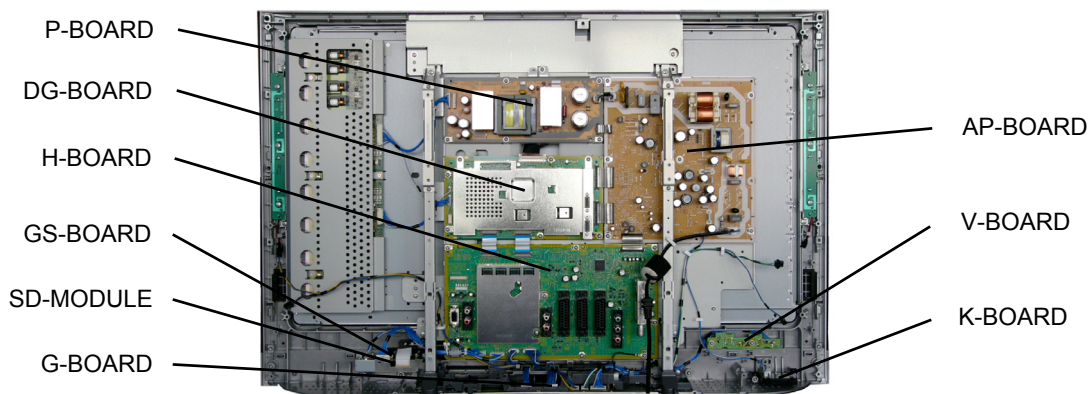

Fig.8

Chassis Board Layout



Board Name	Function
AP-Board	Mains Input, Power Supply Regulator
DG-Board	Global Core, HDMI
G-Board	Local Key, Audio Amplifier
GS-Board	SD Card Slot, SD Card Interface
H-Board	AV Connector, TV tuner, AV Switch
K-Board	Main Switch
P-Board	DC Power Supply
SD-Module	MPEG/JPEG interface
V-Board	Remote Receiver, LED IR, Bats

Setting Inspection Voltage Confirmation

Confirm the following voltages:		
AP board		
Test point	Position	Normal mode Voltage
TP7201	Cathode D7102	7V ± 1V
TP7301	J218	9V ± 0,45V
TP7303	J415	5,1V ± 0,25V
TP7401	JS7958	18,8V ± 0,8V
TP7403	J213	3,3V ± 0,15V
TP7501	JS7503	5,1V ± 0,25V
TP7502	J221	9V ± 0,45V
TP7601	J406	31,5V ± 2,5V
TP7702	JS7702	12,2V ± 0,6V
		Standby mode
TP7201	Cathode D7102	10V ± 2V
TP7301	J218	max 2V
TP7303	J415	max 2V
TP7401	JS7958	max 2V
TP7403	J213	max 2V
TP7501	JS7503	max 2V
TP7502	J221	max 2V
TP7601	J406	max 4,5V
TP7702	JS7702	max 2V

Self Check

Self-check is used to automatically check the bus lines and hexadecimal code of the TV set. To enter Self-Check mode, keep pressing the **STATUS**  button on the remote control and press the down (**-v**) button on the TV set. To exit Self Check, switch off the TV set at the power button.

				MEM O.K.
				GC5 O.K.
				GC3FS O.K.
				AVSW1 O.K.
				AVSW2 O.K.
				TUN1 O.K.
				VIF O.K.
				MSP O.K.
				SDM O.K.
				HDMI O.K.
				ADV O.K.
	TX-32LX600F	TX-32LX600P	TX-26LX600F	TX-26LX600P
OPTION 1	4F	4F	4F	4F
OPTION 2	11	11	11	11
OPTION 3	3A	3A	3A	3A
OPTION 4	D9	59	D9	59
OPTION 5	EB	EB	6B	6B
OPTION 6	AB	AB	AB	AB
OPTION 7	00	00	00	00
OPTION 8	78	78	78	78
OPTION 9	00	00	00	00
OPTION 10	80	80	80	80
OPTION 11	C1	C1	C1	C1
OPTION 12	20	20	20	20
OPTION 13	20	20	20	20
CHECK	02	82	82	02

Display	Ref. No.	Description	P.C.B.
MEM	IC1102	EAROM	DG-Board
GC5	IC4037	GLOBAL CORE	DG-Board
GC3FS	IC4020	GLOBAL CORE FOR SUB	DG-Board
AVSW1	IC3005	AV SWITCH	H-Board
AVSW2	IC2105	AV SWITCH	H-Board
TUN1	TU3201	MULTISTANDART SOUND PROCESSOR	H-Board
VIF	TU3201	VIDEO INTERMEDIATE FREQUENCY	H-Board
MSP	IC2106	MAIN SOUND PROCESSOR	H-Board
SDM	SD-MODULE	MPEG/PHOTO VIEW, SD RECORDING	SD-MODULE
HDMI	IC4026	HDMI I/F RECEIVER	DG-Board
ADV	IC4019	A/D CONVERTER	DG-Board

If the CCU ports have been checked and found to be incorrect or not located then " - - " will appear in place of "O.K.".

Power LED blinking timing chart

1. Subject
Information of LED Flashing timing chart.
2. Contents
When abnormality has occurred the unit, the protection circuit operates and reset to the stand by mode. At this time, the defective block can be identified by number of blinking of the Power LED on the front panel of the unit.

Blinking times	Blinking timing	Contents	Check point
1		Inverter SOS	POWER UNIT LCD PANEL
3		BT_30V, SOUND 18V, PANEL 12V	AP BOARD, H BOARD
4		SUB 9V	AP BOARD, H BOARD DG BOARD
5		SUB 5V	AP BOARD, H BOARD DG BOARD
6		MAIN 9V	AP BOARD, DG BOARD
8		MAIN 3,3V	AP BOARD, H BOARD DG BOARD

Service Mode Function

MPU controls the functions switching for each IICs through IIC bus in this chassis. The following setting and adjustment can be adjusted by remote control in Service Menu

How to enter SERVICE 1

In main menu, move to choose sound menu, set BASS to MAXIMUM, and set TREBLE to MINIMUM.

Simultaneously press INDEX button on remote control and DOWN button (-/v) on the TV set.

How to enter SERVICE 2

Enter the SERVICE 1 mode.

Press the GREEN button to step down to the last menu position.

Set the program position to 99.

Press HOLD button on remote control.

Note:

To exit from Service mode, press N or Power button on remote control.

SERVICE 1

PANASONIC 2006LCD
V1.020

Service 1

SD (RD - SD008):105

Flash PROGRAM
Ext >> TV
SD >> TV

SD PROGRAM
Update

OK to program

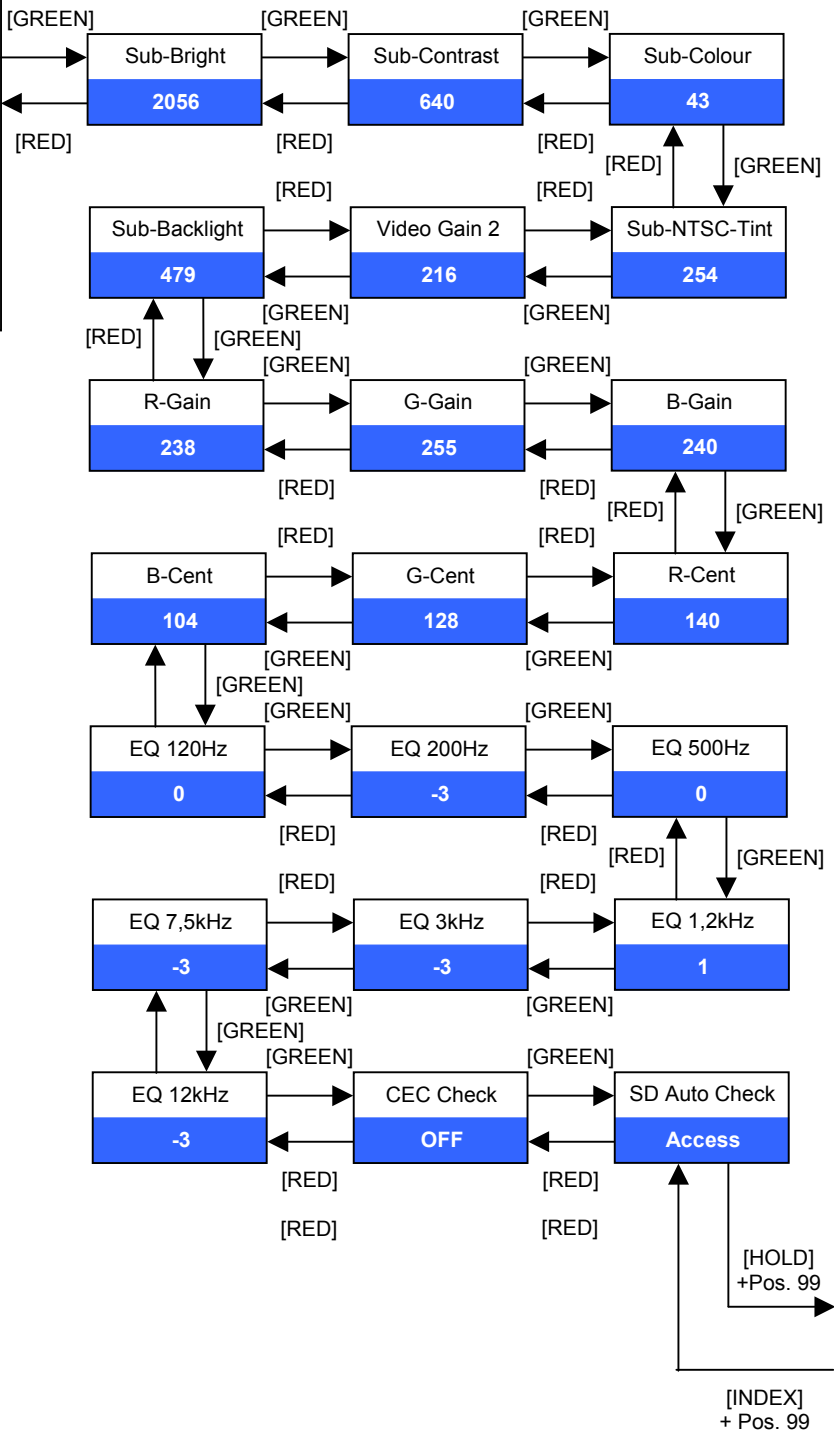

SERVICE 2

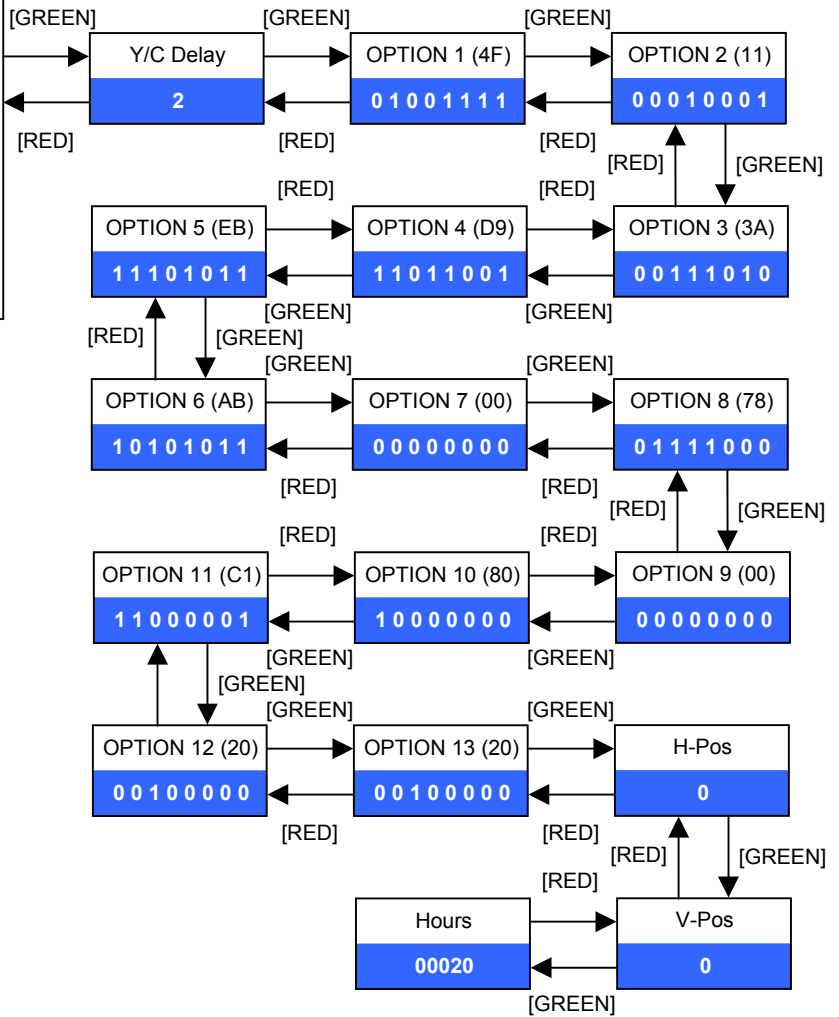
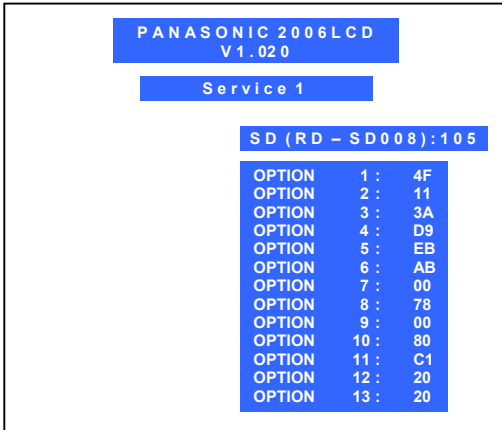

Key Command

- Press the **RED/GREEN** button to step up/down through the functions and adjustments.
- Press the **YELLOW/BLUE** button to change the adjustment values or function.
- Press the numerical button 1-7 to change 0/1 of each option item.
- Press the **OK** button after each adjustment has been made to store the required values.

Option Description

option1		
b0	Colour system	Auto (1)
b1		SECAM (1)
b2		NTSC (1)
b3		M.NTSC (1)
b4	A2 select 6,5MHz	5,742MHz (0) 6,742MHz (1)
b5	SIF	I only (0), BG only (1)
b6		I/BG/DK/L (2), BG/DK (3)
b7	free	
option2		
b0	A2 enable	enable (1)
b1		not use
b2		not use
b3		not use
b4	NICAM enable	enable (1)
b5		not use
b6		not use
b7		not use
option3		
b0	SASO enable	SASO enable (1)
b1	Fine tuning	Enable (1)
b2	Search speed	Slow (1), Fast (0)
b3	Tuner	MACO Tuner (1), Others (0)
b4	HYPER	UHF only (0), UHF/VHF (1)
b5	IF I2C	I2C controlled Tuner IF module (1)
b6	NICAM C4 bit	enable (1)
b7	Blue Back	BLUE BACK on/off selection in menu (0)
option4		
b0	Aspect AUTO	enable (1)
b1	S1/S2 enable	enable (1)
b2	ID-1	enable (1)
b3	User aspect Just	enable (1)
b4	User aspect 14:9	enable (1)
b5	ALBD 14:9	14:9 enable, Zoom3 disable at self wide (1)/Zoom1, Zoom3 enable at self wide (0)
b6	TEXT	enable (1)
b7	TEXT TOP	TOP enable (1)
option5		
b0	CH Blanking	Blanking enable (1)
b1	AV Blanking	Blanking enable (1)
b2	Noise mute	Noise mute enable (0)
b3	sub picture	without sub-picture (0), with sub-picture (1)
b4	2tuner	2tuner (1), 1tuner (0)
b5	AV input	3rotation (1)/2rotation without front RCA (0)
b6	Panel (LCD)	HITACHI Panel (1)/LG Panel (0)
b7	Large size (LCD)	32 (1)/26 (0) for LCD
option6		
b0	SD module	with SD module (1)
b1	SD module Ext. Rec(PAL)	enable (1)
b2	SD module Ext. Rec(NTSC)	enable (1)
b3	SD module Ext. Rec(SECAM)	enable (1)
b4	IDTV	enable (1)
b5	HDMI	enable (1)
b6	Ext. HV input	Without HV input (0)/ with HV input (1)
b7	PC	enable (1)
option7		
Area option		
b0	Asia	Asia (1), Europe (0)
b1	Australia	not use
b2	Ireland/India	Ireland (1)
b3	UK/Korea	UK (1)
b4	Lang1	not use
b5	Lang2	not use
b6	Lower POS	not use
b7	Owner ID	not use

option8		Euro option	
b0	ACI all country	ACI enable (1), only Netherlands (0)	
b1	ACI auto MP	ACI auto multi package enable (1)	
b2	ACI offset	ACI offset for VCR prog. enable (1)	
b3	Power up EC-Mode	Power on EC enable (1)	
b4	AVLink	Q-Link off selectable in menu (1)	
b5	Volume correction	TV Volume correction enable (1)	
b6	MPX/NICAM display	Display NICAM (0), Display MPX (1)	
b7	Albd Reset Off	enable (1)	
option9		Asia option1	
b0	CH Plan	ASIA / M.E. / HK / UK / CHINA (1)	
b1		NZ/ INDNES (1)	
b2		AUSTRALIA (1)	
b3		E.EUROPE (1)	
b4		SPECIAL (1)	
b5		AMERICA (1)	
b6		CATV (1)	
b7		JAPAN (1)	
option10		Asia option2	
b0	NICAM priority	ASIA / M.E. (1)	
b1		HK / UK (1)	
b2		CHINA (1)	
b3		NZ / INDN (1)	
b4		AUSTRA (1)	
b5		E.EURO (1)	
b6		SPECIAL (1)	
b7	HDMI AVI Aspect	enable (1)	
option11		Additional	
b0	Remocon Type	Delux (1), Leader (0)	
b1	Environment AI (PDP)	Enable with viewing mode auto (1)/ disable without viewing mode auto (0)	
b2	WSS 14:9 off	WSS 14:9 off (1)	
b3	Child lock	Child Lock Tuning Menu skip (1)	
b4			
b5	Contrast AI	enable (1) LCD only	
b6	Service H-POS	enable (1)	
b7	Service V-POS	enable (1)	
option12		Additional	
b0			
b1			
b2			
b3			
b4			
b5	SRS	enable (1)	
b6			
b7			
option13		Additional	
b0			
b1			
b2			
b3			
b4			
b5	FTZ	enable (1)	
b6			
b7			

Adjustment Method

Sub-Contrast/White Balance Adjustment

Instrument Name	Connect to	Remarks																												
1. Remote controller 2. LCD WB meter (Minolta CS-1000A equivalent) 3. Communication jig 4. Computer for external control		Correlation can be also taken by CA-210 or equivalent																												
Procedure		Remarks																												
<p>Subcontrast adjustment</p> <ol style="list-style-type: none"> Receive PAL colour bar (100% white) RF signal. Enter "Sub-Contrast" adj. In SERVICE 1 mode. Start adjusting by using Blue Key. If the adjustment finished normally, the letter of "Sub-Contrast" will change from red to black <p>White Balance adjustment</p> <ol style="list-style-type: none"> Procedure basically perform checking using the production software and make automatic adjustment using external computer. It adjust in the mode of Colour balance Normal as follows. <table data-bbox="193 775 959 1032"> <tr> <td colspan="2">TX-32LX600F, TX-32LX600P</td> <td colspan="2">TX-26LX600F, TX-26LX600P</td> </tr> <tr> <td>TOP</td> <td>Normal</td> <td>TOP</td> <td>Normal</td> </tr> <tr> <td></td> <td>x: 0,2800 ± 0,003</td> <td></td> <td>x: 0,2800 ± 0,003</td> </tr> <tr> <td></td> <td>y: 0,2850 ± 0,003</td> <td></td> <td>y: 0,2850 ± 0,003</td> </tr> <tr> <td>GRAY</td> <td>Normal</td> <td>GRAY</td> <td>Normal</td> </tr> <tr> <td></td> <td>x: 0,2800 ± 0,003</td> <td></td> <td>x: 0,2800 ± 0,003</td> </tr> <tr> <td></td> <td>y: 0,2850 ± 0,003</td> <td></td> <td>y: 0,2850 ± 0,003</td> </tr> </table> <p>The address of EEPROM to write is as follows Add. C148-C159</p>		TX-32LX600F, TX-32LX600P		TX-26LX600F, TX-26LX600P		TOP	Normal	TOP	Normal		x: 0,2800 ± 0,003		x: 0,2800 ± 0,003		y: 0,2850 ± 0,003		y: 0,2850 ± 0,003	GRAY	Normal	GRAY	Normal		x: 0,2800 ± 0,003		x: 0,2800 ± 0,003		y: 0,2850 ± 0,003		y: 0,2850 ± 0,003	<p>Let the panel standfor more than 3 hours at more than 20 °C. Basically perform adjustment in the ambient environment of room temperature more than 20 °C. The aging time is more than20 min at above room temperature.</p> <p>Applied signal</p> <p>100% full colour bar 0,7V p-p white peak 87.5% modulation</p>
TX-32LX600F, TX-32LX600P		TX-26LX600F, TX-26LX600P																												
TOP	Normal	TOP	Normal																											
	x: 0,2800 ± 0,003		x: 0,2800 ± 0,003																											
	y: 0,2850 ± 0,003		y: 0,2850 ± 0,003																											
GRAY	Normal	GRAY	Normal																											
	x: 0,2800 ± 0,003		x: 0,2800 ± 0,003																											
	y: 0,2850 ± 0,003		y: 0,2850 ± 0,003																											

Wiring diagram

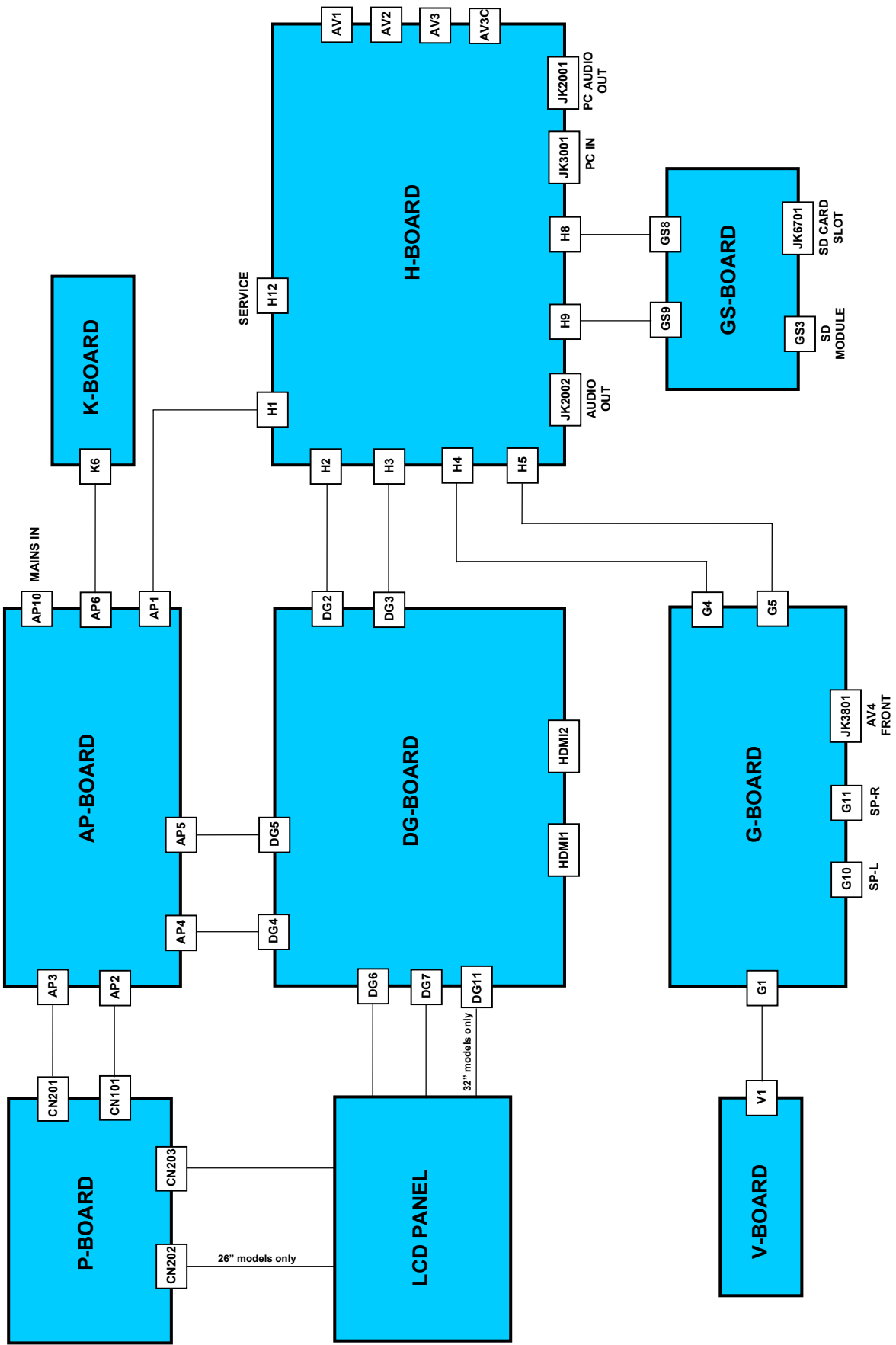

Video & Stereo Audio Block Diagram

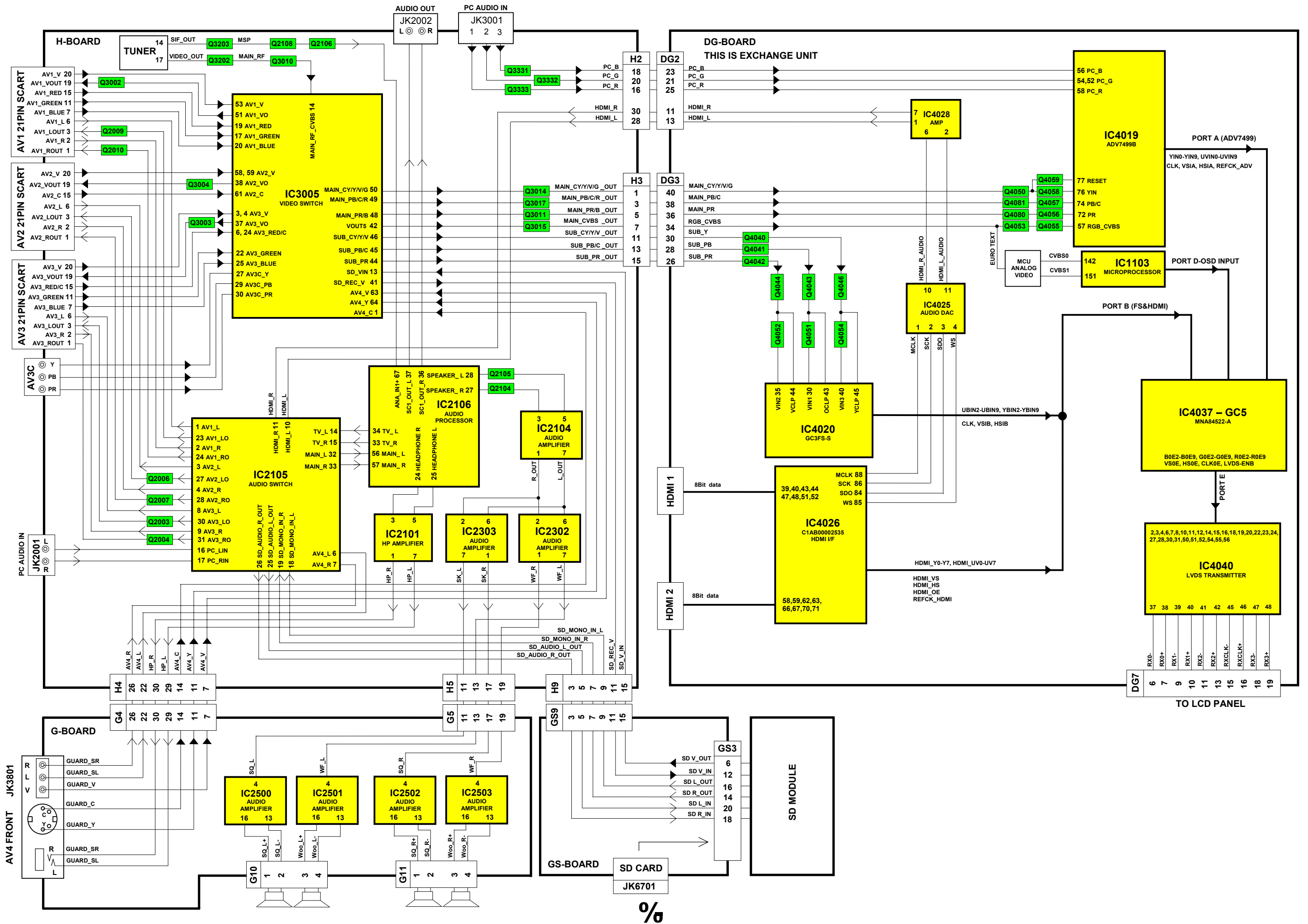

Power Supply Block Diagram

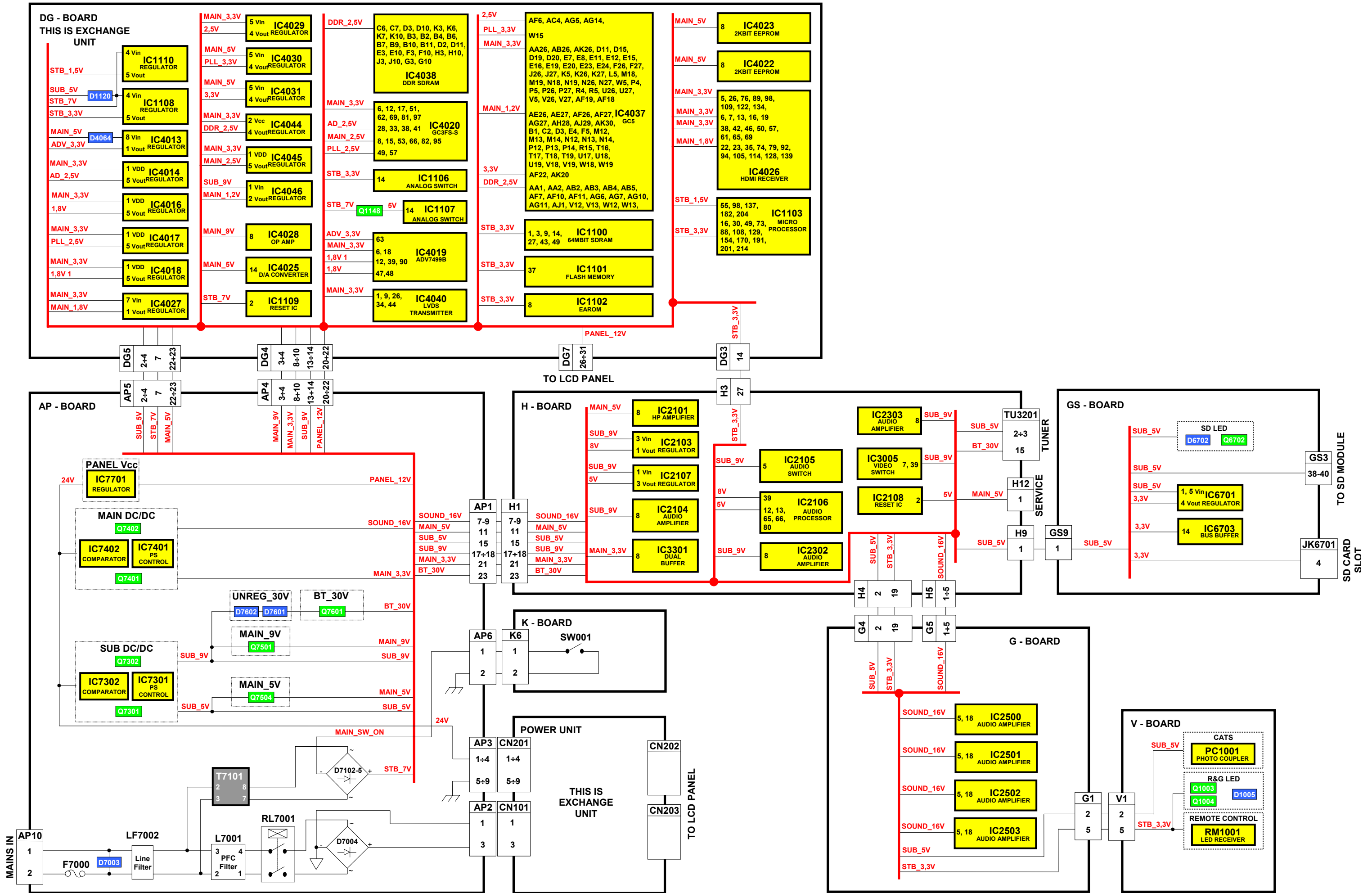

Control Block Diagram

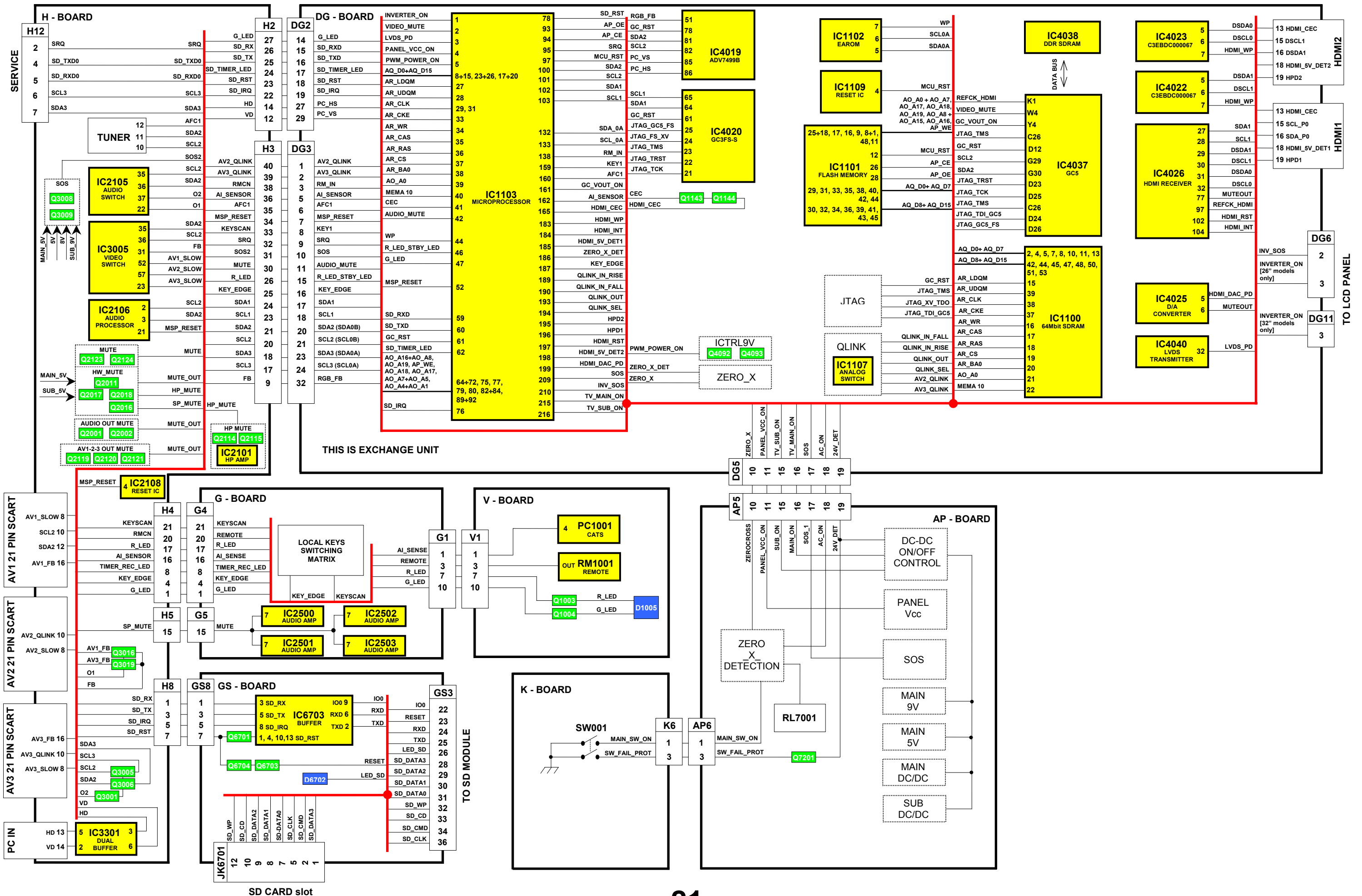

Parts Location

NOTE:
The numbers on the exploded view below refer to the exploded view section of the Replacement Parts List.

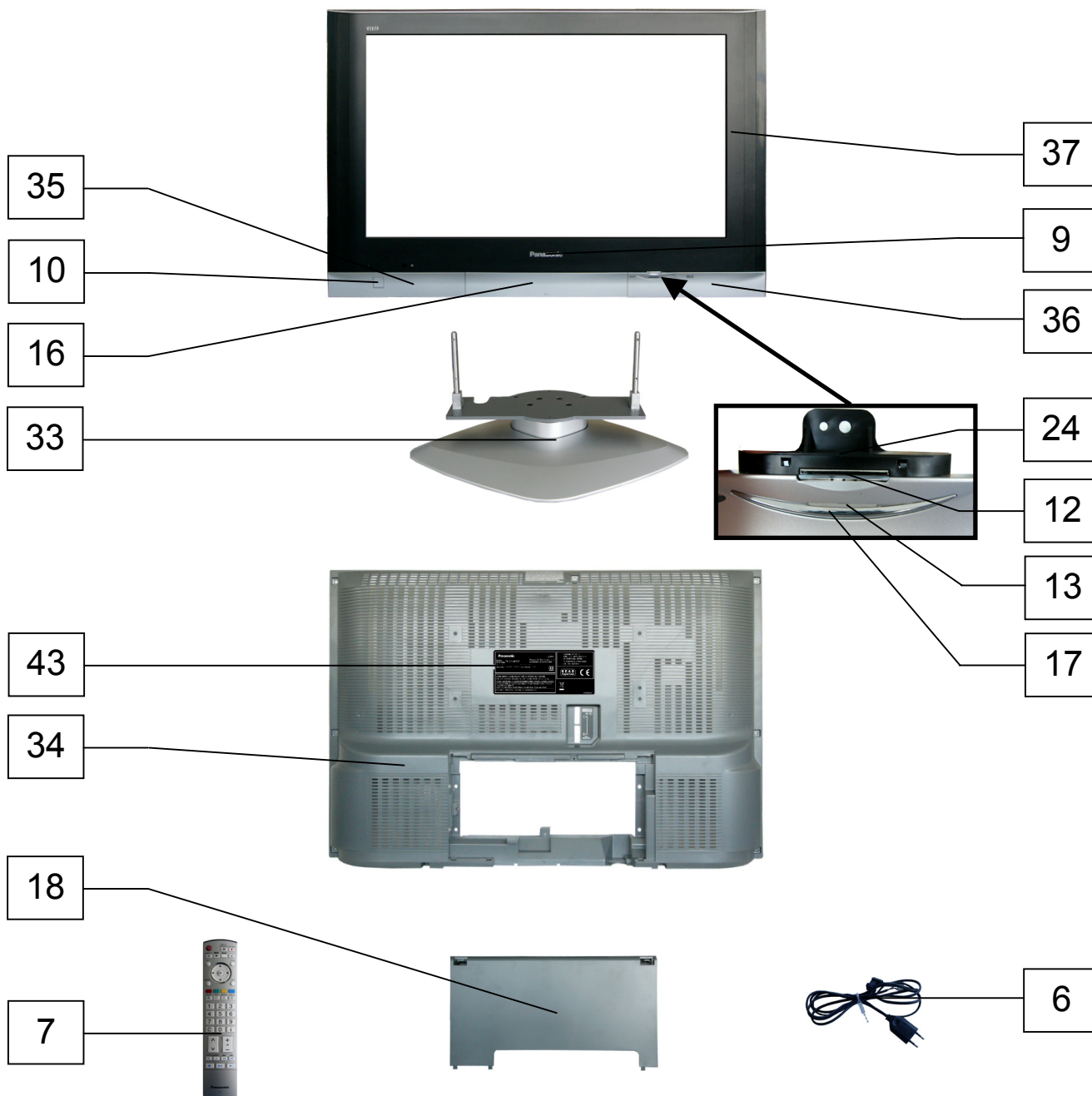

NOTE:
The numbers on the exploded view below refer to the exploded view section of the Replacement Parts List.

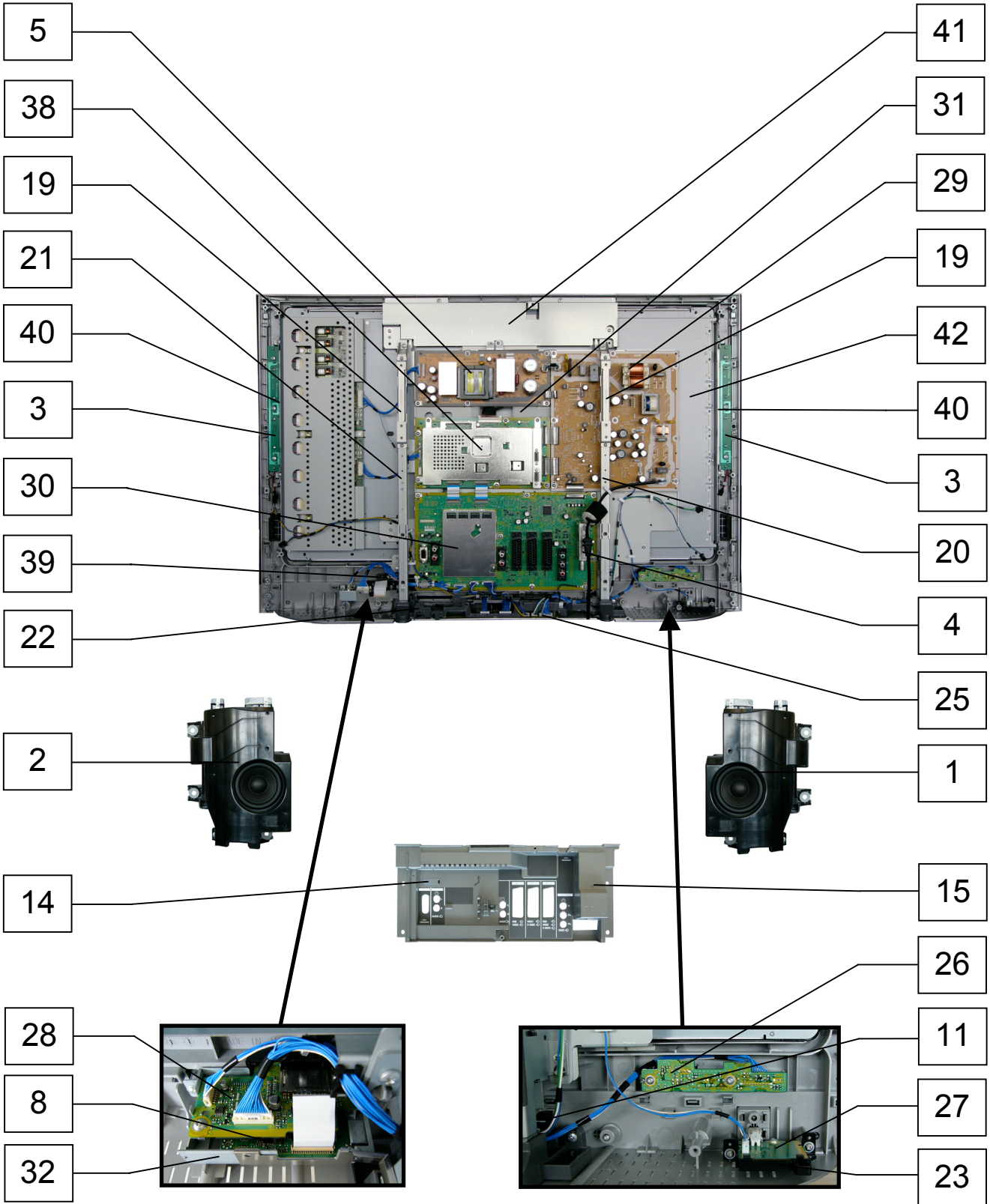

Replacement Parts List











Important Safety Notice

Components Identified by  mark have special characteristics important for safety.
 * When replacing any of these components, use only manufacturers specified parts.
 In case of ordering these spare parts, please always add the complete Model-Type number to your order.

RTL (Retention Time Limited)

Note: The marking (RTL) indicates that the Retention Time is Limited for this item. After the discontinuation of this assembly in production, the item will continue to be available for a specific period of time. The retention period of availability is dependent on the type of assembly, and in accordance with the laws governing part and product retention. After the end of this period, the assembly will no longer be available.

X The marking (X) indicates that board should be exchanged for service.

Cct Ref	Parts Number	Description	
COMMON PARTS			
EXPLODED VIEW			
1	EAB833AL	SPEAKER BOX L	
2	EAB833AR	SPEAKER BOX R	
3	EAK7E14A2	SQUAWKER SP	
4	ENG37A12GF	TUNER	
5	ETXMM614EAA	POWER UNIT	
6	K2CQ2DZ00007	AC CORD	
7	N2QAYB000048	REMOTE CONTROL	
8	RD-SD0010P	SD MODULE	
9	TBMA163	PANASONIC BADGE	
10	TBXA46502	POWER BUTTON	
11	TEKC029	DAMPER	
12	TEKX020	SD DOOR	
13	TKKC5214	SD PANEL	
14	TKKL5290	CONNECTOR COVER	
15	TKP0E12901	REAR AV BRACKET	
16	TKPA94502	DOOR	
17	TKRA46401	SD ORNAMENT	
18	TKXA18501	CABLE COVER	
19	TKZX5183	REAR SUPPORT MTG SUB	
20	TKZX5190	REAR SUPPORT MTG L	
21	TKZX5191	REAR SUPPORT MTG R	
22	TMW0E105	FRONT BRACKET	
23	TMWA044-1	K PRINT BRACKET	
24	TMWX032	SD BRACKET	
25	TNPA3864AA	G P.C.B.	RTL 
26	TNPA3865AB	V P.C.B.	RTL 
27	TNPA3866AA	K P.C.B.	RTL 
28	TNPA3867AA	GS P.C.B.	RTL 
29	TNPA3868AB	AP P.C.B.	RTL 
30	TNPH0657AB	H P.C.B.	RTL 
31	TUA0E0500	MAIN CHASSIS FRAME	
32	TUXE259	GS FIX METAL	
33	TXFBL010Q49	PEDESTAL ASSY	
MISCELLANEOUS COMPONENTS			
.	R6RC/2P	BATTERY	
.	TBLA0145	STAND ASSY	
.	TBLA0146	SUPPORTING FRAME ASSY	
.	TBLG3071	RUBBER FOOT FRONT/REAR	
.	TBLG3073	RUBBER FOOT L/R	
.	TBM0E0383	INDICATION SHEET	
.	TBM0E0600-1	IND.SHEET AV TERMINAL	
.	TBM0E0662	HDMI IND. SHEET	

Cct Ref	Parts Number	Description
.	TBM0E0663	BLIND SHEET
.	TES4G204	POWER BUTTON SPRING
.	TKKC5211-1	PANEL LIGHT
.	XSN3+6FJ	SCREW
.	XSS6+16FJK	SCREW
.	XTB4+18JFJK	SCREW
.	XTV3+10JFJK	SCREW
.	XTV3+12GFJ	SCREW
.	XTW3+12TFJ	SCREW
.	XTWT4+Z15DFJ	SCREW
.	XYN2+F5FJ	SCREW
.	XYN4+F20FJK	SCREW
.	XYN4+F6FJ	SCREW
CK301	TMME075	EDGE SADDLE
CKN08	TMME075	EDGE SADDLE
FC1	J0KG00000011	FERRITE CORE
FC2	J0KG00000011	FERRITE CORE
I.C.s		
IC1100	C3ABPG000145	64MBIT SDRAM
IC1103	MN103SB20RGL	MICROPROCESSOR
IC1107	C0JBAS000128	ANALOG SWITCH
IC1108	C0CBCBD00043	REGULATOR
IC1109	C0EBF0000354	RESET IC
IC1110	C0CBCAD00043	REGULATOR
IC2101	C1BB00000947	AUDIO AMPLIFIER
IC2103	AN77L08M-E1	8V REGULATOR
IC2104	C0ABBA000168	AUDIO AMPLIFIER
IC2105	AN15862A-VT	AUDIO SWITCH
IC2106	C1AB00002469	AUDIO PROCESSOR
IC2107	C0CBADE00049	REGULATOR
IC2108	C0EBF0000354	RESET IC
IC2302	C0ABBA000168	AUDIO AMPLIFIER
IC2303	C0ABBA000168	AUDIO AMPLIFIER
IC2500	C1BB00000998	AUDIO AMPLIFIER
IC2501	C1BB00000998	AUDIO AMPLIFIER
IC2502	C1BB00000998	AUDIO AMPLIFIER
IC2503	C1BB00000998	AUDIO AMPLIFIER
IC3005	AN15867A-VT	VIDEO SWITCH
IC3301	C0JBAZ002205	DUAL BUFFER
IC4013	C0CBCBF00009	REGULATOR
IC4014	C0CBCAC00282	REGULATOR
IC4016	C0CBCAC00275	REGULATOR
IC4017	C0CBCAC00282	REGULATOR
IC4018	C0CBCAC00275	REGULATOR
IC4019	C1AB00002456	ADV7499B
IC4020	C1AB00002202	GC3FS-S
IC4022	C3EBDC000067	2KBIT EEPROM
IC4023	C3EBDC000067	2KBIT EEPROM

Cct Ref	Parts Number	Description
IC4025	C0FBBK000047	D/A CONVERTER
IC4026	C1AB00002535	HDMI RECEIVER
IC4027	C0DBFFD00003	1.8V REGULATOR
IC4028	C0ABBB000230	OPERATIONAL AMPLIFIER
IC4029	C0CBCAC00095	REGULATOR
IC4030	C0CBCBC00062	REGULATOR
IC4031	C0CBCBC00062	REGULATOR
IC4037	MN84522-A	GC5
IC4038	C3ABQJ000048	128MBIT DDR SDRAM
IC4040	C0JBCZ000550	8BIT LVDS TRANSMITTER
IC4044	C0DBEJG00001	2.6V REGULATOR
IC4045	C0CBCAC00282	REGULATOR
IC4046	C0DBAMH00018	REGULATOR
IC6701	C0CBCBD00008	REGULATOR
IC6703	C0JBAZ000851	BUS BUFFER
IC7301	C0DBAYY00055	POWER SUPPLY CONTROL
IC7302	C0BBBA000022	COMPARATOR
IC7401	C0DBAYY00055	POWER SUPPLY CONTROL
IC7402	C0BBBA000022	COMPARATOR
IC7701	C0DAAZH00020	REGULATOR
PC1001	B3JB00000026	PHOTO COUPLER
RM1001	PNA4701M05TV	LED RECEIVER
FUSES		
F7000-1	K3GE1ZA00010	FUSE HOLDER
F7000-2	K3GE1ZA00010	FUSE HOLDER
F7000	K5D502BNA007	AC FUSE
PA3201	K5H2022A0023	FUSE
PA6701	K5H1622A0023	FUSE
DIODES		
D1001	MAZ80430ML	DIODE
D1003	MAZ80430ML	DIODE
D1005	B3CKE0000007	DIODE
D1117	MA2J11100L	DIODE
D1119	B0JCDD000002	DIODE
D1120	B0HCMM000014	DIODE
D1121	MAZ30510ML	DIODE
D1123	MAZ80270HL	DIODE
D1124	MA2J72800L	DIODE
D1125	MA2J11100L	DIODE
D1126	B0HCMM000014	DIODE
D1127	MA2J11100L	DIODE
D1128	B0HCMM000014	DIODE
D1131	MAZ80560ML	DIODE
D1133	MAZ80620ML	DIODE
D1134	MAZ80620ML	DIODE
D1135	MAZ80620ML	DIODE
D1136	MAZ80620ML	DIODE
D1137	MAZ80620ML	DIODE
D1138	MAZ80620ML	DIODE
D1139	MAZ80620ML	DIODE
D1140	MAZ80620ML	DIODE
D1141	MA3X704A0L	DIODE MA704ATX
D1143	MAZ80820ML	DIODE
D2004	MA3X157A0L	DIODE
D2005	MA3X157A0L	DIODE
D2006	MA3X152E0L	DIODE
D2007	MA3X152E0L	DIODE
D2104	B0ACCE000005	DIODE
D2105	MAZ81400ML	DIODE
D2106	MAZ81400ML	DIODE
D2107	MAZ81400ML	DIODE
D2108	MAZ81400ML	DIODE
D2109	MAZ81400ML	DIODE
D2110	MAZ81400ML	DIODE
D2111	MAZ81400ML	DIODE
D2112	MAZ81400ML	DIODE
D2113	MAZ81400ML	DIODE

Cct Ref	Parts Number	Description
D2114	MAZ81400ML	DIODE
D2115	MAZ81400ML	DIODE
D2116	MAZ81400ML	DIODE
D2117	MAZ81400ML	DIODE
D2118	MAZ81400ML	DIODE
D2119	MAZ31200ML	DIODE
D2120	B0ACCE000005	DIODE
D2124	MAZ80560ML	DIODE
D2125	MAZ80560ML	DIODE
D2271	MA2J11100L	DIODE
D2513	MA3X704A0L	DIODE MA704ATX
D2514	MA3X704A0L	DIODE MA704ATX
D2515	MA3X704A0L	DIODE MA704ATX
D2516	MA3X704A0L	DIODE MA704ATX
D2517	MAZ81400ML	DIODE
D2518	MAZ81400ML	DIODE
D2519	MAZ81400ML	DIODE
D2520	MAZ81400ML	DIODE
D3015	MAZ81400ML	DIODE
D3016	MAZ81400ML	DIODE
D3017	MAZ81400ML	DIODE
D3018	MAZ81400ML	DIODE
D3019	MAZ81400ML	DIODE
D3021	MA3X152D0L	DIODE
D3022	MA2J11100L	DIODE
D3023	MA2J11100L	DIODE
D3024	MAZ31000ML	DIODE
D3026	MA2J11100L	DIODE
D3027	MA2J11100L	DIODE
D3028	MA2J11100L	DIODE
D3029	MA2J11100L	DIODE
D3030	MA2J11100L	DIODE
D3031	MA2J11100L	DIODE
D3813	MAZ81400ML	DIODE
D3815	MAZ81400ML	DIODE
D3825	MAZ81400ML	DIODE
D3826	MAZ81400ML	DIODE
D4019	EZJZ0V80008B	VARISTOR
D4020	EZJZ0V80008B	VARISTOR
D4021	EZJZ0V80008B	VARISTOR
D4022	EZJZ0V80008B	VARISTOR
D4023	EZJZ0V80008B	VARISTOR
D4024	EZJZ0V80008B	VARISTOR
D4025	EZJZ0V80008B	VARISTOR
D4026	EZJZ0V80008B	VARISTOR
D4027	EZJZ0V80008B	VARISTOR
D4028	EZJZ0V80008B	VARISTOR
D4029	EZJZ0V80008B	VARISTOR
D4030	EZJZ0V80008B	VARISTOR
D4031	EZJZ0V80008B	VARISTOR
D4032	EZJZ0V80008B	VARISTOR
D4033	EZJZ0V80008B	VARISTOR
D4034	EZJZ0V80008B	VARISTOR
D4035	EZJZ0V80008B	VARISTOR
D4036	EZJZ0V80008B	VARISTOR
D4037	EZJZ0V80008B	VARISTOR
D4038	EZJZ0V80008B	VARISTOR
D4041	EZJZ0V80008B	VARISTOR
D4044	EZJZ0V80008B	VARISTOR
D4045	EZJZ0V80008B	VARISTOR
D4047	MAZ30560ML	DIODE
D4048	MAZ30560ML	DIODE
D4049	B0HCMM000014	DIODE
D4050	B0HCMM000014	DIODE
D4051	B0HCMM000014	DIODE
D4052	B0HCMM000014	DIODE
D4056	MA3X152D0L	DIODE
D4058	MA2J11100L	DIODE

Cct Ref	Parts Number	Description
D4059	B0JCPD000026	DIODE
D4060	MAZ80390LL	DIODE
D4062	MA2J11100L	DIODE
D4063	MA3X152K0L	DIODE
D4064	B0HCMM000014	DIODE
D6702	B3AEB0000065	DIODE
D7002	ERZV10V621T2	VARISTOR
D7003	ERZV10V621T2	VARISTOR
D7004	B0FBAT000008	BRIDGE DIODE
D7101	B0JAME000083	DIODE
D7102	B0JAME000083	DIODE
D7103	B0JAME000083	DIODE
D7104	B0JAME000083	DIODE
D7105	B0JAME000083	DIODE
D7106	B0JAME000083	DIODE
D7108	B0EAKR000032	DIODE
D7203	1SS133T-77	DIODE
D7205	B0HCMM000014	DIODE
D7207	MA2J72900L	DIODE
D7208	MA2J11100L	DIODE
D7209	MA2J11100L	DIODE
D7212	MA2J11100L	DIODE
D7213	MA2J11100L	DIODE
D7214	MAZ42000MF	DIODE
D7215	MAZ41500MF	DIODE
D7216	MAZ82700ML	DIODE
D7217	MA2J11100L	DIODE
D7218	MAZ80750ML	DIODE
D7219	MAZ81000ML	DIODE
D7220	MA2J11100L	DIODE
D7221	MA2J11100L	DIODE
D7222	MAZ80430ML	DIODE
D7223	MAZ82200ML	DIODE
D7224	MA2J11100L	DIODE
D7225	MA2J11100L	DIODE
D7226	MAZ81800ML	DIODE
D7227	MA2J11100L	DIODE
D7228	MAZ41200MF	DIODE
D7230	MAZ42000MF	DIODE
D7311	RK34LFD2	DIODE
D7312	B0JCRG000006	DIODE
D7313	MA3X152D0L	DIODE
D7314	MAZ41500MF	DIODE
D7315	MAZ41500MF	DIODE
D7316	MA2J72900L	DIODE
D7317	MA2J72900L	DIODE
D7320	MAZ81500ML	DIODE
D7321	MAZ81500ML	DIODE
D7322	B0JCMD000010	DIODE
D7323	B0JCMD000010	DIODE
D7324	B0JCMD000010	DIODE
D7325	B0JCMD000010	DIODE
D7403	B0HCMM000014	DIODE
D7404	MA3X152E0L	DIODE
D7405	B0JCRG000006	DIODE
D7406	RK34LFD2	DIODE
D7407	MA3X152D0L	DIODE
D7408	MAZ41500MF	DIODE
D7409	MAZ41500MF	DIODE
D7410	MA2J72900L	DIODE
D7411	MA2J72900L	DIODE
D7412	MA2J72900L	DIODE
D7413	MAZ81800ML	DIODE
D7414	MA2J11100L	DIODE
D7415	B0JCMD000010	DIODE
D7416	B0JCMD000010	DIODE
D7417	B0JCMD000010	DIODE
D7418	B0JCMD000010	DIODE

Cct Ref	Parts Number	Description
D7422	MAZ81500ML	DIODE
D7423	MAZ81500ML	DIODE
D7501	MA2J11100L	DIODE
D7601	B0HCMM000014	DIODE
D7602	B0HCMM000014	DIODE
D7603	MTZJT-7716C	DIODE
D7604	MTZJT-7716C	DIODE
D7605	B0HCMM000014	DIODE
D7606	MA2J11100L	DIODE
D7701	B0HCMM000014	DIODE
D7702	MA3X152E0L	DIODE
D7703	B0JCPG000005	DIODE
TRANSISTORS		
Q1003	2SA207700L	TRANSISTOR
Q1004	2SA207700L	TRANSISTOR
Q1104	B1ABCF000138	TRANSISTOR
Q1109	B1CBHD000002	TRANSISTOR
Q1110	B1CBHD000002	TRANSISTOR
Q1117	B1ABCF000138	TRANSISTOR
Q1118	B1ABCF000138	TRANSISTOR
Q1120	B1ABCF000138	TRANSISTOR
Q1121	B1ABCF000138	TRANSISTOR
Q1122	B1ABCF000138	TRANSISTOR
Q1130	B1ABCF000138	TRANSISTOR
Q1134	B1ABCF000138	TRANSISTOR
Q1135	B1ABCF000138	TRANSISTOR
Q1137	B1ABCF000138	TRANSISTOR
Q1138	B1ABCF000138	TRANSISTOR
Q1143	B1ABDF000034	TRANSISTOR
Q1144	B1ABDF000034	TRANSISTOR
Q1145	2SC584500L	TRANSISTOR
Q1146	B1ABCF000138	TRANSISTOR
Q1147	B1ABCF000138	TRANSISTOR
Q1148	B1ABCF000138	TRANSISTOR
Q1149	B1ABCF000138	TRANSISTOR
Q1150	B1ABCF000138	TRANSISTOR
Q1151	B1ABCF000138	TRANSISTOR
Q1152	B1ABCF000138	TRANSISTOR
Q1153	B1ABCF000138	TRANSISTOR
Q1154	B1ABCF000138	TRANSISTOR
Q1155	B1ADCE000011	TRANSISTOR
Q2001	2SD13280TL	TRANSISTOR
Q2002	2SD13280TL	TRANSISTOR
Q2003	B1ABCF000138	TRANSISTOR
Q2004	B1ABCF000138	TRANSISTOR
Q2006	B1ABCF000138	TRANSISTOR
Q2007	B1ABCF000138	TRANSISTOR
Q2009	B1ABCF000138	TRANSISTOR
Q2010	B1ABCF000138	TRANSISTOR
Q2011	2SA207700L	TRANSISTOR
Q2016	B1ABCF000138	TRANSISTOR
Q2017	2SA207700L	TRANSISTOR
Q2018	2SA207700L	TRANSISTOR
Q2102	2SA207700L	TRANSISTOR
Q2103	2SA207700L	TRANSISTOR
Q2104	2SA207700L	TRANSISTOR
Q2105	2SA207700L	TRANSISTOR
Q2106	B1ABCF000138	TRANSISTOR
Q2108	B1ABCF000138	TRANSISTOR
Q2113	B1ABCF000138	TRANSISTOR
Q2114	2SD13280TL	TRANSISTOR
Q2115	2SD13280TL	TRANSISTOR
Q2119	2SA207700L	TRANSISTOR
Q2120	2SA207700L	TRANSISTOR
Q2121	2SA207700L	TRANSISTOR
Q2122	2SA207700L	TRANSISTOR
Q2123	2SA207700L	TRANSISTOR

Cct Ref	Parts Number	Description
Q2124	B1ABCF000138	TRANSISTOR
Q2271	2SA207700L	TRANSISTOR
Q2272	B1ABCF000138	TRANSISTOR
Q3001	B1ABCF000138	TRANSISTOR
Q3002	2SA207700L	TRANSISTOR
Q3003	2SA207700L	TRANSISTOR
Q3004	2SA207700L	TRANSISTOR
Q3005	B1ABCF000138	TRANSISTOR
Q3006	B1ABCF000138	TRANSISTOR
Q3008	2SA207700L	TRANSISTOR
Q3009	B1ABCF000138	TRANSISTOR
Q3010	2SA207700L	TRANSISTOR
Q3011	2SA207700L	TRANSISTOR
Q3014	2SA207700L	TRANSISTOR
Q3015	2SA207700L	TRANSISTOR
Q3016	B1ABCF000138	TRANSISTOR
Q3017	2SA207700L	TRANSISTOR
Q3019	B1ABCF000138	TRANSISTOR
Q3020	B1ABCF000138	TRANSISTOR
Q3021	B1ABCF000138	TRANSISTOR
Q3022	B1ABCF000138	TRANSISTOR
Q3023	B1ABCF000138	TRANSISTOR
Q3202	2SA207700L	TRANSISTOR
Q3203	2SA207700L	TRANSISTOR
Q3331	2SC24800SL	TRANSISTOR
Q3332	2SC24800SL	TRANSISTOR
Q3333	2SC24800SL	TRANSISTOR
Q4043	2SA207700L	TRANSISTOR
Q4044	2SA207700L	TRANSISTOR
Q4046	2SA207700L	TRANSISTOR
Q4050	B1ABCF000138	TRANSISTOR
Q4051	B1ABCF000138	TRANSISTOR
Q4052	B1ABCF000138	TRANSISTOR
Q4053	B1ABCF000138	TRANSISTOR
Q4054	2SD10300TL	TRANSISTOR
Q4055	2SA207700L	TRANSISTOR
Q4056	2SA207700L	TRANSISTOR
Q4057	2SA207700L	TRANSISTOR
Q4058	2SA207700L	TRANSISTOR
Q4059	2SA207700L	TRANSISTOR
Q4061	B1ABCF000138	TRANSISTOR
Q4062	B1ABCF000138	TRANSISTOR
Q4063	B1ABCF000138	TRANSISTOR
Q4064	B1ABCF000138	TRANSISTOR
Q4065	B1ABDF000034	TRANSISTOR
Q4066	B1ABDF000034	TRANSISTOR
Q4067	B1ABDF000034	TRANSISTOR
Q4068	B1ABDF000034	TRANSISTOR
Q4069	B1ABDF000034	TRANSISTOR
Q4070	B1MBACA00008	TRANSISTOR
Q4071	B1MBACA00008	TRANSISTOR
Q4072	B1ABDF000034	TRANSISTOR
Q4082	2SK122800L	TRANSISTOR
Q4083	2SK122800L	TRANSISTOR
Q4084	2SC39380QL	TRANSISTOR
Q4086	2SC39380QL	TRANSISTOR
Q4092	B1ABCF000138	TRANSISTOR
Q4093	B1ADCE000011	TRANSISTOR
Q4095	B1ABCF000138	TRANSISTOR
Q4096	B1ABCF000138	TRANSISTOR
Q4097	B1ABCF000138	TRANSISTOR
Q4100	2SC39380QL	TRANSISTOR
Q4101	2SC39380QL	TRANSISTOR
Q6701	B1ABCF000138	TRANSISTOR
Q6702	B1ABCF000010	TRANSISTOR
Q6703	B1ABCF000138	TRANSISTOR
Q6704	B1ABCF000138	TRANSISTOR
Q7201	2SD0601ASL	TRANSISTOR

Cct Ref	Parts Number	Description
Q7202	2SD0601ASL	TRANSISTOR
Q7203	2SD0601ASL	TRANSISTOR
Q7204	2SB0709ASL	TRANSISTOR
Q7205	2SB0709ASL	TRANSISTOR
Q7206	2SD0601ASL	TRANSISTOR
Q7207	2SB0709ASL	TRANSISTOR
Q7208	2SB0709ASL	TRANSISTOR
Q7209	2SD0601ASL	TRANSISTOR
Q7210	2SD0601ASL	TRANSISTOR
Q7211	2SC584500L	TRANSISTOR
Q7212	2SA207700L	TRANSISTOR
Q7213	2SD0602ASL	TRANSISTOR
Q7214	2SC584500L	TRANSISTOR
Q7215	2SD0601ASL	TRANSISTOR
Q7216	2SD0601ASL	TRANSISTOR
Q7217	2SD0601ASL	TRANSISTOR
Q7218	2SD0602ASL	TRANSISTOR
Q7301	B1DHFE000001	TRANSISTOR
Q7302	B1DHFE000001	TRANSISTOR
Q7304	2SC584500L	TRANSISTOR
Q7305	2SD0602ARL	TRANSISTOR
Q7306	2SB0710ARL	TRANSISTOR
Q7307	2SB0710ARL	TRANSISTOR
Q7308	2SD0602ARL	TRANSISTOR
Q7401	B1DHFE000001	TRANSISTOR
Q7402	B1DHFE000001	TRANSISTOR
Q7403	2SC584500L	TRANSISTOR
Q7404	2SC584500L	TRANSISTOR
Q7405	2SD0602ARL	TRANSISTOR
Q7406	2SB0710ARL	TRANSISTOR
Q7407	2SB0710ARL	TRANSISTOR
Q7408	2SD0602ARL	TRANSISTOR
Q7410	2SC584500L	TRANSISTOR
Q7501	B1DHDD000033	TRANSISTOR FSS140-TL-E
Q7502	2SC584500L	TRANSISTOR
Q7503	2SC584500L	TRANSISTOR
Q7504	B1DHDD000033	TRANSISTOR FSS140-TL-E
Q7505	2SC584500L	TRANSISTOR
Q7506	2SC584500L	TRANSISTOR
Q7601	2SD0602ASL	TRANSISTOR
Q7701	2SC584500L	TRANSISTOR
Q7702	2SC584500L	TRANSISTOR
TRANSFORMERS		
T7101	ETP35KBZ61HG	TRANSFORMER
COILS		
JS3216	JOJCC0000100	INDUCTOR
JS3217	JOJCC0000100	INDUCTOR
L1100	JOJHC0000078	COIL
L1101	JOJHC0000078	COIL
L1103	JOJHC0000078	COIL
L1104	JOJHC0000078	COIL
L1105	JOJHC0000078	COIL
L1109	JOJHC0000078	COIL
L1110	JOJHC0000078	COIL
L1111	JOJHC0000078	COIL
L1112	JOJHC0000078	COIL
L2001	JOJCC0000364	INDUCTOR
L2002	JOJCC0000364	INDUCTOR
L2003	JOJCC0000100	INDUCTOR
L2004	JOJCC0000100	INDUCTOR
L2005	JOJCC0000100	INDUCTOR
L2006	JOJCC0000100	INDUCTOR
L2007	JOJCC0000100	INDUCTOR
L2008	JOJCC0000100	INDUCTOR
L2009	JOJCC0000100	INDUCTOR
L2010	JOJCC0000100	INDUCTOR
L2011	JOJCC0000100	INDUCTOR

Cct Ref	Parts Number	Description
L2012	J0JCC0000100	INDUCTOR
L2013	J0JCC0000100	INDUCTOR
L2014	J0JCC0000100	INDUCTOR
L2015	J0JCC0000100	INDUCTOR
L2016	J0JCC0000100	INDUCTOR
L2104	ELJPA470KFB	COIL
L2105	J0JHC0000078	COIL
L2106	J0JHC0000078	COIL
L2107	J0JHC0000078	COIL
L2108	J0JCC0000241	INDUCTOR
L2109	J0JCC0000100	INDUCTOR
L2110	J0JCC0000100	INDUCTOR
L2111	J0JCC0000241	INDUCTOR
L2112	J0JCC0000241	INDUCTOR
L2113	J0JCC0000100	INDUCTOR
L2114	J0JCC0000100	INDUCTOR
L2115	J0JCC0000241	INDUCTOR
L2117	ELJFA6R8KFB	COIL
L2118	J0JCC0000241	INDUCTOR
L2120	J0JHC0000078	COIL
L2121	J0JCC0000241	INDUCTOR
L2122	J0JCC0000100	INDUCTOR
L2178	J0JCC0000241	INDUCTOR
L2179	J0JCC0000241	INDUCTOR
L2182	J0JCC0000241	INDUCTOR
L2183	J0JCC0000241	INDUCTOR
L2184	J0JCC0000241	INDUCTOR
L2185	J0JCC0000241	INDUCTOR
L2186	J0JCC0000241	INDUCTOR
L2187	J0JCC0000241	INDUCTOR
L2500	G1C330K00024	COIL
L2501	G1C330K00024	COIL
L2502	G1C330K00024	COIL
L2503	G1C330K00024	COIL
L2508	J0JCC0000011	INDUCTOR
L2509	J0JCC0000011	INDUCTOR
L2510	J0JCC0000011	INDUCTOR
L2511	J0JCC0000011	INDUCTOR
L3001	J0JCC0000100	INDUCTOR
L3002	J0JCC0000100	INDUCTOR
L3003	J0JCC0000100	INDUCTOR
L3026	ELJPA100KFB	COIL
L3027	ELJPA100KFB	COIL
L3028	ELJPA100KFB	COIL
L3202	J0JCC0000241	INDUCTOR
L3203	J0JCC0000241	INDUCTOR
L3205	J0JCC0000364	INDUCTOR
L3206	J0JCC0000364	INDUCTOR
L3210	J0JCC0000364	INDUCTOR
L3212	J0JCC0000100	INDUCTOR
L3304	J0JCC0000241	INDUCTOR
L3305	J0JCC0000241	INDUCTOR
L3306	J0JCC0000241	INDUCTOR
L3307	J0JCC0000241	INDUCTOR
L3811	J0JCC0000100	INDUCTOR
L3812	J0JCC0000100	INDUCTOR
L3813	J0JCC0000364	INDUCTOR
L3814	J0JCC0000364	INDUCTOR
L4021	J0JHC0000078	COIL
L4023	J0JCC0000241	INDUCTOR
L4026	J0JHC0000078	COIL
L4027	J0JHC0000078	COIL
L4028	J0JHC0000078	COIL
L4029	J0JHC0000078	COIL
L4031	J0JHC0000078	COIL
L4032	J0JHC0000078	COIL
L4033	G1C100KA0009	COIL
L4034	J0JCC0000241	INDUCTOR

Cct Ref	Parts Number	Description
L4037	J0JCC0000241	INDUCTOR
L4038	J0JHC0000078	COIL
L4040	J0JHC0000078	COIL
L4041	J0JHC0000078	COIL
L4042	J0JHC0000078	COIL
L4043	J0JHC0000078	COIL
L4044	J0JHC0000078	COIL
L4045	J0JHC0000078	COIL
L4046	J0JHC0000078	COIL
L4048	J0JHC0000078	COIL
L4049	J0JBC0000080	INDUCTOR
L4050	J0JHC0000078	COIL
L4051	J0JHC0000078	COIL
L4052	J0JHC0000045	COIL BLM18PG121SN1D
L4053	J0JHC0000078	COIL
L4054	J0JHC0000078	COIL
L4055	J0JHC0000078	COIL
L4056	J0JCC0000241	INDUCTOR
L4057	J0JCC0000241	INDUCTOR
L4059	J0JCC0000241	INDUCTOR
L4061	J0JCC0000241	INDUCTOR
L4063	G1C100KA0009	COIL
L4065	J0JHC0000078	COIL
L4071	J0JBC0000080	INDUCTOR
L4073	J0JHC0000078	COIL
L4075	J0JHC0000078	COIL
L4076	J0JHC0000078	COIL
L4078	J0JHC0000078	COIL
L4081	J0JCC0000241	INDUCTOR
L4082	J0JHC0000078	COIL
L4084	J0JDC0000054	INDUCTOR
L4085	J0JDC0000054	INDUCTOR
L4086	J0JDC0000054	INDUCTOR
L4087	J0JDC0000054	INDUCTOR
L4088	J0JDC0000054	INDUCTOR
L4089	J0JDC0000054	INDUCTOR
L4090	J0JHC0000078	COIL
L4091	J0JHC0000078	COIL
L4092	J0JCC0000241	INDUCTOR
L4093	J0JDC0000054	INDUCTOR
L4094	J0JCC0000241	INDUCTOR
L4095	G1C220MA0077	COIL
L4096	G1C330MA0167	COIL
L4103	J0JHC0000078	COIL
L4104	J0JDC0000054	INDUCTOR
L4105	J0JDC0000054	INDUCTOR
L4106	J0JDC0000054	INDUCTOR
L4107	J0JDC0000054	INDUCTOR
L4108	J0JDC0000054	INDUCTOR
L4109	J0JDC0000054	INDUCTOR
L4111	J0JDC0000054	INDUCTOR
L4112	J0JDC0000054	INDUCTOR
L4113	J0JDC0000054	INDUCTOR
L4115	J0JDC0000054	INDUCTOR
L4116	J0JDC0000054	INDUCTOR
L4117	TLTAZ100K	COIL
L6701	J0JHC0000045	COIL BLM18PG121SN1D
L6702	J0JHC0000045	COIL BLM18PG121SN1D
L7001	G0C703K00001	CHOKE COIL
L7301	G0A680ZA0037	COIL
L7302	G0C101K00041	COIL
L7401	G0C101K00041	COIL
L7402	G0C101K00041	COIL
L7501	G0A100GA0013	COIL TALL08T100KA
L7702	G0C101K00041	COIL
L7910	G0A100GA0013	COIL TALL08T100KA
L7959	G0A151EA0001	COIL
L7962	G0A100GA0013	COIL TALL08T100KA

Cct Ref	Parts Number	Description
FILTERS		
FL3301	J0HABB000003	FILTER
FL3302	J0HABB000003	FILTER
FL4005	J0HABC000008	FILTER
FL4034	J0HAAB000036	FILTER
FL4035	J0HAAB000036	FILTER
FL4037	J0MAB0000169	FILTER
FL4038	J0MAB0000169	FILTER
FL4039	J0MAB0000169	FILTER
FL4041	F1H0J1050025	FILTER
FL4042	J0HABH000012	FILTER
FL4043	J0HABH000012	FILTER
FL4044	J0HABH000012	FILTER
FL4045	J0HABH000012	FILTER
FL4046	J0HABH000012	FILTER
FL4047	J0HABH000012	FILTER
FL4048	J0HABH000012	FILTER
FL4053	J0HAAB000036	FILTER
LF7002	GOB103H00002	LINE FILTER
CRYSTALS		
X1100	H0J100500030	CRYSTAL
X1101	H0J327200114	CRYSTAL
X2101	H0J184500027	CRYSTAL
X4004	H0J270500087	CRYSTAL
RESISTORS		
C4012	ERJ3GEYJ104V	S.M.CARB 0.1W 5% 100K Ω
C4058	ERJ2GE0R00X	SMD .063W - 0 Ω
C4798	ERJ2GE0R00X	SMD .063W - 0 Ω
C4799	ERJ2GE0R00X	SMD .063W - 0 Ω
C4800	ERJ2GE0R00X	SMD .063W - 0 Ω
C4801	ERJ2GE0R00X	SMD .063W - 0 Ω
C4802	ERJ2GE0R00X	SMD .063W - 0 Ω
C4803	ERJ2GE0R00X	SMD .063W - 0 Ω
JS001	ERJ3GEY0R00	SMD 0.1W - 0 Ω
JS1002	ERJ3GEY0R00	SMD 0.1W - 0 Ω
JS1100	ERJ2GE0R00X	SMD .063W - 0 Ω
JS1101	ERJ2GE0R00X	SMD .063W - 0 Ω
JS1102	ERJ2GE0R00X	SMD .063W - 0 Ω
JS2001	ERJ3GEY0R00	SMD 0.1W - 0 Ω
JS2101	ERJ3GEY0R00	SMD 0.1W - 0 Ω
JS2102	ERJ3GEY0R00	SMD 0.1W - 0 Ω
JS2105	ERJ3GEY0R00	SMD 0.1W - 0 Ω
JS2106	ERJ3GEY0R00	SMD 0.1W - 0 Ω
JS2107	ERJ3GEY0R00	SMD 0.1W - 0 Ω
JS2108	ERJ3GEY0R00	SMD 0.1W - 0 Ω
JS2109	ERJ6GEY0R00	S.M.CARB 0.1W - 0 Ω
JS2500	ERJ6GEY0R00	S.M.CARB 0.1W - 0 Ω
JS3005	ERJ3GEY0R00	SMD 0.1W - 0 Ω
JS3007	ERJ3GEY0R00	SMD 0.1W - 0 Ω
JS3008	ERJ3GEY0R00	SMD 0.1W - 0 Ω
JS3009	ERJ3GEY0R00	SMD 0.1W - 0 Ω
JS3010	ERJ3GEY0R00	SMD 0.1W - 0 Ω
JS3011	ERJ3GEY0R00	SMD 0.1W - 0 Ω
JS3012	ERJ3GEY0R00	SMD 0.1W - 0 Ω
JS3013	ERJ3GEY0R00	SMD 0.1W - 0 Ω
JS3014	ERJ3GEY0R00	SMD 0.1W - 0 Ω
JS3015	ERJ3GEY0R00	SMD 0.1W - 0 Ω
JS3016	ERJ3GEY0R00	SMD 0.1W - 0 Ω
JS3017	ERJ3GEY0R00	SMD 0.1W - 0 Ω
JS3018	ERJ3GEY0R00	SMD 0.1W - 0 Ω
JS3019	ERJ3GEY0R00	SMD 0.1W - 0 Ω
JS3020	ERJ3GEY0R00	SMD 0.1W - 0 Ω
JS3022	ERJ3GEY0R00	SMD 0.1W - 0 Ω
JS3204	ERJ3GEY0R00	SMD 0.1W - 0 Ω
JS3205	ERJ3GEY0R00	SMD 0.1W - 0 Ω
JS3207	ERJ3GEY0R00	SMD 0.1W - 0 Ω
JS3215	ERJ3GEY0R00	SMD 0.1W - 0 Ω

Cct Ref	Parts Number	Description
JS3218	ERJ3GEY0R00	SMD 0.1W - 0 Ω
JS3219	ERJ3GEY0R00	SMD 0.1W - 0 Ω
JS3220	ERJ3GEY0R00	SMD 0.1W - 0 Ω
JS3221	ERJ3GEY0R00	SMD 0.1W - 0 Ω
JS3251	ERJ3GEY0R00	SMD 0.1W - 0 Ω
JS3252	ERJ3GEY0R00	SMD 0.1W - 0 Ω
JS3402	ERJ3GEY0R00	SMD 0.1W - 0 Ω
JS3900	ERJ3GEY0R00	SMD 0.1W - 0 Ω
JS4016	ERJ2GE0R00X	SMD .063W - 0 Ω
JS4017	ERJ2GE0R00X	SMD .063W - 0 Ω
JS4020	ERJ2GE0R00X	SMD .063W - 0 Ω
JS4021	ERJ2GE0R00X	SMD .063W - 0 Ω
JS4022	ERJ2GE0R00X	SMD .063W - 0 Ω
JS4023	ERJ2GE0R00X	SMD .063W - 0 Ω
JS4024	ERJ2GE0R00X	SMD .063W - 0 Ω
JS4027	ERJ2GE0R00X	SMD .063W - 0 Ω
JS4028	ERJ2GE0R00X	SMD .063W - 0 Ω
JS4029	ERJ2GE0R00X	SMD .063W - 0 Ω
JS4033	ERJ2GE0R00X	SMD .063W - 0 Ω
JS4034	ERJ2GE0R00X	SMD .063W - 0 Ω
JS4035	ERJ2GE0R00X	SMD .063W - 0 Ω
JS4036	ERJ2GE0R00X	SMD .063W - 0 Ω
JS4037	ERJ2GE0R00X	SMD .063W - 0 Ω
JS4038	ERJ2GE0R00X	SMD .063W - 0 Ω
JS4039	ERJ2GE0R00X	SMD .063W - 0 Ω
JS4040	ERJ2GE0R00X	SMD .063W - 0 Ω
JS4046	ERJ2GE0R00X	SMD .063W - 0 Ω
JS4069	ERJ2GE0R00X	SMD .063W - 0 Ω
JS4096	ERJ3GEY0R00	SMD 0.1W - 0 Ω
JS4097	ERJ3GEY0R00	SMD 0.1W - 0 Ω
JS4100	ERJ3GEY0R00	SMD 0.1W - 0 Ω
JS4103	ERJ3GEY0R00	SMD 0.1W - 0 Ω
JS4104	ERJ2GE0R00X	SMD .063W - 0 Ω
JS4108	ERJ2GE0R00X	SMD .063W - 0 Ω
JS4118	ERJ3GEY0R00	SMD 0.1W - 0 Ω
JS4119	ERJ3GEY0R00	SMD 0.1W - 0 Ω
JS4121	ERJ3GEY0R00	SMD 0.1W - 0 Ω
JS6701	ERJ3GEY0R00	SMD 0.1W - 0 Ω
JS6704	ERJ6GEY0R00	S.M.CARB 0.1W - 0 Ω
JS6718	ERJ3GEY0R00	SMD 0.1W - 0 Ω
JS6719	ERJ3GEY0R00	SMD 0.1W - 0 Ω
JS6720	ERJ3GEY0R00	SMD 0.1W - 0 Ω
L2191	ERJ3GEY0R00	SMD 0.1W - 0 Ω
L4097	ERJ3GEY0R00	SMD 0.1W - 0 Ω
L4098	ERJ3GEY0R00	SMD 0.1W - 0 Ω
L4099	ERJ3GEY0R00	SMD 0.1W - 0 Ω
L4100	ERJ3GEY0R00	SMD 0.1W - 0 Ω
L4101	ERJ3GEY0R00	SMD 0.1W - 0 Ω
L4102	ERJ3GEY0R00	SMD 0.1W - 0 Ω
R1002	ERJ6GEYJ101	S.M.CARB 0.1W 5% 100 Ω
R1005	ERJ6GEYJ102	S.M.CARB 0.1W 5% 1K Ω
R1007	ERJ6GEYJ103	S.M.CARB 0.1W 5% 10K Ω
R1010	ERJ6GEYJ152	S.M.CARB 0.1W 5% 1K5 Ω
R1011	ERJ6GEYJ243	S.M.CARB 0.1W 5% 24K Ω
R1012	ERJ6GEYJ513	S.M.CARB 0.1W 5% 51K Ω
R1013	ERJ6GEYJ103	S.M.CARB 0.1W 5% 10K Ω
R1014	ERJ6GEYJ681	S.M.CARB 0.1W 5% 680 Ω
R1108	ERJ2GEJ101X	SMD .063W 5% 100 Ω
R1109	ERJ2GEJ101X	SMD .063W 5% 100 Ω
R1110	ERJ2GEJ101X	SMD .063W 5% 100 Ω
R1111	ERJ2GEJ101X	SMD .063W 5% 100 Ω
R1112	ERJ2GEJ101X	SMD .063W 5% 100 Ω
R1113	ERJ2GEJ332X	SMD .063W 5% 3K3 Ω
R1114	ERJ2GE0R00X	SMD .063W - 0 Ω
R1116	ERJ2GEJ562X	SMD .063W 5% 5K6 Ω
R1117	ERJ2GE0R00X	SMD .063W - 0 Ω
R1118	EXB2HV680JV	SMD .063W 5% 68 Ω
R1119	EXB2HV680JV	SMD .063W 5% 68 Ω

Cct Ref	Parts Number	Description			
R1120	ERJ3GEY0R00	SMD	0.1W	-	0 Ω
R1121	ERJ2GEJ220X	SMD	.063W	5%	22 Ω
R1122	ERJ2GEJ220X	SMD	.063W	5%	22 Ω
R1123	ERJ2GEJ473X	SMD	.063W	5%	47K Ω
R1124	ERJ2GEJ332X	SMD	.063W	5%	3K3 Ω
R1125	ERJ2GEJ332X	SMD	.063W	5%	3K3 Ω
R1129	ERJ2GEJ473X	SMD	.063W	5%	47K Ω
R1130	ERJ2GEJ473X	SMD	.063W	5%	47K Ω
R1131	ERJ2GEJ101X	SMD	.063W	5%	100 Ω
R1132	ERJ2GEJ101X	SMD	.063W	5%	100 Ω
R1133	ERJ2GEJ102X	SMD	.063W	5%	1K Ω
R1140	ERJ2GEJ680X	SMD	.063W	5%	68 Ω
R1141	ERJ2GEJ680X	SMD	.063W	5%	68 Ω
R1146	ERJ2GEJ271X	SMD	.063W	5%	270 Ω
R1147	EXB2HV560JV	CHIP RES	.063W	5%	56 Ω
R1148	EXB2HV560JV	CHIP RES	.063W	5%	56 Ω
R1149	EXB2HV680JV	SMD	.063W	5%	68 Ω
R1153	ERJ2GEJ101X	SMD	.063W	5%	100 Ω
R1157	ERJ2GEJ101X	SMD	.063W	5%	100 Ω
R1158	ERJ2GEJ563X	SMD	.063W	5%	56K Ω
R1159	ERJ2GEJ273X	SMD	.063W	5%	27K Ω
R1160	ERJ2GEJ473X	SMD	.063W	5%	47K Ω
R1162	ERJ2GEJ473X	SMD	.063W	5%	47K Ω
R1164	ERJ2GEJ333X	SMD	.063W	5%	33K Ω
R1165	ERJ2GEJ563X	SMD	.063W	5%	56K Ω
R1168	ERJ2GE0R00X	SMD	.063W	-	0 Ω
R1169	ERJ2GE0R00X	SMD	.063W	-	0 Ω
R1174	ERJ2GEJ101X	SMD	.063W	5%	100 Ω
R1177	ERJ2GEJ102X	SMD	.063W	5%	1K Ω
R1178	ERJ2GEJ101X	SMD	.063W	5%	100 Ω
R1179	ERJ2GEJ101X	SMD	.063W	5%	100 Ω
R1180	ERJ2GE0R00X	SMD	.063W	-	0 Ω
R1181	ERJ2GEJ101X	SMD	.063W	5%	100 Ω
R1183	EXB28V680JX	SMD	.031W	5%	68 Ω
R1184	ERJ2GE0R00X	SMD	.063W	-	0 Ω
R1187	EXB2HV680JV	SMD	.063W	5%	68 Ω
R1188	ERJ2GEJ103X	SMD	.063W	5%	10K Ω
R1189	ERJ2GEJ103X	SMD	.063W	5%	10K Ω
R1192	ERJ2GE0R00X	SMD	.063W	-	0 Ω
R1193	ERJ2GEJ101X	SMD	.063W	5%	100 Ω
R1194	ERJ2GEJ101X	SMD	.063W	5%	100 Ω
R1199	ERJ2GEJ103X	SMD	.063W	5%	10K Ω
R1200	EXB2HV680JV	SMD	.063W	5%	68 Ω
R1204	ERJ3GEYJ223V	S.M.CARB	0.1W	5%	22K Ω
R1205	ERJ2GEJ101X	SMD	.063W	5%	100 Ω
R1207	ERJ2GEJ473X	SMD	.063W	5%	47K Ω
R1209	ERJ2GE0R00X	SMD	.063W	-	0 Ω
R1214	ERJ2GEJ103X	SMD	.063W	5%	10K Ω
R1215	ERJ2GEJ101X	SMD	.063W	5%	100 Ω
R1216	ERJ2GEJ101X	SMD	.063W	5%	100 Ω
R1217	ERJ2GEJ101X	SMD	.063W	5%	100 Ω
R1218	ERJ2GEJ680X	SMD	.063W	5%	68 Ω
R1220	ERJ2GEJ680X	SMD	.063W	5%	68 Ω
R1221	ERJ2GEJ332X	SMD	.063W	5%	3K3 Ω
R1222	ERJ2GEJ330X	SMD	.063W	5%	33 Ω
R1223	ERJ2GEJ102X	SMD	.063W	5%	1K Ω
R1224	ERJ2GEJ473X	SMD	.063W	5%	47K Ω
R1225	ERJ2GEJ220X	SMD	.063W	5%	22 Ω
R1226	ERJ2GEJ220X	SMD	.063W	5%	22 Ω
R1228	ERJ2GEJ220X	SMD	.063W	5%	22 Ω
R1229	ERJ2GEJ182X	SMD	.063W	5%	1K8 Ω
R1230	ERJ2GEJ220X	SMD	.063W	5%	22 Ω
R1231	ERJ2GEJ473X	SMD	.063W	5%	47K Ω
R1232	ERJ2GEJ332X	SMD	.063W	5%	3K3 Ω
R1233	ERJ2GEJ332X	SMD	.063W	5%	3K3 Ω
R1234	ERJ2GE0R00X	SMD	.063W	-	0 Ω
R1235	ERJ2GEJ272X	SMD	.063W	5%	2K7 Ω
R1236	ERJ2GEJ272X	SMD	.063W	5%	2K7 Ω

Cct Ref	Parts Number	Description			
R1238	ERJ2GEJ473X	SMD	.063W	5%	47K Ω
R1239	ERJ3EKF1202V	SMD	0.1W	1%	12K Ω
R1240	ERJ2GEJ473X	SMD	.063W	5%	47K Ω
R1241	ERJ2GEJ822X	SMD	.063W	5%	8K2 Ω
R1242	EXB2HV220JV	SMD	.063W	5%	22 Ω
R1243	ERJ2GE0R00X	SMD	.063W	-	0 Ω
R1246	ERJ2GEJ912X	SMD	.063W	5%	9K1 Ω
R1247	ERJ3GEYJ104V	S.M.CARB	0.1W	5%	100K Ω
R1248	ERJ3GEYJ103	SMD	0.1W	5%	10K Ω
R1249	ERJ2GEJ473X	SMD	.063W	5%	47K Ω
R1250	ERJ2GEJ224X	SMD	.063W	5%	220K Ω
R1251	ERJ3GEYJ101	SMD	0.1W	5%	100 Ω
R1252	ERJ2GEJ103X	SMD	.063W	5%	10K Ω
R1253	ERJ2GEJ102X	SMD	.063W	5%	1K Ω
R1254	ERJ2GEJ473X	SMD	.063W	5%	47K Ω
R1256	ERJ2GEJ102X	SMD	.063W	5%	1K Ω
R1259	ERJ2GEJ473X	SMD	.063W	5%	47K Ω
R1263	ERJ2GEJ220X	SMD	.063W	5%	22 Ω
R1264	ERJ2GEJ220X	SMD	.063W	5%	22 Ω
R1268	ERJ3GEYJ103	SMD	0.1W	5%	10K Ω
R1269	ERJ2GE0R00X	SMD	.063W	-	0 Ω
R1270	ERJ2GEJ220X	SMD	.063W	5%	22 Ω
R1271	ERJ2GEJ220X	SMD	.063W	5%	22 Ω
R1272	ERJ2GEJ473X	SMD	.063W	5%	47K Ω
R1273	ERJ3GEYJ223V	S.M.CARB	0.1W	5%	22K Ω
R1275	ERJ3EKF7151V	SMD	0.1W	1%	7K15 Ω
R1276	ERJ2GEJ473X	SMD	.063W	5%	47K Ω
R1277	ERJ2GEJ103X	SMD	.063W	5%	10K Ω
R1278	ERJ2GEJ104X	SMD	.063W	5%	100K Ω
R1279	ERJ2GEJ220X	SMD	.063W	5%	22 Ω
R1280	ERJ2GEJ220X	SMD	.063W	5%	22 Ω
R1281	ERJ2GEJ102X	SMD	.063W	5%	1K Ω
R1282	ERJ6GEYJ103	S.M.CARB	0.1W	5%	10K Ω
R1283	ERJ2GEJ101X	SMD	.063W	5%	100 Ω
R1284	ERJ2GEJ102X	SMD	.063W	5%	1K Ω
R1285	ERJ6GEYJ103	S.M.CARB	0.1W	5%	10K Ω
R1287	ERJ2GEJ183X	SMD	.063W	5%	18K Ω
R1288	ERJ2GE0R00X	SMD	.063W	-	0 Ω
R1290	ERJ3GEYJ104V	S.M.CARB	0.1W	5%	100K Ω
R1291	ERJ2GE0R00X	SMD	.063W	-	0 Ω
R1292	ERJ3GEY0R00	SMD	0.1W	-	0 Ω
R1294	EXB2HV220JV	SMD	.063W	5%	22 Ω
R1298	ERJ3GEYJ223V	S.M.CARB	0.1W	5%	22K Ω
R1300	ERJ2GE0R00X	SMD	.063W	-	0 Ω
R1302	ERJ2GE0R00X	SMD	.063W	-	0 Ω
R1311	ERJ2GEJ220X	SMD	.063W	5%	22 Ω
R1312	ERJ2GEJ220X	SMD	.063W	5%	22 Ω
R1313	ERJ2GEJ272X	SMD	.063W	5%	2K7 Ω
R1314	ERJ2GEJ272X	SMD	.063W	5%	2K7 Ω
R1315	ERJ3GEYJ274V	SMD	0.1W	5%	270K Ω
R1316	ERJ3GEYJ102	SMD	0.1W	5%	1K Ω
R1317	ERJ6GEYJ103	S.M.CARB	0.1W	5%	10K Ω
R1318	ERJ2GEJ332X	SMD	.063W	5%	3K3 Ω
R1319	ERJ2GEJ332X	SMD	.063W	5%	3K3 Ω
R1320	ERJ6GEYJ101	S.M.CARB	0.1W	5%	100 Ω
R1322	ERJ2GEJ333X	SMD	.063W	5%	33K Ω
R1323	ERJ2GEJ473X	SMD	.063W	5%	47K Ω
R1325	ERJ2GE0R00X	SMD	.063W	-	0 Ω
R1326	ERJ2GEJ563X	SMD	.063W	5%	56K Ω
R1327	ERJ2GEJ273X	SMD	.063W	5%	27K Ω
R1328	ERJ2GEJ102X	SMD	.063W	5%	1K Ω
R1329	ERJ2GEJ473X	SMD	.063W	5%	47K Ω
R1332	ERJ2GEJ101X	SMD	.063W	5%	100 Ω
R1334	ERJ2GE0R00X	SMD	.063W	-	0 Ω
R1335	ERJ2GEJ101X	SMD	.063W	5%	100 Ω
R1336	ERJ2GEJ225X	SMD	.063W	5%	220K Ω
R1337	ERJ2GEJ472X	SMD	.063W	5%	4K7 Ω
R1340	ERJ2GEJ473X	SMD	.063W	5%	47K Ω

Cct Ref	Parts Number	Description				
R1341	ERJ2GEJ473X	SMD	.063W	5%	47K Ω	
R1342	ERJ2GEJ103X	SMD	.063W	5%	10K Ω	
R1344	ERJ2GEJ101X	SMD	.063W	5%	100 Ω	
R1350	ERJ2GEJ101X	SMD	.063W	5%	100 Ω	
R1353	ERJ2GEJ223X	SMD	.063W	5%	22K Ω	
R1355	ERJ2GEJ104X	SMD	.063W	5%	100K Ω	
R1358	ERJ2GEJ104X	SMD	.063W	5%	100K Ω	
R1359	ERJ2GEJ224X	SMD	.063W	5%	220K Ω	
R1360	ERJ2GEJ221X	SMD	.063W	5%	220 Ω	
R1361	ERJ2GE0R00X	SMD	.063W	-	0 Ω	
R1364	ERJ2GEJ273X	SMD	.063W	5%	27K Ω	
R1365	ERJ2GE0R00X	SMD	.063W	-	0 Ω	
R1370	ERJ2GEJ104X	SMD	.063W	5%	100K Ω	
R1373	ERJ2GEJ683X	SMD	.063W	5%	68K Ω	
R1378	ERJ3GEY0R00	SMD	0.1W	-	0 Ω	
R1379	ERJ2GEJ331X	SMD	.063W	5%	330 Ω	
R1380	ERJ2GEJ104X	SMD	.063W	5%	100K Ω	
R1381	ERJ2GEJ474X	SMD	.063W	5%	470K Ω	
R1384	ERJ2GEJ102X	SMD	.063W	5%	1K Ω	
R1391	ERJ2GEJ102X	SMD	.063W	5%	1K Ω	
R1392	ERJ2GEJ101X	SMD	.063W	5%	100 Ω	
R1393	ERJ2GEJ101X	SMD	.063W	5%	100 Ω	
R1408	ERJ2GEJ104X	SMD	.063W	5%	100K Ω	
R1409	ERJ2GEJ473X	SMD	.063W	5%	47K Ω	
R1410	ERJ2GEJ102X	SMD	.063W	5%	1K Ω	
R1411	ERJ2GEJ473X	SMD	.063W	5%	47K Ω	
R1413	ERJ2GEJ101X	SMD	.063W	5%	100 Ω	
R1414	ERJ3GEY0R00	SMD	0.1W	-	0 Ω	
R1436	ERJ6GEYJ561	S.M.CARB	0.1W	5%	560 Ω	
R1446	ERJ6GEYJ471	S.M.CARB	0.1W	5%	470 Ω	
R1447	ERJ6GEYJ471	S.M.CARB	0.1W	5%	470 Ω	
R1449	ERJ2GEJ473X	SMD	.063W	5%	47K Ω	
R1451	ERJ2GEJ473X	SMD	.063W	5%	47K Ω	
R1452	ERJ2GEJ473X	SMD	.063W	5%	47K Ω	
R1454	ERJ2GE0R00X	SMD	.063W	-	0 Ω	
R1461	ERJ2GEJ273X	SMD	.063W	5%	27K Ω	
R1462	ERJ2GEJ104X	SMD	.063W	5%	100K Ω	
R1463	ERJ2GEJ473X	SMD	.063W	5%	47K Ω	
R1472	ERJ2GEJ301X	SMD	.063W	5%	300 Ω	
R1475	ERJ2GEJ271X	SMD	.063W	5%	270 Ω	
R1476	ERJ2GEJ271X	SMD	.063W	5%	270 Ω	
R1479	ERJ2GEJ473X	SMD	.063W	5%	47K Ω	
R1482	ERJ2GEJ473X	SMD	.063W	5%	47K Ω	
R1483	ERJ2GEJ101X	SMD	.063W	5%	100 Ω	
R1485	ERJ2GEJ103X	SMD	.063W	5%	10K Ω	
R1486	ERJ2GEJ103X	SMD	.063W	5%	10K Ω	
R1487	ERJ2GEJ103X	SMD	.063W	5%	10K Ω	
R1488	ERJ2GEJ473X	SMD	.063W	5%	47K Ω	
R1494	ERJ2GEJ102X	SMD	.063W	5%	1K Ω	
R1497	ERJ3GEY0R00	SMD	0.1W	-	0 Ω	
R1498	ERJ2GEJ331X	SMD	.063W	5%	330 Ω	
R1499	ERJ2GEJ301X	SMD	.063W	5%	300 Ω	
R1500	ERJ6GEYJ561	S.M.CARB	0.1W	5%	560 Ω	
R1502	ERJ2GEJ101X	SMD	.063W	5%	100 Ω	
R1503	ERJ2GEJ132X	SMD	.063W	5%	1K3 Ω	
R1504	ERJ2GEJ432X	SMD	.063W	5%	4K3 Ω	
R1506	ERJ2GEJ103X	SMD	.063W	5%	10K Ω	
R1507	ERJ2GEJ103X	SMD	.063W	5%	10K Ω	
R1508	ERJ2GEJ103X	SMD	.063W	5%	10K Ω	
R1509	ERJ2GEJ103X	SMD	.063W	5%	10K Ω	
R1510	ERJ2GEJ103X	SMD	.063W	5%	10K Ω	
R2001	ERJ3GEYJ184V	SMD	0.1W	5%	180K Ω	
R2002	ERJ3GEYJ184V	SMD	0.1W	5%	180K Ω	
R2005	ERJ3GEYJ104V	S.M.CARB	0.1W	5%	100K Ω	
R2006	ERJ3GEYJ223V	S.M.CARB	0.1W	5%	22K Ω	
R2007	ERJ3GEYJ223V	S.M.CARB	0.1W	5%	22K Ω	
R2008	ERJ3GEYJ223V	S.M.CARB	0.1W	5%	22K Ω	
R2009	ERJ3GEYJ223V	S.M.CARB	0.1W	5%	22K Ω	

Cct Ref	Parts Number	Description				
R2010	ERJ3GEYJ223V	S.M.CARB	0.1W	5%	22K Ω	
R2011	ERJ3GEYJ223V	S.M.CARB	0.1W	5%	22K Ω	
R2012	ERJ3GEYJ104V	S.M.CARB	0.1W	5%	100K Ω	
R2013	ERJ3GEYJ101	SMD	0.1W	5%	100 Ω	
R2014	ERJ3GEYJ101	SMD	0.1W	5%	100 Ω	
R2015	ERJ3GEYJ331	SMD	0.1W	5%	330 Ω	
R2016	ERJ3GEYJ331	SMD	0.1W	5%	330 Ω	
R2018	ERJ3GEYJ104V	S.M.CARB	0.1W	5%	100K Ω	
R2019	ERJ3GEYJ104V	S.M.CARB	0.1W	5%	100K Ω	
R2021	ERJ3GEY0R00	SMD	0.1W	-	0 Ω	
R2022	ERJ3GEY0R00	SMD	0.1W	-	0 Ω	
R2023	ERJ3GEYJ101	SMD	0.1W	5%	100 Ω	
R2024	ERJ3GEYJ101	SMD	0.1W	5%	100 Ω	
R2027	ERJ3GEYJ104V	S.M.CARB	0.1W	5%	100K Ω	
R2028	ERJ3GEYJ104V	S.M.CARB	0.1W	5%	100K Ω	
R2030	ERJ3GEY0R00	SMD	0.1W	-	0 Ω	
R2031	ERJ3GEYJ101	SMD	0.1W	5%	100 Ω	
R2032	ERJ3GEY0R00	SMD	0.1W	-	0 Ω	
R2033	ERJ3GEYJ101	SMD	0.1W	5%	100 Ω	
R2035	ERJ3GEYJ104V	S.M.CARB	0.1W	5%	100K Ω	
R2036	ERJ3GEYJ104V	S.M.CARB	0.1W	5%	100K Ω	
R2037	ERJ3GEY0R00	SMD	0.1W	-	0 Ω	
R2038	ERJ3GEYJ101	SMD	0.1W	5%	100 Ω	
R2039	ERJ3GEY0R00	SMD	0.1W	-	0 Ω	
R2040	ERJ3GEYJ101	SMD	0.1W	5%	100 Ω	
R2050	ERJ3GEYJ331	SMD	0.1W	5%	330 Ω	
R2052	ERJ3GEYJ331	SMD	0.1W	5%	330 Ω	
R2056	ERJ3GEYJ101	SMD	0.1W	5%	100 Ω	
R2057	ERJ3GEYJ105	SMD	0.1W	5%	1M Ω	
R2060	ERJ3GEYJ101	SMD	0.1W	5%	100 Ω	
R2061	ERJ3GEYJ105	SMD	0.1W	5%	1M Ω	
R2069	ERJ3GEYJ561	SMD	0.1W	5%	560 Ω	
R2071	ERJ3GEYJ563V	S.M.CARB	0.1W	5%	56K Ω	
R2072	ERJ3GEYJ183V	S.M.CARB	0.1W	5%	18K Ω	
R2074	ERJ3GEYJ105	SMD	0.1W	5%	1M Ω	
R2075	ERJ3GEYJ274V	SMD	0.1W	5%	270K Ω	
R2076	ERJ3GEYJ473V	S.M.CARB	0.1W	5%	47K Ω	
R2077	ERJ3GEYJ102	SMD	0.1W	5%	1K Ω	
R2081	ERJ3GEYJ333V	SMD	0.1W	5%	33K Ω	
R2082	ERJ3GEYJ153V	S.M.CARB	0.1W	5%	15K Ω	
R2121	ERJ3GEY0R00	SMD	0.1W	-	0 Ω	
R2123	ERJ3GEY0R00	SMD	0.1W	-	0 Ω	
R2124	ERJ3GEYJ101	SMD	0.1W	5%	100 Ω	
R2125	ERJ3GEYJ101	SMD	0.1W	5%	100 Ω	
R2126	ERJ3GEYJ472	SMD	0.1W	5%	4K7 Ω	
R2127	ERJ3GEYJ472	SMD	0.1W	5%	4K7 Ω	
R2128	ERJ3GEYJ101	SMD	0.1W	5%	100 Ω	
R2129	ERJ3GEYJ101	SMD	0.1W	5%	100 Ω	
R2130	ERJ3GEYJ103	SMD	0.1W	5%	10K Ω	
R2131	ERJ3GEYJ103	SMD	0.1W	5%	10K Ω	
R2132	ERJ3GEYJ333V	SMD	0.1W	5%	33K Ω	
R2133	ERJ3GEY0R00	SMD	0.1W	-	0 Ω	
R2135	ERJ3GEYJ331	SMD	0.1W	5%	330 Ω	
R2136	ERJ3GEYJ331	SMD	0.1W	5%	330 Ω	
R2137	ERJ3GEYJ333V	SMD	0.1W	5%	33K Ω	
R2138	ERJ3GEYJ473V	S.M.CARB	0.1W	5%	47K Ω	
R2139	ERJ3GEYJ221	SMD	0.1W	5%	220 Ω	
R2140	ERJ3GEYJ221	SMD	0.1W	5%	220 Ω	
R2147	ERJ3GEYJ473V	S.M.CARB	0.1W	5%	47K Ω	
R2148	ERJ3GEYJ273	SMD	0.1W	5%	27K Ω	
R2149	ERJ3GEYJ273	SMD	0.1W	5%	27K Ω	
R2151	ERJ3GEY0R00	SMD	0.1W	-	0 Ω	
R2152	ERJ3GEYJ470	SMD	0.1W	5%	47 Ω	
R2153	ERJ3GEYJ221	SMD	0.1W	5%	220 Ω	
R2154	ERJ3GEYJ470	SMD	0.1W	5%	47 Ω	
R2155	ERJ3GEYJ221	SMD	0.1W	5%	220 Ω	
R2156	ERJ3GEYJ221	SMD	0.1W	5%	220 Ω	
R2157	ERJ3GEYJ221	SMD	0.1W	5%	220 Ω	

Cct Ref	Parts Number	Description			
R2158	ERJ3GEYJ221	SMD	0.1W	5%	220 Ω
R2159	ERJ3GEYJ221	SMD	0.1W	5%	220 Ω
R2160	ERJ3GEYJ221	SMD	0.1W	5%	220 Ω
R2161	ERJ3GEYJ331	SMD	0.1W	5%	330 Ω
R2162	ERJ3GEYJ221	SMD	0.1W	5%	220 Ω
R2163	ERJ3GEYJ331	SMD	0.1W	5%	330 Ω
R2164	ERJ3GEYJ221	SMD	0.1W	5%	220 Ω
R2165	ERJ3GEYJ101	SMD	0.1W	5%	100 Ω
R2166	ERJ3GEYJ101	SMD	0.1W	5%	100 Ω
R2167	ERJ3GEYJ221	SMD	0.1W	5%	220 Ω
R2168	ERJ3GEYJ472	SMD	0.1W	5%	4K7 Ω
R2169	ERJ3GEYJ472	SMD	0.1W	5%	4K7 Ω
R2170	ERJ3GEYJ221	SMD	0.1W	5%	220 Ω
R2171	ERJ3GEYJ221	SMD	0.1W	5%	220 Ω
R2172	ERJ3GEYJ221	SMD	0.1W	5%	220 Ω
R2173	ERJ3GEYJ221	SMD	0.1W	5%	220 Ω
R2176	ERJ3GEYJ221	SMD	0.1W	5%	220 Ω
R2177	ERJ3GEYJ221	SMD	0.1W	5%	220 Ω
R2178	ERJ3GEYJ103	SMD	0.1W	5%	10K Ω
R2179	ERJ3GEYJ103	SMD	0.1W	5%	10K Ω
R2180	ERJ3GEYJ561	SMD	0.1W	5%	560 Ω
R2181	ERJ3GEYJ561	SMD	0.1W	5%	560 Ω
R2182	ERJ3GEYJ101	SMD	0.1W	5%	100 Ω
R2183	ERJ3GEYJ101	SMD	0.1W	5%	100 Ω
R2184	ERJ3GEYJ221	SMD	0.1W	5%	220 Ω
R2185	ERJ3GEYJ221	SMD	0.1W	5%	220 Ω
R2186	ERJ3GEYJ221	SMD	0.1W	5%	220 Ω
R2187	ERJ3GEYJ221	SMD	0.1W	5%	220 Ω
R2192	ERJ3GEYJ221	SMD	0.1W	5%	220 Ω
R2193	ERJ3GEYJ221	SMD	0.1W	5%	220 Ω
R2195	ERJ3GEY0R00	SMD	0.1W	-	0 Ω
R2196	ERJ3GEY0R00	SMD	0.1W	-	0 Ω
R2197	ERJ3GEYJ471	SMD	0.1W	5%	470 Ω
R2199	ERJ3GEYJ105	SMD	0.1W	5%	1M Ω
R2202	ERJ3GEYJ101	SMD	0.1W	5%	100 Ω
R2204	ERJ6GEYJ561	S.M.CARB	0.1W	5%	560 Ω
R2208	ERJ3GEYJ471	SMD	0.1W	5%	470 Ω
R2209	ERJ3GEYJ332	SMD	0.1W	5%	3K3 Ω
R2210	ERJ3GEYJ122V	S.M.CARB	0.1W	5%	1K2 Ω
R2211	ERJ3GEY0R00	SMD	0.1W	-	0 Ω
R2213	ERJ3GEYJ103	SMD	0.1W	5%	10K Ω
R2214	ERJ3GEYJ332	SMD	0.1W	5%	3K3 Ω
R2218	ERJ3GEYJ274V	SMD	0.1W	5%	270K Ω
R2221	ERJ3GEYJ104V	S.M.CARB	0.1W	5%	100K Ω
R2229	ERJ3GEYJ473V	S.M.CARB	0.1W	5%	47K Ω
R2231	ERJ3GEY0R00	SMD	0.1W	-	0 Ω
R2234	ERJ3GEYJ391	SMD	0.1W	5%	390 Ω
R2235	ERJ3GEYJ391	SMD	0.1W	5%	390 Ω
R2236	ERJ3GEYJ102	SMD	0.1W	5%	1K Ω
R2237	ERJ3GEYJ105	SMD	0.1W	5%	1M Ω
R2238	ERJ3GEYJ274V	SMD	0.1W	5%	270K Ω
R2239	ERJ3GEYJ473V	S.M.CARB	0.1W	5%	47K Ω
R2240	ERJ3GEYJ102	SMD	0.1W	5%	1K Ω
R2244	ERJ3GEY0R00	SMD	0.1W	-	0 Ω
R2245	ERJ3GEYJ4R7V	SMD	0.1W	5%	4R7 Ω
R2246	ERJ3GEYJ471	SMD	0.1W	5%	470 Ω
R2247	ERJ3GEYJ4R7V	SMD	0.1W	5%	4R7 Ω
R2248	ERJ3GEYJ472	SMD	0.1W	5%	4K7 Ω
R2249	ERJ3GEYJ222	SMD	0.1W	5%	2K2 Ω
R2250	ERJ3GEYJ105	SMD	0.1W	5%	1M Ω
R2251	ERJ3GEYJ274V	SMD	0.1W	5%	270K Ω
R2252	ERJ3GEYJ471	SMD	0.1W	5%	470 Ω
R2255	ERJ3GEY0R00	SMD	0.1W	-	0 Ω
R2256	ERJ3GEY0R00	SMD	0.1W	-	0 Ω
R2259	ERJ3GEY0R00	SMD	0.1W	-	0 Ω
R2260	ERJ3GEYJ473V	S.M.CARB	0.1W	5%	47K Ω
R2261	ERJ3GEYJ102	SMD	0.1W	5%	1K Ω
R2262	ERJ3GEYJ473V	S.M.CARB	0.1W	5%	47K Ω

Cct Ref	Parts Number	Description			
R2263	ERJ3GEYJ102	SMD	0.1W	5%	1K Ω
R2264	ERJ3GEYJ183V	S.M.CARB	0.1W	5%	18K Ω
R2265	ERJ3GEYJ182V	SMD	0.1W	5%	1K8 Ω
R2271	ERJ3GEYJ153V	S.M.CARB	0.1W	5%	15K Ω
R2272	ERJ3GEYJ103	SMD	0.1W	5%	10K Ω
R2273	ERJ3GEYJ124V	SMD	0.1W	5%	120K Ω
R2274	ERJ3GEYJ105	SMD	0.1W	5%	1M Ω
R2275	ERJ3GEYJ222	SMD	0.1W	5%	2K2 Ω
R2301	ERJ3GEYJ153V	S.M.CARB	0.1W	5%	15K Ω
R2303	ERJ3GEYJ153V	S.M.CARB	0.1W	5%	15K Ω
R2304	ERJ3GEYJ153V	S.M.CARB	0.1W	5%	15K Ω
R2306	ERJ3GEYJ153V	S.M.CARB	0.1W	5%	15K Ω
R2319	ERJ3GEYJ102	SMD	0.1W	5%	1K Ω
R2320	ERJ3GEYJ102	SMD	0.1W	5%	1K Ω
R2321	ERJ3GEYJ433V	SMD	0.1W	5%	43K Ω
R2322	ERJ3GEYJ433V	SMD	0.1W	5%	43K Ω
R2327	ERJ3GEYJ203V	SMD	0.1W	5%	20K Ω
R2328	ERJ3GEYJ203V	SMD	0.1W	5%	20K Ω
R2329	ERJ3GEY0R00	SMD	0.1W	-	0 Ω
R2330	ERJ3GEY0R00	SMD	0.1W	-	0 Ω
R2331	ERJ3GEY0R00	SMD	0.1W	-	0 Ω
R2332	ERJ3GEY0R00	SMD	0.1W	-	0 Ω
R2335	ERJ3GEY0R00	SMD	0.1W	-	0 Ω
R2338	ERJ3GEYJ222	SMD	0.1W	5%	2K2 Ω
R2339	ERJ3GEYJ222	SMD	0.1W	5%	2K2 Ω
R2340	ERJ3GEYJ222	SMD	0.1W	5%	2K2 Ω
R2341	ERJ3GEYJ222	SMD	0.1W	5%	2K2 Ω
R2351	ERJ3GEYJ222	SMD	0.1W	5%	2K2 Ω
R2352	ERJ3GEYJ222	SMD	0.1W	5%	2K2 Ω
R2557	ERJ6GEYJ223	S.M.CARB	0.1W	5%	22K Ω
R2558	ERJ6GEYJ103	S.M.CARB	0.1W	5%	10K Ω
R2559	ERJ3GEYJ474	SMD	0.1W	5%	470K Ω
R2560	ERJ3GEYJ392V	S.M.CARB	0.1W	5%	3K9 Ω
R2561	ERJ6GEY0R00	S.M.CARB	0.1W	-	0 Ω
R2562	ERJ3GEYJ102	SMD	0.1W	5%	1K Ω
R2563	ERJ3GEYJ473V	S.M.CARB	0.1W	5%	47K Ω
R2564	ERJ3GEYJ222	SMD	0.1W	5%	2K2 Ω
R2565	ERJ3GEYJ102	SMD	0.1W	5%	1K Ω
R2566	ERJ3GEYJ101	SMD	0.1W	5%	100 Ω
R2569	ERJ6GEYJ100	S.M.CARB	0.1W	5%	10 Ω
R2570	ERJ3GEYJ682	SMD	0.1W	5%	6K8 Ω
R2571	ERJ3GEYJ222	SMD	0.1W	5%	2K2 Ω
R2572	ERJ3GEYJ474	SMD	0.1W	5%	470K Ω
R2573	ERJ3GEYJ392V	S.M.CARB	0.1W	5%	3K9 Ω
R2574	ERJ6GEY0R00	S.M.CARB	0.1W	-	0 Ω
R2575	ERJ3GEYJ102	SMD	0.1W	5%	1K Ω
R2576	ERJ3GEYJ473V	S.M.CARB	0.1W	5%	47K Ω
R2577	ERJ3GEYJ222	SMD	0.1W	5%	2K2 Ω
R2578	ERJ3GEYJ102	SMD	0.1W	5%	1K Ω
R2579	ERJ3GEYJ101	SMD	0.1W	5%	100 Ω
R2582	ERJ6GEYJ100	S.M.CARB	0.1W	5%	10 Ω
R2583	ERJ3GEYJ123	SMD	0.1W	5%	12K Ω
R2584	ERJ3GEYJ222	SMD	0.1W	5%	2K2 Ω
R2585	ERJ3GEYJ474	SMD	0.1W	5%	470K Ω
R2586	ERJ3GEYJ392V	S.M.CARB	0.1W	5%	3K9 Ω
R2587	ERJ6GEYJ390	S.M.CARB	0.1W	5%	39 Ω
R2588	ERJ3GEYJ102	SMD	0.1W	5%	1K Ω
R2589	ERJ3GEYJ473V	S.M.CARB	0.1W	5%	47K Ω
R2590	ERJ3GEYJ222	SMD	0.1W	5%	2K2 Ω
R2591	ERJ3GEYJ102	SMD	0.1W	5%	1K Ω
R2592	ERJ3GEYJ101	SMD	0.1W	5%	100 Ω
R2595	ERJ6GEYJ100	S.M.CARB	0.1W	5%	10 Ω
R2596	ERJ3GEYJ682	SMD	0.1W	5%	6K8 Ω
R2597	ERJ3GEYJ222	SMD	0.1W	5%	2K2 Ω
R2598	ERJ3GEYJ474	SMD	0.1W	5%	470K Ω
R2599	ERJ3GEYJ392V	S.M.CARB	0.1W	5%	3K9 Ω
R2600	ERJ6GEYJ390	S.M.CARB	0.1W	5%	39 Ω
R2601	ERJ3GEYJ102	SMD	0.1W	5%	1K Ω

Cct Ref	Parts Number	Description			
R2602	ERJ3GEYJ473V	S.M.CARB	0.1W	5%	47K Ω
R2603	ERJ3GEYJ222	SMD	0.1W	5%	2K2 Ω
R2604	ERJ3GEYJ102	SMD	0.1W	5%	1K Ω
R2605	ERJ3GEYJ101	SMD	0.1W	5%	100 Ω
R2608	ERJ6GEYJ100	S.M.CARB	0.1W	5%	10 Ω
R2609	ERJ3GEYJ123	SMD	0.1W	5%	12K Ω
R2610	ERJ3GEYJ222	SMD	0.1W	5%	2K2 Ω
R2611	ERJ6ENF6800	S.M. CAR	0.1W	5%	80 Ω
R2623	ERJ3GEY0R00	SMD	0.1W	-	0 Ω
R2624	ERJ3GEY0R00	SMD	0.1W	-	0 Ω
R2626	ERJ6ENF6800	S.M. CAR	0.1W	5%	80 Ω
R2627	ERJ6ENF6800	S.M. CAR	0.1W	5%	80 Ω
R2628	ERJ6ENF6800	S.M. CAR	0.1W	5%	80 Ω
R2634	ERJ3GEY0R00	SMD	0.1W	-	0 Ω
R2635	ERJ3GEY0R00	SMD	0.1W	-	0 Ω
R2636	ERJ3GEY0R00	SMD	0.1W	-	0 Ω
R2637	ERJ3GEY0R00	SMD	0.1W	-	0 Ω
R2645	ERJ3GEY0R00	SMD	0.1W	-	0 Ω
R3001	ERJ6ENF1500	S.M. CAR	0.1W	5%	15 Ω
R3002	ERJ6ENF1500	S.M. CAR	0.1W	5%	15 Ω
R3003	ERJ6ENF75R0	S.M.CARB	0.5W	5%	75 Ω
R3004	ERJ6ENF75R0	S.M.CARB	0.5W	5%	75 Ω
R3005	ERJ6ENF75R0	S.M.CARB	0.5W	5%	75 Ω
R3006	ERJ6ENF1500	S.M. CAR	0.1W	5%	15 Ω
R3007	ERJ6ENF1500	S.M. CAR	0.1W	5%	15 Ω
R3008	ERJ6ENF1500	S.M. CAR	0.1W	5%	15 Ω
R3009	ERJ6ENF75R0	S.M.CARB	0.5W	5%	75 Ω
R3010	ERJ6ENF75R0	S.M.CARB	0.5W	5%	75 Ω
R3011	ERJ6ENF75R0	S.M.CARB	0.5W	5%	75 Ω
R3012	ERJ6ENF75R0	S.M.CARB	0.5W	5%	75 Ω
R3013	ERJ6ENF75R0	S.M.CARB	0.5W	5%	75 Ω
R3014	ERJ6ENF75R0	S.M.CARB	0.5W	5%	75 Ω
R3015	ERJ6ENF75R0	S.M.CARB	0.5W	5%	75 Ω
R3016	ERJ3GEYJ101	SMD	0.1W	5%	100 Ω
R3017	ERJ3GEYJ101	SMD	0.1W	5%	100 Ω
R3018	ERJ3GEYJ680	SMD	0.1W	5%	68 Ω
R3019	ERJ3GEYJ680	SMD	0.1W	5%	68 Ω
R3020	ERJ3EKF2202V	SMD	0.1W	1%	22K Ω
R3021	ERJ3EKF2202V	SMD	0.1W	1%	22K Ω
R3022	ERJ3EKF2202V	SMD	0.1W	1%	22K Ω
R3023	ERJ3EKF1202V	SMD	0.1W	1%	12K Ω
R3024	ERJ3EKF1202V	SMD	0.1W	1%	12K Ω
R3025	ERJ3GEYJ103	SMD	0.1W	5%	10K Ω
R3026	ERJ3GEYJ473V	S.M.CARB	0.1W	5%	47K Ω
R3027	ERJ6ENF75R0	S.M.CARB	0.5W	5%	75 Ω
R3028	ERJ6ENF75R0	S.M.CARB	0.5W	5%	75 Ω
R3030	ERJ6GEYJ361	S.M.CARB	0.1W	5%	360 Ω
R3031	ERJ6ENF75R0	S.M.CARB	0.5W	5%	75 Ω
R3032	ERJ6GEYJ361	S.M.CARB	0.1W	5%	360 Ω
R3033	ERJ6GEYJ361	S.M.CARB	0.1W	5%	360 Ω
R3034	ERJ6GEYJ361	S.M.CARB	0.1W	5%	360 Ω
R3036	ERJ6GEYJ361	S.M.CARB	0.1W	5%	360 Ω
R3037	ERJ6GEYJ361	S.M.CARB	0.1W	5%	360 Ω
R3038	ERJ3GEYJ221	SMD	0.1W	5%	220 Ω
R3039	ERJ3GEYJ221	SMD	0.1W	5%	220 Ω
R3040	ERJ3GEYJ221	SMD	0.1W	5%	220 Ω
R3041	ERJ3GEYJ332	SMD	0.1W	5%	3K3 Ω
R3042	ERJ3GEYJ332	SMD	0.1W	5%	3K3 Ω
R3043	ERJ3GEYJ562	SMD	0.1W	5%	5K6 Ω
R3048	ERJ3GEYJ152	SMD	0.1W	5%	1K5 Ω
R3049	ERJ3GEYJ103	SMD	0.1W	5%	10K Ω
R3050	ERJ3GEYJ103	SMD	0.1W	5%	10K Ω
R3051	ERJ3GEYJ103	SMD	0.1W	5%	10K Ω
R3053	ERJ3GEYJ221	SMD	0.1W	5%	220 Ω
R3054	ERJ3EKF5600V	SMD	0.1W	1%	560 Ω
R3055	ERJ3EKF5600V	SMD	0.1W	1%	560 Ω
R3057	ERJ3GEY0R00	SMD	0.1W	-	0 Ω
R3058	ERJ3GEY0R00	SMD	0.1W	-	0 Ω

Cct Ref	Parts Number	Description			
R3059	ERJ3GEYJ221	SMD	0.1W	5%	220 Ω
R3060	ERJ3GEYJ221	SMD	0.1W	5%	220 Ω
R3061	ERJ3GEYJ221	SMD	0.1W	5%	220 Ω
R3062	ERJ3GEYJ221	SMD	0.1W	5%	220 Ω
R3063	ERJ3GEYJ221	SMD	0.1W	5%	220 Ω
R3064	ERJ3GEYJ221	SMD	0.1W	5%	220 Ω
R3067	ERJ3GEYJ103	SMD	0.1W	5%	10K Ω
R3068	ERJ3EKF75R0V	SMD	0.1W	1%	75 Ω
R3069	ERJ3GEYJ103	SMD	0.1W	5%	10K Ω
R3071	ERJ3GEYJ104V	S.M.CARB	0.1W	5%	100K Ω
R3072	ERJ3GEYJ221	SMD	0.1W	5%	220 Ω
R3074	ERJ3GEYJ221	SMD	0.1W	5%	220 Ω
R3075	ERJ3GEYJ221	SMD	0.1W	5%	220 Ω
R3077	ERJ3GEYJ221	SMD	0.1W	5%	220 Ω
R3078	ERJ3GEY0R00	SMD	0.1W	-	0 Ω
R3079	ERJ3GEYJ221	SMD	0.1W	5%	220 Ω
R3080	ERJ3GEY0R00	SMD	0.1W	-	0 Ω
R3083	ERJ3GEYJ104V	S.M.CARB	0.1W	5%	100K Ω
R3085	ERJ3GEYJ221	SMD	0.1W	5%	220 Ω
R3086	ERJ3GEYJ104V	S.M.CARB	0.1W	5%	100K Ω
R3087	ERJ3GEYJ221	SMD	0.1W	5%	220 Ω
R3089	ERJ3GEYJ470	SMD	0.1W	5%	47 Ω
R3090	ERJ3GEYJ470	SMD	0.1W	5%	47 Ω
R3091	ERJ3GEY0R00	SMD	0.1W	-	0 Ω
R3092	ERJ3GEYJ221	SMD	0.1W	5%	220 Ω
R3093	ERJ3GEY0R00	SMD	0.1W	-	0 Ω
R3094	ERJ3GEYJ221	SMD	0.1W	5%	220 Ω
R3095	ERJ3GEYJ221	SMD	0.1W	5%	220 Ω
R3096	ERJ3GEYJ221	SMD	0.1W	5%	220 Ω
R3097	ERJ3GEYJ221	SMD	0.1W	5%	220 Ω
R3098	ERJ3GEYJ221	SMD	0.1W	5%	220 Ω
R3099	ERJ3GEYJ221	SMD	0.1W	5%	220 Ω
R3100	ERJ3GEYJ221	SMD	0.1W	5%	220 Ω
R3101	ERJ3GEYJ221	SMD	0.1W	5%	220 Ω
R3102	ERJ3GEY0R00	SMD	0.1W	-	0 Ω
R3103	ERJ3GEY0R00	SMD	0.1W	-	0 Ω
R3104	ERJ3GEY0R00	SMD	0.1W	-	0 Ω
R3105	ERJ3GEY0R00	SMD	0.1W	-	0 Ω
R3107	ERJ6ENF1500	S.M. CAR	0.1W	5%	15 Ω
R3108	ERJ6ENF1500	S.M. CAR	0.1W	5%	15 Ω
R3109	ERJ6ENF1500	S.M. CAR	0.1W	5%	15 Ω
R3115	ERJ3GEYJ101	SMD	0.1W	5%	100 Ω
R3118	ERJ3GEYJ101	SMD	0.1W	5%	100 Ω
R3119	ERJ3EKF91R0V	SMD	0.1W	1%	91 Ω
R3120	ERJ3EKF91R0V	SMD	0.1W	1%	91 Ω
R3121	ERJ3EKF1300V	SMD	0.1W	1%	130 Ω
R3122	ERJ3GEYJ101	SMD	0.1W	5%	100 Ω
R3123	ERJ3EKF1000V	SMD	0.1W	1%	100 Ω
R3125	ERJ6GEYJ102	S.M.CARB	0.1W	5%	1K Ω
R3126	ERJ3GEYJ101	SMD	0.1W	5%	100 Ω
R3127	ERJ6GEYJ102	S.M.CARB	0.1W	5%	1K Ω
R3130	ERJ3GEYJ101	SMD	0.1W	5%	100 Ω
R3131	ERJ3GEYJ101	SMD	0.1W	5%	100 Ω
R3132	ERJ3GEYJ103	SMD	0.1W	5%	10K Ω
R3133	ERJ3GEYJ103	SMD	0.1W	5%	10K Ω
R3134	ERJ3GEYJ333V	SMD	0.1W	5%	33K Ω
R3135	ERJ3EKF91R0V	SMD	0.1W	1%	91 Ω
R3136	ERJ3GEYJ333V	SMD	0.1W	5%	33K Ω
R3138	ERJ3EKF1000V	SMD	0.1W	1%	100 Ω
R3139	ERJ6GEYJ102	S.M.CARB	0.1W	5%	1K Ω
R3140	ERJ3EKF1300V	SMD	0.1W	1%	130 Ω
R3141	ERJ6GEYJ102	S.M.CARB	0.1W	5%	1K Ω
R3143	ERJ3GEYJ222	SMD	0.1W	5%	2K2 Ω
R3144	ERJ3GEYJ332	SMD	0.1W	5%	3K3 Ω
R3145	ERJ3GEYJ103	SMD	0.1W	5%	10K Ω
R3146	ERJ3GEYJ331	SMD	0.1W	5%	330 Ω
R3163	ERJ3EKF1202V	SMD	0.1W	1%	12K Ω
R3164	ERJ3GEY0R00	SMD	0.1W	-	0 Ω

Cct Ref	Parts Number	Description			
R3166	ERJ3EKF75R0V	SMD	0.1W	1%	75 Ω
R3167	ERJ3EKF75R0V	SMD	0.1W	1%	75 Ω
R3168	ERJ3GEY0R00	SMD	0.1W	-	0 Ω
R3169	ERJ3GEYJ102	SMD	0.1W	5%	1K Ω
R3170	ERJ3GEY0R00	SMD	0.1W	-	0 Ω
R3171	ERJ3GEYJ471	SMD	0.1W	5%	470 Ω
R3173	ERJ6GEYJ271	S.M.CARB	0.1W	5%	270 Ω
R3175	ERJ3GEY0R00	SMD	0.1W	-	0 Ω
R3176	ERJ3EKF75R0V	SMD	0.1W	1%	75 Ω
R3177	ERJ3GEY0R00	SMD	0.1W	-	0 Ω
R3178	ERJ3GEYJ102	SMD	0.1W	5%	1K Ω
R3180	ERJ3GEYJ101	SMD	0.1W	5%	100 Ω
R3201	ERJ6GEY0R00	S.M.CARB	0.1W	-	0 Ω
R3202	ERJ3GEYJ221	SMD	0.1W	5%	220 Ω
R3203	ERJ6GEYJ561	S.M.CARB	0.1W	5%	560 Ω
R3204	ERJ3GEYJ102	SMD	0.1W	5%	1K Ω
R3205	ERJ3GEYJ102	SMD	0.1W	5%	1K Ω
R3206	ERJ3EKF6802V	SMD	0.1W	1%	68K Ω
R3207	ERJ3EKF3602V	SMD	0.1W	1%	36K Ω
R3209	ERJ3GEY0R00	SMD	0.1W	-	0 Ω
R3210	ERJ3GEY0R00	SMD	0.1W	-	0 Ω
R3213	ERJ3GEY0R00	SMD	0.1W	-	0 Ω
R3214	ERJ3GEY0R00	SMD	0.1W	-	0 Ω
R3215	ERJ3GEY0R00	SMD	0.1W	-	0 Ω
R3216	ERJ3GEY0R00	SMD	0.1W	-	0 Ω
R3217	ERJ3GEY0R00	SMD	0.1W	-	0 Ω
R3218	ERJ3GEY0R00	SMD	0.1W	-	0 Ω
R3219	ERJ3GEY0R00	SMD	0.1W	-	0 Ω
R3220	ERJ3GEY0R00	SMD	0.1W	-	0 Ω
R3221	ERJ3GEY0R00	SMD	0.1W	-	0 Ω
R3256	ERJ3GEYJ221	SMD	0.1W	5%	220 Ω
R3261	ERJ3GEYJ101	SMD	0.1W	5%	100 Ω
R3271	ERJ6ENF1500	S.M. CAR	0.1W	5%	15 Ω
R3272	ERJ6ENF1500	S.M. CAR	0.1W	5%	15 Ω
R3302	ERJ6GEYJ101	S.M.CARB	0.1W	5%	100 Ω
R3305	ERJ6GEYJ101	S.M.CARB	0.1W	5%	100 Ω
R3306	ERJ3GEYJ472	SMD	0.1W	5%	4K7 Ω
R3307	ERJ3GEYJ472	SMD	0.1W	5%	4K7 Ω
R3308	ERJ6GEY0R00	S.M.CARB	0.1W	-	0 Ω
R3309	ERJ6GEY0R00	S.M.CARB	0.1W	-	0 Ω
R3310	ERJ6ENF75R0	S.M.CARB	0.5W	5%	75 Ω
R3311	ERJ6GEY0R00	S.M.CARB	0.1W	-	0 Ω
R3312	ERJ3GEYJ103	SMD	0.1W	5%	10K Ω
R3313	ERJ6ENF75R0	S.M.CARB	0.5W	5%	75 Ω
R3316	ERJ6GEY0R00	S.M.CARB	0.1W	-	0 Ω
R3317	ERJ3GEYJ103	SMD	0.1W	5%	10K Ω
R3318	ERJ6ENF75R0	S.M.CARB	0.5W	5%	75 Ω
R3319	ERJ6GEY0R00	S.M.CARB	0.1W	-	0 Ω
R3325	ERJ3GEY0R00	SMD	0.1W	-	0 Ω
R3339	ERJ3GEY0R00	SMD	0.1W	-	0 Ω
R3341	ERJ3GEYJ183V	S.M.CARB	0.1W	5%	18K Ω
R3342	ERJ3GEYJ183V	S.M.CARB	0.1W	5%	18K Ω
R3343	ERJ3GEYJ221	SMD	0.1W	5%	220 Ω
R3344	ERJ6GEYJ221	S.M.CARB	0.1W	5%	220 Ω
R3345	ERJ3GEYJ183V	S.M.CARB	0.1W	5%	18K Ω
R3346	ERJ3GEYJ183V	S.M.CARB	0.1W	5%	18K Ω
R3347	ERJ3GEYJ221	SMD	0.1W	5%	220 Ω
R3348	ERJ6GEYJ221	S.M.CARB	0.1W	5%	220 Ω
R3349	ERJ3GEYJ183V	S.M.CARB	0.1W	5%	18K Ω
R3350	ERJ3GEYJ183V	S.M.CARB	0.1W	5%	18K Ω
R3351	ERJ3GEYJ221	SMD	0.1W	5%	220 Ω
R3352	ERJ6GEYJ221	S.M.CARB	0.1W	5%	220 Ω
R3359	ERJ3GEYJ330	SMD	0.1W	5%	33 Ω
R3360	ERJ3GEYJ330	SMD	0.1W	5%	33 Ω
R3361	ERJ3GEYJ330	SMD	0.1W	5%	33 Ω
R3362	ERJ3GEYJ680	SMD	0.1W	5%	68 Ω
R3363	ERJ3GEYJ680	SMD	0.1W	5%	68 Ω
R3364	ERJ3GEY0R00	SMD	0.1W	-	0 Ω

Cct Ref	Parts Number	Description			
R3365	ERJ3GEY0R00	SMD	0.1W	-	0 Ω
R3366	ERJ3GEY0R00	SMD	0.1W	-	0 Ω
R3367	ERJ3GEY0R00	SMD	0.1W	-	0 Ω
R3368	ERJ3GEY0R00	SMD	0.1W	-	0 Ω
R3371	ERJ3GEY0R00	SMD	0.1W	-	0 Ω
R3372	ERJ3GEY0R00	SMD	0.1W	-	0 Ω
R3381	ERJ3GEYJ2R2V	SMD	0.1W	5%	2R2 Ω
R3382	ERJ3GEY0R00	SMD	0.1W	-	0 Ω
R3383	ERJ3GEY0R00	SMD	0.1W	-	0 Ω
R3384	ERJ3GEY0R00	SMD	0.1W	-	0 Ω
R3385	ERJ3GEY0R00	SMD	0.1W	-	0 Ω
R3386	ERJ3GEY0R00	SMD	0.1W	-	0 Ω
R3387	ERJ3GEY0R00	SMD	0.1W	-	0 Ω
R3388	ERJ3GEY0R00	SMD	0.1W	-	0 Ω
R3389	ERJ3GEY0R00	SMD	0.1W	-	0 Ω
R3397	ERJ3GEY0R00	SMD	0.1W	-	0 Ω
R3398	ERJ3GEY0R00	SMD	0.1W	-	0 Ω
R3399	ERJ3GEY0R00	SMD	0.1W	-	0 Ω
R3400	ERJ3GEY0R00	SMD	0.1W	-	0 Ω
R3401	ERJ3GEY0R00	SMD	0.1W	-	0 Ω
R3402	ERJ8GEY0R00	S.M.CARB	.125W	-	0 Ω
R3403	ERJ8GEY0R00	S.M.CARB	.125W	-	0 Ω
R3404	ERJ8GEY0R00	S.M.CARB	.125W	-	0 Ω
R3405	ERJ8GEY0R00	S.M.CARB	.125W	-	0 Ω
R3406	ERJ8GEY0R00	S.M.CARB	.125W	-	0 Ω
R3407	ERJ3GEY0R00	SMD	0.1W	-	0 Ω
R3903	ERJ6ENF7151	SMD	.125W	1%	7K15 Ω
R3904	ERJ6GEYJ184	S.M.CARB	0.1W	5%	180K Ω
R3905	ERJ6GEYJ223	S.M.CARB	0.1W	5%	22K Ω
R3906	ERJ6GEYJ223	S.M.CARB	0.1W	5%	22K Ω
R3907	ERJ6GEYJ184	S.M.CARB	0.1W	5%	180K Ω
R3918	ERJ6ENF6651	SMD	.125W	1%	6K65 Ω
R3927	ERJ6ENF1432V	SMD	.125W	1%	14K3 Ω
R3941	ERJ6ENF1741V	SMD	.125W	1%	1K74 Ω
R3966	ERJ6GEY0R00	S.M.CARB	0.1W	-	0 Ω
R3967	ERJ6GEY0R00	S.M.CARB	0.1W	-	0 Ω
R3968	ERJ6GEY0R00	S.M.CARB	0.1W	-	0 Ω
R4002	ERJ3EKF1211V	SMD	0.1W	1%	1K21 Ω
R4003	ERJ3EKF1781V	SMD	0.1W	1%	1K78 Ω
R4004	ERJ2GE0R00X	SMD	.063W	-	0 Ω
R4006	ERJ3EKF1211V	SMD	0.1W	1%	1K21 Ω
R4007	ERJ3EKF1781V	SMD	0.1W	1%	1K78 Ω
R4008	ERJ2GE0R00X	SMD	.063W	-	0 Ω
R4010	ERJ3GEY0R00	SMD	0.1W	-	0 Ω
R4012	ERJ2GEJ104X	SMD	.063W	5%	100K Ω
R4018	ERJ2GE0R00X	SMD	.063W	-	0 Ω
R4023	ERJ2GEJ680X	SMD	.063W	5%	68 Ω
R4026	ERJ2GEJ102X	SMD	.063W	5%	1K Ω
R4027	ERJ2GEJ102X	SMD	.063W	5%	1K Ω
R4031	ERJ2GEJ103X	SMD	.063W	5%	10K Ω
R4032	ERJ2GEJ103X	SMD	.063W	5%	10K Ω
R4037	EXB2HV103JV	SMD	.063W	5%	10K Ω
R4038	EXB2HV103JV	SMD	.063W	5%	10K Ω
R4039	EXB2HV103JV	SMD	.063W	5%	10K Ω
R4053	ERJ2GEJ103X	SMD	.063W	5%	10K Ω
R4055	ERJ6ENF5111V	SMD	.125W	1%	5K11 Ω
R4057	ERJ3EKF3001V	SMD	0.1W	1%	3K Ω
R4064	ERJ2GEJ103X	SMD	.063W	5%	10K Ω
R4065	ERJ2GEJ103X	SMD	.063W	5%	10K Ω
R4066	ERJ2GEJ103X	SMD	.063W	5%	10K Ω
R4067	ERJ2GEJ103X	SMD	.063W	5%	10K Ω
R4088	ERJ2GE0R00X	SMD	.063W	-	0 Ω
R4089	ERJ2GE0R00X	SMD	.063W	-	0 Ω
R4090	ERJ2GE0R00X	SMD	.063W	-	0 Ω
R4091	ERJ2GE0R00X	SMD	.063W	-	0 Ω
R4095	ERJ2GEJ223X	SMD	.063W	5%	22K Ω
R4102	ERJ3GEY0R00	SMD	0.1W	-	0 Ω
R4103	ERJ3GEY0R00	SMD	0.1W	-	0 Ω

Cct Ref	Parts Number	Description			
R4104	ERJ3GEY0R00	SMD	0.1W	-	0 Ω
R4106	ERJ3GEY0R00	SMD	0.1W	-	0 Ω
R4110	ERJ3GEY0R00	SMD	0.1W	-	0 Ω
R4111	ERJ3GEY0R00	SMD	0.1W	-	0 Ω
R4118	ERJ3GEY0R00	SMD	0.1W	-	0 Ω
R4119	ERJ3GEY0R00	SMD	0.1W	-	0 Ω
R4120	ERJ3GEY0R00	SMD	0.1W	-	0 Ω
R4121	ERJ3GEY0R00	SMD	0.1W	-	0 Ω
R4122	ERJ3GEY0R00	SMD	0.1W	-	0 Ω
R4123	ERJ3GEY0R00	SMD	0.1W	-	0 Ω
R4124	ERJ3GEY0R00	SMD	0.1W	-	0 Ω
R4125	ERJ3GEY0R00	SMD	0.1W	-	0 Ω
R4126	ERJ3GEY0R00	SMD	0.1W	-	0 Ω
R4127	ERJ3GEY0R00	SMD	0.1W	-	0 Ω
R4131	ERJ3GEY0R00	SMD	0.1W	-	0 Ω
R4132	ERJ3GEY0R00	SMD	0.1W	-	0 Ω
R4133	ERJ3GEY0R00	SMD	0.1W	-	0 Ω
R4134	ERJ3GEY0R00	SMD	0.1W	-	0 Ω
R4135	ERJ3GEY0R00	SMD	0.1W	-	0 Ω
R4142	ERJ3GEY0R00	SMD	0.1W	-	0 Ω
R4143	ERJ2GE0R00X	SMD	.063W	-	0 Ω
R4144	ERJ3GEY0R00	SMD	0.1W	-	0 Ω
R4145	ERJ2GEJ101X	SMD	.063W	5%	100 Ω
R4146	ERJ2GEJ104X	SMD	.063W	5%	100K Ω
R4147	ERJ2GEJ203X	SMD	.063W	5%	20K Ω
R4149	ERJ2GEJ101X	SMD	.063W	5%	100 Ω
R4151	ERJ2GE0R00X	SMD	.063W	-	0 Ω
R4152	ERJ3EKF3002V	SMD	0.1W	1%	30K Ω
R4153	ERJ3EKF3002V	SMD	0.1W	1%	30K Ω
R4155	ERJ2GE0R00X	SMD	.063W	-	0 Ω
R4156	ERJ3GEY0R00	SMD	0.1W	-	0 Ω
R4169	ERJ2GEJ103X	SMD	.063W	5%	10K Ω
R4170	ERJ2GEJ103X	SMD	.063W	5%	10K Ω
R4171	ERJ2GEJ102X	SMD	.063W	5%	1K Ω
R4172	ERJ2GEJ472X	SMD	.063W	5%	4K7 Ω
R4173	ERJ2GEJ103X	SMD	.063W	5%	10K Ω
R4174	ERJ2GE0R00X	SMD	.063W	-	0 Ω
R4176	ERJ2GE0R00X	SMD	.063W	-	0 Ω
R4182	ERJ3GEY0R00	SMD	0.1W	-	0 Ω
R4183	ERJ2GEJ102X	SMD	.063W	5%	1K Ω
R4184	ERJ2GEJ103X	SMD	.063W	5%	10K Ω
R4185	ERJ2GEJ473X	SMD	.063W	5%	47K Ω
R4186	ERJ2GEJ473X	SMD	.063W	5%	47K Ω
R4187	ERJ2GEJ473X	SMD	.063W	5%	47K Ω
R4188	ERJ3EKF1502V	SMD	0.1W	1%	15K Ω
R4189	ERJ3EKF6802V	SMD	0.1W	1%	68K Ω
R4190	ERJ6GEY0R00	S.M.CARB	0.1W	-	0 Ω
R4192	ERJ2GE0R00X	SMD	.063W	-	0 Ω
R4193	ERJ2GEJ363X	SMD	.063W	5%	36K Ω
R4194	ERJ2GEJ164X	SMD	.063W	5%	160K Ω
R4271	ERJ3GEY0R00	SMD	0.1W	-	0 Ω
R4272	ERJ3GEY0R00	SMD	0.1W	-	0 Ω
R4286	ERJ3GEY0R00	SMD	0.1W	-	0 Ω
R4287	ERJ6GEY0R00	S.M.CARB	0.1W	-	0 Ω
R4293	ERJ3GEY0R00	SMD	0.1W	-	0 Ω
R4338	ERJ2GE0R00X	SMD	.063W	-	0 Ω
R4339	ERJ2GE0R00X	SMD	.063W	-	0 Ω
R4340	ERJ3GEY0R00	SMD	0.1W	-	0 Ω
R4341	ERJ2GE0R00X	SMD	.063W	-	0 Ω
R4434	ERJ2GE0R00X	SMD	.063W	-	0 Ω
R4436	ERJ2GE0R00X	SMD	.063W	-	0 Ω
R4438	ERJ2GE0R00X	SMD	.063W	-	0 Ω
R4442	ERJ3EKF4220V	SMD	0.1W	1%	422 Ω
R4443	ERJ3EKF4220V	SMD	0.1W	1%	422 Ω
R4444	ERJ3EKF3301V	SMD	0.1W	1%	3K3 Ω
R4445	ERJ3EKF3301V	SMD	0.1W	1%	3K3 Ω
R4447	ERJ3EKF7680V	SMD	0.1W	1%	768 Ω
R4449	ERJ3EKF1211V	SMD	0.1W	1%	1K21 Ω

Cct Ref	Parts Number	Description			
R4450	ERJ6GEYJ821	S.M.CARB	0.1W	5%	820 Ω
R4451	ERJ6GEYJ821	S.M.CARB	0.1W	5%	820 Ω
R4454	ERJ6GEYJ681	S.M.CARB	0.1W	5%	680 Ω
R4457	ERJ2GE0R00X	SMD	.063W	-	0 Ω
R4465	ERJ2GEJ103X	SMD	.063W	5%	10K Ω
R4466	ERJ2GEJ330X	SMD	.063W	5%	33 Ω
R4467	ERJ2GEJ330X	SMD	.063W	5%	33 Ω
R4469	ERJ3EKF1500V	SMD	0.1W	1%	150 Ω
R4470	ERJ3EKF1500V	SMD	0.1W	1%	150 Ω
R4476	ERJ2GEJ330X	SMD	.063W	5%	33 Ω
R4477	ERJ6GEYJ471	S.M.CARB	0.1W	5%	470 Ω
R4478	ERJ6GEYJ471	S.M.CARB	0.1W	5%	470 Ω
R4479	ERJ3EKF4220V	SMD	0.1W	1%	422 Ω
R4480	ERJ3EKF4220V	SMD	0.1W	1%	422 Ω
R4481	ERJ3EKF2201V	SMD	0.1W	1%	2K2 Ω
R4484	ERJ2GEJ560X	SMD	.063W	5%	56 Ω
R4485	ERJ2GEJ560X	SMD	.063W	5%	56 Ω
R4486	ERJ3EKF4870V	SMD	0.1W	1%	487 Ω
R4487	ERJ3EKF5600V	SMD	0.1W	1%	560 Ω
R4488	ERJ3EKF2201V	SMD	0.1W	1%	2K2 Ω
R4489	ERJ6GEYJ331	S.M.CARB	0.1W	5%	330 Ω
R4490	ERJ6GEYJ102	S.M.CARB	0.1W	5%	1K Ω
R4491	ERJ2GEJ560X	SMD	.063W	5%	56 Ω
R4492	ERJ6GEYJ102	S.M.CARB	0.1W	5%	1K Ω
R4495	ERJ3EKF4302V	SMD	0.1W	1%	43K Ω
R4496	ERJ6GEYJ102	S.M.CARB	0.1W	5%	1K Ω
R4497	ERJ6GEYJ102	S.M.CARB	0.1W	5%	1K Ω
R4498	ERJ6GEYJ102	S.M.CARB	0.1W	5%	1K Ω
R4499	ERJ6GEYJ102	S.M.CARB	0.1W	5%	1K Ω
R4500	ERJ3EKF2702V	SMD	0.1W	1%	27K Ω
R4501	ERJ6GEYJ102	S.M.CARB	0.1W	5%	1K Ω
R4502	ERJ6GEYJ102	S.M.CARB	0.1W	5%	1K Ω
R4503	ERJ3EKF1600V	SMD	0.1W	1%	160 Ω
R4505	ERJ2GEJ103X	SMD	.063W	5%	10K Ω
R4506	ERJ2GE0R00X	SMD	.063W	-	0 Ω
R4508	ERJ2GE0R00X	SMD	.063W	-	0 Ω
R4510	ERJ2GE0R00X	SMD	.063W	-	0 Ω
R4514	ERJ2GE0R00X	SMD	.063W	-	0 Ω
R4515	ERJ2GE0R00X	SMD	.063W	-	0 Ω
R4516	ERJ2GE0R00X	SMD	.063W	-	0 Ω
R4517	ERJ3EKF1371V	SMD	0.1W	1%	1K37 Ω
R4519	ERJ2GE0R00X	SMD	.063W	-	0 Ω
R4520	ERJ3EKF1691V	SMD	0.1W	1%	1K69 Ω
R4521	ERJ2GEJ220X	SMD	.063W	5%	22 Ω
R4522	ERJ2GEJ220X	SMD	.063W	5%	22 Ω
R4523	ERJ3EKF33R0V	SMD	0.1W	1%	33 Ω
R4524	ERJ3EKF33R0V	SMD	0.1W	1%	33 Ω
R4525	ERJ3EKF33R0V	SMD	0.1W	1%	33 Ω
R4526	ERJ3EKF1401V	SMD	0.1W	1%	1K4 Ω
R4527	ERJ2GEJ220X	SMD	.063W	5%	22 Ω
R4528	ERJ3EKF33R0V	SMD	0.1W	1%	33 Ω
R4529	ERJ3EKF33R0V	SMD	0.1W	1%	33 Ω
R4530	ERJ3EKF33R0V	SMD	0.1W	1%	33 Ω
R4531	ERJ3EKF2701V	SMD	0.1W	1%	2K7 Ω
R4532	ERJ3EKF4700V	SMD	0.1W	1%	470 Ω
R4533	ERJ2GEJ220X	SMD	.063W	5%	22 Ω
R4534	ERJ2GEJ101X	SMD	.063W	5%	100 Ω
R4535	ERJ2GEJ101X	SMD	.063W	5%	100 Ω
R4536	ERJ3EKF1500V	SMD	0.1W	1%	150 Ω
R4537	ERJ3EKF1500V	SMD	0.1W	1%	150 Ω
R4538	ERJ3EKF1500V	SMD	0.1W	1%	150 Ω
R4539	ERJ3EKF1001V	SMD	0.1W	1%	1K Ω
R4541	ERJ2GE0R00X	SMD	.063W	-	0 Ω
R4543	ERJ2GE0R00X	SMD	.063W	-	0 Ω
R4544	ERJ2GEJ220X	SMD	.063W	5%	22 Ω
R4545	ERJ2GE0R00X	SMD	.063W	-	0 Ω
R4546	ERJ2GE0R00X	SMD	.063W	-	0 Ω
R4547	ERJ2GE0R00X	SMD	.063W	-	0 Ω

Cct Ref	Parts Number	Description			
R4548	ERJ2GEJ911X	SMD	.063W	5%	910 Ω
R4549	ERJ2GE0R00X	SMD	.063W	-	0 Ω
R4550	EXB28V220JX	SMD	.031W	5%	22 Ω
R4551	ERJ2GE0R00X	SMD	.063W	-	0 Ω
R4552	EXB28V220JX	SMD	.031W	5%	22 Ω
R4553	ERJ2GEJ101X	SMD	.063W	5%	100 Ω
R4554	ERJ2GEJ220X	SMD	.063W	5%	22 Ω
R4555	EXB28V220JX	SMD	.031W	5%	22 Ω
R4556	ERJ2GEJ220X	SMD	.063W	5%	22 Ω
R4557	ERJ2GEJ220X	SMD	.063W	5%	22 Ω
R4560	EXB28V220JX	SMD	.031W	5%	22 Ω
R4561	EXB28V220JX	SMD	.031W	5%	22 Ω
R4562	ERJ2GEJ560X	SMD	.063W	5%	56 Ω
R4563	ERJ2GEJ220X	SMD	.063W	5%	22 Ω
R4564	ERJ2GEJ220X	SMD	.063W	5%	22 Ω
R4565	ERJ2GEJ220X	SMD	.063W	5%	22 Ω
R4566	ERJ2GEJ560X	SMD	.063W	5%	56 Ω
R4567	ERJ2GEJ470X	SMD	.063W	5%	47 Ω
R4568	ERJ2GEJ101X	SMD	.063W	5%	100 Ω
R4569	EXB2HV560JV	CHIP RES	.063W	5%	56 Ω
R4570	EXB28V560JX	SMD	.031W	5%	56 Ω
R4571	EXB28V560JX	SMD	.031W	5%	56 Ω
R4572	ERJ2GEJ103X	SMD	.063W	5%	10K Ω
R4574	ERJ2GEJ103X	SMD	.063W	5%	10K Ω
R4575	ERJ2GEJ472X	SMD	.063W	5%	4K7 Ω
R4577	ERJ2GEJ222X	SMD	.063W	5%	2K2 Ω
R4578	ERJ2GEJ222X	SMD	.063W	5%	2K2 Ω
R4579	ERJ2GEJ222X	SMD	.063W	5%	2K2 Ω
R4583	ERJ2GEJ390X	SMD	.063W	5%	39 Ω
R4584	ERJ2GEJ390X	SMD	.063W	5%	39 Ω
R4589	ERJ2GEJ2R7X	SMD	.063W	5%	2R7 Ω
R4590	ERJ2GEJ2R7X	SMD	.063W	5%	2R7 Ω
R4591	ERJ2GEJ2R7X	SMD	.063W	5%	2R7 Ω
R4592	ERJ2GEJ2R7X	SMD	.063W	5%	2R7 Ω
R4593	ERJ2GEJ2R7X	SMD	.063W	5%	2R7 Ω
R4594	ERJ2GEJ2R7X	SMD	.063W	5%	2R7 Ω
R4595	ERJ2GEJ2R7X	SMD	.063W	5%	2R7 Ω
R4596	ERJ2GEJ2R7X	SMD	.063W	5%	2R7 Ω
R4597	ERJ2GEJ2R7X	SMD	.063W	5%	2R7 Ω
R4598	ERJ2GEJ2R7X	SMD	.063W	5%	2R7 Ω
R4599	ERJ2GEJ2R7X	SMD	.063W	5%	2R7 Ω
R4600	ERJ2GEJ2R7X	SMD	.063W	5%	2R7 Ω
R4601	ERJ2GEJ2R7X	SMD	.063W	5%	2R7 Ω
R4602	ERJ2GEJ2R7X	SMD	.063W	5%	2R7 Ω
R4603	ERJ2GEJ2R7X	SMD	.063W	5%	2R7 Ω
R4604	ERJ2GEJ2R7X	SMD	.063W	5%	2R7 Ω
R4605	ERJ2GEJ103X	SMD	.063W	5%	10K Ω
R4606	ERJ2GEJ103X	SMD	.063W	5%	10K Ω
R4607	ERJ2GEJ220X	SMD	.063W	5%	22 Ω
R4609	ERJ2GEJ103X	SMD	.063W	5%	10K Ω
R4610	ERJ2GEJ103X	SMD	.063W	5%	10K Ω
R4612	ERJ2GEJ472X	SMD	.063W	5%	4K7 Ω
R4613	ERJ2GEJ472X	SMD	.063W	5%	4K7 Ω
R4617	ERJ2GEJ472X	SMD	.063W	5%	4K7 Ω
R4618	ERJ2GEJ472X	SMD	.063W	5%	4K7 Ω
R4619	ERJ2GEJ473X	SMD	.063W	5%	47K Ω
R4620	ERJ2GEJ560X	SMD	.063W	5%	56 Ω
R4621	ERJ2GEJ473X	SMD	.063W	5%	47K Ω
R4622	ERJ2GEJ560X	SMD	.063W	5%	56 Ω
R4624	ERJ2GEJ560X	SMD	.063W	5%	56 Ω
R4625	ERJ2GEJ103X	SMD	.063W	5%	10K Ω
R4626	ERJ2GEJ560X	SMD	.063W	5%	56 Ω
R4628	ERJ2GEJ103X	SMD	.063W	5%	10K Ω
R4629	ERJ2GEJ472X	SMD	.063W	5%	4K7 Ω
R4630	ERJ2GEJ472X	SMD	.063W	5%	4K7 Ω
R4631	ERJ2GEJ472X	SMD	.063W	5%	4K7 Ω
R4632	ERJ2GEJ472X	SMD	.063W	5%	4K7 Ω
R4633	ERJ2GEJ220X	SMD	.063W	5%	22 Ω

Cct Ref	Parts Number	Description			
R4634	ERJ2GEJ220X	SMD	.063W	5%	22 Ω
R4636	ERJ2GEJ103X	SMD	.063W	5%	10K Ω
R4637	ERJ2GEJ330X	SMD	.063W	5%	33 Ω
R4639	ERJ2GEJ103X	SMD	.063W	5%	10K Ω
R4640	ERJ2GEJ220X	SMD	.063W	5%	22 Ω
R4641	EXB28V330JX	SMD	.031W	5%	33 Ω
R4642	ERJ2GEJ220X	SMD	.063W	5%	22 Ω
R4643	ERJ2GEJ220X	SMD	.063W	5%	22 Ω
R4644	ERJ2GEJ220X	SMD	.063W	5%	22 Ω
R4645	ERJ2GEJ220X	SMD	.063W	5%	22 Ω
R4647	ERJ2GEJ220X	SMD	.063W	5%	22 Ω
R4648	ERJ2GEJ330X	SMD	.063W	5%	33 Ω
R4655	ERJ2GEJ330X	SMD	.063W	5%	33 Ω
R4657	ERJ2GEJ182X	SMD	.063W	5%	1K8 Ω
R4658	ERJ2GEJ220X	SMD	.063W	5%	22 Ω
R4661	ERJ2GEJ472X	SMD	.063W	5%	4K7 Ω
R4662	ERJ2GEJ220X	SMD	.063W	5%	22 Ω
R4665	EXB2HV470JV	SMD	.063W	5%	47 Ω
R4667	EXB2HV470JV	SMD	.063W	5%	47 Ω
R4668	ERJ2GEJ330X	SMD	.063W	5%	33 Ω
R4669	EXB2HV470JV	SMD	.063W	5%	47 Ω
R4672	ERJ2GEJ103X	SMD	.063W	5%	10K Ω
R4673	ERJ2GEJ103X	SMD	.063W	5%	10K Ω
R4675	ERJ3EKF3302V	SMD	0.1W	1%	33K Ω
R4677	ERJ3EKF3302V	SMD	0.1W	1%	33K Ω
R4679	ERJ3EKF2202V	SMD	0.1W	1%	22K Ω
R4680	ERJ3EKF2202V	SMD	0.1W	1%	22K Ω
R4681	ERJ3EKF6192V	SMD	0.1W	1%	61K9 Ω
R4682	ERJ3EKF6192V	SMD	0.1W	1%	61K9 Ω
R4701	ERJ2GEJ680X	SMD	.063W	5%	68 Ω
R4706	ERJ2GE0R00X	SMD	.063W	-	0 Ω
R4708	ERJ2GEJ680X	SMD	.063W	5%	68 Ω
R4709	ERJ2GEJ680X	SMD	.063W	5%	68 Ω
R4711	ERJ2GEJ562X	SMD	.063W	5%	5K6 Ω
R4712	ERJ2GE0R00X	SMD	.063W	-	0 Ω
R4715	ERJ2GE0R00X	SMD	.063W	-	0 Ω
R4718	ERJ2GEJ680X	SMD	.063W	5%	68 Ω
R4719	ERJ2GEJ680X	SMD	.063W	5%	68 Ω
R4720	ERJ2GEJ680X	SMD	.063W	5%	68 Ω
R4727	ERJ2GE0R00X	SMD	.063W	-	0 Ω
R4728	ERJ2GE0R00X	SMD	.063W	-	0 Ω
R4729	ERJ3EKF1500V	SMD	0.1W	1%	150 Ω
R4730	ERJ3EKF4701V	SMD	0.1W	1%	4K7 Ω
R4731	ERJ3EKF1001V	SMD	0.1W	1%	1K Ω
R4732	ERJ3EKF4751V	SMD	0.1W	1%	4K75 Ω
R4733	ERJ3EKF75R0V	SMD	0.1W	1%	75 Ω
R4734	ERJ2GEJ823X	SMD	.063W	5%	82K Ω
R4735	ERJ3EKF2001V	SMD	0.1W	1%	2K Ω
R4736	ERJ2GE0R00X	SMD	.063W	-	0 Ω
R4739	ERJ2GEJ220X	SMD	.063W	5%	22 Ω
R4742	ERJ2GEJ472X	SMD	.063W	5%	4K7 Ω
R4746	ERJ2GEJ680X	SMD	.063W	5%	68 Ω
R4749	EXB2HV680JV	SMD	.063W	5%	68 Ω
R4750	EXB2HV680JV	SMD	.063W	5%	68 Ω
R4751	ERJ2GEJ220X	SMD	.063W	5%	22 Ω
R4752	ERJ2GEJ220X	SMD	.063W	5%	22 Ω
R4753	ERJ2GEJ220X	SMD	.063W	5%	22 Ω
R4756	ERJ2GEJ680X	SMD	.063W	5%	68 Ω
R4757	ERJ2GEJ680X	SMD	.063W	5%	68 Ω
R4758	ERJ2GEJ680X	SMD	.063W	5%	68 Ω
R4759	ERJ2GEJ680X	SMD	.063W	5%	68 Ω
R4762	EXB2HV680JV	SMD	.063W	5%	68 Ω
R4763	ERJ2GE0R00X	SMD	.063W	-	0 Ω
R4764	ERJ2GE0R00X	SMD	.063W	-	0 Ω
R4765	ERJ2GE0R00X	SMD	.063W	-	0 Ω
R4772	EXB2HV470JV	SMD	.063W	5%	47 Ω
R4773	ERJ2GEJ470X	SMD	.063W	5%	47 Ω
R4774	EXB2HV470JV	SMD	.063W	5%	47 Ω

Cct Ref	Parts Number	Description			
R4775	ERJ2GEJ470X	SMD	.063W	5%	47 Ω
R4776	EXB2HV470JV	SMD	.063W	5%	47 Ω
R4777	ERJ2GEJ470X	SMD	.063W	5%	47 Ω
R4778	EXB2HV470JV	SMD	.063W	5%	47 Ω
R4779	ERJ2GEJ470X	SMD	.063W	5%	47 Ω
R4782	ERJ2GEJ220X	SMD	.063W	5%	22 Ω
R4783	ERJ2GEJ472X	SMD	.063W	5%	4K7 Ω
R4784	ERJ2GEJ220X	SMD	.063W	5%	22 Ω
R4785	ERJ2GEJ472X	SMD	.063W	5%	4K7 Ω
R4786	ERJ2GEJ220X	SMD	.063W	5%	22 Ω
R4787	ERJ2GEJ220X	SMD	.063W	5%	22 Ω
R4788	EXB2HV470JV	SMD	.063W	5%	47 Ω
R4789	ERJ2GEJ101X	SMD	.063W	5%	100 Ω
R4791	ERJ2GEJ470X	SMD	.063W	5%	47 Ω
R4792	ERJ2GEJ470X	SMD	.063W	5%	47 Ω
R4793	ERJ2GEJ220X	SMD	.063W	5%	22 Ω
R4794	ERJ2GEJ220X	SMD	.063W	5%	22 Ω
R4796	EXB2HV470JV	SMD	.063W	5%	47 Ω
R4804	ERJ2GEJ101X	SMD	.063W	5%	100 Ω
R4805	ERJ3EKF1001V	SMD	0.1W	1%	1K Ω
R4806	ERJ3EKF1001V	SMD	0.1W	1%	1K Ω
R4807	ERJ2GE0R00X	SMD	.063W	-	0 Ω
R4808	ERJ2GE0R00X	SMD	.063W	-	0 Ω
R4809	ERJ2GE0R00X	SMD	.063W	-	0 Ω
R4810	ERJ2GE0R00X	SMD	.063W	-	0 Ω
R4811	ERJ2GE0R00X	SMD	.063W	-	0 Ω
R4830	ERJ2GE0R00X	SMD	.063W	-	0 Ω
R4831	ERJ2GE0R00X	SMD	.063W	-	0 Ω
R4837	ERJ2GE0R00X	SMD	.063W	-	0 Ω
R4838	ERJ2GEJ112X	SMD	.063W	5%	1K1 Ω
R4898	ERJ3GEY0R00	SMD	0.1W	-	0 Ω
R4899	ERJ2GEJ103X	SMD	.063W	5%	10K Ω
R4900	ERJ2GEJ103X	SMD	.063W	5%	10K Ω
R4901	ERJ2GEJ103X	SMD	.063W	5%	10K Ω
R4902	ERJ2GEJ103X	SMD	.063W	5%	10K Ω
R4903	EXB2HV103JV	SMD	.063W	5%	10K Ω
R4904	EXB2HV103JV	SMD	.063W	5%	10K Ω
R4905	ERJ2GEJ103X	SMD	.063W	5%	10K Ω
R4906	ERJ2GEJ103X	SMD	.063W	5%	10K Ω
R4909	ERJ3GEY0R00	SMD	0.1W	-	0 Ω
R4910	ERJ3GEY0R00	SMD	0.1W	-	0 Ω
R4919	ERJ2GEJ102X	SMD	.063W	5%	1K Ω
R4920	ERJ2GEJ103X	SMD	.063W	5%	10K Ω
R4921	ERJ2GEJ103X	SMD	.063W	5%	10K Ω
R4922	ERJ2GEJ103X	SMD	.063W	5%	10K Ω
R4923	ERJ2GEJ103X	SMD	.063W	5%	10K Ω
R4924	ERJ6ENF6041	SMD	.125W	1%	6K04 Ω
R4925	ERJ3EKF1001V	SMD	0.1W	1%	1K Ω
R4926	ERJ3EKF3901V	SMD	0.1W	1%	3K9 Ω
R4928	ERJ2GE0R00X	SMD	.063W	-	0 Ω
R4929	ERJ2GEJ680X	SMD	.063W	5%	68 Ω
R4939	ERJ2GEJ101X	SMD	.063W	5%	100 Ω
R4940	ERJ2GEJ101X	SMD	.063W	5%	100 Ω
R4941	ERJ3GEY0R00	SMD	0.1W	-	0 Ω
R4943	ERJ2GEJ103X	SMD	.063W	5%	10K Ω
R4944	ERJ2GE0R00X	SMD	.063W	-	0 Ω
R4945	ERJ2GEJ184X	SMD	.063W	5%	180K Ω
R4948	ERJ3GEY0R00	SMD	0.1W	-	0 Ω
R4949	ERJ3GEY0R00	SMD	0.1W	-	0 Ω
R4950	ERJ3GEY0R00	SMD	0.1W	-	0 Ω
R4951	ERJ3GEY0R00	SMD	0.1W	-	0 Ω
R4952	ERJ2GE0R00X	SMD	.063W	-	0 Ω
R4953	ERJ2GE0R00X	SMD	.063W	-	0 Ω
R4954	ERJ2GE0R00X	SMD	.063W	-	0 Ω
R4955	ERJ3GEY0R00	SMD	0.1W	-	0 Ω
R4993	ERJ3GEY0R00	SMD	0.1W	-	0 Ω
R4995	ERJ3GEY0R00	SMD	0.1W	-	0 Ω
R4997	ERJ3GEY0R00	SMD	0.1W	-	0 Ω

Cct Ref	Parts Number	Description			
R6702	ERJ3GEY0R00	SMD	0.1W	-	0 Ω
R6703	ERJ6GEY0R00	S.M.CARB	0.1W	-	0 Ω
R6707	ERJ3GEYJ101	SMD	0.1W	5%	100 Ω
R6715	ERJ6GEYJ220	S.M.CARB	0.1W	5%	22 Ω
R6716	ERJ3GEYJ473V	S.M.CARB	0.1W	5%	47K Ω
R6717	ERJ3GEYJ473V	S.M.CARB	0.1W	5%	47K Ω
R6718	ERJ3GEYJ101	SMD	0.1W	5%	100 Ω
R6719	ERJ3GEYJ101	SMD	0.1W	5%	100 Ω
R6720	ERJ3GEYJ101	SMD	0.1W	5%	100 Ω
R6721	ERJ3GEY0R00	SMD	0.1W	-	0 Ω
R6722	ERJ3GEYJ101	SMD	0.1W	5%	100 Ω
R6723	ERJ3GEYJ101	SMD	0.1W	5%	100 Ω
R6732	ERJ3GEY0R00	SMD	0.1W	-	0 Ω
R6734	ERJ3GEYJ470	SMD	0.1W	5%	47 Ω
R6736	ERJ3GEYJ103	SMD	0.1W	5%	10K Ω
R6742	ERJ6GEYJ820	S.M.CARB	0.1W	5%	82 Ω
R6743	ERJ6GEYJ562	S.M.CARB	0.1W	5%	5K6 Ω
R6745	ERJ3GEYJ103	SMD	0.1W	5%	10K Ω
R6747	ERJ6GEYJ223	S.M.CARB	0.1W	5%	22K Ω
R6748	ERJ3GEYJ101	SMD	0.1W	5%	100 Ω
R6749	ERJ3GEYJ103	SMD	0.1W	5%	10K Ω
R6755	ERJ6GEY0R00	S.M.CARB	0.1W	-	0 Ω
R6756	ERJ6GEYJ470	S.M.CARB	0.1W	5%	47 Ω
R6757	ERJ6GEYJ470	S.M.CARB	0.1W	5%	47 Ω
R6758	ERJ6GEYJ470	S.M.CARB	0.1W	5%	47 Ω
R6759	ERJ6GEYJ470	S.M.CARB	0.1W	5%	47 Ω
R6765	ERJ3GEY0R00	SMD	0.1W	-	0 Ω
R6766	ERJ3GEY0R00	SMD	0.1W	-	0 Ω
R6767	ERJ3GEY0R00	SMD	0.1W	-	0 Ω
R6768	ERJ3GEY0R00	SMD	0.1W	-	0 Ω
R6770	ERJ3GEY0R00	SMD	0.1W	-	0 Ω
R6780	ERJ3GEY0R00	SMD	0.1W	-	0 Ω
R6781	ERJ3GEY0R00	SMD	0.1W	-	0 Ω
R6782	ERJ3GEY0R00	SMD	0.1W	-	0 Ω
R6783	ERJ3GEY0R00	SMD	0.1W	-	0 Ω
R6785	ERJ3GEYJ103	SMD	0.1W	5%	10K Ω
R6786	ERJ3GEYJ103	SMD	0.1W	5%	10K Ω
R6788	ERJ3EKF75R0V	SMD	0.1W	1%	75 Ω
R6789	ERJ3GEY0R00	SMD	0.1W	-	0 Ω
R6790	ERJ3GEY0R00	SMD	0.1W	-	0 Ω
R6791	ERJ3GEY0R00	SMD	0.1W	-	0 Ω
R6792	ERJ3GEY0R00	SMD	0.1W	-	0 Ω
R6793	ERJ3GEYJ473V	S.M.CARB	0.1W	5%	47K Ω
R6794	ERJ3GEYJ103	SMD	0.1W	5%	10K Ω
R6795	ERJ3GEYJ103	SMD	0.1W	5%	10K Ω
R6796	ERJ3GEYJ103	SMD	0.1W	5%	10K Ω
R6797	ERJ3GEYJ103	SMD	0.1W	5%	10K Ω
R6798	ERJ3GEYJ103	SMD	0.1W	5%	10K Ω
R6799	ERJ3GEYJ103	SMD	0.1W	5%	10K Ω
R7002	ERG1SJ471	METAL	0.5W	5%	470 Ω
R7004	D0XB106J0003	LEADED	1W	5%	10M Ω
R7102	ERJ6GEY0R00	S.M.CARB	0.1W	-	0 Ω
R7105	ERJ14YJ101U	SMD	0.25W	5%	100 Ω
R7214	ERJ6GEYJ103	S.M.CARB	0.1W	5%	10K Ω
R7215	ERJ6GEYJ472	S.M.CARB	0.1W	5%	4K7 Ω
R7216	ERJ6GEYJ472	S.M.CARB	0.1W	5%	4K7 Ω
R7217	ERJ6GEYJ103	S.M.CARB	0.1W	5%	10K Ω
R7218	ERJ6GEYJ103	S.M.CARB	0.1W	5%	10K Ω
R7219	ERJ6GEYJ472	S.M.CARB	0.1W	5%	4K7 Ω
R7220	ERDS2TJ221T	CARBON	0.5W	5%	220 Ω
R7221	ERD25TJ331	CARBON	0.25W	5%	330 Ω
R7223	ERJ6GEYJ122	S.M.CARB	0.1W	5%	1K2 Ω
R7224	ERJ6GEYJ302	S.M.CARB	0.1W	5%	3K Ω
R7225	ERJ6GEYJ473	S.M.CARB	0.1W	5%	47K Ω
R7226	ERJ6GEYJ472	S.M.CARB	0.1W	5%	4K7 Ω
R7227	ERJ6GEYJ103	S.M.CARB	0.1W	5%	10K Ω
R7228	ERJ6GEYJ473	S.M.CARB	0.1W	5%	47K Ω
R7229	ERJ6GEYJ473	S.M.CARB	0.1W	5%	47K Ω

Cct Ref	Parts Number	Description				
R7230	ERJ6GEYJ472	S.M.CARB	0.1W	5%	4K7 Ω	
R7231	ERJ6GEYJ472	S.M.CARB	0.1W	5%	4K7 Ω	
R7232	ERJ6GEYJ472	S.M.CARB	0.1W	5%	4K7 Ω	
R7233	ERD25TJ102	CARBON	0.25W	5%	1K Ω	
R7234	ERJ6GEYJ473	S.M.CARB	0.1W	5%	47K Ω	
R7235	ERJ6GEYJ473	S.M.CARB	0.1W	5%	47K Ω	
R7236	ERJ6GEYJ472	S.M.CARB	0.1W	5%	4K7 Ω	
R7237	ERJ6GEYJ472	S.M.CARB	0.1W	5%	4K7 Ω	
R7238	ERJ6GEYJ473	S.M.CARB	0.1W	5%	47K Ω	
R7239	ERJ6GEYJ223	S.M.CARB	0.1W	5%	22K Ω	
R7240	ERDS2TJ241T	CARBON	0.25W	5%	240 Ω	
R7241	ERDS2TJ241T	CARBON	0.25W	5%	240 Ω	
R7242	ERDS2TJ241T	CARBON	0.25W	5%	240 Ω	
R7245	ERJ6GEYJ103	S.M.CARB	0.1W	5%	10K Ω	
R7246	ERJ6GEYJ223	S.M.CARB	0.1W	5%	22K Ω	
R7247	ERJ14YJ222U	SMD	0.25W	5%	2K2 Ω	
R7249	ERJ6GEYJ222	S.M.CARB	0.1W	5%	2K2 Ω	
R7250	ERJ6GEYJ152	S.M.CARB	0.1W	5%	1K5 Ω	
R7251	ERJ14YJ222U	SMD	0.25W	5%	2K2 Ω	
R7252	ERJ6GEYJ223	S.M.CARB	0.1W	5%	22K Ω	
R7253	ERJ6GEYJ472	S.M.CARB	0.1W	5%	4K7 Ω	
R7254	ERJ6GEYJ473	S.M.CARB	0.1W	5%	47K Ω	
R7255	ERJ14YJ332U	SMD	0.25W	5%	3K3 Ω	
R7256	ERJ6GEY0R00	S.M.CARB	0.1W	-	0 Ω	
R7257	ERJ6GEY0R00	S.M.CARB	0.1W	-	0 Ω	
R7258	ERJ14YJ332U	SMD	0.25W	5%	3K3 Ω	
R7259	ERJ6GEYJ223	S.M.CARB	0.1W	5%	22K Ω	
R7260	ERJ6GEYJ223	S.M.CARB	0.1W	5%	22K Ω	
R7261	ERJ6GEY0R00	S.M.CARB	0.1W	-	0 Ω	
R7262	ERJ6GEYJ472	S.M.CARB	0.1W	5%	4K7 Ω	
R7263	ERJ6GEYJ473	S.M.CARB	0.1W	5%	47K Ω	
R7264	ERJ6ENF1002	SMD	0.125	1%	10K Ω	
R7266	ERJ6ENF2702V	SMD	.125W	1%	27K Ω	
R7267	ERD25TJ103	CARBON	0.25W	5%	10K Ω	
R7268	ERJ6GEYJ472	S.M.CARB	0.1W	5%	4K7 Ω	
R7269	ERJ6GEYJ223	S.M.CARB	0.1W	5%	22K Ω	
R7270	ERJ6GEYJ223	S.M.CARB	0.1W	5%	22K Ω	
R7271	ERJ6GEYJ103	S.M.CARB	0.1W	5%	10K Ω	
R7272	ERJ6GEYJ103	S.M.CARB	0.1W	5%	10K Ω	
R7273	ERJ6GEYJ472	S.M.CARB	0.1W	5%	4K7 Ω	
R7275	ERJ6GEYJ103	S.M.CARB	0.1W	5%	10K Ω	
R7276	ERJ6GEYJ103	S.M.CARB	0.1W	5%	10K Ω	
R7301	ERJ6ENF5902V	SMD	.125W	1%	59K Ω	
R7302	ERJ6ENF1002	SMD	0.125	1%	10K Ω	
R7303	ERJ6GEYJ103	S.M.CARB	0.1W	5%	10K Ω	
R7304	ERJ6ENF1002	SMD	0.125	1%	10K Ω	
R7305	ERJ6ENF5902V	SMD	.125W	1%	59K Ω	
R7306	ERJ6ENF5902V	SMD	.125W	1%	59K Ω	
R7307	ERJ6ENF7151	SMD	.125W	1%	7K15 Ω	
R7308	ERJ6GEYJ103	S.M.CARB	0.1W	5%	10K Ω	
R7309	ERJ6ENF7151	SMD	.125W	1%	7K15 Ω	
R7310	ERJ6ENF5902V	SMD	.125W	1%	59K Ω	
R7311	ERJ6ENF1622V	SMD	.125W	1%	16K2 Ω	
R7312	ERJ6ENF1002	SMD	0.125	1%	10K Ω	
R7313	ERJ6ENF1432V	SMD	.125W	1%	14K3 Ω	
R7314	ERJ6ENF1002	SMD	0.125	1%	10K Ω	
R7315	ERJ6GEYJ103	S.M.CARB	0.1W	5%	10K Ω	
R7317	ERJ6GEYJ563	S.M.CARB	0.1W	5%	56K Ω	
R7318	ERJ6ENF1001	S.M.CARB	0.1W	1%	1K Ω	
R7319	ERJ6GEYJ103	S.M.CARB	0.1W	5%	10K Ω	
R7321	ERJ6GEYJ272	S.M.CARB	0.1W	5%	2K7 Ω	
R7322	ERJ6GEYJ100	S.M.CARB	0.1W	5%	10 Ω	
R7323	ERJ6GEYJ100	S.M.CARB	0.1W	5%	10 Ω	
R7324	ERJ6ENF1001	S.M.CARB	0.1W	1%	1K Ω	
R7325	ERJ6ENF4121	SMD	.125W	1%	4K12 Ω	
R7326	ERJ6ENF8201	S.M.CARB	0.1W	1%	8K2 Ω	
R7327	ERDS1TJ1R8V	FILM	0.5W	5%	1R8 Ω	
R7328	ERX2SJR82P	METAL	2W	5%	R82 Ω	

Cct Ref	Parts Number	Description				
R7329	ERJ6GEYJ6R8V	SMD	.125W	5%	6R8 Ω	
R7330	ERJ6GEYJ223	S.M.CARB	0.1W	5%	22K Ω	
R7331	ERJ6GEYJ6R8V	SMD	.125W	5%	6R8 Ω	
R7332	ERDS2TJ472T	CARBON	0.25W	5%	4K7 Ω	
R7335	ERJ6GEY0R00	S.M.CARB	0.1W	-	0 Ω	
R7336	ERJ6ENF2202	SMD	.125W	1%	22K Ω	
R7337	ERJ6GEYJ221	S.M.CARB	0.1W	5%	220 Ω	
R7338	ERJ6GEYJ221	S.M.CARB	0.1W	5%	220 Ω	
R7339	ERJ6GEYJ240	S.M.CARB	0.1W	5%	24 Ω	
R7340	ERJ6GEYJ240	S.M.CARB	0.1W	5%	24 Ω	
R7403	ERJ6GEY0R00	S.M.CARB	0.1W	-	0 Ω	
R7404	ERJ6GEYJ223	S.M.CARB	0.1W	5%	22K Ω	
R7405	ERJ6GEYJ223	S.M.CARB	0.1W	5%	22K Ω	
R7406	ERJ6ENF5902V	SMD	.125W	1%	59K Ω	
R7407	ERJ6ENF1002	SMD	0.125	1%	10K Ω	
R7408	ERJ6GEYJ103	S.M.CARB	0.1W	5%	10K Ω	
R7409	ERJ6ENF1002	SMD	0.125	1%	10K Ω	
R7410	ERJ6ENF5902V	SMD	.125W	1%	59K Ω	
R7411	ERJ6ENF5902V	SMD	.125W	1%	59K Ω	
R7412	ERJ6ENF7151	SMD	.125W	1%	7K15 Ω	
R7413	ERJ6GEYJ103	S.M.CARB	0.1W	5%	10K Ω	
R7414	ERJ6ENF7151	SMD	.125W	1%	7K15 Ω	
R7415	ERJ6ENF5902V	SMD	.125W	1%	59K Ω	
R7416	ERJ6ENF1782V	SMD	.125W	1%	17K8 Ω	
R7417	ERJ6ENF1002	SMD	0.125	1%	10K Ω	
R7418	ERJ6ENF1102V	SMD	.125W	1%	11K Ω	
R7419	ERJ6ENF1002	SMD	0.125	1%	10K Ω	
R7420	ERJ6ENF2202	SMD	.125W	1%	22K Ω	
R7421	ERJ6GEYJ103	S.M.CARB	0.1W	5%	10K Ω	
R7423	ERJ6GEYJ563	S.M.CARB	0.1W	5%	56K Ω	
R7424	ERJ6ENF1001	S.M.CARB	0.1W	1%	1K Ω	
R7425	ERJ6GEYJ103	S.M.CARB	0.1W	5%	10K Ω	
R7427	ERJ6GEYJ222	S.M.CARB	0.1W	5%	2K2 Ω	
R7428	ERJ6GEYJ100	S.M.CARB	0.1W	5%	10 Ω	
R7429	ERJ6GEYJ100	S.M.CARB	0.1W	5%	10 Ω	
R7430	ERJ6ENF1001	S.M.CARB	0.1W	1%	1K Ω	
R7431	ERJ6ENF2371V	SMD	.125W	1%	2K37 Ω	
R7432	ERJ6ENF1782V	SMD	.125W	1%	17K8 Ω	
R7433	ERDS1TJ1R8V	FILM	0.5W	5%	1R8 Ω	
R7434	ERX2SJR47	METAL	2W	5%	R47 Ω	
R7435	ERJ6GEYJ223	S.M.CARB	0.1W	5%	22K Ω	
R7436	ERJ6GEYJ223	S.M.CARB	0.1W	5%	22K Ω	
R7437	ERDS2TJ472T	CARBON	0.25W	5%	4K7 Ω	
R7438	ERDS2TJ104T	CARBON	2W	5%	100K Ω	
R7439	ERDS2TJ223T	CARBON	0.25W	5%	22K Ω	
R7440	ERDS2TJ223T	CARBON	0.25W	5%	22K Ω	
R7441	ERJ6GEYJ221	S.M.CARB	0.1W	5%	220 Ω	
R7442	ERJ6GEYJ221	S.M.CARB	0.1W	5%	220 Ω	
R7443	ERJ6GEYJ6R8V	SMD	.125W	5%	6R8 Ω	
R7444	ERJ6GEYJ6R8V	SMD	.125W	5%	6R8 Ω	
R7445	ERJ6GEYJ223	S.M.CARB	0.1W	5%	22K Ω	
R7446	ERJ6GEYJ103	S.M.CARB	0.1W	5%	10K Ω	
R7447	ERJ6GEYJ103	S.M.CARB	0.1W	5%	10K Ω	
R7448	ERJ6GEYJ240	S.M.CARB	0.1W	5%	24 Ω	
R7449	ERJ6GEYJ240	S.M.CARB	0.1W	5%	24 Ω	
R7501	ERJ6GEYJ223	S.M.CARB	0.1W	5%	22K Ω	
R7502	ERJ6GEYJ223	S.M.CARB	0.1W	5%	22K Ω	
R7503	ERJ6GEYJ222	S.M.CARB	0.1W	5%	2K2 Ω	
R7504	ERJ6GEYJ223	S.M.CARB	0.1W	5%	22K Ω	
R7505	ERJ6GEYJ103	S.M.CARB	0.1W	5%	10K Ω	
R7506	ERJ6GEYJ473	S.M.CARB	0.1W	5%	47K Ω	
R7507	ERJ6GEYJ222	S.M.CARB	0.1W	5%	2K2 Ω	
R7508	ERJ6GEYJ473	S.M.CARB	0.1W	5%	47K Ω	
R7509	ERJ6GEYJ473	S.M.CARB	0.1W	5%	47K Ω	
R7510	ERJ6GEYJ473	S.M.CARB	0.1W	5%	47K Ω	
R7511	ERJ6GEYJ472	S.M.CARB	0.1W	5%	4K7 Ω	
R7512	ERJ6GEYJ103	S.M.CARB	0.1W	5%	10K Ω	
R7513	ERJ6GEYJ103	S.M.CARB	0.1W	5%	10K Ω	

Cct Ref	Parts Number	Description			
R7514	ERJ6GEYJ103	S.M.CARB	0.1W	5%	10K Ω
R7515	ERJ6GEYJ472	S.M.CARB	0.1W	5%	4K7 Ω
R7518	ERJ6GEYJ472	S.M.CARB	0.1W	5%	4K7 Ω
R7519	ERJ6GEYJ472	S.M.CARB	0.1W	5%	4K7 Ω
R7602	ERG1S330P	METAL	1W	5%	33 Ω
R7603	ERJ6GEYJ104	S.M.CARB	0.1W	5%	100K Ω
R7701	ERD25TJ103	CARBON	0.25W	5%	10K Ω
R7702	ERDS2TJ472T	CARBON	0.25W	5%	4K7 Ω
R7703	ERD25TJ103	CARBON	0.25W	5%	10K Ω
R7704	ERJ6GEYJ473	S.M.CARB	0.1W	5%	47K Ω
R7705	ERJ6GEYJ223	S.M.CARB	0.1W	5%	22K Ω
R7706	ERJ6GEYJ103	S.M.CARB	0.1W	5%	10K Ω
R7708	ERJ6ENF1001	S.M.CARB	0.1W	1%	1K Ω
R7709	ERJ6ENF8661V	SMD	.125W	1%	8K66 Ω
R7710	ERJ6GEYJ102	S.M.CARB	0.1W	5%	1K Ω
R7711	ERJ12YJ471U	SMD	0.5W	5%	470 Ω
R7713	ERD25TJ103	CARBON	0.25W	5%	10K Ω
R7714	ERDS2TJ472T	CARBON	0.25W	5%	4K7 Ω
R7953	ERJ6GEY0R00	S.M.CARB	0.1W	-	0 Ω
R7955	ERJ6GEY0R00	S.M.CARB	0.1W	-	0 Ω

CAPACITORS

C1004	ECJ1VF1C104Z	S.M.CAP	16V		100nF
C1005	F2G1C220A022	ELECT	16V		22μF
C1006	ECJ1VF1C104Z	S.M.CAP	16V		100nF
C1007	F2G1C220A022	ELECT	16V		22μF
C1008	F2G0J101A019	ELECT	6.3V		100μF
C1009	F1H0J2250008	CERAMIC	6.3V		2200nF
C1010	ECJ1VF1C104Z	S.M.CAP	16V		100nF
C1100	ECJ0EB1A104K	S.M.CAP	10V		100nF
C1102	ECJ0EB1A104K	S.M.CAP	10V		100nF
C1103	ECJ0EB1E271K	CERAMIC	25V		270pF
C1105	ECJ0EB1E271K	CERAMIC	25V		270pF
C1106	ECJ1VB1A105K	S.M.CAP	10V		1000nF
C1107	F2G0G101A007	ELECT	4V		100μF
C1108	F2G0G101A007	ELECT	4V		100μF
C1109	ECJ0EB1A104K	S.M.CAP	10V		100nF
C1110	ECJ0EB1A104K	S.M.CAP	10V		100nF
C1111	ECJ0EB1A104K	S.M.CAP	10V		100nF
C1112	ECJ0EB1E271K	CERAMIC	25V		270pF
C1114	ECJ0EB1A104K	S.M.CAP	10V		100nF
C1116	ECJ0EB1A104K	S.M.CAP	10V		100nF
C1118	ECJ0EB1A104K	S.M.CAP	10V		100nF
C1119	ECJ0EB1A104K	S.M.CAP	10V		100nF
C1120	ECJ0EB1A104K	S.M.CAP	10V		100nF
C1121	ECJ0EB1A104K	S.M.CAP	10V		100nF
C1122	ECJ0EB1A104K	S.M.CAP	10V		100nF
C1123	ECJ0EB1A104K	S.M.CAP	10V		100nF
C1125	ECJ0EB1A104K	S.M.CAP	10V		100nF
C1127	ECJ0EB1A104K	S.M.CAP	10V		100nF
C1128	ECJ0EB1A104K	S.M.CAP	10V		100nF
C1129	ECJ0EB1A104K	S.M.CAP	10V		100nF
C1130	ECJ0EB1A104K	S.M.CAP	10V		100nF
C1131	ECJ0EB1A104K	S.M.CAP	10V		100nF
C1132	ECJ0EB1A104K	S.M.CAP	10V		100nF
C1133	ECJ1VC1H150	S.M.CAP	50V		15pF
C1134	ECJ1VC1H150	S.M.CAP	50V		15pF
C1135	ECJ0EB1A104K	S.M.CAP	10V		100nF
C1136	ECJ0EB1A104K	S.M.CAP	10V		100nF
C1137	ECJ0EB1A104K	S.M.CAP	10V		100nF
C1138	ECJ0EB1A104K	S.M.CAP	10V		100nF
C1139	ECJ0EB1A104K	S.M.CAP	10V		100nF
C1140	ECJ0EB1A104K	S.M.CAP	10V		100nF
C1141	ECJ0EB1A104K	S.M.CAP	10V		100nF
C1142	ECJ0EB1A104K	S.M.CAP	10V		100nF
C1144	ECJ0EB1A104K	S.M.CAP	10V		100nF
C1145	ECJ0EB1A104K	S.M.CAP	10V		100nF
C1146	ECJ0EB1A104K	S.M.CAP	10V		100nF

Cct Ref	Parts Number	Description			
C1147	ECJ0EB1A104K	S.M.CAP	10V		100nF
C1148	ECJ0EB1A104K	S.M.CAP	10V		100nF
C1149	ECJ0EB1A104K	S.M.CAP	10V		100nF
C1150	ECJ0EB1A104K	S.M.CAP	10V		100nF
C1154	ECJ0EB1A104K	S.M.CAP	10V		100nF
C1155	ECJ0EB1C103K	S.M.CAP	16V		10nF
C1156	ECJ1VC1H220J	S.M.CAP	50V		22pF
C1157	ECJ1VC1H220J	S.M.CAP	50V		22pF
C1158	F1J0J1060004	CERAMIC	6.3V		10μF
C1159	ECJ0EB1A104K	S.M.CAP	10V		100nF
C1162	ECJ0EB1C103K	S.M.CAP	16V		10nF
C1163	ECJ0EB1H101K	S.M.CAP	50V		100pF
C1180	ECJ1VB1H221K	S.M.CAP	50V		220pF
C1181	ECJ1VB1H221K	S.M.CAP	50V		220pF
C1186	ECJ0EB1A104K	S.M.CAP	10V		100nF
C1189	ECJ0EB1A104K	S.M.CAP	10V		100nF
C1190	ECJ0EB1C103K	S.M.CAP	16V		10nF
C1199	ECJ1VC1H101J	S.M.CAP	50V		100pF
C1200	ECJ3YB1C105K	S.M.CAP	16V		1000nF
C1201	ECJ1VB1C105K	SMD	16V		1000nF
C1202	EEH0G101R	ELECT	4V		100μF
C1203	ECJ1VB1H103	S.M.CAP	50V		10nF
C1204	ECJ1VB1H103	S.M.CAP	50V		10nF
C1205	ECJ2FB1C474K	S.M.CAP	16V		470nF
C1206	ECJ2FB1C474K	S.M.CAP	16V		470nF
C1207	ECJ1VB1C563K	S.M.CAP	16V		56nF
C1208	ECJ1VB1C104K	S.M.CAP	16V		100nF
C1209	ECJ1VB1A105K	S.M.CAP	10V		1000nF
C1211	ECJ0EB1A104K	S.M.CAP	10V		100nF
C1212	F2G0G101A007	ELECT	4V		100μF
C1213	ECJ1VB1A105K	S.M.CAP	10V		1000nF
C1214	ECJ1VB1H103	S.M.CAP	50V		10nF
C1215	ECJ1VB1A105K	S.M.CAP	10V		1000nF
C1216	ECJ0EB1A104K	S.M.CAP	10V		100nF
C1219	F2J1C100A024	ELECT	16V		10μF
C1220	F2J1C100A024	ELECT	16V		10μF
C1221	ECJ1VB1C105K	SMD	16V		1000nF
C1222	ECJ1VC1H330J	S.M.CAP	50V		33pF
C1223	ECJ1VB1A105K	S.M.CAP	10V		1000nF
C1225	ECJ1VC1H151J	S.M.CAP	50V		150pF
C1226	ECJ0EB1C103K	S.M.CAP	16V		10nF
C2005	ECJ1VC1H561J	S.M.CAP	50V		560pF
C2006	ECJ1VC1H561J	S.M.CAP	50V		560pF
C2019	ECJ1VC1H561J	S.M.CAP	50V		560pF
C2020	ECJ1VC1H561J	S.M.CAP	50V		560pF
C2021	ECJ1VC1H561J	S.M.CAP	50V		560pF
C2022	ECJ1VC1H561J	S.M.CAP	50V		560pF
C2023	ECJ1VC1H561J	S.M.CAP	50V		560pF
C2024	ECJ1VC1H561J	S.M.CAP	50V		560pF
C2025	ECJ1VC1H561J	S.M.CAP	50V		560pF
C2026	ECJ1VC1H561J	S.M.CAP	50V		560pF
C2027	ECJ1VC1H561J	S.M.CAP	50V		560pF
C2028	ECJ1VC1H561J	S.M.CAP	50V		560pF
C2029	ECJ1VC1H561J	S.M.CAP	50V		560pF
C2030	ECJ1VC1H561J	S.M.CAP	50V		560pF
C2031	ECJ1VC1H561J	S.M.CAP	50V		560pF
C2032	ECJ1VC1H561J	S.M.CAP	50V		560pF
C2051	ECJ3YB1A106M	S.M.CAP	10V		10μF
C2052	ECJ3YB1A106M	S.M.CAP	10V		10μF
C2057	ECJ1VF1C104Z	S.M.CAP	16V		100nF
C2059	ECJ1VF1C104Z	S.M.CAP	16V		100nF
C2063	F2A1E471A151	ELECT	25V		470μF
C2065	F2A1C101A180	ELECT	16V		100μF
C2067	ECJ1VF1A105	S.M.CAP	10V		1μF
C2071	ECJ1VB1C105K	SMD	16V		1000nF
C2118	F2J1E220A028	ELECT	25V		22μF
C2119	F2J1E220A028	ELECT	25V		22μF
C2123	F1H1A1050028	CERAMIC	10V		1μF

Cct Ref	Parts Number	Description			
C2124	F1H1A1050028	CERAMIC	10V	1μF	
C2125	ECJ1VB1H102	S.M.CAP	50V	1nF	
C2126	ECJ1VB1H102	S.M.CAP	50V	1nF	
C2127	EEH1B1C101UP	ELECT	16V	100μF	
C2128	ECJ1VF1C104Z	S.M.CAP	16V	100nF	
C2129	F1H1A1050028	CERAMIC	10V	1μF	
C2130	F1H1A1050028	CERAMIC	10V	1μF	
C2131	ECJ1VF1C104Z	S.M.CAP	16V	100nF	
C2132	EEH1B1C101UP	ELECT	16V	100μF	
C2133	ECJ1VC1H470J	S.M.CAP	50V	47pF	
C2134	ECJ1VC1H470J	S.M.CAP	50V	47pF	
C2135	ECJ1VB1C105K	SMD	16V	1000nF	
C2136	ECJ1VB1C105K	SMD	16V	1000nF	
C2137	ECJ1VF1C104Z	S.M.CAP	16V	100nF	
C2138	ECJ1VF1C104Z	S.M.CAP	16V	100nF	
C2139	ECJ1VF1C104Z	S.M.CAP	16V	100nF	
C2140	ECJ1VF1C104Z	S.M.CAP	16V	100nF	
C2141	ECJ1VF1C104Z	S.M.CAP	16V	100nF	
C2142	ECJ1VF1C104Z	S.M.CAP	16V	100nF	
C2143	ECJ1VF1C104Z	S.M.CAP	16V	100nF	
C2144	ECJ3YB1A106M	S.M.CAP	10V	10μF	
C2145	ECJ3YB1A106M	S.M.CAP	10V	10μF	
C2146	ECJ1VF1C104Z	S.M.CAP	16V	100nF	
C2147	ECJ2FB1A225K	S.M.CAP	10V	2200nF	
C2148	ECJ1VB1C105K	SMD	16V	1000nF	
C2149	ECJ1VB1C105K	SMD	16V	1000nF	
C2150	ECJ1VB1C105K	SMD	16V	1000nF	
C2151	ECJ3YB1A106M	S.M.CAP	10V	10μF	
C2152	ECJ1VB1C105K	SMD	16V	1000nF	
C2153	ECJ3YB1A106M	S.M.CAP	10V	10μF	
C2154	ECJ1VF1C104Z	S.M.CAP	16V	100nF	
C2155	ECJ1VB1C105K	SMD	16V	1000nF	
C2156	ECJ3YB1A106M	S.M.CAP	10V	10μF	
C2157	ECJ1VB1C105K	SMD	16V	1000nF	
C2158	ECJ3YB1A106M	S.M.CAP	10V	10μF	
C2159	ECJ1VB1C105K	SMD	16V	1000nF	
C2160	ECJ1VB1C105K	SMD	16V	1000nF	
C2161	EEH1B1C101UP	ELECT	16V	100μF	
C2162	ECJ1VB1C105K	SMD	16V	1000nF	
C2163	ECJ1VB1C105K	SMD	16V	1000nF	
C2164	ECJ1VB1C105K	SMD	16V	1000nF	
C2165	ECJ1VB1C105K	SMD	16V	1000nF	
C2166	ECJ1VF1C104Z	S.M.CAP	16V	100nF	
C2167	ECJ1VF1C104Z	S.M.CAP	16V	100nF	
C2168	ECJ1VB1C105K	SMD	16V	1000nF	
C2169	ECJ1VB1C105K	SMD	16V	1000nF	
C2172	ECJ1VB1H332K	S.M.CAP	50V	3.3nF	
C2173	ECJ1VB1H103	S.M.CAP	50V	10nF	
C2174	ECJ1VB1H332K	S.M.CAP	50V	3.3nF	
C2175	ECJ1VB1H103	S.M.CAP	50V	10nF	
C2176	ECJ1VB1H103	S.M.CAP	50V	10nF	
C2177	ECJ1VB1H103	S.M.CAP	50V	10nF	
C2178	F2G1C100A022	ELECT	16V	10μF	
C2179	F2G1C100A022	ELECT	16V	10μF	
C2181	ECJ1VF1C104Z	S.M.CAP	16V	100nF	
C2183	F2G1H3R3A031	ELECT	50V	3.3μF	
C2184	ECJ1VF1C104Z	S.M.CAP	16V	100nF	
C2185	ECJ1VF1C104Z	S.M.CAP	16V	100nF	
C2186	EEH1B1C101UP	ELECT	16V	100μF	
C2189	ECJ1VF1C105Z	S.M.CAP	16V	1000nF	
C2190	ECJ1VF1C105Z	S.M.CAP	16V	1000nF	
C2191	ECJ1VF1C104Z	S.M.CAP	16V	100nF	
C2192	F2G1C100A022	ELECT	16V	10μF	
C2193	ECJ1VF1C105Z	S.M.CAP	16V	1000nF	
C2194	ECJ1VF1C105Z	S.M.CAP	16V	1000nF	
C2195	ECJ1VC1H470J	S.M.CAP	50V	47pF	
C2196	ECJ1VF1C104Z	S.M.CAP	16V	100nF	
C2198	EEH1B1C101UP	ELECT	16V	100μF	

Cct Ref	Parts Number	Description			
C2199	ECJ1VC1H560J	S.M.CAP	50V	56pF	
C2200	ECJ1VC1H470J	S.M.CAP	50V	47pF	
C2201	ECJ1VC1H030C	S.M.CAP	50V	3pF	
C2202	ECJ1VC1H050C	S.M.CAP	50V	5pF	
C2203	ECJ1VC1H100D	S.M.CAP	50V	10pF	
C2204	ECJ1VC1H220J	S.M.CAP	50V	22pF	
C2206	EEH1B1C101UP	ELECT	16V	100μF	
C2207	ECJ1VF1C104Z	S.M.CAP	16V	100nF	
C2211	ECJ1VB1C104K	S.M.CAP	16V	100nF	
C2214	ECJ1VB1H102	S.M.CAP	50V	1nF	
C2215	ECJ1VF1C104Z	S.M.CAP	16V	100nF	
C2218	ECJ3YB1A106M	S.M.CAP	10V	10μF	
C2219	ECJ3YB1A106M	S.M.CAP	10V	10μF	
C2220	ECJ3YB1A106M	S.M.CAP	10V	10μF	
C2221	ECJ3YB1A106M	S.M.CAP	10V	10μF	
C2222	ECJ3YB1A106M	S.M.CAP	10V	10μF	
C2223	ECJ3YB1A106M	S.M.CAP	10V	10μF	
C2225	ECJ1VF1A105	S.M.CAP	10V	1μF	
C2226	ECJ1VF1A105	S.M.CAP	10V	1μF	
C2227	ECJ1VF1A105	S.M.CAP	10V	1μF	
C2231	ECJ1VC1H471J	S.M.CAP	50V	470pF	
C2232	ECJ1VC1H471J	S.M.CAP	50V	470pF	
C2233	ECJ1VC1H471J	S.M.CAP	50V	470pF	
C2234	ECJ1VC1H471J	S.M.CAP	50V	470pF	
C2271	ECJ2FB0J475K	S.M.CAP	6.3V	4700nF	
C2272	ECJ1VF1C105Z	S.M.CAP	16V	1000nF	
C2301	ECJ1VB1H223K	S.M.CAP	50V	22nF	
C2302	ECJ1VB1H223K	S.M.CAP	50V	22nF	
C2315	ECJ1VB1H123K	S.M.CAP	50V	12nF	
C2317	ECJ1VB1H123K	S.M.CAP	50V	12nF	
C2318	ECJ1VB1H123K	S.M.CAP	50V	12nF	
C2320	ECJ1VB1H123K	S.M.CAP	50V	12nF	
C2326	ECJ1VB1C473	S.M.CAP	16V	47nF	
C2327	ECJ1VB1C473	S.M.CAP	16V	47nF	
C2328	F2A1C101A180	ELECT	16V	100μF	
C2329	F2A1C101A180	ELECT	16V	100μF	
C2331	ECJ1VF1C104Z	S.M.CAP	16V	100nF	
C2332	ECJ1VF1C104Z	S.M.CAP	16V	100nF	
C2335	ECJ1VF1C104Z	S.M.CAP	16V	100nF	
C2347	F2G1C100A022	ELECT	16V	10μF	
C2348	F1H1A1050028	CERAMIC	10V	1μF	
C2350	ECJ1VF1C104Z	S.M.CAP	16V	100nF	
C2351	EEH1B1C101UP	ELECT	16V	100μF	
C2352	ECJ1VB1C104K	S.M.CAP	16V	100nF	
C2353	EEH1B0J331UP	ELECT	6.3V	330μF	
C2356	ECJ1VB1C104K	S.M.CAP	16V	100nF	
C2357	EEH1B0J331UP	ELECT	6.3V	330μF	
C2366	ECJ1VC1H330J	S.M.CAP	50V	33pF	
C2367	ECJ1VC1H330J	S.M.CAP	50V	33pF	
C2520	F2A1V4710040	ELECT	35V	470μF	
C2521	ECJ2FB1H104	S.M.CAP	50V	100nF	
C2522	ECJ1VB1H222K	S.M.CAP	50V	2.2nF	
C2523	ECJ1VB1H222K	S.M.CAP	50V	2.2nF	
C2524	ECJ1VB1H222K	S.M.CAP	50V	2.2nF	
C2525	F2A1E470A211	ELECT	25V	47μF	
C2526	ECJ2FB1E224K	S.M.CAP	25V	220nF	
C2527	ECJ2FB1H104	S.M.CAP	50V	100nF	
C2528	ECA1EHG102E	ELECT	25V	1000μF	
C2529	ECJ2FB1E224K	S.M.CAP	25V	220nF	
C2530	ECJ1VB1H153K	S.M.CAP	50V	15nF	
C2531	F2A1H2R2A182	ELECT	50V	2.2μF	
C2534	ECJ2FB1E105K	S.M.CAP	25V	1μF	
C2535	ECJ1VB1H221K	S.M.CAP	50V	220pF	
C2536	ECJ1VB1H221K	S.M.CAP	50V	220pF	
C2537	ECJ2FB1H104	S.M.CAP	50V	100nF	
C2538	ECJ1VB1H222K	S.M.CAP	50V	2.2nF	
C2539	ECJ1VB1H222K	S.M.CAP	50V	2.2nF	
C2540	ECJ1VB1H222K	S.M.CAP	50V	2.2nF	

Cct Ref	Parts Number	Description		
C2541	F2A1E470A211	ELECT	25V	47µF
C2542	ECJ2FB1E224K	S.M.CAP	25V	220nF
C2543	ECJ2FB1H104	S.M.CAP	50V	100nF
C2544	ECA1EHG102E	ELECT	25V	1000µF
C2545	ECJ2FB1E224K	S.M.CAP	25V	220nF
C2546	ECJ1VB1H153K	S.M.CAP	50V	15nF
C2547	F2A1H2R2A182	ELECT	50V	2.2µF
C2550	ECJ2FB1E105K	S.M.CAP	25V	1µF
C2551	ECJ1VB1H221K	S.M.CAP	50V	220pF
C2552	ECJ1VB1H221K	S.M.CAP	50V	220pF
C2553	ECJ2FB1H104	S.M.CAP	50V	100nF
C2554	ECJ1VB1H222K	S.M.CAP	50V	2.2nF
C2555	ECJ1VB1H222K	S.M.CAP	50V	2.2nF
C2556	ECJ1VB1H222K	S.M.CAP	50V	2.2nF
C2557	F2A1E470A211	ELECT	25V	47µF
C2558	ECJ2FB1E224K	S.M.CAP	25V	220nF
C2559	ECJ2FB1H104	S.M.CAP	50V	100nF
C2560	ECA1EHG102E	ELECT	25V	1000µF
C2561	ECJ2FB1E224K	S.M.CAP	25V	220nF
C2562	ECJ1VB1H153K	S.M.CAP	50V	15nF
C2563	F2A1H2R2A182	ELECT	50V	2.2µF
C2566	ECJ2FB1E105K	S.M.CAP	25V	1µF
C2567	ECJ1VB1H221K	S.M.CAP	50V	220pF
C2568	ECJ1VB1H221K	S.M.CAP	50V	220pF
C2569	ECJ2FB1H104	S.M.CAP	50V	100nF
C2570	ECJ1VB1H222K	S.M.CAP	50V	2.2nF
C2571	ECJ1VB1H222K	S.M.CAP	50V	2.2nF
C2572	ECJ1VB1H222K	S.M.CAP	50V	2.2nF
C2573	F2A1E470A211	ELECT	25V	47µF
C2574	ECJ2FB1E224K	S.M.CAP	25V	220nF
C2575	ECJ2FB1H104	S.M.CAP	50V	100nF
C2576	ECA1EHG102E	ELECT	25V	1000µF
C2577	ECJ2FB1E224K	S.M.CAP	25V	220nF
C2578	ECJ1VB1H153K	S.M.CAP	50V	15nF
C2579	F2A1H2R2A182	ELECT	50V	2.2µF
C2582	ECJ2FB1E105K	S.M.CAP	25V	1µF
C2583	ECJ1VB1H221K	S.M.CAP	50V	220pF
C2584	ECJ1VB1H221K	S.M.CAP	50V	220pF
C2585	ECJ2FB1H104	S.M.CAP	50V	100nF
C2586	ECUV1H153ZFX	S.M.CAP	50V	15nF
C2587	ECUV1H153ZFX	S.M.CAP	50V	15nF
C2588	ECUV1H153ZFX	S.M.CAP	50V	15nF
C2589	ECUV1H153ZFX	S.M.CAP	50V	15nF
C2590	ECJ1VB1H102	S.M.CAP	50V	1nF
C2591	ECJ1VB1H102	S.M.CAP	50V	1nF
C2592	ECJ1VB1H102	S.M.CAP	50V	1nF
C2593	ECJ1VB1H102	S.M.CAP	50V	1nF
C2611	ECJ2FB1E475M	S.M.CAP	25V	4700nF
C2612	ECJ2FB1E475M	S.M.CAP	25V	4700nF
C2613	ECJ2FB1E475M	S.M.CAP	25V	4700nF
C2614	ECJ2FB1E475M	S.M.CAP	25V	4700nF
C3001	ECJ1VB1H102	S.M.CAP	50V	1nF
C3002	ECJ1VB1H102	S.M.CAP	50V	1nF
C3003	ECJ1VB1H102	S.M.CAP	50V	1nF
C3005	ECJ1VF1C104Z	S.M.CAP	16V	100nF
C3006	ECJ1VF1C104Z	S.M.CAP	16V	100nF
C3007	ECJ1VF1C104Z	S.M.CAP	16V	100nF
C3015	ECJ3YB1C106M	S.M.CAP	16V	10µF
C3016	F2A1E471A151	ELECT	25V	470µF
C3017	F2A1E471A151	ELECT	25V	470µF
C3019	F2A1E471A151	ELECT	25V	470µF
C3021	F1H1A1050028	CERAMIC	10V	1µF
C3022	F1H1A1050028	CERAMIC	10V	1µF
C3023	F1H1A1050028	CERAMIC	10V	1µF
C3024	F1H1A1050028	CERAMIC	10V	1µF
C3025	F1H1A1050028	CERAMIC	10V	1µF
C3026	F1H1A1050028	CERAMIC	10V	1µF
C3027	F1H1A1050028	CERAMIC	10V	1µF

Cct Ref	Parts Number	Description		
C3028	F1H1A1050028	CERAMIC	10V	1µF
C3029	ECJ1VF1C105Z	S.M.CAP	16V	1000nF
C3031	F1H1A1050028	CERAMIC	10V	1µF
C3032	ECJ1VF1C104Z	S.M.CAP	16V	100nF
C3033	F1H1A1050028	CERAMIC	10V	1µF
C3035	F1H1A1050028	CERAMIC	10V	1µF
C3036	F1H1A1050028	CERAMIC	10V	1µF
C3038	ECJ1VF1C104Z	S.M.CAP	16V	100nF
C3039	F1H1A1050028	CERAMIC	10V	1µF
C3040	ECJ1VF1C104Z	S.M.CAP	16V	100nF
C3041	ECJ1VF1C104Z	S.M.CAP	16V	100nF
C3042	F1H1A1050028	CERAMIC	10V	1µF
C3043	F1H1A1050028	CERAMIC	10V	1µF
C3044	ECJ1VF1C104Z	S.M.CAP	16V	100nF
C3045	ECJ1VF1C104Z	S.M.CAP	16V	100nF
C3046	ECJ1VF1C104Z	S.M.CAP	16V	100nF
C3047	F1H1A1050028	CERAMIC	10V	1µF
C3048	ECJ1VF1C104Z	S.M.CAP	16V	100nF
C3049	F1H1A1050028	CERAMIC	10V	1µF
C3050	F1H1A1050028	CERAMIC	10V	1µF
C3051	F1H1A1050028	CERAMIC	10V	1µF
C3052	F1H1A1050028	CERAMIC	10V	1µF
C3053	F1H1A1050028	CERAMIC	10V	1µF
C3054	F1H1A1050028	CERAMIC	10V	1µF
C3055	F1H1A1050028	CERAMIC	10V	1µF
C3056	F1H1A1050028	CERAMIC	10V	1µF
C3057	ECJ1VF1C104Z	S.M.CAP	16V	100nF
C3058	F2A1E471A151	ELECT	25V	470µF
C3059	ECJ1VF1C105Z	S.M.CAP	16V	1000nF
C3061	ECJ1VF1C104Z	S.M.CAP	16V	100nF
C3066	F2J1C4700003	ELECT	16V	47µF
C3067	ECJ1VF1C104Z	S.M.CAP	16V	100nF
C3068	F2J1C4700003	ELECT	16V	47µF
C3069	ECJ1VF1C104Z	S.M.CAP	16V	100nF
C3070	F2J1C4700003	ELECT	16V	47µF
C3071	ECJ1VF1C104Z	S.M.CAP	16V	100nF
C3074	ECJ1VF1C104Z	S.M.CAP	16V	100nF
C3201	ECJ1VF1C104Z	S.M.CAP	16V	100nF
C3206	ECJ1VF1C105Z	S.M.CAP	16V	1000nF
C3207	F2A1A102A214	ELECT	10V	1000µF
C3209	ECJ1VF1C104Z	S.M.CAP	16V	100nF
C3210	F2A1H100A182	ELECT	50V	10µF
C3212	ECJ1VF1H104Z	S.M.CAP	50V	100nF
C3214	ECJ1VF1C104Z	S.M.CAP	16V	100nF
C3216	ECJ1VF1C104Z	S.M.CAP	16V	100nF
C3227	ECJ1VF1C104Z	S.M.CAP	16V	100nF
C3229	ECJ1VF1C104Z	S.M.CAP	16V	100nF
C3230	ECJ1VF1C104Z	S.M.CAP	16V	100nF
C3231	ECJ1VF1C104Z	S.M.CAP	16V	100nF
C3233	ECJ1VF1C104Z	S.M.CAP	16V	100nF
C3235	ECJ1VF1H104Z	S.M.CAP	50V	100nF
C3236	F2A1H100A182	ELECT	50V	10µF
C3237	ECJ1VC1H330J	S.M.CAP	50V	33pF
C3238	ECJ1VC1H330J	S.M.CAP	50V	33pF
C3239	ECJ1VB1H103	S.M.CAP	50V	10nF
C3240	ECJ1VF1H104Z	S.M.CAP	50V	100nF
C3242	ECJ1VF1C104Z	S.M.CAP	16V	100nF
C3243	ECJ1VF1C104Z	S.M.CAP	16V	100nF
C3244	ECJ1VF1C104Z	S.M.CAP	16V	100nF
C3245	F2A1C101A180	ELECT	16V	100µF
C3247	F2A1C101A180	ELECT	16V	100µF
C3248	F2A1C101A180	ELECT	16V	100µF
C3249	F2A1H100A182	ELECT	50V	10µF
C3261	ECJ1VC1H101J	S.M.CAP	50V	100pF
C3281	ECJ1VB1H103	S.M.CAP	50V	10nF
C3282	ECJ1VB1H103	S.M.CAP	50V	10nF
C3283	ECJ1VB1H103	S.M.CAP	50V	10nF
C3305	ECJ1VF1C104Z	S.M.CAP	16V	100nF

Cct Ref	Parts Number	Description			
C3307	F2A1C101A180	ELECT	16V	100µF	
C3309	ECJ1VF1C104Z	S.M.CAP	16V	100nF	
C3848	ECUV1H561KBX	S.M. CAP	50V	560pF	
C3849	ECUV1H561KBX	S.M. CAP	50V	560pF	
C3850	ECJ1VF1H104Z	S.M.CAP	50V	100nF	
C3851	ECJ1VF1H104Z	S.M.CAP	50V	100nF	
C3860	ECJ1VF1C104Z	S.M.CAP	16V	100nF	
C4003	F1J0J1060004	CERAMIC	6.3V	10µF	
C4004	F1J0J1060004	CERAMIC	6.3V	10µF	
C4005	F1J0J1060004	CERAMIC	6.3V	10µF	
C4006	F1J0J1060004	CERAMIC	6.3V	10µF	
C4015	ECJ0EB1C103K	S.M.CAP	16V	10nF	
C4026	ECJ0EB1A104K	S.M.CAP	10V	100nF	
C4031	ECJ0EB1A104K	S.M.CAP	10V	100nF	
C4032	ECJ1VB1A105K	S.M.CAP	10V	1000nF	
C4035	EEH1C470P	ELECT	16V	47µF	
C4037	ECJ1VB1H103	S.M.CAP	50V	10nF	
C4038	ECJ1VB1H103	S.M.CAP	50V	10nF	
C4039	EEH1C470P	ELECT	16V	47µF	
C4042	ECJ0EB1A104K	S.M.CAP	10V	100nF	
C4044	ECJ0EB1C103K	S.M.CAP	16V	10nF	
C4047	ECJ0EB1C103K	S.M.CAP	16V	10nF	
C4050	EEH0G470R	ELECT	4V	47µF	
C4052	EEH1C470P	ELECT	16V	47µF	
C4057	EEH0G221P	ELECT	4V	220µF	
C4112	F1J0J1060004	CERAMIC	6.3V	10µF	
C4115	ECJ0EB1A104K	S.M.CAP	10V	100nF	
C4117	ECJ0EB1A104K	S.M.CAP	10V	100nF	
C4118	ECJ1VB1A105K	S.M.CAP	10V	1000nF	
C4119	F1J1A106A043	CERAMIC	10V	10µF	
C4120	ECJ0EB1A104K	S.M.CAP	10V	100nF	
C4121	F2G0G101A007	ELECT	4V	100µF	
C4122	ECJ1VB1A105K	S.M.CAP	10V	1000nF	
C4123	ECJ1VB1A105K	S.M.CAP	10V	1000nF	
C4129	ECJ0EB1C103K	S.M.CAP	16V	10nF	
C4130	EEFCD0G560ER	ELECT	4V	56µF	
C4138	ECJ0EB1C103K	S.M.CAP	16V	10nF	
C4139	EEH1C470UR	ELECT	16V	47µF	
C4141	ECJ1VB1C104K	S.M.CAP	16V	100nF	
C4142	ECJ1VB1C104K	S.M.CAP	16V	100nF	
C4143	F2G1C470A022	ELECT	16V	47µF	
C4144	ECJ1VC1H050C	S.M.CAP	50V	5pF	
C4145	ECJ1VC1H050C	S.M.CAP	50V	5pF	
C4146	ECJ1VC1H050C	S.M.CAP	50V	5pF	
C4148	ECJ1VB1A105K	S.M.CAP	10V	1000nF	
C4149	ECJ1VB1A105K	S.M.CAP	10V	1000nF	
C4150	ECJ1VB1A105K	S.M.CAP	10V	1000nF	
C4151	ECJ1VB1A105K	S.M.CAP	10V	1000nF	
C4156	F1J1A106A043	CERAMIC	10V	10µF	
C4157	ECJ3YB0J106K	S.M.CAP	6.3V	10µF	
C4158	ECJ1VB1A105K	S.M.CAP	10V	1000nF	
C4159	ECJ1VB1C105K	SMD	16V	1000nF	
C4160	ECJ0EB1A104K	S.M.CAP	10V	100nF	
C4161	ECJ1VB1A105K	S.M.CAP	10V	1000nF	
C4162	ECJ1VB1A105K	S.M.CAP	10V	1000nF	
C4165	ECJ0EC1H101J	S.M.CAP	50V	100pF	
C4168	ECJ1VC1H680J	S.M.CAP	50V	68pF	
C4169	ECJ1VB1A105K	S.M.CAP	10V	1000nF	
C4171	ECJ1VC1H471J	S.M.CAP	50V	470pF	
C4172	ECJ0EB1A104K	S.M.CAP	10V	100nF	
C4173	ECJ0EB1A104K	S.M.CAP	10V	100nF	
C4174	ECJ0EB1A104K	S.M.CAP	10V	100nF	
C4175	ECJ0EB1A104K	S.M.CAP	10V	100nF	
C4176	ECJ2FB0J225K	S.M.CAP	6.3V	2.2µF	
C4177	ECJ2FB1C684K	S.M.CAP	16V	680nF	
C4178	ECJ1VB1C393K	S.M.CAP	16V	39nF	
C4179	EEFCD0G560ER	ELECT	4V	56µF	
C4180	ECJ0EB1A104K	S.M.CAP	10V	100nF	

Cct Ref	Parts Number	Description			
C4181	ECJ0EB1C103K	S.M.CAP	16V	10nF	
C4183	ECJ0EB1A104K	S.M.CAP	10V	100nF	
C4184	F2G1E330A021	ELECT	25V	33µF	
C4185	ECJ3YB0J106K	S.M.CAP	6.3V	10µF	
C4186	ECJ3YB0J106K	S.M.CAP	6.3V	10µF	
C4187	F2G0J470A019	ELECT	6.3V	47µF	
C4188	F1J0J1060004	CERAMIC	6.3V	10µF	
C4189	ECJ0EB1A104K	S.M.CAP	10V	100nF	
C4190	ECJ0EB1A104K	S.M.CAP	10V	100nF	
C4191	ECJ0EB1A104K	S.M.CAP	10V	100nF	
C4192	ECJ0EB1A104K	S.M.CAP	10V	100nF	
C4193	ECJ0EB1H102K	S.M.CAP	50V	1nF	
C4194	ECJ1VB1C104K	S.M.CAP	16V	100nF	
C4195	ECJ1VB1C104K	S.M.CAP	16V	100nF	
C4196	ECJ1VB1C104K	S.M.CAP	16V	100nF	
C4197	ECJ1VB1C104K	S.M.CAP	16V	100nF	
C4198	ECJ1VB1A105K	S.M.CAP	10V	1000nF	
C4199	ECJ0EB1C103K	S.M.CAP	16V	10nF	
C4200	F2G0J470A019	ELECT	6.3V	47µF	
C4201	ECJ0EB1C103K	S.M.CAP	16V	10nF	
C4203	ECJ1VB1A105K	S.M.CAP	10V	1000nF	
C4204	ECJ0EB1A104K	S.M.CAP	10V	100nF	
C4205	ECJ1VB1C104K	S.M.CAP	16V	100nF	
C4206	ECJ1VB1C104K	S.M.CAP	16V	100nF	
C4207	EEH1A101P	ELECT	10V	100µF	
C4208	ECJ0EB1A104K	S.M.CAP	10V	100nF	
C4209	ECJ0EB1A104K	S.M.CAP	10V	100nF	
C4211	ECJ0EB1A104K	S.M.CAP	10V	100nF	
C4212	EEH0G221P	ELECT	4V	220µF	
C4213	ECJ0EB1A104K	S.M.CAP	10V	100nF	
C4214	ECJ0EB1A104K	S.M.CAP	10V	100nF	
C4215	ECJ0EB1A104K	S.M.CAP	10V	100nF	
C4216	F2G0J470A019	ELECT	6.3V	47µF	
C4217	ECJ1VB1C104K	S.M.CAP	16V	100nF	
C4218	ECJ0EB1H102K	S.M.CAP	50V	1nF	
C4219	ECJ0EB1A104K	S.M.CAP	10V	100nF	
C4220	ECJ0EB1C103K	S.M.CAP	16V	10nF	
C4222	ECJ2FB1E475M	S.M.CAP	25V	4700nF	
C4223	ECJ2FB1E475M	S.M.CAP	25V	4700nF	
C4224	ECJ0EB1A104K	S.M.CAP	10V	100nF	
C4225	ECJ1VB1A105K	S.M.CAP	10V	1000nF	
C4226	ECJ1VC1H680J	S.M.CAP	50V	68pF	
C4227	ECJ1VB1C823K	S.M.CAP	16V	82nF	
C4228	ECJ0EB1C103K	S.M.CAP	16V	10nF	
C4229	ECJ1VB1C104K	S.M.CAP	16V	100nF	
C4230	ECJ0EB1A104K	S.M.CAP	10V	100nF	
C4231	ECJ0EB1A104K	S.M.CAP	10V	100nF	
C4232	ECJ0EB1A104K	S.M.CAP	10V	100nF	
C4233	ECJ0EB1A104K	S.M.CAP	10V	100nF	
C4234	ECJ0EB1A104K	S.M.CAP	10V	100nF	
C4235	ECJ0EB1C103K	S.M.CAP	16V	10nF	
C4236	ECJ0EB1A104K	S.M.CAP	10V	100nF	
C4237	ECJ0EB1A104K	S.M.CAP	10V	100nF	
C4238	ECJ0EB1A104K	S.M.CAP	10V	100nF	
C4239	ECJ0EB1A104K	S.M.CAP	10V	100nF	
C4240	ECJ0EB1A104K	S.M.CAP	10V	100nF	
C4241	ECJ0EB1A104K	S.M.CAP	10V	100nF	
C4242	ECJ0EB1A104K	S.M.CAP	10V	100nF	
C4243	ECJ1VB1A105K	S.M.CAP	10V	1000nF	
C4244	ECJ1VB1A105K	S.M.CAP	10V	1000nF	
C4245	ECJ0EB1A104K	S.M.CAP	10V	100nF	
C4246	ECJ0EB1A104K	S.M.CAP	10V	100nF	
C4247	ECJ1VB1A105K	S.M.CAP	10V	1000nF	
C4248	ECJ0EB1A104K	S.M.CAP	10V	100nF	
C4250	ECJ0EB1A104K	S.M.CAP	10V	100nF	
C4251	ECJ0EB1A104K	S.M.CAP	10V	100nF	
C4252	ECJ1VB1A105K	S.M.CAP	10V	1000nF	
C4253	F2G0J470A019	ELECT	6.3V	47µF	

Cct Ref	Parts Number	Description		
C4255	ECJ1VB1H562K	S.M.CAP	50V	5.6nF
C4256	ECJ0EB1A104K	S.M.CAP	10V	100nF
C4257	ECJ1VB0J225K	S.M.CAP	6.3V	2.2µF
C4258	ECJ0EB1A104K	S.M.CAP	10V	100nF
C4259	ECJ1VB0J225K	S.M.CAP	6.3V	2.2µF
C4261	ECJ0EB1A104K	S.M.CAP	10V	100nF
C4262	ECJ0EB1A104K	S.M.CAP	10V	100nF
C4263	ECJ0EB1A104K	S.M.CAP	10V	100nF
C4264	ECJ0EB1A104K	S.M.CAP	10V	100nF
C4265	ECJ0EB1A104K	S.M.CAP	10V	100nF
C4266	ECJ0EB1C103K	S.M.CAP	16V	10nF
C4267	ECJ0EB1A104K	S.M.CAP	10V	100nF
C4268	ECJ0EB1A104K	S.M.CAP	10V	100nF
C4269	ECJ1VB1A105K	S.M.CAP	10V	1000nF
C4270	ECJ0EB1A104K	S.M.CAP	10V	100nF
C4272	F2G0J470A019	ELECT	6.3V	47µF
C4273	ECJ0EB1A104K	S.M.CAP	10V	100nF
C4274	ECJ0EB1A104K	S.M.CAP	10V	100nF
C4275	ECJ0EB1A104K	S.M.CAP	10V	100nF
C4276	ECJ1VB0J225K	S.M.CAP	6.3V	2.2µF
C4277	ECJ1VB0J225K	S.M.CAP	6.3V	2.2µF
C4278	EEH1A101P	ELECT	10V	100µF
C4279	ECJ2FB1E475M	S.M.CAP	25V	4700nF
C4280	ECJ2FB1E475M	S.M.CAP	25V	4700nF
C4281	ECJ0EB1A104K	S.M.CAP	10V	100nF
C4282	ECJ0EB1A104K	S.M.CAP	10V	100nF
C4283	ECJ0EB1A104K	S.M.CAP	10V	100nF
C4284	ECJ0EB1A104K	S.M.CAP	10V	100nF
C4287	ECJ0EB1A104K	S.M.CAP	10V	100nF
C4288	ECJ0EB1A104K	S.M.CAP	10V	100nF
C4289	EEH1A101P	ELECT	6.3V	33µF
C4290	EEH1A101P	ELECT	6.3V	33µF
C4291	ECJ0EB1A104K	S.M.CAP	10V	100nF
C4292	ECJ0EB1A104K	S.M.CAP	10V	100nF
C4296	F1J0J1060004	CERAMIC	6.3V	10µF
C4297	ECJ0EB1A104K	S.M.CAP	10V	100nF
C4298	ECJ1VB1A105K	S.M.CAP	10V	1000nF
C4299	ECJ1VB1A105K	S.M.CAP	10V	1000nF
C4300	ECJ1VB1A105K	S.M.CAP	10V	1000nF
C4301	ECJ1VB1A105K	S.M.CAP	10V	1000nF
C4302	ECJ1VB1A105K	S.M.CAP	10V	1000nF
C4303	ECJ1VB1A105K	S.M.CAP	10V	1000nF
C4304	ECJ1VB1A105K	S.M.CAP	10V	1000nF
C4305	ECJ1VB1A105K	S.M.CAP	10V	1000nF
C4306	ECJ1VB1A105K	S.M.CAP	10V	1000nF
C4307	ECJ0EB1A104K	S.M.CAP	10V	100nF
C4308	ECJ0EB1A104K	S.M.CAP	10V	100nF
C4309	ECJ0EB1A104K	S.M.CAP	10V	100nF
C4310	ECJ0EB1C103K	S.M.CAP	16V	10nF
C4311	ECJ0EB1A104K	S.M.CAP	10V	100nF
C4312	ECJ0EB1C103K	S.M.CAP	16V	10nF
C4313	ECJ0EB1A104K	S.M.CAP	10V	100nF
C4314	ECJ0EB1A104K	S.M.CAP	10V	100nF
C4315	F1J0J1060004	CERAMIC	6.3V	10µF
C4316	ECJ0EB1A104K	S.M.CAP	10V	100nF
C4317	ECJ0EB1A104K	S.M.CAP	10V	100nF
C4318	ECJ0EB1A104K	S.M.CAP	10V	100nF
C4320	ECJ0EB1A104K	S.M.CAP	10V	100nF
C4321	ECJ0EB1A104K	S.M.CAP	10V	100nF
C4322	ECJ0EB1A104K	S.M.CAP	10V	100nF
C4325	ECJ0EB1A104K	S.M.CAP	10V	100nF
C4327	ECJ0EB1A104K	S.M.CAP	10V	100nF
C4329	ECJ0EB1A104K	S.M.CAP	10V	100nF
C4330	ECJ0EB1A104K	S.M.CAP	10V	100nF
C4331	F1J0J1060004	CERAMIC	6.3V	10µF
C4332	ECJ1VB1A105K	S.M.CAP	10V	1000nF
C4333	ECJ0EB1A104K	S.M.CAP	10V	100nF
C4334	ECJ0EB1A104K	S.M.CAP	10V	100nF

Cct Ref	Parts Number	Description		
C4335	ECJ0EB1A104K	S.M.CAP	10V	100nF
C4336	ECJ0EB1A104K	S.M.CAP	10V	100nF
C4337	ECJ0EB1A104K	S.M.CAP	10V	100nF
C4338	ECJ0EB1A104K	S.M.CAP	10V	100nF
C4339	ECJ2FB0J225K	S.M.CAP	6.3V	2.2µF
C4340	ECJ1VC1H471J	S.M.CAP	50V	470pF
C4341	EEH1C470P	ELECT	16V	47µF
C4342	ECJ0EB1A104K	S.M.CAP	10V	100nF
C4343	EEH1C100R	ELECT	16V	10µF
C4344	F1J0J1060004	CERAMIC	6.3V	10µF
C4345	F1J0J1060004	CERAMIC	6.3V	10µF
C4346	ECJ0EB1A104K	S.M.CAP	10V	100nF
C4347	ECJ1VB1A105K	S.M.CAP	10V	1000nF
C4348	EEH1C470P	ELECT	16V	47µF
C4349	ECJ0EB1C103K	S.M.CAP	16V	10nF
C4350	ECJ1VC1H181J	S.M.CAP	50V	180pF
C4351	ECJ1VC1H181J	S.M.CAP	50V	180pF
C4352	ECJ1VC1H330J	S.M.CAP	50V	33pF
C4353	ECJ1VC1H330J	S.M.CAP	50V	33pF
C4354	ECJ0EB1C103K	S.M.CAP	16V	10nF
C4360	ECJ0EB1A104K	S.M.CAP	10V	100nF
C4361	ECJ0EB1C103K	S.M.CAP	16V	10nF
C4362	F1J0J1060004	CERAMIC	6.3V	10µF
C4363	ECJ0EB1A104K	S.M.CAP	10V	100nF
C4364	ECJ0EB1A104K	S.M.CAP	10V	100nF
C4365	ECJ1VB1A105K	S.M.CAP	10V	1000nF
C4366	F2G0J470A019	ELECT	6.3V	47µF
C4367	ECJ0EB1A104K	S.M.CAP	10V	100nF
C4369	ECJ0EB1C223K	S.M.CAP	16V	22nF
C4370	ECJ0EB1H102K	S.M.CAP	50V	1nF
C4371	ECJ0EB1H102K	S.M.CAP	50V	1nF
C4372	ECJ0EB1A104K	S.M.CAP	10V	100nF
C4373	ECJ1VB1A105K	S.M.CAP	10V	1000nF
C4374	ECJ0EB1A104K	S.M.CAP	10V	100nF
C4375	ECJ0EB1H102K	S.M.CAP	50V	1nF
C4376	ECJ0EB1H102K	S.M.CAP	50V	1nF
C4377	ECJ0EB1A104K	S.M.CAP	10V	100nF
C4378	EEH1A101P	ELECT	4V	470µF
C4379	ECJ0EB1A104K	S.M.CAP	10V	100nF
C4380	ECJ0EB1H102K	S.M.CAP	50V	1nF
C4381	ECJ0EB1A104K	S.M.CAP	10V	100nF
C4382	ECJ0EB1A104K	S.M.CAP	10V	100nF
C4383	ECJ0EB1H102K	S.M.CAP	50V	1nF
C4384	ECJ0EB1A104K	S.M.CAP	10V	100nF
C4385	ECJ0EB1H102K	S.M.CAP	50V	1nF
C4386	ECJ0EB1A104K	S.M.CAP	10V	100nF
C4387	ECJ0EB1H102K	S.M.CAP	50V	1nF
C4388	ECJ1VB1A105K	S.M.CAP	10V	1000nF
C4389	ECJ0EB1A104K	S.M.CAP	10V	100nF
C4390	ECJ0EB1H102K	S.M.CAP	50V	1nF
C4391	ECJ1VB1A105K	S.M.CAP	10V	1000nF
C4392	ECJ0EB1A104K	S.M.CAP	10V	100nF
C4393	ECJ0EB1H102K	S.M.CAP	50V	1nF
C4394	ECJ0EB1H102K	S.M.CAP	50V	1nF
C4395	ECJ0EB1A104K	S.M.CAP	10V	100nF
C4396	ECJ0EB1H102K	S.M.CAP	50V	1nF
C4397	ECJ0EB1A104K	S.M.CAP	10V	100nF
C4398	ECJ0EB1A104K	S.M.CAP	10V	100nF
C4399	ECJ1VB1A105K	S.M.CAP	10V	1000nF
C4400	ECJ1VB1A105K	S.M.CAP	10V	1000nF
C4401	ECJ0EB1A104K	S.M.CAP	10V	100nF
C4402	ECJ0EB1H102K	S.M.CAP	50V	1nF
C4403	ECJ0EB1H102K	S.M.CAP	50V	1nF
C4404	ECJ0EB1A104K	S.M.CAP	10V	100nF
C4405	ECJ1VB1A105K	S.M.CAP	10V	1000nF
C4406	ECJ0EB1H102K	S.M.CAP	50V	1nF
C4407	ECJ0EB1A104K	S.M.CAP	10V	100nF
C4408	ECJ0EB1A104K	S.M.CAP	10V	100nF

Cct Ref	Parts Number	Description		
C4409	ECJ0EB1H102K	S.M.CAP	50V	1nF
C4410	ECJ1VB1A105K	S.M.CAP	10V	1000nF
C4411	ECJ0EB1A104K	S.M.CAP	10V	100nF
C4412	ECJ0EB1A104K	S.M.CAP	10V	100nF
C4413	ECJ0EB1H102K	S.M.CAP	50V	1nF
C4414	ECJ0EB1H102K	S.M.CAP	50V	1nF
C4415	ECJ0EB1A104K	S.M.CAP	10V	100nF
C4416	ECJ0EB1C103K	S.M.CAP	16V	10nF
C4417	F2G0J470A019	ELECT	6.3V	47µF
C4418	ECJ1VB1A105K	S.M.CAP	10V	1000nF
C4419	ECJ1VB1A105K	S.M.CAP	10V	1000nF
C4420	ECJ0EB1A104K	S.M.CAP	10V	100nF
C4421	ECJ0EB1A104K	S.M.CAP	10V	100nF
C4422	ECJ0EB1H102K	S.M.CAP	50V	1nF
C4423	ECJ0EB1H102K	S.M.CAP	50V	1nF
C4424	ECJ0EB1H102K	S.M.CAP	50V	1nF
C4425	ECJ0EB1A104K	S.M.CAP	10V	100nF
C4426	ECJ0EB1A104K	S.M.CAP	10V	100nF
C4427	ECJ0EB1H102K	S.M.CAP	50V	1nF
C4428	ECJ0EB1A104K	S.M.CAP	10V	100nF
C4429	ECJ0EB1H102K	S.M.CAP	50V	1nF
C4430	ECJ0EB1H102K	S.M.CAP	50V	1nF
C4431	ECJ1VB1A105K	S.M.CAP	10V	1000nF
C4432	ECJ1VB1A105K	S.M.CAP	10V	1000nF
C4433	ECJ0EB1C103K	S.M.CAP	16V	10nF
C4434	ECJ0EB1H102K	S.M.CAP	50V	1nF
C4435	ECJ1VB1A105K	S.M.CAP	10V	1000nF
C4436	ECJ0EB1H102K	S.M.CAP	50V	1nF
C4437	ECJ0EB1H102K	S.M.CAP	50V	1nF
C4438	ECJ0EB1H102K	S.M.CAP	50V	1nF
C4439	ECJ0EB1H102K	S.M.CAP	50V	1nF
C4440	ECJ0EB1A104K	S.M.CAP	10V	100nF
C4441	ECJ0EB1H102K	S.M.CAP	50V	1nF
C4442	ECJ0EB1H102K	S.M.CAP	50V	1nF
C4443	ECJ0EB1C103K	S.M.CAP	16V	10nF
C4444	ECJ0EB1C103K	S.M.CAP	16V	10nF
C4445	ECJ1VB1A105K	S.M.CAP	10V	1000nF
C4447	ECJ1VB1C104K	S.M.CAP	16V	100nF
C4448	ECJ0EB1C103K	S.M.CAP	16V	10nF
C4450	ECJ0EB1A104K	S.M.CAP	10V	100nF
C4451	ECJ0EB1H102K	S.M.CAP	50V	1nF
C4452	ECJ0EB1A104K	S.M.CAP	10V	100nF
C4453	ECJ0EB1H102K	S.M.CAP	50V	1nF
C4454	ECJ0EB1H102K	S.M.CAP	50V	1nF
C4455	ECJ1VB1A105K	S.M.CAP	10V	1000nF
C4456	ECJ0EB1A104K	S.M.CAP	10V	100nF
C4457	ECJ0EB1H102K	S.M.CAP	50V	1nF
C4458	ECJ0EB1H102K	S.M.CAP	50V	1nF
C4459	ECJ0EB1A104K	S.M.CAP	10V	100nF
C4460	ECJ0EB1H102K	S.M.CAP	50V	1nF
C4461	ECJ1VC1H820J	S.M.CAP	50V	82pF
C4462	ECJ0EB1A104K	S.M.CAP	10V	100nF
C4463	EEFCD0G560ER	ELECT	4V	56µF
C4464	ECJ1VB1A105K	S.M.CAP	10V	1000nF
C4465	ECJ0EB1A104K	S.M.CAP	10V	100nF
C4466	ECJ0EB1C103K	S.M.CAP	16V	10nF
C4467	ECJ0EB1A104K	S.M.CAP	10V	100nF
C4468	F1J0J475A035	CERAMIC	6.3V	4.7µF
C4469	ECJ1VC1H680J	S.M.CAP	50V	68pF
C4470	ECJ0EB1A104K	S.M.CAP	10V	100nF
C4472	ECJ0EB1A104K	S.M.CAP	10V	100nF
C4473	ECJ0EB1A104K	S.M.CAP	10V	100nF
C4474	ECJ0EB1C103K	S.M.CAP	16V	10nF
C4475	ECJ0EB1H102K	S.M.CAP	50V	1nF
C4476	ECJ0EB1H102K	S.M.CAP	50V	1nF
C4477	ECJ0EB1A104K	S.M.CAP	10V	100nF
C4478	ECJ1VB1A105K	S.M.CAP	10V	1000nF
C4479	ECJ0EB1H102K	S.M.CAP	50V	1nF

Cct Ref	Parts Number	Description		
C4480	ECJ0EB1H102K	S.M.CAP	50V	1nF
C4481	ECJ0EB1H102K	S.M.CAP	50V	1nF
C4482	ECJ1VC1H180J	S.M.CAP	50V	18pF
C4483	ECJ1VC1H180J	S.M.CAP	50V	18pF
C4490	F2G0J470A019	ELECT	6.3V	47µF
C4491	ECJ0EB1A104K	S.M.CAP	10V	100nF
C4501	ECJ0EB1A104K	S.M.CAP	10V	100nF
C4502	ECJ0EB1C103K	S.M.CAP	16V	10nF
C4503	ECJ0EB1A104K	S.M.CAP	10V	100nF
C4504	ECJ0EB1C103K	S.M.CAP	16V	10nF
C4505	ECJ0EB1A104K	S.M.CAP	10V	100nF
C4506	ECJ0EB1C103K	S.M.CAP	16V	10nF
C4507	ECJ0EB1A104K	S.M.CAP	10V	100nF
C4508	ECJ0EB1C103K	S.M.CAP	16V	10nF
C4509	ECJ0EB1A104K	S.M.CAP	10V	100nF
C4510	ECJ0EB1A104K	S.M.CAP	10V	100nF
C4511	ECJ0EB1A104K	S.M.CAP	10V	100nF
C4512	ECJ0EB1C103K	S.M.CAP	16V	10nF
C4513	ECJ0EB1A104K	S.M.CAP	10V	100nF
C4514	ECJ0EB1C103K	S.M.CAP	16V	10nF
C4515	ECJ0EB1A104K	S.M.CAP	10V	100nF
C4516	ECJ0EB1A104K	S.M.CAP	10V	100nF
C4517	ECJ0EB1C103K	S.M.CAP	16V	10nF
C4518	ECJ0EB1A104K	S.M.CAP	10V	100nF
C4519	ECJ0EB1C103K	S.M.CAP	16V	10nF
C4520	ECJ0EB1A104K	S.M.CAP	10V	100nF
C4521	ECJ0EB1C103K	S.M.CAP	16V	10nF
C4522	ECJ0EB1A104K	S.M.CAP	10V	100nF
C4523	ECJ0EB1C103K	S.M.CAP	16V	10nF
C4524	ECJ0EB1A104K	S.M.CAP	10V	100nF
C4525	ECJ0EB1C103K	S.M.CAP	16V	10nF
C4526	ECJ0EB1A104K	S.M.CAP	10V	100nF
C4527	ECJ0EB1C103K	S.M.CAP	16V	10nF
C4541	ECJ0EB1A104K	S.M.CAP	10V	100nF
C4543	ECJ1VB1C105K	SMD	16V	1000nF
C4544	ECJ1VB1C105K	SMD	16V	1000nF
C4791	ECJ1VB1C104K	S.M.CAP	16V	100nF
C4792	F2G1E330A021	ELECT	25V	33µF
C4793	ECJ0EB1C103K	S.M.CAP	16V	10nF
C4794	ECJ1VB1C104K	S.M.CAP	16V	100nF
C4795	ECJ0EB1C103K	S.M.CAP	16V	10nF
C4796	ECJ1VB1C104K	S.M.CAP	16V	100nF
C4797	ECJ0EB1C103K	S.M.CAP	16V	10nF
C4804	ECJ0EB1A104K	S.M.CAP	10V	100nF
C4805	ECJ0EB1C103K	S.M.CAP	16V	10nF
C4806	ECJ0EB1A104K	S.M.CAP	10V	100nF
C4807	ECJ0EB1C103K	S.M.CAP	16V	10nF
C4808	ECJ0EB1A104K	S.M.CAP	10V	100nF
C4809	ECJ0EB1C103K	S.M.CAP	16V	10nF
C4810	ECJ0EB1A104K	S.M.CAP	10V	100nF
C4811	ECJ0EB1C103K	S.M.CAP	16V	10nF
C4812	ECJ0EB1A104K	S.M.CAP	10V	100nF
C4813	ECJ0EB1C103K	S.M.CAP	16V	10nF
C4814	ECJ0EB1A104K	S.M.CAP	10V	100nF
C4815	ECJ0EB1C103K	S.M.CAP	16V	10nF
C4816	ECJ0EB1A104K	S.M.CAP	10V	100nF
C4817	ECJ0EB1C103K	S.M.CAP	16V	10nF
C4818	ECJ0EB1A104K	S.M.CAP	10V	100nF
C4819	ECJ0EB1C103K	S.M.CAP	16V	10nF
C4820	ECJ0EB1A104K	S.M.CAP	10V	100nF
C4821	ECJ0EB1C103K	S.M.CAP	16V	10nF
C4822	ECJ0EB1A104K	S.M.CAP	10V	100nF
C4823	ECJ0EB1C103K	S.M.CAP	16V	10nF
C4824	ECJ0EB1A104K	S.M.CAP	10V	100nF
C4825	ECJ0EB1C103K	S.M.CAP	16V	10nF
C4826	ECJ0EB1A104K	S.M.CAP	10V	100nF
C4827	ECJ0EB1C103K	S.M.CAP	16V	10nF
C4828	ECJ0EB1A104K	S.M.CAP	10V	100nF

Cct Ref	Parts Number	Description		
C4829	ECJ0EB1C103K	S.M.CAP	16V	10nF
C4830	ECJ0EB1A104K	S.M.CAP	10V	100nF
C4831	ECJ0EB1C103K	S.M.CAP	16V	10nF
C4832	ECJ0EB1A104K	S.M.CAP	10V	100nF
C4833	ECJ0EB1C103K	S.M.CAP	16V	10nF
C4834	ECJ0EB1A104K	S.M.CAP	10V	100nF
C4835	ECJ0EB1C103K	S.M.CAP	16V	10nF
C4836	ECJ0EB1A104K	S.M.CAP	10V	100nF
C4837	ECJ0EB1C103K	S.M.CAP	16V	10nF
C4838	ECJ0EB1A104K	S.M.CAP	10V	100nF
C4839	ECJ0EB1C103K	S.M.CAP	16V	10nF
C4840	ECJ0EB1A104K	S.M.CAP	10V	100nF
C4841	ECJ0EB1C103K	S.M.CAP	16V	10nF
C4842	ECJ0EB1A104K	S.M.CAP	10V	100nF
C4843	ECJ0EB1C103K	S.M.CAP	16V	10nF
C4844	ECJ1VB1C104K	S.M.CAP	16V	100nF
C4845	ECJ0EB1C103K	S.M.CAP	16V	10nF
C4846	ECJ1VB1C104K	S.M.CAP	16V	100nF
C4847	ECJ0EB1C103K	S.M.CAP	16V	10nF
C4848	ECJ1VB1C104K	S.M.CAP	16V	100nF
C4850	ECJ1VB1C104K	S.M.CAP	16V	100nF
C4851	ECJ0EB1C103K	S.M.CAP	16V	10nF
C4852	ECJ1VB1C104K	S.M.CAP	16V	100nF
C4853	ECJ0EB1C103K	S.M.CAP	16V	10nF
C4854	ECJ1VB1C104K	S.M.CAP	16V	100nF
C4856	ECJ0EB1A104K	S.M.CAP	10V	100nF
C4857	ECJ0EB1C103K	S.M.CAP	16V	10nF
C4858	ECJ0EB1A104K	S.M.CAP	10V	100nF
C4859	ECJ0EB1C103K	S.M.CAP	16V	10nF
C4862	ECJ0EB1A104K	S.M.CAP	10V	100nF
C4863	ECJ0EB1C103K	S.M.CAP	16V	10nF
C4864	ECJ0EB1A104K	S.M.CAP	10V	100nF
C4865	ECJ0EB1C103K	S.M.CAP	16V	10nF
C4866	ECJ0EB1A104K	S.M.CAP	10V	100nF
C4868	ECJ0EB1A104K	S.M.CAP	10V	100nF
C4869	ECJ0EB1C103K	S.M.CAP	16V	10nF
C4870	ECJ0EB1A104K	S.M.CAP	10V	100nF
C4871	ECJ0EB1C103K	S.M.CAP	16V	10nF
C4872	ECJ0EB1A104K	S.M.CAP	10V	100nF
C4873	ECJ0EB1C103K	S.M.CAP	16V	10nF
C4874	ECJ0EB1A104K	S.M.CAP	10V	100nF
C4875	ECJ0EB1C103K	S.M.CAP	16V	10nF
C4876	ECJ0EB1A104K	S.M.CAP	10V	100nF
C4877	ECJ0EB1C103K	S.M.CAP	16V	10nF
C4878	ECJ0EB1A104K	S.M.CAP	10V	100nF
C4879	ECJ0EB1C103K	S.M.CAP	16V	10nF
C4881	F2H0J220A010	ELECT	6.3V	22µF
C4882	ECJ0EB1C103K	S.M.CAP	16V	10nF
C4883	ECJ0EB1C103K	S.M.CAP	16V	10nF
C4884	EEEHB1C470UR	ELECT	16V	47µF
C4887	EEEHB0G221P	ELECT	4V	220µF
C4888	ECJ1VB1A105K	S.M.CAP	10V	1000nF
C4889	ECJ1VC1H220J	S.M.CAP	50V	22pF
C4890	ECJ1VC1H220J	S.M.CAP	50V	22pF
C4891	ECJ1VC1H101J	S.M.CAP	50V	100pF
C4893	ECJ1VB1C105K	SMD	16V	1000nF
C4894	ECJ1VB1C105K	SMD	16V	1000nF
C6706	F2G1C470A022	ELECT	16V	47µF
C6707	ECJ1VB1C104K	S.M.CAP	16V	100nF
C6709	F1H1A1050028	CERAMIC	10V	1µF
C6710	F1H1A1050028	CERAMIC	10V	1µF
C6712	ECJ1VB1C104K	S.M.CAP	16V	100nF
C6713	ECJ1VB1C104K	S.M.CAP	16V	100nF
C6715	ECJ1VB1C104K	S.M.CAP	16V	100nF
C6716	ECJ1VB1H103	S.M.CAP	50V	10nF
C6717	ECJ1VC1H470J	S.M.CAP	50V	47pF
C6718	ECJ1VC1H470J	S.M.CAP	50V	47pF
C6724	ECJ1VC1H470J	S.M.CAP	50V	47pF





Cct Ref	Parts Number	Description		
C6728	ECJ1VC1H101J	S.M.CAP	50V	100pF
C6729	ECJ1VC1H470J	S.M.CAP	50V	47pF
C6730	ECJ1VB1C104K	S.M.CAP	16V	100nF
C6733	ECJ1VB1C104K	S.M.CAP	16V	100nF
C6740	ECJ1VB1C104K	S.M.CAP	16V	100nF
C6741	F2G1C100A022	ELECT	16V	10µF
C6747	ECJ1VB1C104K	S.M.CAP	16V	100nF
C6748	F1H1A1050028	CERAMIC	10V	1µF
C6749	ECJ1VB1C103K	S.M.CAP	16V	10nF
C6750	EEEHB1C101UP	ELECT	16V	100µF
C6751	ECJ1VC1H471J	S.M.CAP	50V	470pF
C6752	ECJ1VC1H471J	S.M.CAP	50V	470pF
C6753	ECJ1VC1H471J	S.M.CAP	50V	470pF
C6754	ECJ1VC1H471J	S.M.CAP	50V	470pF
C7001	ECKCNA331MB7	CERAMIC	250V	330pF
C7002	ECKCNA331MB7	CERAMIC	250V	330pF
C7005	ECKW3A472KBP	CERAMIC	1KV	4.7nF
C7006	ECQU2A334BN9	FILM	275V	330nF
C7007	ECQU2A104BN9	FILM	275V	100nF
C7008	ECQU2A104BN9	FILM	275V	100nF
C7009	ECQU2A334BN9	FILM	275V	330nF
C7010	ECKCNA101MB7	CERAMIC	250V	100pF
C7100	ECUV1H103JCN	S.M.CAP	50V	10nF
C7101	F2A1C472A232	ELECT	16V	4700µF
C7201	F2A1V471A192	ELECT	35V	470µF
C7202	ECUV1H103JCN	S.M.CAP	50V	10nF
C7203	ECUV1H103JCN	S.M.CAP	50V	10nF
C7204	F1J1A1050002	CERAMIC	10V	1µF
C7205	F1J1A1050002	CERAMIC	10V	1µF
C7206	F1J1A1050002	CERAMIC	10V	1µF
C7207	F1J1A1050002	CERAMIC	10V	1µF
C7209	F1J0J2250003	CERAMIC	6.3V	2.2µF
C7210	F2A1C101A121	ELECT	16V	100µF
C7211	ECUV1C224KBX	S.M.CAP	16V	220nF
C7212	F2A1H330A246	ELECT	50V	33µF
C7213	ECUV1H103JCN	S.M.CAP	50V	10nF
C7214	ECUV1H103JCN	S.M.CAP	50V	10nF
C7215	ECUV1H103JCN	S.M.CAP	50V	10nF
C7216	ECJ2FB1H104	S.M.CAP	50V	100nF
C7217	F1J1C104A047	CERAMIC	16V	100nF
C7301	F1J1A1050002	CERAMIC	10V	1µF
C7302	ECJ2VB1H102K	S.M.CAP	50V	1nF
C7303	ECJ2VB1H102K	S.M.CAP	50V	1nF
C7304	ECJ2FB1H104	S.M.CAP	50V	100nF
C7305	ECJ2FB1H104	S.M.CAP	50V	100nF
C7306	ECJ2FB1E105K	S.M.CAP	25V	1µF
C7307	ECJ2FB1E105K	S.M.CAP	25V	1µF
C7308	F1J1C104A047	CERAMIC	16V	100nF
C7309	ECUV1H103JCN	S.M.CAP	50V	10nF
C7310	ECUV1H103JCN	S.M.CAP	50V	10nF
C7311	F1J1C104A047	CERAMIC	16V	100nF
C7312	F1J1C104A047	CERAMIC	16V	100nF
C7313	F2A1H471A531	ELECT	50V	470µF
C7314	F2A1H471A531	ELECT	50V	470µF
C7315	F2A1H471A531	ELECT	50V	470µF
C7316	F2A1C1020027	ELECT	16V	1000µF
C7317	F2A1C1020027	ELECT	16V	1000µF
C7318	ECJ2FB1E105K	S.M.CAP	25V	1µF
C7319	ECJ2FB1E105K	S.M.CAP	25V	1µF
C7401	F1J1C104A047	CERAMIC	16V	100nF
C7402	ECJ2FB1C105K	S.M.CAP	16V	1000nF
C7403	ECJ2VB1H102K	S.M.CAP	50V	1nF
C7404	ECJ2VB1H102K	S.M.CAP	50V	1nF
C7405	ECJ2FB1H104	S.M.CAP	50V	100nF
C7406	ECJ2FB1H104	S.M.CAP	50V	100nF
C7407	ECJ2FB1E105K	S.M.CAP	25V	1µF
C7408	ECJ2FB1E105K	S.M.CAP	25V	1µF
C7409	F1J1C104A047	CERAMIC	16V	100nF

Cct Ref	Parts Number	Description		
C7410	ECUV1H103JCN	S.M.CAP	50V	10nF
C7411	ECUV1H103JCN	S.M.CAP	50V	10nF
C7412	F1J1C104A047	CERAMIC	16V	100nF
C7413	F1J1C104A047	CERAMIC	16V	100nF
C7414	F2A1H471A531	ELECT	50V	470µF
C7415	F2A1H471A531	ELECT	50V	470µF
C7416	F2A1H471A531	ELECT	50V	470µF
C7417	F2A1C1020027	ELECT	16V	1000µF
C7418	F2A1V102A363	ELECT	35V	1000µF
C7419	F1J0J2250003	CERAMIC	6.3V	2.2µF
C7420	ECJ2FB1E105K	S.M.CAP	25V	1µF
C7421	ECJ2FB1E105K	S.M.CAP	25V	1µF
C7422	ECJ2FB1E105K	S.M.CAP	25V	1µF
C7501	F2A1H100A165	ELECT	50V	10µF
C7502	F2A1H100A165	ELECT	50V	10µF
C7503	ECUV1H103JCN	S.M.CAP	50V	10nF
C7504	ECUV1H103JCN	S.M.CAP	50V	10nF
C7505	F1J0J2250003	CERAMIC	6.3V	2.2µF
C7506	F2A1V471A192	ELECT	35V	470µF
C7601	ECJ2FB1E224K	S.M.CAP	25V	220nF
C7602	ECJ2FB1E224K	S.M.CAP	25V	220nF
C7603	ECJ2FB1H104	S.M.CAP	50V	100nF
C7605	ECJ2FB1H104	S.M.CAP	50V	100nF
C7611	ECJ2FB1H104	S.M.CAP	50V	100nF
C7701	ECJ2FB1E105K	S.M.CAP	25V	1µF
C7702	ECUV1H103JCN	S.M.CAP	50V	10nF
C7703	F2A1H221A115	ELECT	50V	220µF
C7704	F2A1C1020027	ELECT	16V	1000µF
C7706	ECUV1H103JCN	S.M.CAP	50V	10nF
C7707	ECJ2FB1H104	S.M.CAP	50V	100nF
C7952	ECUV1H103JCN	S.M.CAP	50V	10nF
C7953	ECUV1H103JCN	S.M.CAP	50V	10nF
C7954	ECUV1H103JCN	S.M.CAP	50V	10nF
C7955	ECUV1H103JCN	S.M.CAP	50V	10nF
C7956	ECUV1H103JCN	S.M.CAP	50V	10nF
C7958	ECUV1H103JCN	S.M.CAP	50V	10nF
C7959	ECUV1H103JCN	S.M.CAP	50V	10nF
C7960	ECUV1H103JCN	S.M.CAP	50V	10nF
C7961	ECUV1H103JCN	S.M.CAP	50V	10nF
C7964	ECUV1H103JCN	S.M.CAP	50V	10nF
C7965	ECUV1H103JCN	S.M.CAP	50V	10nF
C7966	F2A1E1010056	ELECT	25V	100µF
C7967	F2A1E1010056	ELECT	25V	100µF
TERMINALS AND LINKS				
.	K9ZZ00000424	EARTH LUG		
.	TSXL431	H2-DG2,H3-DG3 WIRE		
.	TSXL433	GS3-SD3 WIRE		
AP1	K1KA23A00003	23P CONNECTOR		
AP3	K1KA09A00210	9P CONNECTOR		
AP4	K1KA23A00003	23P CONNECTOR		
AP5	K1KA23A00003	23P CONNECTOR		
AP6	K1KA03AA0193	3P CONNECTOR		
AP10	K1KA02A00613	2P CONNECTOR		
DG2	K1MN40B00044	40P CONNECTOR		
DG3	K1MN40B00044	40P CONNECTOR		
DG4	K1KB23A00003	23P CONNECTOR		
DG5	K1KB23A00003	23P CONNECTOR		
DG6	K1KA08AA0104	8P CONNECTOR		
DG7	K1KB30B00044	30P CONNECTOR		
DG8	K1FY119D0001	HDMI CONNECTOR		
DG9	K1FY119D0001	HDMI CONNECTOR		
G1	K1KA10BA0062	10P CONNECTOR		
G4	K1KA30AA0009	30P CONNECTOR		
G4-H4	TXJ/G40LSM	G4-H4 WIRE		
G5	K1KA20AA0009	20P CONNECTOR		
G5-H5	TXJ/G50LSM	G5-H5 WIRE		
G10	K1KA04BA0061	4P CONNECTOR		

Cct Ref	Parts Number	Description		
G11	K1KA05BA0061	5P CONNECTOR		
G15	K1KA02A00553	2P CONNECTOR		
G15-H	TXJ/HG0LSM	G15 TO H-PRINT		
GS3	K1MN40A00025	40P CONNECTOR		
GS8	K1KA07AA0104	7P CONNECTOR		
GS8-H8	TXJGS80MHJ	GS8-H8 WIRE		
GS9	K1KA15A00148	15P CONNECTOR		
GS9-H9	TXJGS90MHJ	GS9-H9 WIRE		
H1	K1KB23A00003	23P CONNECTOR		
H2	K1MN40B00044	40P CONNECTOR		
H3	K1MN40B00044	40P CONNECTOR		
H4	K1KA30AA0009	30P CONNECTOR		
H5	K1KA20AA0009	20P CONNECTOR		
H8	K1KA07AA0193	7P CONNECTOR		
H9	K1KA15A00148	15P CONNECTOR		
H12	K1KA08AA0193	8P CONNECTOR		
JK2001	K2HA204A00038	JACK		
JK2002	K2HA204A00038	JACK		
JK3001	K1FB315A00005	JACK		
JK3002	K1FB121A00006	SCART SOCKET		
JK3003	K1FB121A00006	SCART SOCKET		
JK3004	K1FB121A00006	SCART SOCKET		
JK3005	K2HA307A00008	JACK		
JK3801	K4BK23B000004	AV TERMINAL		
JK6701	K1NA09E000057	CONNECTOR		
K6	K1KA03AA0193	3P CONNECTOR		
P2-AP2	TXJ/P20MHJ	P2-AP2 WIRE		
V1	K1KA10BA0062	10P CONNECTOR		
SWITCHES				
SW001	K0F162B00002	SWITCH		▲
SW3802	EVQPB105K	SWITCH		
SW3803	EVQPB105K	SWITCH		
SW3804	EVQPB105K	SWITCH		
SW3805	EVQPB105K	SWITCH		
SW3806	EVQPB105K	SWITCH		
RELAYS				
RL7001	K6B2AGA00026	RELAY		▲
DIFFERENCES FOR MODEL TX--26LX600F				
EXPLODED VIEW				
34	TKUC17703	BACK COVER		▲
35	TKPA94803	BOTTOM PANEL L		
36	TKPA94906	BOTTOM PANEL R		
37	TTYA0772	CABINET		▲
38	TNPA3863AG	DG P.C.B. X	RTL	▲
39	TKZC5081	LCD MTG BOTTOM		
40	TKZC5082	LCD MTG L/R		
41	TKZC5080	LCD MTG TOP		
42	L5EDD6Q00019	LCD PANEL		▲
43	TBM0E0660	MODEL LABEL		
MISCELLANEOUS COMPONENTS				
.	TPC0E61402	CARTON		
.	TPD0E0070	BOTTOM CUSHION		
.	TPD0E0071	TOP CUSHION		
.	TPD0E1012-1	REAR CUSHION		
.	TTPA0425	PANEL ASSY L		
.	TTPA0426	PANEL ASSY R		
INSTRUCTION BOOKS				
.	TQB0E0267A	GERMAN		
.	TQB0E0267B	DUTCH		
.	TQB0E0267C	ITALIAN		
.	TQB0E0267D	FRENCH		
.	TQB0E0267E	SPANISH		
.	TQB0E0267F	SWEDISH		
.	TQB0E0267K	DANISH		

Cct Ref	Parts Number	Description
.	TQB0E0267U	ENGLISH
I.C.s		
IC1101	E28F0/031/1E	FLASH SW C3FBMD000223
IC1102	X24C26LX600F	EAROM C3EBJC000061
TRANSISTORS		
Q4098	B1ABCF000138	TRANSISTOR
Q4099	B1ADCE000011	TRANSISTOR
FILTERS		
FL4033	J0HAAB000036	FILTER
RESISTORS		
JS4063	ERJ2GE0R00X	SMD .063W - 0 Ω
R4911	ERJ2GE0R00X	SMD .063W - 0 Ω
R4912	ERJ2GEJ103X	SMD .063W 5% 10K Ω
R4913	ERJ2GEJ102X	SMD .063W 5% 1K Ω
R4914	ERJ2GEJ102X	SMD .063W 5% 1K Ω
R4915	ERJ2GEJ103X	SMD .063W 5% 10K Ω
R4931	ERJ2GE0R00X	SMD .063W - 0 Ω
R4933	ERJ2GE0R00X	SMD .063W - 0 Ω
R4936	ERJ2GE0R00X	SMD .063W - 0 Ω
R4946	ERJ2GEJ103X	SMD .063W 5% 10K Ω
TERMINALS AND LINKS		
AP6-K6	TXJAP60MJJ	AP6-K6 WIRE
DG7-IN	TXJDG70MJJ	DG7-PANEL
G1-V1	TXJV10MJJ	G1-V1 WIRE
G10-SPL	TXJ/G10MJJ	G10-SP L
G11-SPR	TXJ/G11MJJ	G11-SP R
P-INV	TXJ/P40MJJ	CN202-CN04 WIRE
P/DG-I	TXJ/P10MJJ	P(CN203)/DG6-INV(CN01)
DIFFERENCES FOR MODEL TX--26LX600P		
EXPLODED VIEW		
34	TKUC17703	BACK COVER ▲
35	TKPA94803	BOTTOM PANEL L
36	TKPA94906	BOTTOM PANEL R
37	TTYA0772	CABINET ▲
38	TNPA3863AH	DG P.C.B. X RTL ▲
39	TKZC5081	LCD MTG BOTTOM
40	TKZC5082	LCD MTG L/R
41	TKZC5080	LCD MTG TOP
42	L5EDD6Q00019	LCD PANEL ▲
43	TBM0E0661	MODEL LABEL
MISCELLANEOUS COMPONENTS		
.	TPC0E61402	CARTON
.	TPD0E0070	BOTTOM CUSHION
.	TPD0E0071	TOP CUSHION
.	TPD0E1012-1	REAR CUSHION
.	TTPA0425	PANEL ASSY L
.	TTPA0426	PANEL ASSY R
INSTRUCTION BOOKS		
.	TQB0E0268L	RUSSIAN
.	TQB0E0268M	BULGARIAN
.	TQB0E0268N	ROMANIAN
.	TQB0E0268P	POLISH
.	TQB0E0268Q	HUNGARIAN
.	TQB0E0268R	CZECH
.	TQB0E0268U	ENGLISH
.	TQB0E0268Y	UKRAINIAN
I.C.s		
IC1101	E28F0/031/1E	FLASH SW C3FBMD000223
IC1102	X24C26LX600F	EAROM C3EBJC000061
TRANSISTORS		
Q4098	B1ABCF000138	TRANSISTOR
Q4099	B1ADCE000011	TRANSISTOR

Cct Ref	Parts Number	Description
FILTERS		
FL4033	J0HAAB000036	FILTER
RESISTORS		
JS4064	ERJ2GE0R00X	SMD .063W - 0 Ω
R4911	ERJ2GE0R00X	SMD .063W - 0 Ω
R4912	ERJ2GEJ103X	SMD .063W 5% 10K Ω
R4913	ERJ2GEJ102X	SMD .063W 5% 1K Ω
R4914	ERJ2GEJ102X	SMD .063W 5% 1K Ω
R4915	ERJ2GEJ103X	SMD .063W 5% 10K Ω
R4931	ERJ2GE0R00X	SMD .063W - 0 Ω
R4933	ERJ2GE0R00X	SMD .063W - 0 Ω
R4936	ERJ2GE0R00X	SMD .063W - 0 Ω
R4946	ERJ2GEJ103X	SMD .063W 5% 10K Ω
TERMINALS AND LINKS		
AP6-K6	TXJAP60MJJ	AP6-K6 WIRE
DG7-IN	TXJDG70MJJ	DG7-PANEL
G1-V1	TXJV10MJJ	G1-V1 WIRE
G10-SPL	TXJ/G10MJJ	G10-SP L
G11-SPR	TXJ/G11MJJ	G11-SP R
P-INV	TXJ/P40MJJ	CN202-CN04 WIRE
P/DG-I	TXJ/P10MJJ	P(CN203)/DG6-INV(CN01)
DIFFERENCES FOR MODEL TX--32LX600F		
EXPLODED VIEW		
34	TKUC17603	BACK COVER ▲
35	TKPA94603	BOTTOM PANEL L
36	TKPA94706	BOTTOM PANEL R
37	TTYA0771-1	CABINET ▲
38	TNPA3863AB	DG P.C.B. X RTL ▲
39	TKZC5078	LCD MTG BOTTOM
40	TKZC5079	LCD MTG L/R
41	TKZC5077	LCD MTG TOP
42	L5EDD8Q00025	LCD PANEL ▲
43	TBM0E0658	MODEL LABEL
MISCELLANEOUS COMPONENTS		
.	TPC0E61502	CARTON
.	TPD0E0072	BOTTOM CUSHION
.	TPD0E0073	TOP CUSHION
.	TPD0E1013-1	REAR CUSHION
.	TTPA0423	PANEL ASSY L
.	TTPA0424	PANEL ASSY R
INSTRUCTION BOOKS		
.	TQB0E0267A	GERMAN
.	TQB0E0267B	DUTCH
.	TQB0E0267C	ITALIAN
.	TQB0E0267D	FRENCH
.	TQB0E0267E	SPANISH
.	TQB0E0267F	SWEDISH
.	TQB0E0267K	DANISH
.	TQB0E0267U	ENGLISH
I.C.s		
IC1101	E28F0/021/1E	FLASH SW C3FBMD000223
IC1102	X24C32LX600F	EAROM C3EBJC000061
TRANSISTORS		
Q4102	2SC39380QL	TRANSISTOR
Q4103	2SC39380QL	TRANSISTOR
Q4104	2SC39380QL	TRANSISTOR
Q4105	2SC39380QL	TRANSISTOR
Q4106	2SC39380QL	TRANSISTOR
Q4107	2SC39380QL	TRANSISTOR
FILTERS		
FL4055	J0HAAB000036	FILTER
FL4056	J0HAAB000036	FILTER
FL4057	J0HAAB000036	FILTER

Cct Ref	Parts Number	Description
FL4058	JOHAAB000036	FILTER
RESISTORS		
JS4092	ERJ2GE0R00X	SMD .063W - 0 Ω
R4177	ERJ2GE0R00X	SMD .063W - 0 Ω
R4930	ERJ2GE0R00X	SMD .063W - 0 Ω
R4935	ERJ2GE0R00X	SMD .063W - 0 Ω
R4947	ERJ2GE0R00X	SMD .063W - 0 Ω
R4959	ERJ2GEJ103X	SMD .063W 5% 10K Ω
R4960	ERJ2GEJ103X	SMD .063W 5% 10K Ω
R4961	ERJ2GEJ103X	SMD .063W 5% 10K Ω
R4962	ERJ2GEJ103X	SMD .063W 5% 10K Ω
R4963	ERJ2GEJ103X	SMD .063W 5% 10K Ω
R4964	ERJ6ENF5111V	SMD .125W 1% 5K11 Ω
R4965	ERJ3EKF3001V	SMD 0.1W 1% 3K Ω
R4968	ERJ2GEJ103X	SMD .063W 5% 10K Ω
R4969	ERJ2GEJ103X	SMD .063W 5% 10K Ω
R4970	ERJ2GEJ103X	SMD .063W 5% 10K Ω
R4971	ERJ2GEJ103X	SMD .063W 5% 10K Ω
R4972	ERJ2GEJ103X	SMD .063W 5% 10K Ω
R4973	ERJ6ENF5111V	SMD .125W 1% 5K11 Ω
R4974	ERJ3EKF3001V	SMD 0.1W 1% 3K Ω
R4977	ERJ2GEJ103X	SMD .063W 5% 10K Ω
R4978	ERJ2GEJ103X	SMD .063W 5% 10K Ω
R4979	ERJ2GEJ103X	SMD .063W 5% 10K Ω
R4980	ERJ2GEJ103X	SMD .063W 5% 10K Ω
R4981	ERJ2GEJ103X	SMD .063W 5% 10K Ω
R4982	ERJ6ENF5111V	SMD .125W 1% 5K11 Ω
R4983	ERJ3EKF3001V	SMD 0.1W 1% 3K Ω
R4984	ERJ2GEJ680X	SMD .063W 5% 68 Ω
R4985	ERJ2GEJ680X	SMD .063W 5% 68 Ω
R4986	ERJ2GEJ680X	SMD .063W 5% 68 Ω
R4990	ERJ3GEY0R00	SMD 0.1W - 0 Ω
R4991	ERJ3GEY0R00	SMD 0.1W - 0 Ω
R4992	ERJ3GEY0R00	SMD 0.1W - 0 Ω
TERMINALS AND LINKS		
AP6-K6	TXJAP60MHJ	AP6-K6 WIRE
DG6-CN	TXJDG60MHJ	DG6-CN21 WIRE
DG7-IN	TXJDG70MHJ	DG7-PANEL
DG11	K1KA03AA0104	3P CONNECTOR
G1-V1	TXJV10MHJ	G1-V1 WIRE
G10-SPL	TXJ/G10MHJ	G10-SP L
G11-SPR	TXJ/G11MHJ	G11-SP R
P/DG-I	TXJ/P10MHJ	P(CN203)/DG11-INV(CN01)
DIFFERENCES FOR MODEL TX--32LX600P		
EXPLODED VIEW		
34	TKUC17603	BACK COVER 
35	TKPA94603	BOTTOM PANEL L
36	TKPA94706	BOTTOM PANEL R
37	TTYA0771-1	CABINET 
38	TNPA3863AC	DG P.C.B. X  RTL
39	TKZC5078	LCD MTG BOTTOM
40	TKZC5079	LCD MTG L/R
41	TKZC5077	LCD MTG TOP
42	L5EDD8Q00025	LCD PANEL 
43	TBM0E0659	MODEL LABEL
MISCELLANEOUS COMPONENTS		
.	TPC0E61502	CARTON
.	TPD0E0072	BOTTOM CUSHION
.	TPD0E0073	TOP CUSHION
.	TPD0E1013-1	REAR CUSHION
.	TTPA0423	PANEL ASSY L
.	TTPA0424	PANEL ASSY R
INSTRUCTION BOOKS		
.	TQB0E0268L	RUSSIAN

Cct Ref	Parts Number	Description
.	TQB0E0268M	BULGARIAN
.	TQB0E0268N	ROMANIAN
.	TQB0E0268P	POLISH
.	TQB0E0268Q	HUNGARIAN
.	TQB0E0268R	CZECH
.	TQB0E0268U	ENGLISH
.	TQB0E0268Y	UKRAINIAN
I.C.s		
IC1101	E28F0/021/1E	FLASH SW C3FBMD000223
IC1102	X24C32LX600P	EAROM C3EBJC000061
TRANSISTORS		
Q4102	2SC39380QL	TRANSISTOR
Q4103	2SC39380QL	TRANSISTOR
Q4104	2SC39380QL	TRANSISTOR
Q4105	2SC39380QL	TRANSISTOR
Q4106	2SC39380QL	TRANSISTOR
Q4107	2SC39380QL	TRANSISTOR
FILTERS		
FL4055	JOHAAB000036	FILTER
FL4056	JOHAAB000036	FILTER
FL4057	JOHAAB000036	FILTER
FL4058	JOHAAB000036	FILTER
RESISTORS		
JS4093	ERJ2GE0R00X	SMD .063W - 0 Ω
R4177	ERJ2GE0R00X	SMD .063W - 0 Ω
R4930	ERJ2GE0R00X	SMD .063W - 0 Ω
R4935	ERJ2GE0R00X	SMD .063W - 0 Ω
R4947	ERJ2GE0R00X	SMD .063W - 0 Ω
R4959	ERJ2GEJ103X	SMD .063W 5% 10K Ω
R4960	ERJ2GEJ103X	SMD .063W 5% 10K Ω
R4961	ERJ2GEJ103X	SMD .063W 5% 10K Ω
R4962	ERJ2GEJ103X	SMD .063W 5% 10K Ω
R4963	ERJ2GEJ103X	SMD .063W 5% 10K Ω
R4964	ERJ6ENF5111V	SMD .125W 1% 5K11 Ω
R4965	ERJ3EKF3001V	SMD 0.1W 1% 3K Ω
R4968	ERJ2GEJ103X	SMD .063W 5% 10K Ω
R4969	ERJ2GEJ103X	SMD .063W 5% 10K Ω
R4970	ERJ2GEJ103X	SMD .063W 5% 10K Ω
R4971	ERJ2GEJ103X	SMD .063W 5% 10K Ω
R4972	ERJ2GEJ103X	SMD .063W 5% 10K Ω
R4973	ERJ6ENF5111V	SMD .125W 1% 5K11 Ω
R4974	ERJ3EKF3001V	SMD 0.1W 1% 3K Ω
R4977	ERJ2GEJ103X	SMD .063W 5% 10K Ω
R4978	ERJ2GEJ103X	SMD .063W 5% 10K Ω
R4979	ERJ2GEJ103X	SMD .063W 5% 10K Ω
R4980	ERJ2GEJ103X	SMD .063W 5% 10K Ω
R4981	ERJ2GEJ103X	SMD .063W 5% 10K Ω
R4982	ERJ6ENF5111V	SMD .125W 1% 5K11 Ω
R4983	ERJ3EKF3001V	SMD 0.1W 1% 3K Ω
R4984	ERJ2GEJ680X	SMD .063W 5% 68 Ω
R4985	ERJ2GEJ680X	SMD .063W 5% 68 Ω
R4986	ERJ2GEJ680X	SMD .063W 5% 68 Ω
R4990	ERJ3GEY0R00	SMD 0.1W - 0 Ω
R4991	ERJ3GEY0R00	SMD 0.1W - 0 Ω
R4992	ERJ3GEY0R00	SMD 0.1W - 0 Ω
TERMINALS AND LINKS		
AP6-K6	TXJAP60MHJ	AP6-K6 WIRE
DG6-CN	TXJDG60MHJ	DG6-CN21 WIRE
DG7-IN	TXJDG70MHJ	DG7-PANEL
DG11	K1KA03AA0104	3P CONNECTOR
G1-V1	TXJV10MHJ	G1-V1 WIRE
G10-SPL	TXJ/G10MHJ	G10-SP L
G11-SPR	TXJ/G11MHJ	G11-SP R
P/DG-I	TXJ/P10MHJ	P(CN203)/DG11-INV(CN01)



Schematic Diagrams

IMPORTANT SAFETY NOTICE
Components identified by  mark have special characteristics important for safety. When replacing any of these components, use only manufacturers' specified parts.



NOTE

1. RESISTOR
All resistors are carbon 1/4W resistor, unless marked otherwise.
Unit of resistance is OHM (Ω) (k=1,000, M=1,000,000)
2. CAPACITORS
All capacitors are ceramic 50V unless marked otherwise.
Unit of capacitance is μ F unless otherwise stated.
3. COIL
Unit of inductance is μ H, unless otherwise stated.

4. TEST POINT
 Test Point Position

5. EARTH SYMBOL
 Chassis Earth (Cold)
 Line Earth (Hot)

6. VOLTAGE MEASUREMENT
Voltage is measured by a D.C. voltmeter.
Measurement conditions are as follows:
Power source 220V-240V AC, 50/60Hz
Receiving Signal Colour Bar signal (RF)
All customer controls Maximum position

7.
 Indicates the Video signal path
 Indicates the Audio signal path

These schematic diagrams are the latest at time of printing and are subject to change without notice.

REMARKS

- a. Do not touch the hot part, or the hot and cold parts at the same time, as you are liable to a shock hazard.
- b. Do not short circuit the hot and cold circuits as electrical components may be damaged.
- c. Do not connect an instrument, such as an oscilloscope, to the hot and cold circuits simultaneously as this may cause fuse failure. Connect the earth of the instruments to the earth connection of the circuit being measured.
- d. Make sure to disconnect the power plug before removing the chassis.

NOTE

1. The Power Supply Circuit contains a circuit area, which uses a separate power supply to isolate the earth connection. The circuit is defined by HOT and COLD indications in the schematic diagram. All circuits, except the Power Circuit, are COLD.

AP-BOARD

TX-32LX600F+P / TX-26LX600F+P

AP-BOARD TNPA3868 (1/3)

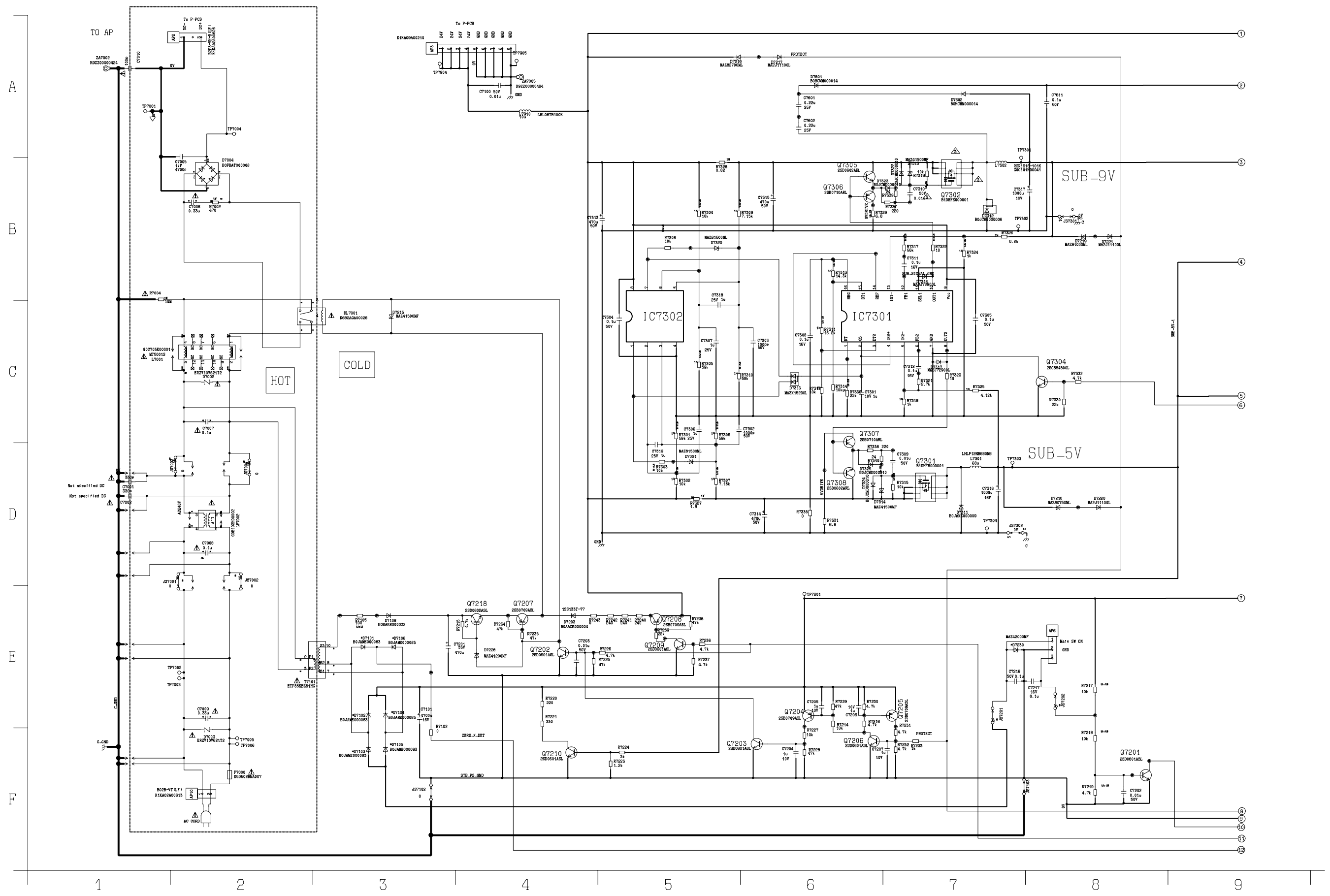

AP-BOARD

TX-32LX600F+P / TX-26LX600F+P

⚠ AP-BOARD TNPA3868 (2/3)

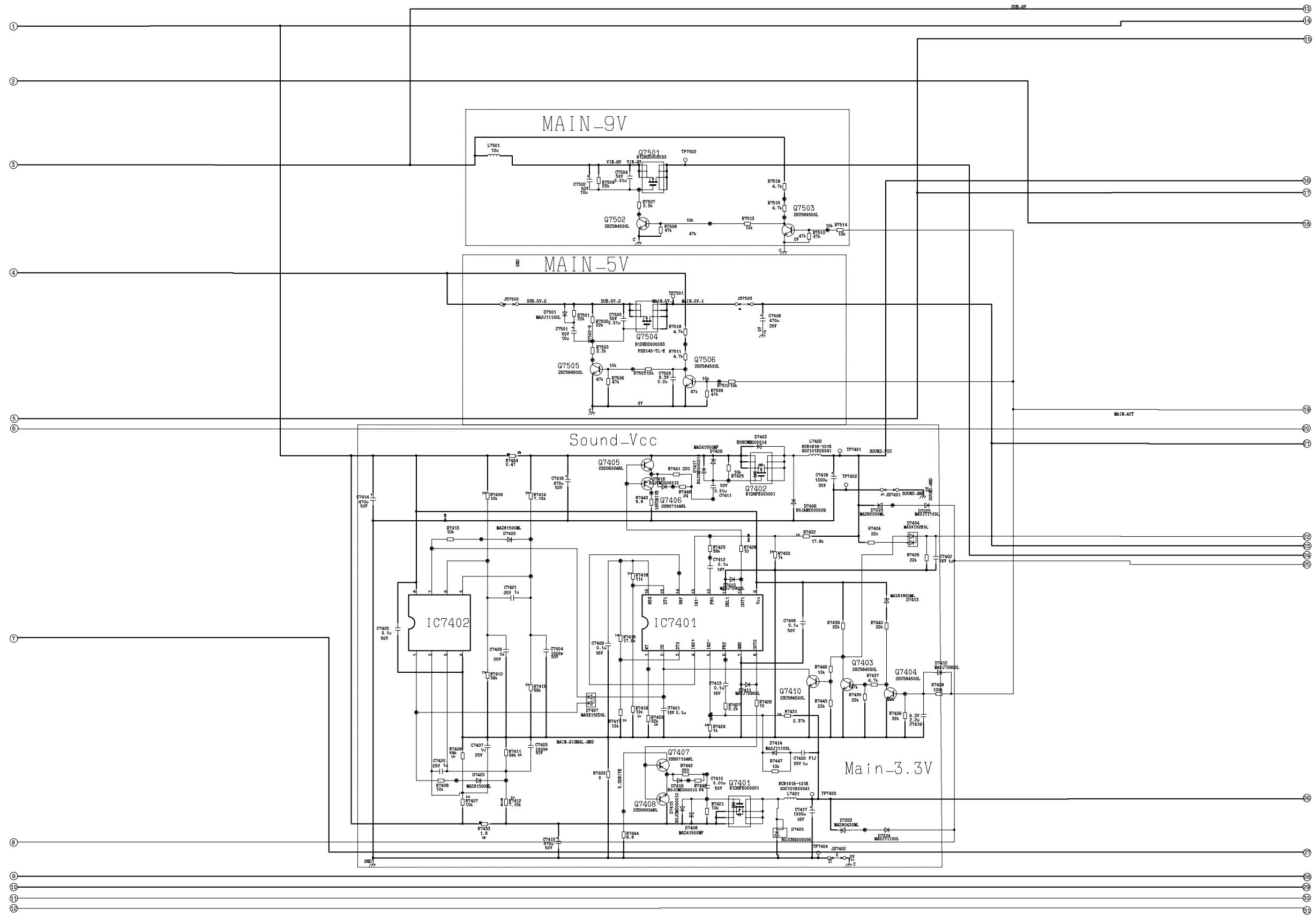

AP-BOARD

TX-32LX600F+P / TX-26LX600F+P

⚠ AP-BOARD TNPA3868 (3/3)

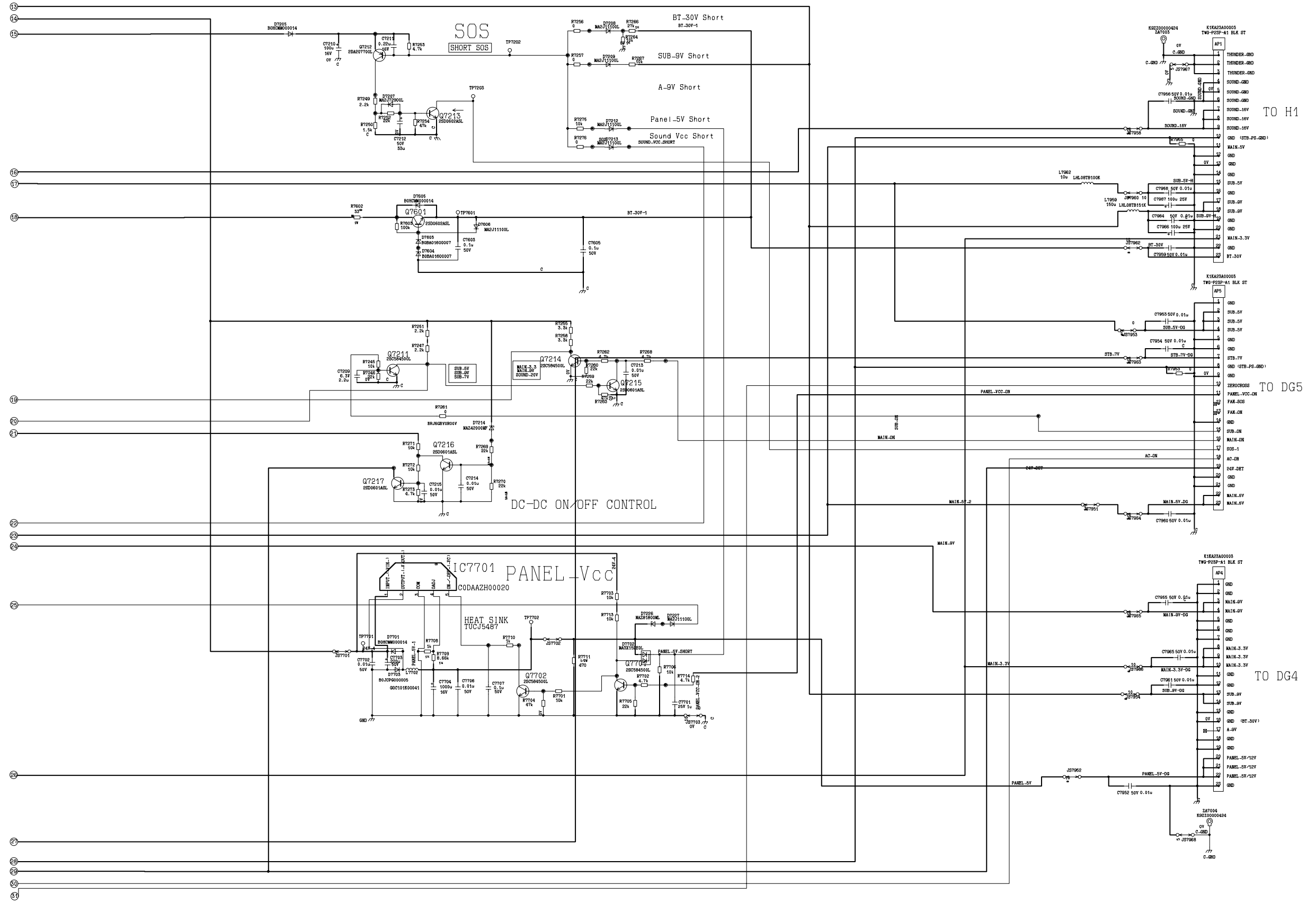

DG-BOARD

TX-32LX600F+P / TX-26LX600F+P

! DG-BOARD TNPA3863 (1/8)

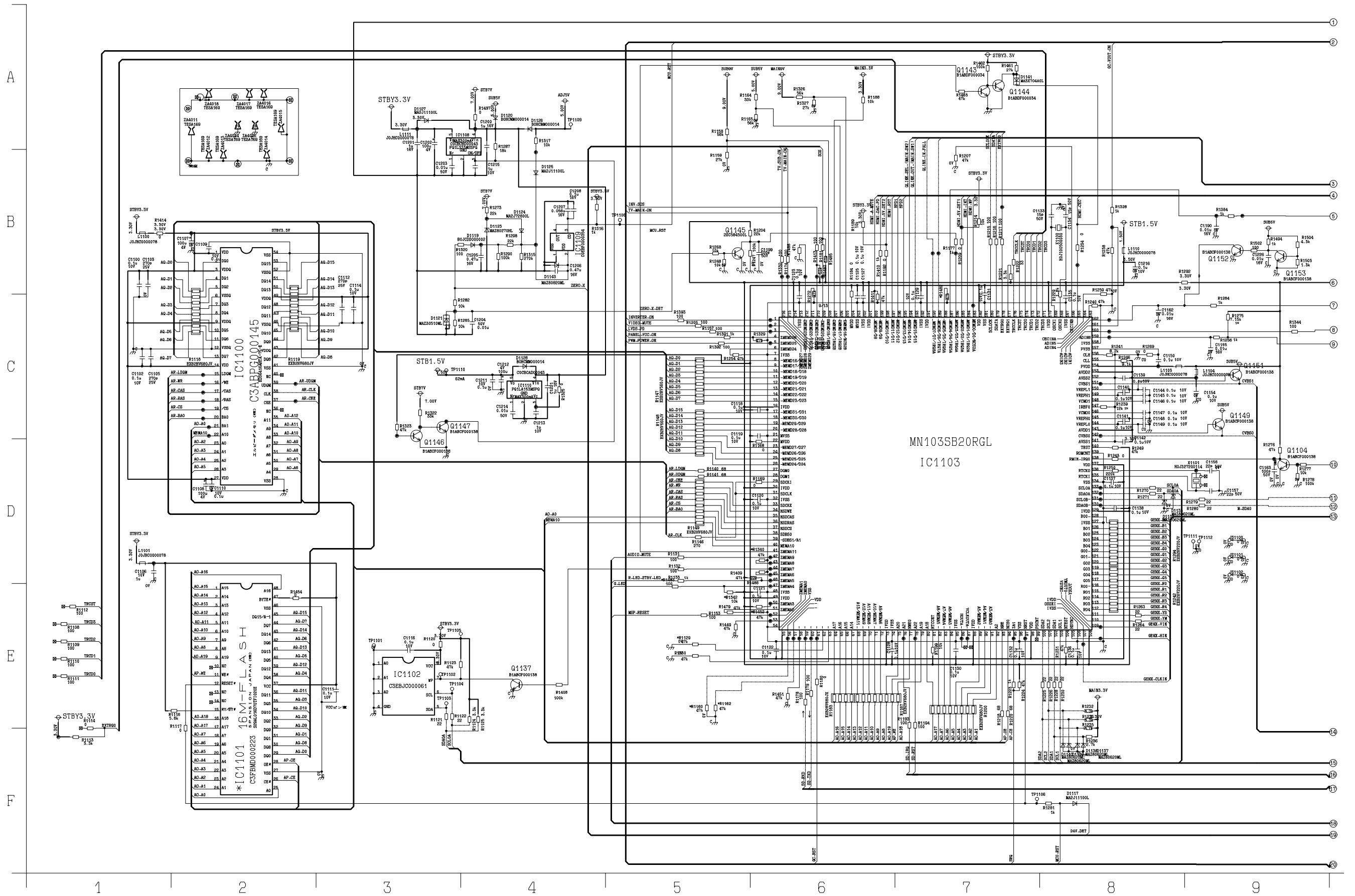

DG-BOARD

TX-32LX600F+P / TX-26LX600F+P

⚠ DG-BOARD TNPA3863 (2/8)

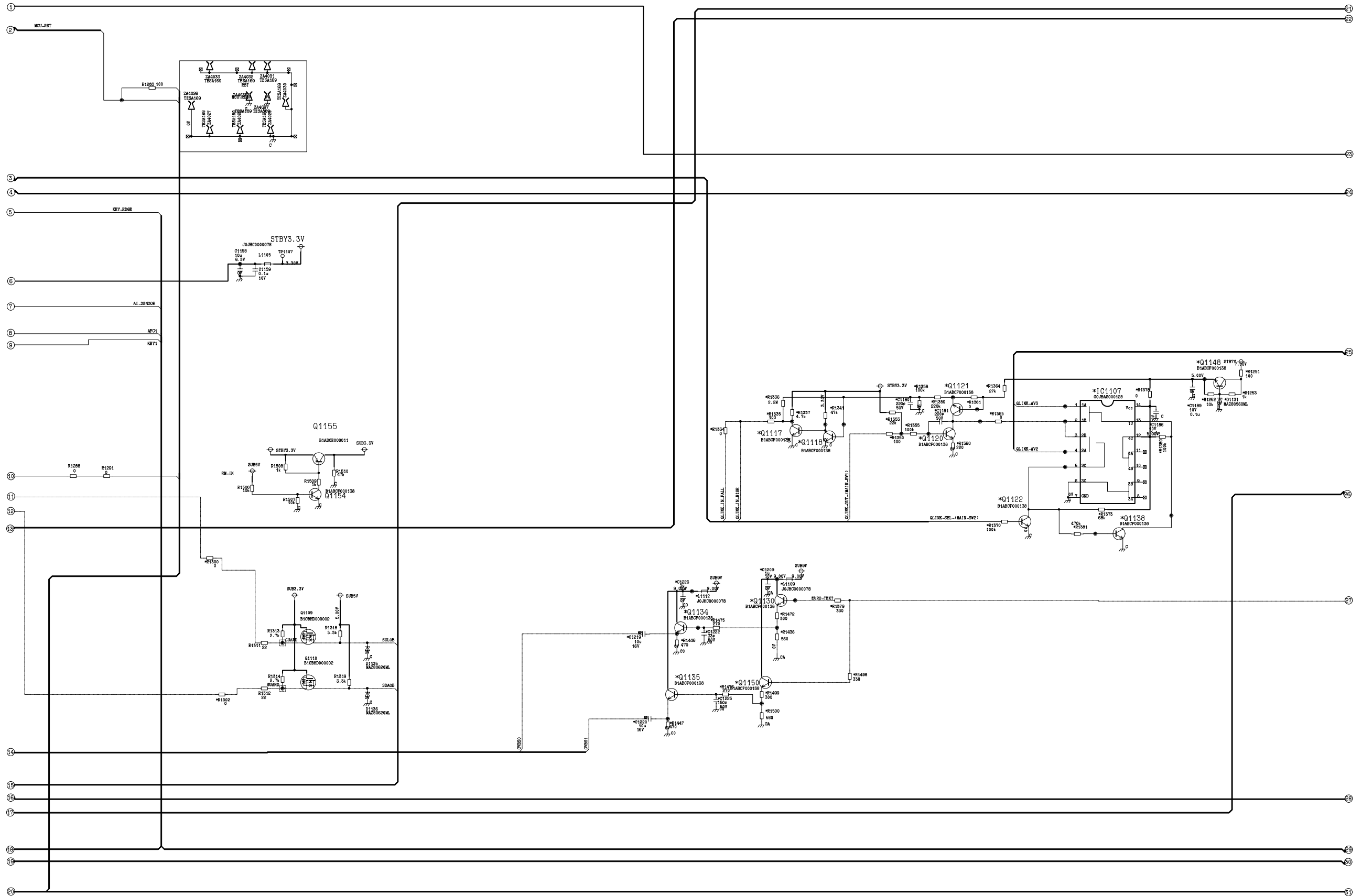

DG-BBOARD

TX-32LX600F+P / TX-26LX600F+P

⚠ DG-BBOARD TNPA3863 (3/8)

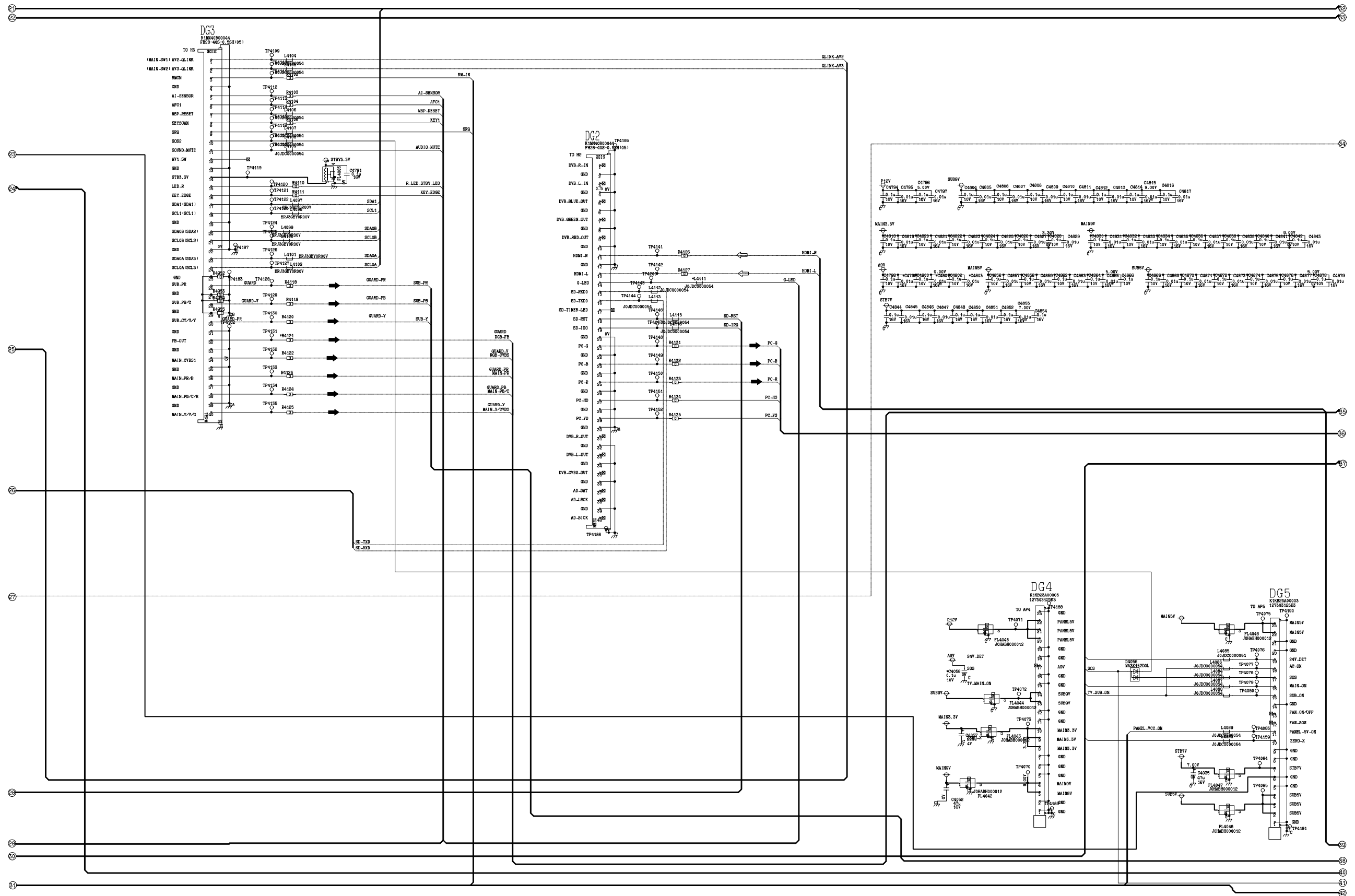

⚠ DG-BOARD TNPA3863 (4/8)

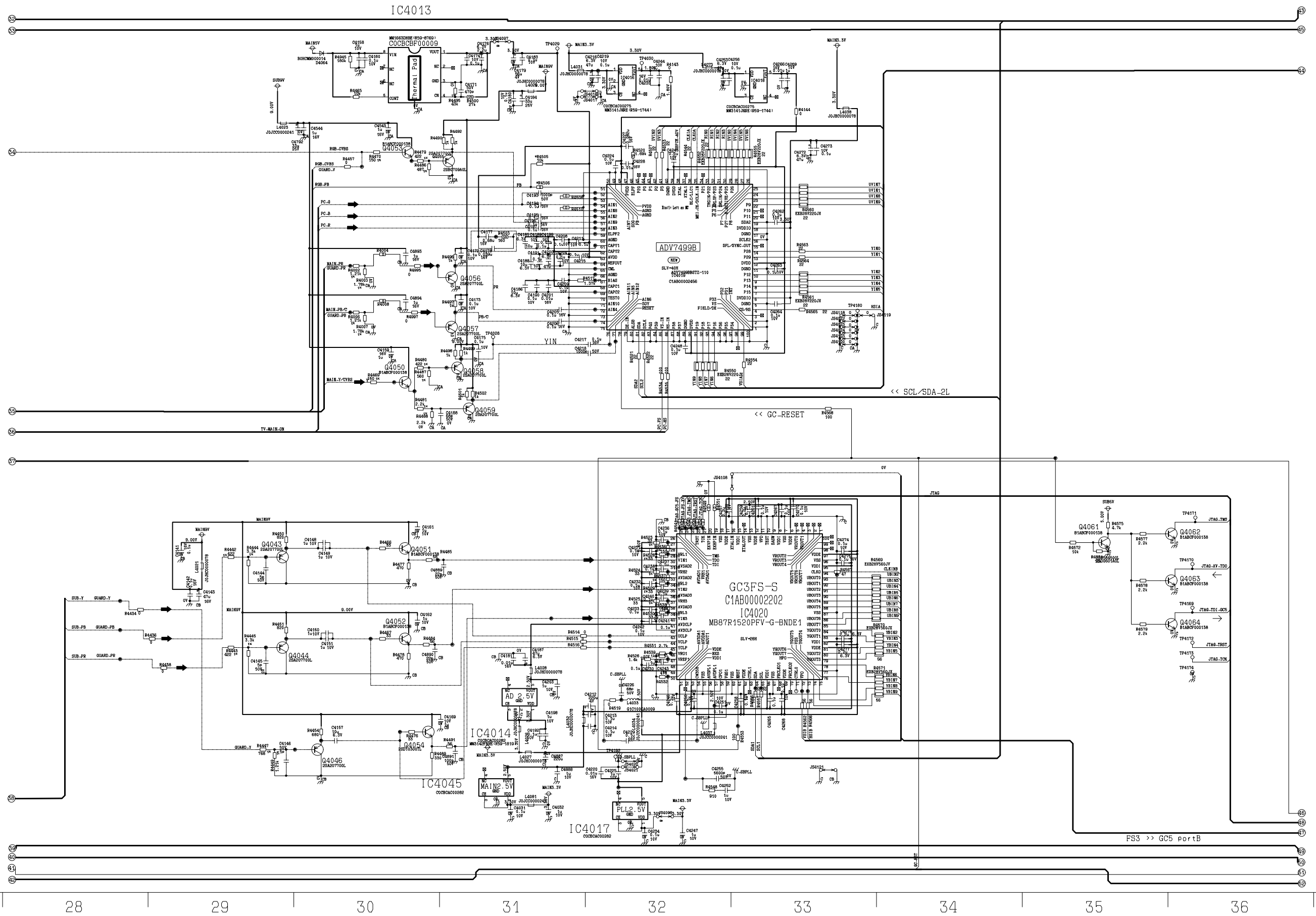

DG-BOARD

TX-32LX600F+P / TX-26LX600F+P

⚠ DG-BOARD TNPA3863 (5/8)

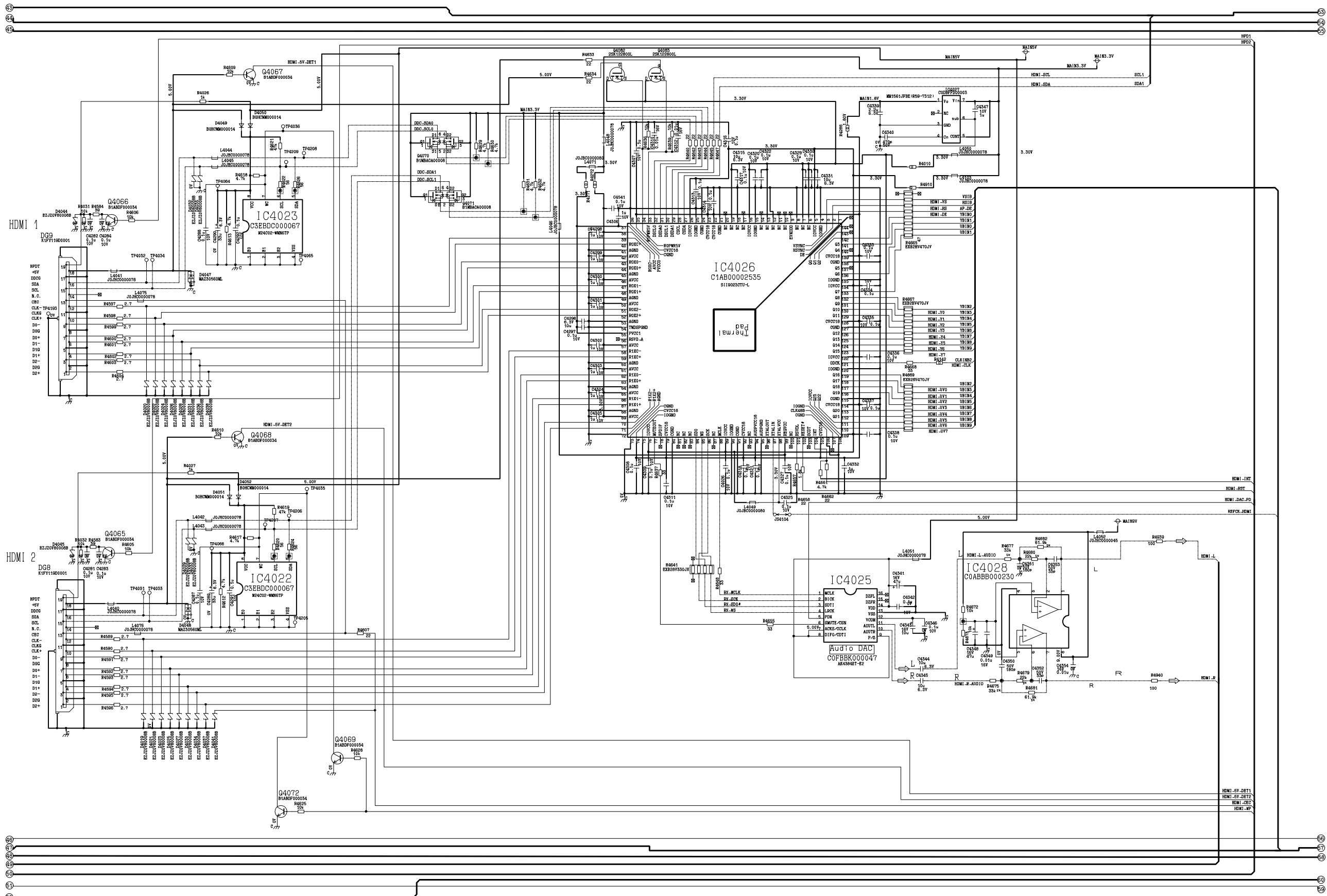

37

38

39

40

41

42

43

44

45

△ DG-BOARD TNPA3863 (6/8)

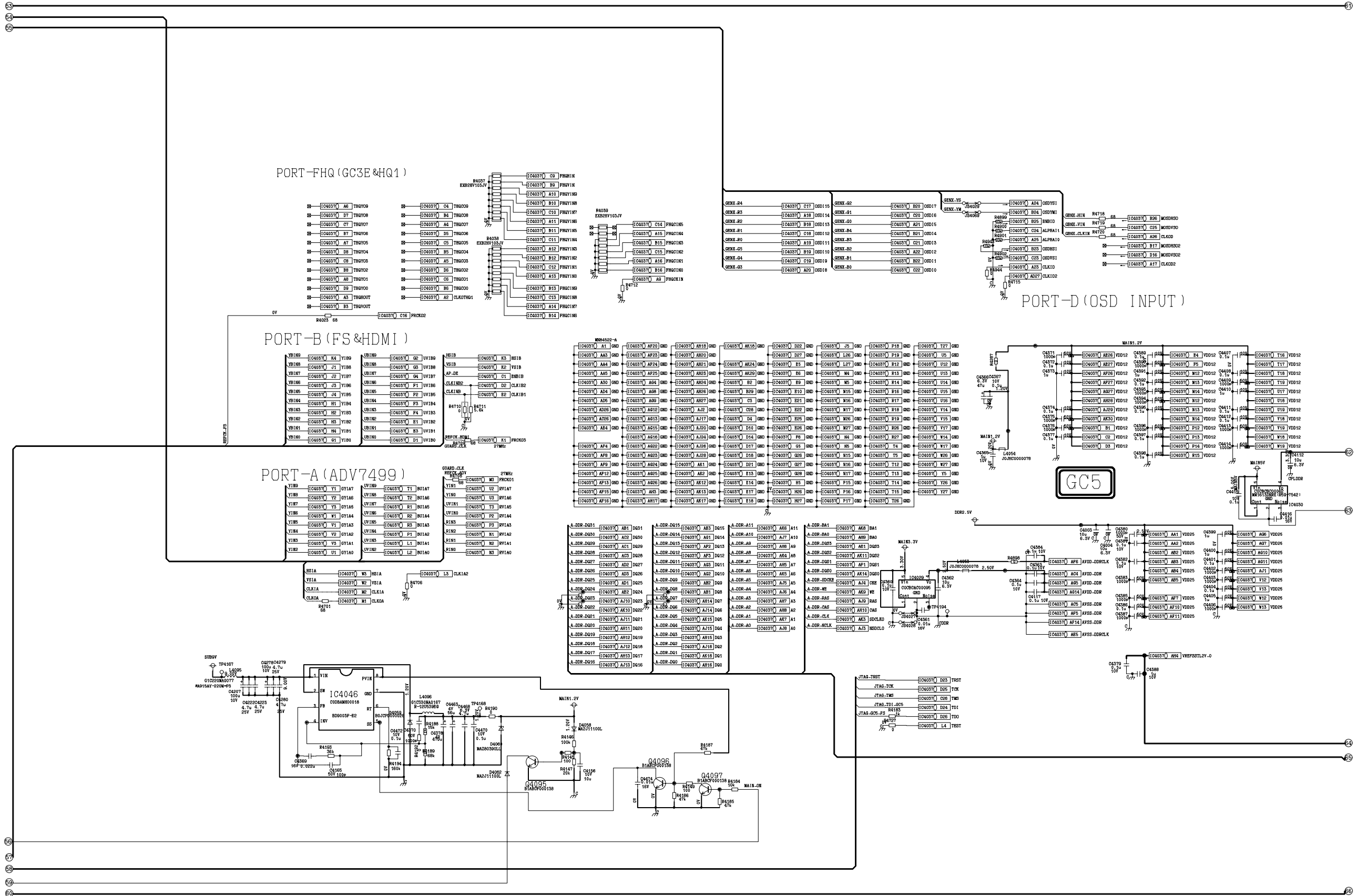

△ DG-BOARD TNPA3863 (7/8)

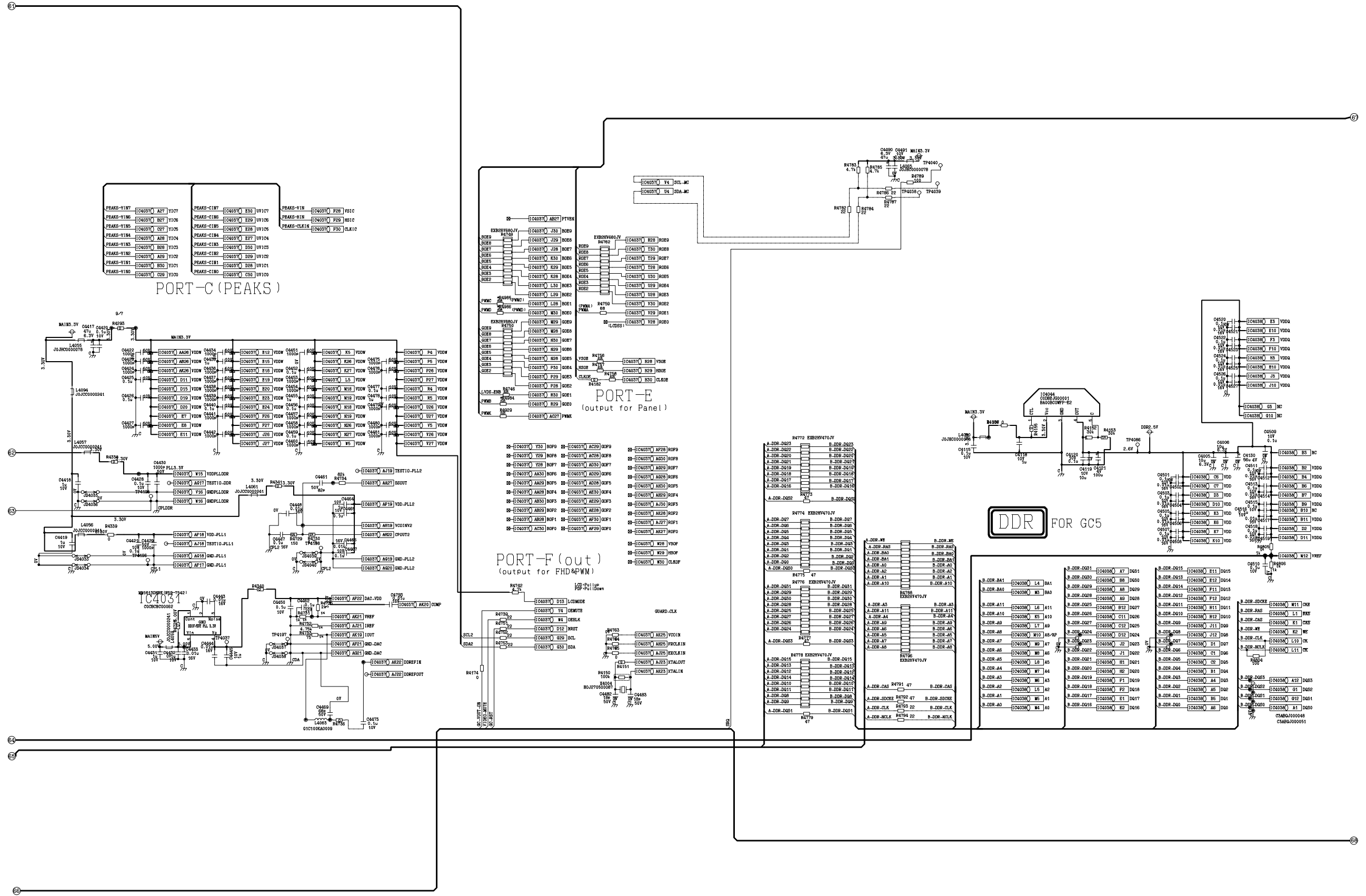

△ DG-BOARD TNPA3863 (8/8)

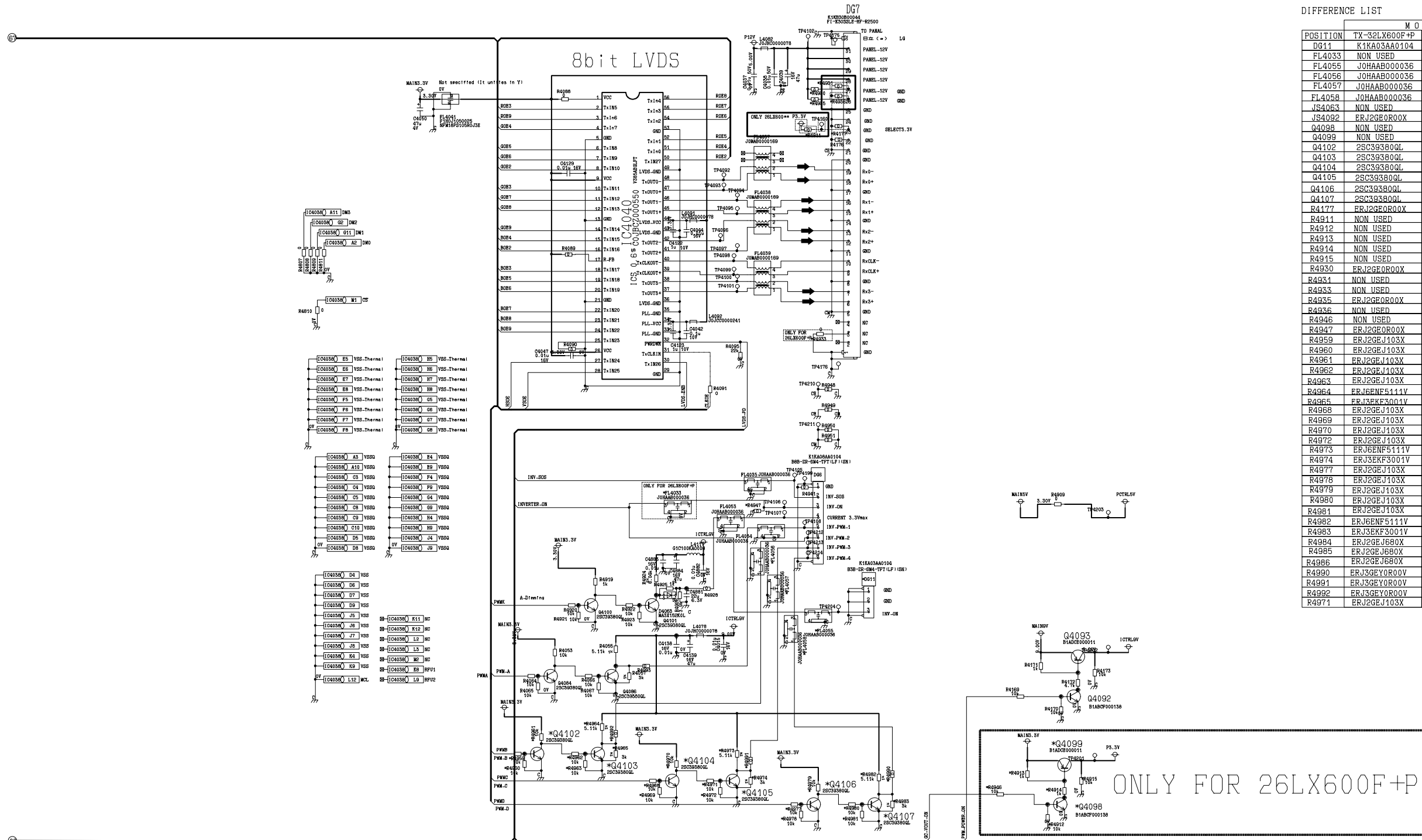

DIFFERENCE LIST

POSITION	M O D E L	
	TX-32LX600F+P	TX-26LX600F+P
DG11	K1KA03AA0104	NON USED
FL4033	NON USED	JOHAAB000036
FL4055	JOHAAB000036	NON USED
FL4056	JOHAAB000036	NON USED
FL4057	JOHAAB000036	NON USED
FL4058	JOHAAB000036	NON USED
JS4063	NON USED	ERJ2GE0R00X
JS4092	ERJ2GE0R00X	NON USED
Q4098	NON USED	B1ABCF000138
Q4099	NON USED	B1ADCF000011
Q4102	2SC39380QL	NON USED
Q4103	2SC39380QL	NON USED
Q4104	2SC39380QL	NON USED
Q4105	2SC39380QL	NON USED
Q4106	2SC39380QL	NON USED
Q4107	2SC39380QL	NON USED
R4177	ERJ2GE0R00X	NON USED
R4911	NON USED	ERJ2GE0R00X
R4912	NON USED	ERJ2GEJ103X
R4913	NON USED	ERJ2GEJ102X
R4914	NON USED	ERJ2GEJ102X
R4915	NON USED	ERJ2GEJ103X
R4930	ERJ2GE0R00X	NON USED
R4931	NON USED	ERJ2GE0R00X
R4933	NON USED	ERJ2GE0R00X
R4935	ERJ2GE0R00X	NON USED
R4936	NON USED	ERJ2GE0R00X
R4946	NON USED	ERJ2GEJ103X
R4947	ERJ2GE0R00X	NON USED
R4959	ERJ2GEJ103X	NON USED
R4960	ERJ2GEJ103X	NON USED
R4961	ERJ2GEJ103X	NON USED
R4962	ERJ2GEJ103X	NON USED
R4963	ERJ2GEJ103X	NON USED
R4964	ERJ3EKF3001V	NON USED
R4965	ERJ3EKF3001V	NON USED
R4968	ERJ2GEJ103X	NON USED
R4969	ERJ2GEJ103X	NON USED
R4970	ERJ2GEJ103X	NON USED
R4972	ERJ2GEJ103X	NON USED
R4973	ERJ6ENF5111V	NON USED
R4974	ERJ3EKF3001V	NON USED
R4977	ERJ2GEJ103X	NON USED
R4978	ERJ2GEJ103X	NON USED
R4979	ERJ2GEJ103X	NON USED
R4980	ERJ2GEJ103X	NON USED
R4981	ERJ2GEJ103X	NON USED
R4982	ERJ6ENF5111V	NON USED
R4983	ERJ3EKF3001V	NON USED
R4984	ERJ2GEJ680X	NON USED
R4985	ERJ2GEJ680X	NON USED
R4986	ERJ2GEJ680X	NON USED
R4990	ERJ3GEY0R00V	NON USED
R4991	ERJ3GEY0R00V	NON USED
R4992	ERJ3GEY0R00V	NON USED
R4971	ERJ2GEJ103X	NON USED

G-BOARD

TX-32LX600F+P / TX-26LX600F+P

⚠ G-BOARD TNPA3864

A
B
C
D
E
F

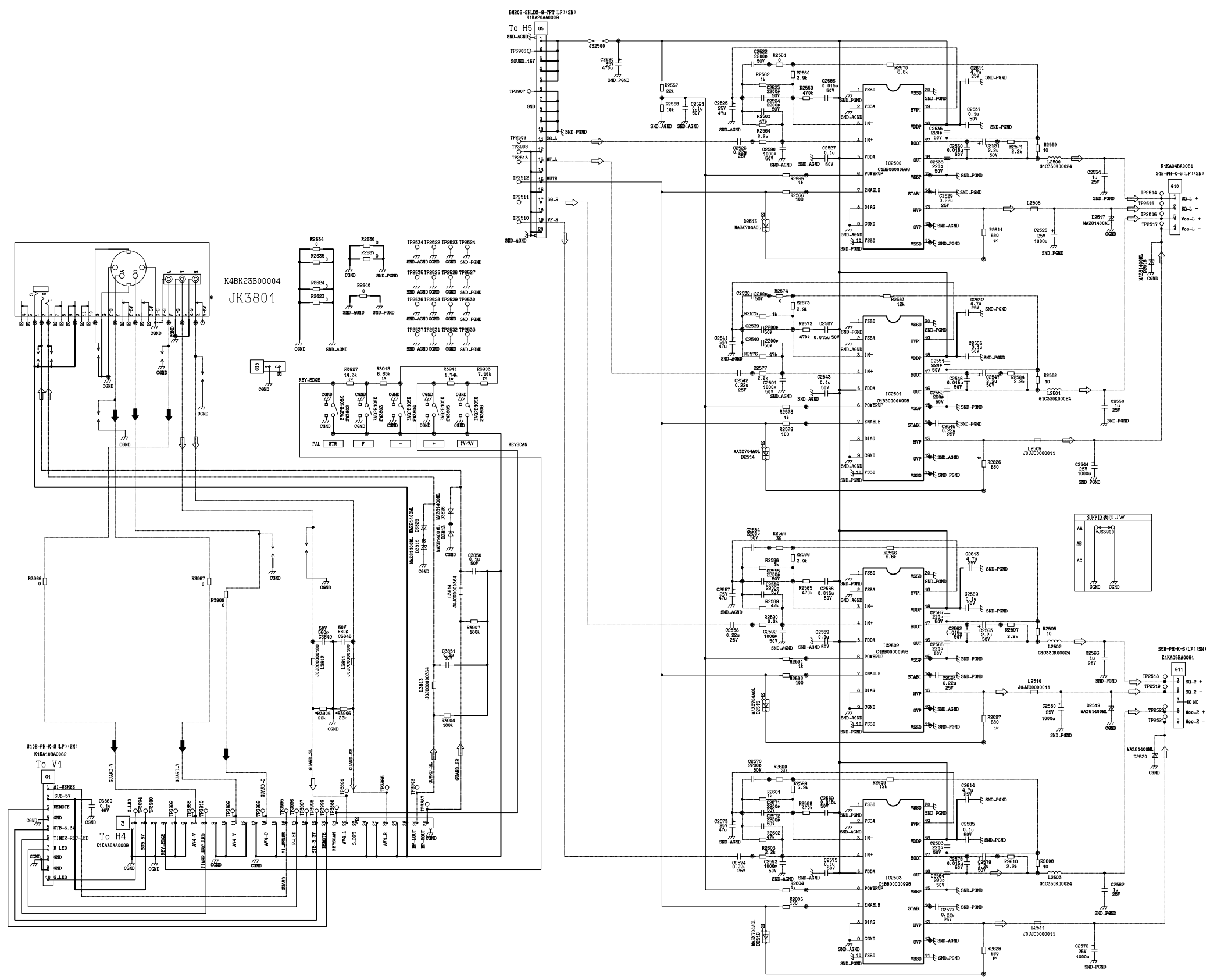

GS-BOARD

TX-32LX600F+P / TX-26LX600F+P

⚠ GS-BOARD TNPA3867

A
B
C
D
E
F

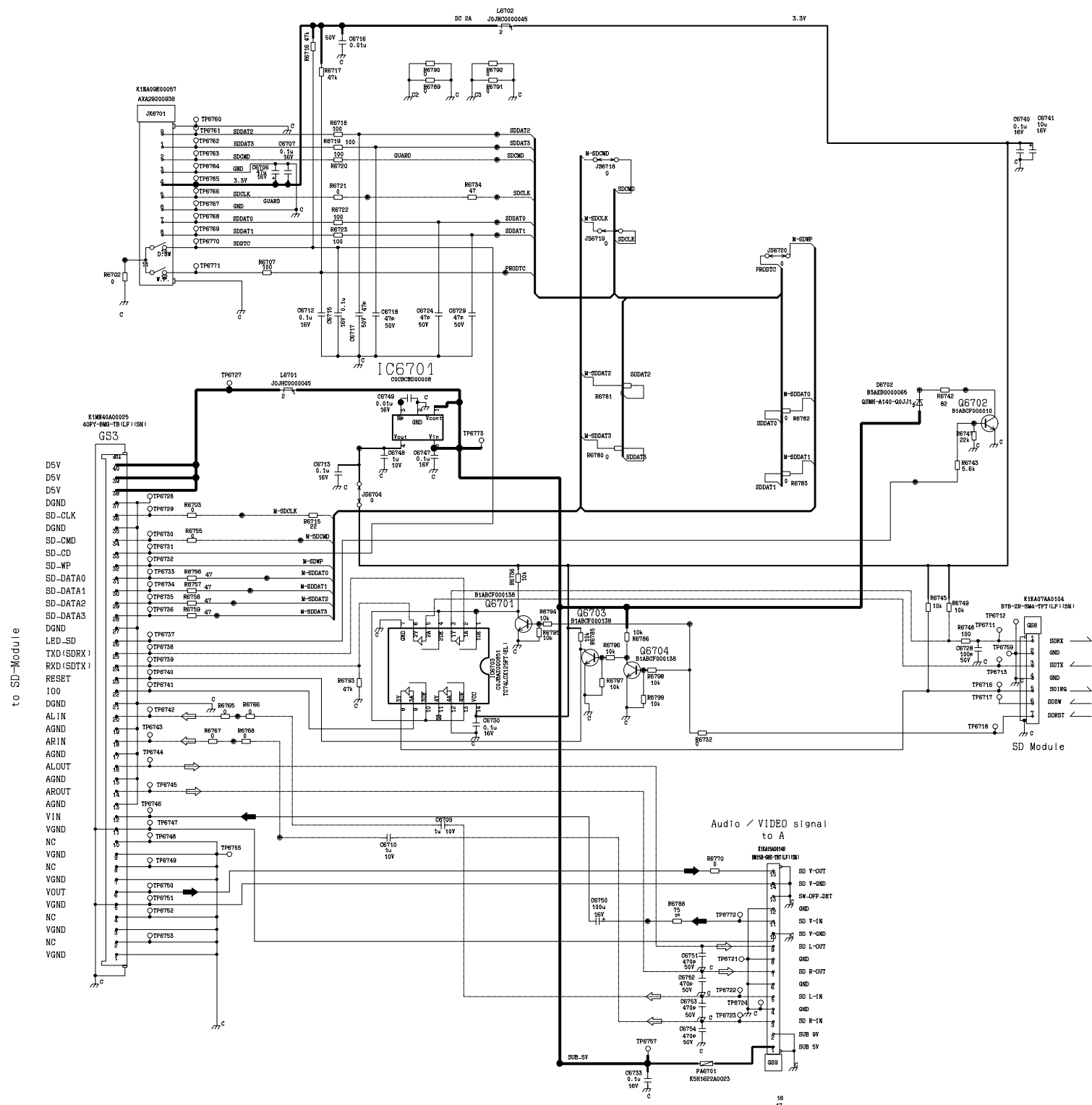

H-BOARD

TX-32LX600F+P / TX-26LX600F+P

! H-BOARD TNP0657 1/4

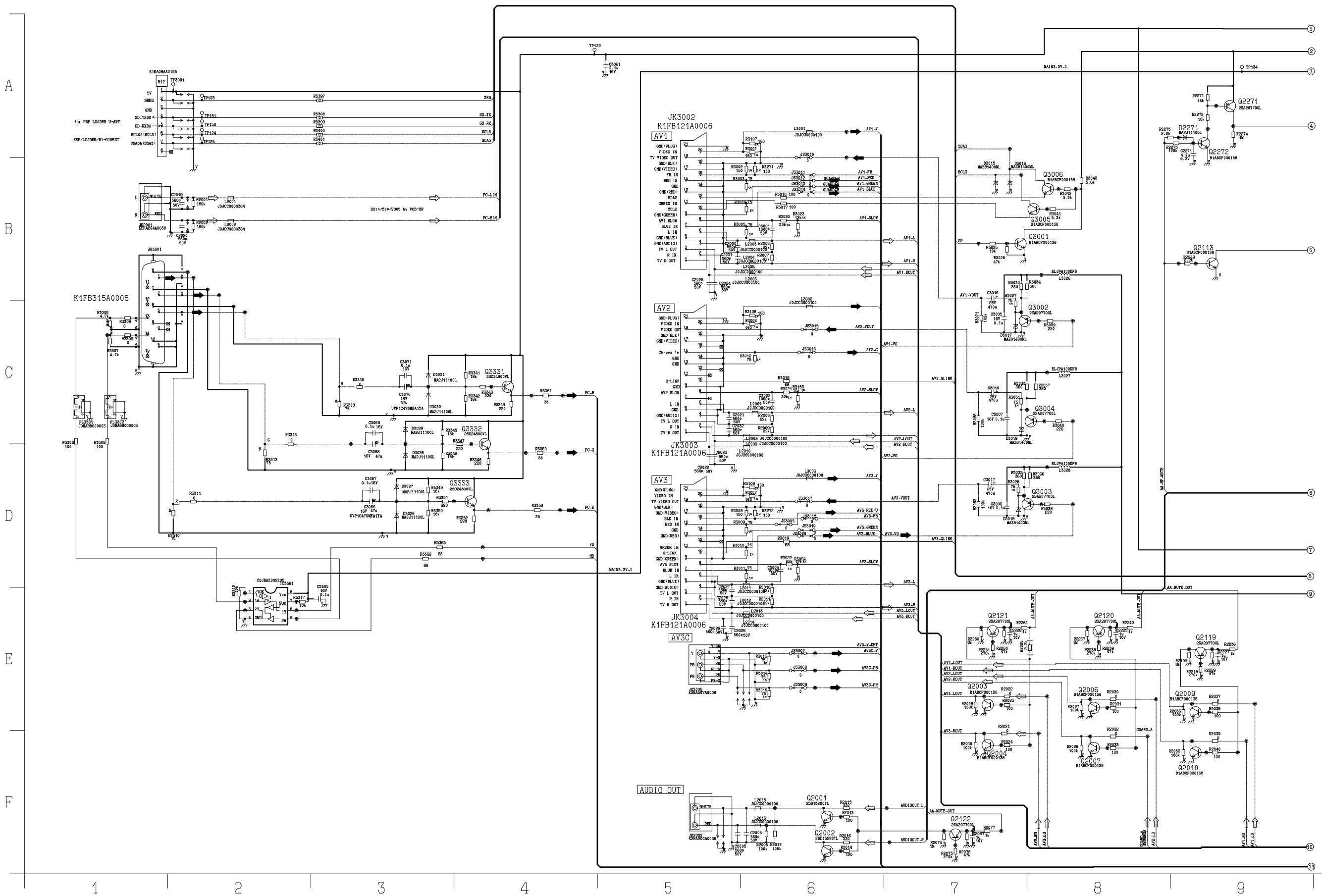

H-BOARD

TX-32LX600F+P / TX-26LX600F+P

! H-BOARD TNPH0657 2/4

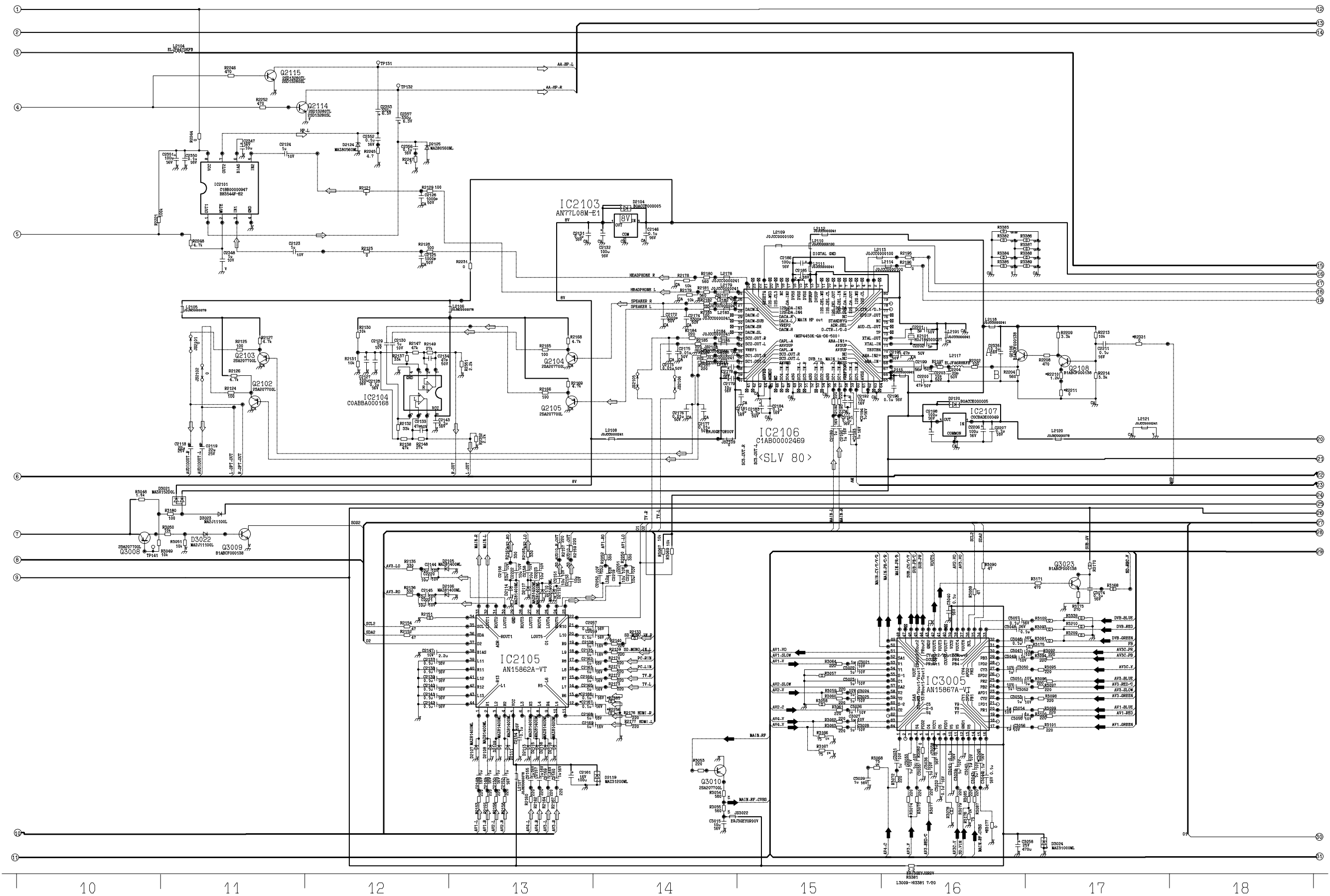

H-BOARD

TX-32LX600F+P / TX-26LX600F+P

! H-BOARD TNPH0657 3/4

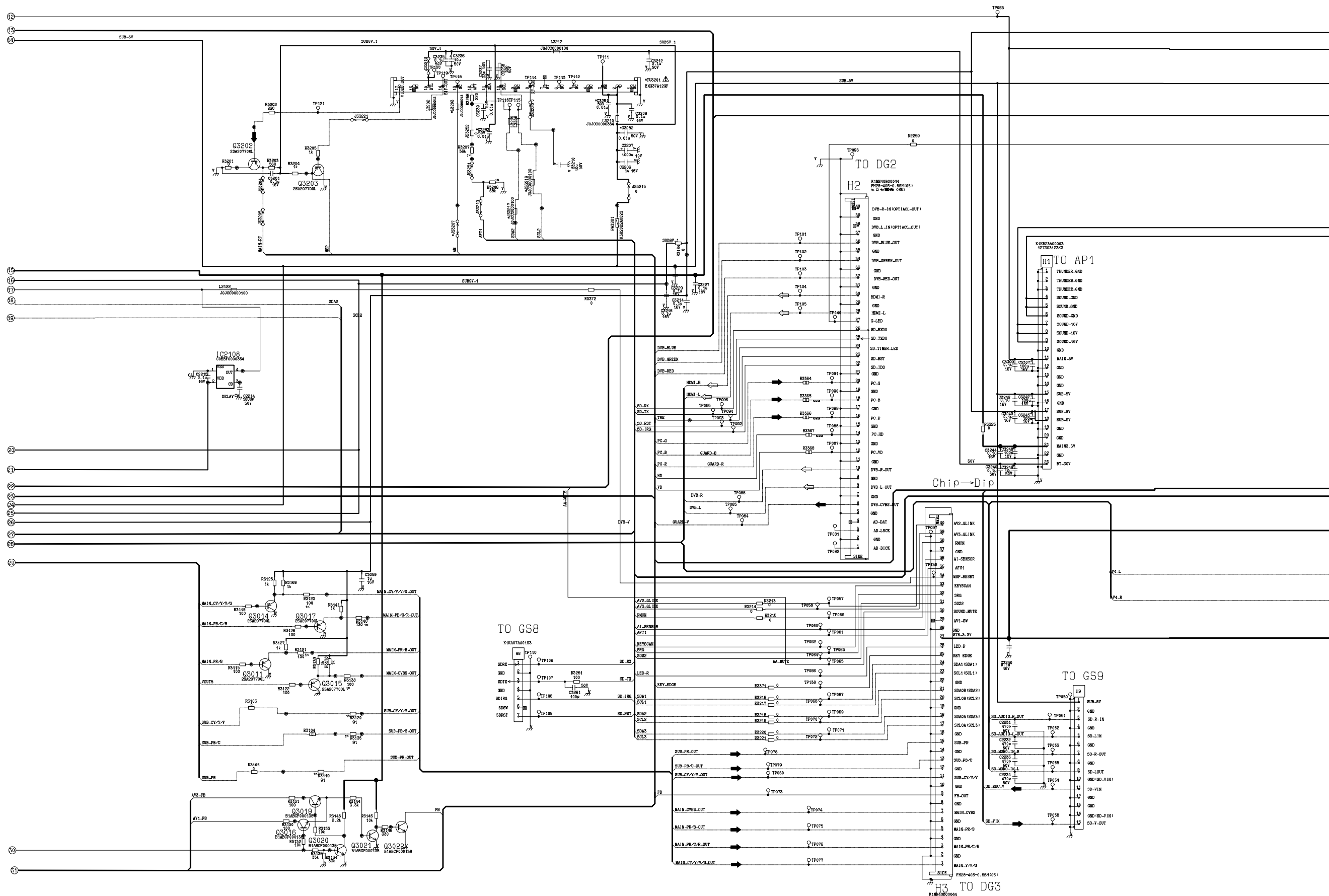

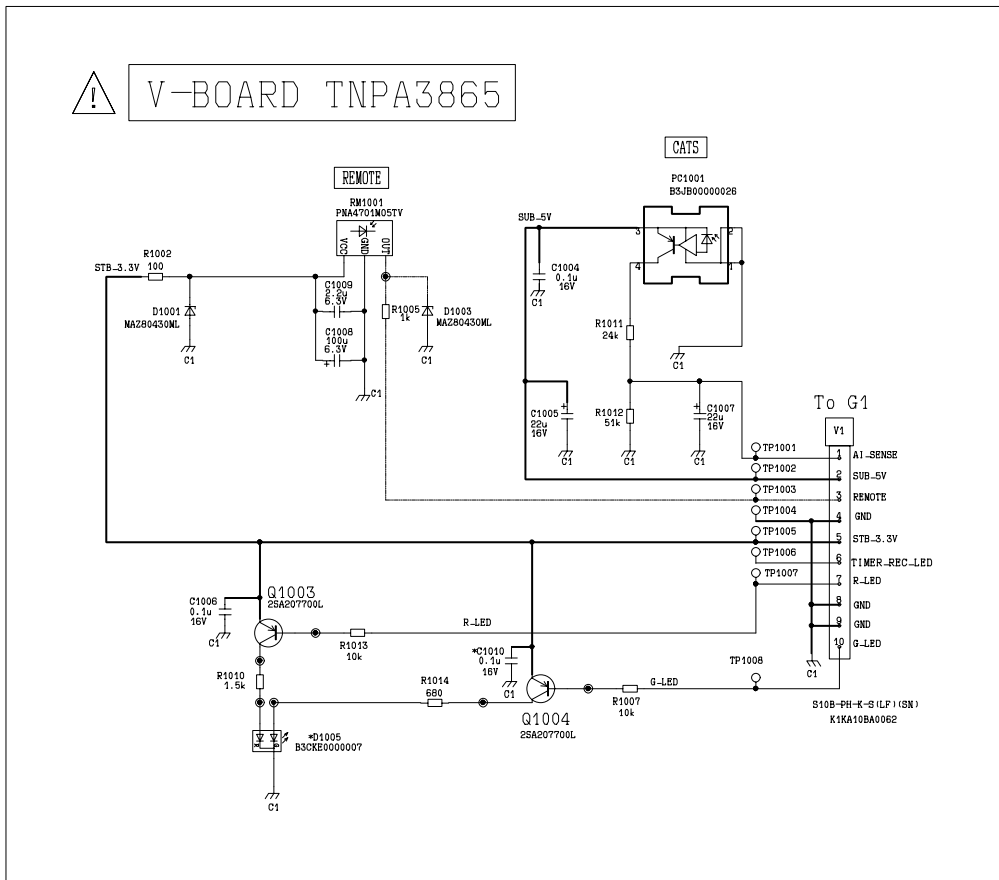

K-BOARD TNPA3866

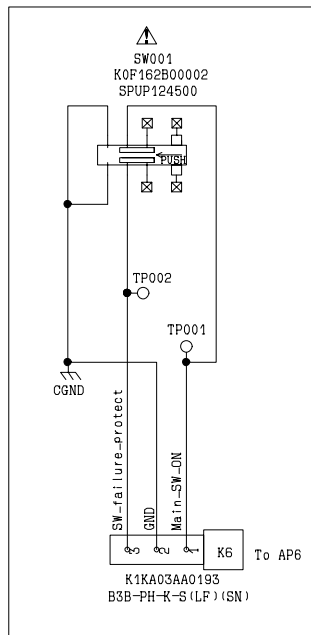

Conductor Views

AP-BOARD TNPA3868

TRAN'S					
Q7201	D3	D7107	C4	D7418	C1
Q7202	D5	D7108	C5	D7423	B1
Q7203	D5	D7203	D5	D7501	E2
Q7204	D5	D7205	D2	D7601	D3
Q7205	D4	D7207	E1	D7602	D3
Q7206	D4	D7208	D1	D7603	E4
Q7207	D5	D7209	D3	D7604	D4
Q7208	E4	D7212	F5	D7605	E4
Q7209	D5	D7213	D2	D7606	E4
Q7210	C5	D7214	E3	D7701	E4
Q7211	D2	D7215	E5	D7702	F4
Q7212	D2	D7216	D4	D7703	E4
Q7213	E1	D7217	D4		
Q7214	E2	D7218	D3		
Q7215	E2	D7219	D3		
Q7216	E2	D7220	D2		
Q7217	D3	D7221	D3	IC'S	
Q7218	D5	D7222	D2	IC7701	E5
Q7301	B2	D7223	D2	IC7301	C4
Q7302	C3	D7224	D2	IC7302	B3
Q7304	C4	D7225	D2	IC7401	C1
Q7305	C3	D7226	E4	IC7402	C1
Q7306	D3	D7227	E4		
Q7307	B3	D7228	D5	TP'S	
Q7308	B3	D7230	B1	TP7001	F6
Q7401	C2	D7311	C2	TP7002	A2
Q7402	D1	D7312	C3	TP7003	A1
Q7403	C2	D7313	C4	TP7004	F6
Q7404	D2	D7314	B3	TP7005	B1
Q7405	C1	D7315	C3	TP7006	B1
Q7406	D1	D7316	C4	TP7201	C4
Q7407	C2	D7317	C4	TP7202	D2
Q7408	C2	D7320	C3	TP7203	F2
Q7410	C2	D7321	B4	TP7301	C3
Q7501	E3	D7322	C3	TP7302	C3
Q7502	D3	D7323	C3	TP7303	C2
Q7503	D3	D7324	B3	TP7304	C2
Q7504	E2	D7325	B3	TP7401	D1
Q7505	E2	D7403	D1	TP7402	D1
Q7506	E2	D7404	D1	TP7403	D2
Q7601	E4	D7405	C2	TP7404	D2
Q7701	E5	D7406	D1	TP7501	E2
Q7702	F5	D7407	C2	TP7502	E3
		D7408	C2	TP7601	F3
		D7409	C1	TP7701	E4
		D7410	C1	TP7702	E4
		D7411	C1	TP7851	F4
		D7412	D2	TP7901	F4
		D7413	C2	TP7902	F4
		D7414	C2	TP7903	F4
		D7415	C2	TP7904	F5
		D7416	C2	TP7905	F5
		D7417	D1		

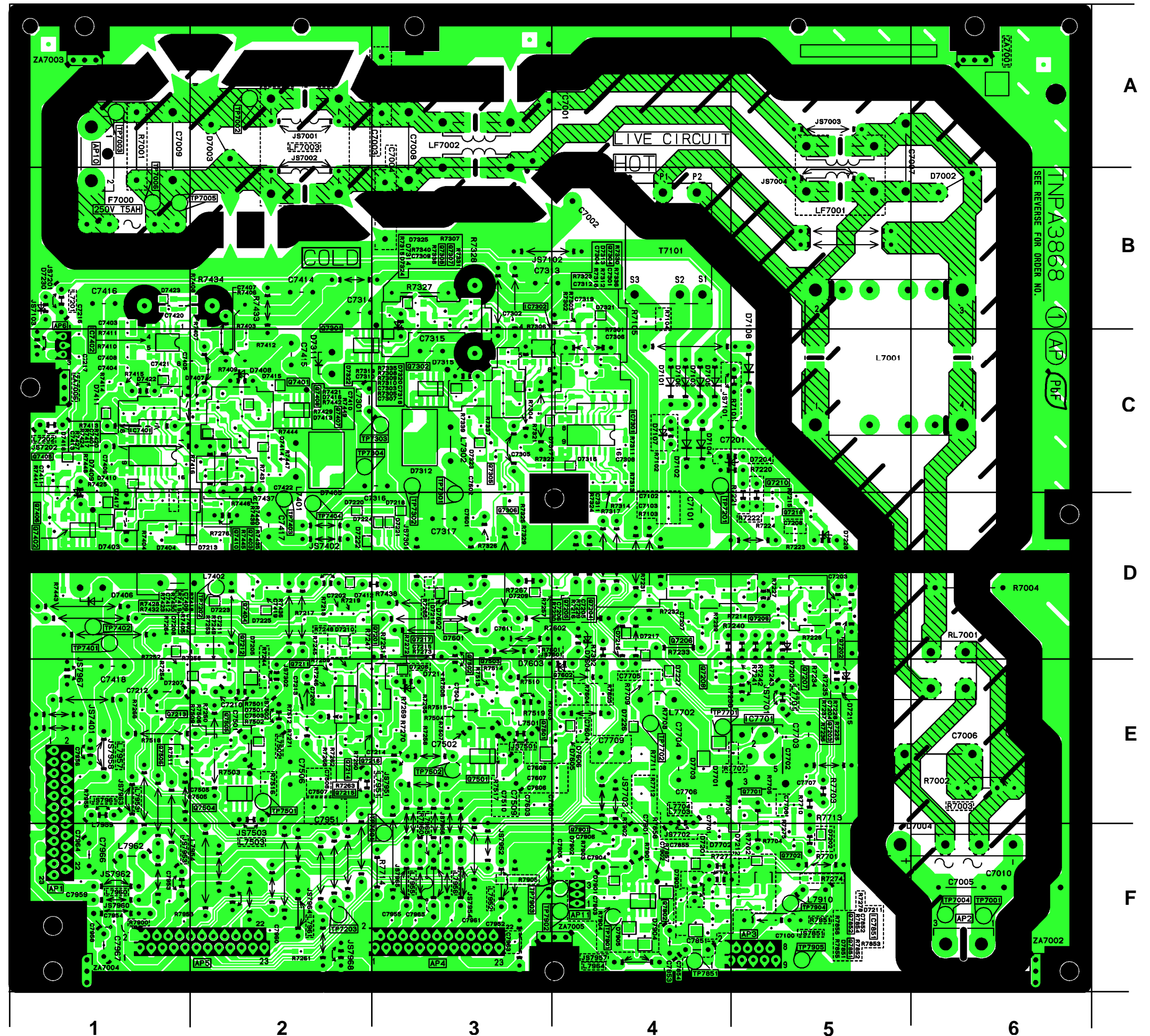

DG-BOARD TNPA3863 - top

TRAN'S		IC'S	
Q1130	A4	IC1100	B1
Q1145	C1	IC1102	B1
Q1148	C1	IC1103	B2
Q1150	A4	IC1107	C1
Q4043	A2	IC1108	A1
Q4044	A2	IC1109	A1
Q4046	A3	IC1110	A1
Q4050	A4	IC4013	A3
Q4051	A2	IC4017	B3
Q4052	A2	IC4019	A3
Q4053	A4	IC4020	B2
Q4054	A3	IC4022	A6
Q4055	A3	IC4023	A5
Q4056	A4	IC4025	B5
Q4057	A4	IC4026	A5
Q4058	A4	IC4027	A5
Q4059	A4	IC4028	B5
Q4063	C2	IC4037	B3
Q4069	A5	IC4038	B4
Q4072	A5	IC4040	C4
Q4084	C4	IC4046	C5
Q4086	C4		
Q4100	C1		
Q4101	C1		
Q4102	C4		
Q4103	C4		
Q4104	C5		
Q4105	C5		
Q4106	C5		
Q4107	C5		

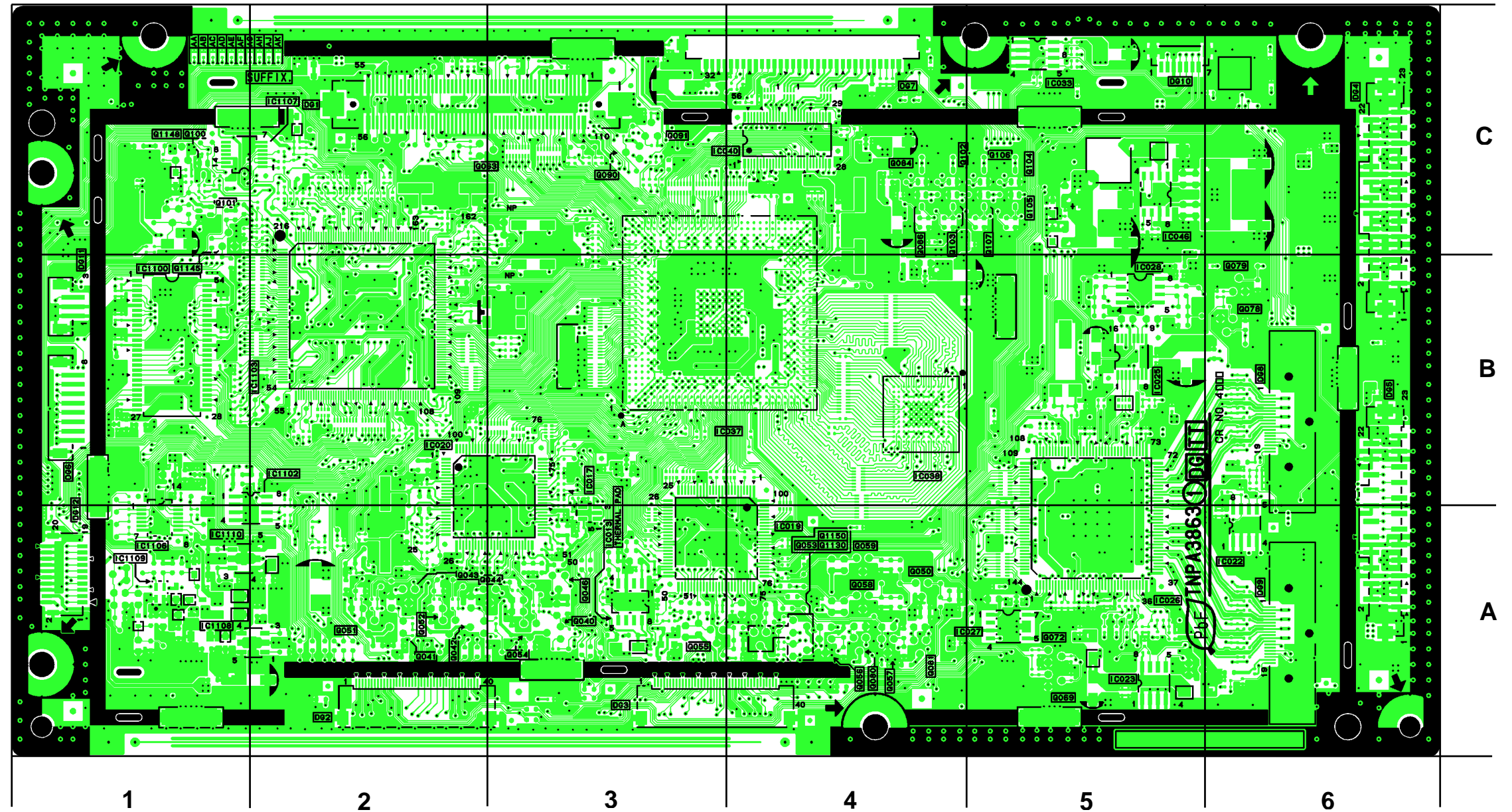

DG-BOARD TNPA3863 - bottom

TRAN'S		
Q1104	B2	Q4065 A6
Q1109	B1	Q4066 A6
Q1110	A1	Q4068 B5
Q1117	C2	Q4070 A5
Q1118	C2	Q4071 A6
Q1120	C2	Q4082 A5
Q1121	C2	Q4083 A5
Q1122	C2	Q4092 C1
Q1134	B3	Q4093 C1
Q1135	C3	Q4095 C5
Q1137	B2	Q4096 C5
Q1138	C1	Q4097 C5
Q1143	B2	Q4098 C4
Q1144	B2	Q4099 C3
Q1146	A2	
Q1147	A2	IC'S
Q1149	B2	IC1101 B2
Q1151	B2	IC4014 A2
Q1152	C2	IC4016 A3
Q1153	C2	IC4018 B3
Q1154	A1	IC4029 B4
Q1155	A1	IC4030 B3
Q4061	A2	IC4031 C4
Q4062	A2	IC4044 B5
Q4064	C3	IC4045 B2

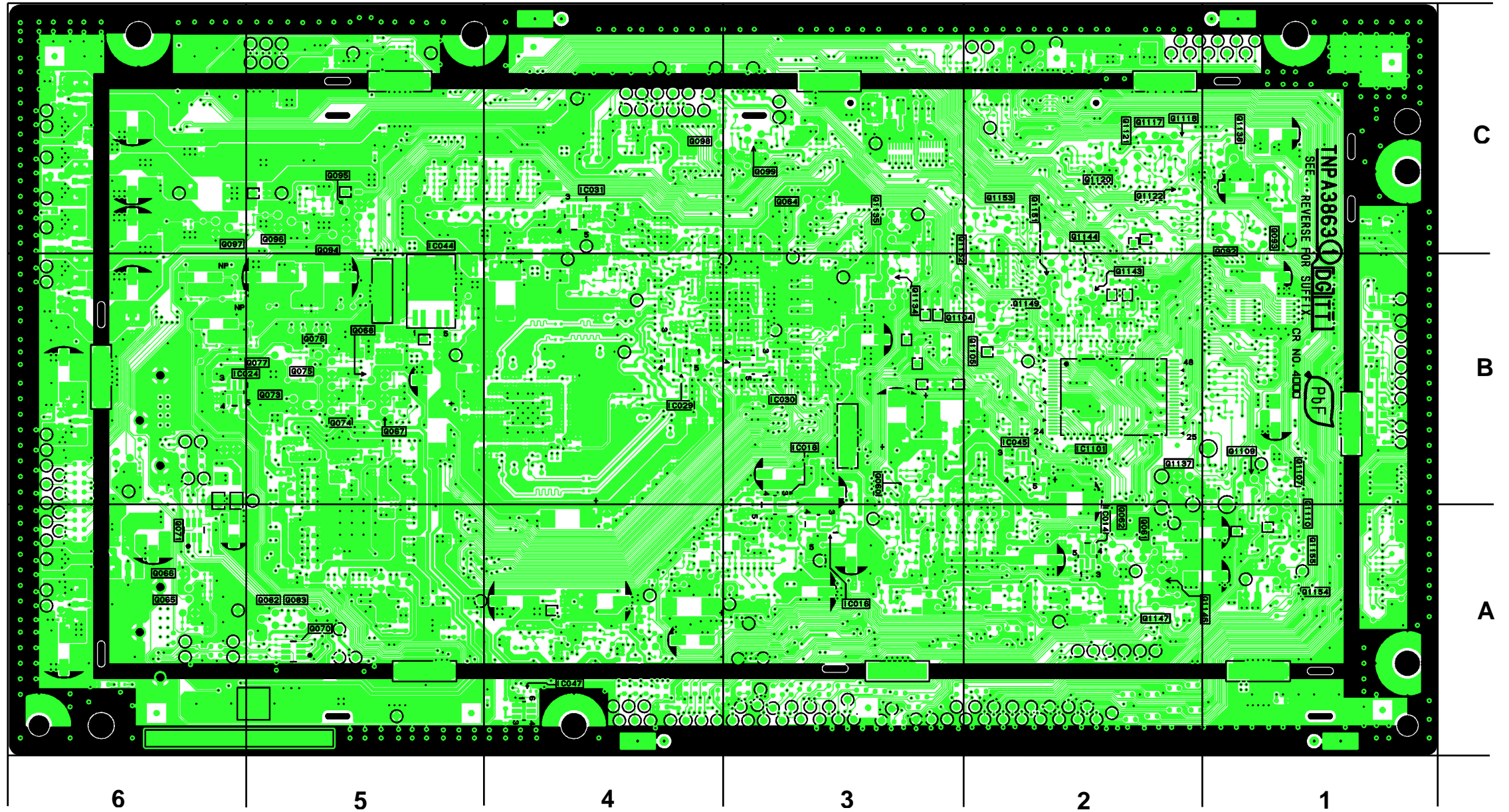

G-BOARD TNPA3864 - top

DIODE'S	
D2513	B2
D2515	B3
D2516	B3
IC'S	
IC2500	A2
IC2501	A2
IC2502	B3
IC2503	A3

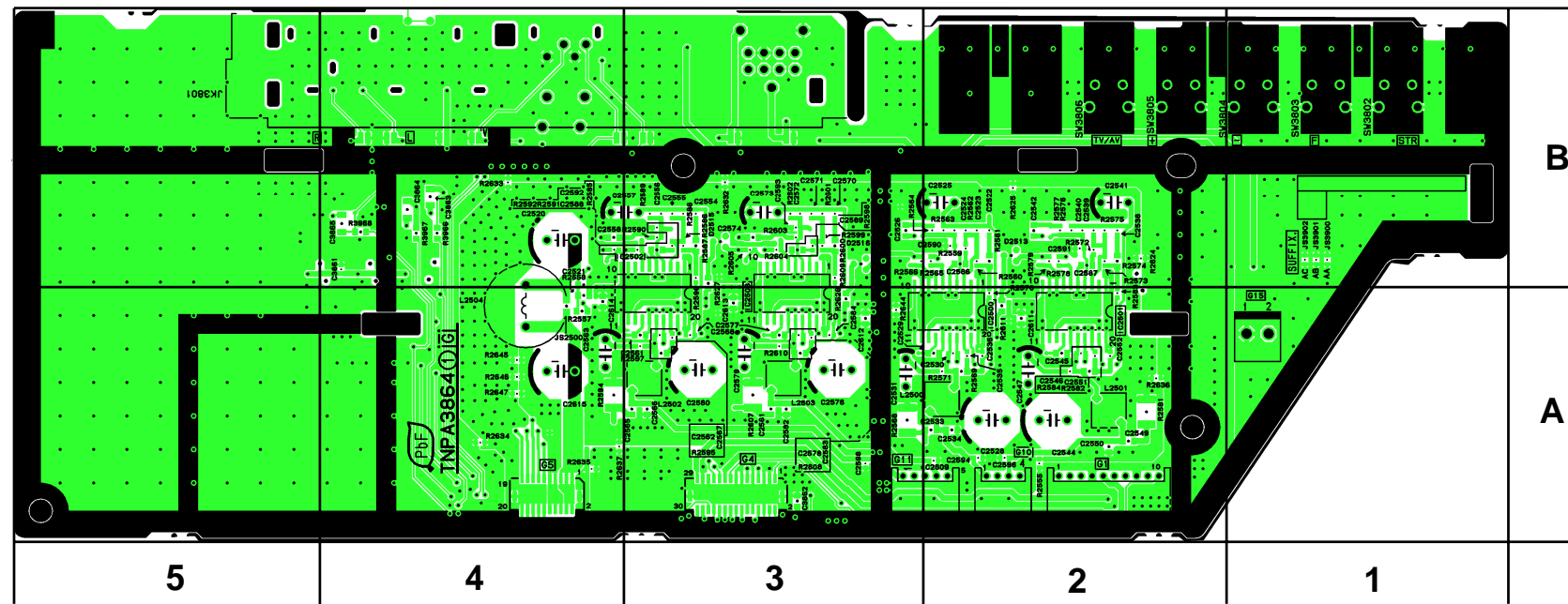

G-BOARD TNPA3864 - bottom

DIODE'S	TP2529	B5	
D2517	A2	TP2530	A3
D2518	A2	TP2531	B3
D2519	A2	TP2532	B3
D2520	A2	TP2533	A3
D3813	B3	TP2534	B2
D3815	B3	TP2535	B2
D3825	B3	TP2536	B3
D3826	B3	TP2537	B3
TP'S	TP3884	B3	
TP2509	A4	TP3885	B4
TP2510	A4	TP3886	B2
TP2511	A4	TP3887	B1
TP2512	A4	TP3888	A4
TP2513	A4	TP3889	A4
TP2514	A2	TP3891	B4
TP2515	A2	TP3892	A4
TP2516	A2	TP3894	A2
TP2517	A2	TP3900	A2
TP2518	A3	TP3902	B1
TP2519	A2	TP3906	A4
TP2520	A2	TP3907	A2
TP2521	A2	TP3908	B2
TP2522	B1	TP3910	A2
TP2523	B2	TP3922	A4
TP2524	A2	TP3995	A2
TP2525	B1	TP3996	A2
TP2526	B3	TP3997	B3
TP2527	A2	TP3998	A2
TP2528	A2	TP3999	A2

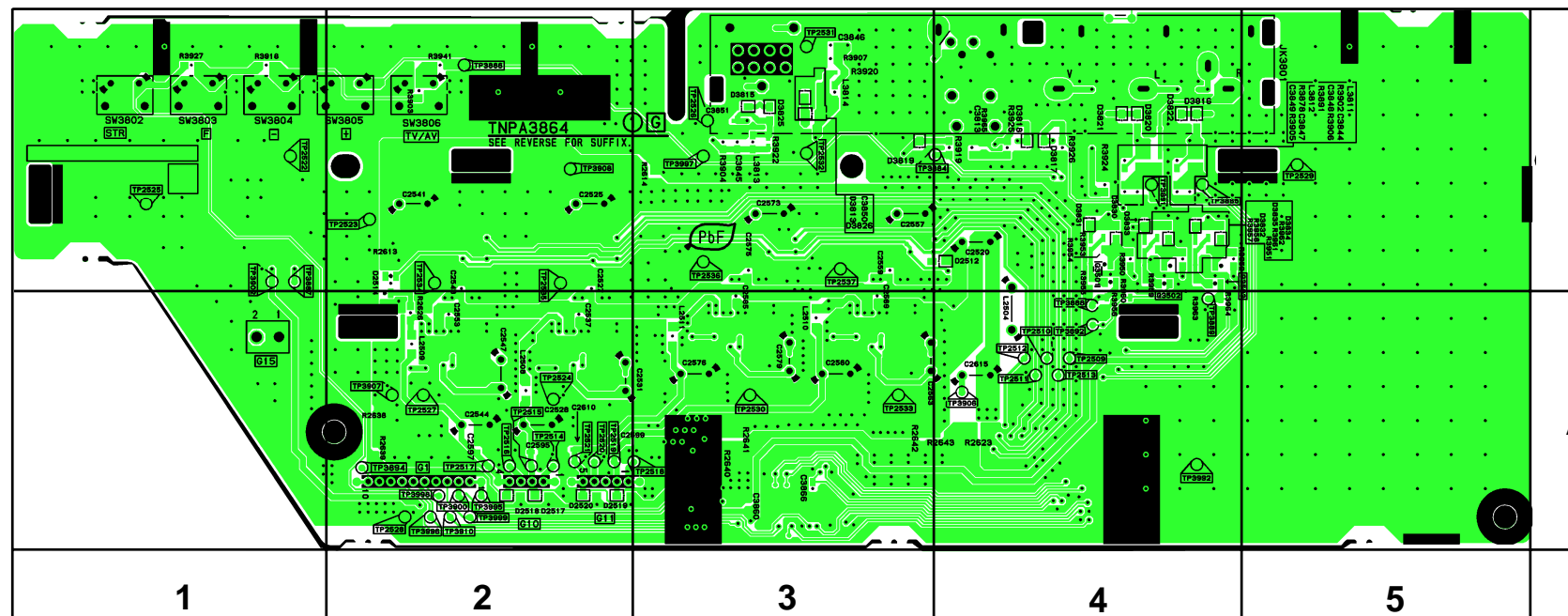

V-BOARD TNPA3865 - top

TRAN'S	
Q1004	A4
DIODE'S	
D1005	A4

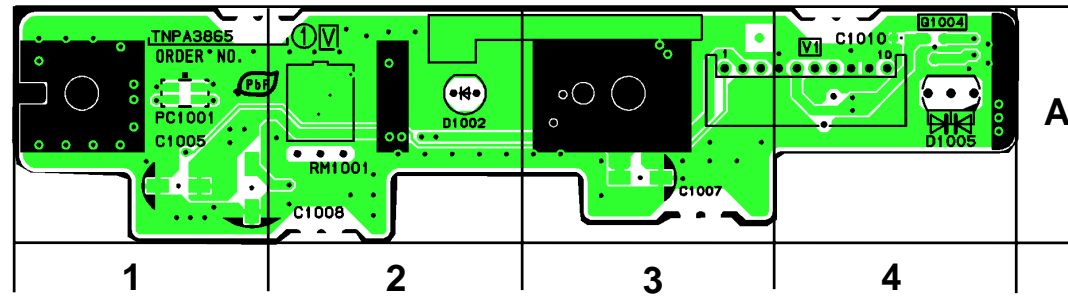

K-BOARD TNPA3866 - top

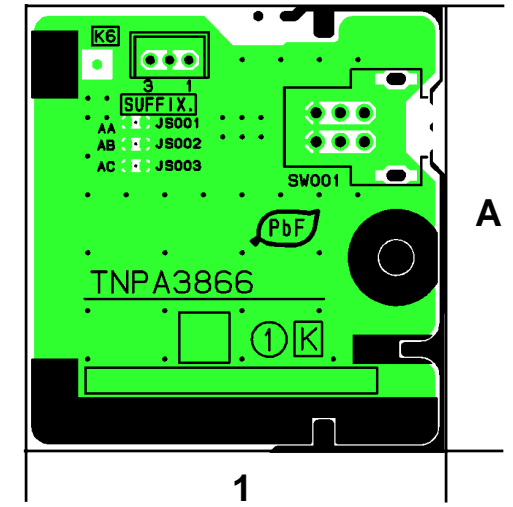

V-BOARD TNPA3865 - bottom

TRAN'S	
Q1003	A3
DIODE'S	
D1001	A2
D1003	A1
TP'S	
TP1001	A2
TP1002	A3
TP1003	A2
TP1004	A1
TP1005	A4
TP1006	A3
TP1007	A3
TP1008	A4
TP1009	A1
TP1010	A1
TP1012	A1

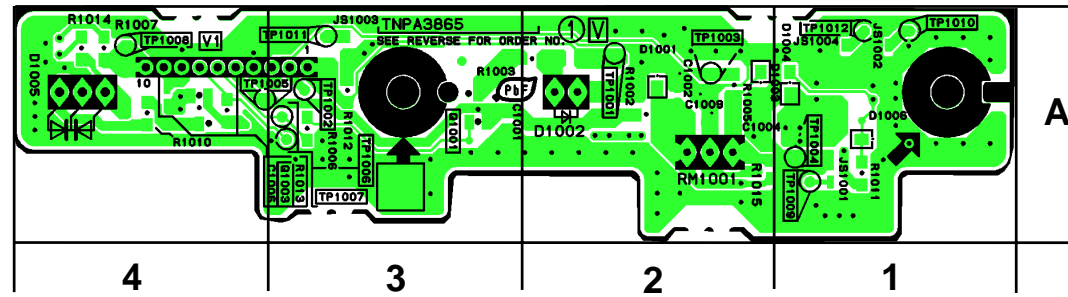

K-BOARD TNPA3866 - bottom

TP'S	
TP001	A1
TP002	A1

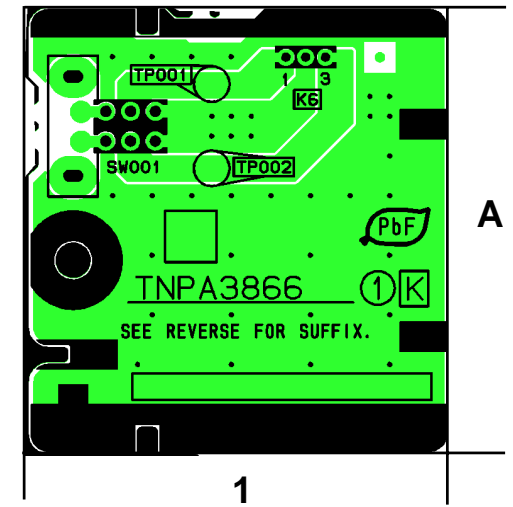

GS-BOARD TNPA3867 - top

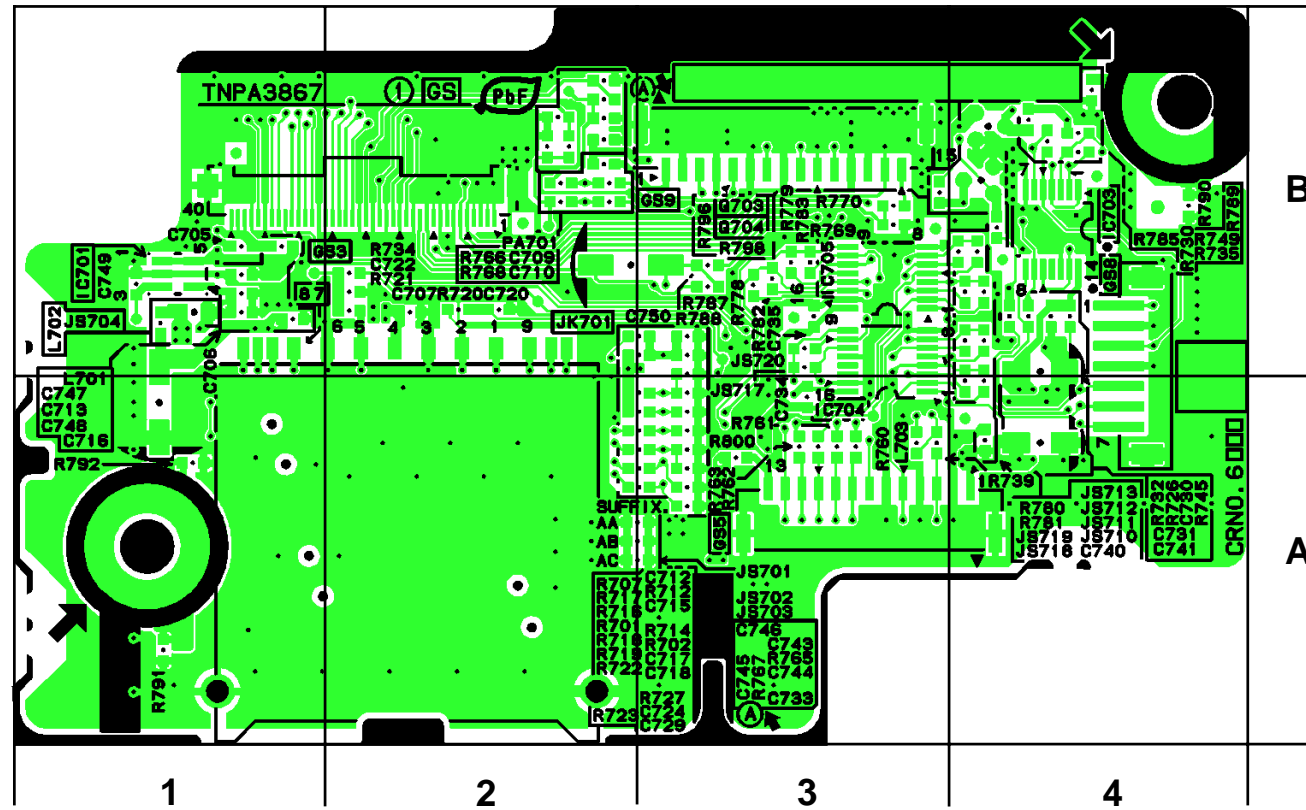

TRAN'S	
Q6703	B3
Q6704	B3
IC'S	
IC6701	B1
IC6703	B4

GS-BOARD TNPA3867 - bottom

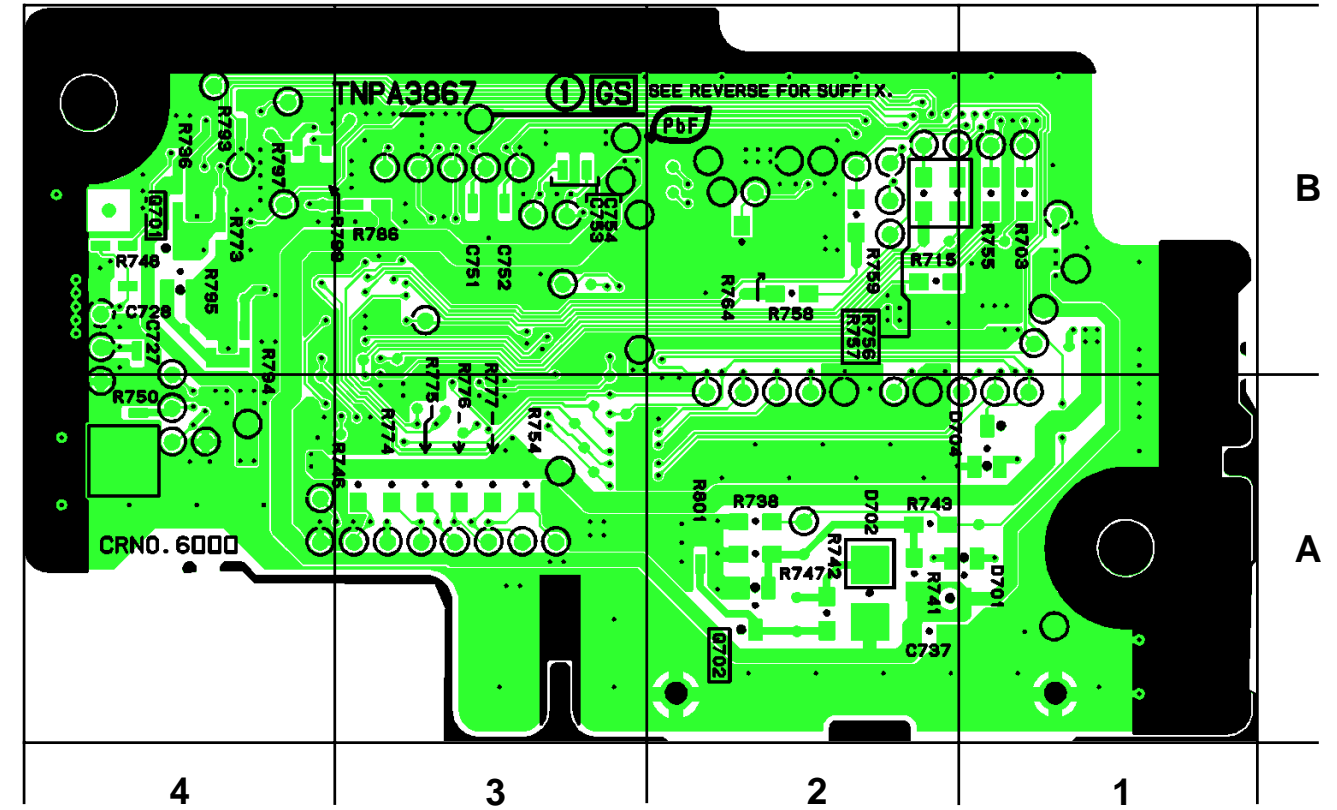

TRAN'S	
Q6701	B4
Q6702	A2
DIODE'S	
D6702	A2

H-BOARD TNPH0657 - top

TRAN'S	Q3021	A4	
Q2001	D4	Q3022	A5
Q2002	E4	Q3023	A3
Q2003	E3	Q3202	B1
Q2004	E3	Q3203	B1
Q2006	E3	Q3331	B8
Q2007	E3	Q3332	B8
Q2009	E4	Q3333	B7
Q2010	E4		
Q2011	C2	DIODE'S	
Q2016	C2	D2004	C2
Q2017	C2	D2005	C2
Q2018	C2	D2006	C2
Q2102	C7	D2007	C2
Q2103	C7	D2104	B5
Q2104	C7	D2106	D5
Q2105	C7	D2119	D6
Q2106	D6	D2120	B6
Q2108	C6	D2271	D7
Q2113	D7	D3017	A4
Q2114	D7	D3018	B3
Q2115	E6	D3019	B4
Q2119	E4	D3021	B5
Q2120	E3	D3024	A2
Q2121	E4	D3026	C7
Q2122	E4	D3027	C7
Q2123	B2	D3028	C8
Q2124	B2	D3029	C8
Q2271	D6	D3030	C8
Q2272	E7	D3031	C8
Q3001	D4		
Q3002	B3	IC'S	
Q3003	B3	IC2103	B5
Q3004	B4	IC2105	D6
Q3008	B5	IC2106	C6
Q3009	B6	IC2107	B6
Q3010	B1	IC2108	C7
Q3011	A4	IC2302	E8
Q3014	A4	IC2303	E8
Q3015	A3	IC3005	B3
Q3016	B4	IC3301	D8
Q3017	A4		
Q3019	B5	TP'S	
Q3020	B4	TP3001	B8

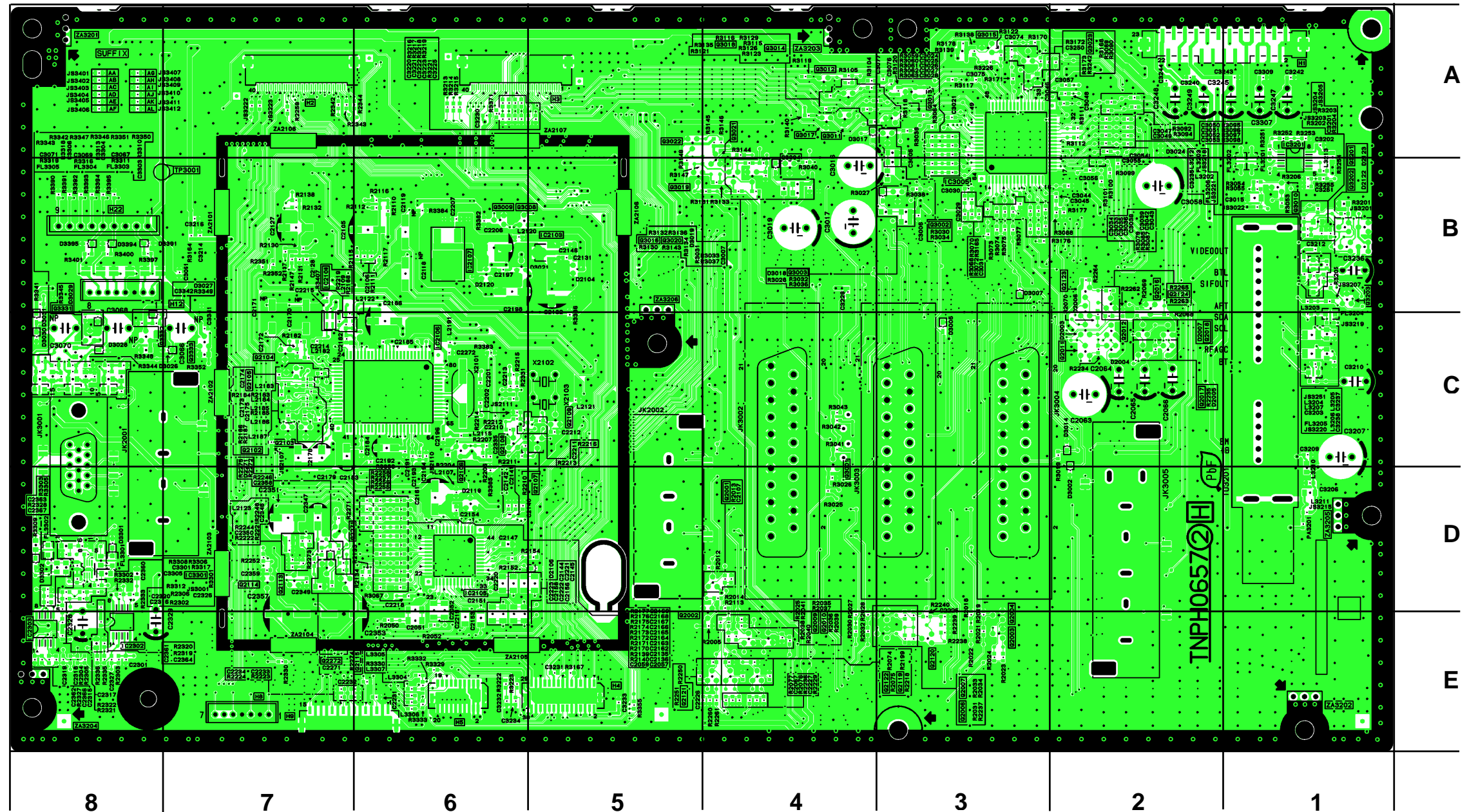

H-BOARD TNPH0657 - bottom

TRAN'S	D2115	D6	
Q3005	C5	D2116	D6
Q3006	C5	D2117	D6
	D2118	D6	
DIODE'S	D2124	D7	
D2105	D5	D2125	D7
D2107	D6	D3015	C4
D2108	D6	D3016	C4
D2109	D6	D3022	B6
D2110	E6	D3023	B5
D2111	D6		
D2112	D6	IC'S	
D2113	D6	IC2101	D7
D2114	D6	IC2104	B7

