



Interconnected Locksets

ANSI/BHMA Grade 2 Certified
Mechanical | Electronic

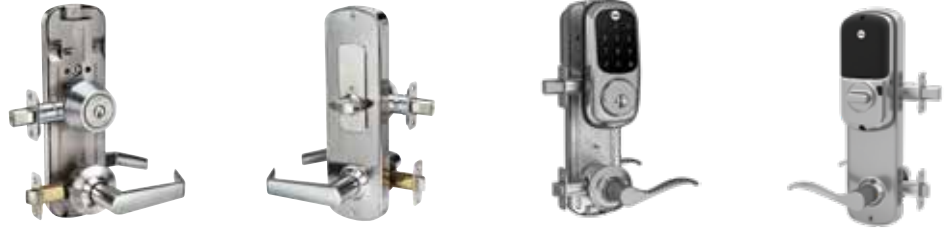



Table of Contents

YH Collection Mechanical Interconnected Locksets	
Infographic.....	3
Specifications.....	4
Functions.....	5
Finishes.....	5
How to Order.....	6
Dimensions.....	7
Exploded View.....	7
Sample Architectural Specification.....	8
Assure Lock Interconnected Locksets	
Infographic.....	9
Specifications.....	10
Functions.....	11
Finishes.....	11
How to Order.....	12
Dimensions.....	13
Exploded View.....	13
Sample Architectural Specification.....	14
Interconnected Lockset Accessories	
Levers.....	15
Cylinders.....	16
Latchbolts.....	17
Strikes.....	19

Yale Assure Lock® Interconnected electronic locksets combine Yale Assure Lock® electronic deadbolts with the convenience of a passage lever assortment for panic proof egress. From the inside, both the latchbolt and the deadbolt are retracted simultaneously in a single motion for a quick and easy exit.

Select from the Yale Assure Lock Interconnected Push Button, Touchscreen, or Key Free for convenient levels of effortless access. This is a significant benefit to multi-family and multi-unit projects commonly requiring re-keying. Push button and touchscreen deadbolts with key override offer keyless options as well as keys for multi-family environments. Go totally key free with an Assure Lock key free model and eliminate the hassle of re-keying.



The Yale YH Collection® mechanical interconnected locksets combine our integrated leverset with the added safety and security of a deadbolt. From the inside, both the latchbolt and the deadbolt are retracted simultaneously in a single motion for quick and easy egress.

The YH Collection face-removable and interchangeable core design provide easy access to the cylinder without having to remove the deadbolt from the door. This is a significant benefit to multi-family projects commonly requiring re-keying.

Community Service

Yale is Habitat for Humanity's national lockset partner and has helped families build strength, stability and self-reliance since 2001.



YH Collection® Mechanical Interconnected Locksets

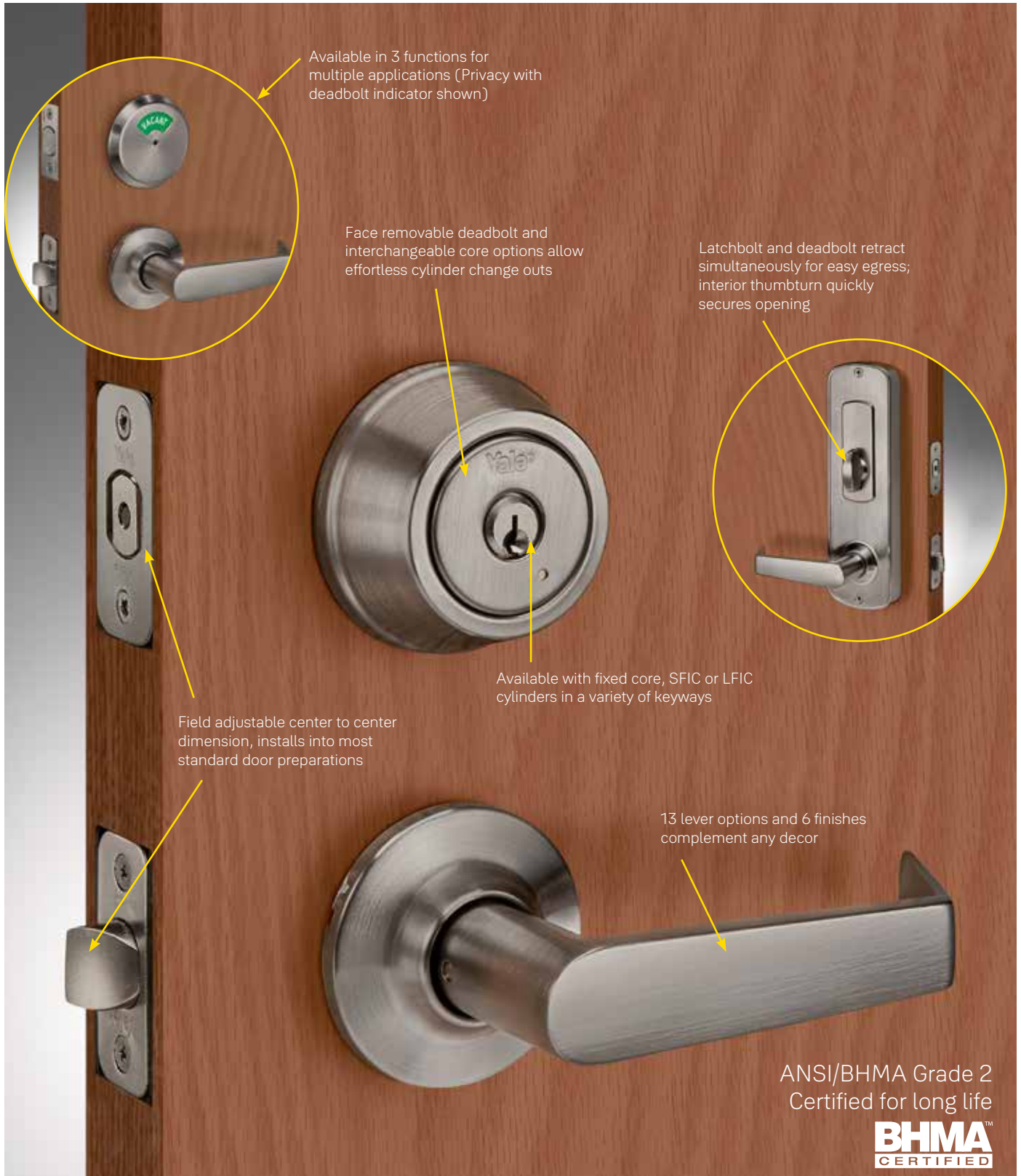

YH Collection® Mechanical Interconnected Locksets



Features

- 2 functions, 14 lever designs and 5 finishes
- Field adjustable from 4" to 5-1/2" center to center
- ANSI/BHMA A156.12 Grade 2 certified
- UL/cUL listed for 90 minute fire doors
- Available with fixed core (Can be ordered as conventional cylinder or SFIC or LFIC cylinder less core.)
- Field reversible handing
- Three year warranty

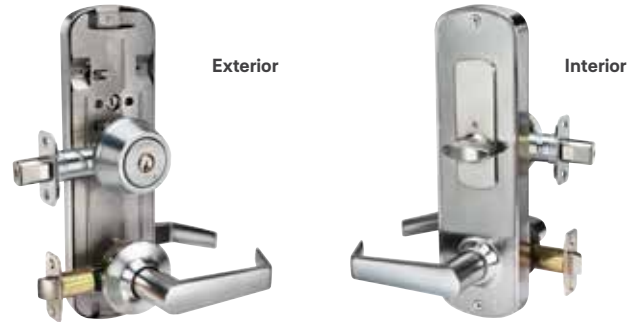

Passage Lever with Fixed Core Cylinder Shown

Specifications

Door Specs	2-1/8" (54mm) face bore, 1" (25mm) edge bore, 4" (102mm) or 5-1/2" (140mm) center to center
Backset	2-3/8" (60mm) or 2-3/4" (70mm)
Door Thickness	1-3/8" (35mm) to 1-3/4" (44mm)
Handing	Field reversible
Latch Faceplate	1" (25mm) W x 2-1/4" (57mm) H; radius corner standard, square corner available to order
Strike	2-1/4" (57mm) Full Lip Lockset and 1-1/8" (29mm) W x 2-3/4" (70mm) H Deadbolt; Radius Corner standard, other strikes available to order.
Cylinder	KW-1 compatible standard, other cylinders/keyways available to order
Keying	KD (Keyed Different) standard, master keying available to order
Packaging	Box pack
ADA	Conforms to ADA requirements for barrier free access when installed at the correct distance from the finished floor
ANSI/BHMA	Certified ANSI/BHMA A156.12, Grade 2
UL/cUL	Listed for 90 minute fire doors
Warranty	Three years





Applications

- Multi-family residences
- Assisted living facilities
- Public restrooms
- Offices and small business applications

YH Collection® Mechanical Interconnected Locksets



Functions

YR852	YR853
<p>Passage</p> <ul style="list-style-type: none"> • Single point lock. • Latchbolt is operated by either lever at all times. • Deadbolt activated by key on outside; inside by T-turn. • Interior lever retracts latch and deadbolt simultaneously. 	<p>Privacy with Deadbolt Indicator</p> <ul style="list-style-type: none"> • Single point lock. • Latchbolt is operated by either lever at all times. • Deadbolt activated by emergency key on outside; inside by T-turn. • Occupancy indicator displays "In Use" when deadbolt thrown or "Vacant" when deadbolt retracted. • Interior lever retracts latch and deadbolt simultaneously.
	

Finishes

ANSI/BHMA Code (US Designation) Finish Description					
<p>605 (US3) Bright Brass, Clear Coated</p>	<p>613E (US10BE) Dark Oxidized Satin Bronze - equivalent</p>	<p>619 (US15) Satin Nickel Plated, Clear Coated</p>	<p>626 (US26D) Satin Chrome Plated</p>	<p>(US10BP) Oil Rubbed Bronze - Permanent</p>	<p>(BSP) Black Suede</p>
					

YH Collection® Interconnected Mechanical Locksets



How To Order

Mechanical Deadbolt with Lever

Lever	Function	Latch		Strike		Cylinder/Core		Backset	Hand	Center to Center	Finish
		Lockset	Deadbolt	Lockset	Deadbolt	Lockset	Deadbolt				
AC = Academy AU = Augusta CH = Charleston DW = Delaware KC = Kincaid MA = Marina MC = McClure MO = Monroe MN = Milan NW = Norwood PB = Pacific Beach WL = Woodland VL = Valdosta VG = Virgo	YR852 = Passage YR853 = Privacy with Deadbolt Indicator	See page 11.		See page 11.		See page 16. LC = Less Cylinder* SFIC-LC = Less Small Format Core LFIC-LC = Less Large Format Core		2-3/8" 2-3/4"	RH LH	4" 5-1/2"	605 (US3) = Bright Brass Clear Coated 613E (US10BE) = Dark Oxidized Satin Bronze - equivalent 619 (US15) = Satin Nickel Plated Clear Coated 626 (US26D) = Satin Chrome Plated OBP (US10BP) = Oil Rubbed Bronze - Permanent (BSP) = Black Suede

* Cylinder that will be installed **MUST** be specified on the order.

Build Your Order String

Quantity	Lever	Function	Latch		Strike		Cylinder/Core		Backset	Handing	Center to Center	Finish
			Lockset	Deadbolt	Lockset	Deadbolt	Lockset	Deadbolt				
Example:	NW	YR852	YR01808	YR01D44	YR02020	YR02086	N/A	YR06Y416	2-3/4"	RH	4"	626

The example above provides a single locking function unit with 2-3/4" square corner latches with a PARA keyway cylinder. Lockset will be preset to RH and 4" CTC.



Dimensions/Exploded View

Center To Center Dimensions

All mechanical locksets easily adjust to either a 4" or 5-1/2" center to center dimension.

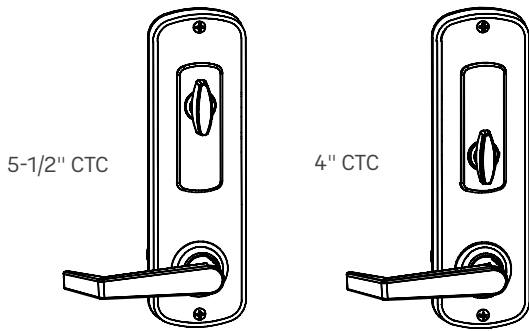

Product Dimensions

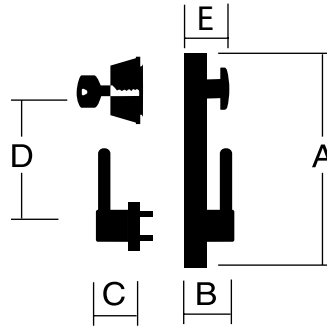

Dimensions				
A	B	C	D	E
10-5/8"	2-5/8"	2-1/2"	4" or 5-1/2"	1-3/4"

Mechanical

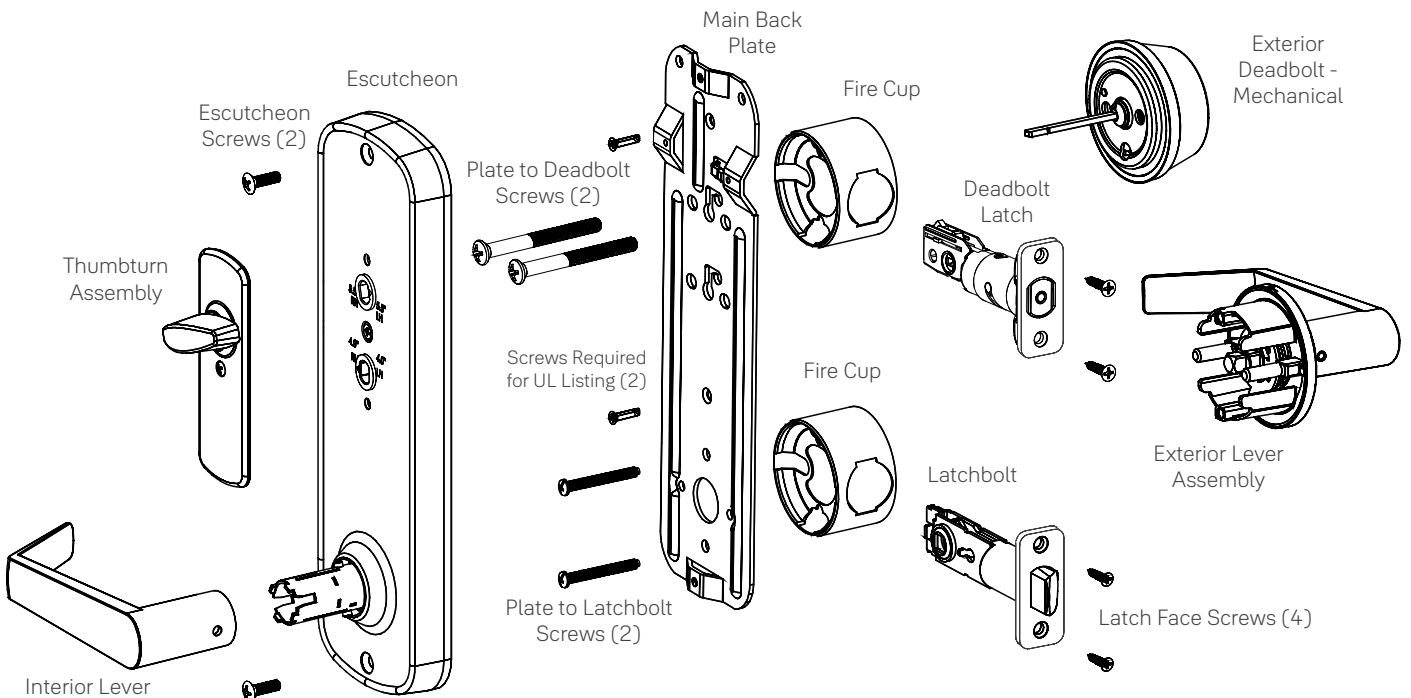

Sample Architectural Specification



All locksets shall be YH Collection® Mechanical Interconnected Lever Locksets provided by Yale Locks & Hardware.

All locksets shall have a simultaneous retraction of latchbolt and deadbolt with a single motion of turning the lever handle.

Locks shall have an interlocking tubular chassis and latchbolt. Chassis mounting screws shall be concealed and accessible only when the levers and roses are removed.

The latchbolt shall have a 1/2" (13mm) throw and entry functions shall include a deadlocking feature to inhibit manipulation when the door is locked.

All locksets shall be adjustable for 1-3/8" (35mm) and 1-3/4" (51mm) door thickness.

All mechanical locksets shall be adjustable for 4" (102mm) and 5-1/2" (140mm) center to center dimension.

Levers shall operate independently and shall have inside and outside lever return springs to prevent lever sag.

All locksets shall include a mechanical cylindrical deadbolt.

All locksets shall be furnished with two keys. All cylinder plugs shall be brass and furnished with 6-pin chambers for master keying capabilities.

All lockset shall be furnished in standard ANSI/BHMA architectural finishes.

Certification:

ANSI/BHMA A156.12, Grade 2

UL/cUL 1-1/2 Hour Fire Rating

ANSI A117.1 Accessibility Code

All locksets shall carry a three-year mechanical warranty.

Yale Assure Lock® Interconnected Locksets



Yale Assure Lock® Interconnected Locksets



Features

- 12 lever designs and 3 finishes
- Available in push button, touchscreen or key free
- 4" or 5-1/2" center to center
- ANSI/BHMA A156.12 Grade 2 certified
- Available with fixed core or SFIC
- Field reversible handing
- Three year warranty on mechanical operation. One year on finish and electronics.



Assure Lock® Interconnected Push Button YRC216



Assure Lock® Interconnected Touchscreen YRC226



Assure Lock® Interconnected YRC256



Specifications

Door Specs	2-1/8" (54mm) Face Bore, 1" (25mm) Edge Bore, 4" (102mm) or 5-1/2" (140mm) Center to Center
Backset	2-3/8" (60mm) or 2-3/4" (70mm)
Door Thickness	1-3/8" (35mm) to 1-3/4" (44mm)
Handing	Field Reversible
Latch Faceplate	1" (25mm) W x 2-1/4" (57mm) H; Radius Corner standard
Strike	2-1/4" (57mm) Full Lip Lockset and 1" (25mm) W x 2-1/4" (57mm) H Deadbolt; Radius Corner standard, other strikes available to order.
Cylinder	KW-1 Compatible standard, other cylinders/keyways available to order
Keyway Option	KWKD*: Kwikset Keyed Different KWKA: Kwikset Keyed Alike SCKD: Schlage C Keyed Different SCKA: Schlage C Keyed Alike SFIC: Small Format Interchangeable Less Cylinder (touchscreen only). Core sold separately. PARA: Yale Para Keyway *If not specified product will ship with this option
Packaging	Box Pack
ADA	Conforms to ADA requirements for barrier free access when installed at the correct distance from the finished floor
ANSI/BHMA	Certified ANSI/BHMA A156.12, Grade 2
UL/cUL	<ul style="list-style-type: none"> • YRC200 - listed for 20 min fire doors and windstorm applications • YRC600 - listed for 90 min fire doors and windstorm applications
Warranty	Three years mechanical operation, one year finish and electronics

Applications



- Multi-family residences
- Assisted living facilities
- Public restrooms
- Offices and small business applications





Yale Assure Lock® Interconnected Locksets



Styles

YRC216	YRC226	YRC256
<p>Passage with Push Button Keypad</p> <ul style="list-style-type: none"> • Uses Yale Assure Lock push button. • Single point lock. • Latchbolt is operated by either lever at all times. • Deadbolt activated by electronic keypad interaction or by key outside; inside by T-turn. • Interior lever retracts latch and deadbolt simultaneously. 	<p>Passage with Touchscreen</p> <ul style="list-style-type: none"> • Uses Yale Assure Lock touchscreen. • Single point lock. • Latchbolt is operated by either lever at all times. • Deadbolt activated electronic touchscreen interaction or by key outside; inside by T-turn. • Interior lever retracts latch and deadbolt simultaneously. 	<p>Passage with Key Free Touchscreen</p> <ul style="list-style-type: none"> • Uses Yale Assure Lock key free touchscreen. • Single point lock. • Latchbolt is operated by either lever at all times. • Deadbolt activated electronic touchscreen interaction outside; inside by T-turn. • Interior lever retracts latch and deadbolt simultaneously. • Use a 9V battery backup on the outside as a override in case the batteries die. 

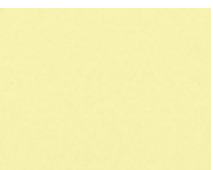
Finishes

ANSI/BHMA Code (US Designation) Finish Description		
<p>605 (US3) Bright Brass, Clear Coated</p>	<p>619 (US15) Satin Nickel Plated, Clear Coated</p>	<p>(US10BP) Oil Rubbed Bronze - Permanent</p>
		

How To Order



Use this outline to build the model number for the Yale Assure Lock® Interconnected Lockset you require.

Style	Technology	Lever	Center to Center	Cylinder	Finish
YRC226 = Touchscreen	NR = No Radio	AC = Academy	4 - 4"	KA = KW Keyed alike	605 (US3) = Bright Brass Clear Coated
YRC216 = Pushbutton	ZW2 = Z-Wave	AU = Augusta	5 - 5-1/2"	SA = SC Keyed alike	619 (US15) = Satin Nickel Plated Clear Coated
YRC256 = Key Free Touchscreen	HA2 = ZigBee CA2 = Control4 CR2 = Crestron	CH = Charleston DE = Delaware KC = Kincaid MA = Marina MC = McClure MN = Milan MO = Monroe NW = Norwood PB = Pacific Beach VG = Virgo VL = Valdosta WL = Woodland		KD = KW Keyed different SD = SC Keyed Different PA = PARA keyed alike PD = PARA Different SF = SFIC*	OBP (US10BP) = Oil Rubbed Bronze - Permanent

*SFIC: Small Format Interchangeable Less Cylinder (touchscreen only). Core sold separately.

Build Your Order String

Quantity	Style	Technology	Lever	Center to Center	Cylinder	Finish
Example:	YRC226	ZW2	NW	4"	KA	619

Notes:

- Order the module compatible with your home or security automation system
- The Yale Real Living Assure Lock® Interconnected lock comes standard with three latches:
 - One adjustable backset deadbolt latch
 - One 2-3/8" backset lever latch
 - One 2-3/4" backset lever latch
 Non-standard latches must be ordered separately.
 All latches are radius corner.
- All master key, builder key or keyed alike requests must be added to the order as a note.



Dimensions/Exploded View

Center To Center Dimensions

All electronic locksets available as 4" or 5-1/2" center to center dimension. Must be ordered this way from the factory and are not field changeable.

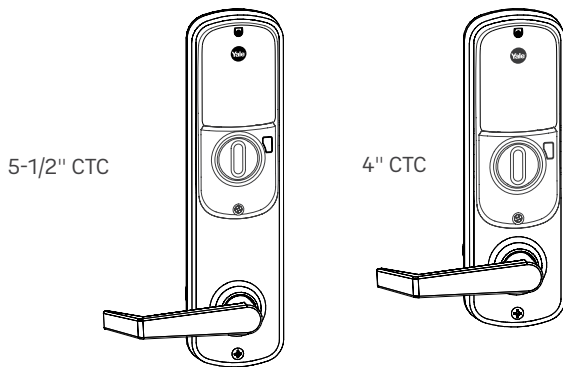

Product Dimensions

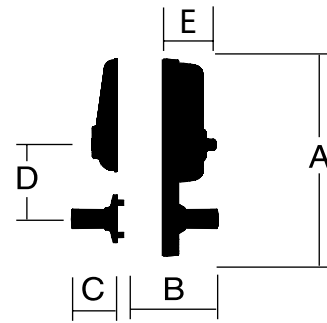

Dimensions				
A	B	C	D	E
10-5/8" 12-1/8"	2-5/8"	2-1/2"	4" 5-1/2"	2-13/16"

Electronic

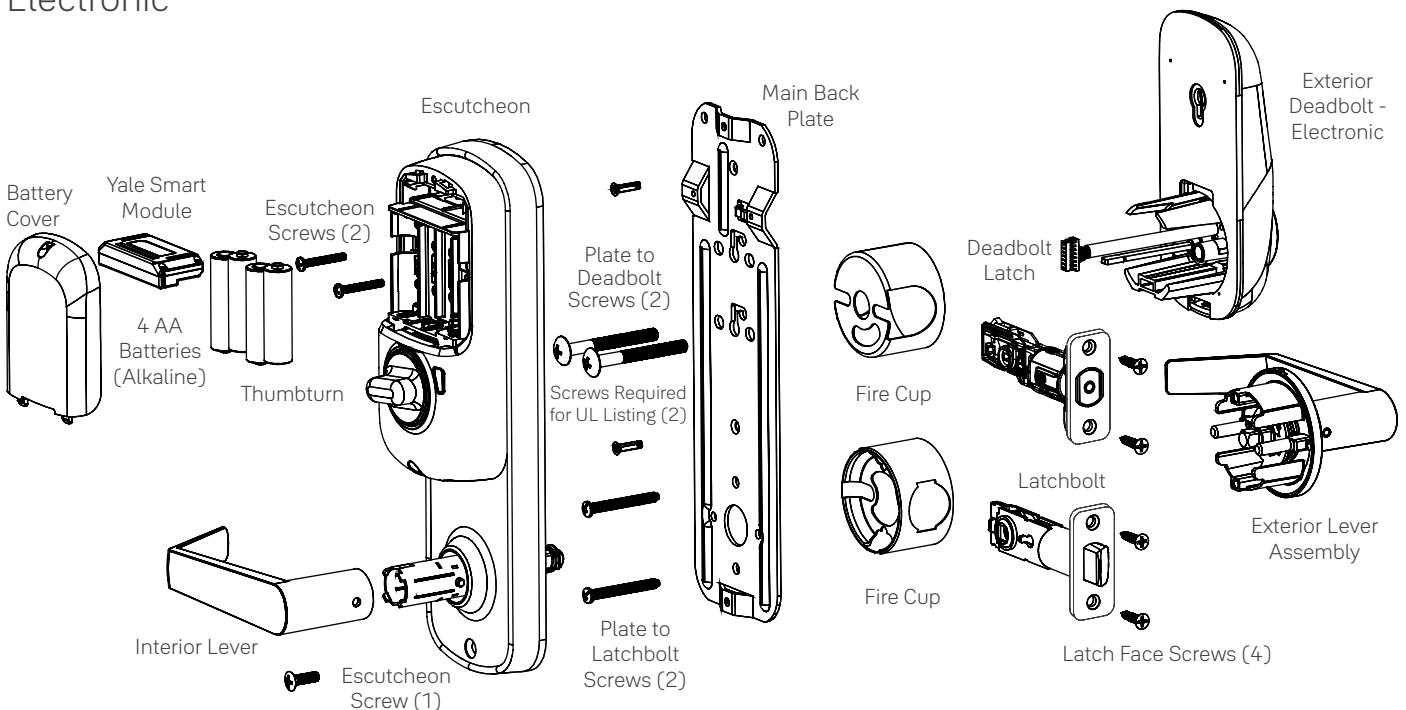

Sample Architectural Specification



All locksets shall be Yale Assure Lock® Interconnected Lever Locksets provided by Yale Locks & Hardware.

All locksets shall have a simultaneous retraction of latchbolt and deadbolt with a single motion of turning the lever handle.

Locks shall have an interlocking tubular chassis and latchbolt. Chassis mounting screws shall be concealed and accessible only when the levers and roses are removed.

The latchbolt shall have a 1/2" (13mm) throw and entry functions shall include a deadlocking feature to inhibit manipulation when the door is locked.

All locksets shall be adjustable for 1-3/8" (35mm) and 1-3/4" (51mm) door thickness.

All electronic locksets shall be available with either a 4" (102mm) or 5-1/2" (140mm) center to center dimension.

Levers shall operate independently and shall have inside and outside lever return springs to prevent lever sag.

All locksets shall include an electronic cylindrical deadbolt.

All locksets shall be furnished with two keys. All cylinder plugs shall be brass and have master keying capabilities.

All lockset shall be furnished in standard ANSI/BHMA architectural finishes.

Certification:

ANSI/BHMA A156.12, Grade 2

UL/cUL Fire Rating

- YRC200 - listed for 20 min fire doors and windstorm applications
- YRC600 - listed for 90 min fire doors and windstorm applications

ANSI A117.1 Accessibility Code











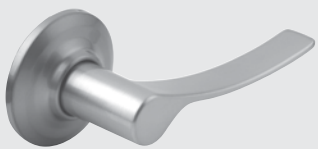
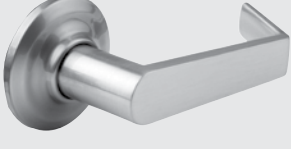

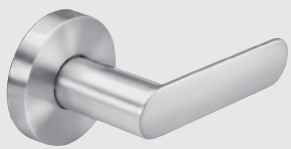
All locksets shall carry a three-year mechanical and one year electronic warranty.

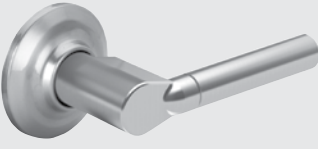
Interconnected Lock Lever Selection



Levers

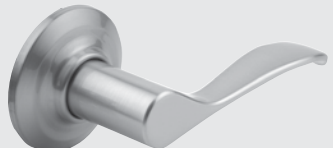
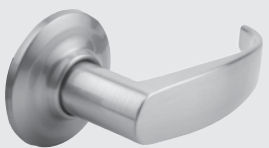
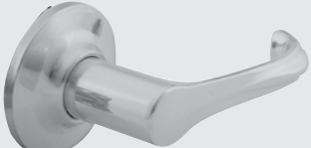
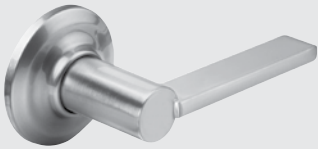

ACADEMY (AC)	 AUGUSTA (AU)	CHARLESTON (CH)	KINCAID (KC)
			
DELAWARE (DW)	MARINA (MA)	McCLURE (MC)	 MONROE (MO)
			
MILAN (MN)	NORWOOD (NW)	 PACIFIC BEACH (PB)	WOODLAND (WL)
			
VALDOSTA (VL)	VIRGO (VG)		
			

Roses only as shown

 Levers available with small format interchangeable core (SFIC) prep x less core. Available for mechanical function YR872 only.

Specify Lever Selection

Electronic and Mechanical Interconnected products ship with standard lever "Norwood" unless otherwise specified on order.





Fixed Core

Lock Type	Keyway	Description	Model Number		Number of Pins
			Lockset	Deadbolt	
Mechanical	Kwikset®	Standard cylinder. Available 1-bitted, KA, KD (std), MK, BK	YR06D013 (605) YR06D016 (626)	YR06D103ICN (605) YR06D106ICN (626)	6
	Yale® PARA	Optional cylinder. Available 0-bitted, KD, KA, MK, BK	YR06Y303 (605) YR06Y306 (626)	YR06Y413ICN (605) YR06Y416ICN (626)	6
	Yale® GA	Optional cylinder. Available 0-bitted, KD, KA, MK, CMK	1803-54K	1803-134S	6
	Arrow AR	Optional cylinder. Available KA, KD	100YC	692C	6
	Schlage® C	Optional cylinder. Available 0-bitted, KD, KA, MK, BK	YR068D01 (605) YR068D05 (626)	YR068D02ICN (605) YR068D06ICN (626)	6
Electronic	Kwikset®	Standard cylinder. Available KA, KD (std), MK	N/A	AYRD200-KW	5
	Yale® PARA	Optional cylinder. Available 0-bitted, KD, KA, MK, BK	N/A	AYRD200-PA	6
	Schlage® C	Optional cylinder. Available 0-Bitted, KA, KD, MK	N/A	AYRD200-SC	5

Note: Other Yale Commercial keyways and cylinder mechanisms available separately. Contact customer service for availability.
605 finish cylinders used with 605, 613E and 10BP finish locks.
626 finish cylinders used with 619 and 626 finish locks.
Specify finish and keying when ordering.

Interchangeable Core

Small Format

Small format interchangeable core is available.
 (Can be ordered as conventional cylinder or SFIC or LFIC cylinder less core.)

To order, specify "x SFIC-LC" for cylinder.
 i.e. AU x YR852 x SFIC-LC x 4" x 626

For entry functions, SFIC is available with for AU, MO and PB designs only. Mechanical only.

All units will be provided less core. Model number A600 or K600 cores can be ordered separately through Yale Commercial.

Large Format (Mechanical Only)

Yale Commercial large format interchangeable core is available for passage function.

To order, specify "x LFIC-LC" for cylinder.
 i.e. AU x YR852 x LFIC-LC x 4" x 626

All units will be provided less 6-pin core only.
 LFIC cores can be ordered separately through Yale Commercial.

Latchbolts



Lockset Latches

Passage (single keyed), privacy and electronic locks supplied with plain (spring) latchbolts. Entry (double keyed) supplied with deadlocking latchbolts.

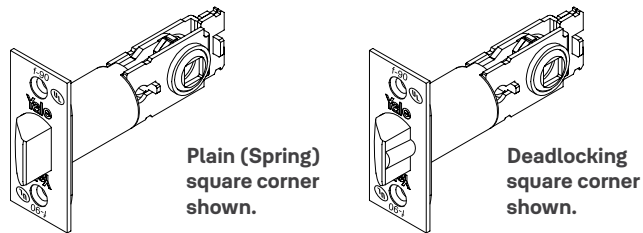

Plain (Spring)					
Model No.	Front	Backset	Front Width	Throw	Latch Diameter**
YR01802*U	Radius	2-3/8" (60mm)	1" (25mm)	1/2" (13mm)	7/8" (22mm)
YR01804*U	Square	2-3/8" (60mm)	1" (25mm)	1/2" (13mm)	7/8" (22mm)
YR01806*U	Radius	2-3/4" (70mm)	1" (25mm)	1/2" (13mm)	7/8" (22mm)
YR01808*U	Square	2-3/4" (70mm)	1" (25mm)	1/2" (13mm)	7/8" (22mm)

Used with YR852, YR853, YRC216, YRC226, YRC246

Deadlocking					
Model No.	Front	Backset	Front Width	Throw	Latch Diameter**
YR01812*U	Radius	2-3/8" (60mm)	1" (25mm)	1/2" (13mm)	7/8" (22mm)
YR01814*U	Square	2-3/8" (60mm)	1" (25mm)	1/2" (13mm)	7/8" (22mm)
YR01816*U	Radius	2-3/4" (70mm)	1" (25mm)	1/2" (13mm)	7/8" (22mm)
YR01818*U	Square	2-3/4" (70mm)	1" (25mm)	1/2" (13mm)	7/8" (22mm)

Used with YR872

Note: All latchbolts are only available with flat fronts, not recommended for beveled doors.

1-1/8" latch filler provided.

***Specify finish when ordering "3" for 605; "6" for 619, 626; "B" for 10BP; "C" for 613E.**

****1/8" sleeve (P/N YR035110) supplied with all latchbolts to accommodate 1" preps.**



Deadbolt Latches

For mechanical locksets with Yale® PARA, KW1 and Schlage® C keyway cylinders and all electronic locksets, adjustable backset deadbolt latches are standard. For all other cylinder types, backset must be specified.

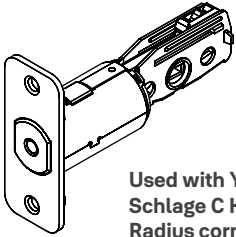

Used with Yale PARA, Kwikset and Schlage C Keyway Cylinders.
Radius corner shown.

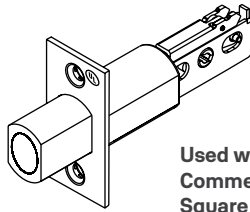

Used with SFIC, Arrow and Yale Commercial Keyway Cylinders.
Square corner shown.

Mechanical				
Model No.	Front	Backset	"W" Front Width	Throw
YR01D44*U	Square	Adjustable^	1" (25mm)	1" (25mm)
YR01D41*U	Radius	Adjustable^	1" (25mm)	1" (25mm)

For use with Yale PARA, Kwikset and Schlage C keyway cylinders

D38	Square	2-3/8" Fixed	1" (25mm)	1" (25mm)
D38R	Radius	2-3/8" Fixed	1" (25mm)	1" (25mm)
D34	Square	2-3/4" Fixed	1" (25mm)	1" (25mm)
D34R	Radius	2-3/4" Fixed	1" (25mm)	1" (25mm)

For use with SFIC, Arrow and Yale Commercial keyway cylinders.

Electronic				
Model No.	Front	Backset	"W" Front Width	Throw
AYRDB	Radius	Adjustable^	1" (25mm)	1" (25mm)

Screw packs not provided for latchbolts ordered separately.

*Specify finish when ordering "3" for 605; "6" for 619, 626; "B" for 10BP; "C" for 613E.

^Adjustable between 2-3/8" and 2-3/4".

Strikes



Yale® interconnected locks are available with a variety of strike options. All strikes are located on the same vertical and horizontal center lines as the latchbolt and deadbolt. All strikes are reversible. Strikes are fabricated of either brass, bronze or stainless steel, depending on the lockset trim finish. When ordering strikes separately, please specify the finish required.

Lockset

<p>Model No. YR02000* Full Lip Strike Radius Corner Standard strike supplied with all units. Plastic strike dust box available separately.</p>	<p>Model No. YR02001* Full Lip Strike Square Corner Optional strike available. Plastic strike dust box available separately.</p>	<p>Model No. YR02020* T-Strike Optional strike available. Plastic strike dust box available separately.</p>
<p>Model No. YR02030* ANSI 4-7/8 Strike with Screw Pack Optional strike available. Plastic strike dust box available separately.</p>	<p>Model No. YR026003 Plastic Strike Dust Box Available separately.</p>	

Deadbolt

<p>Model No. YR02088* Universal Deadbolt Strike Radius Corner Standard strike supplied with all mechanical units. Plastic strike dust box available separately.</p>	<p>Model No. YR02086* Universal Deadbolt Strike Square Corner Optional strike available for all mechanical units. Plastic strike dust box available separately.</p>	<p>Model No. AYRD-SCREW* Deadbolt Strike Radius Corner with Screw Pack Standard strike supplied with all electronic units.</p>	<p>Model No. YR026002 Plastic Strike Dust Box Available Separately.</p>

Note: See Yale Residential price catalog for additional optional deadbolt strikes.

***Specify finish when ordering "3" for 605; "6" for 619, 626; "B" for 10BP; "C" for 613E. Screw packs not provided for strikes ordered separately unless indicated.**



Trusted every day

Customer Service Phone:

1-800-438-1951

Customer Service Fax:

1-800-338-0965

24/7 Support Phone:

1-855-213-5841

24/7 Support Email:

Support@YaleLock.com

Website:

US.YaleHome.com

Email for orders:

orders.yaleres@assaabloy.com

Contact Us

U.S.A.

Yale Locks & Hardware

Address: 225 Episcopal Road

Berlin, CT 06037-4004

Tel: 1-800-438-1951

Fax: 1-800-338-0965

US.YaleHome.com

Canada:

ASSA ABLOY Door Security Solutions Canada

Address: 160 Four Valley Drive

Vaughan, Ontario L4K 4T9

Tel: 1-800-461-3007

Fax: 1-800-461-8989

assaabloydss.ca

International:

ASSA ABLOY Americas International

Tel: 1-905-821-7775

Fax: 1-905-821-1429

assaabloyai.com

THE YALE BRAND, with its unparalleled global reach and range of products, reassures more people in more countries than any other consumer locking solution.

THE ASSA ABLOY GROUP is the world's leading manufacturer and supplier of locking solutions, dedicated to satisfying end-user needs for security, safety and convenience.

Yale®, Assure Lock® and YH Collection® are registered trademarks of Assa Abloy Residential Group. Other products' brand names may be trademarks or registered trademarks of their respective owners and are mentioned for reference purposes only. These materials are protected under US copyright laws. All contents current at time of publication. Assa Abloy Residential Group reserves the right to change availability of any item in this price book, its design, construction and/or its materials. Copyright © 2020, Assa Abloy Residential Group. All rights reserved. Reproduction in whole or in part without the express written permission of Assa Abloy Residential Group, is prohibited.