

# SIEMENS

## SIMATIC NET

### Industrial Ethernet switches SCALANCE XR-500



#### Operating Instructions

<u>Introduction</u>	<b>1</b>
<u>Safety notes</u>	<b>2</b>
<u>Description of the device</u>	<b>3</b>
<u>Assembling</u>	<b>4</b>
<u>Connecting</u>	<b>5</b>
<u>Uninstalling</u>	<b>6</b>
<u>Upkeep and maintenance</u>	<b>7</b>
<u>Technical data</u>	<b>8</b>
<u>Dimension drawings</u>	<b>9</b>
<u>Certification</u>	<b>10</b>

## Legal information

### Warning notice system

This manual contains notices you have to observe in order to ensure your personal safety, as well as to prevent damage to property. The notices referring to your personal safety are highlighted in the manual by a safety alert symbol, notices referring only to property damage have no safety alert symbol. These notices shown below are graded according to the degree of danger.

 <b>DANGER</b>
indicates that death or severe personal injury <b>will</b> result if proper precautions are not taken.
 <b>WARNING</b>
indicates that death or severe personal injury <b>may</b> result if proper precautions are not taken.
 <b>CAUTION</b>
indicates that minor personal injury can result if proper precautions are not taken.
<b>NOTICE</b>
indicates that property damage can result if proper precautions are not taken.

If more than one degree of danger is present, the warning notice representing the highest degree of danger will be used. A notice warning of injury to persons with a safety alert symbol may also include a warning relating to property damage.

### Qualified Personnel

The product/system described in this documentation may be operated only by **personnel qualified** for the specific task in accordance with the relevant documentation, in particular its warning notices and safety instructions. Qualified personnel are those who, based on their training and experience, are capable of identifying risks and avoiding potential hazards when working with these products/systems.

### Proper use of Siemens products

Note the following:

 <b>WARNING</b>
Siemens products may only be used for the applications described in the catalog and in the relevant technical documentation. If products and components from other manufacturers are used, these must be recommended or approved by Siemens. Proper transport, storage, installation, assembly, commissioning, operation and maintenance are required to ensure that the products operate safely and without any problems. The permissible ambient conditions must be complied with. The information in the relevant documentation must be observed.

### Trademarks

All names identified by ® are registered trademarks of Siemens AG. The remaining trademarks in this publication may be trademarks whose use by third parties for their own purposes could violate the rights of the owner.

### Disclaimer of Liability

We have reviewed the contents of this publication to ensure consistency with the hardware and software described. Since variance cannot be precluded entirely, we cannot guarantee full consistency. However, the information in this publication is reviewed regularly and any necessary corrections are included in subsequent editions.

# Table of contents

<b>1</b>	<b>Introduction</b> .....	<b>5</b>
<b>2</b>	<b>Safety notes</b> .....	<b>9</b>
2.1	Security recommendations .....	11
<b>3</b>	<b>Description of the device</b> .....	<b>17</b>
3.1	Product overview .....	17
3.1.1	Permitted ambient temperature .....	20
3.1.2	Accessories.....	21
3.1.2.1	Accessories for the SCALANCE XR-500 product line.....	21
3.1.2.2	Additional accessories for modular devices .....	24
3.2	SELECT/SET button .....	25
3.3	LED display .....	28
3.3.1	The "RM" LED for the "redundancy manager" function.....	28
3.3.2	The "SB" LED for the standby function.....	28
3.3.3	The "F" LED for the fault status .....	28
3.3.4	"DM1" and "DM2" LEDs for the display mode .....	29
3.3.5	"L1" and "L2" LEDs for the power supply .....	29
3.3.6	Port P1, P2, ... LEDs for the port status.....	31
3.4	C-PLUG / KEY-PLUG .....	33
3.4.1	Function of the C-PLUG/KEY-PLUG .....	33
3.4.2	Removal and insertion of the C-PLUG/KEY-PLUG .....	34
3.5	Combo ports .....	36
<b>4</b>	<b>Assembling</b> .....	<b>37</b>
4.1	Safety notices for installation .....	37
4.2	Types of installation .....	40
4.3	19" rack mounting .....	40
4.4	Desktop operation with adhesive feet.....	43
4.5	Four-point mounting.....	45
4.6	Plugging and pulling MM900 media modules.....	47
4.7	Inserting and removing media pluggable transceivers .....	50
4.7.1	Notes on inserting/removing pluggable transceivers.....	50
4.7.2	Inserting an SFP / SFP+ transceiver .....	51
4.7.3	Removing an SFP / SFP+ transceiver.....	52
4.8	Mounting power supply units .....	52
4.8.1	19" rack mounting of the PS598-1 power supply unit.....	52
4.8.2	Mounting the PS598-1 power supply unit on the rear panel of modular device.....	54

<b>5</b>	<b>Connecting .....</b>	<b>57</b>
5.1	Commissioning.....	57
5.2	24 VDC power supply .....	60
5.3	100 to 240 VAC power supply .....	62
5.3.1	Power supply of the SCALANCE XR524-8C and SCALANCE XR526-8C .....	62
5.3.2	Power supply using the PS598-1 power supply unit.....	64
5.3.2.1	Connectors of the PS598-1 power supply unit .....	64
5.3.2.2	LED display of the PS598-1 power supply unit.....	68
5.4	Signaling contact.....	69
5.5	Serial interface .....	71
5.6	Out-of-band interface .....	73
5.7	Block architecture of the XR552-12M .....	74
5.8	Functional ground .....	75
<b>6</b>	<b>Uninstalling .....</b>	<b>77</b>
<b>7</b>	<b>Upkeep and maintenance .....</b>	<b>79</b>
7.1	Changing the fan unit.....	79
7.2	Changing the filter pad.....	82
7.3	Downloading new firmware using TFTP without WBM and CLI .....	84
7.4	Restoring the factory settings .....	85
<b>8</b>	<b>Technical data .....</b>	<b>87</b>
8.1	Technical specifications of the SCALANCE XR524-8C.....	87
8.2	Technical specifications of the SCALANCE XR526-8C.....	91
8.3	Technical specifications of the SCALANCE XR528-6M .....	95
8.4	Technical specifications of the SCALANCE XR552-12M .....	97
8.5	Switching properties.....	99
<b>9</b>	<b>Dimension drawings.....</b>	<b>101</b>
9.1	SCALANCE XR524-8C and SCALANCE XR526-8C .....	101
9.2	SCALANCE XR528-6M .....	102
9.3	SCALANCE XR552-12M .....	103
9.4	Mounting brackets for use on ships .....	104
<b>10</b>	<b>Certification.....</b>	<b>111</b>
10.1	FDA and IEC marks .....	116
10.2	Mechanical stability (in operation).....	116
	<b>Index .....</b>	<b>117</b>

# Introduction

## Purpose of the Operating Instructions

These operating instructions support you when installing and connecting up devices of the SCALANCE XR-500 product line.

The configuration and the integration of the device in a network are not described in these operating instructions.

## Validity of the Operating Instructions

These operating instructions apply to the following devices:

- SCALANCE XR524-8C
- SCALANCE XR526-8C
- SCALANCE XR528-6M
- SCALANCE XR552-12M

## Designations used

Classification	Description	Terms used
Product line	If information applies to all product groups within the product line, the term SCALANCE XR-500 is used.	SCALANCE XR-500
Device	If information relates to a specific device, the device name is used.	SCALANCE XR524-8C SCALANCE XR526-8C SCALANCE XR528-6M SCALANCE XR552-12M
Variant	For a variant of the device, the device name has the appropriate variant added to it in brackets.	SCALANCE XR524-8C (2 x 24 VDC)

## Documentation on configuration

You will find detailed information on configuring the devices in the following configuration manuals:

- SCALANCE XM-400/XR-500 Web Based Management
- SCALANCE XM-400/XR-500 Command Line Interface

You will find the configuration manuals here:

- On the data medium that ships with some products:
  - Product CD / product DVD
  - SIMATIC NET Manual Collection
- On the Internet pages of Siemens Industry Online Support.  
(<http://support.automation.siemens.com/WW/view/en/48803858/133300>)

## Further documentation

In the system manuals "Industrial Ethernet / PROFINET Industrial Ethernet" and "Industrial Ethernet / PROFINET passive network components", you will find information on other SIMATIC NET products that you can operate along with the devices of this product line in an Industrial Ethernet network.

There, you will find among other things optical performance data of the communications partner that you require for the installation.

You will find the system manuals here:

- On the data medium that ships with some products:
  - Product CD / product DVD
  - SIMATIC NET Manual Collection
- On the Internet pages of Siemens Industry Online Support under the following entry IDs:
  - 27069465 (<http://support.automation.siemens.com/WW/view/en/27069465>)  
Industrial Ethernet / PROFINET Industrial Ethernet System Manual
  - 84922825 (<http://support.automation.siemens.com/WW/view/en/84922825>)  
Industrial Ethernet / PROFINET - Passive network components System Manual

## SIMATIC NET manuals

You will find the SIMATIC NET manuals here:

- On the data medium that ships with some products:
  - Product CD / product DVD
  - SIMATIC NET Manual Collection
- On the Internet pages of Siemens Industry Online Support  
(<http://support.automation.siemens.com/WW/view/en/10805878/130000>).

## SIMATIC NET glossary

Explanations of many of the specialist terms used in this documentation can be found in the SIMATIC NET glossary.

You will find the SIMATIC NET glossary here:

- SIMATIC NET Manual Collection or product DVD  
The DVD ships with certain SIMATIC NET products.
- On the Internet under the following address:  
50305045 (<http://support.automation.siemens.com/WW/view/en/50305045>)

## Catalogs

You will find the order numbers for the Siemens products of relevance here in the following catalogs:

- SIMATIC NET Industrial Communication / Industrial Identification, catalog IK PI
- SIMATIC Products for Totally Integrated Automation and Micro Automation, catalog ST 70
- Industry Mall - catalog and ordering system for automation and drive technology, Online catalog

You can request the catalogs and additional information from your Siemens representative.

## Security information

Siemens provides products and solutions with industrial security functions that support the secure operation of plants, solutions, machines, equipment and/or networks. They are important components in a holistic industrial security concept. With this in mind, Siemens' products and solutions undergo continuous development. Siemens recommends strongly that you regularly check for product updates.

For the secure operation of Siemens products and solutions, it is necessary to take suitable preventive action (e.g. cell protection concept) and integrate each component into a holistic, state-of-the-art industrial security concept. Third-party products that may be in use should also be considered. You will find more information about Industrial Security in: Industrial security (<http://www.siemens.com/industrialsecurity>)

To stay informed about product updates as they occur, sign up for a product-specific newsletter. You will find more information about this in Product support (<https://support.industry.siemens.com/cs/ww/en/ps/15247/pm>)

## Unpacking and checking



### **WARNING**

#### **Do not use any parts that show evidence of damage**

If you use damaged parts, there is no guarantee that the device will function according to the specification.

If you use damaged parts, this can lead to the following problems:

- Injury to persons
- Loss of the approvals
- Violation of the EMC regulations
- Damage to the device and other components

Use only undamaged parts.

1. Make sure that the package is complete.
2. Check all the parts for transport damage.





# Safety notes

## Read the safety notices

Note the following safety notices. These relate to the entire working life of the device.

You should also read the safety notices relating to handling in the individual sections, particularly in the sections "Installation" and "Connecting up".

## General notices

 <b>WARNING</b>
<b>Restricted use of the device</b> Devices of the SCALANCE XR-500 product line must not be put into operation in nuclear power plants or other nuclear facilities.
 <b>WARNING</b>
<b>Maximum ambient temperature</b> Note that some factors influence the maximum permitted ambient temperature, refer to the sections "Permitted ambient temperature (Page 20)", "Safety notices for installation (Page 37)", "Desktop operation with adhesive feet (Page 43)" and "Technical data (Page 87)".
 <b>WARNING</b>
<b>Suitable installation location</b> The installation location of a device of the SCALANCE XR-500 product line must be selected so that only qualified service personnel or trained users have access to it. Operation of a device of the SCALANCE XR-500 product line is permitted only when these requirements are met.

**NOTICE**

**Suitable fusing for the power supply cables**

The current on the terminal may not exceed 25 A. Use a fuse, that protects against currents > 25 A. The fuse must meet the following requirements:

In areas according to NEC or CEC:

- Suitable for DC (min. 60 V / 25 A)
- Breaking current at least 10 kA
- Approval according to ANSI/UL 248-1
- Suitable for the protection of DC power supply circuits

In other areas:

- Suitable for DC (min. 60 V / 25 A)
- Breaking current at least 10 kA
- Approval in compliance with IEC 60127-1 / EN 601127-1
- Breaking characteristics: B or C for circuit breakers and fuses
- Suitable for the protection of DC power supply circuits

**Safety notices on use in hazardous areas**

**General safety notices relating to protection against explosion**

 **WARNING**

**Opening the device**

Do not open when energized. Note that this does not apply to opening the service panel in the housing.

**Safety notices for use according to ATEX and IECEx**

If you use the device under ATEX or IECEx conditions you must also keep to the following safety notices in addition to the general safety notices for protection against explosion:

 **WARNING**

**EXPLOSION HAZARD**

Do not press the SELECT/SET button when there is an explosive atmosphere.

**Safety notices when using the device according to Hazardous Locations (HazLoc)**

If you use the device under HazLoc conditions you must also keep to the following safety notices in addition to the general safety notices for protection against explosion:

This equipment is suitable for use in Class I, Division 2, Groups A, B, C and D or non-hazardous locations only.

This equipment is suitable for use in Class I, Zone 2, Group IIC or non-hazardous locations only.

## 2.1 Security recommendations

<b>NOTICE</b>
<b>Information security</b> Connect to the device and change the standard password for the user set in the factory "admin" and "" before you operate the device.

To prevent unauthorized access, note the following security recommendations.

### General

- You should make regular checks to make sure that the device meets these recommendations and/or other security guidelines.
- Evaluate your plant as a whole in terms of security. Use a cell protection concept with suitable products.
- When confidential zones are used, the internal and external network are disconnected, an attacker cannot access the data from the outside.
- Operate the device only within a protected network area.
- Use VPN to encrypt and authenticate communication from and to the devices.
- For data transmission via a non-secure network use an encrypted VPN tunnel (IPsec).
- For operation of the device in a non-secure infrastructure no product liability will be accepted.
- Separate connections correctly (WBM, Telnet, SSH etc.).

### Physical access

- Restrict physical access to the device to qualified personnel.
  - The memory card or the PLUG (C-PLUG, KEY-PLUG) contains sensitive data such as certificates, keys etc. that can be read out and modified.
  - Using the button, you can reset the device to the factory defaults.
- If the device is publicly accessible, disable the functions of the button using the software.
- Lock unused physical ports on the device. Unused ports can be used to gain forbidden access to the plant.

### Software (security functions)

- Keep the software up to date. Check regularly for security updates of the product. You will find information on this on the Internet pages "Industrial Security (<http://www.siemens.com/industrialsecurity>)"
- Inform yourself regularly about security advisories and bulletins published by Siemens productCERT (<http://www.siemens.com/cert/en/cert-security-advisories.htm>).

- Only activate protocols that you really require to use the device.
- Restrict access to the device with a firewall or rules in an access control list (ACL - Access Control List).
- Restrict access to the management of the device with rules in an access control list (ACL).
- The option of VLAN structuring provides good protection against DoS attacks and unauthorized access. Check whether this is practical or useful in your environment.
- Enable logging functions. Use the central logging function to log changes and access attempts centrally. Check the logging information regularly.
- Configure a Syslog server to forward all logs to a central location.

## **Passwords**

- Define rules for the use of devices and assignment of passwords.
- Regularly update passwords and keys to increase security.
- Change all default passwords for users before you operate the device.
- Only use passwords with a high password strength. Avoid weak passwords for example password1, 123456789, abcdefgh.
- Make sure that all passwords are protected and inaccessible to unauthorized personnel.
- Do not use the same password for different users and systems or after it has expired.

## **Keys and certificates**

This section deals with the security keys and certificates you require to set up SSL.

- We strongly recommend that you create your own SSL certificates and make them available.

There are preset certificates and keys on the device. The preset and automatically created SSL certificates are self-signed. We recommend that you use SSL certificates signed either by a reliable external or by an internal certification authority.

The device has an interface via which you can import the certificates and keys.

- Use the certification authority including key revocation and management to sign the certificates.
- Handle user-defined private keys with great caution if you use user-defined SSH or SSL keys.
- Verify certificates and fingerprints on the server and client to avoid "man in the middle" attacks.
- We recommend that you use certificates with a key length of 2048 bits.
- Change keys and certificates immediately, if there is a suspicion of compromise.

## Secure/non-secure protocols

- Avoid or disable non-secure protocols, for example Telnet and TFTP. For historical reasons, these protocols are still available, however not intended for secure applications. Use non-secure protocols on the device with caution.
- Avoid or disable non-secure protocols. Check whether use of the following protocols is necessary:
  - PROFINET
  - Broadcast pings
  - Non authenticated and unencrypted interfaces
  - ICMP (redirect)
  - MRP, HRP
  - GMRP and IGMP
  - LLDP
  - Syslog
  - RADIUS
  - DHCP Options 66/67
  - TFTP
  - GMRP and GVRP
  - Multicast routing
- The following protocols provide secure alternatives:
  - SNMPv1/v2 → SNMPv3  
Check whether use of SNMPv1 is necessary. SNMPv1 is classified as non-secure. Use the option of preventing write access. The product provides you with suitable setting options.  
  
If SNMP is enabled, change the community names. If no unrestricted access is necessary, restrict access with SNMP.  
  
Use SNMPv3 in conjunction with passwords.
  - HTTP → HTTPS
  - TFTP → FTPS
  - Telnet → SSH
  - SNTP → NTP
- Use secure protocols when access to the device is not prevented by physical protection measures.
- To prevent unauthorized access to the device or network, take suitable protective measures against non-secure protocols.
- If you require non-secure protocols and services, operate the device only within a protected network area.

- Restrict the services and protocols available to the outside to a minimum.
- For the DCP function, enable the "DCP read-only" mode after commissioning.

### Port security

- Use port security functions (IEEE 802.1X).
- Enable port authentication on the ports of end devices.
- Use the function "Locked Ports" to block ports for unknown nodes.
- Configure the ports, e.g. edge ports, receive ports, unused ports to block all unnecessary protocols and services.
- Configure the receive ports so that they discard all untagged frames (Tagged Frames Only).

### Available protocols per port

The following list provides you with an overview of the open ports on this device. Keep this in mind when configuring a firewall.

The table includes the following columns:

- **Protocol**  
All protocols that the device supports
- **Port number**  
Port number assigned to the protocol
- **Port status**
  - Open  
The port is always open and cannot be closed.
  - Open (when configured)  
The port is open if it has been configured.

---

#### Note

With some protocols the port may be open although the corresponding protocol is disabled, for example TFTP.

---

- **Default status of the port**
  - Open  
As default the port is open.
  - Closed  
As default the port is closed.
- **Authentication**  
Specifies whether or not the protocol is authenticated during access.

Protocol	Port number	Port status	Default status of the port	Authentication
SSH	TCP/22	Open (when configured)	Open	Yes
TELNET	TCP/23	Open (when configured)	Open	Yes
HTTP	TCP/80	Open (when configured)	Open	Yes
HTTPS	TCP/443	Open (when configured)	Open	Yes
SNTP NTP	UDP/123	Open (when configured)	Closed	No
SNMP	UDP/161	Open (when configured)	Open	Yes
PROFINET	UDP/34964, UDP/49154, 49155	Open	Open	No
Syslog	UDP/514	Open (when configured)	Open	No
EtherNet/IP	TCP/44818, UDP/2222,4 4818	Open (when configured)	Open	No
DHCP	UDP/67,68	Open (when configured)	Closed	No
RADIUS	UDP/1812,1 813	Open (when configured)	Closed	No
TFTP	UDP/69	Open (when configured)	Closed	No
RIP	UDP/520	Open (when configured)	Closed	No

*2.1 Security recommendations*



## Description of the device

### 3.1 Product overview

The type designation of a SCALANCE XR-500 IE switch is made up of several parts that have the following meaning:

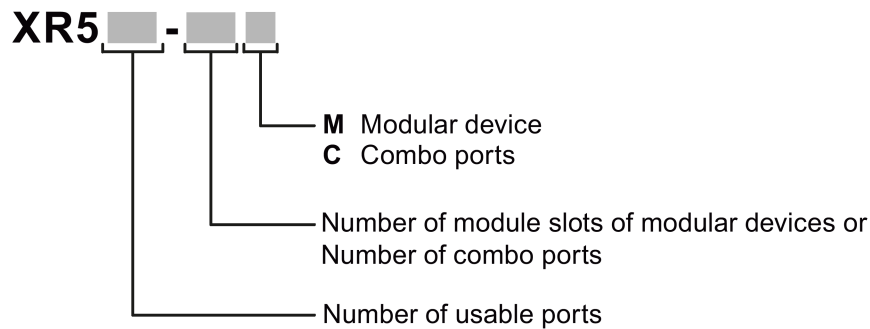

### Article numbers

Device	Properties	Article number	Firmware version
XR524-8C	1 height unit, 2 x 24 VDC, connector for the power supply on the front, layer 3 with KEY-PLUG	6GK5 524-8GS00-2AR2	as of V4.1
	1 height unit, 2 x 24 VDC, connector for the power supply on the front, layer 3 integrated	6GK5 524-8GR00-2AR2	as of V4.1
	1 height unit, 1 x 100 to 240 VAC, connector for the power supply on the rear, layer 3 with KEY-PLUG	6GK5 524-8GS00-3AR2	as of V4.2
	1 height unit, 1 x 100 to 240 VAC, connector for the power supply on the rear, layer 3 integrated	6GK5 524-8GR00-3AR2	as of V4.2
	1 height unit, 2 x 100 to 240 VAC, connector for the power supply on the rear, layer 3 with KEY-PLUG	6GK5 524-8GS00-4AR2	as of V4.2
	1 height unit, 2 x 100 to 240 VAC, connector for the power supply on the rear, layer 3 integrated	6GK5 524-8GR00-4AR2	as of V4.2
XR526-8C	This 1 height unit, 2 SFP+ slots, 2 x 24 VDC, connector for the power supply on the front, layer 3 with KEY-PLUG *)	6GK5 526-8GS00-2AR2	V4.3
	1 height unit, 2 SFP+ slots, 2 x 24 VDC, connector for the power supply on the front, layer 3 integrated *)	6GK5 526-8GR00-2AR2	V4.3
	1 height unit, 2 SFP+ slots, 1 x 100 to 240 VAC, connector for the power supply on the rear, layer 3 with KEY-PLUG	6GK5 526-8GS00-3AR2	V4.3
	1 height unit, 2 SFP+ slots, 1 x 100 to 240 VAC, connector for the power supply on the rear, layer 3 integrated	6GK5 526-8GR00-3AR2	V4.3
	1 height unit, 2 SFP+ slots, 2 x 100 to 240 VAC, connector for the power supply on the rear, layer 3 with KEY-PLUG	6GK5 526-8GS00-4AR2	V4.3
	1 height unit, 2 SFP+ slots, 2 x 100 to 240 VAC, connector for the power supply on the rear, layer 3 integrated	6GK5 526-8GR00-4AR2	V4.3

3.1 Product overview

Device	Properties	Article number	Firmware version
XR528-6M	2 height units, 4 SFP+ slots, 6 modules, layer 3 with KEY-PLUG	6GK5 528-0AA00-2AR2	as of V1.0
	2 height units, 4 SFP+ slots, 6 modules, cable outlet at rear, layer 3 with KEY-PLUG	6GK5 528-0AA00-2HR2	as of V1.0
	2 height units, 4 SFP+ slots, 6 modules, layer 3 integrated	6GK5 528-0AR00-2AR2	as of V1.0
	2 height units, 4 SFP+ slots, 6 modules, cable outlet at rear, layer 3 integrated	6GK5 528-0AR00-2HR2	as of V1.0
XR552-12M	3 height units, 4 SFP+ slots, 12 modules, layer 3 with KEY-PLUG	6GK5 552-0AA00-2AR2	as of V1.0
	3 height units, 4 SFP+ slots, 12 modules, cable outlet at rear, layer 3 with KEY-PLUG	6GK5 552-0AA00-2HR2	as of V1.0
	3 height units, 4 SFP+ slots, 12 modules, layer 3 integrated	6GK5 552-0AR00-2AR2	as of V1.0
	3 height units, 4 SFP+ slots, 12 modules, cable outlet at rear, layer 3 integrated	6GK5 552-0AR00-2HR2	as of V1.0

\*) With the SCALANCE XR526-8C (2 x 24 VDC) if you use SFP/SFP+ pluggable transceivers in the SFP+ slots, the maximum ambient temperature is reduced to 60 °C, see section "Permitted ambient temperature (Page 20)".

Interfaces

Device	Total usable ports	Number of slots for media modules	Modular ports using module slots	Pluggable transceiver slots		Electrical connectors	Combo ports
				SFP	SFP+		
XR524-8C	24	-	-	8	-	24	8
XR526-8C	26	-	-	8	2	24	8
XR528-6M	28	6	24	-	4	-	-
XR552-12M	52	12	48	-	4	-	-

Components of the product

The following components ship with a SCALANCE XR-500:

	SCALANCE XR524-8C	SCALANCE XR526-8C	SCALANCE XR528-6M	SCALANCE XR552-12M
Device with exchangeable medium C-PLUG	•	•	•	•
Product DVD with documentation and software	•	•	•	•
2 brackets for 19" rack installation	•	•	•	•
8 screws for mounting the fixing brackets for 19" rack installation	M3 x 5 countersunk, Drive: Torx	M3 x 5 countersunk, Drive: Torx	M3 x 6 countersunk, Drive: Torx	M3 x 6 countersunk, Drive: Torx
4 adhesive feet for desktop operation	•	•	•	•

	SCALANCE XR524-8C	SCALANCE XR526-8C	SCALANCE XR528-6M	SCALANCE XR552-12M
2 mounting plates and 24 screws for mounting the power supply units (M3 x 6 countersunk, drive: Torx)	-	-	•	•
4-pin terminal block for the 24 VDC power supply	With variants with 24 VDC	With variants with 24 VDC	•	•
2-pin terminal block for the signaling contact	•	•	•	•
Connecting cable for the serial interface with RJ-11 plug and 9-pin D-sub female connector	•	•	•	•
Fan unit	-	-	FAN597-2	FAN597-1
Filter frame with filter pad	-	-	•	•
Covers for the interfaces of the SFP/SFP+	8	10	4	4
Dummy covers for the interfaces of the media module slots	-	-	6	12
Labels for the slot numbers to identify the MM900 media modules in use	-	-	•	•

---

**Note**

When the modules ship, the media module slots are fitted with dummy covers.

---

### 3.1.1 Permitted ambient temperature

The maximum permitted ambient temperature of a device of the product line SCALANCE XR-500 depends on the components used. Note the information with the individual components in the section "Accessories (Page 21)" and the Technical specifications (Page 87).

#### SCALANCE XR524-8C

For SCALANCE XR524-8C (24 VDC), the ambient temperature must not exceed 70 °C.

For SCALANCE XR524-8C (240 VAC), the ambient temperature must not exceed 60 °C.

	SCALANCE XR524-8C (24 VDC)	SCALANCE XR524-8C (240 VAC)
Without pluggable transceiver of the types LH, LH+, ELH or ELH200	-40 °C to +70 °C	-25 °C to +60 °C
With SFP transceivers	-40 °C to +60 °C	-25 °C to +60 °C

#### SCALANCE XR526-8C

For SCALANCE XR526-8C (24 VDC), the ambient temperature must not exceed 70 °C.

For SCALANCE XR526-8C (240 VAC), the ambient temperature must not exceed 60 °C.

	SCALANCE XR526-8C (24 VDC)	SCALANCE XR526-8C (240 VAC)
Without pluggable transceiver of the types LH, LH+, ELH or ELH200	0 °C to +70 °C	0 °C to +60 °C
With SFP transceivers (in SFP slots)	0 °C to +60 °C	0 °C to +60 °C
With SFP transceivers (in SFP+ slots)	0 °C to +60 °C	0 °C to +55 °C
With SFP+ transceivers (in SFP+ slots)	6GK5 993-1AT00-8AA0 6GK5 993-1AU00-8AA0 6GK5 993-1AV00-8AA0	0 °C to +50 °C
	6GK5 993-1AT10-8AA0 6GK5 993-1AU10-8AA0	0 °C to +60 °C

#### SCALANCE XR528-6M and SCALANCE XR552-12M

For SCALANCE XR528-6M and SCALANCE XR552-12M, the ambient temperature must not exceed 60 °C.

	SCALANCE XR528-6M	SCALANCE XR552-12M
Without filter pad and without SFP+ transceiver of the type LH	0 °C to +60 °C	0 °C to +60 °C
With filter pad and without SFP+ transceiver of the type LH	0 °C to +55 °C	0 °C to +55 °C
with filter pad and with SFP+ transceiver of the type LH	0 °C to +50 °C	0 °C to +50 °C

## 3.1.2 Accessories

### Note

You will find detailed information on these products in the operating instructions on the product DVD.

### 3.1.2.1 Accessories for the SCALANCE XR-500 product line

The following accessories are available for the SCALANCE XR-500 product line:

#### Power cable

Type	Description	Article number
Power cable 100 to 240 VAC, straight, 3 m	For Germany, France, Spain, Netherlands, Belgium, Sweden, Austria, Finland	6ES7 900-0AA00-0XA0
Power cable 100 to 240 VAC, straight, 3 m	For Great Britain	6ES7 900-0BA00-0XA0
Power cable 100 to 240 VAC, straight, 3 m	For Switzerland	6ES7 900-0CA00-0XA0
Power cable 100 to 240 VAC, straight, 3 m	For America	6ES7 900-0DA00-0XA0
Power cable 100 to 240 VAC, straight, 3 m	For Italy	6ES7 900-0EA00-0XA0
Power cable 100 to 240 VAC, straight, 3 m	For China	6ES7 900-0FA00-0XA0

#### KEY-PLUG

Type	Article number
KEY-PLUG XR-500	6GK5 905-0PA00

#### SFP transceiver

Type	Properties	Article number
SFP991-1 *	1 x 100 Mbps, LC port optical for glass FO cable (multimode), up to max. 5 km	6GK5 991-1AD00-8AA0
SFP991-1 (C) *	1 x 100 Mbps, SC port optical, for glass FO cable (multimode), up to max. 5 km, varnished	6GK5 991-1AD00-8FA0
SFP991-1LD *	1 x 100 Mbps LC port optical for glass FO cable (single mode) up to max. 26 km	6GK5 991-1AF00-8AA0

3.1 Product overview

Type	Properties	Article number
SFP991-1LD (C) *	1 x 100 Mbps LC port optical for glass FO cable (single mode) up to max. 26 km, varnished	6GK5 991-1AF00-8FA0
SFP991-1LH+ *	1 x 100 Mbps LC port optical for glass FO cable (single mode) up to max. 70 km	6GK5 991-1AE00-8AA0
SFP991-1ELH200 *	1 x 100 Mbps LC port optical for glass FO cable (single mode) up to max. 200 km	6GK5 991-1AE30-8AA0
SFP992-1	1 x 1000 Mbps, LC port optical for glass FO cable (multimode), up to max. 750 m	6GK5 992-1AL00-8AA0
SFP992-1LD	1 x 1000 Mbps LC port optical for glass FO cable (single mode) up to max. 10 km	6GK5 992-1AM00-8AA0
SFP992-1LD (C)	1 x 1000 Mbps LC port optical for glass FO cable (single mode) up to max. 10 km, varnished	6GK5 992-1AM00-8FA0
SFP992-1LH	1 x 1000 Mbps LC port optical for glass FO cable (single mode) up to max. 40 km	6GK5 992-1AN00-8AA0
SFP992-1LH+	1 x 1000 Mbps LC port optical for glass FO cable (single mode) up to max. 70 km	6GK5 992-1AP00-8AA0
SFP992-1ELH	1 x 1000 Mbps LC port optical for glass FO cable (single mode) up to max. 120 km	6GK5 992-1AQ00-8AA0

\* Cannot be operated in SFP+ slots.

**Note**

**Restriction for pluggable transceivers for SCALANCE XR524-8C (2 x 24 VDC) and SCALANCE XR526-8C (2 x DC 24 V)**

If you use pluggable transceivers of the types LH, LH+, ELH or ELH200 with a SCALANCE XR524-8C (2 x 24 VDC) and SCALANCE XR526-8C (2 x 24 VDC) , the maximum ambient temperature is reduced to 60 °C.

For further information on the ambient temperature, refer to sections “Permitted ambient temperature (Page 20)” and “Technical data (Page 87)”.

**Note**

**No far-end fault detection for an SFP transceiver in the SFP+ slot**

If you use an SFP transceiver in an SFP+ slot, no far-end fault detection is possible for this interface.

## SFP+ transceiver

Type	Properties	Article number
SFP993-1	1 x 10 Gbps, LC port optical for glass FO cable (multimode), up to max. 300 m	6GK5 993-1AT00-8AA0 <sup>1)</sup>
	1 x 10 Gbps, LC port optical for glass FO cable (multimode), up to max. 300 m	6GK5 993-1AT10-8AA0 <sup>2)</sup>
SFP993-1LD	1 x 10 Gbps, LC port optical for glass FO cable (single mode), up to max. 10 km	6GK5 993-1AU00-8AA0 <sup>1)</sup>
	1 x 10 Gbps, LC port optical for glass FO cable (single mode), up to max. 10 km	6GK5 993-1AU10-8AA0 <sup>2)</sup>
SFP993-1LH	1 x 10 Gbps, LC port optical for glass FO cable (single mode), up to max. 40 km	6GK5 993-1AV00-8AA0 <sup>1)</sup>

Can only be operated in SFP+ slots.

The following devices have SFP+ slots:

- SCALANCE XR526-8C

---

**Note**
**<sup>1)</sup>Restriction with SFP+ transceivers for SCALANCE XR526-8C**

If you use SFP+ transceivers identified with <sup>1)</sup> with the SCALANCE XR526-8C, the maximum ambient temperature is reduced to 50 °C.

---

**Note**
**<sup>2)</sup>Restriction for DFP+ transceivers for SCALANCE XR526-8C (2 x 24 VDC)**

If you use SFP+ transceivers identified with <sup>2)</sup> with the SCALANCE XR526-8C (2 x 24 VDC), the maximum ambient temperature is reduced to 60 °C.

---

For further information on the ambient temperature, refer to sections “Permitted ambient temperature (Page 20)” and “Technical specifications of the SCALANCE XR526-8C (Page 91)”.

- SCALANCE XR528-6M
- SCALANCE XR552-12M

## 3.1 Product overview

## 3.1.2.2 Additional accessories for modular devices

The following additional accessories are available for devices SCALANCE XR528-6M and SCALANCE XR552-12M:

## Fan unit

Type	Properties	Article number
FAN597-1	For SCALANCE XR552-12M	6GK5 597-1AA00-8AA0
FAN597-2	For SCALANCE XR528-6M	6GK5 597-2AA00-8AA0

**NOTICE****Operation only with fan unit**

Use the devices SCALANCE XR528-6M and SCALANCE XR552-12M only with a correctly fitted fan unit. Operation without the fan is not possible and would damage the device.

## Power supply units

Type	Power	Input voltage	Output voltage	Article number
PS598-1	300 W	100 to 240 VAC	24 VDC	6GK5 598-1AA00-3AA0

## Media modules

Type	Properties	Article number
MM991-4	4 x 100 Mbps, ST ports optical, multimode fiber-optic cable, up to max. 5 km.	6GK5 991-4AB00-8AA0
MM991-4LD	4 x 100 Mbps, ST ports optical, single mode fiber-optic cable, up to max. 26 km.	6GK5 991-4AC00-8AA0
MM992-4	4 x 1000 Mbps, SC ports optical, multimode FO cable, up to max. 750 m.	6GK5 992-4AL00-8AA0
MM992-4LD	4 x 1000 Mbps, SC ports optical, single mode FO cable, up to max. 10 km.	6GK5 992-4AM00-8AA0
MM992-4SFP	4 x 100 / 1000 Mbps, SFP media module	6GK5 992-4AS00-8AA0
MM992-4CU	4 x 10/100/1000 Mbps, RJ-45 ports electrical	6GK5 992-4SA00-8AA0
MM992-4CUC	4 x 10/100/1000 Mbps, RJ-45 ports electrical with securing collars	6GK5 992-4GA00-8AA0
MM992-4PoE	4 x 10/100/1000 Mbps, PoE ports electrical, max 60 W	6GK5 992-4QA00-8AA0
MM992-4PoEC	4 x 10/100/1000 Mbps, PoE ports electrical with securing collars, max 60 W	6GK5 992-4RA00-8AA0



## 3.2 SELECT/SET button

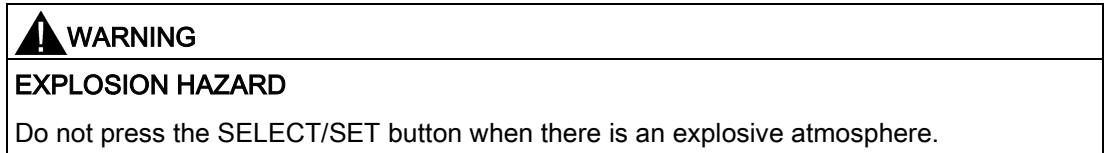

### Position

With a SCALANCE XR-500, the "SELECT/SET" button is on the front of the housing. The "SELECT/SET" button has several functions that are described below.

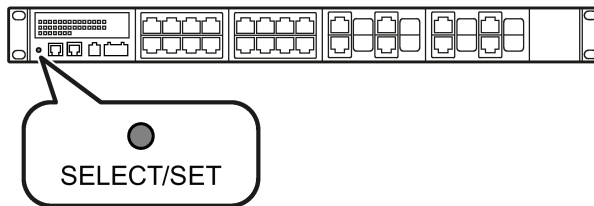

Image 3-1 SELECT/SET button on the SCALANCE XR524-8C SCALANCE XR526-8C is analogous.

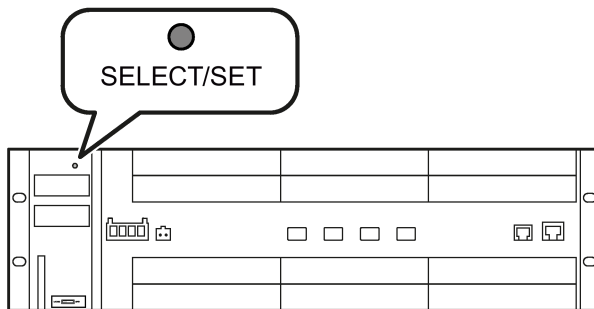

Image 3-2 SELECT/SET button on the SCALANCE XR552-12M SCALANCE XR528-6M is analogous.

### Setting the display mode

By pressing the button briefly, you change to the display mode of the LED display. You will find detailed information on the display modes in the sections ""DM1" and "DM2" LEDs for the display mode (Page 29)" and "Port P1, P2, ... LEDs for the port status (Page 31)".

## Resetting the device to factory defaults

If you reset, all the changes you have made will be overwritten by factory defaults.

To reset the device to the factory defaults, follow the steps below:

1. Switch to display mode A.  
Display mode A is active when the LEDs "DM1" and "DM2" are off.  
When the LEDs "DM1" and "DM2" are lit or flashing, you need to press the "SELECT/SET" button several times briefly until the "DM1" and "DM2" LEDs are off.  
If you do not press the "SELECT/SET" button for longer than 1 minute, the device automatically switches to display mode A.
2. Hold down the "SELECT/SET" button for 12 seconds.  
After 9 seconds, the "DM1" and "DM2" LEDs start to flash for 3 seconds. At the same time, the port LEDs light up one after the other.  
If you release the button before the 12 seconds have elapsed, the reset is canceled.



### CAUTION

#### Restart with the SELECT/SET button disabled for "Restore Factory Defaults"

If you have disabled the SELECT/SET button for "Restore Factory Defaults" in the configuration, this does not apply during the startup phase. When you restart after cycling power, the configuration can nevertheless be deleted using this button. This action cannot be undone and you then need to reload the device configuration. This can lead to disturbances and failures in the corresponding network area.

## Defining the fault mask

Using the fault mask, you specify an individual "good status" for the connected ports and the power supply. Deviations from this status are displayed as errors/faults.

To define the fault mask, follow the steps below:

1. Change to display mode D.  
Display mode D is active when the "DM1" and "DM2" LEDs are lit green.  
If a different display mode is active, press the "SET/SELECT" button several times briefly, until the "DM1" and "DM2" LEDs are lit green.
2. Hold down the "SELECT/SET" button for 5 seconds.  
After 2 seconds, the "DM1" and "DM2" LEDs start to flash for 3 seconds. At the same time the port LEDs go on one after the other.  
After you have pressed the button for 5 seconds, the current settings are stored as the "good status".  
If you release the button before the 5 seconds are up, the previous fault mask is retained.

## Enabling/disabling the redundancy manager

To enable/disable the redundancy manager, follow the steps below:

1. Change to display mode B.  
Display mode B is active when the "DM1" LED is lit green and the "DM2" LED is off.  
If a different display mode is active, press the "SET/SELECT" button several times briefly, until the "DM1" LED is lit green and the "DM2" LED is off.
2. Hold down the "SELECT/SET" button for 5 seconds.  
After 2 seconds, the "DM1", "DM2" and "RM" LEDs start to flash for 3 seconds. At the same time, the port LEDs light up one after the other.  
If you release the button before the 5 seconds have elapsed, the action is canceled.

The result of the action depends on the initial situation:

- **Initial situation:**  
The redundancy manager and media redundancy are disabled.  
**Result:**  
After enabling the redundancy manager, media redundancy is also enabled.
- **Initial situation:**  
The redundancy manager and media redundancy are enabled.  
**Result:**  
After disabling the redundancy manager, media redundancy remains enabled.

### 3.3 LED display

#### 3.3.1 The "RM" LED for the "redundancy manager" function

The "RM" LED indicates whether or not the device is a redundancy manager and whether or not the ring is operating free of error.

LED color	LED status	Meaning
-	Off	The device is not a redundancy manager.
Green	On	The device is a redundancy manager. The ring is working without problems, monitoring is activated.
Green	Flashing	The device is a redundancy manager. An interruption has been detected on the ring and the device has switched through.

#### 3.3.2 The "SB" LED for the standby function

The "SB" LED shows the status of the standby function.

LED color	LED status	Meaning
-	Off	The standby function is disabled.
Green	On	The standby function is enabled. The standby section is passive.
Green	Flashing	The standby function is enabled. The standby section is active.

#### 3.3.3 The "F" LED for the fault status

The "F" LED shows the fault/error status of the device.

##### Meaning during device startup

LED color	LED status	Meaning during device startup
-	Off	Device startup was completed successfully.
Red	On	Device startup is not yet completed or errors have occurred.
Red	Flashing	There are errors in the firmware.

##### Meaning during operation

LED color	LED status	Meaning during operation
-	Off	The device is operating free of errors.
Red	On	The device has detected a problem. The signaling contact has opened.

### 3.3.4 "DM1" and "DM2" LEDs for the display mode

The "DM1" and "DM2" LEDs indicate which display mode is set.

There are 5 display modes (A, B, C, D, and E). Display mode A is the default mode.

Depending on the set display mode, the "L1", "L2" LEDs and the port LEDs show different information.

LED color	LED status		Meaning
	DM1 LED	DM2 LED	
-	Off		Display mode A
Green	On	Off	Display mode B
Green	Off	On	Display mode C
Green	On		Display mode D
Green	Flashing	Off	Display mode E

### Setting the display mode

To set the required display mode, press the "SELECT/SET" button.

If you do not press the "SELECT/SET" button for longer than 1 minute, the device automatically changes to display mode A.

Pressing SELECT/SET button starting at display mode A	LED status		Display mode
	DM1	DM2	
-	Off		Display mode A
Press once	On	Off	Display mode B
Press twice	Off	On	Display mode C
Press three times	On		Display mode D
Press four times	Flashing	Off	Display mode E

### 3.3.5 "L1" and "L2" LEDs for the power supply

The "L1" and "L2" LEDs indicate the current range of the power supply at connectors L1 and L2.

The meaning of the "L1" and "L2" LEDs depends on the set display mode, see section ""DM1" and "DM2" LEDs for the display mode (Page 29)".

#### Voltage limit

For devices with 24 VDC, the voltage limit is 17 VDC.

With devices with 100 to 240 VAC, the voltage limit is 90 VAC.

3.3 LED display

**Meaning in display modes A, B, C and E**

In display modes A, B, C and D, from the "L1" and "L2" LEDs you can see whether the power supply is higher or lower than a certain voltage limit.

Table 3- 1 For devices with a 24 VDC power supply

L1/L2 LED		L1/L2 connector
LED color	LED status	
-	Off	Power supply lower than 17 VDC
Green	On	Power supply higher than 17 VDC

Table 3- 2 Power supply for devices with 100 to 240 VAC

L1/L2 LED		L1/L2 connector
LED color	LED status	
-	Off	Power supply lower than 90 VAC
Green	On	Power supply higher than 90 VAC

**Meaning in display mode D**

In display mode D, the "L1" and "L2" LEDs indicate whether the power supply is monitored.

Table 3- 3 Monitoring for devices with 24 VDC

L1/L2 LED		L1/L2 connector
LED color	LED status	
-	Off	Power supply is not monitored. If the power supply falls below 17 VDC, the signaling contact does not respond.
Green	On	Power supply is monitored. If the power supply falls below 17 VDC, the signaling contact responds.

Table 3- 4 Monitoring for devices with 100 to 240 VAC

L1/L2 LED		L1/L2 connector
LED color	LED status	
-	Off	Power supply is not monitored. If the power supply falls below 90 VAC, the signaling contact does not respond.
Green	On	Power supply is monitored. If the power supply falls below 90 VAC, the signaling contact responds.

### 3.3.6 Port P1, P2, ... LEDs for the port status

The port LEDs "P1", "P2" etc. show information about the corresponding ports.

The meaning of the Port LEDs depends on the set display mode, see section ""DM1" and "DM2" LEDs for the display mode (Page 29)".

#### Meaning in display mode A

In display mode A, the port LEDs indicate whether a valid link exists.

LED color	LED status	Meaning
-	Off	No valid link to the port (for example station turned off or cable not connected).
Green	On	Link exists and port in normal status. In this status, the port can receive and send data.
	Flashes once per period*	Link exists and port in "blocking" status. In this status, the port only receives management data (no user data).
	Flashes three times per period*	Link exists and port turned off by management. In this status, no data is sent or received via the port.
	Flashes four times per period*	Link exists and port is in the "monitor port" status. In this status, the data traffic of another port is mirrored to this port.
Yellow	Flashing / lit	Receiving data at port

\* 1 period  $\triangleq$  2.5 seconds

#### Note

##### LEDS for the SFP+ slots

If SFPs are plugged into SFP+ slots of the SCALANCE XR528-6M and SCALANCE XR552-12M the LEDs do not indicate any data transfer for these slots.

#### Meaning in display mode B

In display mode B, the port LEDs indicate the transmission speed.

LED color	LED status	Meaning
-	Off	Port operating at 10 Mbps
Green	On	Port operating at 100 Mbps
Orange	On	Port operating at 1000 Mbps
Green	Flashing	Port operating at 10 Gbps

If there is a connection problem and the type of transmission is fixed (autonegotiation off), the desired status, in other words the set transmission speed (1000 Mbps, 100 Mbps, 10 Mbps) continues to be displayed. If there is a connection problem and autonegotiation is active, the port LED goes off.

## 3.3 LED display

**Meaning in display mode C**

In display mode C, the port LEDs indicate the mode.

LED color	LED status	Meaning
-	Off	Port operating in half duplex mode
Green	On	Port operating in full duplex mode

**Meaning in display mode D**

In display mode D, the port LEDs indicate whether the port is monitored.

LED color	LED status	Meaning
-	Off	Port is not monitored.
Green	On	Port is monitored for "Link down". If no link was established at the port (e.g. cable not plugged in), the signaling contact indicates an error.
Yellow	On	Port is monitored for "Link up". If a link was established at the port, the signaling contact indicates an error.

**Meaning in display mode E**

In display mode E, the port LEDs indicate whether the connected device is supplied using PoE.

LED color	LED status	Meaning
-	Off	The connected device is not supplied using PoE.
Green	On	The connected device is supplied via PoE.



## 3.4 C-PLUG / KEY-PLUG

### 3.4.1 Function of the C-PLUG/KEY-PLUG

<b>NOTICE</b>
<b>Do not remove or insert a C-PLUG/KEY-PLUG during operation</b>
A C-PLUG/KEY-PLUG may only be removed or inserted when the device is turned off.

#### Saving configuration data and enabling layer 3 functionality

A PLUG is an exchangeable storage medium for storing the configuration data of the device. This allows fast and uncomplicated replacement of a device. The PLUG is taken from the previous device and inserted in the new device. The first time it is started up, the replacement device has the same configuration as the previous device except for the device-specific MAC address set by the vendor.

A C-PLUG stores the current information about the configuration of a device.

In addition to the configuration, a KEY-PLUG also contains a license with which layer 3 functionality is enabled.

---

**Note**

The device can also be operated without a C-PLUG/KEY-PLUG.

---

#### How it works

##### Operating mode

In terms of the C-PLUG / KEY-PLUG, there are three modes for the device:

- Without C-PLUG/KEY-PLUG

The device stores the configuration in internal memory.  
This mode is active if no C-PLUG/KEY-PLUG is inserted.

- With unwritten C-PLUG/KEY-PLUG

If an unwritten C-PLUG/KEY-PLUG (factory status or deleted with Clean function) is used, the local configuration already existing on the device is automatically stored on the inserted C-PLUG/KEY-PLUG during startup.

This mode is active as soon as an unwritten C-PLUG/KEY-PLUG is inserted.

- With written C-PLUG/KEY-PLUG

A device with a written and accepted C-PLUG/KEY-PLUG ("ACCEPTED" status) automatically uses its configuration data during startup.

Acceptance is only possible if the data was written by a compatible device type.

This mode is active as soon as a written C-PLUG/KEY-PLUG is inserted.

### Operation with C-PLUG/KEY-PLUG

The configuration stored on the C-PLUG/KEY-PLUG is displayed via the user interfaces.

If changes are made to the configuration, the device stores the configuration directly on the C-PLUG/KEY-PLUG, if this is in the "ACCEPTED" status. The internal memory is neither read nor written.

### Response to errors

Inserting a C-PLUG/KEY-PLUG that does not contain the configuration of a compatible device type, accidentally removing the C-PLUG/KEY-PLUG or general malfunctions of the C-PLUG/KEY-PLUG are signaled by the diagnostics mechanisms of the device (LEDs, Web-based management (WBM), SNMP, Command Line Interface (CLI) and PROFINET diagnostics).

The user then has the choice of either removing the C-PLUG/KEY-PLUG again or selecting the option to reformat the C-PLUG/KEY-PLUG.

## 3.4.2 Removal and insertion of the C-PLUG/KEY-PLUG

<b>NOTICE</b>
<b>Do not remove or insert a C-PLUG/KEY-PLUG during operation</b>
A C-PLUG/KEY-PLUG may only be removed or inserted when the device is turned off.

### Position of the C-PLUG/KEY-PLUG with rack devices

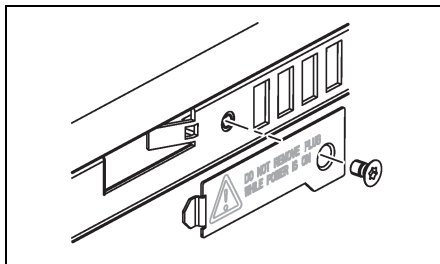
	<p>On a SCALANCE XR524-8C and SCALANCE XR526-8C, the slot is below a cover on the left-hand side of the housing.</p> <p>On a SCALANCE XR528-6M and SCALANCE XR552-12M, the slot is below a cover on the right-hand side of the housing.</p> <p>After undoing the screw (screw head Torx T10), you can remove the cover plate and the slot is accessible.</p>
---	--

### Removing a C-PLUG/KEY-PLUG

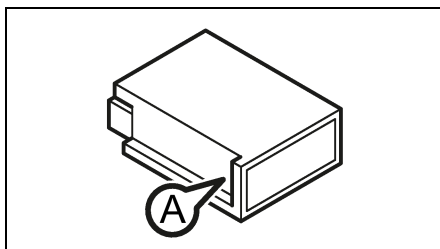
	<ol style="list-style-type: none"><li>1. Turn off the power to the device.</li><li>2. Remove the cover.</li><li>3. Insert a screwdriver between the front edge of the C-PLUG/KEY-PLUG (position A) and the slot and release the C-PLUG/KEY-PLUG.</li><li>4. Remove the C-PLUG/KEY-PLUG and screw the cover plate firmly in place again.</li></ol>
---	---

### Inserting a C-PLUG/KEY-PLUG

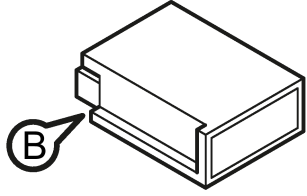
	<ol style="list-style-type: none"><li>1. Turn off the power to the device.</li><li>2. Remove the cover.</li><li>3. The housing of the C-PLUG/KEY-PLUG has a protruding ridge on the long side (position B). The slot has a groove at this position. Insert the C-PLUG/KEY-PLUG into the slot correctly aligned.</li><li>4. Secure the cover plate again with the screws.</li></ol>
---	--

## 3.5 Combo ports

The following devices have combo ports:

- SCALANCE XR524-8C
- SCALANCE XR526-8C

### Characteristics

Combo port is the name for two communication ports. A combo port has the two following jacks:

- a fixed RJ-45 port
- an SFP transceiver slot that can be equipped individually

Of these two ports, only one can ever be active. Using the mode, you can decide how the ports are prioritized.

The port name is the same on both jacks of the combo port, for example "P3C".

For each combo port there is an LED. The LEDs for the combo ports can be identified by a vertical line and the word "COMBO". The labeling of the combo port LEDs does not differ from that of the other LEDs, e.g. "P3".

### Setting the mode

The following modes can be configured for a combo port:

- Mode 1: **auto**

The SFP transceiver port has priority. As soon as an SFP transceiver is plugged in, an existing connection at the fixed RJ-45 port is terminated. If no SFP transceiver is plugged in, a connection can be established via the fixed RJ-45 port.

- Mode 2: **rj45**

The fixed RJ-45 port is independent of the SFP transceiver port.

- Mode 3: **sfp**

The pluggable transceiver port is used independent of the fixed RJ-45 port.

The factory setting for the combo ports is mode 1: auto.

You configure the mode with Web Based Management or the Command Line Interface.

# Assembling

## 4.1 Safety notices for installation

### Safety notices

When installing the device, keep to the safety notices listed below.

 **WARNING**

If a device is operated in an ambient temperature of more than 50 °C, the temperature of the device housing may be higher than 70 °C. The device must therefore be installed so that it is only accessible to service personnel or users that are aware of the reason for restricted access and the required safety measures at an ambient temperature higher than 50 °C.

 **WARNING**

**Ambient temperature for SCALANCE XR526-8C (AC 240V)**

The SCALANCE XR526-8C (AC 240V) devices may only be operated above an ambient temperature of 35 °C if they are in a restricted access location.

A restricted access location means that a device is, for example, installed in a control cabinet and is only accessible to trained personnel.

 **CAUTION**

**Use only approved components**

If you use components and accessories that are not approved for SIMATIC NET devices or their target systems, this may violate the requirements and regulations for safety and electromagnetic compatibility.

- Use only components that are approved for SIMATIC NET devices.
- Create any supports you require according the dimension drawing.

<b>NOTICE</b>
<b>Damage to the device due to inadequate cooling</b>
If the ventilation slits are fully or partly covered, the temperature inside the housing can rise and exceed the maximum permitted temperature causing damage to the device.
The ventilation slits are located on the side panels of the housing. During installation, select a mounting position so that the ventilation slits are always free so that the air can circulate. The clearance to the ventilation slits of the housing must be at least 10 cm.
You will find information about cleaning the air filter in the section "Upkeep and maintenance".
Close unused module slots of modular devices with dummy covers. Open module slots impair the air circulation and can damage the device.
If you mount a SCALANCE XR524-8C or SCALANCE XR526-8C in a rack, leave at least one height unit free above and below.

<b>NOTICE</b>
<b>Warming and premature aging of the IE switch due to direct sunlight</b>
Direct sunlight can heat up the device and can lead to premature aging of the IE switch and its cabling.
Provide suitable shade to protect the IE switch against direct sunlight.

**Note**

During installation and operation, keep to the installation guidelines and safety notices described in this document and in the system manuals "Industrial Ethernet / PROFINET Industrial Ethernet" and "Industrial Ethernet / PROFINET passive network components".

You will find information on the system manuals in the section "Introduction (Page 5)", in "Further documentation".

**Safety notices on use in hazardous areas**

**General safety notices relating to protection against explosion**

 <b>WARNING</b>
<b>EXPLOSION HAZARD</b>
Replacing components may impair suitability for Class 1, Division 2 or Zone 2.

 <b>WARNING</b>
The device is suitable only for operation in the interior.

**⚠ WARNING**

The device may only be operated in an environment with pollution degree 1 or 2 (see IEC 60664-1).

**⚠ WARNING**

When used in hazardous environments corresponding to Class I, Division 2 or Class I, Zone 2, the device must be installed in a cabinet or a suitable enclosure.

**Safety notices for use according to ATEX and IECEx**

If you use the device under ATEX or IECEx conditions you must also keep to the following safety notices in addition to the general safety notices for protection against explosion:

**⚠ WARNING**

To comply with EC Directive 2014/34/EU (ATEX 114) or the conditions of IECEx, this enclosure or cabinet must meet the requirements of at least IP54 in compliance with EN 60529.

**Safety notices when using the device acc. to UL 61010-2-201**

If you use the device under UL 61010-2-201 conditions you must also keep to the following safety notices in addition to the general safety notices for protection against explosion:

**⚠ WARNING**

The devices are "open equipment" acc. to the standard UL 61010-2-201. To fulfill requirements for safe operation with regard to mechanical stability, flame retardation, stability, and protection against contact, the following alternative types of installation are specified:

- Installation in a suitable cabinet.
- Installation in a suitable enclosure.
- Installation in a suitably equipped, enclosed control room.

**⚠ WARNING**

If the cable or housing socket exceeds 70 °C or the branching point of the cables exceeds 60 °C, special precautions must be taken. If the equipment is operated in an air ambient in excess of 40 °C, only use cables with admitted maximum operating temperature of at least 80 °C.

## 4.2 Types of installation

### Mounting the IE switches

For the devices, you have the following options:

- 19" rack mounting
- Desktop operation with adhesive feet
- Secured at 4 points using special mounting brackets

### Mounting modular components

For the modular components, you have the following options:

- Plugging/pulling media modules in the module slots
- Inserting/removing SFP transceivers in media modules for SFP or SFP+ slots
- Inserting/removing SFP+ transceivers in SFP+ slots
- Mounting power supply units

## 4.3 19" rack mounting

### Notes on 19" rack mounting

 **WARNING**

**Increased ambient temperature**

When installed in a closed rack or a rack unit with several devices, the ambient temperature of the rack may be higher than the room temperature. Install the devices in an environment compatible with the maximum ambient temperature specified by the manufacturer.

 **WARNING**

**Reduced air flow**

Install the devices in a rack so that there is an adequate air flow for the reliable operation of the devices.

 **WARNING**

**Mechanical load**

When installing the devices in a rack, avoid the dangers of unequal mechanical load.



** WARNING****Circuit overload**

When connecting the devices to the power supply, avoid the effects of circuit overload on the overcurrent protection and the power supply cables. Take into account the nominal values on the type plate of the devices.

** WARNING****Reliable grounding**

Devices mounted in racks must be reliably grounded. Pay particular attention to supply connectors that are not directly connected to the circuit branch (e.g. socket strip).

---

**Note****Mounting with two mounting brackets**

The device is installed using two mounting brackets on the front of the rack device.

After fitting the two mounting brackets, the rack device can then be installed in a 19" cabinet.

---

**Note****Installation secured at 4 points**

Where mechanical strain is liable to be high, for example when used on a ship, four-point mounting is necessary.

You will find details in the sections "Four-point mounting (Page 45)" and "Mechanical stability (in operation) (Page 116)".

---

Procedure

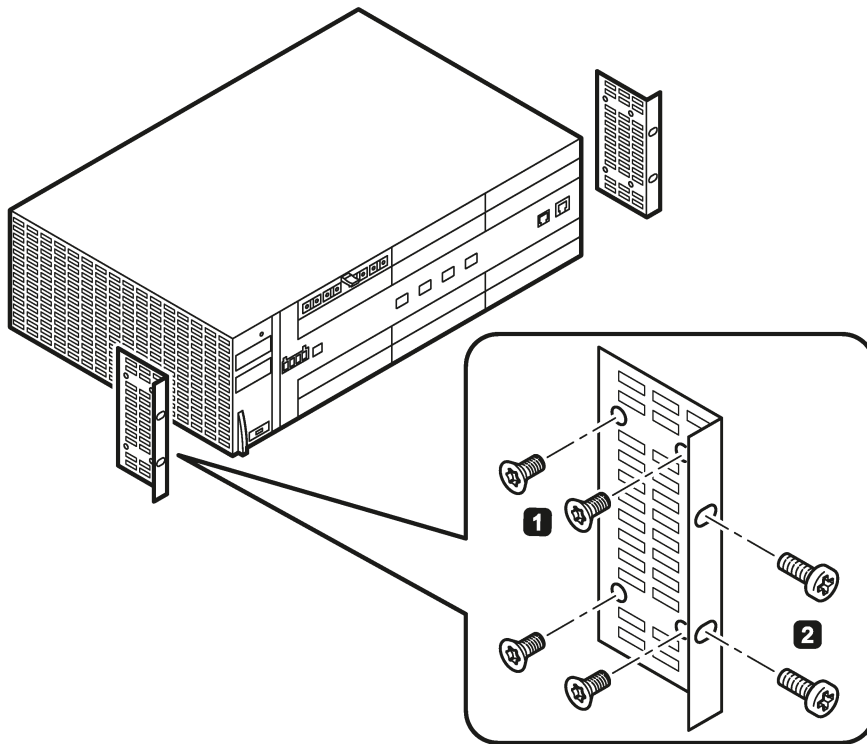

Image 4-1 19" rack mounting of the SCALANCE XR552-12M. SCALANCE XR524-8C, SCALANCE XR526-8C and SCALANCE XR528-6M are mounted in the same way.

To mount the device in a 19" rack, follow the steps below:

1. Secure the two mounting brackets with four screws each (M3 x 6 supplied with the product) to the side panels of the device ①.

The maximum tightening torque for these screws is 0.5 Nm.

The dimensions of the mounting brackets depend on the height units of the device.

2. Position the device at the required location and screw the device to the 19" rack ②.

## 4.4 Desktop operation with adhesive feet

### Notes on desktop operation

 **WARNING**

**Maximum ambient temperature**

Note that several factors influence the maximum permitted ambient temperature, refer to the section "Permitted ambient temperature (Page 20)" and "Technical data (Page 87)".

 **WARNING**

**Ambient temperature for SCALANCE XR526-8C (AC 240V)**

The SCALANCE XR526-8C (AC 240V) devices may only be operated above an ambient temperature of 35 °C if they are in a restricted access location.

A restricted access location means that a device is, for example, installed in a control cabinet and is only accessible to trained personnel.

 **CAUTION**

**No desktop operation with power supply via front terminals is permitted for the SCALANCE XR528-6M and SCALANCE XR552-12M**

The SCALANCE XR528-6M und SCALANCE XR552-12M may only be supplied via the front terminals if they are located in a "restricted access location".

A "restricted access location" means that a device is, for example, installed in a control cabinet and is only accessible to trained personnel.

If one of the named devices is not in a "restricted access location", the power supply units needed to be mounted. When the power supply units are fitted, desktop operation is possible without restrictions.

Desktop operation of the SCALANCE XR528-6M and SCALANCE XR552-12M devices is permitted only when the power supply units are fitted to them.

**Note**

**Strain relief for the cables**

A cable duct or cable tray must be present at a suitable distance from the device to provide strain relief.

## **Procedure**

---

### **Note**

The adhesive feet ship with the product.

---

To mount the device on a desktop with the adhesive feet, follow the steps below:

1. Remove the covering foil on one side of the adhesive feet.
2. Place the adhesive feet on the underside of the device.
3. Remove the remaining covering foils from the adhesive feet.
4. Position the device in the required location.
5. Fix the device in position by applying light pressure to the side edges of the housing.

---

### **Note**

Under no circumstances apply pressure to the center of the device housing, the housing could otherwise be damaged.

---

## 4.5 Four-point mounting

### Notes on four-point mounting

---

**Note****Installation secured at 4 points**

Where mechanical strain is liable to be high, for example when used on a ship, four-point mounting is necessary.

You will find details in the section "Mechanical stability (in operation) (Page 116)".

Example of a four-point mounting: Two mounting brackets on the left-hand side of the device (front and back) and two mounting brackets on the right-hand side of the device (front and back).

---

### Requirements

For the four-point mounting, you require the following:

- 4 suitable brackets
- 4 countersunk screws (M3 x 6) per bracket  
To secure the mounting brackets to the device.
- 2 suitable round-head screws (6 mm diameter) per mounting bracket  
For the surface on which the device is mounted.

### Bracket

To install a SCALANCE XR-500 on a ship horizontally, you require special mounting brackets. You will find the design drawings for constructing the mounting brackets in the section "Mounting brackets for use on ships (Page 104)".

**Brackets for the SCALANCE XR524-8C and SCALANCE XR526-8C**

With the SCALANCE XR524-8C and SCALANCE XR526-8C you can use the same brackets.

The brackets for left and right are identical.

You can also use the mounting brackets intended for 19" rack mounting for the four-point mounting. Two suitable brackets ship with the device. Make the two missing mounting brackets according to the design drawings.

**Brackets for the SCALANCE XR528-6M and SCALANCE XR552-12M**

For SCALANCE XR528-6M and SCALANCE XR552-12M, you require different mounting brackets. The mounting brackets on one side are identical but the mounting brackets for left and right are different.

How to distinguish the mounting brackets is described in the section "Mounting brackets for use on ships (Page 104)".

Make the four mounting brackets according to the design drawings.

## Procedure

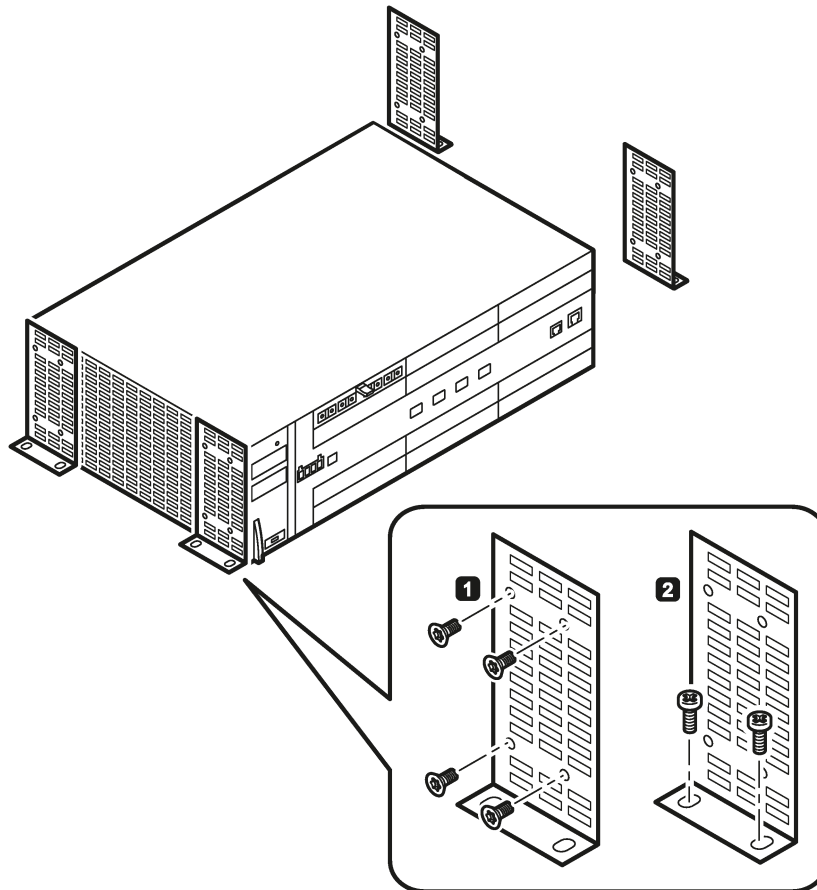

Image 4-2 Attaching the mounting bracket to a SCALANCE XR552-12M. SCALANCE XR524-8C, SCALANCE XR526-8C and SCALANCE XR528-6M are mounted in the same way.

To install the device with a four-point mounting, follow the steps below:

1. Secure the four mounting brackets each with four countersunk screws (M3 x 6 supplied with the product) to the side panels of the device ①.

The maximum tightening torque for these screws is 0.5 Nm.

The dimensions of the mounting brackets depend on the height units of the device.

2. Position the device at the required location and screw the device with suitable round-head screws (6 mm diameter) ②.

## 4.6 Plugging and pulling MM900 media modules

You can use media modules with the following devices:

- SCALANCE XR528-6M
- SCALANCE XR552-12M

### Notes on plugging/pulling media modules

<b>NOTICE</b>
<b>Use only approved media modules</b>
In the module slots of the devices, use only approved media modules "MM900" of the SCALANCE XR-500 IE switches product line.

---

**Note****Slots for PoE modules**

You can only use PoE modules in slots 1, 2 and 3, refer to the following section "Identification of the media module slots and ports".

---

**Note****Factory defaults of the media modules**

When inserting a media module, the parameters of the ports are set to the factory defaults.

First plug a media module into the device, and then assign the parameters for the ports.

---

**Note****The names and labeling of the media modules differ**

Example: The media module is called MM992-4SFP [6GK5 992-4AS00-8AA0], the labeling on the media module is 9924AS.

---

**Identification of the media module slots and ports**

Below, you can see the arrangement of the slots and ports of a SCALANCE XR552-12M:

Slot	1				2				3			
Port	P1	P2	P3	P4	P1	P2	P3	P4	P1	P2	P3	P4
Slot	4				5				6			
Port	P1	P2	P3	P4	P1	P2	P3	P4	P1	P2	P3	P4
Slot					0							
Port (SFP+)					P1	P2	P3	P4				
Slot	7				8				9			
Port	P1	P2	P3	P4	P1	P2	P3	P4	P1	P2	P3	P4
Slot	10				11				12			
Port	P1	P2	P3	P4	P1	P2	P3	P4	P1	P2	P3	P4

A SCALANCE XR528-6M has a total of six slots and four SFP+ ports.

**Note**

**Slot number**

In modular devices, the MM900 media modules can be assigned a slot number. The labels for the slot numbers ship with the modular devices.

**SFP+ ports in slot 0**

The SFP+ ports in slot 0 are part of the basic device.

**Plugging in media module**

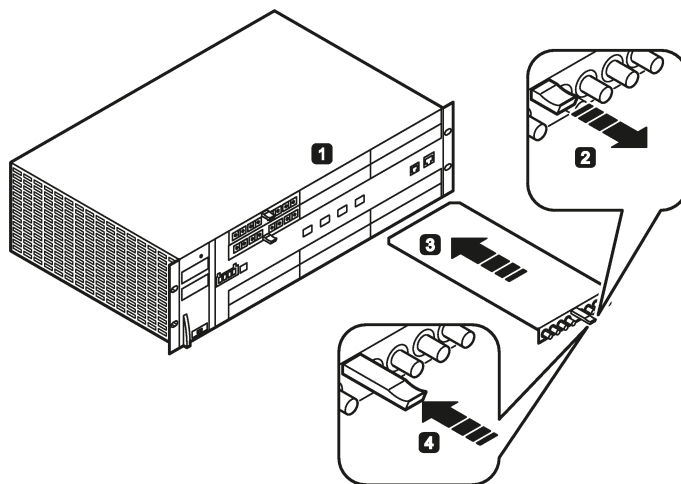

Image 4-3 Plugging a media module into a SCALANCE XR552-12M. SCALANCE XR528-6M is used analogously.



To use MM900 media modules in a modular SCALANCE XR-500, follow the steps below:

1. Remove the dummy cover of the device slot into which you want to insert a media module ①.
2. Pull the handle out of the media module ②.  
The media module cannot be installed unless the handle is pulled out.
3. Place the media module in the guide rails of the device slot ③.  
The media module is correctly installed when it locks easily into the device and the front panel of the module is flush with the front of the device.
4. Push the handle back into the module ④.  
The media module is then locked in place.

### Pulling a media module

To pull a media module, follow the same steps as when plugging, but in the reverse order:

1. Pull out the handle of the media module.
2. Pull the media module out of the device slot.
3. Close the device slot with a dummy cover if you are not plugging in another module.

#### NOTICE

##### Operating the device only with closed module slots

The device meets degree of protection IP20, if all the module slots have either media modules inserted or are closed by dummy covers. Do not start up the device with open module slots since the ingress of objects can lead to damage.

If you operate the device with open module compartments, it is also not possible to guarantee the maximum ambient temperature.

### Exchanging media modules - with change of medium

#### Exchanging a media module

If you replace an electrical media module with an optical media module (or vice versa), this can lead to malfunctions. The IE switch therefore reacts as follows:

- The media module is disabled.
- The red fault LED "F" lights up.
- The event is shown in the log table in WBM.

#### Enabling a media module

To enable the replacement media module, restart the IE switch:

- The media module is active.
- The red fault LED "F" goes off.

## 4.7 Inserting and removing media pluggable transceivers

### 4.7.1 Notes on inserting/removing pluggable transceivers



#### **WARNING**

##### **Use only approved SFP+ transceivers**

If you use SFP+ transceivers that are not approved for SIMATIC NET devices or their target systems, Siemens cannot accept any responsibility as to whether the Ethernet Switch system will function according to the specifications. Siemens can also not guarantee the compatibility and risk-free use of these components.

Use only approved SFP+ transceivers.

---

#### **Note**

##### **Fixed slots for SFP+ transceivers**

The SFP+ transceivers are not suitable for media modules.

SCALANCE XR526-8C has two fixed slots for SFP+ pluggable transceivers.

SCALANCE XR528-6M and SCALANCE XR552-12M have four fixed slots for SFP+ pluggable transceivers.

It is, however, possible to operate SFP transceivers in the fixed SFP+ slots of the device. Note that the SFP+ slots only support SFP transceivers with a transmission rate of 1000 Mbps.

---

#### **Note**

The media module MM992-4SFP and the SFP+ slots may only be fitted with approved SFP or SFP+ transceivers. The SFP media module can be fitted with up to four SFPs.

---

#### **Note**

##### **Plugging and pulling during operation**

You can plug and pull pluggable transceivers during operation. If you have questions on the use of SIMATIC NET products, please contact your Siemens sales partner.

---

## Documentation for SFP transceivers

You will find the operating instructions of the pluggable transceivers here:

- On the data medium that ships with some products:
  - Product CD / product DVD
  - SIMATIC NET Manual Collection
- On the Internet pages of Siemens Industry Online Support (<http://support.automation.siemens.com/WW/view/en/48803858/133300>)

### 4.7.2 Inserting an SFP / SFP+ transceiver

Follow the steps below to insert an SFP / SFP+ transceiver:

1. Remove the sealing plug of the SFP / SFP+ slot.
2. Close the clip of the SFP / SFP+ transceiver.
3. Insert the SFP / SFP+ transceiver in the SFP / SFP+ slot until you hear it engage.  
The SFP / SFP+ transceiver is then firmly secured.
4. Insert the connecting cable into the SFP / SFP+ transceiver until you hear it engage.  
The connecting cable is then firmly secured.

### 4.7.3 Removing an SFP / SFP+ transceiver

#### Notes on deinstallation

 **CAUTION**

**Risk of burns due to the high temperatures of the pluggable transceiver**

The SFP / SFP+ transceivers can be plugged and pulled during operation. Leave the transceiver to cool down as much as possible.

#### Procedure

Follow the steps below to remove an SFP / SFP+ transceiver:

1. Remove the connecting cable of the SFP / SFP+ transceiver.
2. Open the clip of the SFP / SFP+ transceiver.
3. Remove the SFP / SFP+ transceiver from SFP / SFP+ slot.

---

**Note**

**Do not use force**

It must be possible to remove the SFP / SFP+ transceiver easily and without applying any force.

---

4. Close the SFP / SFP+ slot with a sealing plug.

## 4.8 Mounting power supply units

### 4.8.1 19" rack mounting of the PS598-1 power supply unit

#### Notes on 19" rack mounting of the PS598-1 power supply unit

The PS598-1 was developed specifically for use with the SCALANCE XR528-6M and SCALANCE XR552-12M devices. This power supply unit can be mounted directly above or below a SCALANCE XR-500 since the ventilation slits are on the sides of both the basic device and the power supply unit.

 **CAUTION**

**Risk of injury if subjected to irregular mechanical strain**

The device must be mounted in the rack so that even if there is irregular mechanical strain, no dangerous situation can result.

## Procedure

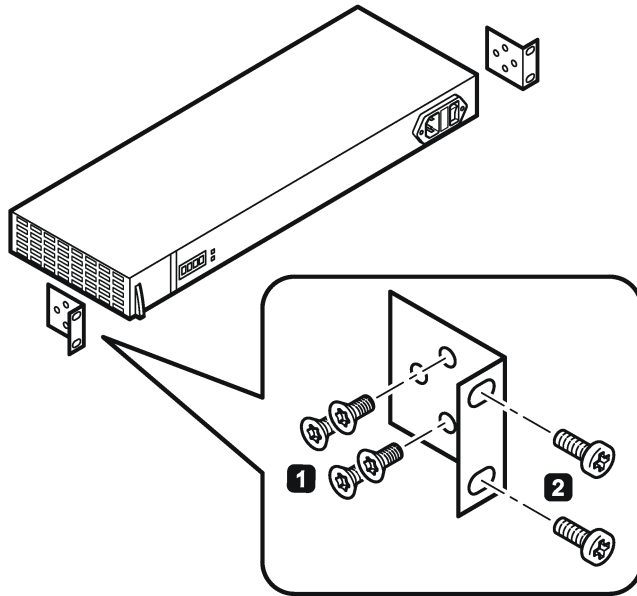

Image 4-4 19" rack mounting of the power supply unit

To mount the PS598-1 power supply unit in a 19" rack, follow the steps below:

1. Secure the two mounting brackets with four screws each (M3 x 6 supplied with the product) to the side panels of the power supply unit ①.

The maximum tightening torque for these screws is 0.5 Nm.

2. Screw the PS598-1 power supply unit to the 19" rack ②.

### 4.8.2 Mounting the PS598-1 power supply unit on the rear panel of modular device

You can mount the PS598-1 power supply unit on the rear panel of the following devices:

- SCALANCE XR528-6M
- SCALANCE XR552-12M

#### Procedure

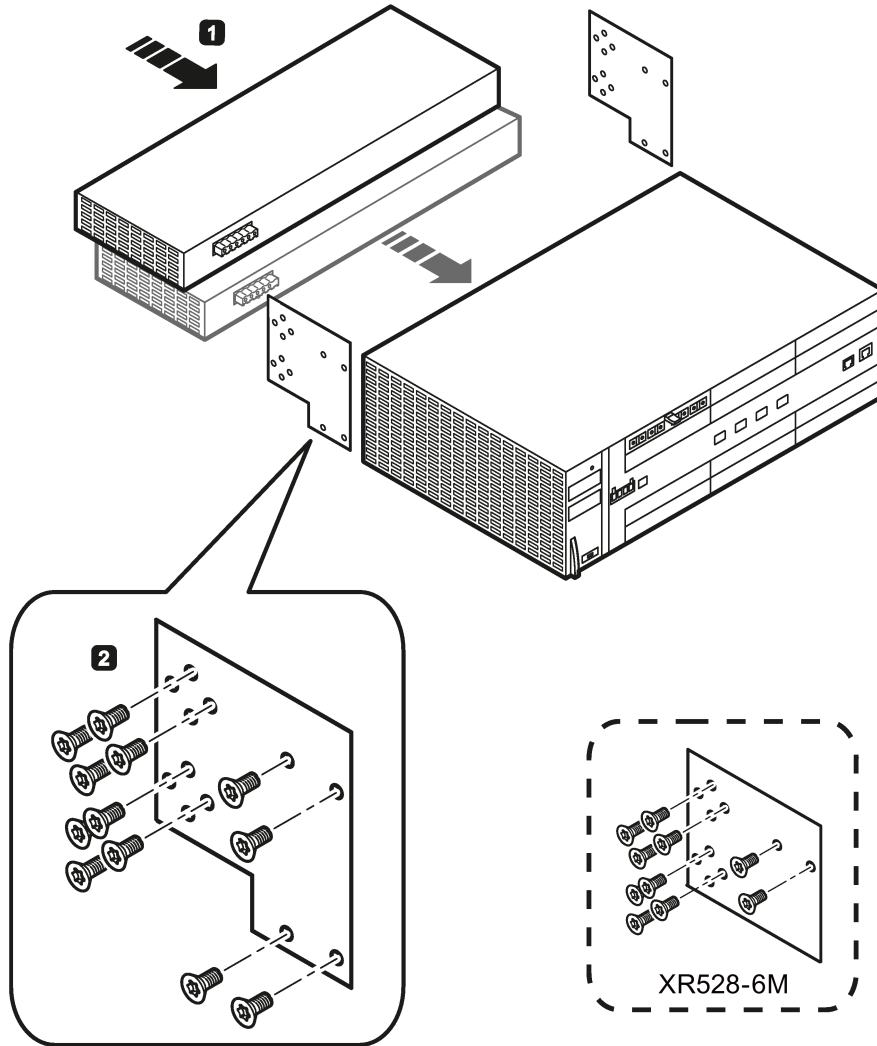

Image 4-5 Rear panel mounting of the SCALANCE XR552-12M. SCALANCE XR528-6M is used analogously.

On the rear panel of an IE switch, there are sockets for the direct connection of a maximum of two PS598-1 power supply units. On the rear of the PS598-1 power supply unit there is a corresponding plug.

To mount the PS598-1 power supply unit on the rear panel of an IE switch, follow the steps below:

1. Fit the PS598-1 power supply unit and the IE switch together ①.

The two devices are equipped with positioning elements that must engage during installation and protect the plug from excessive bending strain.

2. Screw the two devices to the mounting plates supplied with the main device ②.

The maximum tightening torque of the screws is 0.5 Nm.







## Connecting

### 5.1 Commissioning

 <b>WARNING</b>
<b>Commissioning devices and replacement devices</b>
<p>If you use redundancy mechanisms (HRP/MRP ring redundancy and/or redundant coupling of rings with standby), open the redundant path before you insert a new or replacement device in an operational network. A bad configuration or attachment of the Ethernet cables to incorrectly configured ports causes overload in the network and a breakdown in communication.</p>
<p>A device may only be inserted in a network and connected in the following situations:</p>
<ul style="list-style-type: none"><li>• With HRP/MRP:<ul style="list-style-type: none"><li>– Ring redundancy must be activated</li><li>– The mode must be selected correctly.</li><li>– The ring ports of the device being inserted in the HRP/MRP ring must be configured as ring ports.</li></ul></li><li>• With standby link:<ul style="list-style-type: none"><li>– The standby connection must be activated.</li><li>– The "Standby Connection Name" must match the name of the partner device.</li><li>– The port must be configured as a standby port.</li></ul></li></ul>
<p>For further information, refer to the configuration manuals (Page 5).</p>

 <b>WARNING</b>
<p><b>Operation only with safety extra-low voltage</b></p> <p>The device is designed for operation with a directly connectable safety extra-low voltage (SELV). (This does not apply to 100 to 240 V devices).</p> <p>This means that only safety extra-low voltages (SELV) complying with IEC 60950-1 / EN 60950-1 / VDE 0805-1 may be connected.</p> <p>If the equipment is connected to a redundant power supply (two separate power supplies), both must meet these requirements.</p> <p><b>Suitable fusing for the power supply cables</b></p> <p>The current on the terminal must not exceed 25 A.</p> <p>Use a fuse, that protects against currents &gt; 25 A. The fuse must meet the following requirements:</p> <p>In areas according to NEC or CEC:</p> <ul style="list-style-type: none"><li>• Suitable for DC (min. 60 V / 25 A)</li><li>• Breaking current at least 10 kA</li><li>• Approval according to ANSI/UL 248-1</li><li>• Suitable for the protection of DC power supply circuits</li></ul> <p>In other areas:</p> <ul style="list-style-type: none"><li>• Suitable for DC (min. 60 V / 25 A)</li><li>• Breaking current at least 10 kA</li><li>• Approval in compliance with IEC 60127-1 / EN 601127-1</li><li>• Breaking characteristics: B or C for circuit breakers and fuses</li><li>• Suitable for the protection of DC power supply circuits</li></ul>

 <b>WARNING</b>
<p><b>Safety notice for connecting with a LAN ID (Local Area Network)</b></p> <p>A LAN or LAN segment with all the interconnected devices should be contained completely in a single low voltage power distribution in a building. The LAN is designed either for "Environment A" according to IEEE802.3 or "Environment 0" according to IEC TR 62102.</p> <p>Do not connect any electrical connectors directly to the telephone network (telephone network voltage) or a WAN (Wide Area Network).</p>

<b>NOTICE</b>
<b>Failure of the data traffic due to contamination of optical plug-in connections</b> Optical sockets and plugs are sensitive to contamination of the end face. Contamination can lead to the failure of the optical transmission network. Close unused optical sockets and plugs as well as pluggable transceivers and slots with the supplied protective caps. Remove the protective caps only immediately before you use the plug-in connection.

## Safety notices on use in hazardous areas

### General safety notices relating to protection against explosion

 <b>WARNING</b>
<b>EXPLOSION HAZARD</b> Do not connect or disconnect cables to or from the device when a flammable or combustible atmosphere is present.

### Safety notices for use according to ATEX and IECEx

If you use the device under ATEX or IECEx conditions you must also keep to the following safety notices in addition to the general safety notices for protection against explosion:

 <b>WARNING</b>
Take measures to prevent transient voltage surges of more than 40% of the rated voltage. This is the case if you only operate devices with SELV (safety extra-low voltage).

### Safety notices when using the device according to Hazardous Locations (HazLoc)

If you use the device under HazLoc conditions you must also keep to the following safety notices in addition to the general safety notices for protection against explosion:

 <b>WARNING</b>
<b>EXPLOSION HAZARD</b> DO NOT DISCONNECT WHILE CIRCUIT IS LIVE UNLESS AREA IS KNOWN TO BE NON-HAZARDOUS.

## 5.2 24 VDC power supply

### Notes on the power supply

 <b>CAUTION</b>
<b>Overvoltage protection for the power supply cables</b>
<p>If SCALANCE XR-500s are supplied over long 24 V power supply lines or networks, measures are necessary to prevent interference by strong electromagnetic pulses on the supply lines. These can result, for example, due to lightning or switching of large inductive loads.</p> <p>One of the tests used to attest the immunity of the SCALANCE XR-500 to electromagnetic interference is the "surge immunity test" according to EN 61000-4-5. This test requires overvoltage protection for the power supply lines. The following type is, for example, suitable:</p> <p>Dehn Blitzductor BVT AVD 24, order number 918 422</p> <p>Manufacturer: DEHN + SÖHNE GmbH + Co. KG, Hans Dehn Str. 1, Postfach 1640, D-92306 Neumarkt, Germany.</p>

### Information on the power supply

- The power supply is connected using a 4-pin plug-in terminal block. The terminal block ships with the device.
- The power supply can be connected redundantly. Both inputs are isolated. There is no distribution of load. When a redundant power supply is used, the power supply unit with the higher output voltage supplies the SCALANCE XR-500 alone.
- The power supply is connected over a high resistance with the enclosure to allow an ungrounded set up. The two power inputs are non-floating.
- To wire up the power supply connector, use copper cable of the category 14 AWG - 10 AWG or cable with a cross-sectional area of 1.5 mm<sup>2</sup> to 4 mm<sup>2</sup>.

 <b>WARNING</b>
<b>Operation only with safety extra-low voltage</b>
<ul style="list-style-type: none"><li>• The device is designed for operation with a directly connectable safety extra-low voltage (SELV). (This does not apply to 100 to 240 V devices). This means that only safety extra-low voltages (SELV) complying with IEC 60950-1 / UL 60950-1 / EN 60950-1 / VDE 0805-1 may be connected.</li><li>• Do not operate the device with AC voltage or DC voltage higher than 32 VDC.</li></ul>

**Note**

The MM900 media modules are supplied with the required voltage via the modular devices.

The SFP transceivers are supplied with suitable voltage via the SFP media module in a modular device.

**Position and assignment**

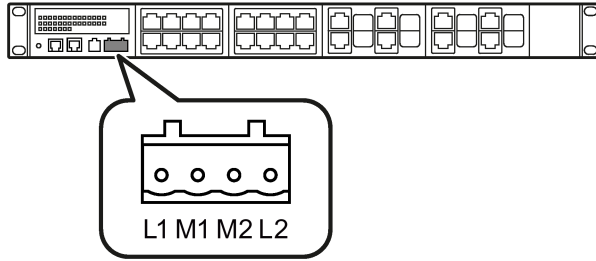

Image 5-1 Position of the terminal block on a SCALANCE XR524-8C SCALANCE XR526-8C is analogous.

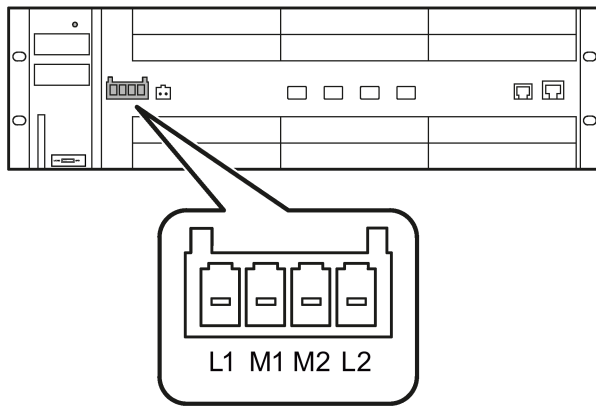



Image 5-2 Position of the terminal block on a SCALANCE XR552-12M SCALANCE XR528-6M is analogous.

Contact	Assignment
L1	+24 VDC
M1	Ground
M2	Ground
L2	+24 VDC

## 5.3 100 to 240 VAC power supply

### 5.3.1 Power supply of the SCALANCE XR524-8C and SCALANCE XR526-8C

#### Notes on the power supply

 <b>WARNING</b>
<b>Danger from line voltage</b>
The supply voltage for the devices listed is 100 to 240 VAC.
This device can only function correctly and safely if it is transported, stored, set up, and installed correctly, and operated and maintained as recommended.
Connecting and disconnecting may only be performed by an electrical specialist.
Connect or disconnect power supply cables only when the power is turned off!

 <b>WARNING</b>
<b>Devices with a 100 to 240 VAC power supply do not have an ATEX or IECEx approval.</b>
Devices with a 100 to 240 V AC power supply are not approved for use in hazardous areas according to EC-RL-94/9 ATEX or IECEx.

<b>NOTICE</b>
<b>Securing cables with dangerous voltage</b>
Make sure that the connector cannot be released accidentally by pulling on the connecting cable. Lay the cables in cable ducts or cable channels and secure the cables, where necessary, with cable ties.

#### Note

##### Use in IT networks

When used in IT networks, the power supply 100 to 240 VAC also applies to the connected IT network: Phase-to-phase.

#### Information on the power supply

The SCALANCE XR524-8C and SCALANCE XR526-8C are available in the following versions for power supply with the 100 to 240 VAC power supply unit:

- With single power supply unit (1 x 100 to 240 VAC)
- With redundant power supply unit (2 x 100 to 240 VAC)

Each power supply unit PS1 and PS2 has its own 2-pin IEC plug C14 with switch.

To connect the power supply, use the cables listed in the section "Accessories (Page 21)".

## Position

The IEC plug with switch S1 Power (position ①) and the socket X1 (position ②) for the input voltage are located on the rear of the device. The second IEC plug for the redundant version is shown in gray in the figure.

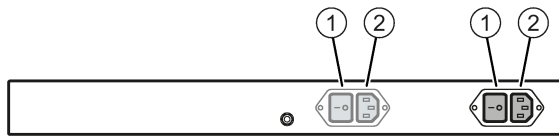

- ① Switch S1 Power
- ② Socket X1

Image 5-3 Position of the IEC connector on a SCALANCE XR524-8C SCALANCE XR526-8C is analogous.

## Grounding

### **WARNING**

#### **Danger from line voltage**

Grounding simply via the housing is inadequate.

In this case, connect the functional ground to ensure reliable operation.

The grounding bolt is located on the rear panel of the device.

### 5.3.2 Power supply using the PS598-1 power supply unit

#### 5.3.2.1 Connectors of the PS598-1 power supply unit

##### Switches for the input voltage

The socket X1 (position ①) and the switch S1 Power (position ③) for the input voltage are located on the right-hand side of the front panel of the housing:



- ① Socket X1
- ② Fuse holder
- ③ Switch S1 Power

Image 5-4 Position of the socket X1 and the switch S1 Power on the PS598-1 power supply unit

#### Notes on the power supply 100 to 240 VAC

##### NOTICE

##### Connect and disconnect the power supply unit only when it is not energized

The PS598-1 power supply unit is not capable of hot plugging. Connecting or disconnecting the PS598-1 when the 100 to 240 VAC power supply is on can damage the PS598-1 power supply unit and the IE switch.

Before connecting or disconnecting the PS598-1 power supply unit, make sure that the switch for the input voltage (position ③) is set to position "0".

##### NOTICE

##### CAUTION/DOUBLE POLE

The fuses FUSE1 and FUSE2 are in the fuse holder (position ②). The fuses are of the type F6.3AH / 250 VAC.

##### NOTICE

##### Overvoltage protection for the power supply cables

If there is any possible overload of the power supply cables, suitable overvoltage protection is necessary. Refer to the values on the type plate.



**NOTICE****Reliable grounding**

Reliable grounding of the devices mounted in the rack must be guaranteed. This applies, in particular, to power supply cables that are not connected directly to the power supply circuit. With the PS598-1 power supply unit, the IEC power connector (IEC 60320-1) provides the connection to protective earth.

**Pin assignment of the X2 socket on the front**

Image 5-5 Position of the socket X2 on the PS598-1 power supply unit

Contact	Assignment
L	+24 VDC
M	Ground
M	Ground
L	+24 VDC

**Pin assignment of the X3 plug on the rear**

Connector X3 is located on the back of the PS598-1. Connector X3 is intended only to connect the PS598-1 directly to SCALANCE XR-528-6M and SCALANCE XR552-12M.

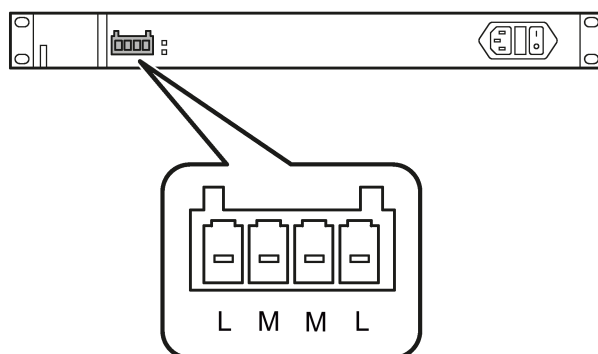
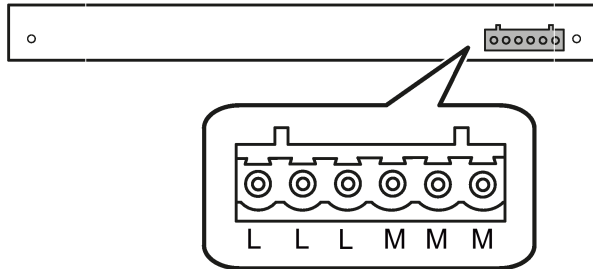

Image 5-6 Position of the plug X3 on the PS598-1 power supply unit

Contact	Assignment
L	+24 VDC
L	
L	
M	Ground
M	
M	

**One PS598-1 per device, no redundancy**

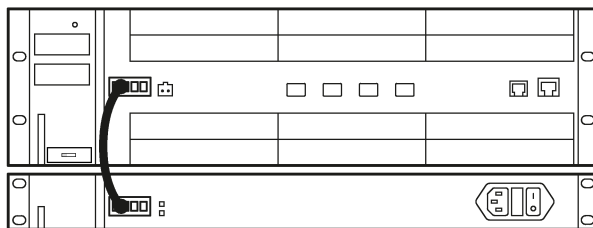

Image 5-7 Connecting a power supply unit to a SCALANCE XR552-12M. SCALANCE XR528-6M is used analogously.

Connect the IE switch and the PS598-1 with one cable for 24 VDC and a cable for ground. As an alternative, you can also mount the PS598-1 on the rear of the IE switch and secure it with screws. In this case, no extra cables are necessary. You will find detailed information in the section "Installation (Page 37)".

### Two PS598-1 per device, 1-out-of-2 redundancy

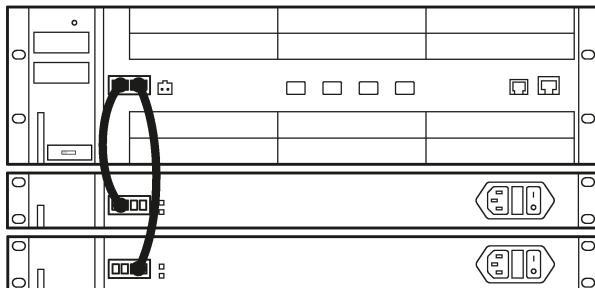

Image 5-8 Connecting two power supply units to a SCALANCE XR552-12M. SCALANCE XR528-6M is used analogously.

Connect the IE switch and the PS598-1 with one cable for 24 VDC and a cable for ground. As an alternative, you can also mount the two PS598-1 power supply units on the rear of the IE switch and secure them with screws. In this case, no extra cables are necessary. You will find detailed information in the section "Assembling (Page 37)". It is also possible to operate the IE switch even after the failure of one PS598-1. The IE switch detects the failure of a power source and signals the failure. The PS598-1 units share the applied load automatically and uniformly.

### Three PS598-1 units for two devices - 2-out-of-3 redundancy

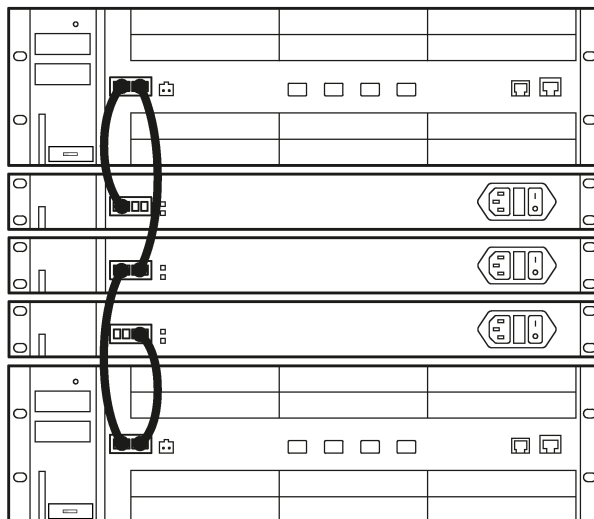

Image 5-9 Connecting three power supply units to a SCALANCE XR552-12M. SCALANCE XR528-6M is used analogously.

Connect each IE switch to its own PS598-1. In addition to this, connect both IE switches to the third PS598-1. Both IE switches devices can now continue to operate after the failure of one PS598-1. The IE switch detects the failure of a power source and signals the failure. The PS598-1 units share the applied load automatically and uniformly.

---

**Note**

**Two connectors for the 24 VDC output voltage**

The PS598-1 has two connectors with the output voltage 24 VDC. Note that you can only use the connector on the front or the connector on the rear of the PS598-1. You cannot operate the device with the connectors on the front and rear at the same time.

---

**Note**

To wire up the power supply connector, use copper cable of the category 14 AWG to 10 AWG or cable with a cross-sectional area of 1.5 to 4 mm<sup>2</sup>.

---

### 5.3.2.2 LED display of the PS598-1 power supply unit

#### LED display

A PS598-1 has two LEDs each, one green and one red. If the green LEDs is lit (24V OK), the output voltage is correctly applied. If the red LED is lit (SHUT DOWN) an error has occurred.

Possible errors/faults:

- The output voltage is not correct.
- Temperature of the PS598-1 is too high.

## 5.4 Signaling contact

### Information on the signaling contact

The signaling contact (relay contact) is a floating switch that signals faults by breaking the contact. The signaling contact is connected to a 2-pin plug-in terminal block.

#### NOTICE

##### Damage due to voltage being too high

The maximum load on the signaling contact is 24 VDC and 100 mA (safety extra-low voltage (SELV)).

Higher voltages or currents can damage the device!

### Position and assignment

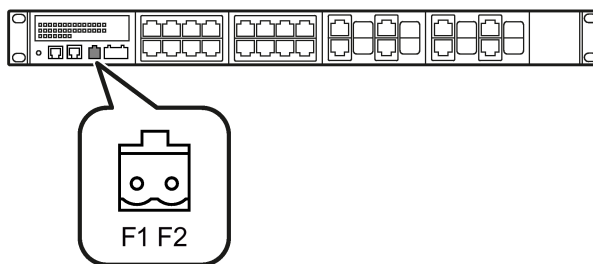

Image 5-10 Position of the signaling contact on a SCALANCE XR524-8C SCALANCE XR526-8C is analogous.

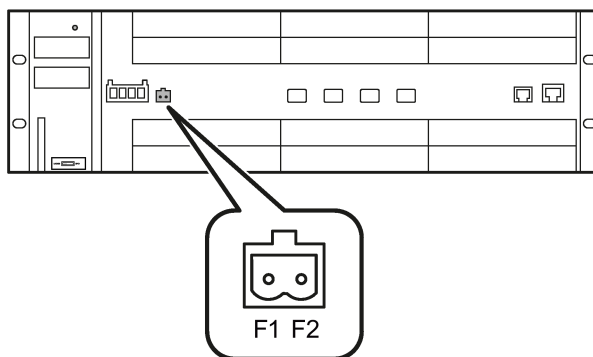

Image 5-11 Position of the signaling contact on a SCALANCE XR552-12M. SCALANCE XR528-6M is analogous.

### Signaling faults

- The signaling of errors/faults by the signaling contact is synchronized with the fault LED "F". All faults/errors indicated by the fault LED "F" (freely configurable) are also signaled by the signaling contact.
- If an internal fault occurs, the fault LED "F" lights up and the signaling contact opens.
- If you connect a communications node to an unmonitored port or disconnect it, this does not cause an error message.
- The signaling contact remains open until one of the following events occurs:
  - The problem is eliminated.
  - The current status is entered in the fault mask as the new desired status.

## 5.5 Serial interface

### Information on the serial interface

- Via the serial interface on the device (RJ-11 jack), you can access the CLI of the device directly via an RS-232 (115200 8N1) connection without assigning an IP address.
- Access to the device is also possible independent of the Ethernet ports.
- To connect the serial interface to the PC, you require a cable with an RJ-11 plug and 9-pin D-sub female connector. The connecting cable for the serial interface ships with the device.

### Position

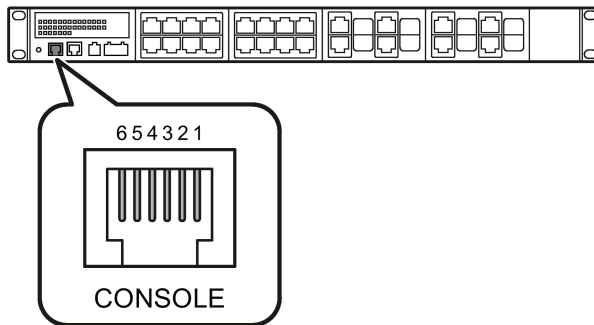

Image 5-12 Position of the RJ-11 jack on a SCALANCE XR524-8C SCALANCE XR526-8C is analogous.

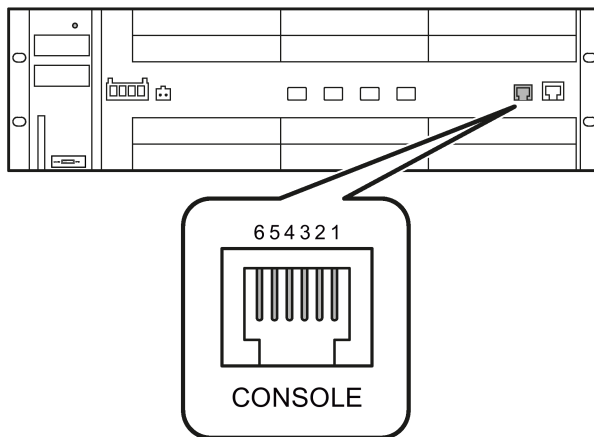

Image 5-13 Position of the RJ-11 jack on a SCALANCE XR552-12M SCALANCE XR528-6M is analogous.

**Assignment of the terminal block**

The supplied connecting cable has the following assignment:

Contact	Pin assignment of the RJ-11 plug	Pin assignment of the D-sub female connector
1	-	-
2	-	TD (Transmit Data)
3	TD (Transmit Data)	RD (Receive Data)
4	SG (Signal Ground)	-
5	RD (Receive Data)	SG (Signal Ground)
6	-	-
7		-
8		-
9		-

---

**Note**

**Pin assignment of the RJ-11 jack on the device**

The RJ-11 jack on the device has a pinout to match the RJ-11 plug of the supplied connecting cable.

---



## 5.6 Out-of-band interface

### Information on the out-of-band interface

- The out-of-band interface is an RJ-45 Ethernet port on the CPU module. The out-of-band interface is not used for routing or switching.
- Access to the device is also possible independent of the other Ethernet ports.
- The out-of-band interface allows direct IP access to the WBM of the device.

### Position

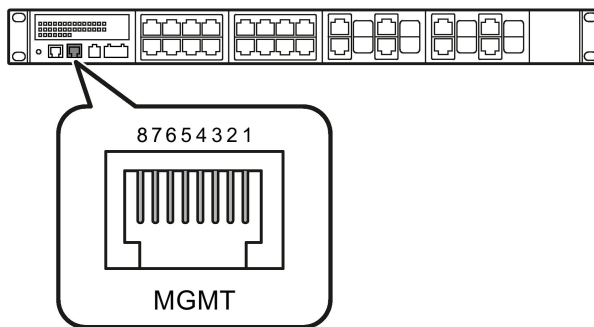

Image 5-14 Position of the out-of-band interface on a SCALANCE XR524-8C. SCALANCE XR526-8C is analogous.

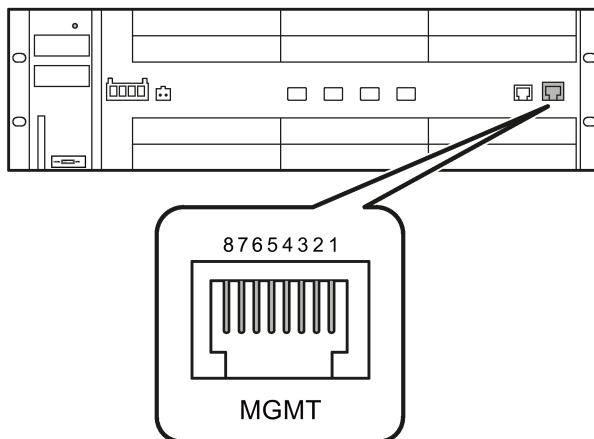

Image 5-15 Position of the out-of-band interface on a SCALANCE XR552-12M. SCALANCE XR528-6M is analogous.

## 5.7 Block architecture of the XR552-12M

### Special features of device-internal data transfer

The SCALANCE XR552-12M has two switch blocks. The assignment of the ports to the two blocks A and B is shown in the graphic below:

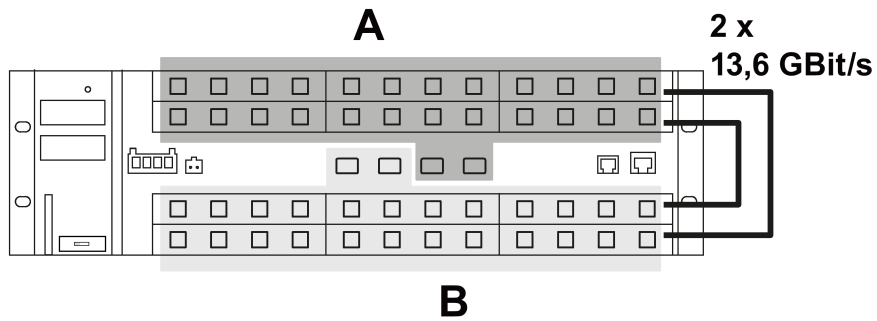

Image 5-16 Block architecture of the SCALANCE XR552-12M

Communication between the switch blocks is via two connections each operating at 13.6 Gbps. This bandwidth must be shared by all ports for inter-block data transfer. For this reason, ports between which a lot of data is transferred should ideally belong to the same switch block. Note that the SCALANCE XR524-8C, the SCALANCE XR526-8C and the SCALANCE XR528-6M only have one switch block and do not require any block architecture.

## 5.8 Functional ground

### Grounding options

Grounding (functional ground) is via the mounting bracket on the device or via the bolts on the rear of the device.

### Position

The connector for the grounding cable is in the center of the rear panel of the device. With a SCALANCE XR552-12M and SCALANCE XR528-6M, grounding is achieved with a screw-in bolt. With a SCALANCE XR524-8C and SCALANCE XR526-8C, grounding is achieved with a pressed-in grounding bolt.

### Fitting grounding bolts

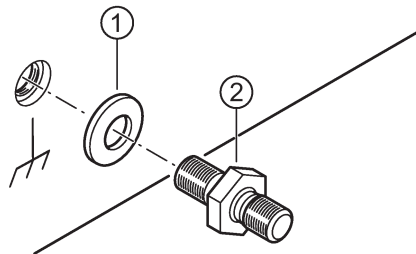

- ① Toothed washer
- ② Grounding bolt

To fit the grounding bolt for a SCALANCE XR552-12M and SCALANCE XR528-6M, follow the steps below:

1. Thread the toothed washer ① onto the bolt.
2. Screw in the grounding bolt ② with a maximum tightening torque of 2 Nm.

Connecting up functional ground

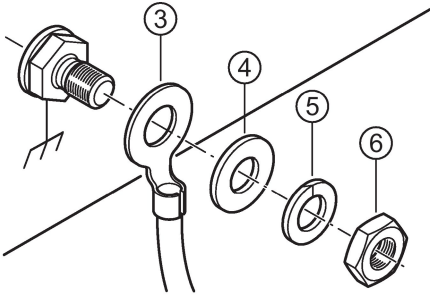
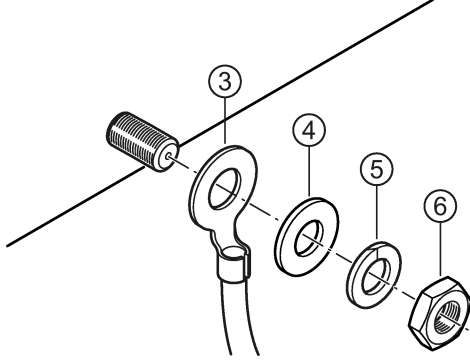
SCALANCE XR552-12M and SCALANCE XR528-6M	SCALANCE XR524-8C and SCALANCE XR526-8C
	
③	Grounding terminal with cable
④	Washer
⑤	Spring washer
⑥	Nut

Follow the steps below to connect the functional ground:

1. Put the parts ③, ④ and ⑤ together on the grounding bolt as shown in the drawing.
2. Tighten the nut ⑥ with a maximum tightening torque of 1.5 Nm.

# Uninstalling

## Uninstalling the device

1. Remove all connectors.
2. Remove the power supply unit/units from the rear of the device.
3. When necessary release the locking mechanisms on the rack device (such as the handles on the media modules or the clip on the SFP/SFP+) to be able to remove the media modules (MM900) or the transceivers (SFP/SFP+).



## Upkeep and maintenance

### 7.1 Changing the fan unit

The following devices have a fan unit:

- SCALANCE XR528-6M
- SCALANCE XR552-12M

<b>NOTICE</b>
<b>Operation of the SCALANCE XR-500 only with fan unit</b>
Use a SCALANCE X-500 only with a correctly fitted fan unit. Operating without the fan is not possible and would damage the device!
You can, however, replace the fan unit during operation. Note the following parameter requirements.

#### Requirement

If you replace the fan unit during operation, the ventilation of the housing may be interrupted at:

- an ambient temperature of 60 °C - 50 °C for a maximum of 30 seconds.
- an ambient temperature of 40 °C - 50 °C for a maximum of 1 minute.
- an ambient temperature lower than 40 °C for a maximum of 2 minutes.

To give yourself more time when replacing the unit, make sure that the device's ambient temperature is as low as possible.

**Procedure**

Follow the steps below to replace the fan unit:

1. Unlock the door in the housing by pushing the catch to the right with a slotted screwdriver ①.

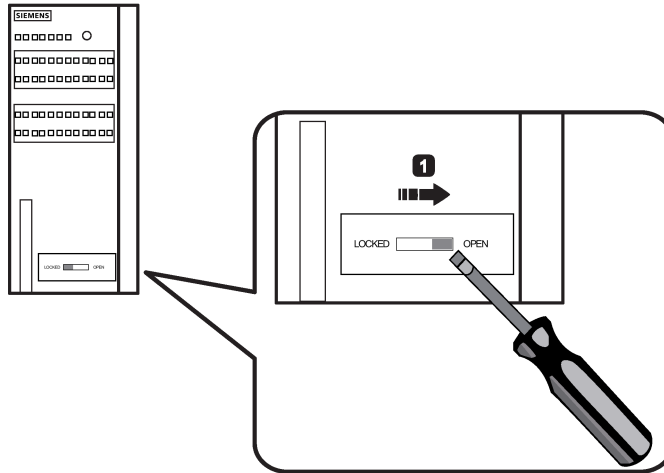

Image 7-1 Opening the housing of a SCALANCE XR552-12M. SCALANCE XR528-6M is used analogously.

2. Open the door in the housing ②.

<b>⚠ WARNING</b>
<b>Danger of injury by touching rotating fan blades</b>
There is a risk of injury if you touch rotating fan blades.
Do not touch rotating fan blades.
Allow the fan blades to come to a stop.

3. Pull the fan unit out of the housing using the handle on the fan unit ③. Note that the filter frame with the filter mat is also automatically pulled out.



4. Disconnect the fan unit and the filter frame ④.

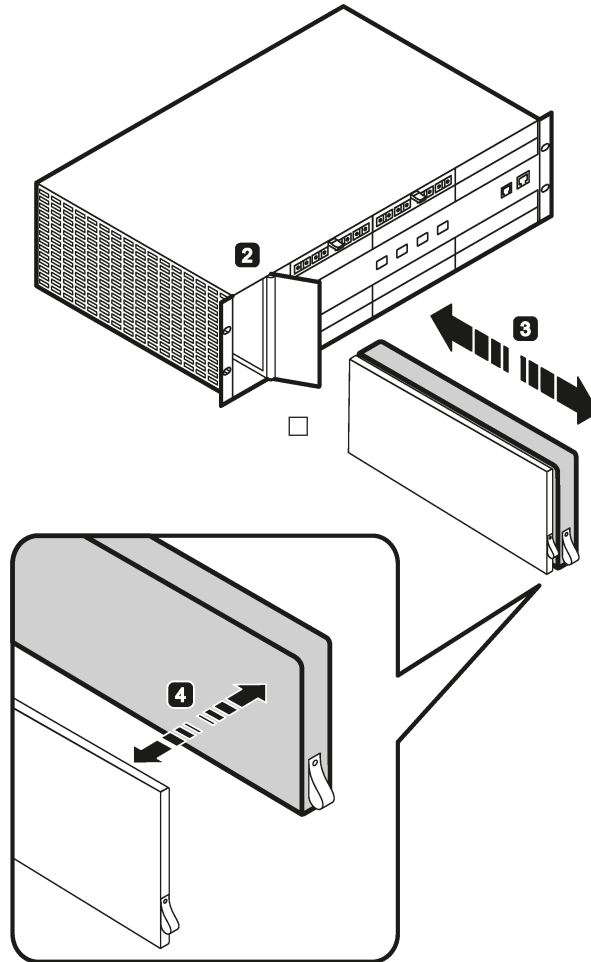

Image 7-2 Changing the fan of a SCALANCE XR552-12M SCALANCE XR528-6M is used analogously.

5. Push the new fan unit into the slot along the guide rails.
6. Push the filter frame into the slot along the guide rails.
7. Close the cover and lock it by pushing the catch from right to left with a slotted screwdriver.

---

**Note**

After turning on the basic device, the fans rotate at full speed for approximately 1 minute before the fan controller becomes active.

---

## 7.2 Changing the filter pad

The following devices have a filter pad:

- SCALANCE XR528-6M
- SCALANCE XR552-12M

### NOTICE

#### Damage to the device due to inadequate ventilation

A badly contaminated filter reduces air flow and can cause the device to be damaged.

Check the degree of contamination of the filter regularly and clean or replace the filter mat as necessary.

### Procedure

Follow the steps below to replace the filter pad:

1. Unlock the door in the housing by pushing the catch to the right with a slotted screwdriver ①.

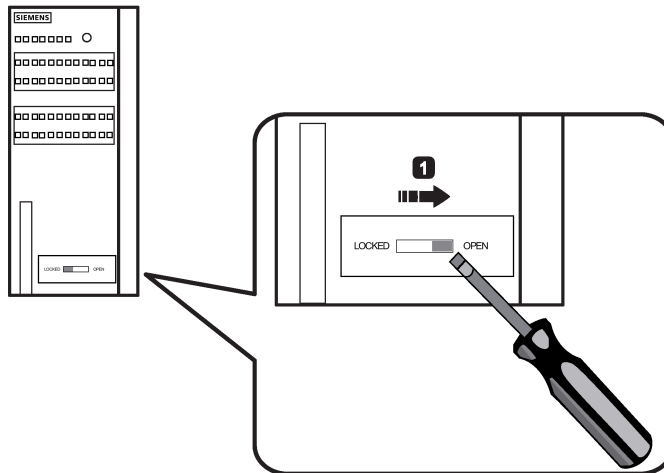

Image 7-3 Opening the housing of a SCALANCE XR552-12M. SCALANCE XR528-6M is used analogously.

2. Open the door in the housing ②.

3. Pull the filter frame out of the housing pulling on the strap of the filter frame ③.

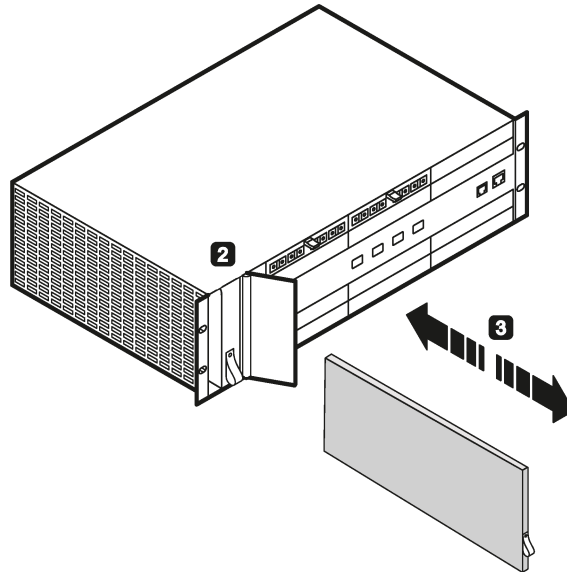

Image 7-4 Changing the filter pad of a SCALANCE XR552-12M SCALANCE XR528-6M is used analogously.

4. Remove the filter pad.
5. Clean or replace the filter pad.
6. Insert the cleaned or new filter mat in the filter frame.
7. Insert the filter frame in the compartment again.
8. Close the cover and lock it by pushing the catch from right to left with a slotted screwdriver.

## 7.3 Downloading new firmware using TFTP without WBM and CLI

### Firmware

The firmware is signed and encrypted. This ensures that only firmware created by Siemens can be downloaded to the device.

### Procedure with Microsoft Windows

Using TFTP, you can supply a device with new firmware even when it cannot be reached using WBM or CLI. This section explains the procedure based on the example of Microsoft Windows.

Follow the steps below to load new firmware using TFTP:

1. Turn off the power to the device.
2. Now press the "SELECT/SET" button and reconnect the power to the device while holding down the button.
3. Hold down the button until the red fault LED "F" starts to flash after approximately 30 seconds.
4. Now release the button. The bootloader of the device waits in this status for a new firmware file that you can download by TFTP.
5. Connect a PC to the out-band interface of the device via an Ethernet cable.
6. Assign an IP address to the device using DHCP or the Primary Setup Tool.
7. Open a Windows command prompt and change to the directory where the file with the new firmware is located and then execute the following command :

```
tftp -i <IP address> put <firmware file>
```

---

#### Note

You can enable TFTP in Microsoft Windows as follows:

"Control Panel" > "Programs and Features" > "Turn Windows features on or off" > "TFTP Client".

---

8. Once the firmware has been transferred completely to the device and validated, there is an automatic restart on the device. This may take several minutes.

## 7.4 Restoring the factory settings

### Procedure

 <b>CAUTION</b>
<b>Previous settings</b> When you reset the device parameters, all previously changed settings are lost.

 <b>CAUTION</b>
<b>Reset despite disabled SELECT/SET button</b> Using the SELECT/SET button, you can always reset the device parameters to the factory settings during the startup phase of the device. This also applies if the function has been disabled using the WBM or CLI. This allows you to reset the device to the factory defaults in an emergency.  If the function has been disabled with the WBM or CLI, it is only disabled on completion of the startup phase.

 <b>CAUTION</b>
<b>Inadvertent reset</b> An inadvertent reset can cause disturbances and failures in the configured network.

To reset the device parameters to the factory defaults, follow the steps below:

1. Turn off the power to the device.
2. Now press the "SELECT/SET" button and reconnect the power to the device while holding down the button.
3. Hold down the button until the red fault LED "F" stops flashing after approximately 40 seconds and is permanently lit.
4. Now release the button and wait until the fault LED "F" goes off again.
5. The device starts automatically with the factory settings.



## Technical data

### 8.1 Technical specifications of the SCALANCE XR524-8C

The following technical specifications apply to the SCALANCE XR524-8C.

<b>Technical specifications</b>		
<b>Attachment to Industrial Ethernet</b>		
Electrical connectors <sup>1)</sup>	Quantity	24
	Connector	RJ-45 jack
	Transmission speed	10 / 100/ 1000 Mbps
Slots for SFP transceivers	Quantity	8
	Connector	SFP transceiver
	Transmission speed	100 / 1000 Mbps
<b>Diagnostics interface</b>		
Serial interface	Quantity	1
	Connector	RJ-11 jack
Out-of-band interface	Quantity	1
	Connector	RJ-45 jack
Signaling contact	Quantity	1
	Design	Terminal block, 2 terminals
	Permitted voltage range	24 VDC
	Load capability	max. 100 mA
<b>Connection to power supply</b>		
2 x 24 VDC	Design	Terminal block, 4 terminals
	Rated voltage	24 VDC
	Voltage range	19.2 VDC - 28.8 VDC
	Fusing	3.15 A / 125 V
	Current consumption	1 A
	Effective power loss	24 W
	Cable cross-section	
	• Minimum	• 0.75 mm <sup>2</sup> (18 AWG)
	• Maximum	• 2.5 mm <sup>2</sup> (12 AWG)
	Properties	Implemented redundantly

8.1 Technical specifications of the SCALANCE XR524-8C

<b>Technical specifications</b>		
1 x 100 to 240 VAC	Design	IEC plug C14 with switch, 2-pin
	Rated voltage	100 / 240 VAC
	Voltage range	90 to 264 VAC
	Frequency	60 Hz / 50 Hz
	Frequency range	47 Hz to 63 Hz
	Fusing	3.15 A / 250 V
	Current consumption at 100 VAC	0.6 A
	Current consumption at 240 VAC	0.37 A
	Effective power loss	24 W
	Properties	Not implemented redundantly
2 x 100 to 240 VAC	Design	IEC plug C14 with switch, 2-pin
	Rated voltage	100 V to 240 V AC
	Voltage range	90 to 264 VAC
	Frequency	60 Hz to 50 Hz
	Frequency range	47 Hz to 63 Hz
	Fusing	3.15 A / 250 V
	Current consumption at 100 VAC	0.6 A
	Current consumption at 240 VAC	0.37 A
	Effective power loss	24 W
	Properties	Implemented redundantly
<b>Permitted ambient conditions</b>		
Ambient temperature For devices with 24 VDC <sup>2)</sup>	When operating without pluggable transceiver of the types LH, LH+, ELH or ELH200 up to 2000 m	-40 °C to +70 °C
	When operating as of 2000 m	The maximum ambient temperature is reduced by 5°C
	During storage	-40 °C to +85 °C
	During transportation	-40 °C to +85 °C
Ambient temperature for devices with 100 to 240 VAC <sup>2)</sup>	When operating without pluggable transceiver of the types LH, LH+, ELH or ELH200 up to 2000 m	-25 °C to +60 °C
	When operating as of 2000 m	The maximum ambient temperature is reduced by 5°C
	During storage	-40 °C to +85 °C
	During transportation	-40 °C to +85 °C
Relative humidity	During operation at 25 °C	≤ 95%, no condensation



<b>Technical specifications</b>		
<b>Design, dimensions and weight</b>		
Weight	2 x 24 VDC	3.8 kg
	1 x 100 to 240 VAC	4.2 kg
	2 x 100 to 240 VAC	4.5 kg
Degree of protection	IP20	
Dimensions without brackets for 19" rack mounting (W x H x D)	446 x 44 x 305 mm (1 height unit)	
Installation options	<ul style="list-style-type: none"> <li>• 19" rack mounting</li> <li>• Desktop operation</li> <li>• Four-point mounting</li> </ul>	
<b>Design of the mounting bracket for use on ships</b>		
Dimensions without brackets for 19" rack mounting (W x H x D)	43.6 x 43.6 x 18.3 mm (1 height unit)	
Plate thickness	1.5 mm	
Inner bending radii	1.5 mm	
Surface of the housing	Stainless steel X6CR17	
<b>Mean time between failure (MTBF)</b>		
• Basic device without pluggable transceiver	2 x 24 VDC	> 21.1 years
	1 x 100 to 240 VAC	> 10.9 years
• at 40 °C ambient temperature	2 x 100 to 240 VAC	> 14.4 years

<sup>1</sup>)When working with electrical connectors, make sure that the isolation between the ports is maintained, see "Isolation between ports".

<sup>2</sup>) Depending on which pluggable transceiver you use, the maximum ambient temperature can change, see section "Permitted ambient temperature (Page 20)".

**Note**

**ISO tolerance and punching burr**

For dimensions without tolerance details, the general tolerances "medium" acc. to DIN ISO 2768 apply. No punching burrs are permitted.

**Isolation between ports**

SCALANCE XR524-8C has four port groups:

- Group 1: P1 - P4 and P13 - P16
- Group 2: P5 - P8 and P17 - P20
- Group 3: P9 - P10 and P21 - P22
- Group 4: P11 - P12 and P23 - P24

The requirements of the isolation voltage for Environment A (IEEE 802.3) are met between ports of the same group, in other words, the electrical isolation of the ports is designed for 500 Vrms (1 minute). Example: between P1 and P15

*8.1 Technical specifications of the SCALANCE XR524-8C*

The requirements of the isolation voltage for Environment B (IEEE 802.3) are met between ports of different groups, in other words, the electrical isolation of the ports is designed for 1500 Vrms (1 minute). Example: between P6 and P23

## 8.2 Technical specifications of the SCALANCE XR526-8C

The following technical specifications apply to the SCALANCE XR526-8C.

<b>Technical specifications</b>		
<b>Attachment to Industrial Ethernet</b>		
Electrical connectors <sup>1)</sup>	Quantity	24
	Connector	RJ-45 jack
	Transmission speed	10 / 100/ 1000 Mbps
Slots for SFP transceivers	Quantity	8
	Connector	SFP transceiver
	Transmission speed	100 / 1000 Mbps
Slots for SFP transceivers (SFP+)	Quantity	2
	Connector	SFP+ transceiver
	Transmission speed	1000 Mbps – 10 Gbps
<b>Diagnostics interface</b>		
Serial interface	Quantity	1
	Connector	RJ-11 jack
Out-of-band interface	Quantity	1
	Connector	RJ-45 jack
Signaling contact	Quantity	1
	Design	Terminal block, 2 terminals
	Permitted voltage range	24 VDC
	Load capability	max. 100 mA
<b>Connection to power supply</b>		
2 x 24 VDC	Design	Terminal block, 4 terminals
	Rated voltage	24 VDC
	Voltage range	19.2 VDC - 28.8 VDC
	Fusing	3.15 A / 125 V
	Current consumption	1.5 A
	Effective power loss	36 W
	Cable cross-section	
	• Minimum	• 0.75 mm <sup>2</sup> (18 AWG)
	• Maximum	• 2.5 mm <sup>2</sup> (12 AWG)
	Properties	Implemented redundantly

**Technical specifications**

1 x 100 to 240 VAC	Design	IEC plug C14 with switch, 2-pin
	Rated voltage	100 V to 240 V AC
	Voltage range	90 to 264 VAC
	Frequency	60 Hz to 50 Hz
	Frequency range	47 Hz to 63 Hz
	Fusing	3.15 A / 250 V
	Current consumption at 100 VAC	0.8 A
	Current consumption at 240 VAC	0.42 A
	Effective power loss	38 W
	Properties	Not implemented redundantly
2 x 100 to 240 VAC	Design	IEC plug C14 with switch, 2-pin
	Rated voltage	100 / 240 VAC
	Voltage range	90 to 264 VAC
	Frequency	60 Hz / 50 Hz
	Frequency range	47 Hz to 63 Hz
	Fusing	3.15 A / 250 V
	Current consumption at 100 VAC	0.8 A
	Current consumption at 240 VAC	0.42 A
	Effective power loss	38 W
	Properties	Implemented redundantly
<b>Permitted ambient conditions</b>		
Ambient temperature For devices with 24 VDC <sup>2)</sup>	When operating without pluggable transceiver of the types LH, LH+, ELH or ELH200 up to 2000 m	0 °C to +70 °C
	When operating as of 2000 m	The maximum ambient temperature is reduced by 5°C
	During storage	-40 °C to +85 °C
	During transportation	-40 °C to +85 °C
Ambient temperature for devices with 100 to 240 VAC <sup>2)</sup>	When operating without pluggable transceiver of the types LH, LH+, ELH or ELH200 up to 2000 m	0 °C to +60 °C
	When operating as of 2000 m	The maximum ambient temperature is reduced by 5°C
	During storage	-40 °C to +85 °C
	During transportation	-40 °C to +85 °C
Relative humidity	During operation at 25 °C	≤ 95%, no condensation

<b>Technical specifications</b>		
<b>Design, dimensions and weight</b>		
Weight	2 x 24 VDC	3.9 kg
	1 x 100 to 240 VAC	4.4 kg
	2 x 100 to 240 VAC	4.7 kg
Degree of protection	IP20	
Dimensions without brackets for 19" rack mounting (W x H x D)	446 x 44 x 305 mm (1 height unit)	
Installation options	<ul style="list-style-type: none"> <li>• 19" rack mounting</li> <li>• Desktop operation</li> <li>• Four-point mounting</li> </ul>	
<b>Design of the mounting bracket for use on ships</b>		
Dimensions without brackets for 19" rack mounting (W x H x D)	43.6 x 43.6 x 18.3 mm (1 height unit)	
Plate thickness	1.5 mm	
Inner bending radii	1.5 mm	
Surface of the housing	Stainless steel X6CR17	
<b>Mean time between failure (MTBF)</b>		
• Basic device without pluggable transceiver	2 x 24 VDC	> 18.61 years
	1 x 100 to 240 VAC	> 10.25 years
• at 40 °C ambient temperature	2 x 100 to 240 VAC	> 13.22 years

<sup>1</sup>)When working with electrical connectors, make sure that the isolation between the ports is maintained, see "Isolation between ports".

<sup>2</sup>) Depending on which pluggable transceiver you use, the maximum ambient temperature can change, see section "Permitted ambient temperature (Page 20)".

**Note**

**ISO tolerance and punching burr**

For dimensions without tolerance details, the general tolerances "medium" acc. to DIN ISO 2768 apply. No punching burrs are permitted.

**Isolation between ports**

SCALANCE XR526-8C has four port groups:

- Group 1: P1 - P4 and P13 - P16
- Group 2: P5 - P8 and P17 - P20
- Group 3: P9 - P10 and P21 - P22
- Group 4: P11 - P12 and P23 - P24

The requirements of the isolation voltage for Environment A (IEEE 802.3) are met between ports of the same group, in other words, the electrical isolation of the ports is designed for 500 Vrms (1 minute). Example: between P1 and P15

*8.2 Technical specifications of the SCALANCE XR526-8C*

The requirements of the isolation voltage for Environment B (IEEE 802.3) are met between ports of different groups, in other words, the electrical isolation of the ports is designed for 1500 Vrms (1 minute). Example: between P6 and P23

## 8.3 Technical specifications of the SCALANCE XR528-6M

The following technical specifications apply to the SCALANCE XR528-6M.

<b>Technical specifications</b>		
<b>Attachment to Industrial Ethernet</b>		
Slots for media modules	Quantity	6
Slots for SFP transceivers (SFP+)	Quantity	4
	Connector	SFP transceivers (LC port)
	Transmission speed	10 Gbps
<b>Diagnostics interface</b>		
Serial interface	Quantity	1
	Connector	RJ-11 jack
Out-of-band interface	Quantity	1
	Connector	RJ-45 jack
Signaling contact	Quantity	1
	Design	Terminal block, 2 terminals
	Permitted voltage range	24 VDC
	Load capability	max. 100 mA
<b>Connection to power supply</b>		
24 VDC power supply	Design	Terminal block, 4 terminals
	Rated voltage	24 VDC
	Voltage range	19.2 VDC - 28.8 VDC
	Fusing	3.15 A / 125 V
	Cable cross-section	
	• Minimum	• 0.75 mm <sup>2</sup> (18 AWG)
	• Maximum	• 2.5 mm <sup>2</sup> (12 AWG)
Properties	Implemented redundantly	
Connector for power supply unit PS598-1	Quantity	2
	Design	Terminal block
Overcurrent protection of the power supply	Non-replaceable fuse	
	Fan unit	T 5 A / 125 V
	Electronics	F 15 A / 125 V
	PoE	F 15 A / 125 V
<b>Electrical data (basic device without media modules)</b>		
24 VDC power supply	Current consumption	0.92 A
	Effective power loss	22 W
<b>Electrical data (basic device with maximum device configuration)</b>		
24 VDC power supply	Current consumption	11.5 A
	Effective power loss	276 W

8.3 Technical specifications of the SCALANCE XR528-6M

<b>Technical specifications</b>		
<b>Permitted ambient conditions</b>		
Ambient temperature <sup>1)</sup>	Operation without filter pad and without SFP+ LH transceiver up to 2000 m	0 °C to +60 °C
	When operating as of 2000 m	The maximum ambient temperature is reduced by 5°C
	During storage	-40 °C to +70 °C
	During transportation	-40 °C to +70 °C
Relative humidity	During operation at 25 °C	≤ 95%, no condensation
<b>Design, dimensions and weight</b>		
Weight (basic device without media modules)	7.2 kg	
Degree of protection (with closed service panel)	IP20	
Dimensions without brackets for 19" rack mounting (W x H x D)	446 x 88 x 305 mm (2 height units)	
Installation options	<ul style="list-style-type: none"> <li>• 19" rack mounting</li> <li>• Desktop operation</li> <li>• Four-point mounting</li> </ul>	
<b>Design of the mounting bracket for use on ships</b>		
Dimensions without brackets for 19" rack mounting (W x H x D)	60 x 87.1 x 18.3 mm (2 height units)	
Plate thickness	1.5 mm	
Inner bending radii	1.5 mm	
Surface of the housing	Stainless steel X6CR17	
<b>Mean time between failure (MTBF)</b>		
	<ul style="list-style-type: none"> <li>• Basic device without media modules</li> <li>• at 40 °C ambient temperature</li> </ul>	> 17.1 years

<sup>1)</sup> Depending on which components you use, the maximum ambient temperature can change, see section "Permitted ambient temperature (Page 20)".

**Note**

**ISO tolerance and punching burr**

For dimensions without tolerance details, the general tolerances "medium" acc. to DIN ISO 2768 apply. No punching burrs are permitted.





8.4 Technical specifications of the SCALANCE XR552-12M

<b>Technical specifications</b>		
<b>Permitted ambient conditions</b>		
Ambient temperature <sup>1)</sup>	Operation without filter pad and without SFP+ LH transceiver up to 2000 m	0 °C to +60 °C
	When operating as of 2000 m	The maximum ambient temperature is reduced by 5°C
	During storage	-40 °C to +70 °C
	During transportation	-40 °C to +70 °C
Relative humidity	During operation at 25 °C	≤ 95%, no condensation
<b>Design, dimensions and weight</b>		
Weight (basic device without media modules)	10 kg	
Degree of protection (with closed service panel)	IP20	
Dimensions without brackets for 19" rack mounting (W x H x D)	446 x 133 x 305 mm (3 height units)	
Installation options	<ul style="list-style-type: none"> <li>• 19" rack mounting</li> <li>• Desktop operation</li> <li>• Four-point mounting</li> </ul>	
<b>Design of the mounting bracket for use on ships</b>		
Dimensions without brackets for 19" rack mounting (W x H x D)	60 x 130.5 x 18.3 mm (3 height units)	
Plate thickness	1.5 mm	
Bending radii	1.5 mm	
Surface of the housing	Stainless steel X6CR17	
<b>Mean time between failure (MTBF)</b>		
	<ul style="list-style-type: none"> <li>• Basic device without media modules</li> <li>• at 40 °C ambient temperature</li> </ul>	> 15.7 years

<sup>1)</sup> Depending on which components you use, the maximum ambient temperature can change, see section "Permitted ambient temperature (Page 20)".

**Note**

**ISO tolerance and punching burr**

For dimensions without tolerance details, the general tolerances "medium" acc. to DIN ISO 2768 apply. No punching burrs are permitted.

## 8.5 Switching properties

The following technical specifications apply to the following device:

- SCALANCE XR524-8C
- SCALANCE XR526-8C
- SCALANCE XR528-6M
- SCALANCE XR552-12M

Table 8- 1 Switching properties

Max. number of learnable addresses	16 000
Aging time	Can be configured (default value: 40 seconds)
Switching technique	Store&Forward
Latency	25-70 microseconds

Table 8- 2 Reconfiguration times for redundancy mechanisms

Redundancy mechanism	Reconfiguration times in ms
HRP	300
Standby link	300
MRP	200

Table 8- 3 Full wire speed switching

Number of frames per second			At a frame length of
At 100 Mbps	At 1000 Mbps	For 10 Gbps	
148810	1488095	14880952	64 bytes
84459	844595	8445946	128 bytes
45290	452899	4528986	256 bytes
23496	234962	2349664	512 bytes
11973	119732	1197318	1024 bytes
9615	96154	961538	1280 bytes
8127	81274	811688	1518 bytes

### Note

The following applies for SCALANCE XR-500:

The number of SCALANCE XR-500 modules connected in a line influences the frame delay. When a frame passes through the switch, this is delayed by the Store&Forward function of the SCALANCE XR-500 by 25-70 microseconds (at 1000 Mbps).



## Dimension drawings

### 9.1 SCALANCE XR524-8C and SCALANCE XR526-8C

View from front and above

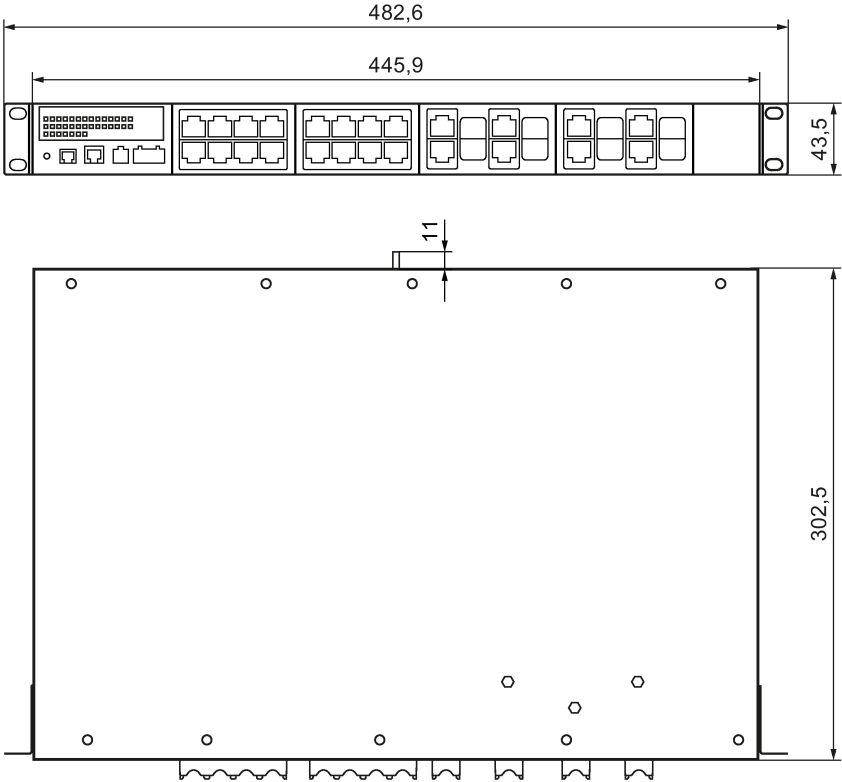

Dimensions are specified in mm.

## 9.2 SCALANCE XR528-6M

View from front and above

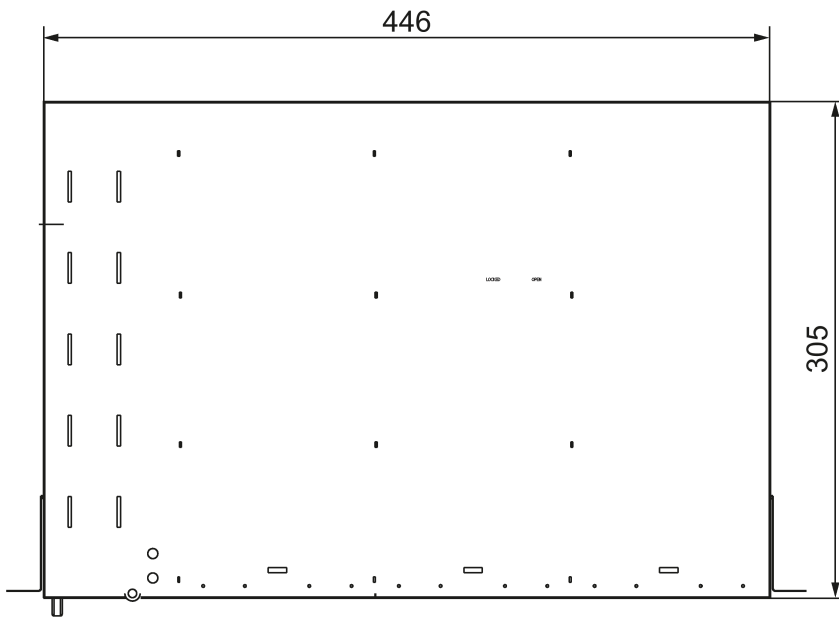
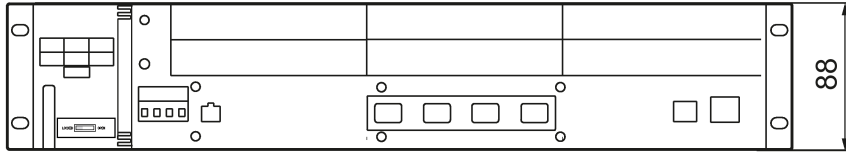

Dimensions are specified in mm.

## 9.3 SCALANCE XR552-12M

View from front and above

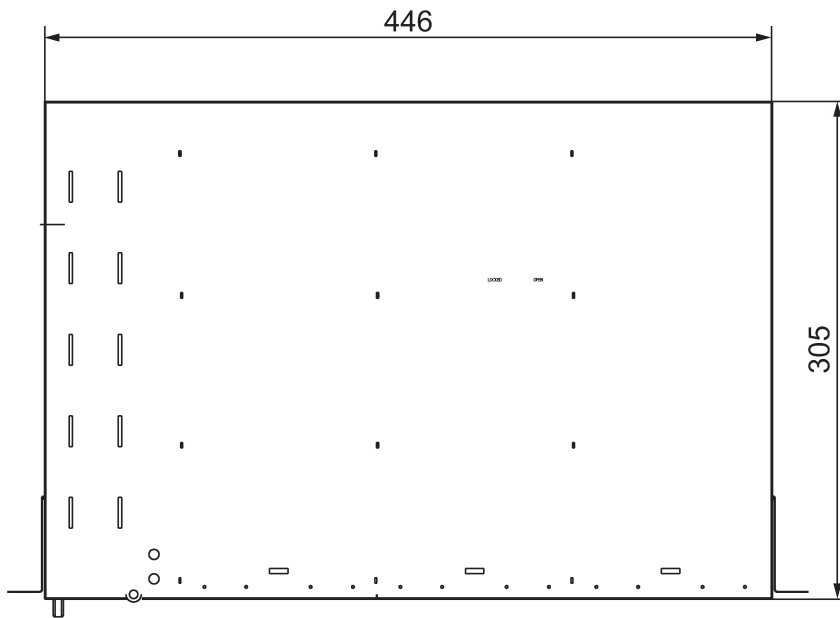
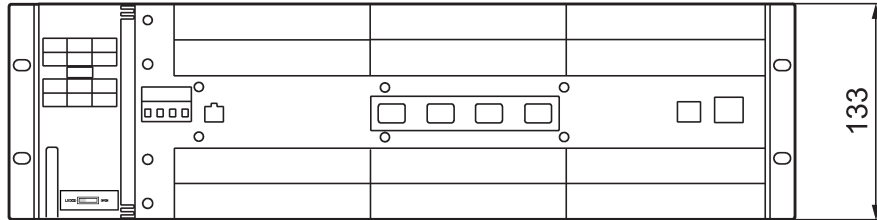

Dimensions are specified in mm.

## 9.4 Mounting brackets for use on ships

### Introduction

To install a SCALANCE XR-500 on a ship horizontally, you require special mounting brackets.

Below you will find the design drawing for making the mounting brackets.

You will find the more information on the construction of the mounting brackets in the section "Technical data (Page 87)".

---

#### Note

##### Different mounting brackets

For the SCALANCE XR524-8C and SCALANCE XR526-8C, the mounting brackets for left and right are identical.

For SCALANCE XR528-6M and SCALANCE XR552-12M, you require different mounting brackets. The mounting brackets on one side are identical but the mounting brackets for left and right are different.

---

#### Note

##### ISO tolerance and punching burr

For dimensions without tolerance details, the general tolerances "medium" acc. to DIN ISO 2768 apply. No punching burrs are permitted.

---



### Brackets for the SCALANCE XR524-8C and SCALANCE XR526-8C

View from the front, top, and side

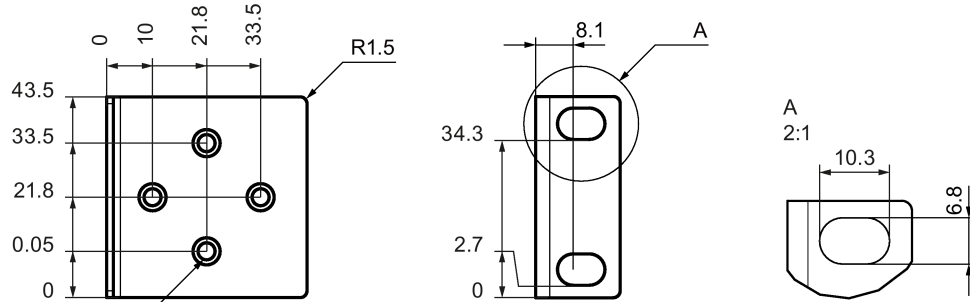

Ø 3.7 (with fiber 1.1 x 45°; 4x)

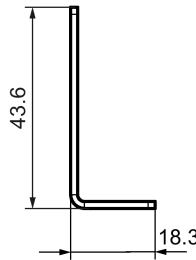
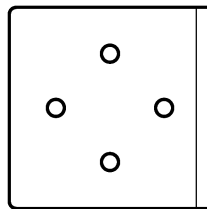

Dimensions are specified in mm.



### Mounting bracket right

View from the front, top, and side (right)

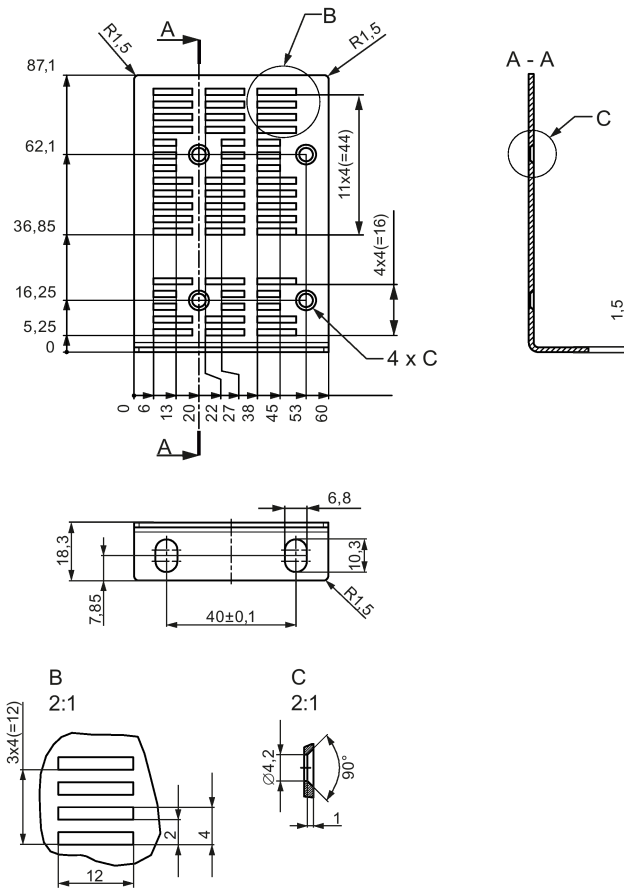

Dimensions are specified in mm.

### Mounting bracket for a SCALANCE XR552-12M

#### Mounting bracket left

View from the front, top, and side (left)

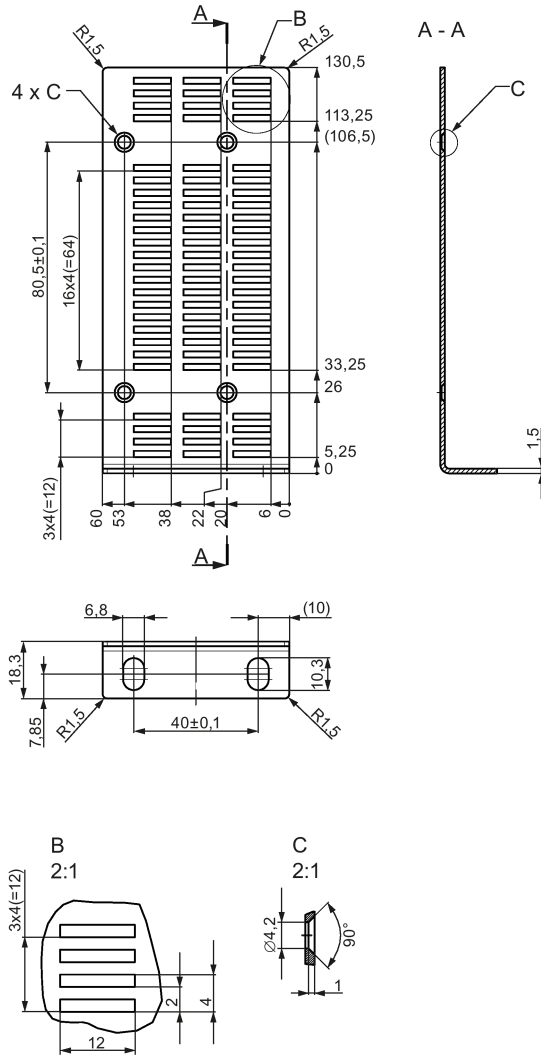

Dimensions are specified in mm.

**Mounting bracket right**

View from the front, top, and side (right)

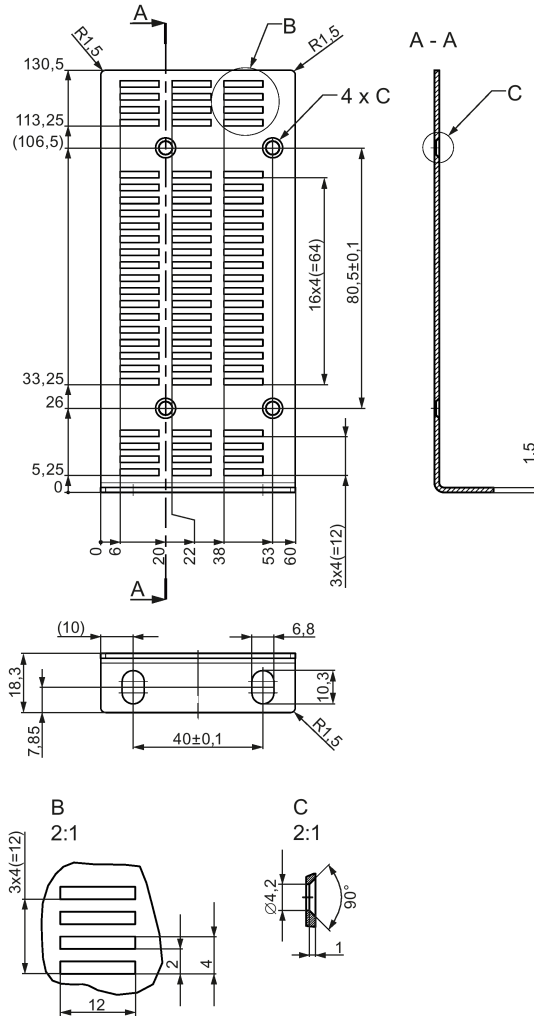

Dimensions are specified in mm.



The SIMATIC NET products described in these Operating Instructions have the approvals listed below.

---

**Note****Issued approvals on the type plate of the device**

The specified approvals apply only when the corresponding mark is printed on the product. You can check which of the following approvals have been granted for your product by the markings on the type plate.

---

## Installation guidelines

The devices meet the requirements if you adhere to the installation and safety instructions contained in this documentation and in the following documentation when installing and operating the devices.

- "Industrial Ethernet / PROFINET Industrial Ethernet" System Manual
- "Industrial Ethernet / PROFINET - Passive network components" System Manual

You will find information on the system manuals in the section "Introduction (Page 5)", in "Further documentation".

- "EMC Installation Guidelines" configuration manual  
60612658 (<http://support.automation.siemens.com/WW/view/en/60612658>)

 <b>WARNING</b>
--

<b>Personal injury and property damage can occur</b>
--

The installation of expansions that are not approved for SIMATIC NET products or their target systems may violate the requirements and regulations for safety and electromagnetic compatibility.
--

Only use expansions that are approved for the system.
---

---

**Note**

The test was performed with a device and a connected communications partner that also meets the requirements of the standards listed above.

When operating the device with a communications partner that does not comply with these standards, adherence to the corresponding values cannot be guaranteed.

---

## EC declaration of conformity

The SIMATIC NET products described in these operating instructions meet the requirements and safety objectives of the following EC directives and comply with the harmonized European standards (EN) for programmable logic controllers which are published in the official documentation of the European Union.

- **2014/34/EU (ATEX explosion protection directive)**

Directive of the European Parliament and the Council of 26 February 2014 on the approximation of the laws of the member states concerning equipment and protective systems intended for use in potentially explosive atmospheres, official journal of the EU L96, 29/03/2014, pages. 309-356

- **2014/30/EU (EMC)**

EMC directive of the European Parliament and of the Council of February 26, 2014 on the approximation of the laws of the member states relating to electromagnetic compatibility; official journal of the EU L96, 29/03/2014, pages. 79-106

- **2011/65/EU (RoHS)**

Directive of the European Parliament and of the Council of 8 June 2011 on the restriction of the use of certain hazardous substances in electrical and electronic equipment

You will find the EC declaration of conformity for these products on the Internet pages of Siemens Industry Online Support (<http://support.automation.siemens.com/WW/view/en/33118389/134200>).

The EC Declaration of Conformity is available for all responsible authorities at:

Siemens Aktiengesellschaft  
 Division Process Industries and Drives  
 Process Automation  
 DE-76181 Karlsruhe  
 Germany

## EC directives

SIMATIC NET products meet the requirements and aims of the following EC directives.

### EMC directive (electromagnetic compatibility)

Until 19.04.2016 the SIMATIC NET products described in these operating instructions meet the requirements of the EC Directive:2004/108/EC "Electromagnetic Compatibility" (EMC directive) and as of 20.04.2016 the EC directive 2014/30/EU.

Field of application	Requirements	
	Emission	Immunity to interference
Industry	EN 61000-6-4	EN 61000-6-2

You will find the current versions of the standards in the currently valid EC declaration of conformity.



## Safety of electrical equipment

In the version put into circulation by Siemens AG, the SIMATIC NET products described in these Operating Instructions conform to the regulations of the following European directive:

- EN 60950-1  
Information technology equipment - Safety - Part 1: General requirements

## Low voltage equipment directive

Devices supplied with 100 to 240 VAC meet the requirements of the directive 2006/95/EC "Electrical Equipment Designed for Use within Certain Voltage Limits" (Low Voltage Equipment Directive). Conformity attested by compliance with the standard EN 60950-1:2010.

## ATEX (explosion protection directive)

 <b>WARNING</b>
<p>When using SIMATIC NET products in hazardous area zone 2, make absolutely sure that the associated conditions in the following document are adhered to:</p> <p>"SIMATIC NET Product Information Use of subassemblies/modules in a Zone 2 Hazardous Area".</p> <p>You will find this document</p> <ul style="list-style-type: none"> <li>• on the data medium that ships with some devices.</li> <li>• on the Internet pages of Siemens Industry Online Support (<a href="http://support.automation.siemens.com/WW/view/en">http://support.automation.siemens.com/WW/view/en</a>).</li> </ul> <p>Enter the document identification number C234 as the search term.</p>

The SIMATIC NET products meet the requirements of the EC directive 94/9/EC "Equipment and Protective Devices for Use in Potentially Explosive Atmospheres". and as of 20.04.2016 the EC directive 2014/34/EU.

ATEX classification:

II 3 G Ex nA IIC T4 Gc

KEMA 07ATEX0145 X

The products meet the requirements of the following standards:

- EN 60079-15 (electrical apparatus for potentially explosive atmospheres; Type of protection "n")
- EN 60079-0 (Explosive atmospheres - Part 0: Equipment - General requirements)

You will find the current versions of the standards in the currently valid ATEX certificates.

---

### Note

Only variants with 24 VDC power supply meet the requirements of this approval.

---

## IECEX

The SIMATIC NET products meet the requirements of explosion protection according to IECEX.

IECEX classification:

Ex nA IIC T4 Gc

DEK 14.0025X

The products meet the requirements of the following standards:

- IEC 60079-15 (Explosive atmospheres - Part 15: Equipment protection by type of protection "n")
- IEC 60079-0 (Explosive atmospheres - Part 0: Equipment - General requirements)

You will find the current versions of the standards in the currently valid IECEX certificates.

---

### Note

Only variants with 24 VDC power supply meet the requirements of this approval.

---

## FM

The product meets the requirements of the standards:

- Factory Mutual Approval Standard Class Number 3611
- FM Hazardous (Classified) Location Electrical Equipment:  
Non Incendive / Class I / Division 2 / Groups A,B,C,D / T4 and  
Non Incendive / Class I / Zone 2 / Group IIC / T4

---

### Note

Only variants with 24 VDC power supply meet the requirements of this approval.

---

## cULus Approval for Information Technology Equipment

cULus Listed I. T. E.

Underwriters Laboratories Inc. complying with

- UL 60950-1 (Information Technology Equipment)
- CSA C22.2 No. 60950-1-03

Report no. E115352

### cULus Approval Hazardous Location

cULus Listed I. T. E. FOR HAZ. LOC.

Underwriters Laboratories Inc. complying with

- UL 60950-1 (Information Technology Equipment)
- ANSI/ISA 12.12.01-2007
- CSA C22.2 No. 213-M1987

Approved for use in  
Cl. 1, Div. 2, GP A, B, C, D T4  
Cl. 1, Zone 2, GP IIC T4

Report no. E240480

---

**Note**

Only variants with 24 VDC power supply meet the requirements of this approval.

---

### RCM

The product meets the requirements of the AS/NZS 2064 standard (Class A).

### MSIP 요구사항 - For Korea only

#### A급 기기(업무용 방송통신기자재)

이 기기는 업무용(A급) 전자파 적합기기로서 판매자 또는 사용자는 이 점을 주의하시기  
바라며, 가정 외의 지역에서 사용하는 것을 목적으로 합니다.

### Marking for the customs union



EAC (Eurasian Conformity)

Customs union of Russia, Belarus and Kazakhstan

Declaration of the conformity according to the technical regulations of the customs union  
(TR CU)

## 10.1 FDA and IEC marks

The following devices meet the FDA and IEC requirements listed below:

Device	Fulfills FDA and IEC requirements
SCALANCE XR524-8C	-
SCALANCE XR526-8C	-
SCALANCE XR528-6M	-
SCALANCE XR552-12M	-

Note: With modular devices , the marking is on the MM900 media modules and the SFP and SFP+ transceivers.



Image 10-1 FDA and IEC approvals

## 10.2 Mechanical stability (in operation)

Device	IEC 60068-2-6 vibration *	IEC 60068-2-6 vibration	IEC 60068-2-27 shock
	5 - 9 Hz: 3.5 mm 9 - 150 Hz: 1 g 1 octave/min, 20 sweeps	10 - 58 Hz: 0.075 mm 85 - 150 Hz: 1 g 1 octave/min, 20 sweeps	15 g, 11 ms duration 6 shocks per axis
SCALANCE XR524-8C	•	•	•
SCALANCE XR526-8C	•	•	•
SCALANCE XR528-6M	•	•	•
SCALANCE XR552-12M	•	•	•

\* When rack mounted with four securing points

# Index

## 1

19" rack mounting, 40, 40

## A

Accessories, 21  
Adhesive foot, 18, 44  
Ambient temperature, 9, 18, 20, 88, 92, 96, 98  
Article number, 17, 21

## B

Bolt, 75  
Bracket, 18, 41, 45, 75, 104

## C

CLI, 6, 34, 71, 84  
Clip, 51  
Combo port, 17, 18, 36  
Command Line Interface, 6, 34, 71, 84  
Components of the product, 18  
Configuration, 5, 26, 33  
Configuration manual, 6, 57  
Connecting cable, 18, 71  
Control cabinet, 41  
C-PLUG, 18, 33, 34

## D

Defining the fault mask, 26  
Desktop operation, 40, 43  
Display mode, 25, 29, 31  
Door in housing, 80, 82  
Dummy cover, 18, 49

## F

Factory defaults, 26  
Factory settings, 26, 47, 85  
Fan unit, 18, 24, 79  
Fault/error status, 28, 70  
Filter frame, 18, 80, 83

Filter pad, 18, 80, 82  
Firmware, 28, 84  
Four-point mounting, 40, 41, 45  
Front terminal, 43  
Functional ground, 75

## G

Glossary, 7  
Grounding, 75  
Grounding bolt, 75

## H

Handle, 49

## I

IEC plug, 63  
Installation location, 9  
Interface, 18

## K

KEY-PLUG, 21, 33, 34

## L

Layer 3, 17, 33  
Layer 3 functionality, 33  
License, 33

## M

Media module, 40, 47  
Media modules, 24  
Modular device, 17, 38, 47, 50, 54, 61  
Module slot, 17, 18, 47  
Mounting plate, 18

## O

Operating mode, 32  
Operating temperature, 38  
Out-of-band interface, 73, 84

Overvoltage protection, 60, 64

## P

PLUG, 33

Pluggable transceiver, 18

Pluggable transceiver slot, 18

Port status, 31

Power cable, 21

Power supply, 29, 60, 62, 64

Power supply unit, 40, 43, 52, 54, 64

Power supply units, 24

## R

Redundancy manager, 27

Reset device, 26

Restore Factory Defaults, 26

Restricted access location, 43

## S

Safety extra-low voltage, 60

Safety notices, 9

for installation, 37

general, 9

Use in hazardous areas, 9, 37

Sealing plug, 51, 52

SELECT/SET button, 25, 29, 84, 85

Serial interface, 71

SFP, 18, 50, 52

SFP / SFP+ transceiver

Notes on deinstallation, 52

Removing, 52

SFP slot, 51, 52

SFP transceiver, 40, 50, 52

SFP/SFP+ transceivers

Inserting, 51

SFP+, 18, 50, 52

SFP+ slot, 40, 51, 52

SFP+ transceiver, 23, 40, 50, 52

Ship, 45

Signaling contact, 28, 69

SIMATIC NET glossary, 7

SIMATIC NET manual, 6

Slot, 51

Slot number, 18, 48

Startup phase, 26, 28, 85

Switch block, 74

System manual, 6, 38, 111

## T

Tensile strain relief, 43

Terminal block, 18, 60, 69

Transmission speed, 31

Type designation, 17

Type of installation, 40

## V

Ventilation slit, 38, 52

Voltage limit, 29, 30

## W

WBM, 6, 34, 73, 84

Web Based Management, 6, 34, 73, 84