



FOOD WASTE DISPOSERS

Installation, Care & Use Manual

TOOLS AND MATERIALS YOU WILL NEED:

Slotted Screwdriver, Adjustable Pliers, Plumber's Putty, Electrical Tape

TOOLS, MATERIALS, AND ACCESSORIES YOU MAY NEED:

Phillips Screwdriver, Drain Auger, 3/8" Electrical Clamp Connector, Wire Nuts (2), Second 1 1/2" Drain Trap, Hammer, Hacksaw, Water Hose Clamp, Pipe Wrench, Copper Ground Wire, Dishwasher Drain Connection Kit, Air Gap, Electrical On/Off Switch, Drain Tube Extension

Read through the entire Installation, Care & Use manual before installing the disposer. Determine which of the tools, materials, and accessories you will need before you begin. Make sure you have all necessary disposer parts before installing the disposer (see part identification diagram below).

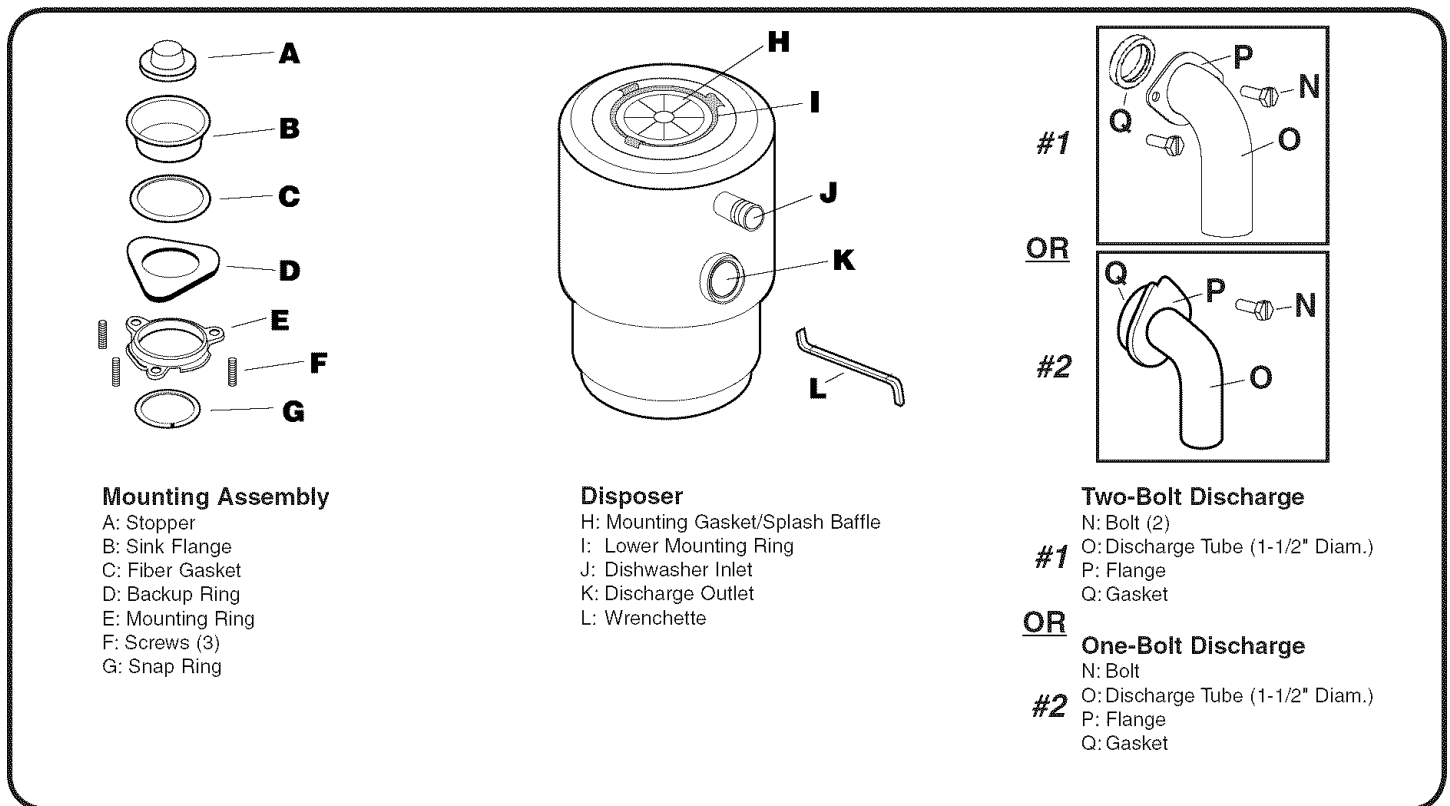

SAFETY SYMBOLS

⚠ DANGER Danger indicates an imminently hazardous situation which, if not avoided, will result in death or serious injury.

⚠ WARNING Warning indicates a potentially hazardous situation which, if not avoided, could result in death or serious injury.

⚠ CAUTION Caution indicates a potentially hazardous situation which, if not avoided, may result in minor or moderate injury.

INSTALLATION INSTRUCTIONS

1 CHECK INSTALLATION DIMENSIONS

- A: Disposer Height
 B: Distance from bottom of sink bowl to centerline of discharge outlet. (Add 1/2" when stainless steel sink is used.)
 C: Distance from centerline of the discharge outlet to end of discharge tube.
 D: Disposer Width
 E: Distance from disposer vertical centerline to centerline of P-trap connection.
 F: Centerline of disposer discharge to centerline at waste pipe entering wall. (Dimension "F" must be greater than 1/4" to prevent standing water in disposer.)

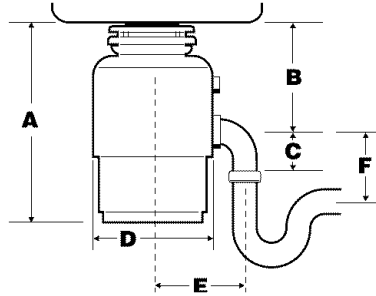

Model	A	B	C	D	E
6010/6012	11 3/8"	6"	4"	6 5/16"	5"
6011/6013	12 5/8"	6"	4"	6 5/16"	5"
60552	12 5/8"	6"	4"	7 1/4"	5"
60553	12 5/8"	6"	4"	7 1/4"	5"
60554	12 3/4"	6 11/16"	4"	8 1/2"	5 3/4"
60556	12 3/4"	6 11/16"	4"	8 1/2"	5 3/4"
60559*	15 7/8"	9 7/16"	4"	7 1/2"	5 3/4"
60562	12 5/8"	6"	4"	7 1/4"	5"
60563	12 5/8"	6"	4"	7 1/4"	5"

* Indicates Batch Feed Model

If replacing an existing disposer, skip ahead to **Instruction 6**.
 If this is a first time installation, continue with **Instruction 2**.

2 DISCONNECT SINK DRAIN

- Loosen nut (A) at top of "P-trap" with pipe wrench (see Figure 2-1).
- Loosen nut (B) at top of extension pipe. Remove extension pipe.
- Loosen nut (C) at base of sink flange. (If nut is corroded or too tight, apply penetrating lubricant.)
- Push sink flange up through sink hole and remove it (see Figure 2-2).
- Clean sink flange area of any putty or other debris.

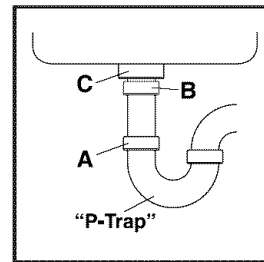

2-1

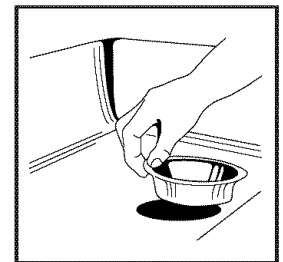

2-2

3 DISASSEMBLE NEW DISPOSER MOUNTING ASSEMBLY

- Insert wrenchette (or screwdriver) into one mounting lug and hold lower mounting ring securely with one hand (see Figure 3-1). With your other hand, turn mounting assembly counterclockwise to remove mounting assembly from lower mounting ring.
- Turn mounting assembly over (see Figure 3-2) and loosen three mounting screws (A) until you can access snap ring (B).
- Use screwdriver to pry snap ring off of sink flange. Mounting assembly will now come apart.

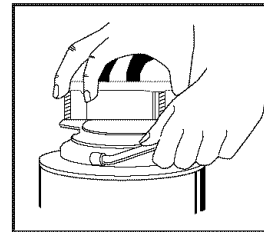

3-1

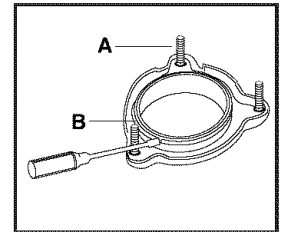

3-2

4 INSTALL FLANGE IN SINK HOLE

- Roll 1/4 pound (4 oz.) of non-hardening plumber's putty to make 3/4" thick rope to seal around sink flange.
- Apply putty evenly around sink hole (see Figure 4-1).
- Press sink flange slowly but firmly into sink drain hole to seat evenly on putty (see Figure 4-2). Use screwdriver or putty knife to scrape all putty from edge of sink hole.

CAUTION

Do not use plumber's putty on any other disposer connection - it may harm disposer and cause property damage.

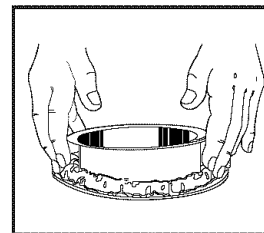

4-1

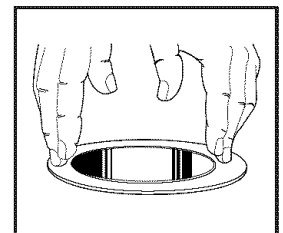

4-2

5 ATTACH UPPER MOUNTING ASSEMBLY TO SINK FLANGE

You may wish to place a weighted object in the sink to hold the sink flange in place. (Place a towel under object in sink to prevent scratching.) Reference Figure 5-1 for part identification.

- Working from under sink, slip fiber gasket and metal backup ring over sink flange.
- Holding fiber gasket and backup ring in place, slip mounting ring over sink flange so it seats against backup ring.
- With fiber gasket, backup ring, and mounting ring tight to sink bottom, slide snap ring onto sink flange until it pops into groove on flange*.
- Tighten three mounting screws up to sink until mounting assembly is seated tightly and evenly against sink.

* Placing a thick, wide rubber band around the sink flange (above the snap ring groove) may help hold parts in place while installing snap ring. (Remember to remove rubber band after snap ring is installed.)

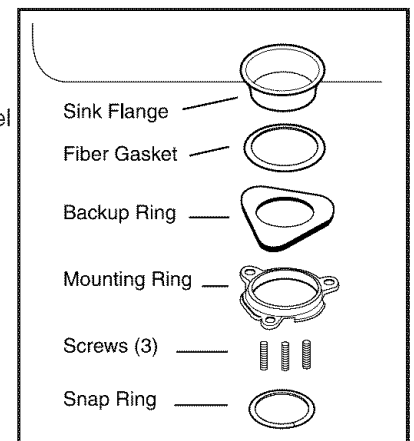

5-1

If you are replacing an existing disposer, go to **Instruction 6**. If this is a first time installation, skip ahead to **Instruction 7**.

6 REMOVE EXISTING DISPOSER

1. Turn off electrical power at fuse box or circuit breaker.

⚠ DANGER

Electric Shock

- Turn off electrical power at fuse box or circuit breaker before removing electrical cover plate.
- Disposer must be grounded. Improper connection can result in electric shock.

⚠ WARNING

Personal Injury

- Do not position your head or body under disposer; unit could fall during removal or installation.

2. Disconnect drain trap from disposer waste discharge tube with adjustable pliers (see Fig. 6-1). (Also disconnect dishwasher drain connection, if required.)
3. Support disposer with one hand and insert end of wrenchette or screwdriver into right side of one mounting lug on lower mounting ring (see Figure 6-2). Lift disposer slightly and loosen lower mounting ring by pushing or pulling wrenchette or screwdriver to left until disposer is free from mounting assembly. (Disposer may be heavy - provide support.)
4. With electrical supply turned off, turn disposer upside down and remove electrical cover plate (see Figure 6-3). Loosen green ground screw and remove wire nuts (see Figure 6-4). Disconnect disposer wires from electrical supply wires. Loosen screw(s) on electrical clamp connector and remove wires from disposer.

- If the new disposer mounting is the same as old one, remove mounting assembly from disposer (**Instruction 3**) and go to **Instruction 7**.
- If the new disposer mounting is different from the old one (or you wish to replace the old sink flange) you must complete Steps 5 - 6 (below), and **Instructions 2 - 5**, then continue with **Instruction 7**.

5. Loosen three mounting screws, pry snap ring off with screwdriver, and remove old mounting assembly (see Figure 6-5). (Some mounting assembly removal requires additional tools.)
6. Push old sink flange up through sink hole (see Figure 6-6). Use screwdriver or putty knife to scrape all old putty from edge of sink hole.

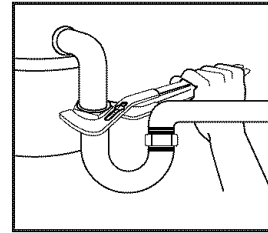

6-1

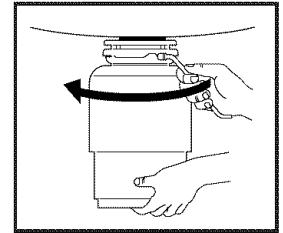

6-2

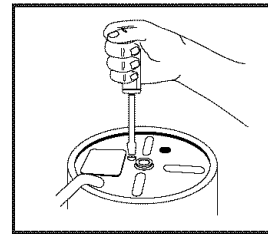

6-3

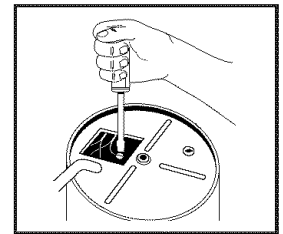

6-4

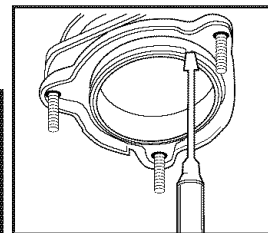

6-5

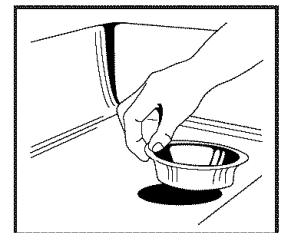

6-6

7 CLEAN SINK DRAIN LINE

Failure to clean sink drain line may result in drain line blockage.

1. Remove P-trap.
2. With drain auger, clear all hardened waste material in horizontal drain line.

If you are not connecting a dishwasher to disposer, go to **Instruction 9**.

8 PREPARE DISHWASHER DRAIN CONNECTION (IF APPLICABLE)

The knockout drain plug should only be removed if you are connecting a built-in dishwasher to the disposer. **NOTE:** If the dishwasher connection is made without removing the plug, the dishwasher may overflow. (Connections must comply with local plumbing codes.)

Remove Knockout Plug

1. Lay disposer on its side and insert screwdriver into dishwasher inlet so tip rests on outer edge of knockout plug.
2. Tap end of screwdriver handle with hammer until molded plug breaks loose (see Figure 8-1).
3. REMOVE LOOSE KNOCKOUT PLUG FROM INSIDE DISPOSER.

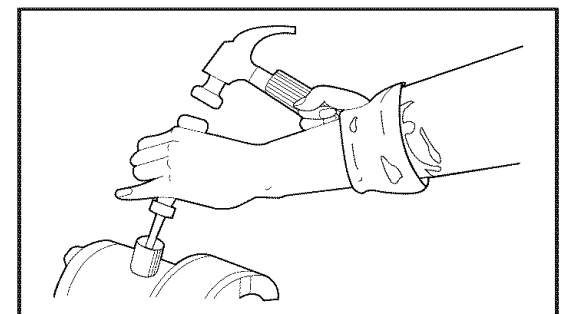

8-1

Attach Dishwasher Drain Connector

If your dishwasher drain hose is 7/8" diameter, go to **Instruction 9**.
If your dishwasher drain hose is not 7/8" diameter, you must attach a dishwasher drain connector to the dishwasher drain inlet. Follow the installation instructions with the connection kit. (You will connect the dishwasher drain hose to the connector in **Instruction 12**.)

CONNECT DISPOSER TO ELECTRICAL SUPPLY

⚠ DANGER

Electric Shock

- Improper connection of the equipment-grounding conductor can result in a risk of electric shock. Check with a qualified electrician or serviceman if you are in doubt as to whether the appliance is properly grounded. Do not modify the plug provided with the appliance - if it will not fit the outlet, have a proper outlet installed by a qualified electrician.
- This disposer must be properly grounded.
- Do not attach ground wire to gas supply pipe.
- Disconnect power before installing or servicing disposer.
- If three-prong, grounded plug is used, plug must be inserted into three-hole, grounded receptacle.
- All wiring must comply with local electrical codes.
- Do not reconnect electrical current at main service panel until proper grounds are installed.

There are two ways to connect electrical power to your disposer:

- 1.) Direct wire
- 2.) Plug in cord - installed at factory, or from Kenmore Kit #60686 (for all models listed in this manual)

Disposer Circuit Requirements

Ensure the following electrical requirements are met before connecting disposer to switch (see Figure 9-1 for typical direct wired electrical circuit diagram):

- Remove fuse (or open the circuit breaker) before connecting disposer to circuit.
- Batch feed disposers do not require a separate wall switch - switch is built into disposer and disposer is wired directly into circuit.
- If junction box is used, connect the junction box to the switch on a separate 15 or 20 Amp, 115 Volt circuit with the appropriate cable. (Use 14 gauge wire with 15 Amp circuit, and 12 gauge wire with 20 Amp circuit).
- If you install a double receptacle to handle other small kitchen appliances, include a wall switch in disposer receptacle circuit and wire other receptacle directly to power source.
- This disposer requires a switch with a marked "Off" position (wired to disconnect all ungrounded supply conductors) installed within sight of the disposer sink opening (1 HP minimum rating).

Connect Disposer to Electrical Supply/Ground Disposer

Follow these instructions to direct wire the disposer. (If adding a cord and plug, follow the directions included with the cord and plug).

1. Remove electrical cover plate from bottom of disposer and pull out black and white wires (see Figure 9-1). **DO NOT REMOVE CARDBOARD INSULATION SHIELD.**
2. Run electrical cable through access hole (A) on bottom of disposer (with 1/2" conduit or 3/8" flex) and secure with clamp connector.
3. Strip wires back approximately 1/2 inch. Connect white (neutral) electrical wire to white disposer wire, and black (hot) electrical wire to black disposer wire (may have colored stripe) with wire nuts (see Figure 9-1). Insulate wire connections with electrical tape, and push connections into disposer housing without displacing cardboard insulation shield. Do not reinstall electrical plate until disposer is properly grounded.

Once the circuit you are using is grounded at the service panel, attach the ground wire to the green ground screw (B) in the electrical cover plate opening and secure the electrical plate (C) (see Figure 9-1).

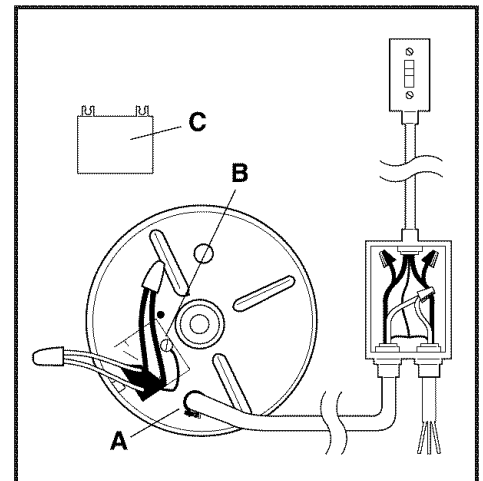

9-1

Grounding Instructions for Direct Wired Units

This appliance must be connected to a grounded, metal, permanent wiring system; or an equipment-grounding conductor must be run with the circuit conductors and connected to the equipment-grounding terminal or lead on the appliance.

Grounding Instructions for Cord Connected Units

This appliance must be grounded. In the event of a malfunction or breakdown, grounding provides a path of least resistance for electric current to reduce the risk of electric shock. This appliance is equipped with a cord having an equipment-grounding conductor and a grounding plug. The plug must be plugged into an appropriate outlet that is properly installed and grounded in accordance with all local codes and ordinances.

10 CONNECT DISPOSER TO MOUNTING ASSEMBLY

Clear any objects from inside the disposer grind chamber before mounting the disposer.

⚠ WARNING

Personal Injury: Do not position your head or body under disposer; unit could fall during installation.

1. Position disposer with three mounting tabs (A) aligned in position to slide over mounting tracks (B) (see Figure 10-1).
2. Lift disposer, insert top end (mounting gasket) into mounting assembly, and turn lower mounting ring to right (with wrenchette or screwdriver) until mounting tabs lock over ridges (C) on mounting ring tracks (see Figure 10-2). (MAKE SURE ALL THREE MOUNTING TABS ARE LOCKED OVER RIDGES.) Disposer will now hang by itself.

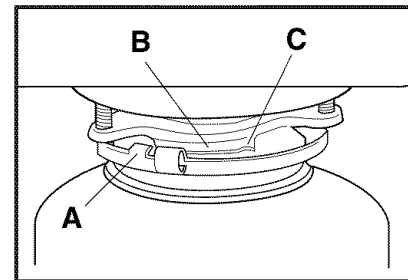

10-1

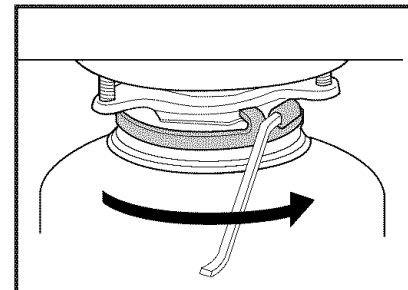

10-2

11 ATTACH DISCHARGE TUBE TO WASTE DRAIN LINE

Determine appropriate installation based upon new installation or plumbing configuration: Two-Bolt Discharge Tube or One-Bolt Discharge Tube.

⚠ CAUTION

Property Damage

Do not use thread sealants or pipe dope; they may harm the disposer and cause property damage.

Two-Bolt Discharge Tube Installation (Preferred Two-Bolt Installation)

If replacing existing disposer, remove and discard existing discharge tube and gasket. (Unit will not seal properly with old discharge tube.)

1. Slide metal flange (A) over discharge tube (B) (see Figure 11-1).
2. Insert rubber gasket (C) into discharge outlet. Secure metal flange and discharge tube to disposer with two bolts (D).
3. Rotate disposer so that discharge tube is aligned with drain trap. (To prevent leaks, do not pull or bend discharge tube to drain trap.) If discharge tube is too long, cut off as much of tube as necessary with hacksaw (make sure cut is straight and clean.) If discharge tube is too short, you can purchase an extension from a hardware store. (Disposer must remain in vertical position to prevent vibration.)
4. Place P-trap nut, then beveled washer (not supplied) on bottom of discharge tube and tighten on drain trap. (If you have a double sink, use separate drain traps for both sides.)
5. Ensure lower mounting ring is securely locked over mounting flange ridges.

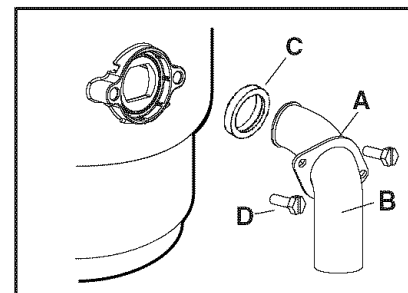

11-1

Although the supplied Discharge Tube is preferred, a straight discharge may be used (see Figure 11-2). Slide metal flange (A) over straight discharge tube (B, not supplied), install rubber gasket (C) into discharge outlet, and secure metal flange and straight discharge tube to disposer with two bolts (D).

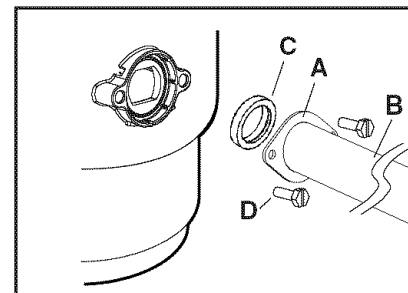

11-2

One-Bolt Discharge Tube Installation (Preferred One-Bolt Installation)

1. Slide metal flange (A) over discharge tube (B) (see Figure 11-3).
2. Rubber gasket (C) must be installed on top end of discharge tube. Secure metal flange and discharge tube to disposer with bolt (D).
3. Rotate disposer so that discharge tube is aligned with drain trap. (To prevent leaks, do not pull or bend discharge tube to drain trap.) If discharge tube is too long, cut off as much of tube as necessary with hacksaw (make sure cut is straight and clean.) If discharge tube is too short, you can purchase an extension from a hardware store. (Disposer must remain in vertical position to prevent vibration.)
4. Place P-trap nut, then beveled washer (not supplied) on bottom of discharge tube and tighten on drain trap. (If you have a double sink, use separate drain traps for both sides.)
5. Ensure lower mounting ring is securely locked over mounting flange ridges.

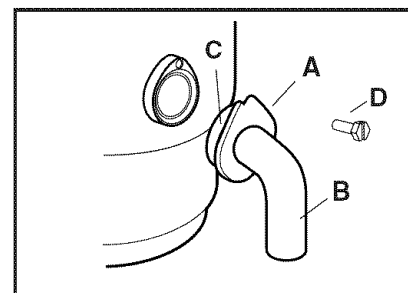

11-3

Although the supplied Discharge Tube is preferred, a straight discharge may be used. Slide metal flange over straight discharge tube (not supplied), install rubber gasket onto discharge tube, and secure metal flange and straight discharge tube to disposer with one bolt (reference Figure 11-2).

12 CONNECT DISHWASHER DRAIN (IF APPLICABLE)

Connect the dishwasher to the disposer through an air gap (A). (Most dishwasher manufacturers recommend that the discharge water runs through an air gap to prevent backflow and/or dishwasher contamination.) Ensure knockout plug is removed (see **Instruction 1**). Plumbing connections must comply with local plumbing codes.

- If you have a 7/8" diameter dishwasher drain hose, use a hose clamp to attach the drain hose to the dishwasher inlet. (Verify that hose you are using is rated for dishwasher use.)
- If you have already attached a dishwasher drain connector to your dishwasher drain hose (for drain hose other than 7/8" diameter), use a hose clamp to attach the drain hose/connector to the dishwasher inlet on the disposer.

13 ATTACH SPECIFICATION DECAL

The disposer specification decal has a removable portion to place on the front side of the installed disposer, containing important information in the event service is required.

1. Detach perforated portion of specification decal from lower portion of disposer.
2. Apply decal to disposer where it can be easily read.

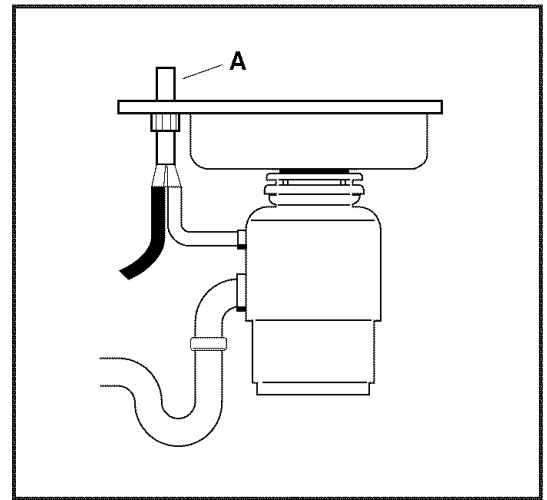

Figure12-1

The disposer installation is complete. Using the stopper, fill the sink with water. Remove the stopper, turn disposer on, and check under sink for leaks. Read ALL SAFETY INSTRUCTIONS on the next page before operating the disposer.

INSTRUCTIONS PERTAINING TO RISK OF FIRE, ELECTRIC SHOCK, OR INJURY TO PERSONS (SAVE THESE INSTRUCTIONS)

⚠ WARNING

When using electric appliances, basic precautions are always to be followed, including:

- Read all instructions before using the appliance.
- To reduce the risk of injury, close supervision is required when an appliance is used near children.
- Do not put fingers or hands into a waste disposer.
- Turn the power switch to the off position before attempting to clear a jam, removing an object from the disposer, or pressing reset button.
- When attempting to loosen a jam in a waster disposer, use the self-service wrenchette or a long wooden object such as a wooden spoon or the wooden handle of a broom or mop.
- When attempting to remove objects from a waste disposer use a long-handled tongs or pliers. For a disposer that is magnetically actuated, use nonmagnetic tools.
- To reduce the risk of injury by materials that are expellable by a waste disposer, do not put the following into a disposer: Clam or oyster shells, caustic drain cleaners or similar products, glass, china, or plastic, large (whole) bones, metal (such as bottle caps, tin cans, or utensils), hot grease or other hot liquids.
- This product is designed to dispose of normal household food waste; inserting materials other than food waste into disposer could cause personal injury and/or property damage.
- To reduce the risk of injury, do not use the sink containing the disposer for purposes other than food preparation (such as baby bathing or washing hair).
- Do not dispose of the following in the disposer: paints, solvents, household cleaners and chemicals, automotive fluids, plastic wrap, or whole corn husks.
- Replace anti-splash baffle when worn to help prevent entry or ejection of material and water.
- FIRE HAZARD: Do not store flammable items such as rags, paper, or aerosol cans near disposer. Do not store or use gasoline or other flammable vapors and liquids in vicinity of disposer.

OPERATING INSTRUCTIONS

CONTINUOUS FEED DISPOSERS

1. Remove stopper from sink opening and run strong flow of cold water.
2. Turn on wall switch to start disposer.
3. Slowly insert food waste into disposer and position stopper to minimize possible ejection of material while grinding (see Figure A).
4. After grinding is complete, turn disposer off and run water for at least 15 seconds to flush drain line.

BATCH FEED DISPOSERS

Batch feed disposer differ from continuous feed models in that the batch feed on/off switch is built into the disposer and activated by the stopper. (See **Instruction 1, Installation Dimensions** chart, for model reference.)

1. Read important safety instructions contained in the Installation, Care & Use manual.
2. Remove stopper from sink opening and place food waste into disposer grind chamber. Do not pack chamber with waste. Place stopper back in sink opening. Run a strong flow of cold water.
3. Turn on disposer by lifting stopper slightly and turning to left or right until disposer starts. (See Figure B; *Seal* - Completely in, *Drain* - Lift 1/4 inch and turn, *Start* - Turn fully left or right.)
4. After grinding is complete, turn disposer off by removing the stopper and allow water to run for at least 15 seconds to flush drain line.

DO...

- First turn on a moderate to strong flow of cold water and then turn on the disposer. Continue running cold water for 15 seconds after grinding is completed to flush the drain line.
- Grind hard materials such as small bones, fruit pits, and ice. A scouring action is created by the particles inside the grind chamber.
- Grind peelings from citrus fruits to freshen up drain smells.
- Use a disposer cleaner, degreaser, or deodorizer as necessary to relieve objectionable odors caused by grease build-up.

DON'T...

- Don't pour grease or fat down your disposer or any drain. It can build up in pipes and cause drain blockages. Put grease in a jar or can and dispose in the trash.
- Don't use hot water when grinding food waste. It is OK to drain hot water into the disposer between grinding periods.
- Don't fill disposer with a lot of vegetable peels all at once. Instead, turn the water and disposer on first and then feed the peels in gradually.
- Don't grind extremely fibrous materials like corn husks, artichokes, etc., to avoid possible drain blockage.
- Don't turn off disposer until grinding is completed and only sound of motor and water is heard.
- Don't be alarmed if a brown discoloration appears on the face of the grinding disc. This is normal. It is surface discoloration only and will not affect the life or performance of the disposer.

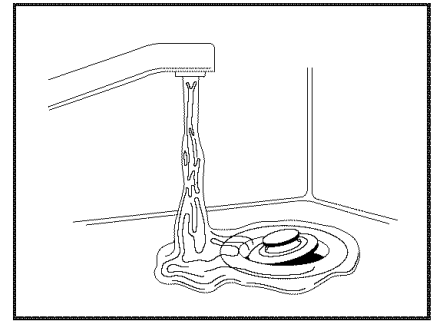

Figure A

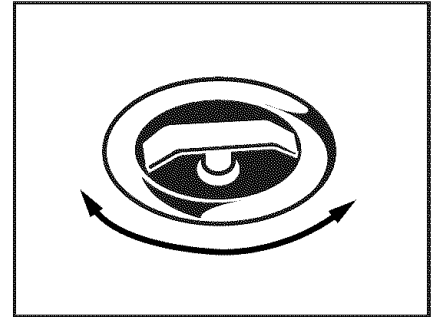

Figure B

CAUTION

Regularly inspect disposer and plumbing fittings for water leaks, as water leaks can cause property damage. Manufacturer cannot be held responsible for property damage as a result of water leaks.

USER-MAINTENANCE INSTRUCTIONS

CLEANING DISPOSER

Over time, food particles may accumulate in the grind chamber and baffle. An odor from the disposer is usually a sign of grease and food buildup, caused by insufficient water flow during and after disposer use. To clean disposer:

1. Turn off disposer and disconnect power supply.
2. Reach through sink opening and clean underside of splash baffle and inside upper lip of grind chamber with scouring pad.
3. Place stopper in sink opening and fill sink halfway with warm water.
4. Mix 1/4 cup baking soda with water. Turn disposer on and remove stopper from sink at same time to wash away loose particles.

RELEASING DISPOSER JAM

If the motor stops during operation, the disposer may be jammed. To release jam:

1. Turn off the disposer and water.
2. Insert one end of the self-service wrenchette into the center hole on the bottom of the disposer (see Figure C). Work the wrenchette back and forth until it turns one full revolution. Remove wrenchette.
3. Reach into the disposer with tongs and remove object(s). Allow the disposer motor to cool for 3 - 5 minutes and lightly push red reset button on the disposer bottom (see Figure C). (If the motor remains inoperative, check the service panel for tripped circuit breakers or blown fuses.)

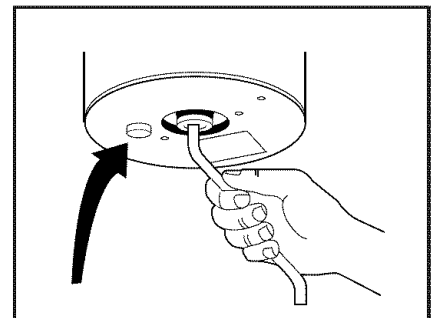

Figure C

KENMORE FOOD WASTE DISPOSER WARRANTY

Model 6010	One Year Full Warranty	Model 60552	Three Year Full Warranty
Model 6011	One Year Full Warranty	Model 60553	Five Year Full Warranty
Model 6012	One Year Full Warranty	Model 60554	Seven Year Full Warranty
Model 6013	One Year Full Warranty	Model 60556	Nine Year Full Warranty
		Model 60559	Five Year Full Warranty
		Model 60562	Four Year Full Warranty
		Model 60563	Five Year Full Warranty

For the duration of the warranty from the date of purchase, Sears will repair or replace, free of charge, defects in material or workmanship which appear in this disposer.

WARRANTY SERVICE IS AVAILABLE BY SIMPLY CONTACTING THE NEAREST SEARS SERVICE CENTER/DEPARTMENT IN THE UNITED STATES. This warranty applies only while this product is in use in the United States.

This warranty gives you specific legal rights, and you may also have other rights, which vary from state to state. This warranty applies only while this product is in use in the United States.

Sears, Roebuck and Co.
Dept. 817WA
Hoffman Estates, IL 60179

To call for repair service:

Call 24 hours a day, 7 days a week

1-800-4-MY-HOMESM (1-800-469-4663)

Para pedir servicio de reparación a domicilio 1-800-676-5811

