



# User Guide

© Copyright 2019 HP Development Company, L.P.

DisplayPort is a trademark owned by the Video Electronics Standards Association (VESA®) in the United States and other countries.

Windows is either a registered trademark or trademark of Microsoft Corporation in the United States and/or other countries.

The information contained herein is subject to change without notice. The only warranties for HP products and services are set forth in the express warranty statements accompanying such products and services. Nothing herein should be construed as constituting an additional warranty. HP shall not be liable for technical or editorial errors or omissions contained herein.

#### **Product notice**





This guide describes features that are common to most models. Some features may not be available on your product. To access the latest user guide, go to <http://www.hp.com/support>, and follow the instructions to find your product. Then select **User Guides**.

First Edition: July 2019

Document Part Number: L69859-001

## About This Guide

This guide provides information about the monitor features, setting up the monitor, and technical specifications.

- 
-  **WARNING!** Indicates a hazardous situation that, if not avoided, **could** result in serious injury or death.
  -  **CAUTION:** Indicates a hazardous situation that, if not avoided, **could** result in minor or moderate injury.
  -  **IMPORTANT:** Indicates information considered important but not hazard-related (for example, messages related to property damage). Warns the user that failure to follow a procedure exactly as described could result in loss of data or in damage to hardware or software. Also contains essential information to explain a concept or to complete a task.
  -  **NOTE:** Contains additional information to emphasize or supplement important points of the main text.
  -  **TIP:** Provides helpful hints for completing a task.
-



---

# Table of contents

|   |           |
|---|-----------|
| <b>1 Getting started</b>                      | <b>1</b>  |
| Important safety information                  | 1         |
| Product features and components               | 2         |
| Features                                      | 2         |
| Rear components                               | 3         |
| Side components                               | 4         |
| Front components                              | 4         |
| Setting up the monitor                        | 5         |
| Installing the monitor stand                  | 5         |
| Mounting the monitor head                     | 5         |
| Attaching an HP Desktop Mini to the monitor   | 6         |
| Routing cables                                | 9         |
| Turning on power                              | 10        |
| Removing the HP Desktop Mini                  | 10        |
| Configuring the monitor as standalone monitor | 10        |
| Connecting a second computer the monitor      | 11        |
| Adjusting the monitor                         | 12        |
| Installing a security cable                   | 13        |
| HP watermark and image retention policy       | 13        |
| <b>2 Using the monitor</b>                    | <b>14</b> |
| Software and utilities                        | 14        |
| The Information file                          | 14        |
| The Image Color Matching file                 | 14        |
| Using the on-screen display (OSD) menu        | 15        |
| Adjusting Low Blue Light Mode                 | 16        |
| Using Auto-Sleep Mode                         | 16        |
| <b>3 Support and troubleshooting</b>          | <b>17</b> |
| Solving common issues                         | 17        |
| Contacting support                            | 17        |
| Preparing to call technical support           | 17        |
| Locating the serial number and product number | 18        |
| <b>4 Maintaining the monitor</b>              | <b>19</b> |
| Maintenance guidelines                        | 19        |

|                            |    |
|----------------------------|----|
| Cleaning the monitor ..... | 19 |
| Shipping the monitor ..... | 20 |

**Appendix A Technical specifications ..... 21**

|                                  |    |
|----------------------------------|----|
| Preset display resolutions ..... | 22 |
| Entering user modes .....        | 22 |
| Energy saver feature .....       | 23 |

**Appendix B Accessibility ..... 24**

|   |    |
|---|----|
| HP and accessibility .....  | 24 |
| Finding the technology tools you need .....                           | 24 |
| The HP commitment .....   | 24 |
| International Association of Accessibility Professionals (IAAP) ..... | 24 |
| Finding the best assistive technology .....                           | 25 |
| Assessing your needs .....  | 25 |
| Accessibility for HP products .....                                   | 25 |
| Standards and legislation .....                                       | 26 |
| Standards .....   | 26 |
| Mandate 376 – EN 301 549 .....  | 26 |
| Web Content Accessibility Guidelines (WCAG) .....                     | 26 |
| Legislation and regulations .....                                     | 26 |
| Useful accessibility resources and links .....                        | 27 |
| Organizations .....   | 27 |
| Educational institutions .....  | 27 |
| Other disability resources .....                                      | 27 |
| HP links .....  | 28 |
| Contacting support .....  | 28 |

---

# 1 Getting started

## Important safety information

An AC adapter and power cord are included with the monitor. If you use another cord, use only a power source and connection appropriate for this monitor. For information about the correct power cord set to use with the monitor, see the *Product Notices* provided in your documentation kit.

---

 **WARNING!** To reduce the risk of electric shock:

- Plug the power cord into an AC outlet that is easily accessible at all times.
- If the power cord has a 3-pin attachment plug, plug the cord into a grounded (earthed) 3-pin outlet.

For your safety, do not place anything on power cords or cables. Care should be taken to route all cords and cables connected to the monitor so that they cannot be stepped on, pulled, grabbed, or tripped over.

To reduce the risk of serious injury, read the *Safety & Comfort Guide*. It describes proper workstation setup, and proper posture, health, and work habits for computer users. The *Safety & Comfort Guide* also provides important electrical and mechanical safety information. The *Safety & Comfort Guide* is available on the Web at <http://www.hp.com/ergo>.

 **IMPORTANT:** For the protection of the monitor and the computer, connect all power cords for the computer and its peripheral devices (such as a monitor, printer, scanner) to a surge protection device such as a power strip or uninterruptible power supply (UPS). Not all power strips provide surge protection; the power strip must be specifically labeled as having this capability. Use a power strip whose manufacturer offers a damage replacement policy so that you can replace the equipment if surge protection fails.

---

Use the appropriate and correctly sized furniture designed to properly support your HP LCD monitor.

 **WARNING!** LCD monitors that are inappropriately situated on dressers, bookcases, shelves, desks, speakers, chests, or carts may fall over and cause personal injury.

Care should be taken to route all cords and cables connected to the LCD monitor so that they cannot be pulled, grabbed, or tripped over.

Be sure that the total ampere rating of the products connected to the AC outlet does not exceed the current rating of the outlet, and that the total ampere rating of the products connected to the cord does not exceed the rating of the cord. Look on the power label to determine the ampere rating (AMPS or A) for each device.

Install the monitor near an AC outlet that you can easily reach. Disconnect the monitor by grasping the plug firmly and pulling it from the AC outlet. Never disconnect the monitor by pulling the cord.

Do not drop the monitor or place it on an unstable surface.

 **NOTE:** This product is suitable for entertainment purposes. Consider placing the monitor in a controlled luminous environment to avoid interference from surrounding light and bright surfaces that may cause disturbing reflections from the screen.

---

# Product features and components

## Features

The monitor features include the following:

- 60.5 cm (23.8-in) diagonal viewable screen area with 1920 × 1080 resolution, plus full-screen support for lower resolutions
- Nonglare panel with an LED backlight
- Wide viewing angle to allow viewing from a sitting or standing position, or when moving from side to side
- Supports a 35 W or 65 W HP Desktop Mini (sold separately) attached to the rear of the monitor in a fully enclosed compartment



**NOTE:** The HP Desktop Mini must be configured with a USB Type-C with 100 W Power Delivery Option card.

---

- Single Power On for both the HP Desktop Mini and the monitor
- On-screen display (OSD) adjustments in several languages for easy setup and screen optimization
- Plug and Play capability, if supported by your operating system
- Tilt, swivel, height, and pivot adjustment capabilities
- Removable stand for flexible monitor head mounting solutions
- VESA® mounting capability for attaching the monitor to a wall mount device or swing arm
- USB Type-C connector for interfacing with an HP Desktop Mini
- 6 USB 3.1 Gen1 ports (4 on the rear and 2 on the side)
- USB Type-B upstream port
- One DisplayPort™ video input
- Audio-out (headset) jack on side
- 2.5 W stereo internal speakers
- 1080p HD webcam
- Security cable slot on rear of monitor for optional security cable
- HDCP (High-bandwidth Digital Content Protection) used on all digital inputs
- Power Saver mode to meet requirements for reduced power consumption



**NOTE:** For safety and regulatory information, see the *Product Notices* provided in your documentation kit. To access the latest user guides or manuals for your product, go to <http://www.hp.com/support> and follow the instructions to find your product. Then select **User Guides**.

---



## Rear components

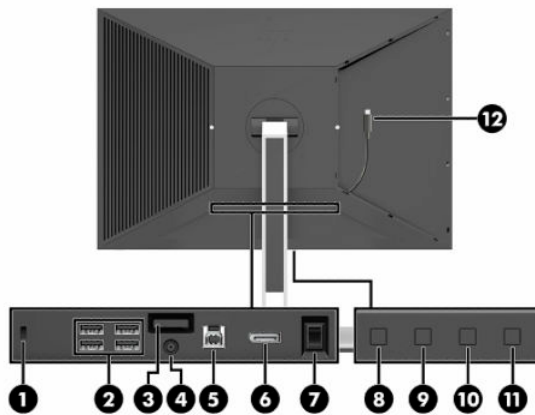

**Table 1-1** Rear components

| Component                    | Description  |
|------------------------------|--|
| (1) Security cable slot      | Connects an optional security cable.   |
| (2) USB 3.1 Gen1 ports (4)   | Connect USB devices.   |
| (3) Stand release latch      | Releases the stand.  |
| (4) Power connector          | Connects an AC adapter.  |
| (5) USB Type-B upstream port | Connects the USB hub cable to a source device such as a computer.  |
| (6) DisplayPort connector    | Connects a DisplayPort cable to a source device such as a computer.  |
| (7) Master power switch      | Turns off all power to the monitor.  |
| (8) <b>Back</b> button       | If the OSD menu is open, press to exit or return to previous menu level.<br>If the OSD menu is closed, press to open the Brightness menu.  |
| (9) <b>Plus</b> button       | If the OSD menu is open, press to navigate forward through the OSD menu and increase adjustment levels.<br>If the OSD menu is closed, press to open the Color menu.              |
| (10) <b>Minus</b> button     | If the OSD menu is open, press to navigate backward through the OSD menu and decrease adjustment levels.<br>If the OSD menu is closed, press to open the Next Active Input menu. |
| (11) <b>Menu/OK</b> button   | Press to open the OSD menu, or select a menu item from the OSD.  |
| (12) USB Type-C cable        | Connects an HP Desktop Mini (sold separately) inserted into the monitor rear compartment.  |



**NOTE:** You can reconfigure the function buttons in the OSD menu to quickly select the most commonly used operations. Press the **Menu** button to open the OSD menu, and then select **Menu**. Select **Assign Buttons**, and then select one of the available options for the button that you want to assign.

## Side components

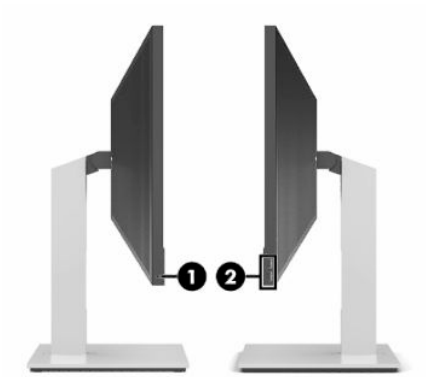
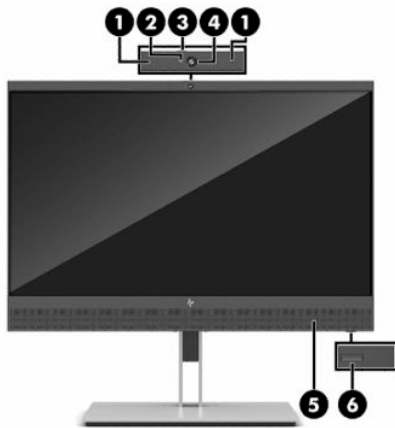

**Table 1-2 Side components**

| Component                  | Description                       |
|----------------------------|-----------------------------------|
| (1) Headset jack           | Connects headphones or a headset. |
| (2) USB 3.1 Gen1 ports (2) | Connect USB devices.              |

**NOTE:** These USB ports support the charging feature.

## Front components



**Table 1-3 Front components**

| Component                  | Description                              |
|----------------------------|--|
| (1) Dual-array microphones | Record sound.                            |
| (2) Webcam light           | Indicates the webcam is on.              |
| (3) Webcam shutter         | Opens or closes the webcam.              |
| (4) Webcam lens            | Allows you to share video of your image. |
| (5) Speaker grill          | Covers the stereo speakers.              |
| (6) Power button           | Turns the monitor on or off.             |

# Setting up the monitor

## Installing the monitor stand

 **IMPORTANT:** To prevent damage to the monitor, do not touch the surface of the LCD panel. Pressure on the panel can cause nonuniformity of color or disorientation of the liquid crystals. If this occurs, the screen will not recover to its normal condition.

1. Position the monitor facedown on a flat surface covered by a soft, clean cloth.
2. Slide the top of the mounting plate on the stand under the upper lip of the recess in the back of the panel (1).
3. Lower the bottom of the stand's mounting plate into the recess until it snaps into place (2).

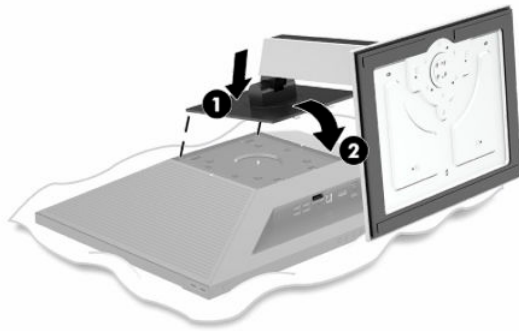

## Mounting the monitor head

The monitor head can be attached to a wall, swing arm, or other mounting fixture.

 **IMPORTANT:** This monitor supports the VESA industry-standard 100 mm mounting holes. To attach a third-party mounting solution to the monitor, four 4 mm, 0.7 pitch, and 10 mm–long screws are required. Longer screws can damage the monitor. Be sure to verify that the manufacturer's mounting solution is compliant with the VESA standard and is rated to support the weight of the monitor head. For best performance, use the power and video cables that are provided with the monitor.

This apparatus is intended to be supported by UL- or CSA-listed wall-mount brackets.

1. Position the monitor facedown on a flat surface covered by a soft, clean cloth.
2. If the monitor head is attached to the stand, remove the monitor head from the stand. Press the release button (1), lift up the bottom of the stand, and then slide the top part of the stand out (2).

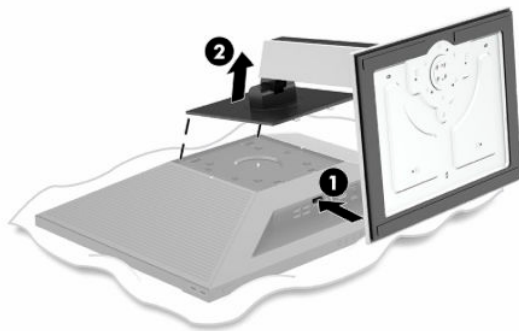

3. Place the VESA cover plate on the rear of the monitor.

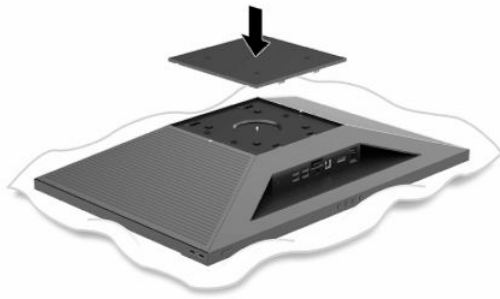

4. To attach the monitor head to a swing arm or other mounting device, insert four mounting screws through the holes on the mounting device and into the screw holes on the rear of the monitor.

 **NOTE:** Follow the mounting device manufacturer's instructions when mounting the monitor to a wall or swing arm.

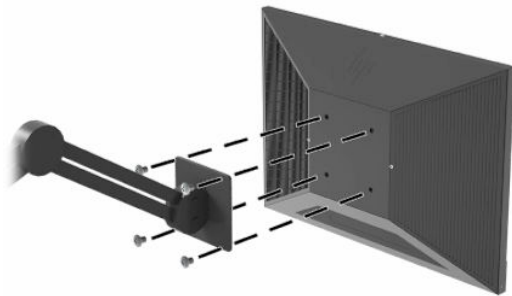

## Attaching an HP Desktop Mini to the monitor

The monitor supports HP EliteDesk and ProDesk HP Desktop Minis configured with 35 W and 65 W processors.

1. Gently remove the panels on the rear by detaching the tabs from the slots, starting with the interior edges (1) and then the external edges (2).

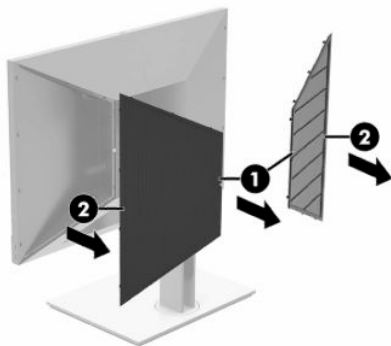

- Slide the HP Desktop Mini into the compartment on the rear of the monitor with the end of the HP Desktop Mini with the USB Type-C port sliding in first until you hear a click that indicates that the HP Desktop Mini is fully engaged.

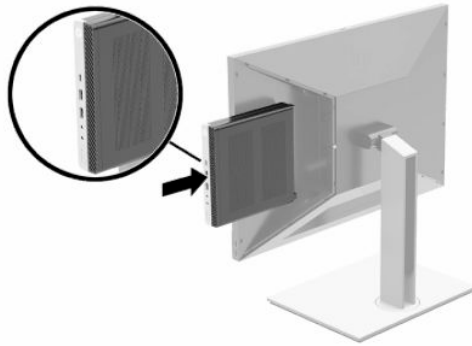

- Connect the USB Type-C cable from the monitor to the USB Type-C port on the rear of the HP Desktop Mini.

 **NOTE:** The USB Type-C connection from the monitor to the HP Desktop Mini functions as a power source for the HP Desktop Mini, a video input to the monitor, and a USB upstream connection for the USB downstream ports on the monitor.

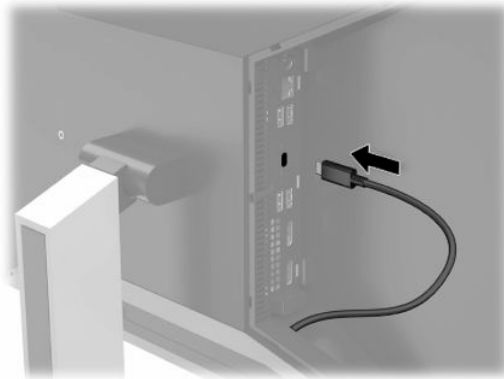

- To add a second monitor, connect a DisplayPort cable between the DisplayPort connector on the HP Desktop Mini and the DisplayPort connector on the second monitor.

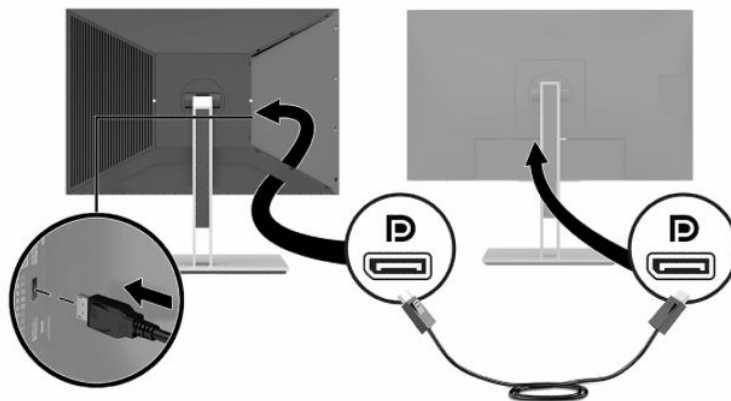

5. Attach the rear covers back onto the rear of the monitor starting with the exterior edges of the panels (1) and then the interior edges of the panels (2). You can install tamper-resistant screws (3) to the covers to deter access to the HP Desktop Mini.

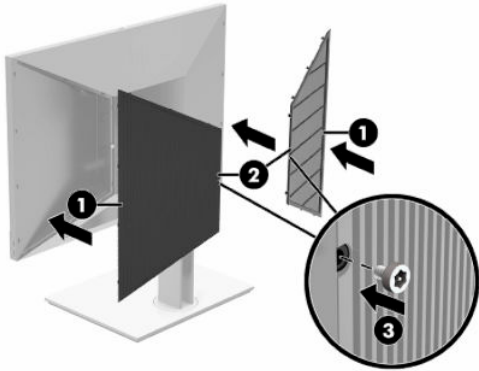

 **NOTE:** There are three tamper-resistant screws inserted on the rear of the monitor that can be removed for securing the panels.

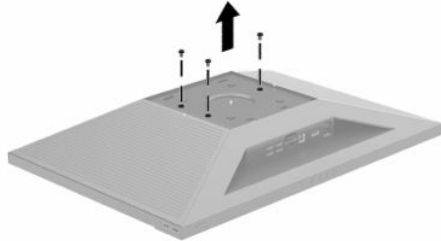

6. Connect one end of the power cord to the AC adapter that came with the product (1) and the other end to a grounded AC outlet (2), and then connect the AC adapter to the power connector on the monitor (3).

 **IMPORTANT:** Do not use the power supply included with the HP Desktop Mini to connect power to the monitor. You must use the power supply included with the monitor.

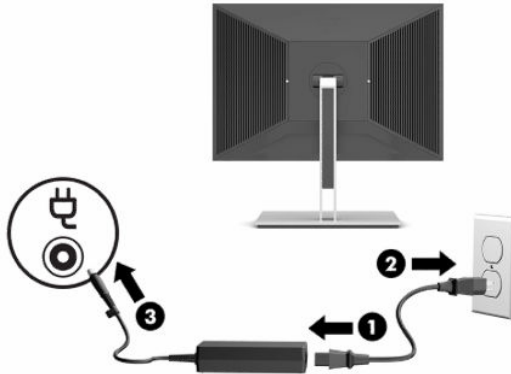

 **WARNING!** To reduce the risk of electric shock or damage to the equipment:

Do not disable the power cord grounding plug. The grounding plug is an important safety feature.

Plug the power cord into a grounded (earthed) AC outlet that is easily accessible at all times.

Disconnect power from the equipment by unplugging the power cord from the AC outlet.

For your safety, do not place anything on power cords or cables. Arrange them so that no one may accidentally step on or trip over them. Do not pull on a cord or cable. When unplugging the power cord from the AC outlet, grasp the cord by the plug.

## Routing cables

Route cables extending from the monitor through the cable management slot on the monitor stand.

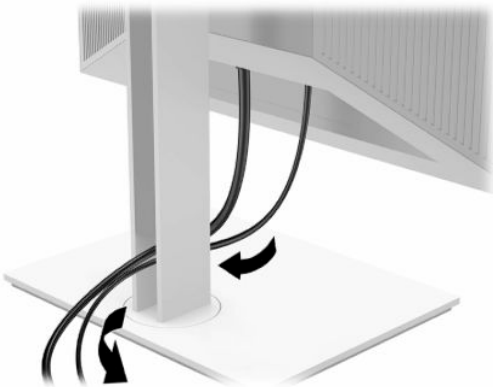

## Turning on power

Press the power button on the front of the monitor to turn it on. The power button will turn on both the monitor and the HP Desktop Mini if the HP Desktop Mini is installed in the rear compartment on the monitor.

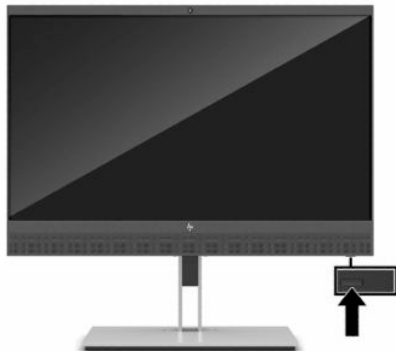

**IMPORTANT:** Burn-in image damage may occur on monitors that display the same static image on the screen for 12 or more consecutive hours of nonuse. To avoid burn-in image damage on the monitor screen, you should always activate a screen saver application or turn off the monitor when it will not be in use for a prolonged period of time. Image retention is a condition that might occur on all LCD screens. A burned-in image on the monitor is not covered under the HP warranty.

## Removing the HP Desktop Mini

1. Turn off power to the monitor.
2. Remove both panels on the rear of the monitor to access the HP Desktop Mini.
3. Disconnect the USB Type-C cable from the HP Desktop Mini (1). Press the release button on the rear of the monitor (2), and then slide the HP Desktop Mini out of the compartment (3) on the rear of the monitor.

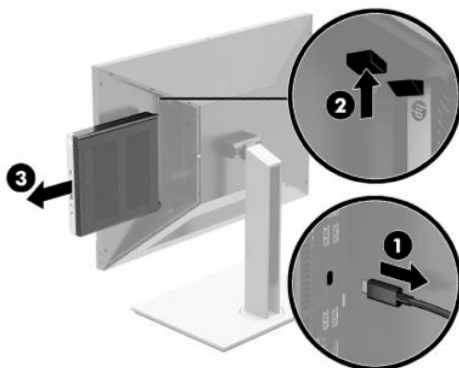

## Configuring the monitor as standalone monitor

The monitor has a USB Type-B upstream port and a DisplayPort connector if the monitor is connected as a standalone monitor.

For video input, connect one end of a DisplayPort cable to the DisplayPort connector on the rear of the monitor and the other end to the DisplayPort connector on the source device.



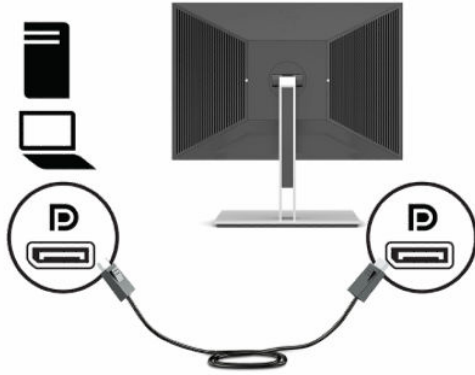

To provide USB downstream support for the monitor, connect the Type-B connector on the USB upstream cable to the USB Type-B upstream port on the rear of the monitor. Then connect the cable's Type-A connector to the USB Type-A downstream port on the source device.

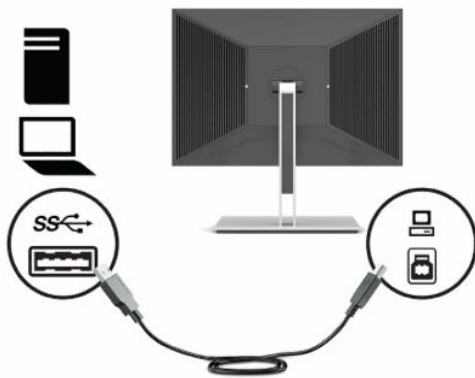

## Connecting a second computer the monitor

You can connect a second computer to the monitor and toggle between the HP Desktop Mini and the second computer.

1. For video input from the second computer, connect one end of a DisplayPort cable to the DisplayPort connector on the rear of the monitor and the other end to the DisplayPort connector on the second computer.

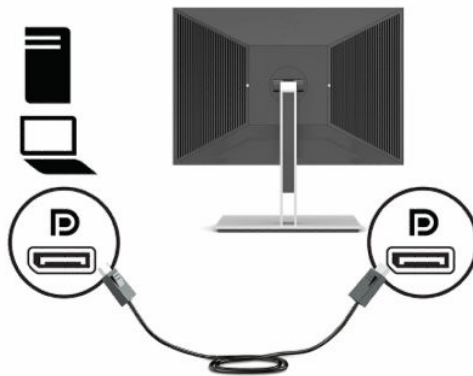

2. To toggle the monitor between the HP Desktop Mini and the second computer, press the **Menu** button to open the OSD. In the OSD, select **Input**, and then select **USB-C Video** for the HP Desktop Mini or **DisplayPort** for the second computer.

## Adjusting the monitor

1. Tilt the monitor head forward or backward to set it to a comfortable eye level.

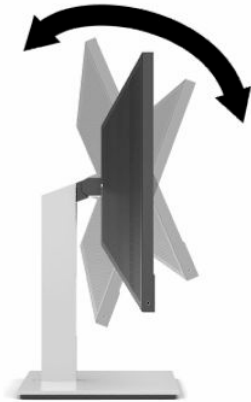

2. Swivel the monitor head to the left or right for the best viewing angle.

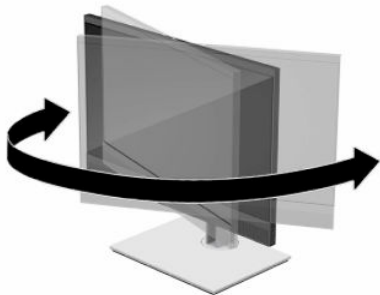

3. Adjust the monitor's height to a comfortable position for your individual workstation. The monitor's top bezel edge should be no higher than eye level. A monitor that is positioned low and reclined may be more comfortable for users with corrective lenses. The monitor should be repositioned as you adjust your working posture throughout the work day.

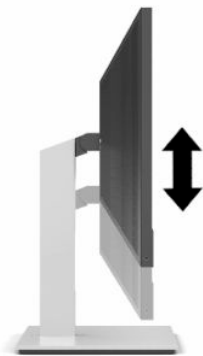

4. You can pivot the monitor head from landscape to portrait orientation viewing to adapt to your application.
  - a. Adjust the monitor to full height position and tilt the monitor head back to full tilt position (1).
  - b. Pivot the monitor head counterclockwise 90° from landscape to portrait orientation (2).

---

 **IMPORTANT:** If the monitor is not in full-height and full-tilt position when pivoting, the bottom corner of the monitor head will come in contact with the base and potentially cause damage to the monitor.

---



---

 **NOTE:** To rotate the OSD menu, press the **Menu** button to open the OSD, select **Menu**, and then select **Menu Position**.

---

## Installing a security cable

You can secure the monitor to a fixed object with an optional security cable available from HP.



## HP watermark and image retention policy

The IPS monitor models are designed with IPS (In-Plane Switching) display technology, which provides ultra-wide viewing angles and advanced image quality. IPS monitors are suitable for a wide variety of advanced image quality applications. This panel technology, however, is not suitable for applications that exhibit static, stationary, or fixed images for long periods of time without the use of screen savers. These types of applications may include camera surveillance, video games, marketing logos, and templates that are displayed on the screen for a prolonged period of time. Static images may cause image retention damage that could look like stains or watermarks on the monitor's screen.

A burned-in image on the monitor is not covered under the HP warranty. To avoid image retention damage, either turn off the monitor when it is not in use, or use the power management setting, if supported on your system, to turn off the monitor when the system is idle.

---

## 2 Using the monitor

### Software and utilities

You can download and install the following files from <http://www.hp.com/support>.

- INF (Information) file
- ICM (Image Color Matching) files

To download the files:

1. Go to <http://www.hp.com/support>.
2. Select **Software and Drivers**.
3. Select your product type.
4. Enter your HP monitor model in the search field and follow the on-screen instructions.

### The Information file

The INF file defines monitor resources used by Windows® operating systems to ensure monitor compatibility with the computer's graphics adapter.

This monitor is Windows Plug and Play-compatible, and the monitor will work correctly without installing the INF file. Monitor Plug and Play-compatibility requires that the computer's graphics card is VESA DDC2-compliant and that the monitor connects directly to the graphics card. Plug and Play does not work through separate BNC-type connectors or through distribution buffers, boxes, or both.

### The Image Color Matching file

The ICM files are data files that are used in conjunction with graphics programs to provide consistent color matching from monitor screen to printer, or from scanner to monitor screen. This file is activated from within graphics programs that support this feature.



---

**NOTE:** The ICM color profile is written in accordance with the International Color Consortium (ICC) Profile Format specification.

---

# Using the on-screen display (OSD) menu

Use the on-screen display (OSD) menu to adjust the screen image based on your viewing preferences. You can access and make adjustments in the OSD using the buttons on the rear of the monitor.

To access the OSD menu and make adjustments:

1. If the monitor is not already on, press the power button to turn on the monitor.
2. To access the OSD menu, press the **Menu** button to open the OSD.
3. Use the three function buttons to navigate, select, and adjust the menu choices. The on-screen button labels vary depending on which menu or submenu is active.

The following table lists the menu selections in the OSD main menu.

**Table 2-1 OSD main menu options and their descriptions**

| Main menu   | Description  |
|-------------|--|
| Brightness  | Adjusts the brightness and contrast level of the screen.   |
| Color       | Selects and adjusts the screen color.  |
| Image       | Adjusts the screen image.  |
| Input       | Selects the video input signal.  |
| Power       | Adjusts the power settings.  |
| Audio       | Adjusts audio levels.  |
| Menu        | Adjusts the on-screen display (OSD) and function button controls.  |
| Management  | Selects the language in which the OSD menu is displayed (the factory default is English), and returns all OSD menu settings to the factory default settings. |
| USB Host    | Selects the USB host.  |
| Information | Selects and displays important information about the monitor.  |
| Exit        | Exits the OSD menu screen.   |

## Adjusting Low Blue Light Mode

Decreasing the blue light emitted by the monitor reduces the blue light exposure to your eyes. This monitor allows you to select a setting to reduce blue light output and create a more relaxing and less stimulating image while you read content on the screen.

To adjust the blue light output from the monitor:

1. Press one of the four OSD bezel buttons on the bottom of the monitor to display the OSD icons on the screen.
2. Press the **Menu** button, select **Color**, and then select **Viewing Modes**.
3. Select your desired setting:
  - **Low Blue Light:** (TUV certified) Reduces blue light for improved eye comfort.
  - **Reading:** Optimizes blue light and brightness for indoor viewing.
  - **Night:** Adjusts to the lowest blue light and reduces the impact on sleep.
4. Select **Exit** from the main menu.

---

 **WARNING!** To reduce the risk of serious injury, read the *Safety & Comfort Guide*. It describes proper workstation setup and proper posture, health, and work habits for computer users. The *Safety & Comfort Guide* also provides important electrical and mechanical safety information. The *Safety & Comfort Guide* is available on the Web at <http://www.hp.com/ergo>.

---

## Using Auto-Sleep Mode

The monitor supports an OSD menu option called Auto-Sleep Mode that allows you to enable or disable a reduced power state for the monitor. When Auto-Sleep Mode is enabled (enabled by default), the monitor will enter a reduced power state when the computer signals low power mode (absence of either horizontal or vertical sync signal).

Upon entering this reduced power state (sleep mode), the monitor screen is blanked, the backlight is turned off, and the power light turns amber. The monitor draws less than 0.5 W of power when in this reduced power state. The monitor will wake from sleep mode when the computer sends an active signal to the monitor (for example, if you activate the mouse or keyboard).

To turn off Auto-Sleep Mode:

1. Press the **Menu** button to open the OSD menu.
2. In the OSD, select **Power**.
3. Select **Auto-Sleep Mode**, and then select **Off**.

# 3 Support and troubleshooting

## Solving common issues

The following table lists possible issues, the possible cause of each issue, and the recommended solutions.

**Table 3-1 Common issues and solutions**

| Issue   | Possible cause   | Solution  |
|---|--|---|
| Screen is blank or video is flashing.                                   | Power cord is disconnected.  | Connect the power cord.   |
|   | Monitor is turned off.   | Press the monitor power button.   |
|   | USB Type-C cable is not connected to the HP Desktop Mini.                      | Connect the USB Type-C cable.   |
|   | System is in sleep mode.   | Press any key on the keyboard or move the mouse to exit sleep mode.   |
| Image appears too dark.   | Brightness setting is too low.   | Open the OSD menu and select <b>Brightness</b> to adjust the brightness scale as needed.                                    |
| “Input Signal Not Found” is displayed on the screen.                    | USB Type-C cable is not connected to the HP Desktop Mini.                      | Connect the USB Type-C cable.   |
| “Input Signal Out of Range” is displayed on the screen.                 | Video resolution and/or refresh rate are set higher than the monitor supports. | Change the settings to a supported setting. See <a href="#">Preset display resolutions on page 22</a> for more information. |
| The monitor is off but it did not seem to enter a low-power sleep mode. | The monitor’s sleep mode is disabled.  | Open the OSD menu and select <b>Power</b> , select <b>Auto-Sleep Mode</b> , and then set auto-sleep to <b>On</b> .          |

## Contacting support

To resolve a hardware or software issue, go to <http://www.hp.com/support>. Use this site to get more information about your product, including links to discussion forums and instructions about troubleshooting. You can also find information about how to contact HP and open a support case.

 **NOTE:** Contact customer support to replace the power cord, the AC adapter (select products only), or any other cables that shipped with your monitor.

## Preparing to call technical support

If you cannot solve an issue using the troubleshooting tips in this section, you might need to call technical support. Have the following information available when you call:

- Monitor model number
- Monitor serial number
- Purchase date on invoice
- Conditions under which the issue occurred

- Error messages received
- Hardware configuration
- Name and version of the hardware and software you are using

## Locating the serial number and product number

The serial number and product number are located on a label on the bottom edge of the monitor head. You may need these numbers when contacting HP about the monitor model.

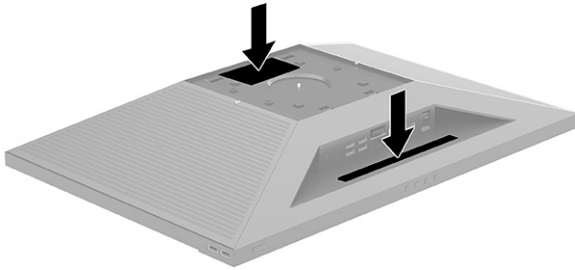



---

# 4 Maintaining the monitor

## Maintenance guidelines

To enhance the performance and extend the life of the monitor:

- Do not open the monitor cabinet or attempt to service this product yourself. Adjust only those controls that are covered in the operating instructions. If the monitor is not operating properly or has been dropped or damaged, contact an authorized HP dealer, reseller, or service provider.
- Use only a power source and connection appropriate for this monitor, as indicated on the label or back plate of the monitor.
- Be sure that the total ampere rating of the products connected to the AC outlet does not exceed the current rating of the AC outlet, and the total ampere rating of the products connected to the cord does not exceed the rating of the cord. Look on the power label to determine the ampere rating (AMPS or A) for each device.
- Install the monitor near an outlet that you can easily reach. Disconnect the monitor by grasping the plug firmly and pulling it from the outlet. Never disconnect the monitor by pulling the cord.
- Turn the monitor off when not in use. You can substantially increase the life expectancy of the monitor by using a screen saver program and turning off the monitor when not in use.



**NOTE:** A burned-in image on the monitor is not covered under the HP warranty.

---

- Slots and openings in the cabinet are provided for ventilation. These openings must not be blocked or covered. Never push objects of any kind into cabinet slots or other openings.
- Do not drop the monitor or place it on an unstable surface.
- Do not allow anything to rest on the power cord. Do not walk on the cord.
- Keep the monitor in a well-ventilated area, away from excessive light, heat, or moisture.
- When removing the monitor stand, you must position the monitor facedown on a soft area to prevent it from getting scratched, defaced, or broken.

## Cleaning the monitor

1. Turn off the monitor and unplug the power cord from the AC outlet.
2. Dust the monitor by wiping the screen and the cabinet with a soft, clean antistatic cloth.
3. For more difficult cleaning situations, use a 50/50 mix of water and isopropyl alcohol.



**IMPORTANT:** Spray the cleaner onto a cloth and use the damp cloth to gently wipe the screen surface. Never spray the cleaner directly on the screen surface. It might run behind the bezel and damage the electronics. The cloth should be moist, but not wet. Water dripping into the ventilation openings or other points of entry can cause damage to the monitor. Allow the monitor to air-dry before use.

**IMPORTANT:** Do not use cleaners that contain any petroleum-based materials such as benzene, thinner, or any volatile substance to clean the monitor screen or cabinet. These chemicals can damage the monitor.

---

## Shipping the monitor

Keep the original packing box in a storage area. You may need it later if you move or ship the monitor.

# A Technical specifications



**NOTE:** All specifications represent the typical specifications provided by HP's component manufacturers; actual performance may vary either higher or lower.

For the latest specifications or additional specifications on this product, go to <http://www.hp.com/go/quickspecs/> and search for your specific monitor model to find the model-specific QuickSpecs.

**Table A-1 Technical specifications**

| Specification                       | Measurement  |                    |
|-------------------------------------|--|--------------------|
| <b>Display</b>                      | <b>60.5 cm</b>   | 23.8-inch          |
| <b>Type</b>                         | IPS LCD  |                    |
| <b>Viewable image size</b>          | <b>60.5 cm</b> diagonal  | 23.8-inch diagonal |
| <b>Weight (with stand)</b>          | <b>7.78 kg</b>   | 17.15 lb           |
| <b>Dimensions (including stand)</b> |  |                    |
| Height                              | <b>50.45 cm</b>  | 19.86 in           |
| Depth                               | <b>24.20 cm</b>  | 9.50 in            |
| Width                               | <b>53.96 cm</b>  | 21.20 in           |
| <b>Height adjustment range</b>      | <b>110 mm</b>  | 4.33 in            |
| <b>Tilt adjustment range</b>        | -5° to 20°   |                    |
| <b>Swivel adjustment range</b>      | 45°  |                    |
| <b>Maximum graphic resolution</b>   | 1920 × 1080 @ 75 Hz  |                    |
| <b>Optimum graphic resolution</b>   | 1920 × 1080 @ 60 Hz  |                    |
| <b>Environmental requirements</b>   |  |                    |
| Operating temperature               | <b>5° C to 35° C</b>   | 41° F to 95° F     |
| Storage temperature                 | <b>-20° C to 60° C</b>   | -4° F to 140° F    |
| Storage humidity                    | 5% to 95% (noncondensing)  |                    |
| Operating humidity                  | 20% to 80% (noncondensing)   |                    |
| <b>Altitude:</b>                    |  |                    |
| Operating                           | <b>0 m to 5,000 m</b>  | 0 ft to 16,400 ft  |
| Storage                             | <b>0 m to 12,192 m</b>   | 0 ft to 40,000 ft  |
| <b>Power source</b>                 | 100–240 VAC 50/60 Hz   |                    |
| <b>Power adapter</b>                | Manufacturer: Lite-On, Chicony, Delta (120 W); AcBel (180 W)<br>Regulatory number: TPN-LA18, TPN-CA19, TPN-DA19 (120 W); TPC-AA62 (180 W)<br>Output rating: 19.5 V / 6.15 A (120 W); 19.5 V / 19.5 A (180 W) |                    |
| <b>Input terminal</b>               | One USB Type-C port, one DisplayPort connector, and one USB Type-B upstream port   |                    |

## Preset display resolutions

The following display resolutions are the most commonly used modes and are set as factory defaults. The monitor automatically recognizes these preset modes, and they will appear properly sized and centered on the screen.

**Table A-2** Preset display resolutions

| Preset | Pixel format | Horz freq (kHz) | Vert freq (Hz) |
|--------|--------------|-----------------|----------------|
| (1)    | 640 × 480    | 31.469          | 59.940         |
| (2)    | 640 × 480    | 31.500          | 75.000         |
| (3)    | 720 × 400    | 31.469          | 70.087         |
| (4)    | 800 × 600    | 37.879          | 60.317         |
| (5)    | 800 × 600    | 46.875          | 75.000         |
| (6)    | 1024 × 768   | 31.469          | 59.940         |
| (7)    | 1024 × 768   | 60.022          | 75.000         |
| (8)    | 1280 × 720   | 45.000          | 60.000         |
| (9)    | 1280 × 800   | 49.702          | 59.810         |
| (10)   | 1280 × 1024  | 63.981          | 60.000         |
| (11)   | 1280 × 1024  | 79.976          | 75.000         |
| (12)   | 1440 × 900   | 55.468          | 59.900         |
| (13)   | 1600 × 900   | 60.000          | 60.000         |
| (14)   | 1680 × 1050  | 65.290          | 59.954         |
| (15)   | 1920 × 1080  | 67.500          | 60.000         |

**Table A-3** Preset display resolutions

| Preset | Timing name | Pixel format | Horz freq (kHz) | Vert freq (Hz) |
|--------|-------------|--------------|-----------------|----------------|
| (1)    | 480p        | 720 × 480    | 31.469          | 59.940         |
| (2)    | 576p        | 720 × 576    | 31.250          | 50.000         |
| (3)    | 720p50      | 1280 × 720   | 37.500          | 50.000         |
| (4)    | 720p60      | 1280 × 720   | 45.000          | 60.000         |
| (5)    | 1080p50     | 1920 × 1080  | 56.250          | 50.000         |
| (6)    | 1080p60     | 1920 × 1080  | 67.500          | 60.000         |

## Entering user modes

Under the following conditions, the video controller signal may occasionally call for a mode that is not preset:

- You are not using a standard graphics adapter.
- You are not using a preset mode.

If this occurs, you may need to readjust the parameters of the monitor screen by using the on-screen display menu. Your changes can be made to any or all of these modes and saved in memory. The monitor automatically stores the new setting and then recognizes the new mode just as it does a preset mode. In addition to the factory preset modes, there are at least 10 user modes that can be entered and stored.

## Energy saver feature

The monitor supports a reduced power state. The reduced power state will be initiated if the monitor detects the absence of either the horizontal sync signal or the vertical sync signal. Upon detecting the absence of these signals, the monitor screen is blanked, the backlight is turned off, and the power light turns amber. When the monitor is in the reduced power state, the monitor will utilize 0.5 watts of power. There is a brief warm-up period before the monitor will return to its normal operating mode.

See the computer manual for instructions on setting energy saver features (sometimes called power management features).



**NOTE:** The energy saver feature only works when the monitor is connected to a computer that has energy saver features.

---

---

## B Accessibility

### HP and accessibility

Because HP works to weave diversity, inclusion, and work/life into the fabric of the company, it is reflected in everything HP does. HP strives to create an inclusive environment focused on connecting people to the power of technology throughout the world.

### Finding the technology tools you need

Technology can unleash your human potential. Assistive technology removes barriers and helps you create independence at home, at work, and in the community. Assistive technology helps increase, maintain, and improve the functional capabilities of electronic and information technology. For more information, see [Finding the best assistive technology on page 25](#).

### The HP commitment

HP is committed to providing products and services that are accessible for people with disabilities. This commitment supports the company's diversity objectives and helps ensure that the benefits of technology are available to all.

The HP accessibility goal is to design, produce, and market products and services that can be effectively used by everyone, including people with disabilities, either on a stand-alone basis or with appropriate assistive devices.

To achieve that goal, this Accessibility Policy establishes seven key objectives to guide HP actions. All HP managers and employees are expected to support these objectives and their implementation in accordance with their roles and responsibilities:

- Raise the level of awareness of accessibility issues within HP, and provide employees with the training they need to design, produce, market, and deliver accessible products and services.
- Develop accessibility guidelines for products and services, and hold product development groups accountable for implementing these guidelines where competitively, technically, and economically feasible.
- Involve people with disabilities in the development of accessibility guidelines and in the design and testing of products and services.
- Document accessibility features, and make information about HP products and services publicly available in an accessible form.
- Establish relationships with leading assistive technology and solution providers.
- Support internal and external research and development that improves assistive technology relevant to HP products and services.
- Support and contribute to industry standards and guidelines for accessibility.

### International Association of Accessibility Professionals (IAAP)

IAAP is a not-for-profit association focused on advancing the accessibility profession through networking, education, and certification. The objective is to help accessibility professionals develop and advance their careers and to better enable organizations to integrate accessibility into their products and infrastructure.

As a founding member, HP joined to participate with other organizations to advance the field of accessibility. This commitment supports HP's accessibility goal of designing, producing, and marketing products and services that people with disabilities can effectively use.

IAAP will make the profession strong by globally connecting individuals, students, and organizations to learn from one another. If you are interested in learning more, go to <http://www.accessibilityassociation.org> to join the online community, sign up for newsletters, and learn about membership options.

## Finding the best assistive technology

Everyone, including people with disabilities or age-related limitations, should be able to communicate, express themselves, and connect with the world using technology. HP is committed to increasing accessibility awareness within HP and with our customers and partners. Whether it's large fonts that are easy on the eyes, voice recognition that lets you give your hands a rest, or any other assistive technology to help with your specific situation—a variety of assistive technologies make HP products easier to use. How do you choose?

## Assessing your needs

Technology can unleash your potential. Assistive technology removes barriers and helps you create independence at home, at work, and in the community. Assistive technology (AT) helps increase, maintain, and improve the functional capabilities of electronic and information technology.

You can choose from many AT products. Your AT assessment should allow you to evaluate several products, answer your questions, and facilitate your selection of the best solution for your situation. You will find that professionals qualified to do AT assessments come from many fields, including those licensed or certified in physical therapy, occupational therapy, speech/language pathology, and other areas of expertise. Others, while not certified or licensed, can also provide evaluation information. You will want to ask about the individual's experience, expertise, and fees to determine if they are appropriate for your needs.

## Accessibility for HP products

The following links provide information about accessibility features and assistive technology, if applicable, included in various HP products. These resources will help you select the specific assistive technology features and product(s) most appropriate for your situation.

- [HP Elite x3—Accessibility Options \(Windows 10 Mobile\)](#)
- [HP PCs—Windows 7 Accessibility Options](#)
- [HP PCs—Windows 8 Accessibility Options](#)
- [HP PC's—Windows 10 Accessibility Options](#)
- [HP Slate 7 Tablets—Enabling Accessibility Features on Your HP Tablet \(Android 4.1/Jelly Bean\)](#)
- [HP SlateBook PCs—Enabling Accessibility Features \(Android 4.3,4.2/Jelly Bean\)](#)
- [HP Chromebook PCs—Enabling Accessibility Features on Your HP Chromebook or Chromebox \(Chrome OS\)](#)
- [HP Shopping—peripherals for HP products](#)

If you need additional support with the accessibility features on your HP product, see [Contacting support on page 28](#).

Additional links to external partners and suppliers that may provide additional assistance:

- [Microsoft Accessibility information \(Windows 7, Windows 8, Windows 10, Microsoft Office\)](#)
- [Google Products accessibility information \(Android, Chrome, Google Apps\)](#)

- [Assistive Technologies sorted by impairment type](#)
- [Assistive Technologies sorted by product type](#)
- [Assistive Technology vendors with product descriptions](#)
- [Assistive Technology Industry Association \(ATIA\)](#)

## Standards and legislation

### Standards

Section 508 of the Federal Acquisition Regulation (FAR) standards was created by the US Access Board to address access to information and communication technology (ICT) for people with physical, sensory, or cognitive disabilities. The standards contain technical criteria specific to various types of technologies, as well as performance-based requirements which focus on functional capabilities of covered products. Specific criteria cover software applications and operating systems, web-based information and applications, computers, telecommunications products, video and multimedia, and self-contained closed products.

### Mandate 376 – EN 301 549

The EN 301 549 standard was created by the European Union within Mandate 376 as the basis for an online toolkit for public procurement of ICT products. The standard specifies the functional accessibility requirements applicable to ICT products and services, together with a description of the test procedures and evaluation methodology for each accessibility requirement.

### Web Content Accessibility Guidelines (WCAG)

Web Content Accessibility Guidelines (WCAG) from the W3C's Web Accessibility Initiative (WAI) helps web designers and developers create sites that better meet the needs of people with disabilities or age-related limitations. WCAG advances accessibility across the full range of web content (text, images, audio, and video) and web applications. WCAG can be precisely tested, is easy to understand and use, and allows web developers flexibility for innovation. WCAG 2.0 has also been approved as [ISO/IEC 40500:2012](#).

WCAG specifically addresses barriers to accessing the web experienced by people with visual, auditory, physical, cognitive, and neurological disabilities, and by older web users with accessibility needs. WCAG 2.0 provides characteristics of accessible content:

- **Perceivable** (for instance, by addressing text alternatives for images, captions for audio, adaptability of presentation, and color contrast)
- **Operable** (by addressing keyboard access, color contrast, timing of input, seizure avoidance, and navigability)
- **Understandable** (by addressing readability, predictability, and input assistance)
- **Robust** (for instance, by addressing compatibility with assistive technologies)

### Legislation and regulations

Accessibility of IT and information has become an area of increasing legislative importance. The links listed below provide information about key legislation, regulations, and standards.

- [United States](#)
- [Canada](#)
- [Europe](#)



- [United Kingdom](#)
- [Australia](#)
- [Worldwide](#)

## Useful accessibility resources and links

The following organizations might be good resources for information about disabilities and age-related limitations.



**NOTE:** This is not an exhaustive list. These organizations are provided for informational purposes only. HP assumes no responsibility for information or contacts you encounter on the Internet. Listing on this page does not imply endorsement by HP.

### Organizations

- American Association of People with Disabilities (AAPD)
- The Association of Assistive Technology Act Programs (ATAP)
- Hearing Loss Association of America (HLAA)
- Information Technology Technical Assistance and Training Center (ITTATC)
- Lighthouse International
- National Association of the Deaf
- National Federation of the Blind
- Rehabilitation Engineering & Assistive Technology Society of North America (RESNA)
- Telecommunications for the Deaf and Hard of Hearing, Inc. (TDI)
- W3C Web Accessibility Initiative (WAI)

### Educational institutions

- California State University, Northridge, Center on Disabilities (CSUN)
- University of Wisconsin - Madison, Trace Center
- University of Minnesota computer accommodations program

### Other disability resources

- ADA (Americans with Disabilities Act) Technical Assistance Program
- ILO Global Business and Disability network
- EnableMart
- European Disability Forum
- Job Accommodation Network
- Microsoft Enable

## HP links

[Our contact webform](#)

[HP comfort and safety guide](#)

[HP public sector sales](#)

## Contacting support



---

**NOTE:** Support is in English only.

---

- Customers who are deaf or hard of hearing who have questions about technical support or accessibility of HP products:
  - Use TRS/VRS/WebCapTel to call (877) 656-7058 Monday through Friday, 6 a.m. to 9 p.m. Mountain Time.
- Customers with other disabilities or age-related limitations who have questions about technical support or accessibility of HP products, choose one of the following options:
  - Call (888) 259-5707 Monday through Friday, 6 a.m. to 9 p.m. Mountain Time.
  - Complete the [Contact form for people with disabilities or age-related limitations](#).