



www.BradyID.com/PetroChem

Visual Safety & Productivity Solutions

For The Chemical, Oil & Gas Industries

Visuals enhance process safety, reliability and efficiency!

Visuals play a critical role in the chemical, oil and gas industries. Chemical processing facilities, petroleum refineries, drilling rigs and tank terminals are all characterized by their hazardous work environment, asset intensive operations, and mission critical processes. In these environments, equipment failure and human error can not only cost millions of dollars in lost production, but can also result in death or serious injury to workers and bystanders.

In most facilities, the control rooms employ real-time information systems and graphical digital displays to keep board operators informed, however the physical plant outside the control room is often only minimally identified. This leaves field operators to rely on their past training and experience as they navigate pipes, vessels and instruments. The lack of visual information and instructions in a production unit puts all individuals within the plant at risk.



Visuals such as pipe markers, tank placards, valve tags, equipment labels and safety signs provide the following critical benefits:

- Enhanced safety and compliance
- Increased capacity and reduced scrap
- Faster, safer shutdowns and turnarounds
- Less downtime and unplanned maintenance
- Longer equipment life and higher return on assets
- Easier job training and less likelihood of human error
- More efficient operations and enhanced production flexibility

NEW!

Don't Miss These New Products!

Signs

- Signs specific to the Chemical, Oil and Gas Industries (Page 11)



Lockout / Tagout

- 3" Shackle Packlocks (Page 39)
- Butterfly Valve Lockout (Page 33)
- Double Looped Cables (Page 32)

New Label Printers

- BBP®33 Benchtop Printer (Page 8)
- BMP®51 Portable Printer (Page 9)



Tags

- Flag Style Blind Tags (Page 41)
- Isolation Blind Tags (Page 41)
- Barricade Tags (Page 57)



Hazard Communication

- Pre-Printed GHS Labels (Page 45)
- Custom Tank and Vessel Signs (Page 49)



Table of Contents

Software.....	4
Printers	6
Signs.....	11
Pipe Markers	21
Valve Tags.....	30
Lockout / Tagout	32
Hazard Communication	44
Confined Space	50
Maintenance Tags	51
Absorbents.....	53
Temporary Barricades.....	57
Safety Tapes	58
Additional Products.....	59



Enhance safety and compliance with Brady's visual workplace solutions.

www.BradyID.com/PetroChem

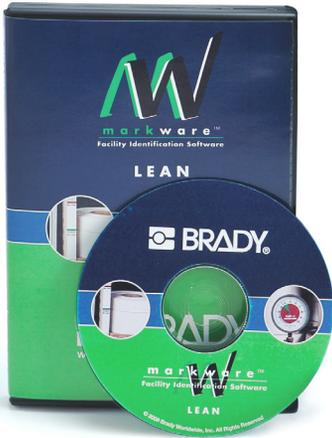

MarkWare™ Lean Tools Facility Identification Software

MarkWare™ Lean Tools is a general industrial identification software application that lets you easily create professional-looking signs, labels and other visuals directly on your computer.

- Print to a Brady label printer* or to most Windows™ inkjet / laser printers
- Pre-formatted templates make general industrial label creation quick and easy
- Select from over 1,000 scalable symbols or import your own logos and photos
- Create barcodes from 15 different symbologies
- Automatically merge data stored in external spreadsheets and databases.

Use MarkWare Lean Tools software to create:

- Safety signs and labels
- Pipe markers and valve tags
- Tank and vessel signs
- Equipment and instrument ID
- Maintenance and inspection tags
- Inventory and storage labels
- Hazardous chemical labels
- And more!

Built-in library with over 1000 high-quality, scalable symbols and pictograms

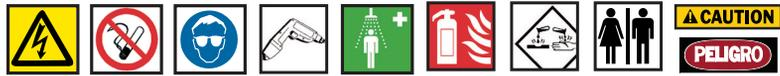

* Multicolor and cutout labels can be created using Brady's GlobalMark® printer. For monochrome labels, use Brady's BBP@31 label printer. See pages 6 for more information.

! Online Video & Demo:
Watch online videos or request a demo by visiting:
www.BradyID.com/Markware



LabelMark™ Professional Labeling Software

Brady's LabelMark™ Labeling Software offers features that make creating labels more efficient. Written specifically for identification applications in the telecommunication, laboratory and electrical markets where wire and cable marking is a constant and tedious job.

LabelMark™ Labeling Software is the easy solution for label design, editing and printing. LabelMark™ Software is a fast system for creating new labels and printing professional, accurate and legible labels.

With built-in templates, wizards, fixed text labels and free form design, LabelMark™ Software simplifies label making in the electrical, industrial, aerospace, laboratory, and telecomm industries.

Features include:

- Insert AutoCAD drawings into label designs
- Batch print multiple label files in a single job
- Group related labels in user-designated job files
- Add text, images, shapes, and 1- or 2-D barcodes
- Import data from text files, spreadsheets or databases

Use LabelMark Professional to create:

- Wire and cable markers
- Terminal block labels
- Patch panel and face plate ID
- Control panel and component marking
- Rating and serial plate ID
- Asset identification labels

! Online Video & Demo:
Watch online videos or request a demo by visiting:
www.BradyID.com/Labelmark



Link360™ Software

Create easy-to-understand procedures that make it easy for employees to properly perform critical lockout and maintenance tasks!

LINK360™ software is a cloud-based solution that takes the time and labor out of creating and managing standardized work procedures. All files are stored and accessed via the internet, eliminating the hassle of having to install and upgrade software on a company computer or network.

The software provides advanced functionality that allows anyone to create visually-instructive procedures in a matter of minutes. It also includes sophisticated features for approving, auditing, updating, deploying and tracking procedures.

Customers can subscribe to one or both of the currently available centers offered through LINK360™ software:



- **Lockout Tagout Center:** Users can create and manage visually instructive lockout procedures, tags, and energy source labels for printing and posting on equipment.



- **Reliability Center:** Manages the creation and access to visually instructive maintenance procedures that assist operators, engineers, and technicians in maintaining machine and equipment performance levels.



Example Maintenance Procedure

Example Lockout Tagout Procedure



More Information:

For more information, visit www.BradyID.com/Link360 or call an Inside Sales Representative at 1-888-311-0775.

InspectNTrack Inspection Management Software

InspectNTrack is a web-based inspection management software designed to schedule, track, and document inspection and maintenance activities or audits on any type of checkpoint. Used with Pocket PCs or tablets, it is the ideal solution for compliance based inspections regulated by any authority having jurisdiction (AHJ).

Features

- Assign tasks and task intervals
- Organize checkpoints into routes and zones
- Guide inputs using structured question sets
- Display reports and dashboards
- Auto-trigger incident reports
- Compatible with handheld pocket PCs

Use InspectNTrack software to manage inspections of:

- Fire extinguishers, fire hoses, etc.
- Breathing apparatus
- Fall-protection harnesses
- Fire/chemical resistant suits
- Safety showers and eyewash stations
- Maintenance inspection points
- Fugitive emissions



More Information:

For more information, visit www.BradyID.com/InspectNTrack or call an Inside Sales Representative at 1-888-311-0775.

InspectNTrack is available in a Standard or Enterprise version. The Enterprise version offers tracking at multiple sites as well as the tablet functionality.

Printers

www.BradyID.com/PetroChem

Printers

Brady Industrial Labeling Printers

Brady's offering of labeling systems lets you create virtually any type of industrial identification onsite and on demand – including everything from small-format wire and cable markers, to valve tags, pipe markers, equipment labels and even large-format NFPA diamond placards and safety signs.

The Brady Durability Advantage

Our visual workplace solutions meet your needs when it comes to critical performance factors, such as UV, thermal, chemical and abrasion resistance, or adhesive properties that will stick and stay stuck to a wide variety of surface materials and types.

For example, we know that customers don't just need outdoor durability OR chemical resistance OR the ability to withstand extreme temperatures. You often need it ALL in one solution. Brady's B-595 indoor/outdoor adhesive vinyl labels are designed and tested to provide superior print durability and adhesion properties that meet or beat the various specialty materials offered by competitors – all in one versatile, high-performing solution.



What Type of Identification Do You Want to Create?

Brady's industrial label systems can be divided into three categories that correlate to specific user needs and applications.

General Industrial Label Printers



Equipment & Facility ID



Safety & Facility Signs



Pipe and Valve Marking



RTK Container Labels

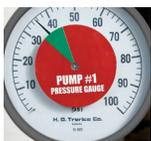

PM Inspection Labels



5S / Lean Labeling

Electrical / Telecomm Label Printers



Self-Laminating Wire Markers



Heat-Shrink Wire Markers



Terminal Block Labels



Patch Panel Labels



Outlet / Faceplate ID



Control Panel Labels

Portable Label Printers



Stock Labeling



Wire & Cable Markers



Electrical ID



Equipment ID



Warning Labels

And other small-format labeling for general industrial, electrical and datacomm applications



General Industrial Label Printers

The Brady printers shown below are specially designed to create large-format output, which is ideal for safety, facility, process & equipment identification applications.



BBP®31 Sign & Label Printer
Ultimate facility & safety printer for walk-up-and-print ease of use and ease of label changeovers. Best choice for multi-user, "Lean event" labeling situations, and centrally located print areas.



GlobalMark®2 Industrial Label Printer
Rugged Safety & Facility ID printer with advanced capabilities of printing multiple print colors onto a label and cutting out basic shapes & text. Ideal for Lean, 5S, and Plant Reliability labeling programs as well as pipe marking and general facility ID.



PowerMark® Sign & Label Printer
Large-format Safety & Facility ID printer with advanced capabilities of printing onto 10" wide material and printing multiple colors onto a label. Ideal for safety signs and any time larger multicolor labels or text are needed.

Prints Large 10" Labels

Printer Specifications			
Warranty	5 year	5 year	5 year
Print Technology	Thermal Transfer	Thermal Transfer	Thermal Transfer
Print Resolution	300 dpi	300 dpi	300 dpi
Max Print Width	4.000"	4.000"	10.000"
Media Widths	0.500" to 4.250"	0.500" to 4.250"	4.000" to 10.000"
Color Printing Capabilities	Single print color on label (some pre-printed multicolor supplies also available)	Multiple print colors (some pre-printed multicolor supplies also available)	Multiple print colors
Auto Cut-off	Yes	Yes	Yes
X-Y Plotter Cutting (cutting out shapes & text)	No	Yes (Color & Cut model)	No
PC Connect or Stand Alone Operation	PC Connect and Stand Alone	PC Connect and Stand Alone	PC Connect and Stand Alone
Ribbon & Label Installation	Labels: Supplied in cartridge, drops into place, 15 sec changeover Ribbon: Supplied in cartridge, snaps into place, 5 sec changeover	Labels: Supplied in cartridge, drops into place, 15 sec changeover Ribbon: Supplied in cartridge, snaps into place, 5 sec changeover	Labels: Supplied on rolls that fit onto grooved gear wheels, 10 sec changeover. Ribbon: Supplied on rolls that fit into grooved gear wheels, 10 sec changeover
Calibration Required?	No (no waste)	No (no waste)	No (no waste)
Label creation & set-up	Automatic (printer or PC software reads data on chip and automatically sets up label size, color, fonts, etc.)	Automatic (printer or PC reads data on chip and automatically sets up label size, color, fonts, etc.)	Automatic (printer or PC reads data on chip and automatically sets up label size, color, fonts, etc.)
Connectivity Options	Standard: USB	Standard: USB	Standard: USB
Compatible Software	MarkWare™ Software, Windows® based driver for 3rd party software use*	MarkWare™ Software, Windows® based driver for 3rd party software use*	MarkWare™ Software, Windows® based driver for 3rd party software use*
Media Options	Indoor / outdoor vinyl Low halide polyester tape Preprinted labels & tags Reflective & phosphorescent tape Tag stock and magnetic tape	Indoor / outdoor vinyl Low halide polyester tape Preprinted labels & tags Reflective & phosphorescent tape Tag stock and magnetic tape	Indoor / outdoor vinyl Low halide polyester Reflective & phosphorescent tape Tag stock and magnetic tape



Pre-Printed Labels

The BBP®31 printer and GlobalMark® printer support labels with preprinted color headers, NFPA diamonds or HMIG color bars.



MarkWare™ Lean Tools Software

Brady's MarkWare™ Lean Tools software lets you create signs, labels and tags, directly from your computer, then print to any of the Brady labeling systems shown above.

View page 4 for more information on software.



More Information:

For more information on all Brady label printers, visit: www.BradyID.com/Printers



Electrical / Telecomm Label Printers

The Brady printers shown below are specially designed to create small-format output, which is ideal for creating wire markers, terminal block labels, cable markers, patch panel labels and outlet / faceplate identification.



BBP33 Label Printer

Hassle-free printer with no wasted labels or calibration. Easiest to train others to use.



IP™ Series Printer

Production printer with some hassle-free set up features but uses bulk-sized rolls



Bradyprinter™ PR Plus Printer

Mission-critical Production line printer. Wire printer for specialty materials and sleeves

Printer Specifications

Printer Specifications	BBP33 Label Printer	IP™ Series Printer	Bradyprinter™ PR Plus Printer
Warranty	5 year	5 year	5 year
Print Technology	Thermal Transfer	Thermal Transfer, Direct Thermal	Thermal Transfer, Direct Thermal
Print Resolution	300 dpi	300 or 600 dpi	300 or 600 dpi
Max Print Width	4.000"	4.160"	4.160"
Media Widths	0.500" to 4.250"	1"-4.160"	1.000"-4.700"
Color Printing Capabilities	Monocolor	Monocolor	Monocolor
Auto Cut-off	Yes	Optional	Optional
X-Y Plotter Cutting (cutting out shapes & text)	No	No	No
PC Connect or Stand Alone Operation	PC Connect only	PC Connect only	PC Connect only
Ribbon & Label Installation	Labels: Supplied in cartridge, drops into place, 15 sec changeover Ribbon: Supplied in cartridge, snaps into place, 5 sec changeover	Labels: loose roll, attach to cartridge & drops in Ribbon: loose roll, "thread-thru" required	Labels: loose roll, "thread-thru" required Ribbon: loose roll, "thread-thru" required
Calibration Required?	No (no waste)	Yes (minimized)	Yes
Label creation & set-up	Automatic (PC software reads data on chip and automatically sets up label size, color, fonts, etc.)	Automatic (PC software reads data on chip and automatically sets up label size, color, fonts, etc.)	Semi-automatic (select label part from software and label sets up)
Connectivity Options	Standard: USB, Ethernet Optional: WiFi, Bluetooth	Standard: Serial, Parallel, USB, Ethernet 10/100	Standard: Serial, USB, Ethernet 10/100
Compatible Software	Labelmark™ Software, MarkWare™ Software, Codesoft™ Software, Windows® based driver for 3rd party software use*	Labelmark™ Software, Codesoft™ Software, Windows® based driver for 3rd party software use*	Labelmark™ Software, Codesoft™ Software, Windows® based driver for 3rd party software use*
Media Options	Self-laminating wire labels Standard adhesive wire labels Heat shrink wire sleeves Inside panel component labels Front of panel pushbutton labels Terminal block labels Die-cut polyester labels Indoor / outdoor vinyl Reflective tape	Self-laminating wire labels Standard adhesive wire labels Heat shrink wire sleeves Inside panel component labels Terminal block labels Die-cut polyester labels	Self-laminating wire labels Standard adhesive wire labels Heat shrink wire sleeves Strap-on Nomex cable tags Inside panel component labels Front of panel pushbutton labels Terminal block labels Die-cut polyester labels



LabelMark™ Professional Labeling Software

Brady's LabelMark™ professional software is designed to simplify label creation for electrical and data communications applications. Compatible with all three of the printers shown above.

More Information:

For more information on all Brady label printers, visit:
www.BradyID.com/Printers

View page 4 for more information on software.



Portable Label Printers

Brady's portable label printers are lightweight, extremely rugged and reliable. The features and media make these printers suitable for use in low-volume, small-format label applications for general identification and electrical / datacomm identification.



BMP®21 Label Printer
Simple to operate and quick to print, it's the must-have labeling tool for voice and data comm, electrical and general industrial crews. Create your labels just once, knowing they'll stay stuck and stay legible for years ahead.



BMP®51 Label Printer
Helps you get the job done faster, easier and with confidence. This labeler has the versatility, print capabilities and convenience to help you tackle your toughest labeling jobs in a snap.



BMP®71 Label Printer
Brady's most versatile portable printer. This easy-to-use labeler can help you cut material waste, save label making time, and print crisp labels more efficiently than ever before.

Printer Specifications			
Warranty	1 year	1 year	1 year
Max Labels Per Day	75 labels/day	500 labels/day	1000 labels/day
Print Resolution	203 dpi	300 dpi	300 dpi
Print Technology	Thermal Transfer	Thermal Transfer	Thermal Transfer
Print Speed	10 mm/sec (0.4 in/sec)	25 mm/sec (1 in/sec)	38 mm/sec (1.50 in/sec)
Tape Widths (inches)	0.25", 0.375", 0.5", 0.75"	Various sizes from 0.235" to 1.50"	Various sizes from 0.25" to 2.00"
Tape Widths (mm)	6.4, 9.5, 12.7, 19.1 mm	6.4, 8.0, 9.5, 12.1, 12.7, 15.9, 19.1, 25.4, 38.1 mm	Various sizes from 6.4 to 50.8 mm
Max Label Width	0.75" (19.1mm)	1.50" (38.1mm)	2.00"
Max Print Width	N/A	1.250" (31.75mm)	1.75"
Memory	12 labels	48 MB / 25,000 labels	200 MB
Continuous vs Die Cut Labels	Continuous labels only	Continuous and die cut labels	Continuous and die cut labels
PC Connectivity	No	Yes	Yes
Software Compatibility	No	LabelMark™ / CodeSoft™ Software	LabelMark™ / MarkWare™ Software
File Transfer from PC to printer	No	Yes	Yes
Wireless Connectivity	No	Yes	No
Connectivity Options	None	USB, Bluetooth (WIFI and Ethernet optional)	USB
Color Capability	Single Color Printing	Single Color Printing	Single Color Printing
Keyboard	ABC	QWERTY	QWERTY
Backlit Screen	Yes	Yes	Yes
Text Sizes	6 (6 to 40 point)	4 to 103 point + autosizing	4 to 174 point + autosizing
Print Rotation	No	Yes	Yes
Serialization	Yes	Yes	Yes - multiple and linked
Barcode	39 and 128	39 and 128	39 and 128
Symbols	78	444	Over 500
Label Types or Application Functions	Wire, Banner Portrait, Banner Landscape, Terminal Block, Patch Panel, Fixed Length	Banner Portrait, Banner Landscape, Wire, Flag Labels, Patch Panel, Terminal Block, Desi Strip, 110 Block, 66 Block, Bix Block, Fixed Length, Small Pipe Markers	Banner Portrait, Banner Landscape, Wire, Flag Labels, Patch Panel, Terminal Block, Desi Strip, 110 Block, 66 Block, Bix Block, Fixed Length, Pipe Markers, Safety Labels
Media Options	Self-laminating wire labels Heat shrink wire sleeves Nylon cloth Electrical panel labels Indoor/outdoor vinyl	Self-laminating wire labels Standard adhesive wire labels Heat shrink wire sleeves Electrical panel labels Terminal block labels Indoor / outdoor vinyl Reflective tape	Self-laminating wire labels Standard adhesive wire labels Heat shrink wire sleeves Electrical panel labels Terminal block labels Indoor / outdoor vinyl Reflective & phosphorescent tape Tag stock and magnetic tape
Power Supply	6 AA's, AC Power (optional)	8AA's, AC Power, Rechargeable Li-Ion battery pack (optional)	Rechargeable Battery, AC Power
Weight	1.66 lbs (0.75kg)	3.18 lbs (1.44kg)	5.49 lbs (2.49kg)

MarkWare™ and LabelMark™ Software

Allowing you to create labels and other identification right on your own computer.

Use MarkWare™ Lean Tools Software to create safety, facility and equipment identification.

Use LabelMark Professional software to create wire/cable markers and other electrical or datacomm identification.



View page 4 for more information on software.

More Information:

For more information on all Brady label printers, visit:
www.BradyID.com/Printers



Choose from 10 different colors!

Make Your Own Valve Tags

- Use your Brady printer to apply labels to these durable tags
- Withstands temperatures of -40°F (-40°C) to 180°F (82°C)
- 1.5" x 3" Tag accepts labels 1.25" x 2.85" or smaller
- 2.5" x 4" Tag accepts labels 2.25" x 3.85" or smaller

Catalog #	Color	Tag Width A Inch (mm)	Tag Height B Inch (mm)
41920	Black	1.500 (38.1)	3.000 (76.2)
41921	Black	2.500 (63.5)	4.000 (101.6)
41922	Yellow	1.500 (38.1)	3.000 (76.2)
41923	Yellow	2.500 (63.5)	4.000 (101.6)
41924	Red	1.500 (38.1)	3.000 (76.2)
41925	Red	2.500 (63.5)	4.000 (101.6)
41926	Blue	1.500 (38.1)	3.000 (76.2)
41927	Blue	2.500 (63.5)	4.000 (101.6)
41928	Green	1.500 (38.1)	3.000 (76.2)
41929	Green	2.500 (63.5)	4.000 (101.6)
87694	Orange	1.500 (38.1)	3.000 (76.2)
87695	Orange	2.500 (63.5)	4.000 (101.6)
87696	White	1.500 (38.1)	3.000 (76.2)
87697	White	2.500 (63.5)	4.000 (101.6)
87698	Gray	1.500 (38.1)	3.000 (76.2)
87699	Gray	2.500 (63.5)	4.000 (101.6)
87710	Brown	1.500 (38.1)	3.000 (76.2)
87711	Brown	2.500 (63.5)	4.000 (101.6)
87712	Tan	1.500 (38.1)	3.000 (76.2)
87713	Tan	2.500 (63.5)	4.000 (101.6)



Blank High Performance Wrap-Around Pipe Marker

- Create custom Wrap-Around Pipe Markers with your printer
- Self-adhesive strip holds pipe marker securely in place
- Service temp: -40°F (-40°C) to 248°F (120°C)

Catalog #	Color	Fits Pipe Outside Diameter Inch (mm)
5600-I	Blue	1.500 - 2.375 (38.1 - 60.3)
5600-II	Blue	2.500 - 7.875 (63.5 - 200.0)
5603-I	Yellow	1.500 - 2.375 (38.1 - 60.3)
5603-II	Yellow	2.500 - 7.875 (63.5 - 200.0)
5602-I	Red	1.500 - 2.375 (38.1 - 60.3)
5602-II	Red	2.500 - 7.875 (63.5 - 200.0)
5601-I	Green	1.500 - 2.375 (38.1 - 60.3)
5601-II	Green	2.500 - 7.875 (63.5 - 200.0)



Label produced on Brady Printer

Snap-on marker

Make Your Own BradySnap-On™ Pipe Markers

- Use blank Brady Snap-On™ Pipe Markers (B-571 material) in combination with self-sticking pipe markers produced on your Brady printers
- Pre-coiled to snap around pipe

Catalog #	Color	Length of Marker Inch (mm)	Fits Pipe Outside Diameter Inch (mm)
4010-A	Yellow	8.000 (203.2)	0.750 - 1.375 (19.1 - 34.9)
4010-B	Yellow	9.000 (228.6)	1.500 - 2.375 (38.1 - 60.3)
4010-F	Yellow	12.000 (304.8)	6.000 - 9.875 (152.4 - 250.8)
4010-C	Yellow	13.000 (330.2)	2.500 - 3.875 (63.5 - 98.4)
42300	Yellow	16.000 (406.4)	0.750 - 1.375 (19.1 - 34.9)
42304	Yellow	16.000 (406.4)	1.125 - 2.375 (28.6 - 60.3)
4010-D	Yellow	21.000 (533.4)	4.000 - 6.000 (101.6 - 152.4)
4010-H	Yellow	32.000 (812.8)	10.000 - 15.000 (254.0 - 381.0)
4011-A	Green	8.000 (203.2)	0.750 - 1.375 (19.1 - 34.9)
4011-B	Green	9.000 (228.6)	1.500 - 2.375 (38.1 - 60.3)
4011-F	Green	12.000 (304.8)	6.000 - 9.875 (152.4 - 250.8)
4011-C	Green	13.000 (330.2)	2.500 - 3.875 (63.5 - 98.4)
42301	Green	16.000 (406.4)	0.750 - 1.375 (19.1 - 34.9)
42305	Green	16.000 (406.4)	1.125 - 2.375 (28.6 - 60.3)
4011-D	Green	21.000 (533.4)	4.000 - 6.000 (101.6 - 152.4)
4011-H	Green	32.000 (812.8)	10.000 - 15.000 (254.0 - 381.0)
4012-A	Red	8.000 (203.2)	0.750 - 1.375 (19.1 - 34.9)
4012-B	Red	9.000 (228.6)	1.500 - 2.375 (38.1 - 60.3)
4012-F	Red	12.000 (304.8)	6.000 - 9.875 (152.4 - 250.8)
4012-C	Red	13.000 (330.2)	2.500 - 3.875 (63.5 - 98.4)
42302	Red	16.000 (406.4)	0.750 - 1.375 (19.1 - 34.9)
42306	Red	16.000 (406.4)	1.125 - 2.375 (28.6 - 60.3)
4012-D	Red	21.000 (533.4)	4.000 - 6.000 (101.6 - 152.4)
4012-H	Red	32.000 (812.8)	10.000 - 15.000 (254.0 - 381.0)
4013-A	Blue	8.000 (203.2)	0.750 (19.1) - 1.375 (34.9)
4013-B	Blue	9.000 (228.6)	0.750 - 1.375 (19.1 - 34.9)
4013-F	Blue	12.000 (304.8)	6.000 - 9.875 (152.4 - 250.8)
4013-C	Blue	13.000 (330.2)	2.500 - 3.875 (63.5 - 98.4)
42303	Blue	16.000 (406.4)	0.750 (19.1) - 1.375 (34.9)
42307	Blue	16.000 (406.4)	1.125 - 2.375 (28.6 - 60.3)
4013-D	Blue	21.000 (533.4)	4.000 - 6.000 (101.6 - 152.4)
4013-H	Blue	32.000 (812.8)	10.000 - 15.000 (254.0 - 381.0)

*outside diameter includes pipe O.D. plus any insulation.



Blank Signs

- Use with your Brady labeler to create rigid signs and placards

Catalog #	Material	Sign Width A Inch (mm)	Sign Height B Inch (mm)
42953	Aluminum (AL)	7.000 (177.8)	10.000 (254.0)
42954	Aluminum (AL)	10.000 (254.0)	14.000 (355.6)
76063	Fiberglass (FG)	7.000 (177.8)	10.000 (254.0)
47000	Fiberglass (FG)	10.000 (254.0)	14.000 (355.6)
25376	Plastic (PL)	7.000 (177.8)	10.000 (254.0)
25377	Plastic (PL)	10.000 (254.0)	14.000 (355.6)
88948	Self-Sticking Polyester (SS)	7.000 (177.8)	10.000 (254.0)
88949	Self-Sticking Polyester (SS)	10.000 (254.0)	14.000 (355.6)

Safety and Traffic Control Signs

Brady is a global leader in facility signage, offering thousands of different signs for safety, maintenance and facility identification. Brady signs feature bright colors, bold text and intuitive pictographs to ensure that the communication is highly visible and easily understood.



Rigid Sign Materials

B-120 Premium Fiberglass

- Most durable, will not chip, fade, rust, shatter or peel for up to 25 years
- Graphics protected under fiberglass layer
- Excellent chemical & abrasion resistance
- Ideal for outdoor and harsh environments

B-347 BradyGlo™ Plastic

- Glow-in-the-dark (photoluminescent) plastic
- Withstands temperature variations (-40°F to 175°F (-40°C to 80°C))
- Ideal for escape or evacuations routes

B-401 Plastic

- Cost-effective durable polystyrene.
- Ideal for directional and informational applications
- Conforms to well-curved surfaces
- Up to 5 year outdoor life

B-555 Aluminum

- Durable for indoor & outdoor usage
- Withstands wind, rain, sunlight and high temperatures
- 5-8 year outdoor life
- Used for parking, building and informational signs

Flexible Signs (Adhesive Backed)

B-302 Self-Sticking Polyester

- Withstands temperature variations (up to 230F)
- Protected graphics holds up to repeated spills and cleanings
- Good for machine/equipment labels
- Permanent adhesive
- Up to 8 year outdoor life

B-324 BradyGlo™ Self-Sticking Polyester

- Glow-in-the-dark (photoluminescent) pressure sensitive polyester
- Charge time of 5 minutes will charge the sign for +10 hours of glow time.
- Ideal for exit and directional signs throughout escape or evacuations routes

B-946 Self-Sticking Durable Vinyl

- High gloss vinyl printed with UV resistant inks
- Permanent cold temp acrylic adhesive
- Good for outdoor applications on curved surfaces
- Fair chemical and abrasion resistance
- Durable, provides up to 10 years outdoor life.

Admittance Signs



131637	7" x 10"	B-120
131638	10" x 14"	B-120
131635	7" x 10"	B-302
131636	10" x 14"	B-302
131633	7" x 10"	B-401
131634	10" x 14"	B-401
131631	7" x 10"	B-555
131632	10" x 14"	B-555



131645	7" x 10"	B-120
131646	10" x 14"	B-120
131643	7" x 10"	B-302
131644	10" x 14"	B-302
131641	7" x 10"	B-401
131642	10" x 14"	B-401
131639	7" x 10"	B-555
131640	10" x 14"	B-555



131621	7" x 10"	B-120
131622	10" x 14"	B-120
131619	7" x 10"	B-302
131620	10" x 14"	B-302
131617	7" x 10"	B-401
131618	10" x 14"	B-401
131615	7" x 10"	B-555
131616	10" x 14"	B-555



131629	7" x 10"	B-120
131630	10" x 14"	B-120
131627	7" x 10"	B-302
131628	10" x 14"	B-302
131625	7" x 10"	B-401
131626	10" x 14"	B-401
131623	7" x 10"	B-555
131624	10" x 14"	B-555



131721	7" x 10"	B-120
131722	10" x 14"	B-120
131719	7" x 10"	B-302
131720	10" x 14"	B-302
131717	7" x 10"	B-401
131718	10" x 14"	B-401
131715	7" x 10"	B-555
131716	10" x 14"	B-555



131661	7" x 10"	B-120
131662	10" x 14"	B-120
131659	7" x 10"	B-302
131660	10" x 14"	B-302
131657	7" x 10"	B-401
131658	10" x 14"	B-401
131655	7" x 10"	B-555
131656	10" x 14"	B-555



131653	7" x 10"	B-120
131654	10" x 14"	B-120
131651	7" x 10"	B-302
131652	10" x 14"	B-302
131649	7" x 10"	B-401
131650	10" x 14"	B-401
131647	7" x 10"	B-555
131648	10" x 14"	B-555



95361	7" x 10"	B-120
95365	10" x 14"	B-120
132057	7" x 10"	B-302
95362	10" x 14"	B-302
95359	7" x 10"	B-401
95364	10" x 14"	B-401
95360	7" x 10"	B-555
95363	10" x 14"	B-555



131677	7" x 10"	B-120
131678	10" x 14"	B-120
131675	7" x 10"	B-302
131676	10" x 14"	B-302
131673	7" x 10"	B-401
131674	10" x 14"	B-401
131671	7" x 10"	B-555
131672	10" x 14"	B-555



131669	7" x 10"	B-120
131670	10" x 14"	B-120
131667	7" x 10"	B-302
131668	10" x 14"	B-302
131665	7" x 10"	B-401
131666	10" x 14"	B-401
131663	7" x 10"	B-555
131664	10" x 14"	B-555



122831	7" x 10"	B-120
47327	10" x 14"	B-120
84131	7" x 10"	B-302
84132	10" x 14"	B-302
22143	7" x 10"	B-401
22144	10" x 14"	B-401
40707	7" x 10"	B-555
40708	10" x 14"	B-555



122850	7" x 10"	B-120
47330	10" x 14"	B-120
75510	14" x 20"	B-120
84155	7" x 10"	B-302
84156	10" x 14"	B-302
22163	7" x 10"	B-401
22164	10" x 14"	B-401
122412	7" x 10"	B-555
40728	10" x 14"	B-555

Safety Signs

www.BradyID.com/PetroChem

Safety Signs

Chemical & Hazardous Material Signs



131825	7" x 10"	B-120
131826	10" x 14"	B-120
131823	7" x 10"	B-302
131824	10" x 14"	B-302
131821	7" x 10"	B-401
131822	10" x 14"	B-401
131819	7" x 10"	B-555
131820	10" x 14"	B-555



131861	7" x 10"	B-120
131862	10" x 14"	B-120
131859	7" x 10"	B-302
131860	10" x 14"	B-302
131857	7" x 10"	B-401
131858	10" x 14"	B-401
131855	7" x 10"	B-555
131856	10" x 14"	B-555



72392	7" x 10"	B-120
73489	10" x 14"	B-120
84345	7" x 10"	B-302
84346	10" x 14"	B-302
22305	7" x 10"	B-401
22306	10" x 14"	B-401
40869	7" x 10"	B-555
40870	10" x 14"	B-555



131753	7" x 10"	B-120
131754	10" x 14"	B-120
131751	7" x 10"	B-302
131752	10" x 14"	B-302
131749	7" x 10"	B-401
131750	10" x 14"	B-401
131747	7" x 10"	B-555
131748	10" x 14"	B-555

Popular Sign Materials

- B-120 - Premium Fiberglass
- B-302 - Self-Sticking Polyester
- B-324 - BradyGlo™ Self-Sticking Polyester
- B-347 - BradyGlo™ Plastic
- B-401 - Plastic
- B-555 - Aluminum



131829	7" x 10"	B-120
72408	10" x 14"	B-120
84355	7" x 10"	B-302
84356	10" x 14"	B-302
22313	7" x 10"	B-401
22314	10" x 14"	B-401
40877	7" x 10"	B-555
40878	10" x 14"	B-555



131809	7" x 10"	B-120
131810	10" x 14"	B-120
131807	7" x 10"	B-302
131808	10" x 14"	B-302
131805	7" x 10"	B-401
131806	10" x 14"	B-401
131803	7" x 10"	B-555
131804	10" x 14"	B-555



131817	7" x 10"	B-120
131818	10" x 14"	B-120
131815	7" x 10"	B-302
131816	10" x 14"	B-302
131813	7" x 10"	B-401
131814	10" x 14"	B-401
131811	7" x 10"	B-555
131812	10" x 14"	B-555



122823	7" x 10"	B-120
70266	10" x 14"	B-120
70267	14" x 20"	B-120
87763	3-1/2" x 5"	B-302
84375	7" x 10"	B-302
84376	10" x 14"	B-302
25428	7" x 10"	B-401
25429	10" x 14"	B-401
122407	7" x 10"	B-555
43006	10" x 14"	B-555



131777	7" x 10"	B-120
131778	10" x 14"	B-120
131775	7" x 10"	B-302
131776	10" x 14"	B-302
131773	7" x 10"	B-401
131774	10" x 14"	B-401
131771	7" x 10"	B-555
131772	10" x 14"	B-555



131801	7" x 10"	B-120
131802	10" x 14"	B-120
131799	7" x 10"	B-302
131800	10" x 14"	B-302
131797	7" x 10"	B-401
131798	10" x 14"	B-401
131795	7" x 10"	B-555
131796	10" x 14"	B-555



131793	7" x 10"	B-120
131794	10" x 14"	B-120
131791	7" x 10"	B-302
131792	10" x 14"	B-302
131789	7" x 10"	B-401
131790	10" x 14"	B-401
131787	7" x 10"	B-555
131788	10" x 14"	B-555



131769	7" x 10"	B-120
131770	10" x 14"	B-120
131767	7" x 10"	B-302
131768	10" x 14"	B-302
131765	7" x 10"	B-401
131766	10" x 14"	B-401
131763	7" x 10"	B-555
131764	10" x 14"	B-555



131761	7" x 10"	B-120
131762	10" x 14"	B-120
131759	7" x 10"	B-302
131760	10" x 14"	B-302
131757	7" x 10"	B-401
131758	10" x 14"	B-401
131755	7" x 10"	B-555
131756	10" x 14"	B-555

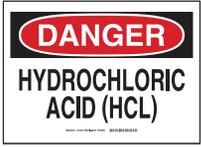

131837	7" x 10"	B-120
131838	10" x 14"	B-120
131835	7" x 10"	B-302
131836	10" x 14"	B-302
131833	7" x 10"	B-401
131834	10" x 14"	B-401
131831	7" x 10"	B-555
131832	10" x 14"	B-555

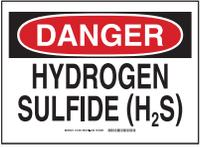

131845	7" x 10"	B-120
131846	10" x 14"	B-120
131843	7" x 10"	B-302
131844	10" x 14"	B-302
131841	7" x 10"	B-401
131842	10" x 14"	B-401
131839	7" x 10"	B-555
131840	10" x 14"	B-555



131853	7" x 10"	B-120
131854	10" x 14"	B-120
131851	7" x 10"	B-302
131852	10" x 14"	B-302
131849	7" x 10"	B-401
131850	10" x 14"	B-401
131847	7" x 10"	B-555
131848	10" x 14"	B-555



131745	7" x 10"	B-120
131746	10" x 14"	B-120
131743	7" x 10"	B-302
131744	10" x 14"	B-302
131741	7" x 10"	B-401
131742	10" x 14"	B-401
131739	7" x 10"	B-555
131740	10" x 14"	B-555



131830	7" x 10"	B-120
73420	10" x 14"	B-120
84439	7" x 10"	B-302
84440	10" x 14"	B-302
22341	7" x 10"	B-401
22342	10" x 14"	B-401
40905	7" x 10"	B-555
40906	10" x 14"	B-555



131885	7" x 10"	B-120
131886	10" x 14"	B-120
131883	7" x 10"	B-302
131884	10" x 14"	B-302
131881	7" x 10"	B-401
131882	10" x 14"	B-401
131879	7" x 10"	B-555
131880	10" x 14"	B-555



131901	7" x 10"	B-120
131902	10" x 14"	B-120
131899	7" x 10"	B-302
131900	10" x 14"	B-302
131897	7" x 10"	B-401
131898	10" x 14"	B-401
131895	7" x 10"	B-555
131896	10" x 14"	B-555



131893	7" x 10"	B-120
131894	10" x 14"	B-120
131891	7" x 10"	B-302
131892	10" x 14"	B-302
131889	7" x 10"	B-401
131890	10" x 14"	B-401
131887	7" x 10"	B-555
131888	10" x 14"	B-555

Chemical & Hazardous Material DOT Vehicle Placards

Class 2:

60391 10.75" x 10.75" B-101 60407 10.75" x 10.75" B-120 60375 10.75" x 10.75" B-946	60421 10.75" x 10.75" B-120	63439 10.75" x 10.75" B-101	63436 10.75" x 10.75" B-120 63406 10.75" x 10.75" B-946	60428 10.75" x 10.75" B-101 60423 10.75" x 10.75" B-120 60433 10.75" x 10.75" B-946	60434 10.75" x 10.75" B-946

Class 3:

60394 10.75" x 10.75" B-101 60410 10.75" x 10.75" B-120 60379 10.75" x 10.75" B-946	63444 10.75" x 10.75" B-101 63423 10.75" x 10.75" B-120 63410 10.75" x 10.75" B-946	63443 10.75" x 10.75" B-101 63422 10.75" x 10.75" B-120 63409 10.75" x 10.75" B-946	63411 10.75" x 10.75" B-946

Class 4:

60398 10.75" x 10.75" B-101 60414 10.75" x 10.75" B-120 60382 10.75" x 10.75" B-946	60413 10.75" x 10.75" B-120	60412 10.75" x 10.75" B-120 60380 10.75" x 10.75" B-946	63448 10.75" x 10.75" B-101 63414 10.75" x 10.75" B-946	63446 10.75" x 10.75" B-101 63425 10.75" x 10.75" B-120 63412 10.75" x 10.75" B-946	63447 10.75" x 10.75" B-101 63426 10.75" x 10.75" B-120

Class 5:

60383 10.75" x 10.75" B-946	63449 10.75" x 10.75" B-101 63428 10.75" x 10.75" B-120 63415 10.75" x 10.75" B-946	60400 10.75" x 10.75" B-101 60416 10.75" x 10.75" B-120 60384 10.75" x 10.75" B-946	63429 10.75" x 10.75" B-120

Class 6:

60390 10.75" x 10.75" B-946	60402 10.75" x 10.75" B-101	63452 10.75" x 10.75" B-101 63431 10.75" x 10.75" B-120 63418 10.75" x 10.75" B-946	60427 10.75" x 10.75" B-120	60431 10.75" x 10.75" B-101 60426 10.75" x 10.75" B-120 60436 10.75" x 10.75" B-946	60425 10.75" x 10.75" B-101 60435 10.75" x 10.75" B-946

Class 7:

63419 10.75" x 10.75" B-946

Class 8:

60403 10.75" x 10.75" B-101 60419 10.75" x 10.75" B-120 60387 10.75" x 10.75" B-946	63454 10.75" x 10.75" B-101 63433 10.75" x 10.75" B-120 63420 10.75" x 10.75" B-946

Class 9:

60404 10.75" x 10.75" B-101 60388 10.75" x 10.75" B-946	63455 10.75" x 10.75" B-101 63434 10.75" x 10.75" B-120 63421 10.75" x 10.75" B-946

Mixed Loads

63212 10.75" x 10.75" B-101 76259 10.75" x 10.75" B-120 76394 10.75" x 10.75" B-946

Safety Signs

www.BradyID.com/PetroChem

Safety Signs

Confined Space Signs



131685	7" x 10"	B-120
131686	10" x 14"	B-120
131683	7" x 10"	B-302
131684	10" x 14"	B-302
131681	7" x 10"	B-401
131682	10" x 14"	B-401
131679	7" x 10"	B-555
131680	10" x 14"	B-555



131695	7" x 10"	B-120
131696	10" x 14"	B-120
40993	7" x 10"	B-555
40994	10" x 14"	B-555



131693	7" x 10"	B-120
131694	10" x 14"	B-120
131691	7" x 10"	B-302
131692	10" x 14"	B-302
131689	7" x 10"	B-401
131690	10" x 14"	B-401
131687	7" x 10"	B-555
131688	10" x 14"	B-555

Popular Sign Materials

- B-120 - Premium Fiberglass
- B-302 - Self-Sticking Polyester
- B-324 - BradyGlo™ Self-Sticking Polyester
- B-347 - BradyGlo™ Plastic
- B-401 - Plastic
- B-555 - Aluminum

Door Signs



80055	9" x 12"	B-959
75063	5" x 14"	B-120



132115	10" x 14"	B-120
132114	10" x 14"	B-401
132113	10" x 14"	B-555



132124	10" x 14"	B-120
132123	10" x 14"	B-401
132122	10" x 14"	B-555



132130	10" x 14"	B-120
132129	10" x 14"	B-401
132128	10" x 14"	B-555



132106	10" x 14"	B-120
132105	10" x 14"	B-401
132104	10" x 14"	B-555



132118	10" x 14"	B-120
132117	10" x 14"	B-401
132116	10" x 14"	B-555



132121	10" x 14"	B-120
132120	10" x 14"	B-401
132119	10" x 14"	B-555



132109	10" x 14"	B-120
132108	10" x 14"	B-401
132107	10" x 14"	B-555



132112	10" x 14"	B-120
132111	10" x 14"	B-401
132110	10" x 14"	B-555



132127	10" x 14"	B-120
132126	10" x 14"	B-401
132125	10" x 14"	B-555



132103	10" x 14"	B-120
75198	14" x 20"	B-120
25870	10" x 14"	B-401
43447	10" x 14"	B-555

Electrical Hazard Signs



122864	7" x 10"	B-120
122726	10" x 14"	B-120
84859	7" x 10"	B-302
84860	10" x 14"	B-302
122530	7" x 10"	B-401
122479	10" x 14"	B-401
122421	7" x 10"	B-555
122355	10" x 14"	B-555



131703	7" x 10"	B-120
131704	10" x 14"	B-120
131706	3" x 3"	B-302
131705	3" x 5"	B-302
131701	7" x 10"	B-302
131702	10" x 14"	B-302
131699	7" x 10"	B-401
131700	10" x 14"	B-401
131697	7" x 10"	B-555
131698	10" x 14"	B-555



131713	7" x 10"	B-120
131714	10" x 14"	B-120
131711	7" x 10"	B-302
131712	10" x 14"	B-302
131709	7" x 10"	B-401
131710	10" x 14"	B-401
131707	7" x 10"	B-555
131708	10" x 14"	B-555



69190	10" x 10"	B-120
131729	10" x 14"	B-120
89152	3" x 3"	B-302
89153	3" x 3"	B-302
88497	10" x 10"	B-302
131730	10" x 14"	B-302
25162	10" x 14"	B-401
42739	10" x 14"	B-555



Exit & Evacuation Signs



132200	7" x 10"	B-120
132201	10" x 14"	B-120



132172	7" x 10"	B-120
132173	10" x 14"	B-120
132174	7" x 10"	B-302
132175	10" x 14"	B-302
132168	7" x 10"	B-401
132169	10" x 14"	B-401
132170	7" x 10"	B-555
132171	10" x 14"	B-555



132156	7" x 10"	B-120
132157	10" x 14"	B-120
132158	7" x 10"	B-302
132159	10" x 14"	B-302
132152	7" x 10"	B-401
132153	10" x 14"	B-401
132154	7" x 10"	B-555
132155	10" x 14"	B-555



132164	7" x 10"	B-120
132165	10" x 14"	B-120
132166	7" x 10"	B-302
132167	10" x 14"	B-302
132160	7" x 10"	B-401
132161	10" x 14"	B-401
132162	7" x 10"	B-555
132163	10" x 14"	B-555



132131	7" x 10"	B-120
--------	----------	-------



41046	10" x 14"	B-555
-------	-----------	-------



132180	7" x 10"	B-120
132181	10" x 14"	B-120
132182	7" x 10"	B-302
132183	10" x 14"	B-302
132176	7" x 10"	B-401
132177	10" x 14"	B-401
132178	7" x 10"	B-555
132179	10" x 14"	B-555



47040	7" x 10"	B-120
47288	10" x 14"	B-120
84673	7" x 10"	B-302
84674	10" x 14"	B-302
22489	7" x 10"	B-401
22490	10" x 14"	B-401
41053	7" x 10"	B-555
41054	10" x 14"	B-555



47035	7" x 14"	B-120
76066	10" x 14"	B-120
122636	7" x 10"	B-302
84632	10" x 14"	B-302
22457	7" x 10"	B-401
22458	10" x 14"	B-401
41021	7" x 10"	B-555
41022	10" x 14"	B-555



47034	7" x 14"	B-120
76067	10" x 14"	B-120
122634	7" x 10"	B-302
84630	10" x 14"	B-302
22455	7" x 10"	B-401
22456	10" x 14"	B-401
41019	7" x 10"	B-555
41020	10" x 14"	B-555



71015	7" x 10"	B-120
71016	10" x 14"	B-120
84687	7" x 10"	B-302
84688	10" x 14"	B-302
22501	7" x 10"	B-401
22502	10" x 14"	B-401
41065	7" x 10"	B-555
41066	10" x 14"	B-555



132188	7" x 10"	B-120
132189	10" x 14"	B-120
132190	7" x 10"	B-302
132191	10" x 14"	B-302
132184	7" x 10"	B-401
132185	10" x 14"	B-401
132186	7" x 10"	B-555
132187	10" x 14"	B-555

BradyGlo™ Exit Signs

- Made of B-324 photoluminescent self-sticking polyester or B-347 photoluminescent plastic
- Compliant with UL/ULC 924 and NFPA Life Safety Code 101
- Non-electric, non-toxic, non-radioactive
- 100% reliable and maintenance free. Lasts for 25 years!



80207	3-1/2" x 10"	B-324
80208	5" x 14"	B-324
80273	3-1/2" x 10"	B-347
80274	5" x 14"	B-347



80211	3-1/2" x 10"	B-324
80212	5" x 14"	B-324
80277	3-1/2" x 10"	B-347
80278	5" x 14"	B-347



80209	3-1/2" x 10"	B-324
80210	5" x 14"	B-324
80275	3-1/2" x 10"	B-347
80276	5" x 14"	B-347



90102	7" x 10"	B-324
90616	10" x 14"	B-324
90944	7" x 10"	B-347
90628	10" x 14"	B-347



73509	7" x 10"	B-324
73510	10" x 14"	B-324
80281	7" x 10"	B-347
80282	10" x 14"	B-347



90492	3-1/2" x 10"	B-324
73545	7" x 10"	B-324
80250	10" x 14"	B-324
85484	7" x 10"	B-347
85523	10" x 14"	B-347



90550	10" x 7"	B-324
90183	14" x 10"	B-324
90714	10" x 7"	B-347
90776	14" x 10"	B-347



IBC/IFC, NYC Compliant BradyGlo™ High Performance Photoluminescent Exit Sign

- Compliant to NFPA Life Safety Code 101 and 2012 IBC regulation and current building codes
- Energy efficient, non-electric, non toxic, non-radioactive and may qualify for LEED credits
- 50ft visibility, 100% reliable and virtually maintenance free
- 3 configurations which can be attached on a surface, ceiling or flag mounted



Frameless BradyGlo™ Exit Signs



Framed Wall Mount Exit Sign

Catalog #	Description	Size	Color
B-347 Frameless Sign			
87807B	B-347 Frameless Sign	8-1/2" x 15"	Red
B-355 Frame Signs			
90885B	B-355 Framed Single Face Sign Wall Mount	8-1/4" x 14-1/4"	Red
90839B	B-355 Framed Single Face Sign w/ Bracket	8-1/4" x 14-1/4"	Red
90840B	B-355 Framed Double Face Sign w/ Bracket	8-1/4" x 14-1/4"	Red

Safety Signs

www.BradyID.com/PetroChem

Safety Signs

Fire Safety Signs



132058	7" x 10"	B-120
69091	10" x 14"	B-120
87776	3-1/2" x 5"	B-302
84720	7" x 10"	B-302
84721	10" x 14"	B-302
132059	7" x 10"	B-401
22530	10" x 14"	B-401
41093	7" x 10"	B-555
41094	10" x 14"	B-555



80161	14" x 10"	B-324
80292	14" x 10"	B-347



122873	7" x 10"	B-120
69071	14" x 10"	B-120
122665	7" x 10"	B-302
86090	14" x 10"	B-302
122538	7" x 10"	B-401
25708	14" x 10"	B-401
122429	7" x 10"	B-555
43285	14" x 10"	B-555
95147	14" x 10"	B-997



90366	14" x 5"	B-302
-------	----------	-------

Popular Sign Materials

- B-120** - Premium Fiberglass
- B-302** - Self-Sticking Polyester
- B-324** - BradyGlo™ Self-Sticking Polyester
- B-347** - BradyGlo™ Plastic
- B-401** - Plastic
- B-555** - Aluminum



V1FL15A 6" x 9" x 4" Acrylic



132148	7" x 10"	B-120
132149	10" x 14"	B-120
132150	7" x 10"	B-302
132151	10" x 14"	B-302
132144	7" x 10"	B-401
132145	10" x 14"	B-401
132146	7" x 10"	B-555
132147	10" x 14"	B-555



132140	7" x 10"	B-120
132141	10" x 14"	B-120
132142	7" x 10"	B-302
132143	10" x 14"	B-302
132136	7" x 10"	B-401
132137	10" x 14"	B-401
132138	7" x 10"	B-555
132139	10" x 14"	B-555



69074	14" x 10"	B-120
86091	14" x 10"	B-302



90369 14" x 28" B-302

When wrapped around columns the word "Fire Extinguisher" is repeated 4 times. Or cut into four 14" x 7" single signs.



47039	14" x 3-1/2"	B-120
71655	24" x 4"	B-120
85261	14" x 3-1/2"	B-302
90367	14" x 5"	B-302



V1FE15A 6" x 8" x 4" Acrylic



90384 14" x 10" B-302



73483	24" x 4"	B-120
85270	14" x 5"	B-302

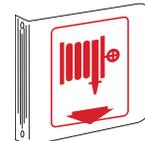

132222 6" x 9" x 4" Acrylic

First Aid & Safety Equipment Signs



132218	7" x 10"	B-120
132219	10" x 14"	B-120
132220	7" x 10"	B-302
132221	10" x 14"	B-302
132214	7" x 10"	B-401
132215	10" x 14"	B-401
132216	7" x 10"	B-555
132217	10" x 14"	B-555



62557	7" x 10"	B-120
122753	10" x 14"	B-120
83935	3-1/2" x 5"	B-302
83760	7" x 10"	B-302
122612	10" x 14"	B-302
21807	7" x 10"	B-401
26582	10" x 14"	B-401
46483	7" x 10"	B-555
46760	10" x 14"	B-555



132227	7" x 10"	B-120
132228	10" x 14"	B-120
132229	7" x 10"	B-302
132230	10" x 14"	B-302
132223	7" x 10"	B-401
132224	10" x 14"	B-401
132225	7" x 10"	B-555
132226	10" x 14"	B-555



83936	3-1/2" x 5"	B-302
83761	7" x 10"	B-302
21808	7" x 10"	B-401
26583	10" x 14"	B-401
46484	7" x 10"	B-555
46761	10" x 14"	B-555



62555	7" x 10"	B-120
62817	10" x 14"	B-120
83933	3-1/2" x 5"	B-302
83758	7" x 10"	B-302
21805	7" x 10"	B-401
26580	10" x 14"	B-401
46481	7" x 10"	B-555
46758	10" x 14"	B-555



132235	7" x 10"	B-120
132236	10" x 14"	B-120
132237	7" x 10"	B-302
132238	10" x 14"	B-302
132231	7" x 10"	B-401
132232	10" x 14"	B-401
132233	7" x 10"	B-555
132234	10" x 14"	B-555



132244	7" x 10"	B-120
132245	10" x 14"	B-120
132246	7" x 10"	B-302
132247	10" x 14"	B-302
132240	7" x 10"	B-401
132241	10" x 14"	B-401
132242	7" x 10"	B-555
132243	10" x 14"	B-555



132239 6" x 9" x 4" Acrylic



V1EW03A 6" x 9" x 4" Acrylic



V1FA03A 6" x 9" x 4" Acrylic



45367 5-1/2" x 10" x 4" B-493



49393 6" x 9" x 4" Acrylic



49393 6" x 9" x 4" Acrylic

Machine & Operational Signs



132082	7" x 10"	B-120
132083	10" x 14"	B-120
132080	7" x 10"	B-302
132081	10" x 14"	B-302
132078	7" x 10"	B-401
132079	10" x 14"	B-401
132076	7" x 10"	B-555
132077	10" x 14"	B-555



132090	7" x 10"	B-120
132091	10" x 14"	B-120
132088	7" x 10"	B-302
132089	10" x 14"	B-302
132086	7" x 10"	B-401
132087	10" x 14"	B-401
132084	7" x 10"	B-555
132085	10" x 14"	B-555



132074	7" x 10"	B-120
132075	10" x 14"	B-120
132072	7" x 10"	B-302
132073	10" x 14"	B-302
132070	7" x 10"	B-401
132071	10" x 14"	B-401
132068	7" x 10"	B-555
132069	10" x 14"	B-555



132066	7" x 10"	B-120
132067	10" x 14"	B-120
132064	7" x 10"	B-302
132065	10" x 14"	B-302
132062	7" x 10"	B-401
132063	10" x 14"	B-401
132060	7" x 10"	B-555
132061	10" x 14"	B-555



122848	7" x 10"	B-120
122718	10" x 14"	B-120
122652	7" x 10"	B-302
122577	10" x 14"	B-302
122521	7" x 10"	B-401
25906	10" x 14"	B-401
122411	7" x 10"	B-555
43483	10" x 14"	B-555



132098	7" x 10"	B-120
132099	10" x 14"	B-120
132096	7" x 10"	B-302
132097	10" x 14"	B-302
132094	7" x 10"	B-401
132095	10" x 14"	B-401
132092	7" x 10"	B-555
132093	10" x 14"	B-555



122816	7" x 10"	B-120
74609	10" x 14"	B-120
87788	3-1/2" x 5"	B-302
88107	7" x 10"	B-302
88108	10" x 14"	B-302
22985	7" x 10"	B-401
22986	10" x 14"	B-401
42508	7" x 10"	B-555
42509	10" x 14"	B-555



131877	7" x 10"	B-120
131878	10" x 14"	B-120
131875	7" x 10"	B-302
131876	10" x 14"	B-302
131873	7" x 10"	B-401
131874	10" x 14"	B-401
131871	7" x 10"	B-555
131872	10" x 14"	B-555



131869	7" x 10"	B-120
131870	10" x 14"	B-120
131867	7" x 10"	B-302
131868	10" x 14"	B-302
131865	7" x 10"	B-401
131866	10" x 14"	B-401
131863	7" x 10"	B-555
131864	10" x 14"	B-555

No Smoking Signs



132003	7" x 10"	B-120
132004	10" x 14"	B-120
132001	7" x 10"	B-302
132002	10" x 14"	B-302
132000	7" x 10"	B-401
25912	10" x 14"	B-401
131999	7" x 10"	B-555
43489	10" x 14"	B-555



131785	7" x 10"	B-120
131786	10" x 14"	B-120
131783	7" x 10"	B-302
131784	10" x 14"	B-302
131781	7" x 10"	B-401
131782	10" x 14"	B-401
131779	7" x 10"	B-555
131780	10" x 14"	B-555



131737	7" x 10"	B-120
131738	10" x 14"	B-120
131735	7" x 10"	B-302
131736	10" x 14"	B-302
131733	7" x 10"	B-401
131734	10" x 14"	B-401
131731	7" x 10"	B-555
131732	10" x 14"	B-555



132011	7" x 10"	B-120
132012	10" x 14"	B-120
132009	7" x 10"	B-302
132010	10" x 14"	B-302
132007	7" x 10"	B-401
132008	10" x 14"	B-401
132005	7" x 10"	B-555
132006	10" x 14"	B-555



72293	10" x 7"	B-120
73486	14" x 10"	B-120
72295	20" x 14"	B-120
87795	3-1/2" x 5"	B-302
88427	7" x 10"	B-302
88428	14" x 10"	B-302
25119	10" x 7"	B-401
25120	14" x 10"	B-401
42696	10" x 7"	B-555
42697	14" x 10"	B-555

Personal Protection Signs



131949	7" x 10"	B-120
131950	10" x 14"	B-120
131947	7" x 10"	B-302
131948	10" x 14"	B-302
131945	7" x 10"	B-401
131946	10" x 14"	B-401
131943	7" x 10"	B-555
131944	10" x 14"	B-555



122900	7" x 10"	B-120
122762	10" x 14"	B-120
122692	7" x 10"	B-302
122616	10" x 14"	B-302
122557	7" x 10"	B-401
25892	10" x 14"	B-401
122449	7" x 10"	B-555
43469	10" x 14"	B-555



131941	7" x 10"	B-120
131942	10" x 14"	B-120
131939	7" x 10"	B-302
131940	10" x 14"	B-302
131937	7" x 10"	B-401
131938	10" x 14"	B-401
131935	7" x 10"	B-555
131936	10" x 14"	B-555



131933	7" x 10"	B-120
131934	10" x 14"	B-120
131931	7" x 10"	B-302
131932	10" x 14"	B-302
131929	7" x 10"	B-401
131930	10" x 14"	B-401
131927	7" x 10"	B-555
131928	10" x 14"	B-555



131925	7" x 10"	B-120
131926	10" x 14"	B-120
131923	7" x 10"	B-302
131924	10" x 14"	B-302
131922	7" x 10"	B-401
25893	10" x 14"	B-401
131921	7" x 10"	B-555
43470	10" x 14"	B-555



131913	7" x 10"	B-120
131914	10" x 14"	B-120
131911	7" x 10"	B-302
131912	10" x 14"	B-302
131910	7" x 10"	B-401
25894	10" x 14"	B-401
131909	7" x 10"	B-555
43471	10" x 14"	B-555



131966	10" x 14"	B-120
131965	10" x 14"	B-302
131964	10" x 14"	B-401
131963	10" x 14"	B-555



131974	10" x 14"	B-120
131973	10" x 14"	B-302
131972	10" x 14"	B-401
131971	10" x 14"	B-555



131970	10" x 14"	B-120
131969	10" x 14"	B-302
131968	10" x 14"	B-401
131967	10" x 14"	B-555



131986	10" x 14"	B-120
131989	10" x 14"	B-302
131984	10" x 14"	B-401
131983	10" x 14"	B-555

Safety Signs

www.BradyID.com/PetroChem

Safety Signs

Personal Protection Signs



131982	10" x 14"	B-120
131981	10" x 14"	B-302
131980	10" x 14"	B-401
131979	10" x 14"	B-555



131962	10" x 14"	B-120
131961	10" x 14"	B-302
131960	10" x 14"	B-401
131959	10" x 14"	B-555



131978	10" x 14"	B-120
131977	10" x 14"	B-302
131976	10" x 14"	B-401
131975	10" x 14"	B-555



131957	7" x 10"	B-120
131958	10" x 14"	B-120
131955	7" x 10"	B-302
131956	10" x 14"	B-302
131953	7" x 10"	B-401
131954	10" x 14"	B-401
131951	7" x 10"	B-555
131952	10" x 14"	B-555



131919	7" x 10"	B-120
131920	10" x 14"	B-120
131917	7" x 10"	B-302
131918	10" x 14"	B-302
131916	7" x 10"	B-401
25895	10" x 14"	B-401
131915	7" x 10"	B-555
43472	10" x 14"	B-555

Popular Sign Materials

- B-120 - Premium Fiberglass
- B-302 - Self-Sticking Polyester
- B-324 - BradyGlo™ Self-Sticking Polyester
- B-347 - BradyGlo™ Plastic
- B-401 - Plastic
- B-555 - Aluminum

Restroom Signs



132100	10" x 7"	B-120
47668	7" x 10"	B-302
47670	7" x 10"	B-401
47671	7" x 10"	B-555



132101	10" x 7"	B-120
47674	7" x 10"	B-302
47676	7" x 10"	B-401
47677	7" x 10"	B-555



70426	4" x 12"	B-120
-------	----------	-------



70593	4" x 12"	B-120
-------	----------	-------

Security Signs



132047	7" x 10"	B-120
132048	10" x 14"	B-120
132045	7" x 10"	B-302
132046	10" x 14"	B-302
132043	7" x 10"	B-401
132044	10" x 14"	B-401
132041	7" x 10"	B-555
132042	10" x 14"	B-555



122866	7" x 10"	B-120
122728	10" x 14"	B-120
122659	7" x 10"	B-302
122582	10" x 14"	B-302
122532	7" x 10"	B-401
122480	10" x 14"	B-401
95481	14" x 20"	B-401
122423	7" x 10"	B-555
122357	10" x 14"	B-555



122886	7" x 10"	B-120
122746	10" x 14"	B-120
122682	7" x 10"	B-302
122604	10" x 14"	B-302
122550	7" x 10"	B-401
122486	10" x 14"	B-401
95491	14" x 20"	B-401
122441	7" x 10"	B-555
122372	10" x 14"	B-555



122888	7" x 10"	B-120
122748	10" x 14"	B-120
122684	7" x 10"	B-302
122606	10" x 14"	B-302
122552	7" x 10"	B-401
122487	10" x 14"	B-401
95494	14" x 20"	B-401
122443	7" x 10"	B-555
122374	10" x 14"	B-555



122867	7" x 10"	B-120
122729	10" x 14"	B-120
122660	7" x 10"	B-302
122583	10" x 14"	B-302
122533	7" x 10"	B-401
95411	10" x 14"	B-401
122424	7" x 10"	B-555
122358	10" x 14"	B-555



122877	7" x 10"	B-120
122738	10" x 14"	B-120
122673	7" x 10"	B-302
122596	10" x 14"	B-302
122542	7" x 10"	B-401
95503	10" x 14"	B-401
122433	7" x 10"	B-555
122365	10" x 14"	B-555



132039	7" x 10"	B-120
132040	10" x 14"	B-120
132037	7" x 10"	B-302
132038	10" x 14"	B-302
132036	7" x 10"	B-401
132034	7" x 10"	B-555
132035	10" x 14"	B-555



122880	7" x 10"	B-120
122741	10" x 14"	B-120
122676	7" x 10"	B-302
122599	10" x 14"	B-302
122545	7" x 10"	B-401
95415	10" x 14"	B-401
122436	7" x 10"	B-555
122368	10" x 14"	B-555



132055	7" x 10"	B-120
132056	10" x 14"	B-120
132053	7" x 10"	B-302
132054	10" x 14"	B-302
132051	7" x 10"	B-401
132052	10" x 14"	B-401
132049	7" x 10"	B-555
132050	10" x 14"	B-555



123482	24" x 36"	B-302
123481	24" x 36"	B-401
123480	10" x 7"	B-555



122878	7" x 10"	B-120
122739	10" x 14"	B-120
122674	7" x 10"	B-302
122597	10" x 14"	B-302
122543	7" x 10"	B-401
95502	10" x 14"	B-401
122434	7" x 10"	B-555
122366	10" x 14"	B-555

103644 30" x 24" Steel

132451 30" x 24" Steel

132449 30" x 24" Steel

Traffic Control Signs



69562 7" x 17" B-120



94225 24" x 24" B-959



94234 24" x 24" B-959
94235 30" x 30" B-959



75094 24" x 24" B-120
75093 30" x 30" B-120
80076 24" x 24" B-959
94150 30" x 30" B-959



High intensity reflective aluminum
95041 30" x 30"



94181 18" x 18" B-959



75113 18" x 18" B-120
94185 18" x 18" B-959



75140 18" x 12" B-120
94116 18" x 12" B-959
94117 24" x 18" B-959



91336 18" x 12" B-120
91362 18" x 12" B-959



94307 30" x 30" B-959



80099 24" x 24" B-959



75203 24" x 18" B-120
94209 24" x 18" B-959



76088 24" x 18" B-120
94213 24" x 18" B-959



75201 24" x 18" B-120
94212 24" x 18" B-959



75200 24" x 18" B-120
94211 24" x 18" B-959



75199 24" x 18" B-120
94210 24" x 18" B-959



75205 18" x 18" B-120
75206 24" x 24" B-120
75207 30" x 30" B-120
94142 18" x 18" B-959
94143 24" x 24" B-959
94144 30" x 30" B-959
94145 36" x 36" B-959



80078 18" x 12" B-959



75062 30" B-120
80071 18" B-959
94148 22" x 22" B-959
80072 30" B-959



High intensity reflective aluminum
95039 30" x 30"
95042 36" x 36"



Custom Safety and Traffic Signs Online



Customize in minutes!
No setup charges!
Ships in 24-48 hours!

Create your own custom safety and traffic signs online!

Brady's custom sign applications make it easy to design and order signs to your exact specifications. Pre-formatted templates and drop-down menus simplify the design process, allowing you to create signs in just seconds!

- 8 sizes; up to 24" x 36"
- 5 materials; including fiberglass, aluminum and self-sticking polyester
- OSHA- or ANSI- compatible formats
- Sign headers in multiple languages
- Hundreds of symbols and pictograms

Start creating your custom signs at www.BradyID.com/customsigns/

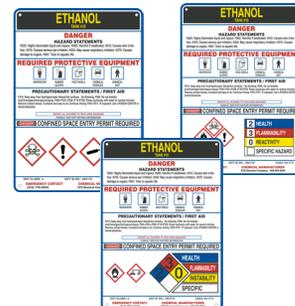

Also Available:
Custom Tank and Vessel Signs

View page 49 for more information or to order.

Safety Signs

www.BradyID.com/PetroChem

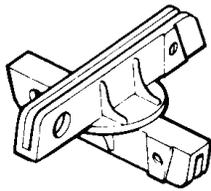

Street Sign 4-Way Cross Piece

- Mount on top of another street sign for additional sign

Catalog #	Description
56681	4-Way Cross Piece



Closed Profile



Open Profile

Tuff-N-Light U-Channel Post

- Ideal for traffic and industrial signage
- Closed profile posts are 6 times torsionally stronger than steel posts
- Open profile for up to 12"x18" signs

Catalog #	Description	Size	Color
97208	Closed profile	8'	White
97210	Closed profile	8'	Green
97207	Open profile	8'	White
97209	Open profile	8'	Green



Mounting Tape

- Indoor/Outdoor B-156 double-faced foam tape
- Bonds well to rough, irregular surfaces
- Service range: 50°F to 180°F
- Roll mounted 1/16" thick foam tape

Catalog #	Description	Size
78273	Mounting Tape	3/4" x 36 yds.
19811	Mounting Tape	1" x 36 yds.

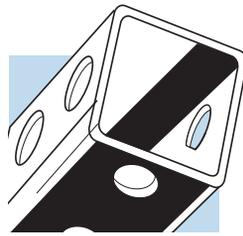

Galvanized Posts

- Galvanized steel posts are manufactured of a high tensile steel and finished with uniform coatings of zinc and clear acrylic to resist corrosion
- Posts have 7/6" diameter holes on 1" centers that run the full length of the post on all four sides.

Catalog #	Description	Size
78998	Square Post	14 gauge, 2" x 2" tube size, 8' Length



Movable Sign Posts

- 35 pound cast iron base with 1-1/2" diameter post
- Post is pre-drilled for signs that are 18"x18", 24"x18", or 24"x24"

Catalog #	Description
86336	14" iron sign base and 48" post kit black
86345	17" iron sign base and 48" post kit black



Vandal-Proof Tufnut™

- Plated steel nut secures tightly to prevent sign theft
- 5/16" nut for use with U-Channel Sign Posts (sold above)

Catalog #	Description
97211	2 Bolts, 2 Washers, 3 Tufnuts™



U-Channel Sign Posts

- Baked green enamel finish on hot-rolled, high-tensile strength steel
- Weight: two pounds per linear foot
- 3/8" holes, 1" on center
- Hardware sold separately below

Catalog #	Description	Size
95047	U-Channel Sign Post	6'
97204	U-Channel Sign Post	8'
97205	U-Channel Sign Post	10'
97206	U-Channel Sign Post	12'
87982	Post Driver	-



Sign Base

- Securely mounts with three expansion bolts and accepts U-channel Posts
- Cast aluminum base is 15" in diameter and includes post mount stub and hardware

Catalog #	Description
86339	15" Diameter, Cast Aluminum



Fence Sign Support Brackets

- Easily attaches signs to fences
- Brackets are constructed of 14 gauge steel with a green baked enamel finish
- 17" bracket fits signs 18"x12" or 18"x18"

Catalog #	Description
86337	17" Bracket w/ hardware

ASME (ANSI) Standard A13.1-2007

The ASME (ANSI) Standard for pipe identification is a widely used guideline in determining pipe identification requirements. The purpose of the standard is to:

- “assist in identification of hazardous materials conveyed in piping systems and their hazards when released into the environment.”
- “Pipes are defined as conduits for the transport of gases, liquids, semi-liquids or fine particulate dust.”

Brady Pipe Marking Systems Meet the ASME (ANSI) A13.1-2007 Standard

The Brady Pipe Marking System instantly tells you all you need to know... pipe contents...direction of flow...whether hazardous or safe.

Brady Pipe Marking Systems Meet the ASME (ANSI) Size Recommendations

The A13.1-2007 standard also makes recommendations as to the size of letter height and length of color field for various pipe diameters. These recommendations are shown in the table.

Outside Diameter of Pipe or Covering	Length of Color Field	Size of Letters
3/4" to 1-1/4"	5"	1/2"
1-1/2" to 2"	8"	3/4"
2 1/2" to 6"	12"	1-1/4"
8" to 10"	24"	2-1/2"
Over 10"	32"	3-1/2"

NOTE: For pipes less than 3/4" in diameter, a permanently legible tag is recommended.

Brady Pipe Marking Systems Meet ASME (ANSI) Color Recommendations

Unmarked pipes mean danger – to both life and property. Numerous injuries have occurred through ignorance of pipe contents, particularly when outside agencies are called in under emergency conditions.

Pipe Classification	Color Scheme
Fire Quenching Fluids	White On Red
Toxic & Corrosive Fluids	Black On Orange
Flammable Fluids	Black On Yellow
Combustible Fluids	White On Brown
Potable, Cooling, Boiler Feed, and Other Water	White On Green
Compressed Air	White On Blue

NOTE: White on brown available upon request.

Brady Pipe Marking Systems Meet the ASME (ANSI) A13.1-2007 Standard

Visibility “Markers shall be located so that they are readily visible to plant personnel from the point of normal approach.” Brady Pipe Markers instantly tell you all you need to know about pipe contents, direction of flow and whether hazardous or safe.

Brady Recommendations for Marker Placement:

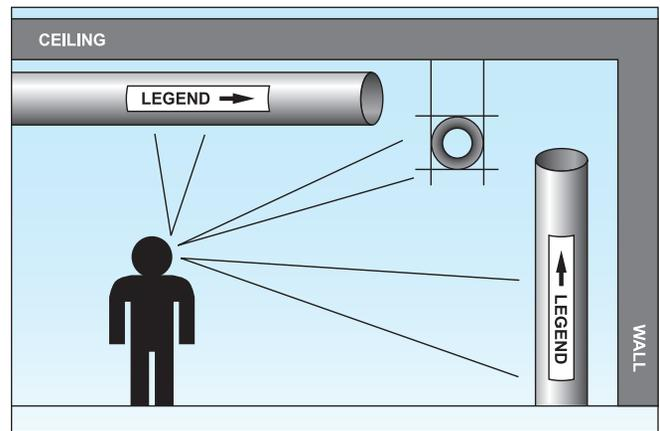
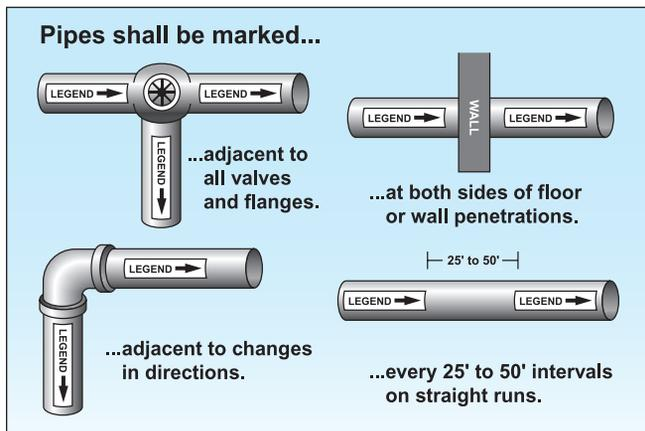

Pipe Markers

www.BradyID.com/PetroChem

Pipe Marker Material Descriptions

Characteristic	HARSH ENVIRONMENT Mechanically Applied		General Purpose		
	B-689 Wrap-Around Polyester	B-681/B-883 High Performance High Visibility	Mechanically Applied B-915 BradySnap-On™ and Strap-On Vinyl	Self-Sticking B-946 Self-Sticking Vinyl	Self-Sticking B-736 Self-Sticking Plastic Film
Plant Environment					
Indoor	Good	Good	Good	Good	Good
Avg. Outdoor Durability (yrs.)	5-8	5-8	5-8	3-5	2-3
Surface Abrasion Resistance	Good	Good	NR	NR	NR
Temperatures					
Min. Installation Temperature	40°F, 5°C	—	—	0°F, -18°C	50°F, 10°C
Upper Temperature Limit	248°F, 120°C	230°F, 110°C	180°F, 82°C	180°F, 82°C	212°F, 100°C
Lower Temperature Limit	-40°F, -40°C	-40°F, -40°C	-40°F, -40°C	-40°F, -40°C	-40°F, -40°C
Pipe Surface					
Dirty, Dusty	Good	Good	Good	NR	NR
Rough	Good	Good	Good	Good	NR
Insulated	Good	Good	Good	Good	Good
Wet	Good	Good	Good	NR	NR
Greasy, Oily	Good	Good	Good	NR	NR
Chemical Resistance					
Organic Solvents (MEK, Acetone, Toluene)	NR	NR	NR	NR	NR
Acids (Sulfuric, HCL, Acetic)	Good	Good	NR	NR	Good
Alkalis (Sodium Hydroxide)	Good	Good	NR	NR	NR
Alcohols (Methanol, Isopropanol)	Good	Good	Good	Good	Good
Grease/Oils (SAE 20, ASTM #3)	Good	Good	Good	Good	Good
Special Properties					
Low PVC - Pipe contact point	Yes	Yes	No	No	No
Low PVC - Whole marker	No	Yes	No	No	No
Low Halogen - Pipe contact point	Yes	Yes	No	No	No
Low Halogen - Whole marker	No	Yes	No	No	No
Meets ASME (ANSI) A13.1	Yes	Yes	Yes	Yes	Yes

n/a = data not available NR = marker not recommended for environment listed Good = marker suitable for environment listed

Self-Sticking Pipe Markers



Self-Sticking Vinyl Pipe Markers

Factory applied industrial grade adhesives simplify marker installation. Simply peel the release coated paper backing from the marker and press the marker in place. Banding each end of the marker with Arrow Tape is recommended to indicate contents flow direction and to secure markers to the pipe.

- **B-946 Self-Sticking Vinyl**
A premium indoor/outdoor grade self-sticking marker product.

Mechanically Applied Pipe Markers



BradySnap-On™ and Strap-On Vinyl

Unlike installing self-sticking markers, there's no need to clean pipe surfaces. Installation time is reduced. Markers are simply snapped, strapped or wrapped in place.

- **B-915 BradySnap-On™ and Strap-On Vinyl**

A mechanically applied, surface printed vinyl pipe marker. Snap-ons are used for pipes less than 6" outside diameter. Strap-ons are designed for pipes from 6" and greater

High Performance Pipe Markers

Brady High Performance Markers are designed for use in harsh environments where there's significant exposure to sunlight, heat, and/or chemicals.

- **B-689 High Performance Polyester**

PVF overlaminated polyester with sealed-in graphics. Markers are resistant to abrasion, chemicals, high humidity, and outdoor weathering. Supplied precooled for easy wrap-around installation on pipes up to 7-7/8" in diameter

- **B-681/B-883 High Performance High Visibility**

B-681 labels are factory applied to our B-883 FRP carrier. Directional arrows are applied by the installer. Markers are fastened to the pipe with Stainless Steel Strapping, sold separately

B-689 High Performance Markers

- PVF overlaminated polyester construction seals in and protects graphics
- Markers resist abrasion, chemicals, high humidity and outdoor weathering
- Pre-coiled for easy wrap-around installation on pipe up to 7-7/8" dia.



B-681/B-883 High Performance, High Visibility (HPHV) Markers

- Ideal for 8" dia. pipes & larger
- Overlaminated graphics are factory applied to a fiberglass plastic carrier
- Includes 2 Heavy-Duty Mounting Clips that apply to pipe using Continuous Stainless Steel Strapping (sold separately)



High Performance Pipe Markers Style and Size Chart

Style Code	Outside Dia.	Letter Height	Max Char.
Style: 0	1/2" to 1-3/8"	1/2"	22
Style: I	1-1/2" to 2-3/8"	3/4"	13
Style: II	2-1/2" to 7-7/8"	1-1/4"	13

HPHV Pipe Markers Style and Size Chart

Style Code	Outside Dia.	Letter Height	Max Char.
Style: HPHV	8" or larger	3-1/2"	16

High Performance Pipe Marker Legends

Legend	Bkgd Color	Style 0	Style I	Style II	Style HPHV
(BLANK LABEL)	Blue	5600-O	5600-I	5600-II	5600-HPHV
(BLANK LABEL)	Green	5601-O	5601-I	5601-II	5601-HPHV
(BLANK LABEL)	Red	5602-O	5602-I	5602-II	5602-HPHV
(BLANK LABEL)	Yellow	5603-O	5603-I	5603-II	5603-HPHV
60# STEAM	Yellow	5609-O	5609-I	5609-II	5609-HPHV
150# STEAM	Yellow	5614-O	5614-I	5614-II	5614-HPHV
AIR	Blue	5625-O	5625-I	5625-II	5625-HPHV
anhydrous ammonia	Yellow	5631-O	5631-I	5631-II	5631-HPHV
BLACK LIQUOR	Yellow	5634-O	5634-I	5634-II	5634-HPHV
BOILER BLOWDOWN	Yellow	5636-O	5636-I	5636-II	5636-HPHV
BOILER FEED WATER	Yellow	5637-O	5637-I	5637-II	5637-HPHV
BOP CONTROL	Yellow	-	-	131058	-
CAUSTIC	Yellow	5643-O	5643-I	5643-II	5643-HPHV
CHEMICAL FEED	Yellow	5645-O	5645-I	5645-II	5645-HPHV
CHILLED WATER	Green	5646-O	5646-I	5646-II	5646-HPHV
CHILLED WATER RETURN	Green	5647-O	5647-I	5647-II	5647-HPHV
CHILLED WATER SUPPLY	Green	5648-O	5648-I	5648-II	5648-HPHV
CITY WATER	Green	5655-O	5655-I	5655-II	5655-HPHV
COMPRESSED AIR	Blue	5660-O	5660-I	5660-II	5660-HPHV
COMPRESSED AIR	Yellow	5661-O	5661-I	5661-II	5661-HPHV
CONDENSATE	Yellow	5662-O	5662-I	5662-II	5662-HPHV
CONDENSATE DRAIN	Green	5663-O	5663-I	5663-II	5663-HPHV
CONDENSATE RETURN	Yellow	5664-O	5664-I	5664-II	5664-HPHV
CONDENSER WATER RETURN	Green	5665-O	5665-I	5665-II	5665-HPHV
COOLING WATER	Green	5668-O	5668-I	5668-II	5668-HPHV
DEMIN. WATER	Green	5672-O	5672-I	5672-II	5672-HPHV
DRILLING MUD	Yellow	-	-	131057	-
DOMESTIC COLD WATER	Green	5673-O	5673-I	5673-II	5673-HPHV
DOMESTIC HOT WATER	Yellow	5675-O	5675-I	5675-II	5675-HPHV
DOMESTIC HOT WATER RETURN	Yellow	5676-O	5676-I	5676-II	5676-HPHV
DRAIN	Green	5678-O	5678-I	5678-II	5678-HPHV
DRAIN	Yellow	5679-O	5679-I	5679-II	5679-HPHV
FIRE PROTECTION	Red	5688-O	5688-I	5688-II	5688-HPHV
FIRE PROTECTION WATER	Red	5689-O	5689-I	5689-II	5689-HPHV
FLOOR DRAIN	Yellow	5690-O	5690-I	5690-II	5690-HPHV
FOUL CONDENSATE	Yellow	5691-O	5691-I	5691-II	5691-HPHV
#6 FUEL OIL	Yellow	5694-O	5694-I	5694-II	5694-HPHV
FUEL OIL	Yellow	5695-O	5695-I	5695-II	5695-HPHV
FUEL OIL RETURN	Yellow	5696-O	5696-I	5696-II	5696-HPHV
FUEL OIL SUPPLY	Yellow	5697-O	5697-I	5697-II	5697-HPHV
GAS - AIR	Yellow	-	-	131060	-
GAS - MIST	Yellow	-	-	131061	-
GREEN LIQUOR	Yellow	5699-O	5699-I	5699-II	5699-HPHV

Legend	Bkgd Color	Style 0	Style I	Style II	Style HPHV
HEATING SUPPLY	Yellow	5701-O	5701-I	5701-II	5701-HPHV
HEATING WATER RETURN	Yellow	5702-O	5702-I	5702-II	5702-HPHV
HEATING WATER SUPPLY	Yellow	5703-O	5703-I	5703-II	5703-HPHV
HIGH PRESSURE STEAM	Yellow	5706-O	5706-I	5706-II	5706-HPHV
HOT OIL	Yellow	-	-	131059	-
HOT WATER	Yellow	5707-O	5707-I	5707-II	5707-HPHV
HYDRAULIC OIL	Yellow	5711-O	5711-I	5711-II	5711-HPHV
INSTRUMENT AIR	Blue	5716-O	5716-I	5716-II	5716-HPHV
LOW PRESSURE CONDENSATE	Yellow	5719-O	5719-I	5719-II	5719-HPHV
LOW PRESSURE STEAM	Yellow	5720-O	5720-I	5720-II	5720-HPHV
MAKE-UP WATER	Green	5722-O	5722-I	5722-II	5722-HPHV
MEDIUM PRESSURE STEAM	Yellow	5723-O	5723-I	5723-II	5723-HPHV
MILL AIR	Blue	5724-O	5724-I	5724-II	5724-HPHV
MILL WATER	Green	5725-O	5725-I	5725-II	5725-HPHV
NATURAL GAS	Yellow	5726-O	5726-I	5726-II	5726-HPHV
NITRIC ACID	Yellow	5727-O	5727-I	5727-II	5727-HPHV
NITROGEN	Green	5728-O	5728-I	5728-II	5728-HPHV
NITROGEN	Yellow	5729-O	5729-I	5729-II	5729-HPHV
NON-POTABLE WATER	Yellow	5730-O	5730-I	5730-II	5730-HPHV
OXYGEN	Yellow	5736-O	5736-I	5736-II	5736-HPHV
PLANT AIR	Yellow	5738-O	5738-I	5738-II	5738-HPHV
PLANT WATER	Green	5739-O	5739-I	5739-II	5739-HPHV
POTABLE WATER	Green	5744-O	5744-I	5744-II	5744-HPHV
PROCESS WATER	Yellow	5746-O	5746-I	5746-II	5746-HPHV
PROCESS WATER	Green	5747-O	5747-I	5747-II	5747-HPHV
RAW WATER	Green	5750-O	5750-I	5750-II	5750-HPHV
ROOF DRAIN	Green	5754-O	5754-I	5754-II	5754-HPHV
SANITARY SEWER	Yellow	5755-O	5755-I	5755-II	5755-HPHV
SEAL WATER	Green	5758-O	5758-I	5758-II	5758-HPHV
SODIUM HYPOCHLORITE	Yellow	5761-O	5761-I	5761-II	5761-HPHV
SPRINKLER WATER	Red	5765-O	5765-I	5765-II	5765-HPHV
STEAM	Yellow	5767-O	5767-I	5767-II	5767-HPHV
STORM DRAIN	Green	5769-O	5769-I	5769-II	5769-HPHV
SULFURIC ACID	Yellow	5774-O	5774-I	5774-II	5774-HPHV
TURPENTINE	Yellow	5776-O	5776-I	5776-II	5776-HPHV
VACUUM	Green	5777-O	5777-I	5777-II	5777-HPHV
VENT	Green	5780-O	5780-I	5780-II	5780-HPHV
VENT	Yellow	5781-O	5781-I	5781-II	5781-HPHV
WARM MILL WATER	Green	5782-O	5782-I	5782-II	5782-HPHV
WASTE WATER	Yellow	5784-O	5784-I	5784-II	5784-HPHV
WATER	Green	5786-O	5786-I	5786-II	5786-HPHV
WATER	Yellow	5787-O	5787-I	5787-II	5787-HPHV
Well Water	Green	5790-O	5790-I	5790-II	5790-HPHV



OSHA Federal Regulation 29 CFR 1910.261

"Pulp, Paper and Paperboard Mills" - This regulation applies to plants where pulp, paper and paperboard are converted.
 "All chlorine, caustic and acid lines shall be marked for positive identification in accordance with ASME (ANSI) Standard A13.1.

Pipe Markers

www.BradyID.com/PetroChem



B-946 Self-Sticking Vinyl Pipe Markers

- Markers meet the requirements of the ASME (ANSI) A13.1 Standard for the identification of piping system contents when used with Directional Flow Arrow Tape
- Durable B-946 material ideal for indoor and outdoor environments
- Supplied on a coated backing material that makes handling and installation easy
- Recommended to use Directional Flow Arrow Tape to indicate flow direction

Style and Size Chart

Style Code	Outside Diameter	Letter Height	Style Description	Style Example
Style: 1HV	8" or greater	3-1/2"	One 4" x 24" marker per card	HEATING RETURN
Style: 1	2-1/2" to 7-7/8"	2"	One 2-1/4" x 14" marker per card	HEATING RETURN
Style: 3C	less than 3/4"	1/2"	Three 2-1/4" x 2-3/4" markers per card plus 8 strips of Arrow Tape	
Style: 4	3/4" to 2-3/8"	3/4"	Four 1-1/8" x 7" markers per card	FIRE AUTO SPRINKLERS FIRE AUTO SPRINKLERS FIRE AUTO SPRINKLERS FIRE AUTO SPRINKLERS

High Performance Pipe Marker Legends

Legend	Bkgd Color	Style 1	Style 1HV	Style 3C	Style 4
(BLANK)	Yellow	7025-1	7025-1HV	7025-3C	7025-4
AIR	Yellow	7005-1	7005-1HV	7005-3C	7005-4
AIR	Blue	7006-1	7006-1HV	7006-3C	7006-4
AIR	Green	7007-1	7007-1HV	7007-3C	7007-4
AIR SUPPLY	Blue	7010-1	7010-1HV	7010-3C	7010-4
AMMONIA	Yellow	7014-1	7014-1HV	7014-3C	7014-4
ARGON	Green	7015-1	7015-1HV	7015-3C	7015-4
ASBESTOS FREE	Blue	7017-1	7017-1HV	7017-3C	7017-4
ASBESTOS FREE INSULATION	Blue	7018-1	7018-1HV	7018-3C	7018-4
ASBESTOS INSULATION	Yellow	7019-1	7019-1HV	7019-3C	7019-4
BOP CONTROL	Yellow	131048	-	-	131053
CHILLED WATER RETURN	Green	7046-1	7046-1HV	7046-3C	7046-4
CHILLED WATER SUPPLY	Green	7047-1	7047-1HV	7047-3C	7047-4
CITY WATER	Green	7054-1	7054-1HV	7054-3C	7054-4
COLD WATER	Green	7055-1	7055-1HV	7055-3C	7055-4
COMPRESSED AIR	Yellow	7058-1	7058-1HV	7058-3C	7058-4
COMPRESSED AIR	Green	7059-1	7059-1HV	7059-3C	7059-4
COMPRESSED AIR	Blue	7060-1	7060-1HV	7060-3C	7060-4
CONDENSATE	Yellow	7061-1	7061-1HV	7061-3C	7061-4
CONDENSATE DRAIN	Yellow	7062-1	7062-1HV	7062-3C	7062-4
CONDENSATE DRAIN	Green	7063-1	7063-1HV	7063-3C	7063-4
CONDENSATE RETURN	Yellow	7065-1	7065-1HV	7065-3C	7065-4
CONDENSER WATER	Green	7067-1	7067-1HV	7067-3C	7067-4
CONDENSER WATER RETURN	Green	7068-1	7068-1HV	7068-3C	7068-4
CONDENSER WATER SUPPLY	Green	7069-1	7069-1HV	7069-3C	7069-4
COOLING WATER	Green	7070-1	7070-1HV	7070-3C	7070-4
COOLING WATER RETURN	Green	7071-1	7071-1HV	7071-3C	7071-4
DEIONIZED WATER	Green	7073-1	7073-1HV	7073-3C	7073-4
DOMESTIC COLD WATER	Green	7084-1	7084-1HV	7084-3C	7084-4
DOMESTIC COLD WATER SUPPLY	Green	7086-1	7086-1HV	7086-3C	7086-4
DOMESTIC HOT WATER	Yellow	7087-1	7087-1HV	7087-3C	7087-4
DOMESTIC HOT WATER RETURN	Yellow	7088-1	7088-1HV	7088-3C	7088-4
DOMESTIC HOT WATER SUPPLY	Yellow	7089-1	7089-1HV	7089-3C	7089-4
DRAIN	Green	7090-1	7090-1HV	7090-3C	7090-4
DRILLING MUD	Yellow	131047	-	-	131052
FIRE AUTO SPRINKLERS	Red	7107-1	7107-1HV	7107-3C	7107-4
FIRE PROTECTION WATER	Red	7110-1	7110-1HV	7110-3C	7110-4
FUEL OIL	Yellow	7115-1	7115-1HV	7115-3C	7115-4
GAS	Yellow	7119-1	7119-1HV	7119-3C	7119-4
GAS - AIR	Yellow	131050	-	-	131055
GAS - MIST	Yellow	131051	-	-	131056
GLYCOL	Yellow	7121-1	7121-1HV	7121-3C	7121-4
GLYCOL RETURN	Yellow	7122-1	7122-1HV	7122-3C	7122-4
GLYCOL SUPPLY	Yellow	7123-1	7123-1HV	7123-3C	7123-4
HEATING RETURN	Yellow	7125-1	7125-1HV	7125-3C	7125-4
HEATING SUPPLY	Yellow	7127-1	7127-1HV	7127-3C	7127-4
HEATING WATER	Yellow	7128-1	7128-1HV	7128-3C	7128-4
HEATING WATER RETURN	Yellow	7129-1	7129-1HV	7129-3C	7129-4
HEATING WATER SUPPLY	Yellow	7130-1	7130-1HV	7130-3C	7130-4
HIGH PRESSURE CONDENSATE	Yellow	7137-1	7137-1HV	7137-3C	7137-4

Legend	Bkgd Color	Style 1	Style 1HV	Style 3C	Style 4
HOT OIL	Yellow	131049	-	-	131054
HOT WATER	Yellow	7146-1	7146-1HV	7146-3C	7146-4
HOT WATER RECIRCULATION	Yellow	7147-1	7147-1HV	7147-3C	7147-4
HOT WATER RETURN	Yellow	7148-1	7148-1HV	7148-3C	7148-4
HOT WATER SUPPLY	Yellow	7149-1	7149-1HV	7149-3C	7149-4
HYDRAULIC OIL	Yellow	8790-1	8790-1HV	8790-3C	8790-4
INDUSTRIAL WATER	Green	7163-1	7163-1HV	7163-3C	7163-4
LOW PRESSURE CONDENSATE	Yellow	7175-1	7175-1HV	7175-3C	7175-4
LOW PRESSURE GAS	Yellow	7176-1	7176-1HV	7176-3C	7176-4
MEDICAL AIR	Yellow	7184-1	7184-1HV	7184-3C	7184-4
MEDICAL VACUUM	White	7186-1	7186-1HV	7186-3C	7186-4
MEDIUM PRESSURE NATURAL GAS	Yellow	7190-1	7190-1HV	7190-3C	7190-4
NATURAL GAS	Yellow	7196-1	7196-1HV	7196-3C	7196-4
NITROGEN	Green	7198-1	7198-1HV	7198-3C	7198-4
NITROGEN	Blue	7200-1	7200-1HV	7200-3C	7200-4
NON-POTABLE WATER	Yellow	7203-1	7203-1HV	7203-3C	7203-4
OVERFLOW	Yellow	7208-1	7208-1HV	7208-3C	7208-4
OXYGEN	Green	7210-1	7210-1HV	7210-3C	7210-4
OXYGEN	Yellow	7209-1	7209-1HV	7209-3C	7209-4
PLANT AIR	Yellow	7212-1	7212-1HV	7212-3C	7212-4
POTABLE WATER	Yellow	7218-1	7218-1HV	7218-3C	7218-4
PROCESS WATER	Green	7224-1	7224-1HV	7224-3C	7224-4
PROPANE GAS	Yellow	7227-1	7227-1HV	7227-3C	7227-4
RAIN WATER	Green	7229-1	7229-1HV	7229-3C	7229-4
REFRIGERANT LIQUID	Yellow	7235-1	7235-1HV	7235-3C	7235-4
RETURN	Green	7242-1	7242-1HV	7242-3C	7242-4
RETURN	Yellow	7244-1	7244-1HV	7244-3C	7244-4
ROOF DRAIN	Green	7247-1	7247-1HV	7247-3C	7247-4
SANITARY SEWER	Green	7250-1	7250-1HV	7250-3C	7250-4
SANITARY SEWER	Yellow	7251-1	7251-1HV	7251-3C	7251-4
SANITARY VENT	Yellow	7252-1	7252-1HV	7252-3C	7252-4
SANITARY WASTE	Yellow	7253-1	7253-1HV	7253-3C	7253-4
SPRINKLER	Red	7267-1	7267-1HV	7267-3C	7267-4
SPRINKLER FIRE	Red	7268-1	7268-1HV	7268-3C	7268-4
SPRINKLER WATER	Red	7269-1	7269-1HV	7269-3C	7269-4
STEAM	Yellow	7270-1	7270-1HV	7270-3C	7270-4
STORM DRAIN	Green	7273-1	7273-1HV	7273-3C	7273-4
STORM SEWER	Green	7274-1	7274-1HV	7274-3C	7274-4
SUPPLY	Green	7282-1	7282-1HV	7282-3C	7282-4
SUPPLY	Yellow	7311-1	7311-1HV	7311-3C	7311-4
TEMPERED WATER	Yellow	7283-1	7283-1HV	7283-3C	7283-4
TOWER WATER	Green	7285-1	7285-1HV	7285-3C	7285-4
VACUUM	Yellow	7291-1	7291-1HV	7291-3C	7291-4
VACUUM	Green	7292-1	7292-1HV	7292-3C	7292-4
VENT	Yellow	7295-1	7295-1HV	7295-3C	7295-4
VENT	Green	7296-1	7296-1HV	7296-3C	7296-4
WASTE	Yellow	7298-1	7298-1HV	7298-3C	7298-4
WASTE	Green	7299-1	7299-1HV	7299-3C	7299-4
WATER	Yellow	7303-1	7303-1HV	7303-3C	7303-4
WATER	Green	7304-1	7304-1HV	7304-3C	7304-4



BradySnap-On™ Pipe Markers

- Designed for general purpose pipe identification on pipes that have an outside diameter between ¾" and 6" (including insulation)
- May be applied to dirty, oily, greasy or rough surfaces
- Meet ASME (ANSI) Standard
- Lightweight coiled plastic can removed and reapplied



Strap-On Pipe Markers

- Designed for general purpose pipe identification on pipes that have a 6" or larger diameter (including insulation)
- May be applied to dirty, oily, greasy or rough surfaces
- Can be removed and reapplied in other areas
- Strap-On Pipe Marker styles F - H include nylon straps

How to order:

1. Choose the desired pipe marker legend below.
2. Replace the asterisk (*) with the style code (A, B, C, D, F, G or H) from the size charts below to indicate your desired pipe marker size and style. (Example: Air = 4001-H)

BradySnap-On™ Pipe Marker Style and Size Chart

Style Code	Outside Diameter	Letter Height
Style: A	¾" to 1-3/8"	1/2"
Style: B	1-1/2" to 2-3/8"	¾"
Style: C	2-1/2" to 3-7/8"	1-1/4"
Style: D	4" to 6"	1-1/4"

Strap-On Pipe Marker Style and Size Chart

Style Code	Outside Diameter	Letter Height
Style: F	6" to 7-7/8"	1-1/4"
Style: G	8" to 9-7/8"	2-1/2"
Style: H	10" to 15"	3-1/2"

BradySnap-On™ and Strap-On Markers Legends

Catalog Number	Legend	Bkgd Color	Catalog Number	Legend	Bkgd Color	Catalog Number	Legend	Bkgd Color
4001 - *	AIR	Green	4185 - *	FIRE MAIN	Red	4103 - *	OIL	Yellow
4002 - *	AIR	Blue	4060 - *	FIRE PROTECTION WATER	Red	4105 - *	OXYGEN	Yellow
4003 - *	AIR	Yellow	4064 - *	FUEL OIL RETURN	Yellow	4106 - *	OXYGEN	Green
4162 - *	ARGON	Blue	4065 - *	FUEL OIL SUPPLY	Yellow	4107 - *	OXYGEN	Blue
4006 - *	ARGON	Green	4067 - *	GAS	Yellow	4108 - *	PLANT AIR	Yellow
4007 - *	ASBESTOS FREE	Blue	4070 - *	HEATING RETURN	Yellow	4110 - *	PLUMBING VENT	Green
4010-A	(BLANK)	Yellow	4071 - *	HEATING SUPPLY	Yellow	4111 - *	POTABLE WATER	Green
4012-A	(BLANK)	Red	4072 - *	HEATING WATER RETURN	Yellow	4113 - *	PROCESS WATER	Green
4019 - *	CARBON DIOXIDE	Yellow	4073 - *	HEATING WATER SUPPLY	Yellow	4114 - *	PROPANE GAS	Yellow
4020 - *	CAUSTIC	Yellow	4074 - *	HELIUM	Green	4119 - *	RETURN	Yellow
4022 - *	CHILLED WATER	Green	4075 - *	HIGH PRESSURE AIR	Yellow	4121 - *	ROOF DRAIN	Green
4023 - *	CHILLED WATER RETURN	Green	4076 - *	HIGH PRESSURE CONDENSATE	Yellow	4122 - *	SANITARY DRAIN	Green
4024 - *	CHILLED WATER SUPPLY	Green	4077 - *	HIGH PRESSURE STEAM	Yellow	4123 - *	SANITARY SEWER	Green
4028 - *	CITY WATER	Green	4078 - *	HIGH PRESSURE WATER	Yellow	4270 - *	SERVICE WATER	Green
4029 - *	COLD WATER	Green	4197 - *	HOT	Yellow	4124 - *	SODIUM HYPOCHLORITE	Yellow
4032 - *	COMPRESSED AIR	Yellow	4079 - *	HOT WATER	Yellow	4127 - *	SPRINKLER FIRE	Red
4033 - *	COMPRESSED AIR	Green	4081 - *	HOT WATER RETURN	Yellow	4128 - *	SPRINKLER WATER	Red
4034 - *	COMPRESSED AIR	Blue	4082 - *	HOT WATER SUPPLY	Yellow	4129 - *	STEAM	Yellow
4035 - *	CONDENSATE	Yellow	4083 - *	HYDRAULIC LINE	Yellow	4132 - *	STORM DRAIN	Green
4036 - *	CONDENSATE DRAIN	Yellow	4199 - *	HYDRAULIC OIL	Yellow	4134 - *	STORM WATER	Green
4037 - *	CONDENSATE RETURN	Yellow	4085 - *	HYDROCHLORIC ACID	Yellow	4136 - *	SULFURIC ACID	Yellow
4043 - *	COOLING WATER RETURN	Green	4086 - *	HYDROGEN	Yellow	4140 - *	TEMPERED WATER	Yellow
4044 - *	COOLING WATER SUPPLY	Green	4089 - *	INSTRUMENT AIR	Blue	4143 - *	TOWER WATER RETURN	Green
4046 - *	DEIONIZED WATER	Green	4225 - *	LAB VENT	Yellow	4146 - *	VACUUM	Yellow
4172 - *	DEIONIZED WATER RETURN	Green	4226 - *	LAB WASTE	Yellow	4147 - *	VACUUM	Green
4173 - *	DEIONIZED WATER SUPPLY	Green	4091 - *	LOW PRESSURE CONDENSATE	Yellow	4148 - *	VENT	Yellow
4048 - *	DOMESTIC COLD WATER	Green	4092 - *	LOW PRESSURE STEAM	Yellow	4150 - *	VENT	Green
4050 - *	DOMESTIC COLD WATER SUPPLY	Green	4097 - *	NATURAL GAS	Yellow	4151 - *	WASTE	Yellow
4051 - *	DOMESTIC HOT WATER	Yellow	4247 - *	NITRIC ACID	Yellow	4152 - *	WASTE WATER	Yellow
4052 - *	DOMESTIC HOT WATER RETURN	Yellow	4098 - *	NITROGEN	Yellow	4153 - *	WASTE WATER	Green
4053 - *	DOMESTIC HOT WATER SUPPLY	Yellow	4099 - *	NITROGEN	Green	4155 - *	WATER	Green
4055 - *	DRAIN	Green	4100 - *	NITROGEN	Blue			
4059 - *	FIRE AUTO SPRINKLERS	Red	4102 - *	NON-POTABLE WATER	Yellow			

Pipe Markers

www.BradyID.com/PetroChem



Custom Pipe Markers Online or On-Demand

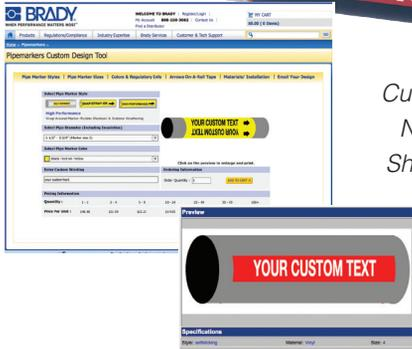

*Customize in minutes!
No setup charges!
Ships in 24-48 hours!*

Create Custom Pipe Markers Online

Brady's online pipe marker application makes it easy to design and order factory-made pipe markers to your exact specifications. Use of preformatted templates and drop-down menus simplifies the design process, allowing you to create pipe markers in just seconds. Once done, the custom pipe markers can be ordered online or emailed to your purchasing department or local Brady distributor.

Start creating custom pipe markers at www.BradyID.com or order custom pipe markers through your distributor with the following form.



Create your own pipe markers onsite and on-demand!

The special pipe marker module in MarkWare Lean Tools software makes it a snap to create pipe markers that conform to ASME, CAN/DBSB and other national standards. Output to a Brady label printer loaded with B-595 adhesive vinyl for the optimum in harsh environment durability! For stainless steel pipes, use B-569 low-halide polyester.

Learn more:

- MarkWare software (page 4)
- Brady label printers (page 6)
- Or visit www.BradyID.com



Custom Pipe Marker Order Form (Fax completed form to your local distributor)

Order Quote Artwork Attached Ship Via: _____ P.O. # or Request # : _____

Customer Information

Company Name: _____ Name: _____
 Address1: _____ Phone #: _____
 Address2: _____ Fax #: _____
 City: _____ State: _____ Zip: _____
 Email: _____

Distributor Information

Distributor: _____ Contact Name: _____
 Account: _____ Fax #: _____ Phone #: _____

Pipe Marker Options

B-946 Self-Sticking	
Style Code	Pipe Outside Diameter
3c - (3mrks/card)	Less than 3/4" OD
4 - (4mrks/card)	3/4" to 2-3/8"
1	2-1/2 to 7-7/8" OD
1HV	8" or larger OD

Arrows sold separately.

Brady Snap-On	
Style Code	Pipe Outside Diameter
A	3/4" to 1-3/8" OD
B	1-1/2" to 2-3/8" OD
C	2-1/2" to 3-7/8" OD
D	4" to 6" OD
F	6 to 7-7/8" OD
G	8" to 9-7/8" OD
H	10" to 15" OD

B-689 High Performance	
Style Code	Pipe Outside Diameter
O	1/2" to 1-3/8" OD
I	1-1/2" to 2-3/8" OD
II	2-1/2" to 7-7/8" OD
III	8" to 10" OD
IV	10" or larger to 16" OD
V	16" or larger to 22" OD
VI	22" or larger to 26" OD

B-946 Semi Conductor & Chemical	
Style Code	Marker Size
28	1/2" x 2-1/4"

Cable Style	
Style Code	Pipe Outside Diameter
CABLE	3/4" to 5/8" OD

B-681 / B-883 High Performance (HPHV)	
Style Code	Pipe Outside Diameter
HPHV	8" or larger OD

Markers printed with arrows.

Custom Orders

	Legend Line 1	Color* (Text / Bkgd)	Pipe Marker Style Code	Material	Quantity
1.					
2.					
3.					
4.					
5.					
6.					
7.					
8.					
9.					
10.					

* Brady standard pipe markers colors are: Yellow, Green, Red, Blue, White, Grey, Brown, Orange, Black, Purple and Clear. Custom colors are available.

Pipe Markers

www.BradyID.com/PetroChem

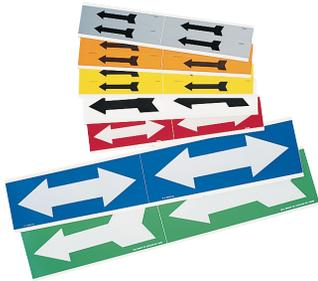

Self Sticking Vinyl Arrows

- Durable B-946 material withstands the elements indoors or out
- Mounted on easy-to-use cards

Color	1-1/8" x 7" (4/Card)	2-1/2" x 7" (2/Card)	4" x 12" (2/Card)
Single Direction Legend			
Blk/Ylw	93242	76507	93390
Wht/Blu	93247	76502	93392
Wht/Red	93252	76505	93394
Wht/Grn	93257	76503	93396
Blk/Org	93262	76504	-
Blk/Wht	93267	76506	-
Blk/Alum	93272	76501	-
Double Direction Legend			
Blk/Ylw	93243	76514	93391
Wht/Blu	93248	76509	-
Wht/Red	-	76512	93395
Wht/Grn	93258	76510	93397



Reflective Pipe Banding

- Increase night time visibility throughout your facility
- Made of 5 mil vinyl
- Withstands temperature of -40°F (-40°C) to 180°F (82°C) degrees.
- Exceeds Federal Spec. C-S-300, Class I and FP-79 type II

Color	1" x 30 yds	2" x 30 yds	4" x 30 yds
Yellow	105976	105982	105988
Green	105973	105979	105985
Red	105974	105980	105986
Blue	105972	105978	105984
Orange	105971	105977	105983
White	105975	105981	105987



Directional Flow Arrow Tape

- Durable B-946 material withstands the elements indoors or out
- Provides 360° visibility
- Supplied in liner-mounted rolled form - use two bands per marker

Color	1" x 30 yds (1440 Arrows)	2" x 30 yds (720 Arrows)	4" x 30 yds (270 Arrows)
Blk/Ylw	91424	91420	91287
Wht/Grn	91425	91421	91290
Wht/Rd	91426	91422	91288
Wht/Blu	91427	91423	91289
Blk/Grn	91412	91416	91408
Blk/Wht	91413	91417	91409
Blk/Org	91414	91418	91410
Blk/Gry	91415	91419	91411



ISO 14726 Pipe Banding Tape

- Help reduce accidents and damage to machinery
- Provides 360° visibility
- ISO14726 Marine Standard defines the principle colors for identifying pipes - each color indicates a certain gauge of substances

Color	1" x 30 yds	2" x 30 yds	4" x 30 yds
Yellow	36301	55260	36287
Red	36302	55261	—
Orange	91428	91430	—
Silver	105579	—	—



Solid Color Banding Tape

- Durable B-946 material withstands the elements indoors or out
- Meets ASME color field size recommendation when used in combination with worded legends and directional flow arrows
- Supplied in liner-mounted rolled form
- Use two bands per marker

Color	1" x 30 yds	2" x 30 yds	4" x 30 yds
Yellow	36301	55260	36287
Green	36304	55263	36290
Red	36302	55261	36288
Blue	36303	55262	36289
Orange	91428	91430	91432
White	91429	91431	91433
Brown	36305	36310	36315
Black	36306	36311	36316
Gray	36307	36312	36317
Purple	36308	36313	36318
Clear	36309	36314	36319



Stock Economy Pipe Banding Tape

- B-88 self-wound, non-printable plastic backed cloth tape
- Stock Economy Pipe Banding Tape is ideal for use in indoor color coding applications.

Color	2" x 60 yds
Yellow	80184
Blue	80187
Black	80191



Blank HPHV Carrier

- Ideal for marking custom markers on the spot
- Fiberglass carrier is blank (no label) and comes with two clips for installation
- Sized to accommodate the largest ASME (ANSI) requirements, 4.25" x 32"

Catalog #	Description
59918	Blank HPHV Carrier

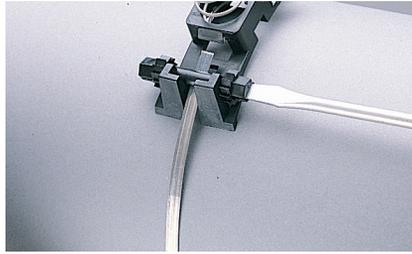

Stainless Steel Strapping

- Type 316 Stainless Steel Strapping is highly corrosion and heat resistant
- Ideal for HPHV pipe markers, HEET Tags or for your own purpose
- Continuous form requires separate stainless steel heads for uses other than HPHV pipe marker installation (sold separately)

Catalog #	Description
42331	1/4" x 100' steel strapping
42332	1/4" x 250' steel strapping
42333	1/4" x 1000' steel strapping

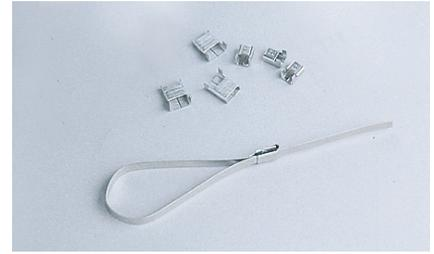

Stainless Steel Banding Heads

- Use with Continuous Strapping to create secure closures
- Stainless steel heads fit 1/4" strapping (sold separately)

Catalog #	Description	Qty.
90910	Type 316 Stainless Steel	100

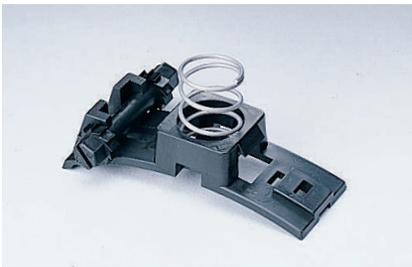

Heavy-Duty Mounting Clips

- For use with HPHV pipe markers

Catalog #	Description
42335	Heavy Duty Clip

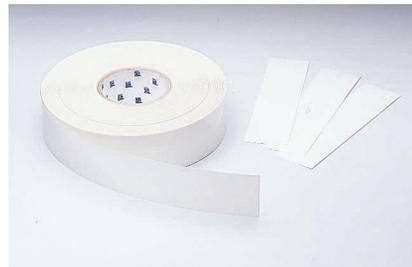

Tape Strip Rolls

- Use to re-secure wrap-around pipe markers should they become damaged need to be moved

Catalog #	Description
59945	2" x 10 yards Tape Strip Roll
59946	2" x 30 yards Tape Strip Roll



Bradylock™ Fastener

- Self-locking heavy duty plastic fastener for Strap-On Markers
- Excellent chemical resistance

Catalog #	Description
41772	1/2" x 150' Bradylock Fastener



Fastening Devices

- 32 mil stainless steel safety wire to be used with wire twister pliers.

Catalog #	Outside Dia.	Length
15424	Stainless Steel Safety Wire	1800 ft



Quik-Apply™ Nylon Straps

- Standard fastener for Quik-Apply™ pipe marker sizes Q1-Q4
- Can be used with a variety of tags including valve and lockout/tagouts

Catalog #	Outside Dia.	Strap Length
91165	1"	6"
91166	2"	7"

? Can't find what you need?

See our complete line of pipemarking solutions at www.BradyID.com.

Valve Tags

www.BradyID.com/PetroChem



ASME A13.1

Recommends the use of a permanently legible tag for identification of materials in pipes less than 3/4" (19mm) in diameter.



B-906 Blank Aluminum Tags

- Anodized aluminum is dyed to offer color-coding options not available with brass tags
- Choose from 1-1/2" or 2" round styles
- Standard package: 25 tags

Color	2" Round	2" Square	1-1/2" Round	1-1/2" Square
Black	87612	87637	87605	87619
Blue	49907	87641	49902	87629
Gold	87608	87633	87601	87615
Green	49908	87642	49903	87630
Light Blue	87613	87638	87606	87620
Natural	49909	87643	49904	87631
Olive Drab	87609	87634	87602	87616
Orange	87611	87636	87604	87618
Pink	87610	87635	87603	87617
Red	49906	87640	49901	87628
Violet	87607	87632	87600	87614
Yellow	49905	87639	49900	87627



Color	3"x1-1/2"	4"x2-1/2"
White	87696	87697
Orange	87694	87695
Red	41924	41925
Yellow	41922	41923
Black	41920	41921
Blue	41926	41927
Brown	87710	87711
Tan	87712	87713
Grey	87698	87699
Green	41928	41929



B-919 Blank Stainless Steel

Ideal for harsh environments or where a stainless steel material is specified

- Tag hole is 3/16"

Catalog #	Size	Qty.
44400	1-1/2" Round	25
44401	1-1/2" Square	25
44402	2" Round	25
44403	2" Square	25



B-907 Stamped Brass Valve Tags

- 1-1/2" diameter stamped valve tags constructed from 19 gauge cartridge brass (40 mils thick)

Catalog #	Bottom Line Number Sequence	Qty.
23200	1 - 25	25
23201	26 - 50	25
23202	51 - 75	25
23203	76 - 100	25

There's More Online: Brady also offers a selection of serial numbers sequences up to 500 as well as tags with stamped legends, including "GAS", "VAC", and "AC". Visit www.BradyID.com for more information.



B-907 Blank Brass Valve Tags

- Standard package: 25 identical tags
- Customize your own brass tags with Brady steel stamps

Catalog #	Description
23210	1-1/2" Round Brass Tag
23211	2" Round Brass Tag
23212	1-1/2" Square Brass Tag
23213	2" Square Brass Tag



B-851 Self-Laminating Polyester Tags

- 2-1/2" x 2" grommeted polyester tags
- Rigid polyester surface exceeds OSHA 50 lb. pull out requirement
- Polyester tags withstand moisture, grease and dirt

Catalog #	Description	Color	Qty.
89252	Blank w/Self Overlam	Red	10
89253	Blank w/Self Overlam	Blue	10
89254	Blank w/Self Overlam	Yellow	10
89255	Blank w/Self Overlam	Green	10

B-418 Durable Plastic Tags

- Tags are lightweight, non-corrosive, non-conductive and impact resistant
- Tag withstands temperatures between -40°F to 260°F
- Rounded corners and hole punched

Customize: Create Your Own High Visibility Tags Onsite

- Create your own high visibility tags onsite and on-demand using MarkWare™ software and the GlobalMark® label printer
- MarkWare™ includes templates that make it easy to create labels to fit the tag holders.
- See page 4 for more information on MarkWare™ software and page 6 for the GlobalMark® printer.





Solid Brass "S" Hooks

- Standard package: 100 "S" Hooks, sold in full packages only

Catalog #	Description	For Valve Stems Up To	Qty.
23305	1-3/4" O.D. Brass	1/2"	100
23304	1-1/2" O.D. Brass	3/8"	100
23303	1-1/4" O.D. Brass	1/4"	100



Lead Seals

- 12" wires with pre-fitted lead seals fit easily around pipes or valves
- Use with Hand Sealing Press (not included)

Catalog #	Description	Qty.
23301	Copper Lead Seals	250



#16 Jack Chain

- Approximately 25 links per foot
- Standard package: 50 feet of chain, sold in full packages only

Catalog #	Description	Qty.
23308	Brass #16	50' of chain
98859	Stainless Steel	50' of chain



Colored Nylon Ties

- Nylon tie provides easy fastening
- Hook ties together to create length

Catalog #	Description	Size	Qty.
98848	Black	8"	100
98849	Blue	8"	100
98850	Green	8"	100
98851	Natural	8"	100
98852	Orange	8"	100
98853	Purple	8"	100
98854	Red	8"	100
98855	Yellow	8"	100



4-1/2" Beaded Chain

- Extremely flexible 4-1/2" bead chain with locking link.
- Standard package contains 100 chains. sold in full packages only

Catalog #	Description	Qty.
23306	4-1/2" long #6 Brass chain	100



Fastener Supplies

- Stranded 48 mil stainless steel wire
- Crimping tool secures and crimps brass clamps
- Zinc wire clamps (double ferrule design) secure or splice wire

Catalog #	Description	Qty.
38090	Zinc Wire Clamps	50
38088	Crimping Tool	1
38091	Stainless Steel Wire (48 mil)	30'



Custom Valve Tags



Order Custom "High Visibility" Tags (B-418)

High Visibility tags allow you to display more detailed information than traditional stamped or engraved tags. In addition, the color-coded tag holders allow employees to distinguish between different types of valves or different processes at a glance and from a distance.

- Polyester label with overlamine adhered to plastic tag holder. UV-resistant overlamine also available for extended outdoor durability
- Durable, lightweight, non-corrosive and non-conductive
- Two sizes and 10 colors
- Bar code options include 3-of-9 and Code 128
- Service temperature: -40°F to 260°F (-40°C to 127°C)

Contact a Brady representative for more information.



Create Custom Tags Online

Brady's online valve tag application makes it easy to design and order factory-made valve tags to your exact specifications. Templates and drop-down menus simplifies the design process, allowing you to create valve tags in just seconds. Once complete, the custom valve tags can be added to your shopping cart and ordered online, or emailed to your purchasing department or local Brady distributor.

- Stamped or engraved tags available in square or round shapes and as 1.5" or 2.0"
- Material options include brass, stainless steel, plastic, aluminum or anodized aluminum
- Alphanumeric legends and serialized numbers

No setup charges and your order ships same or next day!
Get started at www.BradyID.com.

Lockout / Tagout

www.BradyID.com/PetroChem

Cable lockouts – GREAT VERSATILITY!

- The advantage of using cable lockouts is that they can be used in a wide variety of applications
- Cable lockouts can be used to lockout multiple disconnects, valves, etc. with one lockout device
- They can also be used to secure unusual energy isolating devices that are difficult to lock out using conventional means.
- More portable and easier to use than chains, cable lockouts devices are a great addition to any lockout program.



All Purpose Cable Lockout

- Superior chemical, corrosion and temperature resistance properties
- Built-in cable loop keeps cable neatly coiled when stored
- Available with interchangeable sheathed metal (3/16" dia.) or non-conductive nylon (1/8" dia.) cables
- Max. service temperature of cables: Non-Conductive Nylon: -40° to 200° F Sheathed Metal: -30° to 180° F

Catalog #	Description
50943	Lockout w/ 8' sheathed metal cable
50941	Lockout w/ 8' non-conductive nylon cable
50944	Lockout without cable
50947	8' Sheathed metal cable only
50950	12' Sheathed metal cable only
50953	16' Sheathed metal cable only
50956	20' Sheathed metal cable only
50945	8' Non-conductive nylon cable only
50948	12' Non-conductive nylon cable only
50951	16' Non-conductive nylon cable only
50954	20' Non-conductive nylon cable only



Mini Cable Lockout

- Extremely compact and portable - Cable stored internally.
- Push-button self-winding mechanism automatically cinches cable tight
- Superior chemical, corrosion and temperature resistant properties.
- Comes with vinyl-coated steel cable or nonconductive nylon cable
- 6 lock holes accommodate most padlock shackles and hasps
- 6 lock holes accommodate most padlock shackles and hasps
- Body dimensions: 4" dia. x 1-3/4" deep
Cable dimensions: 1/16" outside dia. x 8' length

Catalog #	Description
50940	Mini Cable Lockout w/ Steel Cable
51442	Mini Cable Lockout w/ Nylon Cable



Prinzing Economy Cable Lockout

- Unique lockout device accepts up to six 9/32" diameter padlocks
- Cable Diameter 3/16" outside diameter
- 6' or 10' plastic-coated steel cables

Catalog #	Description
CABLO	Cable Lockout Device w/ 6' cable
CABLO-10	Cable Lockout Device w/ 10' cable



Original Cable Lockout

- Brady's original cable lockout
- Body made of impact modified nylon, available in red, blue or yellow
- Comes with 6' galvanized steel cable (1/8" outside dia.)

Catalog #	Description	Color
65318	Cable Lockout Device w/ 6 ft. cable	Red
45191	Cable Lockout Device w/ 6 ft. cable	Blue
45192	Cable Lockout Device w/ 6 ft. cable	Yellow
65319	8 ft. steel cable only	-
65320	10 ft. steel cable only	-

*Other cable lengths available upon request.



Double Looped Cable Lockout Cables

- Perfect in any situation that requires a flexible lockout device and a visual deterrent
- Much more light weight and easy to spot than typical chains
- Made of plastic coated steel cable
- Cable diameter: 3/16"

Catalog #	Length	Color
131063	Double Looped Cable 2ft	Red
131064	Double Looped Cable 4ft	Red
131065	Double Looped Cable 6ft	Red
131066	Double Looped Cable 8ft	Red

! Valve Lockout Kits

Brady's Lockout Tagout Kits include an array of safety padlocks, lockout tools, tags, valve lockouts and much more.

To view all lockout kits, visit:
www.BradyID.com/lockouttagout

Valve Lockout

From universal valve lockouts to adjustable gate valve lockouts, Brady offers a full line of lockout devices to shut off all types of pressured valves. Gate valve lockout devices deny access and cover the valve handle to help you turn off, and keep off, a pressured situation. With Prinzing ball valve lockouts and Brady's standard, quarter-turn ball valve lockout devices, a comprehensive series of options are available from the global leader in lockout tagout solutions.

Universal Valve Lockout

Lock Out All Types Of Valves With A Single Device!

- Versatile, rugged, easy to use and lightweight device
- Made of industrial-grade steel and nylon for extra impact and chemical resistance
- Open-ended clamp fits over closed rings, wide handles
- Can also be used to lock out large levers, T-handles and other hard-to-secure mechanical devices
- Cable attachment offers choice of 1/8" nonconductive nylon or rustproof sheathed metal cable
- Small: for handle widths up to 1" (max handle thickness 0.6")
- Large: for handle widths up to 1.6" (max handle thickness 1.1")
- Patent No. 5,415,017 and 7,207,198



No need for multiple types and sizes of lockouts – now one device does it all!



Use blocking arm to lock out quarter-turn ball valves.



Attaches to butterfly handles, preventing trigger handle from being squeezed. Valve cannot be repositioned!



Use cable attachment to lock out gate valves.



Use two blocking arms to lock out 3-, 4- or 5-way valves, or to lock valves in the "on", "off", or "throttled" position.

Catalog #	Description
Complete Sets	
51394	Small UVLO w/ 8' Sheathed Cable Attachment & Blocking Arm
51390	Small UVLO w/ 8' Nylon Cable Attachment & Blocking Arm
51392	Large UVLO w/ 8' Sheathed Cable Attachment & Blocking Arm
51388	Large UVLO w/ 8' Nylon Cable Attachment & Blocking Arm
Individual Components	
50924	Small UVLO Base Clamping Unit
50899	Large UVLO Base Clamping Unit
65402	Small Blocking Arm
65403	Large Blocking Arm
51395	Cable Attachment w/ 8-ft Sheathed Cable
50932	Cable Attachment w/ 8-ft Nylon Cable

Other cable lengths also available.

Butterfly Valve Lockout

- Innovative design to lock out butterfly valves with a lever handle in the OFF position
- Will accommodate handle thicknesses of:
Small - 1/8" to 2-1/2" (3.2mm to 63.5mm)
Large - 2" to 4" (50.8mm to 102mm)

Catalog #	Description
121504	Butterfly Valve Lockout - Small
121505	Butterfly Valve Lockout - Large



Small



Large



Lockout / Tagout

www.BradyID.com/PetroChem

Lockout / Tagout



Plug Valve Lockout

- Secure manual plug valves to OSHA-compliant standards
- Four sizes to fit most 1" to 8" diameter manually-actuated plug valves
- Ideal for difficult-to-secure plug valves
- Durable and tamper-resistant
- Service temps from -25°F to 200°F
- Compact in size and easy to use

Catalog #	Description
113231	Lockout for up to 7/8" Stem Dia.
113232	Lockout for 15/16" to 1-3/8" Stem Dia.
113233	Lockout for 1-3/4" to 2-1/8" Stem Dia.
113234	Lockout for 2-3/16" to 2-1/2" Stem Dia.



Adjustable Gate Valve Lockout

- Versatile lockout adjusts to fit 1" to 6-1/2" valve handles, replacing 3 conventional gate valve lockouts
- Durable polypropylene is resistant to temperature changes from -13°F to 194°F
- Comes with danger labels in English, Spanish and French

Catalog #	Description
64057	Adjustable Gate Valve Lockout



Gate Valve Lockouts

- Made of rugged injection-molded polypropylene
- Service temps from -25°F to 200°F
- Unique knockout center fits OS&Y or "rising stem" valves
- Accepts shackles up to 3/8" in dia.
- Supplied with English, Spanish and French danger labels

Fits Valve Handles Dia.	Red	Yellow	Green	Blue
1" to 2-1/2"	65560	65590	65595	65585
2-1/2" to 5"	65561	65591	65596	65586
5" to 6-1/2"	65562	65592	65597	65587
6-1/2" to 10"	65563	65593	65598	65588
10" to 13"	65564	65594	65599	65589

New Lockout / Tagout Technical Data Sheets

Download the technical sheets for over 350 lockout SKUs including lockout devices and padlocks.

These sheets offer lots of information, including:

- Basic product description & photos
- Material information & temperature resistance
- Chemical resistance
- Detailed dimensional data
- MSDS information on the materials

To view all technical data sheets, visit:
www.BradyID.com/techdata

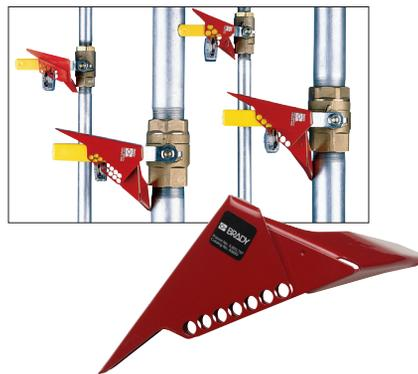

Standard Ball Valve Lockout

- Easy to use, single-piece design locks quarter-turn ball valves in OFF position
- Two sizes fit most valves up to 3"
- 65666 is made of super-tough nylon (service temp -40° to 248° F)
- 65692, 65669 and 65693 are made of powder-coated steel

Catalog #	Max Shackle Dia.	Valve Size / Pipe Dia.	Max Handle Width	Max Handle Thickness
65666	9/32"	1/4" to 1"	1-1/2"	3/4"
65692	3/8"	1/4" to 1"	1-1/2"	3/4"
65669	9/32"	1-1/4" to 3"	2 1/10"	1 1/4"
65693	3/8"	1-1/4" to 3"	1 9/10"	1 1/4"



Prinzing Ball Valve Lockout

- Made from ultra-tuff polypropylene
- Small lockout locks out pipes 1/2" to 2-1/2" in diameter
- Small lockout can also be used to lock valves OPEN on pipes from 1/2" to 1-1/4" in dia.
- Large lockout locks out pipes 2" to 8" in diameter

Size	Red	Blue	Green	Yellow
Small	BS07A-RD	BS07A-BU	BS07A-GN	BS07A-YW
Large	BS08A-RD	BS08A-BU	BS08A-GN	BS08A-YW



120V Snap-On Breaker Lockout

- Designed for 120V breakers that have holes in the switch tongue
- Quick and easy – just snap in place and apply lock!
- Dual cavities accommodate different size switch tongues
- Accepts locks shackles up to 9/32" in diameter
- Dimensions: 0.83"H x 0.35"W x 2.15"L

Catalog #	Description	Qty.
65387	120V Snap-On Circuit Breaker Lockout	1
65688	120V Snap-On Circuit Breaker Lockouts	6



Clamp-On Breaker Lockout

- Extremely versatile – works on a wide range of single-pole and internal-trip multi-pole breakers!
- Use thumbscrew to clamp lockout onto switch tongue, then pull cover over thumbscrew and lock in place to prevent clamp from being loosened
- Accepts shackles up to 9/32" dia.
- Included detachable cleats expand the range of applicable breakers

Catalog #	Description	Qty.
65396	120/277V Clamp-On Breaker Lockout	1
65965	120/277V Clamp-On Breaker Lockout	6
65397	480/600V Clamp-On Breaker Lockout	1
65966	480/600V Clamp-On Breaker Lockout	6

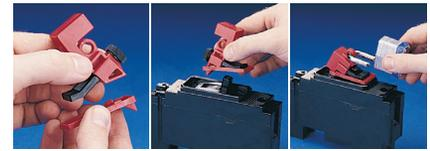

Step 1 Step 2 Step 3



Extra Cleats for Clamp-On Breaker Lockouts

- Use in conjunction with clamp-on breaker lockouts (sold separately)
- Easily clips onto the bottom of the lockout body
- Assures positive restraint for breakers with long, sliding switch throws

Catalog #	Description	Qty.
65404	Cleats For 120/277V Lockout	6
65406	Cleats For 480/600V Lockout	6

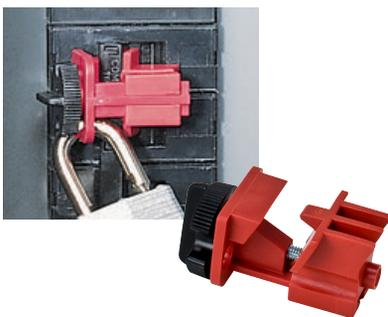

Universal Multi-Pole Breaker Lockout

- Single device works with most major multi-pole breakers that employ a tie-bar
- Made of durable impact-modified nylon
- Compatible with GE, ITE, Sylvania, Challenger, Bryant, Westinghouse, General Switch Co., and more!
- Use thumbscrew to clamp lockout securely over tie bar, then insert lock to prevent clamp from being loosened
- Patent No. 5,300,740

Catalog #	Description	Qty.
66321	Universal Multi-Pole Breaker Lockout	1
66320	Universal Multi-Pole Breaker Lockouts	6

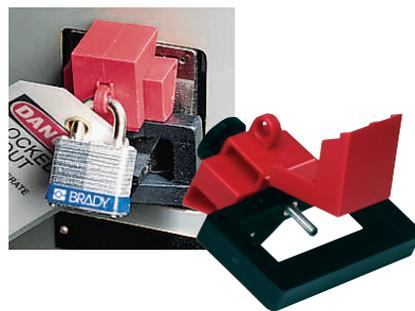

Oversized Clamp On Breaker Lockout

- Oversized 480/600V frame lockout fits breaker switches up to 2 1/4" wide and 7/8" thick
- Made of durable polypropylene and glass filled-impact-modified nylon
- New blade design gets better grip, works on even more breaker models!
- Patent No. 5,500,495

Catalog #	Description	Qty.
65329	Oversized Breaker Lockout	1
65321	Oversized Breaker Lockout	6

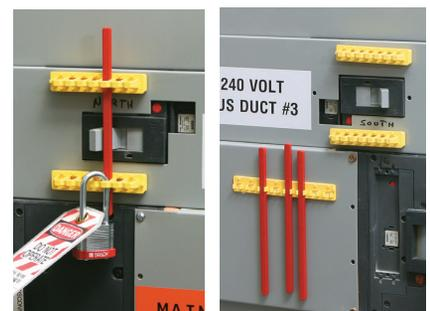

480-600V Breaker Blocker

- Perfect for locking out oversized and irregularly shaped switches
- Self-adhesive backed rails are permanently installed into an electrical panel – simply clean panel surface and adhere – no drilling required!
- Blocking Bars are 7-1/2" long
- Red blocking bar indicates locked off, green bar indicates locked on

Catalog #	Description	Qty.
90892	7.6" Red Blocking Bar	5
90893	7.6" Green Blocking Bar	5
51264	4" Yellow Mounting Rails	2
51265	Blocking Bar Holder	5
90891	Breaker Block Kit*	1

*Kit includes 2 yellow mounting rails, 1 red blocking bar, 1 green blocking bar and 3 alcohol wipes.

Lockout / Tagout

www.BradyID.com/PetroChem

EZ Panel Loc™ System

- Works on wide range of breakers, including single- and multi-pole configurations
- Can be used with most padlocks by making use of unique lock rail system
- Allows panel door to be closed even when lockouts are in place
- Accommodates multiple locks, facilitating group lockout activity without hasps
- Keeps weight off the breakers, protecting delicate electrical components from damage
- Positions locks and tags outside the panel, making sure lockout activity is clearly visible to anyone in the area
- Patent No. 6,727,441

(Not recommended for use with multilock hasps)

Technical Information

- Lockout devices constructed of high-impact Isoplast polymers
- Cables are 2-ft. in length
- Lock rails made of durable isoplast polymers with acrylic adhesive backing
- Lock rails available in 4" or 8" lengths (with 7 or 15 lock loops)

How EZ Panel Loc System Works



Lockout device is unlocked by inserting and turning the black plastic key.



1. Expose the super-bond adhesive on back of rail. Permanently affix to any location on the panel.

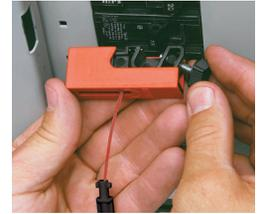

2. Attach the lockout device to the breaker and snap into locked position.



3. Pass plastic key through lock rail and attach lock, preventing key from sliding down cable and opening lockout device.



4. For group lockouts, run key through multiple loops in lock rail and apply locks. No hasps required! (Not recommended for use with multilock hasps)



5. Low-profile lockouts allow panel doors to be closed on most breaker panels.

Covers Most 120V – 277V Breakers!

The EZ Panel Loc™ System comes in two different styles, accommodating an exceptionally wide range of breaker models.

SNAP-ON

For use on Square D NQO and other breakers that have a hole in the switch tongue. Just align pins with hole and snap closed. Pins prevent switch from being thrown.

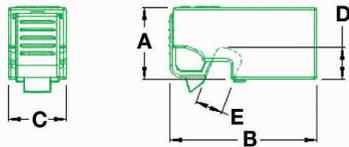

CLAMP-ON

For use on breakers that do not have a hole in the switch tongue. Turn thumbscrew to clamp lockout securely onto switch, then snap the cover closed to prevent thumbwheel from being loosened.

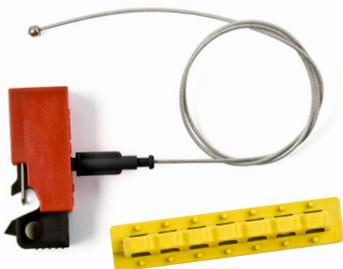
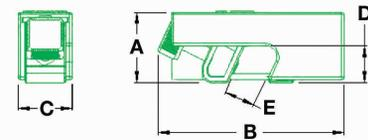

Description	Outer Dimensions (in.)			Switch Clearance (in.)	
	A	B	C	D	E
Snap-On Style	0.90"	1.88"	0.74"	0.40"	0.35"
Clamp-On Style	0.95"	2.56"	0.74"	0.35"	0.42"

Description	1 Per Pkg	6 Per Pkg
Snap-On Lockout Device	51252	65815
Clamp-On Lockout Device	51254	65810
4" Lock Rail	51256	65814
8" Lock Rail	51258	51260



3-In-1 Electrical Plug Lockout

- Accommodates high and low-voltage plugs up to 3" in diameter and 5-1/2" in length
- 2 sliding top lids can be used individually or together to accommodate small, medium and large-diameter cords up to 1-1/4"
- Made of bright yellow thermoplastic
- Visual label supplied in English/Spanish bilingual format

Catalog #	Type
PL023	3-in-1 Plug Lockout



Brady Electrical Plug Lockouts

- Plug lockouts prevent electrical plugs from being inserted into a wall outlet. Use when plug will not remain under the exclusive control of the person performing service or maintenance
- Made of rugged polypropylene
- Small 110V plug lockout: 2"H x 2"D x 3-1/2"W with 1/2" diameter hole for cable
- Large 220/500V plug lockout: 3-1/4"H x 3-1/4"D x 7"W with 1" diameter hole for cable

Catalog #	Type
65674	Small 110V Plugout
65675	Large 220/500V Plugout



Wall Switch Lockouts

- Use with most wall-mounted switches
- Easy to install using existing screws
- 65392 & 65696 come in a high visibility red color and can lock switch in "on" or "off" position
- WSLO feature a patented non-hinge design and are made of strong, clean polycarbonate

Catalog #	Description	Qty.
65392	Red Wall Switch Lockout	1
65696	Red Wall Switch Lockout	6

*Padlock not included



PRINZING Gas Cylinder Lockout

- Prevents access to the main cylinder valve
- No need to match your lockout device to varying diameters and threads of cylinder caps
- Accommodates neck rings up to 3 1/2" diameter
- Installs in seconds to save time

Catalog #	Description
LM023E	Gas Cylinder Lockout



Pneumatic Quick-Disconnect Lockout

- Isolates pneumatic energy without the expense and inconvenience of installing in-line lockout valves
- Device is applied to the male fitting, isolating equipment from all compressed air sources
- Accommodates the majority of 1/4", 1/8", 1/2" male fittings
- Hole in center of device allows for permanent storage on an air hose and a loop on the side can be used to hang the hose and lockout device
- Lockout using a padlock with 1/4" or 9/32" shackle

Catalog #	Description	Qty.
64221	Pneumatic Lockout	1
65645	Pneumatic Lockout	6



Snap Cap™ Gas Cylinder Lockout

- Designed to fit most North American high and low pressure gas cylinders
- Meets DOT standards
- Denies access to the main cylinder control and regulator attachment
- Welded steel construction and powder coated for many years of use

Catalog #	Description	Color
90496	6.5" x 3-1/8" x 11 UN, High Pressure Fine Thread	Yellow
95137	6.5" x 3-1/2" x 11 UN, Low Pressure Fine Thread	Yellow
95138	6.5" x 3-1/8" x 11 UN, High Pressure Coarse Thread	Yellow
95139	6.5" x 3-1/2" x 11 UN, Low Pressure Coarse Thread	Yellow

Lockout / Tagout

www.BradyID.com/PetroChem



OSHA Lockout/Tagout Regulations

1910.147(c)(5) OSHA Lockout Device Requirements state that lockout devices must:

- Tagout devices must:
- Be provided by the employer
 - Be standardized by size, shape or color
 - Be distinguishable from locks used for other purposes. Lockout locks should only be used for lockout!
 - Identify the individual who applied the lock (both tags and lock labels are acceptable for this purpose)
- Be capable of withstanding the usage environment and must be strong enough to prevent removal except by using excessive force with special tools, such as bolt cutters.
 - Most importantly, whenever lockout devices are applied, they must remain under the exclusive control of the individual who attached them. No employee should be able to open a lock attached by someone else.

Keying & Charting Options



Keyed Different

- Brady padlocks come “keyed different” when purchased from stock. This means that the key for one lock should not open another. Brady padlocks use 5- or 6-pin cylinders. Moreover, both cylinders and keys are precision-machined to exacting standards. This enables us to offer a greater number of unique keys than other locks with the same number of pins, making it highly unlikely that you will ever receive a duplicate lock.
- To guarantee that each lock is different, we can chart your locks, ensuring that each Brady padlock you receive is different from the others (see below).



Keyed Alike

- When keyed alike, all locks in a set can be opened with the same key. This option is beneficial when multiple locks are assigned to a single employee. Remember, however, that under OSHA regulations no employee should be able to open a lock applied by someone else. Therefore, keyed alike locks from the same set should never be distributed to multiple employees.

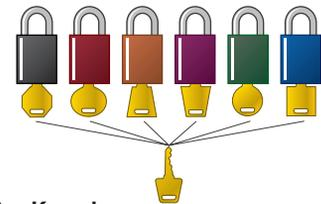

Master Keyed

- A master key can be used to open multiple locks that are keyed differently. This allows supervisors to easily remove a lock in the event of an emergency. In order for employees to retain exclusive control, master keys should be kept in a secure location that is accessible only to management.

Key Charting

- Brady can track or “chart” your key codes upon request in order to simplify ordering replacement locks and to avoid duplicates when ordering additional locks. There is no extra charge for charting. Call for Customer Service at 1-888-272-3946 details!



Choose the lock that’s best suited for your job!

	Compact Safety Padlocks	Safety Padlocks	Key-Retaining Steel Padlocks	Steel Padlocks	Aluminum Padlocks
Compact, lightweight	✓	✓	✓		
Nonconductive body & keyway	✓	✓			
Most corrosion resistant	✓	✓	✓	✓	✓
Most spark resistant	✓	✓			
Most tamperproof		✓	✓	✓	✓
Most rugged		✓		✓	✓



Need a Custom Key Solution?

At Brady, we can help you with your custom keying program. Just call a Brady customer service representative at 1-888-272-3946 to get started!

Key Retaining Steel Padlocks



- Reinforced laminated steel withstands severe physical abuse
- Hardened steel shackle resists tampering, cutting, prying, and rusting
- Body plates individually coated for superior rust protection, offering 13 times better corrosion resistance than normal steel locks
- 5-pin cylinder offers more unique key cuts and increased tamper resistance
- Three shackle sizes: 3/4", 2" or 3" Shackle diameter: 17/64"
Lock Body: 1-1/5"H x 1-5/16"W x 1"D
- Colored bumpers supplied for identification and protection (custom stamping available)
- Made from recycled material
- Key retaining safety feature prevents key from being removed until closed
- Lighter weight than standard Laminated Steel Padlocks
- Each padlock includes 1 key. Custom keying and charting also available. Lock labels sold separately.

Key Retaining Steel Padlocks 3/4" Shackle

Color	Keyed Different 1/Pack	Keyed Different 6/Pack
Red	143126	118935
Green	143128	118936
Blue	143130	118937
Yellow	143132	118938
White	143134	118939
Black	143136	118940
Brown	123272	123280
Purple	123273	123281

Key Retaining Steel Padlocks 2" Shackle

Color	Keyed Different 1/Pack	Keyed Different 6/Pack	Keyed Alike 3/Pack	Keyed Alike 6/Pack
Red	143144	118944	118977	118978
Green	143142	118943	118975	118976
Blue	143140	118942	118973	118974
Yellow	143148	118946	118981	118982
White	143146	118945	118979	118980
Black	143138	118941	118971	118972
Brown	123274	123282	123276	123278
Purple	123275	123283	123277	123279

When keyed alike, all locks in a set can be opened with the same key. This option is beneficial when multiple locks are assigned to a single employee.

Key Retaining Steel Padlocks 3" Shackle

Color	Keyed Different 1/Pack	Keyed Different 6/Pack	Keyed Alike 3/Pack	Keyed Alike 6/Pack
Red	123244	123236	123252	123260
Green	123245	123237	123253	123261
Blue	123246	123238	123254	123262
Yellow	123247	123239	123255	123263
White	123248	123240	123256	123264
Black	123249	123241	123257	123265
Brown	123250	123242	123258	123266
Purple	123251	123243	123259	123267

When keyed alike, all locks in a set can be opened with the same key. This option is beneficial when multiple locks are assigned to a single employee.



Available With Nylon Or Steel Shackles

Safety Padlocks

- Lightweight, nonconductive and non-sparking body
- Special 6-pin cylinder resists tampering
- Fiberglass reinforced nylon body
- Two shackles options: triple-coated hardened steel shackle or nylon
- Service temperature: 0°–250° F (-20°–120° C)
- Lock body dimensions: 1-3/4"H x 1-1/2"W x 4/5"D
- Shackle diameter: 1/4"
- Each padlock includes 1 key and one each English, Spanish and French labels

Safety Padlocks - 1-1/2" Nylon Shackle

Color	Keyed Different 1/Pack	Keyed Different 6/Pack	Keyed Alike 3/Pack	Keyed Alike 6/Pack
Red	123324	123351	123333	123342
Green	123326	123353	123335	123344
Orange	123328	123355	123337	123346
Blue	123325	123352	123334	123343
Yellow	123327	123354	123336	123345
Brown	123330	123357	123339	123348
White	123332	123359	123341	123350
Purple	123331	123358	123340	123349
Black	123329	123356	123338	123347

When keyed alike, all locks in a set can be opened with the same key. This option is beneficial when multiple locks are assigned to a single employee.

Safety Padlocks - 1-1/2" Steel Shackle

Color	Keyed Different 1/Pack	Keyed Different 6/Pack	Keyed Alike 3/Pack	Keyed Alike 6/Pack
Red	99552	51339	105886	105890
Green	99564	51345	105889	105893
Orange	99576	51347	123268	123270
Blue	99556	51344	105887	105891
Yellow	99570	51346	105888	105892
Brown	103033	101956	118947	118948
White	143123	118925	118949	118950
Purple	104919	104916	118951	118952
Black	99580	51353	123269	123271

When keyed alike, all locks in a set can be opened with the same key. This option is beneficial when multiple locks are assigned to a single employee.

Lockout / Tagout

www.BradyID.com/PetroChem

Lockout / Tagout



Aluminum Padlocks

- Lightweight yet rugged with solid aluminum body and shackle - lightest-weight aluminum lock in the market and made from recycled material
- 6-pin cylinder offers more unique key changes, better tamper resistance
- Reserved paracentric keyway provides optimal security (prevents someone from getting a copy made at a local key shop)
- FDA approved lubricant in cylinder
- Anodized aluminum finish gives better fade resistance when used outdoors
- Key retaining safety feature prevents key from being removed until closed
- Aluminum shackle has superior spark and corrosion resistance
- Two shackle sizes: 1" and 1-1/2", shackle diameter: 1/4"
Lock body: 1-3/5"H x 1-1/2"W x 3/4"D
- Each padlock includes 2 keys. Custom keying and charting also available. Lock labels sold separately.

Aluminum Padlocks - 1" Shackle

Color	Keyed Different 1/Pack	Keyed Different 6/Pack
Red	99608	51360
Blue	99609	51361
Green	99610	51362
Yellow	99611	51363
Orange	99612	51368
Black	99613	51369
Brown	104574	104575
Purple	104572	104573
Silver	123320	123322

Aluminum Padlocks - 1-1/2" Shackle

Color	Keyed Different 1/Pack	Keyed Different 6/Pack	Keyed Alike 3/Pack	Keyed Alike 6/Pack
Red	99615	51370	105902	105882
Blue	99616	51371	105903	105883
Green	99617	51376	105881	105885
Yellow	99618	51377	105904	105884
Orange	99619	51378	123432	123437
Black	99620	50274	123433	123438
Brown	104578	104579	123434	123439
Purple	104576	104577	123435	123440
Silver	123321	123323	123436	123441

When keyed alike, all locks in a set can be opened with the same key. This option is beneficial when multiple locks are assigned to a single employee.

Aluminum Padlocks - 3" Shackle

Color	Keyed Different 1/Pack	Keyed Different 6/Pack	Keyed Alike 3/Pack	Keyed Alike 6/Pack
Red	123293	123284	123302	123311
Blue	123294	123285	123303	123312
Green	123295	123286	123304	123313
Yellow	123296	123287	123305	123314
Orange	123297	123288	123306	123315
Black	123298	123289	123307	123316
Brown	123299	123290	123308	123317
Purple	123300	123291	123309	123318
Silver	123301	123292	123310	123319

When keyed alike, all locks in a set can be opened with the same key. This option is beneficial when multiple locks are assigned to a single employee.



Need Additional Padlock Labels?

Use these labels in addition to Brady's safety, steel and aluminum padlocks to send a clear message to workers when a machine is down for service or maintenance.



Safety Padlock Labels

- Durable vinyl labels accept pencil, pen or marker
- Designed to fit Safety Padlocks
- Labels supplied multiple languages

Catalog #	Description	Qty.
51379	English/Spanish/ French	6 of each language



Steel Padlock Labels

- Durable B-826 vinyl labels include overlaminated strips. Labels accept using pencil, pen or marker.
- Designed to fit Steel Padlocks

Catalog #	Description	Size	Qty.
50280	English	3/4"H x 4-1/2"W	6
50281	Spanish	3/4"H x 4-1/2"W	6
50283	French	3/4"H x 4-1/2"W	6



Aluminum Padlock Labels

- Durable B-826 vinyl labels accept pencil, pen or marker
- Designed to fit Aluminum Padlocks

Catalog #	Description	Size	Qty.
50289	English	0.8"H x 1.1"W	6
50292	Spanish	0.8"H x 1.1"W	6
50293	French	0.8"H x 1.1"W	6

Standard Lockout Tags

Communicate safety and lockout information at the point of need with Brady's wide selection of OSHA-compliant Lockout/Tagout tags. Brady's Lockout Tags come in a variety of materials and legends to suit your application needs.

Available Tag Materials:

Heavy Duty Polyester (B-837)

- Durable polyester laminate completely encapsulates and protects graphics
- Withstands moisture, grease, chemicals, and extreme temperatures
- Accepts pencil, pen and marker. Pen and marker can be completely erased using isopropyl alcohol
- Heavy duty construction withstands up to 80 lbs of pull force
- 3/8" dia. heavy-duty brass grommet
- Includes OSHA-compliant nylon fasteners

Economy Polyester (B-851)

- Rigid polyester surface is easy to write on and stays legible longer than cardstock
- Exceeds OSHA 50 lb. pull requirement for tagout devices
- 3/8" dia. rolled brass eyelet accepts most padlock shackles
- Includes OSHA-compliant nylon fasteners

Cardstock (B-853)

- Cost-effective tags designed for one-time use
- Does NOT meet OSHA 50 lb. pull test for tagout devices, but can be used in conjunction with locks (see OSHA Tag Requirements above)
- 3/8" dia. rolled brass eyelet accepts most padlock shackles
- Includes attachment strings



Catalog #	Reverse Legend	Qty.
Heavy Duty Polyester 5-1/2" x 3"		
65502	Side B	25
65535	Side F	25
65670	Side G	25
Economy Polyester 5-3/4" x 3"		
66050	Side B	25
66051	Side F	25
66052	Side G	25
Cardstock 5-3/4" x 3"		
65407	Side B	25
65408	Side F	25
65440	Side G	25

Catalog #	Reverse Legend	Qty.
Heavy Duty Polyester 5-1/2" x 3"		
65520	Side B	25
65525	Side F	25
65671	Side G	25
Economy Polyester 5-3/4" x 3"		
66063	Side B	25
66064	Side F	25
66065	Side G	25
Cardstock 5-3/4" x 3"		
65451	Side B	25
65452	Side F	25
65453	Side G	25

Reverse Legend Options



Reverse Side B

Reverse Side F

Reverse Side G

Isolation Blind Tags

- Made from 10-mil polyester (B-851)
- 3/8" dia. hole with rolled brass eyelet
- Excellent outdoor weather resistance
- Exceeds OSHA 50-lb pull strength requirements
- Includes 25 nylon cable ties



Catalog #	Description	Qty.
132424	Economy Polyester 5-3/4" x 3"	25
132425	Economy Polyester 5-3/4" x 3"	25

Flag Style Blind Tag

- Made from 10-mil polyester (B-851)
- 3/8" diameter hole with rolled brass eyelet
- Excellent outdoor weather resistance, highly visual for safety warnings
- Exceeds OSHA 50-lb pull strength requirements
- Includes 25 nylon cable ties



Catalog #	Legend	Size	Color	Qty.
132452	Install Blind Here	2" x 20"	Black on Green	25
132453	Isolation Blind	2" x 20"	Black on Red	25
132454	Blind Installed	2" x 20"	Black on Red	25



Customize it!

Custom printed blind tags with perforated, detachable stubs also available. Call a Brady representative for more information.

Lockout / Tagout

www.BradyID.com/PetroChem

Lockout / Tagout



Portable Metal Group Lockout Boxes

- Made of heavy duty steel, powder-coated for extra rust resistance
- 12 lock holes on lid, plus one lockable clasp on front
- Standard lock box: 6"H x 9"W x 3-1/2"D
When used for storage, holds up to 40 padlocks
- Extra -large lock box: 6"H x 7-3/8"W x 9-1/2"D
- When used for storage, holds up to 75 padlocks

Catalog #	Description	Size
65699	Red - Standard	6"H x 9"W x 3-1/2"D
51171	Red - XL	6"H x 7-3/8"W x 9-1/2"D

* Padlocks sold separately.



Steel Group Lockout Hasps

- Constructed of vinyl-coated high tensile steel w/ rust resistant plating
- Lock holes: 3/8" diameter

Catalog #	Description	Qty.
65375	1" Diameter Jaws	12
65376	1-1/2" Diameter Jaws	12



Combined Lock Storage / Group Lockout Box

- Handy box features a lockable storage compartment and a group lockout compartment.
- Made of heavy duty steel, powder coated for extra rust resistance
- Lockout compartment has clear window with keyhole slot
- Standard box: 12-1/2"L x 7-1/2"W x 6"D
Compartment: 8-1/2"L x 6"W x 6"D
Compartment holds approx. 50 locks
17 lock holes in group lock box lid
- Large box: 15"L x 10 1/2"W x 9"D
Compartment: 10-1/2"L x 9"W x 9"D
Compartment holds approx. 125 locks
34 padlock holes in group lock box lid

Catalog #	Description	Size
105716	Standard	12-1/2"L x 7-1/2"W x 6"D
105717	Large	15"L x 10-1/2"W x 9"D

* Padlocks sold separately.



Steel Group Lockout Hasps with Tabs

- Tamperproof interlocking tabs prevent unauthorized opening
- Case-hardened steel with rust proof plating and bright red vinyl insulation.
- Maximum 3/8" shackle diameter

Catalog #	Description	Qty.
105718	1" Diameter Jaws	1
105719	1-1/2" Diameter Jaws	1



Metal Wall-Mounted Group Lockout Boxes

- Made of durable, powder-coated steel with key slot on top
- Clear window slides out when locks are removed
- Comes with key pegs and ID labels to simplify key management
- Pre-drilled holes and hardware included for quick mounting
- Small lock box: 7"H x 8"W x 2-1/4"D
7 key pegs that hold 5 keys each
7 lock holes along bottom
- Large lock box: 7"H x 16"W x 2-1/4"D
15 key pegs that hold 5 keys each
12 lock holes along bottom

Catalog #	Description
105714	Small Metal Lock Box
105715	Large Metal Lock Box

* Padlocks sold separately.



Corrosion-Resistant Group Lockout Hasps

- 12 gauge steel is epoxy coated to give superior rust resistance and added dielectric strength
- Yellow plastic coating for added visibility
- Lock holes: 5/16" diameter

Catalog #	Description	Qty.
T218	1" diameter	1
T220	1-1/2" diameter	1



5-Lock Board

- Dimensions: 11-1/2"H x 15-1/2"W
- Components:
 - 6 - Keyed different safety padlocks (99552) or steel padlocks (99500)
 - 1 - 1" Metal hasp (65375)
 - 1 - 1-1/2" Metal hasp (65376)
 - 12 - Heavy duty tags (65520)

Catalog #	Description
51181	5-Lock Board & 5 Safety Padlocks
51186	5-Lock Board & 5 Steel Padlocks
50989	5-Lock Board (Board Only)



10-Lock Board

- Dimensions: 13-1/2"H x 13-1/2"W
- Components:
 - 10 - Keyed different safety padlocks (99552) or steel padlocks (99500)
 - 2 - 1" Metal hasps (65375)
 - 2 - 1-1/2" Metal hasps (65376)
 - 12 - Heavy duty tags (65520)

Catalog #	Description
51187	10-Lock Board & 10 Safety Padlocks
51188	10-Lock Board & 10 Steel Padlocks
50990	10-Lock Board (Board Only)

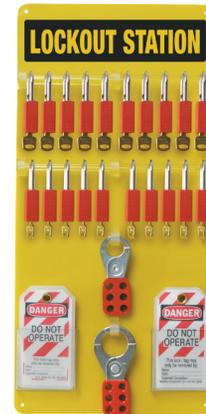

20-Lock Board

- Dimensions: 23-1/2"H x 11-1/2"W
- Components:
 - 20 - Keyed different safety padlocks (99552) or steel padlocks (99500)
 - 2 - 1" Metal hasps (65375)
 - 2 - 1-1/2" Metal hasps (65376)
 - 24 - Heavy duty tags (65520)

Catalog #	Description
51189	20-Lock Board & 20 Safety Padlocks
51194	20-Lock Board & 20 Steel Padlocks
50991	20-Lock Board (Board Only)



36-Lock Board

- Dimensions: 21-1/2"H x 23-1/2"W
- Components:
 - 36 - Keyed different safety padlocks (99552) or steel padlocks (99500)
 - 3 - 1" Metal hasps (65375)
 - 3 - 1-1/2" Metal hasps (65376)
 - 36 - Heavy duty tags (65520)

Catalog #	Description
51195	36-Lock Board & 36 Safety Padlocks
51196	36-Lock Board & 36 Steel Padlocks
50992	36-Lock Board (Board Only)

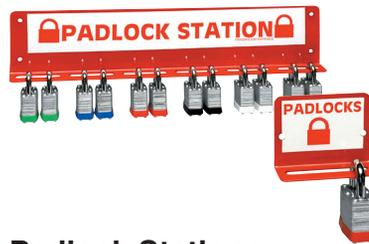

Padlock Stations

- Constructed of 14 gauge steel with red plastic coating
- Small station holds up to 4 padlocks (2-1/4"H x 3"W x 1-1/4"D)
- Large station holds up to 24 padlocks (3"H x 16"W x 1-1/4"D)

Catalog #	Description
LR060E	Small Padlock Station
LR360E	Large Padlock Station

* Padlocks sold separately.

LOCKOUT STATION



Lockout Tagout Online

For additional lock boards, plus other lockout storage devices, kits and carrying cases, visit: www.BradyID.com/lockouttagout



Hazard Communication

www.BradyID.com/PetroChem

Hazard Communication OSHA Standards and GHS (Globally Harmonized System) Compliance

The Occupational Safety and Health Administration (OSHA) Federal Hazard Communication Standard 29 CFR 1910.1200 has become known as the "Right-To-Know" law. This standard gives both employers and employees a right-to-know about the hazardous chemicals they use in the workplace. It is designed to reduce the incidence of chemical source injury and illness in the workplace. In order to accomplish this, employers are required to:

1. Have Safety Data Sheets (SDS) on file for every hazardous chemical in the workplace available to all employees during their work shift.
2. Train employees about the potential hazards, how to identify and safely work with hazardous chemicals and the proper personal protection necessary when working with hazardous chemicals. Employees must be trained before they start a work assignment.
3. Identify and list all of the hazardous chemicals in the workplace.

4. Have a written hazard communication program available for employees, OSHA and outside contractors who enter the workplace.
5. Have labels on all hazardous chemical containers that:
 - List the name and address of the manufacturer
 - List the chemical name
 - List the hazardous and pre-cautionary statements that exist
 - Show applicable health or chemical pictograms
 - Are easily related to the appropriate SDS on file
6. Maintain reports, records and logs for the entire program.
7. Certain states require that you report all of this information to a state agency, department of labor, health department or fire department depending on the state law in effect.

Hard work is necessary to come into compliance with the law. Brady offers a wide variety of products to keep your work to a minimum, while enabling you to implement a complete program that will bring your company into compliance with the Hazard Communication Standard.

GHS (Globally Harmonized System) Compliance

GHS is an acronym for the The Globally Harmonized System of Classification and Labelling of Chemicals. The GHS standard is an international standard created by the United Nations for the purpose of classifying and labelling hazardous chemicals. A majority of countries globally have adopted and are enforcing most elements of the GHS with their regulatory agencies having jurisdiction for this public safety concern.

GHS Status in the U.S.

OSHA published an updated Hazard Communications standard in 2012 that incorporates the major elements of the GHS. A 3 year transitional period allows companies' time to fully implement the new standards in their facilities.

GHS Status around the World

The European Union is already well along the path to full implementation of GHS (referred to as CLP, Classification for Labelling & Packaging, by the EU), and countries in Asia are quickly following in its footsteps.

GHS Workshops Available!

Brady's 3-day GHS Workshops engage participants to visually transform a focus area from current hazcomm labeling into a GHS-compliant area. During these workshops, Brady compliance experts will lead your employees through:

- GHS regulations and pictograms education
- Defining and creating labels using the new standard
- Training on new label requirements and SDS format

Custom GHS Labels Available

All organizations that ship, receive, handle, and maintain potentially hazardous chemicals are impacted by the GHS standard.

- Create your own GHS-compliant labels through your MarkWare™ software on printers such as the Globalmark®2 Industrial Printer and the BBP®31 Sign & Label Printer.
- Brady will also create and print custom GHS labels to your specific labeling requirements:
 - Create labels in English, Spanish, French and more
 - Available in a variety of sizes to fit your needs
 - Contact us at: 1-888-250-3082



Learn more with free downloads from www.BradyID.com/GHS

- Introduction to the Globally Harmonized System Whitepaper
- Safety Data Sheet (SDS) Requirements Document
- Five Steps to Compliant Hazard Communication Program Whitepaper
- Hazard Communication FAQ
- GHS Pictogram and Quick Tips

Pre-Printed GHS Labels

Pre-printed die cut labels identify hazardous products for chemical risks, health risks and environmental risks in accordance to the United Nations' universal approach to classifying and communicating chemical hazards.



GHS Explosive

- Explosives, self-reactives, organic peroxides

Explosive Legend

Catalog #	Size	Material	Qty.
B-7569 Vinyl			
118815	5/8"	B-7569 Vinyl	39/card
118816	1"	B-7569 Vinyl	16/card
118817	2"	B-7569 Vinyl	4/card
B-235 Paper			
118869	5/8"	B-235 Paper	39/card
118870	1"	B-235 Paper	16/card
118871	2"	B-235 Paper	4/card



GHS Flammable

- Flammable gases, liquids, and solids; pyrophorics; self-reactives; self-heating

Flammable Legend

Catalog #	Size	Material	Qty.
B-7569 Vinyl			
118821	5/8"	B-7569 Vinyl	39/card
118822	1"	B-7569 Vinyl	16/card
118823	2"	B-7569 Vinyl	4/card
B-235 Paper			
118875	5/8"	B-235 Paper	39/card
118876	1"	B-235 Paper	16/card
118877	2"	B-235 Paper	4/card



GHS Oxidizing

- Oxidizers, organic peroxides

Oxidizing Legend

Catalog #	Size	Material	Qty.
B-7569 Vinyl			
118827	5/8"	B-7569 Vinyl	39/card
118828	1"	B-7569 Vinyl	16/card
118829	2"	B-7569 Vinyl	4/card
B-235 Paper			
118881	5/8"	B-235 Paper	39/card
118882	1"	B-235 Paper	16/card
118883	2"	B-235 Paper	4/card



GHS Gas Pressure

- Gases under pressure

Gas Pressure Legend

Catalog #	Size	Material	Qty.
B-7569 Vinyl			
118881	5/8"	B-7569 Vinyl	39/card
118882	1"	B-7569 Vinyl	16/card
118883	2"	B-7569 Vinyl	4/card
B-235 Paper			
118887	5/8"	B-235 Paper	39/card
118888	1"	B-235 Paper	16/card
118889	2"	B-235 Paper	4/card



GHS Corrosive

- Corrosives

Corrosive Legend

Catalog #	Size	Material	Qty.
B-7569 Vinyl			
118839	5/8"	B-7569 Vinyl	39/card
118840	1"	B-7569 Vinyl	16/card
118841	2"	B-7569 Vinyl	4/card
B-235 Paper			
118893	5/8"	B-235 Paper	39/card
118894	1"	B-235 Paper	16/card
118895	2"	B-235 Paper	4/card



GHS Severe Toxic

- Severe toxicity

Severe Toxic Legend

Catalog #	Size	Material	Qty.
B-7569 Vinyl			
118845	5/8"	B-7569 Vinyl	39/card
118846	1"	B-7569 Vinyl	16/card
118847	2"	B-7569 Vinyl	4/card
B-235 Paper			
118899	5/8"	B-235 Paper	39/card
118900	1"	B-235 Paper	16/card
118901	2"	B-235 Paper	4/card



GHS Health Danger

- Carcinogens, respiratory sensitizers, reproductive toxicity, target organ toxicity, germ cell mutagens

Health Danger Legend

Catalog #	Size	Material	Qty.
B-7569 Vinyl			
118851	5/8"	B-7569 Vinyl	39/card
118852	1"	B-7569 Vinyl	16/card
118853	2"	B-7569 Vinyl	4/card
B-235 Paper			
118905	5/8"	B-235 Paper	39/card
118906	1"	B-235 Paper	16/card
118907	2"	B-235 Paper	4/card



GHS Acute Toxic

- Acute toxicity, skin and eye irritation, skin sensitizers

Acute Toxic Legend

Catalog #	Size	Material	Qty.
B-7569 Vinyl			
118857	5/8"	B-7569 Vinyl	39/card
118858	1"	B-7569 Vinyl	16/card
118859	2"	B-7569 Vinyl	4/card
B-235 Paper			
118911	5/8"	B-235 Paper	39/card
118912	1"	B-235 Paper	16/card
118913	2"	B-235 Paper	4/card



GHS Environmental

- Aquatic toxicity

Environmental Legend

Catalog #	Size	Material	Qty.
B-7569 Vinyl			
118863	5/8"	B-7569 Vinyl	39/card
118864	1"	B-7569 Vinyl	16/card
118865	2"	B-7569 Vinyl	4/card
B-235 Paper			
118917	5/8"	B-235 Paper	39/card
118918	1"	B-235 Paper	16/card
118919	2"	B-235 Paper	4/card

Hazard Communication

www.BradyID.com/PetroChem



NFPA Placard Kits

- Vinyl kits includes: 10 blank NFPA placards, and 10 characters each of 0 – 4, W, OXY, ACID, COR and ALK
- Fiberglass kits includes: 1 blank NFPA placard, and 10 characters each of 0 – 4, W, OXY, ACID, COR and ALK

Catalog #	Description	Size	Qty.
50053	B946 Vinyl	10" sq	4"
50055	B120 Fiberglass	11" sq	4"
50054	B946 Vinyl	15" sq	6"
50056	B120 Fiberglass	16" sq	6"

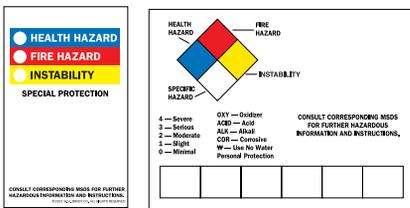

3" x 5" RTK Labels

- Customize these Blank R-T-K Labels by writing your own message on them and adding R-T-K pictograms.

Catalog #	Material	Format	Qty.
121056	Vinyl	NFPA	50



GHS SDS Binders

- Complies with OSHA regulations
- 1.5" dia. ring holds 275-300 sheets
- 3" dia. ring holds 600 sheets
- Durable polyethylene cover, a 36" chain and a pair of sheet lifters

Catalog #	Description
121183	1.5" SDS Binder, English
121184	3" SDS Binder, English
121185	1.5" SDS Binder, English/Spanish
121186	3" SDS Binder, English/Spanish
121187	3" SDS Binder, English/French



Blank NFPA Placards

- Meets NFPA's Code No. 704M and Federal Standard 313
- Place directly on tanks, tanks and vessels, feed hoppers, pipelines and other potentially hazardous equipment
- Use with adhesive numbers and symbols (sold separately)

Catalog #	Description	Size	Qty.
58656	B-120 Fiberglass	11" sq.	1
58510	B-120 Fiberglass	16" sq.	1
58503	B-946 Vinyl	10" sq.	10
58504	B-946 Vinyl	15" sq.	10

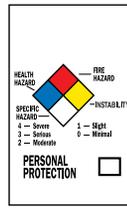

NFPA



HMIG Color Bar

2" x 1-1/4" RTK Labels

- NFPA Diamond or HMIG Color Bar
- Write-on labels allow you to customize your message.

Catalog #	Material	Format	Qty.
58268	Paper	HMIG Color Bar	500
121149	Vinyl	HMIG Color Bar	500
58270	Paper	NFPA	500
121150	Vinyl	NFPA	500



GHS SDS Centers

- 20"H x 14"W x 4.5"D center offered in English and English/Spanish
- Includes 1.5" SDS binder, "Right To Know Compliance Center" backboard, and yellow wire rack

Catalog #	Description
121370	SDS Center – English
121371	SDS Center – English/Spanish



Numbers and Hazard Symbols for NFPA Placards

- Vinyl film w/ permanent adhesive
- Tough outdoor grade self-sticking vinyl characters are black Gothic style (except for magenta radiation trefoil).

Catalog #	Legend	Size	Color	Qty
Numbers and symbols for 10" to 11" Placards				
5140-0	0	4"	Black	10
5140-1	1	4"	Black	10
5140-2	2	4"	Black	10
5140-3	3	4"	Black	10
5140-4	4	4"	Black	10
58672	ACID	2"	Black	10
58693	ALK	2"	Black	10
58688	COR	2"	Black	10
58508	No water symbol	4"	Black	10
58667	OXY	2"	Black	10
58604	Radiation trefoil	4"	Magenta	10

Catalog #	Legend	Size	Color	Qty
Numbers and symbols for 15" to 16" Placards				
5180-0	0	6"	Black	10
5180-1	1	6"	Black	10
5180-2	2	6"	Black	10
5180-3	3	6"	Black	10
5180-4	4	6"	Black	10
121053	ACID	3"	Black	10
121055	ALK	3"	Black	10
121054	COR	3"	Black	10
58509	No water symbol	6"	Black	10
121052	OXY	3"	Black	10
58606	Radiation trefoil	3"	Magenta	10

DOT Placard Signs

Brady also offers placards signs that meet DOT 49CFR Part 172 requirements. These placards are available in a variety of materials and legends.

See page 12 or visit www.BradyID.com to view all placard signs.

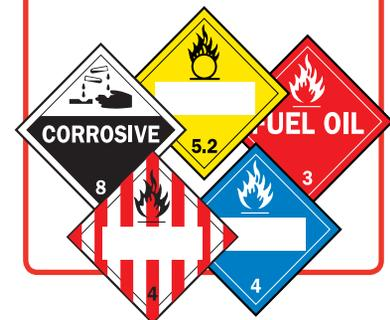



Custom GHS Chemical Labels

Create your own GHS-compliant secondary container labels using MarkWare™ software and the GlobalMark® label printer. Or Brady can also create custom-printed GHS labels to meet your specific requirements:

- Create labels in English, Spanish, French and more
- Available in a variety of sizes

To order: use the form on page 48 or contact a Brady representative.



MarkWare™ Software now includes a GHS / CLP Label Module

- 18 pre-formatted label layouts and approved GHS symbols are built-in
- User selects approved pre-worded hazard statements and GHS symbols which then automatically populates into layout – no need to type everything in
- Prompts for additional variable data which then auto-populates into layout
- Choose a second language and MarkWare auto-populates in the second language
- Contains templates for Globalmark®, BBP®31 and BBP®33 Label Printers

Catalog #	Description
20700	MarkWare™ Software

Already a MarkWare Software user?
Upgrade your current MarkWare to v3.9.1
for the GHS / CLP Label Module. Go to
www.BradyID.com/markware

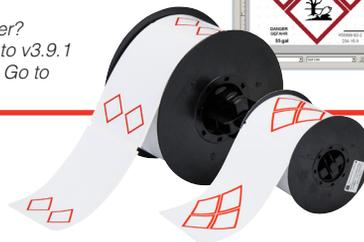

GHS Format



GHS and HMIG Format



GHS and NFPA Format

Custom Tank and Vessel Signs

Brady can also create custom tank and vessel signs to meet your specifications. These signs can be formatted to conform to NFPA or GHS standards. Brady also offers a version that includes both NFPA ratings and GHS pictograms with hazard statements. In addition to physical and health hazards, the signs can also show tank ID information, target organ warnings, PPE requirements, emergency response instructions and storage/mixing guidelines.

Choose from:

- Two sizes: 10" x 14" or 14" x 20"
- Three materials: fiberglass, self-sticking vinyl, or BradyTuff plastic

To order: use the form on page 49 or contact a Brady representative.



Chemical Signs Also Available

Brady offers a variety of chemical signs that can be used to identify your plant's chemical storage and hazardous materials areas. Chemical signs and hazardous material signs are available in a variety of sizes and materials, including photoluminescent and glow-in-the-dark.

View the hazardous chemical signs on page 12 or visit www.BradyID.com.

Hazard Communication

www.BradyID.com/PetroChem

Custom GHS Label Form

When ordering a Custom GHS Label from Brady, please have a Safety Data Sheet (SDS) in hand to fill in the form. The SDS, supplied from your chemical manufacturer must be up-to-date with GHS elements. All required label elements that are needed to fill this form out are found in sections 1-3 in your chemical SDS. (Once label has been created a proof is required.) Once complete, return this form to BradyUSAQuotes@BradyCorp.com or fax to 1-800-292-2289.

Customer Information

Company Name: _____ Name: _____
Address 1: _____ Phone #: _____
Address 2: _____ Fax #: _____
City: _____ State: _____ Zip: _____
Email: _____

Distributor Information

Distributor: _____ Contact Name: _____
Account: _____ Fax #: _____ Phone #: _____

Label Specifications

Label Material

- B-235 Coated Paper
- B-302 Self-Sticking Polyester
- B-7569 Self-Sticking Vinyl

Quantity and Size

(minimum order qty. of 25)

- 3" x 5" Qty. _____
- 4" x 6" Qty. _____
- 4.5" x 7" Qty. _____

Label Package

- Roll Form
- Individual Labels

Label Content

Chemical/Product Name:

Signal Word:

(DANGER or WARNING)

Capacity: _____

Units:

Hazard Statements:

Located on your Safety Data Sheet, please include H-Code if available. i.e. H100

Precautionary Statements/First Aid:

Located on your Safety Data Sheet, please include P-Code if available. i.e. P100

GHS Pictograms:

Locate on your Safety Data Sheet and indicate pictogram number below:
1 Minimum / Maximum 4

Diamond 1: _____ Diamond 3: _____

Diamond 2: _____ Diamond 4: _____



1. Corrosive 2. Severe Toxic 3. Explosive 4. Flammable 5. Environmental



6. Acute Toxic 7. Oxidizing 8. Gas Pressure 9. Health

Additional Label Content:

EC #: _____

CAS #: _____

Index #: _____

Reach Authorization #: _____

Internal Reference #: _____

Chemical Manufacturer Name: _____

Chemical Manufacturer Address: _____

Emergency Contact Phone #: _____

Multiple Languages Requested* _____

* Please indicate languages requested, then provide the necessary translations to the customer service representative after you have received the initial English proof.

Custom Tank & Vessel Signs Order Form

When ordering a Custom GHS Tank & Vessel Sign from Brady, please have a Safety Data Sheet (SDS) in hand to fill in the form. The SDS, supplied from your chemical manufacturer must be up-to-date with GHS elements. All required label elements that are needed to fill this form out are found in sections 1-3 in your chemical SDS. (Once label has been created a proof is required.) Once complete, return this form to BradyUSAQuotes@BradyCorp.com or fax to 1-800-292-2289.

Customer Information

Company Name: _____ Name: _____
 Address 1: _____ Phone #: _____
 Address 2: _____ Fax #: _____
 City: _____ State: _____ Zip: _____
 Email: _____

Distributor Information

Distributor: _____ Contact Name: _____
 Account: _____ Fax #: _____ Phone #: _____

Label Specifications

Label Material	Quantity and Size
<input type="checkbox"/> B-120 Fiberglass	<input type="checkbox"/> 10" x 14" Qty. _____
<input type="checkbox"/> B-302 Self-Sticking	<input type="checkbox"/> 14" x 10" Qty. _____
<input type="checkbox"/> B-401 Vinyl Plastic	<input type="checkbox"/> 20" x 14" Qty. _____

Label Package



Format 1



Format 2



Format 3

Label Content

Tank #: _____

Chemical Name: _____

Signal Word: _____
 (DANGER or WARNING)

Hazard Statements: _____
 Located on your Safety Data Sheet, please include H-Code if available. i.e. H100

Precautionary Statements/First Aid: _____
 Located on your Safety Data Sheet, please include P-Code if available. i.e. P100

GHS Pictograms:
 Located on your Safety Data Sheet, indicate pictogram number below:
 1 Minimum / Maximum 4

Diamond 1: _____ Diamond 3: _____
 Diamond 2: _____ Diamond 4: _____



NFPA Rating:
 Health ____ Fire ____ Instability ____ Specific ____

HMIG Rating:
 Health ____ Fire ____ Instability ____ Specific ____

Protective Equipment Required Pictograms:
 Choose up to 6 icons.

PPE 1: _____ PPE 3: _____ PPE 5: _____
 PPE 2: _____ PPE 4: _____ PPE 6: _____



Additional Label Content:
 DOT Class: _____
 DOT ID #: _____
 CAS #: _____
 Reach Authorization #: _____
 Internal Reference #: _____
 Chemical Manufacturer: _____
 Chemical Manufacturer Name: _____
 Chemical Manufacturer Address: _____
 Emergency Contact Phone #: _____
 Confined Space Entry Permit Required? Yes No

Confined Space

www.BradyID.com/PetroChem

Confined Space

Confined Space Tags

- Heavy duty laminated polyester tags completely encapsulates and protects graphics while withstanding moisture, grease, chemicals, and extreme temperatures (Includes nylon fasteners)
- Economy rigid polyester tags feature a surface that is easy to write on and stays legible longer than cardstock (Includes nylon fasteners)

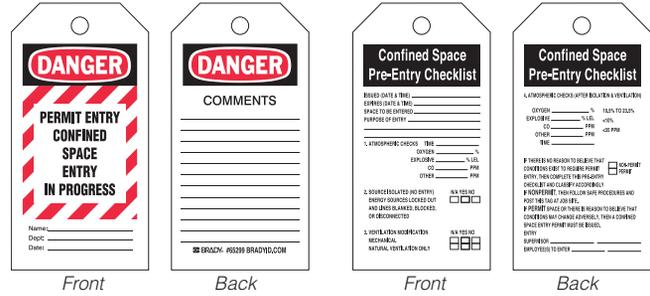

Catalog #	Description	Qty.
65299	Heavy Duty Laminated	25
65270	Economy Polyester	25

Catalog #	Description	Qty.
66322	Heavy Duty Laminated	25
66324	Economy Polyester	25

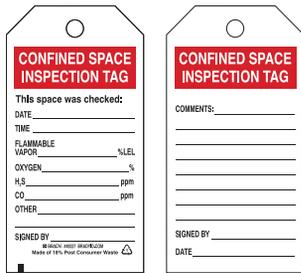

Catalog #	Description	Qty.
50275	Heavy Duty Laminated	25
49227	Economy Polyester	25



Catalog #	Description	Qty.
50248	Heavy Duty Laminated	25
50282	Economy Polyester	25



Catalog #	Description	Qty.
50287	Heavy Duty Laminated	25
50286	Economy Polyester	25



Catalog #	Description	Qty.
50291	Heavy Duty Laminated	25
50290	Economy Polyester	25



Confined Space Permit Holder & Entry Permits

- Provides a confined space warning and easy access to permits
- Made of durable polycarbonate material
- Holds 8-1/2" x 11" forms
Holder dimensions: 12" x 19"
- Permits/forms sold separately

Catalog #	Description
65903	Permit Holder
65937	2-ply Carbonless (25/pk)



Confined Space Floor Stand

- Post cautionary floor stands at all confined space entry points to alert employees of the work in process
- Made of lightweight, high-impact plastic and are printed with the same message on both sides.
- Size is 20"H x 12"W including handle.

Catalog #	Legend	Size
52392	Danger Confined Space (w/ permit holder)	20" x 12"



Confined Space Entry Tag®

Works in conjunction with existing permit to work systems and assist with the requirements of CFR 1910.146 (c) (2), (d) (11) and (f) (2). The system clearly states the minimum requirements of entry to the confined space or whether the area is in prohibition and cannot be entered.

Catalog #	Description	Size	Qty.
ENT-ETSH157	Entrytag Holder	11-1/4" x 6"	10
ENT-ETSI532	Standard Inserts	5-3/4" x 7-5/8"	100
MUL-EITL 230	Man In Tank Tag	2" x 6-1/2"	100
ENT-ETSH157A	Entry Tag Kit*		1

*Kit includes 10 holders, 20 status inserts and 1 pen



Confined Space Signs

Brady's variety of safety signs warn of hazards when entering a confined space. Choose from signs prohibiting entrance or signs to communicate required personal protection.

- View confined space signs on page 14 or visit www.BradyID.com



Self-Laminating Tags

- Constructed of Brady's durable B-851 polyester with a 1 mil polyester overlay



Front Back

Catalog #	Description	Size	Qty.
86456	Economy Poly.	3"x5-3/4"	10
86514	Economy Poly.	4"x7"	10



Front Back

Catalog #	Description	Size	Qty.
86457	Economy Poly.	3"x5-3/4"	10
86515	Economy Poly.	4"x7"	10



Front Back

Catalog #	Description	Size	Qty.
86458	Economy Poly.	3"x5-3/4"	10
86516	Economy Poly.	4"x7"	10



Front Back

Catalog #	Description	Size	Qty.
86459	Economy Poly.	3"x5-3/4"	10
86517	Economy Poly.	4"x7"	10

Inspection Tags

- Inform employees that equipment has been inspected and is safe and in working order
- Ideal to indicate when machines or facility equipment is scheduled for inspection or repair, or to inform employees about the status of the maintenance process
- Tags meet OSHA Standard 1910.145 for accident prevention



Front Back

Catalog #	Description	Size	Qty.
86437	Laminated	3"x5-3/4"	10



Front Back

Catalog #	Description	Size	Qty.
86625	Economy Poly.	4"x7"	10



Front Back

Catalog #	Description	Size	Qty.
86614	Economy Poly.	4"x7"	10



Front Back

Catalog #	Description	Size	Qty.
86442	Laminated	3"x5-3/4"	10
86556	Economy Poly.	3"x5-3/4"	10
86611	Economy Poly.	4"x7"	10
86666	Cardstock	3"x5-3/4"	100



Front Back

Catalog #	Description	Size	Qty.
86620	Economy Poly.	4"x7"	10
86675	Cardstock	3"x5-3/4"	100

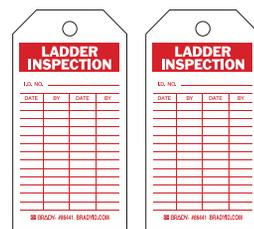

Front Back

Catalog #	Description	Size	Qty.
86441	Laminated	3"x5-3/4"	10



Front Back

Catalog #	Description	Size	Qty.
86624	Economy Poly.	4"x7"	10

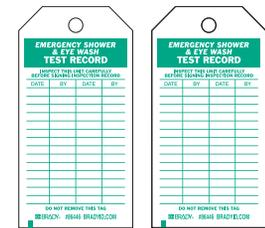

Front Back

Catalog #	Description	Size	Qty.
86446	Economy Poly.	3"x5-3/4"	10
86560	Economy Poly.	3"x5-3/4"	10
86615	Economy Poly.	4"x7"	10

Self-Laminating Blank Tags

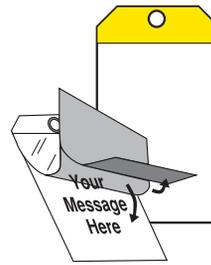

- 10 mils polyester tags flex and conform easily to cables of any size.
- Clear, self-laminating flap protects writing from water.

Catalog #	Description	Qty.
102016	5" x 2.5" White	25
102017	5" x 2.5" Yellow	25
102009	5" x 3.25" White	25
102010	5" x 3.25" Yellow	25

Accident Prevention Tags

- Size is 3" x 5-3/4" with 3/8" metal grommet
- Tags have a self-adhesive, clear overlaminating flap which is pressed over the face of the tag for permanent protection.



Front Back

Catalog #	Description	Size	Qty.
86533	Economy Poly.	3"x5-3/4"	10
86643	Cardstock	3"x5-3/4"	100



Front Back

Catalog #	Description	Size	Qty.
86418	Laminated	3"x5-3/4"	10
86537	Economy Poly.	3"x5-3/4"	10

Maintenance Tags

www.BradyID.com/PetroChem

Scaffolding Tags

- SCAFFTAG® provides system, procedural and legal compliance
- Provides a clear inspection trail giving integrity and control of work carried out
- Essential for companies working with ISO9000 clients



Catalog #	Description	Size	Color	Qty.
SCAF-STH132	Holders	11-3/4" x 3-1/2"	White	10/box
SCAF-STH146	Holders	11-3/4" x 3-1/2"	Red	10/box
SCAF-STSI593	Inspection Inserts	3-1/4" x 7-5/8"	Green	100/pkg
SCAF-STSI594	Caution Inserts	3-1/4" x 7-5/8"	Yellow	100/pkg
SCAF-STH132A	Standard Kit*	-	White	1 kit
SCAF2-STHUSA	Scaffag II Holder	11-1/2" x 6"	White	10/box
SCAF-STSI751	Inspection Inserts	5-3/4" x 7-5/8"	Green	100/pkg
SCAF2-STHUSAA	Scaffag II Kit*	-	White	1 kit

*Kits include 10 Holders, 20 Inserts and 1 Pen

Micro Tag

A safety system which is particularly useful for identifying small plant, equipment, lifting gear and safety harnesses. Color coded and date qualified, the system also has the facility to render equipment in a 'prohibition status' should it be found to be faulty between inspection dates. Meets the requirements for OSHA CFR 1926.502 (d) (21) Personal Fall Arrest systems.



Catalog #	Description	Size	Color	Qty.
MIC-MTIGPI G	Next Inspection Date Due	1-7/8" x 1-1/4"	Green	100
MIC-MTIGPI R	Next Inspection Date Due	1-7/8" x 1-1/4"	Red	100
MIC-MTIGPI Y	Next Inspection Date Due	1-7/8" x 1-1/4"	Yellow	100
MIC-MTHSTD04	Microtag Kit*	-	-	1

*Kit includes 20 holders, 40 cables ties and 1 pen

MultiTag®

Assists with the identification and preventative maintenance requirements of a range of equipment, and may assist with the requirements of CFR 1926.1053 (a) (12), (b) (17) (i) (ii) and CFR 1910.25 (d) (1) (X) US Patent # 314,016



Catalog #	Description	Size	Color	Qty.
MUL-EITHUSA01	Multitag Holder	2-1/4" x 8-1/4"	White	10
MUL-EITL535	Multitag Inserts	2" x 6-1/2"	Green	100
MUL-EITHUSA01A	Multitag Kit	-	-	1

*Kit includes 10 holders, 10 inserts and 1 pen

LadderTags™

LADDERTAG™ is a complete ladder safety management system. Regulations require ladders to be checked for damage, faults and wear before use by an authorized user, and may assist with the requirements of CFR 1926.1053 (a) (12), (b) (17) (i) (ii) and CFR 1910.25 (d) (1) (X)



Catalog #	Description	Size	Color	Qty.
LAD-EITH12	Holders	2-1/4" x 8-1/4"	White	10/box
LAD-EITL521	Inserts	2" x 6-1/2"	Yellow	100/pkg
LAD-EITH/L12	Kit*	-	White	1 kit

*Kit includes 10 holders, 10 inserts and 1 pen

Forklift™ Tag

Assists with the requirements of 1910.178 (q) (7) pre use preventative maintenance and safety inspection for forklift trucks. The FORKLIFT™ holder is permanently attached to the cage of the forklift truck and displays the prohibition sign and the script "DO NOT USE". The FORKLIFT™ insert shows in written and graphic format the daily or pre-shift, inspections be carried out by the first user.



Catalog #	Description	Size	Color	Qty.
FLT-ETSH9	Forklift Holder	11-1/2" x 6"	White	10
FLT-ETSI51	Forklift Inserts	5-3/4" x 7-5/8"	Blue/Yellow	100
FLT-ETSH9A	Forklift Kit*	-	-	1

*Kit includes 10 holders, 10 status inserts and 1 pen

Confined Space EntryTag®

Works in conjunction with existing permit to work systems and assist with the requirements of CFR 1910.146 (c) (2), (d) (11) and (f) (2). ENTRYTAG® is a visual reminder to authorized personnel and assists in instructing non authorized personnel of the critical requirements contained within the permit to work. The system clearly states the minimum requirements of entry to the confined space or whether the area is in prohibition and cannot be entered.

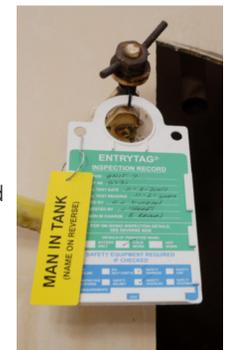

Catalog #	Description	Size	Color	Qty.
ENT-ETSH157	Entrytag Holder	11-1/4" x 6"	White	10
ENT-ETSI532	Standard Inserts	5-3/4" x 7-5/8"	Green	100
MUL-EITL 230	Man In Tank Tag	2" x 6-1/2"	Yellow	100
ENT-ETSH157A	Entry Tag Kit*	-	-	1

*Kit includes 10 holders, 20 status inserts and 1 pen

Absorbent Spill Kits

Accidents do happen, so it's better to be prepared. Brady offers a complete selection of SPC spill kits in a variety of types and sizes to equip you with everything you need to clean-up accidents when they happen. Quickly and easily clean-up spills of oils, solvents, coolants and other fluids. They are ideal for fast response to critical accidents.



Economy Spill Kit

- Highly visible yellow PVC bag for small spills; the right price, the right size and the right value
- Absorbs up to 5 gallons per kit
- Dimensions: 20" L X 16" W X 4" H
- Contents:
 - 10 pads (15" x 19")
 - 2 SOC's (3" x 4')
 - 1 disposal bag
 - 1 pair nitrile gloves
 - 1 instruction sheet

Catalog #	Type	Qty.
SKA-PP	Universal	1
SKA-PP-TAA	Universal	1
SKH-PP	Chemical	1
SKO-PP	Oil Only	1
SKR-PP	Re-Form	1



30-Gallon Spill Kit

- Tough, secure, screw-topped spill kit is reusable and ideal for small-medium responses
- Absorbs up to 36 gallons per kit
- Dimensions: 21.125"Dia. X 28.5"H
- Contents:
 - 25 pads (15" x 19")
 - 6 SOC's (3" x 12")
 - 6 pillows (18" x 18")
 - 3 disposal bags
 - 1 pair goggles
 - 1 pair nitrile gloves
 - Emergency Response Guidebook

Catalog #	Type	Qty.
SKA30	Universal	1
SKA30-TAA	Universal	1
SKO30	Oil Only	1
SKH30	Chemical	1



*Hanging rack sold separately.

Attack Pac Spill Kit

- Space saving, single use kit, packed in puncture and UV resistant foil bag (includes grommet for hanging)
- Absorbs up to 7 gallons per kit
- Dimensions: 20" L X 16" W X 4" H
- Contents:
 - 15 pads (15" x 19")
 - 3 SOC's (3" x 4')
 - 1 disposal bag
 - 1 pair goggles
 - 1 pair nitrile gloves
 - 1 instruction sheet

Catalog #	Type	Qty.
SKA-ATK	Universal	4
SKA-ATK-TAA	Universal	4
SKO-ATK	Oil Only	4
SKH-ATK	Chemical	4
SKR-ATK	Re-Form	4
ATKRO1	Hanging Rack for Attack Pack Spill Kit	1



55-Gallon Drum

- Lever locked 55-gallon drum meets UN specs and is ideal for medium spills
- Absorbs up to 38 gallons per kit
- Dimensions: 24"Dia. X 37"H
- Contents:
 - 50 pads (15" x 19")
 - 4 SOC's (3" x 12")
 - 8 pillows (18" x 18")
 - 5 disposal bags
 - 1 pair goggles
 - 1 pair nitrile gloves
 - Emergency Response Guidebook

Catalog #	Type	Qty.
SKA-55	Universal	1
SKA-55W	Universal (kit w/ wheels)	1
SKA55-TAA	Universal	1
SKO-55	Oil Only	1
SKO-55W	Oil Only (kit w/ wheels)	1
SKH-55	Chemical	1
SKH-55W	Chemical (kit w/ wheels)	1
SKR-55	Re-Form	1



20-Gallon Lab Pack

- UN-approved water and chemical resistant container with screw top lid for small-medium response
- Absorbs up to 17 gallons per kit
- Dimensions: 21"Dia. X 18"H
- Contents:
 - 12 pads (15" x 19")
 - 3 SOC's (3" x 12")
 - 2 pillows (18" x 18")
 - 3 disposal bags
 - 1 pair goggles
 - 1 pair nitrile gloves
 - Emergency Response Guidebook

Catalog #	Type	Qty.
SKA-20	Universal	1
SKA20-TAA	Universal	1
SKH-20	Chemical	1
SKO-20	Oil Only	1
SKR-20	Re-Form	1



95-Gallon Overpack

- Tough, secure, screw-topped overpack for large spills meets UN and DOT specs
- Absorbs up to 75 gallons per kit
- Dimensions: 31.5"Dia. X 35"H
- Contents:
 - 110 pads (15" x 19")
 - 12 SOC's (3" x 4')
 - 8 SOC's (3" x 12")
 - 8 pillows (18" x 18")
 - 10 disposal bags
 - 1 pair goggles
 - 1 pair nitrile gloves
 - Emergency Response Guidebook

Catalog #	Type	Qty.
SKA-95	Universal	1
SKA-95W	Universal (kit w/ wheels)	1
SKO-95	Oil Only	1
SKO-95W	Oil Only (kit w/ wheels)	1
SKH-95	Chemical	1
SKH-95W	Chemical (kit w/ wheels)	1
SKR-95	Re-Form	1

Absorbents

www.BradyID.com/PetroChem

Absorbents

Universal Absorbency Pads and Rolls

Use these all-purpose absorbents to clean-up oils, coolants, solvents and water-based fluids anywhere in your facility. Around machinery, under leaky pipes or fittings, in messy traffic areas, for general maintenance projects – they are your first choice for indoor spill control. Plus, their gray color masks spills and stains – helping you resist the urge to pick up the absorbent before it is fully saturated.



UXT - "Xtra Tough"

- Extra tough absorbents are abrasion resistant and non-abrasive
- Universal Meltblown Polypropylene core
- 3-ply (SMS) construction with spunbond coverstock on both sides

Catalog #	Type	Size	Qty.
UXT Pads			
UXT100	Heavy Wt.*	15"x19"	100
UXT300	Medium Wt.*	15"x19"	100
UXT200	Light Wt.*	15"x19"	200
UXT Rolls			
UXT15P	Heavy Wt.*	15"x150'	1
UXT30DP	Medium Wt.*	30"x150'	1

* Perforated



MRO Plus® Absorbents

- All-purpose maintenance absorbent
- 3-ply (MMM) Meltblown Polypropylene makes it durable and reduces lint

Catalog #	Type	Size	Qty.
MRO Plus Pads			
MRO50	Heavy Wt.*	30"x30"	50
MRO100	Heavy Wt.*	15"x19"	100
MRO100-2	Heavy Wt.*	15"x19"	50
MRO300	Medium Wt.*	15"x19"	100
MRO Plus Rolls			
MRO30-DP	Heavy Wt.*	30"x150'	1
MRO30P	Heavy Wt.*	30"x150'	1
MRO30	Heavy Wt.	30"x150'	1
MRO24-DP	Heavy Wt.*	24"x150'	1
MRO15-DP	Heavy Wt.*	15"x150'	1
MRO15P	Heavy Wt.*	15"x150'	1
MRO15	Heavy Wt.	15"x150'	1
MRO15-DPS	Heavy Wt.*	15"x73'	1
MRO12P	Heavy Wt.*	12"x150'	1
MRO350-DP	Medium Wt.*	30"x150'	1
MRO350	Medium Wt.	30"x150'	1
MRO315P	Medium Wt.*	15"x150'	1

* Perforated



Common Liquids Absorbed:

- Coolants & Solvents
- Gasoline & Oil
- Latex paint
- And other water-based fluids



Re-Form™ Plus Absorbents

- General purpose absorbent made from 80% recycled newsprint and cellulose
- Ideal for wiping and light foot traffic
- Spunbond coverstock on one side
- Class A fire retardant

Catalog #	Type	Size	Qty.
Re-Form Plus Pads			
RFP100	Heavy Wt.*	15"x19"	100
RFP500	Light Wt.*	15"x19"	100
Re-Form Plus Rolls			
RFP28-DP	Heavy Wt.*	28.5"x150'	1
RFP328-DP	Medium Wt.*	28.5"x150'	1
RFP314P	Medium Wt.*	14.25"x150'	1

* Perforated

Chemical Absorbency Pads and Rolls

Alert your employees to the presence of hazardous fluids with green and yellow chemical absorbents from SPC. These surfactant-treated polypropylene pads and rolls can be used on a wide range of chemicals, including hydrofluoric acid and are chemically inert, so they will not react with aggressive fluids.

CH - "Chemical" Absorbents

- Dimpled, yellow absorbent offers high visibility for your hazardous chemical applications
- Meltblown Polypropylene
- Economical single-ply absorbent made with MAXX® technology - improving adsorption and strength



Catalog #	Type	Size	Qty.
Chemical Pads			
CH100	Medium Wt.*	15"x19"	100
CH1212	Medium Wt.	12"x12"	200
CH1212-50	Medium Wt.	12"x12"	50
Chemical Rolls			
CH30DP	Medium Wt.*	30"x150'	1
CH15P	Medium Wt.*	15"x150'	1

* Perforated



Common Liquids Absorbed:

- Acids and bases
- Aggressive chemicals
- Oils
- Solvents
- Citric acid
- Water-based fluids
- Sodium hydroxide
- And other unknown chemicals

Universal Plus Absorbents

- Dimpled and perforated green universal absorbent is chemically inert and ideal for aggressive fluids
- Universal Meltblown Polypropylene
- 3-ply construction makes it stronger, more durable and reduces lint



Catalog #	Type	Size	Qty.
Universal Plus Pads			
SPCUN1719	Medium Wt.*	15"x19"	100
SPCUN1113	Medium Wt.	12"x12"	200
SPCUN1113-50	Medium Wt.	12"x12"	50
Universal Plus Rolls			
SPCUN3800	Medium Wt.*	30"x150'	1
SPCUN1019	Medium Wt.*	15"x150'	2

* Perforated

Oil Only Absorbency Pads and Rolls

Specialized for oil and other petroleum-based spills, oil only pads and rolls will not absorb water and will float indefinitely. These absorbents are unaffected by temperature and impervious to rot and mildew. Ideal for outside use, Brady's oil only SPC products are equally effective in soaking up petroleum-based solvents and paints, vegetable oils and other non-water soluble oil-based fluids.

? Common Liquids Absorbed:

- Cutting fluids
- Hydraulic and brake fluids
- Engine oils
- Lubricants
- Cooking oils
- Gasoline and diesel
- Oil based paints and solvents
- And other oil-based fluids



SXT® Oil Absorbents

- A dimpled and perforated absorbent with spunbond coverstock on both sides for durability with very low linting.
- 3-ply (SMS) construction and Oil Only Meltblown Polypropylene

Catalog #	Type	Size	Qty.
SXT Oil Pads			
SXT100	Heavy Wt.*	15"x19"	100
SXT300	Medium Wt.*	15"x19"	100
SXT200	Light Wt.*	15"x19"	200
SXT Oil Rolls			
SXT30DP	Heavy Wt.*	30"x150'	1
SXT15P	Heavy Wt.*	15"x150'	1

* Perforated



SPC® Oil Absorbents

- Dimpled and perforated absorbent made with MAXX® Technology - greater performance without the extra weight
- Convenient and cost-effective single-ply Oil Only Meltblown Polypropylene

Catalog #	Type	Size	Qty.
SPC Oil Pads			
SPC50	Heavy Wt.	33"x39"	50
SPC100	Heavy Wt.*	15"x19"	100
SPC100B	Heavy Wt. (Blue MBPP Pad)*	15"x19"	100
SPC105	Heavy Wt. (1 side w/ blue coverstock)*	15"x19"	100
SPC300	Medium Wt.*	15"x19"	100
SPC200	Light Wt.*	15"x19"	200
SPC500	Light Wt.*	15"x19"	100
SPC Oil Rolls			
SPC150	Heavy Wt.	38"x144'	1
SPC152	Heavy Wt.	19"x144'	2
SPC19150	Heavy Wt.	19"x144'	1
SPC156	Medium Wt. (1 side w/blue coverstock)*	30"x150'	1

* Perforated



Re-Form™ Oil Only Absorbents

- Repels water and floats making it ideal for outdoor applications.
- Absorbs more than 34 times its weight in liquid
- 40% higher absorption ratio than the next leading absorbent
- Spunbond coverstock on both sides adds durability and reduces linting
- Made from 80% all natural cotton fibers
- Supports corporate sustainability and LEED initiatives

Re-Form™ Absorbents are not intended for use with highly aggressive chemicals.

Catalog #	Type	Size	Qty.
Re-Form Oil Only Pads			
RFODP100	Heavy Wt.*	15"x19"	100
Re-Form Oil Only Rolls			
RFOP28DP	Heavy Wt.*	28.5"x150'	1
RFOP14P	Heavy Wt.*	14.25"x150'	1

* Perforated

Mat & Rug Absorbents

Absorbent mats and rugs keep aisles and walkways slip-free by absorbing and containing oils, liquids or other spills. They are constructed from durable, needle punched, polypropylene fibers. Compared to an entrance mat, absorbent mats and rugs offer better traction, reduce slipperiness and keep liquids from being tracked from one area to the next.

? Common Liquids Absorbed:

- Bases & Oils
- Chemicals
- Solvents
- Water-based fluids

TrackMat Matting

- Extremely durable 3-ply construction features UV-resistant top layer
- Ideal for outdoor use, heavy foot or vehicle traffic
- Highly absorbent polypropylene core
- Non-slip and non-leak barrier backing



Catalog #	Type	Size	Qty.
TrackMat Pads			
TM30	Heavy Wt.	29"x29"	30
TrackMat Rolls			
TM58	Heavy Wt.	58"x80'	1

BSM - Barrier Spill Matting

- Industrial rug with non-slip and leak-proof barrier backing
- Needle-punched polypropylene is durable for high traffic areas
- Tear resistant and will not curl or buckle



Catalog #	Type	Size	Qty.
BSM Rolls			
BSM300	Medium Wt.	36"x300'	1
BSM100	Medium Wt.	36"x100'	1
BSM3650	Medium Wt.	36"x50'	1

Absorbents

www.BradyID.com/PetroChem

Absorbents



BASIC Universal SOCs

- NEW economical absorbent SOC with a cellulose fill
- Suitable for most non-aggressive fluids

Catalog #	Type	Size	Qty.
BSC40	SOC	3'x42'	40
BSC20	SOC	3'x42'	20



Re-Form™ Universal SOCs

- Made from recycled newsprint and other cellulose
- Absorbs oils, solvents and water-based fluid

Catalog #	Type	Size	Qty.
MS-124	SOC	3'x12'	4
MS-806	SOC	3'x8'	6
MS-50	SOC	3'x4'	40
MS-412	SOC	3'x4'	12



Oil Only SOCs

- Specialized oil only polypropylene SOC
- Absorbs oil based liquids while repelling water
- Wringable and can be incinerated

Catalog #	Type	Size	Qty.
OIL124	SOC	3'x12'	4
OIL806	SOC	3'x8'	6
OIL430	SOC	3'x4'	30
OIL412	SOC	3'x4'	12



HAZWIK® SOCs

- Absorbs chemicals, acids and bases
- Flexible design is easily molded around spills

Catalog #	Type	Size	Qty.
HAZ124	SOC	3'x12'	4
HAZ412	SOC	3'x4'	12



ALLWIK® Universal Pillows

- All-purpose polypropylene pillow
- Suitable for most industrial applications
- Ideal for under valves and other dripping applications

Catalog #	Type	Size	Qty.
AW1818	Pillow	18"x18"	16
AW1818-2	Pillow	18"x18"	8
AW99	Pillow	9"x9"	32



Oil Only Pillows

- Specialized oil only polypropylene will not absorb water or water-based liquids
- Ideal for use in waste troughs, coolant tanks, fluid reservoirs and sump wells

Catalog #	Type	Size	Qty.
OIL1818	Pillow	18"x18"	16
OIL1818-2	Pillow	18"x18"	8
OIL99	Pillow	9"x9"	32



HAZWIK® Pillows

- Absorbs chemicals, acids and bases
- Ideal for extra protection during packaging and transport

Catalog #	Type	Size	Qty.
HAZ1818	Pillow	18"x18"	16
HAZ1818-2	Pillow	18"x18"	8
HAZ99	Pillow	9"x9"	32



ALLWIK® Universal Drum Covers

- All-purpose polypropylene drum cover
- Fits 55-gallon drums either with 1 or 2 bungholes
- Create a clean and safe work floor by preventing pump drips from reaching the floor

Catalog #	Type	Size	Qty.
DTA25	Medium Wt. Drum Cover	22" dia.	25



Oil Only Drum Covers

- Specialized oil only polypropylene drum cover fits 55-gallon drums either with 1 or 2 bungholes
- Will not absorb water or water-based solutions
- Prevents pump drips from reaching the floor

Catalog #	Type	Size	Qty.
DTA25	Medium Wt. Drum Cover	22" dia.	25



Absorbent Booms

- Premium SPC® Booms are lint free and easy to handle
- Economical ENV® booms feature a lint-free blue sleeve

Catalog #	Type	Size	Qty.
ENV810	ENV Boom	8"x10'	4
ENV510	ENV Boom	5"x10'	4
SPC810	SPC Boom	8"x10'	4
SPC510	SPC Boom	5"x10'	4
SPC5510*	SPC Boom	5"x10'	2
SPC818	SPC Boom	8"x18"	10
SPC518	SPC Boom	5"x18"	10
SPC318	SPC Boom	3"x18"	25

Temporary Barricades

www.BradyID.com/PetroChem



Barricade Tape

- Non-adhesive B-912 Polyethylene tapes provides fast, on-the-spot warning

Catalog #	Legend	Size	Color
91212	Caution	3" x 200'	Blk/Ylw
91224	Caution Do Not Enter	3" x 200'	Blk/Ylw
91256	Confined Space Do Not Enter	3" x 200'	Blk/Ylw
91200	Danger	3" x 200'	Blk/Red
91450	Caution	3" x 1000'	Blk/Ylw
91451	Caution Do Not Enter	3" x 1000'	Blk/Ylw
91455	Danger	3" x 1000'	Blk/Ylw
91257	Confined Space Do Not Enter	3" x 1000'	Blk/Ylw
91201	Danger	3" x 1000'	Blk/Red
102824	Do Not Enter	3" x 1000'	Blk/Red



BradyLink Warning Posts

- Polyethylene bases and tops; polystyrene posts
- Fillable non-conductive base

Catalog #	Size	Color	Qty.
80943	Small 2.5"D, 40"H, 14" base	Black	6
80944	Small 2.5"D, 40"H, 14" base	Yellow	6
92116	Large 3.0"D, 41"H, 16" base	Black	1
92117	Large 3.0"D, 41"H, 16" base	White	1
92118	Large 3.0"D, 41"H, 16" base	Yellow	1
92119	Large 3.0"D, 41"H, 16" base	Black	6
92120	Large 3.0"D, 41"H, 16" base	White	6
92121	Large 3.0"D, 41"H, 16" base	Yellow	6



Woven Barricade Tape

- Made of B-903 polypropylene
- Contains ultraviolet inhibitors for permanent outdoor marking

Catalog #	Legend	Size
91172	34" x 150'	Black/Yellow
91173	34" x 150'	Magenta/Yellow
91175	34" x 150'	Black/Red
91176	2" x 200'	Black/Yellow
91179	2" x 200'	Black/Red



BradyLink Warning Chain

- Polyethylene chain for indoor use only
- Link design prevents kinking

Catalog #	Size	Color
78234	1-1/2" x 100' Chain	Yellow
78235	1-1/2" x 100' Chain	White
78238	2" x 100' Chain	Yellow
78239	2" x 100' Chain	White
78241	2" x 100' Chain	Orange
78254	2" x 100' Chain	Blk/Ylw
37860	3" x 100' Chain	Yellow
78246	Box of 36, 2" Links	Yellow

Barricade Tags

- Made from durable 10-mil polyester (Brady B-851)
- 3/8" diameter hole with rolled brass eyelet
- Excellent outdoor weather resistance
- Exceeds OSHA 50-lb pull strength requirements



Catalog #	Description	Size	Qty.
132421	Economy Poly.	3"x5-3/4"	25



Catalog #	Description	Size	Qty.
132422	Economy Poly.	3"x5-3/4"	25



Catalog #	Description	Size	Qty.
132423	Economy Poly.	3"x5-3/4"	25

! More online at www.BradyID.com!

Visit Brady online to see more visual workplace and safety products including magnetic, phosphorescent and other numbering and lettering options.

Safety Tapes

www.BradyID.com/PetroChem



Solid Marking Tapes

- Made of long-wearing B-7569 vinyl tape
- Applies quickly and sticks tightly

Not compatible with Universal Line Applicator

Catalog #	Size	Color
Solid		
58200	2" x 36 yd.	Yellow
58201	2" x 36 yd.	Red
58202	2" x 36 yd.	Green
58203	2" x 36 yd.	White
58220	2" x 36 yd.	Blue
58250	3" x 36 yd.	Yellow
58251	3" x 36 yd.	Red
58252	3" x 36 yd.	Green
58253	3" x 36 yd.	White
58221	3" x 36 yd.	Blue
102838	4" x 36 yd.	Yellow
102836	4" x 36 yd.	Red
102834	4" x 36 yd.	Green
102837	4" x 36 yd.	White
102833	4" x 36 yd.	Blue



BradyGlo™ Floor Tapes

- Made of B-324 phosphorescent surface printed polyester
- Designed for safe Low Level Lighting egress pathway marking during power outages and emergency situations

Catalog #	Size	Color
76432	Solid BradyGlo Tape	2" x 15'
76433	Solid BradyGlo Tape	3" x 15'



Stripe Anti-Skid Tape

- Rugged B-916 adhesive-backed polyester tape coated with durable aluminum oxide grit is ideal for indoor and outdoor use
- Bonds permanently to clean, dry floors and withstands grease and oil

Catalog #	Size	Color
78146	1" x 60'	Black & Yellow
78147	2" x 60'	Black & Yellow
78148	3" x 60'	Black & Yellow
78149	4" x 60'	Black & Yellow
78150	6" x 60'	Black & Yellow



Striped/Checked Marking Tape

- B-950 vinyl with permanent adhesive stands up to tough indoor conditions
- Colors sealed beneath protective layer of abrasion resistant clear vinyl

Catalog #	Size	Color
Striped		
55300	1" x 18 yd.	Black/Yellow
55301	1-1/2" x 18 yd.	Black/Yellow
55312	1-1/2" x 18 yd.	Magenta/Yellow
55302	2" x 18 yd.	Black/Yellow
55296	2" x 18 yd.	Red/White
55292	2" x 18 yd.	Black/White
90019	2" x 18 yd.	Green/White
55313	2" x 18 yd.	Magenta/Yellow
55303	3" x 18 yd.	Black/Yellow
55297	3" x 18 yd.	Red/White
55293	3" x 18 yd.	Black/White
55314	3" x 18 yd.	Magenta/Yellow
Checked		
76317	2" x 18 yd.	Black/Yellow
76316	2" x 18 yd.	Black/White



Bradyglo™ Marking Tape

- High Intensity Self Sticking Polyester
- Ideal for marking leading edges of steps, door frames, and handrails

Catalog #	Size	Color
114634	IBC/IFC Compliant Marking Tape	1" x 50'
114636	IBC/IFC Compliant Anti-Slip Tape	1" x 50'
114635	IBC/IFC Compliant Striped Tape	1" x 50'
81873	NYC Approved Marking Tape	1" x 50'
81729	NYC Approved Anti-Slip Tape	1" x 50'
81869	NYC Approved Striped Tape	1" x 50'



Heavy Duty Anti-Skid Tapes

- Aggressive adhesive withstands harsh elements such as oil, fuel and grease
- Durable "high slip resistance" with deeply textured silicon carbide grit
- Ideal for machinery, forklifts, loading docks, ramps, platforms and more

Catalog #	Size	Color
110020	2" x 60'	Black
110019	4" x 60'	Black
110018	6" x 60'	Black
110017	12" x 60'	Black



Reflective Tape

- Made of B-957 reflective tape
- Give an extra margin of safety in low light conditions

Catalog #	Size	Color
Solid		
78985	2" x 15'	White
78986	2" x 15'	Yellow
78989	2" x 15'	Orange
78988	3" x 15'	Yellow
Striped		
76308	2" x 15'	Black/Yellow
76309	2" x 15'	Red/White
76312	3" x 15'	Black/Yellow
76313	3" x 15'	Red/White



Identoline® Underground Warning Tape

- Made of heavy-duty B-720 polyethylene
- Tape is 4.0 mil. thick with a tough tensile strength of 1750 psi

Catalog #	Utility Class	Size	APWA Color
91295	Electric*	3" x 1,000'	Red
91296	Electric	6" x 1,000'	Red
91297	Telephone	6" x 1,000'	Orange
91298	Water	6" x 1,000'	Blue

*Legend appears on one line



Anti-Skid Floor Tape

- B-916 adhesive-backed polyester tape coated with durable aluminum oxide grit
- Bonds permanently to clean, dry floors both indoors and outdoors

Catalog #	Size	Color
78189	1" x 60'	Black
78190	2" x 60'	Black
78198	2" x 60'	Red
78091	2" x 60'	Yellow
78188	2" x 60'	Clear
78191	4" x 60'	Black
78092	4" x 60'	Yellow
78193	6" x 60'	Black
78194	12" x 60'	Black



Bradystake™ Warning Stakes

- Blank stakes with no sign assembly
- Reinforced polymer is rugged and flexible; even when driven over, they bend, but don't break.

Catalog #	Color	Size
96950	Orange With Points	3-3/4"x66"
96951	Yellow With Points	3-3/4"x66"
96921	Yellow Without Points	3-3/4"x66"
96952	Blue With Points	3-3/4"x66"
96953	Green With Points	3-3/4"x66"
96954	White With Points	3-3/4"x66"
96955	Red With Points	3-3/4"x66"
96922	Orange on White Reflective	3-3/4"x66"
96923	Black on Yellow Reflective	3-3/4"x66"



15 Series Numbers & Letters (B-946)

- Premium outdoor grade vinyl with permanent adhesive
- Designed for permanent applications in severe outdoor environments as well as indoors. Special acrylic adhesive adheres strongly, making marker removal difficult

Catalog #	Card Size	Character Height	Markers Per Card
1530-*	1-1/2" x 7/8"	1"	10
1534-*	2-1/4" x 7/8"	1-15/16"	10
1550-*	3-1/2" x 1-1/2"	2-15/16"	6

To order: replace the asterisk (*) with the desired number (0-9), capital letter (A-Z), dash (DSH) or blank (BLNK). Arrows also available.

Bradystake™ Warning Labels

- Made of B-302 self-sticking polyester
- 1" blank area at bottom will accommodate separate label with company name and telephone number
- Avoid custom lead times by ordering these stock labels with Blank Bradystake™ Warning Stakes (sold separately)



Catalog #	Legend	Size
85406	Caution Gas Pipeline Before Digging Call Collect	14" x 3"



Bradylite® Reflective Numbers & Letters (B-997)

- Material reflects light 100 times brighter than a plain white surface
- Will perform despite tough environmental conditions
- For low temp applications can be applied at temperatures as low as 10°F

Catalog #	Marker Size	Character Height	Color	Qty.
5890-*	1-7/8" x 1-3/8"	1-1/2"	Ylw/Blk	25
5000-*	2-7/8" x 1-3/4"	2-1/2"	Ylw/Blk	25
5905-*	1-1/2" x 1"	1"	Ylw/Blk	25
5910-*	1-1/2" x 1"	1"	Blk/Org	25

To order: replace the asterisk (*) with the desired number (0-9), capital letter (A-Z), dash (DSH) or blank (BLNK). Arrows also available.

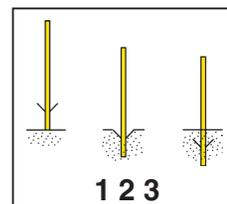

Bradystake™ Anchors

- Made of long-lasting spring steel
- Catches soil around the stake preventing unauthorized removal as well as added stability in loose or sandy soil
- Custom order anchors to be attached to Bradystake™ Warning Stakes at the factory for quick field installation

Catalog #	Legend
97084	Bradystake™ Anchors



Stock Plastic Poly-Lok™

- Deters entry, yet easily removed
- Tamper-resistant Poly-Loks are embossed with the wording "Seal" and are consecutively numbered
- Ships in mats of ten for convenience and better accountability - 100 seals total in package.

Catalog #	Size	Color	Qty.
95193	7-1/2"	Blue	100
95195	7-1/2"	Red	100
95196	7-1/2"	Yellow	100



Stock Metal Ball Seals

- Stock Metal Ball Seals are supplied with consecutive numbering (factory chooses starting number) and the word "SEALED" already embossed

Catalog #	Description	Qty.
95197	Metal Ball Seals	100



There's More Online at www.BradyID.com!

- Over 30,000 products
- Online ordering
- Product Information
- Product Demos
- Custom Orders
- Whitepapers
- Webinars
- And more!

The Brady Advantage



Visual Solutions For Harsh & Hazardous Environments

Brady, a world leader in industrial identification, offers facility, process and equipment identification solutions for use in harsh applications and hazardous environments. Whether the need is for sun (UV), water, chemical or abrasion resistance, or all of the above, we have the solution to meet your needs!

In addition to boasting a large stock offering of safety signs, warning labels, pipemarkers, maintenance tags and other workplace visuals, we also excel at addressing custom needs. Create your own customized visuals, onsite and on-demand with Brady's sign and labeling systems or let Brady print customized visuals for you. Whatever your industrial identification needs, Brady has you covered!

USA
 Customer Service: 1-888-272-3946
 Inside Sales: 1-888-311-0775
www.BradyID.com

Canada
 Customer Service: 1-800-263-6179
www.BradyCanada.ca

Mexico
 Customer Service: 1-800-262-7777
 Inside Sales: 1-800-262-7777 ext 177
www.BradyLatinAmerica.com

