

DHC-2 Beaver



DHC-2 Beaver

Island Wings Select

INSTRUCTION MANUAL

RTF
READY-TO-FLY

Tx-R
TRANSMITTER-READY

Rx-R
RECEIVER-READY

Flyzone™
how high will you soar

SPECIFICATIONS

Wingspan:	59.5 in [1510mm]	Length:	38.5 in [980mm]
Wing Area:	430 in ² [27.7 dm ²]	Radio:	5-channel radio system
Weight:	3–3.25 lb [1360–1470 g]	Motor:	40mm dia. 850kV outrunner, 40A ESC, 12x6 propeller
Wing Loading:	16–17 oz/ft ² [49–52 g/dm ²]		

WARRANTY

Flyzone guarantees this kit to be free from defects in both material and workmanship at the date of purchase. This warranty does not cover any component parts damaged by use or modification. In no case shall Flyzone's liability exceed the original cost of the purchased kit. Further, Flyzone reserves the right to change or modify this warranty without notice.

In that Flyzone has no control over the final assembly or material used for final assembly, no liability shall be assumed nor accepted for any damage resulting from the use by the user of the final user-assembled product. By the act of using the user-assembled product, the user accepts all resulting liability.

If the buyer is not prepared to accept the liability associated with the use of this product, the buyer is advised to return this kit

immediately in new and unused condition to the place of purchase.

To make a warranty claim send the defective part or item to Hobby Services at the address below:

Hobby Services
3002 N. Apollo Dr. Suite 1
Champaign IL 61822 USA

Include a letter stating your name, return shipping address, as much contact information as possible (daytime telephone number, fax number, e-mail address), a detailed description of the problem and a photocopy of the purchase receipt. Upon receipt of the package the problem will be evaluated as quickly as possible.

READ THROUGH THIS MANUAL BEFORE STARTING CONSTRUCTION. IT CONTAINS IMPORTANT INSTRUCTIONS AND WARNINGS CONCERNING THE ASSEMBLY AND USE OF THIS MODEL.

TABLE OF CONTENTS

INTRODUCTION	2	Install the Battery	9
Academy of Model Aeronautics	2	Failsafe Setting	10
FAA Information	2	Failsafe Function	10
SAFETY PRECAUTIONS	2	ESC Operation/Startup	10
REQUIRED FOR COMPLETION	3	Throttle Calibration	11
Transmitter	3	Brake Setting	11
LiPo Battery	3	Hook Up the Rudder and Elevator	12
Charger	3	Hook Up the Flaps and Ailerons	13
KIT INSPECTION	3	FINAL FLIGHT PREPARATION	14
ORDERING REPLACEMENT PARTS	3	Check the Control Throws	14
CONTENTS	4	Mount the Propeller and Spinner	15
ASSEMBLY	5	Motor Safety Precautions	16
Mount the Landing Gear	5	Check the C.G.	16
Mount the Floats	5	FLYING	16
Mount the Horizontal and Vertical Stabilizer	6	REPAIRS	17
Mount the Wings	8	POWERING UP	Back Cover

INTRODUCTION

Thank you for purchasing the Flyzone 1/10th-scale de Havilland DHC-2 Beaver RTF/Tx-R/Rx-R. For anybody who enjoys flying float planes or who aspires to do so for the first time, the Flyzone Beaver is the perfect choice because it maneuvers and flies off the water so well—you virtually can't mess up a takeoff or landing unless you try! Of course, the Beaver is almost just as much at home on dry land as it is in the water. And with the flaps extended you can set your Beaver down on water or on land as light as a feather.

For the latest technical updates or manual corrections to the Beaver, visit the Flyzone site at www.flyzoneplanes.com. Open the "Airplanes" link, then select the "Beaver".

Academy of Model Aeronautics

If you are not already a member of the AMA, please join! The AMA is the governing body of model aviation and membership provides liability insurance coverage, protects modelers' rights and interests and is required to fly at most R/C sites.

Academy of Model Aeronautics

5151 East Memorial Drive
Muncie, IN 47302-9252

Tele. (800) 435-9262
Fax (765) 741-0057



Or via the Internet at: <http://www.modelaircraft.org>

IMPORTANT!!! Two of the most important things you can do to preserve the radio controlled aircraft hobby are to avoid flying near full-scale aircraft and avoid flying near or over groups of people.

FAA Information

As a new owner of an unmanned aircraft system (UAS), you are required to place your FAA number on or in your plane. It

is your responsibility to operate this vehicle safely following the FAA rules. Please contact your local authorities to find out the latest rules and regulations.



In the United States, please visit:
knowbeforeyoufly.org faa.gov/uas

SAFETY PRECAUTIONS

PROTECT YOUR MODEL, YOURSELF AND OTHERS... FOLLOW THESE IMPORTANT SAFETY PRECAUTIONS

1. Your de Havilland Beaver should not be considered a toy, but rather a sophisticated, working model that functions very much like a full-size airplane. Because of its performance capabilities, the Beaver, if not assembled and operated correctly, could possibly cause injury to yourself or spectators and damage to property.

2. You must assemble the Beaver according to the instructions. Do not alter or modify the model, as doing so may result in an unsafe or unflyable model. In a few cases the instructions may differ slightly from the photos. In those instances the written instructions should be considered as correct.

3. If you are not an experienced pilot or have not flown this type of model before, we recommend that you get the assistance of an experienced pilot in your R/C club for your first flights. If you're not a member of a club, your local hobby shop has information about clubs in your area whose membership includes experienced pilots.

4. Check the operation of the model and all components before each flight.

5. **DO NOT install the propeller UNTIL you have completed ALL FOUR of the following steps!**

A. You MUST confirm that the radio system included with the RTF version (or the radio system you provide for the TX-R or RXR) is functioning properly according to pages 10-11.

- B. Understand the operation of the motor/failsafe/ESC in all possible operation scenarios.
- C. Learn how to properly power up and power down for each flight (see back page).
- D. Complete all of the steps in this manual up to the prop installation on page 15..

Install the propeller only AFTER you have completed these four steps.

6. While this kit has been flight tested to exceed normal use, if the plane will be used for extremely high stress flying, or if a motor or battery larger than ones in the recommended range is used, the modeler is responsible for taking steps to reinforce the high stress points and/or substituting hardware more suitable for the increased stress.

We, as the kit manufacturer, provide you with a top quality, thoroughly tested kit and instructions, but ultimately the quality and flyability of your finished model depends on how you build it; therefore, we cannot in any way guarantee the performance of your completed model, and no representations are expressed or implied as to the performance or safety of your completed model.

Remember: Take your time and follow the instructions to end up with a well-built model.

REQUIRED FOR COMPLETION

Other than a #1 and #2 Phillips screwdriver and a few drops of non-permanent threadlocker (GP6MR6060), no adhesives or anything extraordinary is required to assemble the Beaver. The RTF is fully equipped with a complete radio control system, LiPo battery and charger, so no other accessories are required, but the following items are required to complete the Tx-R and Rx-R editions:

Transmitter

The Tx-R includes the Tactic™ TR624 6-Channel 2.4GHz receiver, so you'll need either a Tactic TX610 6-channel 2.4GHz transmitter, or any other 5-channel (or more) transmitter compatible with the Tactic *AnyLink*™ 2.4GHz radio adapter*. Using the *AnyLink* allows any compatible transmitter to work with the Tactic receiver.

- TX610 6-channel transmitter (TACJ2610)
- AnyLink radio adapter* (TACJ2000)

*In addition to the AnyLink radio adapter, some AnyLink-compatible transmitters may also require additional adapter cables. Visit Tx-Ready.com to see the *AnyLink* compatibility chart or contact Product Support at the contact information on this page.

LiPo Battery

The RTF edition of the Beaver includes a Flyzone 3S (11.1V) 1800mAh 20C LiPo battery and the same is recommended for the Tx-R/RX-R, but a 2100mAh battery is also an option for slightly longer flight times (more about flying time on page 16).

- Flyzone 3S (11.1V) 1800mAh 20C LiPo battery (FLZA6024)
- Flyzone 3S (11.1V) 2100mAh 20C LiPo battery (FLZA6173)

Spare batteries may also be purchased and charged at home ahead of time, eliminating the wait between flights for batteries to charge at the field.

Charger

The RTF comes equipped with a Great Planes 3S LiPo balancing *Smart Charger*, but the Tx-R/Rx-R requires a charger to be purchased separately. The *Smart Charger* is a safe way to charge your LiPo battery, but it's very basic and just enough to get you started. The *Smart Charger* charges at a rate of .8 Amps, so it will take at least one-and-a-half hours or more to charge your battery. For those who have the RTF and wish to upgrade their charger, or those with the Tx-R/Rx-R who must purchase a charger, the Duratrax® Onyx™ 235 AC/DC Advanced Peak Charger (DTXP4235) is recommended. The Onyx is perfect for 3S batteries used with the Beaver and may be powered either by an external DC power source (such as a 12V battery), or a 110V AC outlet. The Onyx also has an adjustable charge rate to charge your batteries in as little as a half-hour or less (depending on the condition of your batteries and the manufacturer's specified charge rate). The Onyx can also charge larger batteries and batteries other than LiPos, so it is a versatile charger you can grow into. Finally, the 235 features an LCD digital display screen, so you can see how much capacity it took to recharge the battery (required for monitoring the condition of your batteries and calculating how long you can fly).

NOTE: For use with the Onyx 235, LiPo batteries that come with a Star connector (such as the Flyzone batteries recommended) require a banana plugs-to-Star charge lead (GPMM3148). This can also be used for batteries equipped with a Deans connector.

KIT INSPECTION

Before assembly, take an inventory of this kit to make sure it is complete, and inspect the parts to make sure they are of acceptable quality. If any parts are missing or are not of acceptable quality, or if you need assistance with assembly, contact **Product Support**. When reporting defective or missing parts, use the part names exactly as they are written in the Contents list.

Flyzone Product Support Ph: (217) 398-8970 ext. 5
 3002 N Apollo Drive Suite 1 Fax: (217) 398-7721
 Champaign, IL 61822

E-mail: airsupport@flyzoneplanes.com

ORDERING REPLACEMENT PARTS

Replacement parts for the Flyzone de Havilland Beaver RTF/Tx-R/Rx-R are available using the order numbers in the **Replacement Parts List** that follows. The fastest, most economical service can be provided by your hobby dealer or mail-order company.

To locate a hobby dealer, visit the Flyzone web site at www.flyzoneplanes.com. Click on the Storefront icon at the top of the page to load the Flyzone Dealer Locator. Follow the instructions provided on the page to locate a U.S., Canadian or International dealer.

Parts may also be ordered directly from Hobby Services by calling (217) 398-0007, or via facsimile at (217) 398-7721, but full retail prices and shipping and handling charges will apply. Illinois and Nevada residents will also be charged sales tax. If ordering via fax, include a Visa® or MasterCard® number and expiration date for payment.

Mail parts orders and payments by personal check to: **Hobby Services**
3002 N Apollo Drive, Suite 1
Champaign IL 61822

Be certain to specify the order number exactly as listed in the **Replacement Parts List**. Payment by credit card or personal check only; no C.O.D.

If additional assistance is required for any reason contact Product Support by e-mail at productsupport@flyzoneplanes.com, or by telephone at (217) 398-8970.

DHC-2 de HAVILLAND BEAVER PARTS (ORANGE)

FLZA6265	Fuselage Set
FLZA6266	Wing Set
FLZA6267	Horizontal Stab
FLZA6268	Vertical Stabilizer
FLZA6269	Main Landing Gear
FLZA6271	Cowl
FLZA6275	Float Set
FLZA6276	Float Brackets
FLZA6279	Hatch Set
FLZA6282	Main Wheels
FLZA6284	Wing Strut Set
FLZA6285	Decal Sheet

DHC-2 de HAVILLAND BEAVER ISLAND WINGS PARTS (RED)

FLZA6545	Fuselage Set
FLZA6546	Wing Set
FLZA6547	Horizontal Stabilizer
FLZA6548	Vertical Stabilizer
FLZA6549	Main Landing Gear
FLZA6550	Cowl
FLZA6551	Float Set
FLZA6552	Float Brackets
FLZA6553	Hatch Set
FLZA6554	3-1/2" [90 mm] Tundra Wheels
FLZA6555	Wing Strut Set
FLZA6556	Decal Sheet

DHC-2 de HAVILLAND BEAVER AND ISLAND WINGS COMMON PARTS

FLZA6270	Tail Wheel Set
FLZA6272	12x6 Propeller
FLZA6273	Spinner
FLZA6274	Prop Adapter
FLZA6277	Water Rudders
FLZA6278	Wing Clips
FLZA6280	41-19-850 Motor
FLZA6281	40 Amp ESC
FLZA6283	Servo
FLZA6024	Flyzone LiPo Battery 3S 11.1V 1800mAh 20C
TACJ2610	Tactic TTX610 6Ch SLT 2.4GHz Radio System No Servos
TACL0624	Tactic TR624 6-Channel SLT 2.4GHz Receiver
GPMM3318	Great Planes AC/DC 3S LiPo Balancing Smart Charger

CONTENTS

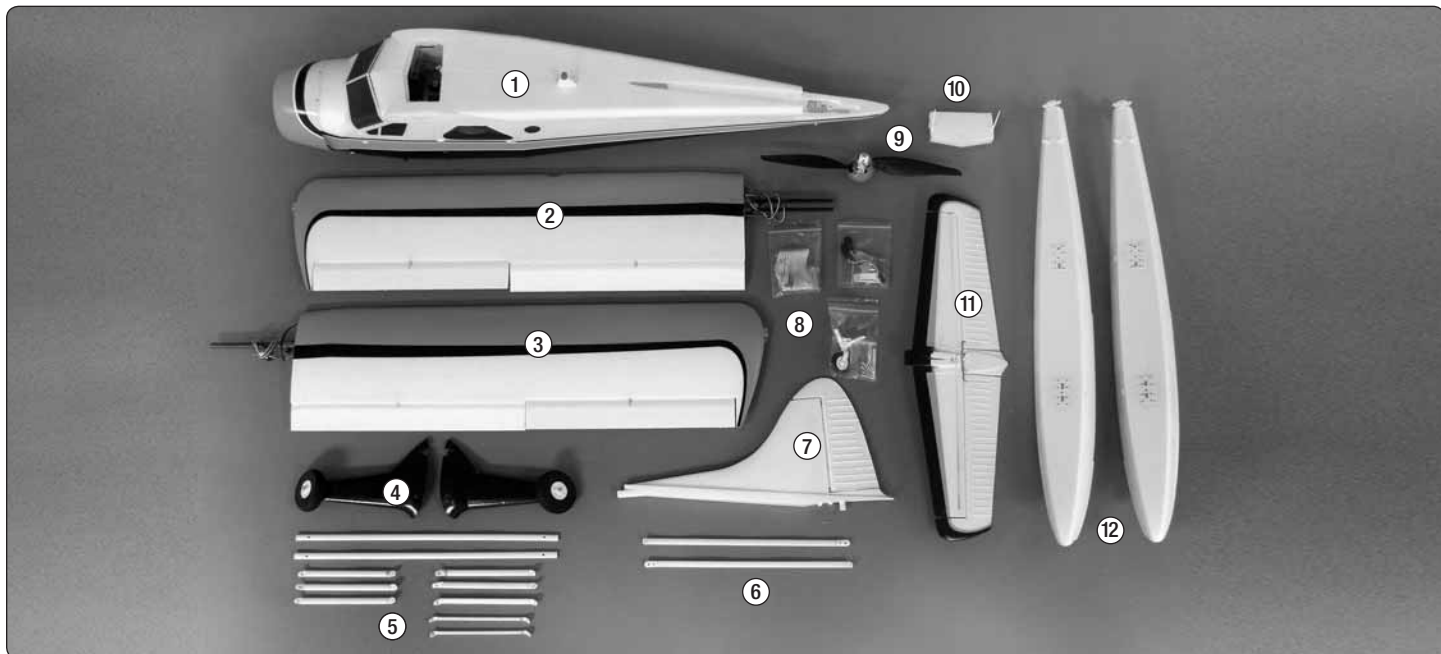

- | | | |
|----------------------|------------------------|-------------------------------|
| 1. Fuselage | 5. Float Brackets | 9. Propeller/Spinner Assembly |
| 2. Left Wing | 6. Wing Struts | 10. Top Hatch |
| 3. Right Wing | 7. Vertical Stabilizer | 11. Horizontal Stabilizer |
| 4. Main Landing Gear | 8. Hardware | 12. Floats |

ASSEMBLY

NOTE: This instruction manual applies to all versions of the DHC-2 Beaver (Rx-R, Tx-R, and RTF), simply skip the steps that do not apply.

Mount the Landing Gear

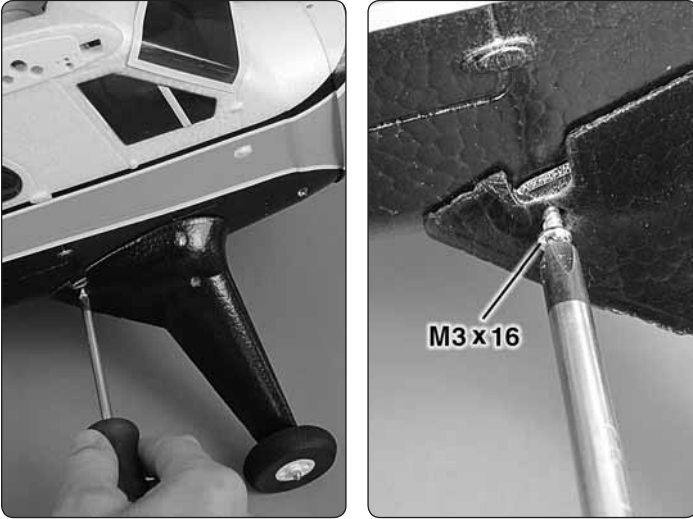

- 1. Use a #2 Phillips screwdriver to fasten both main landing gears to the fuselage with three M3x16 screws in each side.

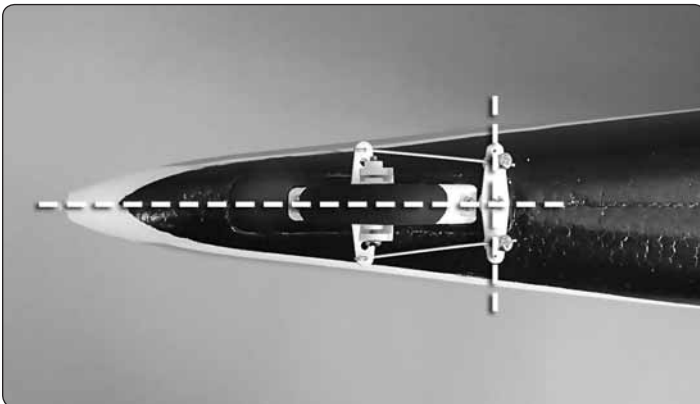
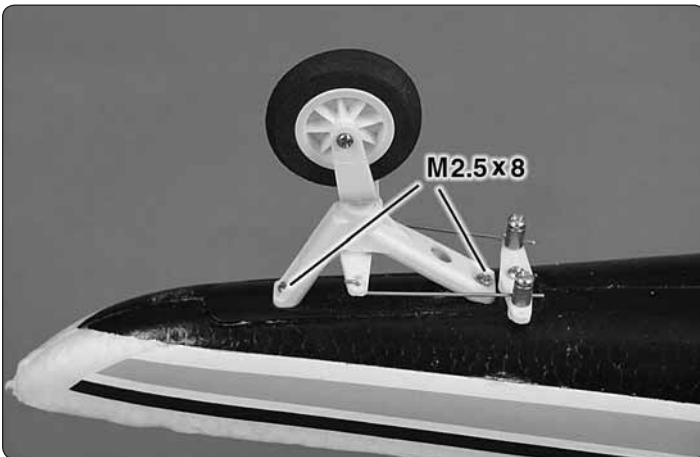

- 2. Mount the tail gear with two M2.5x8 screws, then fasten the pushrod wires as shown. Make sure the tail wheel is perpendicular with the steering arm and tighten the screws.

Mount the Floats

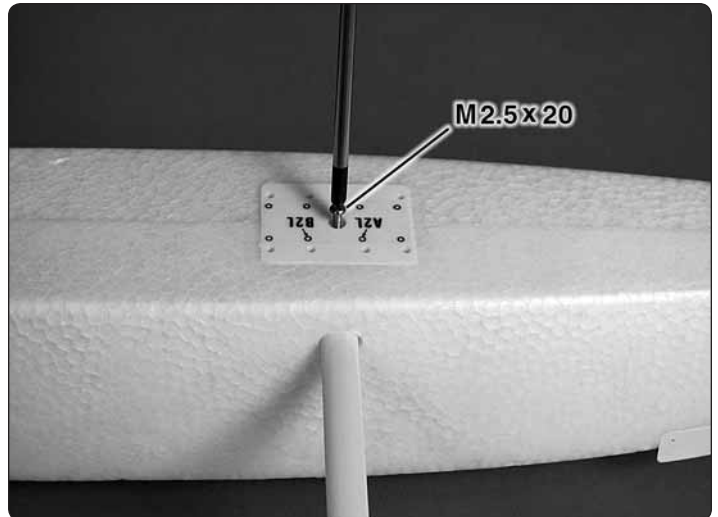
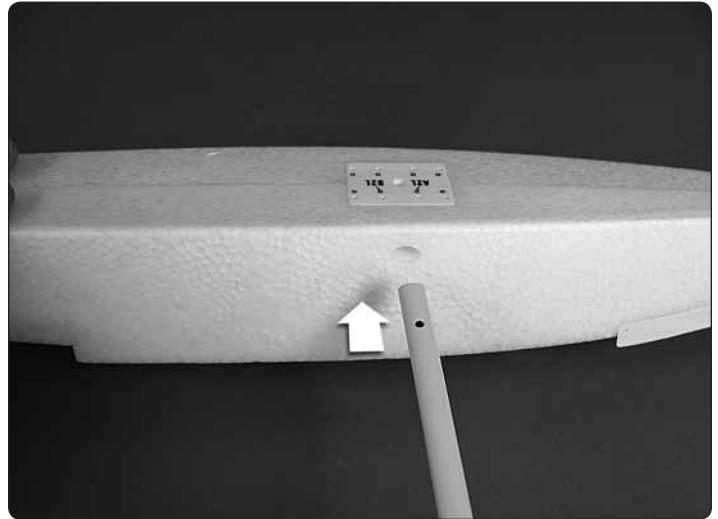

- 1. Connect the floats to each other with the horizontal struts and four M2.5x20 machine-thread screws.

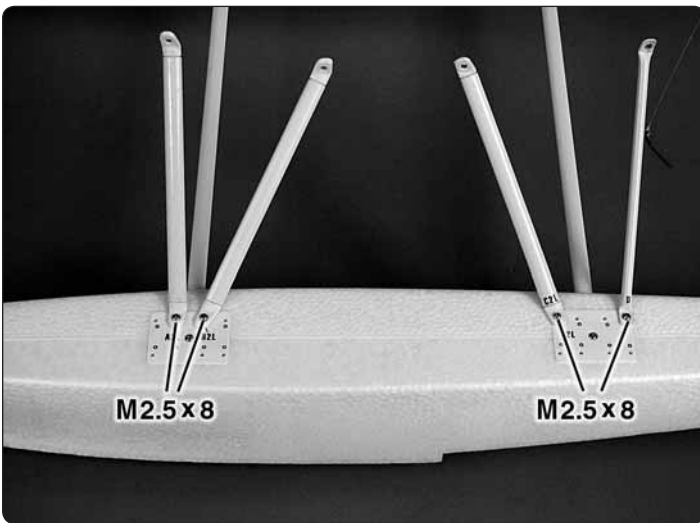
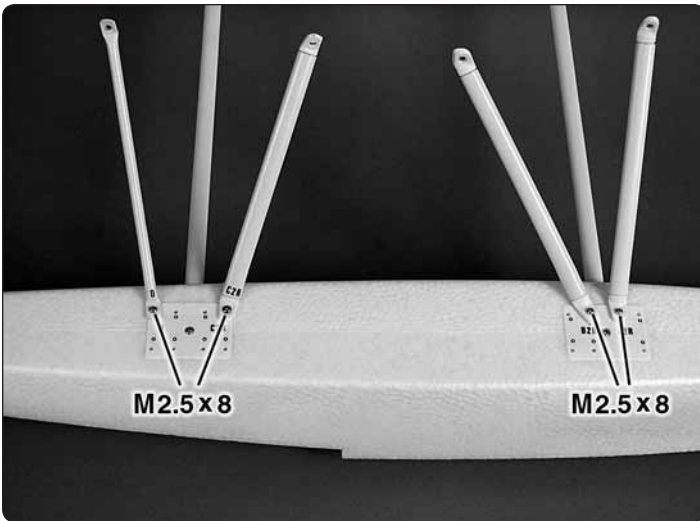

□ 2. Use eight M2.5x8 screws to fasten the braces to the floats, matching the labels printed or molded into the end of each brace to each mount location on each float.

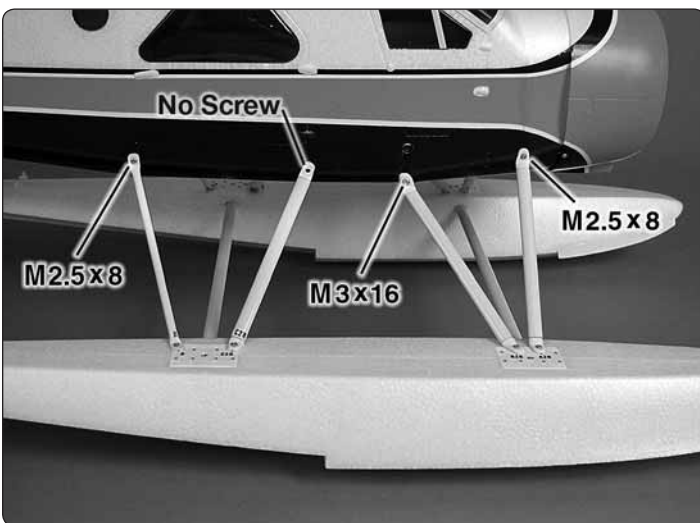

□ 3. Fasten the float braces to the fuselage with one M3x16mm screw and two M2.5x8mm screws in each side of the fuselage. No screw is installed in the third strut at this time.

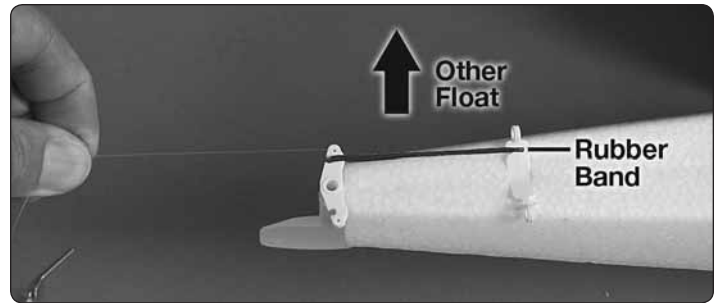

□ 4. Connect a small rubber band to the inside side of each float and water rudder as shown.

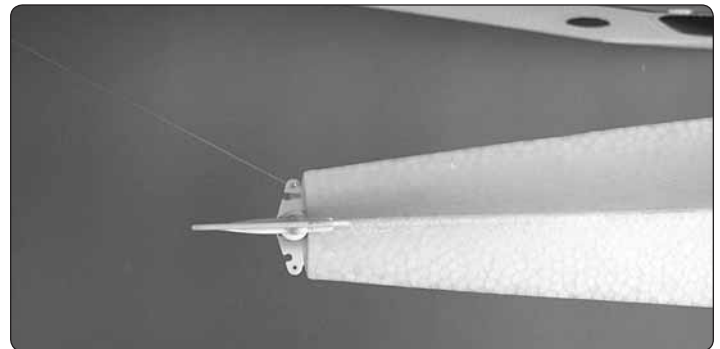
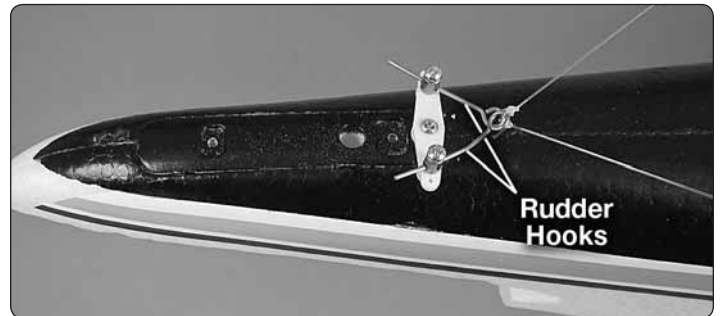

□ 5. Fasten the wire hooks on the end of each rudder line to the connectors in the steering arm. As best as you can, adjust the tension in the lines to center the water rudders—the rudders don't have to be *perfectly* centered, because over time they may drift anyway, and the rudders are forgiving and overall water handling is easy.

Mount the Horizontal and Vertical Stabilizer

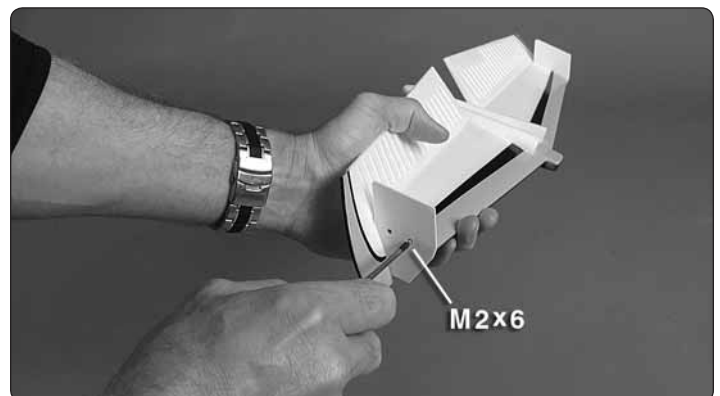

□ 1. Fasten the vertical stabilizers to each end of the horizontal stabilizer (stab) with M2x6 screws.

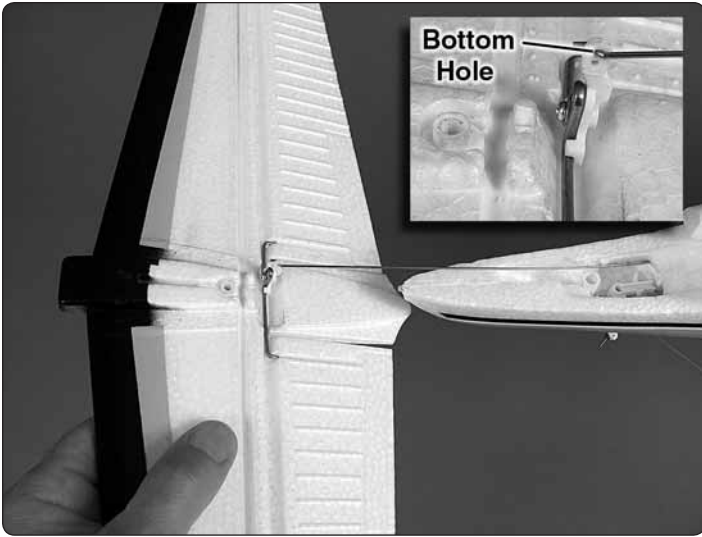

□ 2. Connect the elevator pushrod to the bottom hole in the elevator horn as shown.

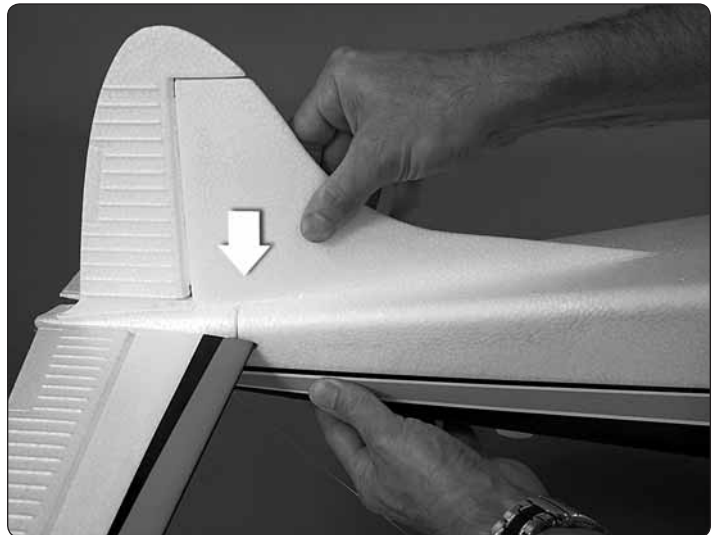
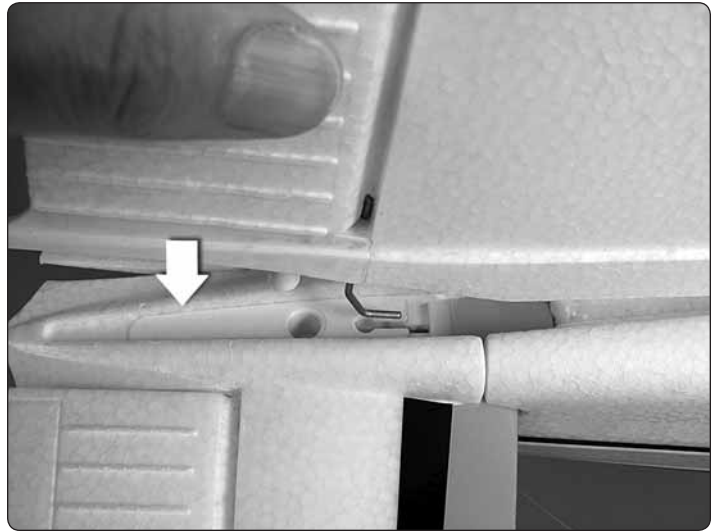
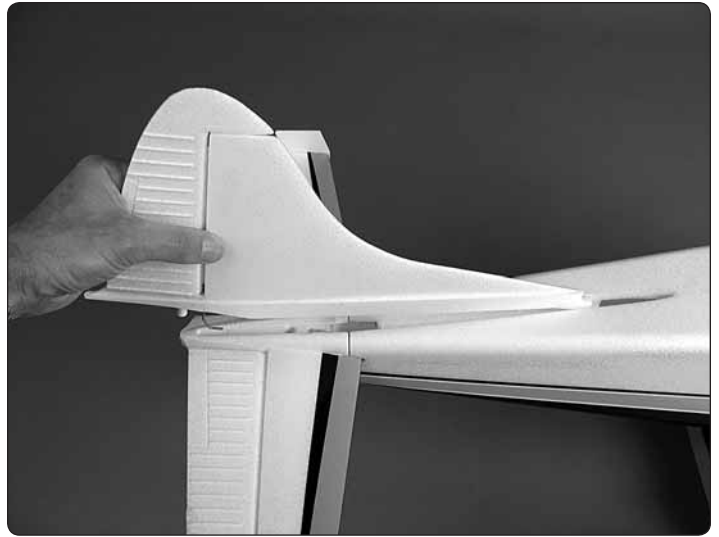

□ 4. Key the rudder torque rod down into the receptacle while fitting the vertical stabilizer (fin) into the fuselage. Tightly press the assembly down into position.

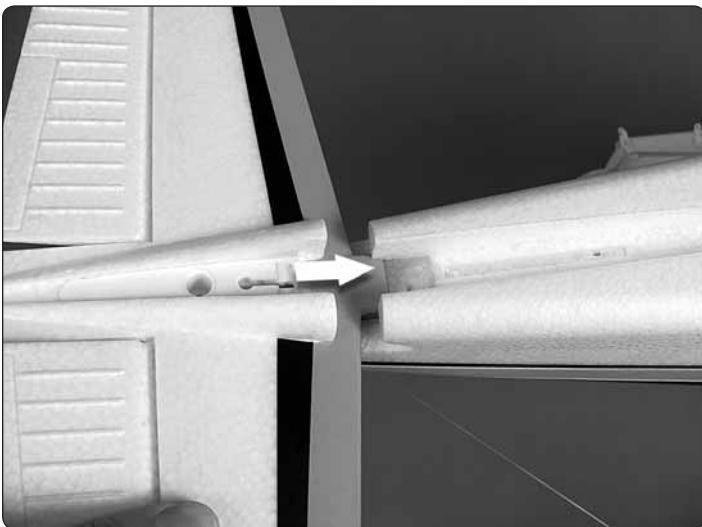

□ 3. Rotate the stab upward and key it into the fuselage.

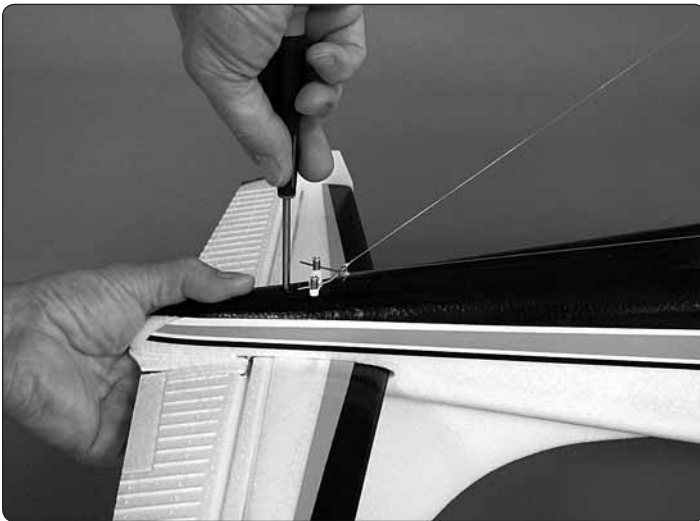
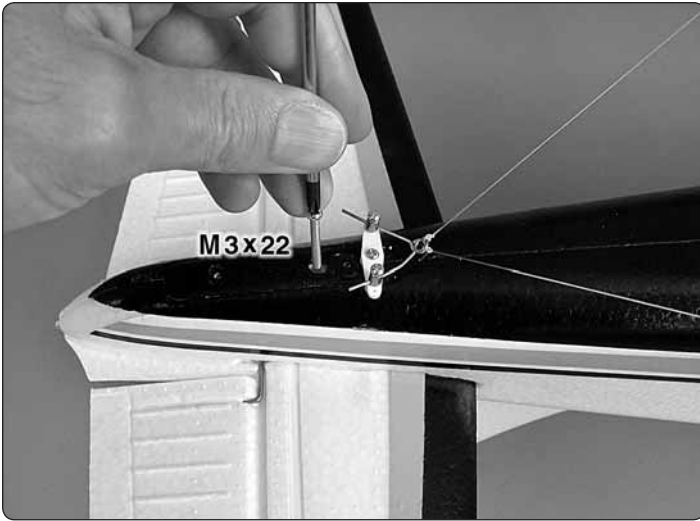

❑ 5. Secure the stab and fin with the M3x22 screw.

Mount the Wings

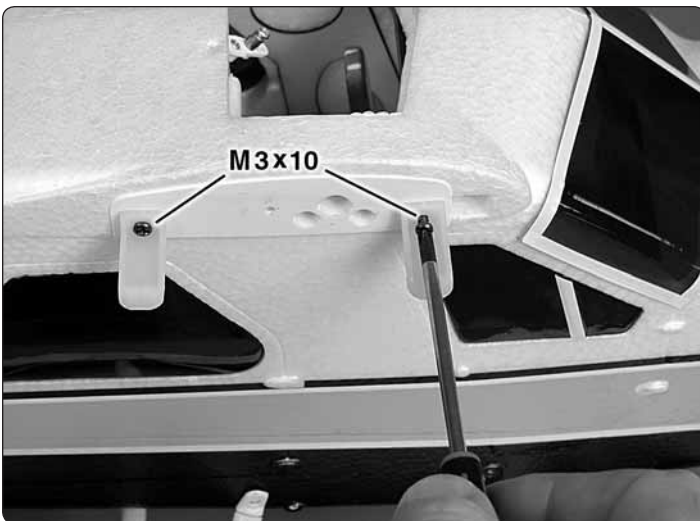

❑ 1. Fasten the wing clips to both sides of the fuselage with four M3x10 screws.

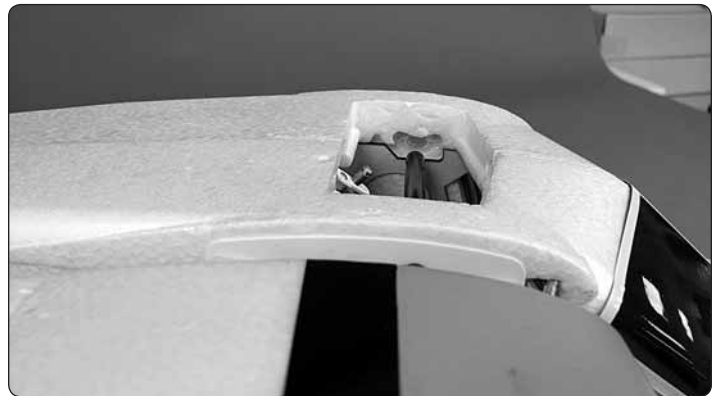
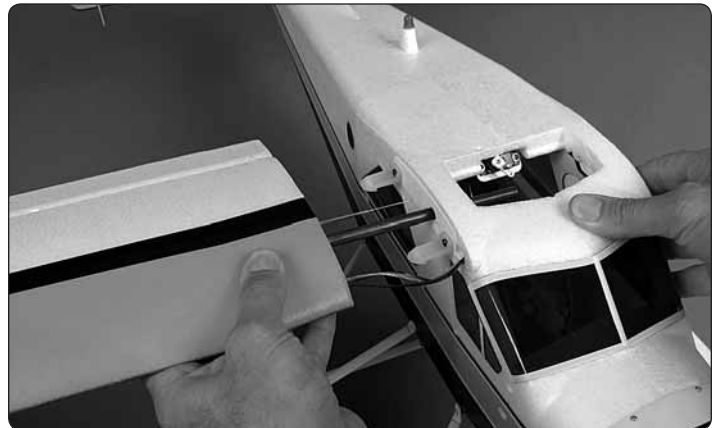
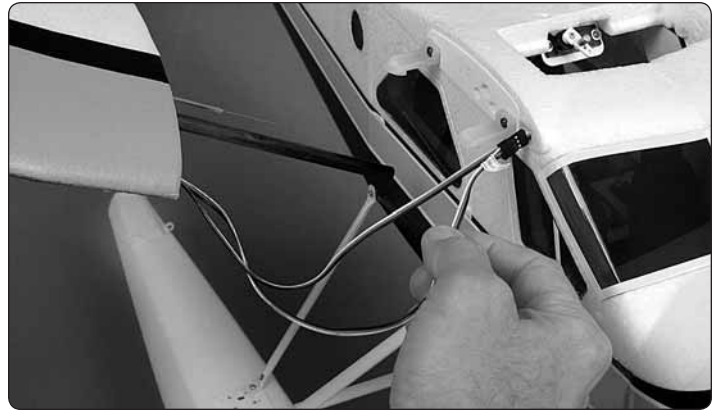

❑ 2. Guide the wires from the right wing into the fuselage, then slide the wing joiner tube and the flap pushrod wire through the corresponding holes. Also guide the flap pushrod wire into the screw-lock connector on the flap servo. Guide the joiner tube through the hole in the left side of the fuselage, then tightly "CLICK!" the wing onto the wing clips.

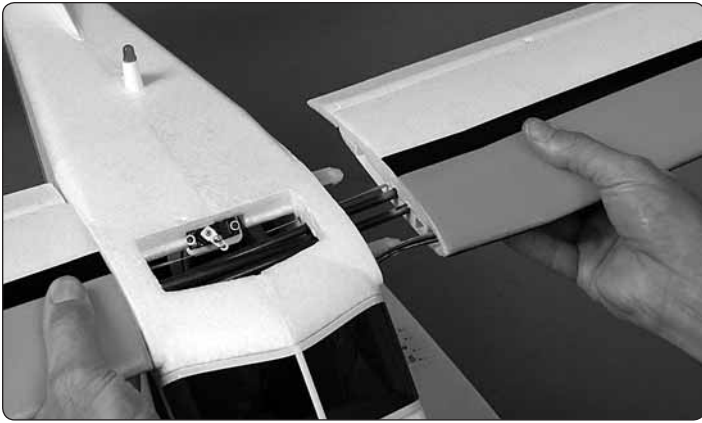

❑ 3. Mount the left wing the same way.

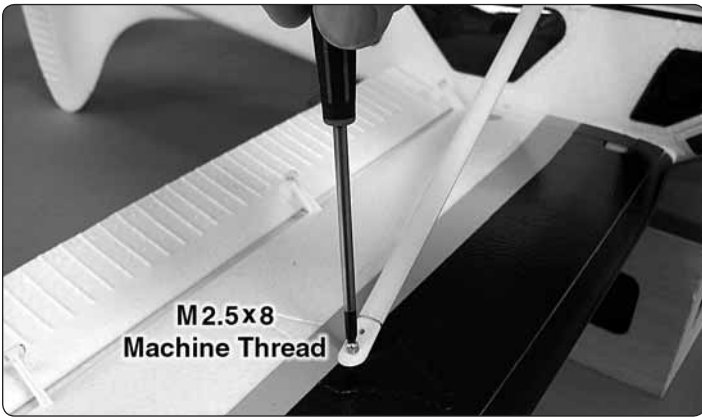

❑ 4. Mount the top of each wing strut to the wing with a M2.5x8 machine-thread screw.

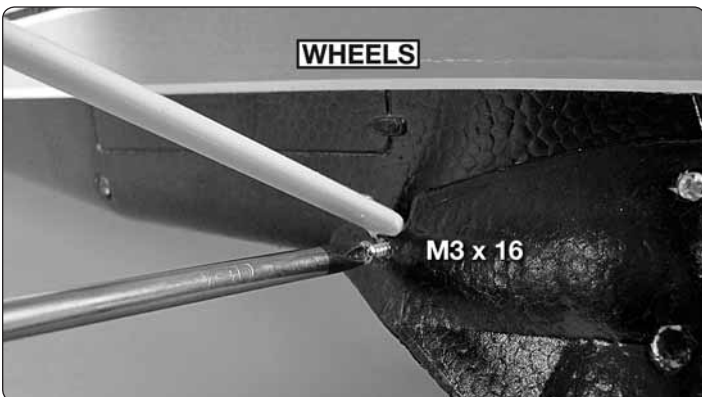
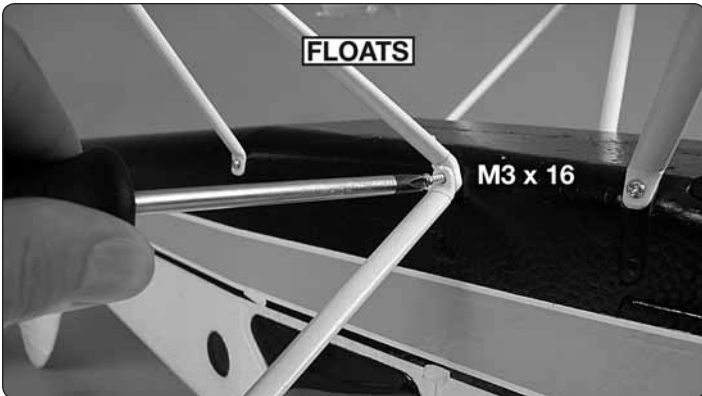

❑ 5. Mount the bottom of each strut to the fuselage over the third float strut (or over the main landing gear) with a M3x16 screw.

Install the Battery



❑ 1. Cut two 1" [25mm] strips from the rougher, "hook" side of the included adhesive-back hook-and-loop material. Apply the strips inside the fuselage where shown and press them down tightly so they adhere.

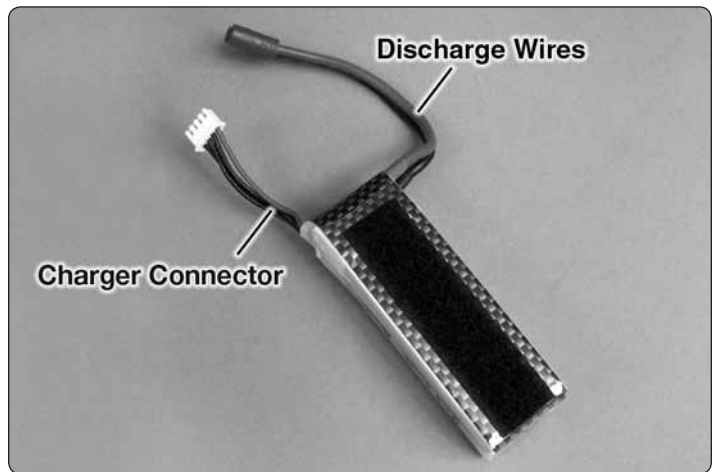

❑ 2. Cut a 3" [76mm] strip from the softer, "loop" side and attach it to the battery so the larger "discharge" wires will be on the right side as shown. (This will position the wires opposite the receiver for a better fit.)

Receiver Installation (Rx-R ONLY)

Install your receiver into the fuselage, connecting the servos according to the labels attached to the wires. Follow the radio manufacturer's recommendations for set-up. Once connected, skip to *Throttle Calibration* on page 11.

Failsafe Setting & Function (RTF/Tx-R Only)

IMPORTANT: Before installing the propeller, it's important for safety reasons to ensure that the failsafe on the receiver is at the 0% throttle preset position as indicated in the instructions below.

The included (Tx-R, RTF versions) Tactic TR624 receiver has a failsafe feature which engages in the event that the radio signal from the transmitter is interrupted. If radio contact is broken, this safety feature causes the servos to automatically move either to a certain position, or hold their last position to prevent the model from moving in an erratic manner. Channels 1, 2, 4, 5, and 6 will enter a "hold" mode, whereby the servos will lock in their last recognized position.

The servo or ESC connected to Channel 3, normally being the throttle control, will move to a pre-set position. The factory default failsafe position for Channel 3 is to move to **0% throttle**. Motor/prop movement should stop if the receiver loses signal from the transmitter. The throttle servo's failsafe position can be manually re-set to any other position if desired, as follows:

1. Install the AA batteries into the included transmitter.

Throttle stick is in the 0% (minimum) position!



2. Make sure the throttle stick is in the minimum position or 0% throttle. **OR** Move the throttle stick to the desired position for the throttle control to revert to if the receiver goes to failsafe.

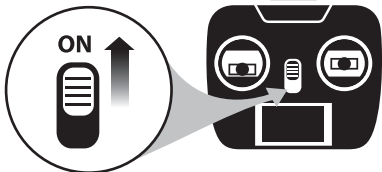

3. Power on the transmitter.

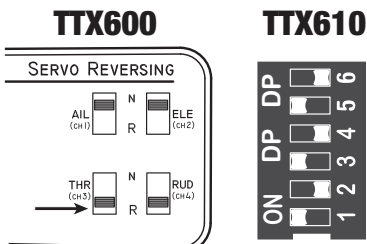

4. Make sure the servo reversing switch for CH3 throttle (located on the front of the TTX610 transmitter **OR** in the battery compartment in the rear of the TTX600 transmitter) is in the "ON" position as shown. **NOTE:** If using an SLT-compatible transmitter or a transmitter with AnyLink, make sure the throttle channel reversing switch is in the "reverse" position.

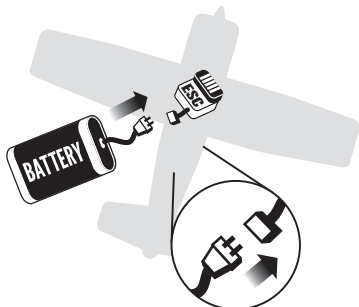

5. Plug in the battery to the aircraft.



6. Press the LINK button on the TR624 receiver (Tx-R, RTF versions) and hold for 2 seconds. The red LINK light should blink and then stay on.

The failsafe is now set. In the event that the receiver loses signal from the transmitter the throttle will revert to 0% or to the preset position. To confirm the desired setting of the failsafe, move the throttle stick to the minimum position ("beep") and turn the transmitter switch to "OFF". Once the failsafe setting is confirmed, turn the transmitter "ON" to regain complete control of the model. **Always remove the propeller from the aircraft before adjusting or testing the failsafe.**

NOTE: If you replace the ESC with a different ESC which has a signal loss feature, the pre-set failsafe position is irrelevant as the signal loss feature will cease the throttle operation if the signal is lost.

ESC Operation/Startup

Seek the assistance of an experienced pilot if new to electric motor operation.

1. Before powering up the model to run the motor or fly, **always** lower the throttle stick to 0% and turn on the transmitter first **before** connecting the battery to the ESC (similarly, always disconnect the battery from the ESC before turning off the transmitter).
2. Always securely hold onto the model when connecting the battery. Holding the model and expecting the propeller to turn will prevent an accident or injury.

Each time you connect the battery to the aircraft, the ESC will send electrical pulses to the motor causing it to chime three times ("♫ 1 2 3") followed by a single, longer beep ("beep"), followed by either one or two more short beeps depending on whether the brake is On or Off (more on the motor brake below). Now the model is ready to fly and the propeller will turn when the throttle is advanced.



If the transmitter is **not** turned On before the battery and ESC are connected (so the receiver is not receiving a signal) the motor will still chime three times ("♫ 1 2 3"), but then will sound consecutive beeps ("beep," "beep," "beep,"...) until the transmitter is turned On, at which time it will resume the starting sequence of the single, long beep ("beep") and one or two short beeps.

If the throttle stick is not all the way down when the battery is connected to the ESC, the motor will beep rapidly ("beep, beep, beep, beep...") until either the battery is disconnected or the throttle stick is returned to the Off /0% position. Then the normal beep sequence will resume.

If the chime sounds followed by continuous, slow beeps (“beep...beep...beep...beep...”), then the receiver is not receiving a signal from the transmitter. You may need to link the receiver to the transmitter, or check the connection between the ESC and the receiver.

Throttle Calibration

If you connect the battery to the ESC and hear the three chimes (“♪ 1 2 3”), but then the motor beeps rapidly (beep, beep, beep, beep, beep, beep...) and does not run when you move the throttle stick, the ESC is not detecting the end points of the throttle stick and requires **calibration**. Recalibration may also be required if you ever switch to a different transmitter, or if you adjust the throttle trim or throttle end points in your transmitter:

1. Remove the propeller.
2. Turn on the transmitter and advance the throttle to the “up” position.
3. Connect the battery to the ESC and hear the chime followed by two long beeps (“beep, beep”) indicating that the ESC has read the top of the throttle range.
4. Move the throttle stick to the low position and again hear a single long beep (“beep”) (signaling that the ESC has read the bottom end of the throttle range) followed by one or two short beeps signaling the completion of the procedure. Now the throttle has been calibrated.

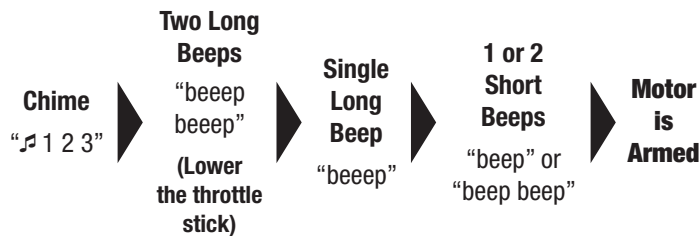

Note: If this recalibration does not work, increase or decrease the throttle trim or end point for low throttle on your transmitter and repeat the procedure.

Brake Setting

The ESC is preset from the factory with the motor brake off, but if you inadvertently turn on the brake, or if the ESC was not set correctly, follow these instructions to turn on or off the brake:

1. Remove the propeller.
2. Turn on the transmitter and move the throttle stick all the way up.
3. Connect a battery to the ESC to power up the ESC and radio.
 - A. Hear the chimes (“♪ 1 2 3”) followed by two long beeps (“beep, beep”) followed by a pause, a short beep (“beep”), another pause, then two more short beeps (“beep, beep”).
 - B. If you do nothing, the brake will not be changed. Disconnect the battery from the ESC.

- C. To change the brake setting (on or off) reconnect the battery to the ESC with the transmitter on and the throttle stick all the way up. Lower the throttle stick after the single short beep to turn the brake off; or lower the throttle stick after the two short beeps to turn the brake on:

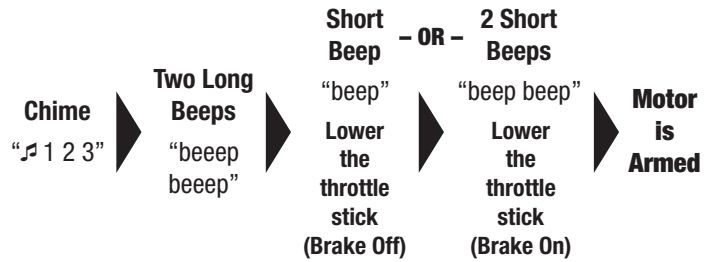

- D. After the throttle stick is lowered to turn the brake on or off, the single, long beep will sound (“beep”) followed by a single short beep (brake off) or two short beeps (brake on) depending on how you just programmed the brake.

Hook Up the Rudder and Elevator

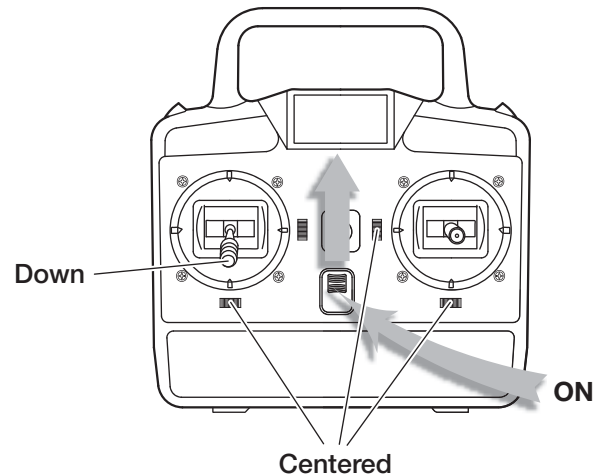

1. Turn on the transmitter, lower the throttle stick all the way to 0%, and center the trims.

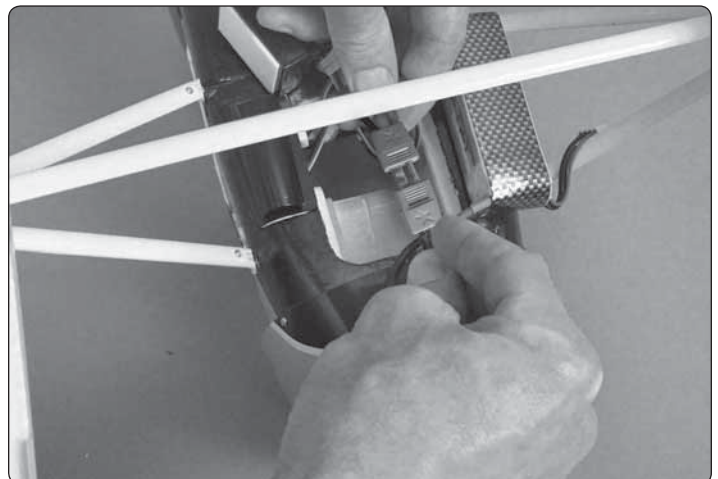

2. Connect the battery to the ESC. If all is working properly, the ESC will send three, short, electrical pulses to the motor causing it to chime three times (“♪1- 2-3”)

followed by a longer, single, lower tone beep (“BEEEP”) followed by a shorter, higher tone beep (“beep”). If the chimes and beeps do not sound in this manner refer to “FAILSAFE/MOTOR/ESC OPERATION” on page 10 to setup the transmitter and ESC correctly.

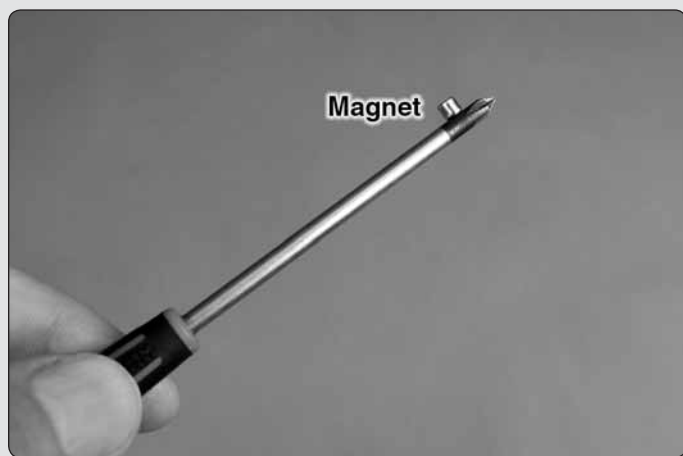

A magnetic screwdriver, or a small magnet stuck to a screw driver to make it magnetic, will be helpful for the next couple of steps.

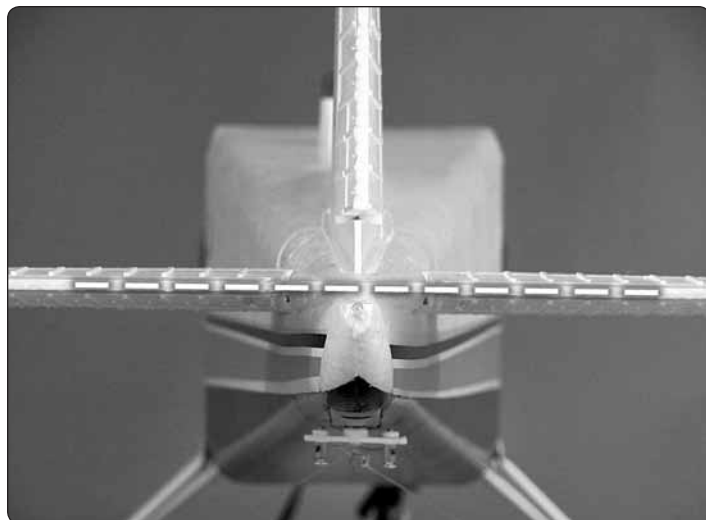

5. Reinstall the screw, but do not tighten yet. **With the transmitter and receiver on, center the elevator and tighten the screw to lock the pushrod down.**

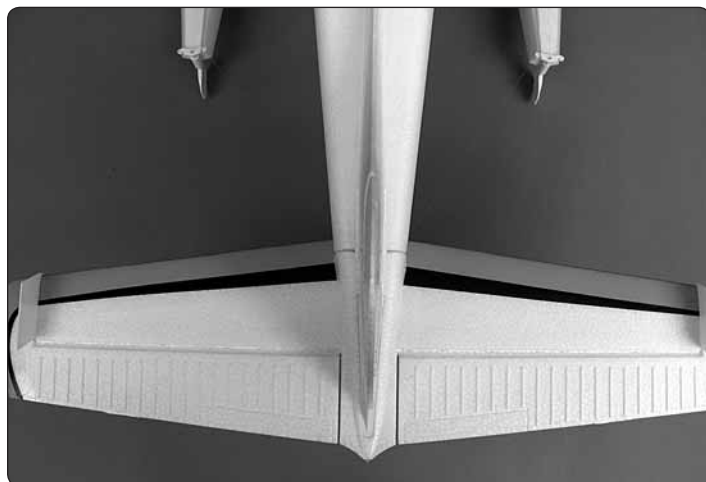
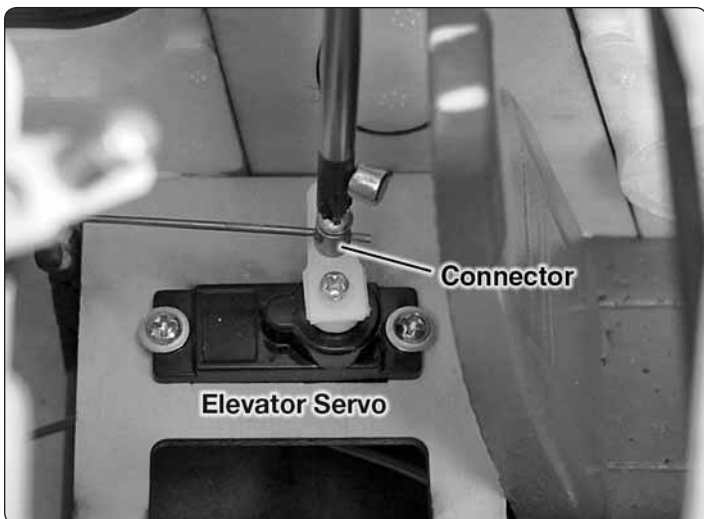

6. Repeat the same procedure for the rudder, making sure it is centered. Lock the pushrod in place on the servo arm with the screw and threadlocker.

7. Disconnect the battery and turn off the transmitter.

3. Remove the screw from the connector on the elevator servo arm.

Hook Up the Flaps and Ailerons



4. Lightly wet the threads of the screw with threadlocker.





❑ 1. Connect the wing lighting wires and the aileron servo wires to the lighting aileron and flap wiring harnesses coming from the receiver.



❑ 2. Turn on the transmitter and install and connect the battery. Then install and secure the hatch.

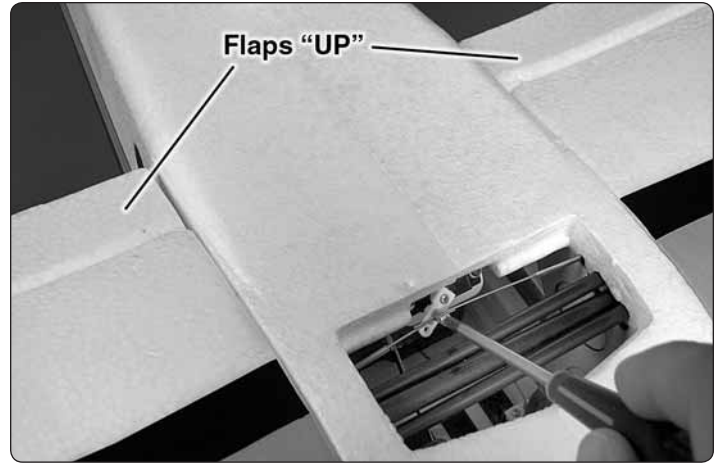

❑ 3. Move the dial or switch on your transmitter that controls the flaps to the "up" position, rotating the flap servo arm clockwise. Remove the screw in the flap servo arm, wet the threads with threadlocker, and then reinstall and tighten the screw so the flaps will be in their fully retracted ("up") position.

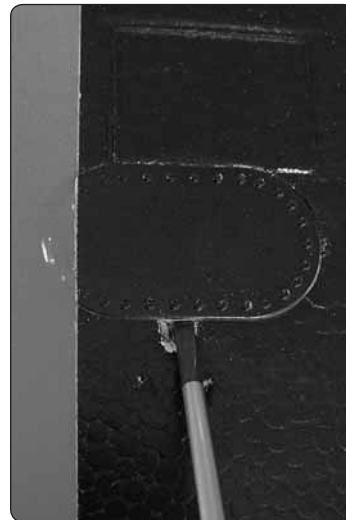
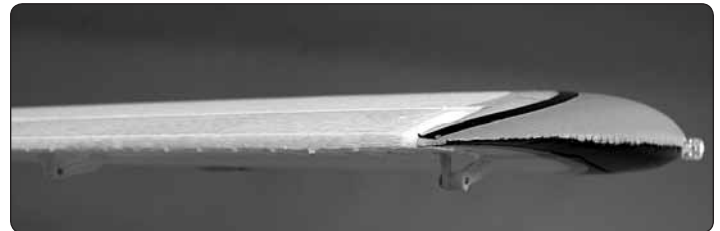

❑ 4. With the system still on, make sure the ailerons are centered and aligned with the wing tips. If necessary, apply a few clicks of aileron trim to get the ailerons centered. If more than a few clicks of trim are required, or if you cannot get both ailerons neutralized, a small screwdriver may be used to pop off one or both aileron servo covers to access the pushrods. Adjust the pushrods in the connectors to get the ailerons centered. When finished, replace the cover, press into position, and hold in place with tape or a dab of glue.

FINAL FLIGHT PREPARATION

Check the Control Throws

Because the servos and pushrods are factory-installed the control throws should already be correct, but because of the effect the control throws can have on a model, it's always a good idea to check them anyway.

4-CHANNEL RADIO SETUP (Standard Mode 2)

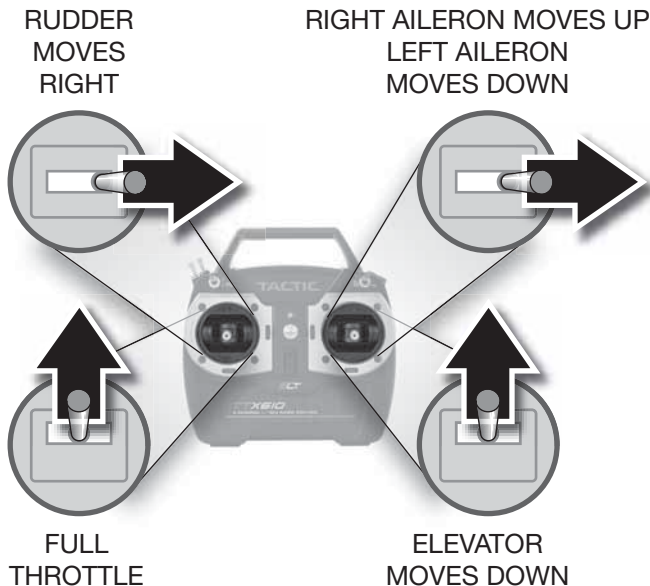

❑ 1. Confirm that the controls are responding in the correct direction according to control inputs from the transmitter. If necessary, use the servo reversing program in your transmitter to change the servo direction of any controls that are moving the wrong way.

❑ 2. If your de Havilland Beaver is configured with wheels, use a small box or something similar to prop up the bottom of the fuselage under the tail so the wings and stab are level (or nearly level).

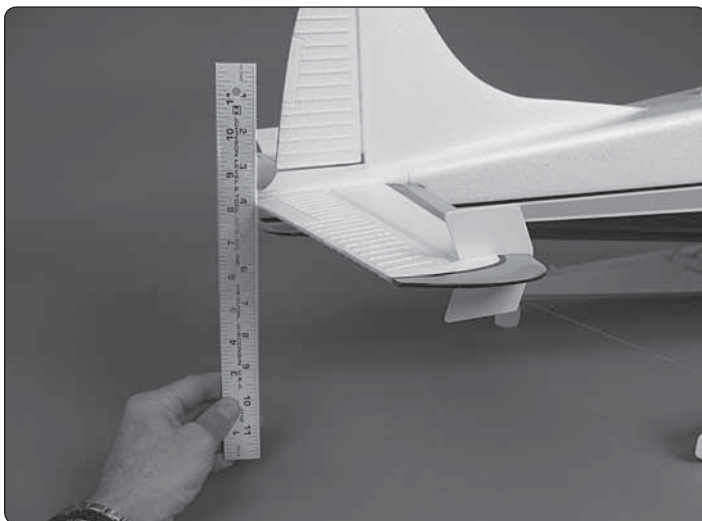

❑ 3. Measure and set the control throws according to the measurements below. The throws are measured at the widest part (front-to-back) of each surface.

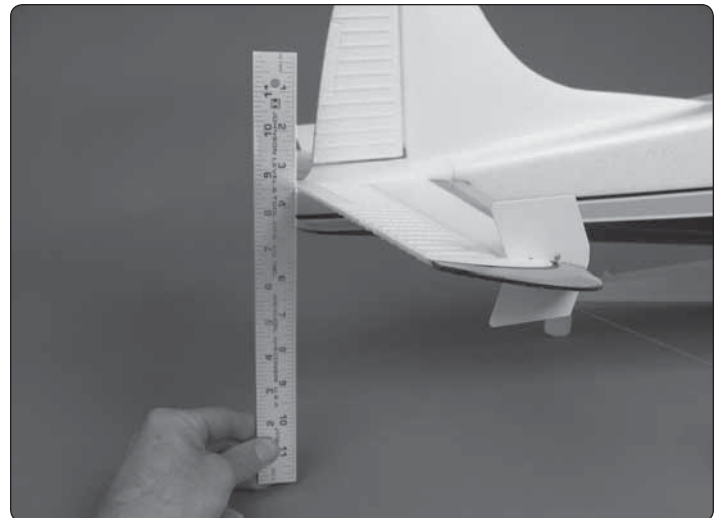

Recommended Control Surface Throws				
INCHES	HIGH RATE		LOW RATE	
	Up	Down	Up	Down
ELEVATOR	7/16"	7/16"	5/16"	5/16"
AILERONS	1/2"	1/2"	3/8"	3/8"
RUDDER (R&L)	1-1/4"	1-1/4"	7/8"	7/8"
FLAP	7/16"			

Recommended Control Surface Throws				
MILLIMETERS	HIGH RATE		LOW RATE	
	Up	Down	Up	Down
ELEVATOR	11 mm	11 mm	8 mm	8 mm
AILERONS	13 mm	13 mm	10 mm	10 mm
RUDDER (R&L)	32 mm	32 mm	22 mm	22 mm
FLAP	11 mm			

Recommended Control Surface Throws				
DEGREES	HIGH RATE		LOW RATE	
	Up	Down	Up	Down
ELEVATOR	10°	10°	8°	8°
AILERONS	20°	20°	14°	14°
RUDDER (R&L)	26°	26°	18°	18°
FLAP	34°			

More Control Throw

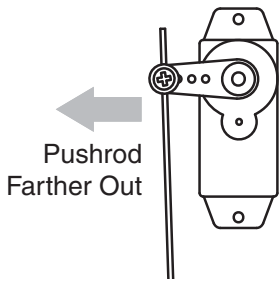

Less Control Throw

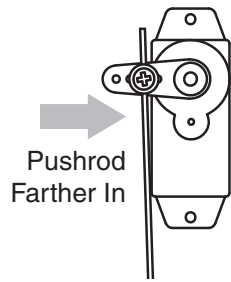

- ❑ 4. If any of the control throws require adjustment use the programming in your transmitter to increase or decrease the throws accordingly. If the programming isn't enough or if your radio doesn't have adjustable throws, the pushrod connectors on the servo arms can be relocated in different holes inward or outward to increase or decrease the throw—moving the pushrods **inward** on the servo arms **decreases** the throw and moving the pushrods **outward** on the servo arms **increases** the throw.

Motor and Prop Safety Precautions

Failure to follow these safety precautions may result in severe injury to yourself and others.

- Wear safety glasses whenever in the proximity of a spinning propeller.
- Do not operate the motor in an area of loose gravel or sand; the propeller may throw such material in your face or eyes.
- Keep spectators as well as your own face and body out of the plane of rotation of the propeller.
- Never connect the battery to the ESC while indoors with the propeller installed.
- Always remove the propeller when testing or making repairs to the model.
- Always stay behind the arc of the propeller when handling the model.
- Always assume the motor may start unexpectedly when the flight battery is connected.
- Always remain outside the arc of the propeller when installing and/or removing the flight battery.
- Keep all loose clothing, long hair or any other loose objects such as pencils or screwdrivers that may fall out pockets away from the propeller.

Mount the Propeller and Spinner



- ❑ 1. Secure the backplate, propeller, washer and nut. Make sure the assembly is secure to the aircraft.



- ❑ 2. Tighten the two Phillips head screws to the spinner.

Check the C.G.

Same as the control throws, the C.G. has a great effect on how every model flies, so do not skip this procedure. If the model is tail-heavy it may be too instable and respond too quickly to the controls. If the model is nose-heavy it may be too stable and not respond fast enough—in either case possibly causing a crash. Do not overlook this important procedure.



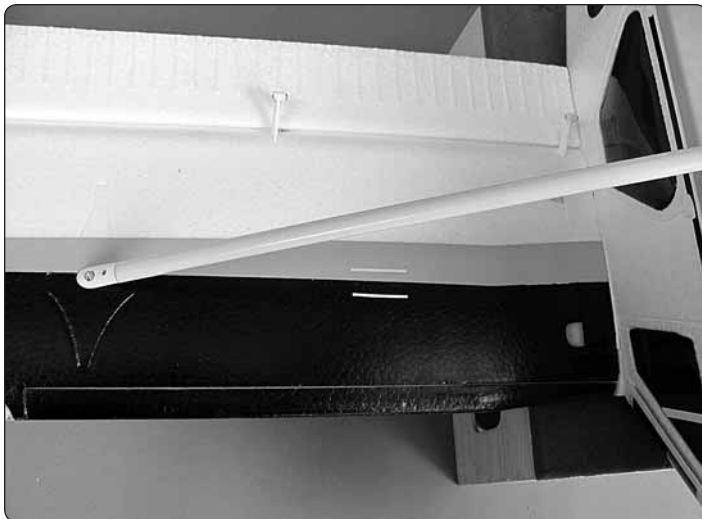
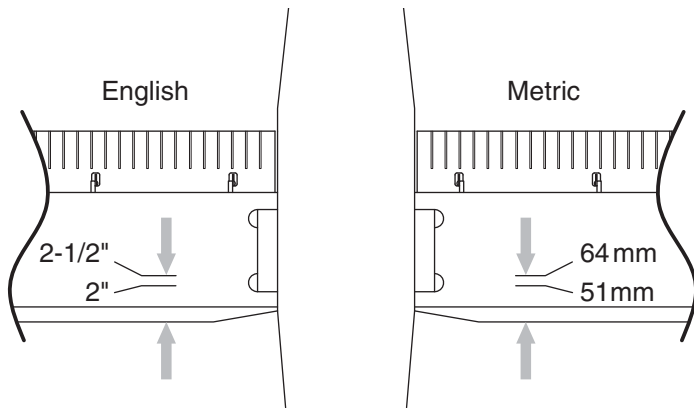

❑ 1. Mark the forward and aft C.G. limits on both sides of the bottom of the wing 2" and 2-1/2" [51mm and 64mm] back from the leading edge where shown—using narrow strips of tape will allow you to feel the marks when lifting the model with your fingertips to balance.

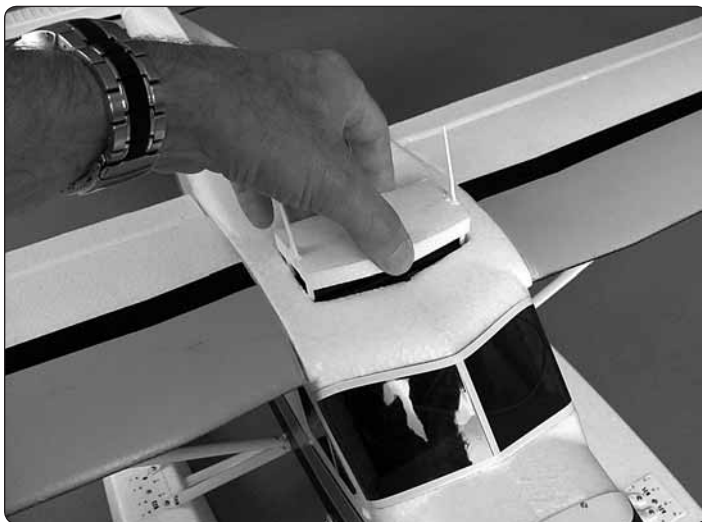

❑ 2. Install the battery, battery hatch and cabin hatch. At this point the Beaver must be in ready-to-fly condition with everything attached and installed including the floats or wheels and battery and propeller.



❑ 4. Lift the model by your fingers between the lines indicating the balance range. As long as the Beaver sits level with your fingers on the forward or aft lines or anywhere between the lines it is properly balanced and ready to fly. If you have to move your fingertips outside the lines the Beaver is out of balance and should not be flown. If necessary, add squares of stick-on lead to the nose or tail to get the Beaver to balance within the specified range.

FLYING

When powering up, make sure the throttle stick is in the minimum (0%) position. Always turn the transmitter ON before plugging the battery into the plane.

The Beaver flies mostly the same as any similar-type, high-wing airplane, but you may find that the roll rate is a little slower. This suits the Beaver well as it is a scale-like, STOL (Short TakeOff and Landing) craft. Just give yourself more time and altitude before trying your first full roll.

The only peculiarity arises when the flaps are extended—if you extend the flaps too soon before the Beaver has lost enough flying speed the nose will pitch up. The way to avoid this is first by making sure you have given the Beaver enough time to slow after cutting the throttle. You can also roll in the flaps gradually. If you have a computer radio you could also mix in some down elevator with flaps. In any regard, once the Beaver reaches “equilibrium” and has initiated a gliding descent the nose will resume a normal, downward glide angle. Similarly, when powering up the throttle with the flaps extended the nose will pitch up, so be ready to counter with down elevator.

Taken verbatim from our flight log book... “Flying the Beaver from water with floats can be described with many adjectives including *astounding, easy, fun, smooth, remarkable, etc.*”

Unless weather conditions are poor, you should have no trouble flying the Beaver from either rough or calm water. The water rudders direct the Beaver well and they don't have to be perfectly centered to be effective (so don't spend an exorbitant amount of time on the work bench working on them!). The Beaver turns more tightly at idle speeds, so if you need to do a U-turn throttle back to bring the Beaver around. At higher speeds during a takeoff run the water rudders have the correct amount of effectiveness to steer the Beaver on its intended path. Takeoffs can be long and graceful or short and steep—either way the floats handle

the water well. If the winds are really high the Beaver can still be flown from water, but avoid turning it directly across the wind. Otherwise, the wind can get under the wing and flip the Beaver over. In the air, the only effect of the floats is that the Beaver flies slightly slower.

Flying “normally” (using half-throttle for general cruising and full-throttle only when required) the Beaver consumes about 200mAh/minute for recommended flight times of about 7 minutes with an 1800mAh battery and about 8.5 minutes with a 2100mAh battery. Flying more aggressively using higher throttle settings, the current draw increases closer to 260mAh/minute for recommended flight times of 5.5 minutes with an 1800mAh battery and 6.5 minutes with a 2100mAh battery.

To find out for yourself how long you can fly, set your timer to a conservative 5 minutes. Fly until the timer sounds, then land. Use a charger with a digital display to find out how much capacity it took to recharge the battery (indicating how much capacity was used). To avoid over discharging your LiPos use only 80% of your battery’s capacity, so multiply your battery’s capacity by .8 to find out how much you have available. Compare the capacity used to 80% of your battery’s capacity and adjust your flight time accordingly.

For example: If using the recommended 1800mAh battery, your target capacity to use for a flight is 1440mAh (1800mAh x .8 = 1440mAh). If you fly for five minutes and it takes 1000mAh to recharge your battery, you still have 440mAh to go before you should land, so adjust your timer to increase your flight time accordingly until you reach your 1440mAh target. (You could also divide 1000mAh by five minutes to figure a current consumption rate of 200mAh/minute. Divide 1440mAh by 200mAh/minute to conclude that you can fly for 7.2 minutes [7 min. 12 sec.]—but round down to 7 minutes.)

When powering down, *always* unplug the battery from the plane *before* turning the transmitter OFF.



It’s also a great idea to use a LiPo battery checker (HCAP0275) to check the battery *before* each flight (to make sure you haven’t inadvertently grabbed a discharged battery) and to check the battery *after* flight to make sure you haven’t over discharged your battery by flying too long. A safe, conservative, minimum voltage is 3.65V – 3.7V per cell right after a flight.

REPAIRS

Parts damaged beyond repair can be purchased separately. The full replacement part list is printed in the front of the manual on page 4. Often though, parts can be repaired and you can get your Beaver back into the air with a little glue and ingenuity.

The Beaver is made from injection-molded EPO (expanded polyolefin) foam which can be glued with just about anything. Most people use regular CA. With CA no clamping is required, but some prefer softer, more flexible adhesives such as white glue or canopy glue. These will require clamps or tape to hold the parts together while the glue dries.

One final note about flying your model. Have a goal or flight plan in mind for every flight. This can be learning a new maneuver(s), improving a maneuver(s) you already know, or learning how the model behaves in certain conditions (such as on high or low rates). This is not necessarily to improve your skills (*though it is never a bad idea!*), but more importantly so you do not surprise yourself by impulsively attempting a maneuver and suddenly finding that you’ve run out of time, altitude or airspeed. Every maneuver should be deliberate, not impulsive. For example, if you’re going to do a loop, check your altitude, mind the wind direction (anticipating rudder corrections that will be required to maintain heading), remember to throttle back at the top, and make certain you are on the desired rates (high/low rates). A flight plan greatly reduces the chances of crashing your model just because of poor planning and impulsive moves. **Remember to think.**

Have a ball! But always stay in control and fly in a safe manner.

GOOD LUCK AND GREAT FLYING!

This model belongs to:

Name

Address

City, State, Zip

Phone Number

FAA Number

AMA Number

Follow these steps in powering your model:

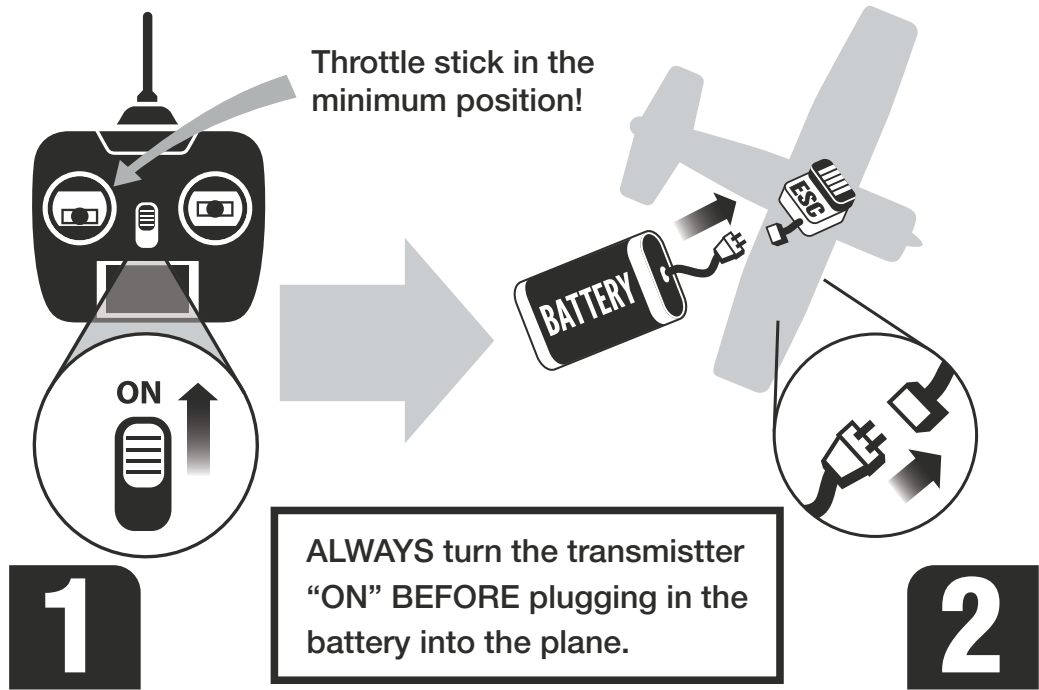

When finished flying:

