

FCC PART 15E TEST REPORT FOR CERTIFICATION
On Behalf of

TCL Entertainment Solutions Limited

Wireless subwoofer

Model Number: S645W-SW

Additional Model: S510W-SW, S4510-SW, S645WE-SW, S645WK-SW,
S645W*-SW(*can be any numerica number"0~9" or alphebtical number "A~Z")

FCC ID: 2ARUDS510WSW

Applicant :	TCL Entertainment Solutions Limited
Address:	7/F, building 22E, 22 science park east avenue Hong Kong science park, SHATIN, N.T. ,Hong Kong, China
Prepared By:	EST Technology Co., Ltd.
	Chilingxiang, Qishantou, Santun, Houjie, Dongguan, Guangdong, China
	Tel: 86-769-83081888-808



Report Number:	ESTE-R2302038
Date of Test:	Dec. 16, 2022~ Feb. 03, 2023
Date of Report:	Feb. 08, 2023

TABLE OF CONTENTS

Description	Page
TEST REPORT VERIFICATION.....	3
1. GENERAL INFORMATION.....	5
1.1. Description of Device (EUT)	5
1.2. The antenna information for EUT	6
1.3. Information of RF Cable	6
2. SUMMARY OF TEST	7
2.1. Summary of test result.....	7
2.2. Test Facilities	8
2.3. Measurement uncertainty for EST Technology Co., Ltd.	9
2.4. Assistant equipment used for test	9
2.5. Block Diagram	9
2.6. Test Mode.....	10
2.7. Channel List	10
2.8. Power Setting of Test Software.....	11
2.9. Duty Cycle of Test Signal	11
2.10. Test Equipment List	12
3. 6DB BANDWIDTH & 26DB BANDWIDTH & 99% OCCUPIED BANDWIDTH.....	14
3.1. Limit	14
3.2. Test Setup.....	14
3.3. Spectrum Analyzer Setting.....	14
3.4. Test Procedure	15
3.5. Test Result.....	15
4. MAXIMUM CONDUCTED OUTPUT POWER	16
4.1. Limit	16
4.2. Test Setup.....	16
4.3. Spectrum Analyzer Setting.....	16
4.4. Test Procedure	16
4.5. Test Result.....	16
5. PEAK POWER SPECTRAL DENSITY	17
5.1. Limit	17
5.2. Test Setup.....	17
5.3. Spectrum Analyzer Setting.....	17
5.4. Test Procedure	17
5.5. Test Result.....	17
6. UNWANTED EMISSIONS AND BAND EDGE	18
6.1. Limit	18
6.2. Test Setup.....	19
6.3. Spectrum Analyzer Setting.....	20
6.4. Test Procedure	21
6.5. Test Result.....	22
7. FREQUENCY STABILITY	31
7.1. Limit	31
7.2. Test Setup.....	31

- 7.3. Spectrum Analyzer Setting..... 31
- 7.4. Test Procedure..... 32
- 7.5. Test Result..... 32
- 8. AC POWER LINE CONDUCTED EMISSIONS 33
 - 8.1. Limit..... 33
 - 8.2. Test Setup..... 33
 - 8.3. Spectrum Analyzer Setting..... 33
 - 8.4. Test Procedure..... 33
 - 8.5. Test Result..... 34
- 9. ANTENNA REQUIREMENTS 36
 - 9.1. Limit..... 36
 - 9.2. Test Result..... 36
- 10. APPENDIX 37
- 11. TEST SETUP PHOTO..... 51
- 12. EUT PHOTO..... 53

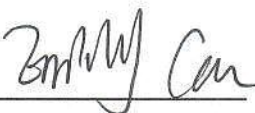
EST Technology Co., Ltd.

Applicant:	TCL Entertainment Solutions Limited		
Address:	7/F, building 22E, 22 science park east avenue Hong Kong science park, SHATIN, N.T. ,Hong Kong, China		
Manufacturer:	TCL OVERSEAS MARKETING LTD		
Address:	5/F, Building 22E, 22 Science Park East Avenue HongKong Science Park Shatin Hong Kong		
Factory:	Zhong Shan City Richsound Electronic Industrial Ltd.		
Address:	NO. 16, East ShaGang Road, GangKou Town, ZhongShan City, GuangDong, China		
E.U.T:	Wireless subwoofer		
Model Number:	S645W-SW		
Additional Model:	S510W, S4510, S645W-SWE, S645W-SWK, S645W-SW*(*can be any numerica Number "0~9" or alphebthical number "A~Z") Note: They are identical except model name.		
Power Supply:	AC 100-240V~50/60Hz, 50W		
Trade Name:	TCL	Serial No.:	-----
Date of Receipt:	Dec. 16, 2022	Date of Test:	Dec. 16, 2022~ Feb. 03, 2023
Test Specification:	FCC Part 15 Subpart E 15.407 ANSI C63.10:2013 FCC KDB 789033 D02 General UNII Test Procedures New Rules v02r01 FCC KDB 662911 D01 Multiple Transmitter Output v02r01		
Test Result:	<p>The device described above is tested by EST Technology Co., Ltd. The measurement results were contained in this test report and EST Technology Co., Ltd. was assumed full responsibility for the accuracy and completeness of these measurements. Also, this report shows that the EUT to be technically compliance with the FCC Rules and Regulations Part 15 Subpart E requirements.</p> <p style="text-align: center;">This report applies to above tested sample only and shall not be reproduced in part without written approval of EST Technology Co., Ltd.</p>		
Prepared by:	Reviewed by:	Date: Feb. 08, 2023	
 _____ Emily Cai / Assistant	 _____ Seven Wang / Engineer	Approved by:  _____ Iceman Hu / Manager	
Other Aspects:	None.		
<i>Abbreviations: OK/P=passed fail/F=failed n.a/N=not applicable E.U.T=equipment under tested</i>			
<i>This test report is based on a single evaluation of one sample of above mentioned products ,It is not permitted to be duplicated in extracts without written approval of EST Technology Co., Ltd.</i>			

1. GENERAL INFORMATION

1.1. Description of Device (EUT)

FCC ID	:	2ARUDS510WSW
Product Name	:	Wireless subwoofer
Model Number	:	S645W-SW
Software Version	:	N/A
Hardware Version	:	N/A
Operation frequency	:	5729 MHz~5849 MHz
Number of channel	:	61 Channels
Modulation	:	FSK
Max Power	:	-9.35dBm
Sample Type	:	Prototype production

Note: For a more detailed features description, please refer to the manufacturer's specifications or the user's manual.

1.2. The antenna information for EUT

Ant No.	Brand	Model Name	Antenna Type	Connector	Gain (dBi)
Left	-	-	Integral	-	0.5

Note:

- (1) After pre-test all antenna configurations, the worst case configuration as list below.
- (2) This information is provided by the applicant.

ANT No.	SISO Configuration	MIMO Configuration
FSK	Left Antenna 1	/

1.3. Information of RF Cable

Cable Loss(dB)	Provided by
1.0	TCL Entertainment Solutions Limited

Note: 1. The customer declared the loss value of the RF Cable, and the test results of this report only apply to the sample as received.
 2. This information is provided by the applicant.

2. SUMMARY OF TEST

2.1. Summary of test result

No.	Description of Test Item	FCC Standard Section	Results
1	6dB Bandwidth & 26dB Bandwidth & 99% Occupied Bandwidth	15.407(a) 15.407(e)	PASS
2	Maximum Conducted Output Power	15.407(a)	PASS
3	Peak Power Spectral Density	15.407(a)	PASS
4	Unwanted Emissions and Band Edge	15.205 15.209 15.407(b)	PASS
5	Frequency Stability	15.407(g)	PASS
6	AC Power Line Conducted Emissions	15.207 15.407(b)(9)	PASS
7	Antenna Requirement	15.203	PASS

Note: "N/A" denotes test is not applicable in this test report.

2.2. Test Facilities

EMC Lab : Certified by CNAS, CHINA
Registration No.: L5288
This Certificate is valid until: November 12, 2023

Certificated by FCC, USA
Designation Number: CN1215
This Certificate is valid until: January 31, 2024

Certificated by A2LA, USA
Registration No.: 4366.01
This Certificate is valid until: January 31, 2024

Certificated by Industry Canada
CAB identifier No.: CN0035
This Certificate is valid until: January 31, 2024

Certificated by VCCI, Japan
Registration No.:C-14103; T-20073; R-13663;
R-20103; G-20097
Date of registration: Apr. 20, 2020
This Certificate is valid until: Apr. 19, 2023

Certificated by TUV Rheinland, Germany
Registration No.: UA 50413872 0001
Date of registration: July 31, 2018

Certificated by Intertek
Registration No.: 2011-RTL-L2-64
Date of registration: November 08, 2018

Name of Firm : EST Technology Co., Ltd.

Site Location : Chilingxiang, Qishantou, Santun, Houjie, Dongguan,
Guangdong, China

2.3. Measurement uncertainty for EST Technology Co., Ltd.

Test Item	Uncertainty
Uncertainty for Conduction emission test	2.54dB
Uncertainty for spurious emissions test (Below 30MHz)	±1.62 dB
Uncertainty for Radiation Emission test (30MHz-1GHz)	3.62
Uncertainty for Radiation Emission test (1GHz to 18GHz)	4.86
Uncertainty for spurious emissions test (18GHz to 40GHz)	4.67
Uncertainty for radio frequency	7×10-8
Uncertainty for conducted RF Power	1.08dB
Uncertainty for Power density test	0.26dB
Temperature	±0.6°C
Humidity	±4.0 %
Volatage DC	±1.0%
Volatage (AC, <10KHz)	±1.5%

Note: This uncertainty represents an expanded uncertainty expressed at approximately the 95% confidence level using a coverage factor of k=2.

2.4. Assistant equipment used for test

Item	Equipment	Brand	Model Name/Type No.	FCC ID	Series No.
-	-	-	-	-	-

Item	Shielded Type	Ferrite Core	Length	Note
1	NO	NO	1.6m	AC Cable

2.5. Block Diagram

For radiated emissions test: EUT was placed on a turn table, which is 0.8 (or 1.5) meter high above ground.

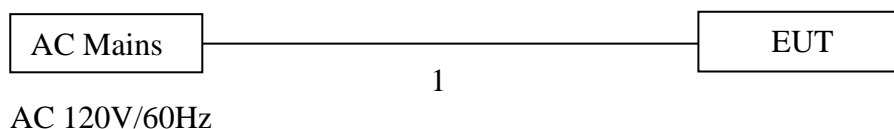

2.6. Test Mode

Pre-scan has been combined all possible modulations and data rates to determine the worst case test mode, the worst case test mode was selected for the final test as listed below.

Test Item	Test Mode	Channel	Modulation	Data rate
6dB Bandwidth	FSK	1/31/61	FSK	-
26dB Bandwidth	FSK	1/31/61	FSK	-
99% Occupied Bandwidth	FSK	1/31/61	FSK	-
Maximum Conducted Output Power	FSK	1/31/61	FSK	-
Peak Power Spectral Density	FSK	1/31/61	FSK	-
Unwanted Emissions and Band Edge(Above 1GHz)	FSK	1/31/61	FSK	-
Unwanted Emissions Below 1GHz	FSK	31	FSK	-
Frequency Stability	FSK	1	FSK	-
AC Power Line Conducted Emissions	FSK	31	FSK	-

Note: In radiated measurement, the EUT had been pre-scan on the positioned of each 3 axis(X,Y,Z), the worst case was found when positioned on **X-plane**.

2.7. Channel List

Channel No.	Frequency (MHz)	Channel No.	Frequency (MHz)	Channel No.	Frequency (MHz)	Channel No.	Frequency (MHz)
1	5729	2	5731	3	5733	4	5735
5	5737	6	5739	7	5741	8	5743
9	5745	10	5747	11	5749	12	5451
13	5753	14	5755	15	5757	16	5759
17	5761	18	5763	19	5765	20	5767
21	5769	22	5771	23	5773	24	5775
25	5777	26	5779	27	5781	28	5783
29	5785	30	5787	31	5789	32	5791
33	5793	34	5795	35	5797	36	5799
37	5801	38	5803	39	5805	40	5807
41	5809	42	5811	43	5813	44	5815
45	5817	46	5819	47	5821	48	5823
49	5825	50	5827	51	5829	52	5831
53	5833	54	5835	55	5837	56	5839
57	5841	58	5843	59	5845	60	5847
61	5849						

2.8. Power Setting of Test Software

Software Name	N/A		
Frequency(MHz)	5729	5789	5849
TX	Default	Default	Default

Note: This information is provided by the applicant.

2.9. Duty Cycle of Test Signal

Refer to section 10: Appendix A

Note:

1. Duty Cycle=On Time/Total Time×100%.
2. Duty Factor=10×LOG(1/Duty Cycle).
3. If duty cycle <98 %, the conducted average output power and average power spectral density should be add duty factor.
4. If duty cycle ≥98 %,the EUT is consider to be transmitting continuously,the conducted average output power and average power spectral density no need to add duty factor.
5. The on-time time is transmission duration(T).
6. The VBW Setting is use for RMS measurement in Unwanted Emissions and Band Edge(Above 1GHz) Test.

2.10. Test Equipment List

For AC power conducted emissions test						
Equipment	Manufacturer	Model No.	Serial No.	Calibration Body	Last Cal.	Next Cal.
EMI Test Receiver	Rohde & Schwarz	ESHS30	EST-E001	LISAI	June 13,22	1 Year
Artificial Mains Network	Rohde & Schwarz	ENV216	EST-E002	LISAI	June 13,22	1 Year
Pulse Limiter	Rohde & Schwarz	ESH3-Z2	EST-E078	LISAI	June 13,22	1 Year
Test Software	Audix	e3-6.111221a	N/A	N/A	N/A	N/A

For radiated emissions test(9KHz-30MHz)						
Equipment	Manufacturer	Model No.	Serial No.	Calibration Body	Last Cal.	Next Cal.
EMI Test Receiver	Rohde & Schwarz	ESR7	EST-E047	LISAI	June 13,22	1 Year
Active Loop Antenna	SCHWARZB ECK	FMZB 1519B	EST-E054	LISAI	June 13,22	1 Year
Test Software	Audix	e3-6.111221a	N/A	N/A	N/A	N/A
9kHz-30MHz Cable	N/A	EST-001	N/A	N/A	N/A	N/A

For radiated emissions test(30MHz-1000MHz)						
Equipment	Manufacturer	Model No.	Serial No.	Calibration Body	Last Cal.	Next Cal.
EMI Test Receiver	Rohde & Schwarz	ESR7	EST-E047	LISAI	June 13,22	1 Year
Bilog Antenna	Teseq	CBL 6111D	EST-E034	LISAI	June 13,22	1 Year
Test Software	Audix	e3-6.111221a	N/A	N/A	N/A	N/A
30-1000MHz Cable	N/A	EST-002	N/A	N/A	N/A	N/A

For radiated emission test(Above 1000MHz)						
Equipment	Manufacturer	Model No.	Serial No.	Calibration Body	Last Cal.	Next Cal.
Horn Antenna	SCHWARZB ECK	BBHA9120D	EST-E031	LISAI	June 13,22	1 Year
Horn Antenna	Com-Power	AHA-840	EST-E133	LISAI	June 13,22	1 Year
Low Noise Amplifier	RF	TRLA-01018 0G45N	EST-E142	LISAI	June 13,22	1 Year
Spectrum Analyzer	Rohde &Schwarz	FSV40	EST-E069	LISAI	June 13,22	1 Year
Test Software	Audix	e3-6.111221a	N/A	N/A	N/A	N/A
Above 1GHz Cable	N/A	EST-003	N/A	N/A	N/A	N/A

For connect EUT antenna terminal test						
Equipment	Manufacturer	Model No.	Serial No.	Calibration Body	Last Cal.	Next Cal.
TS 1120	Tonscend	/	/	/	/	/
Test Software	Tonscend	TS1120-3	3.2.11	/	/	/
RF Control Unit	Tonscend	JS0806-2	EST-E134	LISAI	June 13,22	1 Year
Signal and Spectrum Analyzer	Keysight	N9010B	EST-E141	LISAI	June 13,22	1 Year

3. 6dB BANDWIDTH & 26dB BANDWIDTH & 99% OCCUPIED BANDWIDTH

3.1. Limit

Band	Frequency (MHz)	Test Item	Limit
U-NII-3	5725-5850	6dB Bandwidth&99% Occupied Bandwidth	6dB Bandwidth \geq 500KHz

3.2. Test Setup



3.3. Spectrum Analyzer Setting

6dB Bandwidth	
Spectrum Parameters	Setting
RBW	100KHz
VBW	300KHz
Span	10MHz
Sweep Time	Auto
Detector	Peak
Trace Mode	Max Hold

26dB Bandwidth	
Spectrum Parameters	Setting
RBW	approximately 1% of the emission bandwidth
VBW	>RBW
Span	10MHz
Sweep Time	Auto
Detector	Peak
Trace Mode	Max Hold

99% Occupied Bandwidth	
Spectrum Parameters	Setting
RBW	1% to 5% of the OBW
VBW	approximately three times the RBW
Span	between 1.5 times and 5.0 times the OBW
Sweep Time	Auto
Detector	Peak
Trace Mode	Max Hold

3.4. Test Procedure

For 26dB Bandwidth Measurement :

- a. Connect EUT antenna terminal to the spectrum analyzer with RF cable.
- b. Spectrum analyzer setting parameters in accordance with section 3.3.
- c. Set the EUT transmit continuously with maximum output power.
- d. Allow trace to stabilize, measure the maximum width of the emission that is 26 dB down from the peak of the emission. Compare this with the RBW setting of the instrument. Readjust RBW and repeat measurement as needed until the RBW/EBW ratio is approximately 1%.
- e. Repeat above procedures until all modes and channels were measured.
- f. Record the results in the test report.

For 6dB Bandwidth Measurement :

- a. Connect EUT antenna terminal to the spectrum analyzer with RF cable.
- b. Spectrum analyzer setting parameters in accordance with section 3.3.
- c. Set the EUT transmit continuously with maximum output power.
- d. Allow trace to stabilize, measure the maximum width of the emission that is constrained by the frequencies associated with the two outermost amplitude points (upper and lower frequencies) that are attenuated by 6 dB relative to the maximum level measured in the fundamental emission.
- e. Repeat above procedures until all modes and channels were measured.
- f. Record the results in the test report.

For 99% Occupied Bandwidth Measurement :

- a. Connect EUT antenna terminal to the spectrum analyzer with RF cable.
- b. Spectrum analyzer setting parameters in accordance with section 3.3.
- c. Set the EUT transmit continuously with maximum output power.
- d. Allow trace to stabilize, use the 99% power bandwidth function to measure bandwidth.
- e. Repeat above procedures until all modes and channels were measured.
- f. Record the results in the test report.

3.5. Test Result

Refer to section 10: Appendix B/C/D

4. MAXIMUM CONDUCTED OUTPUT POWER

4.1. Limit

Band	EUT Type	Limit
U-NII-3	All Device	1W(30dBm)

Note: For the Band U-NII-2A and U-NII-2C, the maximum conducted output power limit calculate result refer to section 3.5.

4.2. Test Setup

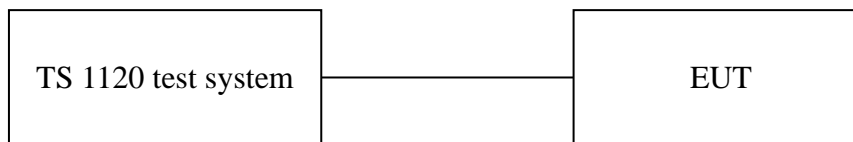

4.3. Spectrum Analyzer Setting

Spectrum Parameters	Setting
RBW	1MHz
VBW	3MHz
Span	10MHz
Sweep Time	Auto
Detector	RMS
Trace Mode	Max Hold

4.4. Test Procedure

- a. Connect EUT antenna terminal to the spectrum analyzer with RF cable.
- b. Spectrum analyzer setting parameters in accordance with section 4.3.
- c. Set the EUT transmit continuously with maximum output power.
- d. Use the channel power function to measure maximum peak output power, allow trace to stabilize, save test pictures.
- e. Repeat above procedures until all modes and channels were measured.
- f. Record the results in the test report.

4.5. Test Result

Refer to section 10: Appendix E

5. PEAK POWER SPECTRAL DENSITY

5.1. Limit

Band	EUT Type	Limit
U-NII-3	All Device	30dBm/500KHz

5.2. Test Setup



5.3. Spectrum Analyzer Setting

Spectrum Parameters	Setting
RBW	500KHz
VBW	2MHz
Span	encompass the entire 26 dB EBW or 99% OBW of the signal
Sweep Time	Auto
Number of Sweep Point	$\geq 2 \times \text{SPAN/RBW}$
Detector	RMS(power averaging)
Trace Average	≥ 100 traces

5.4. Test Procedure

- a. Connect EUT antenna terminal to the spectrum analyzer with RF cable.
- b. Spectrum analyzer setting parameters in accordance with section 5.3.
- c. Set the EUT transmit continuously with maximum output power.
- d. Allow trace to stabilize, use the marker-to-peak function to set the marker to the average of the emission.
- e. If the duty cycle of test signal $< 98\%$, the result = max measured value + $10 \times \log(1/\text{duty cycle})$;
If the duty cycle of test signal $\geq 98\%$, the result = max measured value.
- f. Repeat above procedures until all modes and channels were measured.
- g. Record the results in the test report.

5.5. Test Result

Refer to section 10: Appendix F

6. UNWANTED EMISSIONS AND BAND EDGE

6.1. Limit

The maximum emissions outside of the frequency bands of operation shall be attenuated in accordance with the following limits:

- (1) For transmitters operating in the 5.15-5.25 GHz band: All emissions outside of the 5.15-5.35 GHz band shall not exceed an e.i.r.p. of -27 dBm/MHz.
- (2) For transmitters operating in the 5.25-5.35 GHz band: All emissions outside of the 5.15-5.35 GHz band shall not exceed an e.i.r.p. of -27 dBm/MHz.
- (3) For transmitters operating in the 5.47-5.725 GHz band: All emissions outside of the 5.47-5.725 GHz band shall not exceed an e.i.r.p. of -27 dBm/MHz.
- (4) For transmitters operating in the 5.725-5.85 GHz band: All emissions shall be limited to a level of -27 dBm/MHz at 75 MHz or more above or below the band edge increasing linearly to 10 dBm/MHz at 25 MHz above or below the band edge, and from 25 MHz above or below the band edge increasing linearly to a level of 15.6 dBm/MHz at 5 MHz above or below the band edge, and from 5 MHz above or below the band edge increasing linearly to a level of 27 dBm/MHz at the band edge.

The unwanted emissions which fall in Restricted bands shall not exceed the field strength levels specified in the following table:

15.209 Radiated emission limits

Frequency (MHz)	Field Strength(μ V/m)	Distance(m)
0.009-0.490	2400/F(kHz)	300
0.490-1.705	24000/F(kHz)	30
1.705-30	30	30
30-88	100	3
88-216	150	3
216-960	200	3
Above 960	500	3

15.205 Restricted frequency band

MHz	MHz	MHz	GHz
0.090 - 0.110	16.42 - 16.423	399.9 - 410	4.5 - 5.15
¹ 0.495 - 0.505	16.69475 - 16.69525	608 - 614	5.35 - 5.46
2.1735 - 2.1905	16.80425 - 16.80475	960 - 1240	7.25 - 7.75
4.125 - 4.128	25.5 - 25.67	1300 - 1427	8.025 - 8.5
4.17725 - 4.17775	37.5 - 38.25	1435 - 1626.5	9.0 - 9.2
4.20725 - 4.20775	73 - 74.6	1645.5 - 1646.5	9.3 - 9.5
6.215 - 6.218	74.8 - 75.2	1660 - 1710	10.6 - 12.7
6.26775 - 6.26825	108 - 121.94	1718.8 - 1722.2	13.25 - 13.4
6.31175 - 6.31225	123 - 138	2200 - 2300	14.47 - 14.5
8.291 - 8.294	149.9 - 150.05	2310 - 2390	15.35 - 16.2
8.362 - 8.366	156.52475 - 156.52525	2483.5 - 2500	17.7 - 21.4
8.37625 - 8.38675	156.7 - 156.9	2690 - 2900	22.01 - 23.12
8.41425 - 8.41475	162.0125 - 167.17	3260 - 3267	31.6 - 24.0
12.29 - 12.293	167.72 - 173.2	3332 - 3339	31.2 - 31.8
12.51975 - 12.52025	240 - 285	3345.8 - 3358	36.43 - 36.5
12.57675 - 12.57725	322 - 335.4	3600 - 4400	(²)

Note:

1. $\text{dB}\mu\text{V}/\text{m} = 20\text{Log}(\mu\text{V}/\text{m})$
2. Above 1GHz the formula is used to convert the EIRP to field strength

$$E[\text{dB}\mu\text{V}/\text{m}] = \text{EIRP}[\text{dBm}] - 20 \log (d[\text{m}]) + 104.77,$$
 where E is field strength and d is distance at which the field strength limit is specified in the applicable requirements.
 for example, 3m field strength $(\text{dB}\mu\text{V}/\text{m}) = \text{EIRP} - 20\log(3) + 104.77 = \text{EIRP} + 95.2$

6.2. Test Setup

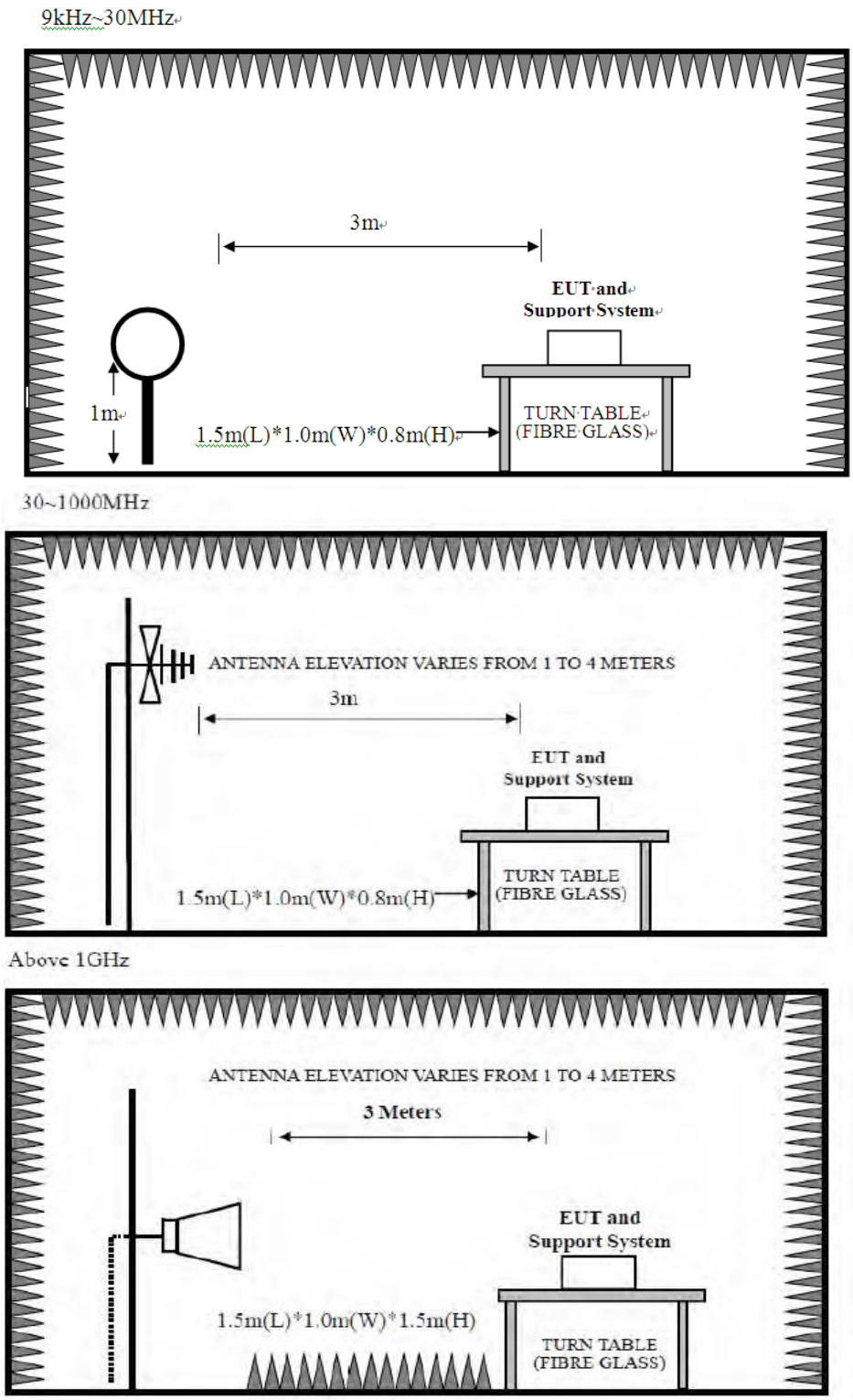

6.3. Spectrum Analyzer Setting

For 9KHz-150KHz

Spectrum Parameters	Setting
RBW	300Hz(for Peak&AVG)/CISPR 200Hz(for QP)
VBW	300Hz(for Peak&AVG)/CISPR 200Hz(for QP)
Start frequency	9KHz
Stop frequency	150KHz
Sweep Time	Auto
Detector	PEAK/QP/AVG
Trace Mode	Max Hold

Note : For 9KHz-90KHz&110KHz-150KHz,the detector is average,other frequency is CISPR QP detector.

For 150KHz-30MHz

Spectrum Parameters	Setting
RBW	9KHz
VBW	9KHz
Start frequency	150KHz
Stop frequency	30MHz
Sweep Time	Auto
Detector	QP
Trace Mode	Max Hold

Note : For 150KHz-490KHz,the detector is average,other frequency is CISPR QP detector.

For 30MHz-1GHz

Spectrum Parameters	Setting
RBW	120KHz
VBW	300KHz
Start frequency	30MHz
Stop frequency	1GHz
Sweep Time	Auto
Detector	QP
Trace Mode	Max Hold

For Above 1GHz

Spectrum Parameters	Setting	
RBW	1MHz	
VBW	PEAK Measurement	AVG Measurement
	3MHz	Duty cycle $\geq 98\%$, VBW=10Hz Duty cycle $< 98\%$, VBW $\geq 1/T$ Video bandwidth mode=RMS (power averaging)
Start frequency	1GHz	
Stop frequency	40GHz	
Sweep Time	Auto	
Detector	PEAK	
Trace Mode	Max Hold	

Note : T is the on-time time of the duty cycle,when EUT transmit continuously with maximum output power,unit is seconds. reference section 2.7 for the on-time time.

6.4. Test Procedure

- a. EUT was placed on a turn table, which is 0.8 meter high above ground for below 1GHz test, and which is 1.5 meter high above ground for above 1GHz test.
- b. EUT is set 3 meters away from the receiving antenna, which is mounted on a antenna tower.
- c. Set the EUT transmit continuously with maximum output power.
- d. The turn table can rotate 360 degrees to determine the position of the maximum emission level.
- e. The antenna can be moved up and down between 1 meter and 4 meters to find out the maximum emission level. Both horizontal and vertical polarization of the antenna are set on test.
- f. Spectrum analyzer setting parameters in accordance with section 6.3.
- g. Repeat above procedures until all channels were measured.
- h. Record the results in the test report.

6.5. Test Result

Radiated Emissions Below 1GHz

EST Technology

Chilingxiang, Qishantou, Santun,
Houjie, Dongguan,Guangdong,China
Tel:+86-769-83081888
Fax:+86-769-83081878

Data: 7 File: \\emc-966-1\test data\2023\RF\ITCL 多媒体\S645W\S645W-SW(FCC IC).EM6 (28)

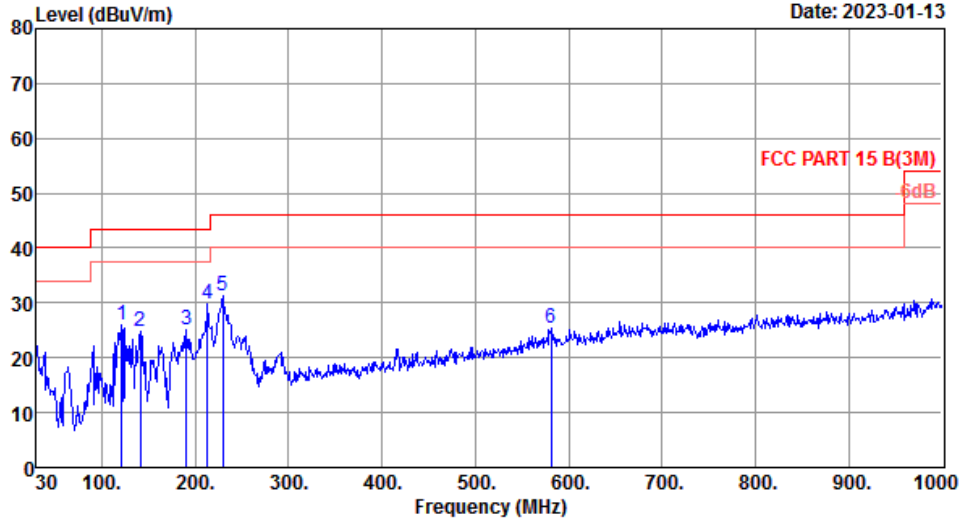

Site no. : 1# 966 Chamber Data no. : 7
 Dis. / Ant. : 3m 37062 Ant. pol. : VERTICAL
 Limit : FCC PART 15 B(3M)
 Env. / Ins. : Temp:23.9°C,Humi:52.3%;Press:101.82KPa
 Engineer : ZQL
 EUT : Wireless subwoofer
 Power : AC 120V/60Hz
 M/N : S645W-SW
 Test Mode : TX Mode

	Freq. (MHz)	ANT Factor (dB/m)	Cable Loss (dB)	Reading (dBuV)	Emission Level (dBuV/m)	Limit (dBuV/m)	Margin (dB)	Remark
1	121.180	11.66	1.07	13.15	25.88	43.50	17.62	QP
2	141.550	12.53	1.10	11.27	24.90	43.50	18.60	QP
3	191.020	9.18	1.18	14.84	25.20	43.50	18.30	QP
4	213.330	9.42	1.34	19.09	29.85	43.50	13.65	QP
5	229.820	10.60	1.40	19.22	31.22	46.00	14.78	QP
6	580.960	20.62	2.16	2.70	25.48	46.00	20.52	QP

Remarks: 1. Emission Level= Antenna Factor + Cable Loss + Reading.
 2. Margin= Limit - Emission Level.
 3. The emission levels that are 20dB below the official limit are not reported.

EST Technology

Chilingxiang, Qishantou, Santun,
Houjie, Dongguan, Guangdong, China
Tel: +86-769-83081888
Fax: +86-769-83081878

Data: 8 File: \\emc-966-1\test data\2023\RF\TTCCL 多媒体\S645W\S645W-SW(FCC IC).EM6 (28) Date: 2023-01-13

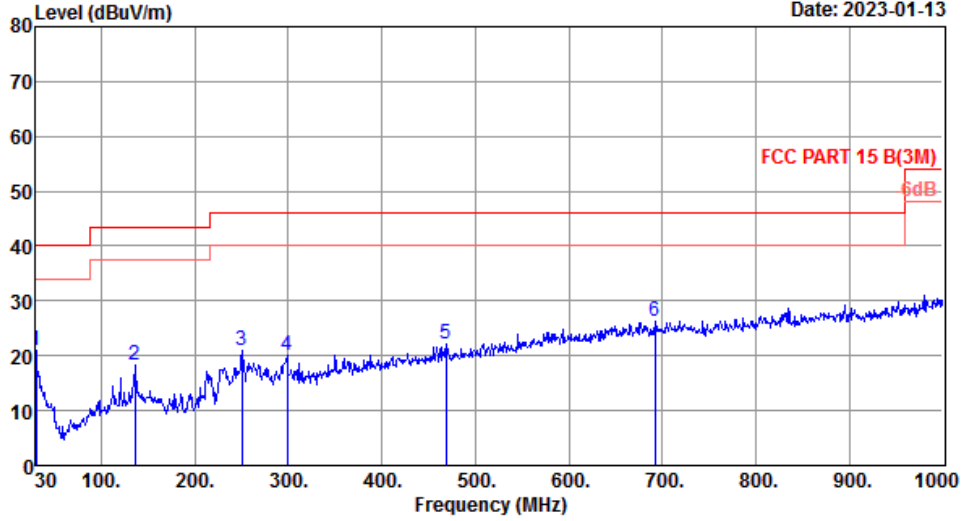

Site no. : 1# 966 Chamber Data no. : 8
 Dis. / Ant. : 3m 37062 Ant. pol. : HORIZONTAL
 Limit : FCC PART 15 B(3M)
 Env. / Ins. : Temp:23.9℃,Humi:52.3%;Press:101.82KPa
 Engineer : ZQL
 EUT : Wireless subwoofer
 Power : AC 120V/60Hz
 M/N : S645W-SW
 Test Mode : TX Mode

	Freq. (MHz)	ANT Factor (dB/m)	Cable Loss (dB)	Reading (dBuV)	Emission Level (dBuV/m)	Limit (dBuV/m)	Margin (dB)	Remark
1	30.000	19.20	0.59	1.20	20.99	40.00	19.01	QP
2	135.730	12.08	1.12	4.98	18.18	43.50	25.32	QP
3	250.190	13.10	1.54	6.44	21.08	46.00	24.92	QP
4	298.690	14.28	1.68	4.05	20.01	46.00	25.99	QP
5	468.440	18.23	2.09	1.72	22.04	46.00	23.96	QP
6	692.510	22.13	2.43	1.79	26.35	46.00	19.65	QP

Remarks: 1. Emission Level= Antenna Factor + Cable Loss + Reading.
 2. Margin= Limit - Emission Level.
 3. The emission levels that are 20dB below the official limit are not reported.

Note:

1. The amplitude of 9KHz to 30MHz spurious emission that is attenuated by more than 20dB below the permissible limit has no need to be reported.
2. All channels had been pre-test, only the worst case was reported.



Radiated Emissions Above 1G

EST Technology

Chilingxiang, Qishantou, Santun,
Houjie, Dongguan, Guangdong, China
Tel: +86-769-83081888
Fax: +86-769-83081878

Data: 11 File: \\emc-966-1\test data\2023\RF\TCL 多媒体\S645W\S645W-SW(FCC IC).EM6 (28) Date: 2023-01-12

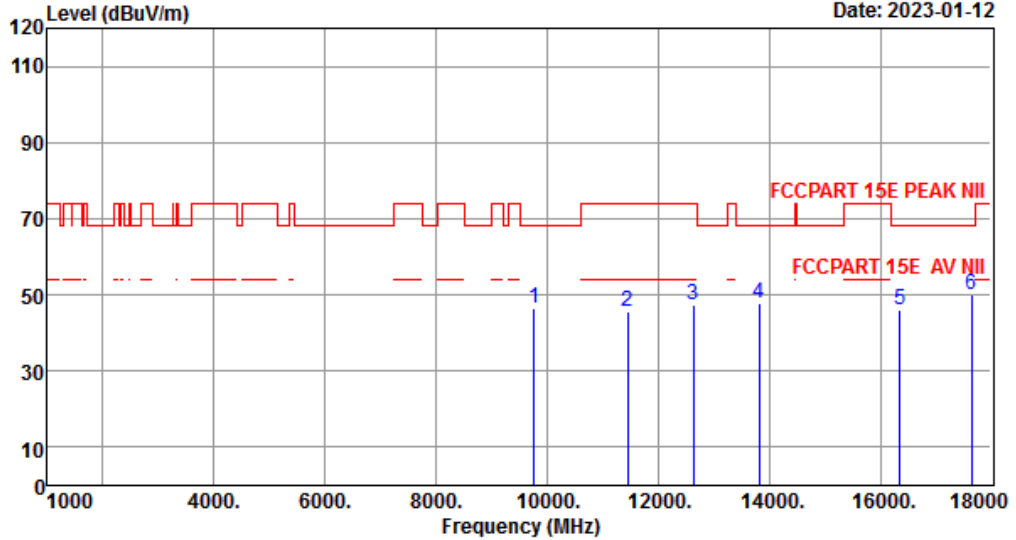

Site no. : 1# 966 Chamber Data no. : 11
 Dis. / Ant. : 3m BBHA9120D 1-18G 2208 Ant. pol. : VERTICAL
 Limit : FCCPART 15E PEAK NII
 Env. / Ins. : Temp:18.9°C;Humi:50%;Press:101.55kPa
 Engineer : JBR
 EUT : Wireless subwoofer

Power : AC 120V/60Hz
 M/N : S645W-SW
 Test Mode : TX 5729MHz

	Freq. (MHz)	Ant. Factor (dB/m)	Cable Loss (dB)	Amp Factor (dB)	Reading (dBuV)	Emission Level (dBuV/m)	Limits (dBuV/m)	Margin (dB)	Remark
1	9772.000	38.15	7.53	44.55	45.30	46.43	68.20	21.77	Peak
2	11458.000	38.85	8.03	43.54	42.21	45.55	74.00	28.45	Peak
3	12628.000	39.37	8.57	42.76	42.32	47.50	74.00	26.50	Peak
4	13818.000	39.95	8.92	41.96	41.06	47.97	68.20	20.23	Peak
5	16351.000	37.98	9.84	44.49	42.73	46.06	68.20	22.14	Peak
6	17643.000	40.42	10.53	43.91	42.91	49.95	68.20	18.25	Peak

Remarks: 1. Emission Level= Antenna Factor + Cable Loss - Amp Factor + Reading.
 2. Margin= Limit - Emission Level.
 3. The emission levels that are 20dB below the official limit are not reported.

Data: 12 File: \\emc-966-1\test data\2023\RF\ITCL 多媒体\S645W\S645W-SW(FCC IC).EM6 (28)

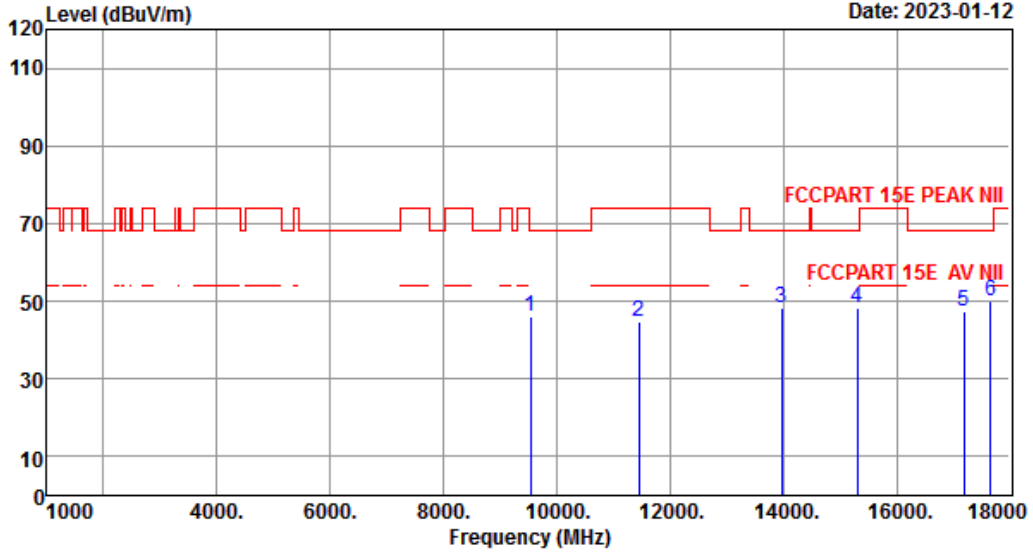

Site no. : 1# 966 Chamber Data no. : 12
 Dis. / Ant. : 3m BBHA9120D 1-18G 2208 Ant. pol. : HORIZONTAL
 Limit : FCCPART 15E PEAK NII
 Env. / Ins. : Temp:18.9°C;Humi:50%;Press:101.55kPa
 Engineer : JBR
 EUT : Wireless subwoofer

Power : AC 120V/60Hz
 M/N : S645W-SW
 Test Mode : TX 5729MHz

	Freq. (MHz)	Ant. Factor (dB/m)	Cable Loss (dB)	Amp Factor (dB)	Reading (dBuV)	Emission Level (dBuV/m)	Limits (dBuV/m)	Margin (dB)	Remark
1	9534.000	38.11	7.39	44.59	44.99	45.90	68.20	22.30	Peak
2	11458.000	38.85	8.03	43.54	41.31	44.65	74.00	29.35	Peak
3	13971.000	39.99	9.09	41.89	41.22	48.41	68.20	19.79	Peak
4	15314.000	38.97	9.50	44.66	44.28	48.09	68.20	20.11	Peak
5	17187.000	38.92	10.30	44.12	42.34	47.44	68.20	20.76	Peak
6	17660.000	40.48	10.54	43.91	43.07	50.18	68.20	18.02	Peak

Remarks: 1. Emission Level= Antenna Factor + Cable Loss - Amp Factor + Reading.
 2. Margin= Limit - Emission Level.
 3. The emission levels that are 20dB below the official limit are not reported.

Data: 13 File: \\emc-966-1\test data\2023\RF\IT\TCL 多媒体\S645W\S645W-SW(FCC IC).EM6 (28)

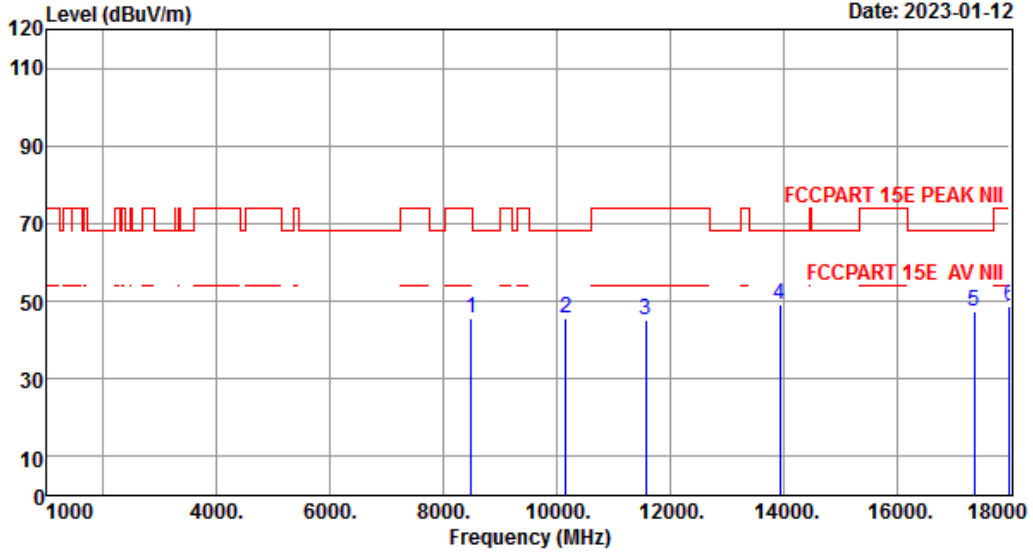

Site no. : 1# 966 Chamber Data no. : 13
 Dis. / Ant. : 3m BBHA9120D 1-18G 2208 Ant. pol. : HORIZONTAL
 Limit : FCCPART 15E PEAK NII
 Env. / Ins. : Temp:18.9°C;Humi:50%;Press:101.55kPa
 Engineer : JBR
 EUT : Wireless subwoofer
 Power : AC 120V/60Hz
 M/N : S645W-SW
 Test Mode : TX 5789MHz

	Freq. (MHz)	Ant. Factor (dB/m)	Cable Loss (dB)	Amp Factor (dB)	Reading (dBuV)	Emission Level (dBuV/m)	Limits (dBuV/m)	Margin (dB)	Remark
1	8497.000	37.40	6.91	44.77	46.26	45.80	74.00	28.20	Peak
2	10163.000	38.31	7.65	44.40	43.98	45.54	68.20	22.66	Peak
3	11578.000	38.84	8.08	43.46	41.92	45.38	74.00	28.62	Peak
4	13937.000	39.98	9.05	41.88	42.08	49.23	68.20	18.97	Peak
5	17367.000	39.51	10.39	44.04	41.52	47.38	68.20	20.82	Peak
6	18000.000	41.60	10.71	43.75	40.24	48.80	74.00	25.20	Peak

Remarks: 1. Emission Level= Antenna Factor + Cable Loss - Amp Factor + Reading.
 2. Margin= Limit - Emission Level.
 3. The emission levels that are 20dB below the official limit are not reported.

Data: 14 File: \\emc-966-1\test data\2023\RF\ITCL 多媒体\S645W\S645W-SW(FCC IC).EM6 (28)

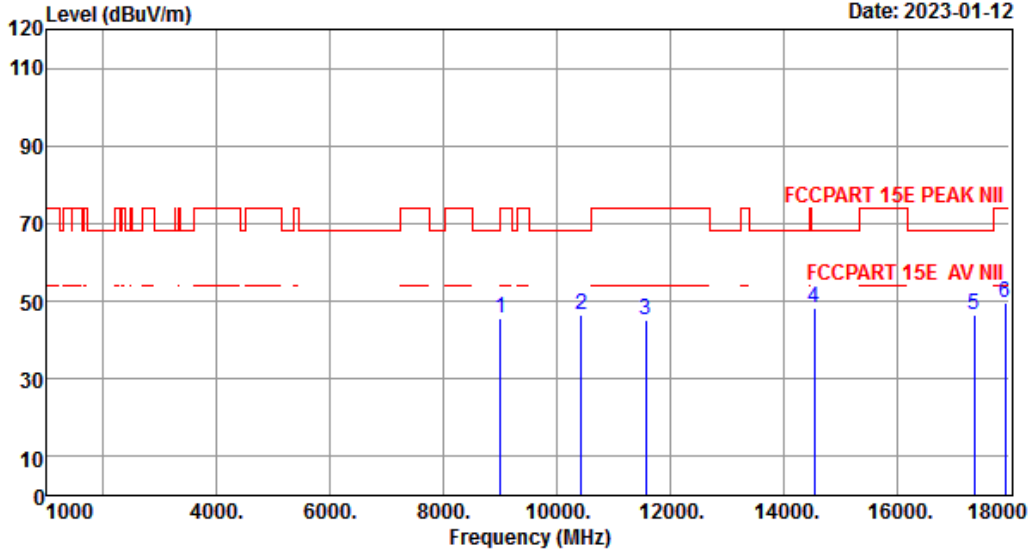

Site no. : 1# 966 Chamber Data no. : 14
 Dis. / Ant. : 3m BBHA9120D 1-18G 2208 Ant. pol. : VERTICAL
 Limit : FCCPART 15E PEAK NII
 Env. / Ins. : Temp:18.9°C;Humi:50%;Press:101.55kPa
 Engineer : JBR
 EUT : Wireless subwoofer

Power : AC 120V/60Hz
 M/N : S645W-SW
 Test Mode : TX 5789MHz

	Freq. (MHz)	Ant. Factor (dB/m)	Cable Loss (dB)	Amp Factor (dB)	Reading (dBuV)	Emission Level (dBuV/m)	Limits (dBuV/m)	Margin (dB)	Remark
1	9007.000	38.00	7.08	44.68	45.01	45.41	74.00	28.59	Peak
2	10435.000	38.50	7.63	44.22	44.37	46.28	68.20	21.92	Peak
3	11578.000	38.84	8.08	43.46	41.75	45.21	74.00	28.79	Peak
4	14549.000	39.73	9.29	43.22	42.56	48.36	68.20	19.84	Peak
5	17367.000	39.51	10.39	44.04	40.77	46.63	68.20	21.57	Peak
6	17915.000	41.32	10.67	43.79	41.45	49.65	74.00	24.35	Peak

Remarks: 1. Emission Level= Antenna Factor + Cable Loss - Amp Factor + Reading.
 2. Margin= Limit - Emission Level.
 3. The emission levels that are 20dB below the official limit are not reported.

Data: 15 File: \\emc-966-1\test data\2023\RF\ITCL 多媒体\S645W\S645W-SW(FCC IC).EM6 (28)

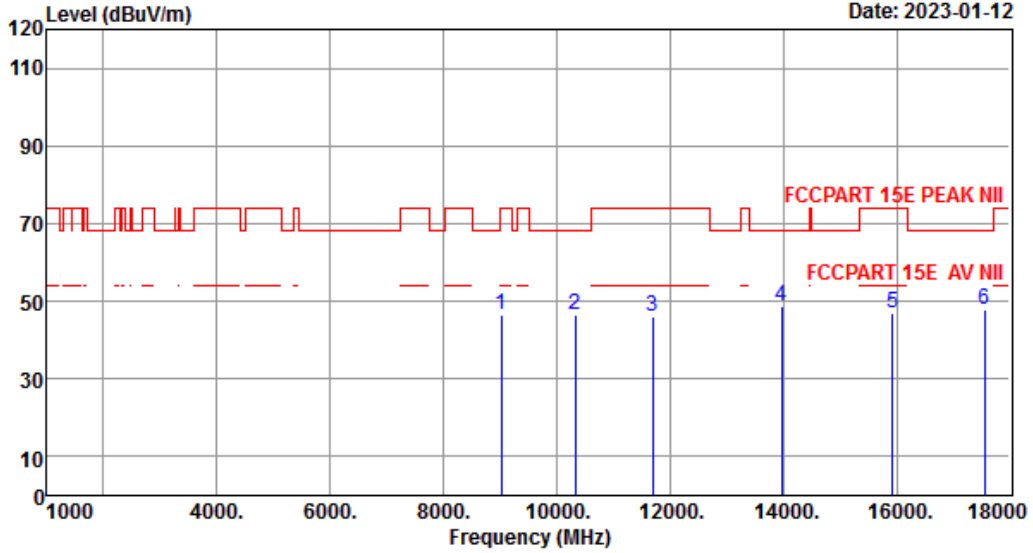

Site no. : 1# 966 Chamber Data no. : 15
 Dis. / Ant. : 3m BBHA9120D 1-18G 2208 Ant. pol. : VERTICAL
 Limit : FCCPART 15E PEAK NII
 Env. / Ins. : Temp:18.9°C;Humi:50%;Press:101.55kPa
 Engineer : JBR
 EUT : Wireless subwoofer

Power : AC 120V/60Hz
 M/N : S645W-SW
 Test Mode : TX 5849MHz

	Freq. (MHz)	Ant. Factor (dB/m)	Cable Loss (dB)	Amp Factor (dB)	Reading (dBuV)	Emission Level (dBuV/m)	Limits (dBuV/m)	Margin (dB)	Remark
1	9024.000	38.00	7.09	44.68	46.10	46.51	74.00	27.49	Peak
2	10333.000	38.43	7.64	44.29	44.62	46.40	68.20	21.80	Peak
3	11698.000	38.83	8.13	43.38	42.61	46.19	74.00	27.81	Peak
4	13971.000	39.99	9.09	41.89	41.51	48.70	68.20	19.50	Peak
5	15926.000	37.93	9.62	44.68	44.19	47.06	74.00	26.94	Peak
6	17547.000	40.11	10.48	43.96	41.15	47.78	68.20	20.42	Peak

Remarks: 1. Emission Level= Antenna Factor + Cable Loss - Amp Factor + Reading.
 2. Margin= Limit - Emission Level.
 3. The emission levels that are 20dB below the official limit are not reported.

EST Technology

Chilingxiang, Qishantou, Santun,
Houjie, Dongguan, Guangdong, China
Tel: +86-769-83081888
Fax: +86-769-83081878

Data: 16 File: \\emc-966-1\test data\2023\RF\IT\TCL 多媒体\S645W\S645W-SW(FCC IC).EM6 (28)

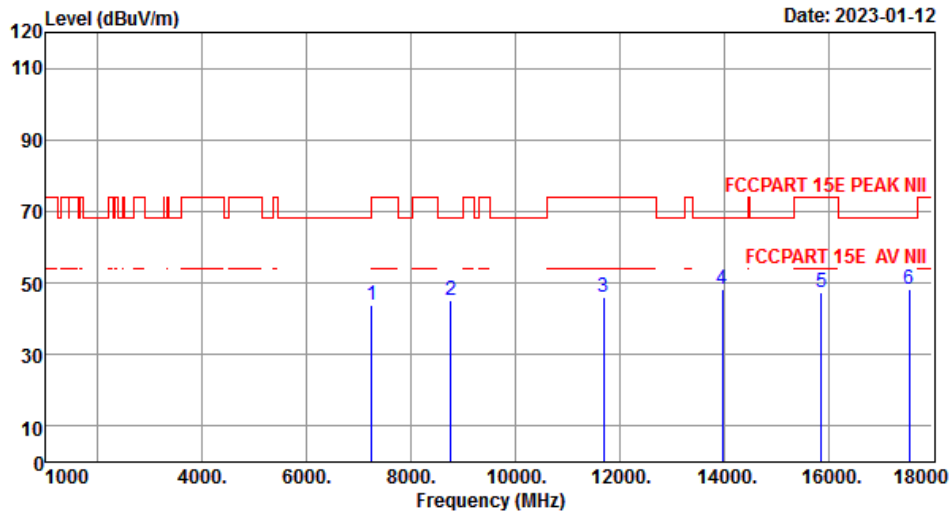

Site no. : 1# 966 Chamber Data no. : 16
 Dis. / Ant. : 3m BBHA9120D 1-18G 2208 Ant. pol. : HORIZONTAL
 Limit : FCCPART 15E PEAK NII
 Env. / Ins. : Temp:18.9°C;Humi:50%;Press:101.55kPa
 Engineer : JBR
 EUT : Wireless subwoofer

Power : AC 120V/60Hz
 M/N : S645W-SW
 Test Mode : TX 5849MHz

	Freq. (MHz)	Ant. Factor (dB/m)	Cable Loss (dB)	Amp Factor (dB)	Reading (dBuV)	Emission Level (dBuV/m)	Limits (dBuV/m)	Margin (dB)	Remark
1	7239.000	36.19	6.28	44.98	46.35	43.84	68.20	24.36	Peak
2	8769.000	37.72	7.00	44.72	45.13	45.13	68.20	23.07	Peak
3	11698.000	38.83	8.13	43.38	42.25	45.83	74.00	28.17	Peak
4	13971.000	39.99	9.09	41.89	41.22	48.41	68.20	19.79	Peak
5	15875.000	38.01	9.61	44.70	44.53	47.45	74.00	26.55	Peak
6	17547.000	40.11	10.48	43.96	41.54	48.17	68.20	20.03	Peak

Remarks: 1. Emission Level= Antenna Factor + Cable Loss - Amp Factor + Reading.
 2. Margin= Limit - Emission Level.
 3. The emission levels that are 20dB below the official limit are not reported.

Note:

1. The amplitude of 18GHz to 40GHz spurious emission that is attenuated by more than 20dB below the permissible limit has no need to be reported.
2. All test mode had been pre-test, only Low/Middle/High Channel of the worst case modulation mode was reported



18000MHz-40000MHz

Pass

Note: The amplitude of spurious emission that is attenuated by more than 20dB below the permissible limit has no need to be reported.

7. FREQUENCY STABILITY

7.1. Limit

Manufacturers of U-NII devices are responsible for ensuring frequency stability such that an emission is maintained within the band of operation under all conditions of normal operation as specified in the operational description.

7.2. Test Setup

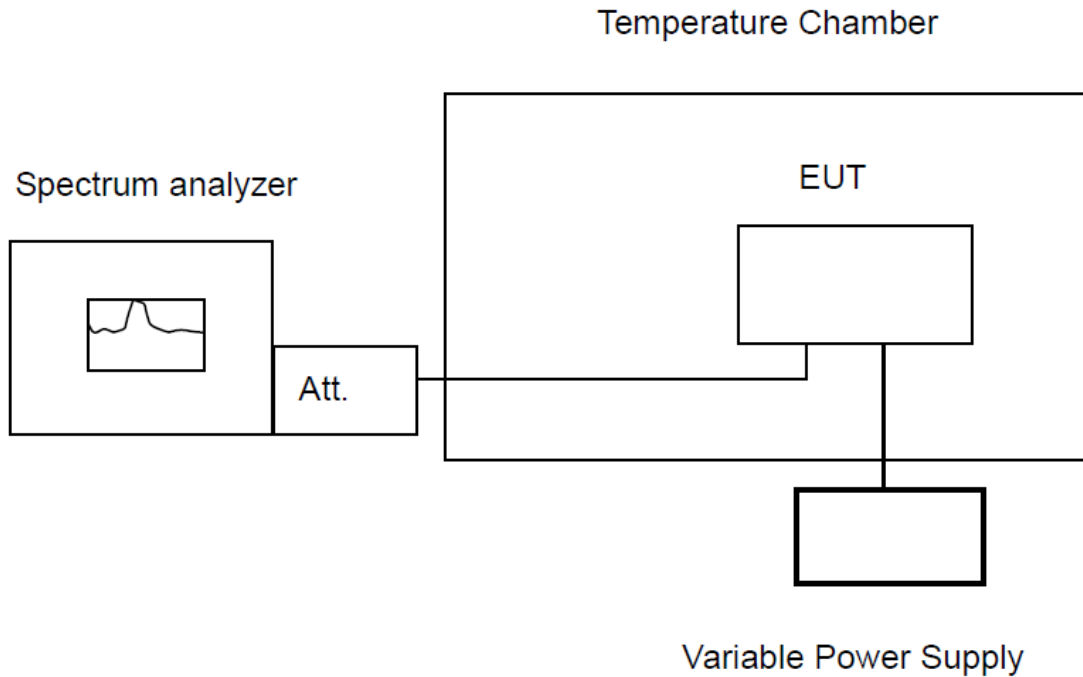

7.3. Spectrum Analyzer Setting

Spectrum Parameters	Setting
RBW	10KHz
VBW	10KHz
Span	200KHz
Sweep Time	Auto
Detector	PEAK
Trace Mode	Max Hold

7.4. Test Procedure

For measurement frequency stability under temperature variation :

- a. Supply the EUT with a nominal ac voltage or install a new or fully charged battery in the EUT.
- b. Turn the EUT OFF and place it inside the environmental temperature chamber.
- c. Connect EUT antenna terminal to the spectrum analyzer with RF cable.
- d. Spectrum analyzer setting parameters in accordance with section 7.3.
- e. Set the temperature control on the chamber to the Specified temperature and allow the oscillator heater and the chamber temperature to stabilize.
- f. Turn the EUT ON with the rated voltage, and the EUT transmit continuously with maximum output power.
- g. Record the operating frequency at startup, and at 2 minutes, 5 minutes, and 10 minutes after the EUT is energized.
- h. Repeat step d through step f to measured the temperature form -20°C to $+50^{\circ}\text{C}$ in 10°C steps.

For frequency stability under voltage variation:

- a. Supply the EUT with a nominal ac voltage or install a new or fully charged battery in the EUT.
- b. Turn the EUT OFF and place it inside the environmental temperature chamber.
- c. Connect EUT antenna terminal to the spectrum analyzer with RF cable.
- d. Spectrum analyzer setting parameters in accordance with section 7.3.
- e. Unless otherwise specified, set the temperature control on the chamber to the ambient room temperature ($+15^{\circ}\text{C}$ to $+25^{\circ}\text{C}$) and allow the oscillator heater and the chamber temperature to stabilize.
- f. Turn the EUT ON with the rated voltage, and the EUT transmit continuously with maximum output power.
- g. Record the operating frequency.
- h. Repeat step d through step f to measured the varied from 85% to 115% of the rated voltage.

7.5. Test Result

Refer to section 10: Appendix H

8. AC POWER LINE CONDUCTED EMISSIONS

8.1. Limit

Frequency			Maximum RF Line Voltage	
			Quasi-Peak Level dB(μV)	Average Level dB(μV)
150kHz	~	500kHz	66 ~ 56*	56 ~ 46*
500kHz	~	5MHz	56	46
5MHz	~	30MHz	60	50

Notes:

1. * Decreasing linearly with logarithm of frequency.
2. The lower limit shall apply at the transition frequencies.

8.2. Test Setup

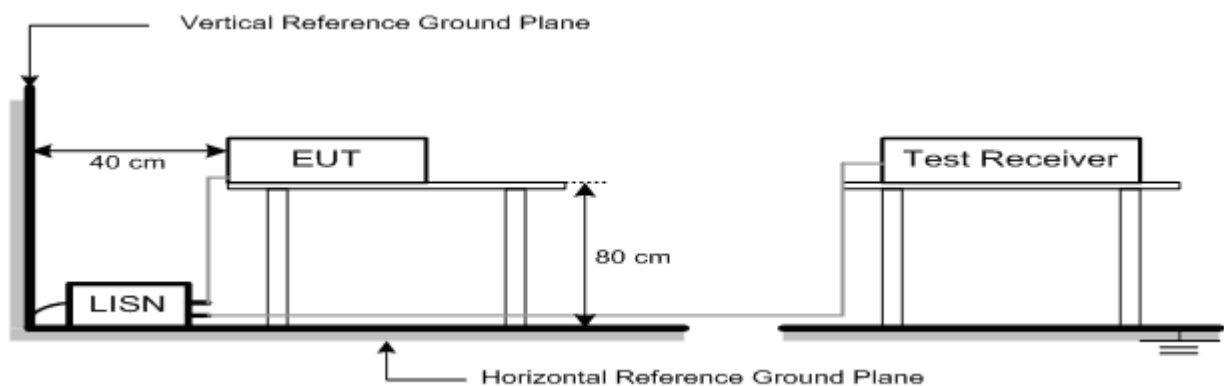

8.3. Spectrum Analyzer Setting

Spectrum Parameters	Setting
RBW	9KHz
VBW	9KHz
Start frequency	150KHz
Stop frequency	30MHz
Sweep Time	Auto
Detector	QP/AVG
Trace Mode	Max Hold

8.4. Test Procedure

- a. The EUT was placed on a non-metallic table, 80cm above the ground plane.
- b. The EUT Power connected to the power mains through a line impedance stabilization network.
- c. Provides a 50 ohm coupling impedance for the EUT (Please refer the block diagram of the test setup and photographs).
- d. Set the EUT transmit continuously with maximum output power.
- e. Spectrum analyzer setting parameters in accordance with section 8.3.
- f. The AC line are checked to find out the maximum conducted emission. In order to find the maximum emission levels, the relative positions of equipment and all of the interface cables shall be changed according to ANSI C63.10: 2013 on Conducted Emission Test.
- g. Record the results in the test report.

8.5. Test Result

EST Technology

Chilingxiang, Qishantou, Santun,
Houjie, Dongguan, Guangdong, China
Tel: +86-769-83081888
Fax: +86-769-83081878

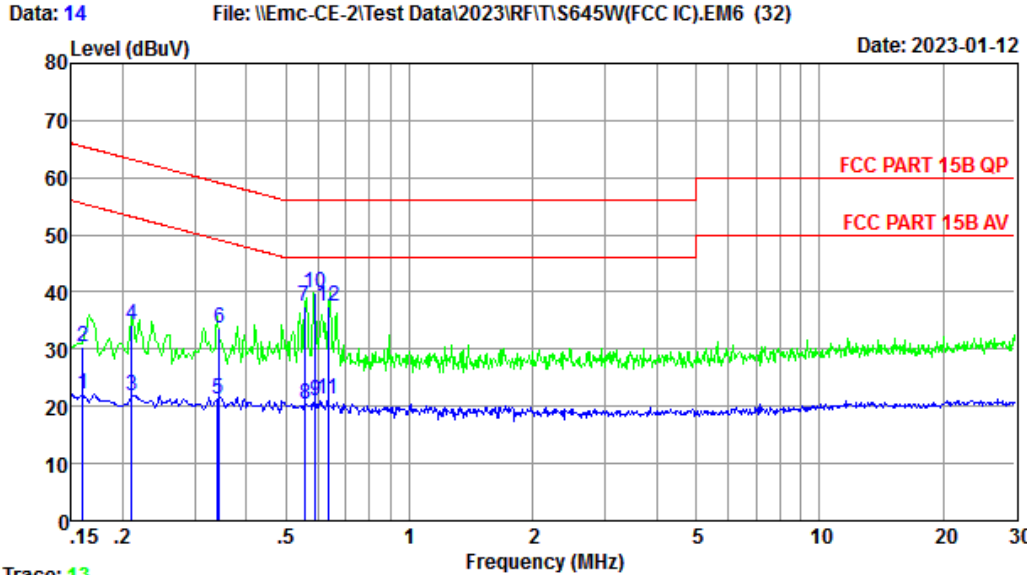

Trace: 13
 Site no : 2#CE Shield Room Data no. : 14
 Env. / Ins. : Temp:22.8°C Humi:58% Press:101.30kPa LINE Phase : NEUTRAL
 Limit : FCC PART 15B QP
 Engineer : XJF
 EUT : Wireless subwoofer
 Power : AC 120V/60Hz
 M/N : S645W-SW
 Test Mode : TX Mode

	Freq. (MHz)	LISN Factor (db)	Cable Loss (db)	Reading dBuV	Emission Level (dBuV)	Limits (dBuV)	Margin (dB)	Remark
1	0.160	9.78	9.69	2.65	22.12	55.47	33.35	Average
2	0.160	9.78	9.69	10.84	30.31	65.47	35.16	QP
3	0.211	9.78	9.84	2.26	21.88	53.18	31.30	Average
4	0.211	9.78	9.84	14.74	34.36	63.18	28.82	QP
5	0.341	9.76	9.92	1.68	21.36	49.18	27.82	Average
6	0.345	9.76	9.92	13.93	33.61	59.09	25.48	QP
7	0.555	9.76	9.92	17.88	37.56	56.00	18.44	QP
8	0.558	9.76	9.92	0.82	20.50	46.00	25.50	Average
9	0.589	9.75	9.92	1.16	20.83	46.00	25.17	Average
10	0.589	9.75	9.92	20.12	39.79	56.00	16.21	QP
11	0.634	9.75	9.92	1.55	21.22	46.00	24.78	Average
12	0.634	9.75	9.92	17.95	37.62	56.00	18.38	QP

Remarks: 1. Emission Level= LISN Factor + Cable Loss + Reading.
 2. Margin= Limit - Emission Level.
 3. If the average limit is met when using a quasi-peak detector, the EUT shall be deemed to meet both limits and measurement with average detector is unnecessary.

Data: 16 File: \\Emc-CE-2\Test Data\2023\RF\T\S645W(FCC IC).EM6 (32) Date: 2023-01-12

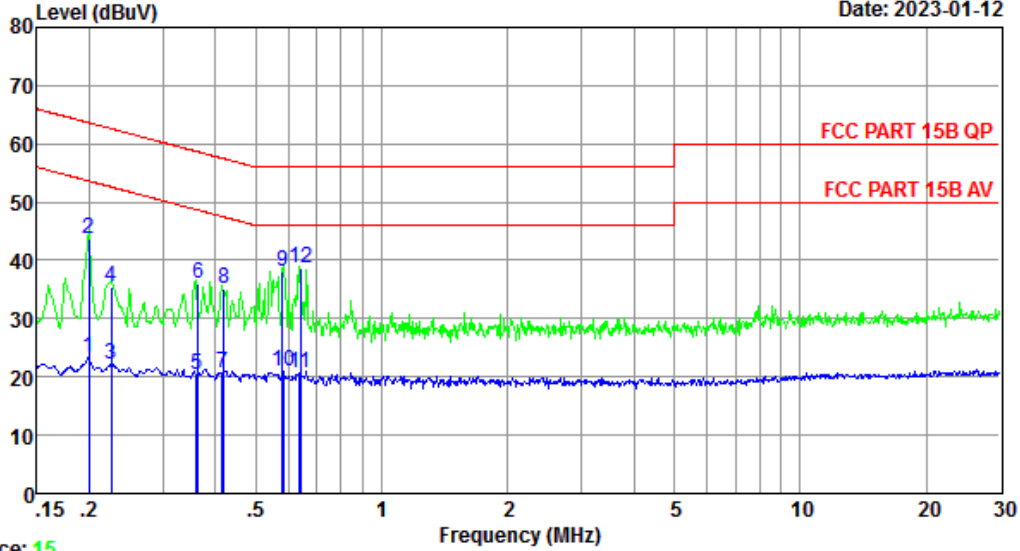

Trace: 15
 Site no : 2#CE Shield Room Data no. : 16
 Env. / Ins. : Temp:22.8°C Humi:58% Press:101.30kPa LINE Phase : LINE
 Limit : FCC PART 15B QP
 Engineer : XJF
 EUT : Wireless subwoofer
 Power : AC 120V/60Hz
 M/N : S645W-SW
 Test Mode : TX Mode

	Freq. (MHz)	LISN Factor (db)	Cable Loss (db)	Reading dBuV	Emission Level (dBuv)	Limits (dBuv)	Margin (dB)	Remark
1	0.200	9.84	9.77	3.83	23.44	53.62	30.18	Average
2	0.200	9.84	9.77	24.11	43.72	63.62	19.90	QP
3	0.226	9.78	9.84	2.58	22.20	52.61	30.41	Average
4	0.226	9.78	9.84	15.91	35.53	62.61	27.08	QP
5	0.361	9.81	9.92	0.69	20.42	48.69	28.27	Average
6	0.363	9.81	9.92	16.15	35.88	58.65	22.77	QP
7	0.415	9.85	9.92	0.89	20.66	47.55	26.89	Average
8	0.419	9.85	9.92	15.26	35.03	57.46	22.43	QP
9	0.579	9.83	9.92	18.40	38.15	56.00	17.85	QP
10	0.582	9.83	9.92	1.35	21.10	46.00	24.90	Average
11	0.637	9.83	9.92	0.79	20.54	46.00	25.46	Average
12	0.641	9.83	9.92	18.82	38.57	56.00	17.43	QP

Remarks: 1. Emission Level= LISN Factor + Cable Loss + Reading.
 2. Margin= Limit - Emission Level.
 3. If the average limit is met when using a quasi-peak detector, the EUT shall be deemed to meet both limits and measurement with average detector is unnecessary.

9. ANTENNA REQUIREMENTS

9.1. Limit

An intentional radiator shall be designed to ensure that no antenna other than that furnished by the responsible party shall be used with the device. The use of a permanently attached antenna or of an antenna that uses a unique coupling to the intentional radiator shall be considered sufficient to comply with the provisions of this section. The manufacturer may design the unit so that a broken antenna can be replaced by the user, but the use of a standard antenna jack or electrical connector is prohibited. This requirement does not apply to carrier current devices or to devices operated under the provisions of §§15.211, 15.213, 15.217, 15.219, 15.221, or §15.236. Further, this requirement does not apply to intentional radiators that must be professionally installed, such as perimeter protection systems and some field disturbance sensors, or to other intentional radiators which, in accordance with §15.31(d), must be measured at the installation site. However, the installer shall be responsible for ensuring that the proper antenna is employed so that the limits in this part are not exceeded.

9.2. Test Result

The antennas used for this product is integral antenna ,so compliance with antenna requirements.
(Please refer to the EUT photo for details)

10. APPENDIX

Appendix A: Duty Cycle Test Result

Test Mode	Antenna	Frequency[MHz]	Transmission Duration [ms]	Transmission Period [ms]	Duty Cycle [%]
FSK	Ant1	5729	30.00	30.00	100.00
		5789	30.00	30.00	100.00
		5849	25.00	25.00	100.00

Test Graphs

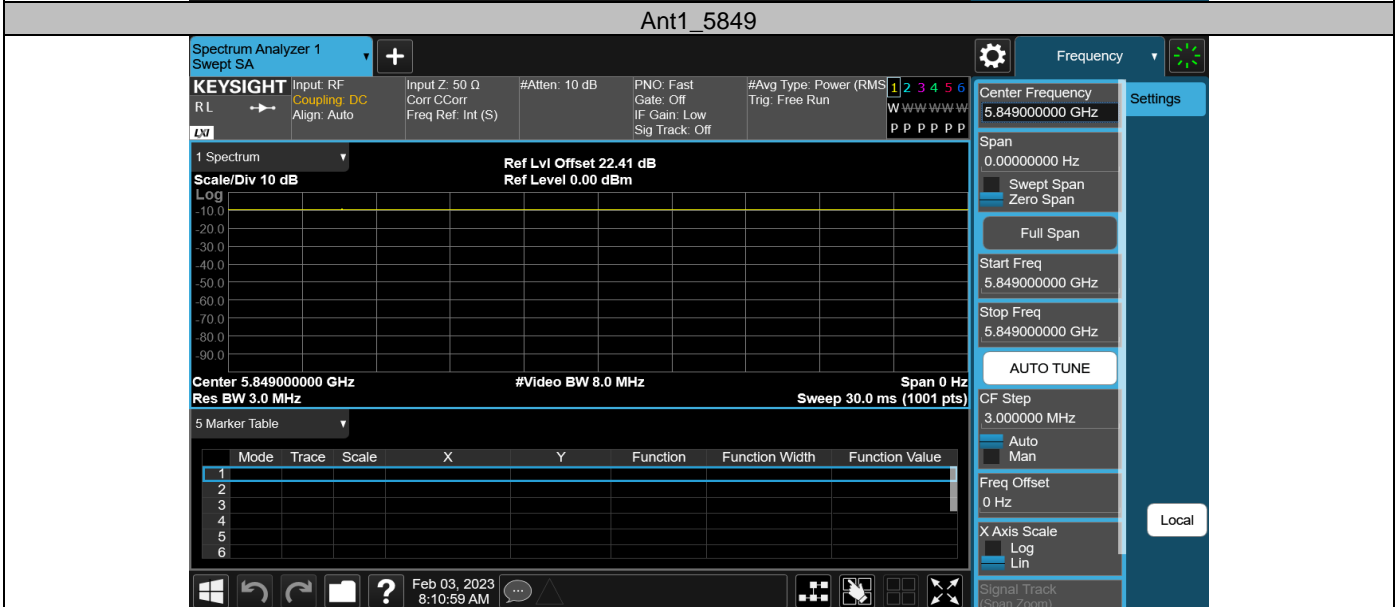
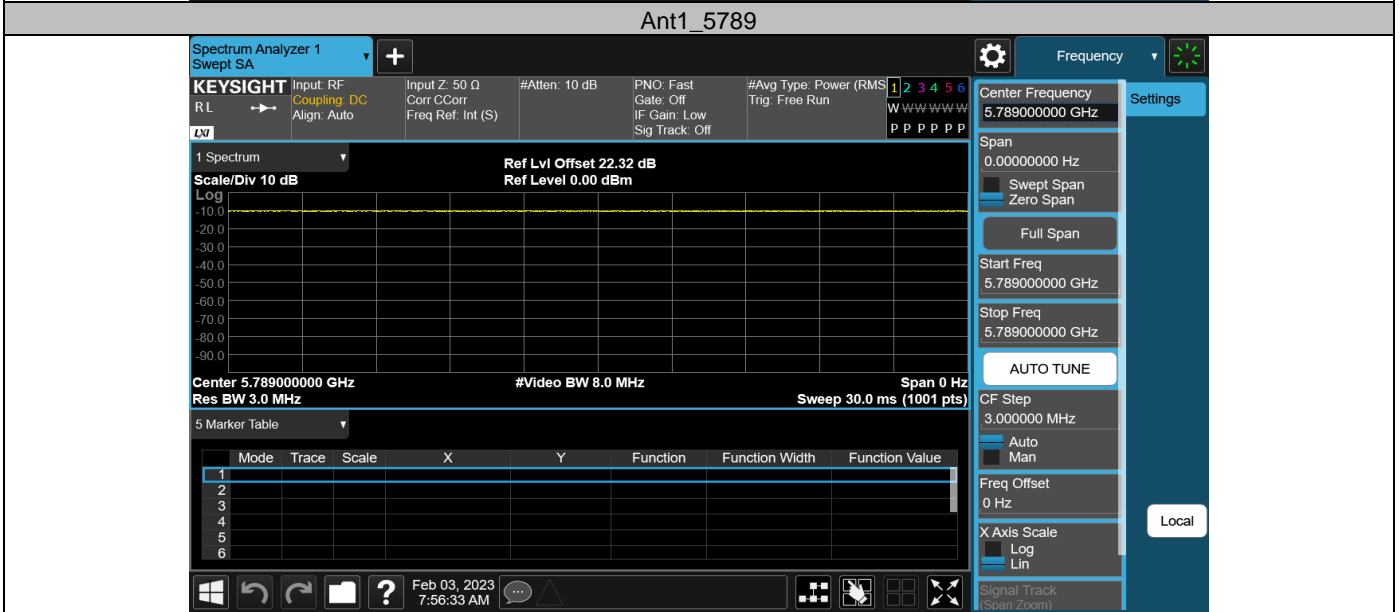
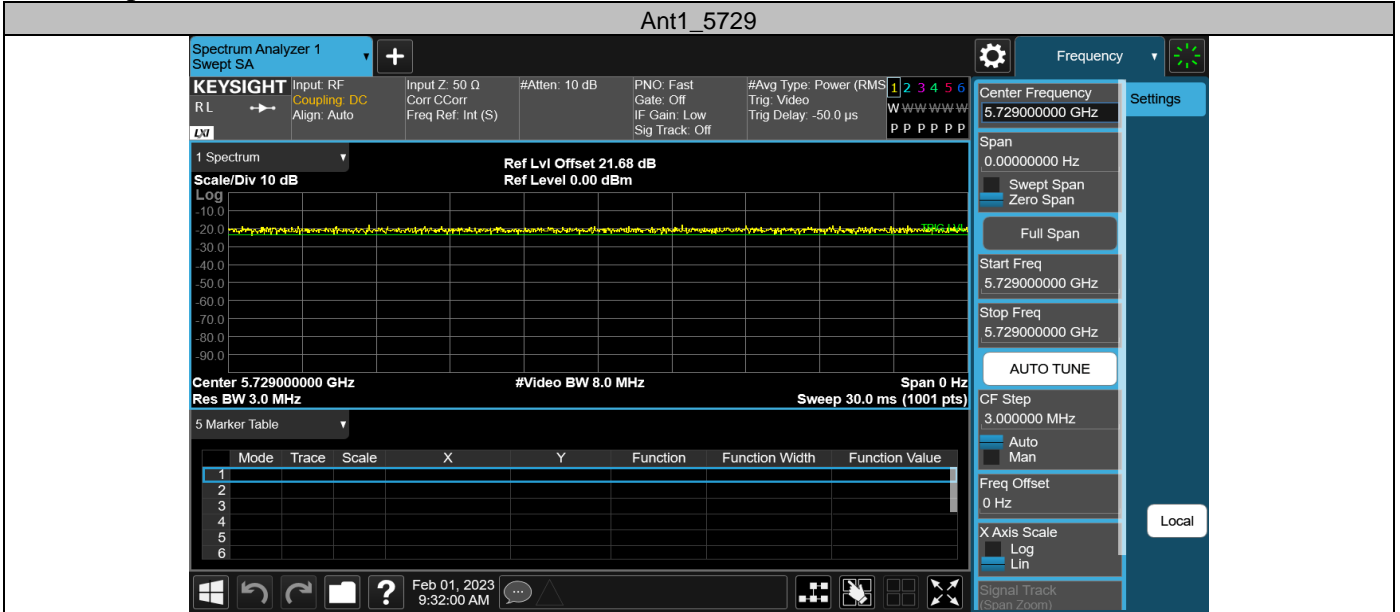

Appendix B: Min emission bandwidth
 Test Result B4

Test Mode	Antenna	Frequency [MHz]	6db EBW [MHz]	FL[MHz]	FH[MHz]	Limit[MHz]	Verdict
FSK	Ant1	5729	1.080	5728.460	5729.540	0.5	PASS
		5789	1.470	5788.260	5789.730	0.5	PASS
		5849	1.360	5848.300	5849.660	0.5	PASS

Test Graphs B4

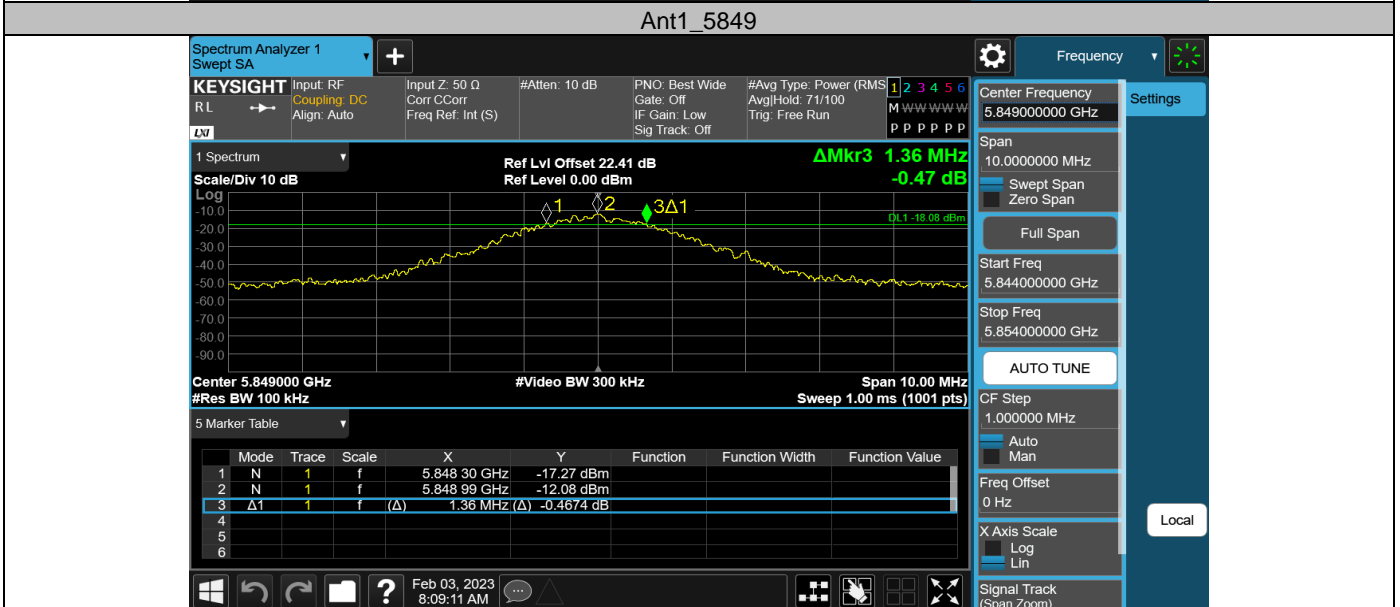
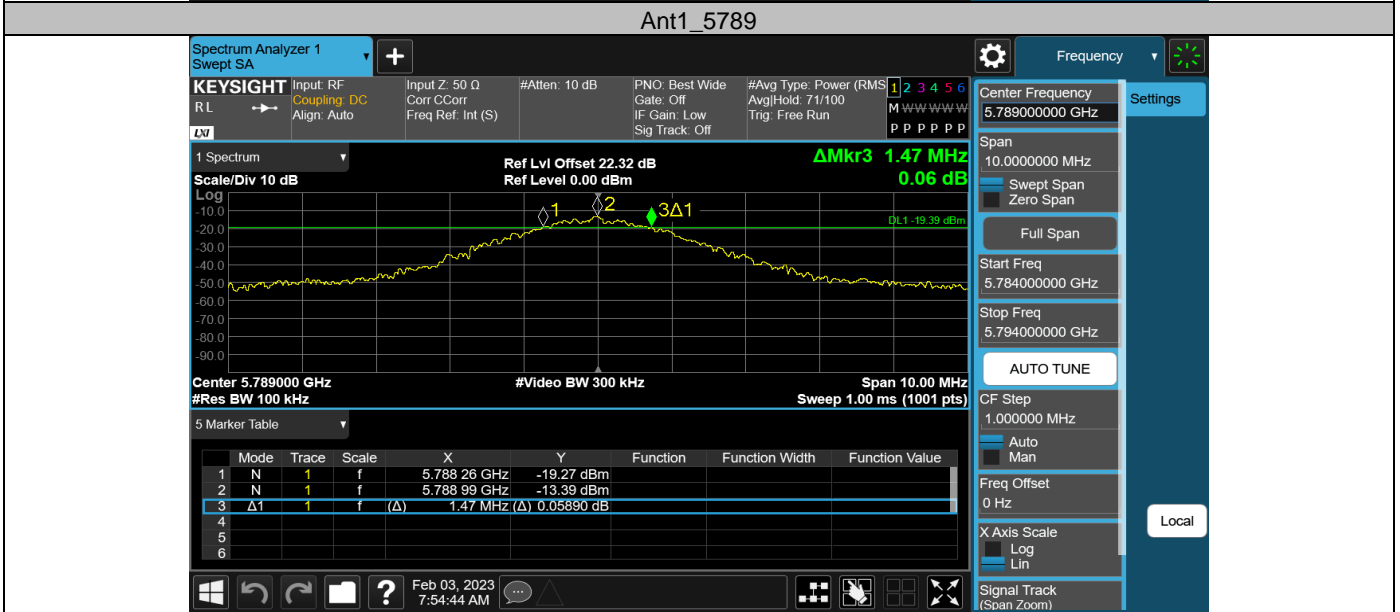
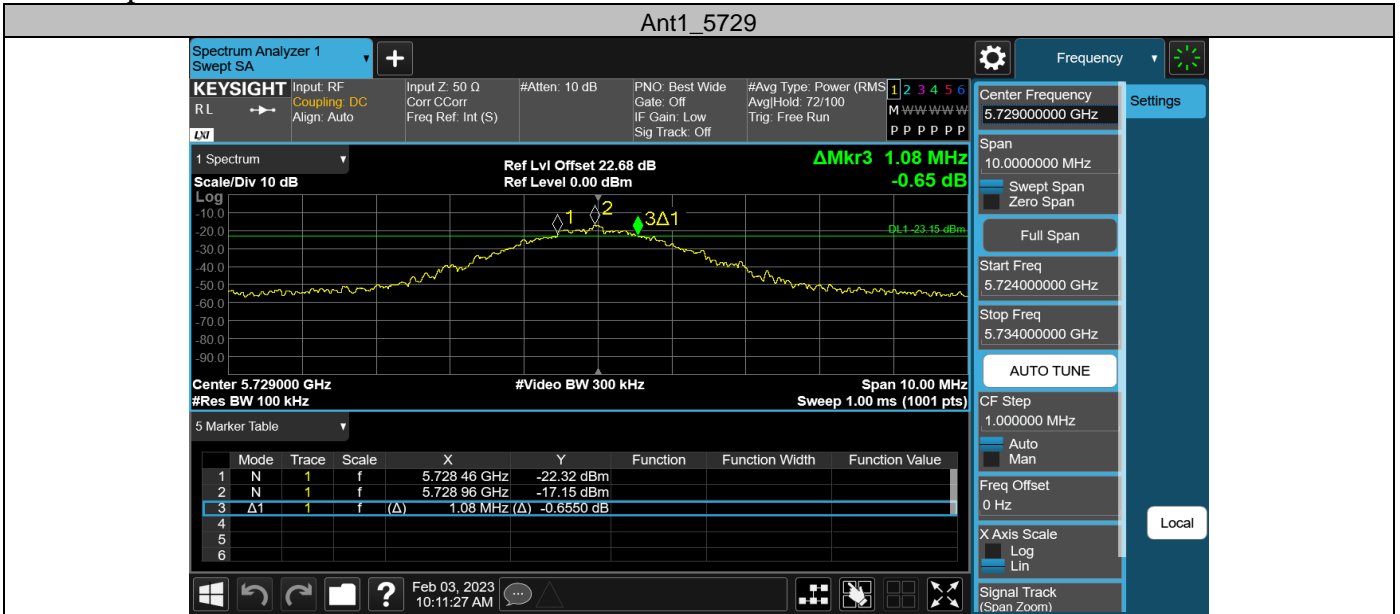

Appendix C: Emission Bandwidth
Test Result

Test Mode	Antenna	Frequency [MHz]	26db EBW [MHz]	FL [MHz]	FH [MHz]	Limit [MHz]	Verdict
FSK	Ant1	5729	4.070	5726.910	5730.980	---	---
		5789	4.090	5786.910	5791.000	---	---
		5849	4.080	5846.900	5850.980	---	---

Test Graphs

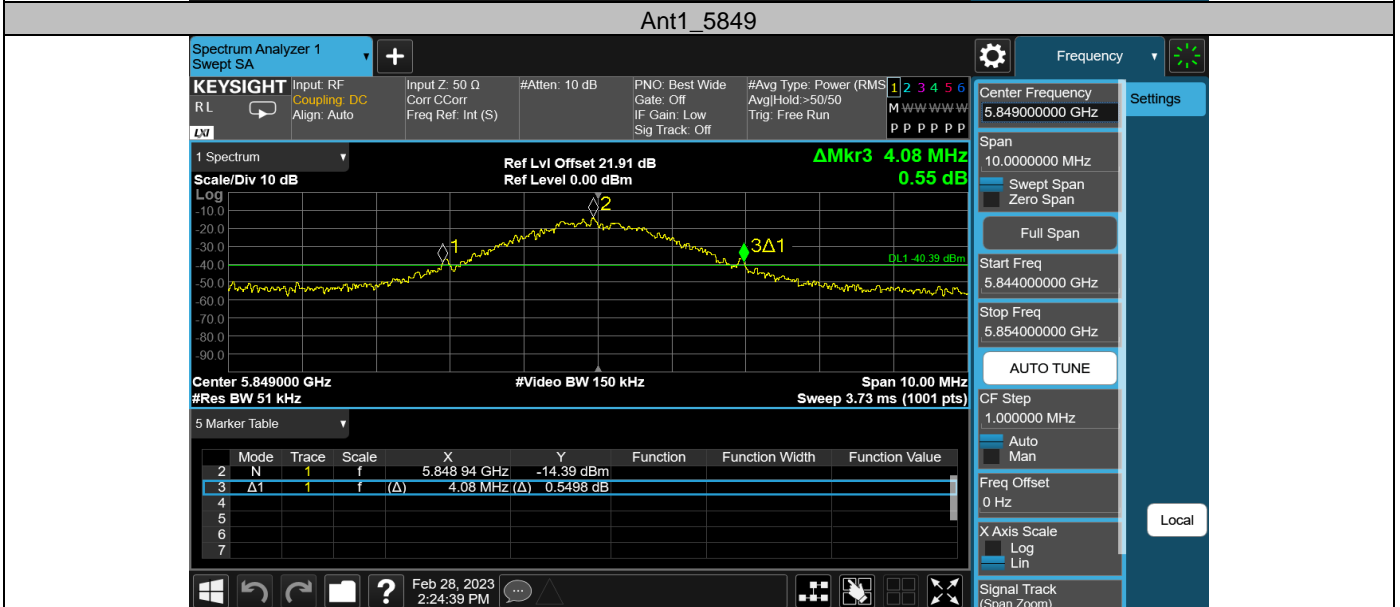
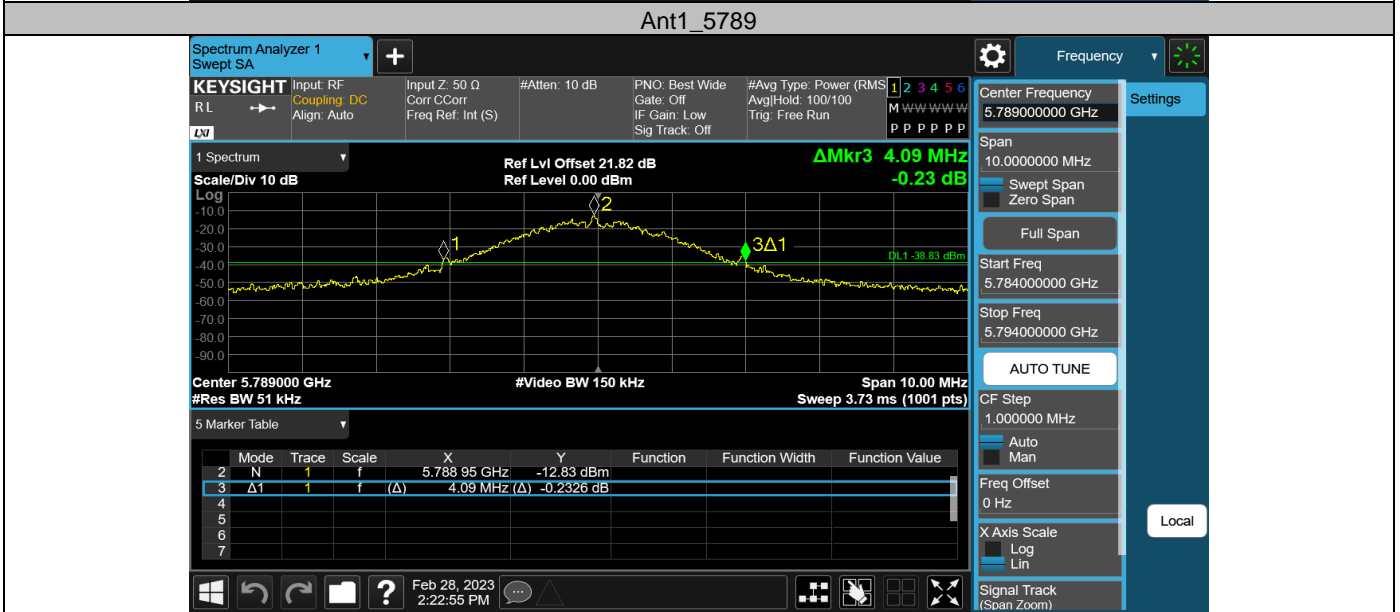
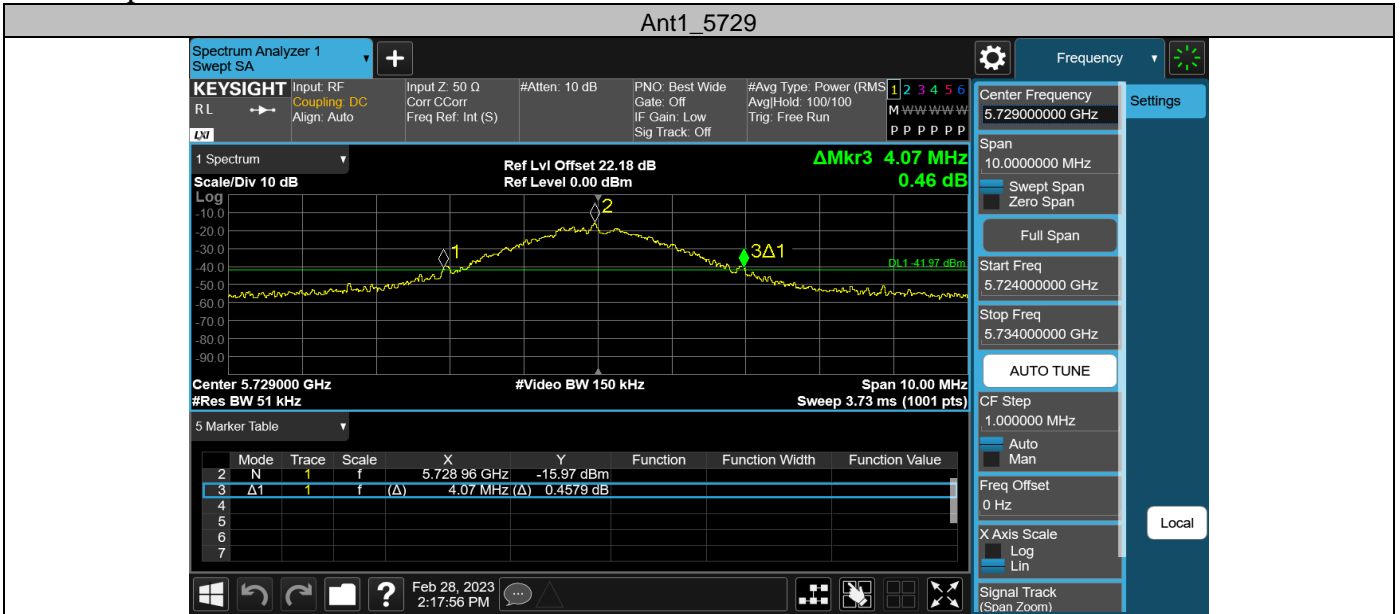

Appendix D: Occupied channel bandwidth
 Test Result

Test Mode	Antenna	Frequency [MHz]	OCB [MHz]	FL [MHz]	FH [MHz]	Limit [MHz]	Verdict
FSK	Ant1	5729	3.0729	5727.4410	5730.5139	---	---
		5789	3.1614	5787.3753	5790.5367	---	---
		5849	3.0347	5847.4487	5850.4834	---	---

Test Graphs

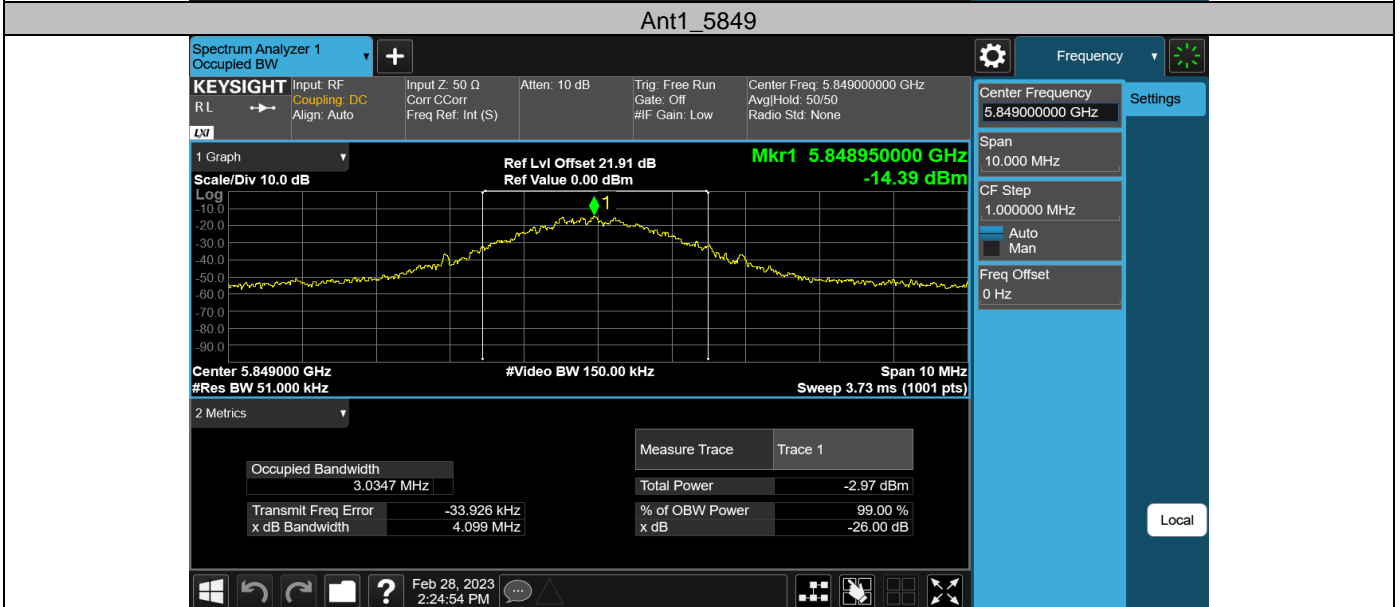
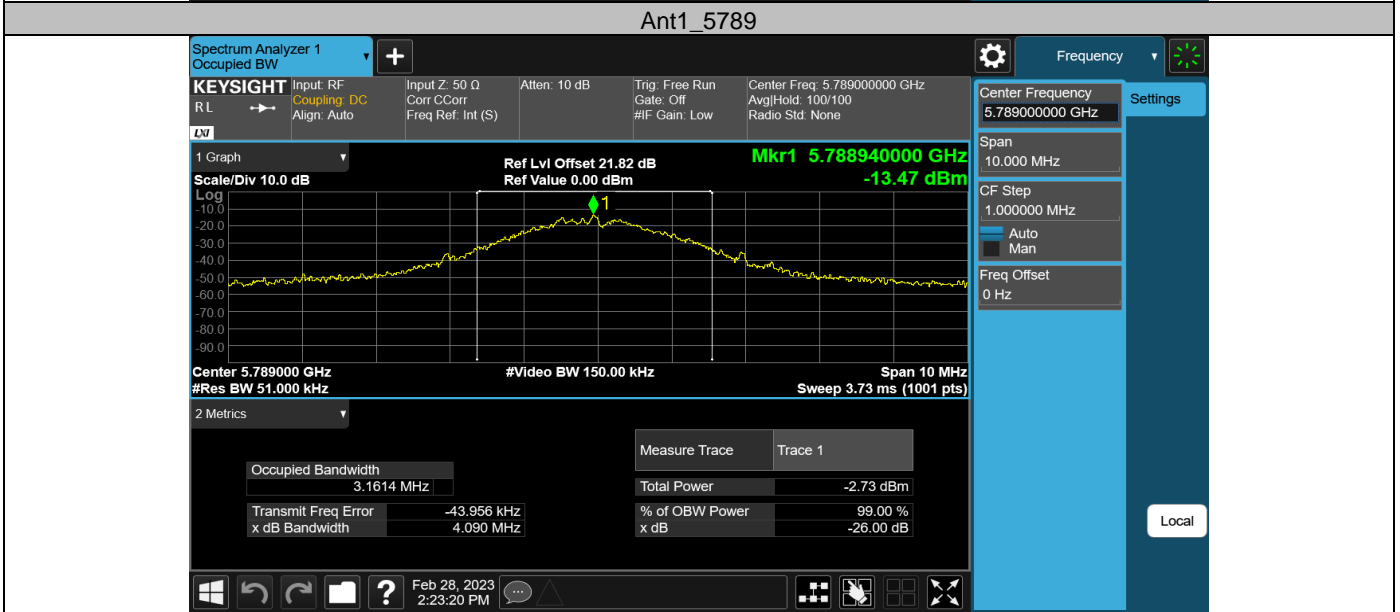
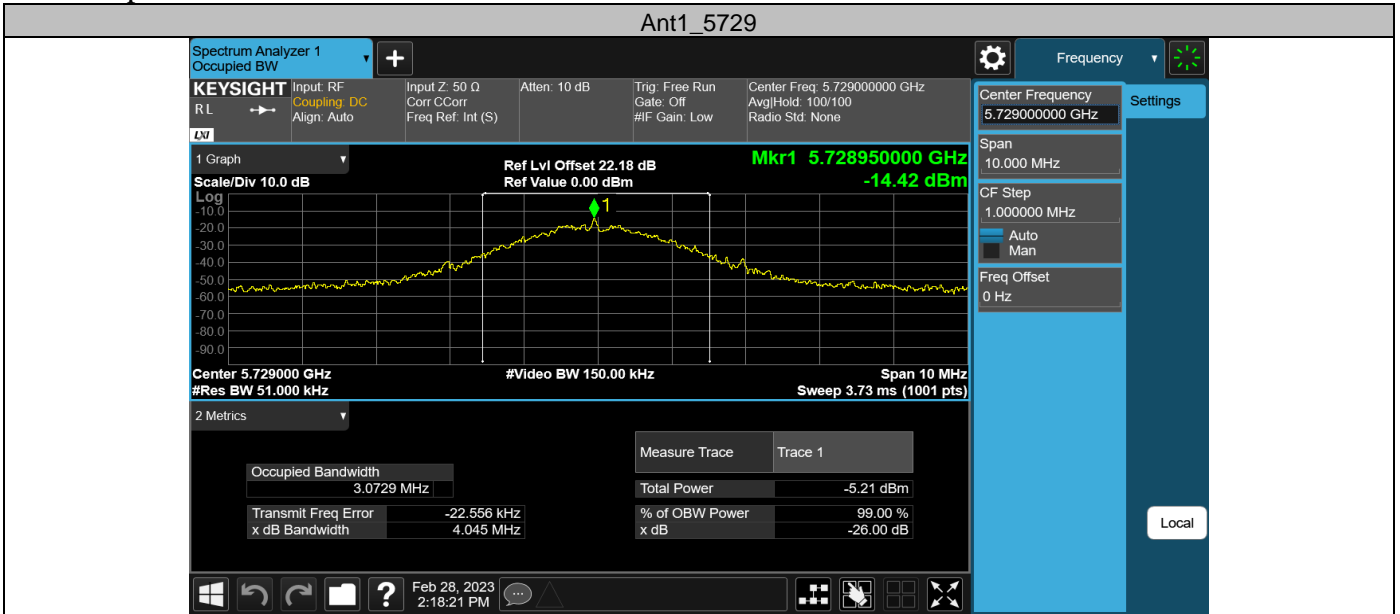

Appendix E: Maximum conducted output power
Test Result Channel Power

Test Mode	Antenna	Frequency[M Hz]	Channel Power [dBm]	Duty Cycle [%]	DC Factor [dBm]	Result [dBm]	Limit [dBm]	Verdict
FSK	Ant1	5729	-9.35	100.00	0.00	-9.35	≤30.00	PASS
		5789	-9.71	100.00	0.00	-9.71	≤30.00	PASS
		5849	-9.59	100.00	0.00	-9.59	≤30.00	PASS

Note : The Duty Cycle Factor is compensated in the graph.

Test Graphs Channel Power

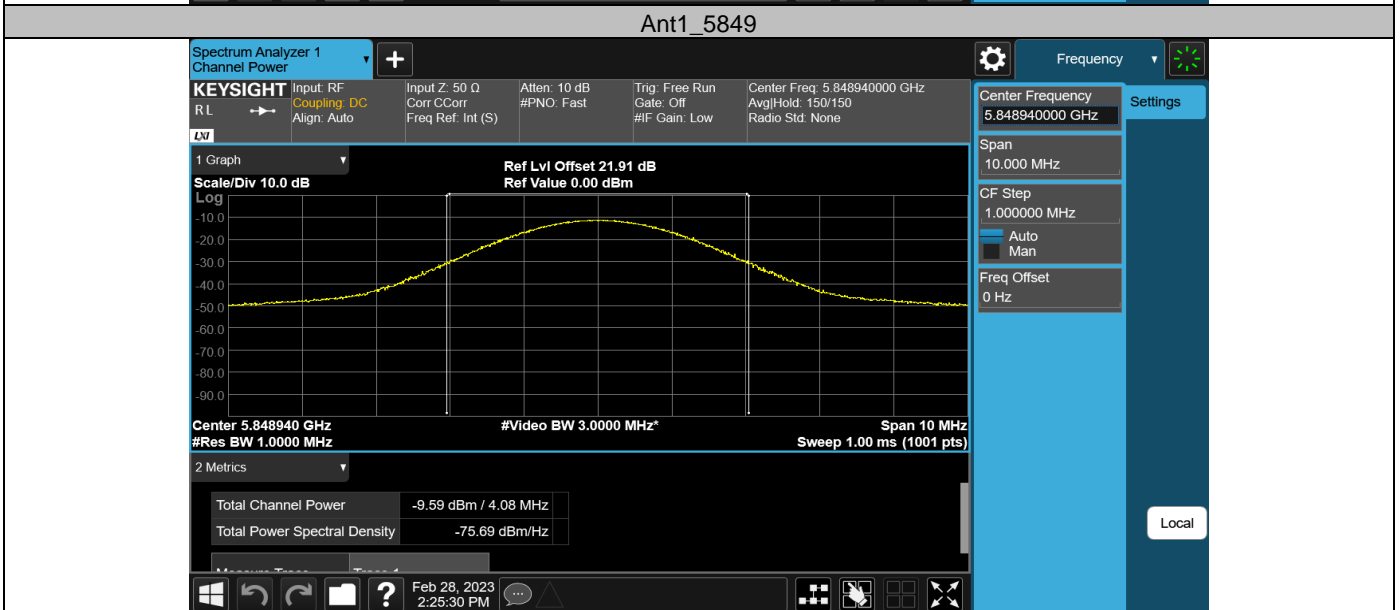
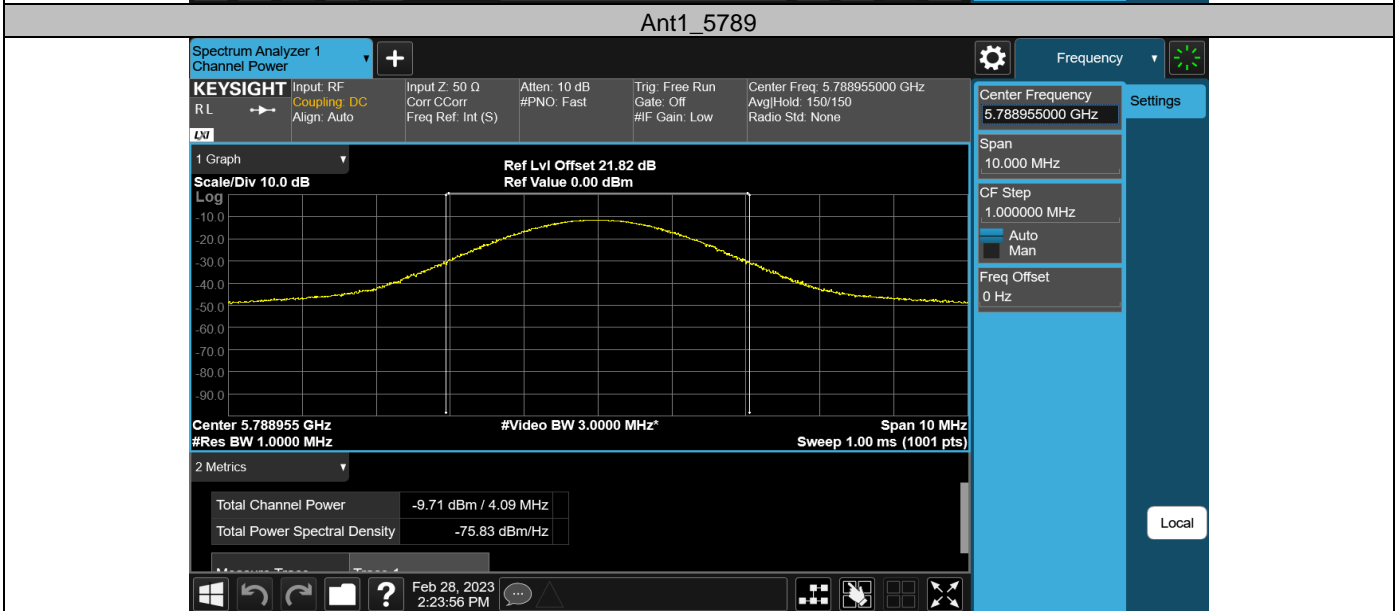
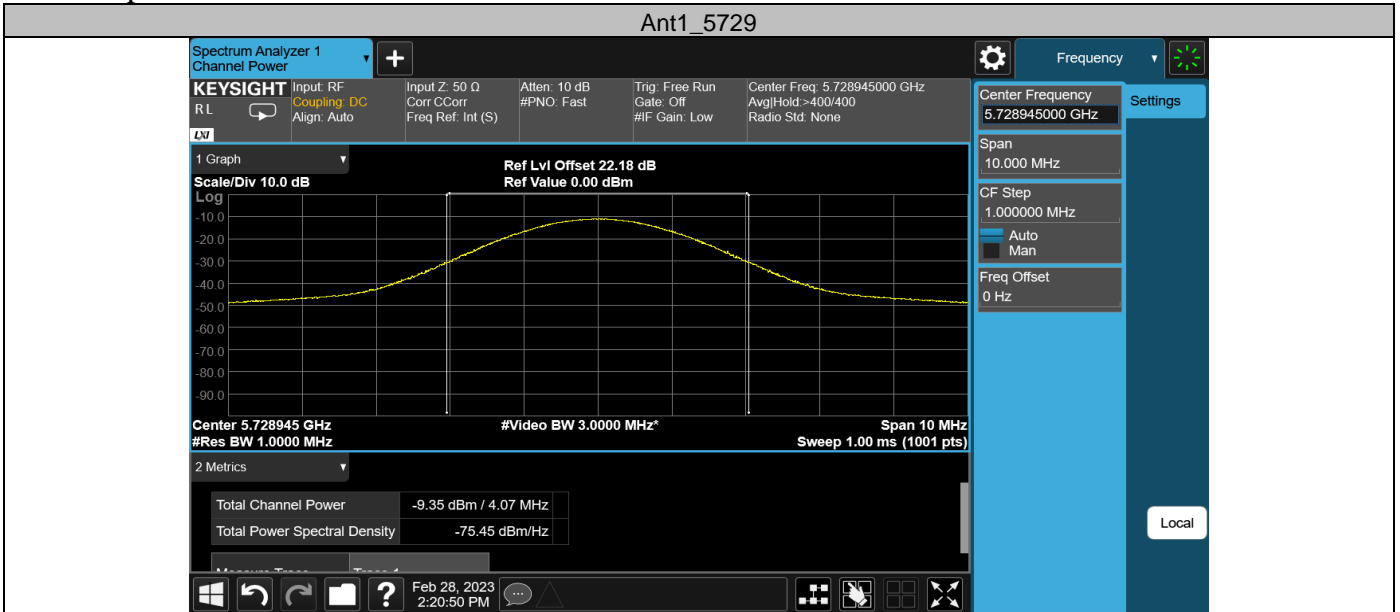

Appendix F: Maximum power spectral density
Test Result

Test Mode	Antenna	Frequency [MHz]	Result [dBm/MHz]	Limit [dBm/MHz]	Verdict
FSK	Ant1	5729	-13.56	≤30.00	PASS
		5789	-14.4	≤30.00	PASS
		5849	-13.61	≤30.00	PASS

Note : 1.The Result and Limit Unit is dBm/500 kHz in the band 5.725–5.85 GHz.
2.The Duty Cycle Factor and RBW Factor is compensated in the graph.

Test Graphs

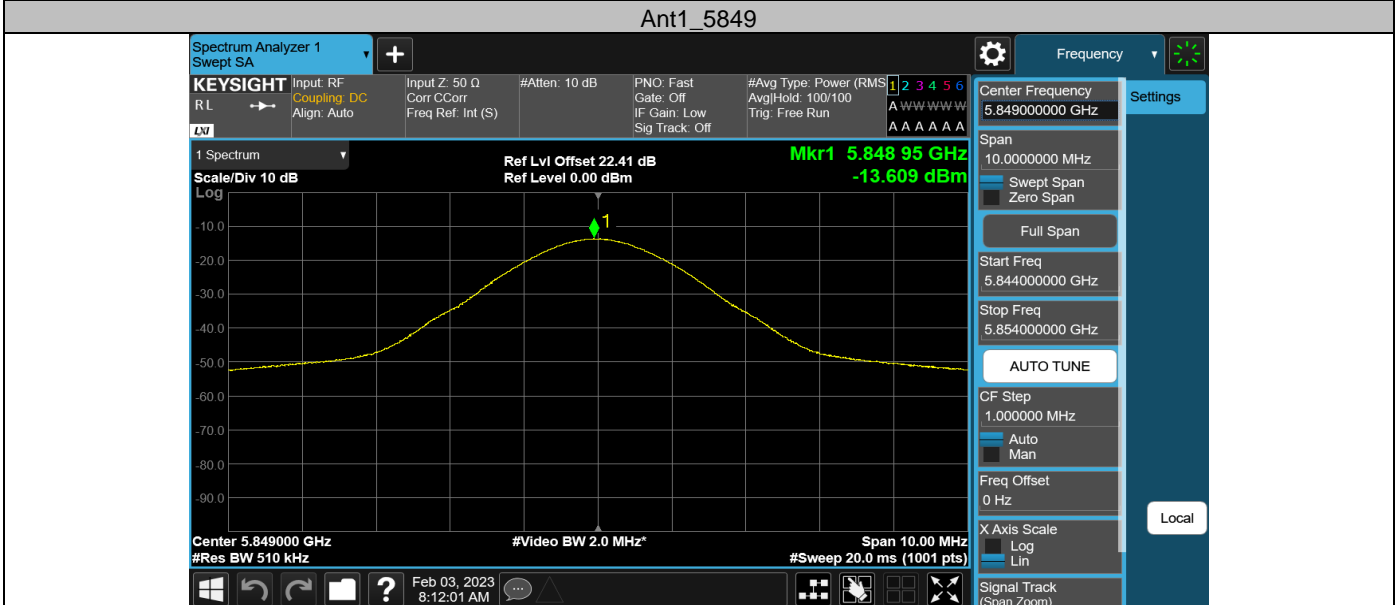
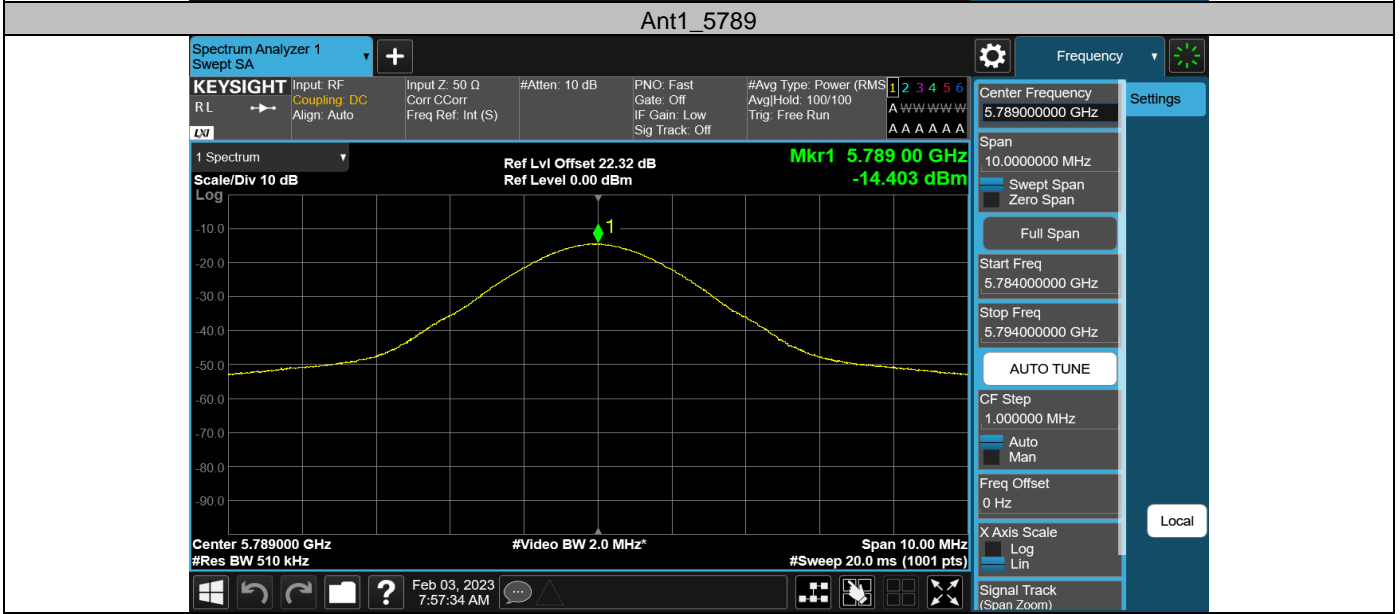

Appendix G: Band edge measurements

Test Result B4

Test Mode	Antenna	Ch Name	Frequency [MHz]	Freq Range [MHz]	Result [dBm]	Limit [dBm]	Verdict
FSK	Ant1	Low	5729	5650~5700	-40.54	≤-3.89	PASS
				5700~5720	-36.84	≤13.89	PASS
				5720~5725	-34.37	≤26.83	PASS
				5760~5650	-41.01	≤-27	PASS
		High	5849	5850~5855	-4.93	≤15.79	PASS
				5855~5875	-34.87	≤10.06	PASS
				5875~5925	-39.7	≤0.82	PASS
				5925~5935	-40.6	≤-27	PASS

Test Graphs B4

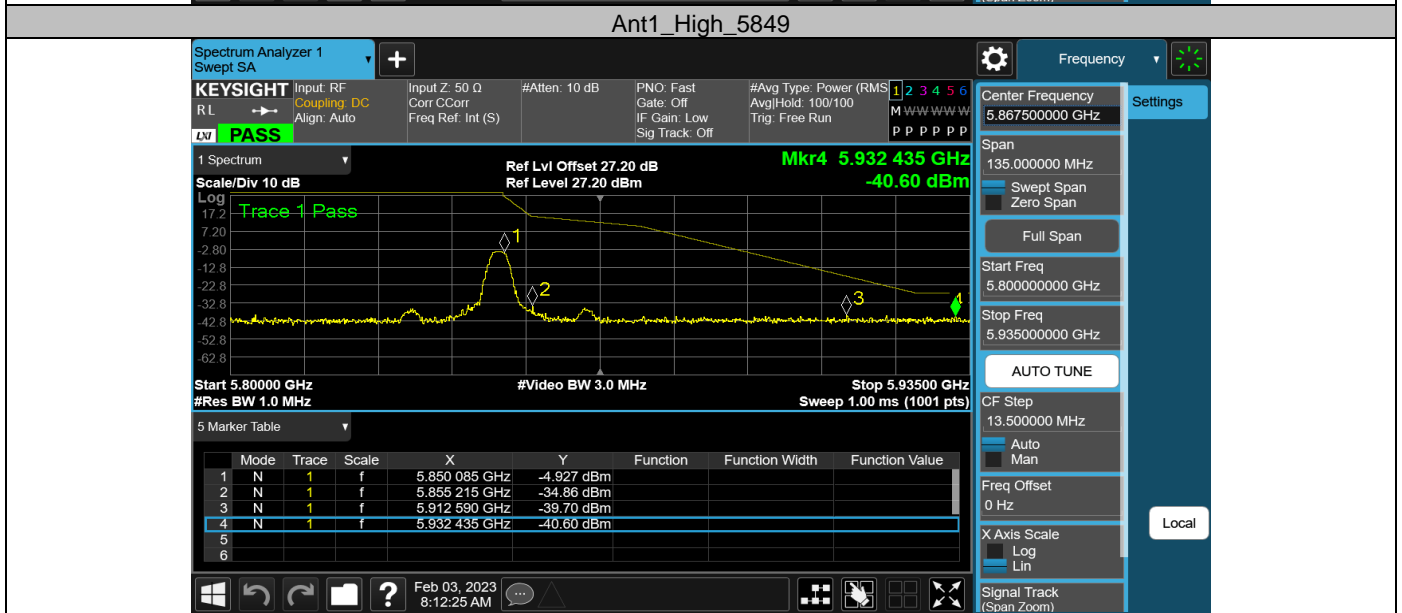
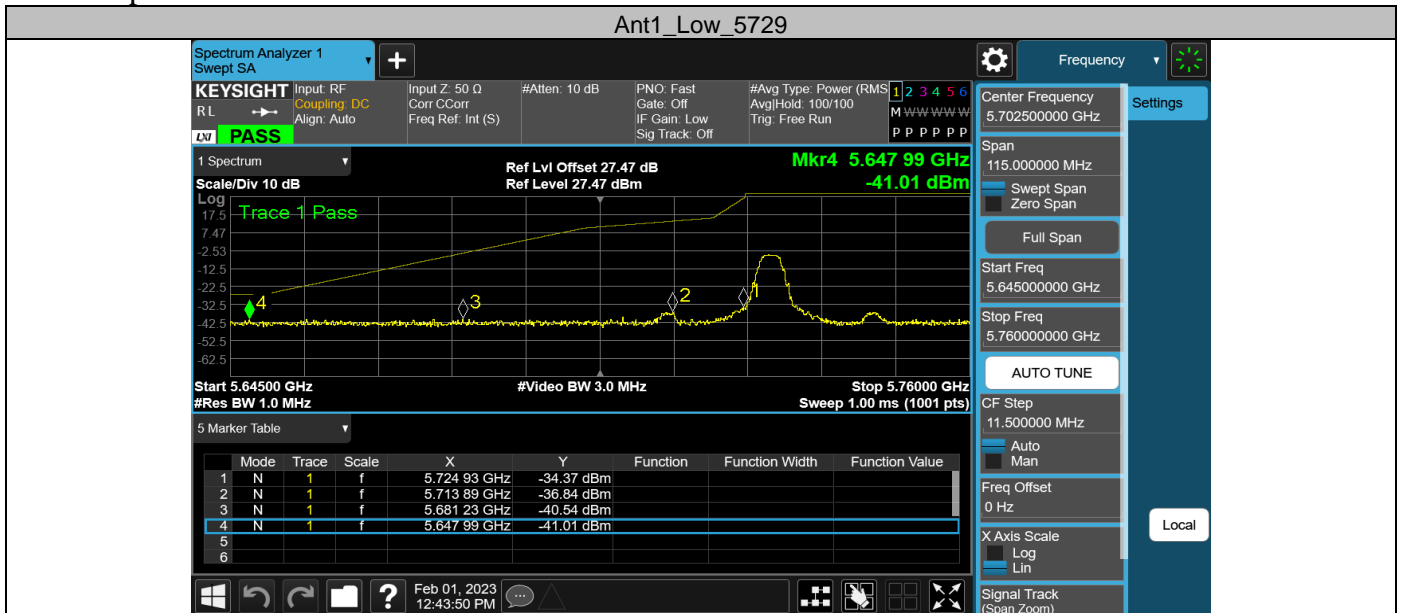

Appendix H: Frequency Stability
Test Result

Voltage								
Test Mode	Antenna	Frequency[M Hz]	Voltage [Vdc]	Temperature (°C)	Deviation (Hz)	Deviation (ppm)	Limit (ppm)	Verdict
FSK	Ant1	5729	NV	NT	-20000.00	-3.491011	20	PASS
			LV	NT	-20000.00	-3.491011	20	PASS
			HV	NT	-20000.00	-3.491011	20	PASS

Temperature								
Test Mode	Antenna	Frequency[M Hz]	Voltage [Vdc]	Temperature (°C)	Deviation (Hz)	Deviation (ppm)	Limit (ppm)	Verdict
FSK	Ant1	5729	NV	-30	-20000.00	-3.491011	20	PASS
			NV	-20	-20000.00	-3.491011	20	PASS
			NV	-10	-20000.00	-3.491011	20	PASS
			NV	0	-20000.00	-3.491011	20	PASS
			NV	10	-20000.00	-3.491011	20	PASS
			NV	20	-20000.00	-3.491011	20	PASS
			NV	30	-20000.00	-3.491011	20	PASS
			NV	40	-20000.00	-3.491011	20	PASS
			NV	50	-20000.00	-3.491011	20	PASS

11. TEST SETUP PHOTO

Conducted Test



Radiated Test (Below 1GHz)

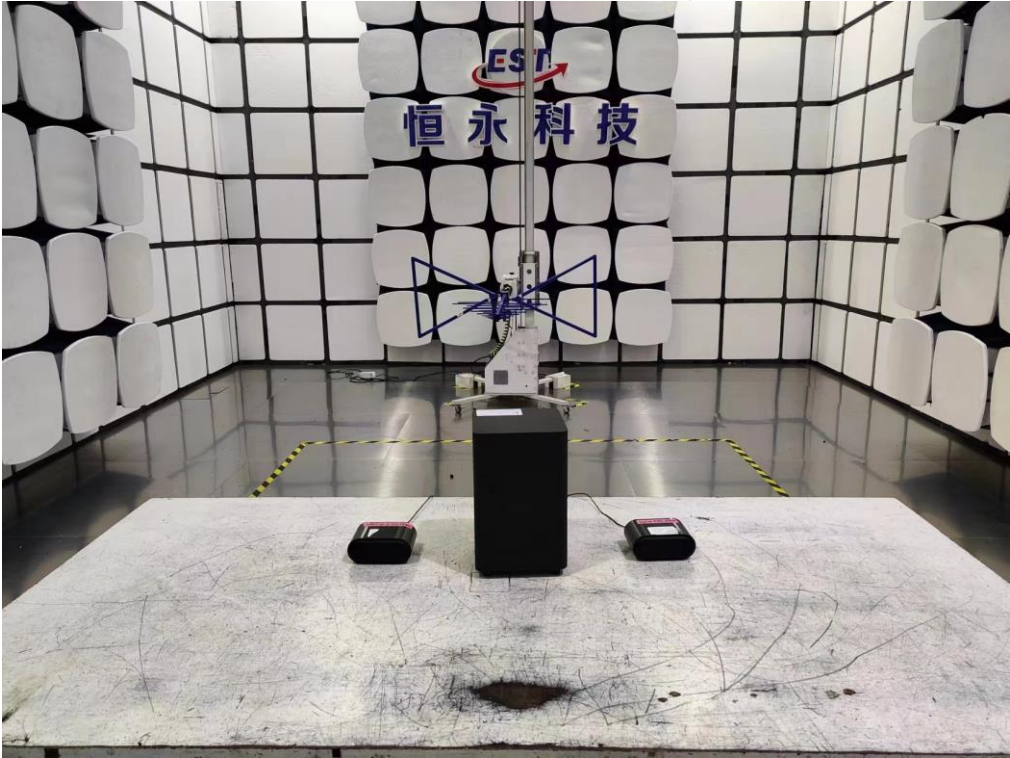

Radiated Test (Above 1GHz)



12.EUT PHOTO

External Photos
M/N: S645W-SW

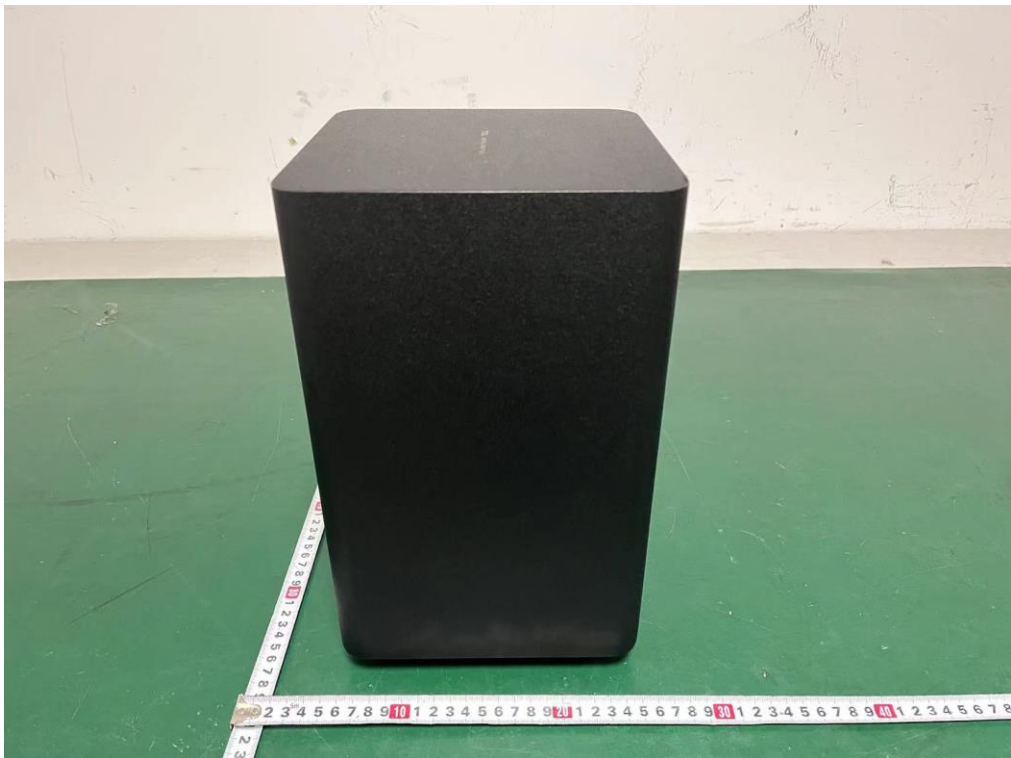
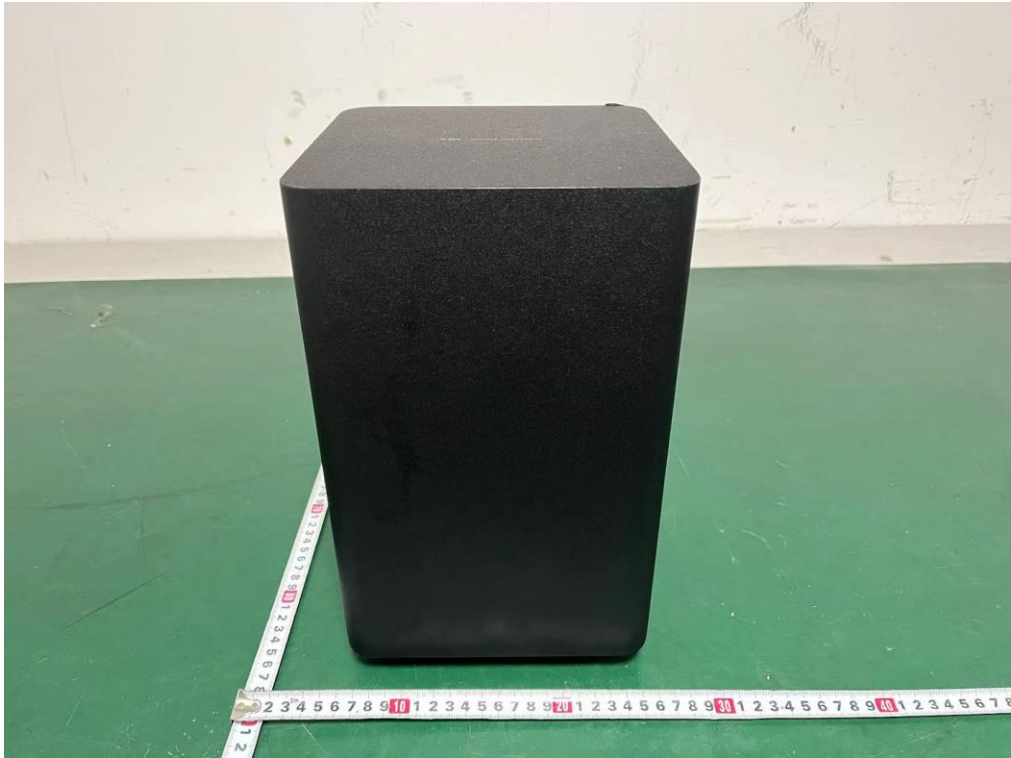

External Photos
M/N: S645W-SW

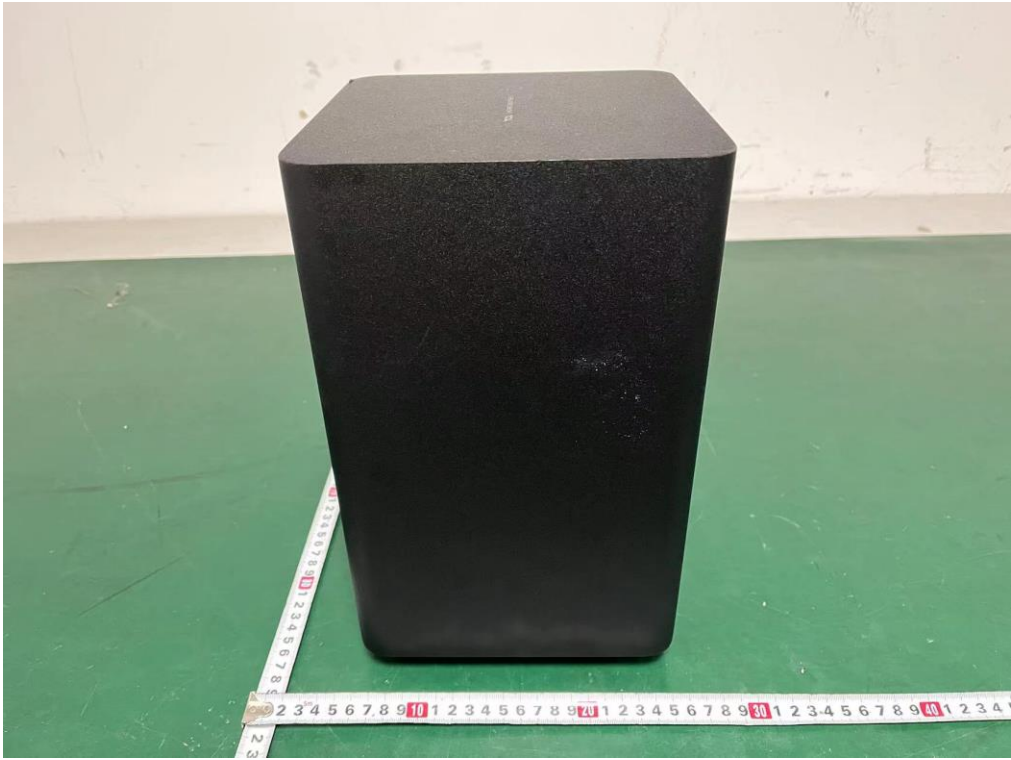

External Photos
M/N: S645W-SW

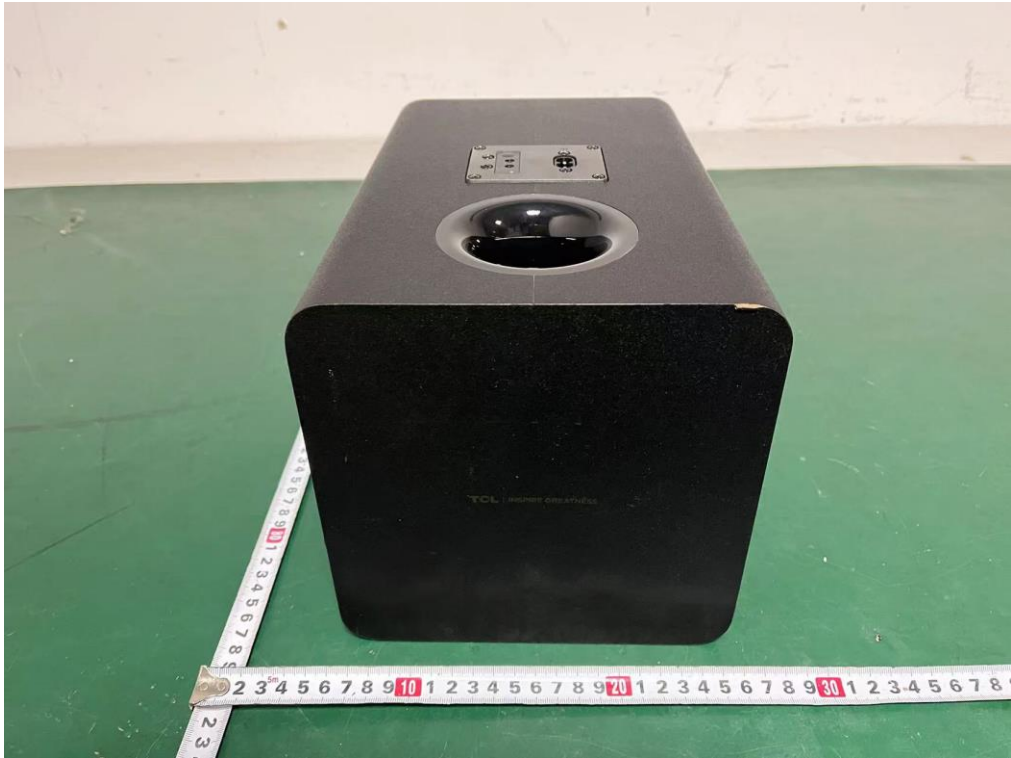

External Photos
M/N: S645W-SW



External Photos
M/N: S645W-SW



External Photos
M/N: S645W-SW



Internal Photos
M/N: S645W-SW

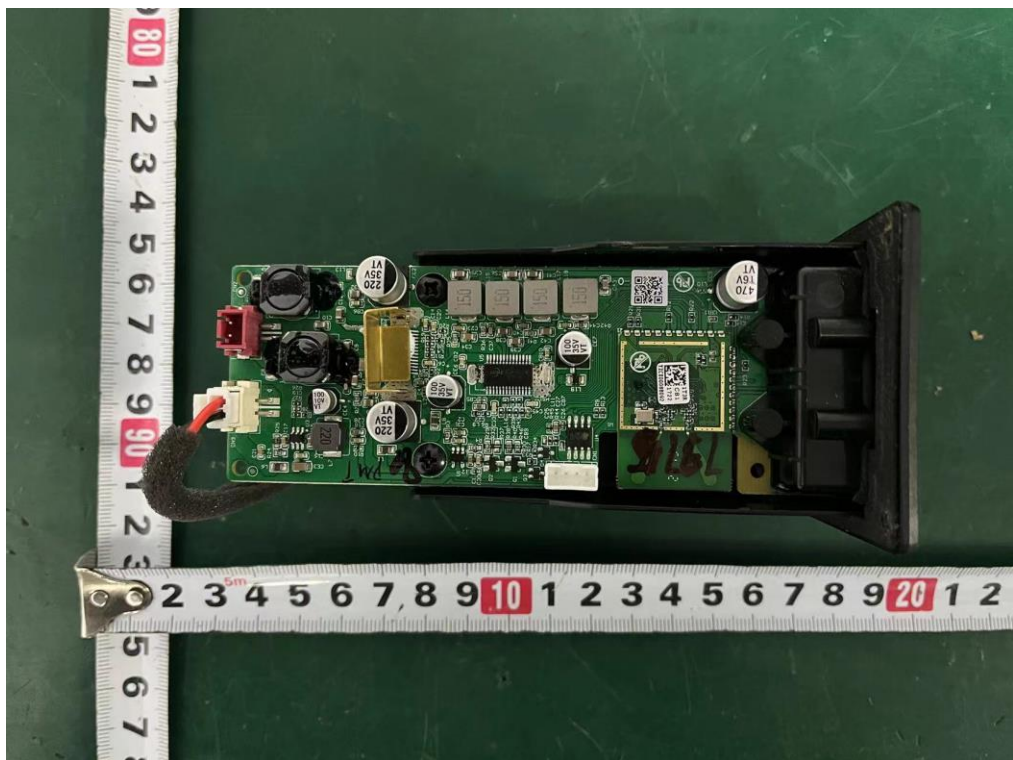
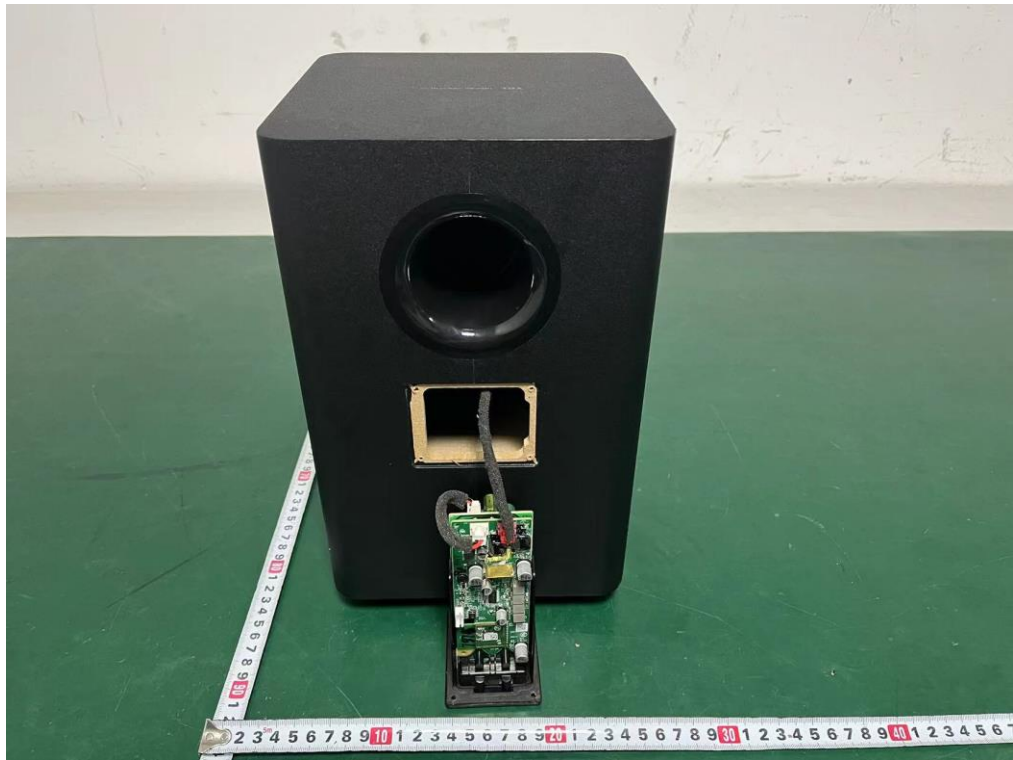

Internal Photos
M/N: S645W-SW

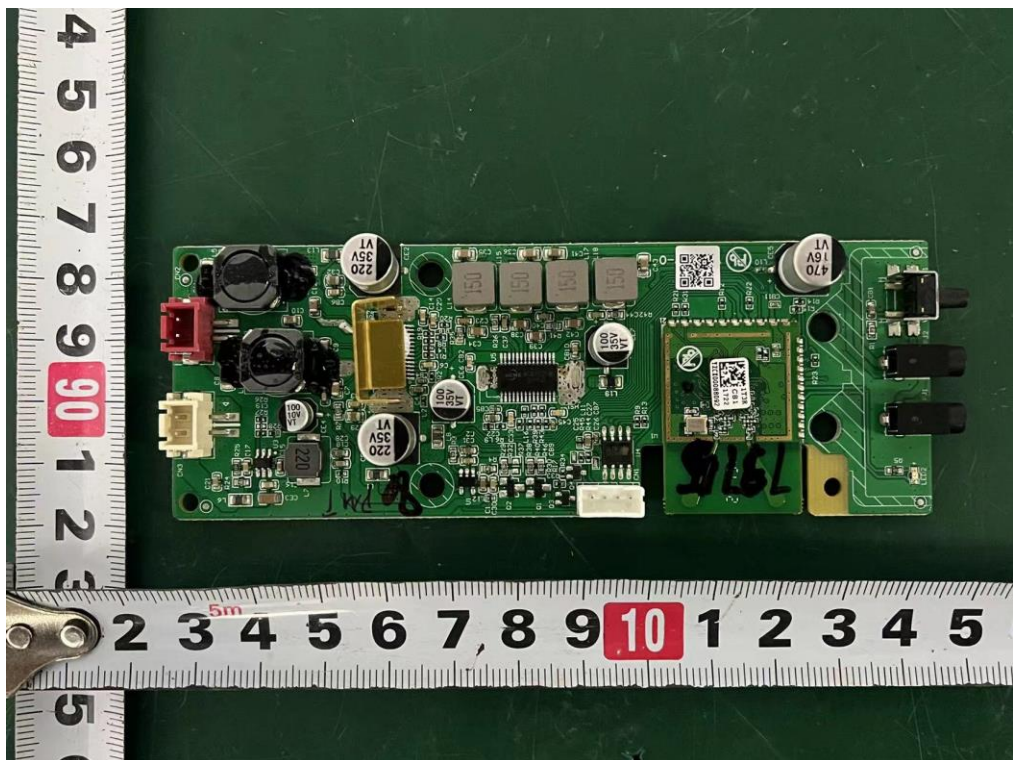
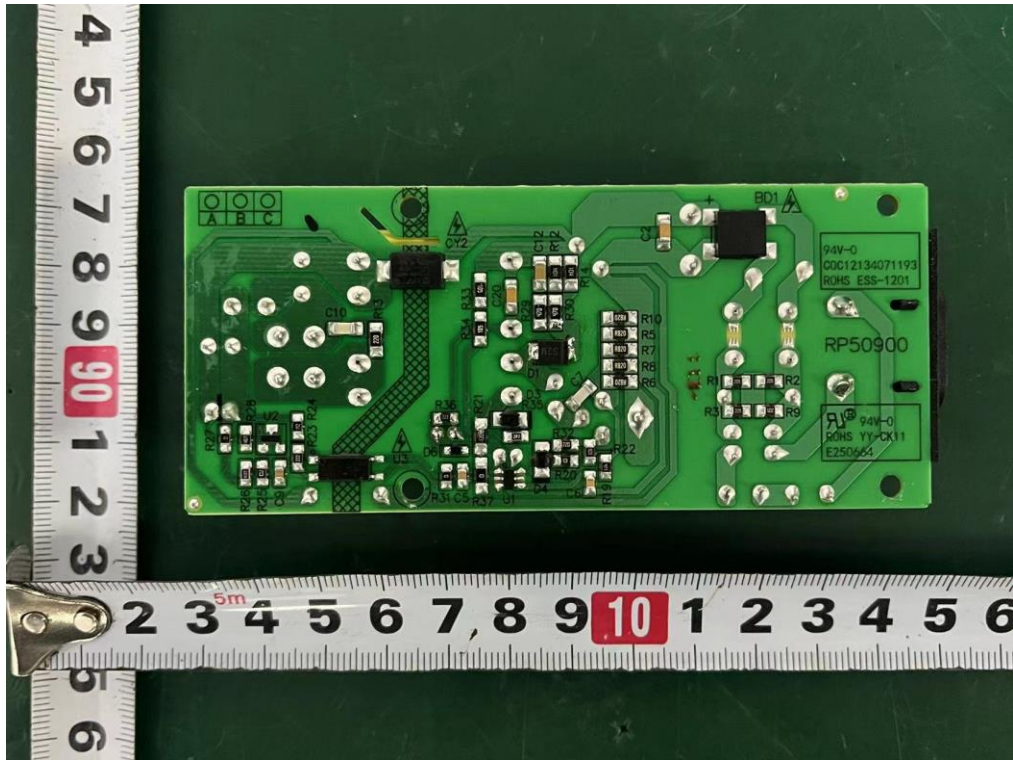

Internal Photos
M/N: S645W-SW

5.8G TX
Left
Antenna

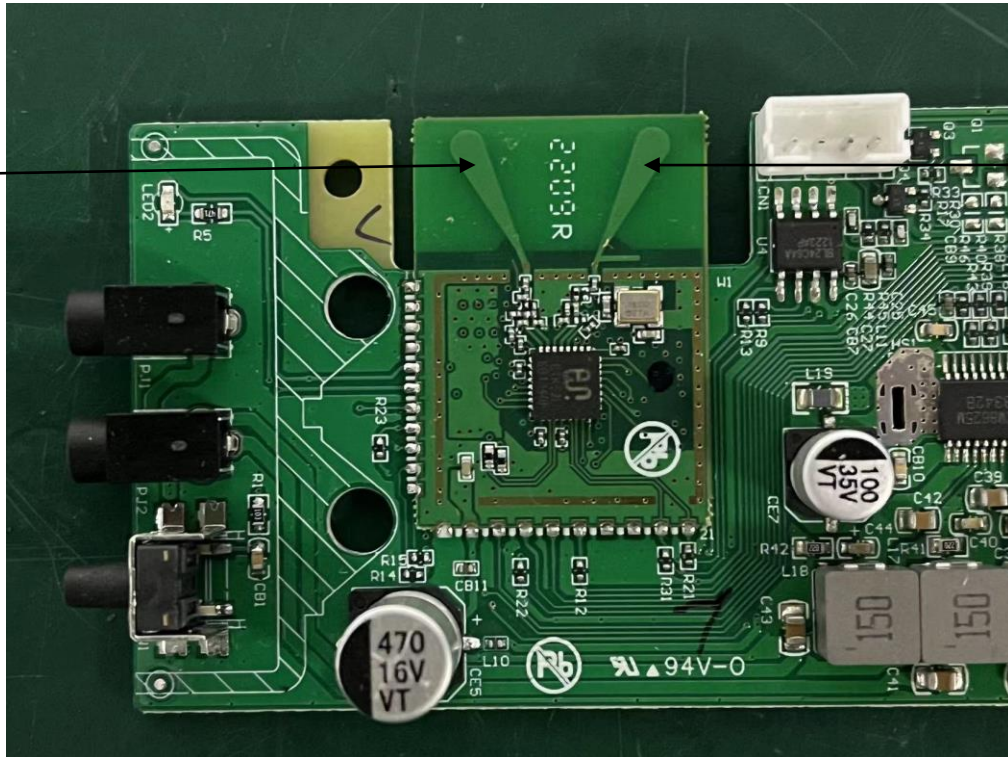

5.8G RX
Right
Antenna

End of Test Report