

Café™ 48" Commercial-Style Gas Rangetop with 6 Burners and Griddle

CAFÉ

DISTINCT BY DESIGN™

CGU486P4TW2 / CGU486P2TS1 / CGU486P3TD1 (NATURAL GAS)



ALSO AVAILABLE IN



CGU486P2TS1
Stainless Steel



CGU486P3TD1
Matte Black

FEATURES & BENEFITS

Versatile Cooktop - The versatile cooktop on this commercial-style rangetop features an entire arsenal of burners that give you the right amount of heat and control to perfectly cook anything from delicate sauces to expertly seared meats.

Color-Matched Manifold - Get a coordinated look with a manifold that matches the rangetop's finish.

Superior Heat Distribution - The industry-exclusive Inspiral burner swirls the cooktop flame under cookware to more evenly spread heat from the center to the edges.

Multi-Ring Burner - A versatile burner offers different-sized flame rings on a single burner element, so it's like having multiple burners in one.

Two Griddle Burners - Cook more at once with two 12,000-BTU powerful burners that can be used together or separately with an optional griddle grill accessory.

Two High-Heat Burners - Boil water quickly with two 18,000-BTU Power Boil burners that give you more cooking power.

Inspiral™ Wok Grate - Perfect for specialty cookware like woks, the Inspiral grate is contoured to fit their shape, concentrating the Inspiral burner's heat for better cooking results.

Built-in Griddle with Thermostat - An 18,000-BTU, Stainless Steel and Aluminum clad griddle features an integrated thermostat, which automatically adjusts heat to hold your set temperature.

Reversible Grill/Griddle Accessory - Optional, reversible rangetop grill/griddle is available for purchase at an additional cost, the part number is UXPRRGG.

Sealed Burner Cooktop - Keep your kitchen sparkling, even when there's a spill, with a sealed burner cooktop design that contains messes for easy cleanup, every time.

Continuous Gas Grates - Continuous, cast-iron gas rangetop grates allow you to easily move heavy cookware across the cooktop surface for a more streamlined cooking experience.

Electric Ignition with Automatic Reignition - Confidently cook over a steady gas flame with this electric ignition rangetop, its automatic reignition feature instantly revives any accidentally extinguished flames.

FEATURES

Ignition System	Electronic w/Auto Reignition
Burner - Left Front	21,000 BTU Multi-ring Burner
Burner - Left Rear	18,000 BTU
Burner - Right Front	10,000 BTU
Burner - Right Rear	18,000 BTU
Burner - Center	12,000 BTU Front / 12,000 BTU Rear
Control Type	Manual Simmer (1-9) Hi
Control Location	Upfront
Cooktop Burner Grate Material	Heavy Cast
Fuel Type	Natural Gas (factory set)
Automatic Re-Ignition	Yes
Simmer Burner	All Burners - Adjustable
Configuration	6 Burners
Dishwasher Safe Knobs	Yes
Griddle Indicator	Yes

POWER/RATINGS

Burner BTU Ratings (000's/BTU) - LP Gas	(1) 18.0; (2) 15.0; (2) 12.0; (1) 9.1
Burner BTU Ratings (000's/BTU) - Natural Gas	(1) 21.0; (2) 18.0; (2) 12.0; (1) 10.0
Volts/Hertz/Amps	120v 60Hz 15A

WEIGHTS & DIMENSIONS

Approximate Shipping Weight	227 lb
Cabinet Width	48 in
Net Weight	171 lb
Overall Depth	27 1/2 in
Overall Height	8 1/2 in
Overall Width	47 7/8 in

ACCESSORIES

Conversion Kit	Included - Nat. Gas to LP
Factory-installed island backguard	Yes
High Altitude Natural Gas	WB28X39728
High Altitude LP	WB28X39729
Reversible Griddle/Grill	UXPRRGG
Optional Backguard	30"-36" adjustable stainless steel backsplash with warming shelf (UXADJB48PSS)

APPEARANCE

Color Appearance	Stainless Steel
Control Knobs	Dishwasher Safe; Commercial-Style; Stainless Steel Appearance
Design Style	Professional

WARRANTY

Parts warranty	Limited 1-year entire appliance
Labor warranty	Limited 1-year entire appliance
Warranty notes	See written warranty for full details

Café™ 48" Commercial-Style Gas Rangetop with 6 Burners and Griddle

CGU486P4TW2 / CGU486P2TS1 / CGU486P3TD1 (NATURAL GAS)

CAFÉ

DISTINCT BY DESIGN™

DIMENSIONS AND INSTALLATION

Commercial-Style rangetops offer a number of choices in size and rangetop configurations.

Backsplash Accessories: The rangetop requires a 12" minimum clearance to a vertical combustible surface at the rear. A backsplash is required for installations with less than 12" clearance. The following backsplash accessories are available, or a custom, non-combustible backsplash can be used.

Backsplash with Warming Shelf: The 30"-36"H adjustable backsplash with warming shelf is a perfect complement when installed with the tapered or straight-sided hoods.

UXADJB48PSS, 30-36" backsplash with shelf

Advance Planning for Commercial-Style Rangetops: Commercial-Style rangetops offer a number of choices in size and rangetop configurations.

All Commercial-Style rangetops are factory set for natural gas.

Note: Conversion kits are included with the rangetop if the wrong gas type was ordered. High Altitude Natural Gas, WB28X39728 and High Altitude LP, WB28X39729, are also available. The kits must be installed by a qualified service technician at additional cost.

Electrical Requirements: Rangetops must be supplied with 120V, 60Hz, and connected to an individual, properly grounded branch circuit protected by a 15 amp circuit breaker or time-delay fuse.

Gas Pressure Regulator:

You must use the gas pressure regulator supplied with this rangetop. For proper operations the inlet pressure to the regulator should be as follows:

Natural Gas:

Minimum pressure: 6" of Water Column / Maximum pressure: 13" of Water Column

Propane (LP) Gas:

Minimum pressure: 11" of Water Column / Maximum pressure: 13" of Water Column
See installation instructions for more details

Product Dimensions and Clearance:

A suitable overhead vent hood is required for models with a grill and is recommended for all other models. Due to the high heat capacity of this unit, particular attention should be paid to the hood and ductwork installation to assure it meets local building codes.

Clearances between rangetop and side wall or combustible material must be at least 12" on each side.

Allow 8" free space below the top surface of countertop. Allow additional clearances below the burner box to install the regulator and make house gas supply connections. Use a 90° elbow to route the gas connections and limit interference with drawers or other cabinetry.

* The opening between a 4" high backsplash must be 36" to allow the rangetop to slide back against the wall.

WARNING: Installations without a hood require 48" minimum to combustibles above the rangetop. A custom hood installation with exposed horizontal combustible surfaces must have an "auto-on" feature. Refer to hood installation instructions for specific hood clearances. The surface of the entire back wall above the countertop and below the hood must be covered with a non-combustible material such as metal, ceramic tile, brick, marble or other stone.

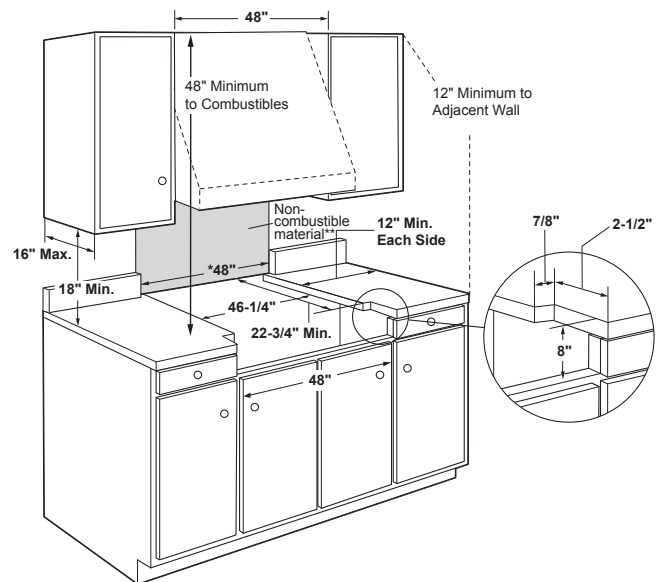
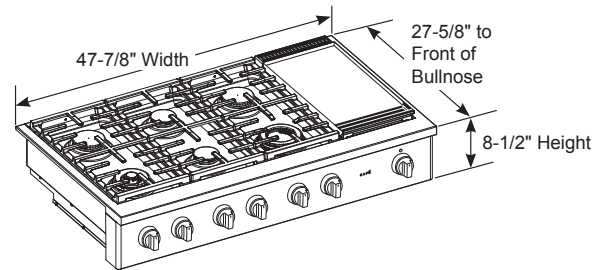

Utility Locations

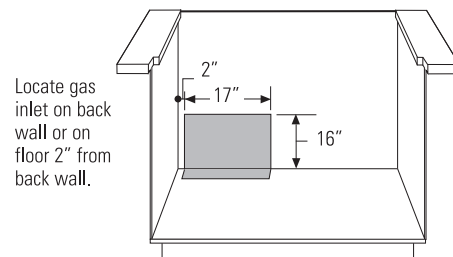

**As defined in the National Fuel Gas Code (ANSI Z223.1/CSA B149.1, Current Edition). Clearances from non-combustible materials are not part of the ANSI Z221.1/CSA 1.1 scope and are not certified by CSA. Clearances less than 12" must be approved by local codes and/or the authority having jurisdiction.

Café™ 48" Commercial-Style Gas Rangetop with 6 Burners and Griddle

CAFÉ

DISTINCT BY DESIGN™

CGU486P4TW2 / CGU486P2TS1 / CGU486P3TD1 (NATURAL GAS)

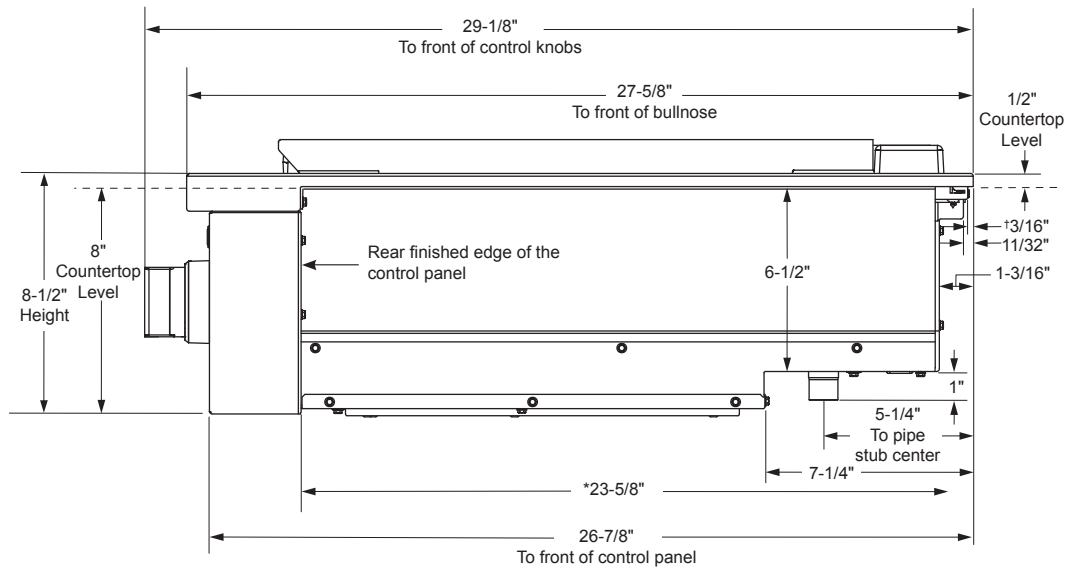

* Minimum cabinet cutout depth from the back of the rear trim to the back finished edge of the control panel - typically, the minimum cabinet depth (front to back). Maximum cabinet cutout depth is 26" minus the countertop overhang.

† Include the overhang of the rear trim when countertop continues behind the product. The overhang is decorative only. The weight of the rangetop is fully supported by the side trims.

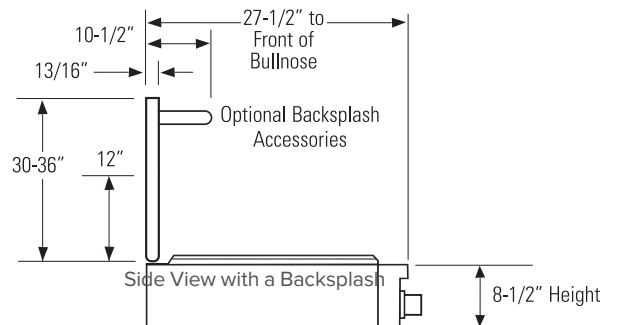
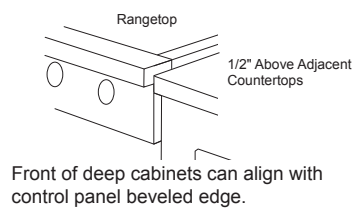
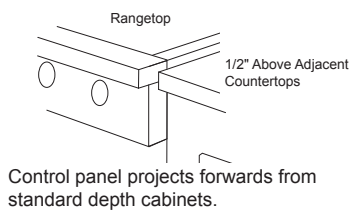

ADDITIONAL ACCESSORIES

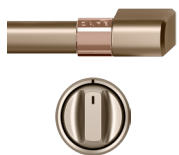

CXPR8HKPTBZ
Brushed Bronze
2 handles, 9 knobs
(standard on Matte White)

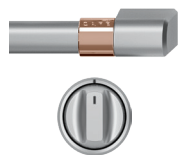

CXPR8HKPTSS
Brushed Stainless
2 handles, 9 knobs
(standard on Matte Black)

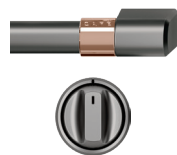

CXPR8HKPTBT
Brushed Black
2 handles, 9 knobs

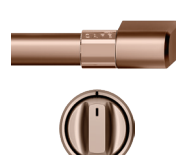

CXPR8HKPTCU
Brushed Copper
2 handles, 9 knobs



UXADJB48PSS
30"-36"H Stainless
Steel Adjustable Height
Backsplash with Shelf

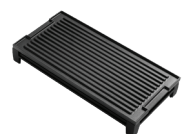

UXPRRGG
Grill/Griddle
Accessory