

Test report No:
2390387R-RF-US-DFS-P09V02

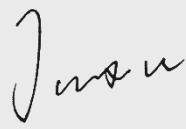
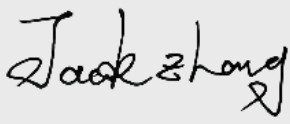

FCC & ISED TEST REPORT

Product Name	POS
Trademark	Elo
Model and /or type reference	EMC-M100C
FCC ID	RBWEMCM100C
IC	10757B-EMCM100C
Applicant's name / address	Elo Touch Solutions, Inc 670 N. McCarthy Blvd., Suite 100, Milpitas, CA 95035, USA.
Test method requested, standard	47 CFR FCC Part 15 (Section 15.407) RSS-Gen Issue 5 RSS-247 Issue 3
Verdict Summary	IN COMPLIANCE
Tested By (name / position & signature)	Jun Xu/ Project Engineer 
Approved by (name / position & signature)	Jack Zhang/ Manager 
Date of issue	2024-05-28
Report Version	V1.0
Report template No	Template_Part 15E-DFS-RF-V1.0

INDEX

	page
Competences and Guarantees	3
General conditions	3
Environmental conditions	3
Possible test case verdicts	4
Abbreviations.....	4
Document History.....	5
Remarks and Comments	5
Used Equipment.....	6
Uncertainty	7
1 General Information	8
1.1 General Description of the Item(s).....	8
1.2 Antenna Information	10
1.3 Channel List.....	11
1.4 Data Rate.....	12
2 UNII Device Description	13
3 Test description.....	14
3.1 Test Setup.....	14
3.2 Limits	15
3.3 Client Device requirement.....	21
3.4 Radar Waveform Calibration.....	22
3.5 Radar Waveform Calibration Result	23
4 Channel Move Time ,Channel Closing Transmission Time and Non-Occupancy Period	24
4.1 Test Procedure	24
4.2 Test Requirement	24
4.3 Test Result of Channel Move Time , Channel Closing Transmission Time and Non-Occupancy Period.....	25

COMPETENCES AND GUARANTEES

DEKRA is a testing laboratory competent to carry out the tests described in this report.

In order to assure the traceability to other national and international laboratories, DEKRA has a calibration and maintenance program for its measurement equipment.

DEKRA guarantees the reliability of the data presented in this report, which is the result of the measurements and the tests performed to the item under test on the date and under the conditions stated in the report and it is based on the knowledge and technical facilities available at DEKRA at the time of performance of the test.

DEKRA is liable to the client for the maintenance of the confidentiality of all information related to the item under test and the results of the test.

The results presented in this Test Report apply only to the particular item under test established in this document.

IMPORTANT: No parts of this report may be reproduced or quoted out of context, in any form or by any means, except in full, without the previous written permission of DEKRA.

GENERAL CONDITIONS

Test Location	No. 99, Hongye Road, Suzhou Industrial Park Suzhou, 215006, P.R. China
Date(receive sample)	Dec. 26, 2023
Date (start test)	Dec. 29, 2023
Date (finish test)	Feb. 22, 2024

1. This report is only referred to the item that has undergone the test.
2. This report does not constitute or imply on its own an approval of the product by the Certification Bodies or Competent Authorities.
3. This document is only valid if complete; no partial reproduction can be made without previous written permission of DEKRA.
4. This test report cannot be used partially or in full for publicity and/or promotional purposes without previous written permission of DEKRA.

ENVIRONMENTAL CONDITIONS

The climatic conditions during the tests are within the limits specified by the manufacturer for the operation of the EUT and the test equipment. The climatic conditions during the tests were within the following limits:

Ambient temperature	15 °C – 35 °C
Relative Humidity air	30% - 60%

If explicitly required in the basic standard or applied product / product family standard the climatic values are recorded and documented separately in this test report.

POSSIBLE TEST CASE VERDICTS

Test case does not apply to test object	N/A
Test object does meet requirement	P (Pass) / PASS
Test object does not meet requirement	F (Fail) / FAIL
Not measured	N/M

ABBREVIATIONS

For the purposes of the present document, the following abbreviations apply:

EUT	: Equipment Under Test
QP	: Quasi-Peak
CAV	: CISPR Average
AV	: Average
CDN	: Coupling Decoupling Network
SAC	: Semi-Anechoic Chamber
OATS	: Open Area Test Site
BW	: Bandwidth
AM	: Amplitude Modulation
PM	: Pulse Modulation
HCP	: Horizontal Coupling Plane
VCP	: Vertical Coupling Plane
U_N	: Nominal voltage
Tx	: Transmitter
Rx	: Receiver
N/A	: Not Applicable
N/M	: Not Measured

DOCUMENT HISTORY

Report No.	Version	Description	Issued Date
2390387R-RF-US-DFS-P09V02	V1.0	Initial issue of report.	2024-05-28

REMARKS AND COMMENTS

1. The equipment under test (EUT) does meet the essential requirements of the stated standard(s)/test(s).
2. These test results on a sample of the device are for the purpose of demonstrating Compliance with 47 CFR FCC Part 15 (Section 15.407 Clauses (h)), RSS-247 Issue 3 Clauses 6.3.
3. The measurement result is considered in conformance with the requirement if it is within the prescribed limit, It is not necessary to account the uncertainty associated with the measurement result.
4. The test results presented in this report relate only to the object tested.
5. The test report shall not be reproduced without the written approval of DEKRA Testing and Certification (Suzhou) Co., Ltd.
6. This report will not be used for social proof function in China market.
7. DEKRA declines any responsibility with the following test data provided by customer that may affect the validity of result:
 - Chapter 1.1 General Description of the Item(s);
 - Chapter 1.2 Antenna Informaion.
 - Chapter 1.3 Channel List.
 - Chapter 1.4 Data Rate.

USED EQUIPMENT

Dynamic Frequency Selection (DFS) / TR-8

Instrument	Manufacturer	Model No.	Serial No.	Cal. Date	Next Cal. Date	Firmware Version	Software version
Wireless Connectivity Tester	R&S	CMW 270	102593	2023.05.20	2024.05.19	V 4.0.60	N/A
Coaxial Cable	N/A	N/A	2477	2023.06.08	2024.06.07	N/A	N/A
Coaxial Cable	N/A	N/A	2478	2023.06.08	2024.06.07	N/A	N/A
High and low temperature and fast temperature change test box	ASTUOD	ASTD-FBT-225K	N/A	2023.05.20	2024.05.19	N/A	N/A
Temperature/Humidity Meter	RTS	RTS-8S	RF08	2023.08.25	2024.08.24	N/A	N/A
Test system							
Instrument	Manufacturer	Model No.	Serial No.	Cal. Date	Next Cal. Date	Firmware Version	Software version
MAX Signal Analyzer	Keysight	N9010A	MY48030494	2023.11.08	2024.11.07	A.14.03	N/A
RF Control Unit	Tonscend	JS0806-2	22G8060594	2023.02.04	2024.02.03	N/A	N/A
RF Control Unit	Tonscend	JS0806-2	22G8060594	2024.01.31	2025.01.30	N/A	N/A
MXG-B RF Vector Signal Generator	Keysight	N5182B	MY61252529	2023.05.20	2024.05.19	B.01.96	N/A
Frequency extender for EXG or MXG	Keysight	N5182BX07	MY59362500	2023.05.20	2024.05.19	N/A	N/A
EXG-B MW Analog Signal Generator	Keysight	N5173B	MY61252566	2023.08.26	2024.08.25	B.01.95	N/A
Test Software	Tonscend	TS1120	JS1120-3	N/A	N/A	N/A	V3.0.22

UNCERTAINTY

Uncertainties have been calculated according to the DEKRA internal document. The reported expanded uncertainties are based on a standard uncertainty multiplied by a coverage factor of $k=2$, providing a level of confidence of approximately 95%.

Test item	Uncertainty
Time	± 1 ms
RF Antenna Port Conducted Emission	± 1.13 dB
Occupied Bandwidth	± 279 Hz
Power Spectral Density	± 1.13 dB
Frequency Stability	± 100 Hz

1 GENERAL INFORMATION

1.1 General Description of the Item(s)

Product Name	POS
Model No.	EMC-M100C
Trademark.	Elo
FCC ID.....	RBWEMCM100C
IC	10757B-EMCM100C
Hardware Version.....	V1.00
Software Version	T14
Manufacturer	Elo Touch Solutions, Inc
Manufacturer Address	670 N. McCarthy Blvd., Suite 100, Milpitas, CA 95035, USA.
Factory.....	ShuoGe Intelligent Technology Co.,Ltd.
Factory address.....	Room 308-310, Building 1, No.2 8th Road, Baiyang Street, Qiantang New Area, Hangzhou City, Zhejiang Province, P.R. China(310018)
Test Sample SN	#1

Wireless specification	WIFI For FCC					
Transmit modes.....	<input checked="" type="checkbox"/>	802.11a	<input checked="" type="checkbox"/>	802.11n(20MHz)	<input checked="" type="checkbox"/>	802.11n(40MHz)
	<input checked="" type="checkbox"/>	802.11ac(20MHz)	<input checked="" type="checkbox"/>	802.11ac(40MHz)	<input checked="" type="checkbox"/>	802.11ac(80MHz)
Frequency Range	802.11a/n/ac(20MHz):5180MHz~5240Mz 802.11n/ac(40MHz):5190MHz~5230Mz 802.11ac(80MHz):5210Mz					
	<input checked="" type="checkbox"/>	<input type="checkbox"/> Outdoor access point				
		<input type="checkbox"/> RF Module				
		<input type="checkbox"/> Fixed point-to-point AP				
		<input checked="" type="checkbox"/> Mobile and Portable Client				
	<input checked="" type="checkbox"/>	802.11a/n/ac(20MHz):5260MHz~5320Mz 802.11n/ac(40MHz):5270MHz~5310Mz 802.11ac(80MHz):5290Mz				
<input checked="" type="checkbox"/>	802.11a/n/ac(20MHz):5500MHz~5700MHz 802.11n/ac(40MHz):5510MHz~5670Mz 802.11ac(80MHz):5530~5610Mz					
<input checked="" type="checkbox"/>	802.11a/n/ac(20MHz):5745MHz~5825MHz 802.11n/ac(40MHz):5755MHz~5805Mz 802.11ac(80MHz):5775Mz					
DFS	<input type="checkbox"/> Master					
	<input checked="" type="checkbox"/> Slave					
Type of Modulation & Data Rate	Refer to Clause 1.4					
Number of channels	802.11a/n/ac(20MHz): 24					
	802.11n/ac(40MHz): 11					
	802.11ac(80MHz): 5					

Wireless specification	WIFI For ISED					
Transmit modes	<input checked="" type="checkbox"/>	802.11a	<input checked="" type="checkbox"/>	802.11n(20MHz)	<input checked="" type="checkbox"/>	802.11n(40MHz)
	<input checked="" type="checkbox"/>	802.11ac(20MHz)	<input checked="" type="checkbox"/>	802.11ac(40MHz)	<input checked="" type="checkbox"/>	802.11ac(80MHz)
Frequency Range	802.11a/n/ac(20MHz):5180MHz~5240Mz 802.11n/ac(40MHz):5190MHz~5230Mz 802.11ac(80MHz):5210Mz					
	<input checked="" type="checkbox"/>	<input type="checkbox"/>	Outdoor access point			
		<input type="checkbox"/>	RF Module			
		<input type="checkbox"/>	Fixed point-to-point AP			
		<input checked="" type="checkbox"/>	Mobile and Portable Client			
	<input checked="" type="checkbox"/>	802.11a/n/ac(20MHz):5260MHz~5320Mz 802.11n/ac(40MHz):5270MHz~5310Mz 802.11ac(80MHz):5290Mz				
<input checked="" type="checkbox"/>	802.11a/n/ac(20MHz):5500MHz~5580MHz, 5660MHz~5700MHz 802.11n/ac(40MHz):5510MHz~5550MHz, 5670Mz 802.11ac(80MHz):5530, 5610Mz					
<input checked="" type="checkbox"/>	802.11a/n/ac(20MHz):5745MHz~5825MHz 802.11n/ac(40MHz):5755MHz~5805Mz 802.11ac(80MHz):5775Mz					
DFS	<input type="checkbox"/> Master					
	<input checked="" type="checkbox"/> Slave					
Type of Modulation & Data Rate	Refer to Clause 1.4					
Number of channels	802.11a/n/ac(20MHz): 21					
	802.11n/ac(40MHz): 11					
	802.11ac(80MHz): 4					

Rated power supply	Voltage and Frequency					
	<input type="checkbox"/>	AC: 220 - 240 V, 50/60 Hz				
	<input type="checkbox"/>	AC: 100 - 240 V, 50/60 Hz				
	<input type="checkbox"/>	DC: 24 Vdc				
	<input type="checkbox"/>	Poe:				
	<input checked="" type="checkbox"/>	Adapter:				
Adapter Model	UES45LCP-SPC					
	Input: 100-240V ~ 50/60Hz,1.3A Output: 5.0V/3.0A,15.0W; 9.0V/3.0A, 27.0W; 12.0V/3.0A,36.0W; 15V/3.0A,45W; 20V/2.25A,45W Max					
Mounting position	<input type="checkbox"/>	Tabletop equipment				
	<input type="checkbox"/>	Wall/Ceiling mounted equipment				
	<input type="checkbox"/>	Floor standing equipment				
	<input checked="" type="checkbox"/>	Hand-held/Portable equipment				
	<input type="checkbox"/>	Other:				

1.2 Antenna Information

Antenna model / type number	N/A		
Antenna serial number	N/A		
Antenna Delivery	<input checked="" type="checkbox"/>	1TX + 1RX	
	<input checked="" type="checkbox"/>	2TX + 2RX	
Antenna technology.....	<input checked="" type="checkbox"/>	SISO	
	<input checked="" type="checkbox"/>	MIMO	<input checked="" type="checkbox"/> CDD <input type="checkbox"/> Beam-forming
Antenna Type	<input type="checkbox"/>	External	<input type="checkbox"/> Dipole
			<input type="checkbox"/> Sectorized
	<input checked="" type="checkbox"/>	Internal	<input type="checkbox"/> PIFA
			<input checked="" type="checkbox"/> FPC
		<input type="checkbox"/> Others.....	
SISO Antenna Gain.....	Antenna1:	5150-5250: -0.05 dBi 5250-5350: 1.37 dBi 5470-5725: 2.58 dBi 5725-5850: 1.30 dBi	
	Antenna2:	5150-5250: 2.81 dBi 5250-5350: 2.59 dBi 5470-5725: 2.67 dBi 5725-5850: 2.89 dBi	
CDD directional gain	For Power:	5150-5250: 2.81 dBi 5250-5350: 2.59 dBi 5470-5725: 2.67 dBi 5725-5850: 2.89 dBi	
	For PSD:	5150-5250: 5.82 dBi 5250-5350: 5.60 dBi 5470-5725: 5.68 dBi 5725-5850: 5.90 dBi	

1.3 Channel List

For FCC:

802.11a/n/ac(20MHz) Working Frequency of Each Channel:							
Channel	Frequency	Channel	Frequency	Channel	Frequency	Channel	Frequency
36	5180 MHz	40	5200 MHz	44	5220 MHz	48	5240 MHz
52	5260 MHz	56	5280 MHz	60	5300 MHz	64	5320 MHz
100	5500 MHz	104	5520 MHz	108	5540 MHz	112	5550 MHz
116	5580 MHz	120	5600 MHz	124	5620 MHz	128	5640 MHz
132	5660 MHz	136	5680 MHz	140	5700 MHz	N/A	N/A
149	5745 MHz	153	5765 MHz	157	5785 MHz	161	5805 MHz
165	5825 MHz	N/A	N/A	N/A	N/A	N/A	N/A
802.11n/ac(40MHz) Working Frequency of Each Channel:							
Channel	Frequency	Channel	Frequency	Channel	Frequency	Channel	Frequency
38	5190 MHz	46	5230 MHz	54	5270 MHz	62	5310 MHz
102	5510 MHz	110	5550 MHz	118	5590 MHz	126	5630 MHz
134	5670 MHz	151	5755 MHz	159	5795 MHz	N/A	N/A
802.11ac(80MHz) Working Frequency of Each Channel:							
Channel	Frequency	Channel	Frequency	Channel	Frequency	Channel	Frequency
42	5210 MHz	58	5290 MHz	106	5530MHz	122	5610 MHz
138	5690 MHz	155	5775 MHz	N/A	N/A	N/A	N/A

For IC:

IEEE 802.11a/n/ac(20MHz) Working Frequency of Each Channel:							
Channel	Frequency	Channel	Frequency	Channel	Frequency	Channel	Frequency
36	5180 MHz	40	5200 MHz	44	5220 MHz	48	5240 MHz
52	5260 MHz	56	5280 MHz	60	5300 MHz	64	5320 MHz
100	5500 MHz	104	5520 MHz	108	5540 MHz	112	5560 MHz
116	5580 MHz	132	5660 MHz	136	5680 MHz	140	5700 MHz
149	5745 MHz	153	5765 MHz	157	5785 MHz	161	5805 MHz
165	5825 MHz	N/A	N/A	N/A	N/A	N/A	N/A
IEEE 802.11n/ac(40MHz)Working Frequency of Each Channel:							
Channel	Frequency	Channel	Frequency	Channel	Frequency	Channel	Frequency
38	5190 MHz	46	5230 MHz	54	5270 MHz	62	5310 MHz
102	5510 MHz	110	5550 MHz	134	5670 MHz	151	5755 MHz
159	5795 MHz	N/A	N/A	N/A	N/A	N/A	N/A
IEEE 802.11ac(80MHz)Working Frequency of Each Channel:							
Channel	Frequency	Channel	Frequency	Channel	Frequency	Channel	Frequency
42	5210 MHz	58	5290 MHz	106	5530 MHz	155	5775 MHz

1.4 Data Rate

IEEE 802.11a

Modulation	R	Data Rate(Mb/s)
BPSK	1/2	6
BPSK	3/4	9
QPSK	1/2	12
QPSK	3/4	18
16-QAM	1/2	24
16-QAM	3/4	36
64-QAM	2/3	48
64-QAM	3/4	54

Note : We have evaluated low/mid/high data rate, the blue font is the highest power data rate.

IEEE 802.11n/ac

Spatial streames	MCS Index	Modulation	R	Data Rate(Mb/s)					
				400ns GI			800ns GI		
				20MHz	40MHz	80MHz	20MHz	40MHz	80MHz
1	0	BPSK	1/2	7.2	15	32.5	6.5	13.5	29.3
1	1	QPSK	1/2	14.4	30	65	13	27	58.5
1	2	QPSK	3/4	21.7	45	97.5	19.5	40.5	87.8
1	3	16-QAM	1/2	28.9	60	130	26	54	117
1	4	16-QAM	3/4	43.3	90	195	39	81	175.5
1	5	64-QAM	2/3	57.8	120	260	52	108	234
1	6	64-QAM	3/4	65	135	292.5	58.5	121.5	263.3
1	7	64-QAM	5/6	72.2	150	325	65	135	292.5
1	8	256QAM	3/4	86.7	180	390	78	162	351
1	9	256QAM	5/6	N/A	200	433.3	N/A	180	390
2	0	BPSK	1/2	14.4	30	65	13	27	58.6
2	1	QPSK	1/2	28.8	60	130	26	54	117
2	2	QPSK	3/4	43.4	90	195	39	81	175.6
2	3	16-QAM	1/2	57.8	120	260	52	108	234
2	4	16-QAM	3/4	86.6	180	390	78	162	351
2	5	64-QAM	2/3	115.6	240	520	104	216	468
2	6	64-QAM	3/4	130	270	585	117	243	526.6
2	7	64-QAM	5/6	144.4	300	650	130	270	585
2	8	256QAM	3/4	173.4	360	780	156	324	702
2	9	256QAM	5/6	N/A	400	866.6	N/A	360	780

Note : We have evaluated low/mid/high data rate, the blue font is the highest power data rate.

Note: The general description of the Item(s), antenna information, data rate and channel list in clause 1 are provided and confirmed by the client.

2 UNII DEVICE DESCRIPTION

The UUT operates in the following band:

1. 5250-5350 MHz
2. 5470-5725 MHz for FCC, 5470-5600 MHz and 5650-5725 MHz for ISSED

The UUT is a Client Device that does not have radar detection capability and ad-hoc function. The highest gain antenna assembly utilized with the EUT has a maximum gain refer to clause 1.2. The 50-ohm Tx/Rx antenna port is connected to the test system to perform conducted tests. TPC is not required since the maximum EIRP is less than 500mW (27dBm).

The UUT utilizes 802.11a/n/ac/ax IP based architecture. Three nominal channel bandwidths, 20 MHz, 40MHz and 80MHz are implemented.

The master device is an ASUS 802.11a/b/g/n/ac/ax Access Point. The ASUS Access Point FCC ID: MSQ-RTAXHP00

The UUT is a client device without radar detection therefore the interference threshold level is not required.

Statement: Information regarding the parameters of the detected Radar Waveforms is not available to the end user.

3 TEST DESCRIPTION

3.1 Test Setup

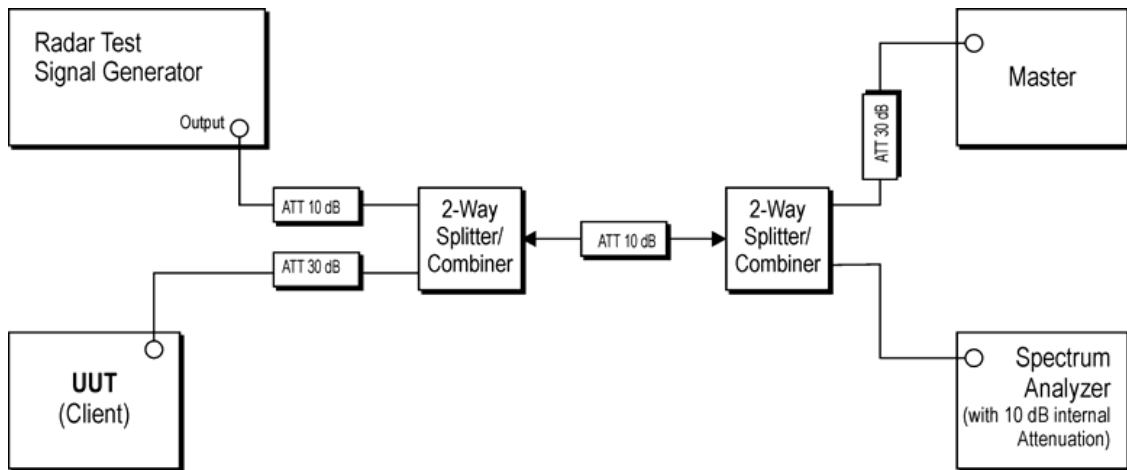

DFS Set-up Photo: Slave and Spectrum Analyzer



3.2 Limits

According to §15.407(h), 905462 D02 UNII DFS Compliance Procedures New Rules v01, 905462 D03 UNII Clients Without Radar Detection New Rules v01r02 and FCC 14-30 APPENDIX “COMPLIANCE MEASUREMENT PROCEDURES FOR UNLICENSED NATIONAL INFORMATION INFRASTRUCTURE DEVICES OPERATING IN THE 5250-5350 MHz AND 5470-5725MHz BANDS INCORPORATING DYNAMIC FREQUENCY SELECTION”.

Applicability of DFS requirements prior to use of a channel

Requirement	Operational Mode		
	Master	Client (without radar detection)	Client (with radar detection)
Non-Occupancy Period	Yes	Not Required	Yes
DFS Detection Threshold	Yes	Not Required	Yes
Channel Availability Check Time	Yes	Not Required	Not Required
U-NII Detection Bandwidth	Yes	Not Required	Yes

Applicability of DFS requirements during normal operation

Requirement	Operational Mode	
	Master or Client (with radar detection)	Client (without radar detection)
DFS Detection Threshold	Yes	Not Required
Channel Closing Transmission Time	Yes	Yes
Channel Move Time	Yes	Yes
U-NII Detection Bandwidth	Yes	Not required

Additional requirements for devices with multiple bandwidth modes	Master Device or Client with Radar Detection	Client (without radar detection)
U-NII Detection Bandwidth and Statistical Performance Check	All BW modes must be tested	Not required
Channel Move Time and Channel Closing Transmission Time	Test using widest BW mode available	Test using the widest BW mode available for the link
All other tests	Any single BW mode	Not required
<p>Note: Frequencies selected for statistical performance check (Section 7.8.4) should include several frequencies within the radar detection bandwidth and frequencies near the edge of the radar detection bandwidth. For 802.11 devices it is suggested to select frequencies in all 20 MHz channel blocks and a null frequencies between the bonded 20 MHz channel blocks.</p>		

DFS Detection Thresholds for Master Devices and Client Devices With Radar Detection

Maximum Transmit Power	Value (see note)
EIRP ≥ 200 milliwatt	-64 dBm
EIRP < 200 milliwatt and power spectral density < 10 dBm/MHz	-62 dBm
EIRP < 200 milliwatt that do not meet the power spectral density requirement	-62 dBm
<p>Note 1: This is the level at the input of the receiver assuming a 0 dBi receive antenna.</p> <p>Note 2: Throughout these test procedures an additional 1 dB has been added to the amplitude of the test transmission waveforms to account for variations in measurement equipment. This will ensure that the test signal is at or above the detection threshold level to trigger a DFS response.</p> <p>Note3: EIRP is based on the highest antenna gain. For MIMO devices refer to KDB Publication 662911 D01.</p>	

DFS Response requirement values

Parameter	Value
Non-Occupancy Period	Minimum 30 minutes
Channel Availability Check Time	60 Seconds
Channel Move Time	10 Seconds (See Note1)
Channel Closing Transmission Time	200 milliseconds + an aggregate of 60 milliseconds over remaining 10 second period. (See Notes 1 and 2)
U-NII Detection Bandwidth	Minimum 100% of the U-NII 99% transmission power bandwidth. See Note 3.
<p>Note 1: Channel Move Time and the Channel Closing Transmission Time should be performed with Radar Type 0. The measurement timing begins at the end of the Radar Type 0 burst.</p> <p>Note 2: The Channel Closing Transmission Time is comprised of 200 milliseconds starting at the beginning of the Channel Move Time plus any additional intermittent control signals required to facilitate a Channel move (an aggregate of 60 milliseconds) during the remainder of the 10 second period. The aggregate duration of control signals will not count quiet periods in between transmissions.</p> <p>Note 3: During the U-NII Detection Bandwidth detection test, radar type 0 should be used. For each frequency step the minimum percentage of detection is 90 percent. Measurements are performed with no data traffic.</p>	

Short Pulse Radar Test Waveforms

Table 5 – Short Pulse Radar Test Waveforms

Radar Type	Pulse Width (μsec)	PRI (μsec)	Number of Pulses	Minimum Percentage of Successful Detection	Minimum Number of Trials
0	1	1428	18	See Note 1	See Note 1
1	1	Test A: 15 unique PRI values randomly selected from the list of 23 PRI values in Table 5a	Roundup $\left\{ \left(\frac{1}{360} \right) \cdot \left(\frac{19 \cdot 10^6}{PRI_{\mu sec}} \right) \right\}$	60%	30
		Test B: 15 unique PRI values randomly selected within the range of 518-3066 μ sec, with a minimum increment of 1 μ sec, excluding PRI values selected in Test A			
2	1-5	150-230	23-29	60%	30
3	6-10	200-500	16-18	60%	30
4	11-20	200-500	12-16	60%	30
Aggregate (Radar Types 1-4)				80%	120
Note 1: Short Pulse Radar Type 0 should be used for the detection bandwidth test, channel move time, and channel closing time tests.					

A minimum of 30 unique waveforms are required for each of the Short Pulse Radar Types 2 through 4. If more than 30 waveforms are used for Short Pulse Radar Types 2 through 4, then each additional waveform must also be unique and not repeated from the previous waveforms. If more than 30 waveforms are used for Short Pulse Radar Type 1, then each additional waveform is generated with Test B and must also be unique and not repeated from the previous waveforms in Tests A or B.

For example if in Short Pulse Radar Type 1 Test B a PRI of 3066 usec is selected, the number of

pulses would be = Roundup $\left\{ \left(\frac{1}{360} \right) \cdot \left(\frac{19 \cdot 10^6}{3066} \right) \right\} = \text{Roundup}\{17.2\} = 18.$

Table 5a - Pulse Repetition Intervals Values for Test A

Pulse Repetition Frequency Number	Pulse Repetition Frequency (Pulses Per Second)	Pulse Repetition Interval (Microseconds)
1	1930.5	518
2	1858.7	538
3	1792.1	558
4	1730.1	578
5	1672.2	598
6	1618.1	618
7	1567.4	638
8	1519.8	658
9	1474.9	678
10	1432.7	698
11	1392.8	718
12	1355	738
13	1319.3	758
14	1285.3	778
15	1253.1	798
16	1222.5	818
17	1193.3	838
18	1165.6	858
19	1139	878
20	1113.6	898
21	1089.3	918
22	1066.1	938
23	326.2	3066

The aggregate is the average of the percentage of successful detections of Short Pulse Radar Types 1-4.

Long Pulse Radar Test Signal

Radar Waveform	Bursts	Pulses Per Burst	Pulse Width (μsec)	Chirp Width (MHz)	PRI (μsec)	Minimum Percentage of Successful Detection	Minimum Trials
5	8-20	1-3	50-100	5-20	1000-2000	80%	30

The parameters for this waveform are randomly chosen. Thirty unique waveforms are required for the long pulse radar test signal. If more than 30 waveforms are used for the long pulse radar test signal, then each additional waveform must also be unique and not repeated from the previous waveforms.

Frequency Hopping Radar Test Signal

Radar Waveform	Pulse Width (μsec)	PRI (μsec)	Hopping Sequence Length (msec)	Pulses Per Hop	Hopping Rate (kHz)	Minimum Percentage of Successful Detection	Minimum Trials
6	1	333	300	9	0.333	70%	30

For the Frequency Hopping Radar Type, the same *Burst* parameters are used for each waveform. The hopping sequence is different for each waveform and a 100-length segment is selected from the hopping sequence defined by the following algorithm:

The first frequency in a hopping sequence is selected randomly from the group of 475 integer frequencies from 5250 – 5724 MHz. Next, the frequency that was just chosen is removed from the group and a frequency is randomly selected from the remaining 474 frequencies in the group. This process continues until all 475 frequencies are chosen for the set. For selection of a random frequency, the frequencies remaining within the group are always treated as equally likely.

3.3 Client Device requirement

- a) A Client Device will not transmit before having received appropriate control signals from a Master Device.
- b) A Client Device will stop all its transmissions whenever instructed by a Master Device to which it is associated and will meet the Channel Move Time and Channel Closing Transmission Time requirements. The Client Device will not resume any transmissions until it has again received control signals from a Master Device.
- c) If a Client Device is performing In-Service Monitoring and detects a Radar Waveform above the DFS Detection Threshold, it will inform the Master Device. This is equivalent to the Master Device detecting the Radar Waveform and d) through f) of section 5.1.1 apply.
- d) Irrespective of Client Device or Master Device detection the Channel Move Time and Channel Closing Transmission Time requirements remain the same.
- e) The client test frequency must be monitored to ensure no transmission of any type has occurred for 30 minutes. Note: If the client moves with the master, the device is considered compliant if nothing appears in the client non-occupancy period test. For devices that shut down (rather than moving channels), no beacons should appear.

3.4 Radar Waveform Calibration

The following equipment setup was used to calibrate the conducted radar waveform. A spectrum analyzer was used to establish the test signal level for each radar type. During this process there were replace 50ohm terminal from master and client device and no transmissions by either the master or client device. The spectrum analyzer was switched to the zero span (time domain) at the frequency of the radar waveform generator. Peak detection was utilized. The spectrum analyzer resolution bandwidth (RBW) and video bandwidth (VBW) were set to 3MHz and 3 MHz.

The signal generator amplitude was set so that the power level measured at the spectrum analyzer was -61dBm due to the interference threshold level is not required.

Conducted Calibration Setup

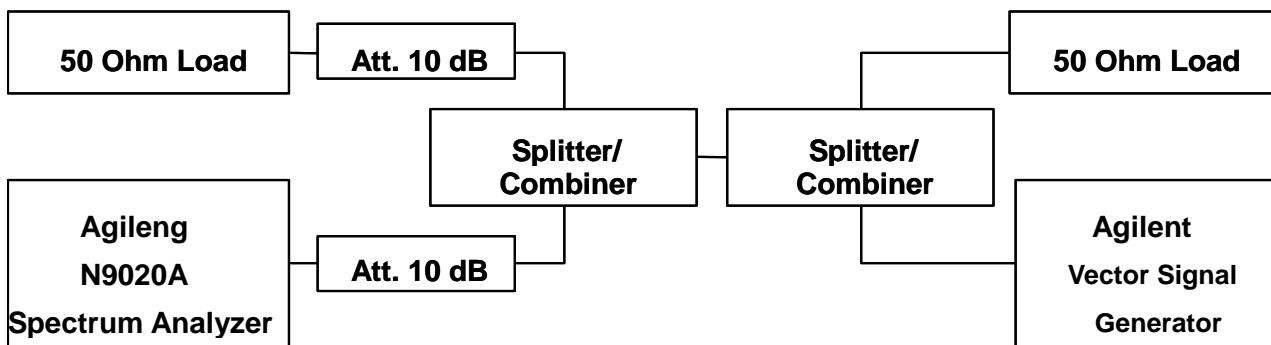

3.5 Radar Waveform Calibration Result

TestMode	Frequency[dbm]	Radar Type	Result	Limit[dbm]	Verdict
11AC80SISO	5290	Type0	-62.46	-62.00	PASS
11AC80SISO	5530	Type0	-62.31	-62.00	PASS

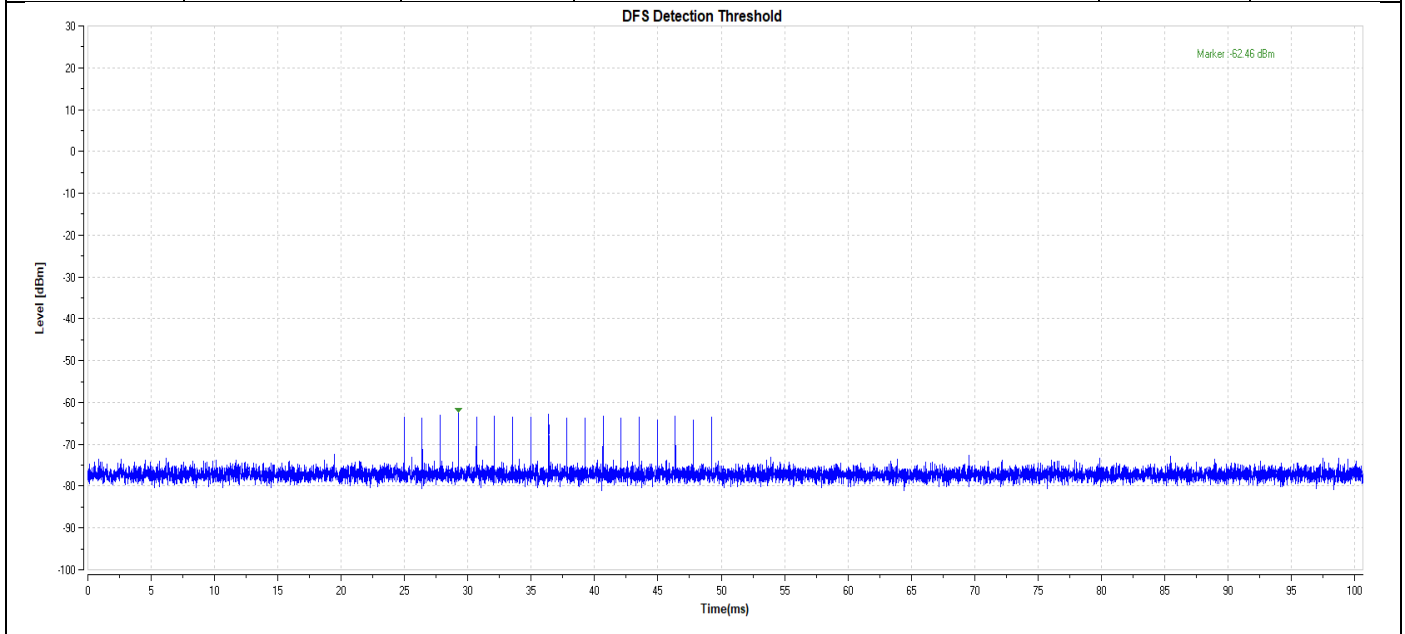

11AC80SISO-5290-Type0-PASS

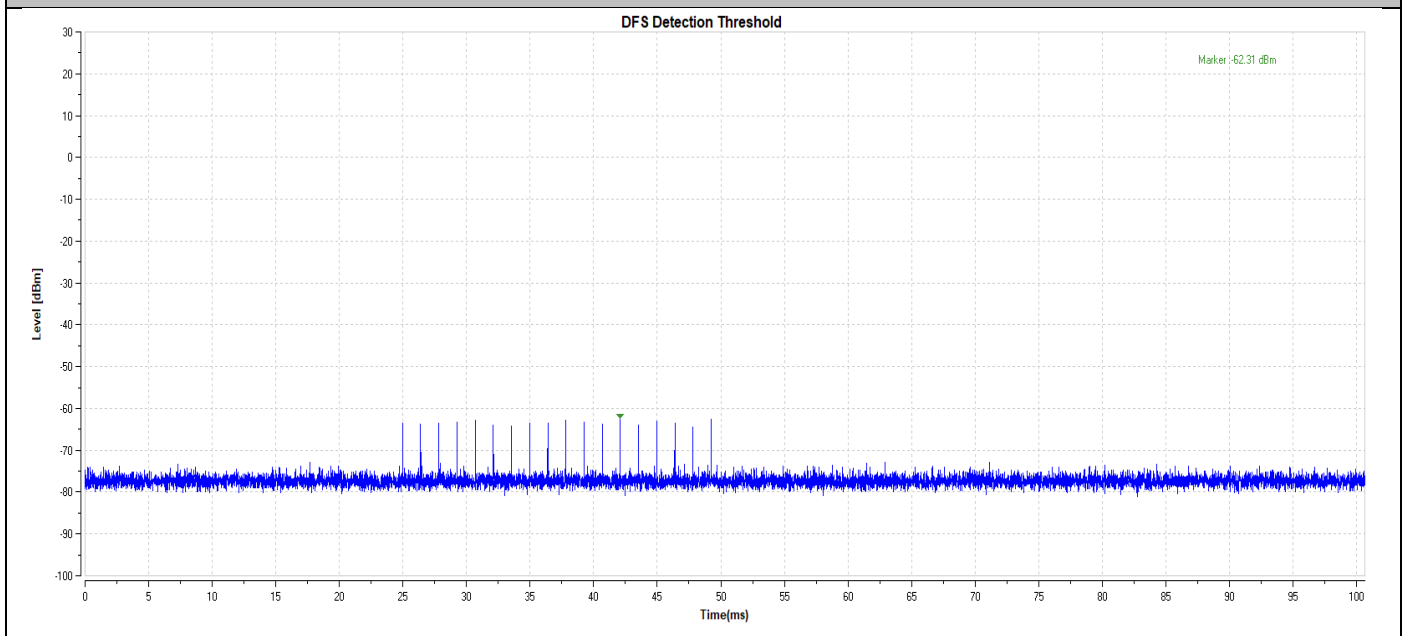

11AC80SISO-5530-Type0-PASS

4 CHANNEL MOVE TIME ,CHANNEL CLOSING TRANSMISSION TIME AND NON-OCCUPANCY PERIOD

4.1 Test Procedure

These tests define how the following DFS parameters are verified during In-Service Monitoring; Channel Closing Transmission Time and Channel Move Time.

The steps below define the procedure to determine the above mentioned parameters when a radar burst with a level -61dBm is generated on the operating channel of the U-NII device.

A U-NII device operating as a Client device will associate with the Master device at 5500MHz.

During the in-service monitoring detection probability and channel moving tests the system was configured with a streaming video file from the master device (sourced by the PC connected to the master device via an Ethernet interface) to the client device. The streamed file was the "FCC" test file and the client device was using Media Player Classic as required by FCC Part 15 Subpart E.

Observe the transmissions of the EUT at the end of the radar burst on the operating channel for duration greater than 10 seconds. Measure and record the transmissions from the spectrum analyzer during the observation time (Channel Move Time). Compare the channel move time and channel closing transmission time results to the limits defined in the DFS Response requirement values table.

The client and DFS-certified master device are associated, and a movie can be streamed as specified in the DFS Order for a non-occupancy period test

The test frequency has been monitored to ensure no transmission of any type has occurred for 30 minutes. Note: If the client moves with the master, the device is considered compliant if nothing appears in the client non-occupancy period test. For devices that shut down (rather than moving channels), no beacons should appear.

4.2 Test Requirement

Parameter	Value
Channel Move Time	10 Seconds
Channel Closing Transmission Time	200 milliseconds + approx. 60 milliseconds over remaining 10 seconds period
Non-Occupancy	the device is considered compliant if nothing appears in the client non-occupancy period test

4.3 Test Result of Channel Move Time , Channel Closing Transmission Time and Non-Occupancy Period

TestMode	Frequency[MHz]	CCTT[ms]	Limit[ms]	CMT[ms]	Limit[ms]	Verdict
11AC80SISO	5530	200+15.6	200+60	9969.4	10000	PASS
11AC80SISO	5290	200+13	200+60	748.8	10000	PASS

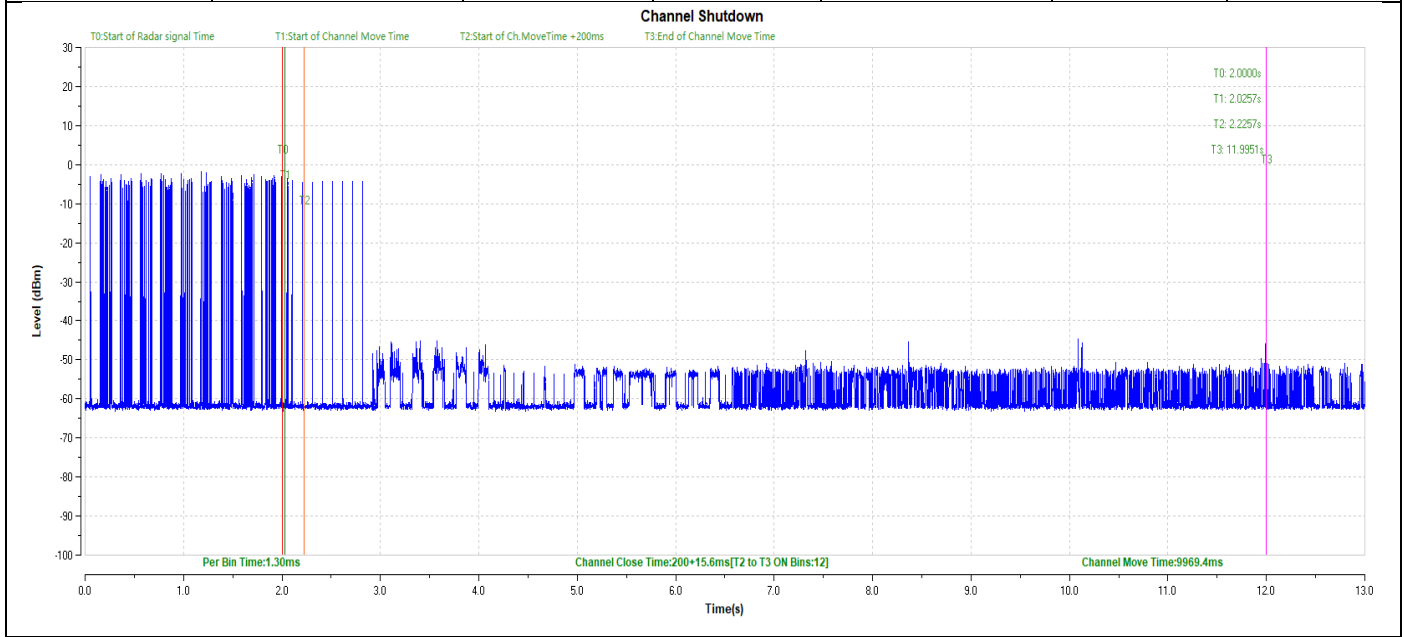

11AC80SISO-5530-Type0-PASS

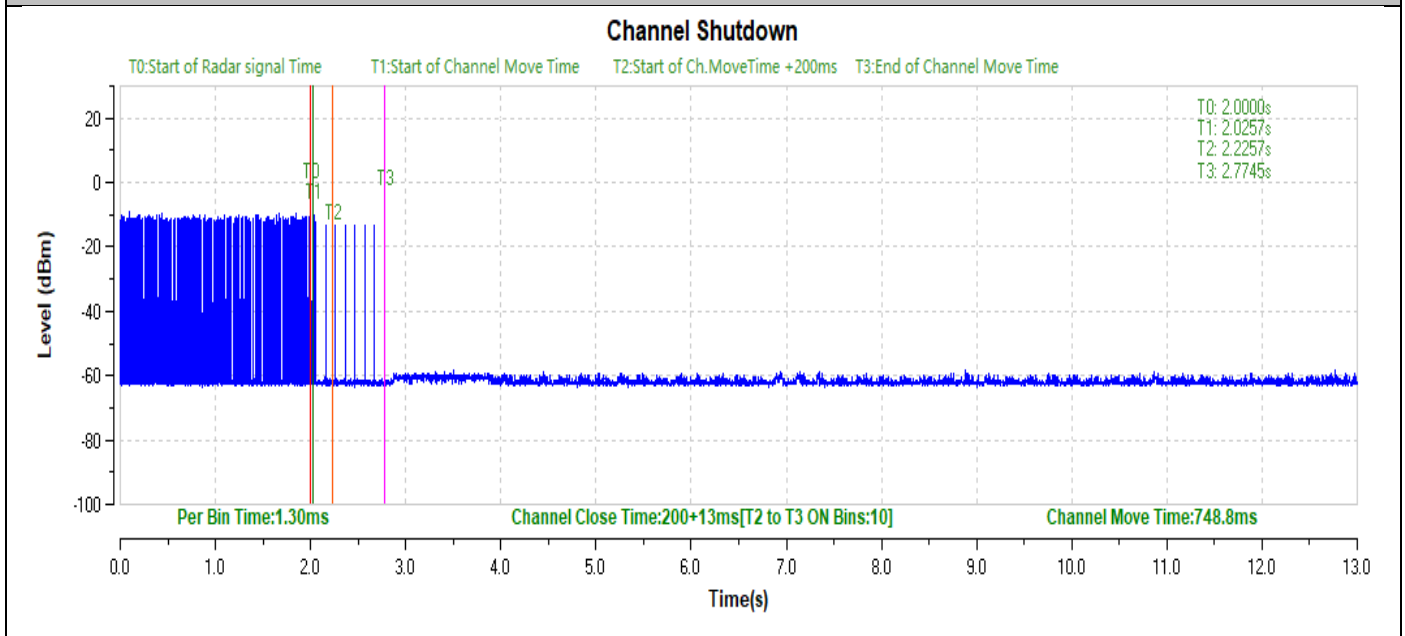

11AC80SISO-5290-Type0-PASS

Non-Occupancy Period :

TestMode	Frequency[MHz]	Result	Limit[s]	Verdict
11AC80SISO	5530	see test graph	≥1800	PASS
11AC80SISO	5290	see test graph	≥1800	PASS

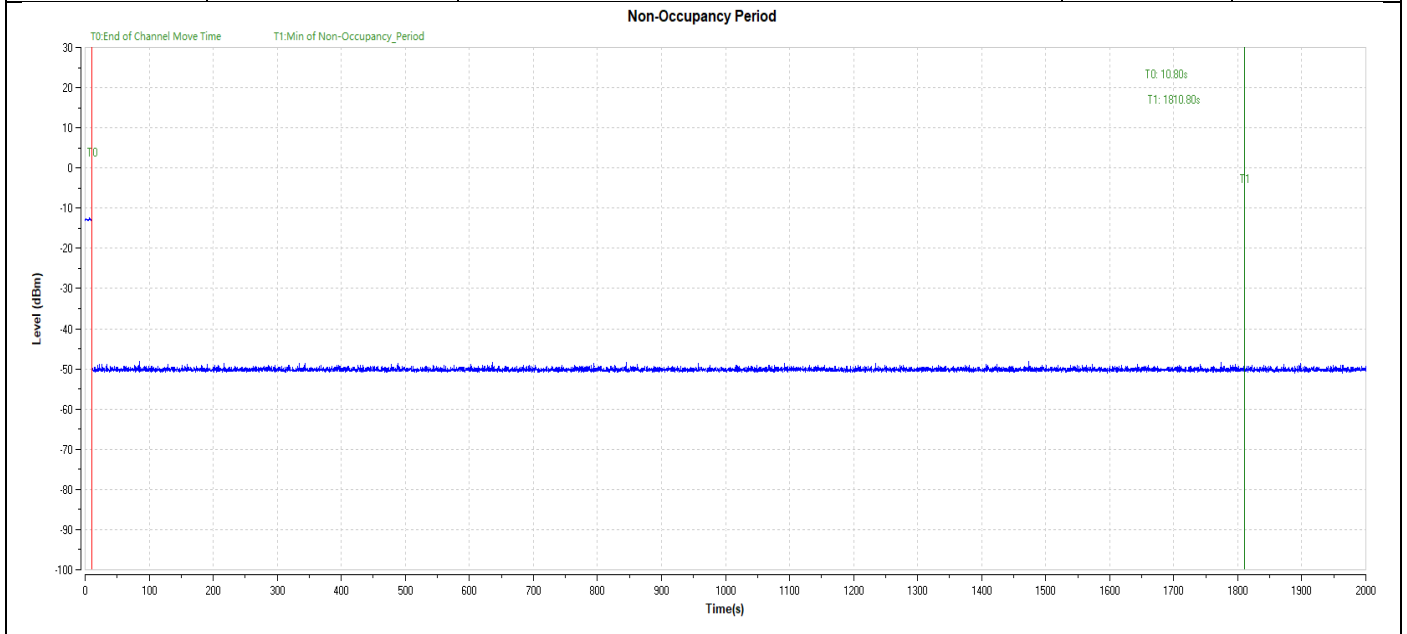

11AC80SISO-5290-Type0-PASS

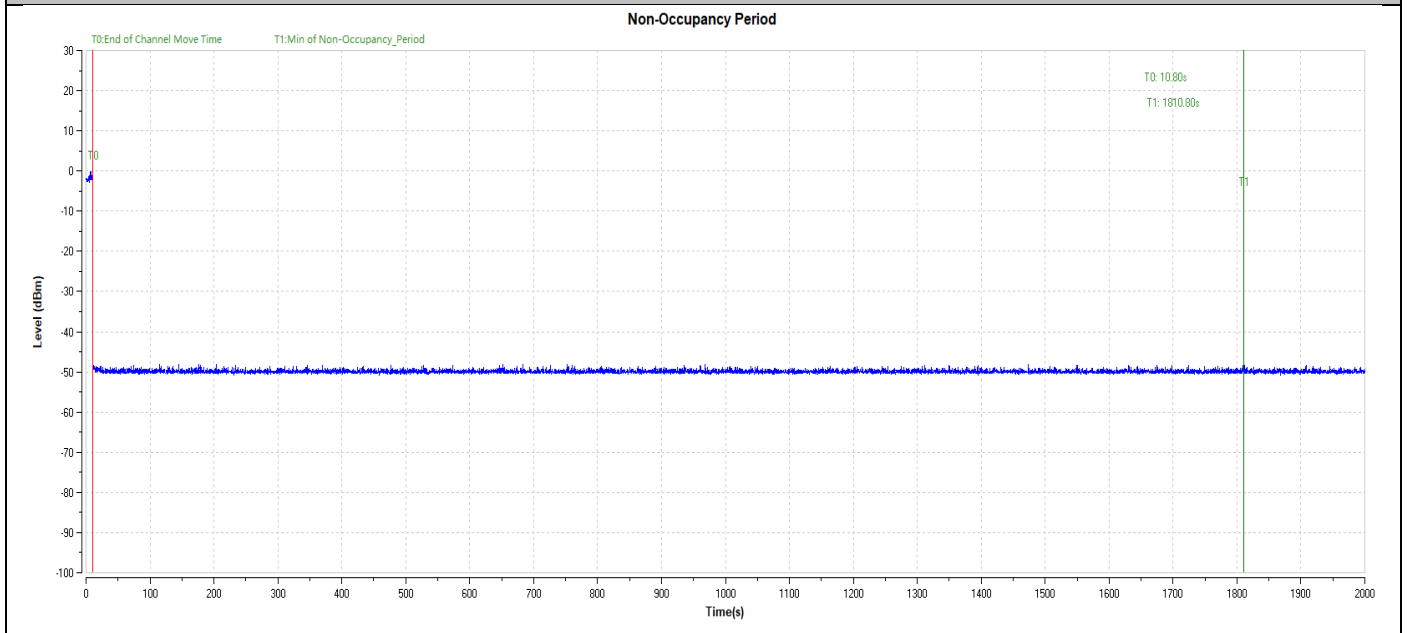

11AC80SISO-5530-Type0-PASS

The End