

VT-COME-BASIC-E2176

Computer-on-Module



Product Brief Introduction





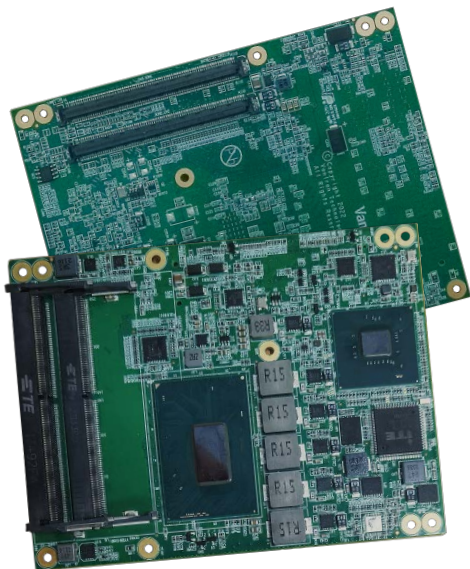

VT-COME-BASIC-E2176 Computer-on-Module features a COM Express® Compact Type 6 form factor, complying with PICMG COMe R2.1 standard. It is powered by Intel Xeon E series high-performance processor that enables the customer to create, test, and deliver solutions faster than ever with lower power consumption. The board supports up to 3 displays to maximize output performance. Meanwhile, it provides a complete set of interfaces and customer expansion options to meet different embedded application scenarios including military industry, intelligent medical health, agriculture, and transportation.

Featuring high flexibility and high performance, the board could work under extreme environments with extended temperatures ranging from 0°C to +60°C, making it a reliable industrial IoT solution.

Exterior and Features



VT-COME-BASIC-E2176

-  Intel Xeon E series high-performance processor
-  Windows 7/8.1/10 operating system or Linux operating system
-  Up to 64GB DDR4
-  Rich interfaces, flexible expansion
-  USB 2.0 & USB 3.0
-  Wide temperature range supported

VT-COME-BASIC-E2176 Computer-on-Module Datasheet

VT-COME-BASIC-E2176		
System	CPU	Intel Xeon E-2186M 6*2.9/4.8GHz Cache 12MB 45W TDP Intel Xeon E-2176M 6*2.7/4.4GHz Cache 12MB 45W TDP Intel Xeon E-2276M 6*2.8/4.7GHz Cache 12MB 45W TDP Intel Xeon E-2286M 8*2.4/5.0GHz Cache 16MB 45W TDP
	Chipset	HM370/CM246 Intel
	Memory	DDR4 SO-DIMM socket, 2400MHz, up to 64GB
	Storage	4 x SATA 3.0
	BIOS	AMI UEFI BIOS
Communication	Ethernet	1 x 10/100/1000 Mbps
Video	Display interface	1 x LVDS/eDP
		1 x VGA
		1 x DDI (Configurable as HDMI/DVI/DP)
I/Os	UART	2 x TTL
	USB	4 x USB 2.0
		4 x USB 3.0
	Bus	1 x PCIe 3.0 x 8
		1 x PCIe 3.0 x 16
		1 x LPC
1 x SMBus		
Audio	1 x HDA audio	
Fan	1 x PWM fan	
Power	Input	8V-14V DC
	Consumption	≤55W
Software	Operating system	Windows 7/8.1/10, Linux
Mechanical	Dimensions	95mm x 125mm
Environment Condition	Temperature	Operating: 0°C~+60°C (-40°C~+75°C supported)
		Storage: -20°C~+85°C
Environment Condition	Humidity	Operating: RH 10%-90% (Non-condensing)
		Storage: RH 5%-95% (Non-condensing)

Block Diagram

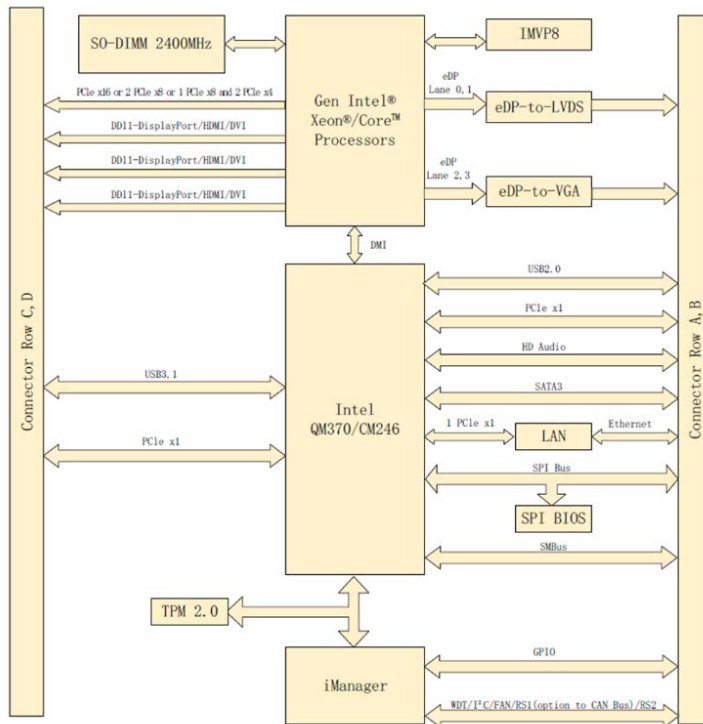

Company Profile

Since 2002 established by two Silicon Valley entrepreneurs, Vantron Technology has been a pioneer in connected IoT devices and IoT platform solutions. Today, Vantron serves countless customers all over the world, some of them are Fortune 500 companies. Products lines cover edge intelligent hardware, IoT communication devices, industrial displays and BlueSphere cloud device management platform.

Vantron has 20 years of experience in R&D of embedded edge intelligent hardware like SOM board and motherboard, and provided users with various embedded solutions with ARM and X86 architecture. From Linux to Windows, from embedded to desktop level, from gateway to server. At the same time, we provide our users with system clipping, driver transplantation and other services.

Vantron IoT communication devices support multi-protocol connection of industrial equipment, edge computing of local data. Abundant wired and wireless connectivity make remote operations and maintenance possible. From electricity and transportation to smart retail, medical and warehousing, Vantron IoT communication device can be deployed anywhere in any business section. Vantron believes its IoT solution to help many companies finish their digital transformation, efficiency of manufacturing and productivities have been improved significantly.

Vantron industrial display systems, ARM and X86 series, are equipped with Rockchip, NXP, MediaTek, Intel and other high-performance processors. It supports various operating systems such as Windows, Linux, and Android. Diverse wireless communications keep your device online all the time. Multiple installation methods make it suitable for a variety of application scenarios. Features like waterproof, dustproof, shatter resistant guarantee the best performance in any environment.

Vantron BlueSphere device management platform, a software product, is playing a big role in Vantron overall IoT solution. Today, Vantron puts more focus on offering complete cost effective, leading-edge yet reliable solutions to help customers carry out their visions.