

ENGINEERING TEST REPORT

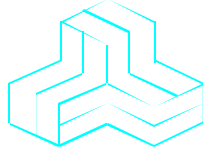

TBD

Model No.: EL705

FCC ID: E5M-EL-705

Applicant: **MICROWAVE DATA SYSTEMS INC.**
175 Science Parkway
Rochester, New York
USA, 14620-4261

Tested in Accordance With

Federal Communications Commission (FCC)
CFR 47, PARTS 2 and 90 (Subpart I)

UltraTech's File No.: MIC28-F90

<p>This Test report is Issued under the Authority of Tri M. Luu, Professional Engineer, Vice President of Engineering UltraTech Group of Labs</p> <p>Date: July 21, 2000</p>		
<p>Report Prepared by: Hannah Truong</p> <p>Issued Date: June 26, 2000</p>	<p>Tested by: Mr. Hung Trinh, EMI/RFI Technician</p> <p>Test Dates: June 15 & 16, 2000</p>	

The results in this Test Report apply only to the sample(s) tested, and the sample tested is randomly selected.

UltraTech

3000 Bristol Circle, Oakville, Ontario, Canada, L6H 6G4
Telephone (905) 829-1570 Facsimile (905) 829-8050

Website: www.ultratech-labs.com Email: vhk.ultratech@sympatico.ca

TABLE OF CONTENTS

EXHIBIT 1.	SUBMITTAL CHECK LIST.....	3
EXHIBIT 2.	INTRODUCTION	4
2.1.	SCOPE.....	4
2.2.	RELATED SUBMITAL(S)/GRANT(S).....	4
2.3.	NORMATIVE REFERENCES	4
EXHIBIT 3.	PERFORMANCE ASSESSMENT	5
3.1.	CLIENT INFORMATION.....	5
3.2.	EQUIPMENT UNDER TEST (EUT) INFORMATION	5
3.3.	SUMMARY OF RF PARAMETERS.....	6
3.4.	EUT'S TECHNICAL SPECIFICATIONS	6
3.5.	LIST OF EUT'S PORTS.....	7
3.6.	ANCILLARY EQUIPMENT	7
EXHIBIT 4.	EUT OPERATING CONDITIONS AND CONFIGURATIONS DURING TESTS	8
4.1.	CLIMATE TEST CONDITIONS.....	8
4.2.	OPERATIONAL TEST CONDITIONS & ARRANGEMENT FOR TEST SIGNALS	8
EXHIBIT 5.	SUMMARY OF TEST RESULTS.....	9
5.1.	LOCATION OF TESTS	9
5.2.	APPLICABILITY & SUMMARY OF EMC EMISSION TEST RESULTS.....	9
5.3.	MODIFICATIONS INCORPORATED IN THE EUT FOR COMPLIANCE PURPOSES.....	9
EXHIBIT 6.	MEASUREMENTS, EXAMINATIONS & TEST DATA FOR EMC EMISSIONS	10
6.1.	TEST PROCEDURES.....	10
6.2.	MEASUREMENT UNCERTAINTIES.....	10
6.3.	MEASUREMENT EQUIPMENT USED:.....	10
6.4.	ESSENTIAL/PRIMARY FUNCTIONS AS DECLARED BY THE MANUFACTURER:.....	10
6.5.	RF POWER OUTPUT @ FCC 2.985 & 90.205.....	11
6.5.1.	<i>Limits @ FCC 90.205.....</i>	<i>11</i>
6.5.2.	<i>Method of Measurements.....</i>	<i>11</i>
6.5.3.	<i>Test Equipment List.....</i>	<i>11</i>
6.5.4.	<i>Test Arrangement.....</i>	<i>11</i>
6.5.5.	<i>Test Data.....</i>	<i>11</i>
6.6.	FREQUENCY STABILITY @ FCC 2.995 & 90.213	12
6.6.1.	<i>Limits @ FCC 90.213.....</i>	<i>12</i>
6.6.2.	<i>Method of Measurements.....</i>	<i>12</i>
6.6.3.	<i>Test Equipment List</i>	<i>13</i>
6.6.4.	<i>Test Arrangement.....</i>	<i>13</i>
6.6.5.	<i>Test Data.....</i>	<i>13</i>
6.7.	EMISSION MASK @ FCC 2.989, 90.208 & 90.210.....	17
6.7.1.	<i>Limits @ FCC 90.209 & 90.210</i>	<i>17</i>
6.7.2.	<i>Method of Measurements.....</i>	<i>17</i>
6.7.3.	<i>Test Equipment List</i>	<i>17</i>
6.7.4.	<i>Test Arrangement.....</i>	<i>17</i>

ULTRATECH GROUP OF LABS

3000 Bristol Circle, Oakville, Ontario, Canada L6H 6G4
Tel. #: 905-829-1570, Fax. #: 905-829-8050, Email: yhk.ultratech@sympatico.ca, Website: <http://www.ultratech-labs.com>

File #: MIC28-F90
June 26, 2000

- Assessed by ITI (UK) Competent Body, NVLAP (USA) Accreditation Body & ACA/AUSTEL (Australia)
- Recognized/Listed by FCC (USA), Industry Canada (Canada)
- All test results contained in this engineering test report are traceable to National Institute of Standards and Technology (NIST)

6.7.5.	Test Data.....	17
6.7.6.	Plots.....	17
6.8.	TRANSMITTER ANTENNA POWER SPURIOUS/HARMONIC CONDUCTED EMISSIONS @ FCC 90.210.....	18
6.8.1.	Limits @ 90.210	18
6.8.2.	Method of Measurements.....	18
6.8.3.	Test Equipment List	18
6.8.4.	Test Arrangement.....	18
6.8.5.	Test Data.....	19
6.8.6.	Plots.....	19
6.9.	TRANSMITTER SPURIOUS/HARMONIC RADIATED EMISSIONS @ FCC 90.210.....	20
6.9.1.	Limits @ FCC 90.210.....	20
6.9.2.	Method of Measurements.....	20
6.9.3.	Test Equipment List	20
6.9.4.	Test Arrangement.....	21
6.9.5.	Test Data.....	22
6.9.6.	Photographs of Test Setup	27
6.10.	TRANSIENT FREQUENCY BEHAVIOR @ 90.214.....	28
6.10.1.	Limits.....	28
6.10.2.	Method of Measurements.....	28
6.10.3.	Test Equipment List	29
6.10.4.	Test Arrangement.....	29
6.10.5.	Test Data.....	30
6.10.6.	Plots.....	30
EXHIBIT 7.	MEASUREMENT UNCERTAINTY.....	31
7.1.	RADIATED EMISSION MEASUREMENT UNCERTAINTY.....	31
EXHIBIT 8.	MEASUREMENT METHODS.....	32
8.1.	EFFECTIVE RADIATED POWER (ERP) MEASUREMENTS.....	32
8.2.	FREQUENCY STABILITY.....	34
8.3.	EMISSION MASK.....	35
8.4.	SPURIOUS EMISSIONS (CONDUCTED).....	35
8.5.	SPURIOUS EMISSIONS (RADIATED).....	36
8.6.	TRANSIENT FREQUENCY BEHAVIOR.....	38

ULTRATECH GROUP OF LABS

3000 Bristol Circle, Oakville, Ontario, Canada L6H 6G4
Tel. #: 905-829-1570, Fax. #: 905-829-8050, Email: vhk.ultratech@sympatico.ca, Website: <http://www.ultratech-labs.com>

File #: MIC28-F90
June 26, 2000

- Assessed by ITI (UK) Competent Body, NVLAP (USA) Accreditation Body & ACA/AUSTEL (Australia)
- Recognized/Listed by FCC (USA), Industry Canada (Canada)
- All test results contained in this engineering test report are traceable to National Institute of Standards and Technology (NIST)

EXHIBIT 1. SUBMITTAL CHECK LIST

Exhibit No.	Exhibit Type	Description of Contents	Quality Check (OK)
1 through 8	Test Report	Exhibit 1: Submittal check lists Exhibit 2: Introduction Exhibit 3: Performance Assessment Exhibit 4: EUT Operation and Configuration during Tests Exhibit 5: Summary of test Results Exhibit 6: Measurement Data Exhibit 7: Measurement Uncertainty Exhibit 8: Measurement Methods	OK OK OK OK OK OK OK
9	Test Report - Plots of Measurement Data	Plots # 1 to 11	OK
10	Test Setup Photos	Photos # 1 to 3	OK
11	Photos of EUT	Photos # 1 to 6	OK
12	Cover Letters	Letter from Ultratech for Certification Request Letter from the Applicant to appoint Ultratech to act as an agent Letter from the Applicant to request for Confidentiality Filing	OK OK OK
13	Attestation Statements	Manufacturer's Declaration for Equipment Specifications, Installation (if it is professionally installed) and Production Quality Production Assurance. Manufacturer's Declaration of Conformity (FCC DoC) for compliance with FCC Part 15, Sub. B, Class B - Computing Devices - if required	None None
14	Application Forms	Form 731 Form 159 Confirmation of Exhibits sent to FCC Status of Exhibits sent to FCC	Electronic Filing Electronic Filing Electronic Filing Electronic Filing
15	ID Label/Location Info	ID Label Location of ID Label	OK OK
16	Block Diagrams	Block diagrams # 1	OK
17	Schematic Diagrams	Schematic diagrams # 1 to 3	OK
18	Parts List/Tune Up Info		None
19	Operational Description		OK
20	RF Exposure Info	Refer to page (iii) for details.	OK
21	Users Manual		OK

ULTRATECH GROUP OF LABS

3000 Bristol Circle, Oakville, Ontario, Canada L6H 6G4
Tel. #: 905-829-1570, Fax. #: 905-829-8050, Email: yhk.ultratech@sympatico.ca, Website: <http://www.ultratech-labs.com>

File #: MIC28-F90
June 26, 2000

- Assessed by ITI (UK) Competent Body, NVLAP (USA) Accreditation Body & ACA/AUSTEL (Australia)
- Recognized/Listed by FCC (USA), Industry Canada (Canada)
- All test results contained in this engineering test report are traceable to National Institute of Standards and Technology (NIST)

EXHIBIT 2. INTRODUCTION

2.1. SCOPE

Reference:	FCC Parts 2 and 90
Title	Telecommunication - Code of Federal Regulations, CFR 47, Parts 2 & 90
Purpose of Test:	To gain FCC Certification Authorization for Radio operating in the frequency band 450-470 MHz (12.5 kHz Channel Spacing).
Test Procedures	Both conducted and radiated emissions measurements were conducted in accordance with American National Standards Institute ANSI C63.4 - American National Standard for Methods of Measurement of Radio-Noise Emissions from Low-Voltage Electrical and Electronic Equipment in the Range of 9 kHz to 40 GHz.

2.2. RELATED SUBMITAL(S)/GRANT(S)

None

2.3. NORMATIVE REFERENCES

Note: When the international publication has been modified by common modifications, indicated by (mod), the relevant EN/HD applies.

Publication	YEAR	Title
FCC CFR Parts 0-19, 80-End	1998	Code of Federal Regulations – Telecommunication
ANSI C63.4	1992	American National Standard for Methods of Measurement of Radio-Noise Emissions from Low-Voltage Electrical and Electronic Equipment in the Range of 9 kHz to 40 GHz
CISPR 22 & EN 55022	1997 1998	Limits and Methods of Measurements of Radio Disturbance Characteristics of Information Technology Equipment
CISPR 16-1		Specification for Radio Disturbance and Immunity measuring apparatus and methods

ULTRATECH GROUP OF LABS

3000 Bristol Circle, Oakville, Ontario, Canada L6H 6G4
Tel. #: 905-829-1570, Fax. #: 905-829-8050, Email: yhk.ultratech@sympatico.ca, Website: <http://www.ultratech-labs.com>

File #: MIC28-F90
June 26, 2000

- Assessed by ITI (UK) Competent Body, NVLAP (USA) Accreditation Body & ACA/AUSTEL (Australia)
- Recognized/Listed by FCC (USA), Industry Canada (Canada)
- All test results contained in this engineering test report are traceable to National Institute of Standards and Technology (NIST)

EXHIBIT 3. PERFORMANCE ASSESSMENT

3.1. CLIENT INFORMATION

APPLICANT:	
Name:	MICROWAVE DATA SYSTEMS INC.
Address:	175 Science Parkway Rochester, New York USA, 14620-4261
Contact Person:	Mr. Michael Rudy Phone #: 1-716-242-8431 Fax #: 1-716-241-5590

MANUFACTURER:	
Name:	MICROWAVE DATA SYSTEMS INC.
Address:	175 Science Parkway Rochester, New York USA, 14620-4261
Contact Person:	Mr. Michael Rudy Phone #: 1-716-242-8431 Fax #: 1-716-241-5590

3.2. EQUIPMENT UNDER TEST (EUT) INFORMATION

The following information (with the exception of the Date of Receipt) has been supplied by the applicant.

Brand Name	MICROWAVE DATA SYSTEMS INC.
Product Name	TBD
Model Name or Number	EL705
Serial Number	896347
Type of Equipment	Radio Communication Equipment
External Power Supply	13.8 VDC
Transmitting/Receiving Antenna Type	Non-integral
Primary User Functions of EUT	Data Transceiver
CPU Clocks	16 MHz

ULTRATECH GROUP OF LABS

3000 Bristol Circle, Oakville, Ontario, Canada L6H 6G4
 Tel. #: 905-829-1570, Fax. #: 905-829-8050, Email: yhk.ultratech@sympatico.ca, Website: <http://www.ultratech-labs.com>

File #: MIC28-F90
 June 26, 2000

- Assessed by ITI (UK) Competent Body, NVLAP (USA) Accreditation Body & ACA/AUSTEL (Australia)
- Recognized/Listed by FCC (USA), Industry Canada (Canada)
- All test results contained in this engineering test report are traceable to National Institute of Standards and Technology (NIST)

3.3. SUMMARY OF RF PARAMETERS

TRANSMITTER	
Type	Synthesized, 12.5 kHz steps
Frequency Range	450-470 MHz
Power Output	+33dBm, nominal
Master Clock Reference	16MHz TCXO, +/-1.5ppm stability

RECEIVER	
Type	Double conversion superheterodyne
Frequency Range	450-470 MHz
Osc. Frequency	45 MHz (1 st IF), 405-425 MHz (1 st LO Range) 450 KHz (2 nd IF), RX Freq. - 44.55 MHz (2 nd LO)

3.4. EUT'S TECHNICAL SPECIFICATIONS

TRANSMITTER	
Equipment Type:	Mobile Base station (fixed use)
Intended Operating Environment:	Commercial, light industry & heavy industry
RF Output Power Rating:	2.2 Watts
Power Supply Requirement:	13.8 VDC
Operating Frequency Range:	450-470 MHz
RF Output Impedance:	50 Ohms
Channel Spacing:	12.5 KHz
Occupied Bandwidth (99%):	9.21 KHz
Antenna Connector Type:	N
Emission Designation:	14K6F1D

* For an average case of commercial telephony, the Necessary Bandwidth is calculated as follows:

1. For FM Digital Modulation:

Channel Spacing = 12.5 KHz, D = 2.5 KHz max, K = 1, M = Data Rate in kb/s / Level of FM,
 Level of FM = 2

(a) M = 9.6/2 kb/s

$B_n = 2M + 2DK = 2(9.6/2) + 2(2.5)(1) = \mathbf{14.6 \text{ KHz}}$

emission designation: 14K6F1D

ULTRATECH GROUP OF LABS

3000 Bristol Circle, Oakville, Ontario, Canada L6H 6G4
 Tel. #: 905-829-1570, Fax. #: 905-829-8050, Email: yhk.ultratech@sympatico.ca, Website: <http://www.ultratech-labs.com>

File #: MIC28-F90
 June 26, 2000

- Assessed by ITI (UK) Competent Body, NVLAP (USA) Accreditation Body & ACA/AUSTEL (Australia)
- Recognized/Listed by FCC (USA), Industry Canada (Canada)
- All test results contained in this engineering test report are traceable to National Institute of Standards and Technology (NIST)

3.5. LIST OF EUT'S PORTS

Port Number	EUT's Port Description	Number of Identical Ports	Connector Type	Cable Type (Shielded/Non-shielded)
1	Antenna Port	1	BNC	Coaxial
2	Diagnostic Port (note 2)	1	DB25	Shielded
3	Power Port	1	Plug In	No

NOTES:

- (1) ***Ports of the EUT which in normal operation were connected to ancillary equipment through interconnecting cables via a representative interconnecting cable to simulate the input/output characteristics. RF input/output was correctly terminated to the 50 Ohm RF Load.***
- (2) ***Ports which are not connected to cables during normal intended operation (for factory/technical services uses only)***

3.6. ANCILLARY EQUIPMENT

No ancillary equipment was necessary to exercise the ports during tests.

ULTRATECH GROUP OF LABS

3000 Bristol Circle, Oakville, Ontario, Canada L6H 6G4
Tel. #: 905-829-1570, Fax. #: 905-829-8050, Email: yhk.ultratech@sympatico.ca, Website: <http://www.ultratech-labs.com>

File #: MIC28-F90
June 26, 2000

- Assessed by ITI (UK) Competent Body, NVLAP (USA) Accreditation Body & ACA/AUSTEL (Australia)
- Recognized/Listed by FCC (USA), Industry Canada (Canada)
- All test results contained in this engineering test report are traceable to National Institute of Standards and Technology (NIST)

EXHIBIT 4. EUT OPERATING CONDITIONS AND CONFIGURATIONS DURING TESTS

4.1. CLIMATE TEST CONDITIONS

The climate conditions of the test environment are as follows:

Temperature:	21°C
Humidity:	51%
Pressure:	102 kPa
Power input source:	13.8 VDC

4.2. OPERATIONAL TEST CONDITIONS & ARRANGEMENT FOR TEST SIGNALS

Operating Modes:	The transmitter was operated in a continuous transmission mode with the carrier modulated as specified in the Test Data.
Special Test Software:	None
Special Hardware Used:	None
Transmitter Test Antenna:	The EUT is tested with the transmitter antenna port terminated to a 50 Ohm RF Load.

ULTRATECH GROUP OF LABS

3000 Bristol Circle, Oakville, Ontario, Canada L6H 6G4
Tel. #: 905-829-1570, Fax. #: 905-829-8050, Email: yhk.ultratech@sympatico.ca, Website: <http://www.ultratech-labs.com>

File #: MIC28-F90
June 26, 2000

- Assessed by ITI (UK) Competent Body, NVLAP (USA) Accreditation Body & ACA/AUSTEL (Australia)
- Recognized/Listed by FCC (USA), Industry Canada (Canada)
- All test results contained in this engineering test report are traceable to National Institute of Standards and Technology (NIST)

EXHIBIT 5. SUMMARY OF TEST RESULTS

5.1. LOCATION OF TESTS

All of the measurements described in this report were performed at Ultratech Group of Labs located in the city of Oakville, Province of Ontario, Canada.

- AC Powerline Conducted Emissions were performed in UltraTech's shielded room, 16'(L) by 12'(W) by 12'(H).
- Radiated Emissions were performed at the Ultratech's 3 Meter Open Field Test Site (OFTS) situated in the Town of Oakville, province of Ontario.

The above sites have been calibrated in accordance with ANSI C63.4, and found to be in compliance with the requirements of Sec. 2.948 of the FCC Rules. The descriptions and site measurement data of the Oakville Open Field Test Site has been filed with FCC office (FCC File No.: 31040/SIT 1300B3) and Industry Canada office (Industry Canada File No.: IC2049). Last Date of Site Calibration: Sep. 20, 1999.

5.2. APPLICABILITY & SUMMARY OF EMC EMISSION TEST RESULTS

FCC PARAGRAPH.	TEST REQUIREMENTS	APPLICABILITY (YES/NO)
90.205 & 2.985	RF Power Output	Yes
90.213 & 2.995	Frequency Stability	Yes
90.242(b)(8) & 2.987(a)	Audio Frequency Response	N/A
90.210 & 2.987(b)	Modulation Limiting	N/A
90.209 90.210 & 2.989	Emission Limitation & Emission Mask	Yes
90.210, 2.997 & 2.991	Emission Limits - Spurious Emissions at Antenna Terminal	Yes
90.210, 2.997 & 2.993	Emission Limits - Field Strength of Spurious Emissions	Yes
90.214	Transient Frequency Behavior	Yes

TBD, Model No.: EL705, by MICROWAVE DATA SYSTEMS INC. has also been tested and found to comply with **FCC Part 15, Subpart B - Radio Receivers and Class A Digital Devices**. The engineering test report has been documented and kept in file and it is available anytime upon FCC request.

5.3. MODIFICATIONS INCORPORATED IN THE EUT FOR COMPLIANCE PURPOSES

None

ULTRATECH GROUP OF LABS

3000 Bristol Circle, Oakville, Ontario, Canada L6H 6G4
 Tel. #: 905-829-1570, Fax. #: 905-829-8050, Email: yhk.ultratech@sympatico.ca, Website: <http://www.ultratech-labs.com>

File #: MIC28-F90
 June 26, 2000

- Assessed by ITI (UK) Competent Body, NVLAP (USA) Accreditation Body & ACA/AUSTEL (Australia)
- Recognized/Listed by FCC (USA), Industry Canada (Canada)
- All test results contained in this engineering test report are traceable to National Institute of Standards and Technology (NIST)

EXHIBIT 6. MEASUREMENTS, EXAMINATIONS & TEST DATA FOR EMC EMISSIONS

6.1. TEST PROCEDURES

This section contains test results only. Details of test methods and procedures can be found in Exhibit 8 of this report

6.2. MEASUREMENT UNCERTAINTIES

The measurement uncertainties stated were calculated in accordance with requirements of UKAS Document NIS 81 with a confidence level of 95%. Please refer to Exhibit 7 for Measurement Uncertainties.

6.3. MEASUREMENT EQUIPMENT USED:

The measurement equipment used complied with the requirements of the Standards referenced in the Methods & Procedures ANSI C63.4:1992 and CISPR 16-1.

6.4. ESSENTIAL/PRIMARY FUNCTIONS AS DECLARED BY THE MANUFACTURER:

The essential function of the EUT is to correctly communicate data to and from radios over RF link.

ULTRATECH GROUP OF LABS

3000 Bristol Circle, Oakville, Ontario, Canada L6H 6G4
Tel. #: 905-829-1570, Fax. #: 905-829-8050, Email: yhk.ultratech@sympatico.ca, Website: <http://www.ultratech-labs.com>

File #: MIC28-F90
June 26, 2000

- Assessed by ITI (UK) Competent Body, NVLAP (USA) Accreditation Body & ACA/AUSTEL (Australia)
- Recognized/Listed by FCC (USA), Industry Canada (Canada)
- *All test results contained in this engineering test report are traceable to National Institute of Standards and Technology (NIST)*

6.5. RF POWER OUTPUT @ FCC 2.985 & 90.205

6.5.1. Limits @ FCC 90.205

Please refer to FCC CFR 47, Part 90, Subpart I, Para. 90.205 for specification details.

6.5.2. Method of Measurements

Please refer to Exhibit 7, Sec. 7.1 for test procedures and test setup.

- *The transmitter terminal was coupled to the Spectrum Analyzer through a 20 dB attenuator*
- *Power of the transmitter channel near the lowest, middle and highest of each frequency block/band were measured using the power meter, and the reading was corrected by added the calibrated attenuator's attenuation value and cable loss.*
- *The RF Output was turned on with standard modulation applied.*

6.5.3. Test Equipment List

Test Instruments	Manufacturer	Model No.	Serial No.	Frequency Range
Spectrum Analyzer/ EMI Receiver	Hewlett Packard	HP 8593EM	3412A00103	9 kHz – 26.5 GHz
Attenuator(s)	Bird	DC – 22 GHz

6.5.4. Test Arrangement

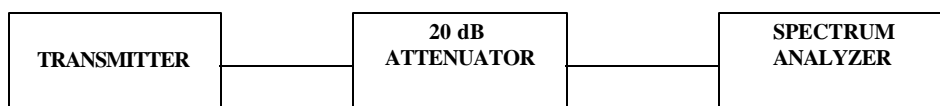

6.5.5. Test Data

TRANSMITTER CHANNEL OUTPUT	FUNDAMENTAL FREQUENCY (MHz)	MEASURED AVERAGE POWER (P) (dBm)	AVERAGE POWER RATING (dBm)
Lowest	450	33.4	33.0
Middle	460	33.2	33.0
Highest	470	33.2	33.0

ULTRATECH GROUP OF LABS

3000 Bristol Circle, Oakville, Ontario, Canada L6H 6G4
 Tel. #: 905-829-1570, Fax. #: 905-829-8050, Email: yhk.ultratech@sympatico.ca, Website: <http://www.ultratech-labs.com>

File #: MIC28-F90
 June 26, 2000

- Assessed by ITI (UK) Competent Body, NVLAP (USA) Accreditation Body & ACA/AUSTEL (Australia)
- Recognized/Listed by FCC (USA), Industry Canada (Canada)
- *All test results contained in this engineering test report are traceable to National Institute of Standards and Technology (NIST)*

6.6. FREQUENCY STABILITY @ FCC 2.995 & 90.213

6.6.1. Limits @ FCC 90.213

Please refer to FCC CFR 47, Part 90, Subpart I, Para. 90.213 for specification details.

FREQUENCY RANGE (MHz)	FIXED & BASE STATIONS			MOBILE STATIONS					
	(ppm)			(ppm)					
				> 2 W			≤ 2 W		
	6.25 kHz	12.5 kHz	25 kHz	6.25 kHz	12.5 kHz	25 kHz	6.25 kHz	12.5 kHz	25 kHz
403-512 MHz	0.5	1.5	2.5	1.0	2.5	5.0	1.0	2.5	5.0

6.6.2. Method of Measurements

Refer to FCC @ 2.995

- (a) The frequency stability shall be measured with variation of ambient temperature as follows: From -30 to +50 centigrade except that specified in subparagraph (2) & (3) of this paragraph.
- (b) Frequency measurements shall be made at extremes of the specified temperature range and at intervals of not more than 10 centigrade through the range. A period of time sufficient to stabilize all of the components of the oscillator circuit at each temperature level shall be allowed prior to frequency measurement. The short term transient effects on the frequency of the transmitter due to keying (except for broadcast transmitters) and any heating element cycling normally occurring at each ambient temperature level also shall be shown. Only the portion or portions of the transmitter containing the frequency determining and stability circuitry need be subjected to the temperature variation test.
- (d) The frequency stability supply shall be measured with variation of primary supply voltage as follows:
 - (1) Vary primary supply voltage from 85 to 115 percent of the nominal value for other than hand carried battery equipment.
 - (2) For hand carried, battery powered equipment, reduce primary supply voltage to the battery operating end point which shall be specified by the manufacturer.
 - (3) The supply voltage shall be measured at the input to the cable normally provide with the equipment, or at the power supply terminals if cables are not normally provided. Effects on frequency of transmitter keying (except for broadcast transmitters) and any heating element cycling at the nominal supply voltage and at each extreme also shall be shown.
- (e) When deemed necessary, the Commission may require tests of frequency stability under conditions in addition to those specifically set out in paragraphs (a), (b), (c) and (d) of this section. (For example, measurements showing the effect of proximity to large metal objects, or of various types of antennas, may be required for portable equipment).

ULTRATECH GROUP OF LABS

3000 Bristol Circle, Oakville, Ontario, Canada L6H 6G4
 Tel. #: 905-829-1570, Fax. #: 905-829-8050, Email: vhk.ultratech@sympatico.ca, Website: <http://www.ultratech-labs.com>

File #: MIC28-F90
 June 26, 2000

- Assessed by ITI (UK) Competent Body, NVLAP (USA) Accreditation Body & ACA/AUSTEL (Australia)
- Recognized/Listed by FCC (USA), Industry Canada (Canada)
- All test results contained in this engineering test report are traceable to National Institute of Standards and Technology (NIST)

6.6.3. Test Equipment List

Test Instruments	Manufacturer	Model No.	Serial No.	Frequency Range
Spectrum Analyzer/ EMI Receiver	Hewlett Packard	HP 8593EM	3412A00103	9 kHz – 26.5 GHz
Attenuator(s)	Bird	DC – 22 GHz
Temperature & Humidity Chamber	Tenney	T5	9723B	-40° to +60° C range

6.6.4. Test Arrangement

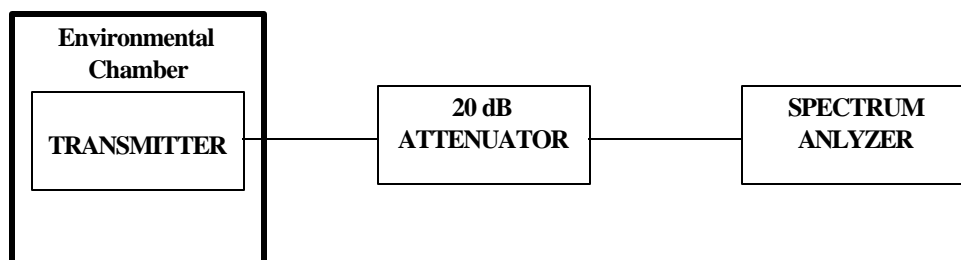

6.6.5. Test Data

Product Name	TBD
Model No.	EL705
Center Frequency	450 MHz
Full Power Level	2.2 Watts
Frequency Tolerance Limit	1125 Hz or ± 2.5 ppm
Max. Frequency Tolerance Measured	-614 Hz or -1.36 ppm @ -30 °C
Input Voltage Rating	13.8 Vdc

ULTRATECH GROUP OF LABS

3000 Bristol Circle, Oakville, Ontario, Canada L6H 6G4
 Tel. #: 905-829-1570, Fax. #: 905-829-8050, Email: yhk.ultratech@sympatico.ca, Website: <http://www.ultratech-labs.com>

File #: MIC28-F90
 June 26, 2000

- Assessed by ITI (UK) Competent Body, NVLAP (USA) Accreditation Body & ACA/AUSTEL (Australia)
- Recognized/Listed by FCC (USA), Industry Canada (Canada)
- All test results contained in this engineering test report are traceable to National Institute of Standards and Technology (NIST)

AMBIENT TEMP. (°C)	KEYED-ON TIME (Minutes)	CENTER FREQUENCY & RF POWER OUTPUT VARIATION					
		Supply Voltage (Nominal) Volts		Supply Voltage (85% of Nominal) Volts		Supply Voltage (115% of Nominal) Volts	
		Hz	dB	Hz	dB	Hz	dB
-30	1	-614	N/A	N/A	N/A	N/A	N/A
	2	-600	N/A	N/A	N/A	N/A	N/A
	3	-579	N/A	N/A	N/A	N/A	N/A
	4	-593	N/A	N/A	N/A	N/A	N/A
	5	-586	N/A	N/A	N/A	N/A	N/A
	6	-557	N/A	N/A	N/A	N/A	N/A
	7	-536	N/A	N/A	N/A	N/A	N/A
	8	-514	N/A	N/A	N/A	N/A	N/A
	9	-500	N/A	N/A	N/A	N/A	N/A
	10	-514	N/A	N/A	N/A	N/A	N/A
-20	1	-164	N/A	N/A	N/A	N/A	N/A
	2	-157	N/A	N/A	N/A	N/A	N/A
	3	-157	N/A	N/A	N/A	N/A	N/A
	4	-135	N/A	N/A	N/A	N/A	N/A
	5	-143	N/A	N/A	N/A	N/A	N/A
	6	-128	N/A	N/A	N/A	N/A	N/A
	7	-107	N/A	N/A	N/A	N/A	N/A
	8	-100	N/A	N/A	N/A	N/A	N/A
	9	+115	N/A	N/A	N/A	N/A	N/A
	10	+129	N/A	N/A	N/A	N/A	N/A
-10	1	+65	N/A	N/A	N/A	N/A	N/A
	2	+86	N/A	N/A	N/A	N/A	N/A
	3	+72	N/A	N/A	N/A	N/A	N/A
	4	+65	N/A	N/A	N/A	N/A	N/A
	5	+57	N/A	N/A	N/A	N/A	N/A
	6	+50	N/A	N/A	N/A	N/A	N/A
	7	+50	N/A	N/A	N/A	N/A	N/A
	8	+36	N/A	N/A	N/A	N/A	N/A
	9	+43	N/A	N/A	N/A	N/A	N/A
	10	+50	N/A	N/A	N/A	N/A	N/A
0	1	-57	N/A	N/A	N/A	N/A	N/A
	2	-64	N/A	N/A	N/A	N/A	N/A
	3	-64	N/A	N/A	N/A	N/A	N/A
	4	-50	N/A	N/A	N/A	N/A	N/A
	5	-64	N/A	N/A	N/A	N/A	N/A
	6	-64	N/A	N/A	N/A	N/A	N/A
	7	-57	N/A	N/A	N/A	N/A	N/A
	8	-64	N/A	N/A	N/A	N/A	N/A
	9	-57	N/A	N/A	N/A	N/A	N/A
	10	-57	N/A	N/A	N/A	N/A	N/A

ULTRATECH GROUP OF LABS

3000 Bristol Circle, Oakville, Ontario, Canada L6H 6G4
 Tel. #: 905-829-1570, Fax. #: 905-829-8050, Email: yhk.ultratech@sympatico.ca, Website: <http://www.ultratech-labs.com>

File #: MIC28-F90
 June 26, 2000

- Assessed by ITI (UK) Competent Body, NVLAP (USA) Accreditation Body & ACA/AUSTEL (Australia)
- Recognized/Listed by FCC (USA), Industry Canada (Canada)
- All test results contained in this engineering test report are traceable to National Institute of Standards and Technology (NIST)

		CENTER FREQUENCY & RF POWER OUTPUT VARIATION					
AMBIENT TEMP. (°C)	KEYED-ON TIME (Minutes)	Supply Voltage (Nominal) 13.8 Volts DC		Supply Voltage (85% of Nominal) 11.73 Volts DC		Supply Voltage (115% of Nominal) 15.87 Volts DC	
		Hz	dB	Hz	dB	Hz	dB
		+10	1	-14	N/A	N/A	N/A
	2	-14	N/A	N/A	N/A	N/A	N/A
	3	-14	N/A	N/A	N/A	N/A	N/A
	4	-21	N/A	N/A	N/A	N/A	N/A
	5	-28	N/A	N/A	N/A	N/A	N/A
	6	-21	N/A	N/A	N/A	N/A	N/A
	7	-21	N/A	N/A	N/A	N/A	N/A
	8	-21	N/A	N/A	N/A	N/A	N/A
	9	-28	N/A	N/A	N/A	N/A	N/A
	10	-20	N/A	N/A	N/A	N/A	N/A
+20	1	+15	N/A	+7	N/A	-21	N/A
	2	+7	N/A	+22	N/A	-28	N/A
	3	+15	N/A	+15	N/A	-21	N/A
	4	+15	N/A	-7	N/A	-21	N/A
	5	+29	N/A	+7	N/A	-28	N/A
	6	+15	N/A	+15	N/A	-14	N/A
	7	+15	N/A	+7	N/A	-21	N/A
	8	+7	N/A	+7	N/A	-28	N/A
	9	+29	N/A	+7	N/A	-21	N/A
	10	+23	N/A	+7	N/A	-28	N/A
+30	1	+57	N/A	N/A	N/A	N/A	N/A
	2	+65	N/A	N/A	N/A	N/A	N/A
	3	+57	N/A	N/A	N/A	N/A	N/A
	4	+50	N/A	N/A	N/A	N/A	N/A
	5	+65	N/A	N/A	N/A	N/A	N/A
	6	+57	N/A	N/A	N/A	N/A	N/A
	7	+57	N/A	N/A	N/A	N/A	N/A
	8	+57	N/A	N/A	N/A	N/A	N/A
	9	+65	N/A	N/A	N/A	N/A	N/A
	10	+65	N/A	N/A	N/A	N/A	N/A
+40	1	+86	N/A	N/A	N/A	N/A	N/A
	2	+93	N/A	N/A	N/A	N/A	N/A
	3	+100	N/A	N/A	N/A	N/A	N/A
	4	+100	N/A	N/A	N/A	N/A	N/A
	5	+100	N/A	N/A	N/A	N/A	N/A
	6	+100	N/A	N/A	N/A	N/A	N/A
	7	+100	N/A	N/A	N/A	N/A	N/A
	8	+107	N/A	N/A	N/A	N/A	N/A
	9	+100	N/A	N/A	N/A	N/A	N/A
	10	+100	N/A	N/A	N/A	N/A	N/A

ULTRATECH GROUP OF LABS

3000 Bristol Circle, Oakville, Ontario, Canada L6H 6G4
 Tel. #: 905-829-1570, Fax. #: 905-829-8050, Email: yhk.ultratech@sympatico.ca, Website: <http://www.ultratech-labs.com>

File #: MIC28-F90
 June 26, 2000

- Assessed by ITI (UK) Competent Body, NVLAP (USA) Accreditation Body & ACA/AUSTEL (Australia)
- Recognized/Listed by FCC (USA), Industry Canada (Canada)
- All test results contained in this engineering test report are traceable to National Institute of Standards and Technology (NIST)

		CENTER FREQUENCY & RF POWER OUTPUT VARIATION					
AMBIENT TEMP. (°C)	KEYED-ON TIME (Minutes)	Supply Voltage (Nominal) Volts		Supply Voltage (85% of Nominal) Volts		Supply Voltage (115% of Nominal) Volts	
		Hz	dB	Hz	dB	Hz	dB
		+50	1	+79	N/A	N/A	N/A
	2	+65	N/A	N/A	N/A	N/A	N/A
	3	+79	N/A	N/A	N/A	N/A	N/A
	4	+72	N/A	N/A	N/A	N/A	N/A
	5	+65	N/A	N/A	N/A	N/A	N/A
	6	+65	N/A	N/A	N/A	N/A	N/A
	7	+72	N/A	N/A	N/A	N/A	N/A
	8	+65	N/A	N/A	N/A	N/A	N/A
	9	+72	N/A	N/A	N/A	N/A	N/A
	10	+65	N/A	N/A	N/A	N/A	N/A
+60	1	+22	N/A	N/A	N/A	N/A	N/A
	2	+29	N/A	N/A	N/A	N/A	N/A
	3	+22	N/A	N/A	N/A	N/A	N/A
	4	+22	N/A	N/A	N/A	N/A	N/A
	5	+29	N/A	N/A	N/A	N/A	N/A
	6	+15	N/A	N/A	N/A	N/A	N/A
	7	+15	N/A	N/A	N/A	N/A	N/A
	8	+29	N/A	N/A	N/A	N/A	N/A
	9	+22	N/A	N/A	N/A	N/A	N/A
	10	+22	N/A	N/A	N/A	N/A	N/A

ULTRATECH GROUP OF LABS

3000 Bristol Circle, Oakville, Ontario, Canada L6H 6G4
 Tel. #: 905-829-1570, Fax. #: 905-829-8050, Email: yhk.ultratech@sympatico.ca, Website: <http://www.ultratech-labs.com>

File #: MIC28-F90
 June 26, 2000

- Assessed by ITI (UK) Competent Body, NVLAP (USA) Accreditation Body & ACA/AUSTEL (Australia)
- Recognized/Listed by FCC (USA), Industry Canada (Canada)
- All test results contained in this engineering test report are traceable to National Institute of Standards and Technology (NIST)

6.7. EMISSION MASK @ FCC 2.989, 90.208 & 90.210

6.7.1. Limits @ FCC 90.209 & 90.210

Emissions shall be attenuated below the mean output power of the transmitter as follows:

FREQUENCY RANGE (MHz)	Maximum Authorized BW (KHz)	CHANNEL SPACING (KHz)	Recommended FREQ. DEVIATION (KHz)	FCC APPLICABLE MASK
403-512	11.25	12.5	2.5	<ul style="list-style-type: none"> 90.210(d): Mask D – Voice & Data

6.7.2. Method of Measurements

Refer to Exhibit 8, Sec. 8.3 of this report for measurement details

6.7.3. Test Equipment List

Test Instruments	Manufacturer	Model No.	Serial No.	Frequency Range
Spectrum Analyzer/ EMI Receiver	Hewlett Packard	HP 8593EM	3412A00103	9 kHz – 26.5 GHz
Attenuator(s)	Bird	DC – 22 GHz
Audio Oscillator	Hewlett Packard	HP 204C	0989A08798	DC to 1.2 MHz

6.7.4. Test Arrangement

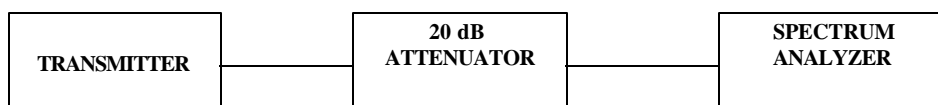

6.7.5. Test Data

Conform. Please refer to the plots below for detailed information.

6.7.6. Plots

Please refer to plots # 3 through # 6 in Exhibit 9 for details of measurements

6.8. TRANSMITTER ANTENNA POWER SPURIOUS/HARMONIC CONDUCTED EMISSIONS @ FCC 90.210

6.8.1. Limits @ 90.210

Emissions shall be attenuated below the mean output power of the transmitter as follows:

FCC RULES	FREQUENCY RANGE	ATTENUATION LIMIT (dBc)
90.210(d) – Voice & data	10 MHz to Lowest frequency of the radio to 10 th harmonic of the highest frequency of the radio	50+10*log(P) or -20 dBm or 70 dBc whichever is less

6.8.2. Method of Measurements

Refer to Exhibit 8, Sec. 8.4 of this report for measurement details

6.8.3. Test Equipment List

Test Instruments	Manufacturer	Model No.	Serial No.	Frequency Range
Spectrum Analyzer/ EMI Receiver	Hewlett Packard	HP 8593EM	3412A00103	9 kHz – 26.5 GHz
Attenuator(s)	Bird	DC – 22 GHz
Audio Oscillator	Hewlett Packard	HP 204C	0989A08798	DC to 1.2 MHz
Hihpass Filter, Microphase	Microphase	CR220HID	IIT11000AC	Cut-off Frequency at 600 MHz, 1.3 GHz or 4 GHz

6.8.4. Test Arrangement

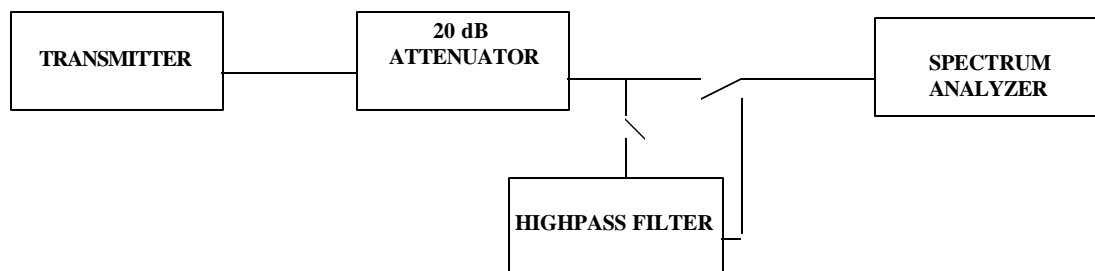

ULTRATECH GROUP OF LABS

3000 Bristol Circle, Oakville, Ontario, Canada L6H 6G4
 Tel. #: 905-829-1570, Fax. #: 905-829-8050, Email: yhk.ultratech@sympatico.ca, Website: <http://www.ultratech-labs.com>

File #: MIC28-F90
 June 26, 2000

- Assessed by ITI (UK) Competent Body, NVLAP (USA) Accreditation Body & ACA/AUSTEL (Australia)
- Recognized/Listed by FCC (USA), Industry Canada (Canada)
- All test results contained in this engineering test report are traceable to National Institute of Standards and Technology (NIST)

6.8.5. Test Data

6.8.5.1. Near Lowest Frequency (450 MHz)

Fundamental Frequency: 450 MHz				
RF Output Power: 2.2 Watts				
Modulation: FM modulation with 3kHz Sine Wave Signal				
FREQUENCY (MHz)	RF LEVEL (dBm)	LIMIT (dBm)	MARGIN (dB)	PASS/ FAIL
210.90	-34.5	-20.0	-14.5	PASS
3605.00	-41.0	-20.0	-21.0	PASS
The emissions were scanned from 10 MHz to 5 GHz and all emissions less 30 dB below the limits were recorded.				

6.8.5.2. Near Middle Frequency (460 MHz)

Fundamental Frequency: 460 MHz				
RF Output Power: 2.1 Watts				
Modulation: FM modulation with 3 kHz Sine Wave Signal				
FREQUENCY (MHz)	RF LEVEL (dBm)	LIMIT (dBm)	MARGIN (dB)	PASS/ FAIL
210.20	-33.2	-20.0	-13.2	PASS
3676.00	-36.7	-20.0	-16.7	PASS
The emissions were scanned from 10 MHz to 5 GHz and all emissions less 20 dB below the limits were recorded.				

6.8.5.3. Near Highest Frequency (470.0000 MHz)

Fundamental Frequency: 470 MHz				
RF Output Power: 2.1 Watts				
Modulation: FM modulation with 3 kHz Sine Wave Signal				
FREQUENCY (MHz)	RF LEVEL (dBm)	LIMIT (dBm)	MARGIN (dB)	PASS/ FAIL
210.20	-33.4	-20.0	-13.4	PASS
3759.00	-41.3	-20.0	-21.3	PASS
4229.00	-53.4	-20.0	-33.4	PASS
The emissions were scanned from 10 MHz to 5 GHz and all emissions less 40 dB below the limits were recorded.				

6.8.6. Plots

Please refer to plots #7 through #9 in Exhibit 9 for details of measurements

ULTRATECH GROUP OF LABS

3000 Bristol Circle, Oakville, Ontario, Canada L6H 6G4
 Tel. #: 905-829-1570, Fax. #: 905-829-8050, Email: yhk.ultratech@sympatico.ca, Website: <http://www.ultratech-labs.com>

File #: MIC28-F90
 June 26, 2000

- Assessed by ITI (UK) Competent Body, NVLAP (USA) Accreditation Body & ACA/AUSTEL (Australia)
- Recognized/Listed by FCC (USA), Industry Canada (Canada)
- All test results contained in this engineering test report are traceable to National Institute of Standards and Technology (NIST)

6.9. TRANSMITTER SPURIOUS/HARMONIC RADIATED EMISSIONS @ FCC 90.210

6.9.1. Limits @ FCC 90.210

Emissions shall be attenuated below the mean output power of the transmitter as follows:

FREQUENCY RANGE (MHz)	Maximum Authorized BW (KHz)	CHANNEL SPACING (KHz)	Recommended FREQ. DEVIATION (KHz)	FCC APPLICABLE MASK
403-512	20.0	25.0	5.0	<ul style="list-style-type: none"> 90.210(b): Mask B – Voice 90.210(c): Mask C – Data
403-512	11.25	12.5	2.5	<ul style="list-style-type: none"> 90.210(d): Mask D – Voice & Data
403-512	6.0	6.25	1.25	<ul style="list-style-type: none"> 90.210(b): Mask E – Voice & Data

6.9.2. Method of Measurements

Refer to Exhibit 8, Sec. 8.5 of this report for measurement details

6.9.3. Test Equipment List

Test Instruments	Manufacturer	Model No.	Serial No.	Frequency Range
Spectrum Analyzer/ EMI Receiver	Advantest	R3271	15050203	100 Hz to 32 GHz with external mixer for frequency above 32 GHz
Microwave Amplifier	Hewlett Packard	HP 83017A		1 GHz to 26.5 GHz
Active Loop Antenna	EMCO	6507	8906-1167	1 kHz – 30 MHz
Biconilog Antenna	EMCO	3143	1029	20 MHz to 2 GHz
Horn Antenna	EMCO	3155	9701-5061	1 GHz – 18 GHz
Horn Antenna	EMCO	3160-09	..	18 GHz – 26.5 GHz
Horn Antenna	EMCO	3160-10	..	26.5 GHz – 40 GHz
Mixer	Tektronix	118-0098-00	..	18 GHz – 26.5 GHz
Mixer	Tektronix	119-0098-00	..	26.5 GHz – 40 GHz

ULTRATECH GROUP OF LABS

3000 Bristol Circle, Oakville, Ontario, Canada L6H 6G4
 Tel. #: 905-829-1570, Fax. #: 905-829-8050, Email: yhk.ultratech@sympatico.ca, Website: <http://www.ultratech-labs.com>

File #: MIC28-F90
 June 26, 2000

- Assessed by ITI (UK) Competent Body, NVLAP (USA) Accreditation Body & ACA/AUSTEL (Australia)
- Recognized/Listed by FCC (USA), Industry Canada (Canada)
- All test results contained in this engineering test report are traceable to National Institute of Standards and Technology (NIST)

6.9.4. Test Arrangement

The following drawings show details of the test setup for radiated emissions measurements

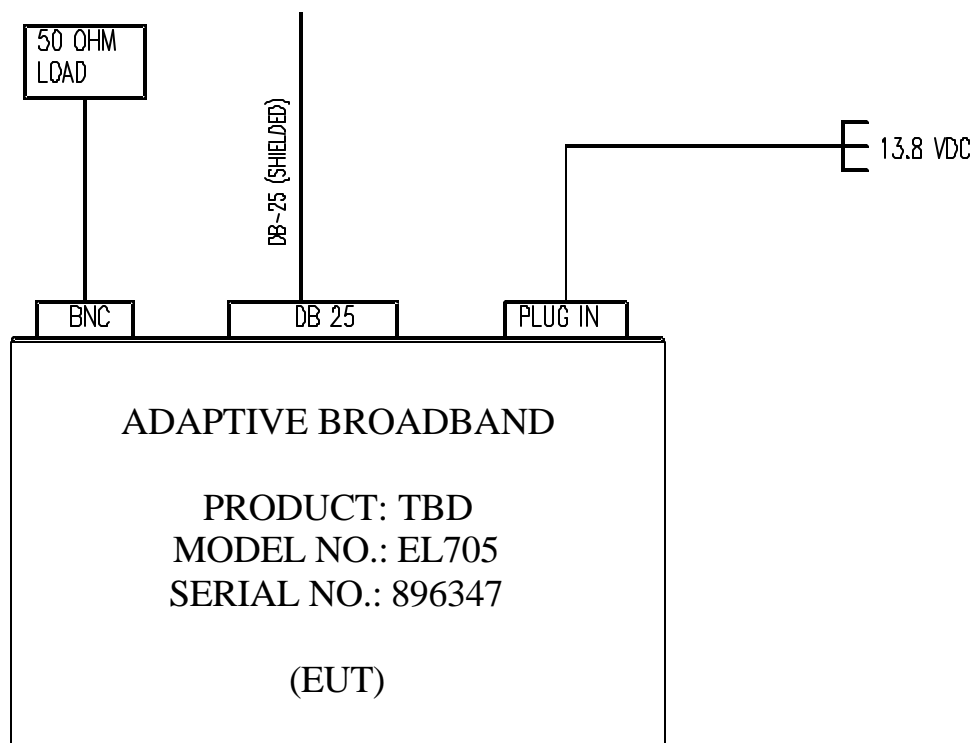

ULTRATECH GROUP OF LABS

3000 Bristol Circle, Oakville, Ontario, Canada L6H 6G4
Tel. #: 905-829-1570, Fax. #: 905-829-8050, Email: yhk.ultratech@sympatico.ca, Website: <http://www.ultratech-labs.com>

File #: MIC28-F90
June 26, 2000

- Assessed by ITI (UK) Competent Body, NVLAP (USA) Accreditation Body & ACA/AUSTEL (Australia)
- Recognized/Listed by FCC (USA), Industry Canada (Canada)
- All test results contained in this engineering test report are traceable to National Institute of Standards and Technology (NIST)

6.9.5. Test Data

6.9.5.1. Near Lowest Frequency (450 MHz)

Fundamental Frequency: 450 MHz							
RF Output Power: 2.2 Watts							
Modulation: FM modulation with 3 kHz Sine Wave Signal							
FREQUENCY (MHz)	RF Field Level @3m (dBuV/m)	RF Power Level (dBm)	DETECTOR USED (PEAK/QP)	ANTENNA PLANE (H/V)	LIMIT @3m (dBm)	MARGIN (dB)	PASS/ FAIL
900.00	40.0	-57.5	PEAK	V	-20.0	-37.5	PASS
900.00	41.2	-56.3	PEAK	H	-20.0	-36.3	PASS
1350.00	49.8	-47.7	PEAK	V	-20.0	-27.7	PASS
1350.00	51.8	-45.7	PEAK	H	-20.0	-25.7	PASS
1800.00	42.5	-55.0	PEAK	V	-20.0	-35.0	PASS
1800.00	44.2	-53.3	PEAK	H	-20.0	-33.3	PASS
2250.00	47.6	-49.9	PEAK	V	-20.0	-29.9	PASS
2250.00	45.7	-51.8	PEAK	H	-20.0	-31.8	PASS
2700.00	52.8	-44.7	PEAK	V	-20.0	-24.7	PASS
2700.00	49.6	-47.9	PEAK	H	-20.0	-27.9	PASS
3150.00	51.3	-46.3	PEAK	V	-20.0	-26.3	PASS
3150.00	45.7	-51.8	PEAK	H	-20.0	-31.8	PASS
3600.00	61.7	-35.8	PEAK	V	-20.0	-15.8	PASS
3600.00	54.3	-43.2	PEAK	H	-20.0	-23.2	PASS
4050.00	58.5	-39.0	PEAK	V	-20.0	-19.0	PASS
4050.00	55.5	-42.0	PEAK	H	-20.0	-22.0	PASS
The emissions were scanned from 10 MHz to 5 GHz and all emissions less 40 dB below the limits were recorded.							

ULTRATECH GROUP OF LABS

3000 Bristol Circle, Oakville, Ontario, Canada L6H 6G4
 Tel. #: 905-829-1570, Fax. #: 905-829-8050, Email: yhk.ultratech@sympatico.ca, Website: <http://www.ultratech-labs.com>

File #: MIC28-F90
 June 26, 2000

- Assessed by ITI (UK) Competent Body, NVLAP (USA) Accreditation Body & ACA/AUSTEL (Australia)
- Recognized/Listed by FCC (USA), Industry Canada (Canada)
- All test results contained in this engineering test report are traceable to National Institute of Standards and Technology (NIST)

ADAPTIVE BROADBAND
TBD, MODEL: EL705
TX Frequency: 450 MHz
Radiated Emissions Measurements at 3 Meter OFTS
Ultratech Engineering Labs Inc.

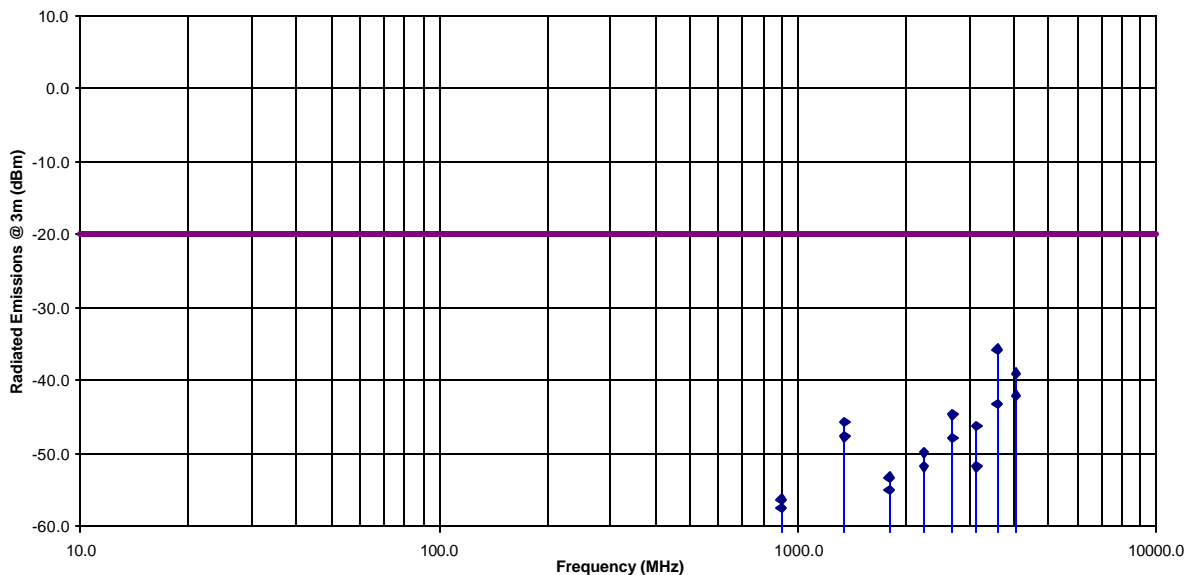

ULTRATECH GROUP OF LABS

3000 Bristol Circle, Oakville, Ontario, Canada L6H 6G4
Tel. #: 905-829-1570, Fax. #: 905-829-8050, Email: yhk.ultratech@sympatico.ca, Website: <http://www.ultratech-labs.com>

File #: MIC28-F90
June 26, 2000

- Assessed by ITI (UK) Competent Body, NVLAP (USA) Accreditation Body & ACA/AUSTEL (Australia)
- Recognized/Listed by FCC (USA), Industry Canada (Canada)
- All test results contained in this engineering test report are traceable to National Institute of Standards and Technology (NIST)

6.9.5.2. Near Middle Frequency (460 MHz)

Fundamental Frequency: 460 MHz RF Output Power: 2.1Watts Modulation: FM modulation with 3 kHz Sine Wave Signal							
FREQUENCY (MHz)	RF Field Level @3m (dBuV/m)	RF Power Level (dBm)	DETECTOR USED (PEAK/QP)	ANTENNA PLANE (H/V)	LIMIT @3m (dBm)	MARGIN (dB)	PASS/ FAIL
920.00	40.9	-56.6	PEAK	V	-20.0	-36.6	PASS
920.00	39.3	-58.2	PEAK	H	-20.0	-38.2	PASS
1380.00	43.9	-53.6	PEAK	V	-20.0	-33.6	PASS
1380.00	45.1	-52.4	PEAK	H	-20.0	-32.4	PASS
1840.00	40.5	-57.0	PEAK	V	-20.0	-37.0	PASS
1840.00	42.2	-55.3	PEAK	H	-20.0	-35.3	PASS
2300.00	43.2	-54.3	PEAK	V	-20.0	-34.3	PASS
2300.00	42.3	-55.2	PEAK	H	-20.0	-35.2	PASS
2760.00	55.3	-42.2	PEAK	V	-20.0	-22.2	PASS
2760.00	50.5	-47.0	PEAK	H	-20.0	-27.0	PASS
3220.00	50.5	-47.0	PEAK	V	-20.0	-27.0	PASS
3220.00	46.6	-50.9	PEAK	H	-20.0	-30.9	PASS
3680.00	66.3	-31.2	PEAK	V	-20.0	-11.2	PASS
3680.00	62.6	-34.9	PEAK	H	-20.0	-14.9	PASS
4140.00	56.8	-40.8	PEAK	V	-20.0	-20.8	PASS
4140.00	54.4	-43.1	PEAK	H	-20.0	-23.1	PASS
4600.00	51.0	-46.5	PEAK	V	-20.0	-26.5	PASS
4600.00	48.6	-48.9	PEAK	H	-20.0	-28.9	PASS

The emissions were scanned from 10 MHz to 5 GHz and all emissions less 40 dB below the limits were recorded.

ULTRATECH GROUP OF LABS

3000 Bristol Circle, Oakville, Ontario, Canada L6H 6G4
 Tel. #: 905-829-1570, Fax. #: 905-829-8050, Email: yhk.ultratech@sympatico.ca, Website: <http://www.ultratech-labs.com>

File #: MIC28-F90
 June 26, 2000

- Assessed by ITI (UK) Competent Body, NVLAP (USA) Accreditation Body & ACA/AUSTEL (Australia)
- Recognized/Listed by FCC (USA), Industry Canada (Canada)
- All test results contained in this engineering test report are traceable to National Institute of Standards and Technology (NIST)

ADAPTIVE BROADBAND
TBD, MODEL NO.: EL705
TX Frequency: 460 MHz
Radiated Emissions Measurements at 3 Meter OFTS
Ultratech Engineering Labs Inc.

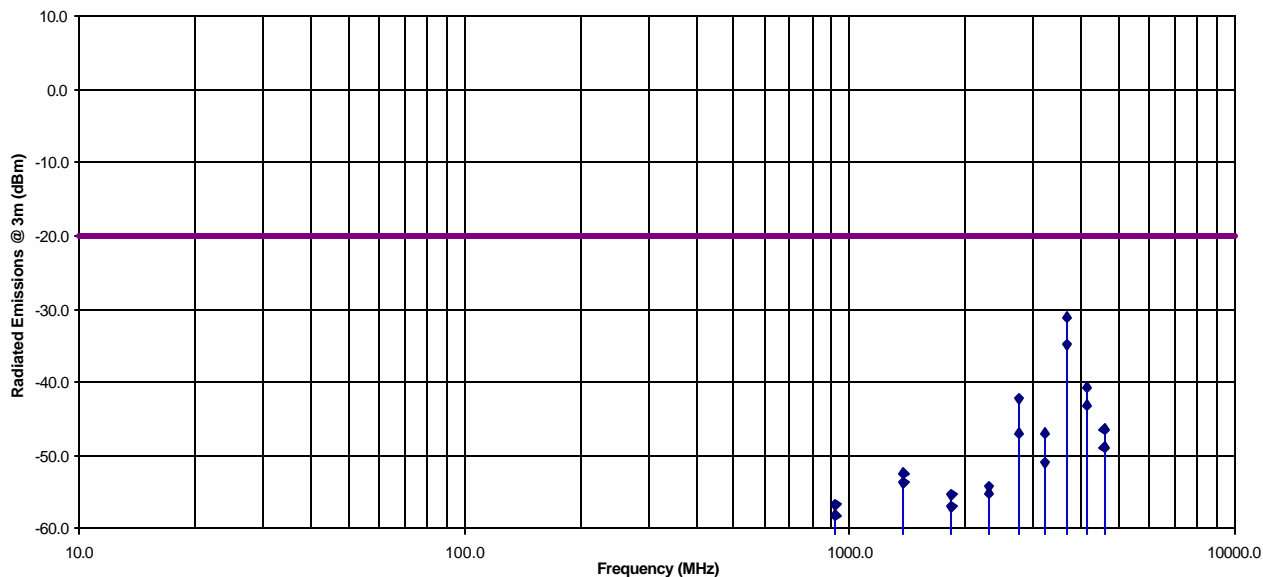

ULTRATECH GROUP OF LABS

3000 Bristol Circle, Oakville, Ontario, Canada L6H 6G4
Tel. #: 905-829-1570, Fax. #: 905-829-8050, Email: yhk.ultratech@sympatico.ca, Website: <http://www.ultratech-labs.com>

File #: MIC28-F90
June 26, 2000

- Assessed by ITI (UK) Competent Body, NVLAP (USA) Accreditation Body & ACA/AUSTEL (Australia)
- Recognized/Listed by FCC (USA), Industry Canada (Canada)
- All test results contained in this engineering test report are traceable to National Institute of Standards and Technology (NIST)

6.9.5.3. Near Highest Frequency (470 MHz)

Fundamental Frequency: 470 MHz							
RF Output Power: 2.1 Watts							
Modulation: FM modulation with 3 kHz Sine Wave Signal							
FREQUENCY (MHz)	RF Field Level @3m (dBuV/m)	RF Power Level (dBm)	DETECTOR USED (PEAK/QP)	ANTENNA PLANE (H/V)	LIMIT @3m (dBm)	MARGIN (dB)	PASS/ FAIL
940.00	44.8	-52.7	PEAK	V	-20.0	-32.7	PASS
940.00	44.4	-53.2	PEAK	H	-20.0	-33.2	PASS
1410.00	46.0	-51.5	PEAK	V	-20.0	-31.5	PASS
1410.00	46.3	-51.2	PEAK	H	-20.0	-31.2	PASS
1880.00	42.7	-54.8	PEAK	V	-20.0	-34.8	PASS
1880.00	40.6	-56.9	PEAK	H	-20.0	-36.9	PASS
2350.00	46.5	-51.0	PEAK	V	-20.0	-31.0	PASS
2350.00	44.5	-53.0	PEAK	H	-20.0	-33.0	PASS
2820.00	51.1	-46.4	PEAK	V	-20.0	-26.4	PASS
2820.00	46.9	-50.6	PEAK	H	-20.0	-30.6	PASS
3290.00	51.3	-46.2	PEAK	V	-20.0	-26.2	PASS
3290.00	48.1	-49.4	PEAK	H	-20.0	-29.4	PASS
3760.00	69.8	-27.7	PEAK	V	-20.0	-7.7	PASS
3760.00	63.2	-34.3	PEAK	H	-20.0	-14.3	PASS
4230.00	64.5	-33.0	PEAK	V	-20.0	-13.0	PASS
4230.00	59.1	-38.4	PEAK	H	-20.0	-18.4	PASS
4700.00	54.6	-42.9	PEAK	V	-20.0	-22.9	PASS
4700.00	50.1	-47.4	PEAK	H	-20.0	-27.4	PASS
The emissions were scanned from 10 MHz to 5 GHz and all emissions less 40 dB below the limits were recorded.							

ULTRATECH GROUP OF LABS

3000 Bristol Circle, Oakville, Ontario, Canada L6H 6G4
 Tel. #: 905-829-1570, Fax. #: 905-829-8050, Email: yhk.ultratech@sympatico.ca, Website: <http://www.ultratech-labs.com>

File #: MIC28-F90
 June 26, 2000

- Assessed by ITI (UK) Competent Body, NVLAP (USA) Accreditation Body & ACA/AUSTEL (Australia)
- Recognized/Listed by FCC (USA), Industry Canada (Canada)
- All test results contained in this engineering test report are traceable to National Institute of Standards and Technology (NIST)

ADAPTIVE BROADBAND
TBD, MODEL: EL705
TX Frequency: 470 MHz
Radiated Emissions Measurements at 3 Meter OFTS
Ultratech Engineering Labs Inc.

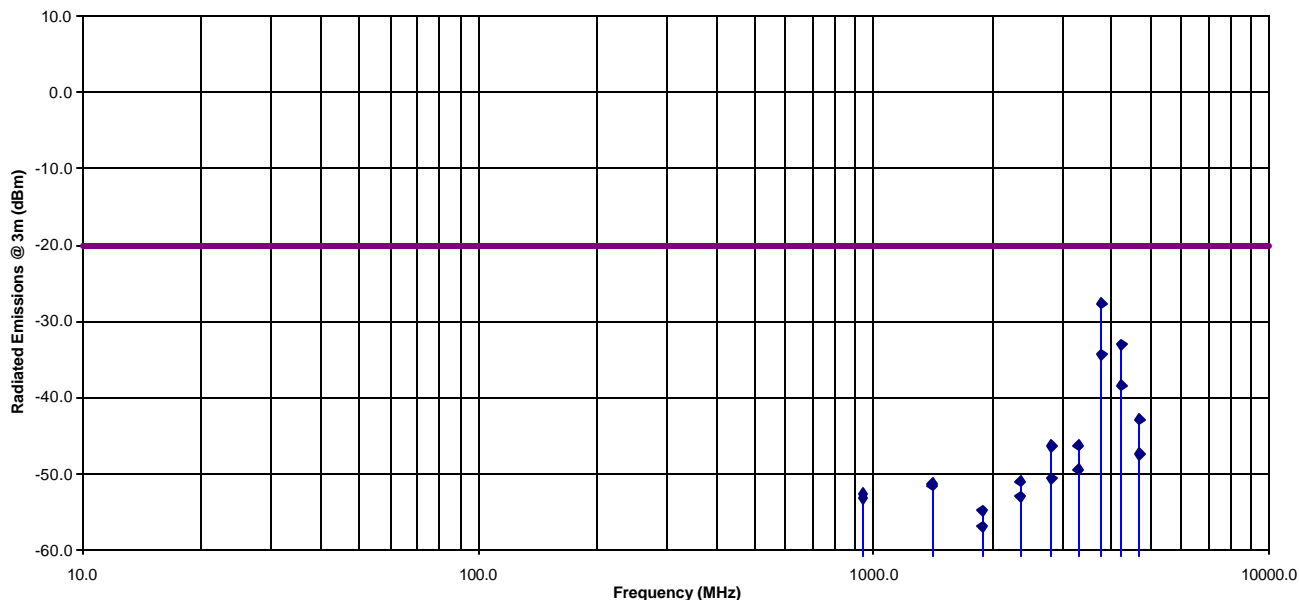

6.9.6. Photographs of Test Setup

Please refer to photos # 1 to # 3 in exhibit 10 for details of test setup.

ULTRATECH GROUP OF LABS

3000 Bristol Circle, Oakville, Ontario, Canada L6H 6G4
Tel. #: 905-829-1570, Fax. #: 905-829-8050, Email: yhk.ultratech@sympatico.ca, Website: <http://www.ultratech-labs.com>

File #: MIC28-F90
June 26, 2000

- Assessed by ITI (UK) Competent Body, NVLAP (USA) Accreditation Body & ACA/AUSTEL (Australia)
- Recognized/Listed by FCC (USA), Industry Canada (Canada)
- All test results contained in this engineering test report are traceable to National Institute of Standards and Technology (NIST)

6.10. TRANSIENT FREQUENCY BEHAVIOR @ 90.214

6.10.1. Limits

Transient frequencies must be within the maximum frequency difference limits during the time intervals indicated:

Transient Frequency Behavior for equipment Designed to Operate on 12.5 KHz Channels

Time Interval ^{1,2}	All Equipment	
	Maximum Frequency Difference ³	421 to 512 MHz
t1 ⁴	± 12.5 KHz	10.0 ms
t2	± 6.25 KHz	25.0 ms
t3 ⁴	± 12.5 KHz	10.0 ms

- (1) ton: the instant when a 1 KHz test signal is completely suppressed, including any capture time due to phasing.
t1: time period immediately after ton
t2: time period after t1
t3: time period from the instant when the transmitter is turned off until toff
toff: the instant when the 1 KHz test signal starts to rise.
- (2) During the time from the end of t2 to the beginning of t3, the frequency difference must not exceed the limits specified in @ 90.213
- (3) Difference between the actual transmitter frequency and assigned transmitter frequency.
- (4) If the transmitter carrier output power rating is 6 watts or less, the frequency difference during this time period may exceed the maximum frequency difference for this time period.

6.10.2. Method of Measurements

Refer to Exhibit 8, Sec. 8.6 of this test report and ANSI/TIA/EIA - 603 - 1992, Sec. 2.2.19, Page 83

ULTRATECH GROUP OF LABS

3000 Bristol Circle, Oakville, Ontario, Canada L6H 6G4
Tel. #: 905-829-1570, Fax. #: 905-829-8050, Email: yhk.ultratech@sympatico.ca, Website: <http://www.ultratech-labs.com>

File #: MIC28-F90
June 26, 2000

- Assessed by ITI (UK) Competent Body, NVLAP (USA) Accreditation Body & ACA/AUSTEL (Australia)
- Recognized/Listed by FCC (USA), Industry Canada (Canada)
- All test results contained in this engineering test report are traceable to National Institute of Standards and Technology (NIST)

6.10.3. Test Equipment List

Test Instruments	Manufacturer	Model No.	Serial No.	Frequency Range
RF Synthesized Signal Generator	Fluke	6061A	...	10 kHz – 1GHz 13 dBm output max. @ 50 Ohms
Communication Analyzer (Test Receiver)	Rohde & Schwarz	SMFP2	879988/057	400 GHz including SINAD, S/N, Modulation meters, AF & RF signal generators and etc....
Network Combiner	Mini-circuit	15542	...	DC to 22 GHz (7 dB insertion loss)
Digital Storage Scope	Phillips	3320A	DQ 646	DC - 5 MHz
67297 RF Detector,	Herotex	DZ122-553	63400	..

6.10.4. Test Arrangement

The following drawings show details of the test setup for Transient Frequency Behavior measurements

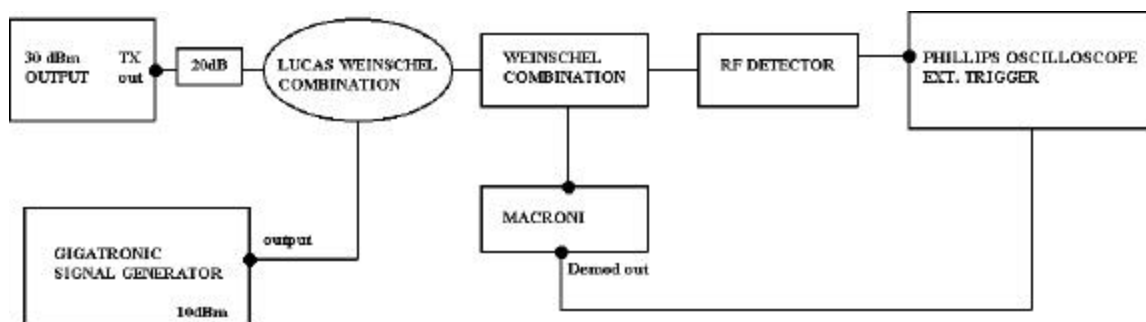

ULTRATECH GROUP OF LABS

3000 Bristol Circle, Oakville, Ontario, Canada L6H 6G4
 Tel. #: 905-829-1570, Fax. #: 905-829-8050, Email: yhk.ultratech@sympatico.ca, Website: <http://www.ultratech-labs.com>

File #: MIC28-F90
 June 26, 2000

- Assessed by ITI (UK) Competent Body, NVLAP (USA) Accreditation Body & ACA/AUSTEL (Australia)
- Recognized/Listed by FCC (USA), Industry Canada (Canada)
- All test results contained in this engineering test report are traceable to National Institute of Standards and Technology (NIST)

6.10.5. Test Data

6.10.5.1. 12.5 kHz Channel Spacing Operation

6.10.5.1.1. Test Configuration #1: Unmodulated

Time Interval	Transient Frequency	Transient Frequency Limit
t1 (10 mS) SWITCH ON CONDITION	5.86 KHz	12.5 kHz or no limit for RF Output PWR < 6 Watts
t2 (25 mS) SWITCH ON CONDITION	0	6.25 kHz
After t2 (10 mS) SWITCH ON CONDITION	0	FCC Limit = ± 1125 Hz (2.5 ppm @ 450 MHz)
Before t3 (10 mS) SWITCH OFF CONDITION	0	FCC Limit = ± 1125 Hz (2.5 ppm @ 450 MHz)
t3 (10 mS) SWITCH OFF CONDITION	0	12.5 kHz or no limit for RF Output PWR < 6 Watts

6.10.5.2. Test Configuration #3: FM modulation with 9600 B/s random data, , Freq. Dev.: 3 KHz

Time Interval	Transient Frequency	Transient Frequency Limit
t1 (10 mS) SWITCH ON CONDITION	9.72 KHz	25 kHz or no limit for RF Output PWR < 6 Watts
t2 (25 mS) SWITCH ON CONDITION	0	12.5 kHz
After t2 (10 mS) SWITCH ON CONDITION	0	FCC Limit = ± 1125 Hz (2.5 ppm @ 450 MHz)
Before t3 (10 mS) SWITCH OFF CONDITION	0	FCC Limit = ± 1125 Hz (2.5 ppm @ 450 MHz)
t3 (10 mS) SWITCH OFF CONDITION	0	25 kHz or no limit for RF Output PWR < 6 Watts

6.10.6. Plots

Please refer to plots # 10 & #11 in Exhibit 9 for details of measurements

ULTRATECH GROUP OF LABS

3000 Bristol Circle, Oakville, Ontario, Canada L6H 6G4
 Tel. #: 905-829-1570, Fax. #: 905-829-8050, Email: yhk.ultratech@sympatico.ca, Website: <http://www.ultratech-labs.com>

File #: MIC28-F90
 June 26, 2000

- Assessed by ITI (UK) Competent Body, NVLAP (USA) Accreditation Body & ACA/AUSTEL (Australia)
- Recognized/Listed by FCC (USA), Industry Canada (Canada)
- All test results contained in this engineering test report are traceable to National Institute of Standards and Technology (NIST)

EXHIBIT 7. MEASUREMENT UNCERTAINTY

The measurement uncertainties stated were calculated in accordance with the requirements of NIST Technical Note 1297 and NIS 81 (1994)

7.1. RADIATED EMISSION MEASUREMENT UNCERTAINTY

CONTRIBUTION (Radiated Emissions)	PROBABILITY DISTRIBUTION	UNCERTAINTY (\pm dB)	
		3 m	10 m
Antenna Factor Calibration	Normal (k=2)	± 1.0	± 1.0
Cable Loss Calibration	Normal (k=2)	± 0.3	± 0.5
EMI Receiver specification	Rectangular	± 1.5	± 1.5
Antenna Directivity	Rectangular	$+0.5$	$+0.5$
Antenna factor variation with height	Rectangular	± 2.0	± 0.5
Antenna phase center variation	Rectangular	0.0	± 0.2
Antenna factor frequency interpolation	Rectangular	± 0.25	± 0.25
Measurement distance variation	Rectangular	± 0.6	± 0.4
Site imperfections	Rectangular	± 2.0	± 2.0
Mismatch: Receiver VRC $\Gamma_1 = 0.2$ Antenna VRC $\Gamma_R = 0.67(Bi) 0.3 (Lp)$ Uncertainty limits $20\text{Log}(1 \pm \Gamma_1 \Gamma_R)$	U-Shaped	+1.1 -1.25	± 0.5
System repeatability	Std. Deviation	± 0.5	± 0.5
Repeatability of EUT		-	-
Combined standard uncertainty	Normal	+2.19 / -2.21	+1.74 / -1.72
Expanded uncertainty U	Normal (k=2)	+4.38 / -4.42	+3.48 / -3.44

Calculation for maximum uncertainty when 3m biconical antenna including a factor of k=2 is used:

$$U = 2u_c(y) = 2x(+2.19) = +4.38 \text{ dB} \quad \text{And} \quad U = 2u_c(y) = 2x(-2.21) = -4.42 \text{ dB}$$

ULTRATECH GROUP OF LABS

3000 Bristol Circle, Oakville, Ontario, Canada L6H 6G4
 Tel. #: 905-829-1570, Fax. #: 905-829-8050, Email: yhk.ultratech@sympatico.ca, Website: <http://www.ultratech-labs.com>

File #: MIC28-F90
 June 26, 2000

- Assessed by ITI (UK) Competent Body, NVLAP (USA) Accreditation Body & ACA/AUSTEL (Australia)
- Recognized/Listed by FCC (USA), Industry Canada (Canada)
- All test results contained in this engineering test report are traceable to National Institute of Standards and Technology (NIST)

EXHIBIT 8. MEASUREMENT METHODS

8.1. EFFECTIVE RADIATED POWER (ERP) MEASUREMENTS

- The following shall be applied to the combination(s) of the radio device and its intended antenna(e).
- If the RF level is user adjustable, all measurements shall be made with the highest power level available to the user for that combination.
- The following method of measurement shall apply to both conducted and radiated measurements.
- The radiated measurements are performed at the Ultratech Calibrated Open Field Test Site.
- The measurement shall be performed using normal operation of the equipment with modulation.

Test procedure shall be as follows:

Step 1: Duty Cycle measurements

- Using a spectrum analyzer with the frequency span set to 0 Hz and the sweep time set at a suitable value to capture the envelope peaks and the duty cycle of the transmitter output signal;
- The duty cycle of the transmitter, $x = \text{Tx on} / (\text{Tx on} + \text{Tx off})$ with $0 < x < 1$, is measure and recorded in the test report. For the purpose of testing, the equipment shall be operated with a duty cycle that is equal or more than 0.1.

Step 2: Calculation of Average EIRP. See Figure 1

- The average output power of the transmitter shall be determined using a wideband, calibrated RF power meter with the power sensor with an integration period that exceeds the repetition period of the transmitter by a factor 5 or more. The observed value shall be recorded as “A” (in dBm);
- The e.i.r.p. shall be calculated from the above measured power output “A”, the observed duty cycle x, and the applicable antenna assembly gain “G” in dBi, according to the formula:

$$\text{EIRP} = \text{A} + \text{G} + 10\log(1/x)$$

Figure 1.

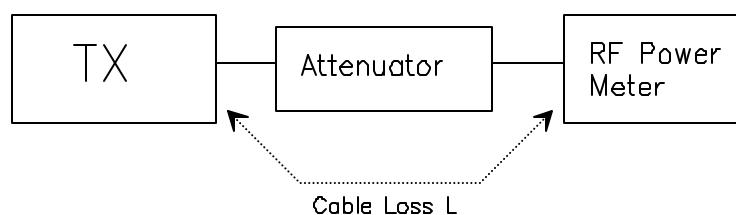

Step 3: Substitution Method. See Figure 2

- (a) The measurements was performed in the absence of modulation (un-modulated)
- (b) Test was performed at listed 3m open area test site (listed with FCC, IC, ITI, NVLAP, ACA & VCCI).
- (c) The transmitter under test was placed at the specified height on a non-conducting turntable (80 cm height)
- (d) The dipole test antenna was used and tuned to the transmitter carrier frequency.
- (e) The spectrum analyzer was tuned to transmitter carrier frequency. The test antenna was lowered or raised from 1 to 4 meters until the maximum signal level was detected.
- (f) The transmitter was rotated through 360° about a vertical axis until a higher maximum signal was received.
- (g) The test antenna was lowered or raised again from 1 to 4 meters until a maximum was obtained. This level was recorded.

ULTRATECH GROUP OF LABS

3000 Bristol Circle, Oakville, Ontario, Canada L6H 6G4
Tel. #: 905-829-1570, Fax. #: 905-829-8050, Email: yhk.ultratech@sympatico.ca, Website: <http://www.ultratech-labs.com>

File #: MIC28-F90
June 26, 2000

- Assessed by ITI (UK) Competent Body, NVLAP (USA) Accreditation Body & ACA/AUSTEL (Australia)
- Recognized/Listed by FCC (USA), Industry Canada (Canada)
- All test results contained in this engineering test report are traceable to National Institute of Standards and Technology (NIST)

- (h) The substitution dipole antenna and the signal generator replaced the transmitter and antenna under test in the same position, and the substitution dipole antenna was placed in vertical polarization. The test dipole antenna was lowered or raised as necessary to ensure that the maximum signal is still received.
- (i) The input signal to the substitution antenna was adjusted in level until an equal or a known related level to that detected from the transmitter was obtained in the test receiver. The maximum carrier radiated power is equal to the power supply by the generator.
- (j) The substitution antenna gain and cable loss were added to the signal generator level for the corrected ERP level.
- (k) Repeat steps (c) to (j) with the substitution antenna oriented in horizontal polarization.
- (l) Actual gain of the EUT's antenna is the difference of the measured ERP and measured RF power at the RF port. Correct the antenna gain if necessary.

Figure 2

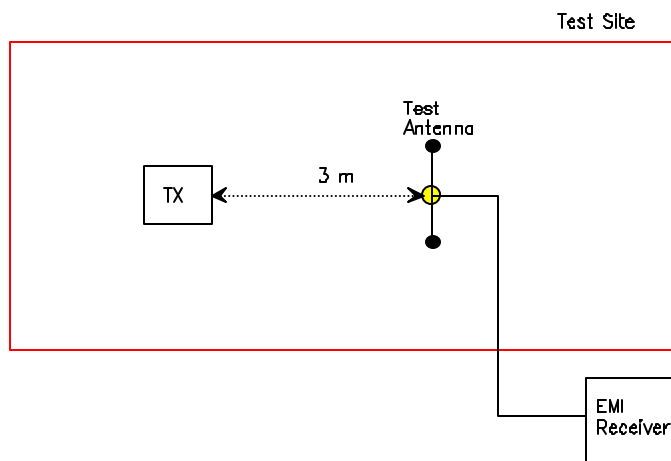
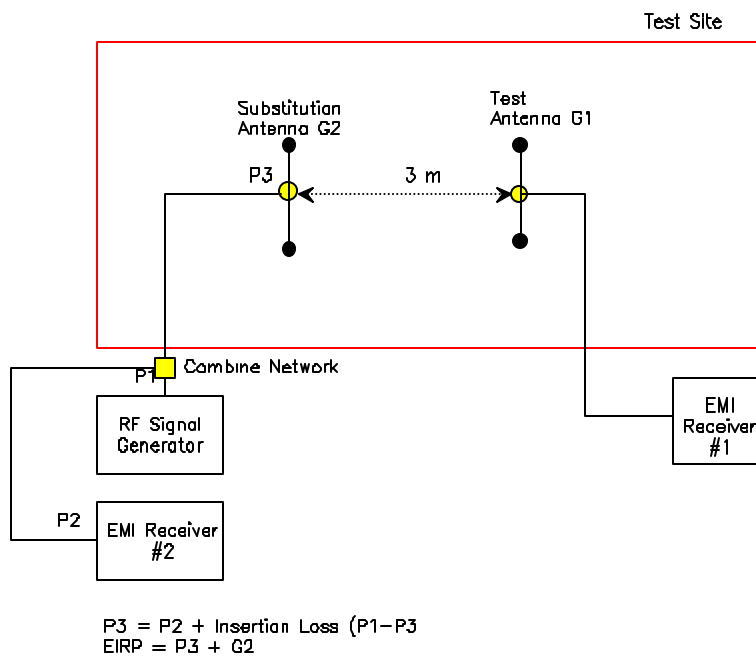

Figure 3



8.2. FREQUENCY STABILITY

Refer to FCC @ 2.995.

- (a) The frequency stability shall be measured with variation of ambient temperature as follows: From -30 to +50 centigrade except that specified in subparagraph (2) & (3) of this paragraph.
- (b) Frequency measurements shall be made at extremes of the specified temperature range and at intervals of not more than 10 centigrade through the range. A period of time sufficient to stabilize all of the components of the oscillator circuit at each temperature level shall be allowed prior to frequency measurement. The short term transient effects on the frequency of the transmitter due to keying (except for broadcast transmitters) and any heating element cycling normally occurring at each ambient temperature level also shall be shown. Only the portion or portions of the transmitter containing the frequency determining and stability circuitry need be subjected to the temperature variation test.
- (d) The frequency stability supply shall be measured with variation of primary supply voltage as follows:
 - (1) Vary primary supply voltage from 85 to 115 percent of the nominal value for other than hand carried battery equipment.
 - (2) For hand carried, battery powered equipment, reduce primary supply voltage to the battery operating end point which shall be specified by the manufacturer.
 - (3) The supply voltage shall be measured at the input to the cable normally provide with the equipment, or at the power supply terminals if cables are not normally provided. Effects on frequency of transmitter keying (except for broadcast transmitters) and any heating element cycling at the nominal supply voltage and at each extreme also shall be shown.
- (f) When deemed necessary, the Commission may require tests of frequency stability under conditions in addition to those specifically set out in paragraphs (a), (b), (c) and (d) of this section. (For example, measurements showing the effect of proximity to large metal objects, or of various types of antennas, may be required for portable equipment).

ULTRATECH GROUP OF LABS

3000 Bristol Circle, Oakville, Ontario, Canada L6H 6G4
Tel. #: 905-829-1570, Fax. #: 905-829-8050, Email: yhk.ultratech@sympatico.ca, Website: <http://www.ultratech-labs.com>

File #: MIC28-F90
June 26, 2000

- Assessed by ITI (UK) Competent Body, NVLAP (USA) Accreditation Body & ACA/AUSTEL (Australia)
- Recognized/Listed by FCC (USA), Industry Canada (Canada)
- *All test results contained in this engineering test report are traceable to National Institute of Standards and Technology (NIST)*

8.3. EMISSION MASK

Voice or Digital Modulation Through a Voice Input Port @ 2.989(c)(i):- The transmitter was modulated by a 2.5 KHz tone signal at an input level 16 dB greater than that required to produce 50% modulation (e.g.: ± 2.5 KHz peak deviation at 1 KHz modulating frequency). The input level was established at the frequency of maximum response of the audio modulating circuit.

Digital Modulation Through a Data Input Port @ 2.989(h):- Transmitters employing digital modulation techniques - when modulated by an input signal such that its amplitude and symbol rate represent the maximum rated conditions under which the equipment will be operated. The signal shall be applied through any filter networks, pseudo-random generators or other devices required in normal service. Additionally, the Emission Masks shall be shown for operation with any devices used for modifying the spectrum when such devices are operational at the discretion of the user.

The following spectrum analyzer bandwidth shall be used for measurement of Emission Mask/Out-of-Band Emission Measurements:

- (1) For 25 kHz Channel Spacing: RBW = 300 Hz
- (2) For 12.5 kHz or 6.25 kHz Channel Spacings: RBW = 100 Hz

The all cases the Video Bandwidth shall be equal or greater than the measuring bandwidth.

8.4. SPURIOUS EMISSIONS (CONDUCTED)

With transmitter modulation characteristics described in Out-of-Band Emissions measurements @ 2.989, the transmitter spurious and harmonic emissions were scanned. The spurious and harmonic emissions were measured with the Spectrum Analyzer controls set as RBW = 30 kHz minimum, VBW \geq RBW and SWEEP TIME = AUTO). The transmitter was operated at a full rated power output, and modulated as follows:

FCC CFR 47, Para. 2.997 - Frequency spectrum to be investigated:- The spectrum was investigated from the lowest radio generated in the equipment up to at least the 10th harmonic of the carrier frequency or to the highest frequency practicable in the present state of the art of measuring techniques, whichever is lower. Particular attention should be paid to harmonics and subharmonics of the carrier frequency. Radiation at the frequencies of multiplier stages should be checked. The amplitude of spurious emissions which are attenuated more than 20 dB below the permissible value need not be reported.

FCC CFR 47, Para. 2.991 - Spurious Emissions at Antenna Terminal:- The radio frequency voltage or powers generated within the equipment and appearing on a spurious frequency shall be checked at the equipment output terminals when properly loaded with a suitable artificial antenna. Curves or equivalent data shall show the magnitude of the harmonic and other spurious emission that can be detected when the equipment is operated under the conditions specified in 2.989 as appropriate. The magnitude of spurious emissions which are attenuated more than 20 dB below the permissible value need not be specified.

ULTRATECH GROUP OF LABS

3000 Bristol Circle, Oakville, Ontario, Canada L6H 6G4
Tel. #: 905-829-1570, Fax. #: 905-829-8050, Email: yhk.ultratech@sympatico.ca, Website: <http://www.ultratech-labs.com>

File #: MIC28-F90
June 26, 2000

- Assessed by ITI (UK) Competent Body, NVLAP (USA) Accreditation Body & ACA/AUSTEL (Australia)
- Recognized/Listed by FCC (USA), Industry Canada (Canada)
- All test results contained in this engineering test report are traceable to National Institute of Standards and Technology (NIST)

8.5. SPURIOUS EMISSIONS (RADIATED)

With transmitter modulation characteristics described in Out-of-Band Emissions measurements @ 2.989, the transmitter spurious and harmonic emissions were scanned. The spurious and harmonic emissions were measured with the Spectrum Analyzer controls set as RBW = 100 kHz minimum , VBW \geq RBW and SWEEP TIME = AUTO). The transmitter was operated at a full rated power output, and modulated as follows:

FCC CFR 47, Para. 2.997 - Frequency spectrum to be investigated:- The spectrum was investigated from the lowest radio generated in the equipment up to at least the 10th harmonic of the carrier frequency or to the highest frequency practicable in the present state of the art of measuring techniques, whichever is lower. Particular attention should be paid to harmonics and subharmonics of the carrier frequency. Radiation at the frequencies of multiplier stages should be checked. The amplitude of spurious emissions which are attenuated more than 20 dB below the permissible value need not be reported.

FCC CFR 47, Para. 2.993 - Field Strength Spurious Emissions

- (a) Measurements was made to detect spurious emissions radiated directly from the cabinet, control circuits, power leads, or intermediate circuit elements under normal conditions of installation and operation. Curves or equivalent data were supplied showing the magnitude of each harmonic and other spurious emission. For this test, single sideband, independent sideband, and controlled carrier transmitters shall be modulated under the conditions specified in paragraph 2.989(c) as appropriate. For equipment operating on frequencies below 1 GHz , an Open Field Test is normally required, with the measuring instrument antenna located in the far field at all test frequencies. In event it is either impractical or impossible to make open field measurements (e.g. a broadcast transmitter installed in a building) measurement will be accepted of the equipment as installed. Such measurements must be accompanied by a description of the site where the measurements were made showing the location of any possible source of reflections which might distort the field strength measurements. Information submitted shall include the relative radiated power of each spurious emission with the reference to the rated power output of the transmitter, assuming all emissions are radiated from half-wave dipole antennas.
- (b) Measurements specified in paragraph (a) of this section shall be made for the following equipment:
 - (1) Those in which the spurious emission are required to be 60 dB or more below the mean power of the transmitter.
 - (2) All equipment operating on frequencies higher than 25 MHz
 - (3) All equipment where the antenna is an integral part of, and attached directly to the transmitter.
 - (4) Other types of equipment as required, when deemed necessary by the Commission.

Maximizing RF Emission Level:

- (a) The measurements was performed with standard modulation
- (b) Test was performed at listed 3m open area test site (listed with FCC, IC, ITI, NVLAP, ACA & VCCI).
- (c) The transmitter under test was placed at the specified height on a non-conducting turntable (80 cm height)
- (d) The biconilog Antenna (20 MHz to 1 GHz) or Horn Antenna (1 GHz to 18 GHz) was used for measuring.
- (e) The spectrum analyzer was tuned to transmitter carrier frequency. The test antenna was lowered or raised from 1 to 4 meters until the maximum signal level was detected.
- (f) The transmitter was rotated through 360° about a vertical axis until a higher maximum signal was received.
- (g) The test antenna was lowered or raised again from 1 to 4 meters until a maximum was obtained. This level was recorded.
- (h) The recorded reading was corrected to the true field strength level by adding the antenna factor, cable loss and subtracting the pre-amplifier gain.
- (i) The field strength level measured at 3m is converted to the power in dBm by subtracting a constant factor of 97.5 dB

ULTRATECH GROUP OF LABS

3000 Bristol Circle, Oakville, Ontario, Canada L6H 6G4
Tel. #: 905-829-1570, Fax. #: 905-829-8050, Email: yhk.ultratech@sympatico.ca, Website: <http://www.ultratech-labs.com>

File #: MIC28-F90
June 26, 2000

- Assessed by ITI (UK) Competent Body, NVLAP (USA) Accreditation Body & ACA/AUSTEL (Australia)
- Recognized/Listed by FCC (USA), Industry Canada (Canada)
- All test results contained in this engineering test report are traceable to National Institute of Standards and Technology (NIST)

METHOD OF CALCULATION FOR TRANSMITTED POWER (P) FROM THE MEASURED FIELD STRENGTH LEVEL (E):

According to IEC 801-3, the power density can be calculated as follows:

$$S = P / (4\pi D^2) \text{ Where: } S: \text{ Power density in watts per square feet}$$

P: Transmitted power in watts
PI: 13.1415
D: Distance in meters

The power density S (W/m²) and electric field E (V/m) is related by:

$$S = E^2 / (120\pi)$$

Accordingly, the field intensity of isotropic radiator in free space can be expressed as follows:

$$E = (30\sqrt{P}) / D = 5.5\sqrt{P} / D$$

For Halfwave dipole antenna or other antennas correlated to dipole in direction of maximum radiation:

$$S = (1.64\sqrt{P}) / (4\pi D^2)$$
$$E = (49.2\sqrt{P}) / D = 7.01\sqrt{P} / D$$

$$P = (E \times D / 7.01)^2$$

Calculation of transmitted power P (dBm) given a measured field intensity E (dBuV/m):

$$\begin{aligned} P(W) &= [E(V/m) \times D / 7.01]^2 \\ P(mW) &= P(W) \times 1000 \\ \Rightarrow P(dBm) &= 10 \log P(mW) \\ &= 20 \log E(V/m) + 20 \log(D) - 20 \log(7.01) + 10 \log 1000 \\ &= E(dBV/m) + 20 \log D + 13 \\ &= E(dBuV/m) - 120 + 20 \log(D) + 13 \\ &= E(dBuV/m) + 20 \log(D) - 107 \end{aligned}$$

The Transmitted Power @ D = 3 Meters

$$P(dBm) = E(dBuV/m) - 97.5$$

8.6. TRANSIENT FREQUENCY BEHAVIOR

1. Connect the transmitter under tests as shown in the above block diagram
2. Set the signal generator to the assigned frequency and modulate with a 1 kHz tone at ± 12.5 kHz deviation and its output level to be 50 dB below the transmitter rf output at the test receiver end.
3. Set the horizontal sweep rate on the storage scope to 10 milliseconds per division and adjust the display to continuously view the 1000 Hz tone from the Demodulator Output Port (DOP) of the Test Receiver. Adjust the vertical scale amplitude control of the scope to display the 1000 Hz at ± 4 divisions vertical Center at the display.
4. Adjust the scope so it will trigger on an increasing magnitude from the RF trigger signal of the transmitter under test when the transmitter was turned on. Set the controls to store the display.
5. The output at the DOP, due to the change in the ratio of the power between the signal generator input power and transmitter output power will, because of the capture effect of the test receiver, produce a change in display: For the first part of the sweep it will show the 1 kHz test signal. Then once the receiver's demodulator has been captured by the transmitter power, the display will show the frequency difference from the assigned frequency to the actual transmitter frequency versus time. The instant when the 1 kHz test signal is completely suppressed (including any capture time due to phasing) is considered to be t_{om} . The trace should be maintained within the allowed divisions during the period t_1 and t_2 .
6. During the time from the end of t_2 to the beginning of t_3 the frequency difference should not exceed the limits set by the FCC in Part 90.214 and the outlined in the Carrier Frequency Stability sections. The allowed limit is equal to FCC frequency tolerance limits specified in FCC 90.213.
7. Repeat the above steps when the transmitter was turned off for measuring t_3 .

ULTRATECH GROUP OF LABS

3000 Bristol Circle, Oakville, Ontario, Canada L6H 6G4
Tel. #: 905-829-1570, Fax. #: 905-829-8050, Email: yhk.ultratech@sympatico.ca, Website: <http://www.ultratech-labs.com>

File #: MIC28-F90
June 26, 2000

- Assessed by ITI (UK) Competent Body, NVLAP (USA) Accreditation Body & ACA/AUSTEL (Australia)
- Recognized/Listed by FCC (USA), Industry Canada (Canada)
- *All test results contained in this engineering test report are traceable to National Institute of Standards and Technology (NIST)*