

SIEMENS



Industrial Remote Communication

Telecontrol

Efficient Telecontrol Solutions

Brochure

Edition
11/2018

siemens.com/telecontrol

Industrial Remote Communication

Industrial Remote Access – a factor for success

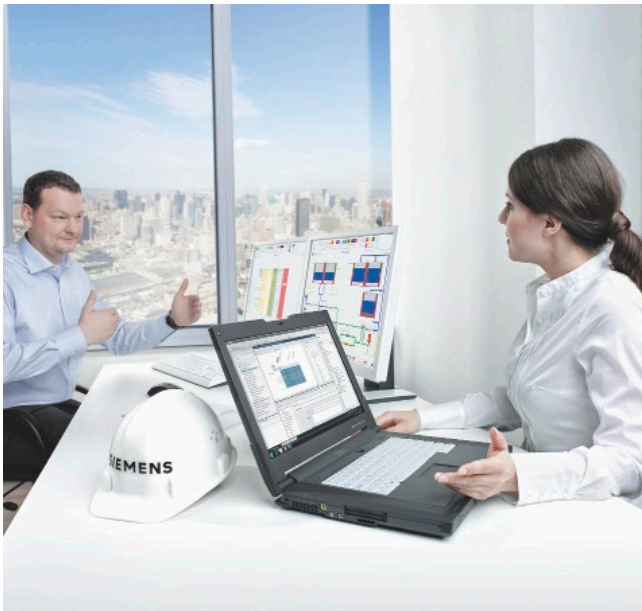

Remote access to distant plants, distant machines, and mobile applications from anywhere in the world is becoming more and more important. This is a key competitive advantage, both in industry and in industry-related areas. The portfolio for Industrial Remote Communication from Siemens offers products, systems and solutions for telecontrol, teleservice and their communication networks (Remote Networks). This enables secured and economical remote access to distributed plants in manufacturing automation, the process industry or in public infrastructures – regardless of the scale.

Telecontrol

Telecontrol is the monitoring and control of distant process stations via one or more central control systems. The data connection to the stations is permanent, or established cyclically or on an event-driven basis.

Teleservice (remote maintenance/diagnostics)

Teleservice is data exchange between physically remote technical systems (machines, computers, etc.) and the control center. The purpose is error detection, diagnostics, maintenance, repair or optimization of the plant. The connection is usually only established when needed.

Communication via Remote Networks

For telecontrol and teleservice applications, communication is essential. Our portfolio for Remote Networks includes network components for wired and wireless communication. Security is a must for remote access. That is why our communication components provide comprehensive security measures such as firewall and VPN.

Telecontrol

Efficient telecontrol solutions



Industrial process plants often extend over large areas – even sometimes crossing national borders. For reliable monitoring, operators require secured and cost-effective access to their remote plants. Siemens offers tailor-made and efficient telecontrol solutions for a wide variety of applications. The telecontrol portfolio includes solutions for the control center as well as for remote terminal units (RTUs). Our products are based on SIMATIC, the world's leading automation system. They are therefore a part of Totally Integrated Automation (TIA), our open system architecture for plant-wide, uniform automation.

Solutions for the control center

Different solutions are available for the control center, depending on the scale and requirements of the applications.

The transmission protocol TeleControl Basic is designed for simple control tasks. It supports a very large number of outstations and is used for transmitting small amounts of data via mobile wireless and the Internet.

For extensive applications with sophisticated control tasks, telecontrol solutions based on SINAUT ST7, IEC 60870-5-101/104 or DNP3 telecontrol protocols are recommended. These systems support numerous network topologies and communication media and are therefore suitable for transmitting large amounts of data via all available communication media (private and public networks, mobile wireless, Internet).

Solutions for Remote Terminal Units

RTUs constitute the outstations of telecontrol systems and monitor and control local processes. Siemens offers components for the creation of modular RTUs based on SIMATIC controllers. In addition, our portfolio includes compact RTUs for special operating conditions, for example, when no local power grid is available.

Networking solutions (Remote Networks)

Siemens offers a broad portfolio of industrial modems and routers for connecting the RTUs to the control center. For information on this topic, please refer to:

[siemens.com/remotenetworks](https://www.siemens.com/remotenetworks)

Solutions for the control center

TeleControl Basic

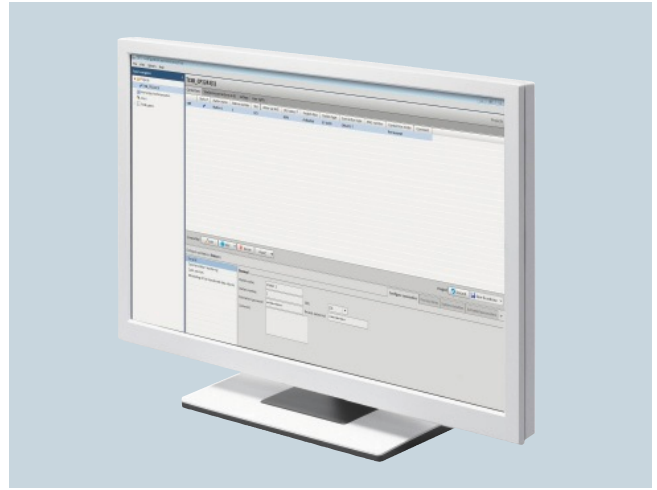

Reduced to the essentials

TeleControl Basic is especially suitable for cost-effective monitoring and control of remote plants, as well as for connecting mobile stations using mobile wireless. This tele-control system is ideal for applications with a low degree of automation, for example, for transmitting process data or for remote diagnostics and maintenance. Typical areas of application are found in the control of process plants, the optimization of public facilities for water/wastewater treatment, energy distribution, and traffic monitoring, as well as in facility management.

The TeleControl Basic system uses TeleControl Server Basic as the control center software. As an OPC UA server, it connects the HMI system (e.g. WinCC, PCS 7 or WinCC OA) to the RTUs.

TeleControl Server Basic allows the management of up to 5,000 outstations. It supports the connection of both modular RTUs based on SIMATIC S7-1200 and SIMATIC ET 200SP as well as the compact remote terminal units of the SIMATIC RTU3000C family. The system enables both remote communication with a control center, as well as direct communication between the SIMATIC remote terminal units.

Stationary or mobile RTUs at remote locations can be conveniently and easily configured with SIMATIC STEP 7 in the TIA Portal.

Plants in water, wastewater or environmental sectors	Centrally controlled facility management	Control and monitoring of traffic control systems	Consumption recording and cost control in power networks	Remote monitoring of machines and automation equipment	Monitoring of mobile stations	Other application options
e.g. <ul style="list-style-type: none"> ■ Hydroelectric power plants ■ Irrigation ■ Drinking water supply ■ Sewage systems ■ Level monitoring 	e.g. <ul style="list-style-type: none"> ■ Lighting ■ Heating ■ Consumption optimization 	e.g. <ul style="list-style-type: none"> ■ Traffic lights ■ Tunnel projects ■ Lighthouses ■ Traffic control systems 	e.g. <ul style="list-style-type: none"> ■ District heating networks ■ Wind power generation ■ Transformer stations ■ Biogas plants ■ Solar 	e.g. <ul style="list-style-type: none"> ■ Air-conditioning systems 	e.g. <ul style="list-style-type: none"> ■ Local public transport ■ Transport ■ Ships on rivers and in coastal areas 	e.g. <ul style="list-style-type: none"> ■ Greenhouses ■ Level measurement in silos

Typical applications for TeleControl Basic

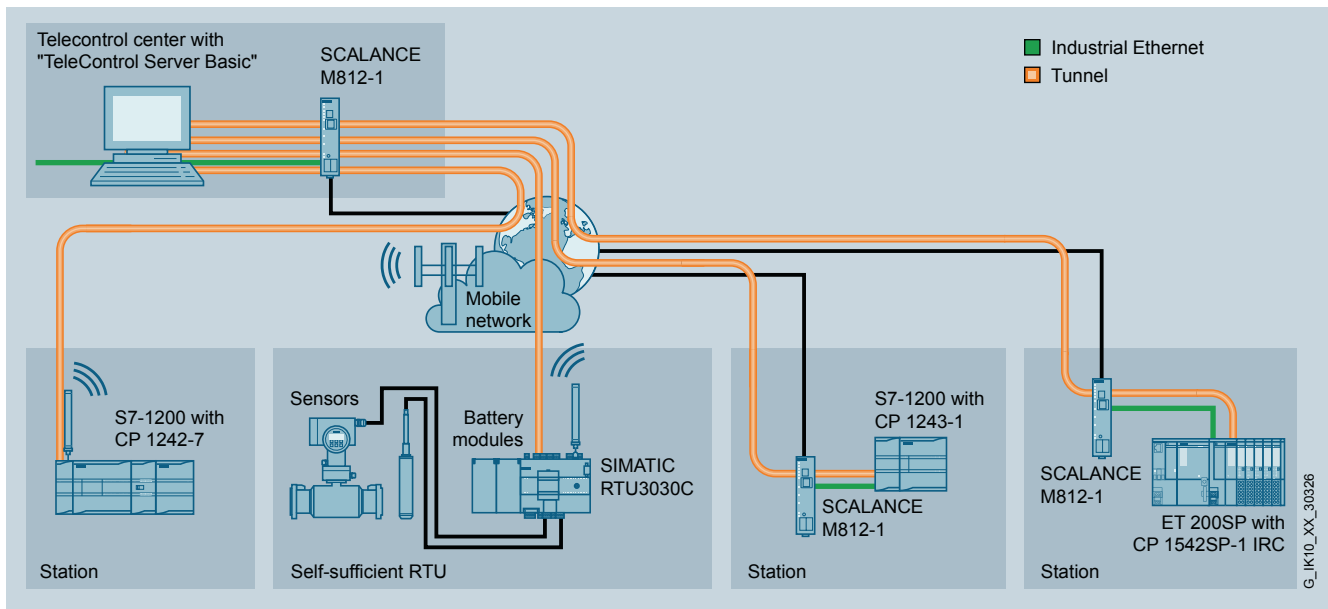

Connection of RTUs to TeleControl Server Basic via mobile wireless or Internet

Advantages of the TeleControl Basic system

- Scalable from a few to up to 5,000 outstations
- Use of the Internet and existing mobile wireless networks – even from different providers – in a single communication system
 - Low communication costs for permanent or on-demand mobile wireless connections due to economical volume tariffs
 - Permanent communication connection via mobile wireless in order to transmit data immediately and detect station failures
 - Service personnel alert via text message
 - TeleControl Server Basic also monitors temporary mobile connections, thereby ideally linking intermittently accessible units, such as the SIMATIC RTU3000C, to the control center.
- Easy configuration of modular SIMATIC RTUs with STEP 7 V15.1 in the TIA Portal
 - Full “data point configuration” for the entire application, i.e. RTU data relevant to the control center is selected via user-friendly “item browsing” in STEP 7. The cyclic or event-controlled transfer of measurements, setpoints or alarms can thus be implemented in only a few operations and without programming effort.
- Easy and convenient configuration of the remote terminal units by multiple users simultaneously with TeleControl Server Basic (multi-user capability)
- “Wake-up” function for stations (from standby mode to online mode) via text message or call
 - Secure authentication before using the wake-up function, for example with the CLIP function
- Maximum security: secured communication with RTUs via secured TeleControl Server Basic tunnel or SINEMA Remote Connect VPN tunnel
- Integrated Teleservice function
 - Remote maintenance and programming of the RTUs, even during operation
- Redundancy: TeleControl Server Basic can be operated redundantly to increase the availability of the automation data
 - If both PCs are located in the same LAN, no additional cabling is necessary for synchronizing the redundant software packages
 - Redundancy mode is possible under Windows Server 2016, 2012 R2 or 2008 R2.

Solutions for the control center

SINAUT ST7, IEC 60870-5 and DNP3

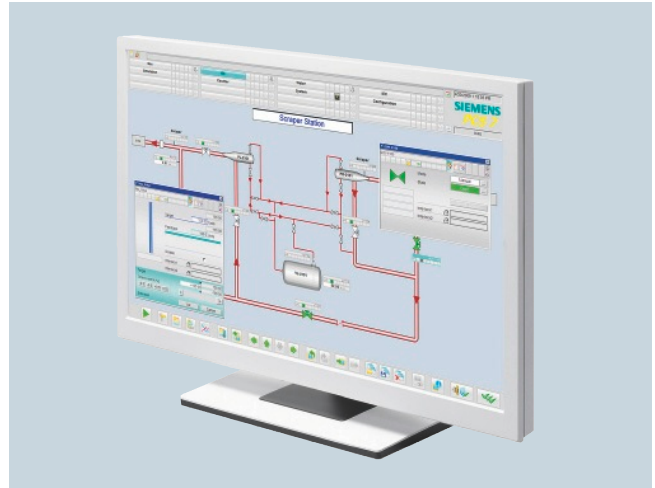
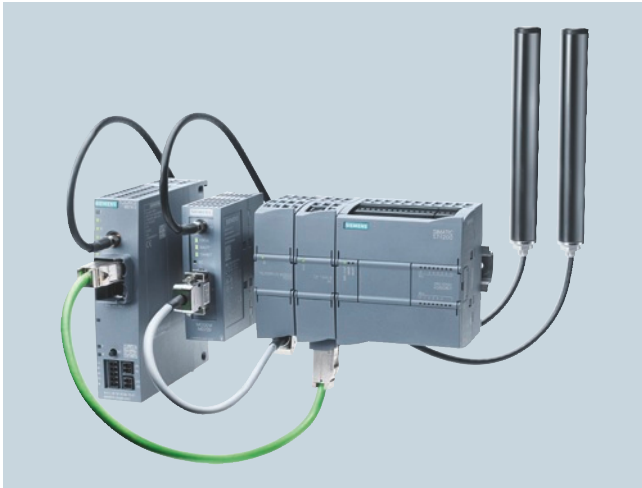

Keeping extensive process plants under control from a distance





Telecontrol systems based on SINAUT ST7, IEC 60870-5-101/104 and DNP3 enable the fully automated, efficient monitoring and control of extensive, remote process plants. The systems connect modular RTUs based on SIMATIC controllers (S7-1200 Basic Controllers, ET 200SP Distributed Controllers or S7-300/400 and S7-1500 Advanced Controllers) and compact RTUs to one or more process control centers. These can be built with single or redundant configurations based on WinCC, PCS 7, WinCC OA (Open Architecture) or SCADA systems from other vendors. Typical application areas are in the water/wastewater sector, the oil & gas industry, district heating and power distribution.

Depending on the type of control center (SCADA software), different control center software packages are used:

- SINAUT ST7cc for WinCC V7
- WinCC OA
- SIMATIC PCS 7 TeleControl and SIMATIC WinCC TeleControl

SINAUT ST7cc for WinCC V7

- Program package for connecting RTUs via SINAUT ST7 telecontrol protocol to a control center based on WinCC
- The process data of the RTUs can be transmitted to the archives made available by WinCC in accordance with the provided time stamp.
- Uses the same partner blocks as the subordinate remote terminal units for object communication (e.g. SEND, RECEIVE). This provides homogeneous and continuous communication engineering between the process and control system, saving time and money.

Water	Oil	Gas	Energy
			
e.g. <ul style="list-style-type: none"> ■ Drinking water supply ■ Water pipelines ■ Wastewater treatment plants ■ Sewage systems ■ Storm water overflow tanks 	e.g. <ul style="list-style-type: none"> ■ Drilling fields ■ Offshore/onshore ■ Oil pipelines ■ Production pipelines 	e.g. <ul style="list-style-type: none"> ■ Gas pipelines ■ Gas preparation ■ Gas supply networks 	e.g. <ul style="list-style-type: none"> ■ District heating ■ Power distribution

Possible Applications

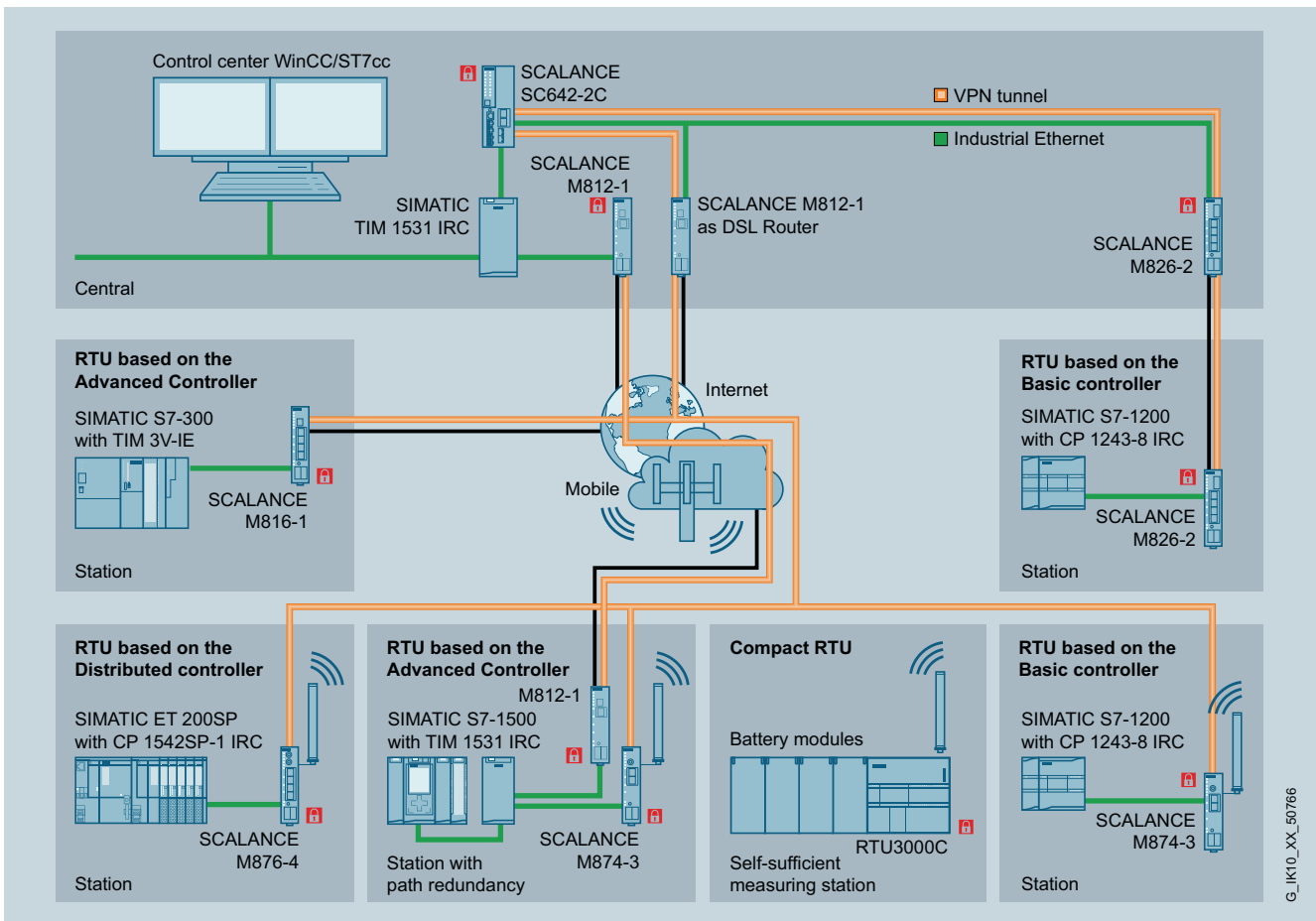

G_IK10_XX_50766

Wide range of transmission networks for connecting substations (RTUs) to the control center

WinCC OA

WinCC OA is a SCADA system for visualizing and operating processes. Single or redundant multi-user systems can be coupled as a distributed system, thus enabling complex control system structures to be built. It features protocol interfaces for SINAUT ST7, DNP3 and IEC 60870-5.

SIMATIC PCS 7 TeleControl and SIMATIC WinCC/TeleControl

- Based on PCS 7 or WinCC which are supplemented with telecontrol connections using various telecontrol protocols such as SINAUT ST7, DNP3 or IEC 60870-5.
- The engineering system is based on DBA technology (Data Base Automation) and features a comprehensive block library that also allows third-party RTUs to be connected.

Connection to control systems from other vendors

Using the SINAUT ST7sc program package with OPC interface, the remote terminal units can also be linked to control systems from other vendors with SINAUT ST7. ST7sc has complex buffer mechanisms which prevent data loss, even if the OPC client fails. All process data is delivered with a time stamp, and configuration of the OPC interface is very user-friendly.

Remote terminal units with standard protocols such as DNP3 or IEC 60870-5 can be connected directly to any control system, provided it has an appropriate master interface.

Transmission networks to match requirements

The control center is connected with the remote terminal units via WAN (Wide Area Network). The telecontrol protocols offer enormous versatility in the choice of the transmission network.

- Dedicated lines (copper and fiber-optic cables)
- Private wireless networks
- Ethernet wireless
- Wireless via Industrial Wireless LAN
- Long distances via fiber-optic cable
- Connection to public networks such as Internet and mobile wireless

The networks can be optimally adapted to prevailing local conditions. Redundant transmission paths can be implemented, meaning a remote terminal unit can be connected to the control center via two networks, for example.

Solutions for the control center

SINAUT ST7, IEC 60870-5 and DNP3

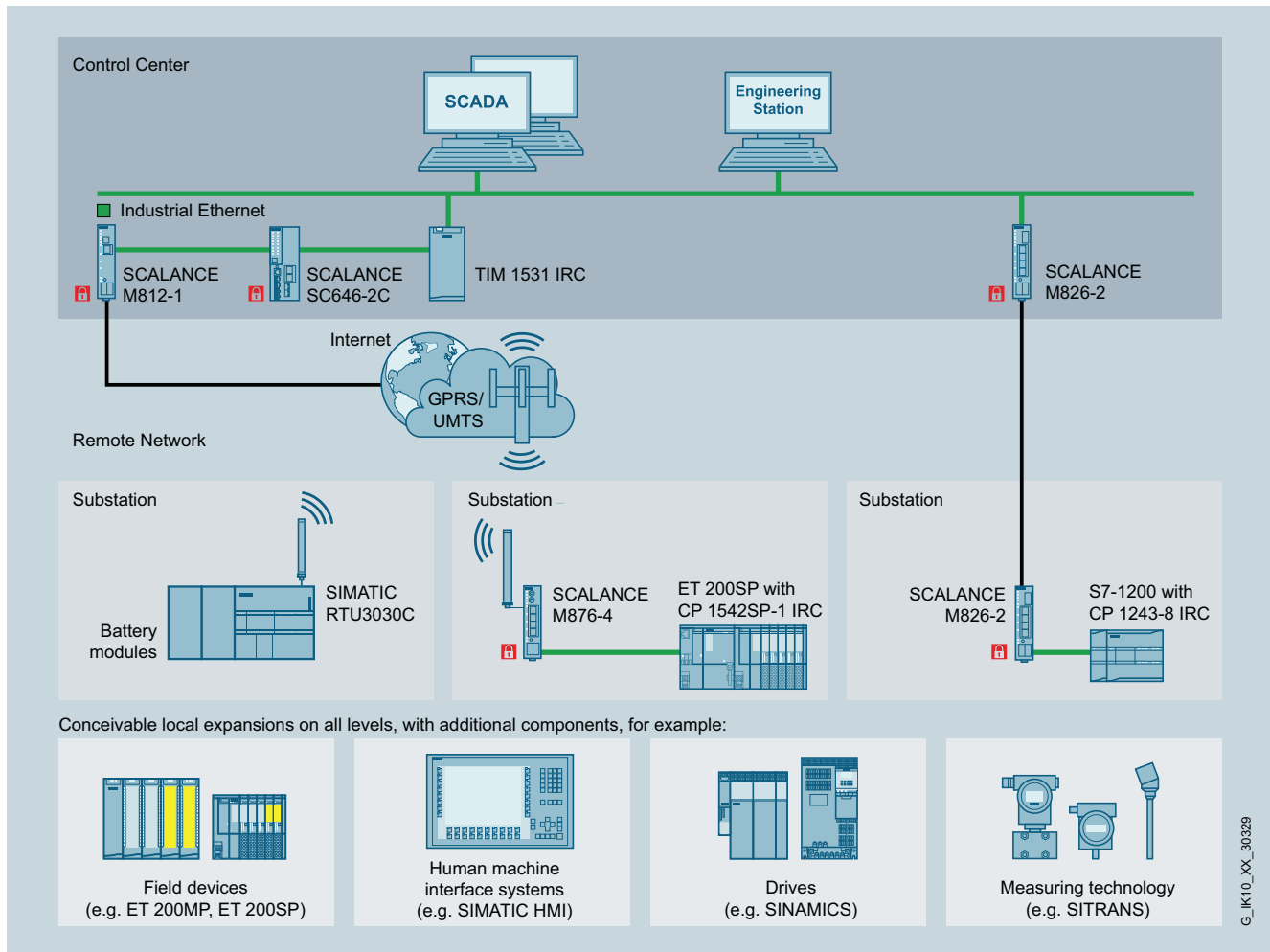

Wide range of communication options via WAN using the example of a PCS 7 TeleControl control center

Advantages

High data security

Measures to prevent data corruption or loss are essential components of telecontrol solutions based on SINAUT ST7, IEC 60870-5 and DNP3. The telecontrol protocols ensure that data reach the partner uncorrupted. Transmission path downtimes are bridged by data buffers in the RTUs. IP-based networks are protected through dedicated VPN solutions/firewalls.

Fully automatic time stamp

To enable subsequent and correct archiving of process data in the control system, all data telegrams are assigned with a time stamp at their place of origin. The entire network is synchronized automatically – including the daylight-saving-related changeovers.

Fast and flexible data communication

Communication is event-controlled. This means that operators are quickly alerted through alarms, states and values from the

process, and they can then influence process control at any time by entering commands or setpoints. At the same time, staff can be notified about new events via text messages. Direct data exchange between the remote terminal units is also possible.

Simple and cost-effective engineering

Telecontrol systems facilitate integrated communications concepts and full integration into the SIMATIC environment. The STEP 7 engineering system is based on SIMATIC tools and permits graphic configuration of complete communication networks, multiple addressing of process data, validity checks, and address comparisons.

Remote programming, remote diagnostics

Program modifications or remote diagnostics in the RTUs are easy to carry out in the communication network, both in the commissioning phase and during operation. This is even possible without interrupting the current process data communication. This saves on-site maintenance and the associated traveling times.

Migration strategy

Investment in the future

Systems and plants need to be constantly expanded and modernized by plant operators to meet customer requirements over the long-term. Since the installed base of hardware, communication networks, application software and know-how of the operating and maintenance personnel represents enormous value, investment security is always of great importance.

To ensure that a migration is successful, the new solution must be future-oriented and optimally adapted to the respective plant, and devised in close cooperation with the plant operators and their system integrators. The foundation is formed by the current telecontrol components for compact and modular RTUs based on the current SIMATIC Controllers, as well as control center software for HMI and SCADA systems. Due to their modular design, they can be flexibly adapted to the realities of the plant and the process requirements, enabling step-by-step system innovation.

A variety of migration scenarios is possible, depending on the specific technical and economical factors of the migration project.



Scenario 1

Replacement of existing operator control and monitoring (HMI) systems by a WinCC/PCS 7 control center

A technically outdated HMI system or its operating system no longer conforms to the latest workplace guidelines and standards or it needs functional enhancements. It can be easily replaced by a new SIMATIC WinCC, PCS 7 or WinCC OA system and adapted to the latest requirements without having to change subordinate systems. Remote terminal units, process I/O, communication networks and application software are retained.

Advantages

- Minimization of costs and risk
- Extension of complete plant lifecycle and opening for new applications or the IT world

Scenario 2

Expansion of an existing plant

The existing plant is retained, but supplemented and modernized by further process stations, subnets or communication media.

Advantages

- Simple, step-by-step expansion of plant capacity
- Manageable risk
- Introduction of new technologies (e.g. HMI, Industrial Ethernet, DSL, mobile wireless, etc.)

Scenario 3

Comprehensive modernization

Bottlenecks in the supply of spare parts, decreasing support, or the need for functional extensions can also force extensive modernization of an old plant with future-oriented telecontrol systems together with SIMATIC control systems. Conversion is usually possible during normal operation. The re-use of the existing I/O level (sensor systems) is supported and the investment in installation, hardware or application engineering is secured.

Advantages

- Increase in performance
- Introduction of new technologies (e.g. HMI, Industrial Ethernet, DSL, mobile wireless, etc.)
- Extension of complete plant lifecycle and opening for new applications or the IT world
- Elimination of bottlenecks and dependencies



Solutions for remote terminal units

SIMATIC RTU3000C – the compact, self-sufficient RTUs

The compact SIMATIC RTU3000C remote terminal units can monitor measuring points even in locations where no local power grid is available. The RTUs are powered by up to six battery modules, or an accumulator combined with a solar panel. Typical applications are leak detection, monitoring of pumping stations and water reservoirs, remote monitoring of liquid levels in tanks and silos, monitoring of agricultural irrigation systems, level monitoring of standing and flowing waters, flood protection and position detection, e.g. of buoys.

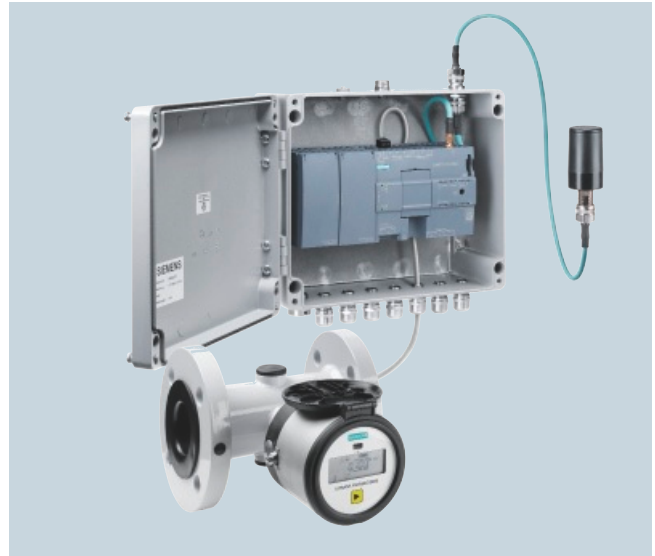
The RTUs record measurement data from connected sensors and transmit the data to individual users or a control center via mobile wireless. The RTU3031C also offers GPS positioning. If defined threshold values are exceeded, the RTUs immediately notify the service personnel via an e-mail or text message alert, enabling them to respond quickly to extraordinary events. The devices feature integrated inputs and outputs. With an extension board, an additional eight sensors can be connected via Modbus RTU¹⁾.



			
	SIMATIC RTU3010C	SIMATIC RTU3030C	SIMATIC RTU3031C
Telecontrol protocols	DNP3, IEC 60870-5-104, TeleControl Basic, SINAUT ST7		
Communication	Any IP-based network via external router, such as SCALANCE M	2G, 3G via integrated modem or external router	2G, 3G via integrated modem or external router; GPS reception
Inputs/outputs	- 8 digital inputs (DI), of which 2 frequency counters - 4 digital outputs (DO) - 4 analog inputs (AI) (8 additional DI for Modbus RTU ¹⁾ with extension board		- 8 digital inputs (DI), of which 2 frequency counters - 8 digital outputs (DO) - 4 analog inputs (AI) (8 additional DI for Modbus RTU ¹⁾ with extension board
Power supply	Freely combinable: 12 ... 24 V DC - 2 x 3 redundant battery modules - Accumulator with solar panel		
Temperature range	-40 ... +70 °C		
Degree of protection	IP20 (IP68 with external enclosure)		
Security	Encrypted e-mail connection, TeleControl Server Basic tunnel, OpenVPN, VPN connection to SINEMA Remote Connect via auto configuration		
Alarm messages	Text message/e-mail alerts		
Configuration	Local and remote via Web-based management		

¹⁾ HART available soon

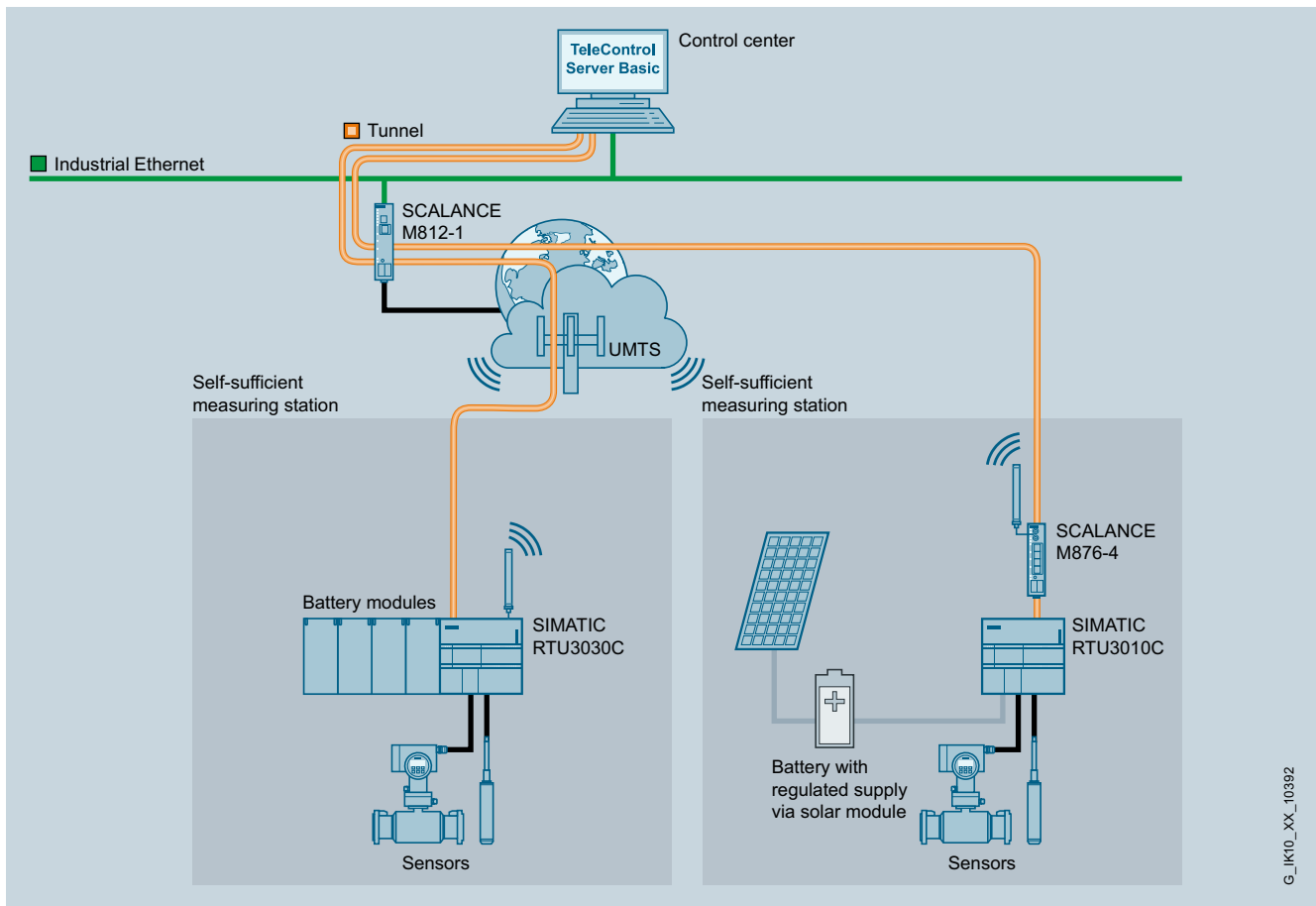

Connection of measuring points with RTU3000C to TeleControl Server Basic

Operating modes

The compact SIMATIC RTUs support four operating modes. This means they only consume power when the application demands it:

Sleep mode

- Power consumption below 2 milliwatts (mW), operation possible over period of several years
- Immediate notification of alarms via e-mail or text message when threshold exceeded
- RTU counts pulses

Update mode

- Retrieval and processing of current process values from connected sensors
- Enabling and disabling of connected devices to save energy

Communication mode

- Establishes communication link to the control center independently
- Transmission of last buffered process values including time stamp

Service mode

- Enables battery replacement without data loss

Advantages of the compact SIMATIC RTUs

- Flexible power supply concept: battery, accumulator with solar panel or 12–24 volt power connection – freely combinable
- Consumption-optimized low-power operation enables battery operation over several years
- Extended temperature range from -40 to +70 °C
- Secured communication
- Communication can be individually configured (time or event-driven)
- Web server on board: convenient configuration via web browser, also remotely
- Data buffering of process values with time stamps ensures a consistent database even with temporary connection failures
- Use as a data logger
- Support of various protocols: TeleControl Basic, SINAUT ST7, DNP3 and IEC 60870-5-104
- External enclosure provides additional protection in accordance with IP68 degree of protection

Solutions for remote terminal units





Modular RTUs with SIMATIC S7-1200 Basic Controller

Modular remote terminal units based on SIMATIC S7-1200 are suited for applications with a low degree of automation. These inexpensive devices are characterized by their small, compact hardware design. They can communicate with telecontrol centers over various telecontrol protocols using communication processors (CPs). The CPs enable cyclical and event-driven transmission of measured values, count values and setpoints, as well as commands and alarms, between the remote terminal unit and the control center. The CPs not only enable smooth data transfer, they also offer comprehensive diagnostic options for quick and informed analysis of the station status.

Advantages of SIMATIC S7-1200 RTUs

- Buffer for several thousand data values with time stamps to bridge transmission link downtimes
- The operating personnel is notified immediately via e-mail or user-specific text message alerts about process statuses and values
- Simple and cost-effective engineering: configuration is performed in a few simple steps, without any programming effort
- Less on-site maintenance and travel costs due to cost-effective remote programming, diagnostics, control and monitoring via the Internet



				
	CP 1242-7 GPRS	CP 1243-7 LTE	CP 1243-1	CP 1243-8 IRC
Telecontrol protocols	TeleControl Basic	TeleControl Basic	TeleControl Basic, DNP3 and IEC 60870-5-104	SINAUT ST7, DNP3 and IEC 60870-5-104
X1 interface	GSM (850 MHz, 900 MHz, 1 800 MHz, 1 900 MHz)	LTE (800 MHz, 1 800 MHz, 2 600 MHz)	Industrial Ethernet (1 x RJ45)	Industrial Ethernet (1 x RJ45) ¹⁾
Temperature range	-20 ... +70 °C			
Data buffering for temporary connection failures	Up to 64,000 data points	Up to 64,000 data points	Up to 64,000 data points (TeleControl Basic, DNP3 or IEC 60870-5-104)	Up to 64,000 data points (DNP3 or IEC 60870-5-104), up to 16,000 data telegrams (ST7)
Alarm messages	Text message/e-mail alerts			
Security	-	Firewall/VPN	Firewall/VPN	Firewall/VPN
Configuration	STEP 7 Basic V14 SP1 or higher	STEP 7 Basic V14 SP1 or higher	STEP 7 Basic V14 SP1 or higher	STEP 7 Professional V14 SP1 or higher plus SINAUT ES
Connection to SINEMA Remote Connect	-	Yes	Yes	Yes

¹⁾ Can be extended with an additional interface by a teleservice module (RS-232, analog dial-up modem, and ISDN)

Modular RTUs with SIMATIC ET 200SP Distributed Controller

Modular RTUs based on the SIMATIC ET 200SP Distributed Controller deliver convincing results thanks to their particularly compact design and impressive performance. They can communicate with a telecontrol center using a range of different telecontrol protocols by means of a CP 1542SP-1 IRC communication processor, thus allowing the benefits of the SIMATIC ET 200SP system to also be used in telecontrol applications.

Advantages of SIMATIC ET 200SP RTUs

- Compact, modular system allows flexible configuration of application-specific RTUs
- Interface to control center via a range of different telecontrol protocols: TeleControl Basic, DNP3, IEC 60870-5-104 or SINAUT ST7
- Quick commissioning thanks to simple configuration in TIA Portal
- Cyclic and/or event-driven transmission of data
- Alerts for pre-defined events via e-mail or text message
- Complete storage of all measured values with time stamp to prevent data loss
- Comprehensive diagnostic options, either locally via LED error messages, in the TIA Portal engineering tool, or via a web server
- Less on-site maintenance and travel costs thanks to remote programming, diagnostics, control and monitoring via the Internet

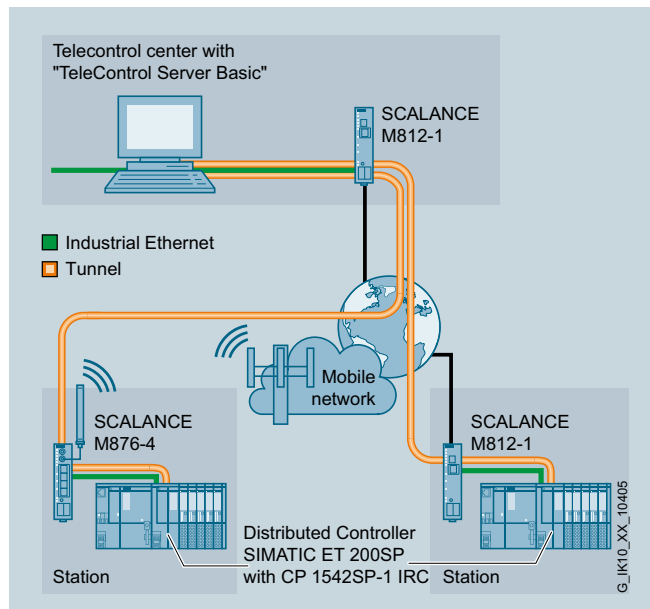
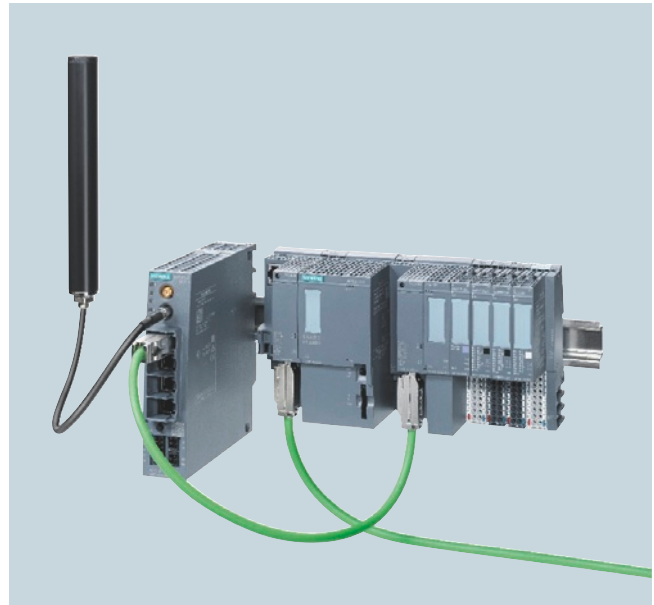

Connection of RTUs based on SIMATIC ET 200SP to TeleControl Server Basic via mobile wireless or Internet

Solutions for remote terminal units

Modular RTUs with SIMATIC S7-1500 Advanced Controller

RTUs based on the SIMATIC S7-1500 Advanced Controller deliver convincing results and the highest levels of performance and flexibility. They can be connected to a control center via the Telecontrol Interface Module TIM 1531 IRC using the SINAUT ST7, DNP3 or IEC 60870-5 telecontrol protocols. The TIM module can also be used both as node and as master station. RTUs based on SIMATIC S7-1500 are particularly suited to complex telecontrol applications, such as in widely dispersed sewage systems, drinking water supplies or district heating systems, as well as in oil extraction and gas supply, power distribution and traffic engineering.

Advantages of SIMATIC S7-1500 RTUs

- Expansion of existing telecontrol systems with SIMATIC S7-1500 stations
- Use as master station or node station possible
- Path redundancy offers high availability even when the primary connection fails
- Central and convenient engineering of the telecontrol network in the TIA Portal saves time and money
- Extensive diagnostic functions including logging of data

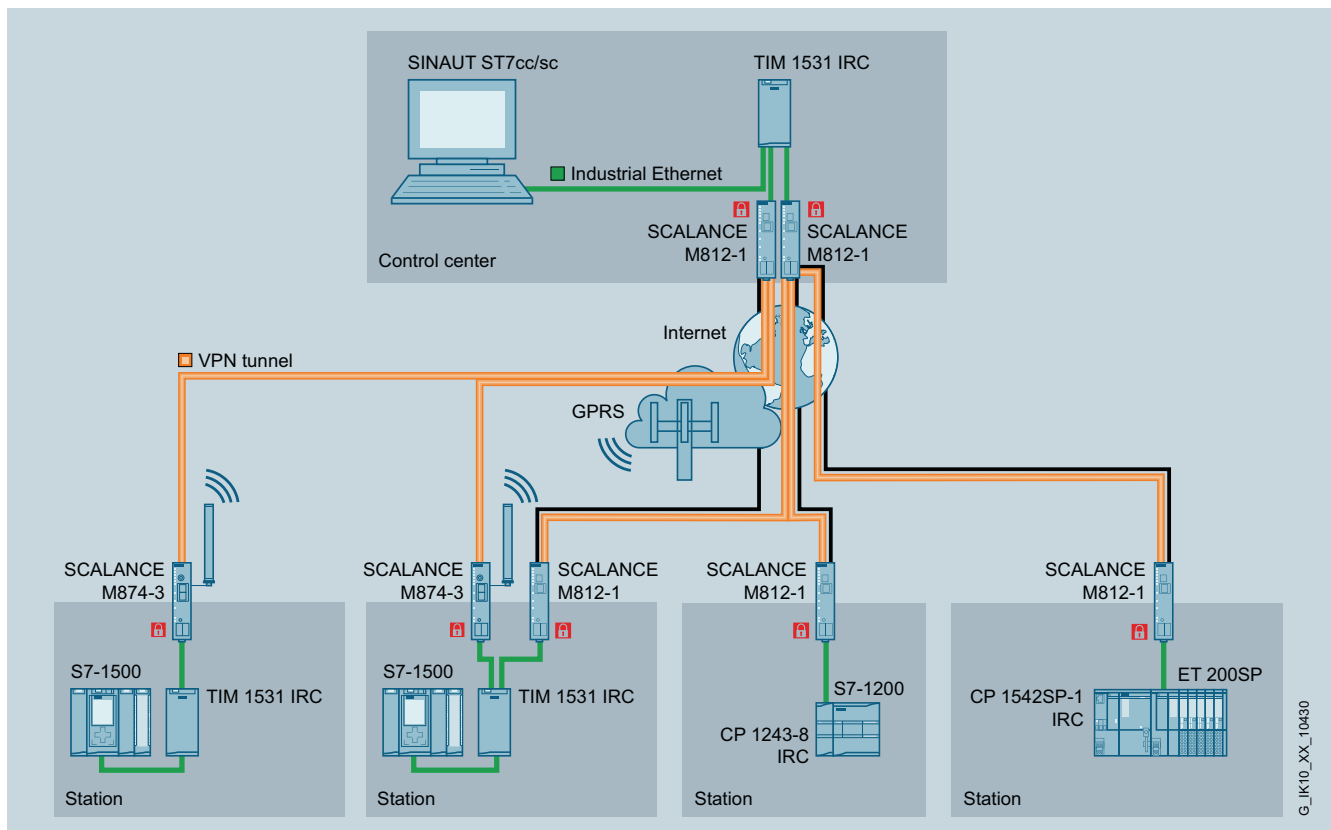

G_IK10_XX_10430

Connection of RTUs based on SIMATIC S7-1500 with TIM 1531 IRC to a telecontrol center



Modular RTUs with SIMATIC S7-400

Modular RTUs based on SIMATIC S7-400 are particularly suitable for complex process plants. Telecontrol Interface Modules (TIMs) are used for the connection to the control center. They enable reliable transmission of control and process data. SINAUT ST7 or DNP3 can be used as communication protocols. TIMs also offer flexible connection options for external modems.

Advantages of SIMATIC S7-400 RTUs

- Telegram buffer for continuous recording of data including time stamp on the TIM if the communication path is faulty or a communication partner is missing, and to reduce connection costs for the dial-up network
- Simple configuration and operation without specialist IT knowledge
- IP communication via encrypted connections
- TIM modules also allow node stations to be set up for structuring the telecontrol application
- Flexible connections options to any IP-based or conventional WAN
- TIM 4R-IE facilitates various transmission paths that can all be different and operated independent of one another – but also in any redundant combination.



			
	TIM 1531 IRC	TIM 4R-IE	TIM 4R-IE DNP3
Telecontrol protocols	SINAUT ST7, DNP3, IEC 60870-5 ¹⁾	SINAUT ST7	DNP3
Interfaces	1 x serial (RS-232 & RS-485) 3 x Industrial Ethernet (RJ45)	2 x serial (RS-232, RS-485) 2 x Industrial Ethernet (RJ45)	2 x serial (RS-232, RS-485) 2 x Industrial Ethernet (RJ45)
Temperature range	0 °C ... +60 °C		
Data buffer for temporary connection failures	Up to 100,000 telegrams (ST7) Up to 250,000 data points (DNP3, IEC)	Up to 56,000 telegrams	Up to 200,000 data points
Application	As outstation, node station or control center		
RTU station type	S7-1500, S7-300, S7-400	S7-300, S7-400	S7-300, S7-400
Alarm messages	E-mail	-	-
Configuration	TIA Portal V14 SP1 or higher	STEP 7 V5.x plus SINAUT ES or TIA Portal V14 SP1 or higher	STEP 7 V5.x plus SINAUT ES or TIA Portal V14 SP1 or higher

¹⁾ With firmware version V2.0 and TIA Portal V15.1

Additional information

Everything you need to know about Industrial Remote Communication/Telecontrol:

www.siemens.com/industrial-remote-communication

www.siemens.com/telecontrol

www.siemens.com/compact-rtu

www.siemens.com/pcs7

Siemens AG
Digital Industry
Process Automation
Postfach 48 48
90026 Nuremberg
Germany

© Siemens AG 2018
Subject to change without prior notice
Article No. 6ZB5530-1SA02-0BA8
IC-FPN9Z-DIPAP-XXXX-12 / Dispo 26000
BR 1118 3.5 ROT 16 En
Printed in Germany

The information provided in this brochure contains merely general descriptions or characteristics of performance which in case of actual use do not always apply as described or which may change as a result of further development of the products.

An obligation to provide the respective characteristics shall only exist if expressly agreed in the terms of contract. Availability and technical specifications are subject to change without notice.

All product designations may be trademarks or product names of Siemens AG or supplier companies whose use by third parties for their own purposes could violate the rights of the owners.

Security information

Siemens provides products and solutions with industrial security functions that support the secure operation of plants, systems, machines and networks.

In order to protect plants, systems, machines and networks against cyber threats, it is necessary to implement – and continuously maintain – a holistic, state-of-the-art industrial security concept. Siemens' products and solutions constitute one element of such a concept.

Customers are responsible for preventing unauthorized access to their plants, systems, machines and networks. Such systems, machines and components should only be connected to the enterprise network or the Internet if and to the extent such a connection is necessary and only when appropriate security measures (e.g. firewalls and/or network segmentation) are in place.

For additional information on industrial security measures that may be implemented, please visit:

<https://www.siemens.com/industrialsecurity>.

Siemens' products and solutions undergo continuous development to make them more secure. Siemens strongly recommends that product updates are applied as soon as they are available and that the latest product versions are used. Use of product versions that are no longer supported, and failure to apply the latest updates may increase customer's exposure to cyber threats.

To stay informed about product updates, subscribe to the Siemens Industrial Security RSS Feed under:

<https://www.siemens.com/industrialsecurity>