

# RE3 UHF Wireless

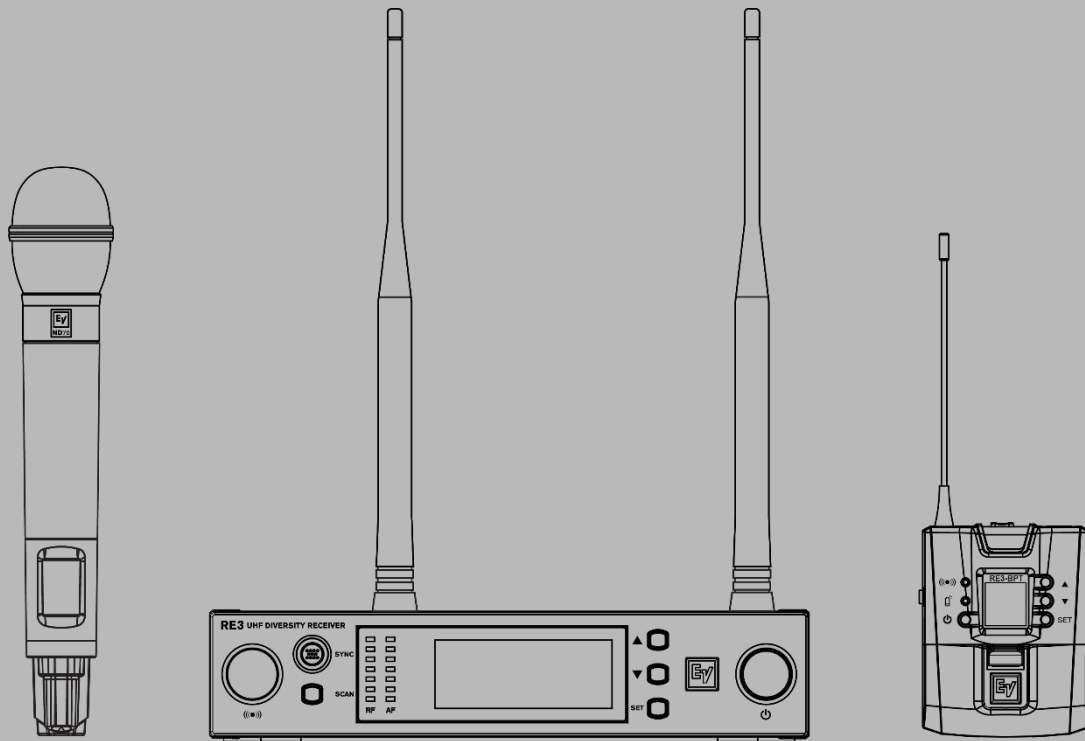





---

# Table of contents

<b>Table of contents</b>	<b>3</b>
<b>1 Safety, precautions, and notices</b>	<b>4</b>
1.1 Important safety instructions	4
1.2 Battery precautions	5
1.3 Notices	5
1.4 Licensing, certifications, restrictions and manufacturers declarations	6
<b>2 Short information</b>	<b>9</b>
2.1 Shipping contents	10
<b>3 Description</b>	<b>11</b>
<b>4 Glossary of terms</b>	<b>13</b>
<b>5 Best practices for successful operation</b>	<b>15</b>
<b>6 Quick setup</b>	<b>17</b>
6.1 Preparing the receiver	17
6.2 Preparing the transmitter	17
6.3 Sync the transmitter to the receiver	17
6.4 Ensure transmitter input sensitivity is set for best signal level	17
<b>7 RE3-RX receiver</b>	<b>19</b>
7.1 Product identification	19
7.2 LCD display	22
7.3 RE3-RX setup menu	22
<b>8 RE3-HHT handheld transmitter</b>	<b>36</b>
8.1 Product identification	36
8.2 LCD display	38
8.3 Installing batteries	39
8.4 RE3-HHT setup menu	39
<b>9 RE3-BPT bodypack transmitter</b>	<b>41</b>
9.1 Product identification	42
9.2 LCD display	44
9.3 Installing batteries	44
9.4 RE3-BPT Setup Menu	45
<b>10 Accessories for RE3</b>	<b>48</b>
<b>11 Troubleshooting and FAQ</b>	<b>50</b>
11.1 Troubleshooting	50
11.2 Frequently Asked Questions	54
<b>12 Technical data</b>	<b>58</b>
<b>13 Frequency Group / Channel Tables</b>	<b>67</b>

# 1 Safety, precautions, and notices

## 1.1 Important safety instructions

 <p><b>WARNING:</b> TO REDUCE THE RISK OF FIRE OR ELECTRIC SHOCK, DO NOT OVEREXPOSE THIS APPLIANCE TO RAIN OR MOISTURE</p> <p><b>AVIS:</b> RISQUE DE CHOC ELECTRIQUE, NE PAS OUVRIR.</p> <p><b>WARNING:</b> THE MAINS PLUG OR DC INLET IS USED AS A DISCONNECT DEVICE. THE DISCONNECT DEVICE SHALL REMAIN READILY OPERABLE.</p> <p><b>WARNING:</b> CONNECT ONLY TO MAINS SOCKET WITH PROTECTIVE EARTHING CONNECTION.</p> <p><b>WARNING:</b> TO REDUCE THE RISK OF ELECTRIC SHOCK, DO NOT REMOVE COVER (OR BACK) AS THERE ARE NO USER-SERVICABLE PARTS INSIDE. REFER SERVICING TO QUALIFIED PERSONNEL.</p>		<p>The exclamation point within an equilateral triangle is intended to alert the user to the presence of important operating and maintenance (servicing) instructions in the literature accompanying the appliance.</p>
--	---	---

1. Read these instructions.
2. Keep these instructions.
3. Heed all warnings.
4. Follow all instructions.
5. Do not use this apparatus near water.
6. Clean only with a dry cloth.
7. Do not block any ventilation openings. Install in accordance with the manufacturer's instructions.
8. Do not install near any heat sources such as radiators, heat registers, stoves, or other apparatus (including amplifiers) that produce heat.
9. Do not defeat the safety purpose of the polarized or grounding-type plug where present. A polarized plug has two blades with one wider than the other. A grounding type plug has two blades and a third grounding prong. The wide blade or the third prong is provided for your safety. If the provided plug does not fit into your outlet, consult an electrician for replacement of the obsolete outlet.
10. Protect the power cord from being walked on or pinched particularly at plugs, convenience receptacles, and the point where they exit from the apparatus.
11. Only use attachments/accessories specified by the manufacturer.
12. Unplug the apparatus during lightning storms or when unused for long periods of time.
13. Refer all servicing to qualified service personnel. Servicing is required when the apparatus has been damaged in any way, such as power-supply cord or plug is damaged, liquid has been

spilled or objects have fallen into the apparatus, the apparatus has been exposed to rain or moisture, does not operate normally, or has been dropped.

14. No naked flame sources, such as lighted candles, should be placed on the apparatus.
15. To reduce the risk of fire or electric shock, do not expose this apparatus to rain or moisture. The apparatus should not be exposed to dripping or splashing. Objects filled with liquids, such as vases or open beverage containers should not be placed on apparatus.
16. To completely disconnect DC power from this apparatus, the DC power supply cord must be unplugged from the apparatus, or the apparatus' external power supply must be unplugged from the AC socket.
17. To completely disconnect AC power from this apparatus' external power supply, the power supply plug must be unplugged at the AC socket.

## 1.2 Battery precautions



Keep batteries out of the reach of children.

Observe and install batteries according to the correct polarity as marked on the battery and the transmitter battery compartment.

Do not expose the battery to excessive heat such as sunshine, fire, or other sources of high heat. Always consider the environment issues and follow local regulations when disposing of batteries. Remove depleted battery immediately.

Danger of explosion if battery is incorrectly replaced. Replace only with the same or equivalent type.

Use only disposable LR6(AA) alkaline or NiMH batteries.

Do not mix new batteries with old ones in the transmitter at the same time.

Do not use different battery types or models.

Do not use a leaking battery. If battery leakage occurs, avoid contact with skin. If contact occurs, immediately wash thoroughly with soap and water.

If battery leakage comes into contact with your eyes, immediately flush with water and seek medical attention.

Remove and safely store batteries away from the transmitter when the transmitter will not be used for 60 or more days.

## 1.3 Notices



### Old electrical and electronic appliances

Electrical or electronic devices that are no longer serviceable must be collected separately and sent for environmentally compatible recycling (in accordance with the European Waste Electrical and Electronic Equipment Directive). To dispose of old electrical or electronic devices, you should use the return and collection systems put in place in the country concerned.

### Copyright and disclaimer

All rights reserved. No part of this document may be reproduced or transmitted in any form by any means, electronic, mechanical, photocopying, recording, or otherwise, without the prior written permission of the publisher. For information on getting permission for reprints and excerpts, contact Electro-Voice. All content including specifications, data, and illustrations in this manual are subject to change without prior notice.

## 1.4 Licensing, certifications, restrictions and manufacturers declarations

Regarding handheld transmitters RE3-HHT-5L (480-524 MHz), RE3-HHT-5H (560-596 MHz), RE3-HHT-6M (653-663 MHz), and bodypack transmitters RE3-BPT-5L (480-524 MHz), RE3-BPT-5H (560-596 MHz), and RE3-BPT-6M (653-663 MHz):

### 1.4.1 FCC information



Certified under FCC Part 15 and FCC Part 74.

FCC ID: B5DH2285L, B5DH2285H, B5DH2286M, B5DB1245L, B5DB1245H, B5DB1246M.

NOTE: Regarding RE3-HHT-6M (653-663 MHz) and RE3-BPT-6M (653-663 MHz); use of frequencies beginning at 653.000 MHz up to 657.000 MHz is covered under FCC Part 74 ID numbers B5DH2286M and B5DB1246M, and require an LPAS user license, however use of frequencies between 657.025 up to 663.000 MHz is covered under FCC Part 15, and do not require an additional user license. For more information, see <https://www.fcc.gov/consumers/guides/operation-wireless-microphones>.

#### FCC Supplier's Declaration of Conformity

47 CFR, Section 2.1077 Compliance Information

##### Product Identifier:

Electro-Voice:  
RE3 Wireless Receiver, AASP Active Antenna Splitter, ALPA Active  
Log Periodic Antenna, RFAMP Antenna Booster, BC2 Battery Charger

##### Responsible Party – U.S. Contact Information

Bosch Security Systems, Inc.  
130 Perinton Parkway  
Fairport, NY 14450  
USA  
Tel: +1 (585) 223-4060

##### FCC Compliance Statement

This device complies with Part 15 of the FCC Rules. Operation is subject to the following two conditions: (1) This device may not be cause harmful interference, and (2) this device must accept any interference received, including interference that may cause undesired operation.

**CAUTION:** Changes or modification made by the user could void the user's authority to operate the equipment.

This equipment has been tested and found to comply with the limits for a Class B digital device, pursuant to Part 15 of the FCC Rules. These limits are designed to provide reasonable protection against harmful interference in a residential installation. This equipment generates, uses, and can radiate radio frequency energy and, if not installed and used in accordance with the instructions, may cause harmful interference to radio communications. However, there is no guarantee that interference will not occur in a particular installation. If this equipment does cause harmful interference to radio or television reception, which can be determined by turning the equipment off and on, the user is encouraged to try to correct the interference by one or more of the following measures:

- Reorient or relocate the receiving antenna.
- Increase the separation between the equipment and the receiver.
- Connect the equipment to an outlet on a circuit different from that to which the receiver is connected.
- Consult the dealer or an experienced radio/TV technician for help.

### 1.4.2 IC (Industry Canada)

Certified in Canada by IC under RSS-102, and RSS-210, and RSS-Gen

IC: 1321A-RE3HHT488, 1321A-RE3HHT560, 1321A-RE3HHT653, 1321A-RE3BPT488, 1321A-RE3BPT560, 1321A-RE3BPT653.

This Class B digital apparatus complies with Canadian ICES-003. Cet appareil numérique de la classe B est conforme à la norme NMB-003 du Canada.

This device complies with Industry Canada license-exempt RSS standard(s). Operation is subject to the following two conditions:

- (1) This device may not cause interference, and
- (2) This device must accept any interference, including interference that may cause undesired operation of the device.

Le présent appareil est conforme aux CNR d'Industrie Canada applicables aux appareils radio exempts de licence. L'exploitation est autorisée aux deux conditions suivantes :

- (1) l'appareil ne doit pas produire de brouillage, et
- (2) l'utilisateur de l'appareil doit accepter tout brouillage radioélectrique subi, même si le brouillage est susceptible d'en compromettre le fonctionnement.

NOTE: Regarding RE3-HHT-6M (653-663 MHz) and RE3-BPT-6M (653-663 MHz); the use of frequencies between 653.025 up to 663.000 MHz, please check the Canada's ISED (Innovation, Science and Economic Development) website for the current information of the license status of this band.

### 1.4.3 Licensing information

Licensing: A ministerial license to operate this equipment may be required in certain areas.

Consult your national authority for possible requirements. Changes or modifications not expressly approved by Electro-Voice could void your authority to operate the equipment. Licensing of Electro-Voice wireless microphone equipment is the user's responsibility, and licensability depends on the user's classification and application, and upon the selected frequencies on which it will operate. Electro-Voice advises the user to contact the appropriate telecommunications authority concerning proper licensing, and before selecting and ordering frequency bands.

### 1.4.4 EU (European Union)

The CE Declaration of Conformity can be obtained and downloaded from: [www.electrovoice.com](http://www.electrovoice.com)

This Equipment is in compliance with the following directives:

- 2011/65/EU RoHS Directive
- 2012/19/EU WEEE Directive
- 2014/53/EU RED Directive

Regarding (applies to) handheld transmitter RE3-HHT-5L (480-524 MHz), RE3-HHT-5H (560-596 MHz), RE3-HHT-6M (653-663 MHz), RE3-HHT-8M (823-865 MHz), and bodypack transmitter RE3-BPT-5L (480-524 MHz), RE3-BPT-5H (560-596 MHz), RE3-BPT-6M (653-663 MHz), and RE3-BPT-8M (823-865 MHz):

This equipment is intended for use in wireless microphone applications.

Some countries in the EEA (European Economic Area) have restrictions placed on this equipment. If an EEA country is not listed it did not have any restrictions of the product at the time this document was published.

The country codes used in regard to these restrictions are the following:

Austria (AT), Belgium (BE), Cyprus (CY), Denmark (DK), Germany (DE), Greece (EL), Spain (ES), Ireland (IE), Iceland (IS), Latvia (LV), Lithuania (LT), Malta (MT), Norway (NO), Slovakia (SK), Sweden (SE) and United Kingdom (UK).

Listed below are these restrictions:

- Transmitters in the ranges, 488 – 524 MHz, 560 – 596 MHz and 653 – 663 MHz, require a license in the following countries: AT, BE, CY, DE, IE, LV, LT, SK, SE, UK.
- Transmitters in the ranges, 488 – 524 MHz, 560 – 596 MHz and 653 – 663 MHz, require the transmitter be used in TV white spaces: AT, DK, IS, MT, NO, ES.
- Transmitters in the ranges, 488 – 524 MHz, 560 – 596 MHz and 653 – 663 MHz, if used outdoor will have geographical restrictions of operation in the United Kingdom (UK)
- Transmitters in the range, 823 – 865, require a license for use in the 823 – 832 MHz range in the following countries: AT, BE, CY, EL, IE, LV, LT, UK.
- Transmitters in the range, 488 – 524 MHz, may only use the range 510 – 524 MHz in Norway (NO).

Note: *TV white spaces* are gaps between operating TV broadcast stations where there are no active TV broadcasts.

Always consult your national authority before placing equipment into operation as requirements and spectrum usage can change.

### 1.4.5 AU and NZ

This device operates under an ACMA class license and must comply with all the terms of that license including operating frequencies.



## 2 Short information

The following table lists products in a family, with CTN (Commercial Type Number) and identifying product name DESCRIPTION.

<b>CTN</b>	<b>DESCRIPTION</b>
RE3-ND76-5L	Handheld set with ND76 head 488-524MHz
RE3-ND76-5H	Handheld set with ND76 head 560-596MHz
RE3-ND76-6M	Handheld set with ND76 head 653-663MHz
RE3-ND76-8M	Handheld set with ND76 head 823-865MHz
RE3-ND76-T	Handheld set with ND76 head 803-806MHz
RE3-ND86-5L	Handheld set with ND86 head 488-524MHz
RE3-ND86-5H	Handheld set with ND86 head 560-596MHz
RE3-ND86-6M	Handheld set with ND86 head 653-663MHz
RE3-ND86-8M	Handheld set with ND86 head 823-865MHz
RE3-ND86-T	Handheld set with ND86 head 803-806MHz
RE3-ND96-5L	Handheld set with ND96 head 488-524MHz
RE3-ND96-5H	Handheld set with ND96 head 560-596MHz
RE3-ND96-6M	Handheld set with ND96 head 653-663MHz
RE3-ND96-8M	Handheld set with ND96 head 823-865MHz
RE3-ND96-T	Handheld set with ND96 head 803-806MHz
RE3-RE420-5L	Handheld set with RE420 head 488-524MHz
RE3-RE420-5H	Handheld set with RE420 head 560-596MHz
RE3-RE420-6M	Handheld set with RE420 head 653-663MHz
RE3-RE420-8M	Handheld set with RE420 head 823-865MHz
RE3-RE420-T	Handheld set with RE420 head 803-806MHz
RE3-RE520-5L	Handheld set with RE520 head 488-524MHz
RE3-RE520-5H	Handheld set with RE520 head 560-596MHz
RE3-RE520-6M	Handheld set with RE520 head 653-663MHz
RE3-RE520-8M	Handheld set with RE520 head 823-865MHz
RE3-RE520-T	Handheld set with RE520 head 803-806MHz
RE3-BPOL-5L	Bodypack set, omni lavalier 488-524MHz
RE3-BPOL-5H	Bodypack set, omni lavalier 560-596MHz
RE3-BPOL-6M	Bodypack set, omni lavalier 653-663MHz
RE3-BPOL-8M	Bodypack set, omni lavalier 823-865MHz
RE3-BPOL-T	Bodypack set, omni lavalier 803-806MHz

RE3-BPCL-5L	Bodypack set, cardioid mic 488-524MHz
RE3-BPCL-5H	Bodypack set, cardioid mic 560-596MHz
RE3-BPCL-6M	Bodypack set, cardioid mic 653-663MHz
RE3-BPCL-8M	Bodypack set, cardioid mic 823-865MHz
RE3-BPCL-T	Bodypack set, cardioid mic 803-806MHz
RE3-BPHW-5L	Bodypack set, headworn mic 488-524MHz
RE3-BPHW-5H	Bodypack set, headworn mic 560-596MHz
RE3-BPHW-6M	Bodypack set, headworn mic 653-663MHz
RE3-BPHW-8M	Bodypack set, headworn mic 823-865MHz
RE3-BPHW-T	Bodypack set, headworn mic 803-806MHz
RE3-BPGC-5L	Bodypack instrument set 488-524MHz
RE3-BPGC-5H	Bodypack instrument set 560-596MHz
RE3-BPGC-6M	Bodypack instrument set 653-663MHz
RE3-BPGC-8M	Bodypack instrument set 823-865MHz
RE3-BPGC-T	Bodypack instrument set 803-806MHz
RE3-BPNID-5L	Bodypack set, no input device 488-524MHz
RE3-BPNID-5H	Bodypack set, no input device 560-596MHz
RE3-BPNID-6M	Bodypack set, no input device 653-663MHz
RE3-BPNID-8M	Bodypack set, no input device 823-865MHz
RE3-BPNID-T	Bodypack set, no input device 803-806MHz

## 2.1 Shipping contents

This manual is packaged in a preconfigured set containing a receiver and its supplied accessories, as well as a transmitter and its supplied accessories. The delivered set configurations vary.

### 2.1.1 Items contained in all sets

Quantity	Component
1	Receiver
2	Receiver antennas
1	Receiver power supply with four power convention specific AC plug clips
2	Rack-mount brackets
2	Rack-mount bracket hole filler plugs
1	Pack of four (4) screws to mount rack brackets
1	Safety booklet
1	Installation manual

## 2.1.2 Set variants (based upon configuration ordered)

### Handheld sets (RE3-ND76, RE3-ND86, RE3-ND96, RE3-RE420, and RE3-RE520)

Quantity	Component
1	Handheld transmitter body
1	Handheld transmitter stand adapter
2	AA alkaline batteries
1	Microphone head Based on the set configuration, the package will contain one (1) microphone head from the following list: <ul style="list-style-type: none"> <li>▪ RE3-ND76 contains 1 ND76-RC3 thread-on head and data sheet</li> <li>▪ RE3-ND86 contains 1 ND86-RC3 thread-on head and data sheet</li> <li>▪ RE3-ND96 contains 1 ND96-RC3 thread-on head and data sheet</li> <li>▪ RE3-RE420 contains 1 RE420-RC3 thread-on head and data sheet</li> <li>▪ RE3-RE520 contains 1 RE520-RC3 thread-on head and data sheet</li> </ul>

### Bodypack sets (RE3-BPOL, RE3-BPCL, RE3-BPHW, RE3-BPGC, and RE3-BPNID)

Quantity	Component
1	Bodypack transmitter
2	AA alkaline batteries
1	Input device Based on the set configuration, the package will contain one input device from the following list: <ul style="list-style-type: none"> <li>▪ RE3-BPOL contains 1 RE3-ACC-OL3 omnidirectional lavalier microphone, clip, windscreen, and data sheet</li> <li>▪ RE3-BPCL contains 1 RE3-ACC-CL3 cardioid lavalier microphone clip, windscreen, and data sheet</li> <li>▪ RE3-BPHW contains 1 RE3-ACC-HW3 cardioid headworn microphone, windscreen, and data sheet</li> <li>▪ RE3-BPGC contains 1 RE3-ACC-GC3 instrument cable with ¼" plug and data sheet</li> </ul>

**NOTE:** RE3-BPNID does not contain an input device.

## 3 Description

Thank you for choosing an Electro-Voice wireless microphone product. Please take time to consult this manual to understand all the features and functions built into your Electro-Voice wireless set and fully utilize its performance capabilities.

RE3 is a range of RF wireless microphone products operating in the UHF portion of the radio spectrum. The use of this portion of the radio spectrum falls under local government regulations which may require the user to obtain and maintain a license to operate the wireless product. It is the user's responsibility to know and adhere to local license requirements.

Primary products, such as receivers and transmitters, are preconfigured into sets covering a wide variety of common applications, making them ideal performance and presentation solutions for both portable productions, as well as fixed installation applications. All sets contain one ½ rack space receiver with antennas, power supply and rack mount, one transmitter with batteries and its input device (as applicable), as well as user documentation sheets.

Additionally, the RE3 extended portfolio contains an extensive assortment of optional accessories to aid in the creation of large, multi-channel, professional-application systems. For a full list of available accessories, see Accessories for RE3, page 48 of this manual.

### Set features

- Rack mountable ½ space receiver with mounting hardware
- Robust metal handheld and bodypack transmitter bodies
- Easy-to-read LDC displays
- Frequency scanning for selecting open frequencies
- Sync function links transmitter to receiver
- Keylock function protects settings from unwanted changes
- Diversity reception technology for trouble-free operation
- Broad selection of transmitter microphone types maximize application diversity
- Wide selection of tuning bandwidths to help compensate for changing global RF regulations
- Frequencies independently adjustable in 25kHz steps
- Eight groups of pre-coordinated frequencies with up to 22 coordinated channels per group
- Simple multi-channel system setup
- Transmitters powered by common AA cells
- Selectable hi and low transmitter power in most global regions.
- Extensive selection of optional system accessories available

See also

Technical data, page 58

Frequency Group / Channel Tables, page 67

## 4 Glossary of terms

Term	Definition
System vs set	Because the terms system and set can be used interchangeably, thereby causing confusion, this manual refers to a <u>set</u> as a single mated pair of one transmitter and one receiver. Whereas a <u>system</u> is the collection of multiple wireless sets and antenna distribution items.
Set	A pre-packaged combination of receiver, receiver antenna, receiver power supply, transmitter, transmitter input device, and other supplied accessories. For example, if you purchased an RE3-ND76-5L, the manufacturer considers it a set. Also it is the basic hardware combination of a mated transmitter and receiver.
SET	A multi-purpose menu navigation key which functions as an enter key, a menu advance key, an item select key, and a save or store key.
Scroll	To navigate up and down menus or item options using the ▲ and ▼ buttons.
Group	A predefined combination of intermodulation-free frequencies.
Channel	As it relates to frequencies within a group, it is the exact frequency a set can be tuned to. As it relates to a multi-channel system, it is the quantity of unique paired transmitters and receivers. For example, a multi-channel system consisting of eight receivers and eight mated transmitters is said to be an eight channel system.
Intermodulation	The adverse reception interference that occurs when two or more non-coordinated frequencies produce harmonics which disrupt reception of one or more channels.
SYNC	The operation of synchronizing a receiver's transmitter data to the mated transmitter.
RX	Abbreviation for receiver.
TX	Abbreviation for transmitter.
RF	Abbreviation for radio frequency. RE3 is an RF wireless microphone set operating in the UHF radio spectrum.
UHF	Abbreviation for ultra-high frequency, and is the term when applied to wireless microphone products as the portion of radio spectrum shared with UHF television signals between 470MHz and 865MHz. Those limits vary by country where used.
MHz	Abbreviation for megahertz denoting frequencies measuring in the millions of cycles per second. A common reference for wireless microphones using this shortened numerical expression could be 652.725MHz (six-hundred fifty-two million, seven hundred twenty-five thousand cycles per second).
Multi-channel system	A system made up of two or more sets where each set is tuned to a specific frequency (channel) which does not interfere with the operation of other

	<p>member sets within the system. A multi-channel system can be made up of sets all from the same frequency band, or sets from multiple frequency bands. When using multiple sets operating in the same frequency band, each set must be operating on a frequency-coordinated channel <i>within the same group</i>.</p>
--	---

## 5 Best practices for successful operation

- Never attempt to operate two or more transmitters on the same frequency at the same time. While multiple receivers can successfully tune to a single transmitted frequency, multiple transmitters simultaneously operating on the same frequency will immediately interfere with each other. If a goal is to create a combo system by adding an optional transmitter (one bodypack transmitter and one handheld transmitter to work with one receiver), only one of those transmitters can be on and tuned to the receiver at a time.
- Ensure the receiver's antennas are properly attached, exposed (not buried within a rack) and oriented as suggested in the Preparing the receiver section, page 17.
- Scan for open frequencies first with transmitter off. The receiver antennas must be properly connected for best scan results.
- When scanning and synchronizing a multi-channel system, scan and synchronize one system at a time. To begin, have all transmitters off and scan system receiver 1 first. Then turn on system transmitter 1 and sync it to receiver 1. Leaving system transmitter 1 on, move on to receiver 2. With system transmitter 1 on, scan system receiver 2 and tune it to the next open frequency within the same group as system 1. Turn on system transmitter 2 and sync it to system receiver 2. Then leave system transmitter 2 on. Follow this process while scanning and syncing all channels within a multi-channel system.
- Always have all member sets of a multi-channel system within the same frequency band operating in the same frequency group. Mixing frequencies (channels) from different groups within the same frequency band is not recommended. Channels within a group are intermodulation-free. Simultaneous operation of channels from different groups may lead to intermodulation interference.
- If desired, use the receiver's mic configuration menu items to set transmitter operating parameters prior to syncing the transmitter to the receiver. If a receiver's mic configuration is changed since the last transmitter sync, resync the transmitter to update its parameter settings.
- Properly setting transmitter sensitivity is key to optimum performance. Best practice: While observing the receiver's AF meter activity, adjust the transmitter sensitivity so that high vocal peaks light the yellow LED segment. Under extremely loud vocal peaks, an occasional red LED segment light is OK, but a solid and constant red LED should be avoided.
- Choosing transmitter low or high power: The transmitter in your set may have two output power setting options (8M band has only one). The higher setting may not be appropriate for your application as it is possible that high may be too high based on the distance between the transmitter and receiver antennas, or other systems within close proximity in a multi-channel system. Low is likely to be sufficient when the set is in a small to medium size room or space. High may be the best choice for large rooms or spaces where the distance between transmitter and receiver antennas is substantial or existing RF conditions limit the range

---

between transmitter and receiver. Simple performance tests will help identify best settings, and having two output power options will aid in successful operation.

- A large multi-channel system can be made up of sets operating in different frequency bands. This is a good method to follow when maximizing a high channel count system potential. Based on RF conditions in the operating vicinity, select appropriate numbers of sets from available bands in your country to achieve a desired high channel count system.



## 6 Quick setup

### 6.1 Preparing the receiver

- a. Remove the receiver, packaged power supply kit and two antennas from the product carton.
- b. Place the receiver either on a stable flat surface or in a 19" rack using the rack kit supplied.
- c. Locate the power supply and attach the supplied AC wall outlet clip which is appropriate for your country's mains power by sliding it into the power supply head, and plug the DC power lead end of the cable into the receiver DC input jack.
- d. Locate, unwrap, and attach the two supplied receiver antennas by inserting them onto the receiver's BNC antenna jacks and locking them into place by applying a right-hand twist. Take special care to ensure the receiver antennas are exposed to open air, not touching any items that would ground them, and oriented 90 degrees to one another and positioned at 45 degrees relative to the floor.
- e. Turn on the receiver by pressing the power button.
- f. Ensure the transmitter for this set is turned off.
- g. Press the scan button and follow the scanning instructions described in Scanning for open channels, page 24.
- h. After the scan is complete, select the group and channel from the results list which best matches your system needs.
- i. Follow the scanning instructions in Scanning for open channels, page 24 to return the receiver's display to the home screen.
- j. Leave the receiver on until the desired mating transmitter has been prepared and synced.

### 6.2 Preparing the transmitter

- a. Remove the transmitter, batteries, and input device (if supplied) from the product carton.
- b. Insert the batteries into the transmitter paying close attention to the battery polarity (+ and -) and matching those polarities to the + and - poles of the battery compartment battery clips.
- c. Connect the transmitter's input device to the transmitter (a bodypack set will contain either a lavalier microphone, headworn microphone, or instrument cable – a handheld set will contain a thread-on microphone head).
- d. Turn on the transmitter by pressing the power button.

### 6.3 Sync the transmitter to the receiver

- a. Locate the transmitter's sync port and the receiver's sync emitter which are both identified with the ((●)) symbol.
- b. Maintaining direct line of sight and a separation distance of two to twelve inches between the transmitter and receiver ports.
- c. Directly aim the transmitter sync port at the receiver sync emitter.
- d. Press the sync button on the front of the receiver to begin the syncing process (green LED flashes on receiver).
- e. Hold the transmitter in place until the sync process is complete. Upon successful sync the transmitter will be tuned to the receiver and ready for use.

### 6.4 Ensure transmitter input sensitivity is set for best signal level

- a. While viewing receiver AF meter activity, perform as you would in a normal performance using proper microphone placement.
- b. Observe the AF meter LED segments. Ideal level should show all green LEDs and the yellow LED lit on emphasis peaks. An occasional red LED is OK, but a constant, solid red LED should be avoided.
- c. Adjust transmitter input sensitivity until item b above is achieved.

Upon successful completion of this section, your set is ready for operation.

# 7 RE3-RX receiver

## 7.1 Product identification

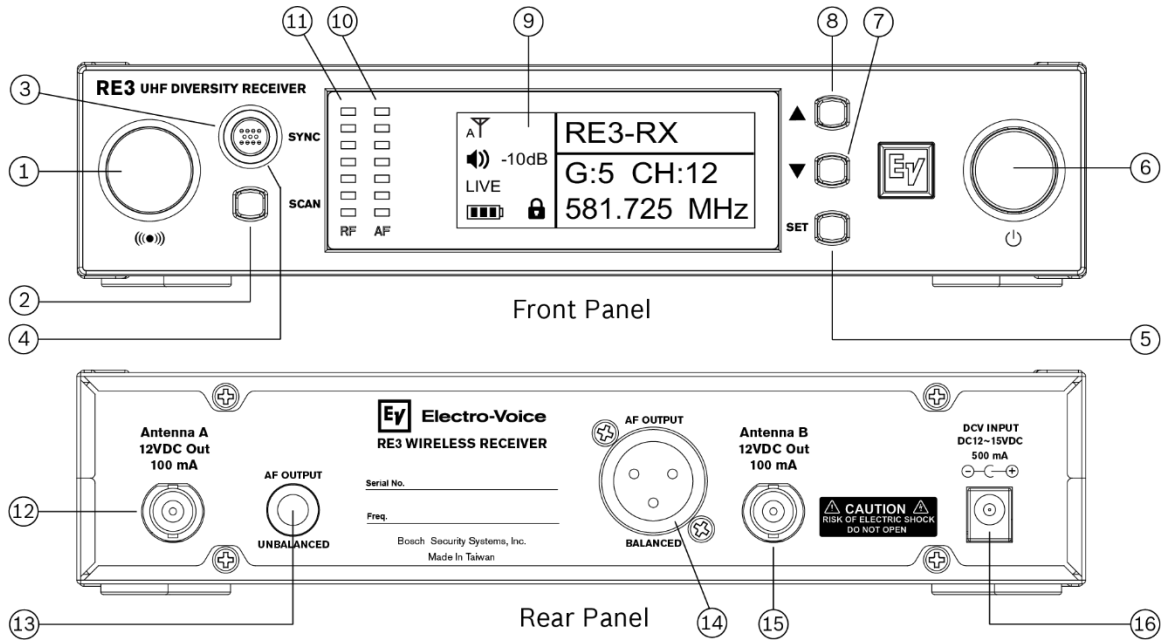

ID	Item	Description, usage and notes
1	Sync signal emitter	This port emits the sync signal to the transmitter. When synchronizing the transmitter to the receiver, aim the transmitter's unobstructed sync port directly toward this emitter. A direct line of sight is required. Maintain a distance between two inches and twelve inches (or between 5cm and 30cm) for best sync performance.
2	SCAN button	Briefly pressing the SCAN button opens the frequency scan menu. Pressing and holding the SCAN button for three seconds opens the scan all groups option directly.
3	SYNC button	A dual-purpose action button. <b>Primary purpose:</b> press to initiate synchronization of the receiver's stored transmitter settings to the transmitter while the receiver is <b>not</b> in parameter edit mode. <b>Secondary purpose:</b> As a menu escape button while in parameter edit mode, press once to return to the previous menu without saving any changes made. Pressing multiple times will escape back the number of menus relative to the number of button pushes made with a final destination of the home screen.
4	SYNC button LED	A circular LED indicator surrounding the SYNC button. The LED will rapidly flash green during the sync operation and will glow solid green when sync operation is successful. The LED will remain solid green after a successful sync operation. If sync fails, the LED will flash green slowly and constantly until a successful sync operation.

<b>5</b>	SET button	The most commonly used menu navigation button, it is a multi-purpose action button which functions as an enter key, a menu advance key, an item select key, and a save or store key.
<b>6</b>	Power button	Turns the receiver on or off. Press in to turn receiver on. Press in again to turn receiver off.
<b>7</b>	▼ down button	This is a dual-purpose menu navigation button. As a menu scroll button, press to scroll downward through main menu items. As an editable parameter value adjuster, pressing the ▼ button will decrease the displayed value of the current parameter, or the next state condition value below the displayed state value. Pressing while displaying main operating menu decreases audio output level.
<b>8</b>	▲ up button	This is a dual-purpose menu navigation button. As a menu scroll button, press to scroll upward through main menu items. As an editable parameter value adjuster, pressing the ▲ button will increase the displayed value of the current parameter, or the next state condition value above the displayed state value. Pressing while displaying main operating menu increases audio output level.
<b>9</b>	LCD display	Backlit LCD displays all operating information and menus.
<b>10</b>	AF meter	AF (audio frequency) meter is a seven-segment LED containing five green, one yellow, and one red segments. It displays the audio signal strength received from the transmitter. Fewer lit segments indicate a weaker audio signal compared to more lit segments indicating a stronger audio signal. Red warns of a potential clip.
<b>11</b>	RF meter	RF (radio frequency) meter is a seven-segment LED containing five green, one yellow, and one red segments. It displays the RF signal strength received from the transmitter. Fewer lit segments indicate a weaker audio signal compared to more lit segments indicating a stronger audio signal. Red indicates high RF signal present at the primary RF receiving circuit.
<b>12</b>	Antenna A jack	BNC RF jack to attach either a supplied half-wave whip antenna, or antenna extension coax cable connected to a front-mounted or remote extension antenna. This jack supplies 12 volts DC booster feed to power in-line RF amplifiers or active antennas when antenna power is set to on (factory default). The RE3 diversity receiver requires connecting antennas to both antenna jacks.
<b>13</b>	AF output jack (unbalanced audio)	¼" audio output jack (¼" TS). Using a standard unbalanced instrument cable with ¼" plugs, connect this to the unbalanced line input jack on a mixer, powered loudspeaker, or instrument amplifier.
<b>14</b>	AF output jack (balanced audio)	XLR audio output jack (XLRM). Using a standard balanced microphone cable, connect this to the balanced microphone input jack (mic level) on a mixer, powered loudspeaker, or signal processor.

<b>15</b>	Antenna B jack	BNC RF jack to attach either a supplied half-wave whip antenna, or antenna extension coax cable connected to a front-mounted or remote extension antenna. This jack also supplies 12 volts DC booster feed to power in-line RF amplifiers or active antennas when antenna power is set to on (factory default). The RE3 diversity receiver requires connecting antennas to both antenna jacks.
<b>16</b>	DC power jack	Connection point for receiver's external power supply. This is where a DC distribution lead connects when using the optional AASP antenna splitter.

## 7.2 LCD display

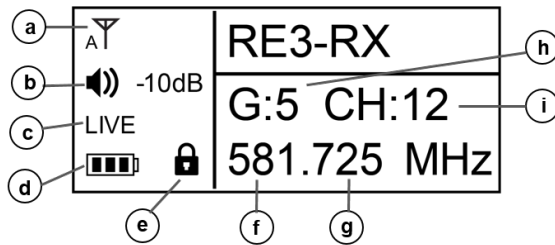

ID	Item	Description, usage and notes
a	Antenna status icon	<p> indicates the diversity circuit is choosing antenna A signal at the moment.</p> <p> indicates the diversity circuit is choosing antenna B signal at the moment.</p> <p> indicates there is no antenna signal present for the diversity circuit to choose.</p>
b	Audio output volume level	Displays the receiver audio output volume level. Menu item adjustment allows settings between 0dB to -50dB in 1dB increments. Beyond -50 is MUTE.
c	Transmitter activity status	Displays the following possible transmitter audio states: LIVE indicates mated transmitter audio is live and present at the receiver. MUTE indicates mated transmitter is in mute mode. NoSYNC indicates no synced transmitter is on.
d	Mated transmitter battery status icon	Indicates the synced transmitter's battery life. = between 40% and 100% charge remains. = between 20% and 39% charge remains. = between 10% and 19% charge remains. = below 10% charge remains. Low Battery begins flashing on display. = no battery info present.
e	KeyLock mode icon	Indicates receiver KeyLock mode is on. Icon disappears from display when off. See turning on and off KeyLock below.
f	Frequency in MHz	The portion of the receiver's tuned frequency to the left of the decimal in millions.
g	Frequency in kHz	The portion of the receiver's tuned frequency to the right of the decimal in thousands.
h	Group number	The group number of the receiver's tuned frequency.
i	Channel	The channel number of the receiver's tuned frequency.

## 7.3 RE3-RX setup menu

### 7.3.1 RE3-RX menu operation

Navigating and using the RE3-RX menu system is simple and intuitive. To change from the home screen to the menu, press and hold the SET button for three seconds.

**SET** is the most commonly used menu navigation button. It is a multi-purpose action button which functions as an enter key, a menu advance key, an item select key, and a save or store key.

Use the ▲ and ▼ navigation buttons to scroll through menus and change values or item states.

**SYNC** serves as a menu exit button while in menu or edit menu modes. Briefly press once to return to the previous menu without saving any changes made. Briefly pressing multiple times will escape back the number of menus relative to the number of button pushes made with a final destination of the home screen.

**NOTE:** Once saved and stored, menu setting changes are recalled the next time receiver is powered up.

**NOTE:** Remember to **SAVE** wanted edits prior to escaping out of a submenu.

### 7.3.2 Menu items overview

Steps to navigating operating menu and submenus:

- Press and hold SET for three seconds.
- Scroll up and down using the ▲ and ▼ buttons.
- Press SET to select an item for investigation or editing. Also, press SET to advance to some submenu option parameters.



<b>M E N U</b>	1. Scan
	2. Frequency
	3. Group/Channel
	4. Squelch
	5. Mic Config
	6. Volume
	7. RX Output Level
	8. Antenna Power
	9. Keylock
	a. Display Option
	b. Reset
	c. Exit

Item	Description
1. Scan	Submenu selection to scan for open frequencies. Selecting opens scan submenu.
2. Frequency	Submenu selection to access manual control in setting frequency. Selecting opens frequency submenu.
3. Group/Channel	Submenu selection to access manual control in setting group and channel. Selecting opens Group/Channel submenu.
4. Squelch	Submenu selection to access squelch setting to control background radio noise. Selecting opens squelch submenu. Factory default is 0 (zero).

5. Mic Config	Submenu selection to access a variety of microphone transmitter parameters, which transfer to the transmitter during SYNC operation. Selecting opens MicConfig submenu.
6. Volume	Submenu selection to access manual control of receiver output volume. Selecting opens setup volume submenu.
7. RX output level	Submenu selection to access manual control of receiver output level. Selecting opens output level submenu where MIC level or LINE level are options.
8. Antenna Power	Submenu selection to access manual control of receiver antenna booster feed voltage. Selecting opens Antenna Power submenu where ON and OFF are options. Factory default is ON.
9. Keylock	Submenu selection to access manual control of Keylock feature operating status. Selecting opens Keylock where ON and OFF are options. Factory default is OFF.
a. Display option	Submenu selection to access manual control of receiver display characteristics. Selecting opens Display Options submenu where contrast and brightness are controlled. Factory defaults are 4.
b. Reset	Submenu selection to access a manual receiver reset to factory default settings. Selecting opens reset submenu.
c. Exit	Returns to home screen.

### 7.3.3 Scanning for open channels

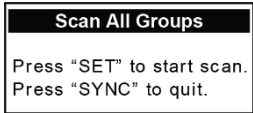
Three methods are available. 1) Briefly press the SCAN button on the front panel to open the Scan submenu (arrive at step 1 below). 2) Press and hold SCAN button on the front panel for 3 seconds to enter “Scan All Groups” dialog (arrive at step 2 below). 3) Select 1 from the main menu to open Scan submenu.

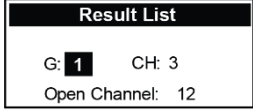
<p><b>1</b> Select 1. All Groups and press SET to begin scan process.</p>	
<p><b>2</b> Press SET to start, or SYNC to quit.</p>	
<p><b>3</b> Wait for scanning process to complete.</p>	
<p>When scan is complete, view the results list.</p> <p><b>4</b> Scroll through groups using ▲ or ▼ noting open channel quantity per group.</p>	



Press SET on the group number having the number of open channels which best meets your wireless system needs. This advances to the CH number.

- 5 CH number is highlighted and displays the first open channel in the group. While highlighted, scrolling through the open channels using ▲ or ▼ will identify all open channels in the group. Note that some channel numbers will not appear as they are not open at the time of the scan. Press SET on CH number. This selects that group and channel the set will operate on.

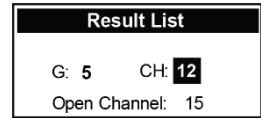

- 6 This also returns to Result List on the scan menu.



- 7 Either scroll ▼ down to Exit and press SET, or press SYNC on the receiver front panel to return to the home screen. The selected Group/Channel and associated Frequency displays on the home screen.

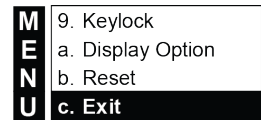

NOTE: This group and channel must be set on the transmitter as well. Follow the SYNC operation steps to sync the transmitter to the receiver, or manually set the transmitter to this group and channel.

NOTE: This process is required for any system of sets, either a single set system, or a multi-channel system.

ALL SETS in a multi-channel system operating on the same frequency band MUST use the same group number.

### 7.3.4 Using the result list during the same session

A session is the period of time after a scan has been performed prior to a receiver power-down. All scan data is stored in temporary memory until power-down. The session expires upon receiver power-down.



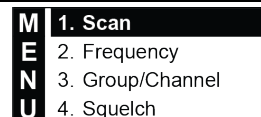

During a session, you can return to the result list to select a different group and channel, or just a different channel within the same group.

- 1 Enter the main menu and select Scan by pressing SET.



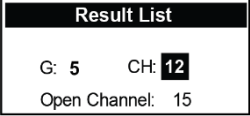

- 2 Press ▼ to scroll down to Result List. Press SET to enter Result List.



- 3** Scroll through groups using the ▲ or ▼ buttons noting open channel quantity per group. Select either the same previous group or a new group by pressing SET. This advances to the channel and CH # highlights.
- 
- 4** Press the ▲ or ▼ button to scroll through open channels. Note that some channel numbers may be skipped because they were not clear at the time of the scan. Press SET on CH number. This selects that group and channel the set will operate on.
- 
- 5** This also returns to Result List on the scan menu.
- 
- 6** Either scroll ▼ down to Exit and press SET, or briefly press SYNC on the receiver front panel to escape to the home screen. The selected Group/Channel and associated Frequency displays on the home screen.
- 
- OR 

### 7.3.5 Scanning current group

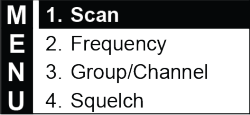

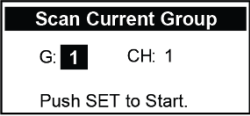
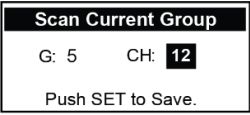

The current assigned group, or a particular selected group can be scanned individually. This process will locate clear channels within that group individually.

- 1** Enter the main menu and select Scan by pressing SET.
- 
- 2** Press the ▼ button to scroll down to Current Group. Press SET to enter Result List.
- 
- 3** The current assigned group is displayed. Prepare to scan that group, or scroll through other groups using ▲ or ▼. Select the group to scan by pressing SET. The scan of that group begins. When the scan is complete, the highlight box advances to channel, and the first clear channel in that group appears.
- 
- 4** Either press SET to save the channel displayed and exit, or press ▲ or ▼ to scroll through to locate the next open channel. A brief scan occurs while locating the next clear channel. Some channel numbers may be skipped because they were not clear at the time of the scan. Press SET to save. This selects that group and channel the set will operate on.
- 

<p><b>5</b> This returns to Current Group on the scan menu.</p>	<table border="1" style="width: 100%; border-collapse: collapse;"> <tr><td style="background-color: #f0f0f0;"><b>M</b></td><td>1. All Groups</td></tr> <tr><td style="background-color: #f0f0f0;"><b>E</b></td><td>2. Result List</td></tr> <tr><td style="background-color: #f0f0f0;"><b>N</b></td><td><b>3. Current Group</b></td></tr> <tr><td style="background-color: #f0f0f0;"><b>U</b></td><td>4. Return</td></tr> </table>	<b>M</b>	1. All Groups	<b>E</b>	2. Result List	<b>N</b>	<b>3. Current Group</b>	<b>U</b>	4. Return
<b>M</b>	1. All Groups								
<b>E</b>	2. Result List								
<b>N</b>	<b>3. Current Group</b>								
<b>U</b>	4. Return								
<p><b>6</b> Either scroll ▼ down to Exit and press SET, or briefly press SYNC on the receiver front panel to return to the home screen. The selected Group/Channel and associated Frequency displays on the home screen.</p>	<table border="1" style="width: 100%; border-collapse: collapse;"> <tr><td style="background-color: #f0f0f0;"><b>M</b></td><td>9. Keylock</td></tr> <tr><td style="background-color: #f0f0f0;"><b>E</b></td><td>a. Display Option</td></tr> <tr><td style="background-color: #f0f0f0;"><b>N</b></td><td>b. Reset</td></tr> <tr><td style="background-color: #f0f0f0;"><b>U</b></td><td><b>c. Exit</b></td></tr> </table> <p style="text-align: center;">OR </p>	<b>M</b>	9. Keylock	<b>E</b>	a. Display Option	<b>N</b>	b. Reset	<b>U</b>	<b>c. Exit</b>
<b>M</b>	9. Keylock								
<b>E</b>	a. Display Option								
<b>N</b>	b. Reset								
<b>U</b>	<b>c. Exit</b>								

### 7.3.6 Return

Selecting Return in the Scan menu returns to the main menu.

<p><b>1</b> While in the Scan menu, press the ▼ button to scroll down to Return. Press SET.</p>	<table border="1" style="width: 100%; border-collapse: collapse;"> <tr><td style="background-color: #f0f0f0;"><b>M</b></td><td>1. All Groups</td></tr> <tr><td style="background-color: #f0f0f0;"><b>E</b></td><td>2. Result List</td></tr> <tr><td style="background-color: #f0f0f0;"><b>N</b></td><td>3. Current Group</td></tr> <tr><td style="background-color: #f0f0f0;"><b>U</b></td><td><b>4. Return</b></td></tr> </table>	<b>M</b>	1. All Groups	<b>E</b>	2. Result List	<b>N</b>	3. Current Group	<b>U</b>	<b>4. Return</b>
<b>M</b>	1. All Groups								
<b>E</b>	2. Result List								
<b>N</b>	3. Current Group								
<b>U</b>	<b>4. Return</b>								
<p><b>2</b> The screen returns to the main menu.</p>	<table border="1" style="width: 100%; border-collapse: collapse;"> <tr><td style="background-color: #f0f0f0;"><b>M</b></td><td><b>1. Scan</b></td></tr> <tr><td style="background-color: #f0f0f0;"><b>E</b></td><td>2. Frequency</td></tr> <tr><td style="background-color: #f0f0f0;"><b>N</b></td><td>3. Group/Channel</td></tr> <tr><td style="background-color: #f0f0f0;"><b>U</b></td><td>4. Squelch</td></tr> </table>	<b>M</b>	<b>1. Scan</b>	<b>E</b>	2. Frequency	<b>N</b>	3. Group/Channel	<b>U</b>	4. Squelch
<b>M</b>	<b>1. Scan</b>								
<b>E</b>	2. Frequency								
<b>N</b>	3. Group/Channel								
<b>U</b>	4. Squelch								
<p><b>3</b> Either scroll ▼ down to Exit and press SET, or briefly press SYNC on the receiver front panel to return to the home screen.</p>	<table border="1" style="width: 100%; border-collapse: collapse;"> <tr><td style="background-color: #f0f0f0;"><b>M</b></td><td>9. Keylock</td></tr> <tr><td style="background-color: #f0f0f0;"><b>E</b></td><td>a. Display Option</td></tr> <tr><td style="background-color: #f0f0f0;"><b>N</b></td><td>b. Reset</td></tr> <tr><td style="background-color: #f0f0f0;"><b>U</b></td><td><b>c. Exit</b></td></tr> </table> <p style="text-align: center;">OR </p>	<b>M</b>	9. Keylock	<b>E</b>	a. Display Option	<b>N</b>	b. Reset	<b>U</b>	<b>c. Exit</b>
<b>M</b>	9. Keylock								
<b>E</b>	a. Display Option								
<b>N</b>	b. Reset								
<b>U</b>	<b>c. Exit</b>								
<p><b>4</b> Home screen</p>	<table border="1" style="width: 100%; border-collapse: collapse;"> <tr><td style="text-align: center;">AT</td><td style="text-align: center;"><b>RE3-RX</b></td></tr> <tr><td style="text-align: center;">-10dB</td><td style="text-align: center;"><b>G:5 CH:12</b></td></tr> <tr><td style="text-align: center;">LIVE</td><td style="text-align: center;"><b>581.725 MHz</b></td></tr> <tr><td style="text-align: center;"></td><td></td></tr> </table>	AT	<b>RE3-RX</b>	-10dB	<b>G:5 CH:12</b>	LIVE	<b>581.725 MHz</b>		
AT	<b>RE3-RX</b>								
-10dB	<b>G:5 CH:12</b>								
LIVE	<b>581.725 MHz</b>								
									

### 7.3.7 Manually setting frequency

Setting custom frequencies manually does not benefit from the scan function of locating clear channels. It is important to note that manually entered custom frequencies may experience interference, which can be avoided by using the scan function.

<p><b>1</b> Press the ▼ button to scroll down to Frequency on the main menu. Select by pressing SET to enter the Setup Frequency screen.</p>	<table border="1" style="width: 100%; border-collapse: collapse;"> <tr><td style="background-color: #f0f0f0;"><b>M</b></td><td>1. Scan</td></tr> <tr><td style="background-color: #f0f0f0;"><b>E</b></td><td><b>2. Frequency</b></td></tr> <tr><td style="background-color: #f0f0f0;"><b>N</b></td><td>3. Group/Channel</td></tr> <tr><td style="background-color: #f0f0f0;"><b>U</b></td><td>4. Squelch</td></tr> </table>	<b>M</b>	1. Scan	<b>E</b>	<b>2. Frequency</b>	<b>N</b>	3. Group/Channel	<b>U</b>	4. Squelch
<b>M</b>	1. Scan								
<b>E</b>	<b>2. Frequency</b>								
<b>N</b>	3. Group/Channel								
<b>U</b>	4. Squelch								
<p><b>2</b> The three digits to the left of the decimal are in millions (MHz) and are highlighted. Pressing ▲ increases frequency in increments of 1 MHz per press, pressing ▼ decreases frequency in increments of 1 MHz per press. Press SET to move to next set of three digits.</p>	<table border="1" style="width: 100%; border-collapse: collapse;"> <tr><td style="text-align: center; background-color: #f0f0f0;"><b>Setup Frequency</b></td></tr> <tr><td style="text-align: center;">581.725 MHz</td></tr> <tr><td style="text-align: center;">G:5 CH:12</td></tr> </table>	<b>Setup Frequency</b>	581.725 MHz	G:5 CH:12					
<b>Setup Frequency</b>									
581.725 MHz									
G:5 CH:12									

- The three digits to the right of the decimal are in thousands (kHz). Pressing ▲ increases frequency in increments of 25 kHz per press, ▼ decreases frequency in increments of 25 kHz per press. The G: \_\_ and CH: \_\_ under the frequency will populate when a preset group and channel match the frequency dialed in.
- 3**
- Setup Frequency**

581 . 725 MHz  
G:5 CH:12
- 
- 4** Press SET to save the custom frequency and to exit to the main menu.
- MENU**

1. Scan  
**2. Frequency**  
3. Group/Channel  
4. Squelch
- 
- 5** Either scroll ▼ down to Exit and press SET, or briefly press SYNC on the receiver front panel to return to the home screen. The selected custom Frequency displays on the home screen.
- MENU**

9. Keylock  
a. Display Option  
b. Reset  
**c. Exit**
- OR 

### 7.3.8 Manually setting group and channel

Setting group and channel manually does not benefit from the scan function of locating clear channels. It is important to note that manually entered group/channel combination may experience interference, which can be avoided by using the scan function.

- 1** Press the ▼ button to scroll down to Group/Channel on the main menu. Select by pressing SET to enter the Setup Group screen.
- MENU**

1. Scan  
2. Frequency  
**3. Group/Channel**  
4. Squelch
- 
- 2** The current selected group number is highlighted. Pressing ▲ increases the group number (1-8) in single digit increments, and pressing ▼ decreases the group number (1-8) in single digit increments. Press SET to move to Channel.
- Setup Group**

581 . 725 MHz  
G: **5** CH:12
- 
- 3** The current selected channel number is highlighted. Pressing ▲ increases the channel number (up to max of 22) in single digit increments, and pressing ▼ decreases the channel number in single digit increments. The frequencies above the G: \_\_ CH \_\_ change to display the frequency of the changed group and channel.
- Setup Group**

581 . 725 MHz  
G:5 CH: **12**
- 
- 4** Press SET to save the chosen Group/Channel and return to the main menu.
- MENU**

1. Scan  
2. Frequency  
**3. Group/Channel**  
4. Squelch
- 
- 5** Either scroll ▼ down to Exit and press SET, or briefly press SYNC on the receiver front panel to return to the home screen. The selected custom Frequency displays on the home screen.
- MENU**

9. Keylock  
a. Display Option  
b. Reset  
**c. Exit**
- OR 

### 7.3.9 Adjusting receiver squelch

Setting the squelch appropriately based on conditions is important to controlling background radio noise, as well as maintaining the desired radio system range (the functional distance between transmitter and receiver antennas). Squelch is basically a noise gate across the receiver's audio path that is keyed open by a combination of audio path signal level, and the presence of a unique combination of tone codes in the received signal. Squelch sets the threshold where the received signal amplitude will open the noise gate. Signals above the threshold will open the audio path gate, while signal levels below the threshold will not open the gate.

**NOTE:** Improperly set squelch negatively affects system range (the distance between transmitter and receiver).

- 1 Press the ▼ button to scroll down to Squelch on the main menu. Select by pressing SET to enter the Setup Squelch screen.

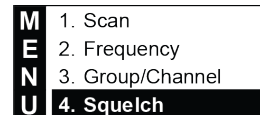

- 2 The display shows the current squelch setting. The numbers on this scale are arbitrary values from -5 to the left of 0, to +10 to the right of 0. Higher number values tighten the gate threshold, while lower number values loosen the gate threshold.

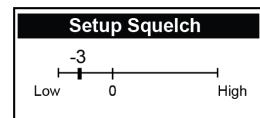

- 3 Pressing the ▲ button moves the fader bar to the right while increasing the displayed value in single digit increments thereby tightening the noise gate, and pressing the ▼ button moves the fader bar to the left while decreasing the displayed value in single digit increments thereby loosening the noise gate.

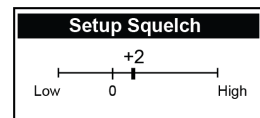

- 4 Press SET to save and return to main menu.

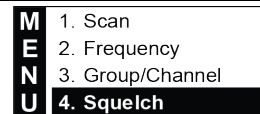

- 5 Either scroll ▼ down to Exit and press SET, or briefly press SYNC on the receiver front panel to return to the home screen.

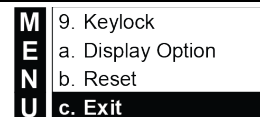

### 7.3.10 Mic Config submenu

Operating parameters of the transmitter can be set up within the MicConfig submenu and written to the transmitter during the SYNC operation.

Enter the submenu as follows:

- 1 Press the ▼ or ▲ button to scroll to MicConfig in the main menu.  
Select by pressing SET to enter the MicConfig screen.

<b>M</b>	2. Frequency
<b>E</b>	3. Group/Channel
<b>N</b>	4. Squelch
<b>U</b>	<b>5. Mic Config</b>

- 2 Press the ▼ or ▲ button to highlight the item to edit.
- 3 Press SET to toggle over and highlight the parameter on the right.
- 4 When highlighted, press ▼ or ▲ to make numerical or status changes to that parameter.
- 5 Press SET to toggle back to the menu option side on left.
- 6 Continue to scroll ▼ or ▲ to other items for editing.
- 7 When finished, scroll to **Save Settings** and **press SET** to save settings to prevent settings being lost.
- 8 Exit Without Save option exits to the main menu without save.

#### Parameter description and setting options:

<b>M</b>	Sensitivity	-3dB
<b>E</b>	Attenuate	OFF
<b>N</b>	RFPower	Low
<b>U</b>	AutoOFF	OFF
	KeyLock	OFF
	Mic Display	Freq.
	SYNC Config	
	Save Settings	
	Exit Without Save	

Item	Description	Setting options
Sensitivity	A means for the transmitter audio input stage to match the output of the connected microphone. Lower values may produce lower transmitter audio gain. Higher values may produce higher transmitter audio gain.	-15dB, -12dB, -9dB, -6dB, -3dB, 0dB, 3dB, 6dB, 9dB, 12dB, 15dB
Attenuate	When set to on, the transmitter audio input stage is attenuated by 20dB, reducing the gain between the microphone output and the transmitter's audio input preamp.	Off or On
RFPower	Selects transmitter RF output power. This option is band specific. NOTE: 8M Band is not adjustable.	Lo or High

AutoOFF	Assigns a time period for the transmitter to automatically turn off once mute is engaged to conserve battery life.	Off, 1 minute, 10 minutes, and 30 minutes
KeyLock	Prevents unwanted tampering with, or changes to transmitter parameter settings.	Off or On
Mic Display	Selects the tuning information displayed on the transmitter home screen.	Freq. or GP/CH
SYNC Config	Allows selection of MicConfig items synced to the transmitter during SYNC operation. Scroll with the ▼ and ▲ buttons. Select or deselect using SET.	<div style="border: 1px solid black; padding: 5px;"> <b>M E N U</b> <ul style="list-style-type: none"> <li><input type="checkbox"/> Frequency</li> <li><input type="checkbox"/> Sensitivity</li> <li><input type="checkbox"/> Attenuate</li> <li><input type="checkbox"/> RF Power</li> <li><input type="checkbox"/> AutoOFF</li> <li><input type="checkbox"/> KeyLock</li> <li>Save and Exit</li> </ul> </div>
Save Settings	Saves setting changes and exits to main menu.	
Exit Without Save	Exits to the main menu without saving changes.	

### 7.3.11 Adjusting receiver volume

Setting the receiver output gain through menu item 6, Volume sets the gain leaving the receiver and arriving at the destination circuit; either a microphone preamp, or a line in preamp.

<b>1</b>	Press the ▼ button to scroll down to Volume from the main menu. Select by pressing SET to enter the Volume screen.	<div style="border: 1px solid black; padding: 2px;"> <b>M E N U</b> </div>	<div style="border: 1px solid black; padding: 2px;"> <ul style="list-style-type: none"> <li>3. Group/Channel</li> <li>4. Squelch</li> <li>5. Mic Config</li> <li style="background-color: black; color: white; padding: 2px;">6. Volume</li> </ul> </div>
<b>2</b>	The display shows the current volume setting in dB of attenuation where 0 dB is the highest output volume, and -50 is the lowest output volume before mute.	<div style="border: 1px solid black; padding: 5px; text-align: center;"> <b>Setup Volume</b>                      -10 dB                 </div>	
<b>3</b>	Use the ▲ and ▼ buttons to adjust to the desired volume. Pressing ▲ increases the volume by 1 dB (press and hold the ▲ button quickly increases the value) and pressing ▼ decreases the volume by 1 dB (press and hold ▼ button quickly decreases the value).		
<b>4</b>	Press SET to save changes and return to main menu.	<div style="border: 1px solid black; padding: 2px;"> <b>M E N U</b> </div>	<div style="border: 1px solid black; padding: 2px;"> <ul style="list-style-type: none"> <li>3. Group/Channel</li> <li>4. Squelch</li> <li>5. Mic Config</li> <li style="background-color: black; color: white; padding: 2px;">6. Volume</li> </ul> </div>
<b>5</b>	Either scroll ▼ down to Exit and press SET, or briefly press SYNC on the receiver front panel to return to the home screen.	<div style="border: 1px solid black; padding: 2px;"> <b>M E N U</b> </div>	<div style="border: 1px solid black; padding: 2px;"> <ul style="list-style-type: none"> <li>9. Keylock</li> <li>a. Display Option</li> <li>b. Reset</li> <li style="background-color: black; color: white; padding: 2px;">c. Exit</li> </ul> </div>



### 7.3.12 Adjusting receiver output level

Setting the receiver output level through menu item 7, RX Output Level assigns either mic level, or line level to the receiver XLR and ¼” TS output jacks. This is an important step in ensuring the signal level leaving the receiver is appropriate for the destination circuit of either a microphone preamp, or a line in preamp.

<p><b>1</b> Press the ▼ button to scroll down to RX Output Level from the main menu. Select by pressing SET to enter the RX Output Level screen.</p>	<table border="1"> <tr><td><b>M</b></td><td>4. Squelch</td></tr> <tr><td><b>E</b></td><td>5. Mic Config</td></tr> <tr><td><b>N</b></td><td>6. Volume</td></tr> <tr><td><b>U</b></td><td><b>7. RX Output Level</b></td></tr> </table>	<b>M</b>	4. Squelch	<b>E</b>	5. Mic Config	<b>N</b>	6. Volume	<b>U</b>	<b>7. RX Output Level</b>
<b>M</b>	4. Squelch								
<b>E</b>	5. Mic Config								
<b>N</b>	6. Volume								
<b>U</b>	<b>7. RX Output Level</b>								
<p><b>2</b> The display shows the current volume setting of either MIC or LINE.</p>	<table border="1"> <tr><th colspan="2">Output Level</th></tr> <tr><td><input type="radio"/></td><td>LINE</td></tr> <tr><td><input checked="" type="radio"/></td><td>MIC</td></tr> </table>	Output Level		<input type="radio"/>	LINE	<input checked="" type="radio"/>	MIC		
Output Level									
<input type="radio"/>	LINE								
<input checked="" type="radio"/>	MIC								
<p><b>3</b> To select desired level, pressing the ▲ button toggles from MIC to LINE, and the ▼ button toggles from LINE to MIC.</p>	<table border="1"> <tr><th colspan="2">Output Level</th></tr> <tr><td><input checked="" type="radio"/></td><td>LINE</td></tr> <tr><td><input type="radio"/></td><td>MIC</td></tr> </table>	Output Level		<input checked="" type="radio"/>	LINE	<input type="radio"/>	MIC		
Output Level									
<input checked="" type="radio"/>	LINE								
<input type="radio"/>	MIC								
<p><b>4</b> Press SET to save changes and return to main menu.</p>	<table border="1"> <tr><td><b>M</b></td><td>4. Squelch</td></tr> <tr><td><b>E</b></td><td>5. Mic Config</td></tr> <tr><td><b>N</b></td><td>6. Volume</td></tr> <tr><td><b>U</b></td><td><b>7. RX Output Level</b></td></tr> </table>	<b>M</b>	4. Squelch	<b>E</b>	5. Mic Config	<b>N</b>	6. Volume	<b>U</b>	<b>7. RX Output Level</b>
<b>M</b>	4. Squelch								
<b>E</b>	5. Mic Config								
<b>N</b>	6. Volume								
<b>U</b>	<b>7. RX Output Level</b>								
<p><b>5</b> Either scroll ▼ down to Exit and press SET, or briefly press SYNC on the receiver front panel to return to the home screen.</p>	<table border="1"> <tr><td><b>M</b></td><td>9. Keylock</td></tr> <tr><td><b>E</b></td><td>a. Display Option</td></tr> <tr><td><b>N</b></td><td>b. Reset</td></tr> <tr><td><b>U</b></td><td><b>c. Exit</b></td></tr> </table>	<b>M</b>	9. Keylock	<b>E</b>	a. Display Option	<b>N</b>	b. Reset	<b>U</b>	<b>c. Exit</b>
<b>M</b>	9. Keylock								
<b>E</b>	a. Display Option								
<b>N</b>	b. Reset								
<b>U</b>	<b>c. Exit</b>								



### 7.3.13 Turning antenna power on and off

The receiver antenna jacks can supply 12vDC booster feed to power the optional RFAMP booster, or ALPA active antenna.

<p><b>1</b> From the main menu, press the ▼ button to scroll down to Antenna Power.</p>	<table border="1"> <tr><td><b>M</b></td><td>5. Mic Config</td></tr> <tr><td><b>E</b></td><td>6. Volume</td></tr> <tr><td><b>N</b></td><td>7. RX Output Level</td></tr> <tr><td><b>U</b></td><td><b>8. Antenna Power</b></td></tr> </table>	<b>M</b>	5. Mic Config	<b>E</b>	6. Volume	<b>N</b>	7. RX Output Level	<b>U</b>	<b>8. Antenna Power</b>
<b>M</b>	5. Mic Config								
<b>E</b>	6. Volume								
<b>N</b>	7. RX Output Level								
<b>U</b>	<b>8. Antenna Power</b>								
<p><b>2</b> The display choices are ON or OFF.</p>	<table border="1"> <tr><th colspan="2">Antenna Power</th></tr> <tr><td><input checked="" type="radio"/></td><td>ON</td></tr> <tr><td><input type="radio"/></td><td>OFF</td></tr> </table>	Antenna Power		<input checked="" type="radio"/>	ON	<input type="radio"/>	OFF		
Antenna Power									
<input checked="" type="radio"/>	ON								
<input type="radio"/>	OFF								
<p><b>3</b> To select, pressing the ▲ button toggles from OFF to ON, and the ▼ button toggles from ON to OFF.</p>	<table border="1"> <tr><th colspan="2">Antenna Power</th></tr> <tr><td><input type="radio"/></td><td>ON</td></tr> <tr><td><input checked="" type="radio"/></td><td>OFF</td></tr> </table>	Antenna Power		<input type="radio"/>	ON	<input checked="" type="radio"/>	OFF		
Antenna Power									
<input type="radio"/>	ON								
<input checked="" type="radio"/>	OFF								



<p><b>4</b> Press SET to save changes and return to main menu.</p>	<table border="1" style="width: 100%; border-collapse: collapse;"> <tr><td style="background-color: #333; color: white; text-align: center;">M</td><td>5. Mic Config</td></tr> <tr><td style="background-color: #333; color: white; text-align: center;">E</td><td>6. Volume</td></tr> <tr><td style="background-color: #333; color: white; text-align: center;">N</td><td>7. RX Output Level</td></tr> <tr><td style="background-color: #333; color: white; text-align: center;">U</td><td><b>8. Antenna Power</b></td></tr> </table>	M	5. Mic Config	E	6. Volume	N	7. RX Output Level	U	<b>8. Antenna Power</b>
M	5. Mic Config								
E	6. Volume								
N	7. RX Output Level								
U	<b>8. Antenna Power</b>								
<p><b>5</b> Either scroll ▼ down to Exit and press SET, or briefly press SYNC on the receiver front panel to return to the home screen.</p>	<table border="1" style="width: 100%; border-collapse: collapse;"> <tr><td style="background-color: #333; color: white; text-align: center;">M</td><td>9. Keylock</td></tr> <tr><td style="background-color: #333; color: white; text-align: center;">E</td><td>a. Display Option</td></tr> <tr><td style="background-color: #333; color: white; text-align: center;">N</td><td>b. Reset</td></tr> <tr><td style="background-color: #333; color: white; text-align: center;">U</td><td><b>c. Exit</b></td></tr> </table> <p style="text-align: center;">OR </p>	M	9. Keylock	E	a. Display Option	N	b. Reset	U	<b>c. Exit</b>
M	9. Keylock								
E	a. Display Option								
N	b. Reset								
U	<b>c. Exit</b>								

### 7.3.14 Keylock

The receiver can be set to Keylock mode, thereby preventing unwanted tampering with, or changes to receiver parameter settings. Menu item 9, Keylock, accesses settings of either on or off.

#### To turn Keylock ON

<p><b>1</b> From the main menu, press the ▼ button to scroll down to Keylock. Select by pressing SET to enter the Keylock screen.</p>	<table border="1" style="width: 100%; border-collapse: collapse;"> <tr><td style="background-color: #333; color: white; text-align: center;">M</td><td>6. Volume</td></tr> <tr><td style="background-color: #333; color: white; text-align: center;">E</td><td>7. RX Output Level</td></tr> <tr><td style="background-color: #333; color: white; text-align: center;">N</td><td>8. Antenna Power</td></tr> <tr><td style="background-color: #333; color: white; text-align: center;">U</td><td><b>9. Keylock</b></td></tr> </table>	M	6. Volume	E	7. RX Output Level	N	8. Antenna Power	U	<b>9. Keylock</b>
M	6. Volume								
E	7. RX Output Level								
N	8. Antenna Power								
U	<b>9. Keylock</b>								
<p><b>2</b> The display shows the setting of OFF.</p>	<table border="1" style="width: 100%; border-collapse: collapse;"> <tr><td style="background-color: #333; color: white; text-align: center;"><b>KeyLock</b></td></tr> <tr><td style="text-align: center;"><input type="radio"/> ON</td></tr> <tr><td style="text-align: center;"><input checked="" type="radio"/> OFF</td></tr> </table>	<b>KeyLock</b>	<input type="radio"/> ON	<input checked="" type="radio"/> OFF					
<b>KeyLock</b>									
<input type="radio"/> ON									
<input checked="" type="radio"/> OFF									
<p><b>3</b> Use the ▲ button to toggle from OFF to ON.</p>	<table border="1" style="width: 100%; border-collapse: collapse;"> <tr><td style="background-color: #333; color: white; text-align: center;"><b>KeyLock</b></td></tr> <tr><td style="text-align: center;"><input checked="" type="radio"/> ON</td></tr> <tr><td style="text-align: center;"><input type="radio"/> OFF</td></tr> </table>	<b>KeyLock</b>	<input checked="" type="radio"/> ON	<input type="radio"/> OFF					
<b>KeyLock</b>									
<input checked="" type="radio"/> ON									
<input type="radio"/> OFF									
<p><b>4</b> Press SET to save changes. The display returns to the home screen where the  icon appears. Access to menus is now LOCKED until unlock is performed.</p>	<table border="1" style="width: 100%; border-collapse: collapse;"> <tr><td style="width: 30px; text-align: center;">AT</td><td style="text-align: center;">RE3-RX</td></tr> <tr><td style="text-align: center;"> -10dB</td><td style="text-align: center;">G:5 CH:12</td></tr> <tr><td style="text-align: center;">LIVE</td><td style="text-align: center;">581.725 MHz</td></tr> <tr><td style="text-align: center;"></td><td style="text-align: center;"></td></tr> </table>	AT	RE3-RX	-10dB	G:5 CH:12	LIVE	581.725 MHz		
AT	RE3-RX								
-10dB	G:5 CH:12								
LIVE	581.725 MHz								

#### To turn Keylock OFF

Entering the menus is not possible when Keylock is on. Keylock must be turned off to access menus.

<p><b>1</b> Press and hold SET for two seconds to enter Keylock screen.</p>	<table border="1" style="width: 100%; border-collapse: collapse;"> <tr><td style="width: 30px; text-align: center;">AT</td><td style="text-align: center;">RE3-RX</td></tr> <tr><td style="text-align: center;"> -10dB</td><td style="text-align: center;">G:5 CH:12</td></tr> <tr><td style="text-align: center;">LIVE</td><td style="text-align: center;">581.725 MHz</td></tr> <tr><td style="text-align: center;"></td><td style="text-align: center;"></td></tr> </table>	AT	RE3-RX	-10dB	G:5 CH:12	LIVE	581.725 MHz		
AT	RE3-RX								
-10dB	G:5 CH:12								
LIVE	581.725 MHz								
<p><b>2</b> The display shows the setting of ON.</p>	<table border="1" style="width: 100%; border-collapse: collapse;"> <tr><td style="background-color: #333; color: white; text-align: center;"><b>KeyLock</b></td></tr> <tr><td style="text-align: center;"><input checked="" type="radio"/> ON</td></tr> <tr><td style="text-align: center;"><input type="radio"/> OFF</td></tr> </table>	<b>KeyLock</b>	<input checked="" type="radio"/> ON	<input type="radio"/> OFF					
<b>KeyLock</b>									
<input checked="" type="radio"/> ON									
<input type="radio"/> OFF									
<p><b>3</b> Press the ▼ button to toggle from ON to OFF.</p>	<table border="1" style="width: 100%; border-collapse: collapse;"> <tr><td style="background-color: #333; color: white; text-align: center;"><b>KeyLock</b></td></tr> <tr><td style="text-align: center;"><input type="radio"/> ON</td></tr> <tr><td style="text-align: center;"><input checked="" type="radio"/> OFF</td></tr> </table>	<b>KeyLock</b>	<input type="radio"/> ON	<input checked="" type="radio"/> OFF					
<b>KeyLock</b>									
<input type="radio"/> ON									
<input checked="" type="radio"/> OFF									

- 4 Press SET to save changes. The display returns to the home screen where the  icon no longer appears.

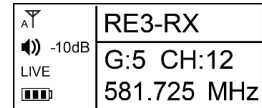

### 7.3.15 Adjusting display options: contrast and brightness

Adjustments to the display contrast and brightness are made in menu item a, Display Options.

- 1 Press the ▼ button to scroll down to Display Options from the main menu. Select by pressing SET to enter the Display Options screen where the screen shows the current settings.



- 2 Contrast setting is highlighted. To make any changes, press the ▲ button to assign higher contrast value, or press the ▼ button to assign lower contrast value. Press set to move to brightness.

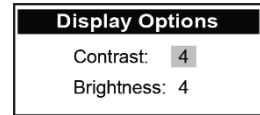

- 3 Current brightness value is highlighted. To make any changes, press the ▲ button to assign higher brightness value, or press the ▼ button to assign lower brightness value.

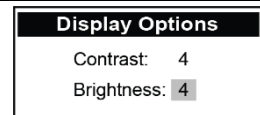

- 4 Press SET to save changes. The display then returns to the main menu.

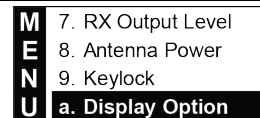

- 5 Press SET to save. The display returns to the main menu.

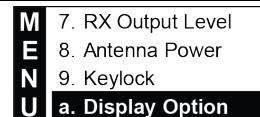

- 6 Either scroll ▼ down to Exit and press SET, or briefly press SYNC on the receiver front panel to return to the home screen. The contrast and brightness changes will impact the appearance of all screens.



### 7.3.16 System reset

Resetting the receiver in menu item b, Reset restores all settings to factory default. Be very sure you want to do this as all custom settings will be erased.

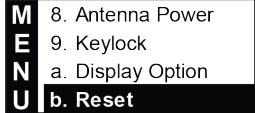
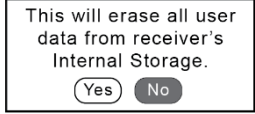
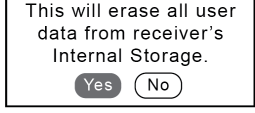
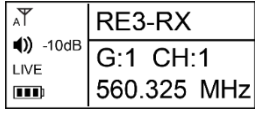
<p><b>1</b> Press the ▼ button to scroll down to Reset from the main menu. Select by pressing SET to enter the Reset screen.</p>	
<p><b>2</b> The reset screen displays the warning message shown. No is highlighted as the default option.</p>	
<p><b>3</b> Press ▲ to toggle to Yes. (NOTE: If Yes is highlighted and you wish to change to No, press the ▼ button to select and highlight No).</p>	
<p><b>4</b> Press SET when you are sure of your choice. If No is selected, Cancel is displayed and the screen returns to the main menu. If Yes is selected, dialogs of “Resetting” and “Reboot” consecutively appear. The receiver restarts with factory default settings. The display then shows the home screen with G:1 and CH:1 as default.</p>	

### 7.3.17 Exit

Select item c, Exit to return to home screen.

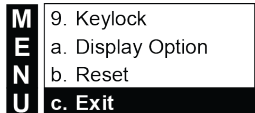
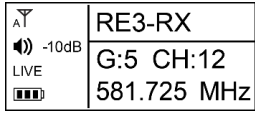
<p><b>1</b> From the main menu, press the ▼ button to scroll down to Exit. Press SET.</p>	
<p><b>2</b> The home screen displays.</p>	

# 8 RE3-HHT handheld transmitter

## 8.1 Product identification

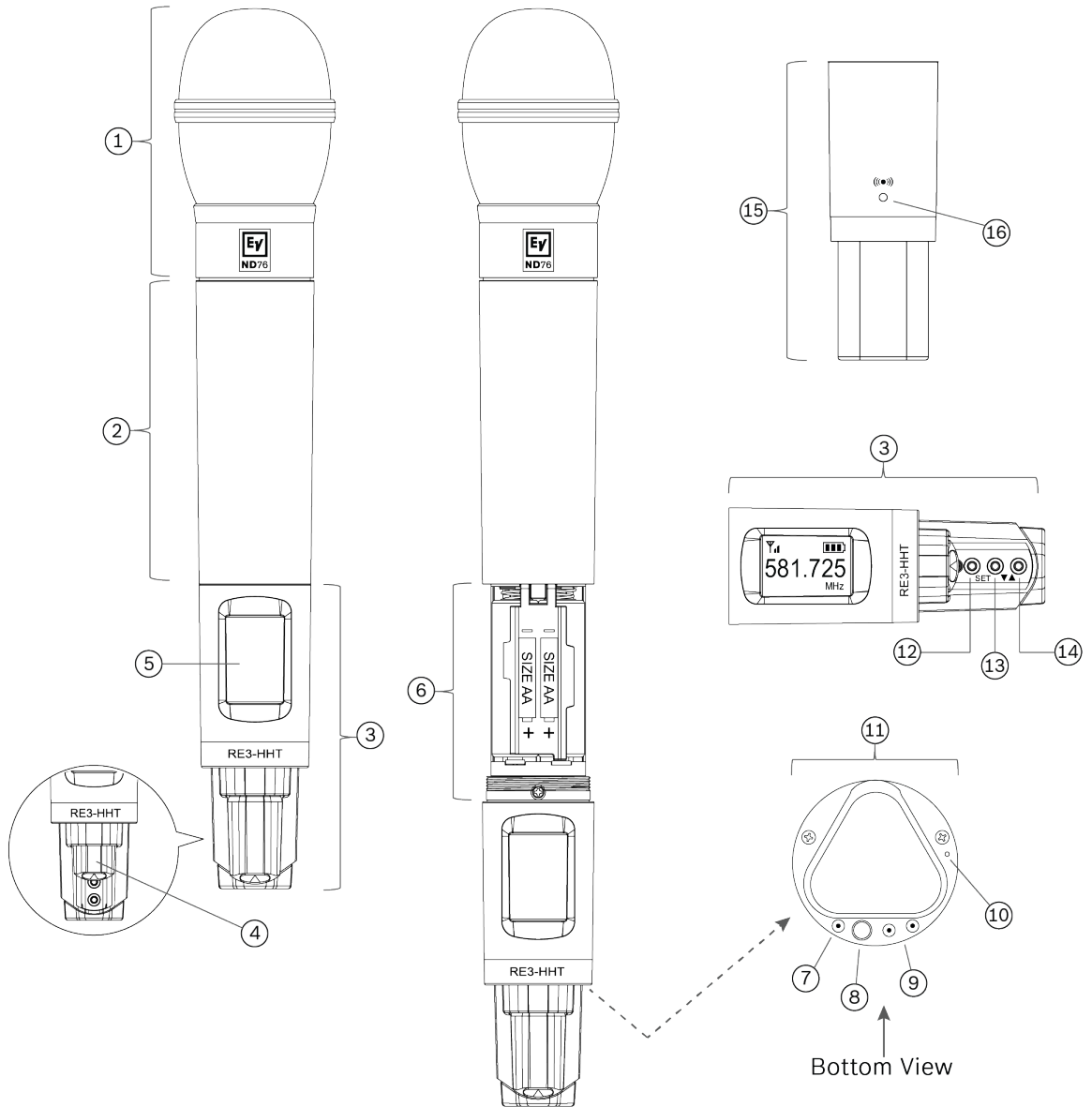

ID	Item	Description, usage and notes
1	Microphone head	RE3 handheld transmitter sets are available with the following microphone head options: ND76-RC3, ND86-RC3, ND96-RC3, RE420-RC3, and RE520-RC3. The heads are interchangeable via the easy-to-use thread-on connection.
2	Transmitter handle / battery cover	This section provides a primary gripping and mounting area, and serves as sliding cover for the battery compartment.

<b>3</b>	Control section	This section contains the LCD display, three menu navigation buttons, power button, charging contacts, LED indicator, and the sync port on opposite side of display.
<b>4</b>	Sliding menu navigation button cover	This sliding cover protects the menu navigation buttons. Sliding the cover toward the LCD display reveals the buttons. Close the cover by sliding it in the other direction protects the buttons.
<b>5</b>	LCD Display	Backlit LCD displays all operating information and menus.
<b>6</b>	Battery compartment	Holds two AA or AA-size rechargeable cells. Install AA cells according to polarity orientation as shown.
<b>7</b>	Charging contact	Three charging contacts, one to the left of the power button and two to the right are for use when using the optional BC2 battery charger and rechargeable cells.
<b>8</b>	Power button	This is a multi-purpose button, functioning as a power on and off switch, a transmitter mute switch, as well as a menu escape switch. To power ON transmitter: press for one second To power OFF transmitter: press and hold until transmitter turns off. PW OFF is displayed. To MUTE transmitter: press briefly (less than one second). MUTE appears on LCD. To UNMUTE transmitter (when muted): press briefly (less than one second). MUTE disappears on LCD display. While in parameter edit mode, press to return to home screen. CANCEL appears on the screen and no setting changes are saved.
<b>9</b>	Charging contacts	Three charging contacts, one to the left of the power button and two to the right are for use when using the optional BC2 battery charger and rechargeable cells.
<b>10</b>	LED indicator	Indicates transmitter operating status as follows: Glow solid green when transmitter is on. Flashes green when transmitter is in mute mode. Glow solid red when battery is low.
<b>11</b>	Transmitter tail end	The lowermost surface in the display and control section.
<b>12</b>	SET button	The most commonly used menu navigation button, it is a multi-purpose action button which functions as an enter key, a menu advance key, and a save or store key.
<b>13</b>	▼ down button	This menu navigation button adjusts the value of an editable parameter. Pressing the ▼ button will decrease the displayed value of the current parameter, or the next state condition value below the displayed state value.

14	▲ up button	This menu navigation button adjusts the value of an editable parameter. Pressing the ▲ button will increase the displayed value of the current parameter, or the next state condition value above the displayed state value.
15	Display and control section - Rear	The side opposite of the LCD display and the sliding navigation button cover
16	Sync signal port	When syncing the transmitter to the receiver, aim the transmitter’s unobstructed sync port directly toward the receiver’s sync emitter. A direct line of sight is required. Maintain a distance between two inches and twelve inches (or between 5cm and 30cm) for best sync performance. The LED indicator (#10) flashes blue during the sync operation and glows solid blue for three seconds when sync operation is successful. The LED return to green after syncing.

## 8.2 LCD display

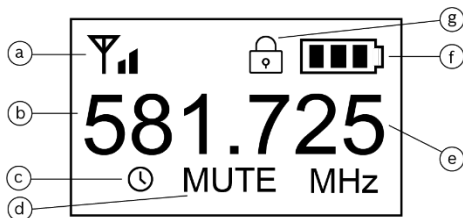

ID	Item	Description, usage and notes
a	RF power icon	The RF power indicator is always visible. Ț indicates RF power is set to low. ȚȚ indicates RF power is set to high (band specific).
b	Frequency in MHz	The portion of the tuned frequency to the left of the decimal in millions when the transmitter home screen is set to Freq.
c	AutoOff icon	The display shows this icon when auto off is engaged. It begins flashing when the transmitter is muted indicating the countdown to shutoff has begun.
d	Mute	The display shows MUTE only when the transmitter is muted.
e	Frequency in kHz	The portion of the tuned frequency to the right of the decimal in thousands when the transmitter home screen is set to Freq.
f	Battery status icon	Indicates battery life. ████ = between 40% and 100% charge remains. ███ = between 20% and 39% charge remains. ██ = between 10% and 19% charge remains. █ = below 10% charge remains. BATTLo appears on the display and the empty cell icon begins flashing when batteries are nearing empty.

g	Keylock icon	Indicates transmitter is in lock mode.
---	--------------	--

### 8.3 Installing batteries



- While gripping the transmitter handle/battery cover section (item 2 shown above) with one hand, grip the control section (item 3 shown above) with the other hand. Using a left-hand twist, unscrew the control section until it is free from the handle. Slide the control section away from the handle until the battery compartment (item 6 shown above) is fully exposed.
- Gently rotate the hinged protective battery cover to expose the battery chamber. Note the battery polarity markings (+ and -) on the protective cover. Both positive (+) contacts are adjacent to the control section male threads.
- Install two fresh, high quality AA alkaline batteries (or fully charged AA size NiMH rechargeable cells) paying close attention to match the polarity markings (+ and -) on each battery to the polarity markings (+ and -) of the battery contacts as shown on the battery cover.
- Once both new batteries are properly installed, rotate the hinged protective battery cover downward until the cover is in contact with the batteries.
- Applying the same gripping technique used while opening the transmitter to expose the batteries, gently slide the battery compartment back inside the handle until the control section can move no further. Using a right hand twist, screw the control section onto the handle section until it is tightly threaded on. Be careful not to overtighten the threads.

### 8.4 RE3-HHT setup menu



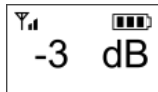

Editing any of the following parameters locally on the transmitter is possible. These edits will override the settings synchronized from the mated receiver. Additionally, any parameter value changes made locally on the transmitter may be overwritten the next time the transmitter is synced to the mated receiver if those parameters are selected in the receiver's sync configuration.

NOTE: No local edits will be possible if the transmitter is in Keylock mode (lock icon displayed). See unlocking instructions below.





NOTE: Press and hold SET for three seconds to enter parameter edit mode. The frequency in millions will begin flashing. Once in parameter edit mode, pressing SET multiple times will advance through the adjustable parameters one parameter per press. The press and hold of SET to enter parameter edit mode counts as the first SET button press.

Function	# of SET button presses		Result
<b>Frequency setup</b>			
 <p>The three digits to the left of the decimal are in millions (MHz). The three digits to the right of the decimal are in thousands (kHz).</p>	1	Millions	<p>▲ increases frequency in increments of 1 MHz per press. ▼ decreases frequency in increments of 1 MHz per press.</p>
	2	Thousands	<p>▲ increases frequency in increments of 25 kHz per press. ▼ decreases frequency in increments of 25 kHz per press.</p>
<p>To save changes: Press SET while thousands is flashing, SAVE is displayed / returns to home screen.</p>			
<b>Group setup</b>			
 <p>The digit to the left of the (-) is the group number The digit(s) to the right of the (-) is the channel number</p>	3	G: #	<p>▲ increases the group number (1-8) in increments of one. ▼ decreases the group number (1-8) in increments of one.</p>
	4	CH: #	<p>▲ increases the channel number (up to 22) in increments of one. ▼ decreases the channel number (up to 22) in increments of one.</p>
<p>To save changes: Press SET while channel number is flashing. SAVE is displayed / returns to home screen.</p>			
<b>Sensitivity setup</b>			
<p>Indication on display: <b>SENSIT</b></p> <p>Displays current sensitivity setting value</p>	5		<p>▲ increases the numeric value in increments of 3dB. ▼ decreases the numeric value in increments of 3dB.</p>
			<p>Setting options (low to high): -15dB, -12dB, -9dB, -6dB, -3dB, 0dB, 3dB, 6dB, 9dB, 12dB, 15dB.</p>
<p>To save changes: Press SET while displaying sensitivity numeric value. SENSIT is displayed briefly / returns to home screen.</p>			



<b>RF Output Power setup</b>			▲ changes low to high. ▼ changes high to low.
Indication on display: <b>RF PWR</b>	6		High ( RFPHI)  will be displayed indicating high RF power.
<b>NOTE:</b> Does not appear in 8M Band menu routine			Low (RFPLO)  will be displayed indicating low RF power.
To save changes: Press SET while displaying RF power value. SAVE is displayed briefly / returns to home screen.			

<b>Auto Off setup</b>			Use ▲ or ▼ to navigate
Indication on display: <b>AUTOOFF</b>	7		Options are: Off, 1 minute, 10 minutes, and 30 minutes.
Assigns a time period for the transmitter to automatically turn off once mute is engaged to conserve battery life.			Displayed as OFF, 1, 10, or 30.  This icon will be displayed indicating an AutoOff timer is set and will begin flashing once transmitter is put into MUTE.
To save changes: Press SET while displaying AutoOFF value. SAVE is displayed briefly / returns to home screen.			

<b>Key Lock setup</b>			Upon entering the Loc screen, pressing ▲ changes OFF to On.  is displayed indicating Keylock is on. Press SET while displaying Loc On. StorE is displayed / returns to home screen.
Indication on display: <b>Loc</b>	8	To lock the transmitter 	While pressing and holding ▲, press and hold SET for two seconds to turn lock ON.  will be displayed and transmitter is locked.
Keylock prevents unwanted tampering with, or changes to transmitter parameter settings. It can be set up locally on the transmitter, or synced from the receiver in the receiver's Mic Config settings.		To unlock the transmitter 	
		OR	To unlock, press and hold SET until On begins flashing. Pressing ▼ toggles On to OFF. Press SET while displaying LocOFF. StorE is displayed / returns to home screen.
		OR	While pressing and holding ▲, press and hold SET for two seconds to turn lock OFF.  will disappear and transmitter is unlocked.

## 9 RE3-BPT bodypack transmitter

## 9.1 Product identification

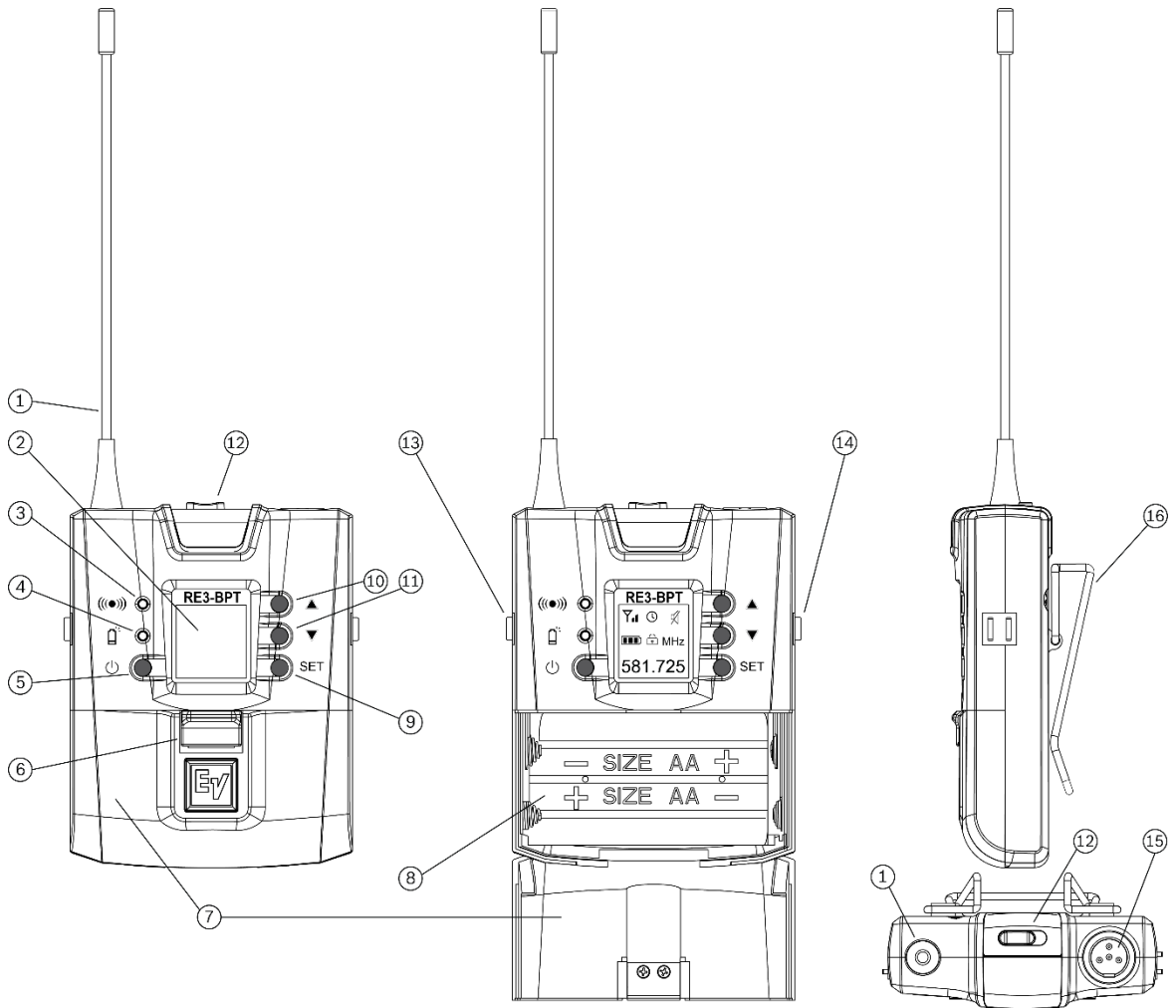

ID	Item	Description, usage and notes
1	Antenna	Flexible antenna. The transmitter will function best when the antenna is oriented vertically (pointing up), exposed to open air, and not in contact with bare skin.
2	LDC display	Backlit LCD displays all operating information and menus. See display section below for details.
3	Sync signal port	When syncing the transmitter to the receiver, aim the transmitter's unobstructed sync port directly toward the receiver's sync emitter. A direct line of sight is required. Maintain a distance between two inches and twelve inches (or between 5cm and 30cm) for best sync performance. The blue LED next to the battery alert icon will flash blue during the sync operation and will glow solid blue for three seconds when sync operation is successful.
4	Battery alert LED	This is a multi-purpose status alert LED: Sync / battery low. Glows solid red when battery low. Flashing blue while syncing. Solid blue for

		three seconds when the transmitter is successfully sync'd to the receiver.
<b>5</b>	Power button	This is a multi-purpose button, functioning as a power on and off switch, as well as a menu escape switch. To power ON transmitter: press briefly. To power OFF transmitter: press and hold for three seconds. Transmitter turns off. While in parameter edit mode, press to escape to home screen. CANCEL appears on the screen and no setting changes are saved.
<b>6</b>	Battery door latch/lock	Slide the latch downward to unlock the battery door. Continue pressing the latch downward while rotating the bottom-hinged door downward to open the battery compartment door.
<b>7</b>	Battery door	Covers and protects batteries.
<b>8</b>	Battery compartment	Holds two AA or AA-size rechargeable cells. Install AA cells according to polarity orientation as shown.
<b>9</b>	SET button	The most commonly used menu navigation button, it is a multi-purpose action button which functions as an enter key, a menu advance key, and a save or store key.
<b>10</b>	▲ (up button)	This menu navigation button adjusts the value of an editable parameter. Pressing the ▲ button will increase the displayed value of the current parameter, or the next state condition value above the displayed state value.
<b>11</b>	▼ (down button)	This menu navigation button adjusts the value of an editable parameter. Pressing the ▼ button will decrease the displayed value of the current parameter, or the next state condition value below the displayed state value.
<b>12</b>	Mute switch	This toggle switch engages mute / unmute function, and the colored LED indicates statuses. Sliding the illuminated switch into the mute position silences the audio. Sliding the illuminated switch away from mute position makes audio live. LED color indicators: ON = solid green. Mute = flashing red. Low battery = solid red.
<b>13</b>	Charging contact (one)	Three charging contacts, one to the left side and two on the right are for use when using the optional BC2 battery charger and rechargeable cells.
<b>14</b>	Charging contacts (two)	Three charging contacts, one to the left side and two on the right are for use when using the optional BC2 battery charger and rechargeable cells.
<b>15</b>	4-pin mini jack	This is the audio input jack where the audio input device (lavalier or headworn microphone, or instrument cable) connects to the transmitter.

16	Belt clip	Using its spring action, this clip secures the transmitter to a belt, waistband, or other stable location.
----	-----------	--

## 9.2 LCD display

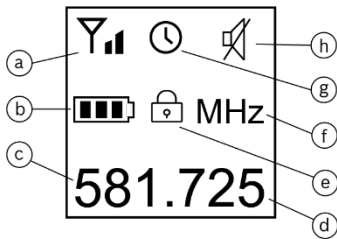

ID	Item	Description, usage and notes
a	RF power icon	The RF power indicator is always visible. Ț indicates RF power is set to low. Ț̣ indicates RF power is set to high (band specific).
b	Battery status icon	Indicates battery life. █ █ █ █ = between 40% and 100% charge remains. █ █ █ = between 20% and 39% charge remains. █ █ = between 10% and 19% charge remains. █ = below 10% charge remains. bAttLo appears on the display and the empty cell icon begins flashing when batteries are nearing empty.
c	Frequency in MHz	The first portion of the tuned frequency to the left of the decimal in millions when the transmitter home screen is set to Freq. If screen is set to display Group/Channel, this screen area will display current group number.
d	Frequency in kHz	The second portion of the tuned frequency to the right of the decimal in thousands when the transmitter home screen is set to Freq. If screen is set to display Group/Channel, this screen area will display current channel number.
e	Keylock icon	Indicates transmitter is in lock mode.
f	MHz	Image is visible the transmitter home screen is set to Freq. Image does not appear when the transmitter home screen is set to Group/Channel.
g	AutoOff icon	This icon indicates auto off is engaged. It begins flashing when the transmitter is muted indicating the countdown to shutoff has begun.
h	Mute icon	The display shows MUTE only when the transmitter is muted.

## 9.3 Installing batteries

- Gently press the sliding magnetic battery door latch (item 6 shown above) downward to unlock, while at the same time rotating the hinged battery door (item 8 shown above) downward to fully open the battery compartment.
- Install two fresh, high quality AA alkaline batteries (or fully charged AA size NiMH rechargeable cells) paying close attention to match the polarity markings (+ and -) on each battery to the polarity markings (+ and -) on the battery contacts.
- Rotate the hinged battery door upward until the compartment door latches shut. The magnetic latch will lock the compartment door.







## 9.4 RE3-BPT Setup Menu

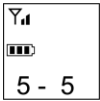

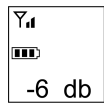
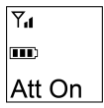

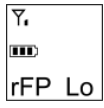

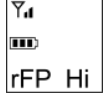
Editing any of the following parameters locally on the transmitter is possible. These edits will override the settings synced from the mated receiver. Additionally, any parameter value changes made locally on the transmitter may be overwritten the next time the transmitter is synced to the mated receiver if those parameters are selected in the receiver's sync configuration.

NOTE: No local edits will be possible if the transmitter is in Keylock mode (lock icon displayed). See unlocking instructions below.

NOTE: Press and hold SET for three seconds to enter parameter edit mode. The frequency in millions will begin flashing. Once in parameter edit mode, pressing SET multiple times will advance through the adjustable parameters one parameter per press. The press and hold of SET to enter parameter edit mode counts as the first SET button press.

Function	# of SET button presses		Result
<b>Frequency setup</b>			
 <p>The three digits to the left of the decimal are in millions (MHz). The three digits to the right of the decimal are in thousands (kHz).</p>	1	Millions	▲ increases frequency in increments of 1 MHz per press. ▼ decreases frequency in increments of 1 MHz per press.
	2	Thousands	▲ increases frequency in increments of 25 kHz per press. ▼ decreases frequency in increments of 25 kHz per press.
To save changes: Press SET while thousands is flashing. StorE is displayed / returns to home screen.			
<b>Group / Channel setup</b>			
 <p>The digit to the left of the (-) is the group number</p>	3	G: #	▲ increases the group number (1-8) in single digit increments. ▼ decreases the group number (1-8) in single digit increments.
	4	CH: #	▲ increases the channel number (up to 22) in single digit increments. ▼ decreases the channel number (up to 22) in increments of one.

<p>The digit(s) to the right of the (-) is the channel number</p>		<p>To save changes: Press SET while channel number is flashing. StorE is displayed / returns to home screen.</p>
<p><b>Sensitivity setup</b></p>		
<p>Indication on display: <b>SEnSit</b> Displays current sensitivity setting value</p>	<p>5</p>	<div data-bbox="798 446 901 553" style="border: 1px solid black; padding: 5px; display: inline-block;">  </div> <p>▲ increases the numeric value in increments of 3dB. ▼ decreases the numeric value in increments of 3dB. Setting options (low to high): -15dB, -12dB, -9dB, -6dB, -3dB, 0dB, 3dB, 6dB, 9dB, 12dB, 15dB.</p>
<p>To save changes: Press SET while displaying sensitivity numeric value. SENSIT is displayed briefly / returns to home screen.</p>		
<p><b>Attenuation setup</b></p>		
<p>Indication on display: <b>Att</b></p>	<p>6</p>	<div data-bbox="798 808 901 915" style="border: 1px solid black; padding: 5px; display: inline-block;">  </div> <p>▲ changes OFF to On, applying 20dB attenuation.</p>
<p>When attenuation is set to on, the transmitter audio input stage is attenuated by 20dB.</p>		<div data-bbox="798 946 901 1053" style="border: 1px solid black; padding: 5px; display: inline-block;">  </div> <p>▼ changes On to OFF.</p>
<p>To save changes: Press SET to store the attenuation status value. StorE is displayed / returns to home screen.</p>		
<p><b>RF Output Power setup</b></p>		
<p>Indication on display: <b>rFP</b></p>	<p>7</p>	<div data-bbox="798 1308 901 1415" style="border: 1px solid black; padding: 5px; display: inline-block;">  </div> <p>▲ changes low to high. ▼ changes high to low. Low (rFP Lo)  will appear on the display indicating low RF power.</p>
<p><b>NOTE:</b> Does not appear in 8M Band menu routine.</p>		<div data-bbox="798 1436 901 1542" style="border: 1px solid black; padding: 5px; display: inline-block;">  </div> <p>High (rFP Hi)  will appear on the display indicating high RF power.</p>
<p>To save changes: Press SET while displaying RF power value. StorE is displayed briefly / returns to home screen.</p>		
<p><b>Auto Off setup</b></p>		
<p>Indication on display: <b>AutoOF</b></p>	<p>8</p>	<p>Use ▲ or ▼ to navigate. Options are: Off, 1 minute, 10 minutes, and 30 minutes. Displayed as OFF, 1, 10, or 30.</p>

<p>Assigns a time period for the transmitter to automatically turn off once mute is engaged to conserve battery life.</p>		<p>This icon will be displayed indicating AutoOff timer is set and will begin flashing once when is put into MUTE.</p> <hr/> <p>To save changes: Press SET while displaying AutoOFF value. StorE is displayed briefly / returns to home screen.</p>
<p><b>Key Lock setup</b></p>		
<p>Indication on display: <b>Loc</b></p> <p>Keylock prevents unwanted tampering with, or changes to transmitter parameter settings. It can be set up locally on the transmitter, or synced from the receiver in the receiver's Mic Config settings.</p>	<p>To lock the transmitter</p>  <p>OR</p> <p>To unlock the transmitter</p> 	<p>Upon entering the Loc screen, pressing ▲ changes OFF to On.  is displayed indicating Keylock is on. Press SET while displaying Loc On. StorE is displayed / returns to home screen.</p> <hr/> <p>While pressing and holding ▲, press and hold SET for two seconds to turn lock ON.  is displayed and the transmitter is locked.</p> <hr/> <p>To unlock, press and hold SET until On begins flashing. Pressing ▼ toggles On to OFF. Press SET while displaying LocOFF. StorE is displayed / returns to home screen.</p> <hr/> <p>While pressing and holding ▲, press and hold SET for two seconds to turn lock OFF.  will disappear and transmitter is unlocked.</p>

9

## 10 Accessories for RE3

### Additional transmitters

RE3-HHT76	RE3 Handheld transmitter with ND76 head
RE3-HHT86	RE3 Handheld transmitter with ND86 head
RE3-HHT96	RE3 Handheld transmitter with ND96 head
RE3-HHT420	RE3 Handheld transmitter with RE420 head
RE3-HHT520	RE3 Handheld transmitter with RE520 head
RE3-BPT	RE3 Bodypack transmitter

### Extra receiver

RE3-RX	RE3 1/2-space receiver with power supply
--------	--

### Antenna distribution

RE3-ACC-AASP	Active antenna splitter, 2-in, 8-out
RE3-ACC-PASP	Passive splitter kit

### Extension antennas and boosters

RE3-ACC-PLPA	Passive log periodic antenna
RE3-ACC-ALPA	Active log periodic antenna
RE3-ACC-RFAMP	Active RF antenna booster

### Rack mounting

RE3-ACC-RMK1	Rack mount kit for single RE3 receiver
RE3-ACC-RMK2	Rack mount kit for two RE3 receivers

### Handheld transmitter microphone heads

ND76-RC3	Wireless head with ND76 capsule
ND86-RC3	Wireless head with ND86 capsule
ND96-RC3	Wireless head with ND96 capsule
RE420-RC3	Wireless head with RE420 capsule
RE520-RC3	Wireless head with RE520 capsule

### Handheld transmitter accessory

RE3-ACC-HHTSA1	Stand adapter for RE3-HHT transmitter
----------------	---------------------------------------

### RE3 series bodypack transmitter input devices

RE3-ACC-OL3	Omnidirectional lavalier mic with 4-pin mini plug
RE3-ACC-CL3	Cardioid lavalier mic with 4-pin mini plug
RE3-ACC-HW3	Headworn mic with 4-pin mini plug
RE3-ACC-GC3	Instrument cable; 1/4" to 4-pin mini plug



---

**Compatible EV and TELEX bodypack transmitter input devices**

---

OLM10	Omnidirectional lavalier condenser mic with 4-pin mini plug
ULM18	Uni-Directional Lapel Mic
ULM21	Cardioid lavalier condenser mic with 4-pin mini plug
RE92TX	Premium cardioid lapel microphone with 4-pin mini plug
RE97LTX-BEIGE	Miniature omnidirectional lapel microphone with 4-pin mini plug, beige
RE97LTX-BLACK	Miniature omnidirectional lapel microphone with 4-pin mini plug, black
RE920TX	Premium cardioid instrument mic with a custom shock mounting clip and 4-pin mini plug
RE97TX-BEIGE	Omnidirectional low profile headworn microphone in light beige color with 4-pin mini plug
RE97TX-BLACK	Omnidirectional low profile headworn microphone in black color with 4-pin mini plug
RE97-2TX-BEIGE	Omnidirectional low profile, double ear headworn microphone with 4-pin mini plug
HM2	Headworn cardioid condenser vocal mic with 4-pin mini plug
HM3	Omnidirectional headworn Mic
HM7	Headworn cardioid condenser vocal mic with 4-pin mini plug
WPHS-746	Headworn condenser vocal mic with 4-pin mini plug. Waterproofing material covers mic and headband
PH-21	Headworn, cardioid condenser mic with 4-pin mini plug
WLM-50	Omni-directional electret lapel mic with 4-pin mini plug
MAC-G3	Guitar cord featuring George L's cable with 4-pin mini plug

**Antenna cables**

---

RE3-ACC-CXUF	Rear to front mount antenna cable kit
RE3-ACC-CXU2	2 foot antenna coax cable (pair)
RE3-ACC-CXU10	10 foot, 50 ohm BNC coax cable (pair)
RE3-ACC-CXU25	25 foot, 50 ohm low loss BNC coax cable
RE3-ACC-CXU50	50 foot, 50 ohm low loss BNC coax cable
RE3-ACC-CXU75	75 foot, 50 ohm low loss BNC coax cable
RE3-ACC-CXU100	100 foot, 50 ohm low loss BNC coax cable

**Battery charging**

---

RE3-ACC-BC2	2-up battery charger. Charges one or two transmitters with rechargeable cells at a time.
-------------	--

# 11 Troubleshooting and FAQ

## 11.1 Troubleshooting

Unpredictable battery consumption.	Poor quality or stale batteries.	Fresh battery life should be >8 hours. Use fresh, good quality alkaline batteries for longest battery life. Transmitter output power will affect battery consumption as high power setting uses more current.
Receiver will not turn on.	Power supply not plugged in.	Ensure power supply is plugged into AC power, and its DC connector is fully plugged into receiver DC input jack.
	DC power distribution cable from AASP splitter not properly connected (if used).	Ensure DC distribution cable is fully plugged into receiver DC input jack and the other end is fully plugged into an AASP DC output jack.
	AC mains circuit is off.	Ensure AC circuit is live by testing another AC powered item. If necessary, locate and reset circuit breaker.
	Power button may be damaged.	The RE3 receiver power button is robust and durable, and is unlikely to fail. If other listed resolutions do not solve the problem contact your local Electro-Voice service center.
Transmitter will not turn on.	Dead batteries.	Replace with fresh, high-quality alkaline batteries.
	Battery polarity reversed.	Ensure battery + and - ends are in contact with the like-marked battery compartment contacts.
	Power button may be damaged.	RE3 transmitter power buttons are robust and durable, and are unlikely to fail. If properly-inserted and known-to-be-fresh batteries will still not turn on transmitter, contact your local Electro-Voice service center.
<b>Symptom</b>	<b>Possible cause</b>	<b>Possible resolution</b>
	Transmit power too low.	Set transmitter power to high setting.

Short transmission range.	Receiver squelch set too high.	Adjust receiver squelch by trying lower number values until desired range is achieved.
	Improperly placed receiver antennas.	Place receiver antennas out in the open in the shared space of the transmitter away from reflective or grounding surfaces.
	Disconnected, incorrect, or failed antenna cable.	Ensure a known-to-be functional and appropriate 50Ω BNC-terminated cable is fully connected at the antenna and receiver.
	Competing RF signal at the receiver.	Turn off the transmitter and observe the receiver RF meter. If any RF is showing, follow the scan process and select a new clear frequency. Then turn on the transmitter and resync it to the receiver's new data.
Low AF signal on receiver meter.	Transmitter sensitivity set too low.	Adjust transmitter sensitivity so that high vocal peaks light the yellow LED segment. Under extremely loud vocal peaks, an occasional red LED segment light is OK, but a solid and constant red LED should be avoided.
Unstable radio reception.	Radio interference.	Turn off the RE3 transmitter and observe the receiver RF meter. If any RF is showing, follow the scan process and select a clear frequency. Then turn on the transmitter and resync it to the receiver's new data.
	Improperly placed receiver antennas.	Place receiver antennas out in the open in the shared space of the transmitter away from reflective or grounding surfaces.
	Disconnected, incorrect, or failed antenna cable.	Ensure known-to-be functional and appropriate 50Ω BNC-terminated cables are fully connected at the antenna and receiver.

Symptom	Possible cause	Possible resolution
Audible dropouts.	Intermittent signal connection at transmitter.	Check for fully connected microphone head or bodypack input device. Ensure proper connection. Determine if a short is causing dropout by shaking cable or manipulating the mic head connection. Use functioning input signal device.
	Intermittent receiver output signal.	Check for fully functioning audio output cable between receiver and sound system input. Test cable by manipulating it at either end near connectors. Replace cable if shorted or intermittent.
	Radio interference.	Turn off the transmitter and observe the receiver RF meter. If any RF is showing, follow the scan process and select a clear frequency. Then turn on the transmitter and resync it to the receiver's new data.
	Receiver squelch set too high.	Adjust receiver squelch by trying lower number values until stable audio is achieved.
	Improperly placed receiver antennas.	Place receiver antennas out in the open in the shared space of the transmitter away from reflective or grounding surfaces.
Receiver display always shows same antenna (A or B) received.	Disconnected antenna.	Check and correct both antenna connections at receiver and antenna jacks.
	Improperly placed receiver antennas.	Place receiver antennas out in the open in the shared space of the transmitter away from reflective or grounding surfaces.
	Disconnected, incorrect, or failed antenna cable.	Ensure a known-to-be functional and appropriate 50Ω BNC-terminated cable is fully connected at the antenna and receiver.

Symptom	Possible cause	Possible resolution
Receiver display shows no antenna.	No synced transmitter on the frequency.	Turn on transmitter and ensure proper sync to receiver.
	No antennas connected.	Properly connect antennas as system configuration requires.
	Active booster or antenna not receiving DC power (if used).	Turn on antenna DC power at receiver or AASP splitter.
Receiver RF meter shows no RF.	No transmitter turned on or synced.	Turn on synced transmitter. If not synced, follow sync process.
	Antennas not connected.	Ensure both antennas are properly connected.
	Active booster or antenna not receiving DC power (if used).	Turn on antenna DC power at receiver or AASP splitter.
	Antenna splitter turned off (if used).	Ensure AASP antenna splitter is turned on.
Receiver RF meter shows RF signal even when synced transmitter is off.	Another RF source is active and generating RF on that frequency which will affect system performance, range, and contribute to possible dropouts.	With the RE3 transmitter off, follow the scan process and select a new clear frequency. Then turn on the transmitter and resync it to the receiver's new data.
Low RF signal when using remote antennas.	Improper antenna selection.	Choose an antenna designed for the remote antenna application such as the optional PLPA or ALPA log periodic, or RFAMP booster with the receiver's stock ½ wave antenna attached.
	Improper cable selection.	A long cable run requires low loss cable made for the application.
	Improper antenna placement.	Antennas should be placed out in the open, preferably in the space where the transmitter is, and not near or touching reflective or grounding materials.
	DC booster feed not on for active antenna or booster.	Make sure the receiver or AASP splitter antenna power is turned on.
	Transmit power may be too low for needed range.	Set transmitter power to high (if equipped).

Symptom	Possible cause	Possible resolution
Transmitter will not sync to receiver.	Transmitter and receiver may not be in the same frequency band.	Ensure transmitter is the same frequency band as the receiver.
	Obstructed sync port or sync emitter.	Ensure that the receiver sync emitter and transmitter sync port are not obstructed and clear of debris. Clear obstruction or debris if required.
	Direct line of sight between sync emitter and sync port is obstructed.	Ensure clear line of sight between receiver sync emitter and the transmitter sync port. Aim port directly at emitter.
	Transmitter sync port out of range with receiver sync emitter.	Maintain recommended range of 2-12 inches between receiver sync emitter and the transmitter sync port.
Receiver display shows NoSYNC.	Synced transmitter is either off or has not been synced.	Turn on synced transmitter. If not synced, follow sync process.
Receiver display shows mute.	Synced transmitter is in mute.	Unmute transmitter when necessary.
Sound system input not receiving high enough signal.	Receiver audio output level too low.	Use receiver up arrow button to adjust output gain to desired level for sound system input.
Sound system input receiving too much gain.	Receiver audio output level too high.	Use receiver down arrow button to adjust output gain to desired level for sound system input.

## 11.2 Frequently Asked Questions

### **Q – Why was my system working fine at sound check, then suddenly it started getting interference during the performance?**

A – Using RF wireless can be quite tricky. Sources of competitive RF are everywhere, and they can appear unpredictably. A competing RF signal that wasn't present during your sound check probably went active during the show. This could be another member of the wireless microphone community in the venue that was off during sound check – possibly another performer's wireless rig was turned on during your show, and now is interfering with your system. The source could also be a computer (CPU) positioned near the receiver or antennas that wasn't on earlier. It could even be as pesky as a cell phone near either the transmitter or receiver, which while not being used for a call, is sending GPS signals periodically, emitting a signal (if close enough to the transmitter or receiver) which could be creating sporadic audible interference. To resolve, rescan the receiver and select a new clear frequency. Then resync the transmitter to the new receiver data.

### **Q – It seems that when the performer walks way out into the audience, the system starts losing signal. Why am I not getting the range from the system I need?**

A – This could indicate a variety of influencing factors. The first thing to check is if your system is, or is not, sharing a frequency with another signal at the receiver. While observing the receiver's RF meter, turn off the transmitter. If the RF meter continues to show signal after the transmitter is off, your transmitter is competing with another signal at the receiver. To solve, perform the scan process, tune the receiver to a new clear frequency, then turn on and sync the transmitter to the new receiver data. The second thing to check is receiver antenna placement and cables. Ensure that your antennas are out in the open in the shared space of the transmitter (meaning not behind walls or in another room), away from reflective or grounding surfaces, and connected to the receiver with appropriately-rated 50Ω BNC-terminated coax cable. The third thing to check is the receiver squelch. Many times, having the squelch set too high will greatly reduce system range. Try lowering the squelch (number value) to increase system range. The fourth thing to check is transmitter output power. If a compromised range is accompanied with low RF signal on the receiver's RF meter, set the transmitter output power to high, then look for improved range.

**Q – Why is it hard to find an open frequency in my location?**

A – RE3 shares the UHF radio spectrum primarily with UHF television broadcasters. Geographically, some broadcast areas are more densely packed with television broadcast signals than others. A full system scan looks through the entire tuning bandwidth of the receiver and will locate frequencies which are not affected by UHF television or other RF signals. Knowing your local RF environment is important. Those local television stations which broadcast their strong and wide signals into the air are regulated by the government, and consulting government databases will help identify the frequency areas occupied by local broadcasters. RE3 tuning bandwidths are relatively wide, allowing generous tuning options, however if the airwaves aligning with your particular RE3 tuning bandwidth are filled up with UHF television, finding open frequencies will be difficult. Selecting the best band for your area is important. Something to consider is if you are using your RE3 set in the USA or Canada, the 6M band will have no competing UHF television signals because 653-663MHz is designated for wireless microphones only as a result of the reallocation of 600MHz initiatives.

**Q – I manually created frequencies for my multi-channel system. Why am I getting interference between the channels?**

A – Manually creating custom tuning schemes without the assistance of frequency coordination software may contribute to the problem described. RE3 frequency groups are strategically created to be intermodulation free using advanced frequency coordination software. It's likely that your self-made grouping has created destructive intermodulation artifacts which would be avoided by staying with our factory groups. Use RE3 factory groupings. They work well.

**Q – Why doesn't the extra RE3 transmitter I bought online work with my RE3 set?**

A – The set you originally purchased was pre-configured with a matching transmitter and receiver, which both operate in the same frequency band (5L, 5H, 6M, etc.). If you add another transmitter, it has to be of the same frequency band to work. As this particular question is about additional transmitters, it should be pointed out that adding a second transmitter to an existing set with plans to use both transmitters at the same time with the one existing receiver will not work. At any given time, one of the two transmitters tuned to the receiver's frequency must be off. If they are both on and the same time, substantial interference will occur.

**Q – Will the lavalier microphone I have with my older RE-2 system work with RE3?**

A – Yes. Legacy Electro-Voice bodypack transmitter input devices with 4-pin mini connectors are compatible with RE3.

**Q – I want to put together an eight-channel RE3 system with two remote antennas on the stage feeding the receiver rack. What do I need?**

A – First, choose the frequency band or bands your system will be operating in. Based on your location, you'll need to evaluate available spectrum and how it aligns with the RE3 band options. Knowing that information, one option would be to select the same band for all eight sets. Another option is to split the eight by selecting four sets from one band, and the other four from another band, thereby allowing room to compensate for unforeseen changes. You'll probably be rack mounting your receivers, so you'll need four RMK2 dual rack mount kits, which will mount the eight receivers in four rack spaces. You'll need two AASP active antenna splitters which will cascade the RF from two antennas into the eight receivers. You'll need either two PLPA passive log periodic antennas, or two ALPA active log periodic antennas on stage. They will mount on standard microphone stands. Choosing between the two will be influenced by coverage area and the length of antenna cable between antenna and receiver rack. The PLPA, although passive, has 10dB of passive gain, and may be fine if the receiver rack is on stage, however the ALPA active antenna has adjustable gain (selectable 3dB and 10dB amplified), and if the cable run to the receiver rack is lengthy, it may be the best choice. You decide. You'll need TWO low-loss coax cables to run the antenna signals to the first AASP splitter. Choices are RE3-ACC-CXU25 twenty-five foot, RE3-ACC-CXU50 fifty foot, RE3-ACC-CXU75 seventy-five foot, or RE3-ACC-CXU100 one hundred foot. The splitter has all cables required if you connect your remote antenna cables to the rear of the first AASP, but if you want to attach the antenna cables at the front of the rack, you'll need to add an RE3-ACC-CXUF rear to front mount antenna cable kit. That should do it.

**Q – Why am I not seeing much audio level on my receiver AF meter?**

A – The transmitter input sensitivity likely needs to be adjusted. It has 30dB of adjustment (-15dB at lowest gain to +15dB at highest gain). On the transmitter, press and hold SET until the characters on the display begin to flash. Continue to progressively press SET until reaching the sensitivity parameter. Press the up button to increase the displayed value. Pressing SET will store the new setting. Continue working with this setting until the receiver's AF meter yellow LED is lighting upon high voice peaks. An occasional red LED will be OK.

**Q – My receiver is in lock mode. How do I unlock it?**

A – Press and hold the SET button for two seconds then use down button to select OFF. Then press SET. Receiver is unlocked.

**Q – Why does my receiver RF meter show RF signal present before I turn on the mated transmitter?**

A – There is a competing RF signal now present on that frequency. With the RE3 transmitter off, follow the scan process and select a new clear frequency. Then turn on the transmitter and resync it to the receiver's new data.

**Q – The frequency I've had my set tuned to has always worked flawlessly. Why is it that when I traveled to an out-of-town gig, I'm getting interference there?**

A – RF environments change city-to-city. When traveling, it's important to remember that UHF television broadcasts are not always on the same channel in every city. Something in the city or



venue you traveled to is different. Follow the scan process and select a new clear frequency. Then turn on the transmitter and resync it to the receiver's new data.

**Q – Our RE3 systems have been working fine in the small venue we play. We decided to try high power on the lead vocal mic transmitter, and now we're having all kinds of problems. What could be wrong?**

A – In your small venue, high output power on any or all of your mics may be too much because of transmitter-to-transmitter, and transmitter-to-receiver proximity. Too much RF gain can actually be more destructive than low RF gain. High RF gain is most useful for long transmission distances, but at short distances, it may contribute to intermodulation with nearby transmitters and receivers. If the low power setting was working for you, switch back to it.

**Q – I have a long distance between where I want my antennas mounted and where the receivers will be located. Do I need antenna boosters and high-end coax?**

A – This might be a very good idea. The purpose of using antenna boosters and/or active antennas is to compensate for the signal loss incurred by the antenna-to-receiver coax cable run. The system you describe will be improved with active RF antenna components and low-loss coax. Coax cable performance is measured by loss factors, i.e., dB of loss per 100 meters. The goal is to deliver to the receiver the approximate RF gain which is received at the antenna. The RE3 optional antenna coax cables should perform as per: 25-foot CXU25 will lose approximately 1.3 dB on the run, the 50-foot CXU50 will lose approximately 1.4 dB on the run, the 75-foot CXU75 will lose approximately 2.4 dB on the run, and the 100-foot CXU100 will lose approximately 4.4 dB on the run. Factoring in the gains of the antennas, the passive log periodic PLPA is +10 dB, the active log periodic ALPA is either +3 dB or +10 dB (selectable), and the active booster RFAMP is +10 dB. So for example, if your antenna cable run is 100 feet, and you deploy ALPA (set to +10 dB) followed by CXU100 (-4.4 dB), the net RF gain at the receiver is approximately +5.6 dB, which is fine. A handy way to think of it is booster/antenna gain minus cable loss equals net received RF gain. We should also emphasize that an RF boosting device should precede the loss, not make up for it after the loss (place a booster at the antenna location, and not the receiver location).

**Q – I'm using an RE3 bodypack wireless for my bass guitar with active pickups and I'm blasting the receiver hard. What could be wrong?**

A – Your bodypack transmitter input pad should be engaged. Locate the -20 dB attenuator setting in the menu and set it to ON. If further transmitter audio signal gain reduction is necessary, locate the sensitivity setting in the menu and bring the sensitivity down a few dB as well.

## 12 Technical data

### RE3-RX receiver

Frequency Oscillation Mode:	Phase-locked loop (PLL)
Carrier Frequency Range:	470 - 865 MHz (tuning bandwidth is band dependent)
Band Names Tuning Bandwidths and Carrier Frequency Ranges	5L: 36 MHz (488-524 MHz) 5H: 36 MHz (560-596 MHz) 6M: 10 MHz (653-663 MHz) T: 3 MHz (803-806 MHz) 8M: (823-865 MHz) 8M is split into two segments: 9 MHz (823-832 MHz) 2 MHz (863-865 MHz)
Sync Frequency:	Ultrasonic 40 kHz
Diversity:	Antenna diversity
Bandwidth:	36MHz
Signal/Noise Ratio:	>100dB(A)
Total Harmonic Distortion (Thd):	<0.6%@1kHz
Receiving Sensitivity:	-81dBm for -12dB SINAD
Frequency Response:	63Hz~16kHz±2dB (BPT) 51Hz~1tkHz±2dB (HHT)
Antenna Type:	Detachable ½ wave with BNC connector
Antenna Booster Power:	DC12 - 15V/100mA
Function Display By:	LCD
Contents Of Display:	Group, channel, frequency, antenna A/B, transmitter battery level, transmitter status (mute, live, or no sync), output level attenuation, AF indication, RF indication, key lock indicator.
Control Functions:	Power, scan, frequency, group, channel, squelch, TX sensitivity, TX attenuation, TX RF power, TX auto off, TX key lock, TX display info, TX sync configuration, RX output volume, RX output level, RX antenna booster power, RX key lock, RX display contrast, RX display brightness, RX system reset.
Sync Data Options:	Frequency, group, channel, sensitivity level, attenuation status, RF power, auto off status, key lock status, transmitter display (freq or Gp/Ch)
Audio Frequency Output Level:	¼" (6.3mm) Phone Jack: -10dBV XLR Jack: -4dBV (Line) & -24dBV (MIC)
Audio Frequency Output Impedance:	240Ω (unbalanced) 1400Ω (balanced)

Squelch and noise muting:	Noise muting and tone code locking
Output Ports:	1 x balanced XLRM jack 1 x unbalanced ¼" TS (6.3mm) jack
Power Supply:	DC12~15V/500mA
Finish:	Black polyurethane paint
Dimensions:	Width: 8.27 inch (210mm) Height: (with feet attached) 1.85 inch (47mm) Height: (without feet attached) 1.73 inch (44mm) Depth: (including antenna jack) 6.89 inch (175mm) Depth: (not including antenna jack) 6.1 inch (155mm)

### RE3-HHT handheld transmitter

Frequency Oscillation Mode:	Phase-locked loop (PLL)
Band Names	5L: 36 MHz (488-524 MHz)
Tuning Bandwidths and Carrier	5H: 36 MHz (560-596 MHz)
Frequency Ranges	6M: 10 MHz (653-663 MHz)
	T: 3 MHz (803-806 MHz)
	8M: (823-865 MHz)
	8M is split into two segments:
	9 MHz (823-832 MHz)
	2 MHz (863-865 MHz)
Sync Frequency:	Ultrasonic
RF Power Output:	Frequency band specific as shown below 5L (488-524MHz): Low 10mW / High 50mW 5H (560-596MHz): Low 10mW / High 50mW 6M (653-663MHz): Low 10mW / High 20mW T (803-806MHz): Low 10mW / High 50mW 8M (823-865MHz): 10mW
Display By:	LCD + LED
Function Controls:	Power, mute, group, channel, frequency, sensitivity adjustment, RF power, auto off, key lock.
RF Stability:	<±10kHz@Fc
Modulation Frequency Shift:	Wideband FM ±48kHz deviation
Harmonic Radiation:	<-50dBc
Battery:	2 x AA alkaline battery or NiMH rechargeable battery
Charging Contacts:	Yes
Microphone Head Coupling:	1.25" diameter, 28 UN-2A thread pitch
Microphone Electrical Contact:	3-ring/3-pin
Finish:	Black polyurethane paint

Dimensions (without head):	Height: 7.52 inch (191mm)
	Width at threaded end: 1.46 inch (37mm)
	Width at control cover: 0.856 inch (22mm)

### RE3-BPT bodypack transmitter

Frequency Oscillation Mode:	Phase-locked loop (PLL)
Band Names: Tuning Bandwidths and Carrier Frequency Ranges:	5L: 36 MHz (488-524 MHz)
	5H: 36 MHz (560-596 MHz)
	6M: 10 MHz (653-663 MHz)
	T: 3 MHz (803-806 MHz)
	8M: (823-865 MHz)
	8M is split into two segments: 9 MHz (823-832 MHz) 2 MHz (863-865 MHz)
Sync Frequency:	Ultrasonic
RF Power Output:	Frequency band specific as shown below 5L (488-524MHz): Low 10mW / High 50mW 5H (560-596MHz): Low 10mW / High 50mW 6M (653-663MHz): Low 10mW / High 20mW T (803-806MHz): Low 10mW / High 50mW 8M (823-865MHz): 10mW
Display By:	LCD + LED
Function Controls:	Power, mute, group, channel, frequency, sensitivity adjustment, input level attenuation, RF power, auto off, key lock.
RF Stability:	<±10kHz@Fc
Modulation Frequency Shift:	Wideband FM ±48kHz deviation
Harmonic Radiation:	<-50dBc
Input Jack:	4-pin mini jack
Battery:	2 x AA alkaline battery or NiMH rechargeable battery
Charging contacts:	Yes
Dimensions (without antenna):	Height: 3.2 inch (81.5mm)
	Width: 2.54 inch (64.5mm)
	Depth: 0.98 inch (25mm)

**RE3-OL3 omnidirectional lavalier**

Element Type:	Self-biased Condenser
Frequency Response:	60Hz - 15 kHz
Polar Pattern:	Omnidirectional
Sensitivity: Open Circuit Voltage. 1 kHz:	17.5mV/Pascal (-35 dBV/PA)
Maximum SPL:	130dB SPL
Impedance:	2200 ohms
Power Requirements:	3-9 VDC
Polarity:	Positive pressure on diaphragm produces positive voltage at pin 2 relative to pin 1
Electrical Contact Pinouts:	Pin #1 - Ground, Shield Pin #2 - Audio Pin #3 - Bias Voltage
Dimensions (Cable length) :	57.1" [1450mm]
Dimensions (Head length) :	0.36" [9.2mm]
Dimensions (Head diameter) :	0.2" [5mm]
Microphone Connector:	4-pin mini plug
Head Finish:	Non-reflecting Black
Material:	Brass, Steel wire cloth grille, Black flexible PVC cable

**RE3-CL3 cardioid lavalier**

Element Type:	Self-biased Condenser
Frequency Response:	100Hz - 15 kHz
Polar Pattern:	Cardioid
Sensitivity: Open Circuit Voltage. 1 kHz:	20mV/Pascal (-34 dBV/PA)
Maximum SPL:	115dB SPL
Impedance:	3700 ohms
Power Requirements:	3-9 VDC
Polarity:	Positive pressure on diaphragm produces positive voltage at pin 2 relative to pin 1
Electrical Contact Pinouts:	Pin #1 - Ground, Shield Pin #2 - Audio Pin #3 - Bias Voltage Pin #4 - N/C

Dimensions (Cable length) :	56.3" [1430mm]
Dimensions (Head length) :	1.04" [26.4mm]
Dimensions (Head diameter) :	0.4" [10.1mm]
Microphone Connector:	4-pin mini plug
Head Finish:	Non-reflecting Black
Material:	Die cast aluminum, Steel wire cloth grille, Black flexible PVC cable

### RE3-HW3 headworn microphone

Element Type:	Self-biased Condenser
Frequency Response:	30Hz - 18 kHz
Polar Pattern:	Supercardioid
Sensitivity: Open Circuit Voltage. 1 kHz:	0.5mV/Pascal (-47 dBV/PA)
Maximum SPL:	130dB SPL
Impedance:	1000 ohms
Power Requirements:	3-9 VDC
Polarity:	Positive pressure on diaphragm produces positive voltage at pin 2 relative to pin 1
Electrical Contact Pinouts:	Pin #1 - Ground, Shield Pin #2 - Audio Pin #3 - Bias Voltage Pin #4 - N/C
Dimensions (Cable length) :	45.28" [1150mm]
Dimensions (Boom length) :	5.83" [148mm]
Microphone Connector:	4-pin mini plug
Head Finish:	Non-reflecting Black
Material:	Black stainless steel painted adjustable headband frame. Molded back facing connector joint with 2.5mm jack for detachable cable, black textured PU. Black painted steel 100mm x 4.5mm flexible mic positing tube. Integrated black TPR mic shock mount. Clear soft silicone tubing at ear contact points.

**RE3-GC3 instrument cable**

Electrical Contact Pinouts:	Pin #1 - Ground, Shield Pin #2 - Audio Pin #3 - N/C Pin #4 - N/C
Connectors:	6.5mm (1/4 inch) phone plug 4-pin mini plug
Dimensions, Cable Length with Connectors:	32.7" (830mm)

**ND76-RC3 dynamic cardioid microphone head**

Element Type:	Dynamic neodymium magnet structure
Frequency response, Close:	30 Hz – 17 kHz
Frequency response, Far:	70 Hz – 17 kHz
Polar Pattern:	Cardioid
Sensitivity, Open Circuit Voltage @ 1 kHz:	5.6 mV/Pascal (-45 dBV/Pa)
Maximum SPL:	135.5 dB SPL (1% THD)
Power Requirements:	4-8 VDC
Polarity:	Positive pressure on diaphragm produces positive voltage at center contact relative to ground contact
Electrical Contact:	3-Ring / 3-Pin
Threaded Coupling:	1.25" Diameter 28 UN-2A Thread Pitch
Finish:	Black polyurethane paint
Materials:	Aluminum, steel, steel wire grille screen
Dimensions, Length:	3.6 in (91 mm)
Diameter:	2.0 in (50.5 mm)

**ND86-RC3 dynamic supercardioid microphone head**

Element Type:	Dynamic neodymium magnet structure
Frequency response, Close:	30 Hz – 17 kHz
Frequency response, Far:	70 Hz – 17 kHz
Polar Pattern:	Supercardioid
Sensitivity, Open Circuit	5.6 mV/Pascal

Voltage @ 1 kHz:	(-45 dBV/Pa)
Maximum SPL:	134.5 dB SPL (1% THD)
Power Requirements:	4-8 VDC
Polarity:	Positive pressure on diaphragm produces positive voltage at center contact relative to ground contact
Electrical Contact:	3-Ring / 3-Pin
Threaded Coupling:	1.25" Diameter 28 UN-2A Thread Pitch
Finish:	Black polyurethane paint
Materials:	Aluminum, steel, steel wire grille screen
Dimensions, Length:	3.6 in (91 mm)
Diameter:	2.0 in (50.5 mm)

### **ND96-RC3 dynamic supercardioid microphone head**

Element Type:	Dynamic neodymium magnet structure
Frequency response, Close:	30 Hz – 15 kHz
Frequency response, Far:	140 Hz – 15 kHz
Polar Pattern:	Supercardioid
Sensitivity, Open Circuit Voltage @ 1 kHz in flat position:	4.7 mV/Pascal (-46.5 dBV/Pa)
Sensitivity, Open Circuit Voltage @ 1 kHz in vocal presence position:	3.2 mV/Pascal (-50 dBV/Pa)
Maximum SPL:	136.5 dB SPL (1@ THD)
Power Requirements:	4-8 VDC
Polarity:	Positive pressure on diaphragm produces positive voltage at center contact relative to ground contact
Electrical Contact:	3-Ring / 3-Pin
Threaded Coupling:	1.25" Diameter 28 UN-2A Thread Pitch
Finish:	Black polyurethane paint
Materials:	Aluminum, steel, steel wire grille screen
Dimensions, Length:	3.3 in (83.5 mm)
Diameter:	2.0 in (50.5 mm)

### **RE420-RC3 condenser cardioid microphone head**



Element Type:	Self-biased Condenser
Frequency Response:	50 Hz to 20,000 Hz
Polar Pattern:	Cardioid
Sensitivity: Open Circuit Voltage. 1 kHz:	5.6mV/Pascal (-45 dBV/PA)
Clipping (max SPL) :	137 dB SPL (1% THD)
Self Noise:	22 dB SPL "A" weighted (0 dB = 20 micropascals)
Dynamic Range:	115 dB
Signal-to-Noise Ratio:	72 dB
Power Requirements:	4-8 VDC
Polarity:	Positive pressure on diaphragm produces positive voltage at center contact relative to ground contact
Electrical Contact:	3-Ring / 3-Pin
Threaded Coupling:	1.25" Diameter 28 UN-2A Thread Pitch
Finish:	Black polyurethane paint
Materials:	Aluminum, steel, steel wire grille screen
Dimensions, Length:	3.36 in (85.3 mm)
Diameter:	1.95 in (49.6 mm)

**RE520-RC3 condenser supercardioid microphone head**

Element Type:	Self-biased Condenser
Frequency Response:	40 Hz to 20,000 Hz
Polar Pattern:	Supercardioid
Sensitivity: Open Circuit Voltage. 1 kHz:	5.6mV/Pascal (-45 dBV/PA)
Clipping (max SPL):	139 dB SPL (1% THD)
Self Noise:	22 dB SPL "A" weighted (0 dB = 20 micropascals)
Dynamic Range:	117 dB
Signal-to-Noise Ratio:	72 dB
Power Requirements:	4-8 VDC
Polarity:	Positive pressure on diaphragm produces positive voltage at center contact relative to ground contact
Electrical Contact:	3-Ring / 3-Pin
Threaded Coupling:	1.25" Diameter 28 UN-2A Thread Pitch
Finish:	Black polyurethane paint
Materials:	Aluminum, steel, steel wire grille screen
Dimensions, Length:	3.36 in (85.3 mm)
Diameter:	1.95 in (49.6 mm)

# 13 Frequency Group / Channel Tables

## Band 5L (488-524 MHz)

RE3 Frequency Band: 5L 488 - 524 MHz Orients to NTSC TV Channels 17 - 22 PAL TV Channels 23 - 27

NTSC	TV Channel Orientation			PAL
	CH	Frequency	CH	
17	<b>Group 1</b>			23
	1	488.325	1	
	2	491.200	2	
18	<b>Group 2</b>			24
	3	493.450	3	
	4	494.700	4	
19	<b>Group 3</b>			25
	5	497.450	5	
	6	500.450	6	
20	<b>Group 4</b>			26
	7	504.200	7	
	8	505.700	8	
21	<b>Group 5</b>			27
	9	510.325	9	
	10	512.825	10	
22	<b>Group 6</b>			28
	11	514.200	11	
	12	518.325	12	
23	<b>Group 7</b>			29
	13	520.700	13	
	14	521.700	14	
17	<b>Group 1</b>			23
	1	488.175	1	
	2	489.375	2	
18	<b>Group 2</b>			24
	3	491.525	3	
	4	494.425	4	
19	<b>Group 3</b>			25
	5	495.500	5	
	6	498.000	6	
20	<b>Group 4</b>			26
	7	503.750	7	
	8	505.500	8	
21	<b>Group 5</b>			27
	9	509.750	9	
	10	514.500	10	
22	<b>Group 6</b>			28
	11	517.525	11	
	12	518.950	12	
23	<b>Group 7</b>			29
	13	521.225	13	
	14	522.125	14	
17	<b>Group 1</b>			23
	1	488.625	1	
	2	490.800	2	
18	<b>Group 2</b>			24
	3	492.575	3	
	4	496.600	4	
19	<b>Group 3</b>			25
	5	498.775	5	
	6	503.275	6	
20	<b>Group 4</b>			26
	7	507.125	7	
	8	508.675	8	
21	<b>Group 5</b>			27
	9	511.425	9	
	10	516.525	10	
22	<b>Group 6</b>			28
	11	518.900	11	
	12	519.900	12	
23	<b>Group 7</b>			29
	13	522.475	13	
	14	523.075	14	
17	<b>Group 1</b>			23
	1	488.800	1	
	2	489.650	2	
18	<b>Group 2</b>			24
	3	492.125	3	
	4	494.225	4	
19	<b>Group 3</b>			25
	5	498.075	5	
	6	502.775	6	
20	<b>Group 4</b>			26
	7	505.400	7	
	8	507.100	8	
21	<b>Group 5</b>			27
	9	511.075	9	
	10	512.375	10	
22	<b>Group 6</b>			28
	11	517.325	11	
	12	520.500	12	
23	<b>Group 7</b>			29
	13	521.525	13	
	14	523.400	14	
17	<b>Group 1</b>			23
	1	488.600	1	
	2	490.475	2	
18	<b>Group 2</b>			24
	3	491.850	3	
	4	493.850	4	
19	<b>Group 3</b>			25
	5	495.600	5	
	6	498.725	6	
20	<b>Group 4</b>			26
	7	499.750	7	
	8	502.225	8	
21	<b>Group 5</b>			27
	9	504.100	9	
	10	505.100	10	
22	<b>Group 6</b>			28
	11	506.475	11	
	12	509.725	12	
23	<b>Group 7</b>			29
	13	512.225	13	
	14	513.650	14	
17	<b>Group 1</b>			23
	1	488.525	1	
	2	489.525	2	
18	<b>Group 2</b>			24
	3	491.400	3	
	4	492.775	4	
19	<b>Group 3</b>			25
	5	495.775	5	
	6	498.400	6	
20	<b>Group 4</b>			26
	7	499.975	7	
	8	500.650	8	
21	<b>Group 5</b>			27
	9	502.400	9	
	10	503.800	10	
22	<b>Group 6</b>			28
	11	506.025	11	
	12	506.775	12	
23	<b>Group 7</b>			29
	13	510.650	13	
	14	512.525	14	
17	<b>Group 1</b>			23
	1	488.825	1	
	2	489.575	2	
18	<b>Group 2</b>			24
	3	491.325	3	
	4	491.950	4	
19	<b>Group 3</b>			25
	5	492.825	5	
	6	494.025	6	
20	<b>Group 4</b>			26
	7	495.700	7	
	8	498.825	8	
21	<b>Group 5</b>			27
	9	500.950	9	
	10	502.325	10	
22	<b>Group 6</b>			28
	11	503.950	11	
	12	507.325	12	
23	<b>Group 7</b>			29
	13	508.575	13	
	14	511.275	14	
17	<b>Group 1</b>			23
	1	489.300	1	
	2	490.425	2	
18	<b>Group 2</b>			24
	3	491.925	3	
	4	492.925	4	
19	<b>Group 3</b>			25
	5	495.175	5	
	6	497.800	6	
20	<b>Group 4</b>			26
	7	499.050	7	
	8	501.800	8	
21	<b>Group 5</b>			27
	9	502.425	9	
	10	504.800	10	
22	<b>Group 6</b>			28
	11	509.300	11	
	12	510.175	12	
23	<b>Group 7</b>			29
	13	512.300	13	
	14	514.675	14	
17	<b>Group 1</b>			23
	1	489.300	1	
	2	490.425	2	
18	<b>Group 2</b>			24
	3	491.925	3	
	4	492.925	4	
19	<b>Group 3</b>			25
	5	495.175	5	
	6	497.800	6	
20	<b>Group 4</b>			26
	7	499.050	7	
	8	501.800	8	
21	<b>Group 5</b>			27
	9	502.425	9	
	10	504.800	10	
22	<b>Group 6</b>			28
	11	509.300	11	
	12	510.175	12	
23	<b>Group 7</b>			29
	13	512.300	13	
	14	514.675	14	
17	<b>Group 1</b>			23
	1	489.300	1	
	2	490.425	2	
18	<b>Group 2</b>			24
	3	491.925	3	
	4	492.925	4	
19	<b>Group 3</b>			25
	5	495.175	5	
	6	497.800	6	
20	<b>Group 4</b>			26
	7	499.050	7	
	8	501.800	8	
21	<b>Group 5</b>			27
	9	502.425	9	
	10	504.800	10	
22	<b>Group 6</b>			28
	11	509.300	11	
	12	510.175	12	
23	<b>Group 7</b>			29
	13	512.300	13	
	14	514.675	14	
17	<b>Group 1</b>			23
	1	489.300	1	
	2	490.425	2	
18	<b>Group 2</b>			24
	3	491.925	3	
	4	492.925	4	
19	<b>Group 3</b>			25
	5	495.175	5	
	6	497.800	6	
20	<b>Group 4</b>			26
	7	499.050	7	
	8	501.800	8	
21	<b>Group 5</b>			27
	9	502.425	9	
	10	504.800	10	
22	<b>Group 6</b>			28
	11	509.300	11	
	12	510.175	12	
23	<b>Group 7</b>			29
	13	512.300	13	
	14	514.675	14	
17	<b>Group 1</b>			23
	1	489.300	1	
	2	490.425	2	
18	<b>Group 2</b>			24
	3	491.925	3	
	4	492.925	4	
19	<b>Group 3</b>			25
	5	495.175	5	
	6	497.800	6	
20	<b>Group 4</b>			26
	7	499.050	7	
	8	501.800	8	
21	<b>Group 5</b>			27
	9	502.425	9	
	10	504.800	10	
22	<b>Group 6</b>			28
	11	509.300	11	
	12	510.175	12	
23	<b>Group 7</b>			29
	13	512.300	13	
	14	514.675	14	
17	<b>Group 1</b>			23
	1	489.300	1	
	2	490.425	2	
18	<b>Group 2</b>			24
	3	491.925	3	
	4	492.925	4	
19	<b>Group 3</b>			25
	5	495.175	5	
	6	497.800	6	
20	<b>Group 4</b>			26
	7	499.050	7	
	8	501.800	8	
21	<b>Group 5</b>			27
	9	502.425	9	
	10	504.800	10	
22	<b>Group 6</b>			28
	11	509.300	11	
	12	510.175	12	
23	<b>Group 7</b>			29
	13	512.300	13	
	14	514.675	14	
17	<b>Group 1</b>			23
	1	489.300	1	
	2	490.425	2	
18	<b>Group 2</b>			24
	3	491.925	3	
	4	492.925	4	
19	<b>Group 3</b>			25
	5	495.175	5	
	6	497.800	6	
20	<b>Group 4</b>			26
	7	499.050	7	
	8	501.800	8	
21	<b>Group 5</b>			27
	9	502.425	9	
	10	504.800	10	
22	<b>Group 6</b>			28
	11	509.300	11	
	12	510.175	12	
23	<b>Group 7</b>			29
	13	512.300	13	
	14	514.675	14	

### Band 5H (560-596 MHz)

RE3 Frequency Band: 5H

560 - 596 MHz

Orients to NTSC TV Channels 29 - 34

PAL TV Channels 32 - 36

NTSC	TV Channel Orientation			PAL
	Group 1			
	CH	Frequency	CH	
29	1	560.325	1	32
	2	563.200	2	
	3	565.450	3	
30	4	566.700	4	33
	5	569.450	5	
31	6	572.450	6	34
	7	576.200	7	
32	8	577.700	8	35
	9	582.325	9	
33	10	584.825	10	36
	11	586.200	11	
34	12	590.325	12	37
	13	592.700	13	
	14	593.700	14	

NTSC	TV Channel Orientation			PAL
	Group 2			
	CH	Frequency	CH	
29	1	560.175	1	32
	2	561.375	2	
	3	563.525	3	
30	4	566.425	4	33
	5	567.500	5	
31	6	570.000	6	34
	7	575.750	7	
32	8	577.500	8	35
	9	581.750	9	
33	10	586.500	10	36
	11	589.525	11	
34	12	590.950	12	37
	13	593.225	13	
	14	594.125	14	

NTSC	TV Channel Orientation			PAL
	Group 3			
	CH	Frequency	CH	
29	1	561.625	1	32
	2	562.800	2	
	3	564.575	3	
30	4	568.600	4	33
	5	570.775	5	
31	6	575.275	6	34
	7	579.125	7	
32	8	580.675	8	35
	9	583.425	9	
33	10	588.525	10	36
	11	590.900	11	
34	12	591.900	12	37
	13	594.475	13	
	14	595.075	14	

NTSC	TV Channel Orientation			PAL
	Group 4			
	CH	Frequency	CH	
29	1	560.800	1	32
	2	561.650	2	
	3	564.125	3	
30	4	566.225	4	33
	5	570.075	5	
31	6	574.775	6	34
	7	577.400	7	
32	8	579.100	8	35
	9	583.075	9	
33	10	584.375	10	36
	11	589.325	11	
34	12	592.500	12	37
	13	593.525	13	
	14	595.400	14	

NTSC	TV Channel Orientation			PAL
	Group 5			
	CH	Frequency	CH	
29	1	560.600	1	32
	2	562.475	2	
	3	563.850	3	
	4	565.850	4	
30	5	567.600	5	33
	6	570.725	6	
31	7	571.750	7	34
	8	574.225	8	
32	9	576.100	9	35
	10	577.100	10	
33	11	578.475	11	36
	12	581.725	12	
34	13	584.225	13	37
	14	585.650	14	
35	15	588.100	15	38
	16	588.975	16	
36	17	590.150	17	39
	18	590.850	18	
37	19	593.350	19	40
	20	594.850	20	
	21	595.475	21	

NTSC	TV Channel Orientation			PAL
	Group 6			
	CH	Frequency	CH	
29	1	560.525	1	32
	2	561.525	2	
	3	563.400	3	
	4	564.775	4	
30	5	567.775	5	33
	6	570.400	6	
31	7	571.975	7	34
	8	572.650	8	
32	9	574.400	9	35
	10	575.800	10	
33	11	578.025	11	36
	12	578.775	12	
34	13	582.650	13	37
	14	584.525	14	
35	15	586.150	15	38
	16	588.650	16	
36	17	590.525	17	39
	18	590.525	18	
37	19	593.025	19	40
	20	593.900	20	
38	21	595.150	21	41
	22	595.850	22	

NTSC	TV Channel Orientation			PAL
	Group 7			
	CH	Frequency	CH	
29	1	560.825	1	32
	2	561.575	2	
	3	563.325	3	
	4	563.950	4	
	5	564.825	5	
30	6	566.025	6	33
	7	567.700	7	
	8	570.825	8	
31	9	572.950	9	34
	10	574.325	10	
32	11	575.950	11	35
	12	579.325	12	
33	13	580.575	13	36
	14	583.275	14	
34	15	586.325	15	37
	16	588.375	16	
35	17	589.950	17	38
	18	591.825	18	
36	19	592.825	19	39
	20	594.200	20	
37	21	594.950	21	40
	22	595.950	22	

NTSC	TV Channel Orientation			PAL
	Group 8			
	CH	Frequency	CH	
29	1	561.300	1	32
	2	562.425	2	
	3	563.925	3	
	4	564.925	4	
30	5	567.175	5	33
	6	569.800	6	
31	7	571.050	7	34
	8	573.800	8	
32	9	574.425	9	35
	10	576.800	10	
33	11	581.300	11	36
	12	582.175	12	
34	13	584.300	13	37
	14	586.675	14	
35	15	587.800	15	38
	16	589.300	16	
36	17	593.050	17	39
	18	593.800	18	
37	19	595.175	19	40
	20	595.925	20	

**Band 6M (653-663 MHz)**

**RE3 Frequency Band: 6M 653 - 663 MHz**

Operates within the \*North American Duplex Gap  
 \* Portions of this gap require user license as noted

Required	License Requirement	
	CH	Group 1 Frequency
Y	1	653.150
Y	2	654.150
Y	3	655.600
Y	4	656.050
Y	5	656.750
N	6	658.325
N	7	660.100
N	8	661.375
N	9	662.250

Required	License Requirement	
	CH	Group 2 Frequency
Y	1	653.800
Y	2	654.900
Y	3	655.525
Y	4	656.500
N	5	657.775
N	6	658.550
N	7	660.975
N	8	662.400
N	9	662.850

Required	License Requirement	
	CH	Group 3 Frequency
Y	1	653.125
Y	2	653.575
Y	3	655.675
N	4	657.000
N	5	657.950
N	6	659.400
N	7	661.050
N	8	662.150
N	9	662.950

Required	License Requirement	
	CH	Group 4 Frequency
Y	1	653.675
Y	2	654.500
Y	3	655.825
Y	4	656.950
N	5	657.650
N	6	659.975
N	7	660.425
N	8	661.425
N	9	662.000

Required	License Requirement	
	CH	Group 5 Frequency
Y	1	653.225
Y	2	653.650
Y	3	654.650
Y	4	655.050
Y	5	656.275
N	6	657.325
N	7	659.100
N	8	660.275
N	9	660.675
N	10	661.250
N	11	661.650
N	12	662.800

Required	License Requirement	
	CH	Group 6 Frequency
Y	1	653.050
Y	2	653.525
Y	3	654.300
Y	4	655.325
Y	5	656.000
Y	6	656.900
N	7	658.000
N	8	659.275
N	9	659.750
N	10	661.125
N	11	662.275
N	12	662.775

Required	License Requirement	
	CH	Group 7 Frequency
Y	1	653.500
Y	2	654.250
Y	3	655.175
Y	4	655.900
N	5	657.200
N	6	657.725
N	7	658.950
N	8	659.900
N	9	660.525
N	10	661.550
N	11	662.325
N	12	662.925

Required	License Requirement	
	CH	Group 8 Frequency
Y	1	653.250
Y	2	653.850
Y	3	654.750
Y	4	655.150
Y	5	655.850
N	6	657.450
N	7	658.675
N	8	659.475
N	9	660.800
N	10	661.225
N	11	661.925
N	12	662.425

### Band T (803-806 MHz)

RE3 Frequency Band: T 803 - 806 MHz Orients to PAL TV Channel 62 No NTSC Orientation

NTSC	TV Channel Orientation			PAL
	CH	Frequency	CH	
	<b>Group 1</b>			
	1	803.100	1	62
	2	803.675	2	
	3	804.600	3	
	4	805.300	4	
	5	805.750	5	

NTSC	TV Channel Orientation			PAL
	CH	Frequency	CH	
	<b>Group 2</b>			
	1	803.300	1	62
	2	803.825	2	
	3	804.725	3	
	4	805.125	4	
	5	805.825	5	

NTSC	TV Channel Orientation			PAL
	CH	Frequency	CH	
	<b>Group 3</b>			
	1	803.325	1	62
	2	803.725	2	
	3	804.375	3	
	4	805.250	4	
	5	805.775	5	

NTSC	TV Channel Orientation			PAL
	CH	Frequency	CH	
	<b>Group 4</b>			
	1	803.275	1	62
	2	803.850	2	
	3	804.775	3	
	4	805.475	4	
	5	805.925	5	

NTSC	TV Channel Orientation			PAL
	CH	Frequency	CH	
	<b>Group 5</b>			
	1	803.050	1	62
	2	803.425	2	
	3	804.000	3	
	4	804.750	4	
	5	805.325	5	
	6	805.675	6	

NTSC	TV Channel Orientation			PAL
	CH	Frequency	CH	
	<b>Group 6</b>			
	1	803.125	1	62
	2	803.600	2	
	3	804.650	3	
	4	805.000	4	
	5	805.525	5	
	6	805.875	6	

NTSC	TV Channel Orientation			PAL
	CH	Frequency	CH	
	<b>Group 7</b>			
	1	803.200	1	62
	2	803.575	2	
	3	804.175	3	
	4	804.950	4	
	5	805.550	5	
	6	805.900	6	

NTSC	TV Channel Orientation			PAL
	CH	Frequency	CH	
	<b>Group 8</b>			
	1	803.150	1	62
	2	803.550	2	
	3	804.125	3	
	4	804.900	4	
	5	805.500	5	
	6	805.850	6	

### Band 8M (823-865 MHz)

RE3 Frequency Band: 8m 823 - 865 MHz Orients to PAL TV Channel 65 - 70 No NTSC Orientation

NTSC	TV Channel Orientation			PAL
	CH	Frequency	CH	
	<b>Group 1</b>			
	1	823.150	1	65
	2	824.200	2	
	3	825.675	3	
	4	826.600	4	
	5	827.950	5	
	6	829.625	6	
	7	830.825	7	
	8	831.525	8	

NTSC	TV Channel Orientation			PAL
	CH	Frequency	CH	
	<b>Group 2</b>			
	1	863.100	1	70
	2	863.475	2	
	3	864.025	3	
	4	864.750	4	

NTSC	TV Channel Orientation			PAL
	CH	Frequency	CH	
	<b>Group 3</b>			
	1	823.475	1	65
	2	824.600	2	
	3	826.500	3	
	4	827.900	4	
	5	829.950	5	
	6	831.725	6	
	7	863.150	7	
	8	863.875	8	
	9	864.425	9	
	10	864.800	10	

NTSC	TV Channel Orientation			PAL
	CH	Frequency	CH	
	<b>Group 4</b>			
	1	823.175	1	65
	2	824.275	2	
	3	826.050	3	
	4	827.575	4	
	5	829.875	5	
	6	831.275	6	
	7	863.125	7	
	8	863.500	8	
	9	864.050	9	
	10	864.775	10	

NTSC	TV Channel Orientation			PAL
	CH	Frequency	CH	
	<b>Group 5</b>			
	1	823.300	1	65
	2	824.800	2	
	3	827.000	3	
	4	828.775	4	
	5	829.925	5	
	6	831.900	6	
	7	863.175	7	
	8	863.900	8	
	9	864.450	9	
	10	864.825	10	

NTSC	TV Channel Orientation			PAL
	CH	Frequency	CH	
	<b>Group 6</b>			
	1	823.350	1	65
	2	823.825	2	
	3	824.550	3	
	4	824.975	4	
	5	826.325	5	
	6	827.150	6	
	7	828.550	7	
	8	829.500	8	
	9	830.275	9	
	10	831.225	10	
	11	831.625	11	
	12	863.200	12	
	13	863.575	13	
	14	864.125	14	
	15	864.850	15	

NTSC	TV Channel Orientation			PAL
	CH	Frequency	CH	
	<b>Group 7</b>			
	1	823.975	1	65
	2	824.475	2	
	3	825.375	3	
	4	826.025	4	
	5	826.975	5	
	6	828.275	6	
	7	829.000	7	
	8	830.300	8	
	9	830.750	9	
	10	831.375	10	
	11	831.775	11	
	12	863.225	12	
	13	863.700	13	
	14	864.525	14	
	15	864.875	15	

NTSC	TV Channel Orientation			PAL
	CH	Frequency	CH	
	<b>Group 8</b>			
	1	823.425	1	65
	2	824.400	2	
	3	825.200	3	
	4	825.775	4	
	5	826.525	5	
	6	827.675	6	
	7	828.350	7	
	8	829.400	8	
	9	829.850	9	
	10	830.650	10	
	11	831.675	11	
	12	863.250	12	
	13	863.600	13	
	14	864.400	14	
	15	864.900	15	



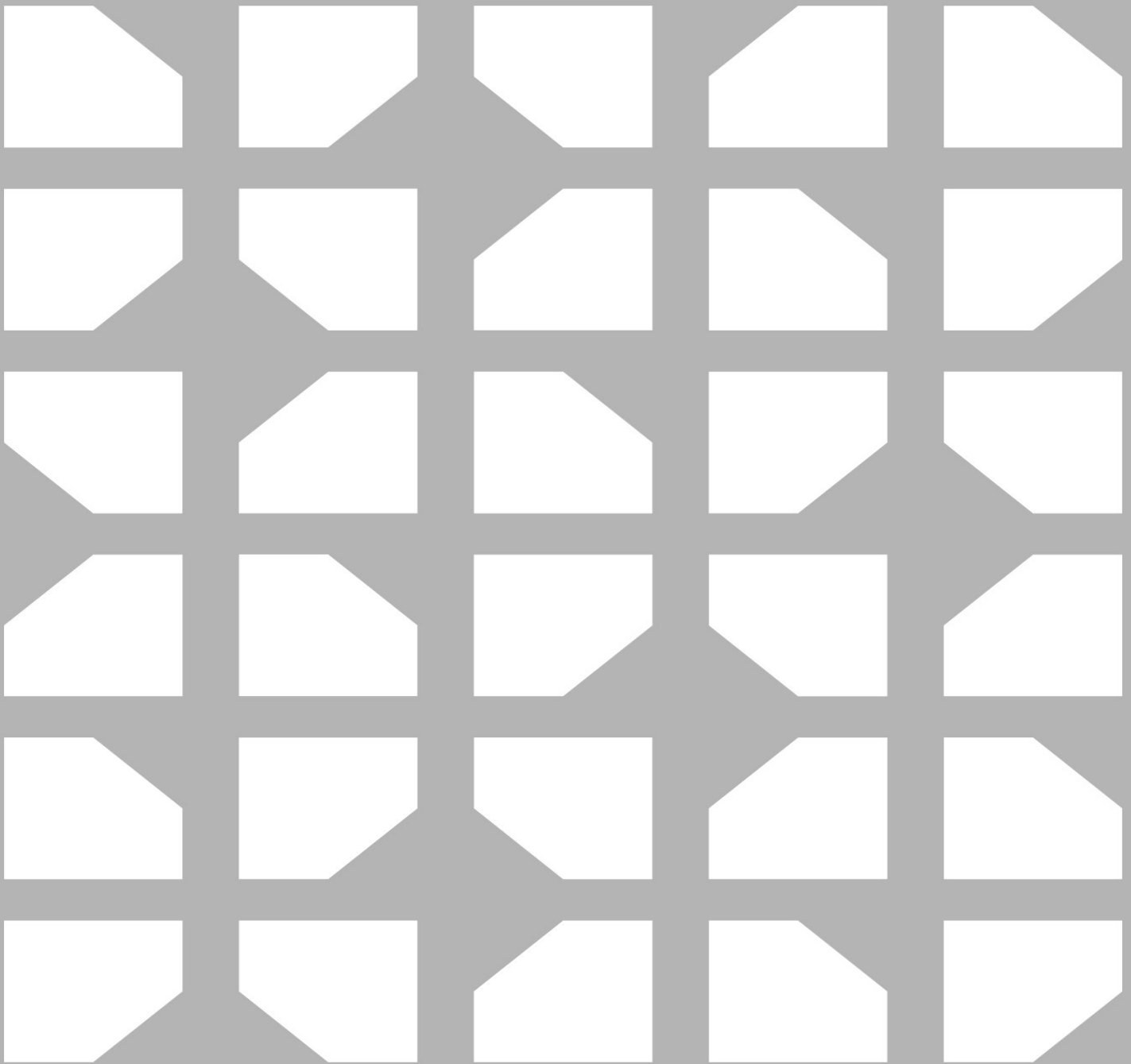

**Bosch Sicherheitssysteme GmbH**

Robert-Bosch-Ring 5  
85630 Grasbrunn  
Germany

[www.boschsecurity.com](http://www.boschsecurity.com)

© Bosch Sicherheitssysteme GmbH, 2018

**Bosch Security Systems, Inc**

12000 Portland Avenue South  
Burnsville MN 55337  
USA

[www.electrovoice.com](http://www.electrovoice.com)