

Panasonic®

Operating Instructions and User Guide

Model: NE-C1275

PROFESSIONAL MICROWAVE COMBINATION OVEN

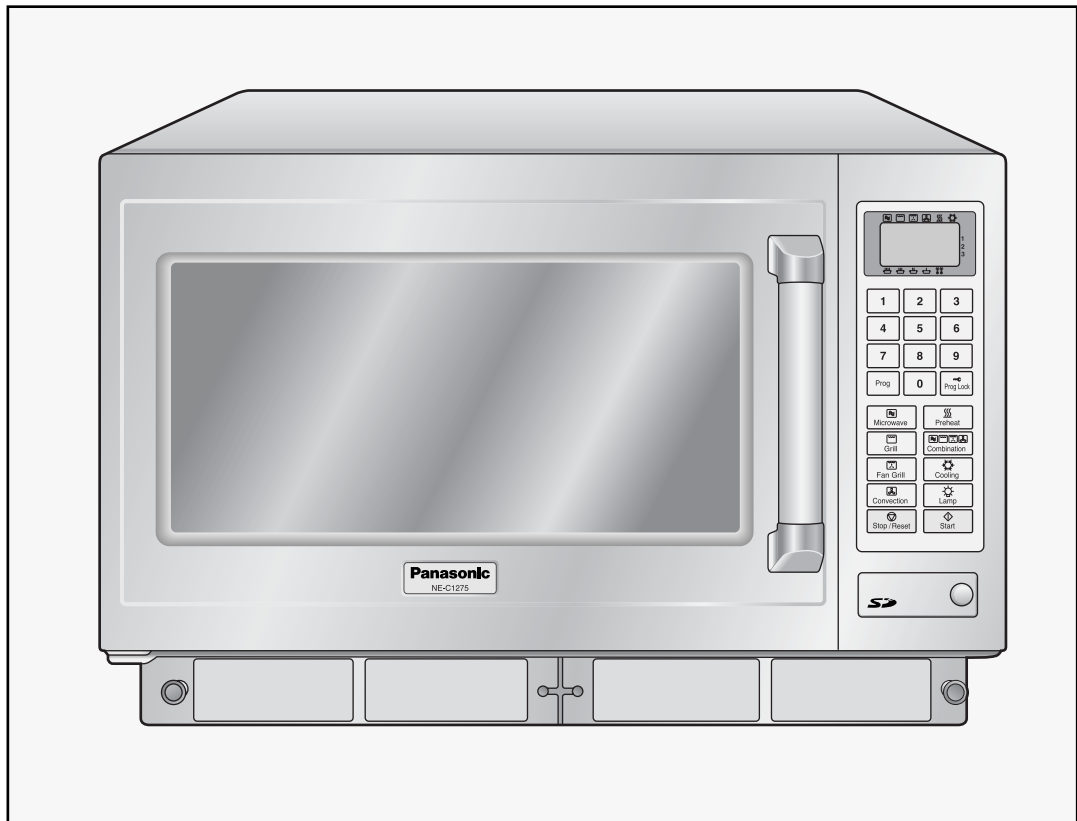

FOR COMMERCIAL USE

IMPORTANT

Before operating this oven, all users should read these instructions carefully.

Important safety information is enclosed.

(See pages 2-5)

This product is an equipment that fulfills the European standard for EMC disturbances (EMC = Electromagnetic Compatibility) EN 55011. According to this standard this product is an equipment of group 2, class B and is within required limits. Group 2 means that radio-frequency energy is intentionally generated in the form of electromagnetic radiation for warming and cooking of food. Class B means that this product may be used in normal household areas.

Operating Instructions

	page
Safety Information	2 - 5
Accessories Supplied	5
Your Oven Explained / Display Window	6
Control Panel	7
Operating your Oven as a Microwave	8 - 9
Operating your Oven on Convection	10 - 11
Operating your Oven on Grill Convection	12 - 13
Operating your Oven on Grill	14 - 15
Operating your Oven on Fan Grill	16 - 17
Operating your Oven on Combination	18 - 21
Setting the Memory Programmes	22 - 23
Using the Memory Programmes	23
How to Activate Programme Lock	24
How to Deactivate Programme Lock / Programme List	25
Keeping your Oven Hot	26
Cooling your Oven quickly	27
How to change the Beep Tone	28
How to change Cleaning Interval of Air Filter	29
Types of Container to Use on Microwave	31
Common Problems / Common Queries	68 - 69
When to call a Service Engineer	70 - 71
Care of your Oven and Cleaning	72 - 73
SD Memory Card	74
Storing Programme Data on SD Memory Card	75 - 77
Technical Specifications	78
Information on disposal for Users of waste Electronic Equipment	79
Glossary of Terms / Dish Test / If Arcing Occurs	80
Index	81



Cooking Guide

	page
How a Microwave Works / Standing Time	30
Reheating by Microwave	32 - 35
Suggested Reheating Times	36 - 41
Defrosting by Microwave	42
Useful Defrosting Times	43 - 44
Cooking by Microwave	45
Useful Cooking Times	46 - 47
Using the CONVECTION Function / Cook times	48 - 49
Using the GRILL CONVECTION Function / Cook times	50 - 51
Using the GRILL Function / Cook times	52 - 53
Using the FAN GRILL Function / Cook times	54
Using the COMBINATION Function / Using 5 Presets	55
Reheating by Combination	56 - 57
Cooking Fish on Combination	58
Cooking Meat on Combination	58 - 59
Suggested Reheating / Cooking Times (Combination)	60 - 67

Safety Information

1. Earthing instructions

WARNING: THIS APPLIANCE MUST BE EARTHED.

This appliance is supplied with a moulded three pin mains plug for your safety and convenience. A 13 amp fuse is fitted in this plug. Should the fuse need to be replaced, please ensure that the replacement fuse has a rating of 13 amps and that it is approved by ASTA or BSI to BS1362. Check for the ASTA mark  or the BSI mark  on the body of the fuse.

If the plug contains a removable fuse cover, you must ensure that it is refitted when the fuse is replaced. If you lose the fuse cover, the plug must not be used until a replacement cover is obtained. A replacement fuse cover can be purchased from your local Panasonic Dealer.

IF THE FITTED MOULDED PLUG IS UNSUITABLE FOR THE SOCKET OUTLET THEN THE FUSE SHOULD BE REMOVED AND THE PLUG CUT OFF AND DISPOSED OF SAFELY AND AN APPROPRIATE ONE FITTED. THERE IS A DANGER OF SEVERE ELECTRICAL SHOCK IF THE CUT OFF PLUG IS INSERTED INTO ANY 13 AMP SOCKET. If a new plug is to be fitted, please observe the wiring code as shown. If in any doubt, please consult a qualified electrician.

IMPORTANT: The wires in mains lead are coloured in accordance with the following code:

Green-and-yellow: Earth
Blue: Neutral
Brown: Live

As the colours of the wire in the mains lead of this appliance may not correspond with the coloured markings identifying the terminals in your plug, proceed as follows:

The wire which is coloured GREEN-AND-YELLOW must be connected to the terminal in the plug which is marked with the letter E or by the Earth symbol  or coloured GREEN or GREEN-AND-YELLOW.

The wire which is coloured BLUE must be connected to the terminal in the plug which is marked with the letter N or coloured BLACK. The wire which is coloured BROWN must be connected to the terminal in the plug which is marked with the letter L or coloured RED.

How to replace the fuse

Open the fuse compartment with a screwdriver and replace the fuse.

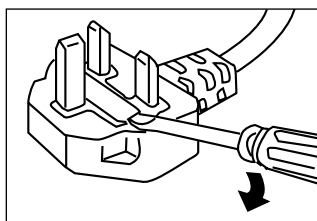

When an outlet is not earthed:

It is the personal responsibility and obligation of the customer to have it replaced with a properly earthed outlet.

2. Voltage and Power

The voltage used must be the same as specified on the oven. Using a higher voltage than that which is specified is dangerous, and may result in a fire or other type of accident causing damage.

3. Service

It is dangerous for anyone other than a service technician trained by the manufacturer to perform repair service.

Do not remove the outer casing of the oven.

High voltages are present inside the cabinet. Repairs and adjustments should be done only by qualified service personnel. Contact the manufacturer.

Door Seals

Do not attempt to tamper with or make any adjustments or repairs to door, control panel housing, safety interlock switches or any other part of the oven. Do not remove outer panel from the oven.

The door seals and door seal areas should always be kept clean-use a damp cloth.

4. Operation when empty

The appliance must not be operated by MICROWAVE or COMBINATION WITHOUT FOOD IN THE OVEN. Operation when empty will damage the appliance.

5. Cord

If the supply cord is damaged, it must be replaced by the manufacture or its service agent or a similarly qualified person in order to avoid a hazard.

Do not immerse oven in water. Keep cord away from heated surfaces. Do not let cord hang over the edge of table or work top. The back of the appliance heats up during use. Do not allow the cord to be in contact with the back of the appliance or cabinet surface.

6. Hot Surfaces

Exterior oven surfaces, including air vents on the cabinet and the oven door will get hot during use. (Grill, Convection and Combination) Take care when opening or closing door and when inserting or removing food and accessories.

The oven has heaters situated in the top and back of the oven. After use, the roof, walls and floor will be very hot.

7. Switching off.

In case of electronic failure, oven can only be turned off at outlet.

When you first unpack your Oven

1.Examine your Oven

Unpack oven, retain all packing material, and examine the oven for any damage such as dents, broken door latches or cracks in the door. Notify supplier immediately if unit is damaged.
N.B DO NOT install if unit is damaged.

2.Door Seals

The appliance should be inspected for damage to the door seals and door seal areas and if these areas are damaged the appliance should not be operated until it has been repaired by a service technician trained by the manufacturer.

3.Guarantee card

Fill out and post the pre-addressed guarantee card.

4.Removal of protective film

A protective film is used to prevent scratching of the outer case during transportation. Peel this film off before installation or use.

Placement of Oven

1.Placement of Oven

Oven must be placed on a flat, stable surface. For proper operation, the oven must have sufficient air flow.
A gap of at least 5 cm (2 inches) must be available at the right and left hand sides and back wall of the oven. A minimum space of 20 cm (8 inches) must be left above the oven and the 2 exhaust vents at the rear.

2.Shelves

Do not place the oven on a shelf directly above or beside a gas or electric hob, cooker or deep fat fryer. The oven may be damaged. It is dangerous to position this oven on a shelf which is so high that food and accessories cannot be safely removed by the user.

3.Stacking

DO NOT attempt to stack these ovens.

Operation

1.Air vents

This oven requires free airflow at the back for maximum cooling efficiency.
DO NOT BLOCK THE AIR VENTS.

2.Maximum room temperature

Do not operate the oven when the room temperature is higher than 40°C (104°F) and/or the humidity is more than 90%. Free airflow around the oven is important.

3.Outdoor use

Do not use outdoors.

4.Storage of accessories

When the oven is not being used, do not store any objects other than oven accessories inside the oven in case it is accidentally turned on. In case of electronic failure, oven can only be turned off at outlet.

Caution

1.Before Use

Before using CONVECTION, COMBINATION, GRILL, GRILL CONVECTION or FAN GRILL function for the first time, operate this oven without food on CONVECTION 250°C for 20 minutes. This will allow the oil that is used for rust protection to be burned off. Remove all accessories from the oven.

2.Smoke/Fire

During cooking with MICROWAVE mode, if smoke is observed, keep the Oven door closed, and switch off or disconnect the oven from the supply. If materials inside the oven should ignite, keep oven door closed, press STOP/RESET pad. Switch off at outlet. If possible, shut off power at the fuse or circuit breaker panel.

3.Interference

There is a possibility of a small amount of interference with weak broadcast signals if the oven is too close to a radio or TV.

4.Heater Operation

When using HIGH, MEDIUM, LOW and SIMMER powers, half the Grill elements and the CONVECTION fan operate to reduce the build up of condensation. Take care NOT TO TOUCH OVEN CEILING.

5.Cleaning

Failure to maintain the oven in a clean condition could lead to deterioration of the oven interior and could adversely affect the life of the appliance and possibly result in a hazardous situation.
Do not clean this appliance with a water jet.
A steam cleaner is not to be used.

Important Information - Read Carefully

1. Heating Times

As MICROWAVE and COMBINATION heating times are much shorter than other cooking methods, it is essential that recommended heating times are not exceeded without first checking the food.

Cooking times given in the charts are approximate. Factors that may affect cooking times are: starting temperature, volume, size and shape of foods and dishes used.

Fire!

If the recommended heating times are exceeded the food will be spoiled and in extreme circumstances could catch fire and possibly damage the interior of the oven. It is critical that the Oven is cleaned regularly and kept free of excess grease. See Care of your Oven and Cleaning.

(See pages 72 - 73)

2. Small Quantities of Foods

Small quantities of food or foods with low moisture content can burn, dry out or catch on fire if cooked too long.

Fire!

If materials inside the oven should ignite, keep the oven door closed, press STOP/RESET pad. Switch off at outlet, if possible or shut off power at the fuse or circuit breaker panel.

3. Food Components

Foods high in sugar, salt, fats and moisture content heat faster by Microwave because their properties attract microwave energy. Denser foods high in protein and fibre, absorb microwave energy slower which means a longer heating time.

4. Food High in Fat/Sugar

It is important to correctly set the heating time for food with a high fat, alcohol and sugar content. If these foods are heated by microwave for too long they can ignite. NEVER LEAVE UNATTENDED. eg. Doughnuts, syrup sponge puddings, Christmas puddings and mince pies.

5. Eggs

Eggs in their shell and whole hard-boiled eggs should not be heated in microwave ovens since they may exploded, even after microwave heating has ended.

6. Piercing Skins

Potatoes, apples, egg yolks, whole vegetables and sausages are examples of food with non-porous skins. These must be pierced using a fork before cooking by MICROWAVE to prevent bursting.

7. Deep fat frying

Do not attempt to deep fat fry in your oven.

8. Checking Internal Temperature

To ensure the complete destruction of food poisoning bacteria such as Lysteria and Salmonella, ensure the internal temperature of the food reaches at least 72°C when reheating. Use a suitable thermometer with probe attachment to check the temperature at the end of the heating time. Heat for a longer time if the correct temperatures are not reached. DO NOT use a domestic meat thermometer - use only correctly calibrated equipment.

9. Liquids

When heating liquids by MICROWAVE, eg. soup, sauces and beverages, overheating the liquid beyond boiling point can occur without evidence of bubbling.

This could result in a sudden boil over of the hot liquid. To prevent this possibility, the following steps should be taken:

- Avoid using straight-sided containers with narrow necks.
- Do not overheat.
- Stir the liquid before placing the container in the oven and again halfway through the heating time.
- After heating, allow to stand in the oven for a short time, stirring again before carefully removing the container.

10. Paper, Plastic

When heating food in plastic or paper containers, check the oven frequently as these types of containers may ignite if overheated.

(See page 31)

Do not use re-cycled paper products, as they may contain impurities which may cause sparks and/or fires when used, unless packaging states they are specifically designed for microwave use.

11. Reheating

It is essential reheated food is served "piping hot" (72°C). Always check before serving and if in doubt return food to oven for further heating.

12. Standing Times

Standing times are essential for foods cooked or reheated by MICROWAVE or COMBINATION. During the stand time, heat will continue to conduct to the centre to cook the food completely. The denser the food, the longer the stand time. Reheated foods also require a standing time.

13. Accessories

Follow specific instructions in this guide for proper use of oven accessories and cookware. Failure to do so could damage the oven. Take care when removing food and/or accessories from the oven. The Wire Rack Shelf provided DOES NOT have a non-tip lock—take care if you pull it out to remove food.

Important Information - Read Carefully

14. Cooking containers

Before use on MICROWAVE and COMBINATION, always check that containers are suitable. (See pages 31, 55.)

DO NOT MICROWAVE sealed containers as they will explode.

15. Fan motor operation

After using MICROWAVE, CONVECTION, COMBINATION, GRILL, FAN GRILL or GRILL CONVECTION the fan motor always rotates for approx. 5 minutes to cool the electric components. This is normal and you can take out food even though fan motor operates.

16. Baby bottles/jars

Feeding bottles and baby food jars shall be open when heated and the contents are to be stirred or shaken, and the temperature is to be checked before consumption, in order to avoid burns.

17. When children use oven

This oven is not intended for use by persons (including children) with reduced physical, sensory or mental capabilities, or lack of experience and knowledge unless they have been given supervision or instruction concerning the use of the oven by a person responsible for their safety. Children should be supervised to ensure they do not play with the oven.

Accessories Supplied

SD Memory Card

Part No. RP-SD016BCS0

An SD Memory Card is included with the oven and carries excel files to enable programming via your Personal Computer. Up to 99 of your own cooking programmes can be stored via the SD Memory Card. If the SD Card is lost or develops a fault, please contact Service Engineer. See pages 74-77 for information on using the SD Card and the memory programming software.

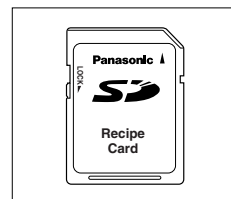

Air Filter

PLEASE ENSURE THAT AIR FILTERS ARE INSTALLED BEFORE USING THE OVEN.

Operation without Air Filters will allow dirt and grease to block air vents causing the oven to overheat. See page 73 for installation.

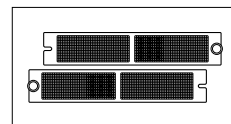

Ceramic Insulating Tray

Part No. A06033230GP

When using metal dishes on COMBINATION, place the Ceramic Insulating Tray between the food container and the Wire Rack Shelf. The Ceramic Insulating Tray should remain in the oven during preheating on a combination programme. If placing food directly on the Ceramic Insulating Tray, ensure it is clean and free of excess grease. COOL the Ceramic Insulating Tray before cleaning to avoid breakage. Ceramic Insulating Tray should be placed on base of oven to catch drips when grilling.

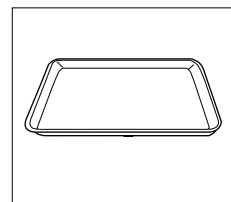

Wire Rack Shelf

Part No. A06023C50BPS

The shelf can be used on CONVECTION, COMBINATION, GRILL, GRILL CONVECTION and FAN GRILL functions. DO NOT leave shelf in oven on MICROWAVE ONLY function. DO NOT PLACE METAL CONTAINERS DIRECTLY ON WIRE RACK SHELF when using COMBINATION function. Use the Ceramic Insulation Tray.

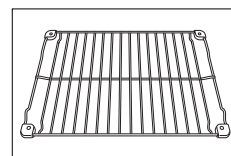

There is **NO NON-TIP** Safety Lock on Shelf— take care when removing food.

Installing Wire Rack Shelf

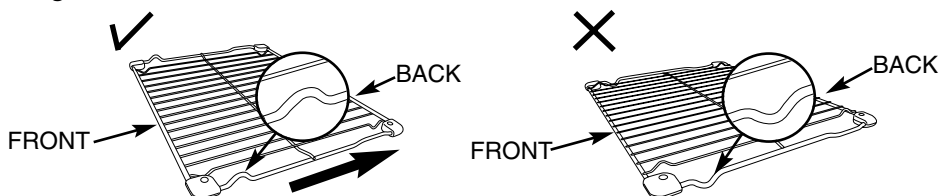

Insert into the cavity.

Your oven Explained

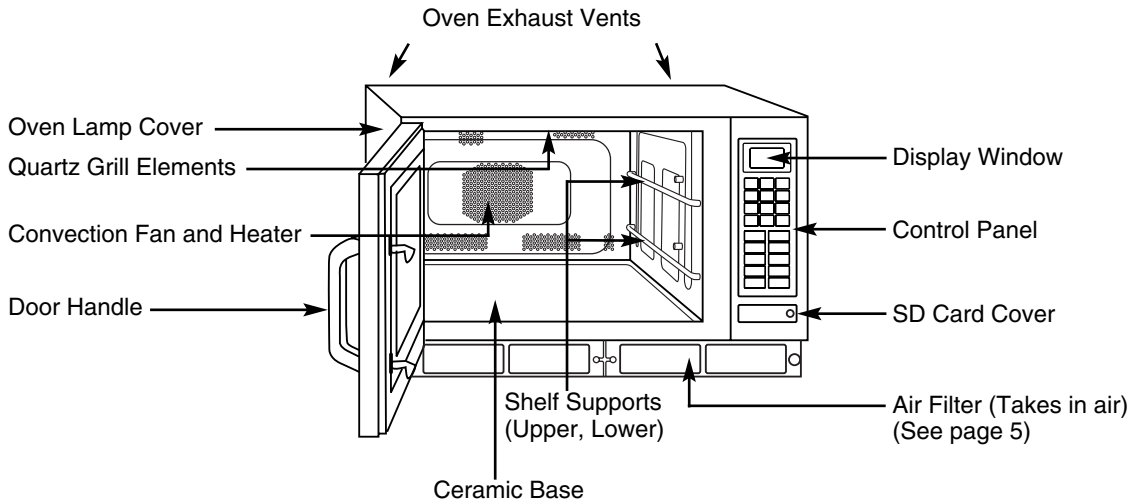

Display Window

The cursor will illuminate to indicate the programme set. Always check the cursor position before you press Start Pad.

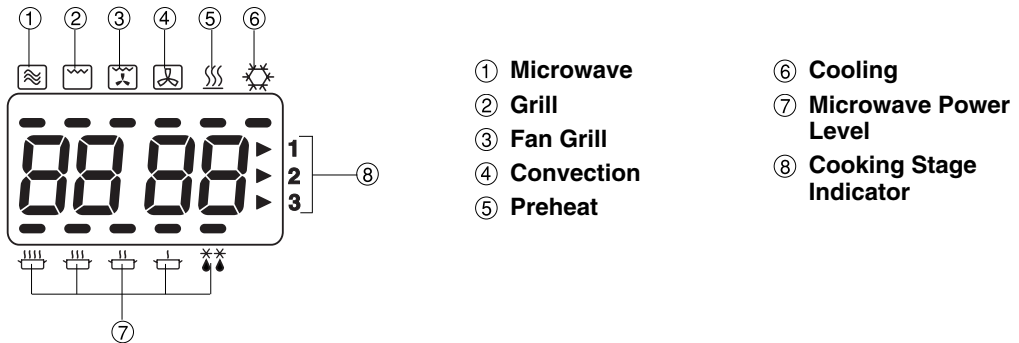

Control Panel

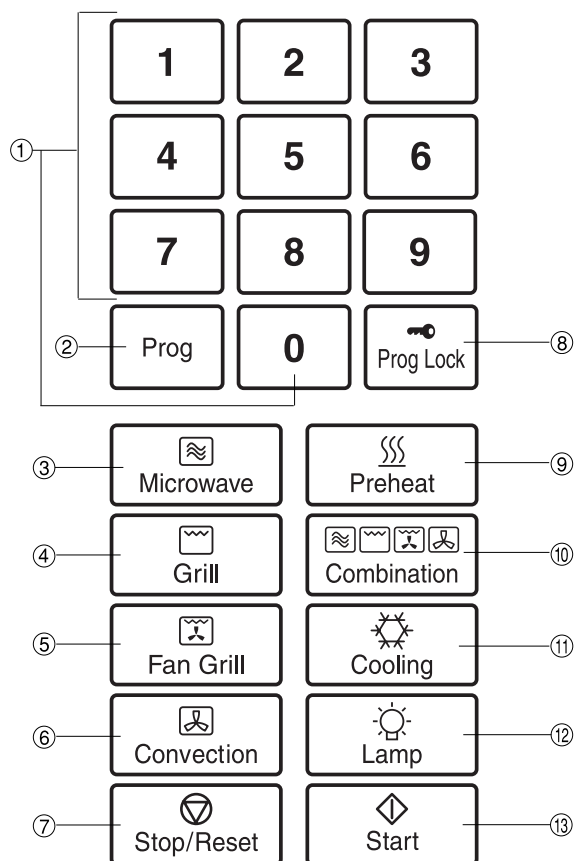

- ① Number Pads
- ② Prog (Programme) Pad
- ③ Microwave Pad
- ④ Grill Pad
- ⑤ Fan Grill Pad
- ⑥ Convection Pad
- ⑦ Stop/Reset Pad
- ⑧ Prog Lock (Programme Lock) Pad
- ⑨ Preheat Pad
- ⑩ Combination Pad
- ⑪ Cooling Pad
- ⑫ Oven Lamp Pad
- ⑬ Start Pad

Operating your Oven as a Microwave

CONTROLS TO USE

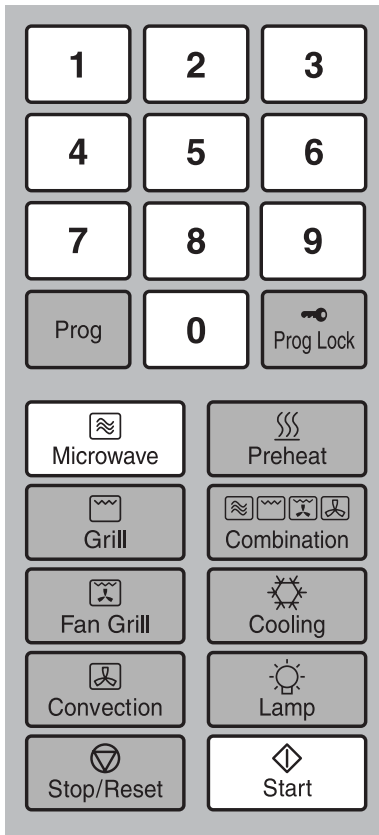

ACTION	INFORMATION	DISPLAY
1 Open Door. Put in Food. Close Door.	The oven lamp will come on. Oven lamp turns off.	
2 Select Power Level. 	Press Microwave Pad to select correct power. eg. HIGH—see below.	
3 Select Time.	Press Number Pads to set a heating time. eg. 4 mins. 30 secs. Press Pads 4, 3 and 0. Max time you can set: HIGH, MEDIUM 15 mins Other 60 mins	
4 Press Start Pad. 	Display window will count down time. The cooling fan will be turned on.	
5 Open Door.	At end of heating programme, oven beeps 3 times, and "0" flashes in window until door is opened. Remove food. Display window will indicate the previous programme.	End of Programme Open Door

ACCESSORIES TO USE

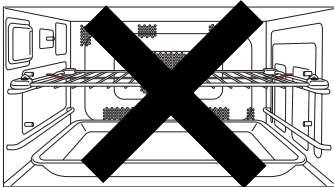

Do not use the Wire Rack Shelf or Ceramic Insulating Tray when cooking by microwave.

PRESS	POWER LEVEL	WATTS
Once	HIGH	1150
Twice	MEDIUM	850
3 Times	LOW	560
4 Times	SIMMER	420
5 Times	DEFROST	180
6 Times	— STAND	0

Operating your Oven as a Microwave

Hot Surfaces

Take great care when removing hot food. Use oven gloves.

Multi-Stage (Sequential) Heating

The oven can be programmed with up to 3 different stages to operate in sequence. These can be MICROWAVE, GRILL, CONVECTION, FAN GRILL, GRILL CONVECTION or COMBINATION functions. If a required heating time is greater than 15 minutes on HIGH or MEDIUM power, use 2 stage programming.

For 2 stage programming:

Follow steps 1-3 then enter the next heating programme, and press START Pad.



For 3 stage programming:

Follow 2 stage programming and enter a 3rd heating programme before pressing START Pad.



Oven Lamp

The Oven Lamp switches off when the door is closed. If you want to check the food, press Lamp Pad, it will then illuminate for 10 seconds.

The Oven Lamp turns on whenever the door is opened.



Repeat Feature

You can repeat the same heating programme if you press START Pad within 1 minute of the previous programme finishing.

After 1 minute, if START Pad is not pressed the display goes blank if the oven door is closed.

After 30 minutes returns to "0" if the oven door is open.



Stop/Reset Pad

Before heating: One press clears the display.

During heating: One press stops the heating cycle and two presses clear the display.

N.B. see page 24 for operation whilst in Programme Lock.





Operating your Oven on Convection

CONTROLS TO USE



* The oven will memorise the last CONVECTION temperature used should you wish to use the same one again. Press the CONVECTION pad when cooking is complete & the last temperature used will be displayed.

ACTION	INFORMATION	DISPLAY
1 Open Door. Put in Food. Close Door.	The oven lamp will come on. Oven lamp turns off.	
2 Press Convection Pad.* 	Select required oven temperature. eg. 180°C Continue to press Convection Pad until temperature required appears in display window. Temperature counts up in 10°C from 100°C-250°C.	
3 Select Time.	Press Number Pads to set a heating time. eg. 18 mins. Press Pads 1,8,0 and 0. Max heating time is: 99 mins. 99 secs.	
4 Press Start Pad. 	Display window will count down time. The Convection fan turns on.	
5 Open Door.	At end of heating programme, oven beeps 3 times, and "0" flashes in window until door is opened. Remove food. Display window will indicate the previous programme.	End of Programme Open Door

ACCESSORIES TO USE

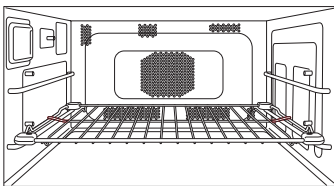

For best results place the cooking container on Wire Rack Shelf in LOWER position. Food can be placed directly on the Wire Rack Shelf if it is thoroughly cleaned before use.

Caution:

There is NO NON-TIP Safety Lock on Wire Rack Shelf. Take care when removing food.

Operating your Oven on Convection

Hot Surfaces

Take great care when removing hot food. Use oven gloves.

Multi-Stage (Sequential) Heating

The oven can be programmed with up to 3 different stages to operate in sequence. These can be MICROWAVE, GRILL, CONVECTION, FAN GRILL, GRILL CONVECTION or COMBINATION functions.

For 2 stage programming:

Follow steps 1-3 then enter the next heating programme, and press START Pad.

For 3 stage programming:

Follow 2 stage programming and enter a 3rd heating programme before pressing START Pad.



Recalling Convection Temperature

The temperature selected can be checked during operation by pressing Convection Pad. Temperature will be displayed for 3 seconds before returning to remaining heating time.

The temperature cannot be altered during a programme.



Preheat

For best results on Convection the oven should be preheated.
(see page 26)



Oven Lamp

The Oven Lamp switches off when the door is closed. If you want to check the food, press the Oven Lamp Pad, it will then illuminate for 10 seconds.

The Oven Lamp turns on whenever the door is opened.

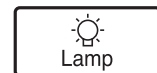

Repeat Feature

You can repeat the same heating programme if you touch the START Pad within 1 minute of the previous programme finishing.

After 1 minute, if START Pad is not pressed the display goes blank if the oven door is closed.

After 30 minutes returns to "0" if the oven door is open.



Stop/Reset Pad

Before heating: One press clears the display.

During heating: One press stops the heating cycle and two presses clear the display.

N.B. see page 24 for operation whilst in Programme Lock.



Operating your Oven on Grill Convection

CONTROLS TO USE



* The oven will memorise the last CONVECTION temperature used should you wish to use the same one again. Press the CONVECTION pad when cooking is complete & the last temperature used will be displayed.

ACTION	INFORMATION	DISPLAY
1 Open Door. Put in Food. Close Door.	The oven lamp will come on. Oven lamp turns off.	
2 Press Grill Pad. 	High or Low level can be selected but Grill level is automatically fixed after pressing Convection pad.	
3 Press Convection Pad.* 	Select required oven temperature. eg. 180°C Continue to press Convection Pad until temperature required appears in display window. Temperature counts up in 10°C from 100°C-250°C	
4 Select Time.	Press Number Pads to set a heating time. eg. 18 mins. Press Pads 1,8,0 and 0. Max heating time is: 99 min. 99 secs.	
5 Press Start Pad. 	Display window will count down time. The Convection fan turns on.	
6 Open Door.	At end of heating programme, oven beeps 3 times, and "0" flashes in window until door is opened. Remove food. Display window will indicate the previous programme.	End of Programme Open Door

ACCESSORIES TO USE

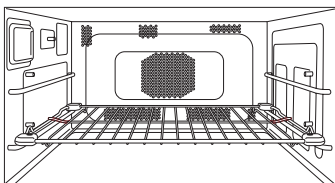

For best results place the cooking container on Wire Rack Shelf in the LOWER position. Food can be placed directly on the Wire Rack Shelf if it is thoroughly cleaned before use.

Caution:

There is NO NON-TIP Safety Lock on Wire Rack Shelf. Take care when removing food.

Operating your Oven on Grill Convection

Hot Surfaces

Take great care when removing hot food. Use oven gloves.

Multi-Stage (Sequential) Heating

The oven can be programmed with up to 3 different stages to operate in sequence. These can be MICROWAVE, GRILL, CONVECTION, FAN GRILL, GRILL CONVECTION or COMBINATION functions. If a required heating time is greater than 15 minutes on HIGH or MEDIUM power, use 2 stage programming.

For 2 stage programming:

Follow steps 1-3 then enter the next heating programme, and press START Pad.

For 3 stage programming:

Follow 2 stage programming and enter a 3rd heating programme before pressing START Pad.

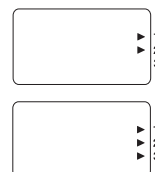

Recalling Convection Temperature

The temperature selected can be checked during operation by pressing Convection Pad. Temperature will be displayed for 3 seconds before returning to remaining heating time. The temperature cannot be altered during a programme. Recalling Grill level is not available.



Preheat

For best results on Grill Convection the oven should be preheated. (see page 26)

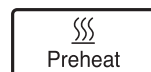

Oven Lamp

The Oven Lamp switches off when the door is closed. If you want to check the food, press Lamp Pad, it will then illuminate for 10 seconds. The Oven Lamp turns on whenever the door is opened.

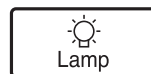

Repeat Feature

You can repeat the same heating programme if you press START Pad within 1 minute of the previous programme finishing. After 1 minute, if START Pad is not pressed the display goes blank if the oven door is closed. After 30 minutes returns to "0" if the oven door is open.



Stop/Reset Pad



Before heating: One press clears the display.
During heating: One press stops the heating cycle and two presses clear the display.
N.B. see page 24 for operation whilst in Programme Lock.



Operating your Oven on Grill

CONTROLS TO USE



ACTION	INFORMATION	DISPLAY						
1 Open Door. Put in Food. Close Door.	The oven lamp will come on. Oven lamp turns off.							
2 Press Grill Pad. 	Select required Grill level. eg. High <table style="margin-left: auto; margin-right: auto;"> <tr> <td>Display</td> <td>Output</td> </tr> <tr> <td>1 press Hi</td> <td>1800 W</td> </tr> <tr> <td>2 presses Lo</td> <td>1450 W</td> </tr> </table>	Display	Output	1 press Hi	1800 W	2 presses Lo	1450 W	
Display	Output							
1 press Hi	1800 W							
2 presses Lo	1450 W							
3 Select Time.	Press Number Pads to set a heating time. eg. 10 mins. Press Pads 1,0,0 and 0. Max heating time is: 60 mins.							
4 Press Start Pad. 	Display window will count down time. The convection fan turns on.							
5 Open Door.	At end of heating programme, oven beeps 3 times, and "0" flashes in window until door is opened. Remove food. Display window will indicate the previous programme.	End of Programme Open Door 						

ACCESSORIES TO USE

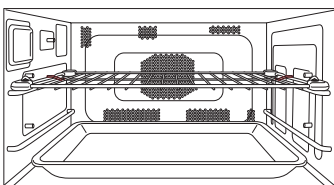

For best results place the food on Wire Rack Shelf in UPPER position. Ceramic Insulating Tray may be placed on base of oven to catch splashes and drips. Small items of food that might fall between Wire Rack Shelf can be cooked directly on ceramic Insulating Tray on Wire Rack Shelf in UPPER position. Drain frequently to avoid excessive spitting. Deep dishes may be finished under the grill placed on the Wire Rack Shelf in the LOWER position or placed directly on ceramic base.

Caution:

There is NO NON-TIP Safety Lock on Wire Rack Shelf. Take care when removing food.

Operating your Oven on Grill

Hot Surfaces

Take great care when removing hot food. Use oven gloves.

Multi-Stage (Sequential) Heating

The oven can be programmed with up to 3 different stages to operate in sequence. These can be MICROWAVE, GRILL, CONVECTION, FAN GRILL, GRILL CONVECTION or COMBINATION functions.

For 2 stage programming:

Follow steps 1-3 then enter the next heating programme, then press START Pad.

For 3 stage programming:

Follow 2 stage programming and enter a 3rd heating programme before pressing START Pad.



Recalling Grill level

The Grill level selected can be checked during operation by pressing Grill Pad. The Grill level will be displayed for 3 seconds before returning to remaining heating time.



Preheat

For best results on Grill the oven should be preheated. (see page 26)

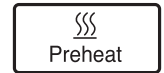

Oven Lamp

The Oven Lamp switches off when the door is closed. If you want to check the food, press Oven Lamp Pad, it will then illuminate for 10 seconds. The Oven Lamp turns on whenever the door is opened.

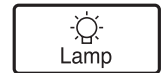

Repeat Feature

You can repeat the same heating programme if you touch the Start Pad within 1 minute of the previous programme finishing. After 1 minute, if Start Pad is not pressed the display goes blank if the oven door is closed. After 30 minutes returns to "0" if the oven door is open.









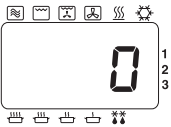

Stop/Reset Pad

Before heating: One press clears the display.
During heating: One press stops the heating cycle and two presses clear the display.
N.B. see page 24 for operation whilst in Programme Lock.

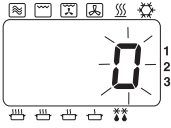

Operating your Oven on Fan Grill

CONTROLS TO USE	ACTION	INFORMATION	DISPLAY
	1 Open Door. Put in Food. Close Door.	The oven lamp will come on. Oven lamp turns off.	
	2 Press Fan Grill Pad.* 	Select required Fan Grill temperature. eg. 180°C Continue to press Fan Grill Pad until temperature required appears in display window. Temperature counts up in 10°C from 100°C-250°C	
	3 Select Time.	Press Number Pads to set a heating time. eg.20 mins. Press Pads 2,0,0 and 0. Max heating time is: 99 mins. 99 secs.	
	4 Press Start Pad. 	Display window will count down time. The convection fan turns on.	
	5 Open Door.	At end of heating programme, oven beeps 3 times, and "0" flashes in window until door is opened. Remove food. Display window will indicate the previous programme.	End of Programme  Open Door 

* The oven will memorise the last FAN GRILL temperature used should you wish to use the same one again. Press the FAN GRILL pad when cooking is complete & the last temperature used will be displayed.

ACCESSORIES TO USE

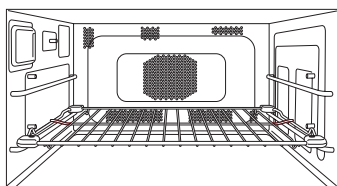

For best results place the cooking container on Wire Rack Shelf in the LOWER position. Food can be placed directly on the Wire Rack Shelf if it is thoroughly cleaned before use.

Caution:

There is NO NON-TIP Safety Lock on Wire Rack Shelf. Take care when removing food.

Operating your Oven on Fan Grill

Hot Surfaces

Take great care when removing hot food. Use oven gloves.

Multi-Stage (Sequential) Heating

The oven can be programmed with up to 3 different stages to operate in sequence. These can be MICROWAVE, GRILL, CONVECTION, FAN GRILL, GRILL CONVECTION or COMBINATION functions.

For 2 stage programming:

Follow steps 1-3 then enter the next heating programme, then press START Pad.

For 3 stage programming:

Follow 2 stage programming and enter a 3rd heating programme before pressing START Pad.



Recalling Fan Grill Temperature

The temperature selected can be checked during operation by pressing Fan Grill Pad. Temperature will be displayed for 3 seconds before returning to remaining heating time.

The temperature cannot be altered during a programme.



Preheat

For best result on Fan Grill the oven should be preheated.
(see page 26)

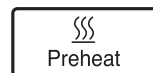

Oven Lamp

The Oven Lamp switches off when the door is closed. If you want to check the food, press Oven Lamp Pad, it will then illuminate for 10 seconds.

The Oven Lamp turns on whenever the door is opened.

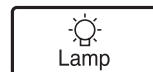

Repeat Feature

You can repeat the same heating programme if you touch the Start Pad within 1 minute of the previous programme finishing.

After 1 minute, if Start Pad is not pressed the display goes blank if the oven door is closed.

After 30 minutes returns to "0" if the oven door is open.



Stop/Reset Pad

Before heating: One press clears the display.

During heating: One press stops the heating cycle and two presses clear the display.

N.B. see page 24 for operation whilst in Programme Lock.



Operating your Oven on Combination

ACCESSORIES TO USE

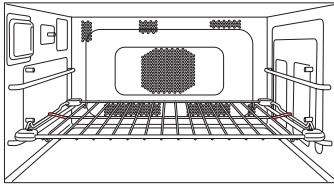

For best results place food on Wire Rack Shelf in the LOWER position. The Ceramic Insulating Tray MUST be used if the cooking container is metal, NEVER place a metal container directly onto the WIRE SHELF when cooking by COMBINATION as arcing may occur and damage the dish/oven. (See page 55.)

Caution:

There is NO NON-TIP Safety Lock on Wire Rack Shelf. Take care when removing food.

Preset Combination

CONTROLS TO USE

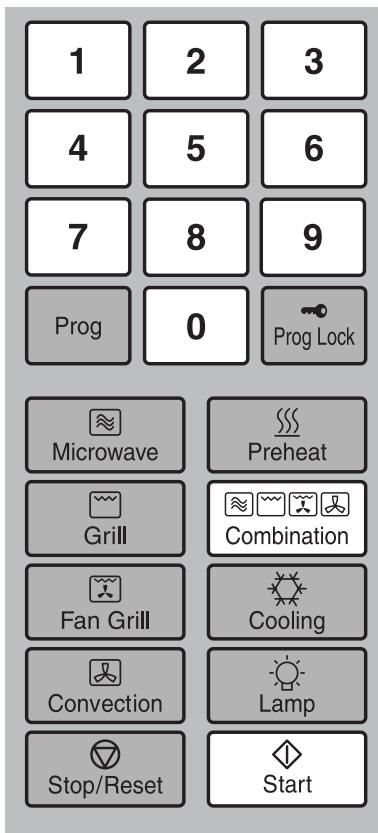











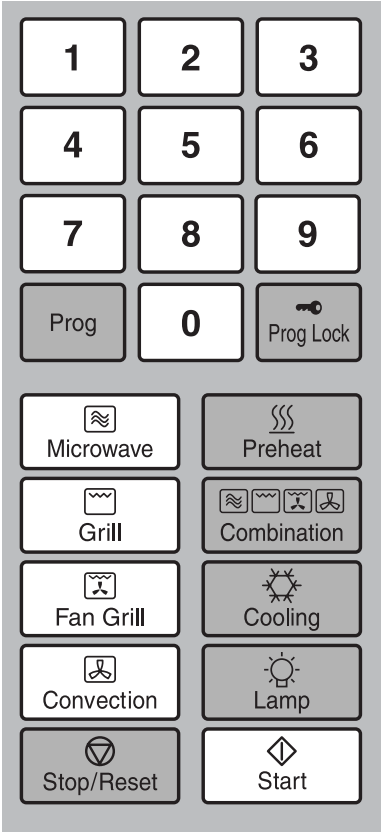
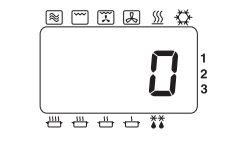

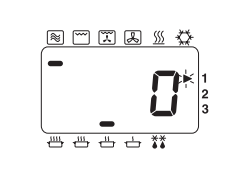
* Combi 1 may only be used as the **first stage** of a 2 or 3 stage cooking programme.

ACTION	INFORMATION	DISPLAY
1 Open Door. Put in Food. Close Door.	The oven lamp will come on. Oven lamp turns off.	
2 Press Combination Pad. 	Select Preset Combination Number. (1-5) eg. 1—see below.	
3 Select Time.	Press Number Pads to set a heating time. eg.3 mins. Press pads 3,0 and 0. Max heating time is: 5 min.	
3 Press Start Pad. 	Display window will count down time.	
4 Open Door.	At end of heating programme, oven beeps 3 times, and “0” flashes in window until door is opened. Remove food. Display window will indicate the previous programme.	End of Programme Open Door

PRESS	DISPLAY	MICROWAVE POWER	GRILL OR CONVECTION SETTING	GRILL LEVEL OR CONVECTION TEMPERATURE	MAXIMUM HEATING TIME
Once	1*	HIGH	Fan Grill	250°C	5 mins
Twice	2	SIMMER	Fan Grill	250°C	60 mins
3 Times	3	DEFROST	Fan Grill	250°C	60 mins
4 Times	4	LOW	Grill Convection	250°C	60 mins
5 Times	5	LOW	Grill	Hi	60 mins

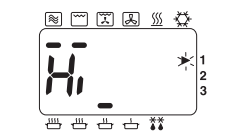
Operating your Oven on Combination

Manual Combination

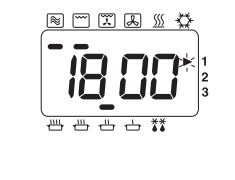
CONTROLS TO USE	ACTION	INFORMATION	DISPLAY									
	<p>1 Open Door. Put in Food.</p> <p>Close Door.</p>	<p>The oven lamp will come on.</p> <p>Oven lamp turns off.</p>										
	<p>2 Select Power Level. **</p> <p> Microwave</p>	<p>Press Microwave Pad to select correct power. eg. LOW.</p>										
	<p>3 Press Grill Pad</p> <p></p> <p>or</p> <p>Fan Grill Pad ***</p> <p></p> <p>or</p> <p>Convection Pad ***</p> <p></p> <p>or</p> <p>Grill Pad *</p> <p></p> <p>+</p> <p>Convection Pad * ***</p> <p></p>	<p>MWO + GRILL Select Grill Level.</p> <table border="0"> <tr> <td></td> <td>Display</td> <td>Output</td> </tr> <tr> <td>1 press</td> <td>Hi</td> <td>1800 W</td> </tr> <tr> <td>2 presses</td> <td>Lo</td> <td>1450 W</td> </tr> </table> <p>eg. Hi.</p> <p>OR</p> <p>MWO + FAN GRILL Press Fan Grill Pad until required temperature appears in display. eg. 200°C.</p> <p>OR</p> <p>MWO + CONVECTION Press Convection Pad until required temperature appears in display. eg. 200°C.</p> <p>OR</p> <p>MWO + GRILL CONVECTION Hi or Lo level can be selected but Grill level is automatically fixed after pressing Convection Pad.</p> <p>+</p> <p>Press Convection Pad until required temperature appears in display. eg. 200°C.</p>		Display	Output	1 press	Hi	1800 W	2 presses	Lo	1450 W	    <p>+</p> 
	Display	Output										
1 press	Hi	1800 W										
2 presses	Lo	1450 W										
	<p>4 Select Time.</p>	<p>Press Number Pads to set a heating time. eg. MWO + GRILL 18 mins. Press pads 1,8,0 and 0 Max heating time is: 60 mins.</p>										

* Combination of Microwave and Grill and Convection is possible.





** Combination settings using HIGH or MEDIUM power may only be used as **first stage** of a 2 or 3 stage cooking programme and for a maximum 5 minutes heating time.

*** The oven will memorise the last CONVECTION, GRILL CONVECTION, or FAN GRILL temperature used on COMBINATION should you wish to use the same one again. Press the CONVECTION or FAN GRILL pad when cooking is complete & the last temperature used will be displayed.

(ACTIONS 5 - 6 continued on next page.)

Combination

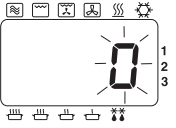
Operating your Oven on Combination

ACTION	INFORMATION	DISPLAY
<p>5 Press Start Pad.</p> 	<p>Display window will count down time.</p>	
<p>6 Open Door.</p>	<p>At end of heating programme, oven beeps 3 times, and "0" flashes in window until door is opened.</p> <p>Remove food. Display window will indicate the previous programme.</p>	<p>End of Programme</p>  <p>Open Door</p> 

Hot Surfaces

Take great care when removing hot food. Use oven gloves.

Multi-Stage (Sequential) Heating

The Oven can be programmed with up to 3 different stages to operate in sequence. These can be MICROWAVE, GRILL, CONVECTION, FAN GRILL, GRILL CONVECTION or COMBINATION functions.

For 2 stage programming:

Follow steps 1-4 then enter the next heating and press START Pad.



For 3 stage programming:

Follow 2 stage programming and enter a 3rd heating programme before pressing START Pad.



Preheat

For best results on combination the oven should be preheated.
(See page 26.)

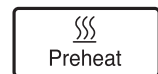

Operating your Oven on Combination

Recalling Preset Combination Number (Only Preset Combination)

The Preset Combination Number (1 - 5) selected can be checked during operation by pressing Combination Pad.

The Preset Combination Number will be displayed for 3 seconds before returning to remaining heating time.

Recalling Grill level (Only Manual Combination and Grill Combination)

The Grill level selected can be checked during operation by pressing Grill Pad. The Grill level will be displayed for 3 seconds before returning to remaining heating time.



Recalling Convection Temperature (Only Manual Combination)

The temperature selected can be checked during operation by pressing Convection Pad. Temperature will be displayed for 3 seconds before returning to remaining heating time.

The temperature cannot be altered during a programme.



Recalling Fan Grill Temperature (Only Manual Combination)

The temperature selected can be checked during operation by pressing the Fan Grill Pad. The temperature will be displayed for 3 seconds before returning to remaining heating time.

The temperature cannot be altered during a programme.



Oven Lamp

The Oven Lamp switches off when the door is closed. If you want to check the food, press Lamp Pad, it will then illuminate for 10 seconds. The Oven Lamp turns on whenever the door is opened.

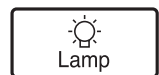

Repeat Feature

You can repeat the same heating programme if you touch the START Pad within 1 minute of the previous programme finishing.

After 1 minute, if START Pad is not pressed the display goes blank if the oven door is closed.

After 30 minutes returns to "0" if the oven door is open.



Stop/Reset Pad

Before heating: One press clears the display.

During heating: One press stops the heating cycle and two presses clear the display.

N.B. see page 24 for operation whilst in Programme Lock.



Setting the Memory Programmes









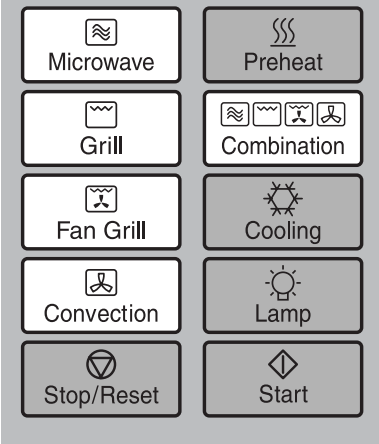

Please ensure that the SD Memory Card is inserted in the Oven.

Your oven has 99 blank memory programmes for your own heating requirement.

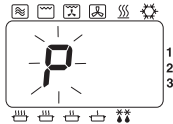
All 99 Memory Programmes can be set manually using the Prog Pad on the Control Panel.

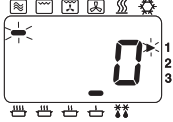
However, these programmes can be stored onto the SD Memory Card using your personal computer (see pages 75-77).

Any programme information stored directly onto the SD Memory Card will override any manual programmes previously set.

CONTROLS TO USE	ACTION	INFORMATION	DISPLAY
	<p>1 Open Door.</p>	<p>The oven lamp will come on.</p>	
	<p>2 Press Prog Pad.</p> 	<p>Keep pad pressed for 2 seconds until "P" is displayed.</p> <p>KEEP DOOR OPEN</p>	
	<p>3 Press Programme Number.</p>	<p>eg. To set Programme 03: SIMMER 20 mins. Press Number Pads 0 and 3. If programme has been previously set, this will appear in the display. If the programme memory is empty then the programme number will appear in the display.</p>	
	<p>4 Select Power.</p>	<p>eg. Press Microwave Power Pad 4 times.</p>	
	<p>5 Select Time.</p>	<p>eg. Press Number Pads 2, 0, 0, and 0.</p>	
	<p>6 Press Prog Pad.</p> 	<p>After 3 seconds display returns to "0".</p>	

Setting the Memory Programmes

Programme Lock

It is NOT possible to enter a programme when Programme Lock is set.



Multi-stage (Sequential Cooking)





It is possible to programme into the memory a 2 or 3 stage programme using MICROWAVE, CONVECTION, GRILL, FAN GRILL, GRILL CONVECTION or COMBINATION.

Changing a Memory Programme

To change a programme simply follow steps 1-6 on previous page entering your new programme.

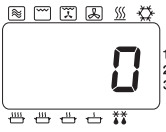
Using the Memory Programmes

Please ensure SD Memory Card is inserted in the oven.





ACTION	INFORMATION	DISPLAY
<p>1 Open Door. Put in Food.</p> <p>CLOSE DOOR.</p>	<p>The oven lamp will come on.</p> <p>Oven lamp turns off.</p>	
<p>2 Press Number Pads required.</p>	<p>eg. For programme 03. Press Number Pads 0 and 3. This example is preset Memory Programme: SIMMER power 20 mins.</p>	
<p>3 Press START.</p> <div data-bbox="179 1358 278 1406" style="border: 1px solid black; padding: 5px; text-align: center; width: fit-content; margin: 0 auto;">  Start </div>	<p>Display window will count down time.</p>	

Programme Lock

If programme lock is activated, programme starts immediately therefore there is no need to press START Pad.

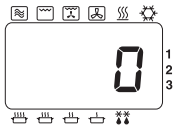

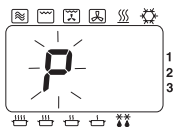
How to Activate Programme Lock

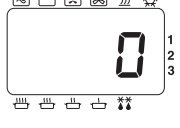
CONTROLS TO USE	ACTION	INFORMATION	DISPLAY
	1 Open Door.	The oven lamp will come on.	
	2 Press and hold Prog Lock Pad. 	"P" is displayed. KEEP DOOR OPEN. After 2 seconds.... After 3 seconds.....	  

One Touch Operating Mode

When Programme Lock is activated, oven operates in "ONE TOUCH" mode, i.e. press required memory programme number and oven immediately starts.
No need to press START Pad.

Interrupted Programme

If the door is opened during a programme, the remaining heating time will be cancelled.

Repeat Feature

Once a manual heating programme has finished, the oven will automatically display the programme again for a repeat programme, even if the Programme Lock is activated.

Setting New Programs



When the Programme Lock is activated it is not possible to enter a Memory Programme or change the Beep tone.
(See page 28.)

Stop/Reset Pad

During heating, one press stops the heating cycle, the programme is cleared and display returns to "0".

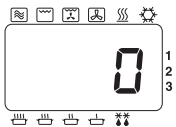

How to Deactivate Programme Lock

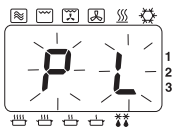
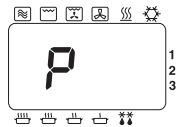
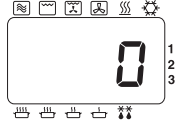
ACTION	INFORMATION	DISPLAY
1 Open Door.	The oven lamp will come on.	
2 Press Prog Lock Pad. 	Keep key pressed for 2 seconds until "P" is displayed. KEEP DOOR OPEN. After 2 seconds.... After 3 seconds...	  

Two Touch Operating Mode

The oven reverts to 2 TOUCH OPERATION mode when you deactivate Programme Lock. Press required Number Pads then press START Pad.

Interrupted Programme

If the door is opened during a programme, once programme lock is deactivated, the remaining heating time will be retained in the display window until the door is closed and START Pad is pressed.

Repeat Feature

Once a manual heating programme has finished, the oven will automatically display the programme again for a repeat programme with the Programme Lock deactivated.

Setting New Programs









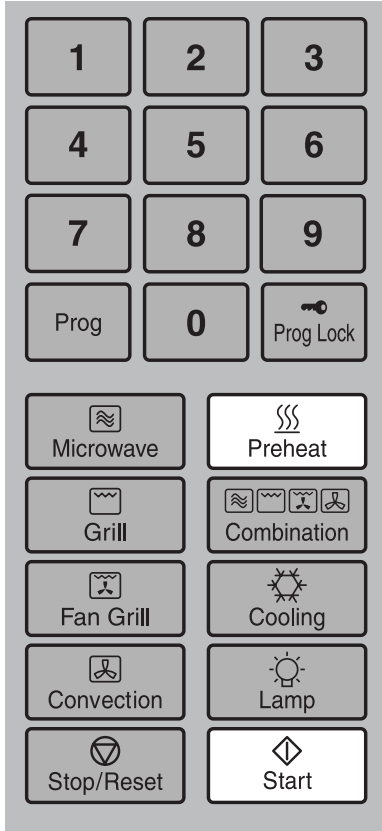
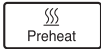

Once Programme Lock is released, you can enter new heating programs.

Programme List

It is possible to check the programmes that have been entered into the SD Memory Card. With the door open, press START pad and Number pad 1 simultaneously. (The Oven will make an acknowledging beep). After 2 seconds, the display window will show each individual stage of each Memory Programme in the order 01, 02, 03 etc. Finally, it will display the Beep Tone setting, the Programme Lock symbol (P.L), the time interval for cleaning of the Air Filter, before clearing to "0".

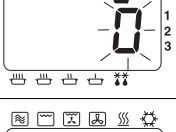

Keeping your Oven Hot

To assist in faster heating and browning results, the PREHEAT feature is designed to keep your oven at a background temperature of 190°C, 220°C or 240°C for a hot start before using a GRILL, CONVECTION, FAN GRILL, GRILL CONVECTION or COMBINATION function.

CONTROLS TO USE	ACTION	INFORMATION	DISPLAY
	1 Press Preheat Pad. * 	Select a required Preheat temperature when display is blank or "0". eg. 220°C 1 press 190°C 2 presses 220°C 3 presses 240°C	
	2 Press Start Pad. 	Preheat temperature will be maintained at the selected temperature. Preheat temperature is reached when "P" flashes. The door must remain closed. If oven is not used, preheat automatically switches off after 4 hours.	 
	3 Open Door. Close Door Press Start Pad. 	Place food in oven. Select programme. eg. Convection 220°C 15 min Display window will count down time.	   
	4 Open Door.	Display window will indicate the previous programme. If Start Pad is not pressed within 1 minute, oven reverts to PREHEAT temperature previously selected.	 After 1 minute 



* The oven will memorise the last PREHEAT temperature used should you wish to use the same one again. Press the PREHEAT Pad and the last temperature used will be displayed.

Notes on Preheat and Cooling:





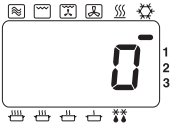

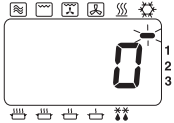
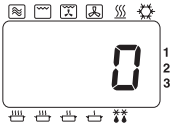
-  Only PREHEAT and COOLING functions can be selected when the display is blank. All other programmes must have "0" in display.
-  You can select PREHEAT function during a COOLING function and vice versa.
-  After a heating function has completed, oven will revert to PREHEAT function automatically.

Cooling your Oven quickly

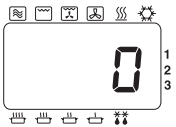
To quickly cool the oven cavity, the Panasonic Combi has a Cooling Pad. The Cooling Pad can be used effectively at the end of a cooking session to cool the oven for cleaning or if it is required for defrosting or heating by MICROWAVE whilst on PREHEAT function.

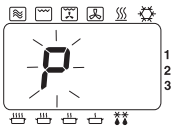

ACTION	INFORMATION	DISPLAY
<p>1 Press Cooling Pad.</p> 	<p>You can select cooling when the display is blank (door closed), or when "0" is in the display (door open).</p>	<p>(eg. Display has "0")</p> 
<p>2 Press Start Pad.</p> 	<ul style="list-style-type: none"> • The COOLING fan and CONVECTION fan will turn on. • The oven door can be opened or closed but cools fastest when the door is open. • The oven will cool in 3-30 mins. depending on temperature. 	
<p>3 Once the oven has cooled.</p>	<p>The cooling and convection fans switch off.</p>	

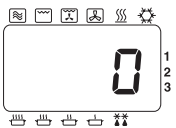
How to change the Beep Tone

ACTION	INFORMATION	DISPLAY															
1 Open Door. Keep Door Open.	The oven lamp will come on.																
2 Press Prog Pad. 	Keep pressed Pad for 2 seconds.																
3 Press Start Pad. 	Press Start Pad to choose sound level required. (eg. twice for Medium) <table border="1" data-bbox="463 585 998 720"> <thead> <tr> <th>No. Presses</th> <th>Display</th> <th>Sound level</th> </tr> </thead> <tbody> <tr> <td>1</td> <td>b-3</td> <td>Loudest</td> </tr> <tr> <td>2</td> <td>b-2</td> <td>Medium</td> </tr> <tr> <td>3</td> <td>b-1</td> <td>Quietest</td> </tr> <tr> <td>4</td> <td>b-0</td> <td>Silent</td> </tr> </tbody> </table>	No. Presses	Display	Sound level	1	b-3	Loudest	2	b-2	Medium	3	b-1	Quietest	4	b-0	Silent	
No. Presses	Display	Sound level															
1	b-3	Loudest															
2	b-2	Medium															
3	b-1	Quietest															
4	b-0	Silent															
4 Press Prog Pad. 	After 3 seconds, display returns to "0".	 <p style="text-align: center;">After 3 seconds</p> 															

How to change Cleaning Interval of the Air Filter

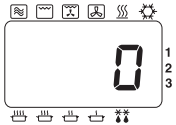
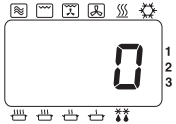
A warning to clean the Air Filter will appear as “FILt” in the Display Window.
 The oven is programmed to display the “FILt” warning after 500 hours of use.
 When “FILt” appears in the Display Window, remove the Air Filter and clean it with hot soapy water.
 Press Stop/Reset Pad to clear the display.

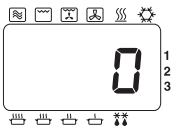
ACTION	INFORMATION	DISPLAY
1 Open Door.	The oven lamp will come on.	
2 Close the door while pressing START Pad and open the door again. <div style="border: 1px solid black; width: 60px; height: 20px; margin: 5px auto; text-align: center; padding: 2px;"> Start </div> KEEP DOOR OPEN.		
3 Press Number Pad 3. <div style="border: 1px solid black; width: 40px; height: 20px; margin: 5px auto; text-align: center; padding: 2px;"> 3 </div>	The currently programmed interval will appear. eg. 500 hours.	
4 Select new cleaning interval by pressing Number Pads.	Up to 9999 hours. eg. 600 hours. Press Number Pads 6, 0 and 0.	
5 Press Prog Pad. <div style="border: 1px solid black; width: 40px; height: 20px; margin: 5px auto; text-align: center; padding: 2px;"> Prog </div>	After 3 seconds, display returns to “0”.	

To check the total number of hours used,

- 1 Open the door. Keep door open.
- 2 Press Number Pad “3” while pressing Start Pad.
- 3 The total number of hours used will appear in Display Window.
eg. If the oven has been used for 20 hours,



After 3 seconds, display returns to “0”.

How a Microwave Works

To get the most from your Panasonic Combi it is helpful to understand how the oven works as a Microwave. Once connected to an outlet, the electricity flows along the flex and is converted into microwave energy by the MAGNETRON. Microwaves are ultra high frequency waves, and belong to the same category as radio and television waves. These are directed into the cavity through the WAVE GUIDE. When they reach the cavity, the microwaves will behave in one of three ways:

1. Reflection

They will REFLECT off metal. The inner walls of your oven are made of stainless steel, so that the microwave energy can bounce evenly around the cavity. Of course, the microwaves will also reflect off metal cooking containers and accessories, such as saucepans and platters. For this reason, NEVER use the Wire Rack Shelf on Microwave only.

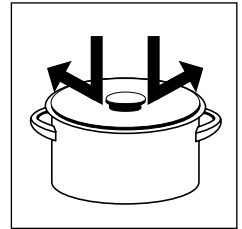

2. Transmission

The microwaves will TRANSMIT through paper, plastic, glass and china and, therefore, it is containers made of these substances that are used in microwave cookery.

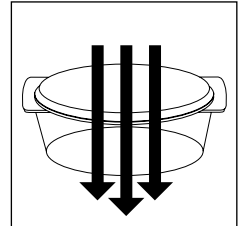

3. Absorption

The microwave energy is ABSORBED by the food. The energy penetrates the outside area of the food causing the molecules to vibrate over 2,450,000,000 times a second. This vibration causes the water molecules to rub against each other producing frictional heat which cooks this outer part of the food; the heat is then conducted through the food to cook the centre. Food, therefore, cooks from the outside, inwards.

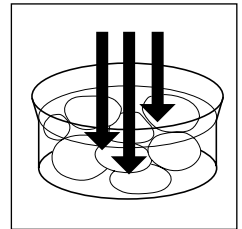

Standing Time

The heat that builds up on the outside of the food is still being conducted to the centre, even after the microwave oven has switched off. This period is known as the "Standing Time". The time it takes for the food to finish cooking will vary depending on its shape, size and type. For example, a jacket potato will need to stand for at least 5-10 minutes after the end of the cooking time and during this time the temperature at the centre will increase. A pastry pie that has been reheated will only need a standing time of 1-2 minutes for heat to distribute evenly.

If the food is put back in the Microwave and heated again before the standing time has elapsed, the food can very quickly become overcooked.

Types of container to use on Microwave

1. Glass

DO USE: Heat Resistant glass eg. Pyrex
DO NOT USE:
Delicate glass, lead crystal which may crack or arc.

2. China/Ceramics

DO USE: Glazed china dishes, porcelain and ceramic dishes designed for cooking.
DO NOT USE:
Fine bone china dishes with metal patterns. Jugs with glued handles.

3. Pottery/Earthenware/Stoneware

DO USE: If completely glazed.
DO NOT USE:
If unglazed - these dishes can absorb water which absorbs energy.
This makes the dish hot and increases the heating time.

4. Foil/Metal

DO USE: For reheating only:
Individual portion, open topped foil containers. Take care the containers do not touch WALLS or DOOR of oven.
Do not cook in foil containers.
Small amounts of Aluminium foil can be used to shield joints of meat during defrosting - take care that foil doesn't touch sides or door.
DO NOT USE:
Metal platters, Wire Rack Shelf, any dish with METAL PATTERN or TRIM. METAL SKEWERS. DO NOT RE-USE FOIL CONTAINERS - ARCING may occur as they become DENTED / DAMAGED. Do not use Le Crueset-style dishes (Cast iron covered by enamel). These can be used on convection or grill.

5. Plastic

DO USE: High temperature plastic like Durable Polysulfon rather than soft flexible dishes.
(Remove any metal twist ties.)
DO NOT USE:
Melamine, Polypropilen, Phenol Urea, also do not use plastic food storage bags and containers eg. Margarine, Yoghurt and Mayonnaise tubs.

6. Covering Films

DO USE: Non plasticiser cling film designed for Microwave use. Do not allow film to touch food. To prevent nasty steam burns, pierce film to allow it to escape and remove film from dish carefully.
DO NOT USE:
Film designed only for covering food.

7. Wood/Wicker

DO USE: Wooden skewers designed for food use.
DO NOT USE:
Wicker baskets, wooden bowls (with prolonged use these tend to dry out and may ignite)

8. Paper

DO USE: Disposable, polyester coated paper board dishes if designed for microwave.
DO NOT USE:
Paper napkins (these can ignite), wax coated cups, recycled products (unless stated suitable by manufacturer)

Reheating by Microwave

The microwave mode of your Panasonic Combi will be most frequently used to reheat food. Although the oven is provided with a rotating wave guide, all reheating times, and uniformity of heating, will vary according to several factors as below.

1. Choosing the correct reheat time

When heating foods for the first time it is necessary to experiment, to obtain the correct timings. Standardising portion size and ensuring refrigeration runs without variation will enable a routine to be developed for a particular food product. Always remember that the times given by both microwave and food manufacturers are approximate and should be used as a guideline.

2. Stirring

Wherever possible stir food halfway through the heating time and again at the end. This ensures the heat spreads evenly throughout the food.

3. Is the food safely reheated ?

A high level of hygiene is necessary to prevent food poisoning by such bacteria as Lysteria and Salmonella. Your Panasonic Combi will heat food to the temperatures required and will do so much faster than other methods of heating. The Department of Health has stated that a temperature of **70°C** maintained for 2 minutes will ensure the complete destruction of Lysteria and Salmonella bacteria and the right heating time, coupled with the standing time, makes certain the food has been heated correctly.

What you can do - Ensure food has reached a temperature of at least **72°C**. Check the centre and the thickest part of the food with a food thermometer as these are the last areas to heat. When the catering operation has been standardised as much as possible, it will not be necessary to check every dish that passes through the microwave oven, but an occasional spot check ensures the food is being served to the highest standards.

4. Standing food before serving

Allow food to stand at the end of the heating time. For small items, eg. sausage rolls, by the time the dish has been collected and served it will have had sufficient standing time. Foods such as meat pies and plated meals, however, will need 1-2 minutes for the heat to completely penetrate the centre. Do not be tempted to put the food back for additional heating time until after the standing time has been completed; putting the food back too soon will only result in overcooked and wasted food. The standing time can be used affectively to add additional foods to the plate, or to garnish attractively before serving.

Affects of the dish

1. shape

A round dish heats food more evenly than a square dish. The corners of a square dish receive double microwave energy and result in bubbling overcooked corners whilst the centre of the food is cold. Oval dishes give a better result but there may still be areas of hot bubbling food at the the two "ends".

2. Depth

A shallow dish heats more quickly than a deep dish. Microwave energy only penetrates the outside of the food. food in a shallow dish heats evenly from all directions. In a deep dish the food in the centre relies on conduction and takes longer to heat.

3. Material

Heavy earthenware and china dishes will slow the heating process by absorbing some of the heat from the food itself. A thinner, lighter china is a better choice as this will not impede the cooking time.

4. Glazed finish

Always choose a glazed dish. An unglazed or chipped container can absorb water when it is washed. As microwave energy is attracted to moisture the water molecules contained in the china heat up, not only causing the dish to get hot but also slowing down the reheating time.

5. Shape of base

If possible, always choose a dish that has rounded rather than sharp corners at the base to prevent over cooking.

Affects of the foods

1.Starting Temperature

The colder the food the longer it will take to heat to 72°C. Extra time must be allowed if food has been defrosted as the centre may still be icy.

2.Headspace

When heating liquids, ensure they do not completely fill their containers; a headspace allows the liquids to be stirred during and at the end of the heating time without spillage.

3.Covering foods

A container covered with either cling film, a plastic plate cover or even the lid to the dish, will heat fractionally faster than an uncovered dish. Do not cover foods which require a drier texture, such as pastries, as the steam that becomes trapped under the cover will cause the food to go soggy.

4.Crisp Foods

Reheat pastry and bread items, such as sausage rolls, pies and croissants, on a plastic rack to reduce the chance of “sogginess”. The rack allows the air to circulate beneath the food and remove steam which causes moist, limp pastry. Your Panasonic Combi offers a COMBINATION facility which will help crisp pastry items as they reheat.

5.Uneven shapes

When heating uneven shaped pieces of food, place the thick part of one piece against the thin part of the second. This helps the food to heat more evenly.

6.Porous Foods/Dense foods

Porous foods reheat more quickly than dense heavy foods.

7.Food with “Skins”

When reheating foods with a skin such as fish, chicken or baked beans, reduce the power to a lower setting to prevent the food from heating too quickly and “exploding”.

8.Heating two dishes together

It is possible to reheat two products with the same heating time together. For example, two Chicken Curries with a reheating time of 4 minutes each or one Taglatelle Carbonara and one moussaka, both of which have a heating time of 4 minutes each.

9.Doubling Quantities

A reheating time is based on weight and usually a time is given for a particular quantity of food, i.e. 11oz Lasagne takes 2 minutes. When the number of portions to be heated together doubles, then the reheating time will need to be increased by 75-100%. Two portions will take 4 minutes 30 seconds to 5 minutes. Generally two lighter textured products such as pastries will take the shorter time, whilst two denser products such as Lasagne will take the longer time.

10.Frozen Foods

For speed, some foods can be reheated from frozen but they must be foods that can be STIRRED eg meat sauce, Chilli con Carne. Set the total reheat time but open the door to stir regularly.

DO NOT COVER.

AVOID REHEATING solid foods that cannot be stirred, eg Lasagnes/Shepherds Pies from frozen. **Avoid reheating PLATED MEALS** from frozen.

Reheating by Microwave

Tips for Reheating your own Homemade Foods

Serving foods prepared in-house gives a homemade quality to the menu and allows for seasonality. However, for best results, follow the tips below if they are to be regenerated in your Panasonic Combi Oven.

1.Overcooking

Do not overcook vegetables - slightly undercook them, and they will finish cooking during the reheating time.

2.Sauces

Make any foods in sauces with lighter gravies rather than heavy, thick ones, as this helps the food heat evenly.

3.Plated Meals

To ensure even heating arrange the single component foods of a plated meal carefully. Place denser foods, such as whole vegetables and portions of meat or fish, to the outside of the plate, and smaller items, towards the centre. Do not pile foods up but keep them in a single layer; mashed potato should be spread out rather than mounded up. The food can look attractive but always give the Microwave a chance to heat evenly and thoroughly.

4.Vegetables

Dot vegetables with butter and pour gravy over the meat to prevent drying out and to help with even heating.

5.Rice

Arrange meat sauces served with rice, side by side rather than in the traditional circle of rice with the sauce in the centre. The sauce should be flattened slightly, whilst the rice is piled up.

6.Potato Topped Pies

Potato-topped pies and au gratin dishes, eg Cottage Pie, are difficult to reheat as the consistency of the potato will heat faster. Always ensure the filling is deeper than the potato.

7.Stirring

Stir any sauce- based foods before heating, particularly if they have been defrosted. This ensures any icy particles or cold areas are fully broken up and the food is of an even temperature.

8.Browning/Finishing Dishes

If you are preparing dishes in bulk for freezing or refrigeration, don't forget that because your Panasonic Combi is a microwave and conventional oven, you can choose to brown foods at the end of preparation but before storing, or store unbrowned and reheat on CONVECTION.

9.Heating two dishes together

If you wish to reheat more than one dish, place them side by side on the base of the cavity and NEVER use the Wire Rack Shelf for reheating on 2 levels.

10.Heating Times

It is impossible to give the heating time of an individual plated meal as each will contain a different variety of foods in differing quantities. Follow the arranging tips already mentioned and ensure the thickest piece of food has reached 72°C.

Tips for Reheating Commercially Prepared Foods

Always choose a supplier who offers an extensive and well made range of meals, which because prior research has gone into their products, heats efficiently in the microwave oven. The majority of distributors of prepared foods supply their dishes frozen. They recommend the dishes are defrosted prior to reheating. Always follow their instructions carefully.

1.Heating Times

On the following charts, we have listed for your convenience, many commercially prepared foods. Use the times suggested for particular foods as a guide only.

2.Containers

A time band is suggested to accommodate the use of different containers, for example, an earthenware pot will need the longer time to reheat because of its thickness, whilst a plastic or heat resistant glass will take slightly less time.

3.Power level

On some more solid dishes, such as Lasagne and Cottage Pie, it may be advisable to select a lower microwave power setting, rather than the maximum power setting, to obtain an acceptable meal. This will take longer to heat but produces an improved result to the waiting customer.

4.Defrosted Foods

It is always more beneficial to reheat a defrosted product rather than a frozen one. A defrosted dish will heat evenly, faster and without the fuss and bother that a frozen dish will cause. It is important to ensure that solid, ready-made meals are always defrosted prior to reheating. These meals cannot be stirred during the heating time and if heated from frozen they would begin to overcook around the edges whilst the centre area is still cold and may be even still slightly frozen.

5.Arranging Food

Remember to arrange food correctly, with the thicker parts to the outside and thinner parts to the centre.

6.Sealed Containers

If the food is contained in its own sealed container, pierce the top film with a fork to let out the excess steam. During heating, instead of stirring the food, lightly shake the container.

7.Pies - Pastry topped

Ensure the pastry is loosened from the sides of container with pastry topped meals. If the pastry has formed a seal with the container and is then heated quickly, the air trapped under the pastry expands very quickly causing the top to fly off.

8.Multiple vegetable portions

It is possible to heat vegetables with the same time per portion together.

9.Solid meals

With individual portions of solid meals, such as Lasagne and Macaroni Cheese, slightly indent the centre of the food with the back of a spoon. This will make the centre thinner and easier for the heat to penetrate.

10.Pre-browned Foods

Many commercially prepared cooked foods eg sausages may be prebrowned. They only require heating by MICROWAVE and do not require heating by COMBINATION.

Check manufacturers instructions for best result.

Suggested Reheating Times

Multi Portion Entrées

FOOD	WEIGHT	START TEMP	APPROX. TIME HIGH POWER
Hungarian Goulash	1.36kg	2°C	9 - 10 mins
	3lb	-18°C	18 - 19 mins
Hickory Chicken	1.36kg	2°C	9 ¹ / ₂ - 10 ¹ / ₂ mins
	3lb	-18°C	19 - 20 mins
Chicken Tikka Masala	1.36kg	2°C	9 ¹ / ₂ - 10 ¹ / ₂ mins
	3lb	-18°C	19 - 20 mins
Lamb Rogan Josh	1.36kg	2°C	8 - 9 mins
	3lb	-18°C	17 - 18 mins
Chilli Con Carne	1.47kg	2°C	8 ¹ / ₂ - 9 ¹ / ₂ mins
	3lb 4oz	-18°C	17 - 18 mins
Pork or Chicken Sweet and Sour	1.36kg	2°C	8 ¹ / ₂ - 9 ¹ / ₂ mins
	3lb	-18°C	17 - 18 mins
Spicy Sausage Casserole	1.76kg	2°C	11 - 12 mins
	3lb 14oz	-18°C	23 - 25 mins
Chicken Casserole	1.36kg	2°C	8 - 9 mins
	3lb	-18°C	16 - 17 mins
Irish Stew	1.36kg	2°C	9 - 10 mins
	3lb	-18°C	17 - 18 mins
Stew with Dumplings	1.81kg	2°C	10 ¹ / ₂ - 11 ¹ / ₂ mins
	4lb	-18°C	19 - 20 mins
Vienna Steaks with Gravy	1.42kg	2°C	11 - 12 mins
	3lb 2oz	-18°C	20 - 21 mins
Liver and Bacon	1.36kg	2°C	8 - 9 mins
	3lb	-18°C	17 - 18 mins
Chicken or Beef Curry	1.36kg	2°C	8 ¹ / ₂ - 9 ¹ / ₂ mins
	3lb	-18°C	16 - 17 mins
Mushroom Stroganoff	1.36kg	2°C	7 - 8 mins
	3lb	-18°C	15 - 16 mins
Vegetable/Quorn® Tikka masala/Curry	1.36kg	2°C	8 - 9 mins
	3lb	-18°C	16 - 17 mins
Vegetable Chilli	1.42kg	2°C	8 - 9 mins
	3lb 2oz	-18°C	16 ¹ / ₂ - 17 ¹ / ₂ mins

NOTES:

Heating times will vary with the quantity of food: more food requires a longer heating time.

Adjust the heating time as follows:

±100g (4oz) will usually be covered by the suggested time band

±225g (8oz) add or deduct 30secs

±450g (1lb) add or deduct 1 min.

Suggested Reheating Times

Multi Portion Entrées

FOOD	WEIGHT	START TEMP	APPROX. TIME HIGH POWER
Vegetarian Risotto	1.59kg	2°C	8 - 9 mins
	3lb 8oz	-18°C	17 - 18 mins
Sliced meats in Gravy	1.19kg	2°C	8 - 9 mins
	2lb 10oz	-18°C	17 - 18 mins
Cooked Pie Fillings	3.04kg 7lb 8oz	-18°C	35 - 40 mins
Cod in Butter Sauce	1.5kg	2°C	14 - 15 mins
	3lb 5oz	-18°C	23 - 24 mins
Faggots in Gravy	1.70kg	2°C	13 - 14 mins
	3lb 12oz	-18°C	22 - 23 mins
Chicken Spanish Style	1.19kg	2°C	8 - 9 mins
	2lb 10oz	-18°C	16 - 17 mins

Individual Entrées

FOOD	WEIGHT	START TEMP	QUANTITY	APPROX. TIME HIGH POWER
Ham and Basil Cappelletti	350g 12oz	2°C	1	2½ - 3 mins
			2	5 - 5½ mins
	-18°C	1	5 - 5½ mins	
Chicken Tikka Masala	250g 9oz	2°C	1	2½ - 3 mins
			2	4½ - 5 mins
	-18°C	1	5½ - 6 mins	
Green Thai Curry	300g 11oz	2°C	1	2½ - 3 mins
			2	4½ - 5 mins
	-18°C	1	5½ - 6 mins	
Vegetable Tikka Masala	300g 11oz	2°C	1	2 - 2½ mins
			2	4 - 4½ mins
	-18°C	1	4½ - 5 mins	
Tomato and Vegetable Tagliatelle	300g 11oz	2°C	1	2 - 2½ mins
			2	4 - 4½ mins
	-18°C	1	5 - 5½ mins	

NOTES:

REMEMBER: Wherever possible

1. Stir foods before, halfway through and at the end of a heating time.
2. Cover food.
3. Ensure the thickest piece of food or centre reaches 72°C.

Suggested Reheating Times

Individual Entrées

FOOD	WEIGHT	START TEMP	QUANTITY	APPROX. TIME HIGH POWER
Chilli con Carne	300g 11oz	2°C	1	3½ - 4 mins
			2	6 - 6½ mins
		-18°C	1	6 - 6½ mins
Chicken Curry with Rice	300g 11oz	2°C	1	3½ - 4 mins
			2	5½ - 6 mins
		-18°C	1	5½ - 6 mins
Irish Stew	300g 11oz	2°C	1	3½ - 4 mins
			2	5½ - 6 mins
		-18°C	1	6 - 6½ mins
Vegetable Curry	300g 11oz	2°C	1	2 - 2½ mins
			2	4 - 4½ mins
		-18°C	1	4½ - 5 mins
Vegetable Mexicana	290g 10½oz	2°C	1	4 - 4½ mins
			2	6 - 6½ mins
		-18°C	—	DEFROST FIRST
Spaghetti Bolognese	300g 11oz	2°C	1	3½ - 4 mins
			2	5½ - 6 mins
		-18°C	1	6 - 6½ mins
Lasagne	300g 11oz	2°C	1	3½ - 4 mins
			2	5½ - 6 mins
		-18°C	—	DEFROST FIRST
Smoked Haddock Pasta with Prawns & Mushrooms	290g 10½oz	2°C	1	4 - 4½ mins
			2	6 - 6½ mins
		-18°C	1	6 - 6½ mins
Tuna Pasta Bake	300g 11oz	2°C	1	3 - 3½ mins
			2	4½ - 5 mins
		-18°C	—	DEFROST FIRST
Tagliatelle Carbonara	300g 11oz	2°C	1	4 - 4½ mins
			2	6 - 6½ mins
		-18°C	1	5½ - 6 mins
Cottage Pie	340g 11¾oz	2°C	1	3½ - 4 mins
			2	5½ - 6 mins
		-18°C	—	DEFROST FIRST
Moussaka	295g 10¾oz	2°C	1	4 - 4½ mins
			2	6 - 6½ mins
		-18°C	—	DEFROST FIRST

NOTES:

REMEMBER: Wherever possible

1. Stir foods before, halfway through and at the end of a heating time.
2. Cover food.
3. Ensure the thickest piece of food or centre reaches 72°C.

Suggested Reheating Times

Individual Entrées

FOOD	WEIGHT	START TEMP	QUANTITY	APPROX. TIME HIGH POWER
Mushroom & Nut Fettucine	280g 10 ¹ / ₄ oz	2°C	1	3 ¹ / ₂ - 4 mins
			2	5 ¹ / ₂ - 6 mins
	-18°C	1	5 ¹ / ₂ - 6 mins	
Macaroni Cheese	300g 11oz	2°C	1	3 ¹ / ₂ - 4 mins
			2	5 ¹ / ₂ - 6 mins
	-18°C	—	DEFROST FIRST	
Cauliflower Cheese	300g 11oz	2°C	1	4 - 4 ¹ / ₂ mins
			2	6 - 6 ¹ / ₂ mins
	-18°C	—	DEFROST FIRST	
Vegetable Chilli	290g 10 ¹ / ₂ oz	2°C	1	2 ³ / ₄ - 3 mins
			2	4 - 4 ¹ / ₂ mins
	-18°C	1	6 - 6 ¹ / ₂ mins	
Vegetable Strogonoff	290g 10 ¹ / ₂ oz	2°C	1	3 ¹ / ₂ - 4 mins
			2	5 - 5 ¹ / ₂ mins
	-18°C	1	6 - 6 ¹ / ₂ mins	
Lentil Crumble	300g 11oz	2°C	1	3 - 3 ¹ / ₂ mins
			2	4 ¹ / ₂ - 5 mins
	-18°C	—	DEFROST FIRST	
Pie Fillings	250g 9oz	2°C	1	3 ¹ / ₂ - 4 mins
			2	5 - 5 ¹ / ₂ mins
	-18°C	1	5 ¹ / ₂ - 6 mins	

NOTES:

REMEMBER: Wherever possible

1. Stir foods before, halfway through and at the end of a heating time.
2. Cover food.
3. Ensure the thickest piece of food or centre reaches 72°C.

Suggested Reheating Times

Snack/Bar Foods

FOOD	WEIGHT	START TEMP	QUANTITY	APPROX. TIME HIGH POWER
Cooked Bacon Slices	8g / 1/4oz	-18°C	20	2 1/2 mins
Barbecue Half Rack Ribs	200-250g / 7-9oz	-18°C	1	3 1/2 - 4 1/2 mins
Chicken Tikka	175g / 6oz	-18°C	—	2 - 2 1/2 mins
Wings of Fire	100g / 4oz	-18°C	—	1 1/2 mins
Cooked Chicken Drumsticks	50-75g / 2-3oz	-18°C	1	1 min 45 secs - 2 mins
Cooked half Chicken	275g / 10oz	-18°C	1	6 1/2 - 7mins
Cooked Quarter Chicken	150-200g / 5-7oz	-18°C	1	3 1/2 - 4 mins
Cooked Suprême of Chicken	160g / 5 1/4oz	-18°C	1	3 1/2 mins
Cooked Breast of Chicken	250-300g / 9-11oz	-18°C	1	7 - 7 1/2 mins
Cooked Diced Chicken Meat	450g / 1lb	-18°C	—	4 1/2 mins
Cooked Chicken/Pork Sate	35g / 1 1/2oz	-18°C	3	1 min
Omelettes	100g / 4oz	-18°C	1	2 mins 20 secs
Baked Yorkshire Pudding	80g / 3 1/2oz	-18°C	1	50 secs
Peanut sauce	10oz / 275g	-18°C	1	5 mins
Pizza	180mm / 7inch	-18°C	1	2 mins
Quiche Slices	100g / 4oz	-18°C	1	45 secs
Baked Sausage Rolls	150g / 5oz	-18°C	1	1 min 50 secs
Baked Pies/Pasties	175g / 6oz	-18°C	1	3 mins
Naan Bread	150g / 5oz	-18°C	1	1 min
Burger buns & rolls	50g / 2oz	-18°C	1	20 secs
Rice Portions	175g / 6oz	-18°C	1bag	1 min 50 secs
Salad Mixes	100g / 4oz	-18°C	—	1 min 50 secs
Rice Salad Mixes	100g / 4oz	-18°C	—	1 min 40 secs
Baked Beans	175g / 6oz	Ambient	—	1 min 20 secs

À La Carte

FOOD	WEIGHT	START TEMP	QUANTITY	APPROX. TIME HIGH POWER
Filled Pasta in Sauce	280g / 10 1/4oz	-18°C	1	6 mins
Duckling à la Orange	275g / 10oz	-18°C	1	*6 - 6 1/2 mins
Chicken Breast with Leek and Stilton	250g / 9oz	-18°C	1	*7 - 7 1/2 mins
Vension in red Wine	290g / 10 1/2oz	-18°C	1	5 mins
Salmon in Asparagus Sauce	200g / 7oz	-18°C	1	*5 - 6 mins

*USE MEDIUM POWER

NOTES:

REMEMBER: Wherever possible

1. Stir foods before, halfway through and at the end of a heating time.
2. Cover food.
3. Ensure the thickest piece of food or centre reaches 72°C.

Suggested Reheating Times

Cooked Vegetables

FOOD	WEIGHT	START TEMP	QUANTITY	APPROX. TIME HIGH POWER
Baked Jacket Potatoes	250g / 9oz	2°C	1	2 mins
		-18°C	1	4 mins
Baked Potato Shells	75g / 3oz	-18°C	2	1 min 30secs
Beans	100g / 4oz	2°C	—	1 min
Brussel Sprouts	100g / 4oz	2°C	—	1 min
Cauliflower Florets	100g / 4oz	2°C	—	1 min
Broccoli	100g / 4oz	2°C	—	50 secs
Baby Carrots	100g / 4oz	2°C	—	1 min
Courgettes	100g / 4oz	2°C	—	1 min
New Potatoes	175g / 6oz	2°C	—	1 min 50 secs
Vegetable Selections	100g / 4oz	2°C	—	50 secs
Potato Mash	175g / 6oz	-18°C	—	3 mins

Sweets/Puddings

FOOD	WEIGHT	START TEMP	QUANTITY	APPROX. TIME HIGH POWER
Crepes	20g / ³ / ₄ oz	2°C	2	30 secs
Scones	55g / 2 ¹ / ₄ oz	2°C	1	15 secs
		-18°C	1	20 secs
Teacakes	75g / 3oz	-18°C	1	20 secs
Doughnuts	50g / 2oz	2°C	1	10 secs
Mini Patisserie	12g / ¹ / ₂ oz	-18°C	1	15 secs
Danish Pastries	75g / 3oz	-18°C	1	25 secs
Pre-cut Fruit Flans	100g / 4oz	2°C	1 slice	40 secs
		-18°C	1 slice	1 min
Microwave Puddings	175g / 6oz	-18°C	1	1 min 30 secs
Traditional Pudding	100g / 4oz	-18°C	1 slice	45 secs
Custard Sticks	50g / 2oz	-18°C	3	1 min

NOTES:

REMEMBER: Wherever possible

1. Stir foods before, halfway through and at the end of a heating time.
2. Cover food.
3. Ensure the thickest piece of food or centre reaches 72°C.

Defrosting by Microwave

The ability to defrost foods quickly is another excellent benefit of your Panasonic Combi. The quality of the defrosted food will depend a great deal on the care the food receives in freezing and defrosting, so always ensure that the best food is frozen and that it is packaged correctly.

Ensure the freezer is running at the correct temperature (-18°C or below) and that it is not overloaded with food or ice. Always label and date foods so that they can be used in strict rotation.

Always defrost using the Defrost power setting. NEVER try hurry the defrosting by selecting a higher power level as this will only over-defrost the food, causing it to become tough and inedible leading to waste.

Follow these tips for best results:

1. Meat

Place meats on a rack, trivet or upturned saucer in a shallow dish. This enables the water to drain from the food and defrost correctly; if the food sits in the liquid it is likely to begin to cook and a poached effect is created.

2. Foods in Foil

Transfer foods packaged in aluminium foil containers into suitable microwaveable dishes before defrosting.

3. Arranging

Arrange the food evenly and in a shallow layer on the rack or plate. Do not pile foods up as this will prevent the food at the bottom from defrosting in the same time as the food on the top.

4. Uneven Shapes

Always arrange thick areas of the food to the outside of the dish, and thinner areas to the centre. This is particularly important for chops and chicken portions. Where possible, arrange two uneven shaped pieces of food in a dish with the thick area of one piece to the thin area of the other, to ensure even defrosting.

5. Shielding

Check food to ensure it does not over-defrost. Remove any defrosted food, if possible, and turn and shield thinner areas of food. It will be necessary to shield the breast, ends of the legs and wings on a chicken, and the head and tail of a whole fish. Separate items such as chops, sausages and steaks and rearrange in a single layer as soon as possible. To shield, cover defrosted, and thinner, or fatty areas of food, with small pieces of aluminium foil. This will reflect the microwave energy away from that area to prevent it from over defrosting and beginning to cook.

Check foods at least twice during the defrosting time and shield, as necessary, ensuring the foil is still securely in place.

N.B. Ensure the foil does not touch the side or roof of the cavity or "arcing" may occur. If this does happen, stop the microwave and rearrange the foods.

6. Cooling

For best results DEFROST foods in a cool oven. (See page 27.)

7. Standing Time

Food should still feel icy at the end of the defrosting time; this will disappear during the standing time. Do NOT be tempted to put food back to continue to defrost in the microwave as this will lead to over defrosting. Allow small items of food to stand for 15 minutes before cooking; larger pieces of food will need longer. Cover foods during the standing time, to prevent contamination by airborne bacteria.

8. Container Shape

Foods in square shaped containers need careful attention during defrosting to prevent corners from beginning to cook. It may be necessary to stop larger portions of food during the defrosting time to shield the corners with aluminium foil. After defrosting, always remember to transfer the food into more suitable, round containers before reheating in the microwave.

9. Stirring

Foods that can be stirred, such as curries, casseroles and meat sauces, should, as the defrosting time progresses, be broken up and stirred. Stir the food before, and after, the standing time as this helps to break up the ice particles and speed up defrosting.

10. Solid foods

Foods that can not be stirred, eg lasagne, Cottage Pie and pastry-topped dishes, benefit from standing for a period of time in the middle of defrosting. This enables the product to defrost through to the centre without the edges becoming excessively hot, use the Multi-stage programme facility.

See page 9.

11. Foods not listed in Defrost Charts

To defrost food not mentioned in the charts, select the Defrost power setting and as a rough GUIDE, allow 20-30 seconds per 1oz/25g of food. When using this method do not leave the food unattended as it defrosts, but check frequently.

NOTE:

Calculate the defrosting time accurately and follow any specific instructions.

Useful Defrosting Times

FOOD	WEIGHT	INSTRUCTIONS	APPROX. TIME PER 450g/1lb 2oz	STAND TIME
Prawns	450g 1lb 2oz	Stir halfway through defrosting time	6 mins	5 mins. Wash under cold water
Fish fillets	450g 1lb 2oz	Rearrange halfway through defrosting time	8 mins	10 mins. Wash under cold water
Whole fish	350g 12oz	Shield head and tail after half time	10 mins	10 mins. Wash under cold water
Lamb Joints	450g 1lb 2oz	Place on rack. After half time stand for 15 mins, shield and continue.	12 mins	45 - 60 mins
Pork Joints	450g 1lb 2oz	As Lamb joints	9 mins	45 - 60 mins
Beef Joints	450g 1lb 2oz	As Lamb joints	9 mins	45 - 60 mins
Steaks	450g 1lb 2oz	Turn and separate	10 mins	10 mins
Minced/Cubed Meats	450g 1lb 2oz	Break up and remove any defrosted meat halfway through time	6 - 8 mins	10 mins
Chicken	450g 1lb 2oz	Place on rack. After half time, shield, turn and remove giblets.	13 mins	30 mins. Wash well
Chicken Portions	450g 1lb 2oz	Place on rack and arrange correctly	9 mins	10 mins
Turkey	450g 1lb 2oz	Place on rack, after half time. Stand for 15 mins, shield and continue.	12 mins	45 -60 mins
Chops	450g 1lb 2oz	As Chicken Portions.	5 mins	10 mins
Gammon	450g 1lb 2oz	Separate rashers during defrosting time	8 mins	10 mins
Bacon	450g 1lb 2oz	As Gammon Remove any defrosted rashers	9 mins	10 mins

NOTES:

Check food regularly during defrosting to ensure over-defrosting does not occur.

Useful Defrosting Time

FOOD	WEIGHT	INSTRUCTIONS	APPROX. TIME PER 450g/1lb 2oz	STAND TIME
Sausages	450g/ 1lb 2oz	Separate and rearrange after half time.	6 mins	10 mins
Multi portion Entrées-Stirrabable	1.36kg/3lb	Place in suitable dish. Stir well halfway through.	20 mins	20-30 mins Stir well
Multi portion Entrées-Non-Stirrabable	1.36kg/3lb	Place in suitable dish, Shield corners as necessary.	30 mins	20-30 mins
Individual Entrées-Stirrabable	300g/11oz	Place in suitable dish, Stir well halfway through.	8 mins	5-10 mins Stir well
Individual Entrées-Non-Stirrabable	300g/11oz	Place in suitable dish, Stand for 5 mins during defrosting.	12 mins	5-10 mins
Chocolate Mousse Gateau	20cm/8"	Remove all packaging and place on plate.	3 mins	10 mins
Fruit	450g/1lb 2oz	Place in shallow dish. Stir carefully after half time.	6 mins	10 mins
Baked Fruit	1.22kg/ 2lb 11oz	Leave in foil container	9 mins	15 mins
Passion Cake (Pre-Cut)	24cm/9"	Remove all packaging and place on plate.	5 mins	10 mins
Black Forest Gateau	24cm/9"	Remove all packaging and place on plate.	4 mins	10 mins
Banoffi Pie (Pre-Cut)	26cm/10"	Remove all packaging and place on plate.	6 mins	10 mins
Toffee Apple & Pecan Pie	26cm/10"	Remove all packaging and place on plate.	11 mins	10-20 mins

NOTES:

Check food regularly during defrosting to ensure over defrosting does not occur.

Commercial ovens are primarily used for reheating and defrosting. It is possible however to cook certain foods eg. fish and vegetables very successfully by microwave. These foods should be limited to small quantities as larger amounts will not offer any time saving.

Fish

1. Arranging

When cooking fillets or whole fish, always arrange the thicker part to the outside of the container and, wherever possible, make even-shaped parcels of fish. Cook two whole fish together, placed head to tail with backbone towards the outside of the dish.

2. Shielding

Single whole fish will need to have the head and tail ends shielded with aluminium foil halfway through the cooking time.
(See page 42)

3. Whole fish

Score the sides of whole fish prior to cooking; this prevents the skin from bursting and splattering the oven cavity. A better result is obtained if whole fish are cooked on a LOWER power setting rather than HIGH power.

4. Fish fillets

Fish fillets should be rolled so that the head and tail of the fillet overlap forming a fish parcel. Any number of fillets can be cooked together, on HIGH power, in this way. Arranging food in this manner means that it cooks evenly and without the need to shield with aluminium foil.

Vegetables

1. Adding salt

Vegetables cooked by microwave, retain their colour and texture. The short cooking times and small quantity of cooking liquid required ensures the vegetables do not lose their nutritive value. Do not add salt to the vegetables.

2. Cooking vegetables together

It is possible to cook a selection of vegetables together in the same dish if they have roughly the same cooking time per pound. Do not, for example, cook new potatoes alongside frozen peas, as the peas will be cooked and the potatoes almost raw.

3. Adding water

A small amount of water is required to generate sufficient steam to begin to cook the vegetables; the microwave energy will then complete the cooking within the vegetables themselves. If too much liquid is added this will increase the cooking time considerably.

4. Container size

Choose the size of the dish to match the quantity of vegetables to be cooked. A large, covered bowl with only a handful of food in the base does not cook very well.

5. Arranging

Always arrange the denser parts of the vegetables to the outside of the dish. With vegetables such as broccoli the denser part is the stalk.

6. Part-cooking

If the vegetables are going to be pre-cooked for plating up, refrigerating and regenerating at a later date, reduce the cooking time by about a third; during the reheating time the vegetables will complete their cooking, retaining their "bite".

7. Standing time

It is important to allow vegetables to stand before testing to see if they are correctly cooked. This prevents the vegetables over cooking and becoming tough.

Useful Cooking Times

Fresh Vegetables (Per 450g / 1lb 2oz)

FOOD	INSTRUCTIONS	APPROX. TIME HIGH POWER	STAND TIME
Beans	Trim ends. Slice thinly. Add 4tbsp/60ml water. Cover.	5 - 5 ¹ / ₂ mins	5 mins
Broccoli	Trim stems, cut cross in base. Arrange stem to outside. Add 4tbsp/60ml water. Cover.	5 - 5 ¹ / ₂ mins	5 mins
Cabbage	Shread, remove thick parts of stem. Add 12tbsp/180ml water. Cover.	7 mins	5 mins
Carrots	Slice evenly. Add 4tbsp/60ml water. Cover.	4 - 4 ¹ / ₂ mins	5 mins
Cauliflower	Divide into florets. Add 4tbsp/60ml water. Cover.	7 mins	5 mins
Courgettes	Slice evenly. Add 2tbsp/30ml water. Cover.	4 - 4 ¹ / ₂ mins	5 mins
Potatoes	Cut evenly. Add 4tbsp/60ml water. Cover.	7 - 7 ¹ / ₂ mins	5 mins
Vegetable Selection	Cut evenly. Add 4tbsp/60ml water. Cover.	6 mins	5 mins

Frozen Vegetables (Per 450g / 1lb 2oz)

FOOD	INSTRUCTIONS	APPROX. TIME HIGH POWER	STAND TIME
Beans	Add 2tbsp/30ml water, cover.	7 mins	5 mins
Broccoli	Add 4tbsp/60ml water, cover.	6 mins	5 mins
Brussel Sprouts	Add 4tbsp/60ml water, cover.	7 mins	5 mins
Cauliflower	Add 4tbsp/60ml water, cover.	7 mins	5 mins
Baby Carrots	Add 2tbsp/30ml water, cover.	7 mins	5 mins
Courgettes	No water.Cover.	5 ¹ / ₂ mins	5 mins
Corn	Add 2tbsp/30ml water, cover.	5 ¹ / ₂ mins	5 mins
Vegetable Selection	Add 2tbsp/30ml water, cover.	5 ¹ / ₂ mins	5 mins
Peas	Add 2tbsp/30ml water, cover.	5 ¹ / ₂ mins	5 mins

Useful Cooking Times

Frozen Fish (Per 450g / 1lb 2oz)

FOOD	INSTRUCTIONS	APPROX. TIME HIGH POWER	STAND TIME
Whole fish	Shield as required during cooking time. Cover.	5 mins	5 mins
Fish fillets/steaks	Arrange correctly. Cover.	4 mins	5 mins

Using the Convection Function

Type of Container to use

DO USE: Any container suitable for conventional ovens eg metal, ceramic, earthenware, enamelled cast iron etc.
DO NOT USE: Plastic containers, food films, wood/wicker, glass, paper.

Suitable Foods

Convection is suitable to bake cakes, bread, biscuits or pastries.

Reducing cooking temperature

The fan forces hot air over the food thus heating food very efficiently. To avoid over-cooking and drying of the surface it is recommended that normal cooking temperatures are reduced by 10-20°C. Cooking times by convection are also usually shorter compared to conventional ovens.

Two level cooking

Do not attempt to use the Wire Rack Shelf to cook on two levels.

Positioning food

Convection ovens rely on good circulation of air. For best results ensure food/containers are placed in the centre of the Wire Rack Shelf and avoid the container touching back wall or covering venting holes. To allow good circulation of hot air, the maximum sized dish used should be no greater than

Width: 12ins (30cms)
Depth: 4ins (10cms)
Diameter: 11ins (28cms)

Preheating

For best results, always place food into a preheated oven.
See page 26.

Hot surfaces

Take care when removing dishes from the oven after cooking as the Wire Rack and surfaces will be hot.

All foods should be placed on the Lower Shelf Position

Using the Convection Function

Suggested Cooking times

Below are suggested cooking times for popular foods however the time required will depend on shape/size of dishes as well as method of preparation.

FOOD	QUANTITY WEIGHT	DISH	OVEN TEMP	COOKING TIME
CAKES / BISCUITS				
Rich Fruit	36 slice	28cm square tin	160°C +140°C	1½ - 2 hrs
Genoise	12 portion	28cm round tin	180°C	40 mins
Victoria Sponge	12 portion	28 x 23cm oblong tin	180°C	25 mins
Whisked Sponge	10 portion	20 x 30cm oblong tin	190°C	10 mins
Fruit Scones	12	Baking sheet	200°C	13 mins
Cookies	12	Baking sheet	170°C	13 mins
PASTRY / BREADS				
Choux Buns	12	Baking sheet	200°C	20 - 30 mins
Vol au Vents	12	Baking sheet	220°C	12 mins
Sausage Rolls (frozen)	12	Baking sheet	220°C	30 mins
Puff Pastry ovals	3 x (15 x 10cm)	Baking sheet	220°C	15 mins
Petit Pain	8 x 40g	Baking sheet	200°C	15 mins
PUDDINGS				
Bread Pudding	12 portion	20 x 30cm	180°C	50 mins
Bakewell Tart	12 portion	20 x 30cm	180°C	35 mins
Misc.				
Yorkshire Puddings	12	Bun tin	220°C	20 mins

Using the Grill Convection Function

Type of Container to use

DO USE: Any container suitable for conventional ovens eg metal, ceramic, earthenware, enamelled cast iron etc.
DO NOT USE: Plastic containers, food films, wood/wicker, glass, paper.

Suitable Foods

Grill Convection is particularly suitable for roasting meat, poultry and vegetables.

Reducing cooking temperature

The fan forces hot air over the food thus heating food very efficiently. To avoid over-cooking and drying of the surface it is recommended that normal cooking temperatures are reduced by 10-20°C. Cooking times by Grill Convection are also usually shorter compared to conventional ovens.

Two level cooking

Do not attempt to use the Wire Rack Shelf to cook on Two levels.

Positioning food

Convection ovens rely on good circulation of air. For best results ensure food/containers are placed in the centre of the Wire Rack Shelf and avoid container touching the back wall or covering venting holes.

To allow good circulation of hot air, the maximum sized dish used should be no greater than

Width: 12ins (30cms)

Depth: 4ins (10cms)

Diameter: 11ins (28cms)

Preheating

For best results, always place food into a preheated oven.
(See page 26.)

Hot surfaces

Take care when removing dishes from the oven after cooking as Wire Rack and surfaces will be hot.

All foods should be placed on the Lower Shelf Position

Using the Grill Convection Function

Suggested Cooking times

Below are suggested cooking times for popular foods however the time required will depend on shape/size of dishes as well as method of preparation.

FOOD	QUANTITY WEIGHT	DISH	GRILL* CONVECTION TEMPERATURE	COOKING TIME
Chicken	2.5kg 5 1/4 lb	Ceramic Tray	Grill + 180°C	15 mins per 450g / 1lb + 15 mins
Chicken leg portions	900g 2lb	Ceramic Tray	Grill + 190°C	25 mins
Duck	2.7kg 6lb	Roasting tin	Grill + 190°C	15 mins per 450g / 1lb + 20 mins
Pork	2.2kg 5lb	Ceramic Tray	Grill + 180°C	30mins per 450g / 1lb + 30 mins
Beef	1.6kg 3 1/2 lb	Ceramic Tray	Grill + 190°C	Rare 20 mins Medium 25 mins Well-done 30 mins per 450g / 1lb
Lamb	2 x 1.4kg 3lb	Roasting tin	Grill + 180°C	20 mins per 450g / 1lb + 20 mins
Mixed Mediterranean vegetables	450g 1lb	Oven-proof dish	Grill + 220°C	25 mins

* Grill level will be set automatically when a Convection temperature is selected.

Note: All timings based on a preheat temperature of 220°C.

Using the Grill Function

Type of container to use

DO USE: Any container suitable for fierce grilling eg stainless steel, Le Creuset, Ceramics, Baking Sheets etc.
DO NOT USE: Plastic containers, fine ceramics, cling film etc.

Suitable Foods

Grill is particularly suitable for steaks, burgers, fish & bacon.

Caution: Turning food

Take great care when turning food - Wire Rack Shelf and oven walls will be extremely hot.
Take care as there is NO NON-TIP LOCK mechanism on Wire Rack Shelf.

Door closed

The grill will only operate when the door is closed.

Smoke

It is essential that the walls and particularly the roof of the oven are kept free of grease to avoid excessive smoking when the grill function is operated.

Preheating

For best results, always place food into a preheated oven.
See page 26.

Hot Surfaces

Take care when removing dishes from the oven after cooking as the Wire Rack and surfaces will be hot.

All foods should be placed on the Upper Shelf Position

Turning

Most foods benefit from turning halfway during cooking.

Draining

Don't forget to drain juices from foods halfway during cooking to prevent excessive smoke and splatter.

Using the Grill Function

Suggested Cooking times

Below are suggested cooking times for popular grilled foods. The time required will depend on the start temperature, depth and shape of food. Most foods benefit from turning halfway during cooking.

FOOD	QUANTITY WEIGHT	GRILL SETTING	COOKING TIME
FISH			
Whole Trout	2 / 400g each	Low	12 mins
Salmon Steaks	6 / 175g each	Low	12 mins
MEAT			
Burgers-fresh	4 / 100g 4oz	High	8 mins
Gammon steaks	2 / 250g 8oz	High	10 mins
Rump steak-medium	1.4kg 3lb	High	10 mins
Sirloin steak-medium	900g 2lb	High	6 mins
Bacon	12 rashers	High	6 mins
MISC			
Tomatoes	450g 1lb	High	10 mins
Mushrooms	450g 1lb	High	6 mins
Brulee- finishing	8 ramekins	High	6 mins

Note: All timings based on preheat temperature of 220°C.

Using the Fan Grill Function

Type of container to use

DO USE: Any container suitable for fierce grilling eg stainless steel, Le Creuset, Ceramics, Baking Sheets etc.
DO NOT USE: Plastic containers, fine ceramics, cling film etc.

Suitable Foods

Fan Grill is particularly suitable for cooking pizzas, chops & sausages.

Door closed

The Fan Grill will only operate when the door is closed.

Smoke

It is essential that the walls and particularly the roof of the oven are kept free of grease to avoid excessive smoking when the Fan Grill function is operated.

Preheating

For best results, always place food into a preheated oven.
(See page 26.)

Hot Surfaces

Take care when removing dishes from the oven after cooking as the Wire Rack and surfaces will be hot.

Shelf position

All foods should be placed on the lower shelf position.

Turning

Some foods, eg sausages will require turning halfway through cooking.

Draining

Don't forget to drain juices from foods halfway during cooking to prevent excessive smoke and splatter.

Suggested Cooking times

Below are suggested cooking times for popular foods. The time required will depend on the start temperature, depth and shape of food.

FOOD	QUANTITY WEIGHT	FAN GRILL TEMP	COOKING TIME
Oven chips - frozen	900g/2lb	220°C	15mins
Pizza - frozen	400g/20cm	210°C	10mins
Garlic bread slices - frozen	6/160g	220°C	5mins
Lamp chops	8/760g	220°C	15mins
Pork chops	4/760g	220°C	20mins
Sausages - chilled	8/450g	230°C	14mins

Note : All timings based on a preheat temperature of 220°C

Using the Combination Function

Type of container to use

Combination programmes use microwaves and heat (CONVECTION or GRILL CONVECTION or GRILL or FAN GRILL) therefore you must choose the container carefully.

DO USE: Metal containers check they do not have jagged metal seams. Ceramics that do not have a metal pattern. Heat proof glass and china.

DO NOT USE:

Enamelled items (that may be chipped). Dishes with gold/metal pattern. Enamelled cast iron eg. Le Creuset. Any dish that's not heatproof eg plastics, and cling film.

Accessories to use

The Wire Rack Shelf may be placed in either shelf position depending on the type of COMBINATION programme in use. ie UPPER position for a GRILL COMBINATION or FAN GRILL COMBINATION and LOWER position for CONVECTION/GRILL CONVECTION COMBINATION. The Ceramic Insulating Tray must be used when food is placed in a metal container. NEVER place a metal container onto the Wire Rack Shelf if cooking by Combination as arcing may occur and damage the dish/oven.

Metal Containers

Avoid using large or deep sided metal containers. This will restrict the effectiveness of Microwaves and lengthen the heating time. Use heat-proof ceramic containers for best results on Combination.

Draining Fat

When cooking meat joints and other fatty items, drain fat to avoid excessive splatter and smoke.

Preheating

For best results, place food in a preheated oven.

(See page 26.)

Two level Cooking

DO NOT attempt to use the Wire Rack Shelf to cook on two levels.

Standing Time

As a COMBINATION setting uses Microwave energy to cook the food, it is important to allow a standing time for the food to finish cooking.

(See page 30.)

As a rough guide recipes cooking fish, vegetables, and small parts will require 5-10 minutes standing time and joints and whole poultry will require 15-20 minutes standing time.

NOTES:

1. If arcing occurs !

Stop oven immediately and continue to cook by Convection / Grill Convection / Fan Grill only and transfer food to a suitable container.

2. Check the food is cooked thoroughly at the end of the standing time.

Guidelines for using the 5 Preset Combination Settings

PRESS	DISPLAY	SUITABLE FOODS
Once	1	Reheating chilled pastry, chilled entrees, baking pies & en croute dishes, jacket potatoes.
Twice	2	Reheating frozen pastry, oven chips & snacks. Cooking fish.
3 Times	3	Reheating frozen pizzas, breads & patisserie. Cooking steaks & chops.
4 Times	4	Cooking frozen en croute dishes, roasting vegetables, cooking sausages.
5 Times	5	Cooking bacon, burgers, frozen fish, & reheating pre-cooked meats.

Reheating by Combination

Tips for Reheating your own Homemade Foods

1. Containers

If you are preparing recipes for freezing to regenerate on Combination, choose containers that are microwave safe as well as heat-proof and suitable for freezing.

To make good use of the microwave energy the containers should not be too deep.

When preparing multi-portion recipes, select a container that is not too large for cavity of the oven as this may restrict circulation of the hot air.

2. Reheating two dishes together

Ensure that you serve your recipes in identical dishes if reheating more than one dish at a time, so they reheat at the same speed.
NEVER use the Wire Rack Shelf for reheating on two levels.

3. Memory Programmes

Consistency in preparation and careful choice of serving dish will mean you can use the Memory Programmes to reheat a regularly requested item. Some experimentation may be needed at first to select the correct setting however as long as you do not vary from the standard set, you can be confident of the Memory Programme chosen. Don't forget to probe dishes to check that they are 72°C in the centre, or thickest part, before serving.

4. Increasing Quantities

When increasing quantities, choose an adequately larger container. If reheating on GRILL COMBINATION, a larger quantity may need to be reheated using a Multi-stage (sequential) programme ie MICROWAVE only then GRILL COMBINATION as the food does not overbrown before it is thoroughly heated through.

Reheating by Combination

Tips for Reheating Commercially Prepared Foods

Many Commercially prepared foods are ideal for reheating on COMBINATION - offering the advantage of large time saving as only a fraction of the conventional heating time is required. It also means that many foods will have a "freshly cooked" appearance due to the crisping and browning that takes place -more appetising for many recipes than MICROWAVE only.

1.Using Supplier's Instructions

Check the pack instructions carefully as these will be a good indication of how to choose your combination programme.

2.Choosing the Programme

Refer to the following charts and find a similar food to select an appropriate programme. Many commercially frozen foods are partially cooked eg quiche, may have a part-cooked pastry base with an uncooked filling, or an en croute may be fully cooked in the centre even if the pastry is raw. CHECK CAREFULLY whether the food is already cooked and requires reheating only or whether it contains uncooked components and must be thoroughly cooked before serving. Generally, a food that requires cooking will be more successful on a lower Temperature/Microwave power and longer heating time. Foods that require reheating only are heated for a shorter time and may benefit from higher temperatures.

3.Checking Temperature

Always ensure that the food has reached a temperature of at least 72°C if it is being reheated.If the food requires cooking, then check it has reached the appropriate temperature.

4.Variations in weight

If the foods to be reheated vary in weight from those shown in the charts over, reduce/increase the times appropriately.

If the products are reheated by a Multi-stage (sequential) programme, reduce/increase the MICROWAVE only times first but leave the browning GRILL times the same.

If cooking/reheating products from frozen by a Multi-stage(sequential) programme double the microwave time given for reheating from "fridge" temperature and add a further 50-75% extra to the browning GRILL time.

If cooking/reheating products from frozen by a straight COMBINATION CONVECTION setting, add approximately 50% extra time to the time required from "fridge" temperature.

5.Containers

If a particularly solid food or dish that cannot be stirred eg Lasagne, is contained in foil, transfer to a suitable non-metallic dish whilst frozen.

6.Pre-browned foods

Many commercially prepared cooked foods eg. sausages may be pre-browned. These are often better reheated by MICROWAVE only rather than COMBINATION. Foods that are pre-browned, but require further crisping, should be reheated on COMBINATION CONVECTION / GRILL CONVECTION / FAN GRILL.

7.Arranging

It is essential that individual items are arranged evenly for thorough reheating by MICROWAVE and browning by GRILL/CONVECTION/FAN GRILL /GRILL CONVECTION.

NOTES:

DO NOT attempt to reheat any food that is suitable only for DEEP FAT FRYING.
DO NOT ATTEMPT TO FRY IN OVEN.

Always reheat foods in a preheated oven.

Cooking Fish on Combination

1. Arranging

When cooking fillets or whole fish, always arrange the thicker part to the outside of the container. Two fish cooked together should be placed head to tail, with the backbone towards the outside to the dish. Fish steaks should be arranged with the thinner tall end towards the centre. DO NOT PILE fish up - for best results cook in a single layer.

2. Adding fat / oil / seasoning

To help keep the fish moist, brush with oil or dot with butter before cooking. DO NOT season with salt.

3. Covering

DO NOT COVER fish when cooking by COMBINATION.

4. Shelf position

For GRILL COMBINATION which is suitable for small whole fish, steaks, fillets, use UPPER shelf position. For CONVECTION COMBINATION which is suitable for larger whole fish, use LOWER shelf position.

5. Accessories / Containers

DO NOT use metal containers for cooking by COMBINATION - microwave-safe glass or ceramics are ideal. If the fish is placed on the Ceramic Insulating Tray, ensure it is thoroughly cleaned beforehand.

Cooking Meat on Combination

Tips for cooking joints of meat on Combination

1. Turning / Basting / Draining

For best results, joints of meat should be turned halfway through cooking and basted. Drain away any excess meat juices and fat.

2. Shielding

Unevenly shaped joints will benefit from shielding with smooth pieces of aluminium foil. However, ensure the foil is not in contact with Wire Rack Shelf, walls, roof or door of the oven. Shield thin ends of legs of lamb and corners of rolled joints.

3. Covering

DO NOT cover meat joints when cooking by Combination.

4. Accessories / Containers

If the joints are placed on the Ceramic Insulating Tray, ensure it is thoroughly cleaned before use.

5. Shelf position

Use the LOWER shelf position.

6. Calculating the Cooking Time

As a rough guide, cook the joints for $\frac{1}{2}$ to $\frac{2}{3}$ of the total conventional cooking time.

When cooking by combination, drop the convection temperature by 10°C compared to the normal convection temperature.

Always under-estimate the cooking time and return the joint for further cooking if necessary. Check internal temperature before STANDING.

7. Standing

Allow joints to STAND for 20 minutes before carving.

8. Maximum Weight

DO NOT attempt to cook joints over 6lb (2.7kg) in weight. Avoid excessively fatty joints.

9. Maximum Microwave Power

For best results ONLY use SIMMER or DEFROST power to avoid over-cooking and drying out the joints.

Cooking Meat on Combination

Tips for cooking Poultry on Combination

1. Turning / Basting / Draining

For best results, whole chickens should be turned halfway through cooking and basted. Drain any excess meat juices and fat.

2. Shielding

To prevent over-cooking, shield the breast, wings and legs of chicken, duck and turkey with smooth pieces of aluminium foil. Ensure foil does not touch Wire Rack Shelf, walls, roof or door of oven.

3. Covering

DO NOT cover poultry when cooking by Combination.

4. Stuffing

DO NOT stuff the complete cavity of poultry if cooking by Combination. Neck end of bird only may be stuffed. Cook stuffing separately on Microwave SIMMER power.

5. Calculating the Cooking Time

As a rough guide, cook poultry $\frac{2}{3}$ of the usual total conventional cooking time. For poultry, best results are obtained by using the same temperature as for conventional cooking. Check the internal temperature before STANDING.

6. Standing

Allow poultry to STAND for 15-20 minutes before carving.

7. Maximum Weight

DO NOT attempt to cook joints over 6lb (2.7kg) in weight. Avoid excessively fatty joints.

Tips for cooking Small Cuts on Combination

1. Turning

Most thicker, cuts benefit from turning during cooking. When turning, remove Wire Rack Shelf completely. If cooking small items directly on Ceramic Insulating Tray, remove tray to turn food - DO NOT leave shelf extended from oven as there is NO NON-TIP SAFETY LOCK.

2. Arranging

Arrange small cuts evenly and for best results use full width of oven. DO NOT pile foods on top of each other, arrange in a single layer only.

3. Draining Juices

For best results, place food directly on Wire Rack Shelf using Ceramic Insulating Tray on base of oven to catch drips. This tray must be removed for cleaning to avoid excessive smoke/splatter and to cook efficiently.

Small items can be placed directly on Ceramic Insulating Tray on top of Wire Rack Shelf.

4. Standing Time

Small cuts require 5-10 minutes STANDING time before serving.

5. Calculating the Cooking Time

Cooking small cuts on Combination grill allows most cuts to brown and crisp more quickly than when conventionally grilled. Allow roughly $\frac{2}{3}$ the conventional time as a guide.

6. Container

DO NOT place food on a metal tray/container as this will slow down cooking time by reducing effect of Microwave Power.

7. Cleaning the Oven

It is essential that the oven is kept very clean for Combination Grill, to avoid excess smoke and splatter.

Suggested Reheating Times

Multi-Portion Entrées

All on lower Shelf Position

FOOD	WEIGHT	START TEMP	SETTING	APPROX. TIME
Macaroni Cheese	1.36kg	2°C	1. HIGH power	9 mins
	3lb		2. Combi 5	8 mins
Cottage Pie	1.81kg	2°C	1. HIGH power	8 mins
	4lb		2. Combi 4	15 mins
Vegetable Crumble	1.58kg 3lb 6oz	2°C	Combi 4	15 mins
Bean Hotpot	1.58kg	2°C	1. HIGH power	11 mins
	3lb 6oz		2. Combi 5	8 mins
Vegetable Chilli	1.58kg	2°C	1. HIGH power	9 mins
	3lb 6oz		2. Combi 5	8 mins
Broccoli and Cream Cheese Italienne	1.36kg	2°C	1. HIGH power	7 mins
	3lb		2. Combi 5	8 mins
Cauliflower Cheese	1.67kg	2°C	1. HIGH power	13 mins
	3lb 10oz		2. Combi 5	9 mins
Cottage Garden Pie	1.58kg	2°C	1. HIGH power	7 mins
	3lb 6oz		2. Combi 5	8 mins
Steak and Kidney Pie	1.36kg	-18°C	1. HIGH power	8 mins
	3lb		2. Combi 4	15 mins
Moussaka	2.04kg	2°C	1. HIGH power	15 mins
	4lb 6oz		2. Combi 5	6 mins
Lasagne Verdi	1.58kg	2°C	1. HIGH power	8 mins
	3lb 6oz		2. Combi 4	10 mins
Cannelloni	1.58kg	2°C	1. HIGH power	8 mins
	3lb 6oz		2. Combi 4	10 mins
Tuna Pasta Bake	1.7kg	2°C	1. HIGH power	8 mins
	3lb 12oz		2. Combi 4	10 mins
Fisherman's Pie	1.98kg	2°C	1. HIGH power	8 mins
	4lb 6oz		2. Combi 4	12 mins
Lancashire Hotpot	1.58kg	2°C	1. HIGH power	5 mins
	3lb 6oz		2. Combi 4	15 mins
Vegetable Lasagne	1.8kg	2°C	1. HIGH power	8 mins
	4lb		2. Combi 4	10 mins

NOTES:

All timings are based on a Preheat temperature of 190°C.
Always check temperature reaches 72°C before serving.

Suggested Reheating Times

Individual Entrées

All on lower Shelf position

FOOD	WEIGHT	START TEMP	QTY	SETTING	APPROX. TIME
Lasagne Verdi	325g 11 ¹ / ₂ oz	2°C	1	Combi 1	3 ¹ / ₂ mins
			2	1. Combi 1 2. HIGH power	5 mins 1 ¹ / ₂ mins
		-18°C	1	1. Combi 1 2. HIGH power	4 mins 4 mins
Macaroni Cheese	325g 11 ¹ / ₂ oz	2°C	1	Combi 1	3 mins
			2	1. Combi 1 2. HIGH power	4 mins 2 mins
Vegetable Lasagne	325g 11 ¹ / ₂ oz	2°C	1	Combi 1	3 ¹ / ₂ mins
			2	1. Combi 1 2. HIGH power	5 mins 2 mins
		-18°C	1	1. Combi 1 2. HIGH power	5 mins 4 mins
Broccoli & Cream Cheese Bake	300g 11oz	2°C	1	Combi 1	4 mins
			2	1. Combi 1 2. HIGH power	5 mins 4 mins
Cottage Pie	325g 11 ¹ / ₂ oz	2°C	1	Combi 1	4 mins
			2	1. Combi 1 2. HIGH power	5 mins 2 mins
		-18°C	1	1. Combi 1 2. HIGH power	4 mins 4 ¹ / ₂ mins
Vegetable Cumberland Pie	300g 11oz	2°C	1	Combi 1	3 mins
			2	1. Combi 1 2. HIGH power	3 mins 2 ¹ / ₂ mins
		-18°C	1	1. Combi 1 2. HIGH power	5 mins 4 mins
Steak and Ale Pie	250g 9oz	2°C	1	Combi 1	4 mins
			2	1. Combi 1 2. HIGH power	5 mins 1 mins

NOTES:

All timings are based on Preheat temperature of 220°C.

Suggested Reheating / Cooking Times

Vegetables - Reheating

FOOD	WEIGHT	SHELF LEVEL	START TEMP	QTY	SETTING	APPROX. TIME
Breaded onion rings	225g 8oz	Upper	-18°C	—	Combi 5	4 ¹ / ₂ mins
Onion Baji	210g / 7 ¹ / ₂ oz 35g each	Upper	-18°C	6	Combi 2	4 mins 45secs
Vegetable Samosa	200g / 7oz 50g each	Upper	-18°C	4	Combi 2	5 mins
Spring Rolls	175g / 6oz 30g each	Upper	-18°C	6	Combi 2	3mins 45secs
Oven Chips	250g 9oz	Upper	-18°C	—	Combi 2	5 - 6 mins
Hash Browns	225g / 8oz 30g each	Upper	-18°C	8	Combi 2	8 mins
Roast Potatoes	350g 12oz	Upper	-18°C	—	Combi 2	8 mins
Breaded Mushrooms	225g 8oz	Upper	-18°C	—	Combi 5	4 ¹ / ₂ mins
Gratin Dauphinoise	225g 8oz	Lower	-18°C	—	1. HIGH power 2. Combi 4	2 ¹ / ₂ mins 3 mins
			2°C	—	1. HIGH power 2. Combi 5	1 min 30secs 2 ¹ / ₂ mins

NOTES:

All timings are based on Preheat temperature of 220°C.

Vegetables - Cooking

FOOD	WEIGHT	SHELF LEVEL	START TEMP	QTY	SETTING	APPROX. TIME
Roast Potatoes	450g 1lb	Lower	Ambient	—	1. HIGH power 2. Combi 4	1 ¹ / ₂ mins 7 ¹ / ₂ mins
Roast Mixed Root Vegetables	450g 1lb	Lower	Ambient	—	1. HIGH power 2. Combi 4	1 ¹ / ₂ mins 7 ¹ / ₂ mins
Roast Mixed Mediterranean Vegetables	450g 1lb	Lower	Ambient	—	Combi 4	7 mins
Gratin Dauphinoise	800g 1lb 12oz	Lower	Ambient	—	Combi 4	12 mins
Jacket potatoes	250-275g 9-10oz	Lower	Ambient	2	1. Combi 1 2. HIGH power	5 mins 2 mins
				4	1. Combi 1 2. HIGH power 3. Combi 5	5 mins 5 mins 2 mins
				6	1. Combi 1 2. HIGH power 3. Combi 5	5 mins 8 mins 2 mins

NOTES:

All timings are based on Preheat temperature of 220°C.

Suggested Reheating / Cooking Times

Fish - Reheating

FOOD	WEIGHT	SHELF LEVEL	START TEMP	QTY	SETTING	APPROX. TIME
Battercrisp Cod/ Haddock	540g 1lb 4oz	Upper	-18°C	4	Combi 5	12 mins
Fish Cakes	260g 9 ¹ / ₂ oz	Upper	2°C	4	Combi 2	5 ¹ / ₂ mins
			-18°C	4	Combi 5	5 mins
Salmon en Croute	190g 6 ¹ / ₂ oz	Lower	2°C	1	Combi 1	3 mins 15secs
			-18°C	1	1. HIGH power 2. Combi 4	1 ¹ / ₂ mins 3 ¹ / ₂ mins
				2	1. HIGH power 2. Combi 4	3 ¹ / ₂ mins 4 mins

NOTES:

All timings are based on Preheat temperature of 220°C.

Fish - Cooking

FOOD	WEIGHT	SHELF LEVEL	START TEMP	QTY	SETTING	APPROX. TIME
Fish fillets	240g / 8oz 120g each	Upper	2°C	2	Combi 2	4 mins
Fish steaks	700g / 1lb 8oz 175g each	Upper	2°C	4	Combi 2	7 ¹ / ₂ mins
Whole fish	250g 10oz	Lower	-18°C	1	Combi 2	5 ¹ / ₂ mins
				2	Combi 2	8 mins

NOTES:

All timings are based on Preheat temperature of 220°C.

Meat and Poultry - Reheating

FOOD	WEIGHT	SHELF LEVEL	START TEMP	QTY	SETTING	APPROX. TIME
Chicken / Beef Wellington	210g 7 ¹ / ₂ oz	Lower	-18°C	1	1. HIGH power 2. Combi 4	2 ¹ / ₂ mins 2 ¹ / ₂ mins
				2	1. HIGH power 2. Combi 4	3 ¹ / ₂ mins 3 mins
Chicken Kiev	140g 4 ¹ / ₂ oz	Lower	-18°C	1	1. HIGH power 2. Combi 4	1 min 3 mins
				2	1. HIGH power 2. Combi 4	1 ¹ / ₂ mins 5 mins
Chicken Cordon Bleu	160g 5 ¹ / ₂ oz	Lower	-18°C	1	1. HIGH power 2. Combi 4	1 min 4 mins
				2	1. HIGH power 2. Combi 4	2 mins 5 mins

NOTES:

All timings are based on Preheat temperature of 220°C.

Suggested Reheating Times

Meat and Poultry - Reheating

FOOD	WEIGHT	SHELF LEVEL	START TEMP	QTY	SETTING	APPROX. TIME
Half roast Chicken	400g 14oz	Lower	2°C	1	1.HIGH power 2.Combi 5	3 mins 2½ mins
				2	1.HIGH power 2.Combi 5	3 mins 4 mins
Chicken breasts	275g 10oz	Lower	2°C	2	1.HIGH power 2.Combi 5	1 min 3½ mins
				4	1.HIGH power 2.Combi 5	4½ mins 4½ mins
Butterfly chicken fillets	200g 7oz	Upper	2°C	1	Combi 5	3½ mins
				4	Combi 5	5½ mins
Chicken Quarter	275g 10oz	Lower	2°C	2	1.HIGH power 2.Combi 5	1½ mins 4 mins
				4	1.HIGH power 2.Combi 5	4½ mins 5 mins
Chicken Drumstick	80g 3½oz	Upper	2°C	4	Combi 5	3½ mins
Chicken Wings	225g 8oz	Upper	-18°C	—	1.HIGH power 2.Combi 5	2 mins 2½ mins
	450g 1lb	Upper	-18°C	—	1.HIGH power 2.Combi 5	3½ mins 4 mins
Half Roast Duck	300g 11oz	Upper	2°C	1	1.HIGH power 2.Combi 5	3 mins 2 mins
				2	1.HIGH power 2.Combi 5	3½ mins 3½ mins
			-18°C	1	Combi 2	7½ mins
				2	Combi 2	9½ mins

NOTES:

All timings are based on Preheat temperature of 220°C.

Suggested Cooking Times

Meat and Poultry - Cooking

FOOD	WEIGHT	SHELF LEVEL	START TEMP	QTY	SETTING	APPROX. TIME
Rack of Lamb	275g 10oz	Lower	-18°C	1	Combi 4	6½ mins
				2	Combi 4	9 mins
Lamb Loin chops	700g 1lb 9oz	Upper	2°C	6	Combi 3	10 mins
Lamb Cutlets	700g 1lb 9oz	Upper	2°C	6	Combi 3	11½ mins
Leg of Lamb	2.7kg / 6lb max	Lower	2°C	1	Grill Convection 190°C + DEFROST	9 mins per 450g / 1lb
Pork Loin Chops	450g 1lb	Upper	2°C	2	Combi 2	8 mins
Gammon Steaks	450g 1lb	Upper	2°C	2	Combi 3	7½ mins
Sausage	450g 1lb	Lower	2°C	8	1. Combi 4	5 mins
					2. Fan Grill 250 °C	2 mins
Cumberland Sausage Coils	450g 1lb	Lower	2°C	3	1. Combi 4	5½ mins
					2. Fan Grill 250°C	2 mins
Bacon Rashers	250g 9oz	Upper	2°C	9	Combi 5	4 mins
Leg of Pork	2.7kg / 6lb max	Lower	2°C	1	Grill Convection 200°C + SIMMER	13 mins Per 450g / 1lb
Sirloin Steaks	450g 1lb	Upper	2°C	3	Combi 3	6-6½ mins
Beef Burgers	450g 1lb	Upper	2°C	4	Combi 5	8 mins
	450g 1lb	Upper	-18°C	4	Combi 2	10 mins
Beef Topside Joint	2.7kg / 6lb max	Lower	2°C	1	Grill Convection 190°C + DEFROST	11 mins Rare 12 mins Medium 14 mins Well per 450g / 1lb
Whole Duck	2.7kg / 6lb max	Lower	2°C	1	Grill Convection 190°C + SIMMER	6 mins per 450g / 1lb
Whole Turkey	2.7kg / 6lb max	Lower	2°C	1	Grill Convection 180°C + DEFROST	10 mins per 450g / 1lb
Whole Chicken	2.7kg / 6lb max	Lower	2°C	1	Grill Convection 190°C + LOW	8 mins per 450g / 1lb
Chicken Leg Portions	730g 1lb 10oz	Lower	2°C	4	Combi 4	11 mins
Chicken Breast Portions	520g 1lb 3oz	Lower	2°C	4	Combi 4	8 mins

NOTES:

All timings are based on Preheat temperature of 220°C.

Suggested Reheating Times

Bread and Pizzas - Reheating

FOOD	WEIGHT	SHELF LEVEL	START TEMP	QTY	SETTING	APPROX. TIME
Mini Garlic Baguette	75g 3oz	Lower	-18°C	4	Combi 3	5 mins
Garlic Bread Slices	75g 3oz	Lower	-18°C	6	Combi 3	5 mins
Naan Bread	100g 4oz	Upper	-18°C	2	Combi 3	2½ mins
Ciabatta Rolls	85g 3½oz	Lower	-18°C	4	Combi 3	5½ mins
Mini Focaccia	60g 2½oz	Lower	-18°C	4	Combi 3	4 mins
Pitta Bread	60g 2½oz	Upper	-18°C	3	Combi 3	3½ mins
Part-baked Rolls	50g 2oz	Lower	-18°C	4	Combi 3	3 mins
Part-baked Demi-baguette	120g 4½oz	Lower	-18°C	2	Combi 3	5 mins
Deep pan Pizza	400g 14oz	Lower	-18°C	1	1. HIGH power 2. Combi 3	30 secs 9½ mins
Thin and Crispy Pizza	285g 10½oz	Lower	-18°C	1	Combi 3	6 mins
Pannini	110g 4¼oz	Lower	-18°C	1	1. HIGH power 2. Combi 4	15 secs 1½ mins
	200g 7oz	Lower	-18°C	1	1. HIGH power 2. Combi 4	30 secs 2 mins

NOTES:

All timings are based on Preheat temperature of 220°C.

Suggested Reheating Times

Miscellaneous - Reheating

FOOD	WEIGHT	SHELF LEVEL	START TEMP	QTY	SETTING	APPROX. TIME
Cornish Pasty	175g 6oz	Lower	2°C	2	Combi 1	3 mins
			-18°C	2	1. Combi 1 2. HIGH power	3 mins 1 min
Steak Pie	250g 9oz	Lower	2°C	1	Combi 1	2 mins 15 secs
			-18°C	1	1. Combi 1 2. HIGH power	3 mins 2½ mins
Individual Quiche	180g 6½oz	Lower	2°C	1	Combi 2	4 mins 15 secs
Yorkshire Pudding	15g ½oz	Lower	-18°C	6	Combi 3	3 mins
				12	Combi 3	4 mins
Sausage Rolls	65g 2½oz	Lower	-18°C	4	Combi 2	4 mins

NOTES:

All timings are based on Preheat temperature of 220°C.

Sweets and Pastries - Reheating

FOOD	WEIGHT	SHELF LEVEL	START TEMP	QTY	SETTING	APPROX. TIME
Croissants	40g 1½oz	Lower	-18°C	4	Combi 3	2½ mins
Scones	80g 2¾oz	Lower	-18°C	2	Combi 3	2½ mins
Pain au Raisin	50g 2oz	Lower	-18°C	2	Combi 3	2 mins
Fruit Pie	650g 1lb 4oz	Lower	2°C	1	1. High power 2. 190°C + SIMMER	3 mins 10 mins
Deep Apple Pie	1.4kg 2lb 6oz	Lower	2°C	1	1. HIGH power 2. Convection 250°C	4 mins 11 mins
Apple Strudel	700g 1lb 9oz	Lower	-18°C	1	Combi 3	15 mins

NOTES:

All timings are based on Preheat temperature of 220°C.

Common Problems

This section tries to solve any common problems you may have. Remember to always keep your Operating Guide on hand for reference.

PROBLEM	CAUSE	SOLUTION
Food cools quickly after Microwave or Combination cooking.	Food insufficiently heated.	Return to oven for additional cooking.
Foods take longer to cook, defrost or reheat than stated.	Oven not receiving enough power.	Check oven is plugged into its own 13amp socket. Do not use extension cable or adapters.
	Food type, size, weight, temperature not exactly as stated.	The stated times are only a guide. Heating will be improved with the use of correct containers and arranging. Remember to vary the heating, if the food is colder or heavier than stated.
	Oven dirty and food debris is absorbing the microwave energy.	Ensure the oven is cleaned regularly.
Liquids boil over when cooked by microwave or combination.	Containers too small.	Use a container twice the volume of the liquid.
Vegetables become wrinkly and hard when cooked/reheated by microwave.	Vegetables over-cooked.	Allow standing time when cooking and slightly undercook vegetables, if they are to be reheated.
Foods heat unevenly.	Foods incorrectly arranged or incompatible foods are being heated together.	Arrange foods, so that thicker parts are on the outside of the plate and smaller foods to the centre. Do not heat very dense foods with porous foods as the later will heat faster.
Only one side of cavity heats.	Foods incorrectly arranged.	Rearrange foods as above. It is impossible for only one side of the cavity to receive microwaves as the energy is distributed by a rotating guide. if the magnetron is no longer working all food will remain cold.
Foods heated by microwave are hard and tough.	Foods overcooked.	Reduce the time or power with more delicate foods.
Foods “explode” during heating.	Power level too high.	Reduce power level.
	Skins of foods i.e potatoes, chicken are not pierced.	Pierce skins on foods to release pressure build up during heating. NEVER try to boil eggs in shells.
Foods that have been defrosted do not heat in the centre.	Foods have not been sufficiently defrosted or allowed to stand before reheating.	Check that foods are between 1-4°C before going on to reheat. If the edges of the food are getting too warm shield with foil. (See page 42.)

Common Problems

PROBLEM	CAUSE	SOLUTION
Dishes get hot.	Steam trapped within container transferring heat to dish.	This is normal, particularly in covered dishes. Remove lids/film carefully to prevent steam burns.
	The dish is absorbing the microwave energy.	Carry out the dish test given with Glossary of Terms. Do not use unsuitable dishes.
	If the "Preheat" function is in operation, the dish will absorb some of the residual heat in the cavity.	This is normal and an excellent way of heating the plate !
Condensation appears in the cavity and door.	Food is heating faster than the steam can be expelled.	This is normal and the condensation should be wiped off a soft cloth. Ensure air vents are not blocked.
Steam is expelled from around the door.	The steam is finding an exit from cavity.	This is normal. The intricate workings of the door safety devices will prevent the escape of microwave energy but not steam or cooking smells.
Smoke appears around the door when grilling.	Fat from foods is splashing on to the grill elements and burning.	Stop the oven and drain away all excess fat and juices. Watch the food carefully as it grills. Ensure the cavity ceiling is cleaned regularly.
The ceramic cavity base cracks.	Operator mis-use.	Be careful to place the food carefully on the base of the cavity. Do not slam or drop the food: the base is made from ceramic not painted metal.

Common Queries

Question	Answer
Can I use the oven Off-Shore ?	Yes if the supply is 50Hz. The oven will not Operate at 60Hz.
Where can I obtain additional oven accessories ?	Contact the manufacturer or the dealer from whom you purchased the oven.
Can the oven be stacked.	Do not stack your Panasonic Combi Oven on other microwaves of similar or different models. It is best to site your oven clear of all other kitchen equipment which may produce excess humidity i.e. oven ranges, deep-fat fryers etc.
Can I dry tea towels and clothes in the oven ?	No. Never put these, or similar items in your Panasonic Combi Oven.
How often should the oven be serviced ?	It is best to be guided by your authorised Service Agent. This depends on usage however keep oven clean.

When to Call a Service Engineer

If an “F” Appears In The Display

Your Panasonic Combi Oven is equipped with a Self Diagnostic Failure Code System; this means the oven monitors its own operation and will show a failure code in the display window in the unlikely event of a malfunction.

If a Failure Code appears in the display window (it will appear as an “F” then a two digit number) follow these steps:

1. Close the door and switch off at socket. Ensure all air vents are clear.
2. Leave 1 minute and then reconnect the oven at the mains.
3. Open the door and place food or a jug of water in the cavity, close the door.
4. Try the same function that had been in operation prior to the appearance of the Failure Code in the display window.

If the Failure Code appears again, then contact the dealer from which you purchased the oven, the manufacturer or a known Approved Service Agent. See contacting a Service Engineer.

If a “U” Appears In The Display

A fault with the SD Memory Card will also show as a Failure Code in the display window (it will appear as a “U” then a two digit number). Follow the steps in the following chart:

CODE	PROBLEM	WHAT TO DO
U16	SD Memory Card is locked.	<p>Take out the SD Memory Card & remove the Lock. (see below). Insert the SD Memory Card again.</p> <div style="text-align: center;"> <p>Lock is removed when this part is pushed upwards.</p>  </div>
U17	<p>There is no programme data from this oven on the SD Memory Card.</p> <p>Programme data on the SD Memory Card is damaged.</p>	<p>An SD Memory Card confirms that it is attached to this oven. Please check whether there is programme data from the oven on the SD Memory Card in your personal computer.</p> <p>(See page P.75)</p> <p>When programme data is deleted, please contact Service Engineer.</p>
U19	SD Memory Card is not inserted.	Remove the SD Card Cover and insert an SD Memory Card.

If There Is Damage To The Oven

Contact a Service Engineer immediately if you find damage to the supply cord, control panel, cavity, or the door. It is best not to use the oven again until you have ascertained from the Service Agent that it is safe to do so. Remember to give the Service Engineer as much information as possible. See contacting a Service Engineer.

If The Oven Is Not Working

If you find the oven is not working, follow these points before contacting a Service Engineer. Check:

1. The oven door is closed.
2. The required function(s) have been set correctly and the Start Pad pressed.
(See pages 8 - 29.)
3. The programme lock has not been activated or deactivated against your requirements.
4. The oven is connected to a 13 amp socket and the supply is operational. Try another power point, there maybe a problem with the socket or even a total power failure.
5. The oven is not connected to the electrical supply by means of an adaptor or extension cable.
6. The air vents are not blocked. If they are, unblock them, leave the oven for 15 minutes and then try again.
7. The "Common Problems" section on pages 68 - 69.

If the oven is still not operational contact your Service Agent with all your details. See contacting a Service Engineer.

Note: Do remember that the lamp will not come on in your Panasonic Combi Oven whilst the oven is in operation, unless you select the lamp pad.

Contacting A Service Engineer

When contacting a "Service Agent" always remember to state clearly the following information:

1. The address and name, if applicable, of the site where the oven is situated.
2. The telephone number of that site.
3. A contact name at that site.
4. The model number and serial number of the oven; these numbers can be found on the rating plate, situated by the control panel just inside the door.
5. The problem with the oven, including the Failure Code number.
6. If known, from where and when the oven was purchased.
7. When the site will be open for an engineer to visit.

Care of your Oven and Cleaning

It is essential that you follow these points to get the maximum use from your oven. Microwaves are attracted to moisture and grease: therefore a dirty oven does not cook EFFICIENTLY.

1. Before Cleaning

Switch off at the socket.

Cool the oven before cleaning. Use the COOLING programme.

(See page 27)

The door may be left open to cool the oven quickly.

2. Door seals

Pay special attention to cleaning the door seals and door seal areas.

Regularly wipe the Drip Ledge to avoid a build up of moisture and grease.

3. Door

Keep the inside glass of the door clean by wiping regularly with a soft damp cloth. Small amounts of oven cleaner can be used - DO NOT SPRAY DIRECTLY onto door - **spray onto a cloth and wipe over.**

Do not use harsh detergents or abrasives.

4. Oven walls

The walls should be wiped regularly with a soft damp cloth. Small amounts of oven cleaner can be used - DO NOT SPRAY DIRECTLY onto walls - spray onto a cloth and wipe over.

DO NOT ALLOW OVEN CLEANER NEAR THE HOLES IN THE WALL OF THE OVEN.

If corrosive cleaner gets behind the wall, your oven could be damaged.

Do not allow cleaning liquids to seep into openings.

Keep the shelf runners free from grease and food debris.

The back wall of the oven has a heat resistant coating. Clean this area with oven cleaner applied onto a cloth and wipe over.

Do not use wire wool scourers to clean the oven interior.

Excess grease can be softened for ease of cleaning by placing 1 - 1 1/2 pints of hot water in a microwave-safe bowl with a chopped, fresh lemon. Heat on High Power for 10 - 15 minutes. The moisture produced on the walls should then be wiped with a soapy cloth.

5. Floor

The wave guide is situated beneath the ceramic base of the oven. Any spills must be wiped off to ensure even heating. **Do not use harsh detergents or abrasives.**

6. Roof

The roof contains the 4 Quartz Grill elements. Before cleaning ensure oven has cooled to avoid burns.

Wipe the roof regularly with a damp cloth to minimise build up of grease.

7. Control Panel / SD Card Cover

If the control panel and SD Card Cover becomes dirty, clean with a soft, dry or well wrung cloth.

Do not use harsh detergents or abrasive on Control Panel. DO NOT use a saturated cloth as the remaining moisture may damage the panel.

8. Accessories

The accessories should be cleaned regularly to maximise efficiency of the oven.

Ceramic Tray - Clean Ceramic Tray after every use but DO NOT PLACE HOT CERAMIC INSULATING TRAY directly under a COLD tap - the tray may shatter. You can wash the ceramic tray in the dishwasher or by hand in hot, soapy water.

Wire Rack Shelf - This should be cleaned after every session. Take care not to use harsh abrasive.

9. Air Filter

Clean the Air Filters occasionally according to the following instructions. Problems may occur with the oven if the filters become clogged with dirt or grease. If the Air Filter becomes blocked this will cause an overheat problem on the oven.

- Remove the right Air Filter from the front bottom skirt by pulling the Right Pop Pin straight out. Then slide the filter to the right and lift it off the post at the centre. Remove the left Air Filter in the same way.
- Wash the filters in hot, soapy water.
- To replace, align the filter with the centre post, and holding the front of the Pop Pin forward, locate the back of the pin into its hole. Press the front of the pin and it will pop into place. Be sure to replace the air filters before using the oven.

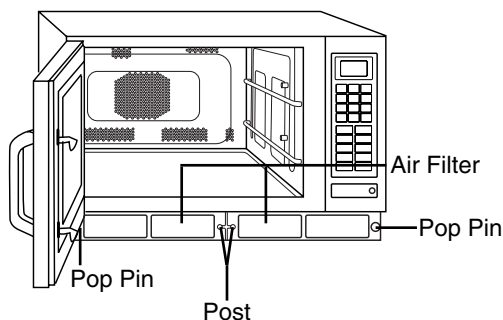

Note: When "FILT" sign appears in Display Window, remove Air Filter and clean it with hot, soapy water. Press Stop / Reset Pad to clear the display.

10. Replacing Oven Lamp

If the Oven lamp burns out you can replace it yourself by following these simple directions:

- Unscrew the Oven Lamp cover, located on the left side of the cabinet.
- Replace the old lamp with a new 240/220V 25W Max, E-14 lamp.
- Close the Oven Lamp Cover and replace screw.

CAUTION:

Switch off from electricity supply before replacing the Oven Lamp.

Damage

If the oven becomes damaged in any way, contact a Service Engineer before continuing use.

CAUTION:

Do not clean this appliance with a water jet.
Do not use any non-specified chemical cleaners or spray anything directly into the oven cavity.

SD Memory Card

An SD Memory Card is included in the unit purchased. It allows you to store up to 99 Memory Programmes in the oven.

Use the card when storing or recalling Memory Programmes.

You can record the Memory Programme data onto your SD Memory Card using your personal computer.

Refer to Storing Programme Data on SD Memory Card on pages 75 - 77.

How to insert / remove the SD Memory Card

Before you insert / remove an SD Memory Card, always disconnect the oven from the power supply. If this is not possible, the display window should be blank, otherwise, the data on the SD Memory Card may be damaged.

How to remove

1. Unscrew the SD Card Cover and remove it.

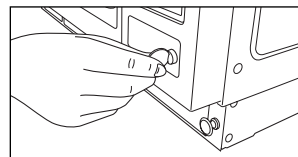

2. Push the SD Memory Card with your finger to draw it out. Then, remove it.

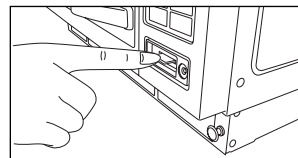

How to insert

1. Insert an SD Memory Card with its label facing up as indicated by the mark until it snaps into place.

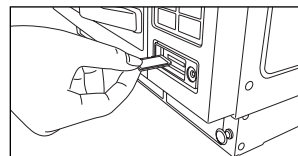

2. Fit the left edge of the SD Card Cover. Screw to close at the right-hand side.

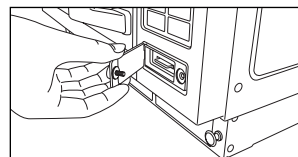

Caution:

1. Always close the SD Card Cover except when an SD Memory Card is inserted/removed in order to prevent water or dust from entering.
2. Insert only an SD Memory Card specified for this oven. Do not use any other type or substitute SD Memory Card.
3. Keep the removed SD Memory Card away from static electricity.
4. Do not disassemble or modify SD Memory Cards.
5. Do not apply a physical shock to SD Memory Cards. Do not bend, drop, or get them wet.
6. Do not touch the metal terminals of an SD Memory Card with your hand or metal.
7. Do not remove the label. Do not paste another label onto the SD Memory Card.
8. Do not leave SD Memory Cards in locations subject to high temperatures or direct sunlight.
9. Do not leave SD Memory Cards in locations subject to corrosive gases.
10. If the SD Memory Card is lost or becomes faulty, please contact a Service Engineer to obtain a replacement.

Storing Programme Data on SD Memory Card

Warning

1. It is prohibited to copy the data on an SD Memory Card for business purposes or reproduce it on a website.
2. The “SD” logo is a trademark.
3. Microsoft Windows is a trademark of Microsoft Corporation, U.S.A.
4. The other various designations, brand names, etc. are the registered trademarks of their respective companies.
5. The names of products you use may be different from those used in this booklet. Windows, messages, etc. used in this booklet may be different from those on your personal computer depending on the environment (OS versions, etc.). Carefully read the instructions for your personal computer for how to use it.

Storing Programme Data using your Personal Computer

Caution:

1. It is recommended to use SD Memory Cards with Microsoft Windows 2000, Microsoft Excel 2000, or later.
2. Unlock the SD Memory Card otherwise the programme data cannot be stored.

How to store programme data

1. Turn ON your personal computer and activate Windows.
2. Insert an SD Memory Card into the SD card Reader on your personal computer.
3. Double-click the SD Memory Card drive in the “My Computer” folder.
Double-click “meigroup” folder.
Double-click “NE1275BP” folder.
Double-click “Recipe(NE-1275BPQ)_V1.0.xls” to open an Excel file.
4. “User Cooking Data Sheet” appears on the desktop.
Note: For the first time, a “Security Warning” will appear. (This will not appear the second time onwards.)
Tick the text box for “Always trust macros from this source.” and click “Enable Macros”.
5. Begin by entering the data in “Dish Name”.
6. Select the “Function” cell, and the drop-down menu will appear. Select the first cooking function from the drop-down list.

No.	Dish Name	Function	Stage1			T Min
			MW Power	Grill Power	Temp	
01	Jacket Potatoes					
02						
03		MW				
04		GR				
05		FGR				
06		CV				
07		GR+CV				
08		MW+GR				
		MW+FGR				

When the cooking function is selected, options will appear in colour, once they have been selected they will change to black.

Storing Programme Data on SD Memory Card

7. Select options from the drop-down menus and enter the data for each cooking stage of the programme.
 Example: Combination of Microwave (Medium) + Grill + Convection (200°C) for 5 minutes.

Microwave Power eg. Medium

Stage1					
Function	MW Power	Grill Power	Temp	Time	
				Min	Sec
MW+GR+CV	<input type="text" value=""/>				
	<div style="border: 1px solid black; padding: 2px;"> Hi Med Low Simmer Def Stand </div>				

Grill Power

Stage1					
Function	MW Power	Grill Power	Temp	Time	
				Min	Sec
MW+GR+CV	Med	<input type="text" value=""/>			
		Default			

Convection Temperature eg. 200°C

Stage1					
Function	MW Power	Grill Power	Temp	Time	
				Min	Sec
MW+GR+CV	Med	Default	<input type="text" value=""/>		
			<div style="border: 1px solid black; padding: 2px;"> 100 110 120 130 140 150 160 </div>		

Cooking Time eg. 5 minutes

Stage1					
Function	MW Power	Grill Power	Temp	Time	
				Min	Sec
MW+GR+CV	Med	Default	200	5	0

Note:

The Excel programme will not allow you to enter data that is not applicable to the cooking function you have selected.

Storing Programme Data on SD Memory Card

- When all the programme data has been entered, click “Save Data”.
The confirmation screen is displayed. Click “Yes”.

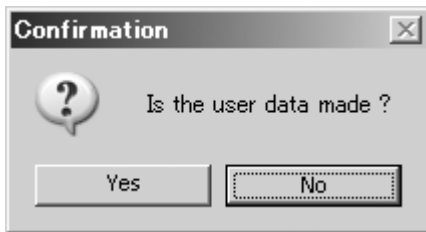

- Note: If the following message appears, then click “OK”.
The data entered is incorrect. The line with the incorrect data will be highlighted allowing you to correct the programme data.



- Click “OK”, and the programme data entry will be completed.



The registered “Dish Name” you have chosen will be reflected in the “User Menu List” (another sheet of the same Excel work book). You can freely enter text in the “Comment” column. You can print this sheet for reference.

How to delete the Programme data.

- Execute procedures 1 to 3 in “How to store programme data” page 75.
- Click “Data Clear”.
- Click “Yes” on the confirmation screen and the programme data will all be deleted.

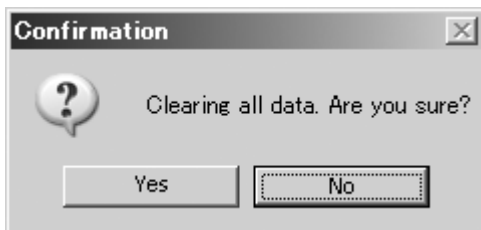

Technical Specifications

Model No.	NE-C1275
Power Source	230 - 240 V / 50 Hz, Single phase
Outlet	13 A
Required Power - Max	12.2A 2.9kW
- Microwave	2000 W
- Grill	1850 W
- Convection Heater	1950 W
Output - Microwave	1150 W (IEC Test Procedure)
Grill	1800 W
Convection Heater	1800 W
Frequency	2450 MHz
Outer Dimensions (W x D x H)	600 mm x 484 mm x 383 mm
Cavity Dimensions (W x D x H)	406 mm x 336 mm x 217 mm
Net Weight	41 kgs (includes accessories)

Specifications subject to change without notice.

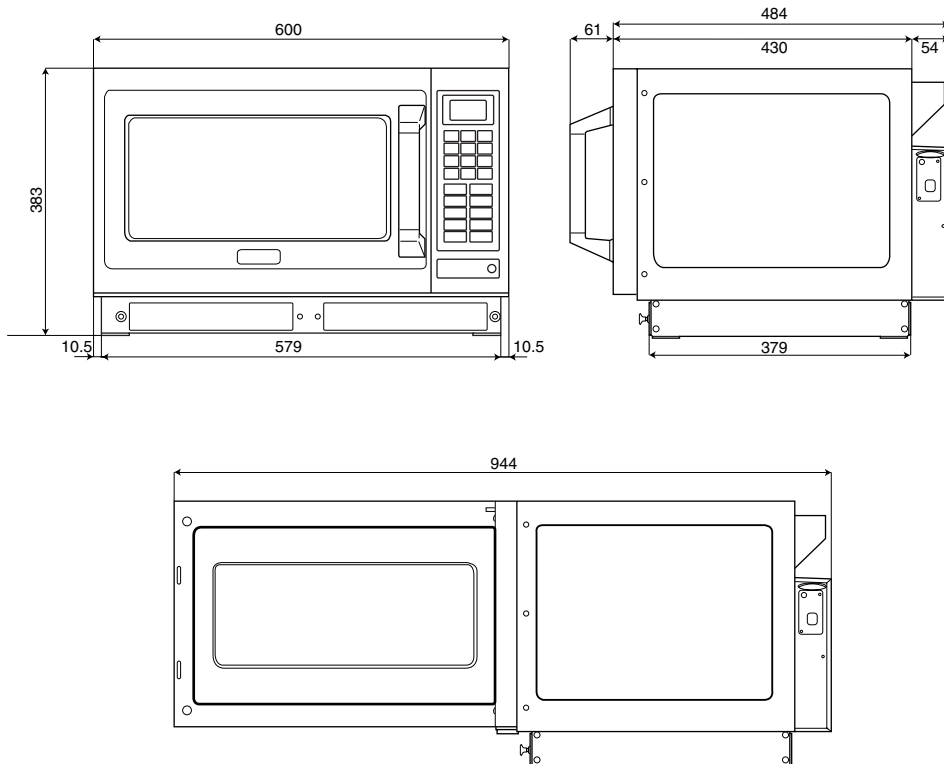

Information on Disposal for Users of Waste Electrical & Electronic Equipment (private households)



This symbol on the products and/or accompanying documents means that used electrical and electronic products should not be mixed with general household waste. For proper treatment, recovery and recycling, please take these products to designated collection points, where they will be accepted on a free of charge basis. Alternatively, in some countries you may be able to return your products to your local retailer upon the purchase of an equivalent new product.

Disposing of this product correctly will help to save valuable resources and prevent any potential negative effects on human health and the environment which could otherwise arise from inappropriate waste handling. Please contact your local authority for further details of your nearest designated collection point.

Penalties may be applicable for incorrect disposal of this waste, in accordance with national legislation.

For business users in the European Union

If you wish to discard electrical and electronic equipment, please contact your dealer or supplier for further information.

Information on Disposal in other Countries outside the European Union

This symbol is only valid in the European Union.

If you wish to discard this product, please contact your local authority or dealer and ask for the correct method of disposal.

Glossary of Terms

Arranging

Positioning the food correctly on the plate to obtain even heating.

Cavity

The interior of the oven where the food is placed for heating.

Ceramic Insulating Tray

Accessory supplied with oven specifically to place between a metal container and Wire Rack Shelf when cooking by COMBINATION.

Combination

Combining Microwave energy with either Grill, Fan Grill or Convection, or with both Grill and Convection

Commercially prepared foods

Foods prepared and cooked at the manufacturers and supplied, usually in a frozen form, to caterers.

Conduction

Transfer of heat through the food, giving even temperature distribution.

Cooking/Prime cooking

The process of heating raw foods.

Defrosting

The processing of taking cooked or raw food from a frozen to thawed state.

Density

The compactness of foods: of open or close texture.

Home-made foods

Foods prepared "in house" from raw ingredients.

Magnetron

The component responsible for changing electrical energy to microwave energy.

Reheating

The process of heating previously cooked foods to a specific temperature.

Salmonella/Lysteria

Food poisoning bacteria.

Sequential/Multi-stage heating

A series (maximum 3) of separate heating settings with times entered before START pad is pressed. The oven then automatically operates the different settings in sequence.

Shielding

Covering areas of food already defrosted or cooked, with aluminium foil.

Standing Time

Non-heating time after defrosting or heating to allow conduction of heat to centre of foods.

Watts/Kilowatts

The measured unit of power; there are 1000 watts (W) in one kilowatt (kW).

Waveguide

A rotating metal plate which disperses the microwave energy into the cavity.

Wire Rack Shelf

Accessory supplied with oven to use as shelf when heating by COMBINATION, CONVECTION, FAN GRILL, GRILL CONVECTION or GRILL.

Dish Test

To check if a container is suitable for use on MICROWAVE, follow instructions below:

1. Check on the base of a container to see if it is microwave safe. If you are uncertain, check a piece of china using the simple dish test.
2. Place a microwave safe container with $\frac{1}{2}$ pint (300ml) of cold water on base of microwave. Alongside, place container to be tested. Heat on HIGH power for 1 minute.

Result: A suitable container for microwave will remain fairly cool but the water will feel warm. If the container is warm or hot then it is absorbing some microwave energy and SHOULD NOT be used. China which absorbs energy will not harm the oven but will slow down the heating of the food.

If Arcing Occurs

Arcing is the static discharge during microwave heating which occurs between any two metals eg the side of the cavity and a metal container: characterised by a blue flash.

If arcing occurs, stop oven immediately. Check that, if a metal container is being used, it is not touching sides or door of oven. Transfer food to a suitable container if necessary.

Arcing may also occur if foil is incorrectly used to shield during DEFROSTING and COOKING. Use SMOOTH pieces of foil and make sure they do not touch roof or walls of oven.

Arcing may also occur if food splashes are not cleaned off and become carbonised. KEEP OVEN AND ACCESSORIES CLEAN.

Index

A		M	
Accessories Supplied	5	Meat Joints: Combination	58,59
Affects of the Dish: Microwave	32	Meat Charts: Combination	63,64,65
Affects of the Food: Microwave	33	Memory programmes	22,23
Arcing	80	Microwave Operation	8,9
B		Multi-Stage Heating	9,11,13,15,17,20
Beep Tone	28	O	
C		One Touch Operation	24
Care of your Oven and Cleaning	3,72,73	Operating: as a Microwave	8,9
Caution	3	on Combination	18-21
Ceramic Insulation Tray	5	on Convection	10,11
Combination	18-21,56-59	on Fan Grill	16,17
Commercially prepared Foods	35,57	on Grill	14,15
Common Problems / Queries	68,69	on Grill Convection	12,13
Containers	31,32,35,44,48,50, 52,54,55	P	
Control panel		Placement of Oven	3
Convection	10,11,48,49	Power levels	8
Cooking Times: Combination	62,63,65	Preheat	11,13,15,17,20,26
Convection	49	Preset Combination	18
Fan Grill	54	Programme List	25
Grill	53	Programme Lock	24,25
Grill Convection	51	R	
Microwave	46-47	Recalling Fan Grill Temperature	17
Cooling Oven	27	Recalling Grill level	15
D		Recalling Convection Temperature	11,13,21
Deep Fat Frying	4	Reheating Times: Combination	60-64,66,67
Defrosting	42	Microwave	36-41
Defrosting Times	43,44	Repeat Feature	9,11,13,15,17,21,24,25
Dish Test	80	S	
Display Window	6	Safety Information	2
E		SD Memory Card	5, 70, 74-77
Eggs	4	Self-Diagnostic Failure Code	70
F		Sequential Heating	9,11,13,15,17,20
Fan Grill	16,17,54	Service	70,71
Fire	3,4	Shielding	42,45,58,59
G		Stacking	3
Glossary of terms	80	Standing Time	4,30,42,58,59
Grill	14,15,52	Stop/Reset Pad	9,11,13,15,17,21,24
Grill Convection	12,13,50	T	
H		Technical Specifications	78
Heater Operation	3	Two Touch Operation	25
Homemade Foods	34,56	U	
Hot Oven	26	Unpacking Your Oven	3
Hot Surfaces	9,11,13,15,17,20	W	
How a Microwave Works	30	When to call a Service Engineer	70,71
I		Wire Rack Shelf	5
Important Information	4,5	T	
Interrupted Programme	24,25	U	
K		U	
Keeping Oven Hot	26	U	

Panasonic Corporation

Microwave Oven Business Unit
800 Tsutsui-cho, Yamatokoriyama City, Nara 639-1188, Japan
<http://panasonic.net>

A00033C54BP
F0905 - 3108
Printed in Japan