

User Manual

QQH Z12-2

15.6" Full HD Portable Monitor

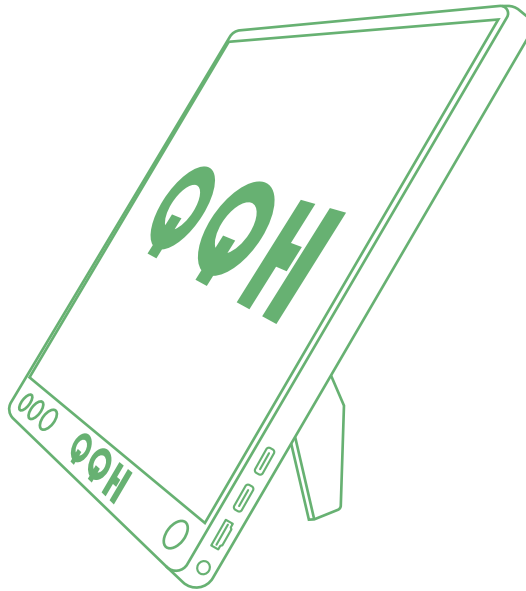

Note: Any technical problem pls contact support team

[support@qqhmonitor.com]

Not Satisfied? Need Help?

Scan to email!



If you have any technical problems with QQH Portable Monitor, Contact us immediately for the best solution.

QQH Tech Support



support@qqhmonitor.com

**[12-Month Warranty]
[24/7 After-sales Service]**

Content

Package List	1
Monitor Introduction	2
Foldable Kickstand	4
Connect Condition	5
Connect with Devices	6
Display Setting	11
OSD Function Introduction	13
Specifications	18
Supported Devices and Models	19
Care & Cleaning	21
Notices	22
Troubleshooting	23
Contact us	25

Package List



15.6" Portable Monitor



USB-C to
USB-C Cable



Mini HDMI to
HDMI Cable



USB-C to USB-A
Cable (Power Supply)



5V/2.4 A Power
Adapter

Monitor Introduction

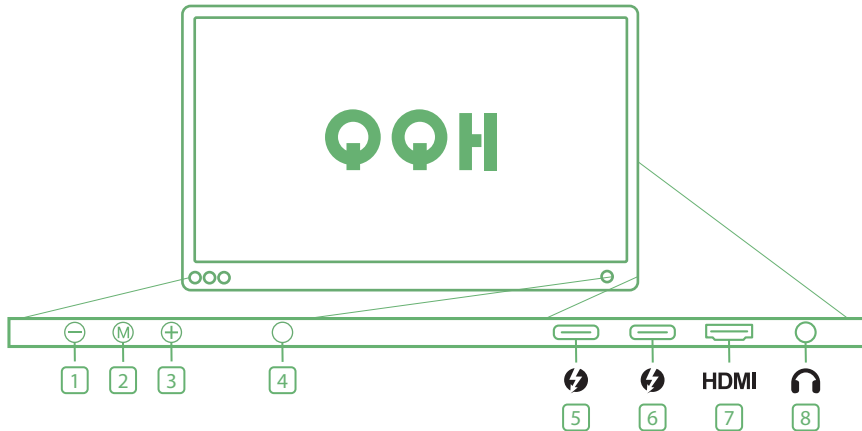

- 1 Brightness Shortcut/Decrease Button/Down Button**
- 2 Menu**
 - Press the M button to turn to the OSD menu.
- 3 Volume Shortcut/Increase Button/Up Button**
- 4 Power Button/Back Button**

Long press for 3s to turn the screen on/off. Short press to back to the previous page.
- 5 Type-C Full Function Port**
 - Supply power(5~20V voltage input);
 - Transmit the audio, video signal.
- 6 Type-C Full Function Port**
 - Supply power(5~20V voltage input);
 - Transmit the audio, video signal.
- 7 Mini HDMI Port**

Audio and video signal transmission. (It does not provide power)
- 8 3.5mm Audio Outport**

Headsets, speakers or digital audio equipment extension interface.

Monitor Introduction

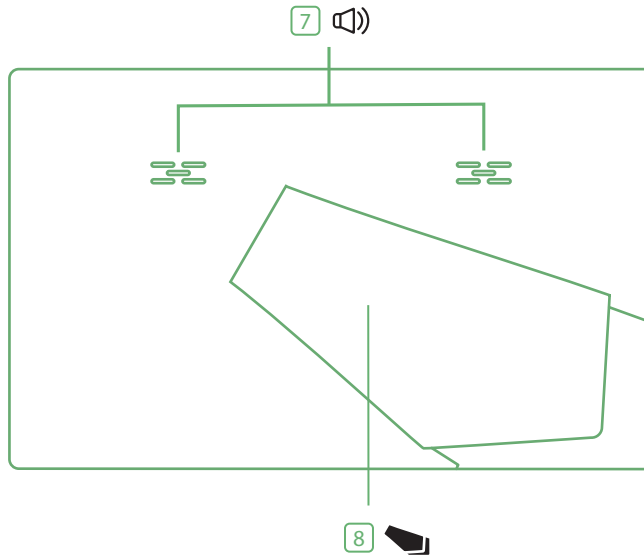

7

Dual Speakers

Listen to music, movies, games, and multimedia files.

8

Foldable Kickstand

Comes with hidden foldable kickstand.

HDMI[®]
HIGH-DEFINITION MULTIMEDIA INTERFACE

The terms HDMI, HDMI High - Definition Multimedia Interface, HDMI trade dress and the HDMI Logos are trademarks or registered trademarks of HDMI Licensing Administrator, Inc.

Foldable Kickstand

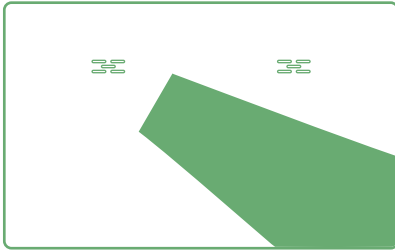

Foldable hidden kickstand,
portable to carry.

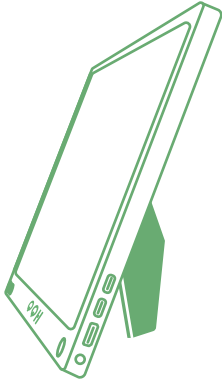

Use as kickstand to stand the
monitor as landscape mode.



Use as kickstand to stand the monitor
as portrait mode.

Note:

- 1) The Portrait mode needs to be set on Devices Setting.
- 2) The foldable stand has a little suction, when using it as a stand, please be gentle when moving to prevent the stand from retracting.
- 3) Please place it away from the edge of the desk when using it to prevent the display from falling and breaking.

Connect Condition

1 Connect with External Power Supply

Connect your monitor to the power supply with the [USB-C to USB-A Cable] and the Adapter provided, plug in the [USB-C to USB-C Cable] OR [Mini HDMI to HDMI Cable] for video output.

2 Connect without External Power Supply

Only works with full-function USB-C port. Please plug in the [USB-C to USB-C Cable] to the USB-C full-function port and make sure the USB-C port of your device is full-function.

Note: The monitor does not have an internal battery. Before using, please make sure the connected devices or power adapter can supply at least 5V/2.4A power.

Connect with Devices

USB-C Laptop

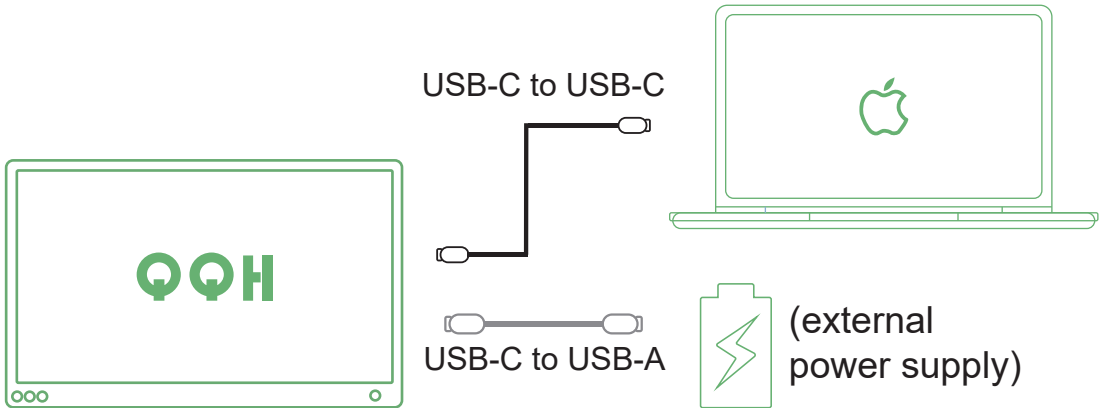

1. If you want to adjust the brightness and volume above 80%, pls make sure the external power supply of 5V/2.4A or above be connected.
2. Not all laptops with USB-C port can work with QQH Monitor. Pls check if the USB-C port of your laptop is compatible with audio and video signal transmission. If not, it would need to change a way to connect or it will need a corresponding adapter to connect.

Connect with Devices

USB-C Phone

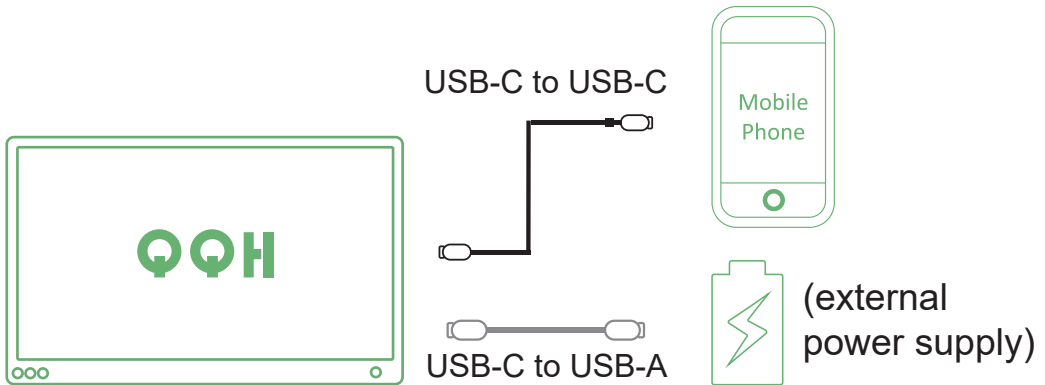



- 1 If there is no external power supply, the phone would supply power to the monitor. Then the monitor would turn to energy-saving mode, brightness will be automatically adjusted to 30%.
- 2 If plug-in an external power(5V/2.4A or above), the monitor can reversely charge the phone. (Please use at least 16W charger or power bank as the external power supply for getting enough working current)
- 3 Not all Phones with USB-C port can work with QQH Monitor. Pls check if the USB-C port of your phone is compatible with audio and video signal transmission.

Connect with Devices

HDMI PC/Laptop



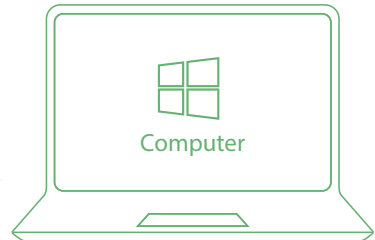

Mini HD to HD

USB-C to USB-A



OR

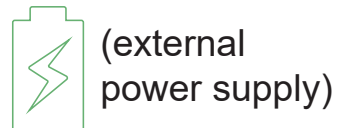
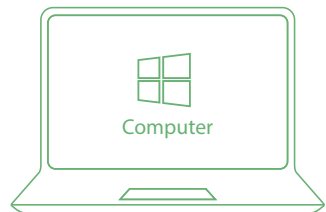

Mini HD to HD

USB-C to USB-A



Note: HDMI port does not supply power. The monitor needs an external power supply (5V/2.4A or above) or USB-A to USB-C cable to supply.

Connect with Devices

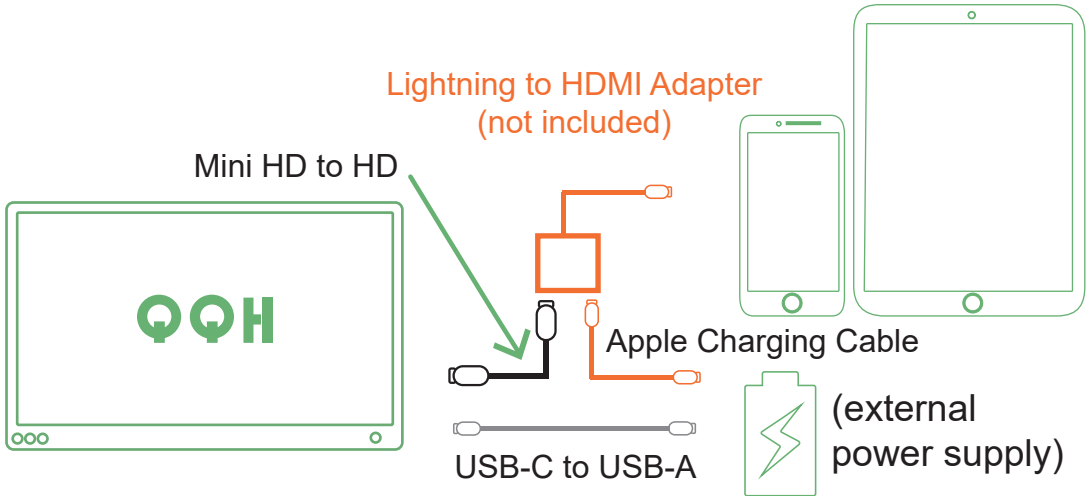
iOS Devices





- 1 Connecting your iOS device with QQH requires a Lightning to HDMI adapter (not included).
- 2 Before connecting, pls make sure your Lightning to HDMI adapter works.
- 3 The lightning to HDMI adapter and the monitor both need a power supply.

Connect with Devices

HDMI Other Devices



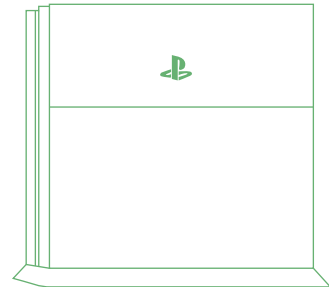

Mini HD to HD

USB-C to USB-A



OR

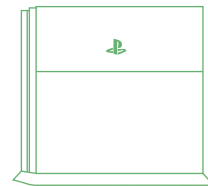

Mini HD to HD

USB-C to USB-A



(external
power supply)

Note: Please connect the external power supply first then the mini HDMI to HDMI cable to ensure smooth transmission.

Display Setting

Multiple-Display Setting for Windows

1 Right-click the desktop and select either Screen Resolution (Windows 7/8) or Display Settings (Windows 10/11)

2 **Screen Rotate Setting:** Click the Display Orientation drop-down list, and then select Landscape or Portrait.

3 **Duplicate & Extend Mode Setting:** Click the Multiple displays drop-down list, and then select Extend/Duplicate these displays. Note: If you cannot see the additional monitor listed, click Detect. If does not work, try restarting your computer and do steps again.

The image shows a screenshot of the Windows Settings application, specifically the 'Display' section. The interface is split into three panels. The left panel shows the 'Settings' navigation pane with 'Display' selected. The middle panel shows the 'Display' settings, including 'Color', 'Windows HD Color', 'Scale and layout', and 'Advanced scaling settings'. The 'Display orientation' dropdown menu is open, showing options: Landscape, Portrait, Landscape (flipped), and Portrait (flipped). The 'Multiple displays' dropdown menu is also open, showing options: Duplicate these displays, Show only on 1, and Show only on 2. A callout box with the text 'Note: If you cannot find the Orientation option, please check if your laptop/PC has this function.' points to the 'Display orientation' dropdown. Another callout box with the text 'Multiple displays' points to the 'Multiple displays' dropdown. A third callout box with the text 'Multiple displays' points to the 'Multiple displays' dropdown in the right panel.

1

2

3

Display orientation

Multiple displays

Multiple displays

Note: If you cannot find the Orientation option, please check if your laptop/PC has this function.

Display Setting

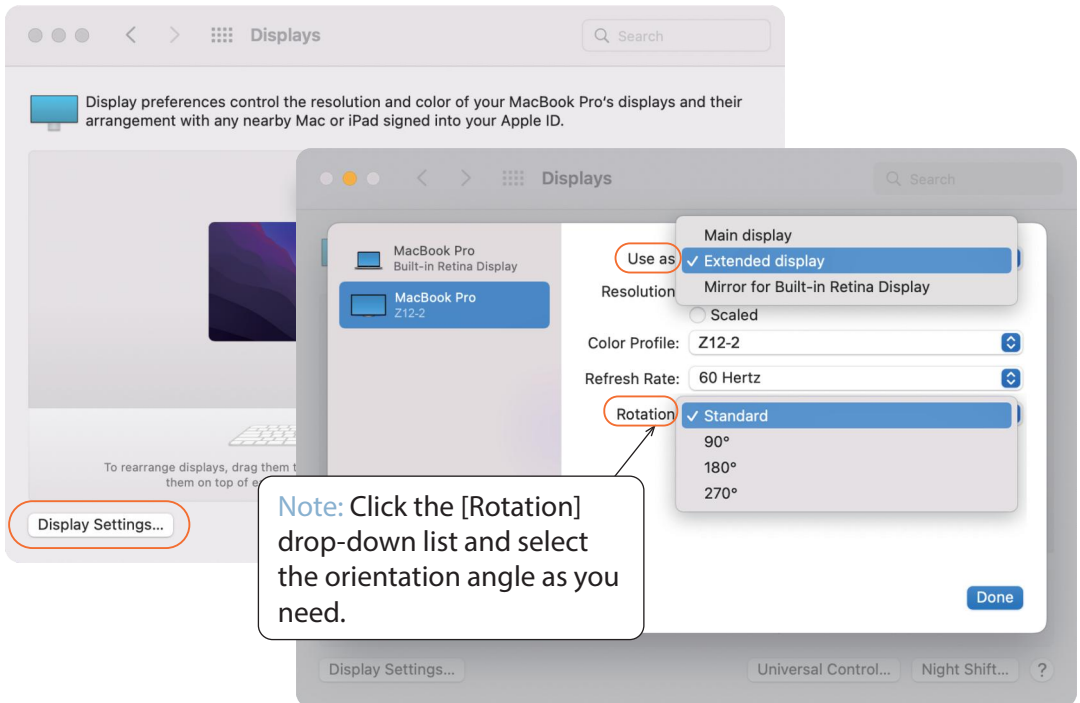

Multiple-Display Setting for Mac

- 1 Choose Apple menu > System Preferences, then click Displays.
- 2 Click the Display Setting
- 3 Choose the display mode you prefer [Main display/Extended display/Mirror]



OSD Function Introduction





Fast Control

- 1. Adjust Brightness:** Press the  (Brightness Button) to open the Brightness Menu, Adjust the Brightness from 0-100.
- 2. Adjust Volume:** Press the  (Volume Button) to open the Volume Menu, Adjust the Volume from 0-100.

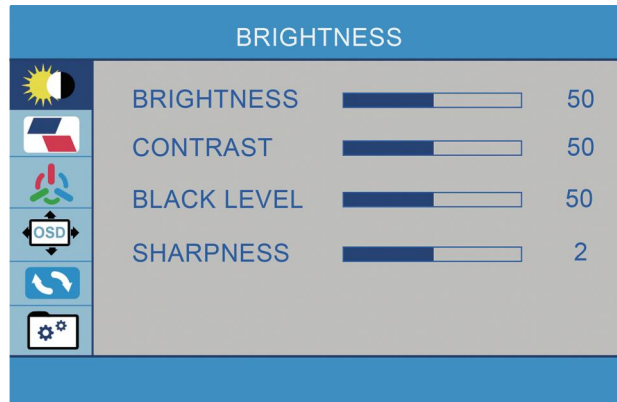

BRIGHTNESS
IMAGE
COLOR TEMP.
OSD SETTING
RESET
MISC.



- 1** Press the  to turn on the OSD menu.
- 2** Press the  /  to control the cursor on the menu.
- 3** Press the  to confirm.
- 4** Short press the power button/back button to back to the upper page.

OSD Function Introduction

OSD Setting - Brightness

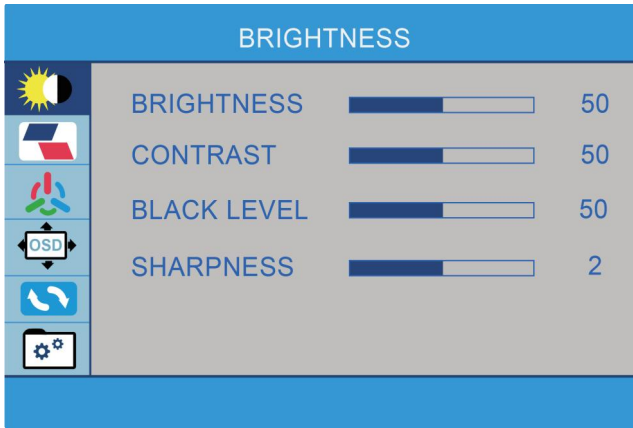

1. **Brightness:** Allows you to adjust the brightness(Range: 0~100).
2. **Contrast:** Adjust the contrast between the objects and the background(Range: 0~100).
3. **Black Level:** Adjust the level of the brightness at the darkest part of a visual image(Range: 0~100).
4. **Sharpness:** Make the outline of objects clearer(Range: 0~4).

Note: When the monitor is connected to devices, if there is no external power supply and there's not enough power supply, brightness will be automatically adjusted to 30 if it is at a high value. If you adjust the brightness to over 80, the screen will turn black. Please use the wall charger to power on the monitor to avoid a black or flashing screen.

OSD Function Introduction

OSD Setting - Image



1. **ECO:** Contains 6 applicable scene modes.
(Standard/RTS/FPS/Text/Movie/Game Modes)
2. **DCR:** Dynamic Contrast Ratio. Select on/off to enable/disable dynamic contrast ratio function.
3. **ASPECT:** Adjust the aspect ratio to 4:3 / 16:9.

Note: Some parameters like Brightness and Contrast cannot be adjusted if ECO is set to [RTS/FPS/Text/Movie/Game] mode or DCR is turned on.

OSD Function Introduction

OSD Setting - Color Temp.

Color Temp. : Contains 2 preset color modes - Cool / Warm and User Mode(Freely adjust the below 3 RGB colors - Red/Green/Blue based on favor.)



OSD Setting - OSD Setting

- 1. Language:** Modify OSD language to English/Francais /Deutsch/Chinese/Italiano, etc. There are 12 Languages.
- 2. OSD Timer:** Adjust the time the OSD Menu display remains on the screen.
- 3. Transparency:** Adjust the transparency of the OSD Menu.

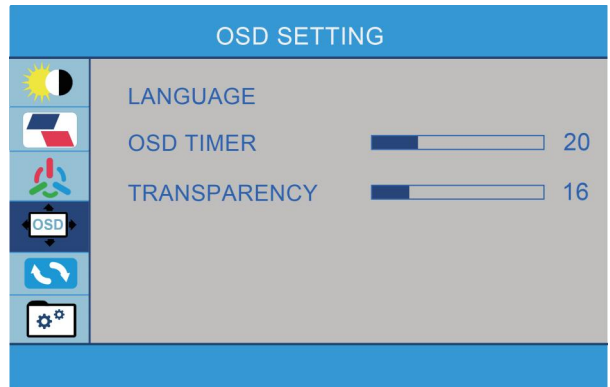

OSD Function Introduction

OSD Setting - RESET

1. **Reset:** Return all the settings to the default factory settings.
2. **Mute:** Mute the display.
3. **Volume:** Adjust the display volume.

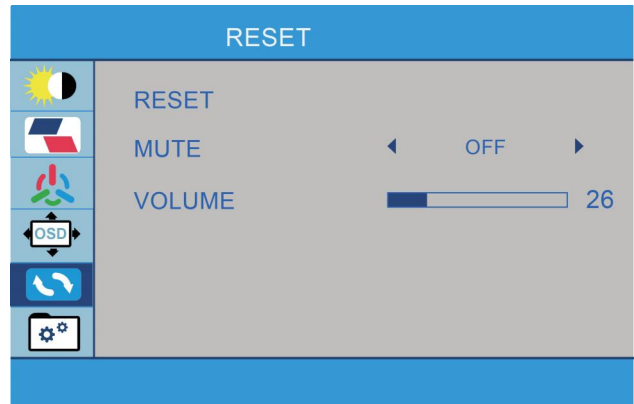

OSD Setting - MISC.

1. **Signal Source:** Switch signal sources to HDMI or Type-C.
2. **Low Blue Light:** Filters out harmful blue light, which can cause eye fatigue.

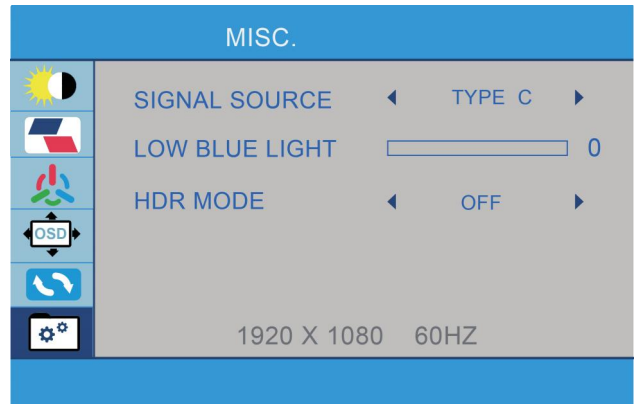

Specifications

Product: QQH-Z12-2 Portable Monitor

Visible Area: 344.16*194.59mm

Panel Type: IPS LCD

Contrast Ratio: 1200: 1

Resolution: 1920*1080

Color Temperature: 6800K

Brightness: 280cd/m²

Aspect Ratio: 16:9

Display Color: 16.7M

Speaker: Built-in Speaker (1W*2)

Visual Angle: H: 89°/89° V: 89°/89°

Dimensions: 362.9X226.4X14.5mm

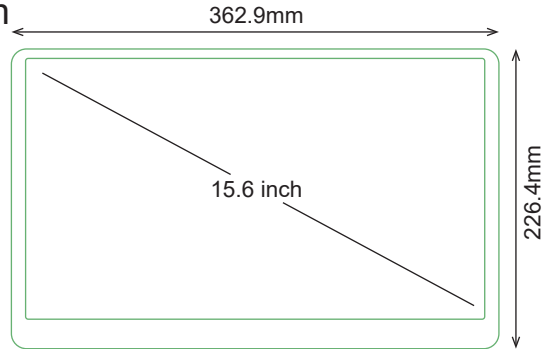

Output Interface: 3.5mm Headphone Interface

Input Interface: Mini HD (Video signal), 2 Type-C Full Function (Video Data, Power Supply).

System Requirement: Devices with HD output interface.

Computer or mobile phones with Type-C Full Function Port that support video output.

Supported Devices and Models

Laptop / Tablets

Brand	Model
Apple	MacBook 12inch, MacBook Pro2016/2017/2018/2019/2020/2021/2022, MacBook Air2018/2019/2020/2021/2022, MacMini 2020 (Intel/M1); iPad Pro 2018, iPad Pro(M1 Chip), iPad Air(4th generation)
Lenovo	Legion Y7000/Y7000P/Y9000K, YOGA6 Pro, ThinkPad x1 Carbon/Yoga, LenovoMIIX 720-12IKB, Miix 720, XiaoXin Pro13, XiaoXinPro16
DELL	G3/G5/G7Series, Inspiron 5000/7000, Inspiron 5310, XPS13, XPS15
HP	OMEN 4 Pro, EliteBook 1050 G1, EliteBook Folio G1
Microsoft	Surface Book 2, Surface Book 3, Surface Go Series, Surface Laptop 3, Surface Laptop 4
ASUS	ZenBook3, ZenBook3 pro, ZenBook xSeries, U4100UN, U5100UQ, ROG Series
HUAWEI	MateBook D, MateBook X, MateBook Xp Pro, MateBook E, MateBook 13, HUAWEI MATEPad Pro
Razer	Blade Stealth
HONOR	MagicBook
Xiaomi	Air12.5/13.3inch, Pro15.6inch, Xiaomi Gaming Laptop, Xiaomi Book Pro, Xiaomi Pad 5 Pro

Note: Please find out the video output port on your device and connect with the monitor based on our connecting guide.

Video Output Port: HDMI, USC Type-C, Thunderbolt, Display Port, VGA;

- Only USB-C port with USB 3.1 or above version can stream video.

- Devices that do not have HDMI and USB-C ports but have other video output ports will need to purchase additional adapters to connect.

Supported Devices and Models

Phone

Brand	Model
Apple	iPhone(need lightning to HDMI adapter - Not included)
Samsung	DEX, S8/S9/S9+/S10/S10e/S10+/S20/S21/S22; Note 8/Note 9/Note 10/ Note 20
HUAWEI	Mate 10/Mate 10 Pro/Mate 20/Mate 20 Pro/Mate 20X/Mate 20 RS/ Mate30/Mate30 Pro/Mate 40/Mate 40 Pro/Mate RS; P20/P20 Pro/P30/ P40/P40 Pro
OPPO	R17 Pro, one plus 7pro, OPPO Reno, OPPO Reno5 Pro, Find
ASUS	ROG gaming phone, ROG gaming phone2
HONOR	Note 10, Magic 2, V20(Only for V20), V30
Razer	Razer Phone
Xiaomi	Xiaomi 10
HTC	U Ultra
SONY	SONY XPERIA(J9110), Xperia 10 III (A102SO)
More Brand	Updating

Note:

1. For iPhone, needs a Lightning to HDMI adapter to connect (refer to P9).
2. For other compatible problems or any problems you meet when connecting QQH Monitor, please contact the QQH support team with your device's detailed model ID for consultation: support@qqhmonitor.com

Care & Cleaning

Care Tips:

1. Use a smart case to protect the screen when you go out with the monitor.
2. Try to avoid the monitor screen colliding with other hard objects when putting it in the backpack.
3. Gently plug or unplug the cable.
4. Wipe the screen frequently to prevent dust accumulation and affecting the use.

Cleaning Tips:

1. Turn your monitor off first and unplug all the cables.
2. Clean the monitor surface with a lint-free, non-abrasive cloth. Stubborn stains may be removed with a cloth dampened with a mild cleaner.
3. Avoid using a cleaner containing alcohol or acetone. Use a cleaner intended for use with the LCD. Never spray cleaner directly on the screen, as it may drip inside the monitor and cause an electric shock.

Notices

- Before setting up the QQH Monitor, pls carefully read all the instructions on the manual.
- To prevent fire or shock hazards, never expose the monitor to rain or moisture.
- Never attempt to open the monitor cabinet.
- Before using, make sure all the cables are correctly connected and power cables are not damaged. It's suggested to use our included cable to connect. If you meet any problem or detect any damage, contact our support team immediately. (support@qqhmonitor.com)
- Avoid dust, humidity, and temperature extremes. Do not place it in any area where it may be wet.
- Place the monitor on a stable surface. Do not place the display on the edge of the table to prevent falling to the ground and breaking down.
- Please avoid collision of the display with other objects to prevent the screen from breaking.
- Never push objects or spill liquid of any kind into the slots on the monitor cabinet.
- If you encounter any problem with this portable monitor, contact us (support@qqhmonitor.com) immediately, we will provide you the best solution.

Troubleshooting

● The power LED is not ON.

- 1) Press the power button to check if the monitor is in the ON mode.
- 2) Check if the cable is properly connected to the monitor and the device/power outlet.

● Can't connect with device(Show “No Signal”, “Power Saving”)

- 1) Check if the connected devices are compatible with QQH.
Ex: Some USB-C port does not support video output, just use for charging or data transmission.
- 2) Check if the monitor and your devices are in the “ON” mode.
- 3) Make sure the cable is properly connected between the QQH monitor and the computer. And please ensure that the monitor has been charged by the connected device or the included 5V/2.4A power adapter.

[Note]

The monitor doesn't have an internal battery, and the HDMI port does not supply power, if connect the device with HDMI, pls make sure to plug in the power cord to the monitor.

- 4) Make sure you are using the included cable. If you change other cables to connect, please make sure they are HDMI 2.0 or the USB-C cable supports USB 3.1.
- 5) Inspect the signal cable and make sure none of the pins are bent.
- 6) Connect the monitor with other available devices to check.

If still can't connect, pls contact [\[support@qqhmonitor.com\]](mailto:support@qqhmonitor.com) to consult.

Troubleshooting

- **The screen flickers in various colors when starting up.**

- 1) Long Press the power button for 3s to turn off the monitor and restart it again.
- 2) Make sure all the cables needed are properly connected between the QQH monitor and the computer.

- **Brightness/Contrast/Volume shows grey and can't be adjusted.**

- 1) Please make sure the HDR mode is turned off and Scene (ECO) Mode or CDR Mode is not adjusted.
- 2) Reset the Monitor to factory setting on OSD Menu - Reset.

- **Screen image bounces or a wave pattern preset in the image.**

- 1) Make sure the USB cable is properly connected between the USB monitor and the computer.
- 2) Move electrical devices that may cause electrical interference.

- **The screen image has color defects.**

- 1) Inspect the USB cable and make sure that none of the pins are bent.
- 2) Turn off the monitor and Restart to see if it still exists.

Any technical problem you meet pls feel free to contact our tech support team [support@qqhmonitor.com] for consulting, we will provide you with the best solution to solve your problem.

Contact us

Any technical problem you meet

Contact us!



: support@qqhmonitor.com

Scan to email!

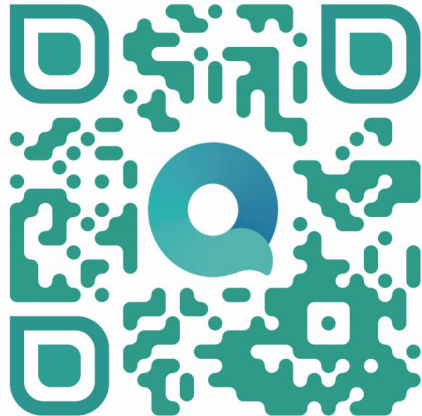

If you have any technical problems with QQH Portable Monitor, Contact us immediately for the best solution.

QQH Provides

[12-Month Warranty]

[1-1 Professional Service]

[24/7 After-sales Consultation]