

MODEL SR850

DSP Lock-In Amplifier



1290-D Reamwood Avenue
Sunnyvale, California 94089
Phone: (408) 744-9040 • Fax: (408) 744-9049
email: info@thinkSRS.com • www.thinkSRS.com

Copyright © 1992 by SRS, Inc.
All Rights Reserved.

Revision 2.0 (01/2009)

TABLE OF CONTENTS

GENERAL INFORMATION

Safety and Preparation for Use	1-3
Specifications	1-5
Abridged Command List	1-7

GETTING STARTED

Your First Measurements	2-1
The Basic Lock-in	2-3
Displays and Traces	2-7
Outputs, Offsets and Expands	2-13
Scans and Sweeps	2-17
Using the Disk Drive	2-23
Aux Outputs and Inputs	2-31
Trace Math	2-35

SR850 BASICS

What is a Lock-in Amplifier?	3-1
What Does a Lock-in Measure?	3-3
The SR850 Functional Diagram	3-5
Reference Channel	3-7
Phase Sensitive Detectors	3-9
Time Constants and DC Gain	3-11
DC Outputs and Scaling	3-13
Dynamic Reserve	3-17
Signal Input Amplifier and Filters	3-19
Input Connections	3-21
Intrinsic (Random) Noise Sources	3-23
External Noise Sources	3-25
Noise Measurements	3-27

OPERATION

FRONT PANEL	4-1
Power On/Off and Power On Tests	4-1
Video Display	4-1
Soft Keys	4-2
Keypad	4-2
Spin Knob	4-2
Disk Drive	4-2
Front Panel BNC Connectors	4-2

SCREEN DISPLAY	4-5
Default Display	4-5
Data Traces	4-6
Single/Dual Trace Displays	4-7
Bar Graphs	4-9
Polar Graphs	4-10
Strip Charts	4-11
Trace Scans, Sweeps and Aliasing	4-13
Settings and Input/Output Monitor	4-15
Menu Display	4-15
Status Indicators	4-16

KEYPAD	4-19
Normal and Alternate Keys	4-19
Menu Keys	4-19

Additional Menus	4-20
Entry Keys	4-20
START/CONT and PAUSE/RESET	4-20
CURSOR	4-21
ACTIVE DISPLAY	4-21
MARK	4-21
CURSOR MAX/MIN	4-22
AUTO RESERVE	4-22
AUTO GAIN	4-22
AUTO PHASE	4-22
AUTO SETUP	4-22
AUTOSCALE	4-22
PRINT to a PRINTER	4-23
PRINT to a FILE	4-23
HELP	4-23
LOCAL	4-23

REAR PANEL	4-25
Power Entry Module	4-25
IEEE-488 Connector	4-25
RS232 Connector	4-25
Parallel Printer Connector	4-25
PC Keyboard Connector	4-25
Rear Panel BNC Connectors	4-26
Aux Inputs (A/D Inputs)	4-26
Aux Outputs (D/A Outputs)	4-26
X and Y Outputs	4-26
Signal Monitor Output	4-26
Trigger Input	4-27
TTL Sync Output	4-27
Preamplifier Connector	4-27

USING SRS PREAMPS	4-27
--------------------------	------

MENUS

Menu Guide	5-1
Default Settings	5-2
Reference and Phase Menu	5-3
Input and Filters Menu	5-7
Gain and Time Constant Menu	5-9
Output and Offset Menu	5-15
Trace and Scan Menu	5-17
Display and Scale Menu	5-21
Aux Outputs Menu	5-25
Cursor Setup Menu	5-29
Edit Mark Menu	5-31
Math Menu	5-33
Disk Menu	5-41
System Setup Menu	5-49

PROGRAMMING

GPIB Communications	6-1
RS232 Communications	6-1
Status Indicators and Queues	6-1
Command Syntax	6-1

Table of Contents

Interface Ready and Status	6-2	SERVICE	
GET (Group Execute Trigger)	6-2	Circuit Boards	8-1
DETAILED COMMAND LIST	6-3	Adjusting DC Offset and CMRR	8-3
Reference and Phase	6-4	Adjusting Notch Filters	8-6
Input and Filter	6-6	CIRCUITRY	
Gain and Time Constant	6-7	Circuit Boards	9-1
Output and Offset	6-9	Video Driver and CRT	9-1
Trace and Scan	6-10	CPU Board	9-3
Display and Scale	6-11	Power Supply Board	9-5
Cursor	6-13	DSP Logic Board	9-7
Mark	6-14	Analog Input Board	9-9
Aux Input and Output	6-15	PARTS LISTS	
Math	6-16	Power Supply Board	9-11
Store and Recall	6-18	DSP Logic Board	9-13
Setup	6-19	Analog Input Board	9-20
Print and Plot	6-21	CPU Board	9-27
Front Panel and Auto Functions	6-22	Chassis Assembly	9-32
Data Transfer	6-23	Miscellaneous	9-35
Interface	6-28	SCHEMATIC DIAGRAMS	
Status Reporting	6-29	CPU Board	
STATUS BYTE DEFINITIONS	6-30	Power Supply Board	
Serial Poll Status Byte	6-30	DSP Logic Board	
Service Requests	6-31	Analog Input Board	
Standard Event Status Byte	6-31	PROGRAM EXAMPLES	
LIA Status Byte	6-32	Microsoft C, National Instr GPIB	6-33
Error Status Byte	6-32	QUICKBASIC, National Instr GPIB	6-39
PROGRAM EXAMPLES		TESTING	
Microsoft C, National Instr GPIB	6-33	Introduction	7-1
QUICKBASIC, National Instr GPIB	6-39	Preset	7-1
TESTING		Serial Number	7-1
Introduction	7-1	Firmware Revision	7-1
Preset	7-1	General Installation	7-2
Serial Number	7-1	Necessary Equipment	7-3
Firmware Revision	7-1	If A Test Fails	7-3
General Installation	7-2	PERFORMANCE TESTS	
Necessary Equipment	7-3	Self Tests	7-5
If A Test Fails	7-3	DC Offset	7-7
PERFORMANCE TESTS		Common Mode Rejection	7-9
Self Tests	7-5	Amplitude Accuracy and Flatness	7-11
DC Offset	7-7	Amplitude Linearity	7-13
Common Mode Rejection	7-9	Frequency Accuracy	7-15
Amplitude Accuracy and Flatness	7-11	Phase Accuracy	7-17
Amplitude Linearity	7-13	Sine Output Amplitude	7-19
Frequency Accuracy	7-15	DC Outputs and Inputs	7-21
Phase Accuracy	7-17	Input Noise	7-23
Sine Output Amplitude	7-19	PERFORMANCE TEST RECORD	7-25
DC Outputs and Inputs	7-21		
Input Noise	7-23		
PERFORMANCE TEST RECORD	7-25		

SAFETY AND PREPARATION FOR USE

WARNING

Dangerous voltages, capable of causing injury or death, are present in this instrument. Use extreme caution whenever the instrument covers are removed. Do not remove the covers while the unit is plugged into a live outlet.

CAUTION

This instrument may be damaged if operated with the LINE VOLTAGE SELECTOR set for the wrong AC line voltage or if the wrong fuse is installed.

LINE VOLTAGE SELECTION

The SR850 operates from a 100V, 120V, 220V, or 240V nominal AC power source having a line frequency of 50 or 60 Hz. Before connecting the power cord to a power source, verify that the LINE VOLTAGE SELECTOR card, located in the rear panel fuse holder, is set so that the correct AC input voltage value is visible.

Conversion to other AC input voltages requires a change in the fuse holder voltage card position and fuse value. Disconnect the power cord, open the fuse holder cover door and rotate the fuse-pull lever to remove the fuse. Remove the small printed circuit board and select the operating voltage by orienting the printed circuit board so that the desired voltage is visible when pushed firmly into its slot. Rotate the fuse-pull lever back into its normal position and insert the correct fuse into the fuse holder.

LINE FUSE

Verify that the correct line fuse is installed before connecting the line cord. For 100V/120V, use a 1 Amp fuse and for 220V/240V, use a 1/2 Amp fuse.

LINE CORD

The SR850 has a detachable, three-wire power cord for connection to the power source and to a protective ground. The exposed metal parts of the instrument are connected to the outlet ground to protect against electrical shock. Always use an

outlet which has a properly connected protective ground.

SERVICE

Do not attempt to service or adjust this instrument unless another person, capable of providing first aid or resuscitation, is present.

Do not install substitute parts or perform any unauthorized modifications to this instrument. Contact the factory for instructions on how to return the instrument for authorized service and adjustment.

FURNISHED ACCESSORIES

- Power Cord
- Operating Manual

ENVIRONMENTAL CONDITIONS

OPERATING

Temperature: +10° C to +40° C
(Specifications apply over +18° C to +28° C)
Relative Humidity: <90% Non-condensing

NON-OPERATING

Temperature: -25° C to 65° C
Humidity: <95% Non-condensing

WARNING REGARDING USE WITH PHOTOMULTIPLIERS AND OTHER DETECTORS

The front end amplifier of this instrument is easily damaged if a photomultiplier is used improperly with the amplifier. When left completely unterminated, a cable connected to a PMT can charge to several hundred volts in a relatively short time. If this cable is connected to the inputs of the SR850 the stored charge may damage the front-end op amps. To avoid this problem, always discharge the cable and connect the PMT output to the SR850 input before turning the PMT on.

SR850 DSP LOCK-IN AMPLIFIER

SPECIFICATIONS

SIGNAL CHANNEL

Voltage Inputs	Single-ended (A) or differential (A-B).
Current Input	10^6 or 10^8 Volts/Amp.
Full Scale Sensitivity	2 nV to 1 V in a 1-2-5-10 sequence (expand off).
Input Impedance	Voltage: 10 M Ω +25 pF, AC or DC coupled. Current: 1 k Ω to virtual ground.
Gain Accuracy	$\pm 1\%$ from 20°C to 30°C (notch filters off), $\pm 0.2\%$ typical.
Input Noise	6 nV/ $\sqrt{\text{Hz}}$ at 1 kHz (typical).
Signal Filters	60 (50) Hz and 120(100) Hz notch filters (Q=4).
CMRR	100 dB at 10 kHz (DC Coupled), decreasing by 6 db/octave above 10 kHz
Dynamic Reserve	Greater than 100 dB (with no signal filters).
Harmonic Distortion	<-90 dB to 10 kHz, <-80 dB to 100 kHz.

REFERENCE CHANNEL

Frequency Range	1 mHz to 102 kHz
Reference Input	TTL (rising or falling edge) or Sine. Sine input is 1 M Ω , AC coupled (>1 Hz). 400 mV pk-pk minimum signal.
Phase Resolution	0.001°
Absolute Phase Error	<1°
Relative Phase Error	<0.001°
Orthogonality	90° \pm 0.001°
Phase Noise	External synthesized reference: 0.005° rms at 1 kHz, 100 ms, 12 dB/oct. Internal reference: crystal synthesized, <0.0001° rms at 1 kHz.
Phase Drift	<0.01°/°C below 10 kHz <0.1°/°C to 100 kHz
Harmonic Detect	Detect at Nxf where N<32767 and Nxf<102 kHz.
Acquisition Time	(2 cycles + 5 ms) or 40 ms, whichever is greater.

DEMODULATOR

Zero Stability	Digital displays have no zero drift on all dynamic reserves. Analog outputs: <5 ppm/°C for all dynamic reserves.
Time Constants	10 μ s to 30 s (reference > 200 Hz). 6, 12, 18, 24 dB/oct rolloff. up to 30000 s (reference < 200 Hz). 6, 12, 18, 24 dB/oct rolloff. Synchronous filtering available below 200 Hz.
Harmonic Rejection	-90 dB

INTERNAL OSCILLATOR

Frequency	1 mHz to 102 kHz.
Frequency Accuracy	25 ppm + 30 μ Hz
Frequency Resolution	5 digits or 0.1 mHz, whichever is greater.
Frequency Sweeps	Linear and Log.
Distortion	f<10 kHz, below -80 dBc. f>10 kHz, below -70 dBc. 1 Vrms amplitude.
Output Impedance	50 Ω
Amplitude	4 mVrms to 5 Vrms (into a high impedance load) with 2 mV resolution. (2 mVrms to 2.5 Vrms into 50 Ω load).
Amplitude Accuracy	1%
Amplitude Stability	50 ppm/°C
Outputs	Sine output on front panel. TTL sync output on rear panel. When using an external reference, both outputs are phase locked to the external reference.

SR850 DSP Lock-In Amplifier

INPUTS AND OUTPUTS

Channel 1 Output	X, R, ϕ , or Trace 1-4. Traces are defined as $A \cdot B/C$ or $A \cdot B/C^2$ where A, B, and C are selected from the quantities Unity, X, Y, R, ϕ , Xnoise, Ynoise, Rnoise, Aux Inputs 1 through 4, or Frequency. Output Voltage: ± 10 V full scale. 10 mA max output current.
Channel 2 Output	Y, R, ϕ , or Trace 1-4. Traces are defined as $A \cdot B/C$ or $A \cdot B/C^2$ where A, B, and C are selected from the quantities Unity, X, Y, R, ϕ , Xnoise, Ynoise, Rnoise, Aux Inputs 1 through 4, or Frequency. Output Voltage: ± 10 V full scale. 10 mA max output current.
X and Y Outputs	Rear panel outputs of cosine (X) and sine (Y) components. Output Voltage: ± 10 V. 10 mA max output current.
Aux. Outputs	4 BNC Digital to Analog outputs. ± 10 V full scale, 1 mV resolution. May be set to a fixed voltage or swept in amplitude (linear or log). 10 mA max output current.
Aux. Inputs	4 BNC Analog to Digital inputs. Differential inputs with $1\text{ M}\Omega$ input impedance on both shield and center conductor. ± 10 V full scale, 1 mV resolution.
Trigger Input	TTL trigger input triggers each data sample and/or start of scan.
Monitor Output	Analog output of signal amplifiers (before the demodulator).

DISPLAYS

Screen Format	Single or dual display.
Displayed Quantities	Each display may show one of the traces. Traces are defined as $A \cdot B/C$ or $A \cdot B/C^2$ where A, B and C are selected from the quantities Unity, X, Y, R, ϕ , Xnoise, Ynoise, Rnoise, Aux Inputs 1 through 4, or Frequency.
Display Types	Large numeric readout with bar graph, polar graph, and strip chart.
Chart Data Buffer	64k data points may be stored and displayed on strip charts. The buffer can be configured as a single trace with 64k points, 2 traces with 32k points each, or 4 traces with 16k points each. The internal data sample rate ranges from 512 Hz down to 1 point every 16 seconds. Samples can also be triggered.

ANALYSIS FUNCTIONS

Smoothing	5 - 25 point Savitsky-Golay smoothing of trace regions.
Curve Fits	Line, Exponential, and Gaussian fits of trace regions.
Calculator	Arithmetic, trigonometric, and logarithmic calculations on trace regions.
Statistics	Mean and standard deviation of trace regions.

GENERAL

Monitor	Monochrome CRT. 640H by 480V resolution. Adjustable brightness and screen position.
Interfaces	IEEE-488, RS232 and Printer interfaces standard. All instrument functions can be controlled through the IEEE-488 and RS232 interfaces. A PC keyboard input is provided for additional flexibility.
Preamp Power	Power connector for SR550 and SR552 preamplifiers.
Hardcopy	Screen dumps to dot matrix and HP LaserJet compatible printers. Data plots to HP-GL compatible plotters (via RS232 or IEEE-488). Screens can also be saved to disk as PCX image files.
Disk	3.5 inch DOS compatible format, 720 kbyte capacity. Storage of data and setups.
Power	60 Watts, 100/120/220/240 VAC, 50/60 Hz.
Dimensions	17"W x 6.25"H x 19.5"D
Weight	40 lbs.
Warranty	One year parts and labor on materials and workmanship.

COMMAND LIST

VARIABLES	i,j,k,l,m	Integers
	f	Frequency (real)
	x,y,z	Real Numbers
	s	String
REFERENCE and PHASE	<u>page</u>	<u>description</u>
PHAS (?) {x}	6-4	Set (Query) the Phase Shift to x degrees.
FMOD (?) {}	6-4	Set (Query) the Reference Source to Internal (0), Sweep (1), or External (2).
FREQ (?) {}	6-4	Set (Query) the Reference Frequency to f Hz. Set only in Internal reference mode.
SWPT (?) {}	6-4	Set (Query) the Internal Sweep Type to Linear (0) or logarithmic (1).
SLLM (?) {}	6-4	Set (Query) the Start Frequency to f Hz. Set only in Internal Sweep mode.
SULM (?) {}	6-4	Set (Query) the Stop Frequency to f Hz. Set only in Internal Sweep mode.
RSLP (?) {}	6-4	Set (Query) the External Reference Slope to Sine(0), TTL Rising (1), or TTL Falling (2).
HARM (?) {}	6-5	Set (Query) the Detection Harmonic to 1 i 32767 and i*f 102 kHz.
SLVL (?) {x}	6-5	Set (Query) the Sine Output Amplitude to x Vrms. 0.004 x 5.000.
INPUT and FILTER	<u>page</u>	<u>description</u>
ISRC (?) {}	6-6	Set (Query) the Input Configuration to A (0), A-B (1), or I (2).
IGAN (?) {}	6-6	Set (Query) the Current Conversion Gain to 1 M (0) or 100 M (1).
IGND (?) {}	6-6	Set (Query) the Input Shield Grounding to Float (0) or Ground (1).
ICPL (?) {}	6-6	Set (Query) the Input Coupling to AC (0) or DC (1).
ILIN (?) {}	6-6	Set (Query) the Line Notch Filters to Out (0), Line In (1), 2xLine In (2), or Both In (3).
GAIN and TIME CONSTANT	<u>page</u>	<u>description</u>
SENS (?) {}	6-7	Set (Query) the Sensitivity to 2 nV (0) through 1 V (26) rms full scale.
RMOD (?) {}	6-7	Set (Query) the Dynamic Reserve Mode to Max (0), Manual (1), or Min (2).
RSRV (?) {}	6-7	Set (Query) the Dynamic Reserve to i th reserve. Set will switch to Manual Reserve Mode.
OFLT (?) {}	6-7	Set (Query) the Time Constant to 10 μs (0) through 30 ks (19).
OFSL (?) {}	6-8	Set (Query) the Low Pass Filter Slope to 6 (0), 12 (1), 18 (2) or 24 (3) dB/oct.
SYNC (?) {}	6-8	Set (Query) the Synchronous Filter to Off (0) or On below 200 Hz (1).
OUTPUT and OFFSET	<u>page</u>	<u>description</u>
FOUT (?) i {}, j}	6-9	Set (Query) the CH1 (i=1) or CH2 (2) Output Source to XY,R, , Trace 1, 2, 3, 4 (j=0...6).
OEXP (?) i {}, x, j}	6-9	Set (Query) the X, Y, R (i=1,2,3) Offset to x percent and Expand to j. -105.00 x 105.00 and 1 j 256.
AOFF i	6-9	Auto Offset X, Y, R (i=1,2,3).
TRACE and SCAN	<u>page</u>	<u>description</u>
TRCD (?) i {}, j, k, l, m}	6-10	Set (Query) the Definition of Trace i (1-4) to j*k/l and Store (m=1) or Not Store (0). j, k, l select 1, X, Y, R, q, Xn, Yn, Rn, Aux 1, Aux 2, Aux 3, Aux4, or F (j,k,l = 0...12). l=13-24 selects X ² through F ² .
SRAT (?) {}	6-10	Set (Query) the Sample Rate to 62.5 mHz (0) through 512 Hz (13) or Trigger (14).
SLEN (?) {x}	6-10	Set (Query) the Scan Length to x seconds.
SEND (?) {}	6-10	Set (Query) the Scan Mode to 1 Shot (0) or Loop (1).
TRIG	6-10	Software trigger command. Same as trigger input.
DISPLAY and SCALE	<u>page</u>	<u>description</u>
ASCL	6-11	Auto Scale the active display.
ADSP (?) {}	6-11	Set (Query) the active display to Full (0), Top (1) or Bottom (2). Full screen is always active.
SMOD (?) {}	6-11	Set (Query) the Screen Format to Single (0) or Up/Down dual (1) display mode.
MNTR (?) {}	6-11	Set (Query) the Monitor Display to settings (0) or Input/Output (1).
DTYP (?) i {}, j}	6-11	Set (Query) the Full (i=0), Top (i=1) or Bottom (i=2) Display Type to Polar (j=0), Blank (j=1), Bar (j=2) or Chart (j=3).

DTRC (?) i {, j}	6-11	Set (Query) theFull (i=0), Top (i=1) or Bottom (i=2) Display Trace to trace j (1,2,3,4).
DSCL (?) {x}	6-11	Set (Query) theFull (i=0), Top (i=1) or Bottom (i=2) Display Range to x.
DOFF (?) {x}	6-11	Set (Query) theFull (i=0), Top (i=1) or Bottom (i=2) Display Center value to x.
DHZZ (?) {i}	6-12	Set (Query) theFull (i=0), Top (i=1) or Bottom (i=2) Display Horizontal Scale to 2 ms (0) through 200 ks (32) per div.
RBIN? i	6-12	Query the bin number at the right edge of the Full (i=0), Top (i=1) or Bottom (i=2) chart display.

CURSOR

	<u>page</u>	<u>description</u>
CSEK (?) {i}	6-13	Set (Query) the active display Cursor Seek mode to Max (0), Min (1) or Mean (2).
CWID (?) {i}	6-13	Set (Query) the active display Cursor Width to Off (0), Narrow (1), Wide (2) or Spot (3).
CDIV (?) {i}	6-13	Set (Query) the active display Chart Divisions to 8 (0), 10 (1) or None (2).
CLNK (?) {i}	6-13	Set (Query) the Cursor Control Mode to Linked (0) or Separate (1).
CDSP (?) {i}	6-13	Set (Query) the active display Cursor Readout to Delay (0), Bin (1), Fswep (2) or Time (3).
CMAX	6-13	Move active chart cursor to max or min. Same as pressing [CURSOR MAX/MIN] key.
CURS? i	6-13	Query the cursor horz,vert position of Full (0), Top (1) or Bottom (2) chart display.
CBIN (?) {i}	6-13	Set (Query) the center of the cursor region in the active chart display. i is the bin number.

MARK

	<u>page</u>	<u>description</u>
MARK	6-14	Places a mark in the data buffer. Same as pressing [MARK] key.
MDEL	6-14	Delete the nearest mark to the left of the cursor. Same as pressing <Marker Delete> softkey.
CNXT	6-14	Move active chart cursor to next mark to the right.
CPRV	6-14	Move active chart cursor to next mark to the left.
MACT?	6-14	Query the number of active marks. Also returns the active mark numbers.
MBIN? i	6-14	Query the bin number of mark #i.
MTXT (?) i {,s}	6-14	Set (Query) the label text for mark #i.

AUX INPUT/OUTPUT

	<u>page</u>	<u>description</u>
OAUX ? i	6-15	Query the value of Aux Input i (1,2,3,4).
AUXM(?) i{, j}	6-15	Set (Query) the Output Mode of Aux Output i (1,2,3,4). j selects Fixed (0), Log (1) or Linear (2).
AUXV (?) i {, x}	6-15	Set (Query) voltage of Aux Output i (1,2,3,4) to x Volts. -10.500 x 10.500. Fixed Output Mode only.
SAUX (?) i {, x, y, z}	6-15	Set (Query) the Aux Output i (1,2,3,4) Sweep Limits to Start (x), Stop (y) and Offset (z) voltages. 0.001 x,y 21.000 and -10.500 z 10.500.
TSTR (?) {i}	6-15	Set (Query) the Trigger Starts Scan? mode to No (0) or Yes (1).

MATH

	<u>page</u>	<u>description</u>
SMTH i	6-16	Smooth the data within the active chart using 5 (0), 11 (1), 17 (2), 21 (3), 25 (4) point width.
COPR (?) {i}	6-16	Set (Query) the Calculator Operation to +, -, x, /, sin, cos, tan, x, x ² , log, 10 ^x (i=0...10).
CALC	6-17	Do the Calculation selected by COPR with the argument set by CTRC or CARG.
CAGT (?) {i}	6-17	Set (Query) the Calculation Argument Type to Trace (0) or Constant (1).
CTRC (?) {i}	6-17	Set (Query) the Trace Argument to Trace i (1,2,3,4).
CARG (?) {x}	6-17	Set (Query) the Constant Argument value to x.
FTYP (?) {i}	6-17	Set (Query) the Fit Type to Linear (0), Exponential (1) or Gaussian (2).
FITT i, j	6-17	Fit the data within the chart region between i% and j% from the left edge. 0 i,j 100.
PARS ? i	6-17	Query the fit parameters a (0), b (1), c (2) or t0 (3).
STAT i, j	6-17	Statistically analyze the data within the chart region between i% and j% from the left edge. 0 i,j 100.
SPAR ? i	6-17	Query the Statistical results mean (0), standard dev (1), total (2) or delta time (3).

STORE AND RECALL FILE

	<u>page</u>	<u>description</u>
FNAM (?) {s}	6-18	Set (Query) the current File Name to string s.
SDAT	6-18	Save the Active Display's Trace Data to the file specified by FNAM.
SASC	6-18	Save the Active Display's Trace Data in ASCII format to the file specified by FNAM.
SSET	6-18	Save the Settings to the file specified by FNAM.

RDAT	6-18	Recall the Trace Data from the file specified by FNAM to the active display's trace buffer.
RSET	6-18	Recall the Settings from the file specified by FNAM.

SETUP

	<u>page</u>	<u>description</u>
OUTX (?) {i}	6-19	Set (Query) the Output Interface to RS232 (0) or GPIB (1).
OVRM (?) {i}	6-19	Set (Query) the GPIB Override Remote state to Off (0) or On (1).
KCLK (?) {i}	6-19	Set (Query) the Key Click to Off (0) or On (1).
ALRM (?) {i}	6-19	Set (Query) the Alarms to Off (0) or On (1).
THRS (?) {i}	6-19	Set (Query) the Hours to 0 i 23.
TMIN (?) {i}	6-19	Set (Query) the Minutes to 0 i 59.
TSEC (?) {i}	6-19	Set (Query) the Seconds to 0 i 59.
DMTH (?) {i}	6-19	Set (Query) the Month to 1 1 12.
DDAY (?) {i}	6-19	Set (Query) the Day to 1 1 31.
DYRS (?) {i}	6-19	Set (Query) the Year to 0 1 99.
PLTM (?) {i}	6-19	Set (Query) the Plotter Mode to RS232 (0) or GPIB (1).
PLTB (?) {i}	6-19	Set (Query) the Plotter Baud Rate to 300 (0), 1200 (1), 2400 (2), 4800 (3), 9600 (4).
PLTA (?) {i}	6-19	Set (Query) the Plotter GPIB Address to 0 i 30.
PLTS (?) {i}	6-19	Set (Query) the Plot Speed to Fast (0) or Slow (1).
PNTR (?) {i}	6-19	Set (Query) the Trace Pen Number to 1 i 6.
PNGD (?) {i}	6-20	Set (Query) the Grid Pen Number to 1 i 6.
PNAL (?) {i}	6-20	Set (Query) the Alphanumeric Pen Number to 1 i 6.
PNCR (?) {i}	6-20	Set (Query) the Cursor Pen Number to 1 i 6.
PRNT (?) {i}	6-20	Set (Query) the Printer Type to Epson (0), HP (1) or File (2).

PRINT AND PLOT

	<u>page</u>	<u>description</u>
PRSC	6-21	Print the screen. Same as the [PRINT] key.
PALL	6-21	Plot the display(s).
PTRC	6-21	Plot the trace(s) only.
PCUR	6-21	Plot the cursor(s) only.

FRONT PANEL CONTROLS

AUTO FUNCTIONS

	<u>page</u>	<u>description</u>
STRT	6-22	Start or continue a scan. Same as [START/CONT] key.
PAUS	6-22	Pause a scan. Does not reset a paused or done scan.
REST	6-22	Reset the scan. All stored data is lost.
ASCL	6-11	Auto Scale the active display.
ATRC (?) {i}	6-22	Set (Query) the active display to Top (0) or Bottom (1). Full screen is always active.
AGAN	6-22	Auto Gain function. Same as pressing the [AUTO GAIN] key.
ARSV	6-22	Auto Reserve function. Same as pressing the [AUTO RESERVE] key.
APHS	6-22	Auto Phase function. Same as pressing the [AUTO PHASE] key.
AOFF i	6-22	Auto Offset X,Y or R (i=1,2,3).
CMAX	6-22	Move Cursor to Max or Min. Same as pressing the [CURSOR MAX/MIN] key.

DATA TRANSFER

	<u>page</u>	<u>description</u>
OUTP? i	6-23	Query the value of X (1), Y (2), R (3) or (4). Returns ASCII floating point value.
OUTR? i	6-23	Query the value of Trace i (1,2,3,4). Returns ASCII floating point value.
OAUX? i	6-23	Query the value of Aux Input i (1,2,3,4). Returns ASCII floating point value.
SPTS? i	6-23	Query the number of points stored in Trace i (1,2,3,4).
TRCA? i,j,k	6-23	Read k 1 points starting at bin j 0 from trace i (1,2,3,4) in ASCII floating point.
TRCB? i,j,k	6-23	Read k 1 points starting at bin j 0 from trace i (1,2,3,4) in IEEE binary floating point.
TRCL? i,j,k	6-24	Read k 1 points starting at bin j 0 from trace i (1,2,3,4) in non-normalized binary floating point.
FAST (?) {i}	6-25	Set (Query) Fast Data Transfer Mode On (1 or 2) or Off (0). On will transfer binary X and Y every sample during a scan over the GPIB interface.
STRD	6-25	Start a scan after 0.5sec delay. Use with Fast Data Transfer Mode.

SR850 DSP Lock-In Amplifier

INTERFACE	<u>page</u>	<u>description</u>
*RST	6-26	Reset the unit to its default configurations.
*IDN?	6-26	Read the SR850 device identification string.
LOCL(?) {i}	6-26	Set (Query) the Local/Remote state to LOCAL (0), REMOTE (1), or LOCAL LOCKOUT (2).
OVRM (?) {i}	6-26	Set (Query) the GPIB Override Remote state to Off (0) or On (1).
TRIG	6-26	Software trigger command. Same as trigger input.
STATUS	<u>page</u>	<u>description</u>
*CLS	6-27	Clear all status bytes.
*ESE (?) {i} {,j}	6-27	Set (Query) the Standard Event Status Byte Enable Register to the decimal value i (0-255). *ESE i,j sets bit i (0-7) to j (0 or 1). *ESE? queries the byte. *ESE?i queries only bit i.
*ESR? {i}	6-27	Query the Standard Event Status Byte. If i is included, only bit i is queried.
*SRE (?) {i} {,j}	6-27	Set (Query) the Serial Poll Enable Register to the decimal value i (0-255). *SRE i,j sets bit i (0-7) to j (0 or 1). *SRE? queries the byte, *SRE?i queries only bit i.
*STB? {i}	6-27	Query the Serial Poll Status Byte. If i is included, only bit i is queried.
*PSC (?) {i}	6-27	Set (Query) the Power On Status Clear bit to Set (1) or Clear (0).
ERRE (?) {i} {,j}	6-27	Set (Query) the Error Status Enable Register to the decimal value i (0-255). ERRE i,j sets bit i (0-7) to j (0 or 1). ERRE? queries the byte, ERRE?i queries only bit i.
ERRS? {i}	6-27	Query the Error Status Byte. If i is included, only bit i is queried.
LIAE (?) {i} {,j}	6-27	Set (Query) the LIA Status Enable Register to the decimal value i (0-255). LIAE i,j sets bit i (0-7) to j (0 or 1). LIAE? queries the byte, LIAE?i queries only bit i.
LIAS? {i}	6-27	Query the LIA Status Byte. If i is included, only bit i is queried.

STATUS BYTE DEFINITIONS

SERIAL POLL STATUS BYTE (6-28)

<u>bit</u>	<u>name</u>	<u>usage</u>
0	SCN	No data is being acquired
1	IFC	No command execution in progress
2	ERR	Unmasked bit in error status byte set
3	LIA	Unmasked bit in LIA status byte set
4	MAV	The interface output buffer is non-empty
5	ESB	Unmasked bit in standard status byte set
6	SRQ	SRQ (service request) has occurred
7	Unused	

LIA STATUS BYTE (6-29)

<u>bit</u>	<u>name</u>	<u>usage</u>
0	RESRV	Set when a RESRV overload is detected
1	FILTR	Set when a FILTR overload is detected
2	OUTPT	Set when a OUTPT overload is detected
3	UNLK	Set when reference unlock is detected
4	RANGE	Set when detection freq crosses 200 Hz
5	TC	Set when time constant is changed
6	TRIG	Set when unit is triggered
7	PLOT	Set when a plot is completed

STANDARD EVENT STATUS BYTE (6-29)

<u>bit</u>	<u>name</u>	<u>usage</u>
0	INP	Set on input queue overflow
1	Unused	
2	QRY	Set on output queue overflow
3	Unused	
4	EXE	Set when command execution error occurs
5	CMD	Set when an illegal command is received
6	URQ	Set by any key press or knob rotation
7	PON	Set by power-on

ERROR STATUS BYTE (6-30)

<u>bit</u>	<u>name</u>	<u>usage</u>
0	Prn/Plt Err	Set when an printing or plotting error occurs
1	Backup Error	Set when battery backup fails
2	RAM Error	Set when RAM Memory test finds an error
3	Disk Error	Set when a disk error occurs
4	ROM Error	Set when ROM Memory test finds an error
5	GPIB Error	Set when GPIB binary data transfer aborts
6	DSP Error	Set when DSP test finds an error
7	Math Error	Set when an internal math error occurs

YOUR FIRST MEASUREMENTS

The sample measurements described in this section are designed to acquaint the first time user with the SR850 DSP Lock-In Amplifier. Do not be concerned that your measurements do not exactly agree with these exercises. The focus of these measurement exercises is to learn how to use the instrument.

It is highly recommended that the first time user step through some or all of these exercises before attempting to perform an actual experiment.

The experimental procedures are detailed in two columns. The left column lists the actual steps in the experiment. The right column is an explanation of each step.

Key Types

There are two types of front panel keys which will be referred to in this manual. Hardkeys are those keys with labels printed on them. Their function is determined by the label and does not change. Hardkeys are referenced by brackets like this - [HARDKEY]. The softkeys are the six gray keys along the right edge of the screen. Their function is labelled by a menu box displayed on the screen next to the key. Softkey functions change depending upon the situation. Softkeys will be referred to as the <Soft Key> or simply the Soft Key.

Hardkeys

The keypad consists of five groups of hardkeys. The ENTRY keys are used to enter numeric parameters which have been highlighted by a softkey. The MENU keys select a menu of softkeys. Pressing a menu key will change the menu boxes which are displayed next to the softkeys. Each menu groups together similar parameters and functions. The CONTROL keys start and stop actual data acquisition, select the cursor and toggle the active display. These keys are not in a menu since they are used frequently and while displaying any menu. The SYSTEM keys output the screen to a printer and display help messages. These keys can also be accessed from any menu. The AUTO keys perform auto functions such as Auto Gain and Auto Phase.

Softkeys

The SR850 has a menu driven user interface. The 6 softkeys to the right of the video display have different functions depending upon the information displayed in the menu boxes at the right of the video display. In general, the softkeys have two uses. The first is to toggle a feature on and off or to choose between settings. The second is to highlight a parameter which is then changed using the knob or numeric keypad. In both cases, the softkey selects the parameter which is displayed adjacent to it.

Knob

The knob is used to adjust parameters which have been highlighted by a softkey. Many numeric entry fields may be adjusted with the knob. In addition, many parameters are adjusted only with the knob. These are typically parameters with a limited set of values, such as sensitivity or time constant. In these cases, the parameter is selected by a softkey. The [CURSOR] key will set the knob function to scrolling the cursor within the active chart display.

THE BASIC LOCK-IN

This measurement is designed to use the internal oscillator to explore some of the basic lock-in functions. You will need BNC cables.

Specifically, you will measure the amplitude of the Sine Out at various frequencies, sensitivities, time constants and phase shifts. The "normal" lock-in display will be used throughout this exercise.

1. Disconnect all cables from the lock-in. Turn the power on while holding down the [] (backspace) key. Wait until the power-on tests are completed.

When the power is turned on with the backspace key depressed, the lock-in returns to its default settings. See the Default Settings list in the Menu section for a complete listing of the settings.

The display is the "normal" lock-in display. The lock-in setup is displayed across the top of the screen. The sensitivity, reserve, time constant, prefilters and input configuration are all easily visible. Watch how these indicators change as you change parameters. The upper numeric readout and bar graph shows the value of $X (R\cos \theta)$ and the lower graph shows the the value of $Y (R\sin \theta)$.

2. Connect the Sine Out on the front panel to the A input using a BNC cable.

The input impedance of the lock-in is $10\text{ M}\Omega$. The Sine Out has an output impedance of $50\ \Omega$. Since the Sine Output amplitude is specified into a high impedance load, the output impedance does not affect the amplitude.

The lock-in defaults to the internal oscillator reference set at 1.000 kHz . The reference mode (Intrnl) and frequency are displayed at the bottom of the screen. In this mode, the lock-in generates a synchronous sine output at the internal reference frequency.

The sine amplitude is $1.000\text{ V}_{\text{rms}}$ and the sensitivity is 1 V_{rms} . Since the phase shift of the sine output is very close to zero, the upper display (X) should read close to 1.000 V and the lower display (Y) should read close to 0.000 V .

3. Press [AUTO PHASE]

Automatically adjust the reference phase shift to eliminate any residual phase error. This should set the value of Y to zero.

4. Press [REF/PHASE]

Display the Reference and Phase menu. The phase shift (displayed in the top menu box) should be close to zero.

The Basic Lock-in

5. Press the <Rotate 90 deg> softkey.

This adds 90° to the reference phase shift. The value of X drops to zero and Y becomes minus the magnitude (-1.000 V).

Press the <deg.> softkey.

Highlight the phase shift.

Use the knob to adjust the phase shift until Y is zero and X is equal to the positive amplitude.

The knob can be used to adjust parameters which are continuous, such as phase, amplitude and frequency. The final phase value should be close to zero again.

Press [9] [0] [ENTER]

Phase shifts can also be entered numerically.

Press [AUTO PHASE]

Use the Auto Phase function to return Y to zero and X to the amplitude.

6. Press <Ref. Frequency>

Highlight the internal reference frequency menu.

Press [1] [2] [.] [3] [4] [5] [EXP] [3] [ENTER]

Enter 12.345 kHz in exponential form. The measured signal amplitude should stay within 1% of 1 V and the phase shift should stay close to zero (the value of Y should stay close to zero).

Press [1] [0] [0] [0] [ENTER]

Parameters can be entered in real or integer form as well. In this case, the frequency is changed to 1.000 kHz.

The internal oscillator is crystal synthesized with 25 ppm of frequency error. The frequency can be set with 5 digit or 0.1 mHz resolution, whichever is greater.

7. Press <Sine Output>

Highlight the sine output amplitude.

Use the knob to adjust the amplitude.

As the amplitude is changed, the measured value of X should equal the sine output amplitude.

Press [.] [0] [1] [ENTER]

The amplitude may be entered numerically also.

The sine amplitude can be set from 4 mV to 5 V rms into high impedance (half the amplitude into a 50 load).

8. Press [GAIN/TC]

Display the Gain and Time Constant menu.

Press [AUTO GAIN]

The Auto Gain function will adjust the sensitivity so

- that the measured magnitude (R) is a sizable percentage of full scale.
9. Press <Sensitivity>
- Use the knob to change the sensitivity to 50 mV.
- Change the sensitivity back to 20 mV.
- Highlight the full scale sensitivity.
- Parameters which are discrete values, such as sensitivity and time constant, can only be changed with the knob. Numeric entry is not allowed for these parameters.
10. Press <Time Constant>
- Use the knob to change the time constant to 300 μ s.
- Change the time constant to 3 ms.
- Highlight the time constant.
- The values of X and Y become noisy. This is because the 2f component of the output (at 2 kHz) is no longer attenuated completely by the low pass filters.
- Let's leave the time constant short and change the filter slope.
11. Press the <Filter db/oct.> softkey until 6 dB/oct is selected.
- Parameters which have their available options displayed within the menu box are selected by pressing the corresponding softkey until the desired option is chosen.
- The X and Y outputs are somewhat noisy at this short time constant and only 1 pole of low pass filtering.
- Press <Filter db/oct.> again to select 12 dB/oct.
- The outputs are less noisy with 2 poles of filtering.
- Press <Filter db/oct.> twice to select 24 dB/oct.
- With 4 poles of low pass filtering, even this short time constant attenuates the 2f component reasonably well and provides steady readings.
- Press <Filter db/oct> again to select 6 dB/oct.
- Let's leave the filtering short and the outputs noisy for now.
12. Press [REF/PHASE]
- Display the Reference and Phase menu.
- Press <Ref. Frequency>
- Highlight the internal reference frequency.
- Press [5] [0] [ENTER]
- Enter 50 Hz for the reference frequency. With a 3 ms time constant and only 6 dB/oct of filtering, the output is totally dominated by the 2f component at 50 Hz.

13. Press [GAIN/TC]
Press <Synchronous> to select <200 Hz.

Display the Gain and Time Constant menu again. This turns on synchronous filtering whenever the detection frequency is below 200 Hz.

Synchronous filtering effectively removes output components at multiples of the detection frequency. At low frequencies, this filter is a very effective way to remove $2f$ without requiring extremely long time constants.

The outputs are now very quiet and steady, even though the time constant is very short. The response time of the synchronous filter is equal to the period of the detection frequency (20 ms in this case).

This concludes this measurement example. You should have a feeling for the basic operation of the menus, knob and numeric entry. Basic lock-in parameters have been introduced and you should be able to perform simple measurements.

DISPLAYS and TRACES

This measurement is designed to use the internal oscillator and an external signal source to explore some of the display types. You will need a synthesized function generator capable of providing a 100 mVrms sine wave at 1.000 kHz (the DS345 from SRS will suffice), BNC cables and a terminator appropriate for the generator function output.

Specifically, you will display the lock-in outputs when measuring a signal close to, but not equal to, the internal reference frequency. This setup ensures changing outputs which are more illustrative than steady outputs. The displays will be configured to show X, Y, R and ϕ in bar graph and polar formats. The example Scans and Sweeps demonstrates the use of the chart graph.

1. Disconnect all cables from the lock-in. Turn the power on while holding down the [] (backspace) key. Wait until the power-on tests are completed.

When the power is turned on with the backspace key depressed, the lock-in returns to its default settings. See the Default Settings list in the Menu section for a complete listing of the settings.

The display is the "normal" lock-in display. The lock-in setup is displayed across the top of the screen. The sensitivity, reserve, time constant, prefilters and input configuration are all easily visible. Watch how these indicators change as you change parameters. The upper numeric readout and bar graph shows the value of X ($R\cos\phi$) and the lower graph shows the the value of Y ($R\sin\phi$).

2. Turn on the function generator, set the frequency to 1.0000 kHz (exactly) and the amplitude to 500 mVrms.

Connect the function output (sine wave) from the synthesized function generator to the A input using a BNC cable and appropriate terminator.

The input impedance of the lock-in is 10 M Ω . The generator may require a terminator. Many generators have either a 50 Ω or 600 Ω output impedance. Use the appropriate feedthrough or T termination if necessary. In general, not using a terminator means that the function output amplitude will not agree with the generator setting.

The lock-in defaults to the internal oscillator reference set at 1.000 kHz. The reference mode (Intrnl) and frequency are displayed at the bottom of the screen. In this mode, the internal oscillator sets the detection frequency.

The internal oscillator is crystal synthesized so that the actual reference frequency should be very close to the actual generator frequency. The X and Y displays should read values which change very slowly. The lock-in and the generator are not phase locked but they are at the same frequency with some slowly changing phase.

3. Press [REF/PHASE]

Display the Reference and Phase menu.

Displays and Traces

Press <Ref. Frequency>

Use the knob to change the frequency to 999.80 Hz.

Highlight the internal oscillator frequency.

By setting the lock-in reference 0.2 Hz away from the signal frequency, the X and Y outputs are 0.2 Hz sine waves (difference between reference and signal frequency). The X and Y output displays should now oscillate at about 0.2 Hz (the accuracy is determined by the crystals of the generator and the lock-in).

4. Press [DISPLAY/SCALE]

Display the Display and Scale menu.

The SR850 collects data in the form of traces. There are 4 definable traces and only these trace quantities may be displayed. The default definition of these traces is X, Y, R and for traces 1, 2, 3 and 4.

The Display Scale menu box shows the display parameters for the Full (screen), Top or Bottom (split screen) displays. In this case, the Top display parameters are shown.

Press <Type/Trace> twice to highlight the displayed trace number.

Each display shows one of the data traces. The Top display defaults to showing trace 1 which has a default definition of X. Thus the top bar graph shows the X output.

Use the knob to change the trace number to 3.

Trace 3 has a default definition of R so showing trace 3 on the top graph will display the quantity R.

R is phase independent so it shows a steady value (close to 0.500 V).

Press [AUTO SCALE]

[AUTO SCALE] automatically scales the active display. The top display is the active display (as indicated by the inverse trace identifier at the upper left of the display).

5. Press <Full, Top or Bottom> to select Bottom.

To modify the bottom graph, you must display the bottom graph's parameters in the Display Scale menu box. This also makes the bottom display the active display (for autoscaling). The trace indicator (at the upper left of each display) is highlighted on the active display.

Press <Type/Trace> twice to highlight the displayed trace number.

The bottom display defaults to trace 2 (Y).

Use the knob to change the trace number to 4.

Trace 4 is . The phase between the reference and the signal changes by 360° every 5 sec (0.2 Hz difference frequency).

- Press [AUTO SCALE]
- [AUTO SCALE] automatically scales the active display. In this case, the trace data is moving and autoscaling may not do a very satisfactory job.
- Press the <± Range> softkey. This is the fifth softkey from the top.
- To manually set the graph scale, you set the range (±) and center value (@). The graph displays a scale equal to the center value plus and minus the range.
- Press [1] [8] [0] [ENTER]
- In this case, set the bar graph to ±180°. The bar graph should be a linear phase ramp at 0.2 Hz.
6. Press <Monitor> to select Input/Output.
- The monitor display at the top of the screen monitors either the lock-in settings (sensitivity, time constant, etc.) or the measured lock-in inputs and outputs (X, Y, R, and Aux In 1-4).
- The Input/Output monitor allows you to see all of the measured quantities, even if they are not shown on the larger displays.
7. Press <Format> to select Single.
- The screen is now setup for a single display. The default display type for the full screen display is a polar graph.
- The polar graph plots the quantities X and Y on an X-Y axis. The resulting vector has a length equal to the magnitude R and has a phase angle relative to the positive X axis equal to θ . In this case, since the phase is rotating at the difference frequency, the vector rotates at 0.2 Hz.
8. Press [REF/PHASE]
- Display the Reference and Phase menu.
- Press <Ref. Frequency>
- Highlight the internal oscillator frequency.
- Use the knob to adjust the frequency slowly to try to stop the rotation of the signal vector.
- As the internal reference frequency gets closer to the signal frequency, the rotation gets slower and slower. If the frequencies are EXACTLY equal, then the phase is constant.
9. Use a BNC cable to connect the TTL SYNC output from the generator to the Reference Input of the lock-in.
- By using the signal source as the external reference, the lock-in will phase lock its internal oscillator to the signal frequency and the phase will be a constant.
- Press <Ref. Source>
- Highlight the reference source.
- Use the knob to select External.
- Select external reference mode. The lock-in will phase lock to the signal at the Reference Input.

Displays and Traces

Press <Ref. Slope> to select Rising Edge.

With a TTL reference signal, the slope needs to be set to either rising or falling edge.

The signal vector on the polar graph will not rotate since the phase is a constant. The actual phase depends upon the phase difference between the function output and the sync output from the generator.

The external reference frequency (as measured by the lock-in) is displayed at the bottom of the screen. The reference mode is shown as Ext+ for external TTL rising edge. The LOCK indicator should be on (successfully locked to the external reference).

10. Press [DISPLAY/SCALE]

Display the Display and Scale menu.

Press <Format> to select Up/Down.

Change the screen to dual display mode again.

11. Press [TRACE/SCAN]

Display the Trace and Scan menu.

Press <1 / 2 / 3 / 4> to select trace 3.

Trace 3 is defined as R and is displayed on the top graph. Let's change the definition of trace 3 to something else.

Press the second softkey, next to the trace definition, to highlight the R.

Traces are defined as $A \cdot B / C$. The quantities A, B, and C are selected from the various quantities measured by the lock-in.

Use the knob to change the A parameter from R to X.

Trace 3 has now been redefined to be X. The top graph now displays X. The trace definition is shown at the upper left of each graph.

Press the second softkey to highlight the denominator (C) of the trace definition.

Traces may be defined to be ratios and products of 2 or 3 quantities.

Use the knob to change the C parameter from 1 to R.

Trace 3 is now defined as X/R and is equal to $\cos \theta$, independent of the signal amplitude. The traces can be defined to display the most useful quantities for a given experiment. Trace data may be stored in the data buffers. Scans and chart graphs will be discussed in a later example.

12. Press [REF/PHASE]

Change the reference phase shift to check that trace 3 displays $\cos \theta$.

Press [AUTO PHASE]

Automatically adjust the measured phase shift to zero. The top display should show $\cos 0^\circ$ or 1.

Press <deg.>

Highlight the phase shift.

Using the keypad, enter a phase shift which is 45° greater than the displayed phase shift.

At a measured phase shift of 45° , trace 3 should equal $\cos 45^\circ$ or 0.707.

This concludes this measurement example. You should have a feeling for the basic operation of the display types and trace definitions.

OUTPUTS, OFFSETS and EXPANDS

This measurement is designed to use the internal oscillator to explore some of the basic lock-in outputs. You will need BNC cables and a digital voltmeter (DVM).

Specifically, you will measure the amplitude of the Sine Out and provide analog outputs proportional to the measurement. The effect of offsets and expands on the displayed values and the analog outputs will be explored.

1. Disconnect all cables from the lock-in. Turn the power on while holding down the [] (backspace) key. Wait until the power-on tests are completed.

When the power is turned on with the backspace key depressed, the lock-in returns to its default settings. See the Default Settings list in the Menu section for a complete listing of the settings.

The display is the "normal" lock-in display. The lock-in setup is displayed across the top of the screen. The sensitivity, reserve, time constant, prefilters and input configuration are all easily visible. Watch how these indicators change as you change parameters. The upper numeric readout and bar graph shows the value of X ($R\cos$) and the lower graph shows the the value of Y ($R\sin$).

2. Connect the Sine Out on the front panel to the A input using a BNC cable.

The input impedance of the lock-in is 10 M Ω . The Sine Out has an output impedance of 50 Ω . Since the Sine Output amplitude is specified into a high impedance load, the output impedance does not affect the amplitude.

The lock-in defaults to the internal oscillator reference set at 1.000 kHz. The reference mode (Intrnl) and frequency are displayed at the bottom of the screen. In this mode, the lock-in generates a synchronous sine output at the internal reference frequency.

The sine amplitude is 1.000 Vrms and the sensitivity is 1 V(rms). Since the phase shift of the sine output is very close to zero, the upper display (X) should read close to 1.000 V and the lower display (Y) should read close to 0.000 V.

3. Connect the CH1 output on the front panel to the DVM. Set the DVM to read DC Volts.

The CH1 output defaults to X. The output voltage is simply $(X/\text{Sensitivity} - \text{Offset}) \times \text{Expand} \times 10\text{V}$. In this case, $X = 1.000\text{ V}$, the sensitivity = 1 V, the offset is zero percent and the expand is 1. The output should thus be 10 V or 100% of full scale.

Outputs, Offsets and Expands

4. Press [REF/PHASE] Display the Reference and Phase menu.
- Press <Sine Output> Highlight the sine output amplitude.
- Press [.] [5] [ENTER] Enter an amplitude of 0.5 V. The top display should show X=0.5 V and the CH1 output should be 5 V on the DVM.
5. Press [OUTPUT/OFFSET] Display the Output and Offset menu. This menu chooses which measured parameters or traces are output on CH1 and CH2. In addition, the X, Y and R offsets and expands are programmed in this menu.
- The Offset & Expand menu box displays the offset and expand of either X, Y or R. In this case, the X offset and expand is displayed. The <X,Y,R> soft-key selects the which offset and expand is displayed.
- Press <Auto Offset> Auto Offset automatically adjusts the Xoffset (or Y or R) such that X (or Y or R) becomes zero. The offset should be about 50% in this case. Offsets are useful for making relative measurements. In analog lock-ins, offsets were generally used to remove DC output errors from the lock-in itself. The SR850 has no DC output errors and the offset is not required for most measurements.
- The offset affects both the displayed value of X and any analog output proportional to X. The CH1 output should be zero in this case.
- The highlighted OFFST indicator turns on at the bottom left of the top display to indicate that the displayed trace is affected by an offset.
- Press <Offset> Highlight the X offset.
- Press [4] [0] [ENTER] Enter an offset of 40% of full scale. The output offsets are a percentage of full scale. The percentage does not change with the sensitivity. The displayed value of X should be 0.100 V (0.5 V - 40% of full scale). The CH1 output voltage is $(X/\text{Sensitivity} - \text{Offset}) \times \text{Expand} \times 10\text{V}$.
- $$\text{CH1 Out} = (0.5/1.0 - 0.4) \times 1 \times 10\text{V} = 1 \text{ V}$$
- Press <Expand> Highlight the X expand.
- Set the expand to 10 using the knob or the numeric entry keys. With an expand of 10, the display has one more digit of resolution (100.XX mV).

The highlighted EXPD indicator turns on at the bottom left of the top display to indicate that the displayed trace is affected by an expand.

The CH1 output is $(X/\text{Sensitivity} - \text{Offset}) \times \text{Expand} \times 10\text{V}$. In this case, the output voltage is

$$\text{CH1 Out} = (0.5/1.0 - 0.4) \times 10 \times 10\text{V} = 10\text{V}$$

The expand allows the output gain to be increased by up to 256. The output voltage is limited to 10.9 V and any output which tries to be greater will turn on the OUTPT overload indicator at the bottom left of the screen.

With offset and expand, the output voltage gain and offset can be programmed to provide control of feedback signals with the proper bias and gain for a variety of situations.

Offsets do add and subtract from the displayed values while expand increases the resolution of the display.

6. Connect the DVM to the X output on the rear panel.

The X and Y outputs on the rear panel always provide voltages proportional to X and Y (with offset and expand). The X output voltage should be 10 V, just like the CH1 output.

The front panel outputs can be configured to output different traces quantities while the rear panel outputs always output X and Y.

Outputs proportional to X and Y (rear panel, CH1 or CH2) have 100 kHz of bandwidth. The CH1 and CH2 outputs, when configured to be proportional to R, , or a trace (even a trace defined as X or Y) are updated at 512 Hz and have a 200 Hz bandwidth. It is important to keep this in mind if you use very short time constants.

7. Connect the DVM to the CH1 output on the front panel again.

Press <Expand>

Press [1] [ENTER]

Press <Offset>

Press [0] [ENTER]

Let's change CH1 to a trace.

First, set the X expand back to 1.

Set the X offset back to 0.0%.

X Should be 0.500 V again and the CH1 output

Press <Source>

Use the knob to select Trace1.

8. Press [TRACE/SCAN]

Press the second softkey, next to the trace definition, to highlight the X.

Use the knob to change the numerator from X to 1.

Press the second softkey twice to highlight the denominator (C) of the trace definition.

Use the knob to change the denominator from 1 to X.

should be 5.0 V.

Highlight the CH1 source. The CH1 output is proportional to this source.

CH1 can be proportional to X, R, , or Trace 1-4. Choose Trace 1. Trace 1 has a default definition of X so the CH1 output should remain 5.0 V (but its bandwidth is only 200 Hz instead of 100 kHz).

Display the Trace and Scan menu.

Traces are defined as $A \cdot B / C$. The quantities A, B, and C are selected from the various quantities measured by the lock-in.

Trace 1 is defined as X by default. Let's change it to 1/X.

Trace 1 is now $1 \cdot 1 / 1$ and the top display shows 1.000

Change the denominator.

Trace 1 is now defined as 1/X. The top display shows Trace 1. The trace definition is shown at the upper left of the top display. The trace units are shown at the bottom center of the top display (1/V).

Remember, X was 0.5V. Thus, 1/X is $1/0.5 = 2.0$ (1/V). The display should show 2.0 (or very close). Displays use the actual measured quantities to calculate the value of a trace. If X was 5 mV, the value of Trace 1 would be 1/5 mV or 200 (1/V). Traces are calculated using Volts, degrees, and Hz for the units of A, B and C.

The CH1 output voltage is 0.2V. This is because trace output voltages are calculated using the output voltages of the A, B and C quantities rather than their displayed values. In this case, $X=0.5V$. As an analog output voltage, this would be 5.0 V (1/2 scale of 1V full scale sensitivity). The 1/X output voltage is $1/5.0V$ or 0.2 V.

See the DC Outputs and Scaling discussion in the Lock-In Basics section for more detailed information.

SCANS and SWEEPS

This measurement is designed to use the internal oscillator to explore some of the basic lock-in functions. You will need BNC cables.

Specifically, you will measure the response of the line notch filters by sweeping the internal reference frequency and measuring the sine output. Traces and strip chart displays will be used to record X, Y, R and ϕ as the signal is swept through the input notch filters.

1. Disconnect all cables from the lock-in. Turn the power on while holding down the [] (backspace) key. Wait until the power-on tests are completed.

When the power is turned on with the backspace key depressed, the lock-in returns to its default settings. See the Default Settings list in the Menu section for a complete listing of the settings.

The display is the "normal" lock-in display. The lock-in setup is displayed across the top of the screen. The sensitivity, reserve, time constant, prefilters and input configuration are all easily visible. Watch how these indicators change as you change parameters. The upper numeric readout and bar graph shows the value of X ($R\cos\phi$) and the lower graph shows the the value of Y ($R\sin\phi$).

2. Connect the Sine Out on the front panel to the A input using a BNC cable.

The input impedance of the lock-in is 10 M Ω . The Sine Out has an output impedance of 50 Ω . Since the Sine Output amplitude is specified into a high impedance load, the output impedance does not affect the amplitude.

The lock-in defaults to the internal oscillator reference set at 1.000 kHz. The reference mode (Intrnl) and frequency are displayed at the bottom of the screen. In this mode, the lock-in generates a synchronous sine output at the internal reference frequency.

The sine amplitude is 1.000 Vrms and the sensitivity is 1 V(rms). Since the phase shift of the sine output is very close to zero, the upper display (X) should read close to 1.000 V and the lower display (Y) should read close to 0.000 V.

3. Press [INPUT/FILTERS]

Display the Input and Filters menu. This menu allows the input configuration to be changed.

Press the <Line Notches> softkey until Both filters are selected.

With the line notch filters engaged, signal inputs at 60 (50) Hz and 120 (100) Hz are removed. Note that the line filter indicators at the top of the screen are both on.

Scans and Sweeps

4. Press [DISPLAY/SCALE]

Display the Display and Scale menu. This menu configures and scales the different screen displays and graphs.

Press the <Type/Trace> softkey to select the Trace number.

Use the knob to select Trace 3.

Highlight the trace number for the Top Bar graph. The SR850 acquires and displays data in the form of traces. The default definitions for the 4 traces are X, Y, R and . These definitions may be changed.

Display the magnitude R (Trace 3) on the top graph.
5. Press [REF/PHASE]

Display the Reference and Phase menu.

Press <Ref. Source>

Use the knob to select Internal Sweep.

Choose internal reference frequency sweep. In this mode, the SR850 will sweep the internal oscillator from a start to a stop frequency.
6. Press <Sweep Menu>
- Set the sweep start and stop frequencies in this submenu. Sweeps may be linear or logarithmic. In this case, let's use a linear sweep.

Press <Start>

Highlight the start frequency.

Press [4] [0] [ENTER].

Set the start frequency to 40 Hz. The reference changes to 40.000 Hz as shown in the frequency readout at the bottom center of the screen.

Press <Stop>

Highlight the stop frequency.

Press [1] [6] [0] [ENTER].

Set the stop frequency to 160 Hz.
7. Press [GAIN/TC]

Display the Gain and Time Constant menu.

Press <Time Constant> and use the knob to select 10 ms.

Choose a short time constant so that the frequency can be swept in a reasonably short time.

Press <Synchronous> to select <200 Hz.

Since the sweep frequencies are below 200 Hz, you can take advantage of the synchronous filter to remove the 2f component of the output without using a long time constant.
8. Press [TRACE/SCAN]

Display the Trace and Scan menu. This menu allows the trace definitions to be changed and the scan (sweep) to be configured. Trace data is sampled and stored in the buffers at the sample rate. Swept parameters (reference frequency in this case) are also updated at the sample rate (immediately after the data is sampled). The scan time

sets the amount of time the buffer will store and the length of any sweep.

In this measurement, let's leave the trace definitions equal to the defaults and just change the sample rate and scan time.

Press <Sample Rate>

Highlight the sample rate.

Use the knob to select 32 Hz.

The trace data will be sampled at 32 Hz and stored in the buffer. After each data point is recorded, the reference frequency will be updated. This determines the resolution of our data along the time axis.

Press <Scan Length>

Highlight the scan length.

Press [1] [0] [0] [ENTER]

Set the scan length to 100 seconds (1:40). This configures the data buffer to hold 3200 data points (32 Hz sample rate x 100 second scan length). The scan length is also the sweep time for the internal frequency sweep. Sweeps are always coordinated with the data acquisition. In this case, the sweep range is 120 Hz (40 Hz to 160 Hz) and will take 100 seconds and be updated 3200 times. Each stored data point will represent a frequency increment of 0.0375 Hz (120/3200).

Press <1 Shot/Loop> to select 1 Shot.

Scans can repeat (Loop) or stop when finished (1 Shot). Let's take a single scan of data.

Now you're finally ready to start the scan.

9. Press [START/CONT]

The [START/CONT] key starts the scan and sweep. The scan indicator at the bottom left corner of the screen switches from STOP to Run 1 (single scan in progress). The reference frequency readout at the bottom center displays the frequency while sweeping.

As the frequency passes through 60 (50) Hz and 120 (100) Hz, the value of R should drop close to zero as the signal sweeps through each input notch filter.

When the scan is complete, the scan indicator switches to DONE and the frequency should be 160 Hz.

Now let's try displaying the data in a more meaningful way.

Scans and Sweeps

10. Press [DISPLAY/SCALE] Display the Display and Scale menu.
- Press <Format> to select Single. Choose a full screen display.
- Press <Type> Highlight the display type (the default is polar).
- Use the knob to select Chart. Let's view the stored data on a chart graph.
- Press <Type> again to highlight the Trace number. Use the knob to select Trace 3. To view R on the chart, you need to display Trace 3. The chart now displays R vs time (frequency).
- Press [AUTO SCALE] Auto Scale the graph.
11. Press the < \pm Range> softkey. This is the fifth softkey from the top. To manually adjust the graph scale, you change the center value and range. Highlight the range (\pm).
- Use the knob to select 1.000 e0 (1 V) for the range. The graph displays a vertical scale equal to the center value plus and minus the range. The range can also be entered numerically to any value. The knob adjusts the range in a 1-2-5 sequence.
- Press the < \pm Range> softkey again to highlight the center value (@). Highlight the center value.
- Press [0] [ENTER] Set the center to zero.
- The graph always displays the center and range below the chart in the units of the trace being displayed. The default horizontal scale is 10 seconds per division. This can be changed but let's leave it since the entire scan fits perfectly on the screen.
12. Press [CURSOR] This key activates the cursor. The knob now controls the cursor. The cursor coordinates are displayed at the top right of the chart. When the cursor coordinates are surrounded by a box, the cursor is active and the knob will move the cursor.
- Use the knob to read specific data points from the graph. The cursor horizontal position is displayed in units of seconds (time from the end of the scan) and the vertical position is in the trace units. Since this is an internal frequency sweep, let's read the frequency as the horizontal position.
- Press [CURSOR SETUP] Display the Cursor Setup menu. The cursor can be configured in many different modes. The cursor can be defined as a region where the marker seeks the max or min within the region. Cursors on split screen charts can also be linked together.
- Press <Cursor Readout> twice to select F sweep. Set the cursor display to show the frequency and trace value of each data point. The reference fre-

quency of each point is displayed in the cursor coordinate display.

The graph shows all 3200 data points at once. Since the screen resolution only has 640 pixels across, each X-axis value must represent multiple data points. The cursor reads the Max, Min or Mean of the data points graphed at each X-axis position.

To read the notch filter minimum frequencies, select Min.

The cursor displays the frequency and trace value of the smallest data point graphed at each horizontal X-axis position.

Press <Cursor Seek> to select Min.

Use the knob to read the frequencies of the notch filter zeroes or minimums.

13. Press [DISPLAY/SCALE]

Press <Type/Trace> to highlight the Trace number again.

Use the knob to select Trace 1.

Use the knob to select Trace 2.

Use the knob to select Trace 4.
Press [AUTO SCALE].

Show the Display and Scale menu again.

The SR850 can store up to 4 traces simultaneously. In the default configuration, all 4 traces are stored. Let's take a look at the other traces.

Trace 1 is X. This corresponds to the real part of the filter response.

Trace 2 is Y. This corresponds to the quadrature part of the filter response (or derivative of X).

Trace 4 is ϕ . This is the phase response of the filters. The phase approaches 180° at the exact filter notch frequencies and approaches zero at frequencies far from the notches. In many experiments, the phase (or quadrature) measurements yield a far more exact measure of the actual resonant or peak frequency than R.

14. Press [PAUSE/RESET]

Pressing the [PAUSE/RESET] key while DONE will reset the scan and sweep. The stored data is lost and the scan indicator shows STOP again. Swept parameters (frequency in this case) return to their start values and the graph is blanked.

15. Press [START/CONT]

Let's take the data again, this time while displaying the chart to show the scan data in progress. The data scrolls in from the right. New points are added at the right edge and the old points move to the left. This is a strip chart type of graph.

The buffers can be configured for a single scan (1 Shot) as in this measurement, or continuous

looping (Loop). In the loop mode, scans repeat indefinitely and the entire data buffer is filled at the sample rate. When the end is reached, new points are added at the beginning again, overwriting the oldest data. This mode is convenient for always storing the last buffer full of data. If something worth saving occurs, simply pause the scan and save, print or plot the data.

16. When the scan is complete, press [TRACE/SCAN].

Display the Trace and Scan menu.

Press <1 Shot/Loop> to select Loop.

Choose the loop buffer.

Press [PAUSE/RESET]

Reset the scan and data buffer.

Press [START/CONT] to start the scan again.

This time, the scan and sweep will repeat at the end. The buffer is capable of storing 16000 points (for 4 traces). Each scan is 3200 points so 5 complete sweeps can be stored in the buffer.

17. Press [PAUSE/RESET] ONCE.

Pause the scan by pressing the [PAUSE/RESET] key once while the scan is in progress. The scan indicator shows PAUSE. Pressing this key again will reset the data!!!

Press [START/CONT]

Resume the scan with [START/CONT] key.

Let the scan run for more than 100 seconds so data scrolls past the left edge of the graph.

18. Press [DISPLAY/SCALE]

Show the Display and Scale menu.

Press <sec/div> (the last softkey).

Highlight the horizontal chart scale.

Use the knob to select 20 S/div.

Twice as much data will now be shown on the graph. 2 complete sweeps can now be displayed on the graph.

USING THE DISK DRIVE

The disk drive on the SR850 may be used to store 3 types of files.

1. Data File

This includes the data in the active display trace. In addition to the data, the instrument state (sensitivity, input configuration, time constant, reference, scan parameters, aux outputs) and the trace definition of the stored trace are saved. Data files are recalled into the trace buffer of the active display. If the present trace buffer is configured to hold less points than the stored trace, then points are recalled starting with the oldest point in the stored trace until the trace buffer is filled. The stored instrument state and the trace definition of the recalled trace are recalled as well. When data is recalled from disk, the instrument state is changed to the state in effect when the data was stored!

2. ASCII Data File

This file saves the data in the active display trace in ASCII format. These files may not be recalled to the display. This format is convenient when transferring data to a PC application. ASCII files are much larger than the binary data file for the same trace.

3. Settings File

This file stores the lock-in settings. This includes the instrument state (see Data file) as well as the system setup (printer, plotter, etc.) Recalling this file will change the lock-in setup to that stored in the file.

The disk drive uses double-sided, double density (DS/DD) 3.5" disks. The disk capacity is 720k. The SR850 uses the DOS format. A disk which was formatted on a PC or PS2 (for 720k) may be used. Files written by the SR850 may be copied or read on a DOS computer.

This measurement is designed to familiarize the user with the disk drive. We will use the internal oscillator to provide a signal so that there is some data to save and recall. Specifically, you will save and recall a data file and a settings file.

STORING AND RECALLING DATA

1. Disconnect all cables from the lock-in. Turn the power on while holding down the [] (backspace) key. Wait until the power-on tests are completed.

When the power is turned on with the backspace key depressed, the lock-in returns to its default settings. See the Default Settings list in the Menu section for a complete listing of the settings.

The display is the "normal" lock-in display. The lock-in setup is displayed across the top of the screen. The upper numeric readout and bar graph shows the value of $X (R\cos)$ and the lower graph shows the the value of $Y (R\sin)$.

2. Connect the Sine Out on the front panel to the A input using a BNC.

The input impedance of the lock-in is $10 M \Omega$. The Sine Out has an output impedance of 50Ω . Since the Sine Output amplitude is specified into a high impedance load, the output impedance does not affect the amplitude.

The lock-in defaults to the internal oscillator refer-

- ence set at 1.000 kHz. The reference mode (Intrnl) and frequency are displayed at the bottom of the screen. In this mode, the lock-in generates a synchronous sine output at the internal reference frequency.
- The sine amplitude is 1.000 Vrms and the sensitivity is 1 V(rms). Since the phase shift of the sine output is very close to zero, the upper display (X) should read close to 1.000 V and the lower display (Y) should read close to 0.000 V.
3. Press [AUTO PHASE]
Automatically adjust the phase shift so that Y is zero and X is equal to the magnitude.
 4. Press [DISPLAY/SCALE]
Show the Display and Scale menu.
Press <Format> to select Single display.
Change the screen to a full screen display.
Press <Type>
Highlight the display type.
Use the knob to adjust the display type to Chart.
With the chart display, we can see the data stored in the trace buffers.
 5. Press [TRACE/SCAN]
Display the Trace and Scan menu.
Press <Scan Length>
Highlight the scan length.
Press [1] [0] [0] [ENTER]
Set the scan length to 100 seconds. At the default sample rate of 1 Hz, this represents 100 points in the scan.
Press <1 Shot/Loop> to select 1 Shot.
Take one scan and then stop.
 6. Press [REF/PHASE]
Display the Reference and Phase menu.
Press [START/CONT]
Start the scan. The quantity X is sampled and stored at a rate of 1 Hz. The trace buffer is graphed on the chart display as the data is taken.
Press <Rotate 90 deg.> a few times during the scan to generate some changes in the data.
Each time the phase is shifted by 90°, the value of X changes from (plus or minus) the signal amplitude to zero and back.
After 100 seconds, the scan will finish and we can save the graph on disk.
 7. Put a blank double-sided, double density (DS/DD)3.5" disk into the drive.
Use a blank if disk if possible, otherwise any disk that you don't mind formatting will do. Make sure the write protect tab is off.

8. Press [DISK] Display the Disk menu.
- Press <Disk Utils> Choose Disk Utilities.
- Press <Disk Format> Make sure that the disk does not contain any information that you want. Formatting the disk takes about a minute.
- Press <Return> Go back to the main Store and Recall menu.
- Press <Data Save> Display the Data Save menu.
- Press <File Name> Now we need a file name.
- Press [ALT] [ALT] lets you enter the letter characters printed below each key. The numbers function as normal.
- Press [D] [A] [T] [A] [1] [ALT] Type a file name such as DATA1 (or any legal DOS file name) and turn off the ALT mode.
- Press <Data Save> This saves the trace data which is displayed on the active display to disk using the file name specified above. If the entered file name has no extension, then the extension .85T is appended to the file name.
- All stored data points in the selected trace are saved. Only the trace in the active display is saved. In this case, only trace 1 (X) is saved, even though the other traces have data stored.
- In addition to the data, the instrument state (most lock-in parameters, scan parameters, and the active trace definition) is stored.
9. Press [DISPLAY/SCALE] Let's change the display to show another trace.
- Press <Type/Trace> twice to highlight the trace number. The other traces are stored in the buffer and can be displayed at any time.
- Use the knob to change the trace number to 2. This displays trace 2 (Y) on the chart so we can save it also.
10. Press [DISK] Display the Disk menu.
- Press <Data Save> Choose the Data Save menu.
- Press <File Name> Save trace 2 (Y) using a new file name. This way you can have multiple files in the disk catalog.
- Press [ALT] [D] [A] [T] [A] [2] [ALT] Use the file name DATA2 (or any legal DOS file name) and turn off the ALT mode.

The Disk Drive

- Press <Data Save> Save Trace 2.
11. Press <Catalog> to select On. Display the disk catalog. This display lists all of the files on the disk. The files which you just saved should appear in the catalog. Each file has a name, extension, and type. The file type for binary trace data is TRC.
- Press <Return> Go back to the main Store and Recall menu.
12. Press [PAUSE RESET] Reset the scan. This clears the data buffers within the lock-in.
13. Press <Data Recall> Display the Data Recall menu.
- Press <Catalog> to select On. Display the disk catalog. The 2 files which you just saved should be listed.
- Use the knob to select the first file. The knob chooses a file in the catalog display. Let's recall the X data (the file made by saving Trace 1).
- Press <Data Recall> This recalls the data file from disk and stores it in the active display trace. The active display trace is redefined to agree with the recalled data trace definition. In this case, the data is recalled into Trace 2 (since it is currently being shown on the active display). Trace 2 becomes defined as X since that is the trace definition of the recalled data.
- Data acquisition is paused so no new data will be taken.
- If the active display is not a chart, the data is still recalled into the trace which is shown by the active display. For example, if the active display is a bar graph showing Trace 2, then the recalled data fills Trace 2. The trace is redefined to agree with the recalled data and the bar graph will show the present value of the redefined trace.
- Data files may not be recalled into traces which are not presently being stored.
14. Press [DISPLAY/SCALE] Show the Display and Scale menu.
- Press <Format> to select Up/Down Choose the dual display format.
- Press<Type> Highlight the Top display type.

Use the knob to select the Chart display.	Display two charts.
Press <Full, Top or Bottom> to select Bottom.	Select the bottom display. The bottom display type should be highlighted.
Use the knob to select the Chart display for the bottom display.	Both displays should be charts.
Press [AUTO SCALE]	Auto scale the bottom display. The [AUTO SCALE] will scale the active display. In this case, the bottom display is active since we just changed it. The active display shows its trace number in inverse at the upper left of the display.
	Note that both Trace 1 (top) and Trace 2 (bottom) are defined as X. Trace 2 is the recalled X data. Trace 1, which was empty before the data was recalled, has been filled with zeroes so that its length agrees with the recalled trace.
	All stored traces must have the same length. If the recalled data trace has less points than existing traces in memory, then the recalled trace is padded with zeroes until it is the same length. If the recalled data has more points than the existing traces in memory (as was the case here), the existing traces are padded with zeroes until they are the same length as the recalled trace. Data is never destroyed in the recall process.
	If the recalled trace has more points than the existing trace buffer allocation (16k points for 4 stored traces, 32k points for 2 stored traces, or 64k points for 1 stored trace), then as many points are recalled as will fit in the existing trace buffer. The other existing traces are either padded with zeroes or left alone, depending upon how many points are presently stored.
Press [ACTIVE DISPLAY]	Make the top display active. The top display trace number should be highlighted at the upper left of the top display. This makes Trace 1 the active display trace.
15. Press [DISK]	Let's recall the stored Y trace into Trace 1.
Press <Data Recall>	Display the Data Recall menu.
Press <Catalog> to select On.	Display the disk catalog.
Use the knob to select the second file.	The knob chooses a file in the catalog display. Let's recall the Y data (the file made by saving Trace 2).

Press <Data Recall>

This recalls the data file from disk and stores it in the active display trace. The active display trace is redefined to agree with the recalled data trace definition. In this case, the data is recalled into Trace 1 (since it is currently being shown on the active display). Trace 1 becomes defined as Y since that is the trace definition of the recalled data.

The existing data in Trace 2 (bottom display) is not changed.

Press [AUTO SCALE]

Auto Scale the top display.

In general, the existing lock-in state may not agree with the state stored in the recalled data file. In this case, the lock-in state is also recalled along with the data. Existing data in other traces is not destroyed but may lose their meaning given the new lock-in state. For example, if the existing data sample rate is 1 Hz and data is stored in the traces, recalling a data file whose data was stored at 2 Hz will change the sample rate to 2 Hz. The existing data is not destroyed but will be displayed as if the data was sampled at 2 Hz. If the state was not recalled with the data, then the recalled data would have no meaning. This way, the recalled data is meaningful. Existing data is presumably more easily recaptured and can also be saved if important.

STORING AND RECALLING SETTINGS

1. Turn the lock-in on while holding down the [] (backspace) key. Wait until the power-on tests are completed. Disconnect any cables from the lock-in.

When the power is turned on with the backspace key depressed, the lock-in returns to its default settings. See the Default Settings list in the Menu section for a complete listing of the settings.

Change the lock-in setup so that we have a non-default setup to save.
2. Press [GAIN/TC]

Show the Gain and Time Constant menu.

Press <Sensitivity>

Highlight the full scale sensitivity.

Use the knob to change the sensitivity to 100 mV.

Select 100 mV.

Press <Time Constant>

Highlight the time constant.

Use the knob to select 1 S.

Select 1 second.
3. Press [DISK]

Display the Disk menu.

Press <Settings Save>

Choose the Settings Save menu.

Press <File Name>

Now we need a file name.

Press [ALT]

[ALT] lets you enter the letters printed below each key. The numbers function as normal.

Press [T] [E] [S] [T] [1] [ALT]

Type a file name such as TEST1 (or any legal DOS file name) and turn off the ALT mode.

Press <Settings Save>

This saves the setup to disk using the file name specified above. If the entered file name has no extension, then the extension .85S is appended to the file name.
4. Turn the lock-in off and on while holding down the [] (backspace) key. Wait until the power-on tests are complete.

Change the lock-in setup back to the default setup. Now let's recall the lock-in setup that we just saved.

Press [GAIN/TC]

Check that the sensitivity and time constant are 1V and 100 ms (default values).
5. Press [DISK]

Display the Disk menu.

Press <Settings Recall>

Choose the Settings Recall menu.

The Disk Drive

Press <Catalog>

Display the disk catalog listing. Note that settings files have the file type SET.

Use the knob to select the settings file which you just saved.

When the disk catalog is displayed, the knob highlights a file. Use the knob to choose the file TEST1 to recall.

6. Press <Settings Recall>

This recalls the settings from the file TEST1. The lock-in settings are changed to those stored in TEST1.

Press [GAIN/TC]

The sensitivity and time constant should be the same as those in effect when you created the file.

Settings files store the lock-in state (sensitivity, time constant, reference, etc.), the display setup (display format, type, trace parameters, etc.) as well as the system setup (plotter, printer, interface settings, etc.).

AUX OUTPUTS and INPUTS

This measurement is designed to illustrate the use of the Aux Outputs and Inputs on the rear panel. You will need BNC cables and a digital voltmeter (DVM).

Specifically, you will set the Aux Output voltages and measure them with the DVM. These outputs will then be connected to the Aux Inputs to simulate external DC voltages which the lock-in can measure.

1. Disconnect all cables from the lock-in. Turn the power on while holding down the [] (backspace) key. Wait until the power-on tests are completed.

When the power is turned on with the backspace key depressed, the lock-in returns to its default settings. See the Default Settings list in the Menu section for a complete listing of the settings.

2. Connect Aux Out 1 on the rear panel to the DVM. Set the DVM to read DC volts.

The 4 Aux Outputs can provide programmable voltages between -10 and +10 volts. The outputs can be a fixed voltage or they can sweep with the scan.

3. Press [AUX OUTPUTS]

Display the Aux Output menu.

Press <Voltage>

Highlight the output voltage of Aux Out 1.

Press [1] [0] [ENTER]

Change the output to 10V. The DVM should display 10.0 V. The knob can also be used to adjust the voltages.

Press [-] [5] [ENTER]

Change the output to -5V. The DVM should display -5.0 V.

The 4 outputs are useful for controlling other parameters in an experiment, such as pressure, temperature, wavelength, etc.

4. Press [DISPLAY/SCALE]

Show the Display and Scale menu.

Press <Monitor> to select Input/Output.

Change the monitor display at the top of the screen to show the Aux Inputs (A1, A2, A3 and A4).

The Aux Inputs can read 4 analog voltages. These inputs are useful for monitoring and measuring other parameters in an experiment, such as pressure, temperature, position, etc.

We'll use Aux Out 1 to provide an analog voltage to measure.

Aux Outputs and Inputs

5. Disconnect the DVM from Aux Out 1. Connect Aux Out 1 to Aux In 1 on the rear panel.

The A1 monitor should now display -5 V. The monitor display shows all 4 Aux Inputs. To display and save the Aux Input values, a trace needs to be defined to measure an Aux Input.

6. Press [TRACE/SCAN]

Display the Trace and Scan menu.

Press the second softkey, next to the trace definition, to highlight the X.

Trace 1 is defined as X. Let's change it to Aux Input 1.

Use the knob to change the A parameter from X to AI1.

The Aux Inputs are abbreviated AI1, AI2, AI3 and AI4. Trace 1 is now defined as AI1. The top graph shows trace 1 and should display -5.0 V.

The traces can measure Aux Inputs directly. In addition, these inputs can be used to multiply or divide other quantities (such as X, Y or R) for ratio normalization or gain modulation.

Press [AUTO SCALE]

Auto Scale the top bar graph.

Now let's setup a voltage sweep on Aux Output 1.

7. Press <Scan Length>

Highlight the scan length.

Press [1] [0] [0] [ENTER]

Set the scan time to 100 seconds. The sample rate is 1 Hz so the scan is 100 samples long.

8. Press [AUX OUTPUTS]

Display the Aux Output menu again.

Press <Fixed / Log / Linear> twice to select Linear.

Choose a linear sweep for Aux Output 1. Each Aux Output may be swept in voltage in either log or linear fashion.

Press <Start>

Highlight the start voltage.

Press [1] [ENTER]

Enter 1 V for the start voltage. The Aux 1 output changes to 1 V since data acquisition is stopped right now. All swept parameters return to their start values when a scan is stopped.

Press <Stop>

Highlight the stop voltage.

Press [5] [ENTER]

Enter 5 V for the stop voltage.

The offset voltage is used to offset the sweep without changing the start and stop. For log (exponential) sweeps, the offset allows much more flexibility in defining the range and acceleration of a sweep.

9. Press [START/CONT]

Start the scan. Aux Out 1 will linearly ramp from

1 V to 5 V in 100 seconds updating every second. The output voltage is measured on Aux In 1, recorded in Trace 1 and displayed on the top graph.

10. Press [DISPLAY/SCALE]

Press <Type / Trace> to highlight the type of the top display.

Use the knob to change the display type to Chart.

Show the Display and Scale menu.

The top display is a bar graph. Let's change it to a chart to show the history of Aux In 1.

The chart display shows the history of the sweep.

The SR850 can be used as a general purpose 4 channel digital chart recorder. The displays can be scaled vertically and horizontally with full cursor readouts. Data can be stored on disk and output to a printer or plotter.

TRACE MATH

This example is designed to familiarize the user with the trace math functions in the lock-in. You will need BNC cables and a 50 Ω terminator.

Specifically, you will record the input noise in a trace and perform various calculations with the trace. The internal oscillator will also be used to provide signal data for curve fits.

There are a few points to remember about the trace math functions.

Math functions may only be performed on trace data which is stored in a trace buffer and displayed in the active chart display. Data which are not within the time window of the chart are not operated upon. Use the horizontal chart scale to select the size of the time window and move the cursor to pan the window to the desired portion of the trace buffer. Data which exceeds the upper or lower display range of the graph are, of course, operated upon.

The amount of time a math function takes to complete depends upon its complexity and the number of data points which are operated on. For example, 25-point smoothing takes longer than 5-point smoothing while each type of smoothing takes longer the more points there are. Do not operate on more points than necessary.

Math functions can only be performed while data acquisition is stopped, either by pausing or finishing a scan. Some math operations change the stored trace data. Resuming a scan after smoothing, for example, will result in a trace where a region of the trace is smoothed and other regions are not.

1. Disconnect all cables from the lock-in. Turn the power on while holding down the [] (backspace) key. Wait until the power-on tests are completed.

When the power is turned on with the backspace key depressed, the lock-in returns to its default settings. See the Default Settings list in the Menu section for a complete listing of the settings.

The display is the "normal" lock-in display. The lock-in setup is displayed across the top of the screen. The upper numeric readout and bar graph shows the value of $X (R\cos \theta)$ and the lower graph shows the the value of $Y (R\sin \theta)$.

2. Connect a 50 Ω terminator to the A input.

The input impedance of the lock-in is 10 M Ω . The terminator effectively provides a short at the input so that the input noise is predominantly the voltage noise of the input transistors.

The lock-in defaults to the internal oscillator reference set at 1.000 kHz. All measurements will be made at 1 kHz in this example.

3. Press [GAIN/TC]
Press <Sensitivity>

Display the Gain and Time Constant menu.

Highlight the sensitivity.

Use the knob to select 50 nV.

To measure the input noise, we need to use an appropriate sensitivity.

4. Press [TRACE/SCAN]

Display the Trace and Scan menu.

Press <Sample Rate>

Since the time constant is 100 ms, we need a sample rate greater than 1 Hz to record the output.

Use the knob to change the sample rate to 16 Hz.

Choose 16 Hz as the sample rate.

Leave the scan mode on Loop. Data will be recorded indefinitely with the trace buffer storing the last 16k (1000 seconds) of data.

5. Press [DISPLAY/SCALE]

Show the Display and Scale menu.

Press <Format> to select Single.

Use a full screen display.

Press <Type>

Highlight the display type.

Use the knob to select Chart.

Math functions require a chart display.

Press <± Range>

Highlight the chart range.

Press [5] [0] [EXP] [-] [9] [ENTER]

Enter 50 nV for the chart range.

Press <sec/Div> (the last softkey).

Highlight the horizontal time scale.

Use the knob to select 5.0 S/Div.

Change the scale to 5.0 S/Div so 50 seconds of data will fill the graph.

6. Press [START/CONT]

Start the scan. The X output is recorded on the chart display. The chart shows the last 50 seconds of data. The graph should be a noisy trace about 2 divisions peak to peak.

Wait until the data fills the graph (50 sec) and data starts scrolling past the left edge.

Press [PAUSE/CONT]

Pause the data acquisition. No new data is recorded and the graph stops scrolling to the left.

7. Press [MATH]

Display the Math menu.

Press <Stats>

Choose the Statistics menu.

Press <Do Stats>

The mean, standard deviation, total and time span are calculated for the data between the left and right limits. The limits are shown as vertical heavy dashed lines. The limits default to the left

and right edge of the graph display. In this case, 50 seconds of data (800 data points at 16 Hz sample rate).

The results are displayed at the bottom of the screen. The standard deviation () should be about 6 nV or so. This is the rms noise of the input in a noise equivalent bandwidth of 1.2 Hz (100 ms, 12 dB/oct time constant). The input noise (in Volts/ Hz) is thus the standard deviation divided by the square root of 1.2 Hz.

The lock-in can measure noise directly in V/ Hz, this measurement is meant to illustrate the statistical functions.

Press <Return> twice.

Return to the main Math menu.

8. Press <Smooth>

Choose the Smoothing menu.

Press <17 point>

Perform 17 point smoothing on the noisy data. The data should become less noisy and smoother. Smoothing reduces narrow variations in the data.

Press [CURSOR]

Let the knob move the cursor.

Use the knob to move the cursor past the left edge of the graph. The data will scroll to the right to display unsmoothed portions of the trace.

The smoothing operation changed the data within the time window of the graph. Data which was not displayed was not smoothed. This trace now contains a region which has been smoothed and a region which is untouched.

Smoothing changes the data in the buffer and the original unsmoothed points are lost.

Press <Return>

Return to the main Math menu.

8. Press <Calc>

Choose the Calculator menu.

Press <Operation>

Highlight the operation.

Use the knob to select x^2 .

Let's square the data.

Press <Do Calc.>

Calculations are performed on all of the data within the time window of the graph. Let the calculation finish.

Press [AUTO SCALE]

X squared is a positive quantity. The magnitude of the data is now 10^{-18} so auto scale is required to view the data.

Use the knob to select .

Select square root.

Trace Math

- | | |
|---|--|
| Press <Do Calc.> | The net effect is to take the absolute value of X. Let the calculation finish. |
| Press [AUTO SCALE] | The magnitude of the data is back to 10^{-9} . |
| Use the knob to select log10. | Take the log of X . |
| Press <Do Calc.> | Let the calculation finish. |
| Use the knob to select *. | Let's multiply the data by something. |
| Press <Argument Type> to select Constant. | Multiply the data by a constant. |
| Press <Constant Value> | Highlight the constant value. |
| Press [2] [0] [ENTER] | Enter 20. |
| Press <Do Calc.> | The final data is $20\log X $ which results in a graph of X scaled in dBV. Let the calculation finish. |
| Press [AUTO SCALE] | Auto scale the graph. |
| Press [CURSOR] | Activate the cursor. |
| Use the knob to read points from the graph. | The values of the data should be in the range below -160 dBV and below. |
| 9. Press [PAUSE/RESET] | Clear the data buffers for the next measurement. |
| 10. Press [DISPLAY/SCALE] | Show the Display and Scale menu. |
| Press <Format> to select Up/Down. | Display the bar graphs. |
| 11. Press [GAIN/TC] | Display the Gain and Time Constant menu. |
| Press <Sensitivity> | Highlight the sensitivity. |
| Use the knob to change the sensitivity to 1V. | Change the sensitivity to measure the Sine Out. |
| Press <Time Constant> | Highlight the time constant. |
| Use the knob to change the time constant to 3S. | Use a long time constant. |
| Press <Filter db/oct.> until 6 db is selected. | Choose the simplest filter response. |
| 12. Press [TRACE/SCAN] | Show the Trace and Scan menu. |
| Press <Scan Length> | Highlight the scan length. |
| Press [5] [0] [ENTER] | Enter a scan length of 50 seconds. |

- Press <1 Shot/Loop> to select 1 Shot.
- Stop data acquisition after the scan is complete.
13. Connect the Sine Out to the A input using a BNC cable.
- The input impedance of the lock-in is 10 M Ω . The Sine Out has an output impedance of 50 Ω . Since the Sine Output amplitude is specified into a high impedance load, the output impedance does not affect the amplitude.
- Wait until the value of X reaches 1 V.
- The sine amplitude is 1.000 V_{rms} and the sensitivity is 1 V(rms). Since the phase shift of the sine output is very close to zero, the upper display (X) should read close to 1.000 V and the lower display (Y) should read close to 0.000 V.
14. Press [DISPLAY/SCALE]
- Show the Display and Scale menu.
- Press <Format> to select Single.
- Display the full screen chart again.
- Press the < \pm Range> softkey. This is the fifth softkey from the top.
- Set the chart scale.
- Press [1] [ENTER]
- Set the range to ± 1 V.
- Press the < \pm Range> softkey again to highlight the center (@) value.
- Set the chart center.
- Press [0] [ENTER]
- Set the chart center to zero.
15. Press [START/CONT] and after about 10 seconds, remove the cable from the A input.
- Start the scan. When the cable is removed, the value of X should decrease to zero over the next 15 seconds or so.
- Wait until the scan finishes. When the scan is finished, the DONE indicator at the bottom left of the screen will switch on.
- The graph should be an exponential decay starting when the cable was removed from the input. Let's fit a curve to this data.
16. Press [MATH]
- Display the Math menu.
- Press <Fit>
- Choose the Fit menu.
- Press <Fit Type> to select Exp.
- Choose exponential fit.
- Press [CURSOR]
- Activate the cursor.
- Use the knob to position the cursor at the point where the signal starts to decay.
- Use the cursor to determine the graph region over which the curve fit will be calculated.

- | | |
|---|---|
| Press <Left Limit> | Set the left limit of the region at the start of the signal decay. |
| Use the knob to position the cursor 3 divisions to the right of the left limit. | Select the smallest region which covers the signal decay. |
| Press <Right Limit> | Set the right limit. |
| Move the cursor farther to the right. | The fit region is between the two limit marks (vertical heavy dashed lines). Only the data between the limits is used to calculate the fit. |
| Press <Do Fit> | Curve fit calculations can take a long time if the fit region encompasses a lot of data points. Try to use the smallest region possible when performing fits.

The curve fit uses a multi-iteration chi-squared minimization technique. After each iteration, the value of χ^2 is displayed at the bottom of the screen. Pressing the last softkey during the fit will terminate the calculation after the current iteration.

The fit parameters are displayed in a window in the center of the screen. The decay parameter b should be 3 seconds (6 db time constant). |
| 17. Press any key to continue. | The first time a key is pressed, the parameter window is removed. The curve fit is plotted over the data on the graph. |
| Press any key to continue. | The next key removes the curve fit from the graph. |
| 18. Press <Fit Type> twice to select Line. | Try fitting a line to this region. |
| Press <Do Fit> | Fit a line to this region. |
| Press any key to continue. | Remove the parameter window. The calculated fit is terrible of course. |
| Press any key to continue. | Remove the curve fit. |
| 19. Press [DISPLAY/SCALE] | Show the Display and Scale menu. |
| Press <S/Div> | Highlight the horizontal scale. |
| Use the knob to change the horizontal time scale to 1 S/Div. | Zoom in on the graph. |
| Press [CURSOR] | Activate the cursor. |

Move the cursor past the left edge of the graph to pan the data window until the signal decay becomes visible again.

Scroll the data to show the signal decay region.

20. Press [MATH]

Go back to the Math menu.

Press <Fit>

Choose the Fit menu.

Press <View Params>

View the most recent fit. The most recent fit is stored in memory and can be viewed again.

Press any key to continue.

Remove the parameter window so that the plotted fit can be seen. The fit is now being displayed at a different graph scale than before. Details on the quality of the fit can be examined up close.

Press any key to continue.

Remove the fit from the graph.

The math functions are very powerful data analysis tools. Together with the flexible trace definitions, the SR850 can perform complex data acquisition and analysis tasks.

WHAT IS A LOCK-IN AMPLIFIER?

Lock-in amplifiers are used to detect and measure very small AC signals - all the way down to a few nanovolts! Accurate measurements may be made even when the small signal is obscured by noise sources many thousands of times larger.

Lock-in amplifiers use a technique known as phase-sensitive detection to single out the component of the signal at a specific reference frequency AND phase. Noise signals at frequencies other than the reference frequency are rejected and do not affect the measurement.

Why use a lock-in?

Let's consider an example. Suppose the signal is a 10 nV sine wave at 10 kHz. Clearly some amplification is required. A good low noise amplifier will have about 5 nV/√Hz of input noise. If the amplifier bandwidth is 100 kHz and the gain is 1000, then we can expect our output to be 10 μV of signal (10 nV x 1000) and 1.6 mV of broadband noise (5 nV/√Hz x √100 kHz x 1000). We won't have much luck measuring the output signal unless we single out the frequency of interest.

If we follow the amplifier with a band pass filter with a Q=100 (a VERY good filter) centered at 10 kHz, any signal in a 100 Hz bandwidth will be detected (10 kHz/Q). The noise in the filter pass band will be 50 μV (5 nV/√Hz x √100 Hz x 1000) and the signal will still be 10 μV. The output noise is much greater than the signal and an accurate measurement can not be made. Further gain will not help the signal to noise problem.

Now try following the amplifier with a phase-sensitive detector (PSD). The PSD can detect the signal at 10 kHz with a bandwidth as narrow as 0.01 Hz! In this case, the noise in the detection bandwidth will be only 0.5 μV (5 nV/√Hz x √0.01 Hz x 1000) while the signal is still 10 μV. The signal to noise ratio is now 20 and an accurate measurement of the signal is possible.

What is phase-sensitive detection?

Lock-in measurements require a frequency reference. Typically an experiment is excited at a fixed frequency (from an oscillator or function generator) and the lock-in detects the response from the

experiment at the reference frequency. In the diagram below, the reference signal is a square wave at frequency ω_r . This might be the sync output from a function generator. If the sine output from the function generator is used to excite the experiment, the response might be the signal waveform shown below. The signal is $V_{sig}\sin(\omega_r t + \phi_{sig})$ where V_{sig} is the signal amplitude.

The SR850 generates its own sine wave, shown as the lock-in reference below. The lock-in reference is $V_L\sin(\omega_L t + \phi_{ref})$.

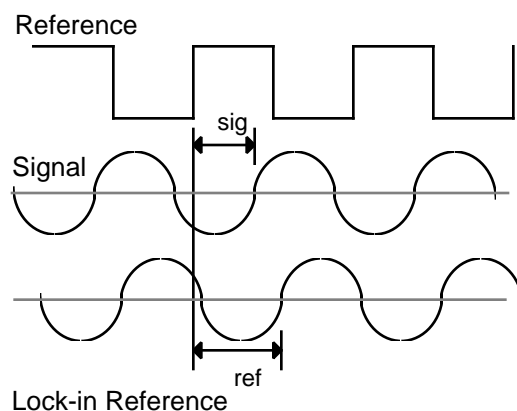

The SR850 amplifies the signal and then multiplies it by the lock-in reference using a phase-sensitive detector or multiplier. The output of the PSD is simply the product of two sine waves.

$$V_{psd} = V_{sig}V_L\sin(\omega_r t + \phi_{sig})\sin(\omega_L t + \phi_{ref})$$

$$= \frac{1}{2} V_{sig}V_L\cos([\omega_r - \omega_L]t + \phi_{sig} - \phi_{ref}) - \frac{1}{2} V_{sig}V_L\cos([\omega_r + \omega_L]t + \phi_{sig} + \phi_{ref})$$

The PSD output is two AC signals, one at the difference frequency ($\omega_r - \omega_L$) and the other at the sum frequency ($\omega_r + \omega_L$).

If the PSD output is passed through a low pass filter, the AC signals are removed. What will be left? In the general case, nothing. However, if ω_r equals ω_L , the difference frequency component will be a DC signal. In this case, the filtered PSD output will be

$$V_{psd} = \frac{1}{2} V_{sig}V_L\cos(\phi_{sig} - \phi_{ref})$$

This is a very nice signal - it is a DC signal proportional to the signal amplitude.

Narrow band detection

Now suppose the input is made up of signal plus noise. The PSD and low pass filter only detect signals whose frequencies are very close to the lock-in reference frequency. Noise signals at frequencies far from the reference are attenuated at the PSD output by the low pass filter (neither $\text{noise}^-_{\text{ref}}$ nor $\text{noise}^+_{\text{ref}}$ are close to DC). Noise at frequencies very close to the reference frequency will result in very low frequency AC outputs from the PSD ($|\text{noise}^-_{\text{ref}}|$ is small). Their attenuation depends upon the low pass filter bandwidth and roll-off. A narrower bandwidth will remove noise sources very close to the reference frequency, a wider bandwidth allows these signals to pass. The low pass filter bandwidth determines the bandwidth of detection. Only the signal at the reference frequency will result in a true DC output and be unaffected by the low pass filter. This is the signal we want to measure.

Where does the lock-in reference come from?

We need to make the lock-in reference the same as the signal frequency, i.e. $f_r = f_L$. Not only do the frequencies have to be the same, the phase between the signals can not change with time, otherwise $\cos(\omega_{\text{sig}} - \omega_{\text{ref}})$ will change and V_{psd} will not be a DC signal. In other words, the lock-in reference needs to be phase-locked to the signal reference.

Lock-in amplifiers use a phase-locked-loop (PLL) to generate the reference signal. An external reference signal (in this case, the reference square wave) is provided to the lock-in. The PLL in the lock-in locks the internal reference oscillator to this external reference, resulting in a reference sine wave at f_r with a fixed phase shift of ϕ_{ref} . Since the PLL actively tracks the external reference, changes in the external reference frequency do not affect the measurement.

All lock-in measurements require a reference signal.

In this case, the reference is provided by the excitation source (the function generator). This is called an external reference source. In many situations, the SR850's internal oscillator may be used instead. The internal oscillator is just like a function generator (with variable sine output and a TTL

sync) which is always phase-locked to the reference oscillator.

Magnitude and phase

Remember that the PSD output is proportional to $V_{\text{sig}} \cos(\omega_{\text{sig}} - \omega_{\text{ref}})$ where ϕ is the phase difference between the signal and the lock-in reference oscillator. By adjusting ϕ_{ref} we can make ϕ equal to zero, in which case we can measure V_{sig} ($\cos 0 = 1$). Conversely, if ϕ is 90° , there will be no output at all. A lock-in with a single PSD is called a single-phase lock-in and its output is $V_{\text{sig}} \cos \phi$.

This phase dependency can be eliminated by adding a second PSD. If the second PSD multiplies the signal with the reference oscillator shifted by 90° , i.e. $V_L \sin(\omega_{\text{ref}} + 90^\circ)$, its low pass filtered output will be

$$V_{\text{psd2}} = 1/2 V_{\text{sig}} V_L \sin(\omega_{\text{sig}} - \omega_{\text{ref}})$$

$$V_{\text{psd2}} \sim V_{\text{sig}} \sin \phi$$

Now we have two outputs, one proportional to $\cos \phi$ and the other proportional to $\sin \phi$. If we call the first output X and the second Y,

$$X = V_{\text{sig}} \cos \phi \quad Y = V_{\text{sig}} \sin \phi$$

these two quantities represent the signal as a vector relative to the lock-in reference oscillator. X is called the 'in-phase' component and Y the 'quadrature' component. This is because when $\phi = 0$, X measures the signal while Y is zero.

By computing the magnitude (R) of the signal vector, the phase dependency is removed.

$$R = (X^2 + Y^2)^{1/2} = V_{\text{sig}}$$

R measures the signal amplitude and does not depend upon the phase between the signal and lock-in reference.

A dual-phase lock-in, such as the SR850, has two PSD's, with reference oscillators 90° apart, and can measure X, Y and R directly. In addition, the phase ϕ between the signal and lock-in reference, can be measured according to

$$\phi = \tan^{-1}(Y/X)$$

WHAT DOES A LOCK-IN MEASURE?

So what exactly does the SR850 measure? Fourier's theorem basically states that any input signal can be represented as the sum of many, many sine waves of differing amplitudes, frequencies and phases. This is generally considered as representing the signal in the "frequency domain". Normal oscilloscopes display the signal in the "time domain". Except in the case of clean sine waves, the time domain representation does not convey very much information about the various frequencies which make up the signal.

What does the SR850 measure?

The SR850 multiplies the signal by a pure sine wave at the reference frequency. All components of the input signal are multiplied by the reference simultaneously. Mathematically speaking, sine waves of differing frequencies are orthogonal, i.e. the average of the product of two sine waves is zero unless the frequencies are EXACTLY the same. In the SR850, the product of this multiplication yields a DC output signal proportional to the component of the signal whose frequency is exactly locked to the reference frequency. The low pass filter which follows the multiplier provides the averaging which removes the products of the reference with components at all other frequencies.

The SR850, because it multiplies the signal with a pure sine wave, measures the single Fourier (sine) component of the signal at the reference frequency. Let's take a look at an example. Suppose the input signal is a simple square wave at frequency f . The square wave is actually composed of many sine waves at multiples of f with carefully related amplitudes and phases. A 2V pk-pk square wave can be expressed as

$$S(t) = 1.273\sin(\omega t) + 0.4244\sin(3\omega t) + 0.2546\sin(5\omega t) + \dots$$

where $\omega = 2\pi f$. The SR850, locked to f will single out the first component. The measured signal will be $1.273\sin(\omega t)$, not the 2V pk-pk that you'd measure on a scope.

In the general case, the input consists of signal plus noise. Noise is represented as varying signals at all frequencies. The ideal lock-in only responds to noise at the reference frequency. Noise at other frequencies is removed by the low pass filter fol-

lowing the multiplier. This "bandwidth narrowing" is the primary advantage that a lock-in amplifier provides. Only inputs at frequencies at the reference frequency result in an output.

RMS or Peak?

Lock-in amplifiers as a general rule display the input signal in Volts RMS. When the SR850 displays a magnitude of 1V (rms), the component of the input signal at the reference frequency is a sine wave with an amplitude of $1\sqrt{2}$ or 2.8 V pk-pk.

Thus, in the previous example with a 2 V pk-pk square wave input, the SR850 would detect the first sine component, $1.273\sin(\omega t)$. The measured and displayed magnitude would be 0.90 V (rms) ($1/\sqrt{2} \times 1.273$).

Degrees or Radians?

In this discussion, frequencies have been referred to as f (Hz) and ω ($2\pi f$ radians/sec). This is because people measure frequencies in cycles per second and math works best in radians. For purposes of measurement, frequencies as measured in a lock-in amplifier are in Hz. The equations used to explain the actual calculations are sometimes written using ω to simplify the expressions.

Phase is always reported in degrees. Once again, this is more by custom than by choice. Equations written as $\sin(\omega t + \phi)$ are written as if ϕ is in radians mostly for simplicity. Lock-in amplifiers always manipulate and measure phase in degrees.

THE FUNCTIONAL SR850

The functional block diagram of the SR850 DSP Lock-In Amplifier is shown below. The functions in the gray area are handled by the digital signal processor (DSP). We'll discuss the DSP aspects of the SR850 as they come up in each functional block description.

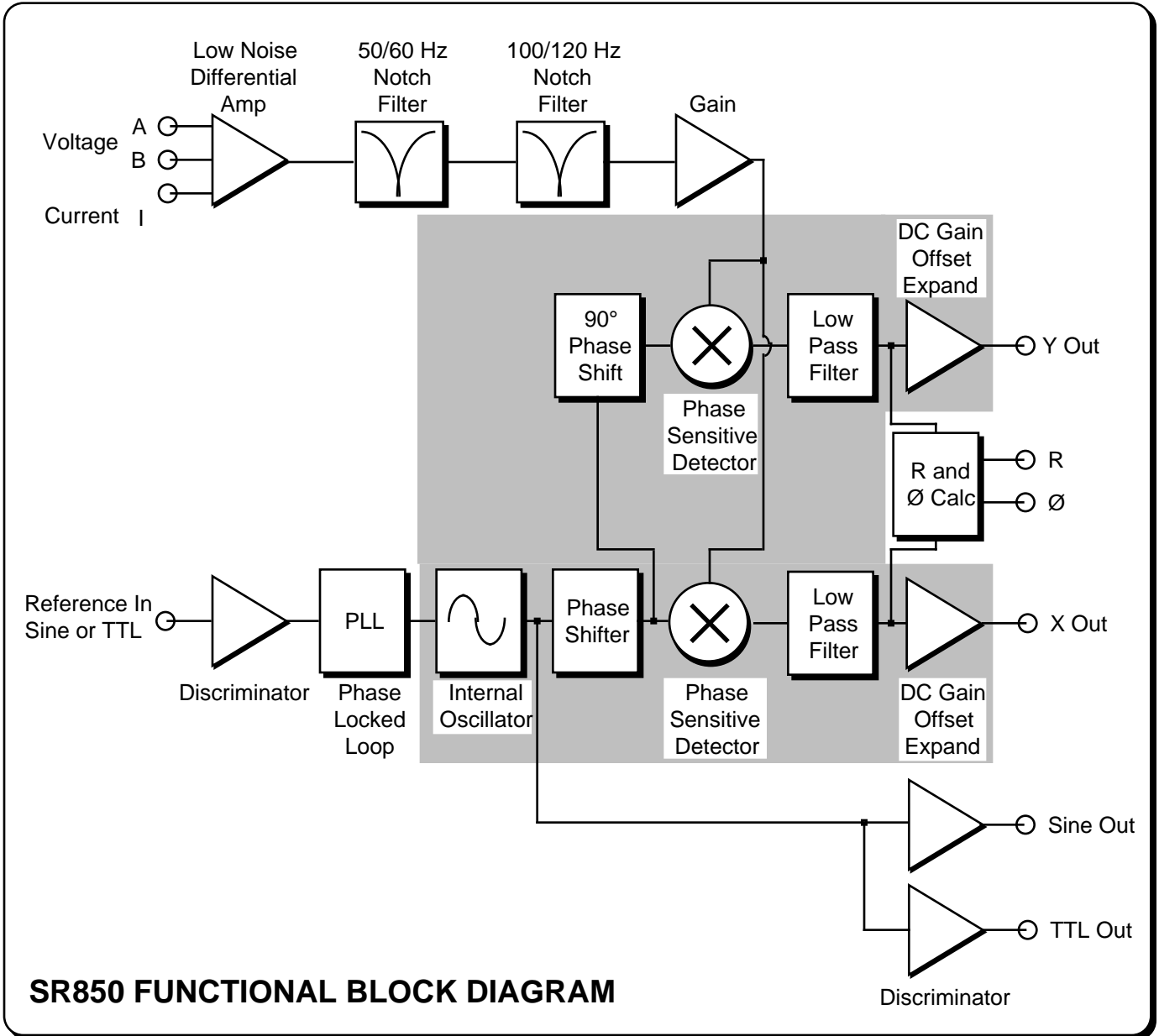

SR850 FUNCTIONAL BLOCK DIAGRAM

REFERENCE CHANNEL

A lock-in amplifier requires a reference oscillator phase-locked to the signal frequency. In general, this is accomplished by phase-locking an internal oscillator to an externally provided reference signal. This reference signal usually comes from the signal source which is providing the excitation to the experiment.

Reference Input

The SR850 reference input can accept an analog signal (like a sine wave) or a TTL logic signal. The first case is called External Sine. The input is AC coupled (above 1 Hz) and the input impedance is $1\text{ M}\Omega$. A sine wave input greater than 200 mV pk will trigger the input discriminator. Positive zero crossings are detected and considered to be the zero for the reference phase shift.

TTL reference signals can be used at all frequencies up to 102 kHz. **For frequencies below 1 Hz, a TTL reference signal is required.** Many function generators provide a TTL SYNC output which can be used as the reference. This is convenient since the generator's sine output might be smaller than 200 mV or be varied in amplitude. The SYNC signal will provide a stable reference regardless of the sine amplitude.

When using a TTL reference, the reference input can be set to External Rising (detect rising edges) or External Falling (detect falling edges). In each case, the internal oscillator is locked (at zero phase) to the detected edge.

Internal Oscillator

The internal oscillator in the SR850 is basically a 100 kHz function generator with sine and TTL sync outputs. The oscillator can be phase-locked to the external reference.

The oscillator generates a digitally synthesized sine wave. The digital signal processor, or DSP, sends computed sine values to a 16 bit digital-to-analog converter every $4\ \mu\text{s}$ (256 kHz). An anti-aliasing filter converts this sampled signal into a low distortion sine wave. The internal oscillator sine wave is output at the SINE OUT BNC on the front panel. The amplitude of this output may be set from 4 mV to 5 V.

When an external reference is used, this internal

oscillator sine wave is phase-locked to the reference. The rising zero crossing is locked to the detected reference zero crossing or edge. In this mode, the SINE OUT provides a sine wave phase-locked to the external reference. At low frequencies (below 10 Hz), the phase locking is accomplished digitally by the DSP. At higher frequencies, a discrete phase comparator is used.

The internal oscillator may be used without an external reference. In the Internal Reference mode, the SINE OUT provides the excitation for the experiment. The phase-locked-loop is not used in this mode since the lock-in reference is providing the excitation signal.

The TTL OUT on the rear panel provides a TTL sync output. The internal oscillator's rising zero crossings are detected and translated to TTL levels. This output is a square wave.

Reference Oscillators and Phase

The internal oscillator sine wave is not the reference signal to the phase sensitive detectors. The DSP computes a second sine wave, phase shifted by ϕ_{ref} from the internal oscillator (and thus from an external reference), as the reference input to the X phase sensitive detector. This waveform is $\sin(\omega_{\text{ref}}t + \phi_{\text{ref}})$. The reference phase shift is adjustable in $.001^\circ$ increments.

The input to the Y PSD is a third sine wave, computed by the DSP, shifted by 90° from the second sine wave. This waveform is $\sin(\omega_{\text{ref}}t + \phi_{\text{ref}} + 90^\circ)$.

Both reference sine waves are calculated to 20 bits of accuracy and a new point is calculated every $4\ \mu\text{s}$ (256 kHz). The phase shifts (ϕ_{ref} and the 90° shift) are also exact numbers and accurate to better than $.001^\circ$. Neither waveform is actually output in analog form since the phase sensitive detectors are actually multiply instructions inside the DSP.

Phase Jitter

When an external reference is used, the phase-locked loop adds a little phase jitter. The internal oscillator is supposed to be locked with zero phase shift relative the external reference. Phase jitter means that the average phase shift is zero but the instantaneous phase shift has a few milli-

degrees of noise. This shows up at the output as noise in phase or quadrature measurements.

Phase noise can also cause noise to appear at the X and Y outputs. This is because a reference oscillator with a lot of phase noise is the same as a reference whose frequency spectrum is spread out. That is, the reference is not a single frequency, but a distribution of frequencies about the true reference frequency. These spurious frequencies are attenuated quite a bit but still cause problems. The spurious reference frequencies result in signals close to the reference being detected. Noise at nearby frequencies now appears near DC and affects the lock-in output.

Phase noise in the SR850 is very low and generally causes no problems. In applications requiring no phase jitter, the internal reference mode should be used. Since there is no PLL, the internal oscillator and the reference sine waves are directly linked and there is no jitter in the measured phase. (Actually, the phase jitter is the phase noise of a crystal oscillator and is very, very small).

Harmonic Detection

It is possible to compute the two PSD reference sine waves at a multiple of the internal oscillator frequency. In this case, the lock-in detects signals at $Nx_{f_{ref}}$ which are synchronous with the reference. The SINE OUT frequency is not affected. The SR850 can detect at any harmonic up to $N=32767$ as long as $Nx_{f_{ref}}$ does not exceed 102 kHz.

THE PHASE SENSITIVE DETECTORS (PSD's)

The SR850 multiplies the signal with the reference sine waves digitally. The amplified signal is converted to digital form using a 16 bit A/D converter sampling at 256 kHz. The A/D converter is preceded by a 102 kHz anti-aliasing filter to prevent higher frequency inputs from aliasing below 102 kHz. The signal amplifier and filters will be discussed later.

This input data stream is multiplied, a point at a time, with the computed reference sine waves described previously. Every 4 μ s, the input signal is sampled and the result is multiplied by the two reference sine waves (90° apart).

Digital PSD vs Analog PSD

The phase sensitive detectors (PSD's) in the SR850 act as linear multipliers, that is, they multiply the signal with a reference sine wave. Analog PSD's (both square wave and linear) have many problems associated with them. The main problems are harmonic rejection, output offsets, limited dynamic reserve and gain error.

The digital PSD multiplies the digitized signal with a digitally computed reference sine wave. Because the reference sine waves are computed to 20 bits of accuracy, they have very low harmonic content. In fact, the harmonics are at the -120 dB level! This means that the signal is multiplied by a single reference sine wave (instead of a reference and its many harmonics) and only the signal at this single reference frequency is detected. The SR850 is completely insensitive to signals at harmonics of the reference. In contrast, a square wave multiplying lock-in will detect at all of the odd harmonics of the reference (a square wave contains many large odd harmonics).

Output offset is a problem because the signal of interest is a DC output from the PSD and an output offset contributes to error and zero drift. The offset problems of analog PSD's are eliminated using the digital multiplier. There are no erroneous DC output offsets from the digital multiplication of the signal and reference. In fact, the actual multiplication is totally free from errors.

The dynamic reserve of an analog PSD is limited to about 60 dB. When there is a large noise signal present, 1000 times or 60 dB greater than the full

scale signal, the analog PSD measures the signal with an error. The error is caused by non-linearity in the multiplication (the error at the output depends upon the amplitude of the input). This error can be quite large (10% of full scale) and depends upon the noise amplitude, frequency, and waveform. Since noise generally varies quite a bit in these parameters, the PSD error causes quite a bit of output uncertainty.

In the digital lock-in, the dynamic reserve is limited by the quality of the A/D conversion. Once the input signal is digitized, no further errors are introduced. Certainly the accuracy of the multiplication does not depend on the size of the numbers. The A/D converter used in the SR850 is extremely linear, meaning that the presence of large noise signals does not impair its ability to correctly digitize a small signal. In fact, the dynamic reserve of the SR850 can exceed 100 dB without any problems. We'll talk more about dynamic reserve a little later.

An analog linear PSD multiplies the signal by an analog reference sine wave. Any amplitude variation in the reference amplitude shows up directly as a variation in the overall gain. Analog sine wave generators are susceptible to amplitude drift, especially as a function of temperature. The digital reference sine wave has a precise amplitude and never changes. This eliminates a major source of gain error in a linear analog lock-in.

The overall performance of a lock-in amplifier is largely determined by the performance of its phase sensitive detectors. In virtually all respects, the digital PSD outperforms its analog counterparts.

We've discussed how the digital signal processor in the SR850 computes the internal oscillator and two reference sine waves and handles both phase sensitive detectors. In the next section, we'll see the same DSP perform the low pass filtering and DC amplification required at the output of the PSD's. Here again, the digital technique eliminates many of the problems associated with analog lock-in amplifiers.

TIME CONSTANTS and DC GAIN

Remember, the output of the PSD contains many signals. Most of the output signals have frequencies which are either the sum or difference between an input signal frequency and the reference frequency. Only the component of the input signal whose frequency is exactly equal to the reference frequency will result in a DC output.

The low pass filter at the PSD output removes all of the unwanted AC signals, both the $2F$ (sum of the signal and the reference) and the noise components. This filter is what makes the lock-in such a narrow band detector.

Time Constants

Lock-in amplifiers have traditionally set the low pass filter bandwidth by setting the time constant. The time constant is simply $1/2 f$ where f is the -3 dB frequency of the filter. The low pass filters are simple 6 dB/oct roll off, RC type filters. A 1 second time constant referred to a filter whose -3 dB point occurred at 0.16 Hz and rolled off at 6 dB/oct beyond 0.16 Hz. Typically, there are two successive filters so that the overall filter can roll off at either 6 dB or 12 dB per octave. The time constant referred to the -3 dB point of each filter alone (not the combined filter).

The notion of time constant arises from the fact that the actual output is supposed to be a DC signal. In fact, when there is noise at the input, there is noise on the output. By increasing the time constant, the output becomes more steady and easier to measure reliably. The trade off comes when real changes in the input signal take many time constants to be reflected at the output. This is because a single RC filter requires about 5 time constants to settle to its final value. The time constant reflects how slowly the output responds, and thus the degree of output smoothing.

Note that the SR850 displays the time constant and the equivalent noise bandwidth (ENBW) in the time constant menu. The ENBW is NOT the filter -3 dB pole, it is the effective bandwidth for Gaussian noise. More about this later.

Digital Filters vs Analog Filters

The SR850 improves on analog filters in many ways. First, analog lock-ins provide at most, two stages of filtering with a maximum roll off of

12 dB/oct. This limitation is usually due to space and expense. Each filter needs to have many different time constant settings. The different settings require different components and switches to select them, all of which is costly and space consuming.

The digital signal processor in the SR850 handles all of the low pass filtering. Each PSD can be followed by up to four filter stages for up to 24 dB/oct of roll off. Since the filters are digital, the SR850 is not limited to just two stages of filtering.

Why is the increased roll off desirable? Consider an example where the reference is at 1 kHz and a large noise signal is at 1.05 kHz. The PSD noise outputs are at 50 Hz (difference) and 2.05 kHz (sum). Clearly the 50 Hz component is the more difficult to low pass filter. If the noise signal is 80 dB above the full scale signal and we would like to measure the signal to 1% (-40 dB), then the 50 Hz component needs to be reduced by 120 dB. To do this in two stages would require a time constant of at least 3 seconds. To accomplish the same attenuation in four stages only requires 100 ms of time constant. In the second case, the output will respond 30 times faster and the experiment will take less time.

Synchronous Filters

Another advantage of digital filtering is the ability to do synchronous filtering. Even if the input signal has no noise, the PSD output always contains a component at $2F$ (sum frequency of signal and reference) whose amplitude equals or exceeds the desired DC output depending upon the phase. At low frequencies, the time constant required to attenuate the $2F$ component can be quite long. For example, at 1 Hz, the $2F$ output is at 2 Hz and to attenuate the 2 Hz by 60 dB in two stages requires a time constant of 3 seconds.

A synchronous filter, on the other hand, operates totally differently. The PSD output is averaged over a complete cycle of the reference frequency. The result is that all components at multiples of the reference ($2F$ included) are notched out completely. In the case of a clean signal, almost no additional filtering would be required. This is increasingly useful the lower the reference frequency. Imagine what the time constant would

need to be at 0.001 Hz!

In the SR850, synchronous filters are available at detection frequencies below 200 Hz. At higher frequencies, the filters are not required (2F is easily removed without using long time constants). Below 200 Hz, the synchronous filter follows either one or two stages of normal filters. The output of the synchronous filter is followed by two more stages of normal filters. This combination of filters notches all multiples of the reference frequency and provides overall noise attenuation as well.

Long Time Constants

Time constants above 100 seconds are difficult to accomplish using analog filters. This is simply because the capacitor required for the RC filter is prohibitively large (in value and in size!). Why would you use such a long time constant? Sometimes you have no choice. If the reference is well below 1 Hz and there is a lot of low frequency noise, then the PSD output contains many very low frequency components. The synchronous filter only notches multiples of the reference frequency, the noise is filtered by the normal filters.

The SR850 can provide time constants as long as 30000 seconds at reference frequencies below 200 Hz. Obviously you don't use long time constants unless absolutely necessary, but they're available.

DC Output Gain

How big is the DC output from the PSD? It depends on the dynamic reserve. With 60 dB of dynamic reserve, a noise signal can be 1000 times (60 dB) greater than a full scale signal. At the PSD, the noise can not exceed the PSD's input range. In an analog lock-in, the PSD input range might be 5V. With 60 dB of dynamic reserve, the signal will be only 5 mV at the PSD input. The PSD typically has no gain so the DC output from the PSD will only be a few millivolts! Even if the PSD had no DC output errors, amplifying this millivolt signal up to 10 V is error prone. The DC output gain needs to be about the same as the dynamic reserve (1000 in this case) to provide a 10 V output for a full scale input signal. An offset as small as 1 mV will appear as 1 V at the output! In fact, the PSD output offset plus the input offset of the DC amplifier needs to be on the order of 10 μ V in order to not affect the measurement. If the dynamic reserve is increased to 80dB, then this offset needs to be 10 times smaller still. This

is one of the reasons why analog lock-ins do not perform well at very high dynamic reserve.

The digital lock-in does not have an analog DC amplifier. The output gain is yet another function handled by the digital signal processor. We already know that the digital PSD has no DC output offset. Likewise, the digital DC amplifier has no input offset. Amplification is simply taking input numbers and multiplying by the gain. This allows the SR850 to operate with 100 dB of dynamic reserve without any output offset or zero drift.

What about resolution?

Just like the analog lock-in where the noise can not exceed the input range of the PSD, in the digital lock-in, the noise can not exceed the input range of the A/D converter. With a 16 bit A/D converter, a dynamic reserve of 60 dB means that while the noise has a range of the full 16 bits, the full scale signal only uses 6 bits. With a dynamic reserve of 80 dB, the full scale signal uses only 2.5 bits. And with 100 dB dynamic reserve, the signal is below a single bit! Clearly multiplying these numbers by a large gain is not going to result in a sensible output. Where does the output resolution come from?

The answer is filtering. The low pass filters effectively combine many data samples together. For example, at a 1 second time constant, the output is the result of averaging data over the previous 4 or 5 seconds. At a sample rate of 256 kHz, this means each output point is the exponential average of over a million data points. (A new output point is computed every 4 μ s and is a moving exponential average). What happens when you average a million points? To first order, the resulting average has more resolution than the incoming data points by a factor of million. This represents a gain of 20 bits in resolution over the raw data. A 1 bit input data stream is converted to 20 bits of output resolution from 1 out of a million all the way up to a million out of a million or 1.

The compromise here is that with high dynamic reserve (large DC gains), some filtering is required. The shortest time constants are not available when the dynamic reserve is very high. This is not really a limitation since presumably there is noise which is requiring the high dynamic reserve and thus substantial output filtering will also be required.

DC OUTPUTS and SCALING

The SR850 has X and Y outputs on the rear panel and Channel 1 and 2 (CH1 and CH2) outputs on the front panel.

X and Y

The X and Y rear panel outputs are the outputs from the two phase sensitive detectors with low pass filtering, offset and expand. These outputs are the traditional outputs of an analog lock-in. The X and Y outputs have an output bandwidth of 100 kHz.

CH1 and CH2

The two front panel outputs can be configured to output voltages proportional to X, Y, R, θ , or Traces 1-4.

If the outputs are set to X or Y, these outputs duplicate the rear panel outputs.

If they are set to R or θ the output voltages are proportional to the calculated values of R and θ . These calculations are performed at a rate of 512 Hz and the R and θ outputs are updated at the 512 Hz rate.

If the outputs are proportional to a data trace, then the output is also updated at 512 Hz. The traces are defined in the TRACE menu as $A \cdot B / C$ where A,B,C can be X, Y, R, θ , Xnoise, Ynoise, Rnoise, Frequency, Aux Inputs 1-4, or unity (C may also be any quantity squared). If a trace is defined as simply X, this trace, when output through CH1 or CH2, will only update at 512 Hz. It is better in this case to set CH1 to output X directly, rather than the trace defined as X. The output scale of a data trace is discussed later in this section.

X, Y, R and θ Output scales

The sensitivity of the lock-in is the rms amplitude of an input sine (at the reference frequency) which results in a full scale DC output. Traditionally, full scale means 10 VDC at the X, Y or R BNC output. The overall gain (input to output) of the amplifier is then 10 V/sensitivity. This gain is distributed between AC gain before the PSD and DC gain following the PSD. Changing the dynamic reserve at a given sensitivity changes the gain distribution while keeping the overall gain constant.

The SR850 considers 10 V to be full scale for any

output proportional to simply X, Y or R. This is the output scale for the X and Y rear panel outputs as well as the CH1 and CH2 outputs when configured to output X, Y or R. When the CH1 or CH2 outputs are proportional to a data trace which is simply defined as X, Y or R, the output scale is also 10 V full scale.

Lock-in amplifiers are designed to measure the RMS value of the AC input signal. All sensitivities and X, Y and R outputs and displays are RMS values.

Phase is a quantity which ranges from -180° to $+180^\circ$ regardless of the sensitivity. When the CH1 or CH2 outputs a voltage proportional to θ , the output scale is $18^\circ/\text{Volt}$ or $180^\circ=10\text{V}$.

X, Y and R Output Offset and Expand

The SR850 has the ability to offset the X, Y and R outputs. This is useful when measuring deviations in the signal around some nominal value. The offset can be set so that the output is offset to zero. Changes in the output can then be read directly from the display or output voltages. The offset is specified as a percentage of full scale and the percentage does not change when the sensitivity is changed. Offsets up to $\pm 105\%$ can be programmed.

The X, Y and R outputs may also be expanded. This simply takes the output (minus its offset) and multiplies by an expansion factor. Thus, a signal which is only 10% of full scale can be expanded to provide 10 V of output rather than only 1 V. The normal use for expand is to expand the measurement resolution around some value which is not zero. For example, suppose a signal has a nominal value of 0.9 mV and we want to measure small deviations, say 10 μV or so, in the signal. The sensitivity of the lock-in needs to be 1 mV to accommodate the nominal signal. If the offset is set so to 90% of full scale, then the nominal 0.9 mV signal will result in a zero output. The 10 μV deviations in the signal only provide 100 mV of DC output. If the output is expanded by 10, these small deviations are magnified by 10 and provide outputs of 1 VDC.

The SR850 can expand the output by a factor from 1 to 256 provided the expanded output does not exceed full scale. In the above example, the 10 μV

deviations can be expanded up to 100 times before they exceed full scale (at 1 mV sensitivity).

The analog output with offset and expand is

$$\text{Output} = (\text{signal/sensitivity} - \text{offset}) \times \text{Expand} \times 10\text{V}$$

where offset is a fraction of 1 (50%=0.5), expand is an integer from 1 to 256 and the output can not exceed 10 V. In the above example,

$$\text{Output} = (0.91\text{mV}/1\text{mV} - 0.9) \times 10 \times 10\text{V} = 1\text{V}$$

for a signal which is 10 μV greater than the 0.9 mV nominal. (Offset = 0.9 and expand =10).

The X and Y offset and expand functions in the SR850 are output functions, they do NOT affect the calculation of R or ϕ . R has its own output offset and expand.

Trace displays

Only data traces may be displayed on the screen. In order to display the quantity X, it is necessary to define a trace to be X and then choose to display that trace.

Output offsets ARE reflected in data trace displays which depend upon X, Y or R. For example, a trace which is defined as X is affected by the X offset. When the X output is offset to zero, the displayed trace value on the screen will drop to zero also. Any display which is showing a trace which is affected by a non-zero offset will display a highlighted **Offst** indicator at the lower left of the display.

Output expands do NOT increase the displayed values of X, Y or R in data traces. Expand increases the resolution of the X, Y or R value used to calculate the trace value. For example, a trace which is defined as X does not increase its displayed value when X is expanded. This is because the expand function increases the resolution with which the signal is measured, not the size of the input signal. The displayed value will show an increased resolution but will continue to display the original value of X minus the X offset. Any display which is showing a trace which is affected by a non-unity expand will display a highlighted **Expd** indicator at the lower left of the display.

Complex data traces are displayed and stored in the actual units of the computed quantity. For

example, if a trace is defined as $X \cdot \phi / \text{Aux } 1$ and $X=1 \text{ mV}$, $\phi=37^\circ$, and $\text{Aux } 1= 2.34 \text{ V}$, then the trace value is $0.001 \times 37/2.34 \text{ Volt} \cdot \text{degrees per Volt}$ or 0.01581 Vdeg/V . This value is not changed by the sensitivity (X is the input signal, not the output voltage) or by X expand. An X offset will, however, change the value of this trace.

Trace output scaling

What about CH1 or CH2 outputs proportional to data traces which are not simply X, Y, R or ϕ ? If a trace is defined as $A \cdot B/C$, then the trace output voltage depends upon the values of each parameter. Trace output voltages are calculated by determining the output voltages for the individual quantities, A, B and C. The individual output voltages (-10 V to +10 V) are then combined using the trace definition to determine the trace output voltage.

For example, suppose a trace is defined as X/R . The parameters X and R scale as 10 V for a full scale input signal. If the sensitivity is 1 V and the measured values are $X=500 \text{ mV}$ and $R=1 \text{ V}$, the X output would be 5 V and the R output would be 10 V. The trace output voltage is simply $(X=5 \text{ V})/(R=10 \text{ V})=0.5 \text{ V}$.

Output voltages for traces which are defined as A, B, A/C , B/C or $A \cdot B/C$ are calculated using the output voltages for A, B and C. Traces defined as $A \cdot B$ (A,B 1, C=1) have output voltages which are the product of the A and B output voltages divided by 10.

For example, suppose a trace is defined as $X \cdot \phi$. The parameter X scales as 10 V for a full scale input signal and ϕ scales as 10 V for 180° of phase shift. If the measured X is 1 V on the 1 V sensitivity, X would be 100% of full scale or 10 V. If the phase is 180° , then ϕ is also 10 V. The trace output voltage is thus, $(X=10 \text{ V}) \cdot (\phi=10 \text{ V})/10=10 \text{ V}$. The extra factor of 10 allows products of two full scale quantities to be output.

X, Y and R output offsets ARE reflected in trace outputs which depend upon X, Y or R. For example, a trace which is defined as X and output through CH1 or CH2 is affected by the X offset. When the X output is offset to zero, the trace output voltage will drop to zero also.

Output expands DO increase the output voltage of X, Y or R in trace outputs. Expand increases the

output voltages of X, Y or R in trace output calculations. For example, a trace which is defined as X and output through CH1 or CH2 increases its output voltage by the expand factor when X is expanded. This is because the output voltage of X is expanded.

The output voltage scales for the individual quantities are listed below.

X,Y,R (signal/sensitivity-offset)xExpandx10V
10V/180°

Xn,Yn,Rn (noise signal/sensitivity)xExpandx10V

Aux In 1-4 output voltage = Aux input voltage

1 1V

F 5V - 10V for each octave in frequency.

For example,

1000 Hz = 5V

1200 Hz = 6V

1600 Hz = 8V

1800 Hz = 9V

1990 Hz = 9.95V

2000 Hz = 5V (next octave)

The octaves are defined as follows,

...

62.5 Hz - 125 Hz

125 Hz - 250 Hz

250 Hz - 500 Hz

500 Hz - 1000 Hz

1 kHz - 2 kHz

4 kHz - 8 kHz

8 kHz - 16 kHz

...

DYNAMIC RESERVE

We've mentioned dynamic reserve quite a bit in the preceding discussions. It's time to clarify dynamic reserve a bit.

What is dynamic reserve really?

Suppose the lock-in input consists of a full scale signal at f_{ref} plus noise at some other frequency. The traditional definition of dynamic reserve is the ratio of the largest tolerable noise signal to the full scale signal, expressed in dB. For example, if full scale is 1 μ V, then a dynamic reserve of 60 dB means noise as large as 1 mV (60 dB greater than full scale) can be tolerated at the input without overload.

The problem with this definition is the word 'tolerable'. Clearly the noise at the dynamic reserve limit should not cause an overload anywhere in the instrument - not in the input signal amplifier, PSD, low pass filter or DC amplifier. This is accomplished by adjusting the distribution of the gain. To achieve high reserve, the input signal gain is set very low so the noise is not likely to overload. This means that the signal at the PSD is also very small. The low pass filter then removes the large noise components from the PSD output which allows the remaining DC component to be amplified (a lot) to reach 10 V full scale. There is no problem running the input amplifier at low gain. However, as we have discussed previously, analog lock-ins have a problem with high reserve because of the linearity of the PSD and the DC offsets of the PSD and DC amplifier. In an analog lock-in, large noise signals almost always disturb the measurement in some way.

The most common problem is a DC output error caused by the noise signal. This can appear as an offset or as a gain error. Since both effects are dependent upon the noise amplitude and frequency, they can not be offset to zero in all cases and will limit the measurement accuracy. Because the errors are DC in nature, increasing the time constant does not help. Most lock-ins define tolerable noise as noise levels which do not affect the output more than a few percent of full scale. This is more severe than simply not overloading.

Another effect of high dynamic reserve is to generate noise and drift at the output. This comes about because the DC output amplifier is running at very

high gain and low frequency noise and offset drift at the PSD output or the DC amplifier input will be amplified and appear large at the output. The noise is more tolerable than the DC drift errors since increasing the time constant will attenuate the noise. The DC drift in an analog lock-in is usually on the order of 1000ppm/ $^{\circ}$ C when using 60 dB of dynamic reserve. This means that the zero point moves 1% of full scale over 10 $^{\circ}$ C temperature change. This is generally considered the limit of tolerable.

Lastly, dynamic reserve depends on the noise frequency. Clearly noise at the reference frequency will make its way to the output without attenuation. So the dynamic reserve at f_{ref} is 0dB. As the noise frequency moves away from the reference frequency, the dynamic reserve increases. Why? Because the low pass filter after the PSD attenuates the noise components. Remember, the PSD outputs are at a frequency of $|f_{noise}-f_{ref}|$. The rate at which the reserve increases depends upon the low pass filter time constant and roll off. The reserve increases at the rate at which the filter rolls off. This is why 24 dB/oct filters are better than 6 or 12 dB/oct filters. When the noise frequency is far away, the reserve is limited by the gain distribution and overload level of each gain element. This reserve level is the dynamic reserve referred to in the specifications.

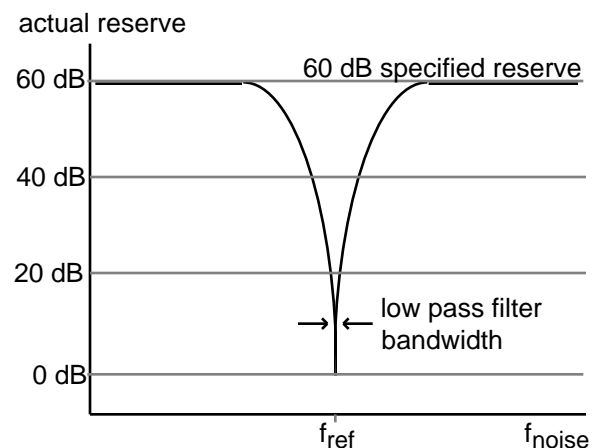

The above graph shows the actual reserve vs the frequency of the noise. In some instruments, the signal input attenuates frequencies far outside the lock-in's operating range ($f_{noise} \gg 100$ kHz). In these cases, the reserve can be higher at these

frequencies than within the operating range. While this may be a nice specification, removing noise at frequencies very far from the reference does not require a lock-in amplifier. Lock-ins are used when there is noise at frequencies near the signal. Thus, the dynamic reserve for noise within the operating range is more important.

Dynamic reserve in the SR850

The SR850, with its digital phase sensitive detectors, does not suffer from DC output errors caused by large noise signals. The dynamic reserve can be increased to above 100 dB without measurement error. Large noise signals do not cause output errors from the PSD. The large DC gain does not result in increased output drift.

In fact, the only drawback to using ultra high dynamic reserves (>60 dB) is the increased output noise due to the noise of the A/D converter. This increase in output noise is only present when the dynamic reserve is increased above 60 dB AND above the minimum reserve. (If the minimum reserve is 80 dB, then increasing to 90 dB may increase the noise. As we'll discuss next, the minimum reserve does not have increased output noise no matter how large it is.)

To set a scale, the SR850's output noise at 100 dB dynamic reserve is only measurable when the signal input is grounded. Let's do a simple experiment. If the lock-in reference is at 1 kHz and a large signal is applied at 9.5 kHz, what will the lock-in output be? If the signal is increased to the dynamic reserve limit (100 dB greater than full scale), the output will reflect the noise of the signal at 1 kHz. The spectrum of any pure sine generator always has a noise floor, i.e. there is some noise at all frequencies. So even though the applied signal is at 9.5 kHz, there will be noise at all other frequencies, including the 1 kHz lock-in reference. This noise will be detected by the lock-in and appear as noise at the output. This output noise will typically be greater than the SR850's own output noise. In fact, virtually all signal sources will have a noise floor which will dominate the lock-in output noise. Of course, noise signals are generally much noisier than pure sine generators and will have much higher broadband noise floors.

If the noise does not reach the reserve limit, the SR850's own output noise may become detectable at ultra high reserves. In this case, simply lower the dynamic reserve and the DC gain will

decrease and the output noise will decrease also. In general, do not run with more reserve than necessary. Certainly don't use ultra high reserve when there is virtually no noise at all.

The frequency dependence of dynamic reserve is inherent in the lock-in detection technique. The SR850, by providing more low pass filter stages, can increase the dynamic reserve close to the reference frequency. The specified reserve applies to noise signals within the operating range of the lock-in, i.e. frequencies below 100 kHz. The reserve at higher frequencies is actually higher but is generally not that useful.

Minimum dynamic reserve

The SR850 always has a minimum amount of dynamic reserve. This minimum reserve changes with the sensitivity (gain) of the instrument. At high gains (full scale sensitivity of 50 μV and below), the minimum dynamic reserve increases from 37 dB at the same rate as the sensitivity increases. For example, the minimum reserve at 5 μV sensitivity is 57 dB. In many analog lock-ins, the reserve can be lower. Why can't the SR850 run with lower reserve at this sensitivity?

The answer to this question is - Why would you want lower reserve? In an analog lock-in, lower reserve means less output error and drift. In the SR850, more reserve does not increase the output error or drift. More reserve can increase the output noise though. However, if the analog signal gain before the A/D converter is high enough, the 5 nV/ Hz noise of the signal input will be amplified to a level greater than the input noise of the A/D converter. At this point, the detected noise will reflect the actual noise at the signal input and not the A/D converter's noise. Increasing the analog gain (decreasing the reserve) will not decrease the output noise. Thus, there is no reason to decrease the reserve. At a sensitivity of 5 μV , the analog gain is sufficiently high so that A/D converter noise is not a problem. Sensitivities below 5 μV do not require any more gain since the signal to noise ratio will not be improved (the front end noise dominates). The SR850 does not increase the gain below the 5 μV sensitivity, instead, the minimum reserve increases. Of course, the input gain can be decreased and the reserve increased, in which case the A/D converter noise might be detected in the absence of any signal input.

SIGNAL INPUT AMPLIFIER and FILTERS

A lock-in can measure signals as small as a few nanovolts. A low noise signal amplifier is required to boost the signal to a level where the A/D converter can digitize the signal without degrading the signal to noise. The analog gain in the SR850 ranges from roughly 7 to 1000. As discussed previously, higher gains do not improve signal to noise and are not necessary.

The overall gain (AC plus DC) is determined by the sensitivity. The distribution of the gain (AC versus DC) is set by the dynamic reserve.

Input noise

The input noise of the SR850 signal amplifier is about 5 nVrms/ Hz. What does this noise figure mean? Let's set up an experiment. If an amplifier has 5 nVrms/ Hz of input noise and a gain of 1000, then the output will have 5 μ Vrms/ Hz of noise. Suppose the amplifier output is low pass filtered with a single RC filter (6 dB/oct roll off) with a time constant of 100 ms. What will be the noise at the filter output?

Amplifier input noise and Johnson noise of resistors are Gaussian in nature. That is, the amount of noise is proportional to the square root of the bandwidth in which the noise is measured. A single stage RC filter has an equivalent noise bandwidth (ENBW) of $1/4T$ where T is the time constant (RxC). This means that Gaussian noise at the filter input is filtered with an effective bandwidth equal to the ENBW. In this example, the filter sees 5 μ Vrms/ Hz of noise at its input. It has an ENBW of $1/(4 \times 100\text{ms})$ or 2.5 Hz. The voltage noise at the filter output will be 5 μ Vrms/ Hz \times 2.5Hz or 7.9 μ Vrms. For Gaussian noise, the peak to peak noise is about 5 times the rms noise. Thus, the output will have about 40 μ V pk-pk of noise.

Input noise for a lock-in works the same way. For sensitivities below about 5 μ V full scale, the input noise will determine the output noise (at minimum reserve). The amount of noise at the output is determined by the ENBW of the low pass filter. The SR850 displays the ENBW in the Time Constant menu. The ENBW depends upon the time constant and filter roll off. For example, suppose the SR850 is set to 5 μ V full scale with a 100 ms time constant and 6 dB/oct of filter roll off. The

lock-in will measure the input noise with an ENBW of 2.5 Hz. This translates to 7.9 nVrms at the input. At the output, this represents about 0.16% of full scale (7.9 nV/5 μ V). The peak to peak noise will be about 0.8% of full scale.

All of this assumes that the signal input is being driven from a low impedance source. Remember resistors have Johnson noise equal to $0.13 \times R$ nVrms/ Hz. Even a 50 resistor has almost 1 nVrms/ Hz of noise! A signal source impedance of 2k will have a Johnson noise greater than the SR850's input noise. To determine the overall noise of multiple noise sources, take the square root of the sum of the squares of the individual noise figures. For example, if a 2k source impedance is used, the Johnson noise will be 5.8 nVrms/ Hz. The overall noise at the SR850 input will be $[5^2 + 5.8^2]^{1/2}$ or 7.7 nVrms/ Hz.

We'll talk more about noise sources later in this section.

At lower gains (sensitivities above 50 μ V), there is not enough gain at high reserve to amplify the input noise to a level greater than the noise of the A/D converter. In these cases, the output noise is determined by the A/D noise. Fortunately, at these sensitivities, the DC gain is low and the noise at the output is negligible.

Notch filters

The SR850 has two notch filters in the signal amplifier chain. These are pre-tuned to the line frequency (50 or 60 Hz) and twice the line frequency (100 or 120 Hz). In circumstances where the largest noise signals are at the power line frequencies, these filters can be engaged to remove noise signals at these frequencies. Removing the largest noise signals before the final gain stage can reduce the amount of dynamic reserve required to perform a measurement. To the extent that these filters reduce the required reserve to either 60 dB or the minimum reserve (whichever is higher), then some improvement might be gained. If the required reserve without these notch filters is below 60 dB or if the minimum reserve is sufficient, then these filters do not significantly improve the measurement.

Using either of these filters precludes making

measurements in the vicinity of the notch frequencies. These filters have a finite range of attenuation, generally 10 Hz or so. Thus, if the lock-in is making measurements at 70 Hz, do not use the 60 Hz notch filter! The signal will be attenuated and the measurement will be in error. When measuring phase shifts, these filters can affect phase measurements up to an octave away.

Anti-aliasing filter

After all of the signal filtering and amplification, there is an anti-aliasing filter. This filter is required by the signal digitization process. According to the Nyquist criterion, signals must be sampled at a frequency at least twice the highest signal frequency. In this case, the highest signal frequency is 100 kHz and the sampling frequency is 256 kHz so things are ok. However, no signals above 128 kHz can be allowed to reach the A/D converter. These signals would violate the Nyquist criterion and be undersampled. The result of this undersampling is to make these higher frequency signals appear as lower frequencies in the digital data stream. Thus a signal at 175 kHz would appear below 100 kHz in the digital data stream and be detectable by the digital PSD. This would be a problem.

To avoid this undersampling, the analog signal is filtered to remove any signals above 154 kHz (when sampling at 256 kHz, signals above 154 kHz will appear below 102 kHz). This filter has a flat pass band from DC to 102 kHz so as not to affect measurements in the operating range of the lock-in. The filter rolls off from 102 kHz to 154 kHz and achieves an attenuation above 154 kHz of at least 100 dB. Amplitude variations and phase shifts due to this filter are calibrated out at the factory and do not affect measurements. This filter is transparent to the user.

Input Impedance

The input impedance of the SR850 is 10 M Ω . If a higher input impedance is desired, then the SR550 remote preamplifier must be used. The SR550 has an input impedance of 100 M Ω and is AC coupled from 1 Hz to 100 kHz.

INPUT CONNECTIONS

In order to achieve the best accuracy for a given measurement, care must be taken to minimize the various noise sources which can be found in the laboratory. With intrinsic noise (Johnson noise, $1/f$ noise or input noise), the experiment or detector must be designed with these noise sources in mind. These noise sources are present regardless of the input connections. The effect of noise sources in the laboratory (such as motors, signal generators, etc.) and the problem of differential grounds between the detector and the lock-in can be minimized by careful input connections.

There are two basic methods for connecting a voltage signal to the lock-in - the single-ended connection is more convenient while the differential connection eliminates spurious pick-up more effectively.

Single-Ended Voltage Connection (A)

In the first method, the lock-in uses the A input in a single-ended mode. The lock-in detects the signal as the voltage between the center and outer conductors of the A input only. The lock-in does not force the shield of the A cable to ground, rather it is internally connected to the lock-in's ground via a resistor. The value of this resistor is chosen in the INPUT menu. Float uses 1 k Ω and Ground uses 10 Ω . This avoids ground loop problems between the experiment and the lock-in due to differing ground potentials. The lock-in lets the shield 'quasi-float' in order to sense the experiment ground. However, noise pickup on the shield will appear as noise to the lock-in. This is bad since the lock-in cannot reject this noise. Common mode noise, which appears on both the center and shield, is rejected by the 100 dB CMRR of the lock-in input, but noise on only the shield is not rejected at all.

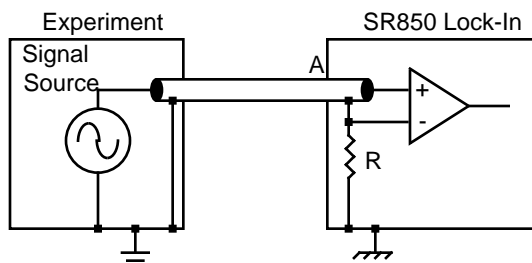

Grounds may be at different potentials

Differential Voltage Connection (A-B)

The second method of connection is the differential mode. The lock-in measures the voltage difference between the center conductors of the A and B inputs. Both of the signal connections are shielded from spurious pick-up. Noise pickup on the shields does not translate into signal noise since the shields are ignored.

When using two cables, it is important that both cables travel the same path between the experiment and the lock-in. Specifically, there should not be a large loop area enclosed by the two cables. Large loop areas are susceptible to magnetic pickup.

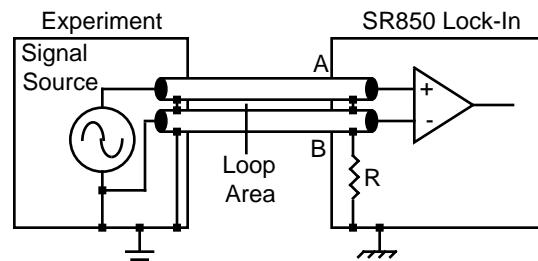

Grounds may be at different potentials

Common Mode Signals

Common mode signals are those signals which appear equally on both center and shield (A) or both A and B (A-B). With either connection scheme, it is important to minimize both the common mode noise and the common mode signal. Notice that the signal source is held near ground potential in both illustrations above. If the signal source floats at a nonzero potential, the signal which appears on both the A and B inputs will not be perfectly cancelled. The common mode rejection ratio (CMRR) specifies the degree of cancellation. For low frequencies, the CMRR of 100 dB indicates that the common mode signal is canceled to 1 part in 10^5 . Even with a CMRR of 100 dB, a 100 mV common mode signal behaves like a 1 μ V differential signal! This is especially bad if the common mode signal is at the reference frequency (this happens a lot due to ground loops). The CMRR decreases by about 6 dB/octave (20 dB/decade) starting at around 1 kHz.

Current Input (I)

The current input on the SR850 uses the A input BNC. Voltage or current input is chosen in the INPUT menu. The current input has a 1 kΩ input impedance and a current gain of either 10⁶ or 10⁸ Volts/Amp. Currents from 1 μA down to 2 fA full scale can be measured.

The impedance of the signal source is the most important factor to consider in deciding between voltage and current measurements.

For high source impedances, greater than 1 MΩ (10⁶ gain) or 100 MΩ (10⁸ gain), and small currents, use the current input. Its relatively low impedance greatly reduces the amplitude and phase errors caused by the cable capacitance-source impedance time constant. The cable capacitance should still be kept small to minimize the high frequency noise gain of the current preamplifier.

For moderate to low source impedances, or larger currents, the voltage input is preferred. A small value resistor may be used to shunt the signal current and generate a voltage signal. The lock-in then measures the voltage across the shunt resistor. Select the resistor value to keep the shunt voltage small (so it does not affect the source current) while providing enough signal for the lock-in to measure.

Which current gain should you use? The current gain determines the input current noise of the lock-in as well as its measurement bandwidth. Signals far above the input bandwidth are attenuated by 6 dB/oct. The noise and bandwidth are listed below.

<u>Gain</u>	<u>Noise</u>	<u>Bandwidth</u>
10 ⁶	130 fA/ Hz	70 kHz
10 ⁸	13 fA/ Hz	700 Hz

The current gain is selected in the INPUT menu when the I input is in use.

AC vs DC Coupling

The signal input can be either AC or DC coupled. The AC coupling high pass filter passes signals above 160 mHz (0.16 Hz) and attenuates signals at lower frequencies. AC coupling should be used at frequencies above 50 mHz whenever possible. At lower frequencies, DC coupling is required.

A DC signal, if not removed by the AC coupling filter, will multiply with the reference sine wave and produce an output at the reference frequency. This signal is not normally present and needs to be removed by the low pass filter. If the DC component of the signal is large, then this output will be large and require a long time constant to remove. AC coupling removes the DC component of the signal without any sacrifice in signal as long as the frequency is above 160 mHz.

The current input current to voltage preamplifier is always DC coupled. AC coupling can be selected following the current preamplifier to remove any DC current signal.

INTRINSIC (RANDOM) NOISE SOURCES

Random noise finds its way into experiments in a variety of ways. Good experimental design can reduce these noise sources and improve the measurement stability and accuracy.

There are a variety of intrinsic noise sources which are present in all electronic signals. These sources are physical in origin.

Johnson noise

Every resistor generates a noise voltage across its terminals due to thermal fluctuations in the electron density within the resistor itself. These fluctuations give rise to an open-circuit noise voltage,

$$V_{\text{noise}} (\text{rms}) = (4kTRf)^{1/2}$$

where k =Boltzmann's constant (1.38×10^{-23} J/°K), T is the temperature in °Kelvin (typically 300°K), R is the resistance in Ohms, and f is the bandwidth in Hz. f is the bandwidth of the measurement.

Since the input signal amplifier in the SR850 has a bandwidth of approximately 300 kHz, the effective noise at the amplifier input is $V_{\text{noise}} = 70 \sqrt{R}$ nVrms or $350 \sqrt{R}$ nV pk-pk. This noise is broadband and if the source impedance of the signal is large, can determine the amount of dynamic reserve required.

The amount of noise measured by the lock-in is determined by the measurement bandwidth. Remember, the lock-in does not narrow its detection bandwidth until after the phase sensitive detectors. In a lock-in, the equivalent noise bandwidth (ENBW) of the low pass filter (time constant) sets the detection bandwidth. In this case, the measured noise of a resistor at the lock-in input, typically the source impedance of the signal, is simply

$$V_{\text{noise}} (\text{rms}) = 0.13 \sqrt{R} \sqrt{\text{ENBW}} \text{ nV}$$

The SR850 displays the ENBW in the TIME CONSTANT menu. This is the correct noise bandwidth for the time constant and the number of poles and should be used to calculate the detected Johnson noise. The displayed ENBW does not take the synchronous filter into account.

The signal amplifier bandwidth determines the

amount of broadband noise that will be amplified. This affects the dynamic reserve. The time constant sets the amount of noise which will be measured at the reference frequency. See the SIGNAL INPUT AMPLIFIER discussion for more information about Johnson noise.

Shot noise

Electric current has noise due to the finite nature of the charge carriers. There is always some non-uniformity in the electron flow which generates noise in the current. This noise is called shot noise. This can appear as voltage noise when current is passed through a resistor, or as noise in a current measurement. The shot noise or current noise is given by

$$I_{\text{noise}} (\text{rms}) = (2qI f)^{1/2}$$

where q is the electron charge (1.6×10^{-19} Coulomb), I is the RMS AC current or DC current depending upon the circuit, and f is the bandwidth.

When the current input of a lock-in is used to measure an AC signal current, the bandwidth is typically so small that shot noise is not important.

1/f noise

Every 10^6 resistor, no matter what it is made of, has the same Johnson noise. However, there is excess noise in addition to Johnson noise which arises from fluctuations in resistance due to the current flowing through the resistor. For carbon composition resistors, this is typically $0.1 \mu\text{V}$ - $3 \mu\text{V}$ of rms noise per Volt of applied across the resistor. Metal film and wire-wound resistors have about 10 times less noise. This noise has a $1/f$ spectrum and makes measurements at low frequencies more difficult.

Other sources of $1/f$ noise include noise found in vacuum tubes and semiconductors.

Total noise

All of these noise sources are incoherent. The total random noise is the square root of the sum of the squares of all the incoherent noise sources.

EXTERNAL NOISE SOURCES

In addition to the intrinsic noise sources discussed in the previously, there are a variety of external noise sources within the laboratory.

Most of these noise sources are asynchronous, i.e. they are not related to the reference and do not occur at the reference frequency or its harmonics. Examples include lighting fixtures, motors, cooling units, radios, computer screens, etc. These noise sources affect the measurement by increasing the required dynamic reserve or lengthening the time constant.

Some noise sources, however, are related to the reference and, if picked up in the signal, will add or subtract from the actual signal and cause errors in the measurement. Typical sources of synchronous noise are ground loops between the experiment, detector and lock-in, and electronic pick up from the reference oscillator or experimental apparatus.

Many of these noise sources can be minimized with good laboratory practice and experiment design. There are several ways in which noise sources are coupled into the signal path.

Capacitive coupling

An AC voltage from a nearby piece of apparatus can couple to a detector via a stray capacitance. Although C_{stray} may be very small, the coupled noise may still be larger than a weak experimental signal. This is especially damaging if the coupled noise is synchronous (at the reference frequency).

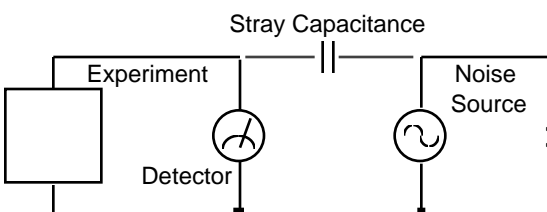

We can estimate the noise current caused by a stray capacitance by,

$$i = C_{\text{stray}} \frac{dV}{dt} = C_{\text{stray}} V_{\text{noise}}$$

where ω is 2 times the noise frequency, V_{noise} is the noise amplitude, and C_{stray} is the stray capacitance.

For example, if the noise source is a power circuit, then $f = 60 \text{ Hz}$ and $V_{\text{noise}} = 120 \text{ V}$. C_{stray} can be estimated using a parallel plate equivalent capacitor. If the capacitance is roughly an area of 1 cm^2 at a separated by 10 cm , then C_{stray} is 0.009 pF . The resulting noise current will be 400 pA (at 60 Hz). This small noise current can be thousands of times larger than the signal current. If the noise source is at a higher frequency, the coupled noise will be even greater.

If the noise source is at the reference frequency, then the problem is much worse. The lock-in rejects noise at other frequencies, but pick-up at the reference frequency appears as signal!

Cures for capacitive noise coupling include:

- 1) Removing or turning off the noise source.
- 2) Keeping the noise source far from the experiment (reducing C_{stray}). Do not bring the signal cables close to the noise source.
- 3) Designing the experiment to measure voltages with low impedance (noise current generates very little voltage).
- 4) Installing capacitive shielding by placing both the experiment and detector in a metal box.

Inductive coupling

An AC current in a nearby piece of apparatus can couple to the experiment via a magnetic field. A changing current in a nearby circuit gives rise to a changing magnetic field which induces an emf ($d\Phi_B/dt$) in the loop connecting the detector to the experiment. This is like a transformer with the experiment-detector loop as the secondary winding.

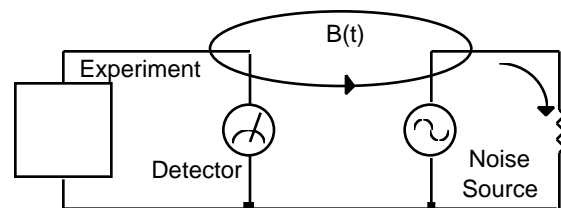

Cures for inductively coupled noise include:

- 1) Removing or turning off the interfering noise source.
- 2) Reduce the area of the pick-up loop by using twisted pairs or coaxial cables, or even twisting the 2 coaxial cables used in differential connections.
- 3) Using magnetic shielding to prevent the magnetic field from crossing the area of the experiment.
- 4) Measuring currents, not voltages, from high impedance detectors.

Resistive coupling or ground loops

Currents flowing through the ground connections can give rise to noise voltages. This is especially a problem with reference frequency ground currents.

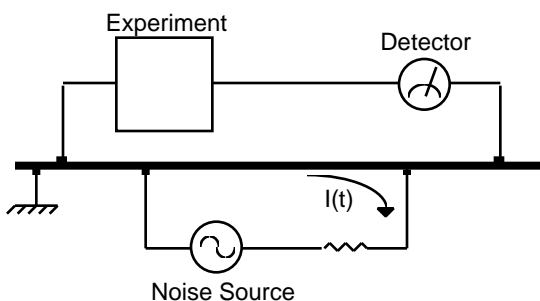

In this illustration, the detector is measuring the signal relative to a ground far from the rest of the experiment. The experiment senses the detector signal plus the voltage due to the noise source's ground return current passing through the finite resistance of the ground between the experiment and the detector. The detector and the experiment are grounded at different places which, in this case, are at different potentials.

Cures for ground loop problems include:

- 1) Grounding everything to the same physical point.
- 2) Using a heavy ground bus to reduce the resistance of ground connections.
- 3) Removing sources of large ground currents from the ground bus used for small signals.

Microphonics

Not all sources of noise are electrical in origin. Mechanical noise can be translated into electrical noise by microphonic effects. Physical changes in the experiment or cables (due to vibrations for example) can result in electrical noise over the entire frequency range of the lock-in.

For example, consider a coaxial cable connecting a detector to a lock-in. The capacitance of the cable is a function of its geometry. Mechanical vibrations in the cable translate into a capacitance that varies in time, typically at the vibration frequency. Since the cable is governed by $Q=CV$, taking the derivative, we have

$$C \frac{dV}{dt} + V \frac{dC}{dt} = \frac{dQ}{dt} = i$$

Mechanical vibrations in the cable which cause a dC/dt will give rise to a current in the cable. This current affects the detector and the measured signal.

Some ways to minimize microphonic signals are:

- 1) Eliminate mechanical vibrations near the experiment.
- 2) Tie down cables carrying sensitive signals so they do not move.
- 3) Use a low noise cable that is designed to reduce microphonic effects.

Thermocouple effects

The emf created by junctions between dissimilar metals can give rise to many microvolts of slowly varying potentials. This source of noise is typically at very low frequency since the temperature of the detector and experiment generally changes slowly. This effect is large on the scale of many detector outputs and can be a problem for low frequency measurements, especially in the mHz range.

Some ways to minimize thermocouple effects are:

- 1) Hold the temperature of the experiment or detector constant.
- 2) Use a compensation junction, i.e. a second junction in reverse polarity which generates an emf to cancel the thermal potential of the first junction. This second junction should be held at the same temperature as the first junction.

NOISE MEASUREMENTS

Lock-in amplifiers can be used to measure noise. Noise measurements are generally used to characterize components and detectors.

The SR850 measures input signal noise AT the reference frequency. Many noise sources have a frequency dependence which the lock-in can measure.

How does a lock-in measure noise?

Remember that the lock-in detects signals close to the reference frequency. How close? Input signals within the detection bandwidth set by the low pass filter time constant and roll-off appear at the output at a frequency $f=f_{\text{sig}}-f_{\text{ref}}$. Input noise near f_{ref} appears as noise at the output with a bandwidth of DC to the detection bandwidth.

The noise is simply the standard deviation (root of the mean of the squared deviations) of the measured X, Y or R . The SR850 can measure this noise exactly by recording the output quantity on a chart display and then calculating the standard deviation using the trace math functions. The noise, in Volts/ Hz, is simply the standard deviation divided by the square root of the equivalent noise bandwidth of the time constant.

For Gaussian noise, the equivalent noise bandwidth (ENBW) of a low pass filter is the bandwidth of the perfect rectangular filter which passes the same amount of noise as the real filter. The ENBW is displayed along with the time constant in the GAIN/TC menu.

Noise estimation

The above technique, while mathematically sound, can not provide a real time output or an analog output proportional to the measured noise. For these measurements, the SR850 can estimate the X, Y or R noise directly.

To display or record the noise of X, for example, simply define a trace as Xn (in the Trace/Scan menu). The quantity Xn is computed in real time and is an estimate of the noise of X. The quantities Yn and Rn are estimations of the Y noise and R noise.

The quantity Xn is computed from the measured values of X using the following algorithm. The

moving average of X is computed. This is the mean value of X over some past history. The present mean value of X is subtracted from the present value of X to find the deviation of X from the mean. Finally, the moving average of the absolute value of the deviations is calculated. This calculation is called the mean average deviation or MAD. This is not the same as an RMS calculation. However, if the noise is Gaussian in nature, then the RMS noise and the MAD noise are related by a constant factor.

The SR850 uses the MAD method to estimate the RMS noise quantities Xn, Yn and Rn. The advantage of this technique is its numerical simplicity and speed.

The noise calculations for X, Y and R occur at 512 Hz. At each sample, the mean and moving average of the absolute value of the deviations is calculated. The averaging time (for the mean and average deviation) depends upon the time constant. The averaging time is selected by the SR850 and ranges from 10 to 80 times the time constant. Shorter averaging times yield a very poor estimate of the noise (the mean varies rapidly and the deviations are not averaged well). Longer averaging times, while yielding better results, take a long time to settle to a steady answer.

To change the settling time, change the time constant. Remember, shorter settling times use smaller time constants (higher noise bandwidths) and yield noisier noise estimates.

The quantities Xn, Yn and Rn are displayed in units of Volts/ Hz. The ENBW of the time constant is already factored into the calculation. Thus, the mean value of Xn should not depend upon the time constant.

The SR850 performs the noise calculations all of the time, whether or not Xn, Yn or Rn are being recorded or displayed. Thus, as soon as Xn is displayed, the value shown is up to date and no settling time is required. If the sensitivity is changed, then the noise estimate will need to settle to the correct value.

For most applications, noise estimation and standard deviation calculations yield the same answer.

Which method you use depends upon the requirements of the experiment.

R noise

The quantity R_n can be somewhat hard to understand. For example, suppose X and Y are equally noisy and centered about zero. The values of R are always positive (magnitude) and thus average to a nonzero value. In this case, X and Y noise result in an average R which can be interpreted as the minimum detectable value of R . Increasing the time constant reduces the X and Y output noise and reduces this average value of R . The calculation of R noise by either method will typically yield a value smaller than either X_n or Y_n . This is because X and Y have both positive and negative values with a zero center yielding large deviations while R is always positive with a non zero mean and has smaller deviations. In this case, R noise is mathematically defined but not indicative of the Gaussian noise typically measured.

If there is a nonzero steady state value of R such that the noise excursions of R are small compared with the mean R , then R noise is meaningful. This is the case when measuring noise in the presence of real detectable signal. In this case, the value R_n approaches X_n and Y_n .

FRONT PANEL

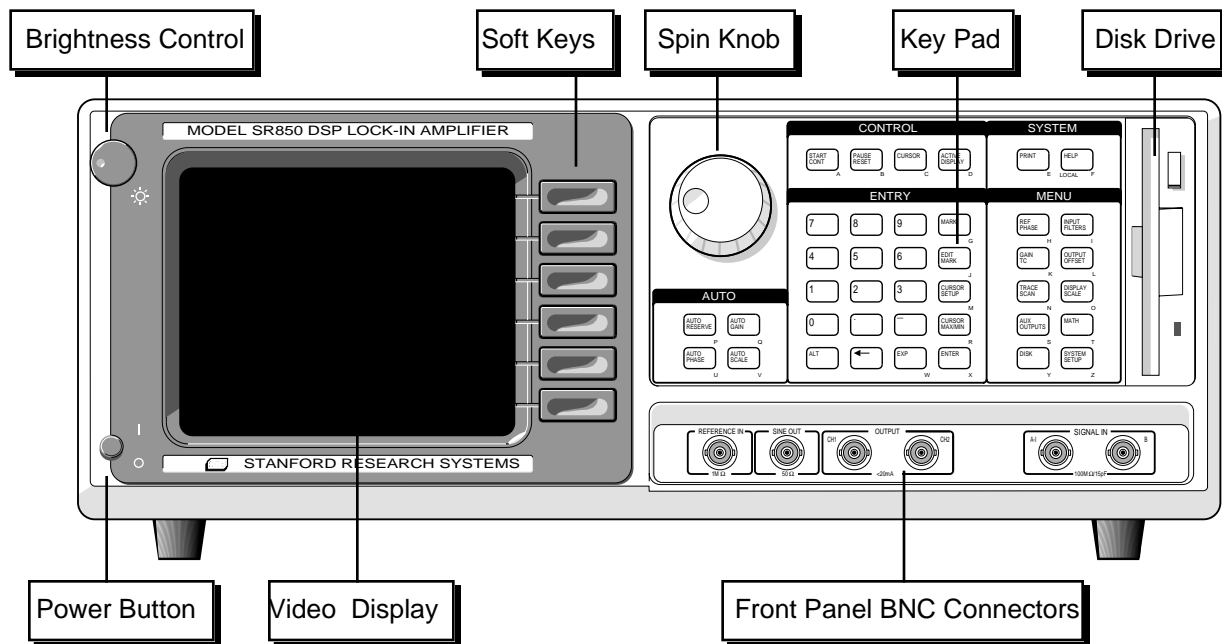

POWER BUTTON

The SR850 is turned on by pushing in the power button. The video display may take a few seconds to warm up and become visible. Adjust the brightness until the screen is easily readable. The model, firmware version and serial number of the unit are displayed when the power is turned on.

A series of internal tests are performed at this point. Each test is displayed as it is performed and the results are represented graphically as OK or NOT OK. The tests are described below.

RAM This test performs a read/write test to the processor RAM. In addition, the nonvolatile backup memory is tested. All instrument settings are stored in nonvolatile memory and are retained when the power is turned off. If the memory check passes, then the instrument returns to the settings in effect when the power was last turned off. If there is a memory error, then the stored settings are lost and the default settings are used.

ROM This test checks the processor ROM.

CLR This test indicates whether the unit is being reset. To reset the unit, hold down the

backspace [←] key while the power is turned on. The unit will use the default settings. The default setup is listed in a later chapter.

CLK This test checks the CMOS clock and calendar for a valid date and time. If there is an error, the time will be reset to a default time. Change the clock settings using the SYSTEM SETUP menu.

DSP This test checks the digital signal processor (DSP).

VIDEO DISPLAY

The monochrome video display is the user interface for data display and front panel programming operations. The resolution of the display is 640H by 480V. The brightness is adjusted using the brightness control knob located at the upper left corner. As with most video displays, do not set the brightness higher than necessary. The display may be adjusted left/right and up/down in the Screen Settings function in the SYSTEM SETUP menu.

The main area of the display is occupied by the output display(s). Both single and dual trace displays are available. In addition, each display can be formatted as a large numeric readout with bar graph, a polar graph, or a strip chart.

A complete description of the screen display options follows in the next section.

SOFT KEYS

The SR850 has a menu driven user interface. The 6 soft keys to the right of the video display have different functions depending upon the information displayed in the menu boxes at the right of the screen. In general, the soft keys have two uses. The first is to toggle a feature on and off or to choose between various options. The second is to highlight a parameter which is then changed using the spin knob or numeric keypad. In both cases, the soft keys select the parameters which are displayed adjacent to them.

KEYPAD

The keypad consists of five groups of keys. The ENTRY keys are used to enter numeric parameters which have been highlighted by a soft key. The MENU keys select a menu of soft keys. Pressing a menu key will change the menu boxes which are displayed next to the soft keys. Each menu presents a group of related parameters and functions. The CONTROL keys start and stop actual data acquisition, select the cursor and toggle the active display. These keys are not in a menu since they are used frequently and while displaying any menu. The SYSTEM keys print the screen to a printer and display help messages. Once again, these keys can be accessed from any menu. The AUTO keys perform auto functions and are accessible from any menu.

A complete description of the keys follows in the next section.

SPIN KNOB

The spin knob is used to adjust parameters which have been highlighted using the soft keys. Most numeric entry fields may be adjusted using the knob. Some parameters with many options, sensitivity for example, use the knob to select the desired option. In addition, functions such as display zooming and scrolling use the knob as well.

In these cases, the knob function is selected by the soft keys. The [CURSOR] key, which can be pressed at any time, will set the knob function to scrolling the cursor if there is a strip chart displayed.

DISK DRIVE

The 3.5" disk drive is used to store data and instrument settings. Double sided, double density disks should be used. The disk capacity is 720k bytes formatted. The disk format is DOS compatible. Disks written by the SR850 may be read by PC compatible computers equipped with a 3.5" drive and DOS 3.0 or higher.

Only use double sided double density (DS/DD) disks. Do not use high density (DS/HD) disks.

FRONT PANEL BNC CONNECTORS

Refer to the previous section, SR850 Basics, for detailed information about each input or output.

Reference Input

The reference input can be a sine wave (rising zero crossing detected) or a TTL pulse or square wave (rising or falling edge). The input impedance is 1 M Ω AC coupled (>1 Hz) for the sine input. For low frequencies (<1 Hz), it is necessary to use a TTL reference signal. The TTL input provides the best overall performance and should be used whenever possible.

Sine Out

The internal oscillator output has a 50 Ω output impedance and varies in amplitude from 4 mVrms to 5 Vrms. The output level is specified into a high impedance load. If the output is terminated in a low impedance, such as 50 Ω , the amplitude will be less than the programmed amplitude (half for a 50 Ω load).

This output is active even when an external reference is used. In this case, the sine wave is phase locked to the reference and its amplitude is programmable.

A TTL sync output is provided on the rear panel. This output is useful for triggering scopes and other equipment at the reference frequency. The TTL sync output is a square wave derived from the zero crossings of the sine output.

Ch1 & Ch2 Outputs

The Channel 1 and Channel 2 outputs can be configured to output a voltage from -10 V to +10 V proportional to X, Y, R, , or Traces 1 through 4. ± 10 V is full scale. The outputs can source 10 mA maximum.

Signal Inputs

The input mode may be single-ended, A, or differential, A-B. The A and B inputs are voltage inputs with 10 M Ω , 25 pF input impedance. Their connector shields are isolated from the chassis by 10 (Ground) or 1 k Ω (Float). Do not apply more than 50 V to either input. The shields should never exceed 1 V. The I (current) input is 1 k Ω to a virtual ground.

SCREEN DISPLAY

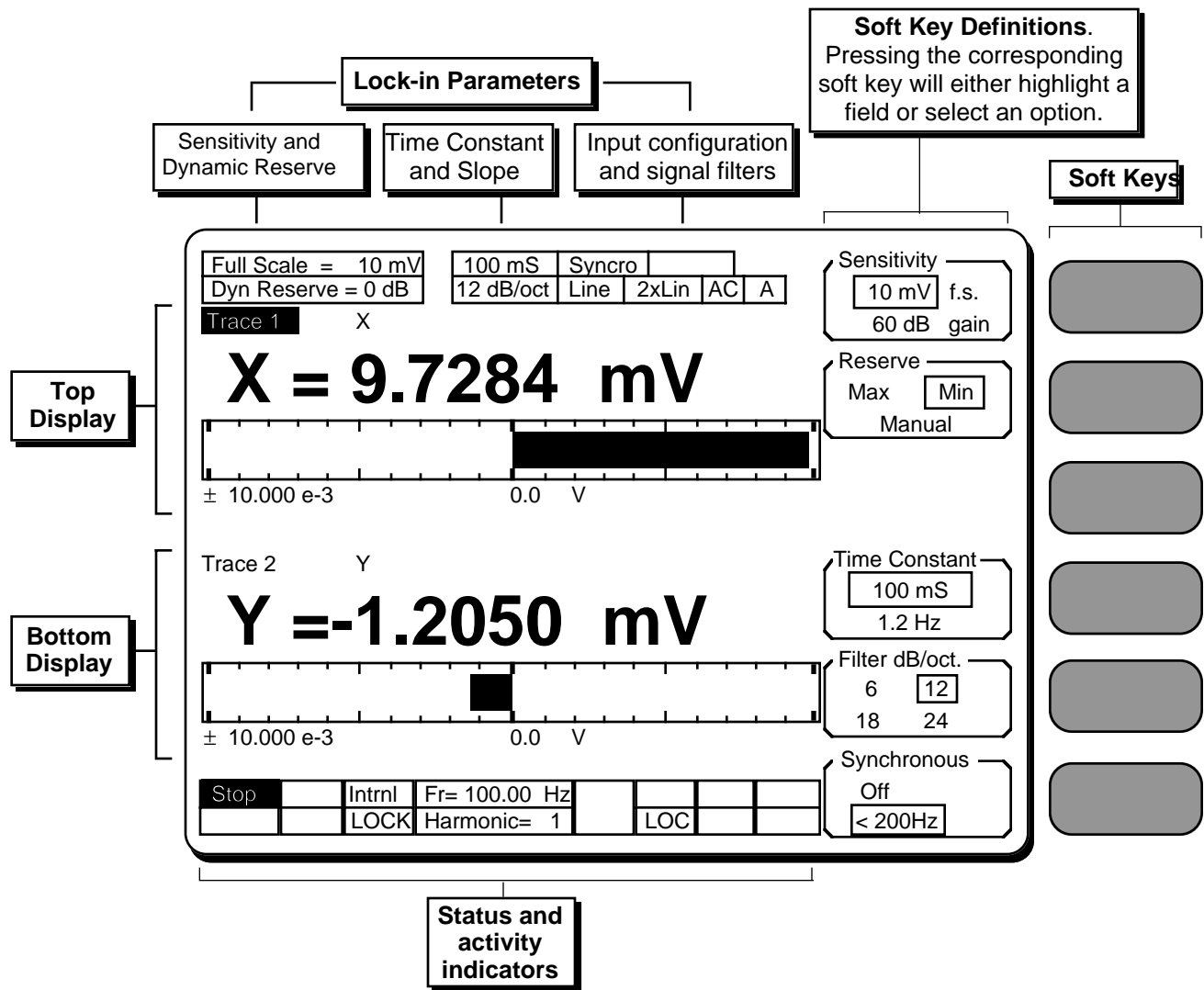

DEFAULT DISPLAY

The SR850's default display is shown above. This is the display format in effect when the unit is turned on.

This screen resembles a "normal" lock-in front panel. The lock-in setup is displayed across the top of the screen. The sensitivity, reserve, time constant, prefilters and input configuration are all easily visible. The upper numeric readout and bar graph show the value of X ($R\cos\theta$) and the lower graph shows the value of Y ($R\sin\theta$).

The bar graphs are normally scaled so that plus full scale is at the right end, minus full scale is at

the left end, and zero is in the middle. Whenever the sensitivity is changed, the bar graphs are scaled to the full scale sensitivity. The [AUTO SCALE] key will scale the active display to the actual measured signal (the center remains zero). The range and center of a bar graph may be manually adjusted to expand a portion of the scale.

Status indicators are displayed across the bottom of the screen. These include the reference mode, unlock alert, reference frequency, harmonic detect, overloads, and GPIB/RS232 activity, error and remote status.

DATA TRACES

The SR850 collects and displays data in the form of traces. There are four data traces which may be defined. Each trace is defined as $A \cdot B / C$ where the parameters A, B, and C are chosen from X, Y, R, , Xnoise, Ynoise, Rnoise, Aux Inputs 1-4, Frequency, and unity (1). C can also be any quantity squared. The traces are defined in the TRACE/SCAN menu.

Only data traces may be displayed. In order to display the quantity X, it is necessary to define a trace to be X and then choose to display that trace.

When the unit is reset, the traces are defined as follows:

- Trace 1 X
- Trace 2 Y
- Trace 3 R
- Trace 4 θ

where B and C are set to unity in each case.

In most cases, the default trace definitions will suffice. For specialized situations, the traces may be redefined to fit the experiment. Some examples:

- Trace 3 R/AI1 Magnitude/Aux Input 1. This normalizes the magnitude to an external slowly varying signal. (detector output normalized to laser power for instance.)
- Trace 4 Xn Xnoise. The SR850 calculates the rms noise of X in the bandwidth determined by the time constant.
- Trace 3 AI3 Aux Input 3. Store and display the value of Aux Input 3. The SR850 can monitor an external voltage while recording normal lock-in quantities such as X, Y, R or .
- Trace 4 F Frequency. Store the reference frequency along with the X, Y, R or .

SINGLE and DUAL TRACE DISPLAYS

The screen can be formatted as a single trace (Single) display or a dual trace (Up/Down) display. The screen format is selected in the DISPLAY/SCALE menu. There are three displays which may be configured, the Single screen display and the Top and Bottom displays for the split screen. Each display can show a different trace using a separate display type.

There are three different display types - Bar (with large numbers), Polar, and Chart (of stored traces only). The Bar graph resembles a "normal" lock-in display. The Polar graph plots X and Y on a circular graph to illustrate the signal as a vector relative to the reference. The Chart displays stored data in a strip chart form, complete with zooming, panning and cursor. In order to use the analysis functions such as curve fitting, the data must be stored in the buffer and displayed in a strip chart.

The default screen (pg. 4-5) is a dual trace display where the top display shows Trace 1 (X) and the bottom display shows Trace 2 (Y). Both displays are bar graphs.

Remember, only data traces may be displayed. The traces are defined in the TRACE/SCAN menu. The choices of which traces are displayed, and in which formats, are selected in the DISPLAY/SCALE menu.

A dual trace screen showing both Bar and Chart displays is shown below. Each display is labelled with a trace identifier indicating which trace is being displayed. The trace definition is also shown. In the screen below, the top display is showing Trace 1 which is defined to be X.

One of the displays is the active display. The active display is denoted by displaying the trace identifier in inverse video (bottom display below). Certain functions, such as Auto Scale and cursor movement, affect the active display only. The [ACTIVE DISPLAY] key is used to switch the active display between the top and bottom displays. A full screen display is always the active display.

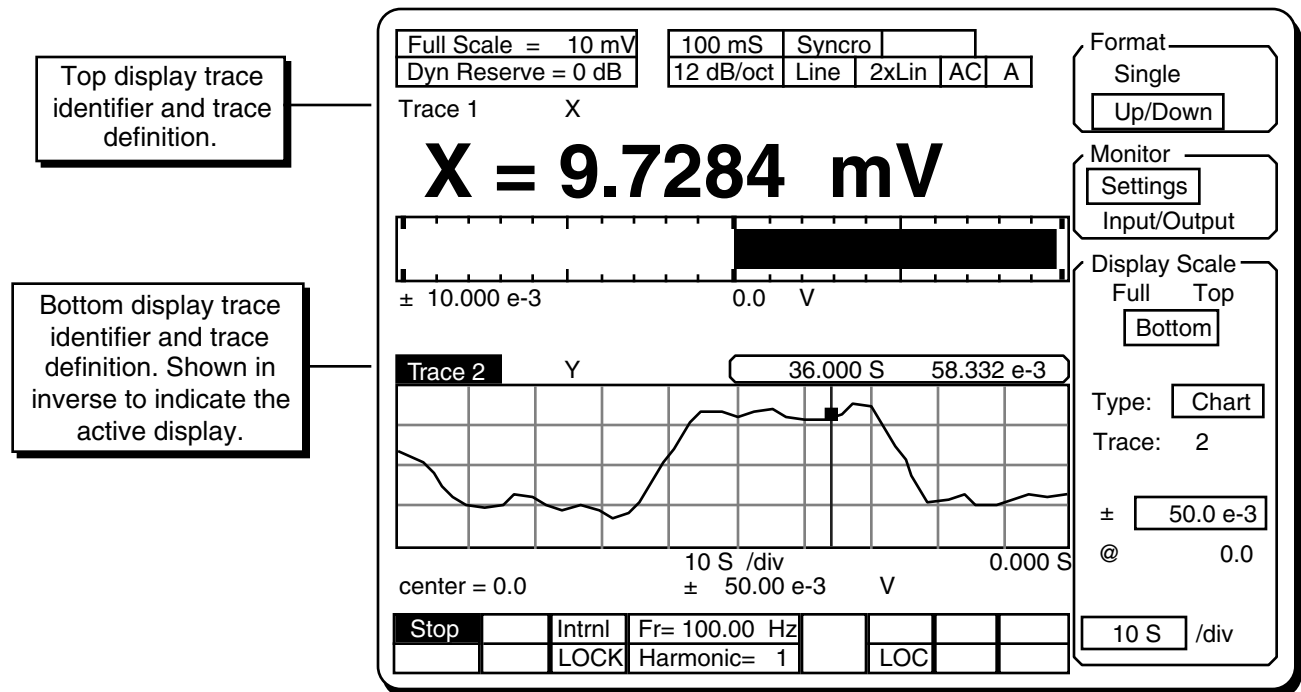

BAR GRAPHS

The most commonly used display type is the Bar graph with large numeric readout. This display most closely resembles a "normal" lock-in. The bar graph display is shown below. The bar graph only occupies half of the screen, even when the screen format is full height. Thus, it generally makes sense to use the bar graph in split screen mode and show two bar graphs.

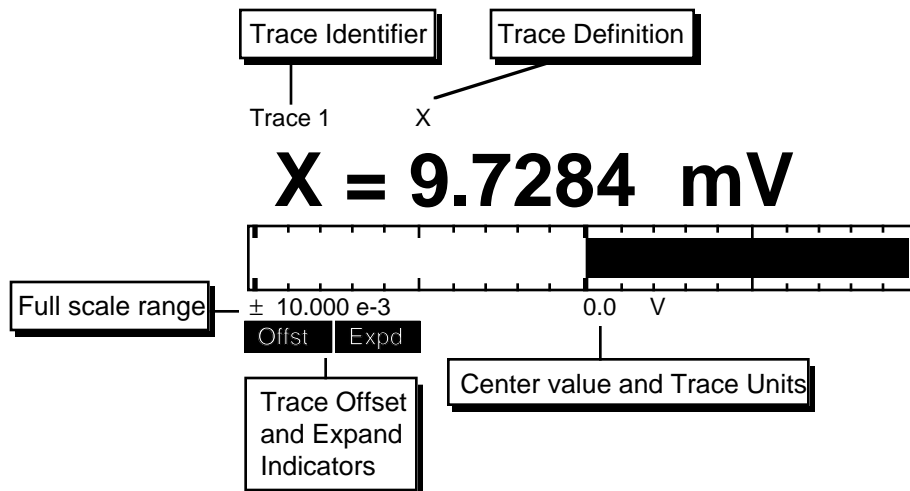

Trace Identifier and Active Display

The bar graph is labelled with a trace identifier above it. This indicates which trace is being displayed. The trace definition is shown next to the identifier. If this display is the active display, the trace identifier will be in inverse. When a bar graph is the active display, the [AUTO SCALE] key will scale the bar graph. There is no cursor function for this display. Pressing the [CURSOR] key will not activate a cursor.

When the trace definition is simple (X, Y, R, θ or F) the trace definition is displayed in the large numeric readout (X=). If the trace is defined as X_n, Y_n, R_n, AI1, AI2, AI3 or AI4, or involves a product or ratio (A•B/C where either B or C or both are non-unity), then the large readout simply shows 'T1=' (for Trace 1) instead of the actual parameter(s) being monitored. The trace definition above the readout is always displayed fully however.

Bar Range and Center

The graph range and center value are displayed below the graph. These values are in the units of the displayed trace.

Bar Scaling

The bar graph scaling can be changed in the DISPLAY/SCALE menu. Both the center value and the range can be changed. This allows the bar

graph to expand a portion of the full scale range around a nominal value. The bar will always be drawn from the center (nominal value).

For the simple traces, X, Y, and R, changing the sensitivity will automatically scale the bar graphs so the range is equal to the sensitivity and zero is at the center. For other trace definitions, the bar scaling is not changed when the sensitivity is changed.

Using [AUTO SCALE] will adjust the range to make the measured output greater than 40% of the new range. [AUTO SCALE] always returns the center to zero.

Rate

The bar graph is updated at a rate of about 7 Hz while the numeric readout changes at about 2 Hz. When the data is noisy, the bar graph more accurately shows the "noisiness" while with steady readings, the numeric display is an accurate measure of the signal.

Offset and Expand

If the trace being shown is affected by a non-zero offset or a non-unity expand, then the Offst and Expd alert indicators are turned on.

POLAR GRAPHS

The polar graph is a convenient way to view magnitude and phase. The signal is represented as a vector on an X-Y coordinate axes. The full screen polar display is shown below. The split screen polar graph is half as big.

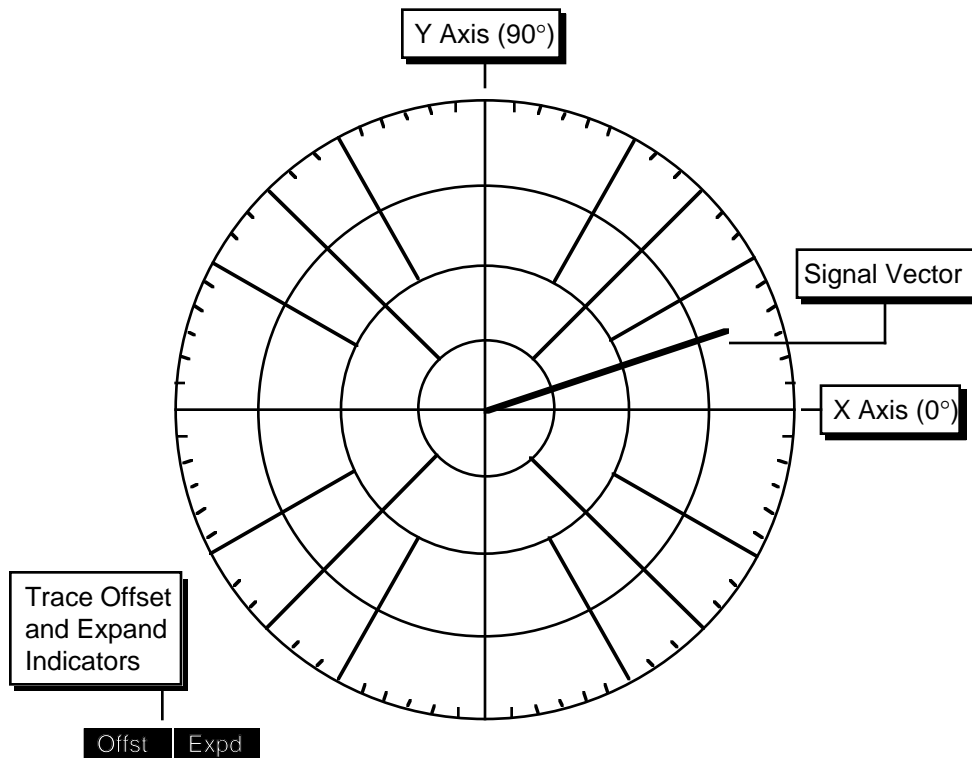

Plot of X and Y

The polar graph is not labelled - there is no trace identifier above it. This is because the polar graph always plots X and Y as a vector. This display cannot be changed to display any other traces. Changes made to X and Y, such as offsets, will change the vector on the polar graph. Changes made to R, such as offset, will not.

The [ACTIVE DISPLAY] key will not select this display since there is no cursor associated with it and it cannot be autoscaled.

Scale

The graph is oriented like a normal X-Y axes. Positive X is to the right and positive Y is up, and zero is in the center. The four circles indicate 25%, 50%, 75% and 100% of full scale. The polar graph is always scaled to the full scale sensitivity. Note that X and Y can both be full scale in amplitude and the resultant vector exceed full scale by 2 (at 45°).

Signal Vector

Coherent signals have a steady phase and the signal vector will have a steady direction. Signals which are noisy will move around in direction as well as magnitude. The polar display can quickly give a feeling for whether a signal is coherent or not. Signals whose frequencies are close to, but not synchronous with the reference frequency will to rotate at the difference frequency between the signal and reference.

Offset and Expand

If the either X or Y has a non-zero offset or a non-unity expand, then the Offst and Expd alert indicators are turned on. The vector is plots the offset and expanded quantities X and Y. If X and Y have unequal expands (differing gains), the signal vector is generally not meaningful.

STRIP CHARTS

Chart displays are used to view stored traces. Only stored traces have a time history, thus, only stored traces may be displayed on a chart. The full screen chart display is shown below. If the split screen format is used, the chart will display half as many vertical divisions but will be the same as the full size display in all other aspects.

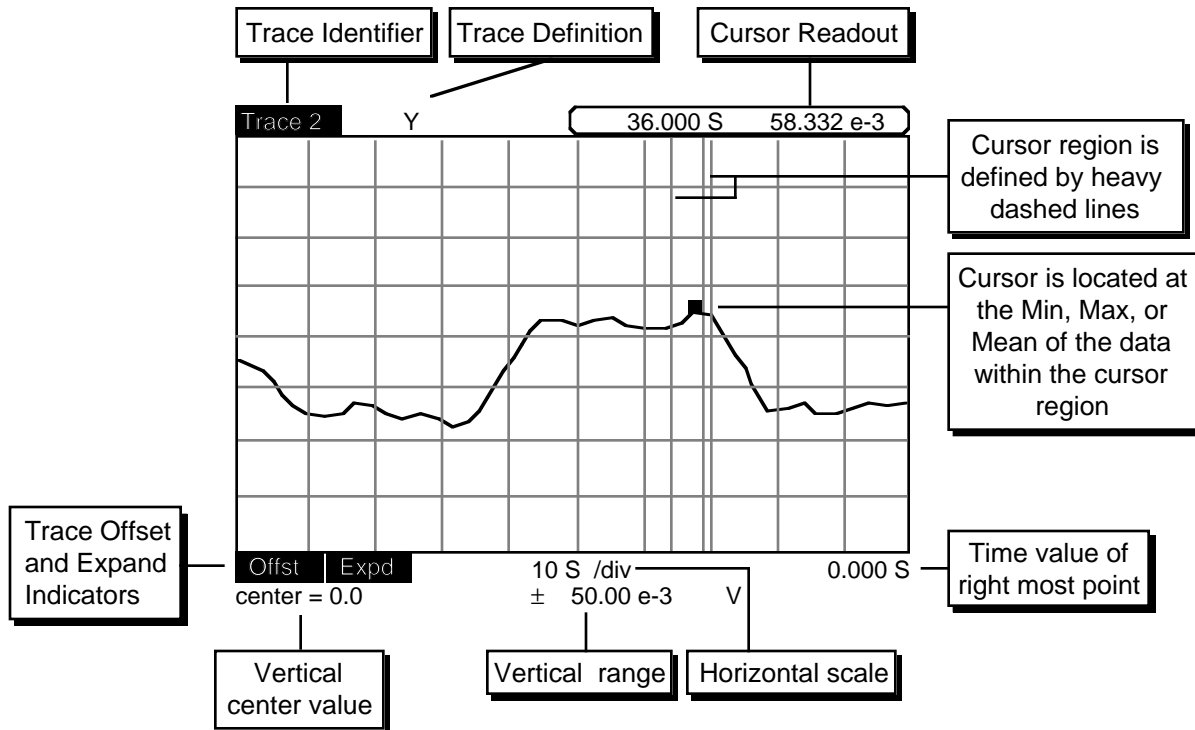

Trace Identifier and Active Display

The chart is labelled with a trace identifier at the upper left. This indicates which trace is being displayed. The trace definition is shown next to the identifier. If this display is the active display, the trace identifier will be in inverse. When a chart is the active display, the [AUTO SCALE] key will scale the chart so all of the displayed data is on the graph. In addition, when a chart is the active display, pressing the [CURSOR] key will activate the cursor.

Chart Scaling

The graph vertical range is the center value plus and minus the range. The center value is the value of a data point located at the vertical midpoint of the graph. The horizontal scale is the number of seconds per division across the graph. The time value of the right most point is shown at the bottom right. When the most recent point is at the right, the time shown will be 0.000 S.

The chart scaling can be changed in the DISPLAY/SCALE menu. Both the vertical scale (center value and range) and horizontal scale can be changed. [AUTO SCALE] will automatically adjust the vertical center and range to display all of the data within the graph. [AUTO SCALE] will not change the horizontal scale.

By changing the horizontal scale, the entire trace buffer can be displayed at once or a small portion may be expanded. If only a portion of the buffer is being displayed, use the cursor to pan right and left within the buffer.

Offset and Expand

If the trace being shown is affected by a non-zero offset or a non-unity expand, then the Offst and Expd alert indicators are turned on.

Data Scrolling

The chart display acts like a strip chart recorder where the pen is drawing the most recent data. For example, if the sample rate is 1 Hz (1 point taken per second) and the horizontal scale is 10 S/div, then the graph displays 100 data points (10 divisions x 10 points per division). As new data is taken, the old data scrolls to the left at the rate of 10 S/div. This is because new points are added at a fixed location (right edge of the graph) just like a strip recorder. In this case, the time value of the right most point is 0.000 S meaning the most recent data point.

The chart displays a fixed window in time which is 10 divisions wide (100 seconds in this case) starting Tright seconds ago (where Tright is the time value of the right most point). Since the data is always getting older, it scrolls left continuously (whenever data is being taken).

Cursor

The cursor region is the graph region between the two heavy vertical dashed lines. The cursor region may be set to 1 division (wide), 1/2 division (norm), or a single vertical line (spot). The cursor region does not change with horizontal scaling. The cursor is the small square which seeks the minimum, maximum, or mean of the data within the cursor region. When seeking min or max, the cursor is located at the position of the data point which is the min or max. This allows peaks and valleys in the data to be easily specified. When seeking the mean, the X position of the cursor is at the center of the cursor region and the Y position is the mean of the data within the region. The cursor type is defined in the CURSOR SETUP menu.

Often the display is scaled such that there are many more data points than can be resolved on the display. The chart display is 496 pixels wide. If more than that number of data points are being displayed, then each horizontal position represents multiple data points. In this case, a vertical line is drawn between the minimum and maximum data points represented by a single horizontal location. In this case, even the spot cursor region represents multiple data points. The cursor will seek the max, min or mean of these data points.

Pressing the [CURSOR] key will draw a box around the cursor readout of the active chart display. Use the [ACTIVE DISPLAY] key to select the

desired display (top or bottom). When the cursor readout is surrounded by this box, the knob adjusts the position of the cursor region. Moving the cursor beyond the edge of the graph pans the display left (showing older data points) and right (showing more recent data points). Remember, the time window shown in the graph does not change with time. As the data points get older, the data will scroll to the left as new points are taken.

Cursor Display

The cursor readout displays the horizontal position and the trace data at the cursor. The horizontal position is displayed as time (from the beginning of the trace), delay (time from the most recent point), bin (number of data points since the start), and frequency (if the reference is internally swept). In this illustration, the cursor point was taken 36 seconds before the most recent point.

Marks

While data is being added to the data buffer, events may be marked using the [MARK] key. Pressing [MARK] will tag the next trace buffer location. A mark will appear on the chart and will scroll with the data. This is analogous to marking a real strip chart while it is recording. Marks are useful for marking when an external event occurred or when the experimental conditions changed.

A maximum of eight marks may be placed in the data buffer. A mark will appear on ALL stored traces at the same buffer location. The different mark symbols are shown below.



A mark is always placed at the buffer start to mark the oldest (first) data point at the start of a scan.

The [EDIT MARK] key allows the mark data to be viewed. The value of each stored trace and the time the mark was placed is displayed. The user can add comments to the mark data to label a specific event.

When trace data is saved to disk, the marks are saved as well. When a trace is recalled from disk, the marks are recalled as well. Existing marks are replaced with the recalled marks.

TRACE SCANS, SWEEPS & ALIASING

Trace and Scan parameters are selected in the TRACE/SCAN menu.

Trace Storage

Having defined up to four data traces for an experiment, the issue of data storage needs to be addressed. **Only traces that are stored may be displayed in strip chart form.** If a graph or record of a trace over time is desired, then that trace's data must be stored. The SR850 can record up to 64000 data points in memory. The data buffer can store 64000 points of a single trace, 32000 points of two traces, or 16000 points of all four traces. When defining the traces, the Store or Do Not Store option needs to be decided. The default is all four traces stored.

Data Points and Bins

Data points stored in a trace are sometimes referred to by their bin position within the trace buffer. The oldest data point is bin0, the next point is bin1, etc. A trace with N points numbers them from 0 to N-1.

Sample Rate

The Sample Rate can be varied from 512 Hz down to 62.5 mHz (1 point every 16 sec). The sample rate sets how often points are added to the storage buffers. All stored traces are sampled at the same rate (and at the same times).

In addition to the internal sample rates, samples can be triggered by an external TTL trigger. This mode is selected by increasing the sample rate past 512 Hz. In this mode, a sample is recorded within 2 ms of a rising edge trigger on the rear panel Trigger input. Triggers which occur faster than 512 Hz are ignored. When viewing an externally triggered data trace on a chart graph, set the cursor readout to Bin (in the CURSOR SETUP menu). This displays the horizontal position of the cursor as bin or data point number rather than time (for scaling purposes, the time scale of the graph is based upon a 1 Hz sample rate - bins and seconds are equivalent).

Scan Length

The Scan Length is the time duration of a single scan expressed in seconds. The maximum scan length is determined by the number of stored traces (maximum storage buffer length) and the sample rate. When storing a single trace, the maximum

scan length is 125 seconds at 512 Hz or 12 days at 62.5 mHz (64000 points). Changing the sample rate will only change the scan length if the maximum number of data points is already being used. Otherwise, the number of data points in the scan is changed to keep the scan length constant. The number of points in the buffer can vary from 1 to a maximum of 16000, 32000, or 64000 depending upon the number of traces being stored.

There is only one Scan Length, i.e. the number of points stored will be the same for all traces being stored.

Sweep Time

The scan length is the sweep time for frequency sweeps and Aux Output sweeps. Swept parameters are synchronized with the data acquisition. For example, if the internal reference is programmed to sweep from 1 kHz to 2 kHz, the sweep will take a scan length to finish. The frequency will change once per stored point. Thus, if the sample rate is 1 Hz and the scan length is 100 seconds, the frequency will change 100 times and move from 1 kHz to 2 kHz in 100 seconds. At each sample, the trace data is stored before the swept parameter is changed. The next data point is taken after one sample interval to allow the outputs to settle as long as possible.

End of Scan

When the scan is complete, data storage can stop or continue.

The first case is called 1 Shot (data points are stored for a single Scan Length). At the end of the scan, data acquisition stops and swept parameters are held at their final stop values.

The second case is called Loop. In this case, a new scan is started at the end of each scan. Scans repeat indefinitely until halted by the user. The data buffer will store as many points as possible (16000, 32000 or 64000 depending upon the number of stored traces). The buffer will start filling at the start and will hold as many scans as will fit. The buffer always holds at least one complete scan. If the scan is short, then the buffer will hold multiple scans of data. When the buffer end is reached, the buffer starts filling at the beginning again. The oldest data will be overwritten and lost. This looping continues indefinitely. In this mode,

Screen Display

the scan length is only meaningful if parameters are being swept. Once the trace buffer has looped around, the oldest point (at any time) is at bin#0 and the most recent point is at bin#k where k is the buffer length (minus 1).

The default mode is Loop.

Default Scan

Upon reset, all four traces are stored for a maximum of 16000 points. The sample rate is 1 Hz, the scan length is 16000 seconds and the scan mode is Loop. The trace definitions are X, Y, R and for Traces 1-4.

Starting and Stopping a Scan

The [START/CONT] and [PAUSE/RESET] keys are used to control data acquisition. Basically, the [START/CONT] key starts a scan or continues a paused scan and the [PAUSE/RESET] key pauses a scan or resets a finished scan. See the discussion of keypad operation later in this section for details. Scans can also be controlled via the computer interfaces. See the programming section for an explanation.

In addition, the rear panel Trigger input can be used to start a scan. To select this mode, set the Trigger Starts option in the AUX menu. In this mode, a rising TTL trigger will act the same as the [START/CONT] key. The sample rate can be either internal or Triggered. In the first case, the trigger starts the scan and data is sampled at the programmed sample rate (up to 512 Hz). In the latter case, the first trigger will start the scan and data will be sampled at every subsequent trigger.

Aliasing Effects

In any sampled data stream, it is possible to sample a high frequency signal such that it will appear to be a much lower frequency. This is called aliasing.

For example, suppose the lock-in is detecting a signal near 1 Hz with a relatively short time constant. The X output will have a DC component and a 2 Hz component (2xf). If the sample rate is 2 Hz, then the samples may be taken as illustrated below.

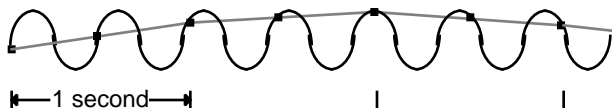

The samples represent a sine wave much slower than 2 Hz that isn't actually present in the output! The chart display of this trace will show a sine wave at a very low frequency and will be rather misleading. In this case, a much higher sampling rate will solve the problem.

Aliasing occurs whenever the output signal being sampled contains signals at frequencies greater than 1/2 the sample rate. The effect is most noticeable when trying to sample an output frequency at an integer multiple of the sample rate (as above). The above aliasing problem will be the same for a 1 kHz output (500 times the sample rate) as for the 2 Hz output.

Generally, the highest possible sample rate should be used given the desired scan length and number of stored traces. The lock-in time constant and filter slope should be chosen to attenuate signals at frequencies higher than 1/2 the sample rate as much as possible.

Aliasing can occur with the polar and bar graph displays as well. These displays sample the output signal at a fixed rate.

SETTINGS & INPUT/OUTPUT MONITOR

The upper two lines of the screen are the monitor display (see the screen on pg. 4-5). The lock-in settings (sensitivity, time constant, etc.) or the lock-in signal measurements (X, Y, R, , and the Aux Inputs) may be monitored. Use the DISPLAY menu to select the type of monitor (Settings or Input/Output).

Full Scale = 10 mV	100 mS	Syncro	DigPll			
Dyn Reserve = 40 dB	12 dB/oct	Line	2xLin	AC	A	

The Settings Monitor is shown above. The sensitivity, dynamic reserve, time constant and roll-off are always displayed. When the synchronous output filter is selected AND the detection frequency is below 200 Hz, then Syncro will be displayed. If the detection frequency is above 200 Hz, synchronous filtering is not active and Syncro is not displayed. When the external reference is below 10 Hz, the digital phase lock loop is active and DigPll is displayed.

The input filters are shown when they are in, their display boxes are empty when the corresponding filter is out. The input coupling and type (A, A-B, or I) are always shown.

X= 135.23 mV	R= 137.14 mV	A1= 0.000 V	A3= 0.000 V
Y= 22.78 mV	= 9.56 °	A2= 0.000 V	A4= 0.000 V

The Input/Output Monitor is shown above. The values of X, Y, R and are shown, regardless of the trace definitions or displays chosen. In addition, the readings of the rear panel Aux Inputs are displayed. These readings are updated a few times a second.

MENU DISPLAY

The Soft Key menu boxes define the functions of the 6 soft keys to the right of the screen. The menu boxes are grouped into menus. Pressing each of the ten Menu keys will display a different menu of boxes. Related functions are grouped into a single menu.

In general, pressing a soft key does one of two things. One is to toggle between 2 or 3 specific options. An example is the Filter Slope box illustrated on page 4-5. Pressing the fourth soft key toggles the slope from 6 to 12 to 18 to 24 and back to 6 dB/oct.

The second soft key mode is to highlight an entry field and knob function. An example would be the Phase Adjust. Pressing this soft key will highlight the phase setting. The phase may then be adjusted with the knob or entered as a value using the numeric entry keys. Each menu is described at length in a following section.

STATUS INDICATORS

Run RESRV	FILTR OUTPT	Ext S UNLOCK	Fr= 100.00 Hz Harmonic= 1	GPIB ↔	ERR LOC	SRQ ALT	TRIG
--------------	----------------	-----------------	------------------------------	-----------	------------	------------	------

There are a number of status indicators which are displayed at the bottom of the screen. These include the scan, unlock, and overload indicators, the reference frequency and source, and interface status.

Stop • Run 1 • Run • Pause • Done

When the data buffers are reset (pressing [PAUSE RESET] while paused or done), then Stop will be indicated.

When a scan is in progress in the 1 Shot mode, Run 1 is indicated. The storage of trace data in the buffer continues until the scan is complete at which time Done is displayed.

If a Loop scan is in progress, Run is displayed. The storage of trace data in the buffer may continue indefinitely. When the buffer fills, the oldest data is written over.

If the scan is paused (with the [PAUSE/RESET] key for instance), then the Pause indicator will be on. Pressing [START/CONT] will continue the scan from a paused state.

RESRV • INPUT

If the analog signal amplifier overloads before the phase sensitive detector, then RESRV or INPUT is displayed.

RESRV indicates that the signal amplifier is overloaded. Change the sensitivity or increase the dynamic reserve.

INPUT indicates that the actual signal input is overloaded. This occurs for voltage inputs greater than 1.4Vpk (unless removed by AC coupling) or current inputs greater than 10 μ A DC or 1.4 μ A AC (1M gain) or 100 nA DC or 14 nA AC (100M gain). Reduce the input signal level.

FILTR

If an overload occurs in the low pass filters after the PSD's, then FILTR is displayed. Increase the time constant or filter roll-off or decrease the dynamic reserve.

OUTPT

If the output (either X, Y, R or a trace output voltage) is greater than 1.09 times full scale, then OUTPT is displayed. This can occur if the sensitivity is too low or if the output is expanded such that the output voltage exceeds 10 V. Note that a trace output can overload even if it is not being displayed on the screen or output to CH1 or CH2.

Intrnl • Sweep • Ext S • Ext + • Ext -

If the internal reference is being used, then Intrnl is displayed. If the internal reference frequency is being swept, then Sweep is displayed. When using an external reference source, the reference mode may be set to Sine (Ext S), Rising TTL edge (Ext +), or Falling TTL edge (Ext -).

LOCK • UNLOCK

The UNLOCK indicator turns on if the SR850 can not lock to the external reference. LOCK is displayed when the SR850 is successfully locked to the reference. LOCK is always on when in internal reference mode.

Fr= XX.YYY Hz

The reference frequency (internal or external) is displayed continuously.

Harmonic = N

The SR850 can detect synchronous signals at N times the reference frequency. Generally, N is equal to 1.

GPIB • RS232

Flashes when there is activity on the computer interfaces. This does not flash for printer or plotter activity.

ERR

Flashes whenever there is a computer interface error such as an illegal command or out of range parameter is received. This does not flash for a printer or plotter error.

LOC • REM

REM is on when the front panel is locked out by a computer interface. No front panel adjustments may be made. To return the unit to local control (if

allowed), press the [HELP] key. LOC is on whenever local front panel control is allowed (usually on).

SRQ

This indicator is on whenever a GPIB Service Request is generated by the SR850. SRQ stays on until a serial poll is completed.

ALT

Indicates that the ALTERNATE keypad is in use. The ALTERNATE keypad uses the alphabetic legends printed below each key. To enter the ALT mode, press the [ALT] key once. Pressing the keys will now enter letters into the active entry field. The [0]...[9], [.] , [-], [] and [ALT] have the same function in the ALTERNATE keypad. To return to the normal keypad, press the [ALT] key again.

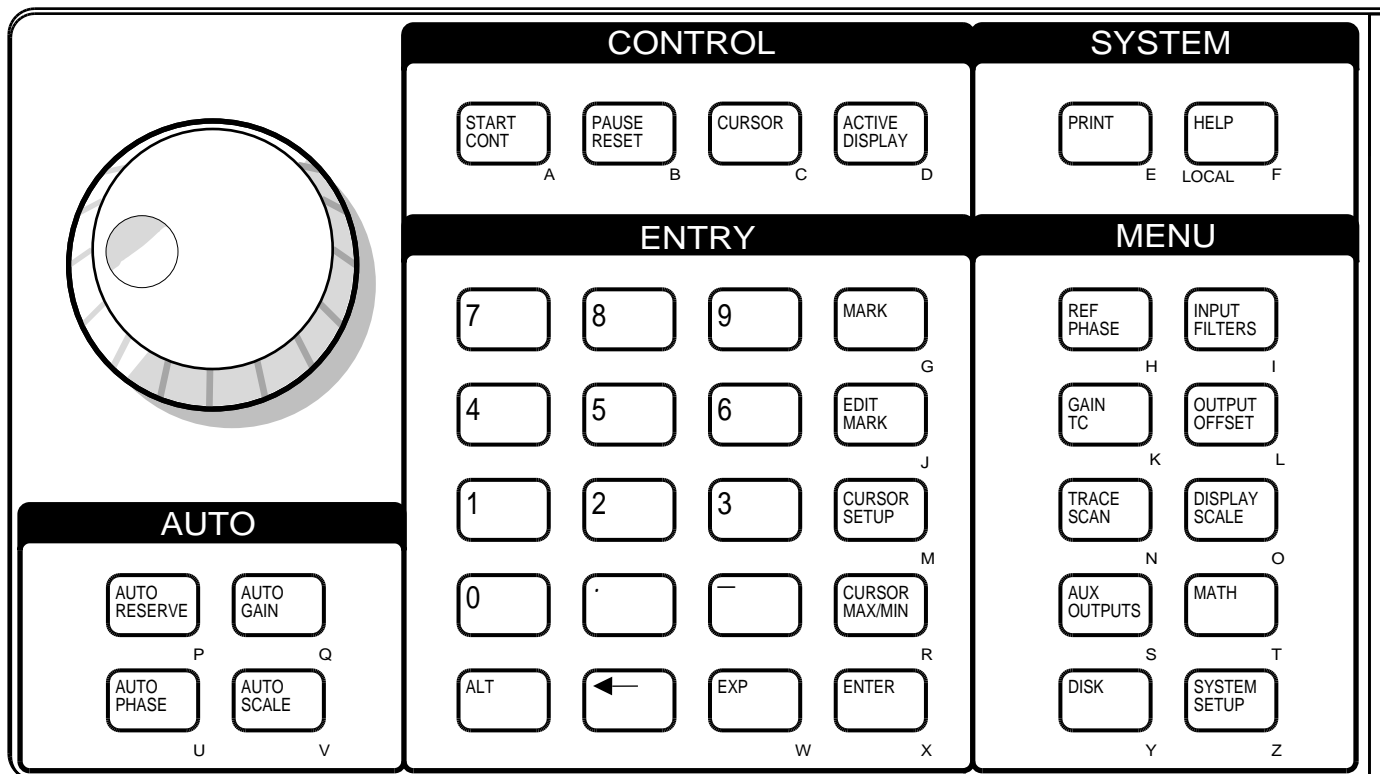

NORMAL AND ALTERNATE KEYS

The normal key definitions are printed on each key. In addition, each key also has an alternate definition printed below it. The [ALT] key toggles the keypad between the two definitions. The ALT screen indicator is on when the alternate definitions are in use. The [0]...[9], [.] , [-], [←] and [ALT] keys have the same definition in both modes. The alternate keys should only be used when accessing files on the disk drive or entering labels.

MENU KEYS

All operating parameters of the SR850 are grouped into function menus. The ten menu keys select which menu of parameters is displayed next to the six soft keys. The soft keys then either toggle a parameter, highlight a parameter entry field (for numeric entry or knob adjustment), or display a submenu. These menus are listed below.

[REF/PHASE]

Sets the reference source and phase shift. Also sets the internal oscillator frequency, sweep limits and output level.

[INPUT/FILTERS]

Configures the signal inputs and selects the notch prefilters.

[GAIN/TC]

Select the full scale sensitivity, dynamic reserve, time constant and roll-off.

[OUTPUT/OFFSET]

Configures the Channel 1 and 2 front panel outputs and sets the X, Y and R output offsets and output expands.

[TRACE/SCAN]

Define the four data traces, the scan length and sample rate.

[DISPLAY/SCALE]

Select full screen or split screen display, settings or input/output monitor, and display scaling.

[AUX OUTPUTS]

Program the four Aux Output voltages and sweep limits. Also select scan starts with trigger.

[MATH]

Provides data smoothing, curve fitting, statistical analysis, and calculator functions for operating on stored data traces.

[DISK]

This menu stores and recalls data and settings to and from the disk. Also contains a disk utilities submenu.

[SYSTEM SETUP]

The SETTINGS submenu configures the computer interfaces, sound, real time clock, plotter, printer, and screen location. The PLOT submenu plots trace data on a plotter. The TEST submenu tests the keypad, external keyboard, knob, RS232 interface, printer interface, disk drive, video screen, and memory. The INFO submenu displays various information screens.

ADDITIONAL MENUS

In addition to the menus described above, there are two other menus. These are accessed by the [CURSOR SETUP] and [EDIT MARK] keys.

[CURSOR SETUP]

Sets the cursor type, width and readout.

[EDIT MARK]

This menu is used to edit marks and move the cursor to the next mark.

Detailed descriptions of each menu are provided in the next chapter.

ENTRY KEYS

The numeric entry keys can be used to directly enter parameter values. Parameters may be entered only if their menu box is displayed and their entry field is highlighted. For example, if the REF/PHASE menu is displayed, the first soft key is next to the Phase Shift box. Pressing this soft key will highlight the entry field displaying the phase shift. The menu box will appear as below.

A new phase shift may now be entered using the numeric keys. For example, to set the phase shift to 12.34 degrees, press [1] [2] [.] [3] [4] and then the [ENTER] key. Entries may be made in exponential form using the [EXP] key. The entry above may be made by pressing [1] [.] [2] [3] [4] [EXP] [1] and then the [ENTER] key.

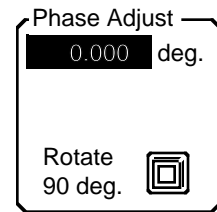

The backspace [←] key may be used to correct any entry errors made before pressing [ENTER]. To cancel the entry before pressing [ENTER], press the same soft key which highlighted the field. The entry will revert to its original value.

In general, whenever a numeric entry field is highlighted, the knob may also be used to adjust the value. In this case, the knob will adjust the phase in 0.001° increments for fine adjustments. If the knob is turned while making a numeric entry but before the [ENTER] key has been pressed, the knob will adjust the original value (the numeric entry is cancelled).

Some entry fields allow only knob adjustment or only numeric entry.

[START/CONT] and [PAUSE/RESET]

The [START/CONT] and [PAUSE/RESET] keys are used to start, pause, continue, and reset data acquisition scans. The [START/CONT] key starts a scan (and any programmed sweep). Stored traces are sampled at the sample rate and stored in the data buffer. If charts are displayed, the displayed data will scroll across the graph. Swept parameters such as internal reference frequency and Aux Outputs start changing at the sample rate. The scan indicator at the bottom left of the screen will show Run (Loop) or Run 1 (1 Shot scan) to indicate that data is being acquired in the loop buffer or single shot scan mode.

If the unit is acquiring and displaying data, then pressing the [PAUSE/RESET] key will pause data acquisition. The scan indicator switches to Pause and no new data points will be stored and the chart display will not scroll. Any sweeps in progress will also pause. Bar and polar graphs are not affected. Pressing [PAUSE/RESET] again will erase the data buffer and reset sweeps. Pressing [START/CONT] will resume data acquisition.

[PAUSE/RESET] will erase the data buffer whenever data acquisition is Paused or Done.

To clear a buffer while a scan is in progress, two presses of the [PAUSE/RESET] key are required. However, at the end of a single shot scan, the data acquisition will be Done. This state is equivalent to a paused state and a single press of the [PAUSE/RESET] key will destroy the data!

Whenever the scan is reset and the data buffers are empty, Stop is displayed.

[CURSOR]

Pressing the [CURSOR] key will draw a box around the cursor readout of the active chart display as illustrated below.

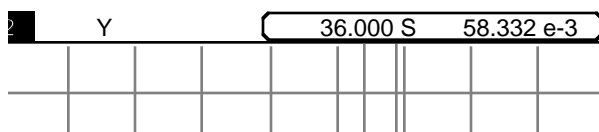

Use the [ACTIVE DISPLAY] key to select the desired (top or bottom) display. When the cursor readout is surrounded by this box, the knob adjusts the position of the cursor region. Moving the cursor beyond the edge of the graph will pan the display left (showing older data points) and right (showing more recent data points). Remember, the time window shown in the graph does not change. As the data points get older, data will scroll off the left as new points are taken.

When the [CURSOR] key is pressed, any previously highlighted parameter field (in a menu box) will become non-highlighted. Pressing a soft key to again highlight a new parameter field will let the knob adjust the new parameter while the cursor becomes unselected.

This key has no affect unless the active display is a chart graph. Bar and polar graphs have no cursor.

[ACTIVE DISPLAY]

Pressing [ACTIVE DISPLAY] toggles the active display. In the single full height display format, this key does nothing (the displayed graph is always the active one). In the dual screen display, [ACTIVE DISPLAY] switches which display is active (top or bottom), as indicated by the high-

lighted trace identification at the upper left of each

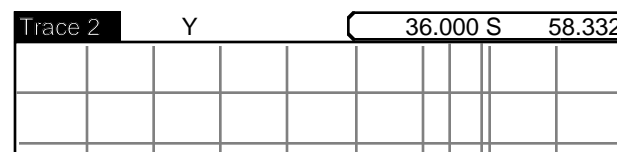

display as illustrated below.

The active display determines which display the [AUTO SCALE], [CURSOR] and [CURSOR MAX/MIN] keys will affect. [AUTO SCALE] auto-scales the active display. If the active display is a chart, the [CURSOR] key selects the cursor for knob movement and the [CURSOR MAX/MIN] key finds the max or min of the graph. Polar graphs are never the active display since they can not be scaled and have no cursor.

[MARK]

While data is being added to the data buffer, events may be marked using the [MARK] key. Pressing the [MARK] key will tag the next buffer location. A mark will appear on the chart and will scroll with the data. This is analogous to marking a real strip chart while it is recording. Marks are useful for marking when an external event occurred or when the experimental conditions changed.

A maximum of eight marks may be placed in the data buffer. A mark will appear on all stored traces



at the same buffer location. The different mark symbols are shown below.

A mark is always placed at the buffer start to mark the first and oldest data point in the scan.

The [EDIT MARK] menu allows the mark data to be viewed. The value of each stored trace and the time the mark was placed is displayed. The user can add comments to the mark data to label a specific event.

When trace data is saved to disk, the marks are

saved as well. When a trace is recalled from disk, the marks are recalled as well. Existing marks are replaced with the recalled marks.

[CURSOR MAX/MIN]

Pressing [CURSOR MAX/MIN] will center the cursor region around the maximum or minimum data value on the active chart display. The Cursor Seek mode in the CURSOR SETUP menu chooses whether this key finds the max or min. If the cursor seeks the mean, then the [CURSOR MAX/MIN] key finds the maximum on-screen point. The cursor will be positioned at the Min, Max, or Mean of the data within the region, depending upon the cursor seek mode. The [CURSOR MAX/MIN] key only searches the data which is on the screen. If the max/min value occurs at more than one location, then the one closest to the left edge is found.

[AUTO RESERVE]

Pressing [AUTO RESERVE] will adjust the dynamic reserve to the minimum reserve required. To do this, the reserve is decreased until a RESRV overload is detected, indicating that the analog input amplifier is overloaded. The reserve is then increased to remove the overload.

Auto Reserve will work only if the overloading noise source has a frequency greater than a few Hz. Lower frequency noise sources may overload so infrequently that Auto Reserve can not detect it.

[AUTO RESERVE] does not change the notch pre-filter settings.

[AUTO GAIN]

[AUTO GAIN] will adjust the sensitivity so that the detected signal magnitude is a sizable percentage of full scale. If the present value of R is a very small percentage of full scale when [AUTO GAIN] is pressed, then Auto Gain will respond very quickly. If R is very much greater than full scale, then Auto Gain may take several time constants to reach the optimum gain setting. Auto Gain will stop before reaching the optimum sensitivity if a RESRV overload is detected.

[AUTO GAIN] does not adjust the time constant or roll-off.

[AUTO PHASE]

[AUTO PHASE] adjusts the reference phase shift so that the measured signal phase is 0° . This is done by subtracting the measured value of θ from the programmed reference phase shift. It will take several time constants for the outputs to reach their new values during which time θ will move towards 0° . Do not press [AUTO PHASE] again until the outputs have stabilized. When the measurement is noisy or if the outputs are changing, Auto Phase may not result in a zero phase.

AUTO SETUP

There is no truly reliable way to automatically setup a lock-in amplifier for all possible input signals. In most cases, the following procedure should setup the SR850 to measure the input signal.

1. Press [AUTO GAIN] to set the sensitivity.
2. Press [AUTO RESERVE].
3. Adjust the time constant and roll-off until there is no FILTR overload.
4. Press [AUTO PHASE] if desired.
5. Repeat if necessary.

At very low frequencies, the auto functions may not function properly. This is because very low frequency signals overload very infrequently and the time constants used tend to be very long.

[AUTOSCALE]

Chart displays and bar graphs may be Auto Scaled. Auto Scaling only affects the displays - the data values and the front and rear panel analog outputs are not affected.

Pressing [AUTOSCALE] when a bar graph is the active display sets the range of the graph so that the present reading will be a major percentage of the range. The center will always be set to zero. If the data is rapidly changing, then Auto Scaling may not result in the optimum scaling. Both the range and center may be manually adjusted in the DISPLAY/SCALE menu.

Pressing [AUTO SCALE] when a chart graph is the active display will automatically set the vertical range and center value to display the entire range of the data. [AUTOSCALE] does not affect the horizontal scaling. [AUTOSCALE] only operates on the data which is presently displayed on the graph. Data which has scrolled past the left edge of the graph does not affect the scaling.

[AUTOSCALE] may be pressed at any time during or after data acquisition.

[AUTOSCALE] does not affect a polar graph.

[PRINT] TO A PRINTER

[PRINT] will print the screen display to a printer attached to the rear panel parallel printer port. The entire screen, including text and menus, is printed. The time and date will also be printed. The printer type needs to be configured in the SYSTEM SETUP menu before using [PRINT]. A "Printing in Progress" message will appear on the screen while printing occurs. No other front panel operations may be performed until printing is completed. If no printer is attached or there is a printer error, then the print operation is aborted after about 10 seconds. A "Print Aborted!" message will appear briefly on the screen.

Pressing the backspace [←] key will abort the printout.

[PRINT] TO A DISK FILE

If File is chosen as the printer type (in the SYSTEM SETUP menu), then [PRINT] will save the screen image as a PCX format file on the disk. Files are automatically named SCRNX.XXX.PCX

where XXXX is a file number. PCX files can be imported directly into many PC draw and paint programs and easily incorporated into word processing documents.

[HELP]

[HELP] provides on screen help with any key or soft key. Pressing [HELP] followed by any key will display information about the function or use of that key. [HELP] with a soft key will describe the menu item next to the soft key. Pressing another key will exit the help screen.

The [PRINT] key is the one key for which no help is available. Pressing [PRINT] at any time will print the screen, including the help screens.

[LOCAL]

When a host computer places the unit in the REMOTE state, no keypad input or knob adjustment is allowed. The REM indicator is on in the status bar at the bottom of the screen. To return to front panel operation, press the [HELP] key.

REAR PANEL

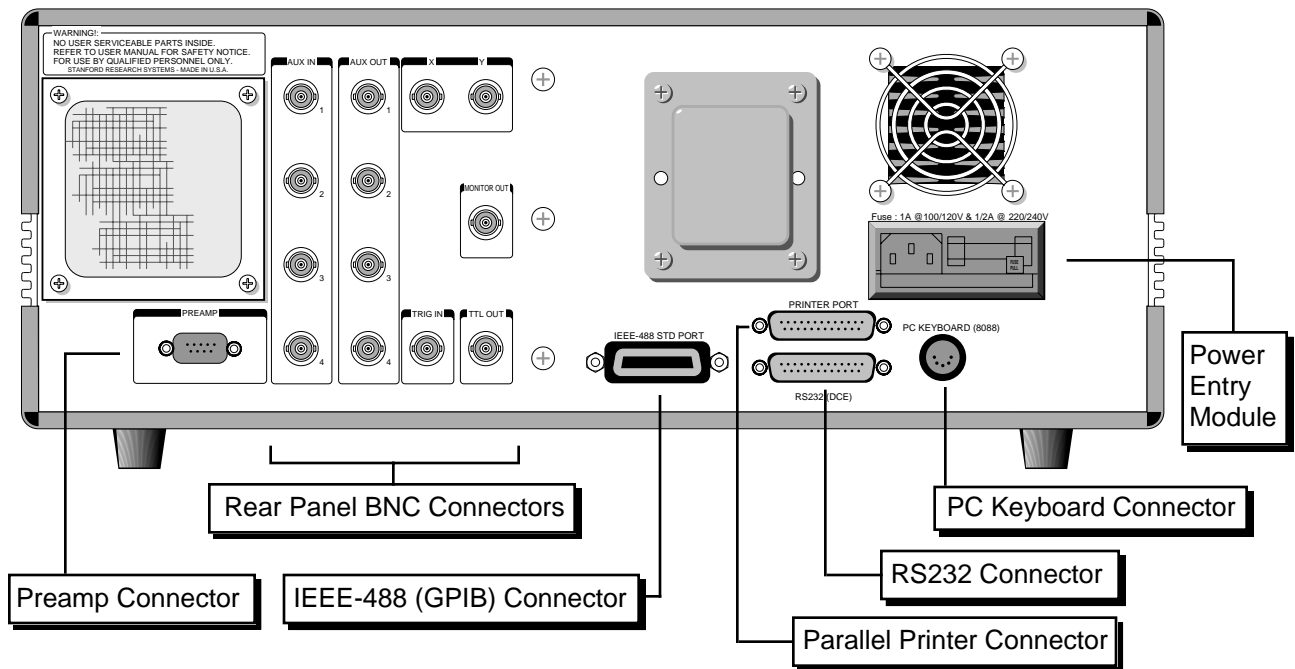

POWER ENTRY MODULE

The power entry module is used to fuse the AC line voltage input, select the line voltage, and block high frequency noise from entering or exiting the instrument. Refer to the first page of this manual for instructions on selecting the correct line voltage and fuse.

IEEE-488 CONNECTOR

The 24 pin IEEE-488 connector allows a computer to control the SR850 via the IEEE-488 (GPIB) instrument bus. The address of the instrument is set in the SETUP GPIB menu.

Also, a GPIB plotter with HPGL compatible graphics may be connected to the IEEE-488 port. In this case, the SR850 will control the plotter to generate plots of the screen graph. Use the SYSTEM SETUP menu to configure the SR850 for use with a GPIB plotter.

RS232 CONNECTOR

The RS232 interface connector is configured as a DCE (transmit on pin 3, receive on pin 2). The baud rate, parity, and word length are programmed from the SYSTEM SETUP menu. To

connect the SR850 to a PC serial adapter, which is usually a DTE, use a straight thru serial cable.

Also, a serial plotter with HPGL compatible graphics may be connected to the RS232 port. The SR850 will drive the plotter to generate plots of the screen graph. Use the SYSTEM SETUP menu to configure the SR850 for use with a serial plotter.

PARALLEL PRINTER CONNECTOR

The [PRINT] key will print the screen to an Epson compatible graphics printer or an HP LaserJet compatible laser printer. Use a standard printer cable to attach the printer to the printer port. Use the SYSTEM SETUP menu to choose the printer.

PC KEYBOARD CONNECTOR

An IBM PC compatible keyboard may be attached to the keyboard connector. An AT keyboard must be in its PC or 8088 mode. Pressing ALT with a letter on the keyboard is equivalent to pressing the front panel key associated with that letter. (The letters are shown under each key.) For example, ALT-A is [START] and ALT-Q is [AUTO GAIN]. The function keys F1-F6 are equivalent to the six soft keys. The right and left arrow keys function as the knob. Keyboard number, letter and Enter keys function normally.

REAR PANEL BNC CONNECTORS

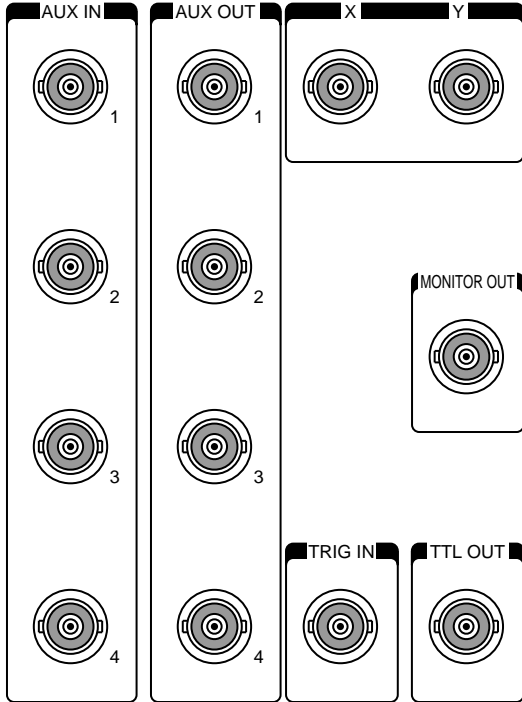

AUX IN 1-4 (A/D Inputs)

These are auxiliary analog inputs which can be digitized by the SR850. The range is -10V to +10V and the resolution is 16 bits (1/3 mV). The input impedance is 1 M .

These inputs may be displayed and stored as traces on the displays. The inputs are sampled at the scan sample rate, which may be as fast as 512 Hz. These inputs allow signals other than the lock-in outputs to be acquired and stored. Furthermore, complex quantities such as X/Aux1 (ratio) may be acquired and stored directly as trace quantities.

AUX OUT 1-4 (D/A Outputs)

These are auxiliary analog outputs. The range is -10V to +10V and the resolution is 1 mV. The output impedance is <1 and the output current is limited to 10 mA.

These outputs may be programmed from the front panel or via the computer interfaces. They may be set to fixed voltages or they may be programmed to sweep between two voltages. Sweeps may be either linear or logarithmic. When sweeping, the outputs change at the sample rate and the sweep

time is the scan length. Output voltage sweeps are coordinated with the data acquisition. Sweeps start and stop with the [START/CONT] and [PAUSE/RESET] keys. Pausing data acquisition will pause an Aux Out sweep. Resetting the data buffer will reset a sweeping Aux Out to its starting value.

X and Y

The X and Y lock-in outputs are always available at these connectors. The bandwidth of these outputs is 100 kHz. A full scale input signal will generate $\pm 10V$ at these outputs. The output impedance is <1 and the output current is limited to 10 mA.

These outputs are affected by the X and Y offsets and expands. The actual outputs are

$$X \text{ Output} = (X/\text{sensitivity} - \text{offset}) \times \text{Expand} \times 10V$$

$$Y \text{ Output} = (Y/\text{sensitivity} - \text{offset}) \times \text{Expand} \times 10V$$

where the offset is a percentage of full scale and the expand is an integer from 1 to 256. The offsets and expand are set in the OUTPUT/OFFSET menu.

MONITOR OUT

This BNC provides a buffered output from the signal amplifiers and prefilters. This is the signal just before the A/D converter and PSD. The output impedance is <1 and the output current is limited to 10 mA.

The gain from the signal input to the monitor output is the overall gain minus the dynamic reserve minus 3dB. The overall gain is specified in dB in the Sensitivity menu box (in the Gain menu). The actual dynamic reserve is shown in the monitor settings display. For example, if the sensitivity is 10 mV, the gain is 60dB. If the dynamic reserve is 21dB, then the gain from the input to the monitor output is $60 - 21 - 3 = 36\text{dB}$ or a gain of 63. A 10 mV (rms) input will result in a .63 Vrms or .9 Vpk output. The gain is only accurate to about 1.5dB or 20%.

This output is useful for determining the cause of input overloads and the effects of prefiltering. However, because the analog gain never exceeds 2000, very small signals may not be amplified enough to viewed at the monitor output.

TRIG IN

This TTL input may be used to trigger data samples and/or to start data acquisition. When the sample rate is set to Trigger, samples are recorded whenever there is a rising edge at the Trigger input. The maximum sample rate is 512 Hz. If the Trigger Starts is selected (in the AUX menu), then a rising edge will have the same effect as pressing the [START/CONT] key. Frequency and Aux Output sweeps will also start with this trigger. If the sample rate is internally set, then samples are recorded at the programmed sample rate. If the sample rate is Trigger, then samples are recorded at every subsequent trigger. (The first trigger starts the scan and takes the first data point, subsequent triggers record the rest of the data points.)

TTL OUT

This output is the TTL sync output for the internal oscillator. The output is a square wave whose edges are linked to the sine wave zero crossings. This is useful when the sine output amplitude is small and a synchronous trigger is required (to a scope for example). This output is active even when locked to an external reference.

PREAMP CONNECTOR

This 9 pin "D" connector provides power and control signals to external preamplifiers such as the SR550 and SR552. The power connections are described below.

Pin	Voltage
1	+20V
2	+5V
6	-20V
7	Signal Ground
8	Ground

USING SRS PREAMPS

When using either the SR550 or SR552, connect the power cable (standard 9 pin D connectors) from the preamp to the rear panel preamp connector on the SR850. Use BNC cables to connect the A output from the preamp to the A input of the SR850. The B output from the preamp (preamp ground) may be connected to the B input of the SR850. In this case, use A-B as the input configuration. Be sure to twist the A and B cables so that there is no differential noise pickup between the cables.

The SR550 and SR552 are **AC coupled from 1 Hz to 100 kHz**. The SR550 has an input impedance of 100 M Ω , the SR552 has 100 k Ω . Set the SR850 to AC coupled since the signal must be above 1 Hz.

The SR850 does NOT compensate for the gain of the preamp. The SR850 sets both preamps to their maximum gains. Measurements made by the SR850 with a preamp need to be divided by the gain of the preamp. The SR550 has a gain of 10 and the SR552 has a gain of 100.

Make sure that the preamp is at least 3 feet from the SR850 to avoid excess interference from the video display. Do not bring the preamp cables near the CRT.

Default Settings	5-2	Edit Mark	5-31
		Marker Labels	
		Cursor To Next Mark	
Reference and Phase	5-3	Math	5-33
Internal/External Reference		Smooth	
Internal Osc Frequency and Amplitude		Fit Line, Exponential or Gaussian	
Internal Sweeps		Calculator	
External Reference Modes		Stats	
Harmonic Detect			
Input and Filters	5-7	Disk	5-41
Input Configuration		Save and Recall Data	
Coupling and Grounding		Save and Recall Settings	
Line Notch Filters		Disk Utilities	
Gain and Time Constant	5-9	System Setup	
Sensitivity		Settings	5-49
Dynamic Reserve		Com	
Time Constant		Sound	
Filter Slope		Plotter	
Synchronous Filtering		Printer	
		Screen	
Output and Offset	5-15	Time	
Front Panel CH1 and CH2		Plot	5-61
X, Y and R Offset and Expand		Plot All, Trace, Marker	
Auto Offset		Info	5-63
		Specifications	
Trace and Scan	5-17	SRS	
Trace Definitions		Operation	
Sample Rate		Commands	
Scan Length and Mode		Status bytes	
		Test	5-65
Display and Scale	5-21	Keypad	
Single or Dual Display Format		Keyboard	
Monitor		Knob	
Display Scales		Disk drive	
		RS232	
Aux Outputs	5-25	Memory	
Fixed or Swept Outputs		Screen	
Output Voltage and Sweep Limits		Printer	
Cursor Setup	5-29		
Max, Min or Mean Seeking			
Cursor Region Width			
Vertical Grid			
Linked Cursors			
Cursor Readout			

DEFAULT SETTINGS

If the [] (backspace) key is held down when the power is turned on, the lock-in settings will be set to the defaults shown below rather than the settings that were in effect when the power was last turned off. The default settings may also be recalled using the *RST command over the computer interface. In this case, the communications parameters and status registers are not changed.

REFERENCE / PHASE

Phase	0.000°
Reference Source	Internal
Reference Slope	Sine
Harmonic	1
Sine Output	1.000 Vrms
Internal Frequency	1.000 kHz
Internal Sweep	Linear
Sweep Start	1.0000 kHz
Sweep Stop	2.0000 kHz

INPUT / FILTERS

Source	A
Current Gain	1M
Grounding	Float
Coupling	AC
Line Notches	Out

GAIN / TC

Sensitivity	1 V
Reserve	Min
Manual Reserve	3 dB
Time Constant	100 ms
Filter dB/oct.	12 dB
Synchronous	Off

OUTPUT / OFFSET

CH1 Source	X
CH2 Source	Y
Offsets	0.00%
Expands	1

TRACE / SCAN

Trace 1	X
Trace 2	Y
Trace 3	R
Trace 4	
Store	All Traces
Sample Rate	1 Hz
Scan Length	16000
Scan Mode	Loop

DISPLAY / SCALE

Format	Up/Down
Monitor	Settings
Top Display	Bar, Trace 1
Top Display Scale	0±1.000e0
Bottom Display	Bar, Trace 2
Bottom Display Scale	0±1.000e0
Full Display	Polar
Horizontal Scales	10 s/div

AUX OUTPUT

All Outputs	Fixed
All Output Voltages	0.000 V
All Start Voltages	1.000 V
All Stop Voltages	2.000 V
All Offset Voltages	0.000 V
Trigger Starts	No

MATH

Fit Type	Line
Calc Operation	x
Argument Type	Trace
Argument Trace	4
Constant	0.0

SYSTEM SETUP

Output To	GPIB
GPIB Address	8
Override Remote	Yes
RS232 Baud Rate	9600
Word Length	8 bits
Parity	None
Key Click	On
Alarms	On
Plot Mode	RS232
Plotter Baud Rate	9600
Plotter GPIB Address	1
Plot Speed	Fast
Trace Pen	1
Grid Pen	1
Alpha Pen	1
Cursor Pen	1
Printer Type	Epson

STATUS ENABLE REGISTERS

Cleared

REFERENCE AND PHASE MENU

Reference and Phase

The Reference and Phase menu sets the reference source, phase shift, and detection harmonic. The internal oscillator frequency, sweeps, and amplitude are also specified in this menu.

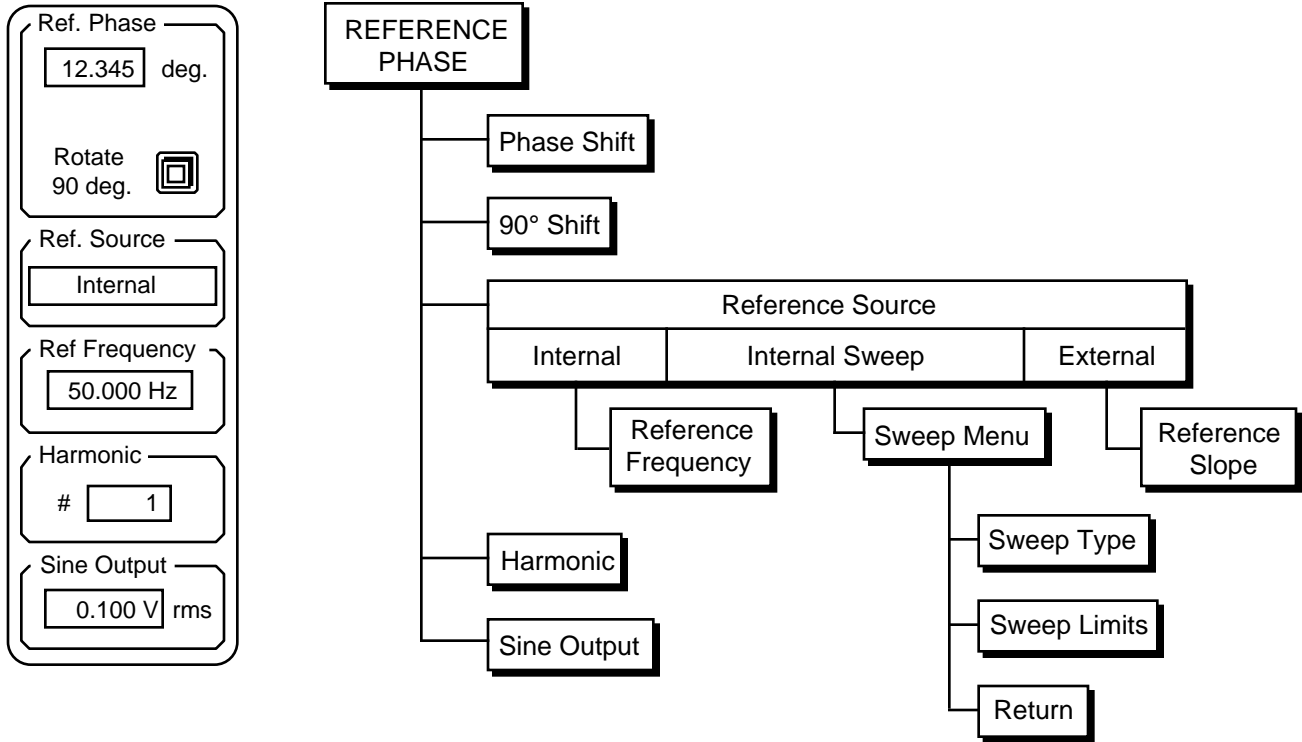

Reference Phase

Pressing the Reference Phase key (top soft key) selects the reference phase shift as the active entry field. A new phase shift may be entered from the numeric keypad or the knob may be used to adjust the phase. The phase shift ranges from -180° to $+180^\circ$ with 0.001° resolution. A numerically entered phase is rounded to the nearest 0.001° .

Pressing the Rotate 90 Degrees soft key will add 90.000° to the present value of the phase shift.

When using an external reference, the reference phase shift is the phase between the external reference and the digital sine wave which is multiplying the signal in the PSD. This is also the phase between the sine output and the digital sine wave used by the PSD in either internal or external reference mode. Changing this phase shift only shifts internal sine waves. The effect of this phase shift can only be seen at the lock-in outputs X, Y and . R is phase independent.

Auto Phase

Pressing [AUTO PHASE] will adjust the reference phase shift so that the measured signal phase is 0° . This is done by subtracting the present measured value of from the reference phase shift. It will take several time constants for the outputs to reach their new values. Auto Phase may not result in a zero phase if the measurement is noisy or changing.

Reference Source

The Reference Source key selects the source of the lock-in reference. Turn the knob to select the desired source, either Internal, Internal Sweep, or External. Keypad entry is not allowed for this entry field.

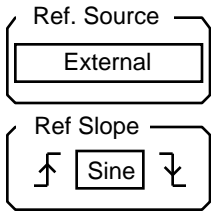

External When the reference source is External, the SR850 will phase lock to the external reference provided at the Reference Input BNC. The SR850 will lock to frequencies between 0.001 Hz and 102.0 kHz. The upper limit is reduced to 102 kHz/N where N is the harmonic number if N is greater than 1.

Ref Slope This key selects the reference input discriminator mode. This selection is only available when the reference source is external.

When either TTL Rising Edge or TTL Falling Edge is selected, the SR850 locks to the selected edge of a TTL square wave or pulse train. For reliable operation, the TTL signal should exceed 3.5 V when high and be less than 0.5 V when low. The input is directed past the analog discriminator and is DC coupled into a TTL input gate. This input mode should be used whenever possible since it is less noise prone than the sine wave discriminator. **For very low frequencies (<1 Hz), a TTL reference MUST be used.**

Sine input mode locks the SR850 to the rising zero crossings of an analog signal at the Reference Input BNC. This signal should be a clean sine wave at least 200 mVpk in amplitude. In this input mode, the Reference Input is AC coupled (above 1 Hz) with an input impedance of 1 MΩ. This mode can not be used at frequencies far below 1 Hz. At very low frequencies, the TTL input modes must be used.

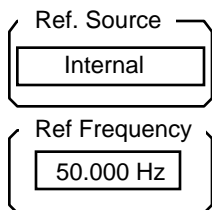

Internal When the reference source is Internal, the SR850's synthesized internal reference is used as the reference. The Reference Input BNC is ignored in this case. In this mode, the Sine Out or TTL Sync Out provides the excitation for the measurement.

Reference Frequency Pressing this key selects the internal oscillator frequency as the active entry field. This field is only available when the reference source is internal. The frequency may be adjusted with the knob or directly entered from the keypad. The frequency has 5 digits or 0.1 mHz resolution, whichever is larger.

The frequency can range from 0.001 Hz to 102.00 kHz. The upper limit is decreased if the harmonic number is greater than 1. In this case, the upper limit is 102 kHz/N where N is the harmonic number.

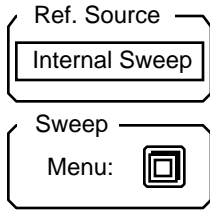

Internal Sweep When the reference source is Internal Sweep, the SR850's synthesized internal reference is used as the reference and swept in frequency. Internal frequency sweeps are linked to the data acquisition scan. The frequency is changed once per sample (after the trace data is recorded) and sweeps from the start to stop frequency in one scan length amount of time. Pausing a scan with the [PAUSE RESET] key will pause a sweep. Resetting a scan will reset the frequency to the start frequency.

When using a sweep, it is useful to set the cursor readout to F_{sweep} (in the CURSOR SETUP menu). In this mode, the cursor will read the frequency as the horizontal coordinate.

Sweep Menu This key displays the internal reference sweep menu described below. This menu is only available when the reference source is Internal Sweep.

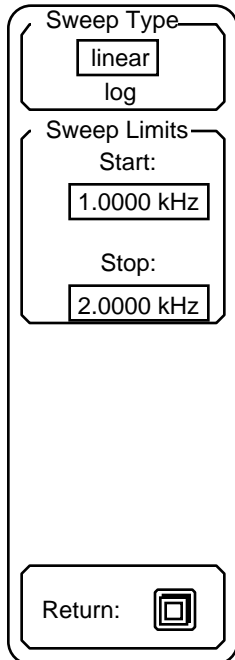

Sweep Type The frequency sweep can be linear or logarithmic (actually exponential). Remember, the resolution of the sweep is determined by the number of samples in the scan, i.e. the scan length times the sample rate. If the number of samples is small, the sweep will be very coarse.

Sweep Limits The upper field is the sweep start frequency and the lower field is the sweep stop frequency. Pressing either key will select an active entry field. The frequencies may be adjusted using the knob or entered directly with the keypad. The frequency can be swept in either direction.

Return This key returns to the main Reference Phase menu.

Harmonic

The SR850 can detect signals at harmonics of the reference frequency. The SR850 multiplies the input signal with digital sine waves at a multiple of the reference. Only signals at this harmonic will be detected. Signals at the original reference frequency are not detected and are attenuated as if they were noise.

Pressing this key selects the harmonic number field as the active entry field. The harmonic number may be adjusted using the knob or entered directly with the keypad. Harmonics up to 32767 times the reference can be detected as long as the harmonic frequency does not exceed 102 kHz.

If the harmonic number is set to N then the reference frequency is limited to 102 kHz/N.

The harmonic number is always displayed in the status bar at the bottom of the screen.

Sine Output

Pressing this key selects the Sine Output Amplitude as the active entry field. The sine amplitude may be set from 4 mVrms to 5 Vrms. The output impedance of the Sine Out is 50 Ω . If the signal is terminated in 50 Ω , the amplitude will be half of the programmed value.

When the reference mode is internal, this is the excitation source provided by the SR850. When an external reference is used, this sine output provides a sine wave phase locked to the external reference. The SR850 provides a synchronous sinusoidal excitation signal even when an external TTL reference is used.

The rear panel TTL Output provides a TTL square wave at the reference frequency. This square wave is generated by discriminating the zero crossings of the sine output. This signal can provide a trigger or sync signal to the experiment when the internal reference source is used. This signal is also available when the reference is externally provided. In this case, the TTL Output is phase locked to the external reference.

INPUT AND FILTERS MENU

Input and Filters

The Input and Filters menu sets the input signal source and configuration. The input notch filters are also selected in this menu. See the SR850 Basics section for a discussion of the different input configurations and the signal filters.

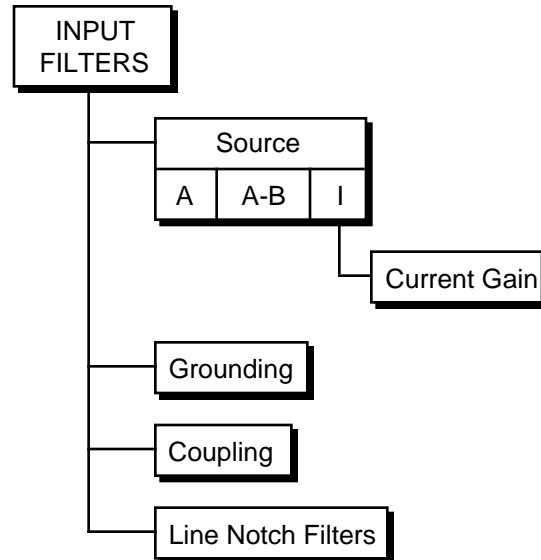
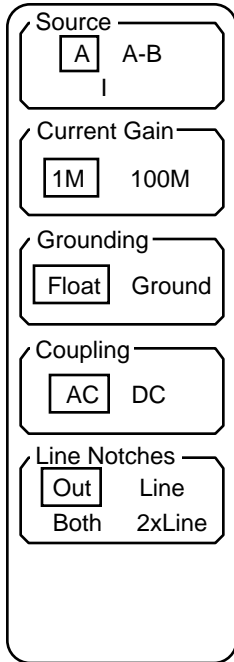

Source

The Input Source key selects the front end signal input configuration. The input amplifier can be either a single-ended (A) or differential (A-B) voltage or a current (I).

The voltage inputs have a $10\text{ M}\Omega$, 25 pF input impedance. Their connector shields are isolated from the chassis by either $10\text{ k}\Omega$ (Ground) or $10\text{ k}\Omega$ (Float). Do not apply more than 50 V to either input. **The shields should never exceed 1 V.**

The current input uses the A connector. The input is $1\text{ k}\Omega$ to a virtual ground. The largest allowable DC current before overload is $10\text{ }\mu\text{A}$ (1 M gain) or 100 nA (100 M gain). No current larger than 10 mA should ever be applied to this input.

Current Gain

This key selects the current gain when using the current input as the signal source. This menu box is only available if the current input is selected above.

The current gain determines the input current noise as well as the input bandwidth. The 100 M gain has 10 times lower noise but 100 times lower bandwidth. Make sure that the signal frequency is below the input bandwidth. The noise and bandwidth are listed below.

<u>Gain</u>	<u>Noise</u>	<u>Bandwidth</u>
1M	130 fA/ Hz	70 kHz
100M	13 fA/ Hz	700 Hz

The impedance of the signal source should be greater than 1 M when using the 1M gain or 100 M when using the 100M gain.

Changing the current gain does not change the instrument sensitivity. Sensitivities above 10 nA require a current gain of 1 M. Sensitivities between 20 nA and 1 μ A automatically select the 1 M current gain. At sensitivities below 20 nA, changing the sensitivity does not change the current gain.

Grounding

This key chooses the shield grounding configuration. The shields of the input connectors (A and B) are not connected directly to the lock-in chassis ground. In Float mode, the shields are connected by 10 k to the chassis ground. In Ground mode, the shields are connected by 10 to ground. Typically, the shields should be grounded if the signal source is floating and floating if the signal source is grounded. **Do not exceed 1 V on the shields.**

Coupling

This key selects the input coupling. The signal input can be either AC or DC coupled. The current input is coupled after the current to voltage conversion. The current input itself is always DC coupled (1 k to virtual ground).

The AC coupling high pass filter passes signals above 160 mHz and attenuates signals at lower frequencies. AC coupling should be used at frequencies above 160 mHz whenever possible. At lower frequencies, DC coupling is required. AC coupling results in gain and phase errors at low frequencies. **Remember, the Reference Input is AC coupled when a sine reference is used. This also results in phase errors at low frequencies.**

Line Notches

This key selects no line notch filters engaged (Out), either the line frequency (Line) or twice line frequency (2xLine) notch engaged, or Both filters engaged. The line notch filters are pre-tuned to the line frequency (50 or 60 Hz) and twice the line frequency (100 or 120 Hz).

These filters have an attenuation depth of at least 30 dB. These filters have a finite range of attenuation, generally 10 Hz or so. If the reference frequency is 70 Hz, do not use the 60 Hz notch filter! The signal will be attenuated and the phase shifted. See the SR850 Basics section for a discussion of when these filters improve a measurement.

GAIN AND TIME CONSTANT MENU

Gain and Time Cons

The Gain and Time Constant menu sets the full scale sensitivity and dynamic reserve. The low pass filter time constant and slope are also selected in this menu. See the SR850 Basics section for a discussion of gain, time constants and dynamic reserve.

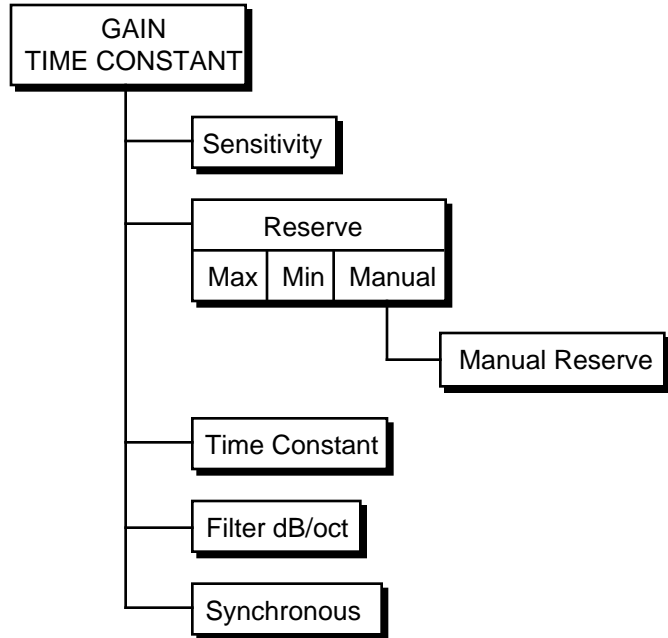
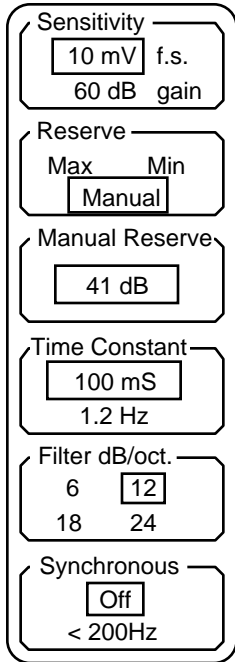

Sensitivity

The Sensitivity key selects the full scale sensitivity as the active entry field. Use the knob to adjust the sensitivity. Keypad entry is not allowed for this parameter. The gain displayed below the sensitivity is the overall instrument gain, output divided by input. This is simply 10 V (full scale DC output of X, Y, or R) divided by the sensitivity expressed in dB.

The full scale sensitivity can range from 2 nV to 1 V (rms) or 2 fA to 1 μ A (rms). The sensitivity indication is not changed by the X, Y, or R output expand. The expand functions increase the output scale as well as the resolution of the trace data. Whenever the sensitivity is changed, any displayed bar graph will change its range to full scale with zero at the center.

Changing the sensitivity may change the dynamic reserve. Sensitivity takes precedence over dynamic reserve. See the next page for more details.

Auto Gain

Pressing the [AUTO GAIN] key will automatically adjust the sensitivity based upon the detected signal magnitude (R). Auto Gain may take a long time if the time constant is very long.

Reserve

This key selects either maximum, minimum or manual dynamic reserve. When the reserve is maximum, the SR850 automatically selects the maximum reserve available at the present full scale sensitivity. When the reserve is minimum, the minimum available reserve is selected. The dynamic reserve is displayed in the settings display at the top of the screen (if selected in the DISPLAY/SCALE menu).

When the reserve is manual, the reserve is set by the user to a value between the min and max reserve. The reserve is set in 10 dB increments.

Changing the sensitivity may change the reserve. With max or min reserve, the max or min reserve of the new sensitivity is used. **With manual reserve, the reserve is kept the same relative to the minimum reserve.** For example, if the sensitivity is 10 mV and the reserve is 21 dB (20 dB above the minimum for this sensitivity), changing the sensitivity to 5 mV will change the reserve to 27 dB (20 dB above the 7 dB minimum). If the new sensitivity does not have a reserve high enough to satisfy this rule, then the max sensitivity will be used instead.

The minimum and maximum reserve limits for each sensitivity are listed below.

<u>Sensitivity</u>	<u>Min Reserve (dB)</u>	<u>Max Reserve (dB)</u>
1 V	0	0
500 mV	6	6
200 mV	4	14
100 mV	0	20
50 mV	6	26
20 mV	4	34
10 mV	0	40
5 mV	6	46
2 mV	4	54
1 mV	10	60
500 μ V	16	66
200 μ V	24	74
100 μ V	30	80
50 μ V	36	86
20 μ V	44	94
10 μ V	50	100
5 μ V	56	106
2 μ V	64	114
1 μ V	70	120
500 nV	76	126
200 nV	84	134
100 nV	90	140
50 nV	96	146
20 nV	104	154
10 nV	110	160
5 nV	116	166
2 nV	124	174

Do not use ultra high dynamic reserves above 120 dB unless absolutely necessary. It will be very likely that the noise floor of any interfering

signal will obscure the signal at the reference and make detection difficult if not impossible. See the SR850 Basics section for more information.

Man Reserve

This key selects the Manual Reserve entry field for knob adjustment. Keypad entry is not allowed for this parameter. This menu box is available only if manual reserve is selected above. The reserve may be set between the minimum and maximum values in 10 dB increments. The min and max reserve limits change with sensitivity (see the table on the previous page). If the sensitivity is changed, the manual reserve may also be changed as described above.

Auto Reserve

Pressing [AUTO RESERVE] will change the reserve to manual and adjust the dynamic reserve to the minimum reserve required. Auto Reserve will not work if there are low frequency noise sources which overload infrequently.

Time Constant

This key selects the Time Constant as the active field. Use the knob to adjust the time constant. Keypad entry is not allowed for this parameter. The time constant may be set from 10 μ s to 30 s (det. freq.>200 Hz) or 30 ks (det. freq. <200 Hz).

The maximum time constant is 30 s if the detection frequency is above 200 Hz and 30 ks if the frequency is below 200 Hz. The actual range switches at 203.12 Hz when the frequency is increasing and at 199.21 Hz when the frequency is decreasing. The time constant may not be adjusted beyond the maximum for the present detection frequency. If the frequency is below 200 Hz and 100 s is the time constant and the frequency increases above 200 Hz, the time constant WILL change to 30 s. Decreasing the frequency back below 200 Hz will NOT change the time constant back to 100 s.

The absolute minimum time constant is 10 μ s. The actual minimum time constant depends upon the filter slope and the DC gain in the low pass filter (dynamic reserve plus expand). The minimum time constant is only restricted if the dynamic reserve plus expand is high and the filter slope is low - not a normal operating situation. The tables below list the minimum time constants for the different filter slopes and gains.

6 dB/oct	<u>DC gain (dB)</u>	<u>min time constant</u>
	<45	10 μ s
	<55	30 μ s
	<65	100 μ s
	<75	300 μ s
	<85	1 ms
	<95	3 ms
	<105	10 ms
	<115	30 ms
	<125	100 ms
	<135	300 ms
	<145	1 s
	<155	3 s

Gain and Time Constant Menu

	<165	10 s
	<175	30 s
12 dB/oct	<u>DC gain (dB)</u>	<u>min time constant</u>
	<55	10 μ s
	<75	30 μ s
	<95	100 μ s
	<115	300 μ s
	<135	1 ms
	<155	3 ms
	<175	10 ms
18 dB/oct	<u>DC gain (dB)</u>	<u>min time constant</u>
	<62	10 μ s
	<92	30 μ s
	<122	100 μ s
	<152	300 μ s
	<182	1 ms
24 dB/oct	<u>DC gain (dB)</u>	<u>min time constant</u>
	<72	10 μ s
	<112	30 μ s
	<152	100 μ s
	<182	300 μ s

To use these tables, choose the correct table for the filter slope in use. Calculate the DC gain by adding the reserve to the expand (expressed in dB). Find the smallest DC gain entry which is larger than the gain in use. Read the minimum time constant for this entry. For example, if the slope is 12 dB/oct, the reserve is 65 dB, and the X expand is 10 (20 dB), then the DC gain is 85 dB and the min time constant is 100 μ s.

Time constant is a low priority parameter. If the sensitivity, dynamic reserve, or filter slope change, and the present time constant is below the new minimum, the time constant WILL change to the new minimum. Remember, changing the sensitivity may change the reserve and thus change the time constant.

Choosing a short time constant limits the amount of expand available. The X and Y expands may not be increased such that the present time constant will be shorter than the minimum time constant for the reserve plus expand. Changing the expand does NOT change the time constant.

Displayed below the time constant in the menu is the equivalent noise bandwidth (ENBW) of the low pass filter. This is the measurement bandwidth for Gaussian noise and depends upon the time constant and filter slope. (See the Noise discussion in the SR850 Basics section.)

Analog Outputs with Short Time Constants

When using short time constants below 10 ms, the X and Y analog outputs from the rear panel or the CH1 and CH2 outputs configured to output X or Y should be used. These outputs have a 100 kHz bandwidth and are accurate even with short time constants. Trace outputs are updated at a 512 Hz rate, as are the R and outputs. These outputs do not accurately reflect high frequency outputs.

Filter dB/oct

This key selects the low pass filter slope (number of poles). Each pole contributes 6 dB/oct of roll off. Using a higher slope can decrease the required time constant and make a measurement faster. The filter slope affects the minimum time constant (see above). Changing the slope may change the time constant if the present time constant is shorter than the minimum time constant at the new filter slope.

Synchronous

Pressing this key selects no synchronous filtering (Off) or synchronous filtering on below 200 Hz (<200 Hz). In the second case, the synchronous filter is switched on when the detection frequency decreases below 199.21 Hz and switched off when the detection frequency increases above 203.12 Hz. The detection frequency is the reference frequency times the harmonic detect number. The Syncro indicator in the Settings monitor (at the top of the screen) is turned on whenever synchronous filtering is on.

When the synchronous filter is on, the phase sensitive detectors (PSD's) are followed by 2 poles of low pass filtering, the synchronous filter, then 2 more poles of low pass filtering. The low pass filters are set by the time constant and filter slope. If the filter slope requires less than 4 poles (<24 dB/oct), then the unused poles are set to a minimum time constant. The poles which are set by the time constant are the ones closest to the PSD's. For example, if the time constant is 100 ms with 12 dB/oct slope and synchronous filtering is on, then the PSD's are followed by two poles of low pass filtering with 100 ms time constant, the synchronous filter, then two poles of minimum time constant.

Synchronous filtering removes outputs at harmonics of the reference frequency, most commonly 2xf. This is very effective at low reference frequencies since 2xf outputs would require very long time constants to remove. The synchronous filter does NOT attenuate broadband noise (except at the harmonic frequencies). The low pass filters remove outputs due to noise and interfering signals. See the SR850 Basics section for a discussion of time constants and filtering.

Note:

The synchronous filter averages the outputs over a complete period. Each period is divided into 128 equal time slots. At each slot, the average over the previous 128 slots is computed and output. This results in an output rate of 128xf. This output is then smoothed by the two poles of filtering which follow the synchronous filter.

The settling time of the synchronous filter is one period of the detection frequency. If the amplitude, frequency, phase, time constant or slope is changed, then the outputs will settle for one period. These transients are because the synchronous filter provides a steady output only if the input is repetitive from period to period. The transient response also depends upon the time constants of the regular filters. Very short time constants (<<period) have little effect on the transient response. Longer time constants (<period) can magnify the amplitude of a transient. Much longer time constants (> period) will increase the settling time far beyond a period.

Gain and Time Constant Menu

Use of the synchronous filter results in a reduction in amplitude resolution.

OUTPUT AND OFFSET MENU

Output and Offset

The Output and Offset menu selects the CH1 and CH2 outputs and sets the X, Y and R offsets and expands. See the SR850 Basics section for a discussion of the DC outputs and scaling.

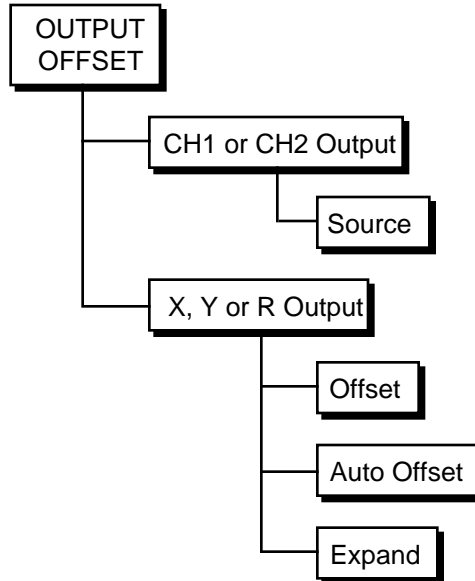
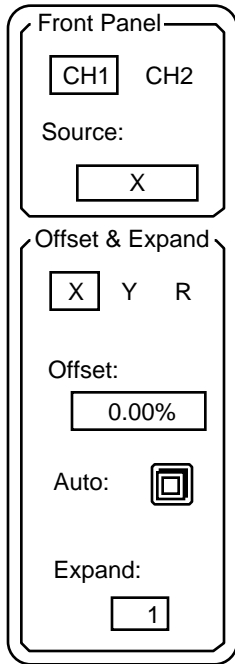

Front Panel CH1 and CH2

The SR850 has two front panel output BNC connectors called Channel 1 (CH1) and Channel 2 (CH2). These outputs can provide voltages proportional to X, Y, R, , or traces 1-4. Outputs proportional to X or Y have a bandwidth of 100 kHz (the outputs are updated at 256 kHz). These outputs are the traditional outputs of a lock-in. Outputs proportional to R, , or a data trace (even if the trace is simply X or Y) have a bandwidth of 200 Hz (updated at 512 Hz).

CH1 or CH2

The Source entry field displays the quantity being output from either CH1 or CH2. The first soft key selects whether CH1 or CH2's output source quantity is being displayed. Pressing this key toggles between CH1 and CH2.

Source

Pressing this key selects the output source quantity for either CH1 or CH2 as the active entry field. Use the knob to select the desired output parameter. Keypad entry is not allowed.

CH1 can be proportional to X, R, , Trace1, Trace2, Trace3, or Trace 4.
CH2 can be proportional to Y, R, , Trace1, Trace2, Trace3, or Trace 4.

Remember, outputs proportional X or Y have 100 kHz of bandwidth. The other output quantities should only be used if the time constant is sufficiently long so there are no high frequency outputs.

See the SR850 Basics section for output scaling information.

Output Offset and Expand The X, Y and R outputs may be offset and expanded. See the SR850 Basics section for a complete discussion of scaling, offsets and expands.

Briefly, X, Y and R analog outputs (either the rear panel X and Y or the front panel CH1 or CH2 proportional to X, Y or R) are determined by

$$\text{Output} = (\text{signal/sensitivity} - \text{offset}) \times \text{Expand} \times 10 \text{ V}$$

The output is normally 10 V for a full scale signal. The offset subtracts a percentage of full scale from the output. Expand multiplies the remainder by a factor from 1 to 256 (output limited to 10 V).

Output offsets ARE reflected in data trace displays which depend upon X, Y or R.

X and Y offsets do NOT affect the calculation of R or . X and Y offsets WILL affect a polar graph since a polar graph plots X and Y. The R offset does NOT affect a polar graph.

Output expands do NOT increase the displayed values of X, Y or R in data traces. Expand increases the resolution of the X, Y or R value in a trace.

Displays which are showing a trace which is affected by a non-zero offset or a non-unity expand have their Offst and Expd indicators turned on (at the lower left of each display).

X, Y or R This key selects which output quantity's offset and expand will be displayed and adjusted in this menu box. Only X, Y and R have offsets and expands. can be offset by adjusting the reference phase shift.

Offset Pressing this key selects the Offset as the active entry field. This is the offset of the output quantity selected above. The offset ranges from -105.00% to 105.00% of full scale. This offset percentage does not change with sensitivity - it is an output function. The offset may be entered numerically or adjusted with the knob.

Auto Offset Pressing this key automatically sets the offset percentage to offset the selected output quantity to zero.

Expand Pressing this key selects the Expand as the active entry field. This is the output expand for the output quantity selected above (X, Y or R). The expand ranges from 1 to 256. The output can never exceed full scale when expanded. For example, if an output is 20% of full scale, the largest expand (with no offset) which does not overload is 5. An output expanded beyond full scale will OUTPT overload.

Short Time Constant Limitations

The maximum expand is also limited by short time constants. A short time constant places a limit on the total amount of DC gain (reserve plus expand) available. If the time constant is short, the filter slope low and the dynamic reserve high, then the maximum expand may be less than 256. See the table of time constants and DC gains in the Gain and Time Constant menu section.

TRACE AND SCAN MENU

Trace and Scan

The Trace and Scan menu defines the four data traces and the data buffer usage. The sample rate and scan time for data storage and sweeps are set in this menu. See the Data Traces and Trace Scans and Sweeps discussion in the Screen Display Operation section for more information.

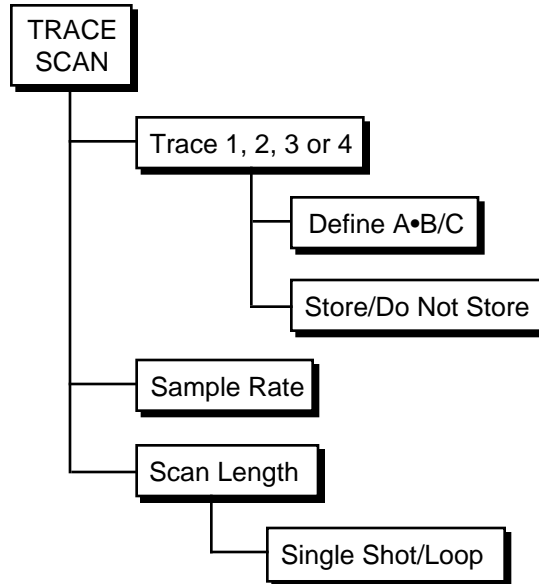
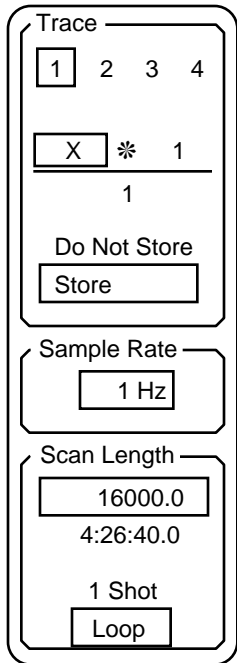

Trace

The SR850 collects and displays data in the form of traces. There are four data traces which may be defined. Each trace is defined as $A \cdot B / C$ where the parameters A, B and C are chosen from X, Y, R, , Xnoise, Ynoise, Rnoise, Aux Inputs 1-4 (rear panel), Frequency, and unity (1). C can also be any quantity squared.

Only data traces may be displayed. In order to display the quantity X, a trace must be defined to be X and then displayed (see the DISPLAY/SCALE menu).

When the unit is reset, the traces are defined as
Trace 1 = X, Trace 2 = Y, Trace 3 = R, Trace 4 = .

Trace 1, 2, 3 or 4

Pressing this key selects Trace 1, 2, 3 or 4. The selected trace's definition and storage mode is displayed below the trace selection. Only the selected trace's definition and storage mode may be changed.

A * B / C

Pressing this key highlights the boxed parameter (either A, B or C in the equation $A \cdot B / C$). The highlighted parameter may be changed using the knob. Pressing the key again highlights the next parameter and so on. In the illustration above, the A parameter is boxed and is set to X. The parameters B and C are both unity.

The A, B and C parameters may be set to the quantities X, Y, R, , Xnoise, Ynoise, Rnoise, Aux Inputs 1-4 (on the rear panel), Frequency, and unity. C may also be any quantity squared. X, Y, R and are the normal lock-in output quantities. Frequency is useful when the reference is unknown or changing (as in an external sweep). The rear panel aux inputs can digitize a slowly varying signal with 16 bits of resolution to monitor external parameters which affect the lock-in measurement. The noise values are calculated by the SR850 and represent the noise of the signal in the equivalent noise bandwidth of the low pass filter time constant. See the SR850 Basics section for more about noise measurements.

Normal measurements rarely require a trace other than simply X, Y, R or . Ratio normalization to an external voltage requires a trace defined as R/Aux Input 1 for example. Noise or frequency may be displayed by defining a trace as Xnoise or Frequency.

Store/Do Not Store

Pressing this key selects whether the trace selected above will be stored in the data buffer or not. If store is chosen, when the scan begins, trace data will be stored in the data buffer at the sample rate. The data buffer can record up to 64000 data points in memory. This buffer can be 64000 points of a single trace, 32000 points of two traces, or 16000 points of all four traces.

Data is stored only while data acquisition is in progress. The [START/CONT] key starts a data scan. The Run or Run 1 scan indicators are turned on in the status bar at the bottom of the screen.

Only traces that are stored may be displayed in strip chart form.

See the SR850 Operation section for more about trace scans.

Sample Rate

This key selects the Sample Rate as the active field. Use the knob to adjust the sample rate. The sample rate can be varied from 62.5 mHz (1 point every 16 sec.) up to 512 Hz. Increasing the sample rate past 512 Hz will select Triggered samples. In this mode, a sample is recorded within 2 ms of a rising edge trigger on the rear panel Trigger input. Triggers which occur faster than 512 Hz are ignored. When the sample rate is set to Triggered, the chart displays assume a sample rate of 1 per second for scaling purposes. Simply read the graphs as triggers per division instead of seconds per division.

The sample rate sets how often points are added to the storage buffers. All stored traces are sampled at the same rate (and at the same times).

Swept parameters (internal oscillator frequency or Aux Outputs) are synchronized with the data acquisition. Swept parameters change once per sample (even if no traces are being stored). The parameter is updated after the data points for each sample are taken. The settling time for each point is thus $1/(\text{sample rate})$.

Aliasing effects can occur whenever the trace being sampled contains signals at frequencies greater than twice the sample rate. The effect is most noticeable when trying to sample an output whose frequency is a multiple of the sample rate. Generally, the highest possible sample rate should be used given the desired scan length and the buffer size. The time constant and filter slope should be chosen to eliminate output signals at frequencies higher than twice the sample rate.

See the Trace Scan discussion in the Operation section for more details.

Scan Length

The scan length is the length of the data acquisition scan (and sweeps) in seconds. The minimum scan length is 1 second and the maximum scan length is the maximum number of points in the data buffer (16000, 32000, or 64000) divided by the sample rate. Changing the sample rate will only change the scan length if the present scan length is greater than the new maximum scan length. Otherwise, the number of points in the scan is changed to keep the scan length constant.

When the sample rate is triggered, the sample rate is assumed to be 1 Hz for display scaling and scan length purposes. The time (in seconds) is equal to the sample number.

The sample rate sets how often points are added to the storage buffers. All stored traces are sampled at the same rate (and at the same times).

See the Trace Scan and Sweep discussion in the Operation section for more details.

Scan Length

This key selects the Scan Length as the active entry field. Enter the scan length numerically from the keypad or use the knob to adjust it. The scan length is entered in seconds. The scan length is displayed in hours:minutes:seconds format below the entry field.

1 Shot or Loop

Pressing this key selects 1 Shot or Loop scan mode.

When the scan (or sweep) is complete, data storage (or sweeping) can stop or continue.

1 Shot scan mode means that data points are stored for a single scan. At the end of the scan, data acquisition stops and swept parameters are held at their final stop values.

Loop scan mode means that a new scan (or sweep) is started at the end of each scan. Scans (and sweeps) repeat indefinitely until halted by the user. The data buffer will store as many scans as possible. The buffer always holds at least one complete scan. If the scan does not fill the entire buffer, then multiple scans of data are stored. When the buffer is full, new data is added at the beginning of the buffer, overwriting the oldest data.

DISPLAY AND SCALE MENU

Display and Scale

The Display and Scale menu selects the screen format, the displayed traces, and the display types. The bar graph and chart display scales may be adjusted in this menu. See the Operation section for more information about the different displays.

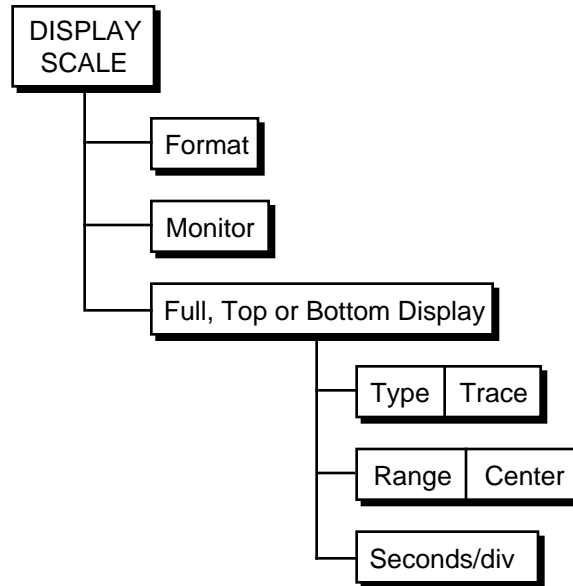
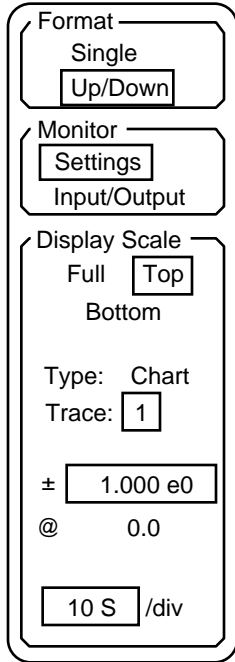

Format

The Format key toggles between single and dual display screen formats. In dual display format, the [ACTIVE DISPLAY] key selects the active display for Auto Scale and Cursor functions.

Monitor

The Monitor key toggles the monitor display between displaying the lock-in settings and the lock-in inputs and outputs. The monitor display is the upper two lines of the screen.

The settings monitor displays the sensitivity, dynamic reserve, time constant and rolloff, signal filters, and input configuration.

The Input/Output monitor displays the values of X, Y, R and as well as the rear panel Aux Inputs.

Display Scale

Each of the displays (full screen, top and bottom) has a Type (bar, chart or polar). Bars and charts display one of the four data traces. Polar graphs always plot X and Y. Bars and charts have a range and center trace value. Charts have a horizontal scale as well.

See the Operation section for a complete description of each type of display.

Display and Scale Menu

Full, Top or Bottom Display

Pressing this key selects which display's type, trace and scaling will be adjusted and displayed in this menu box. If the format is full screen, the top and bottom displays can not be selected. If the format is dual display, then only top or bottom can be selected.

Type and Trace

Pressing this key highlights the boxed parameter (either Type or Trace). The highlighted parameter may be changed using the knob. Pressing the key again highlights the other parameter (either Type or Trace). In the illustration above, the Trace parameter is boxed and is set to 1. Pressing this key will highlight the trace number and allow the knob to change it. Pressing this key again will highlight the type, Chart in this case.

The display type may be set to Polar, Bar, Chart or Blank.

The blank display clears the display area of the screen.

The polar graph has no trace or scale information since it always displays X and Y and the graph is scaled to the sensitivity. If the display is polar, the trace and scale may not be selected or changed.

The bar graph has trace and range and center parameters displayed. The bar graph has no horizontal (time) scale.

The chart graph has trace, range and center as well as horizontal scale information.

The trace parameter selects which data trace will be displayed in the selected display. **Only data traces may be displayed.** Only bar and chart displays have a selectable trace. The trace number and definition is shown in the screen display.

Range and Center

Bar graph and chart vertical scales are represented as a center value plus and minus a range. The range is the upper (\pm) parameter, the center is the lower (@). Pressing this key highlights the boxed parameter (either range or center). The highlighted parameter may be changed with the knob or entered numerically. Pressing the key again highlights the other parameter (either range or center). In the illustration above, the range is boxed and set to 1.000 V and the center value is zero.

Both the center and range may be changed for a bar graph. This allows the bar graph to expand a portion of the full scale range around a nominal value. The bar is always drawn from the center (nominal) value. Pressing [AUTO SCALE] while a bar graph is the active display will set the center to zero and adjust the range so that the bar is at least 40% of the new range.

The vertical chart scale places the center value at the vertical midpoint of the graph. The top of the graph is the center plus the range and the bottom is the center minus the range. Pressing [AUTO SCALE] while a chart graph is the active display will change both the center and range to display all of the data within the graph. Data which has scrolled off the graph edge is not taken into account when auto scaling.

Seconds/div Chart graphs have a horizontal scale which determines how much of the data buffer will be displayed. The horizontal scale is the number of seconds per division across the graph. By changing the horizontal scale, the entire trace buffer can be displayed at once or a small portion may be expanded. If only a portion of the buffer is displayed, use the cursor to pan right and left within the buffer. To activate the cursor, select the chart as the active display and press [CURSOR].

The horizontal scale may be set from 2 ms/div to 100 ks/div. If the scale is such that the amount of time across the graph is less than 1/sample rate, there may not be any data points on the graph.

AUX OUTPUTS MENU

Aux Outputs

The Aux Outputs menu programs the rear panel auxiliary D/A outputs. The outputs may be set to fixed voltages or programmed to sweep. In addition, the Trigger input can be configured to start scans.

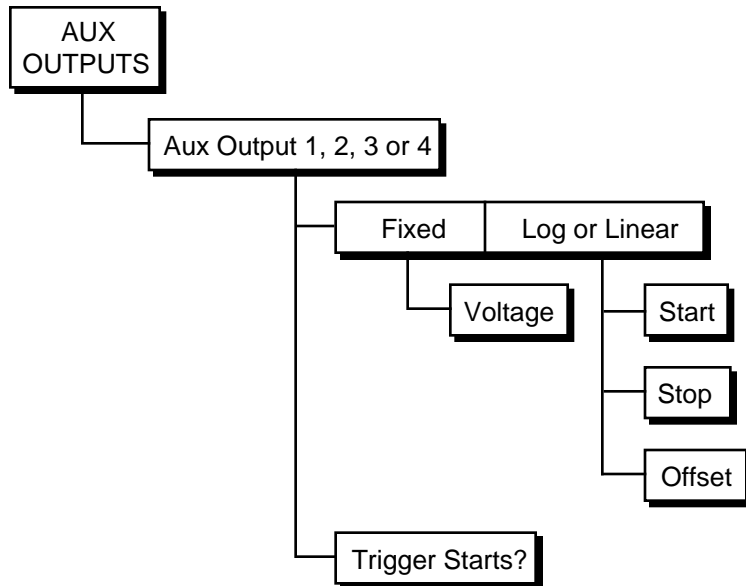
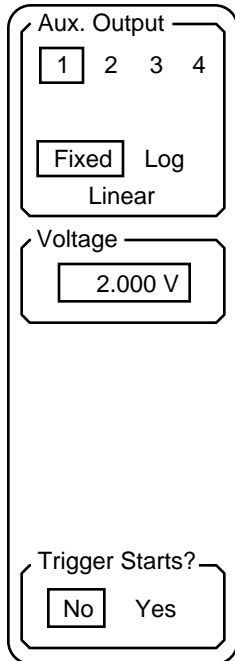

Aux Outputs

The four aux outputs on the rear panel are general purpose analog outputs which may be programmed by the user. They may be set to fixed voltages or swept between two voltages. Sweeps may be either linear or logarithmic (actually exponential).

When sweeping, the outputs change at the sample rate and the sweep time is the scan length. Sweeps may be 1 Shot (single sweep) or Loop (repeat) as set by the scan mode. Scan and sample parameters are set in the Trace Scan menu. Sweeps start and stop with the [START/CONT] and [PAUSE/RESET] keys. Pausing data acquisition will pause a sweeping output. Resetting the scan will reset a swept output to its start voltage. At the end of a single shot sweep, a swept output is held at its stop value.

Aux Out 1, 2, 3 or 4

Pressing this key selects which aux output's mode, voltage, limits and offset are adjusted and displayed in this menu. Pressing this key toggles from 1 through 4 and back to 1.

Fixed, Log or Linear

Pressing this key selects the mode for the selected aux output. Each output may be set to a fixed voltage or swept in log or linear fashion. Choosing a sweep while a scan is in progress is not allowed.

Voltage

This menu box displays the fixed voltage at the selected aux output. This menu box is only displayed if the output is Fixed.

If the output is Fixed, pressing this key will select the voltage as the active entry field. The fixed voltage level can be adjusted with the knob or entered from the keypad. The voltage can range from -10 V to +10 V with 1 mV resolution.

Sweep Limits

An output which is in linear or log sweep mode has its sweep limits and offset value displayed.

A swept output is a linear or logarithmic progression from the start value to the stop value, plus the offset value. Sweeps are computed based upon the start and stop values and then offset by the offset value. This allows a single definition to work for both linear and log sweeps. For example, a linear sweep with a start of 1 V and a stop of 5 V and an offset of -4 V will sweep linearly from -3 V to 1 V. A log sweep with the same parameters will be computed as a sweep from 1 V to 5 V (a factor of 5) and then be offset by -4 V. This allows log sweeps to provide negative outputs (for which log is not defined).

The sweep limits can range from 0.001 V to 21 V and the offset can range from -10.5 V to +10.5 V. Outputs cannot be programmed to be outside the -10.5 V to 10.5 V range. Adjusting the limits such that an output voltage would be outside this range will change the offset in the opposite direction to pin the outputs to -10.5 V or 10.5 V. The same is true when adjusting the offset - the limits will change to pin the outputs.

To number of points in the scan and the limits determine the actual sweep progression. The number of points is the scan (sweep) length multiplied by the sample rate. A 100 second scan with a 4 Hz sample rate has 400 points. This is how many data points will be recorded in this scan as well as the number of points in the sweep.

A linear sweep divides the sweep range (stop-start) into N equal increments where N is the number of points in the sweep. If the increment is less than 1 mV, then two or more successive points may have the same output value.

A log progression is one where the ratio of each point to the previous point is a constant.

$$V_i = V_{i-1} \times k$$

If N points are required to progress from the start to the stop, then k is determined by

$$V_{\text{stop}} = V_{\text{start}} \times k^N$$

The start and stop voltages are restricted to positive values from 0.001 V to 21 V.

A log sweep from a higher voltage to a lower voltage is just the reverse progression as the sweep from lower to higher. More time will be spent at lower voltages.

Sweep Limits

Start:
1.000 V

Stop:
2.000 V

Offset:
0.000 V

Start If the selected aux output is in a sweep mode, then pressing this key will select the start voltage as the active entry field. The value may be adjusted with the knob or entered with the keypad. The start voltage can range from 0.001 V to 21 V.

Stop If the selected aux output is in a sweep mode, then pressing this key will select the stop voltage as the active entry field. The value may be adjusted with the knob or entered with the keypad. The stop voltage can range from 0.001 V to 21 V.

Offset If the selected aux output is in a sweep mode, then pressing this key will select the offset voltage as the active entry field. The value may be adjusted with the knob or entered with the keypad. The offset voltage can range from -10.5 V to 10.5 V.

Trigger Starts?

This key selects the scan start mode. Choosing Yes allows the rear panel trigger input to start a data scan and frequency or aux output sweep. If the sample rate is internally set, then samples are taken at the sample rate and further triggers are ignored. If the sample rate is triggered, then the first trigger starts the scan and data is sampled at every subsequent trigger. Swept parameters are also changed at every trigger.

Choosing No requires that scans be started with the [START/CONT] key or via an interface command.

CURSOR SETUP MENU

Cursor Setup

The Cursor Setup menu is activated with the [CURSOR SETUP] key in the Entry area of the keypad. This menu is used to set the cursor modes. Each display (full, top or bottom) has its own cursor (which is active only if the display is a chart). The cursor information displayed in this menu is for the active display.

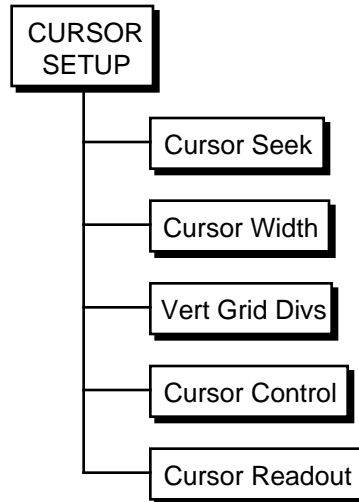
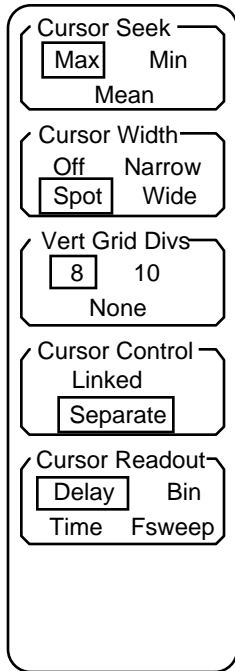

Cursor Seek

The cursor marker searches the data points within the cursor region for the maximum or minimum data value, or calculates the mean of the region. This key toggles between Max, Min, and Mean. Cursors are available only for chart displays. Each display (full, top or bottom) has its own cursor seek type.

When seeking minimum or maximum, the cursor marker is located at the minimum or maximum data point. This allows peaks and valleys in the data to be read easily. When seeking mean, the horizontal position of the cursor marker is the center of the cursor region and the vertical position is the mean of the data within the region. When a spot cursor region is used, the cursor marker is confined to a single horizontal screen location. However, depending upon the horizontal scaling, each horizontal screen location may represent multiple data points. The cursor marker can still seek the minimum, maximum, or mean of the data at a single horizontal screen location.

Cursor Setup Menu

Cursor Width

This function selects the width of the cursor region defined by the vertical dashed lines on the chart display. Cursors are available only for chart displays. Each display (full, top or bottom) has its own cursor width.

Narrow is 1/2 of a division, Wide is 1 division, and Spot is a single horizontal position on the graph (the cursor is a single dashed line).

Off removes the cursor from the graph.

Vert Grid Divs

This key selects the number of vertical divisions on the chart graph. The full screen chart may have 8 or 10 divisions while the top and bottom dual display charts may have 4 or 5 divisions. None selects no grid marks on the graph at all. Depending upon the graph scaling, either 4 or 5 divisions should yield an even scale per division.

Cursor Control

This function links the cursors in the dual chart display mode together. Adjusting the position of the active chart cursor will move the other cursor to the same horizontal position.

Cursor Readout

This function sets the cursor horizontal position readout.

Delay displays the cursor position as time from the most recent point in the buffer. Time increases to the left.

Time displays the cursor position as time from the first point in the buffer. Time increases to the right.

Bin displays the cursor position as point number within the buffer with bin 0 being the first point.

Fsweep displays the cursor position as frequency based upon the internal reference sweep limits and sweep type. This readout uses the reference frequency sweep parameters even if the reference is not sweeping.

Edit Mark

The Edit Mark menu is activated with the [EDIT MARK] key in the Entry area of the keypad. This menu is used to label marks in the data buffer. See the discussion on chart graphs in the Operation section for more information about marks. The cursors may also be moved to the mark locations.

Marks may only be inserted, edited or deleted if the active display is a chart display.

Marks are saved with the trace data when data is saved to disk. When data is recalled from disk, the existing marks are replaced with the recalled marks.

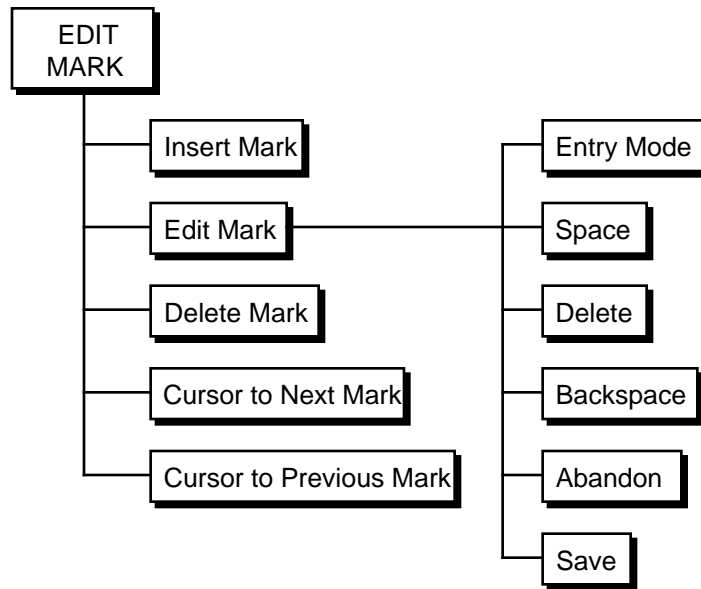
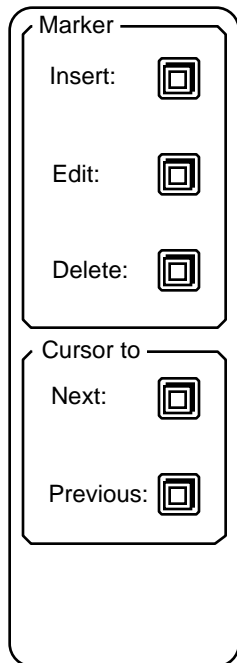

Insert Mark

Marks are normally added to the data buffer by pressing the [MARK] key while a scan is in progress. When a scan is paused or completed, marks may added to the existing buffer by using the Insert Mark function. This key will add a mark at the cursor location. This mark will behave exactly the same as a mark added during the scan.

Edit Mark

This key activates a submenu which allows marks to be labelled and viewed. This key will select the nearest mark to the left of the cursor (towards older points) and display the trace values and mark time and label on the screen. The mark label may be entered or edited with the submenu.

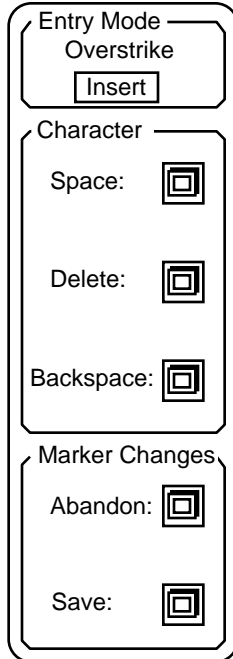

The square entry cursor indicates where text will be entered in the label. Use the knob to move the square back and forth. To enter letters, press the [ALT] key to switch to the alternate keypad.

Entry Mode Characters may be entered in the label by writing over the existing characters (Overstrike) or by moving the existing characters to the right (Insert).

Space Press this key to enter a space in the mark label.

Delete Press this key to delete a character from the mark label.

Backspace Press this key to backspace the entry cursor to the left, deleting existing characters to the left.

Abandon Changes Press this key to abandon any changes made to the mark label. This key will return to the main Edit Mark menu. Changes made to the mark label are ignored.

Save Changes Press this key to save the changes made to the mark label. This key will return to the main Edit Mark menu.

Delete Mark

This key will **delete** the nearest mark to the left of the cursor (towards older points). Pressing this key successively will continue to delete marks until no marks remain to the left of the cursor position!

Cursor to Next

This key moves the cursor of the active chart display to the next mark to the right. If the mark is off the right edge of the graph, then the display is panned to the right until the next mark is on the graph.

Cursor to Previous

This key moves the cursor of the active chart display to the next mark to the left. If the mark is off the left edge of the graph, then the display is panned to the left until the previous mark is on the graph.

Math

The Math menu is used to smooth, fit, change and analyze trace data. Math functions only operate on the data which is displayed within the active display.

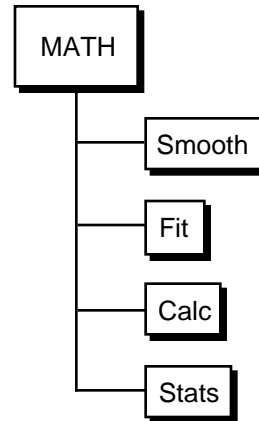
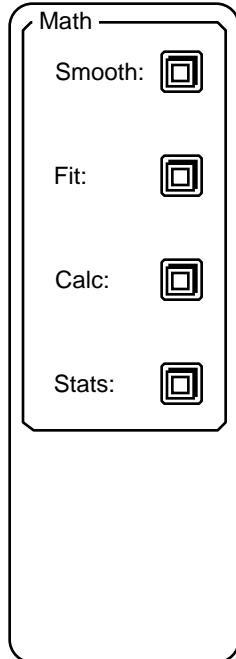

Math Keys

Each Math key activates a sub menu. Each sub menu is described in detail in the following pages.

Math functions may only be performed on trace data which is stored in a trace buffer and displayed in the active chart display. Data which are not within the time window of the chart are not operated upon. Use the horizontal chart scale to select the size of the time window and move the cursor to pan the window to the correct portion of the trace buffer. Data which exceeds the upper or lower bounds of the graph are, of course, operated upon.

The amount of time a math function takes to complete depends upon its complexity and the number of data points which are operated on. For example, 25-point smoothing takes longer than 5-point smoothing while each type of smoothing takes longer the more points there are. Do not operate on more points than necessary.

Math functions can only be performed while data acquisition is stopped, either by pausing or finishing a scan. Some math operations change the stored trace data. Resuming a scan after smoothing, for example, will result in a trace where a region of the trace is smoothed and other regions are not.

Smooth

The Smooth sub menu will smooth the data within the active chart display using the Savitsky-Golay algorithm. For details on the Savitsky-Golay smoothing technique, see Abraham Savitsky and Marcel J. E. Golay, "Smoothing and Differentiation of Data by Simplified Least Squares Procedures", *Analytical Chemistry*, (36) 8, July 1964. In essence, smoothing removes features which are narrower than the number of smoothing points.

Smoothing is performed only on the data which is stored in a trace buffer and displayed on a chart. The chart must be the active display. Data which are outside the time window of the chart are not smoothed.

Smoothing alters the data in the trace memory. Original unsmoothed data is replaced with new smoothed values. Once smoothed, the data can not be restored to its original values. **To avoid accidentally losing original data, save the trace to a disk file before performing Smooth menu operations.**

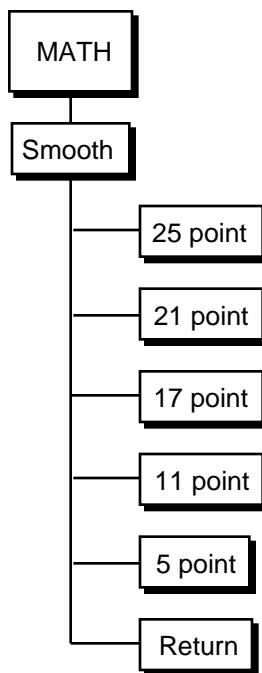
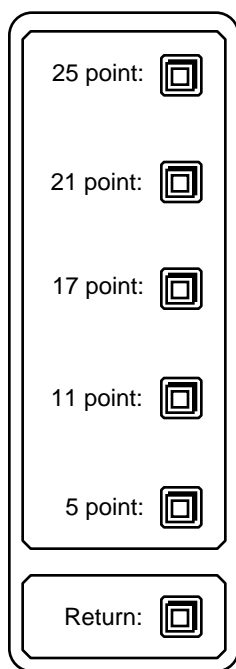

25 point
21 point
17 point
11 point
5 point

Pressing a smoothing key will smooth the data within the active chart display with the corresponding width. A width of 25 points means that features which span less than 25 points will be smoothed out. The smoothing width in time is simply the number of points divided by the sample rate.

While calculations are in progress, the "Smoothing..." message is displayed at the bottom of the screen. Smoothing may be repeated until the desired noise reduction is attained.

Return

The Return key will return to the main Math menu.

Fit

The Fit sub menu allows the user to fit one of three curves to the data within the active chart display - lines, exponentials, and Gaussians. Fitting is done using the Marquardt 'Gradient-expansion' algorithm to minimize chi-squared.

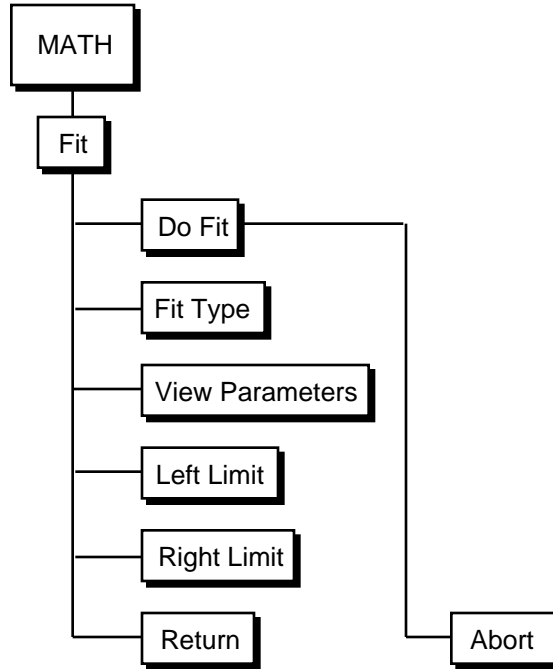
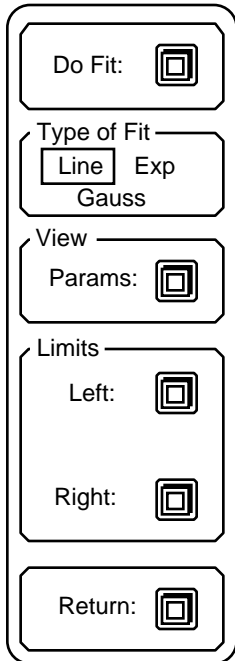

Do Fit

Pressing this key starts the actual fit calculations. While calculations are in progress, the "Calculating fit..." message is displayed at the bottom of the screen. The algorithm is designed to iterate until the change in chi-squared falls below 0.1%, although the fit may be terminated at any time by pressing the Abort (Return) softkey. The value of chi-squared is shown after each iteration.

When the fit terminates, the best fit curve is plotted and the parameters of the fit are displayed in a window at the center of the screen. Pressing any key to continue will remove the parameter window while leaving the best fit curve on the display. Pressing another key to continue will remove the curve and restore the graph to normal. See View Parameters below for a description of each fit.

Type of Fit

This function toggles the Type of Fit between line, exponential, and Gaussian. The fit takes place only within the fit region defined by the Left and Right Limits (see below) on the active chart graph.

View Parameters

The View Parameters function displays the most recent curve fit and parameter window. For example, if a fit was performed and then the Fit menu exited, the fit will be erased from the screen. If the graph is then scaled differently using the Display Scale menu and then the Fit menu

re-entered, the View Parameters function will re-display the best fit curve and the parameter window.

Both the Do Fit and View Parameters functions result in a display screen like the one shown below.

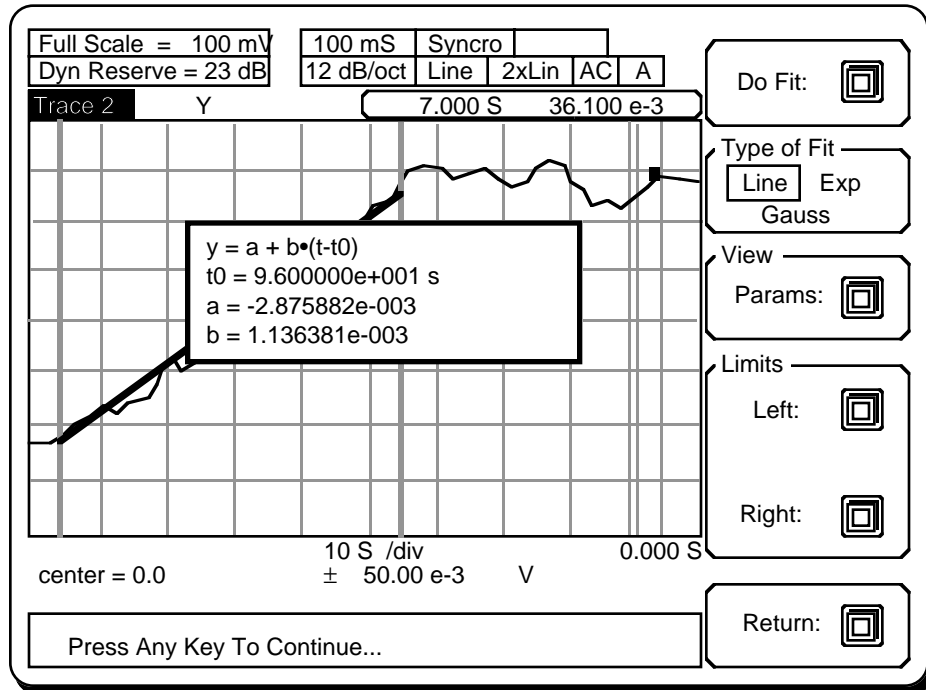

In this example screen, the fit is a line. The curve fit region is delimited by the two limit markers (heavy dashed vertical lines) as described below. The final curve fit is plotted between the limit markers along with the data. The parameters of the fit are displayed in the window at the center.

Each type of fit has a different parameter display. The horizontal coordinate is t (cursor readout in time, i.e. increasing to the right) and the vertical coordinate is the trace value (in the units of the display).

- Line Fit:** $y = a + b \cdot (t - t_0)$
 t_0 = horizontal offset in time
 a = vertical offset in trace units
 b = slope in trace units/second
- Exp. Fit:** $y = a e^{-(t - t_0)/b} + c$
 t_0 = horizontal offset in time
 a = amplitude in trace units
 b = time constant in time
 c = vertical offset in trace units
- Gauss. Fit:** $y = a e^{-1/2(t/b)^2} + c$ where $t = t - t_0$
 t_0 = peak center position in time
 a = amplitude in trace units
 b = line width in time
 c = vertical offset in trace units

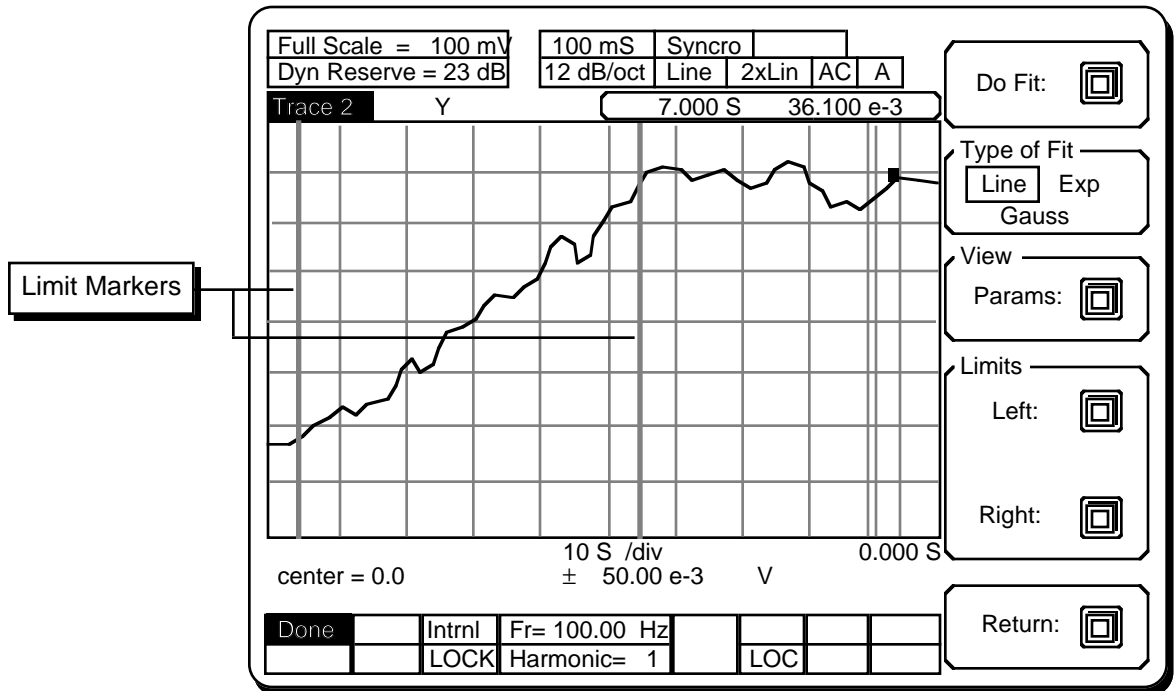

Return

The Return key will return to the main Math menu. Re-entering the Fit menu and using the View Parameters function will re-display the most recent fit.

Calc

The Calculation sub menu allows the user perform simple arithmetic calculations with data displayed in the active chart. Operations are performed only on the data within the chart, not the entire trace buffer.

An operation which overflows (such as divide by zero) will display an error message and abort.

Performing a calculation on the data will change the data. Once changed, the data can not be restored to its original values. **To avoid accidentally losing original data, save the trace data to a disk file before performing Calc menu operations.**

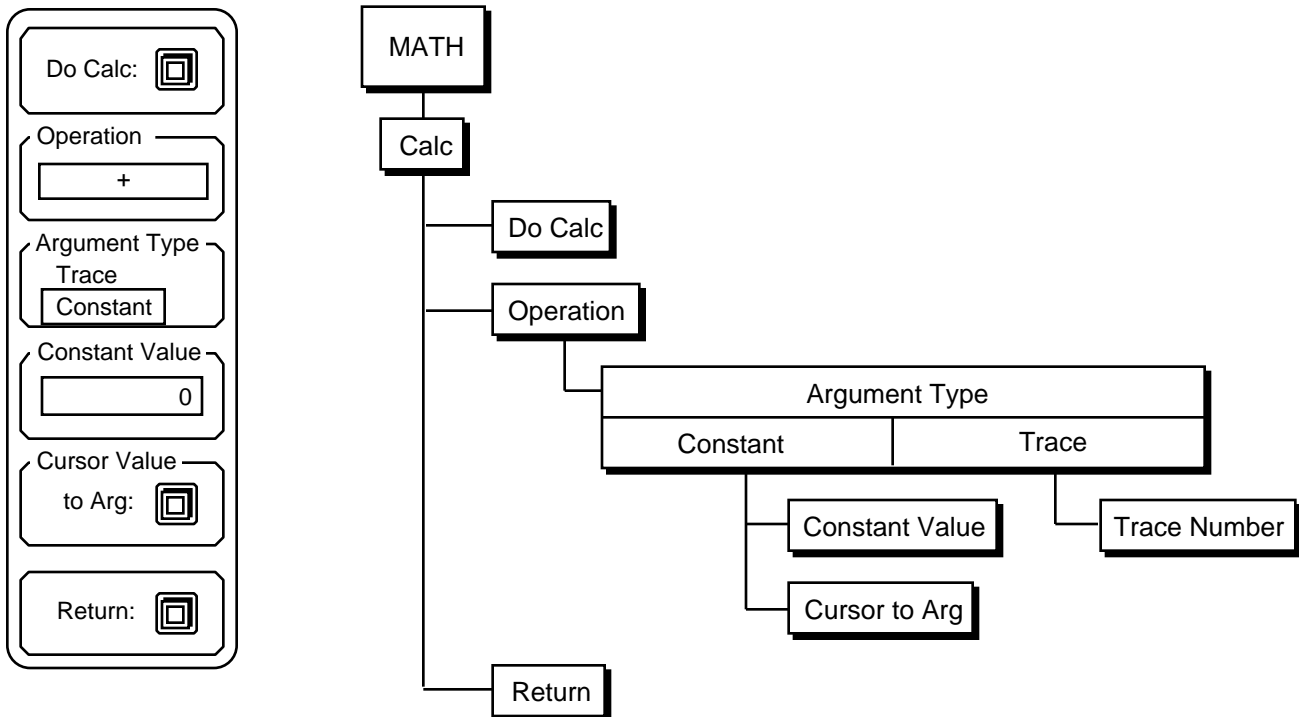

Do Calc

Pressing this key starts the actual calculation. While calculations are in progress, the "Calculating..." message is displayed at the bottom of the screen. The calculation uses the operation specified by the Operation menu box below and uses the argument chosen by the Argument keys. Note that many operations will require an AutoScale to display the result on the graph.

Operation

The Operation key highlights the operator as the active field for knob selection. Turn the knob to select +, -, x, /, sin, cos, tan, x^2 , log 10, 10^x . The add, subtract, multiply, and divide functions require a second argument (entered below) which may be a constant or another trace.

Argument Type

The +, -, x, / operations require a second argument. The Argument Type function selects between a constant argument and another trace. A constant argument adds or subtracts a constant to the trace or multiplies or divides the trace by a constant. A trace argument uses a data trace as the argument. In this case, calculations are performed on a point by point basis. The trace which is in the active chart display is where the results are stored. The active chart determines the time window over which these operations are performed. In the case of divide, the trace in the active display is divided by the argument trace.

In all cases, the arguments are not corrected for units. Constants should be entered in the trace units. Adding two traces adds their values, even if their units are not the same. The units of the resulting trace are not changed. A trace may be scaled before being used as an argument using x or / with a constant conversion factor.

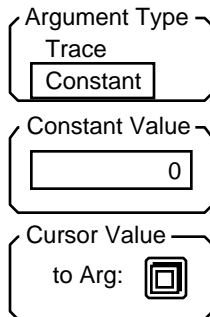

If the Argument type is a constant, then the Argument and Cursor functions are displayed.

Constant Value Pressing the Constant Value key activates the constant argument entry field. Use the keypad to enter a numerical argument. Integer (-3), real (-3.0), or floating point (-0.3E+1) formats are all allowed.

Cursor Value to Arg. The Cursor Value to Arg key will copy the trace value of the cursor marker to the constant argument field above. This is convenient when subtracting a baseline or normalizing to a data point.

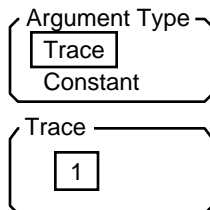

If the Argument type is a trace, then the trace selection function is displayed.

Trace Pressing the Trace key activates the trace number entry field. Use the knob to select trace 1, 2, 3 or 4. A trace must be stored in order to be used as an argument.

Return

The Return key will return to the main Math menu.

Stats

The Stats sub menu calculates a variety of statistical information about a chart display calculation region defined by the Left and Right Limits.

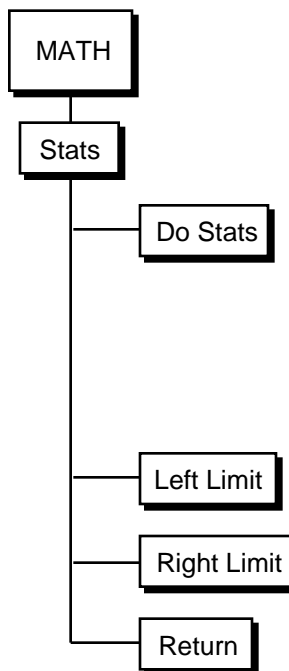
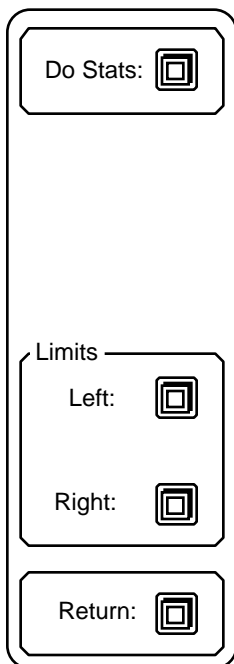

Do Stats

Pressing this key starts the actual calculation. While calculations are in progress, the "Calculating Statistics..." message is displayed at the bottom of the screen. For the display region defined by the Left and Right Limits, the mean, standard deviation, total, and delta time defined by the region endpoints are calculated and displayed below the graph. The total is the sum of all the data points within the region. The delta time is the time difference between the limits.

Total	= -4.799722e+000	= 1.139963e-001
Mean	= -7.163765e-002	Delta t = 4.288000e+000 s

Left and Right Limit

The Left and Right Limit functions set the left and right limits of the calculation region. The default positions of the limits are the the left and right edges of the graph. To move a limit, use the knob to move the cursor to the desired location of the limit (press [CURSOR] to activate the cursor). Pressing the Left or Right Limit key will set the limit to the cursor position. The Limits are set each time a limit key is pressed. The limits are shown as heavy dashed vertical lines on the graph. See the description of Limits under the Fit sub menu.

Return

The Return key will return to the main Math menu.

Disk

The Disk menu is used to save and recall data and settings to and from disk. The Disk Utilities submenu can erase files and format blank disks. Files are saved as DOS files and can be read by a DOS compatible computer with a 3.5" disk drive.

The SR850 uses double sided, double density disks (DS/DD). Do not use high density (DS/HD) disks.

The maximum number of files allowed on a disk is 114. This is the DOS limitation on the number of directory entries in the root directory.

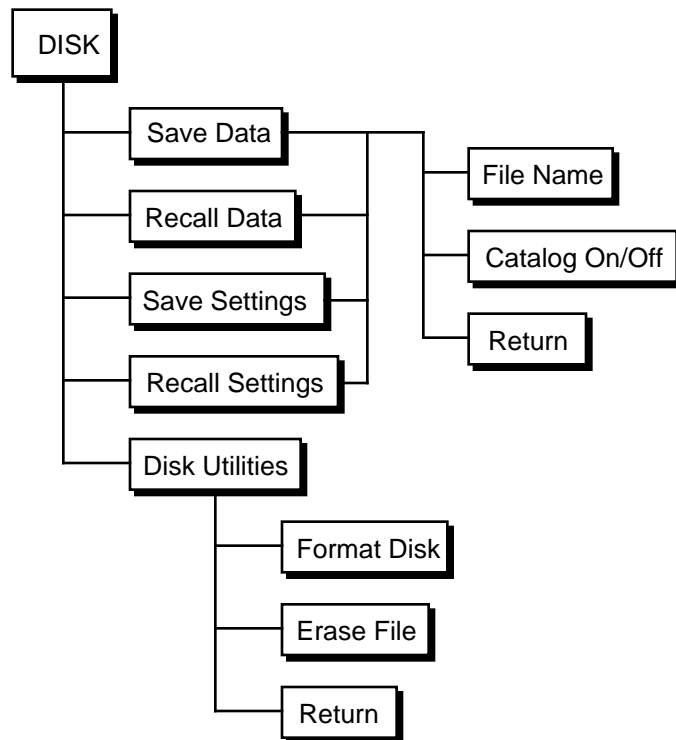
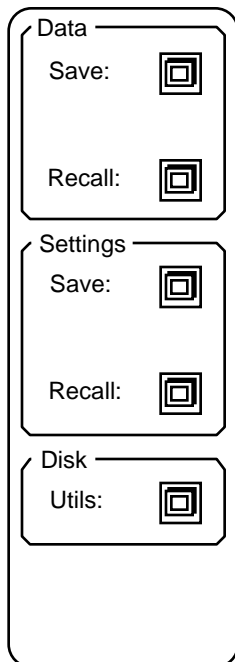

Disk Keys

Each softkey in this menu activates a submenu. The submenus are described in detail on the following pages.

Save Data

The Save Data submenu is used to save the trace data which is on the active chart display to the disk.

The image shows a vertical menu with five sections, each enclosed in a rounded rectangle. The first section is labeled 'Data' and contains the text 'Save:' followed by a square icon with a smaller square inside. The second section is labeled 'ASCII' and contains the text 'Save:' followed by the same square icon. The third section is labeled 'File Name' and contains a text entry field with the word 'TEST' inside. The fourth section is labeled 'Catalog' and contains two radio buttons, one labeled 'On' and one labeled 'Off'. The fifth section is labeled 'Return:' followed by the square icon.

Save Data

Pressing this key will save the trace which is displayed by the active chart display to the file specified in the File Name field. Only a single trace is saved in a file, even if more traces are stored in the buffer. If the active display is not a chart, no action is taken.

The ENTIRE trace is saved, including data which is currently not within the chart time window. Data is stored in binary form and requires 4 bytes per data point. The number of data points is the scan length times the sample rate. Be aware that long scans at high sample rates take up large amounts of disk space and take longer to save and recall. Try to define the scans so that the files are a manageable size.

Marks are saved with the trace data.

In addition, the instrument state (sensitivity, input configuration, time constant, reference, scan parameters, aux outputs) and the trace definition of the stored trace are saved.

Save ASCII Data

Pressing this key will save the trace in the active chart display to disk in ASCII format. Only the trace data is saved. The data is saved as "1.236774e-002<cr><lf>4.564522e-002<cr><lf>7.890034e-002<cr><lf>..." where "1.236774e-002" is the first (bin 0) data point, "4.564522e-002" is the next data point, etc. The data is exactly as if read from the cursor display.

The ENTIRE trace is saved, including data which is currently not within the chart time window. Ascii storage requires about 15 bytes per point. The number of data points is the scan length times the sample rate. The required file size may exceed the disk capacity! Try to define the scan so that the files are a manageable size.

The ASCII format is a convenient way to transfer data to other programs on a PC. The file is a simple DOS text file. **ASCII files may not be recalled on the SR850!**

File Name

This key activates the File Name entry field. File names are entered using the alternate keypad. The [ALT] key allows letters to be entered. DOS file name conventions must be followed, i.e. file names are 8 characters or less with an extension of up to 3 characters. "ABC-DEFGH.XYZ" is a valid file name. It is not necessary to press [ENTER] following the file name. DOS sub-directories are not supported.

Full Scale = 10 mV		100 mS	Syncro			
Dyn Reserve = 3 dB		12 dB/oct	Line	2xLin	AC	A
Name	Ext	Type	Size	Date	Time	
ABCD	DAT	TRC	1894	02/07/91	22:53:10	
TEST	85S	SET	450	02/22/91	14:47:28	
SPECT1	85T	TRC	16384	03/13/91	09:21:41	
MYDATA	85T	TRC	16384	04/11/91	11:21:01	
Free = 720280 bytes						
Stop		Intrnl	Fr= 100.00 Hz			
		LOCK	Harmonic= 1		LOC	

Data Save: 

ASCII Save: 

File Name

Catalog On Off

Return: 

Recall Data

The Recall Data submenu is used to recall data from a binary disk file into the trace which is displayed by the active display. For example, if the full screen display is a chart showing Trace 2, then recalling a trace from disk will read the file into Trace 2. The stored trace definition is recalled with the data and changes the definition of Trace 2.

All stored traces must have the same length. If the recalled data trace has less points than existing traces in memory, then the recalled trace is padded with zeroes until it is the same length. If the recalled data has more points than the existing traces in memory, the existing traces are padded with zeroes until they are the same length as the recalled trace. Data is never destroyed in the recall process.

If the recalled trace has more points than the existing trace buffer allocation (16k points for 4 stored traces, 32k for 2 stored traces, or 64k for 1 stored trace), then as many points are recalled as will fit in the existing trace buffer (starting with the most recent data). The other existing traces are either padded with zeroes or left alone, depending upon how many points are presently stored.

Data files may not be recalled into traces which are not presently being stored.

The existing marks are replaced with the marks recalled with the data.

In general, the existing lock-in state may not agree with the state stored in the recalled data file. In this case, the lock-in state is also recalled along with the data. Existing data in other traces is not destroyed but may lose their meaning given the new lock-in state. For example, if the existing data sample rate is 1 Hz and data is stored in the traces, recalling a data file whose data was stored at 2 Hz will change the sample rate to 2 Hz. The existing data is not destroyed but will be displayed as if the data was sampled at 2 Hz. If the state was not recalled with the data, then the recalled data would have no meaning. This way, the recalled data is meaningful. Existing data is presumably more easily recaptured and can also be saved if important.

The diagram shows a vertical menu with four distinct sections, each enclosed in a rounded rectangular border:

- Data**: Labeled at the top left. Below it is the text "Recall:" followed by a square icon with a smaller square inside.
- File Name**: Labeled at the top left. Below it is a rectangular input field containing the text "TEST".
- Catalog**: Labeled at the top left. Below it are two options: "On" (with a small square icon) and "Off".
- Return**: Labeled at the top left. Below it is a square icon with a smaller square inside.

Recall Data Pressing this key will recall the trace data and instrument state from the file specified in the File Name field.

If the file specified is not on the disk or is not a data file, then an error message will appear. Ascii files may not be recalled.

File Name This key activates the File Name entry field. File names are entered using the keypad and alternate keypad. The [ALT] key allows letters to be entered. DOS file name conventions must be followed, i.e. file names are 8 characters or less with an extension of up to 3 characters. "ABCDEFGH.XYZ" is a valid file name. It is not necessary to press [ENTER] following the file name. DOS sub-directories are not supported. All files are read from the root directory.

Catalog On/Off This key toggles the file catalog display screen on and off. The use of this key is identical to the Catalog On/Off function in the Save Data submenu described previously.

Return The Return key will return to the main Disk menu. Return also removes the catalog display screen and restores the displays.

Save Settings

The Save Settings submenu is used to save the lock-in settings to a disk file. The settings include all parameters which are set with the menus.

The diagram shows a vertical menu structure with four main sections, each enclosed in a rounded rectangular box:

- Setting**: A label above a box containing the text "Save:" followed by a square icon with a smaller square inside.
- File Name**: A label above a text input field containing the text "TEST".
- Catalog**: A label above a box containing two options: "On" and "Off".
- Return**: A label above a square icon with a smaller square inside.

Save Settings

Pressing this key will save the current lock-in settings to the file specified in the File Name field.

File Name

This key activates the File Name entry field. File names are entered using the keypad and alternate keypad. The [ALT] key allows letters to be entered. DOS file name conventions must be followed, i.e. file names are 8 characters or less with an extension of up to 3 characters. "ABCDEFGH.XYZ" is a valid file name. It is not necessary to press [ENTER] following the file name. DOS sub-directories are not supported. All files are saved to the root directory.

Catalog On/Off

This key toggles the file catalog display screen on and off. The use of this key is identical to the Catalog On/Off function in the Save Data submenu describe previously.

Return

The Return key will return to the main Disk menu. Return also removes the catalog display screen and restores the displays.

Recall Settings

The Recall Settings submenu is used to recall the lock-in settings from a disk file. The settings include all parameters which are set with the menus.

The diagram illustrates the Recall Settings submenu interface. It consists of four vertically stacked menu items, each enclosed in a rounded rectangular box:

- Recall:** A label followed by a square icon with a smaller square inside.
- File Name:** A label followed by a text input field containing the text "TEST".
- Catalog:** A label followed by two options: "On" (which is selected, indicated by a small square) and "Off".
- Return:** A label followed by a square icon with a smaller square inside.

Recall Settings

Pressing this key will read the settings information from the file specified in the File Name field. The lock-in will be configured according to the recalled settings. **Any trace data presently in memory is lost.**

File Name

This key activates the File Name entry field. File names are entered using the keypad and alternate keypad. The [ALT] key allows letters to be entered. DOS file name conventions must be followed, i.e. file names are 8 characters or less with an extension of up to 3 characters. "ABCDEFGH.XYZ" is a valid file name. It is not necessary to press [ENTER] following the file name. DOS sub-directories are not supported. All files are read from the root directory.

Catalog On/Off

This key toggles the file catalog display screen on and off. The use of this key is identical to the Catalog On/Off function in the Save Data sub menu.

Return

The Return key will return to the main Disk menu. Return also removes the catalog display screen and restores the displays.

Disk Utilities

The Disk Utilities submenu contains the Format Disk and Erase File functions. **These functions should be used with care since disk data will be erased.** The catalog screen may be displayed with this submenu if a formatted disk is in the drive.

The diagram illustrates the Disk Utilities menu structure. It consists of five vertically stacked rectangular boxes, each containing a function name and a corresponding key symbol (a square with a smaller square inside). The first box is labeled 'File' and contains 'Erase:'. The second box is labeled 'Disk' and contains 'Format:'. The third box is labeled 'File Name' and contains a text input field with 'TEST' inside. The fourth box is labeled 'Catalog' and contains two radio buttons, 'On' and 'Off'. The fifth box is labeled 'Return:' and contains a key symbol.

Erase File This function will erase the file specified in the File Name field. Make sure the selected file is the correct file **before** pressing this key.

Format Disk Pressing this key will format the disk. Formatting a disk involves erasing all information on the disk and rewriting the directory. **Formatting a disk destroys all data presently on the disk.** Use caution when choosing this function.

Disk capacity is 720k formatted. The maximum number of directory entries is 114. This is the DOS limitation on the number of files allowed in the root directory.

File Name This key activates the File Name entry field. File names are entered using the keypad and alternate keypad. The [ALT] key allows letters to be entered. DOS file name conventions must be followed, i.e. file names are 8 characters or less with an extension of up to 3 characters. "ABCDEFGH.XYZ" is a valid file name. It is not necessary to press [ENTER] following the file name. DOS sub-directories are not supported. All files are read from the root directory.

Catalog On/Off This key toggles the file catalog display screen on and off. The use of this key is identical to the Catalog On/Off function in the Save Data sub menu.

Return The Return key will return to the main Disk menu. Return also removes the catalog display screen and restores the displays.

SYSTEM SETUP MENU

System Setup

The System Setup menu is used to configure the system parameters. The Settings submenu configures the printer, plotter and computer interfaces, and the screen, sound and clock/calendar parameters. The Plot submenu is used to plot the screen display to an HPGL compatible plotter. The Info submenu displays various information screens. The Test submenu selects various hardware tests.

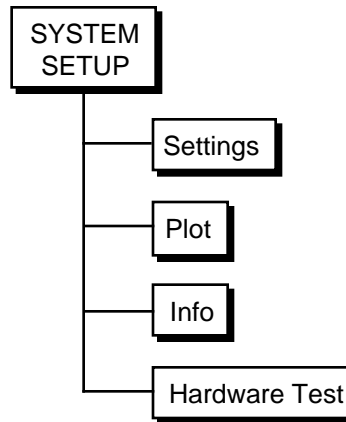
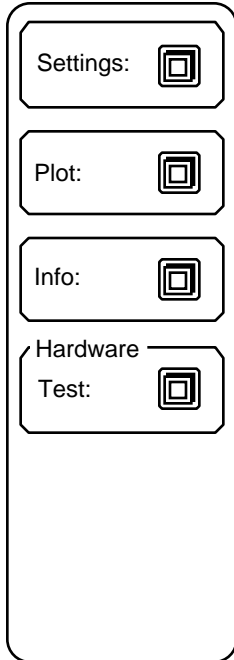

Setup Keys

Each System Setup key activates a submenu. Each submenu is described in detail in the following pages.

System Setup Menu

Settings

The Settings menu is used to configure the printer, plotter and computer interfaces, and to set the screen, sound and clock/calendar parameters.

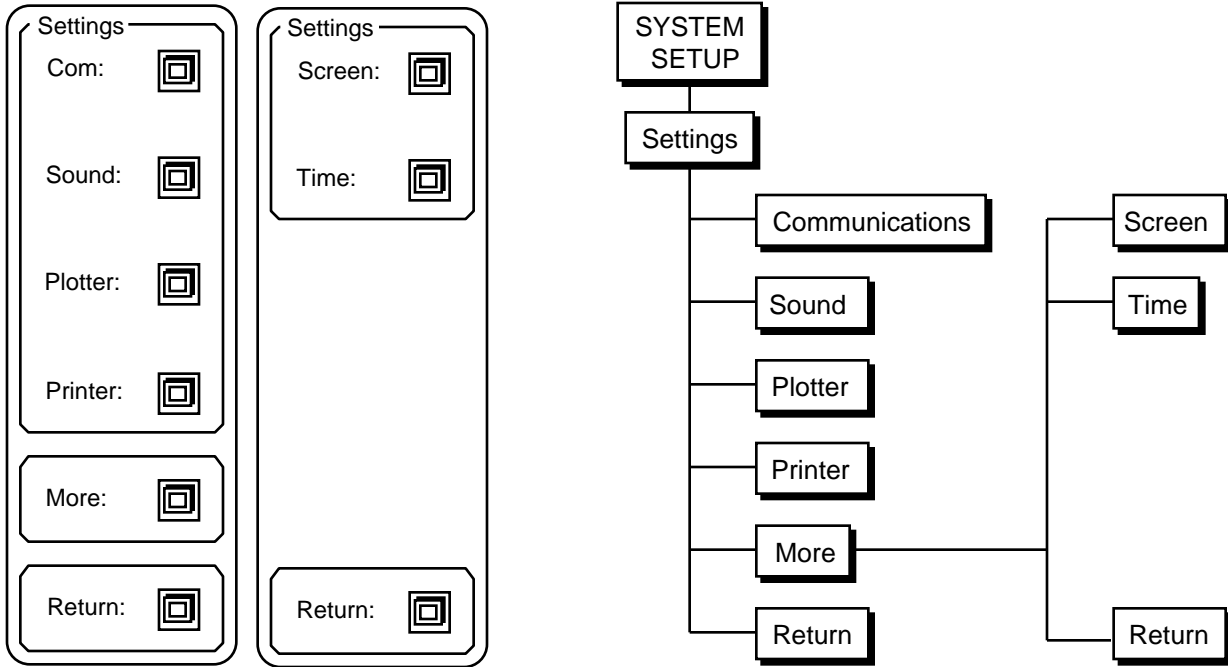

Settings Keys

The Settings menu consists of two menus, with each key activating a submenu. Use the More and Return softkeys to toggle between the two menus.

Setup Communications Communication parameters in this submenu should not be altered while the computer interface is active.

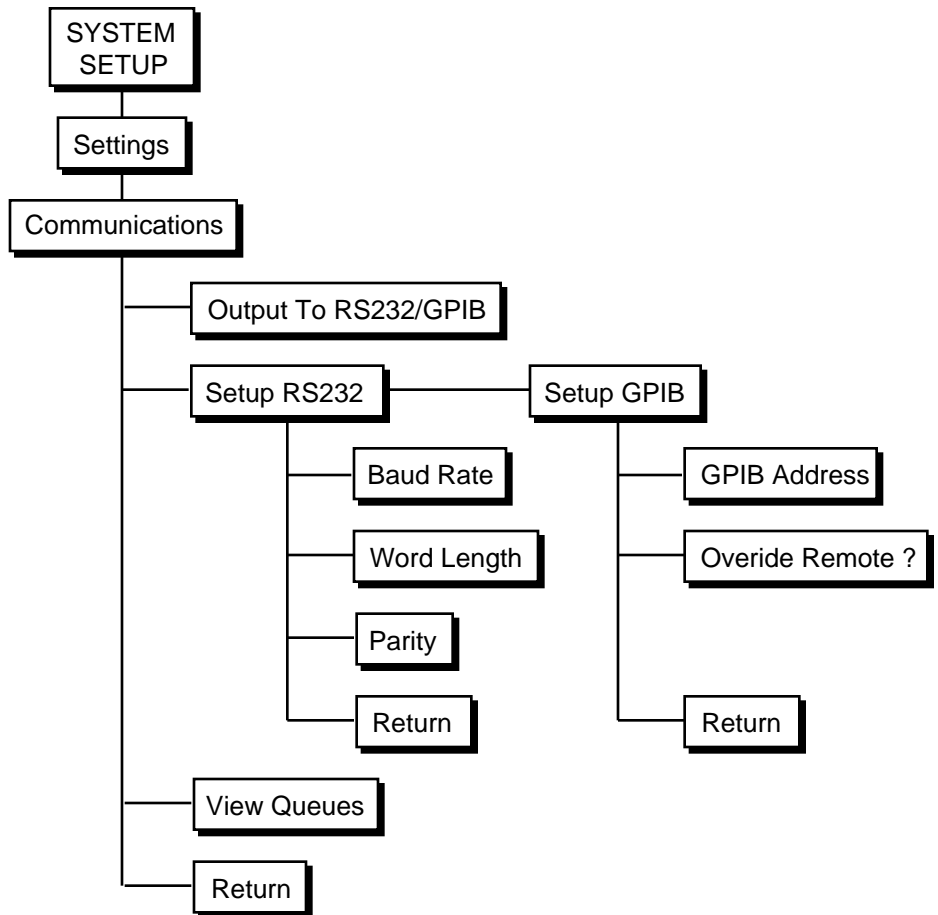
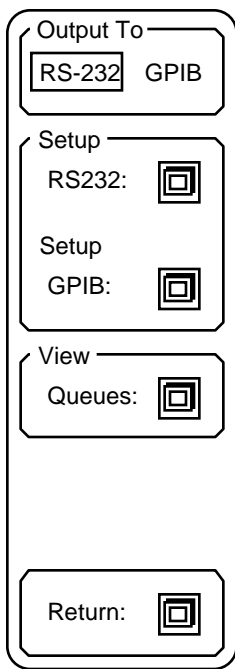

Output to RS232/GPIB

The SR850 only outputs data to one interface at a time. Commands may be received over both interfaces but responses are directed only to the interface selected by this key. Make sure that the Output interface is set correctly before attempting to program the SR850 from a computer. The first command sent by any program should be to set the output to the correct interface.

System Setup Menu

Setup RS232

The Setup RS232 key activates the RS232 parameters submenu. Baud rate, word length, and parity may be configured in this submenu.

Baud Rate
9600 bd

Word Length
7 bits 8 bits

Parity
Even
Odd None

Return: 

Baud Rate The Baud Rate key allows the knob to adjust the RS232 baud rate. The baud rate can be set to any standard value from 300 to 19200 baud.

Word Length This key toggles the character length. The RS232 character length can be 7 or 8 bits. 8 bits is standard.

Parity This key toggles the parity. The RS232 parity can be Even, Odd, or None.

Return The Return key will return to the Setup Communications menu.

Setup GPIB

The Setup GPIB key activates the GPIB parameters submenu. GPIB instrument address and Remote Override are set in this submenu.

GPIB Address
8

Override Remote?
No Yes

Return: 

GPIB Address This key activates the GPIB Address entry field for numeric and knob entry. The instrument address can be set from 0 to 30.

Override Remote ? In general, every GPIB interface command will put the SR850 into the REMOTE state with the front panel inactivated. To defeat this feature, set the Override Remote ? to Yes. In this mode, the front panel is not locked out when the unit is in the REMOTE state.

If the SR850 is in the REMOTE state, the [HELP] key returns the unit to local front panel control.

Return The Return key will return to the Setup Communications menu.

View Queues

The last 256 characters received or transmitted by the SR850 may be displayed to help find programming errors. The View Queues key will display the interface buffers at the time the key is pressed. This screen is updated regularly to display new interface activity. The View Queues screen may slow down the communications between the SR850 and a host computer. In general, the View Queues screen should be displayed only when testing or debugging a host program.

The most recent data is displayed at the right of the upper line of each queue display. For example, in the screen below, the *IDN?[lf] string was the most recently received command. The [lf] character is a line-feed and is the string delimiter. The most recently transmitted string is "Stanford_Research_Systems,SR850,s/n00001,ver001"[lf] in response to the *IDN? command. Unrecognized characters are ignored and not displayed. The terminator character on the output queue is always shown as a [lf]. When the output is directed to the RS232 interface, a carriage return [cr] is actually sent in place of the [lf].

Press any key (except [PRINT]) to restore the screen to the graph mode.

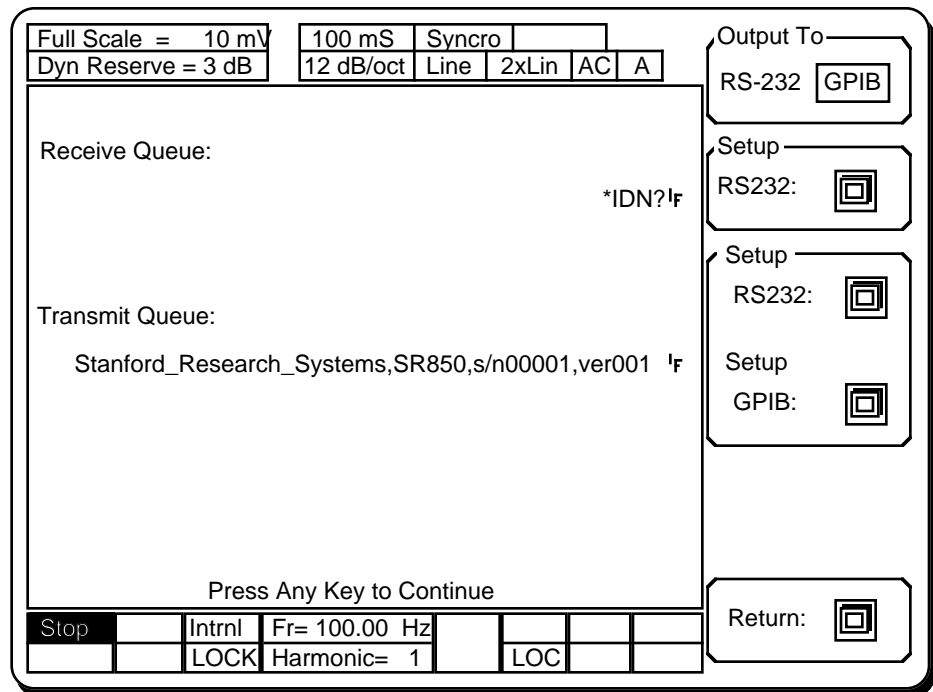

Return

The Return key will return to the main Settings menu.

Setup Sound

The Setup Sound key activates the sound submenu. Key click and alarms are enabled and disabled in this menu.

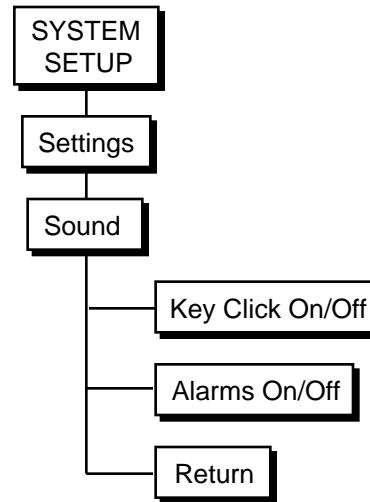
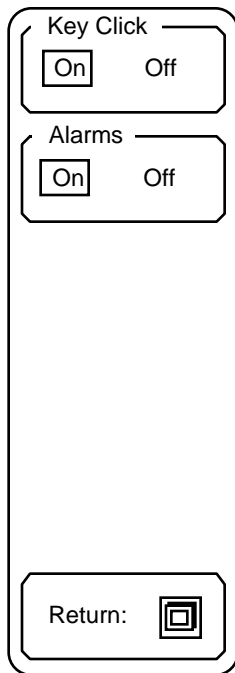

Key Click

This key turns the key click on and off.

Alarms

This key enables and disables the audible alarms. Alarms will sound whenever a front panel programming error or interface error occurs. Alarms are also used to draw the user's attention to a message.

Return

The Return key will return to the main Settings menu.

Setup Plotter

The Setup Plotter submenu configures the SR850 plotter driver. Interface, plot speed, and pen definitions are set in this submenu. To actually start plotting, use the [PLOT] key to select the Plot menu.

Plot Mode
 RS232 GPIB

Baud Rate

Plot Speed
 Fast Slow

Define Pens:

Return:

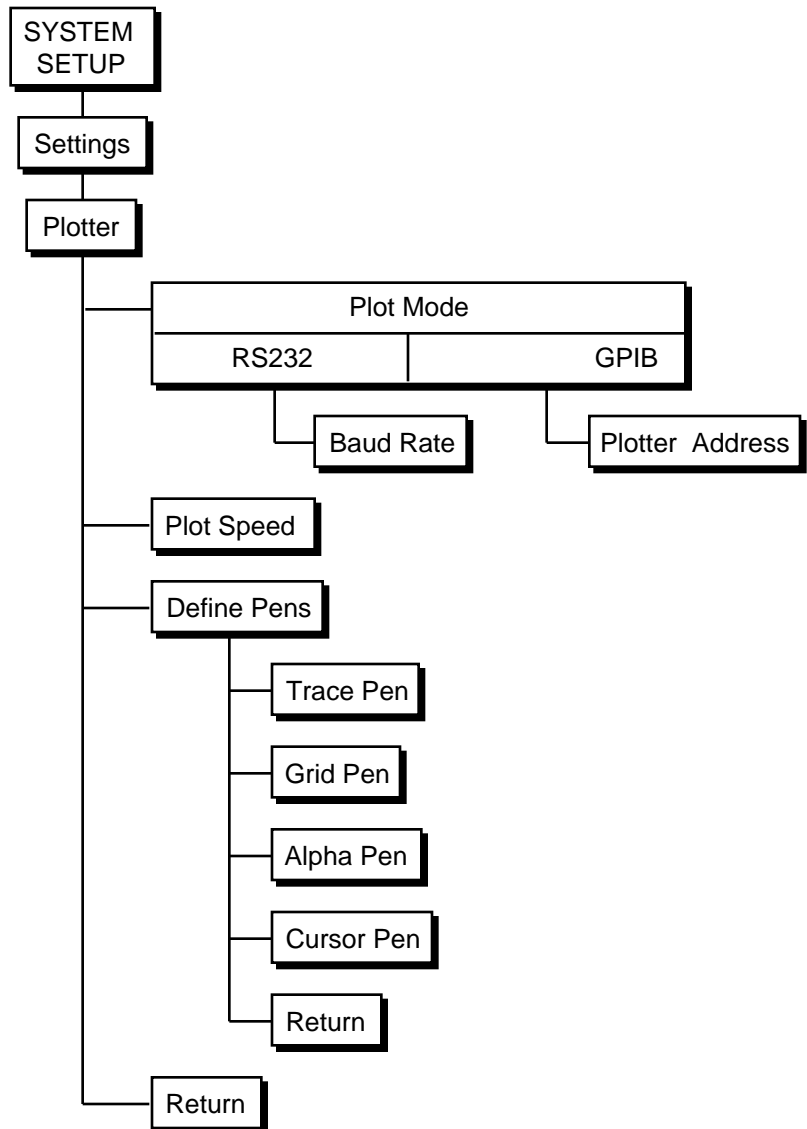

Plot Mode

The SR850 can drive either an RS232 or GPIB interface plotter. The plotter must be HP-GL compatible. This function selects which interface to use. The plotter connects to the RS232 or GPIB connector on the rear panel.

Baud Rate

Baud Rate

If the Plot Mode is RS232, then the Baud Rate for the plotter may be selected. The baud rate is adjusted using the knob and must match the baud rate of the plotter.

System Setup Menu

Plotter Addr.

Plotter Addr. If the Plot Mode is GPIB, then the Plotter Address must be set. The Plotter Address may be entered from the keypad or by using the knob. The Plotter Address must agree with the address of the plotter in use.

In this mode, the plotter must be the only device attached to the SR850 GPIB interface.

Plot Speed

This key toggles the Plot Speed. Normally, when plotting on paper, the Fast Plot Speed is used. When plotting on transparencies or other non-standard media, the Slow plot speed may be better.

Define Pens

Many plotters have a multipen carousel. In this case, each part of the screen may be plotted using a different color pen. The Define Pens key activates a submenu in which each feature of the screen may be assigned a pen number. The allowable pen numbers are from 1 to 6. When using a single pen plotter, all features are plotted using the one pen regardless of the pen definitions.

Trace Pen

Grid Pen

Alpha Pen

Cursor Pen

Return: 

Trace Pen This field assigns a pen number to the data traces on the screen.

Grid Pen This field assigns a pen number to the graph grids.

Alpha Pen This field assigns a pen number to all of the alphanumeric labels on the screen.

Cursor Pen This field assigns a pen number to the dashed cursor region lines and marker.

Return This key returns to the Setup Plotter menu.

Return

The Return key will return to the main Settings menu.

Setup Printer

The Setup Printer menu is used to select the type of printer attached to the parallel printer port. The [PRINT] key prints the screen to the printer. If File is chosen as the printer type, then [PRINT] will save the screen image as a PCX file on the disk.

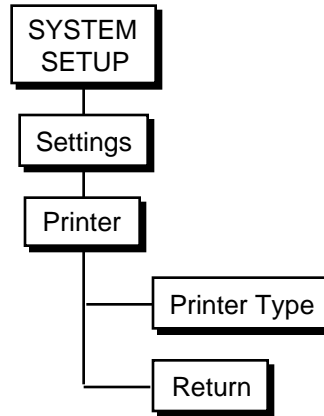
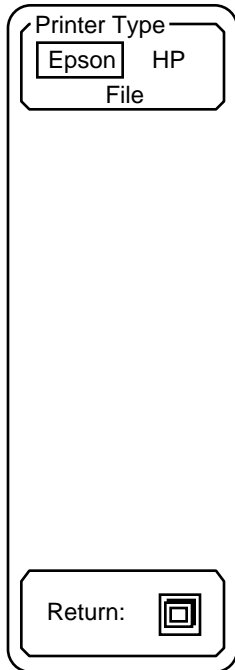

Printer Type

This function toggles the Printer Type between Epson, HP and File. Epson is used for any Epson compatible graphics dot matrix printer and HP is used for an HP LaserJet laser printer or compatible. File is used to save the screen image as a PCX file on the disk. The files are automatically named SCRNX.XXX.PCX. PCX files can be imported directly into many paint and draw programs on a PC. This allows SR850 charts and graphs to be easily incorporated into documents on a PC. Press the [PRINT] key to print the screen on the printer or to a file.

Return

The Return key will return to the main Settings menu.

Setup Screen

The Setup Screen submenu is used to adjust the position of the display on the screen. The display area may be moved left, right, up and down.

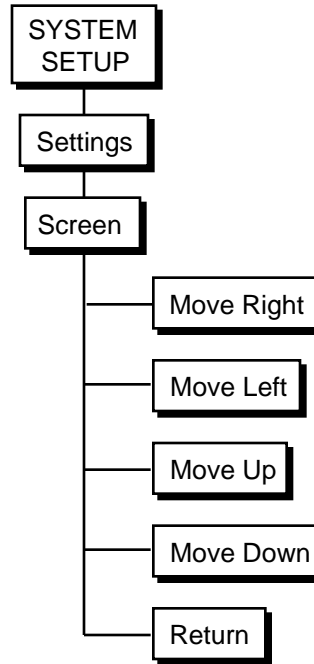
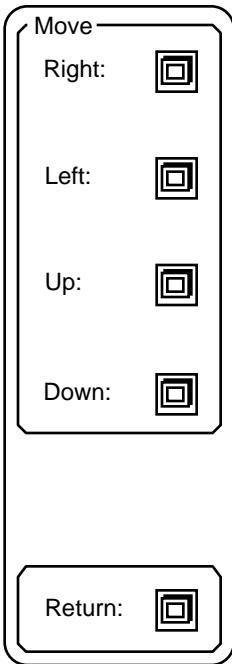

The screen position is stored in non-volatile memory and is retained when the power is turned off. To restore the screen to the default position, power the unit on with the [] (backspace) key pressed.

Move Right

This function moves the display to the right on the screen.

Move Left

This function moves the display to the left on the screen.

Move Up

This function moves the display up on the screen.

Move Down

This function moves the display down on the screen.

Return

The Return key will return to the main Settings menu.

Setup Time

The Setup Time key activates the clock/calendar submenu. The time and date are used to label all screen prints and plots as well as disk files. This menu is used to check or change the time and date.

The screenshot shows a vertical menu with two input fields. The top field is labeled 'Time' and contains '03 : 45 : 12'. The second field is labeled 'Date' and contains '03 / 15 / 91'. At the bottom of the menu is a 'Return:' label next to a square button with a smaller square inside it.

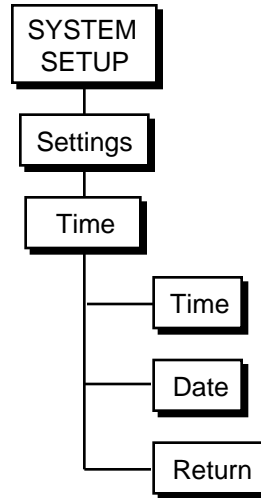

Time

The time is displayed as hours:minutes:seconds. A 24 hour format is used. This key toggles the entry field from hours to minutes to seconds. A new entry may be made using the knob. The clock is set whenever the highlighted value is changed.

Date

The date is displayed as month:day:year. This key toggles the entry field from months to days to years. A new entry may be made using the knob. The calendar is set whenever the highlighted value is changed.

Return

The Return key will return to the main Settings menu.

Plot

The Plot submenu is used to plot the screen display to an HPGL compatible plotter. Use the Plotter Settings menu to configure the plotter interface.

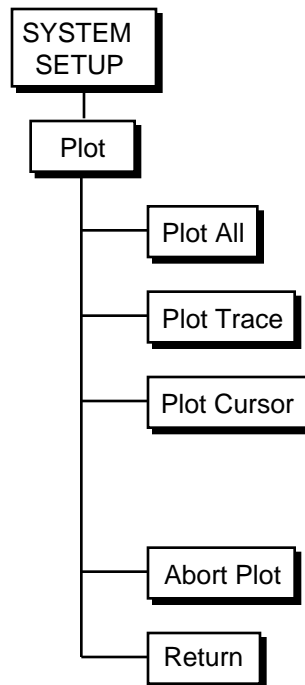
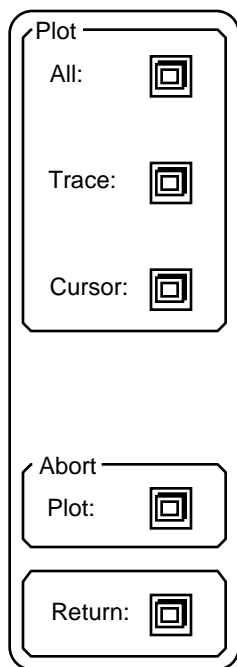

Plot All

The Plot All key generates a plot of the entire display, including the scale and marker information. In single display format only the full screen graph is plotted. In dual trace mode both displays are plotted. Each feature uses the pen assigned in the Plotter Settings submenu in the System Setup menu. The marker is plotted only if it is presently displayed.

Plot Trace

The Plot Trace key plots only the data trace(s). This allows multiple data traces to be plotted on a single sheet. Traces may be plotted in different colors by changing pen definitions or pens between plots. In single display format, the full screen graph is plotted. In dual trace mode, both displays are plotted.

Plot Cursor

The Plot Cursor key plots the cursor if the cursor is presently displayed on the screen. Use the Cursor Setup menu to turn the cursor display on and off. The cursor information is plotted next to the cursor. This is useful when a trace has multiple peaks which need to be marked on the plot. First Plot All with the cursor at one location, then move the cursor and Plot Cursor.

Plot Abort

Pressing this key aborts the plot.

Return

The Return key will return to the main System Setup menu.

Info

The Info submenu displays various information screens which may be helpful to the user.

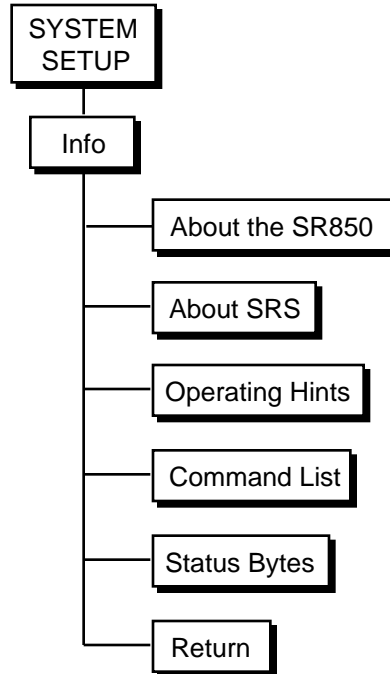
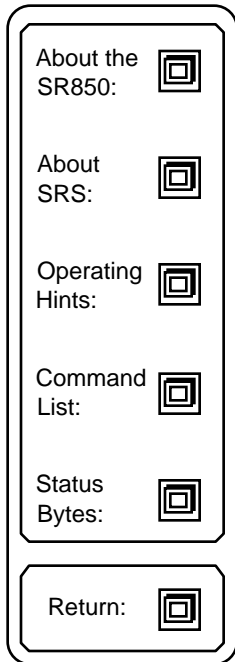

About the SR850

This key displays the SR850 specifications.

About SRS

This key displays information about Stanford Research Systems, Inc.

Operating Hints

This key displays information about the use of the SR850.

Command List

This key displays a list of the remote commands available.

Status Bytes

This key displays an explanation of the remote programming status bytes.

Return

The Return key will return to the main System Setup menu.

Test Hardware

The Test submenu allows the user to test various features of the SR850 such as the keypad, knob, screen, memory, etc. Use the More softkey to select the second test menu screen.

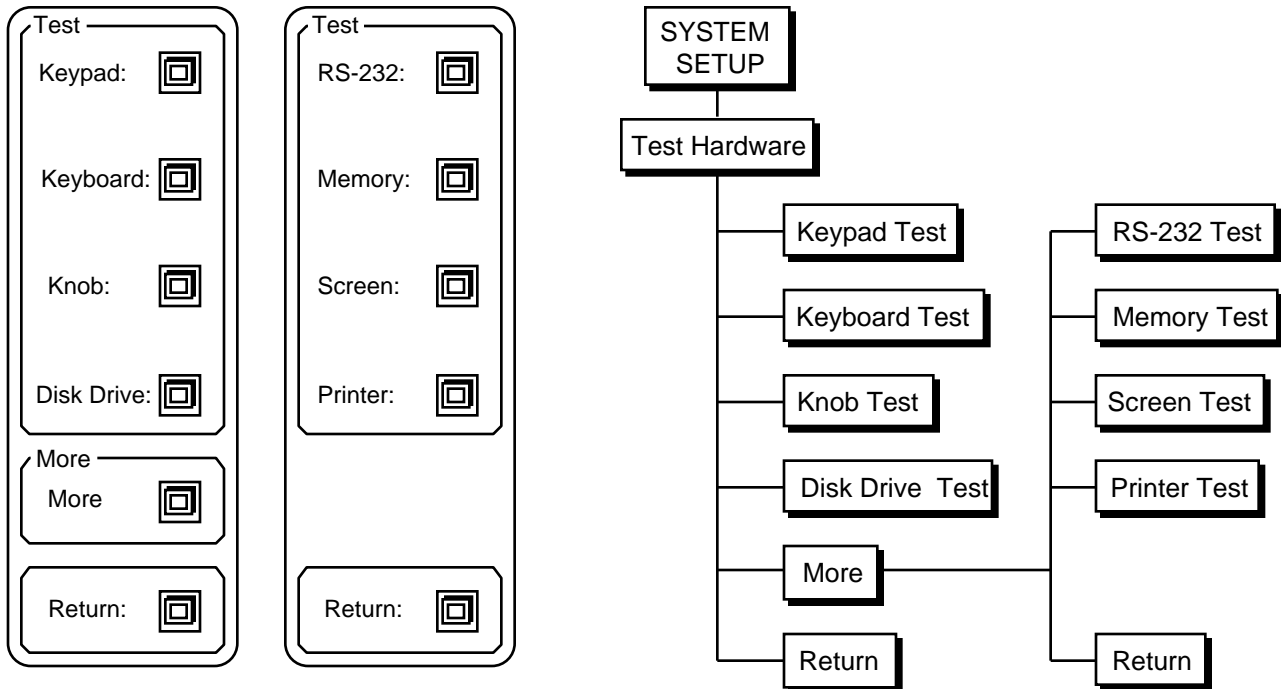

Keypad Test

This key activates the keypad test screen. The keypad test screen displays a map of the keypad with each key represented by a small square. Pressing each key will highlight the corresponding square. When all squares are highlighted, the test is complete.

Keyboard Test

This key activates the keyboard test screen. Characters typed on an attached PC keyboard (in PC or 8088 mode) will be displayed on the test screen. If the displayed characters are accurate, then the keyboard interface is functioning and the keyboard is configured correctly. If not, check that the keyboard is in the correct mode. Many keyboards have a switch on the bottom to select PC (8088) or AT (80286) mode.

Knob Test

This key activates the knob test screen. A circle with a marker is displayed. Select one of the 4 speeds displayed in the menu. Turning the knob will cause the marker to move around the circle verifying knob action and direction. Using speed 1 or 2 is best when checking direction of movement.

System Setup Menu

Disk Drive Test

Pressing this key activates the disk drive test screen. **Continuing with this test will destroy any data on the disk currently in the drive.** Therefore remove any disk containing data from the drive and insert a scratch disk. This test will check the controller, format the disk, and read and write data to the disk. The entire test takes approximately 2 minutes.

Use the Return function to skip this test and return to the previous menu.

RS-232 Test

Pressing this key activates the RS232 test screen. A special loop back adapter is required to complete this test. The loop back adapter is simply a mating connector with pins 2 and 3 connected so characters transmitted by the SR850 will be received by the SR850.

Memory Test

The Memory Test key activates a memory test submenu. Select the desired memory test.

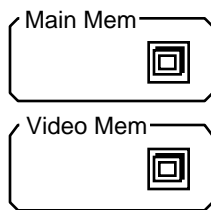

Main Memory Pressing this key tests the program ROM and data RAM on the CPU board.

Video Memory Pressing this key tests the video display RAM. A video pattern will scroll through the display while the test is done.

Return The Return key will return to the Test submenu.

Screen Test

This key displays a test pattern on the screen.

Printer Test

The Printer Test key activates a submenu.

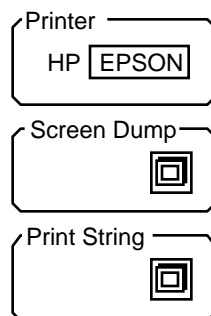

Printer Type The Printer Type key selects the type of printer attached to the parallel printer port. Any Epson compatible graphics printer or HP LaserJet compatible printer is supported.

Screen Dump Pressing this key will print the screen on the printer. This action is the same as using the [PRINT] key.

Print String Pressing this key prints a text string to the printer. If the Print String test works but the Screen Dump test fails, then the printer probably does not support the Epson or HP LaserJet graphics mode.

Return The Return key will return to the Test submenu.

Return

Pressing this key returns to the first Test submenu. Pressing Return again displays the System Setup menu.

INTRODUCTION

The SR850 DSP Lock-in Amplifier may be remotely programmed via either the RS232 or GPIB (IEEE-488) interfaces. Any computer supporting one of these interfaces may be used to program the SR850. Both interfaces are receiving at all times, however, **the SR850 will send responses only to the interface specified in the System Setup menu** (Output To RS232/GPIB function). **Use the OUTX command at the beginning of every program to direct the responses to the correct interface.** All front panel features (except power) may be controlled.

COMMUNICATING WITH GPIB

The SR850 supports the IEEE-488.1 (1978) interface standard. It also supports the required common commands of the IEEE-488.2 (1987) standard. Before attempting to communicate with the SR850 over the GPIB interface, the SR850's device address must be set. The address is set in the Setup GPIB menu and may be set between 0 and 30.

COMMUNICATING WITH RS232

The SR850 is configured as a DCE (transmit on pin 3, receive on pin 2) device and supports CTS/DTR hardware handshaking. The CTS signal (pin 5) is an output indicating that the SR850 is ready, while the DTR signal (pin 20) is an input that is used to control the SR850's data transmission. If desired, the handshake pins may be ignored and a simple 3 wire interface (pins 2,3 and 7) may be used. The RS232 interface baud rate, number of data bits, and parity must be set. These are set in the Setup RS232 menu.

STATUS INDICATORS AND QUEUES

To assist in programming, the SR850 has 5 interface status indicators which are displayed at the bottom of the screen. The RS232/GPIB Activity indicator flashes whenever a character is received or transmitted over either interface. The ERR indicator flashes when an error, such as an illegal command, or parameter out of range, has been detected. The REM indicator is on whenever the

SR850 is in a remote state (front panel locked out). The LOC indicator is on when the front panel is active (Local Mode). The SRQ indicator is on when the SR850 generates a service request. SRQ stays on until a serial poll is completed.

To help find program errors, the SR850 can display the interface buffers on the screen. This screen is activated by the View Queue function in the Setup Communications menu. The last 256 characters received and transmitted by the SR850 are displayed.

COMMAND SYNTAX

Communications with the SR850 uses ASCII characters. Commands may be in either UPPER or lower case and may contain any number of embedded space characters. A command to the SR850 consists of a four character command mnemonic, arguments if necessary, and a command terminator. The terminator must be a linefeed <lf> or carriage return <cr> on RS232, or a linefeed <lf> or EOI on GPIB. No command processing occurs until a command terminator is received. Commands function identically on GPIB and RS232 whenever possible. Command mnemonics beginning with an asterisk "*" are IEEE-488.2 (1987) defined common commands. These commands also function identically on RS232. Commands may require one or more parameters. Multiple parameters are separated by commas (,).

Multiple commands may be sent on one command line by separating them with semicolons (;). The difference between sending several commands on the same line and sending several independent commands is that when a command line is parsed and executed, the entire line is executed before any other device action proceeds.

There is no need to wait between commands. The SR850 has a 256 character input buffer and processes commands in the order received. If the buffer fills up, the SR850 will hold off handshaking on the GPIB and attempt to hold off handshaking on RS232. Similarly, the SR850 has a 256 character output buffer to store outputs until the host

computer is ready to receive. If either buffer overflows, both buffers are cleared and an error reported.

The present value of a particular parameter may be determined by querying the SR850 for its value. A query is formed by appending a question mark "?" to the command mnemonic and omitting the desired parameter from the command. Values returned by the SR850 are sent as a string of ASCII characters terminated by a carriage return <cr> on RS232 and by a line-feed <lf> on GPIB. If multiple queries are sent on one command line (separated by semicolons, of course) the answers will be returned individually, each with a terminator.

Examples of Command Formats

FMOD 0<lf>	Set reference source to internal
FREQ 10E3 <lf>	Set the internal reference frequency to 10000 Hz (10 kHz)
*IDN? <lf>	Queries the device identification
STRT <lf>	Starts data acquisition (same as [START] key)
OUTP? 1 <lf>	Queries the value of X

INTERFACE READY AND STATUS

The Interface Ready bit (bit 1) in the Serial Poll Status Byte signals that the SR850 is ready to receive and execute a command. When a command is received, this bit is cleared indicating that an operation is in progress. While the operation is in progress, no other commands will be processed. Commands received during this time are stored in the buffer to be processed later. Only GPIB serial polling will generate a response while a command is in progress. When the command execution terminates, the Interface Ready bit is set again and new commands will be processed. Since most commands execute very quickly, the host computer does not need to continually check the Interface Ready bit. Commands may be sent one after another and they will be processed immediately.

However, some commands, such as file commands and math operations, may require a long time to execute. In addition, the host program may need to check that these operations executed without error. In these cases, after the command is

sent, the Status Bytes should be queried.

When using the GPIB interface, serial polling may be used to check the Interface Ready bit in the Serial Poll Byte while an operation is in progress. After the Interface Ready bit becomes set, signaling the completion of the command, then the ERR or ESB bit may be checked to verify successful completion of the command.

If the RS232 interface is used, or serial polling is not available, then the *STB?, *ESR?, ERRS?, and LIAS? status query commands may be used to query the Status Bytes. Since the SR850 processes one command at a time, the status query will not be processed until the previous operation is finished. Thus a response to the status query in itself signals that the previous command is finished. The query response may then be checked for various errors.

For example, the command line SDAT;ERRS? <lf> will save the data to disk and return the Error Status Byte when finished. The Disk Error bit (bit 3) may be checked to make sure that the Save Data (SDAT) command terminated without error. Since the Save Data command may take a long time to execute, it is important that the host computer interface does not time out while waiting for the response to the ERRS? query. In the case where the host interface times out before the ERRS? response, the host program must wait before sending the ERRS? query.

GET (GROUP EXECUTE TRIGGER)

The GPIB interface command GET is the same as the TRIG command. GET is the same as a trigger input. GET only has an effect if the sampling rate is triggered or if triggers start a scan.

DETAILED COMMAND LIST

The four letter mnemonic in each command sequence specifies the command. The rest of the sequence consists of parameters. Multiple parameters are separated by commas. Parameters shown in { } are optional or may be queried while those not in { } are required. Commands that may be queried have a question mark in parentheses (?) after the mnemonic. Commands that may ONLY be queried have a ? after the mnemonic. Commands that MAY NOT be queried have no ?. Do not send () or { } as part of the command.

The variables are defined as follows.

i, j, k, l, m	integers
x, y, z	real numbers
f	frequency
s	string

All numeric variables may be expressed in integer, floating point or exponential formats (i.e., the number five can be either 5, 5.0, or .5E1). Strings are sent as a sequence of ASCII characters.

Remember!

All responses are directed to the interface selected in the Setup Communications Output To RS232/GPIB function, regardless of which interface received the query. **Use the OUTX command to select the correct interface at the beginning of every program.**

REFERENCE and PHASE COMMANDS

PHAS (?) {x}	The PHAS command sets or queries the reference phase shift. The parameter x is the phase (real number of degrees). The PHAS x command will set the phase shift to x. The value of x will be rounded to 0.001°. The phase may be programmed from -360.000 x 719.999 and will be wrapped around at ±180°. For example, the PHAS 541.0 command will set the phase to -179.000° (541-360=181=-179). The PHAS? queries the phase shift.
FMOD (?) {i}	The FMOD command sets or queries the reference source. The parameter i selects internal (i=0), internal sweep (i=1) or external (i=2).
FREQ (?) {f}	The FREQ command sets or queries the reference frequency. The FREQ? query command will return the reference frequency (in internal or external mode). The FREQ? query reads the frequency displayed at the bottom of the screen. The FREQ f command sets the frequency of the internal oscillator. This command is allowed only if the reference source is internal. The parameter f is a frequency (real number of Hz). The value of f will be rounded to 5 digits or 0.0001 Hz, whichever is greater. The value of f is limited to 0.001 f 102000. If the harmonic number is greater than 1, then the frequency is limited to nxf 102 kHz where n is the harmonic number.
SWPT (?) {i}	The SWPT command sets or queries the type of frequency sweep when the reference source is internal sweep. The parameter i=0 selects linear and i=1 selects logarithmic. The sweep type may not be changed while a scan (sweep) is in progress.
SLLM (?) {f}	The SLLM command sets or queries the start frequency of the internal frequency sweep. This parameter may be set in any reference mode. The sweep limit may not be changed while a scan (sweep) is in progress. The parameter f is a frequency (real number of Hz). The value of f will be rounded to 5 digits or 0.0001 Hz, whichever is greater. The value of f is limited to 0.001 f 102000. If the harmonic number is greater than 1, then the frequency is limited to nxf 102 kHz where n is the harmonic number.
SULM (?) {f}	The SULM command sets or queries the stop frequency of the internal frequency sweep. This parameter may be set in any reference mode. The sweep limit may not be changed while a scan (sweep) is in progress. The parameter f is a frequency (real number of Hz). The value of f will be rounded to 5 digits or 0.0001 Hz, whichever is greater. The value of f is limited to 0.001 f 102000. If the harmonic number is greater than 1, then the frequency is limited to nxf 102 kHz where n is the harmonic number.
RSLP (?) {i}	The RSLP command sets or queries the reference slope when using the external reference mode. The parameter i selects sine zero crossing (i=0), TTL rising edge (i=1), , or TTL falling edge (i=2). At frequencies below 1 Hz, the a TTL reference must be used.

HARM (?) {i}

The HARM command sets or queries the detection harmonic. This parameter is an integer from 1 to 32767. The HARM i command will set the lock-in to detect at the i^{th} harmonic of the reference frequency. The value of i is limited by $ixf \leq 102 \text{ kHz}$. If the value of i requires a detection frequency greater than 102 kHz, then the harmonic number will be set to the largest value of i such that $ixf \leq 102 \text{ kHz}$.

SLVL (?) {x}

The SLVL command sets or queries the amplitude of the sine output. The parameter x is a voltage (real number of Volts). The value of x will be rounded to 0.002V. The value of x is limited to $0.004 \leq x \leq 5.000$.

INPUT and FILTER COMMANDS

ISRC (?) {i}	The ISRC command sets or queries the input configuration. The parameter <i>i</i> selects A (<i>i</i> =0), A-B (<i>i</i> =1) or I (<i>i</i> =2).
IGAN (?) {i}	<p>The IGAN command sets or queries the conversion gain of the current input. The parameter <i>i</i> selects 1 M (=<i>i</i>=0), 100 M (=<i>i</i>=1). This parameter has no effect unless the input is configured to measure current.</p> <p>Changing the current gain does not change the instrument sensitivity. Sensitivities above 10 nA require a current gain of 1 M . Sensitivities between 20 nA and 1 μA automatically select the 1 M current gain. At sensitivities below 20 nA, changing the sensitivity does not change the current gain.</p>
IGND (?) {i}	The IGND command sets or queries the input shield grounding. The parameter <i>i</i> selects Float (<i>i</i> =0) or Ground (<i>i</i> =1).
ICPL (?) {i}	The ICPL command sets or queries the input coupling. The parameter <i>i</i> selects AC (<i>i</i> =0) or DC (<i>i</i> =1).
ILIN (?) {i}	The ILIN command sets or queries the input line notch filter status. The parameter <i>i</i> selects Out or no filters (<i>i</i> =0), Line notch in (<i>i</i> =1), 2xLine notch in (<i>i</i> =2) or Both notch filters in (<i>i</i> =3).

GAIN and TIME CONSTANT COMMANDS

SENS (?) {i}

The SENS command sets or queries the sensitivity. The parameter i selects a sensitivity below.

<u>i</u>	<u>sensitivity</u>	<u>i</u>	<u>sensitivity</u>
0	2 nV/fA	13	50 μ V/pA
1	5 nV/fA	14	100 μ V/pA
2	10 nV/fA	15	200 μ V/pA
3	20 nV/fA	16	500 μ V/pA
4	50 nV/fA	17	1 mV/nA
5	100 nV/fA	18	2 mV/nA
6	200 nV/fA	19	5 mV/nA
7	500 nV/fA	20	10 mV/nA
8	1 μ V/pA	21	20 mV/nA
9	2 μ V/pA	22	50 mV/nA
10	5 μ V/pA	23	100 mV/nA
11	10 μ V/pA	24	200 mV/nA
12	20 μ V/pA	25	500 mV/nA
		26	1 V/ μ A

RMOD (?) {i}

The RMOD command sets or queries the reserve mode. The parameter i selects Max (i=0), Manual (i=1) or Min (i=2).

RSRV (?) {i}

The RSRV command sets or queries the dynamic reserve. The RSRV i command sets the manual reserve to the ith available reserve (0 i 5). RSRV 0 selects the minimum reserve for the present sensitivity and time constant. RSRV 1 selects the next highest reserve and so on. The reserve increases by 10 dB for each successive value of i. If the RSRVi command requests a reserve greater than the max available at the present sensitivity, the max reserve will be used. RSRV5 always sets the reserve to the max. The reserve can be set only if Manual reserve mode is selected. The RSRV? query returns the reserve index i (0 i 5).

See the Reserve section in the Gain and Time Constant menu section for a listing of the available reserves.

OFLT (?) {i}

The OFLT command sets or queries the time constant. The parameter i selects a time constant below.

<u>i</u>	<u>time constant</u>	<u>i</u>	<u>time constant</u>
0	10 μ s	10	1 s
1	30 μ s	11	3 s
2	100 μ s	12	10 s
3	300 μ s	13	30 s
4	1 ms	14	100 s
5	3 ms	15	300 s
6	10 ms	16	1 ks
7	30 ms	17	3 ks
8	100 ms	18	10 ks
9	300 ms	19	30 ks

Time constants greater than 30s may NOT be set if the harmonic x ref. frequency (detection frequency) exceeds 200 Hz. Time constants shorter than the minimum time constant (based upon the filter slope and dynamic reserve) will set the time constant to the minimum allowed time constant. See the GAIN/TC menu section.

OFSL (?) {i}

The OFSL command sets or queries the low pass filter slope. The parameter i selects 6 dB/oct (i=0), 12 dB/oct (i=1), 18 dB/oct (i=2) or 24 dB/oct (i=3).

SYNC (?) {i}

The SYNC command sets or queries the synchronous filter status. The parameter i selects Off (i=0) or synchronous filtering below 200 Hz (i=1). Synchronous filtering is turned on only if the detection frequency (reference x harmonic number) is less than 200 Hz.

OUTPUT and OFFSET COMMANDS

FOUT (?) i {, j}

The FOUT command sets or queries the front panel (CH1 and CH2) output sources. The parameter i selects CH1 (i=1) or CH2 (i=2) and is required. The FOUT i, j command sets output i to quantity j where j is listed below. The definition of j is different for the two outputs.

CH1 (i=1)		CH2 (i=2)	
i	output quantity	i	output quantity
0	X	0	Y
1	R	1	R
2		2	
3	Trace 1	3	Trace 1
4	Trace 2	4	Trace 2
5	Trace 3	5	Trace 3
6	Trace 4	6	Trace 4

OEXP (?) i {, x, j}

The OEXP command sets or queries the output offsets and expands. The parameter i selects X (i=1), Y (i=2) or R (i=3) and is required. The parameter x is the offset in percent (-105.00 x 105.00) and j is the expand (1 j 256). The OEXP i, x, j command will set the offset and expand for quantity i. This command requires BOTH x and j. The OEXP? i command queries the offset and expand of quantity i. The returned string contains both the offset and expand separated by a comma. For example, if the OEXP? 2 command returns "50.00,10" then the Y offset is 50.00% and Y expand is 10.

AOFF i

The AOFF i command automatically offsets X (i=1), Y (i=2) or R (i=3) to zero. The parameter i is required. This command is equivalent to pressing the Auto softkey in the Offset & Expand menu box.

TRACE and SCAN COMMANDS

TRCD (?) i {j, k, l, m}

The TRCD command sets or queries the trace definitions. The parameter i selects the trace number (1, 2, 3 or 4) and is required. The TRCD i, j, k, l, m command defines trace i to quantity j times quantity k divided by quantity l and the trace will be stored (m=1) or not stored (m=0). This command requires all of the parameters. The parameters j, k and l select the quantities listed below. Only l can be greater than 12.

<u>j, k, l</u>	<u>quantity</u>	<u>j, k, l</u>	<u>quantity</u>	<u>l</u>	<u>quantity</u>	<u>l</u>	<u>quantity</u>
0	1	7	Rn	13	X ²	19	Rn ²
1	X	8	AI1	14	Y ²	20	AI1 ²
2	Y	9	AI2	15	R ²	21	AI2 ²
3	R	10	AI3	16	²	22	AI3 ²
4		11	AI4	17	Xn ²	23	AI4 ²
5	Xn	12	F	18	Yn ²	24	F ²
6	Yn						

For example, the TRCD 1,1,2,3,1 command defines trace 1 as X•Y/R and stores trace 1.

The TRCD? i command queries the trace definition of trace i. The returned string contains j, k, l and m separated by commas. For example, if the TRCD? 1 command returns "1,2,3,1" then trace 1 is defined as X•Y/R and is stored.

SRAT (?) {i}

The SRAT command sets or queries the scan sample rate. The parameter i selects the sample rate listed below.

<u>i</u>	<u>quantity</u>	<u>i</u>	<u>quantity</u>
0	62.5 mHz	7	8 Hz
1	125 mHz	8	16 Hz
2	250 mHz	9	32 Hz
3	500 mHz	10	64 Hz
4	1 Hz	11	128 Hz
5	2 Hz	12	256 Hz
6	4 Hz	13	512 Hz
		14	Trigger

SLEN (?) {x}

The SLEN command sets or queries the scan length. The parameter x is the scan length (real number of seconds). The scan length will be set to the closest allowed time given the sample rate and the number of stored traces. The buffer holds 16000 points for 4 stored traces, 32000 points for 2 traces and 64000 points of 1 trace. The maximum scan length is the buffer size divided by the sample rate. The minimum is 1.0 sec.

SEND (?) {i}

The SEND command sets or queries the scan mode. The parameter i selects 1 Shot (i=0) or Loop (i=1).

TRIG

The TRIG command is the software trigger command. This command has the same effect as a trigger at the rear panel trigger input.

DISPLAY and SCALE COMMANDS

ASCL	The ASCL command auto scales the active display. This command is just like pressing the [AUTO SCALE] key. Only Bar and Chart displays are affected.
ADSP (?) {i}	The ADSP command selects the active display. The parameter i selects Full (i=0), Top (i=1) or Bottom (i=2). The selected display must be presently displayed on the screen otherwise an error will result.
SMOD (?) {i}	The SMOD command sets or queries the screen format. The parameter i selects Single or full screen display (i=0), or Up/Down dual display (i=1).
MNTR (?) {i}	The MNTR command sets or queries the monitor display mode. The parameter i selects Settings monitor (i=0), or Input/Output monitor (i=1).
DTYP (?) i {, j}	The DTYP command sets or queries the display type. The parameter i selects the Full (i=0), Top (i=1) or Bottom (i=2) display and is required. The parameter j selects Polar (i=0), Blank (i=1), Bar (i=2) or Chart (i=3). An error is generated if the DTYP command tries to set the display type of a display which is not on the screen. The DTYP?i query can check any display's type.
DTRC (?) i {, j}	The DTRC command sets or queries the displayed trace number. The parameter i selects the Full (i=0), Top (i=1) or Bottom (i=2) display and is required. The parameter j is the trace number (1, 2, 3 or 4). An error is generated if the DTRC command tries to set the trace number of a display which is not on the screen. The DTRC?i query can check any display's trace.
DSCL (?) i {, x}	The DSCL command sets or queries the display range. The parameter i selects the Full (i=0), Top (i=1) or Bottom (i=2) display and is required. The parameter x is the range (real number with the units of the displayed trace). The value of x is limited to $10^{-18} < x < 10^{18}$. An error is generated if the DSCL command tries to set the range of a display which is not on the screen. The range only affects bar and chart display types.
DOFF (?) i {, x}	The DOFF command sets or queries the display center value or offset. The parameter i selects the Full (i=0), Top (i=1) or Bottom (i=2) display and is required. The parameter x is the center value (real number with the units of the display trace). The value of x is limited to $10^{-12} < x < 10^{12}$. An error is generated if the DOFF command tries to set the center of a display which is not on the screen. The center only affects bar and chart display types.

DHVS (?) i {, j}

The DHVS command sets or queries the display horizontal scale. The parameter i selects the Full (i=0), Top (i=1) or Bottom (i=2) display and is required. The parameter j selects a scale listed below. An error is generated if the DHVS command tries to set the horizontal scale of a display which is not on the screen. The horizontal scale only affects chart display types.

<u>i</u>	<u>time/div</u>	<u>i</u>	<u>time/div</u>
0	2 mS	17	200 S
1	5 mS	18	5 min
2	10 mS	19	500 S
3	20 mS	20	10 min
4	50 mS	21	1 kS
5	0.1 S	22	20 min
6	0.2 S	23	2 kS
7	0.5 S	24	1 hour
8	1.0 S	25	5 kS
9	2.0 S	26	2 hour
10	5.0 S	27	10 kS
11	10 S	28	3 hour
12	20 S	29	20 kS
13	50 S	30	50 kS
14	1 min	31	100 kS
15	100 S	32	200 kS
16	2 min		

The minimum scale is related to the sample rate. The minimum scales is (1/sample rate) per division. This displays a minimum of 10 points on the chart. The maximum scale is also related to the sample rate. The scale cannot exceed that which would display the entire buffer on the chart at once.

RBIN? i

The RBIN?i command queries the bin number at the right edge of the Full (i=0), Top (i=1) or Bottom (i=2) chart display. The selected display must be a chart display. RBIN? along with CBIN can be used to position the time window of the active chart display over a specific trace region.

CURSOR COMMANDS

- CSEK (?) {i}** The CSEK command sets or queries the cursor seek mode of the active display. The parameter *i* selects Max (*i*=0), Min (*i*=1) or Mean (*i*=2). Each display has its own cursor seek mode. Use the ATRC and SMOD commands to select the desired display. Only chart displays have a cursor.
- CWID (?) {i}** The CWID command sets or queries the cursor width of the active display. The parameter *i* selects Off (*i*=0), Narrow (*i*=1), Wide (*i*=2) or Spot (*i*=3). Each display has its own cursor width. Use the ATRC and SMOD commands to select the desired display. Only chart displays have a cursor.
- CDIV (?) {i}** The CDIV command sets or queries the vertical divisions of the active display. The parameter *i* selects 8 (*i*=0), 10 (*i*=1) or None (*i*=2). Each display has its own vertical division mode. Use the ATRC and SMOD commands to select the desired display. This only affects chart displays.
- CLNK (?) {i}** The CLNK command sets or queries the cursor control mode. The parameter *i* selects Linked (*i*=0) or Separate (*i*=1). Only chart displays have a cursor.
- CDSP (?) {i}** The CDSP command sets or queries the cursor readout mode of the active display. The parameter *i* selects Delay (*i*=0), Bin (*i*=1), Fsweep (*i*=2) or Time (*i*=3). Only chart displays have a cursor.
- CMAX** The CMAX command is just like pressing the [CURSOR MAX/MIN] key. The cursor will move to the max or min of the data (as set by the CSEK command) on the active chart display. Only effective if the active display is a chart display.
- CURS? i** The CURS? command queries the cursor position of the full (*i*=0), top (*i*=1) or bottom (*i*=2) chart display. The selected display must be a chart display. The result is returned as an X,Y pair of numbers separated by a comma. The first number is the horizontal position (in bin, delay, time or sweep frequency) and the second is the vertical position. The returned values are those displayed in the cursor readout above the selected chart display.
- CBIN (?) {i}** The CBIN command sets or queries the cursor bin position of the **active chart display**. The active display must be a chart display. CBIN? returns the bin number of the cursor. This is the bin at the center of the cursor region, not the cursor readout position (which selects the min, max or mean of the data within the cursor region). Remember, even a spot cursor can span multiple data bins depending upon the scaling. The CBIN *i* command moves the cursor to bin *i*. If bin *i* is outside the time window of the chart, then the chart is panned left or right until bin *i* is at either the left edge (bin *i* to the left of the window) or right edge (bin *i* to the right of the window).
- Remember, CBIN references the center of the cursor region. The CURS? query reads the actual cursor location (as displayed in the cursor readout) which is the max, min or mean of the data bins within the cursor region.

MARK COMMANDS

MARK	The MARK command is just like pressing the [MARK] key. A mark will be placed in the data buffer at the next sample. This command has an effect only when a scan is in progress.
CNXT	The CNXT command moves the cursor of the active chart display to the next mark to the right. If the mark is off the right edge of the graph, then the display is panned to the right until the next mark is found.
CPRV	The CPRV command moves the cursor of the active chart display to the next mark to the left. If the mark is off the left edge of the graph, then the display is panned to the left until the next mark is found.
MDEL	The MDEL command is just like pressing the Marker Delete softkey. This command will delete the nearest mark to the left of the cursor.
MACT?	The MACT? command queries the number of active marks (0-8). If the number of active marks is greater than 0, then the number of marks is followed by the active mark numbers, separated by commas. For example, if MACT? returns 3,0,2,6 then there are 3 active marks - mark #0, #2 and #6.
MBIN? i	The MBIN?i command queries the bin number of mark #i. Remember, all displays use the same marks. If mark #i is not active, then -1 is returned. With the mark bin number, use TRCA? to read the trace data at mark #i.
MTXT (?) i {,s}	The MTXT command sets or queries the label field for mark #i. Remember, all displays use the same marks. The parameter i must select an active mark (0-7). Use MACT? to determine which marks are active. MTXT?i reads the label field for mark #i. The default label is the date and time. The MTXT i,s sets the mark label to string s. Spaces are not recognized, use '_' (underbar) instead.

AUX INPUT and OUTPUT COMMANDS

- OAUX? i** The OAUX? command queries the Aux Input values. The parameter i selects an Aux Input (1, 2, 3 or 4) and is required. The Aux Input voltages are returned as ASCII strings with units of Volts. The resolution is 1/3 mV. This command is a query only command.
- AUXM (?) i {, j}** The AUXM command sets or queries the Aux Output mode. The parameter i selects an Aux Output (1, 2, 3 or 4) and is required. The parameter j selects Fixed (j=0), Log sweep (j=1) or Linear sweep (j=2).
- AUXV (?) i {, x}** The AUXV command sets or queries the Aux Output voltage when the output is in fixed voltage mode. The parameter i selects an Aux Output (1, 2, 3 or 4) and is required. If i selects an output which is set to sweep, then the AUXV command will generate an error. The parameter x is the output voltage (real number of Volts) and is limited to -10.500 x 10.500. The output voltage will be set to the nearest mV.
- SAUX (?) i {, x, y, z}** The SAUX command sets or queries the Aux Output sweep limits and offsets. The parameter i selects an Aux Output (1, 2, 3 or 4) and is required. If i selects an output which is set to fixed voltage mode, then the SAUX command will generate an error. The parameter x is the sweep start voltage. The parameter y is the sweep stop voltage. The parameter z is the sweep offset voltage. The parameters x, y and z are real numbers of Volts. The values of x and y are limited to 0.001 x,y 21.000. The value of z is limited to -10.500 z 10.500. The voltages will be set to the nearest mV.
- The SAUX? i query will return x,y,z if the output is in a sweep mode. The return string is in ASCII and multiple parameters are separated by commas. For example, the SAUX?1 command returns "3.456,7.890,0.000" if output 1 is sweeping from 3.456V to 7.890V with 0.000V offset.
- Any set of sweep parameters which would result in an output voltage outside of the -10.5V V 10.5V range results in an error.
- TSTR (?) {i}** The TSTR command sets or queries the trigger start scan mode. The parameter i selects No (i=0) or Yes (i=1).

MATH COMMANDS

The math functions operate on the trace which is graphed in the active display. If the display type is polar, then the trace most recently displayed (in a bar or chart) will be used. If the active display trace is not stored, then the math functions will generate an error and have no effect.

The Smooth and Calculator functions CHANGE the stored data. Only the data which is within the time window of the chart graph is operated upon. If the display type is not a chart, then the most recent horizontal chart scale and position will be used to determine the region of the trace which is operated upon.

The Fit and Statistics functions do NOT change the stored data. However, these functions only analyze a portion of the data within the time window of the active chart display. If the display type is not a chart, then the most recent horizontal chart scale and position will be used to determine the time window. The region of interest within the window is determined by the left and right limits. These limits are specified in percent where 0% is at the left edge, 10% is at the first division from the left, and 100% is at the right edge of the chart graph.

When using the math commands SMTH, FITT, STAT and CALC, the status bytes should be queried after the command is sent to check if the command generated an error. Common sources of errors are divide by zero and math overflow. For example, the command line `CALC;*ESR?<lf>` will perform a calculation and then return the Standard Event Status Byte when finished. This allows the host program to determine when the CALC command is finished and whether an error occurred. The Execution Error bit (bit 4) may be checked to make sure that the CALC command terminated without an error.

SMTH i

The SMTH i command smooths the data trace of the active display. The parameter i selects a smoothing width.

<u>i</u>	<u>smoothing width</u>
0	5 points
1	11 points
2	17 points
3	21 points
4	25 points

The SMTH i command may take some time to complete. Use a status byte query to detect when the smoothing operation is done. If a scan is in progress, the SMTH command will Pause the scan.

COPR (?) {i}

The COPR i command sets or queries the type of math operation selected. The parameter i selects the operation.

<u>i</u>	<u>operation</u>
0	+
1	-
2	*
3	/
4	sin
5	cos
6	tan
7	x
8	x ²
9	log
10	10 ^x

CALC	The CALC command starts the calculation selected by the COPR command. This may take some time. Use a status query command to detect when the calculation is done. Make sure that CTRC or CARG have been used to set the argument (if required by the operation) before using the CALC command. If a scan is in progress, the CALC command will Pause the scan.
CAGT (?) {i}	The CAGT command sets or queries the argument type. The parameter i selects Trace (i=0) or Constant (i=1).
CTRC (?) {i}	The CTRC command sets or queries the trace argument number. The parameter i selects Trace 1, 2, 3 or 4 (i=1, 2, 3, 4). The selected trace must be stored.
CARG (?) {x}	The CARG command sets or queries the constant argument value. The parameter x is a real number.
FTYP (?) {i}	The FTYP i command sets or queries the type of fit. The parameter i selects the Line (i=0), Exponential (i=1) or Gaussian (i=2).
FITT i, j	<p>The FITT i,j command starts the fitting calculations. The fit takes place only within the chart region defined as i% and j% from the left edge. The parameters i and j are integers from 0 to 100 and j must be greater than i.</p> <p>The fit may take some time. Use a status query command to detect when the fit operation is done. If a scan is in progress, the FITT command will Pause the scan.</p>
PARS ? i	The PARS? i command queries the fit parameters after a curve fit has been performed. If no fit has been done or the selected parameter is unused in the fit, the PARS? command returns invalid data. The curve fit parameters are a, b, c and t0 (see the Math menu section of this manual). The parameter i selects a fit parameter to read. The value of i from 0 to 3 selects a, b, c or t0.
STAT i, j	<p>The STAT i,j command starts the statistics calculations. Only the data within the chart region defined as i% and j% from the left edge are analyzed. The parameters i and j are integers from 0 to 100 and j must be greater than i.</p> <p>The analysis may take some time. Use a status query command to detect when the calculation is done.</p>
SPAR ? i	The SPAR? i command queries the results of a statistical calculation. If no analysis has been done, the SPAR? command returns invalid data. The STAT command calculates the mean, standard deviation, total data, and delta time (see the Math menu section of this manual). The parameter i selects the parameter to read. The value of i from 0 to 3 selects mean, standard deviation, total data, and delta time.

STORE AND RECALL FILE COMMANDS

When using file commands, the status byte should be queried after the command is sent to check if the command generated an error. Common sources of errors are file not on disk, no space on disk, and no disk in drive. For example, the command line `SDAT;ERRS? <lf>` will save the data to disk and return the Error Status Byte when finished. The Disk Error bit may be checked to make sure that the Save Trace command terminated without error.

FNAM (?) {s}

The FNAM command sets or queries the active file name. All file operations use the name specified by the FNAM command. **Be sure to use the FNAM s command before any file operation commands.** For example, "FNAM MYDATA.DAT" will set the active file name to MYDATA.DAT. DOS file name conventions must be followed, i.e. file names are 8 characters or less with an optional extension of up to 3 characters. Subdirectories are not supported. All file access is to the root directory.

SDAT

The SDAT command saves the active display's data trace, trace definition and the instrument state to the file specified by the FNAM command. See the Disk menu section for more details. This command is the same as the Data Save softkey.

SASC

The SASC command saves the active display's data trace in ascii format to the file specified by the FNAM command. See the Disk menu section for more details. This command is the same as the Ascii Save softkey.

SSET

The SSET command saves the instrument setup to the file specified by the FNAM command. See the Disk menu section for more details. This command is the same as the Setting Save softkey.

RDAT

The RDAT command recalls the trace data, trace definition and instrument state from the file specified by the FNAM command. The data is stored in the active display's trace. See the Disk menu section for more details. This command is the same as the Data Recall softkey.

RSET

The RSET command recalls the instrument setup from the file specified by the FNAM command. See the Disk menu section for more details. This command is the same as the Setting Recall softkey.

SETUP COMMANDS

OUTX (?) {i}	The OUTX command sets the output interface to RS232 (i=0) or GPIB (i=1). The OUTX i command should be sent before any query commands to direct the responses to the interface in use.
OVRM (?) {i}	The OVRM command sets or queries the GPIB Override Remote Yes/No condition. The parameter i selects No (i=0) or Yes (i=1).
KCLK (?) {i}	The KCLK command sets or queries the key click On (i=1) or Off (i=0) state.
ALRM (?) {i}	The ALRM command sets or queries the alarm On (i=1) or Off (i=0) state.
THRS (?) {i}	The THRS command sets or queries the hours setting of the clock. The value of i is in the range 0 i 23.
TMIN (?) {i}	The TMIN command sets or queries the minutes setting of the clock. The value of i is in the range 0 i 59.
TSEC (?) {i}	The TSEC command sets or queries the seconds setting of the clock. The value of i is in the range 0 i 59.
DMTH (?) {i}	The DMTH command sets or queries the months setting of the calendar. The value of i is in the range 1 i 12.
DDAY (?) {i}	The DDAY command sets or queries the days setting of the calendar. The value of i is in the range 1 i 31.
DYRS (?) {i}	The DYRS command sets or queries the years setting of the calendar. The value of i is in the range 0 i 99.
PLTM (?) {i}	The PLTM command sets or queries the plotter mode. If i=0 plotting is directed to the RS232 interface, if i=1 plotting is to the GPIB interface.
PLTB (?) {i}	The PLTB command sets or queries the RS232 plotter baud rate. The parameter i ranges from 0 to 4 and selects baud rates of 300 (0), 1200 (1), 2400 (2), 4800 (3), and 9600 (4). This baud rate should match the baud rate of the plotter in use.
PLTA (?) {i}	The PLTA command sets or queries the GPIB plotter address. The parameter i ranges from 0 to 30 and should agree with the address of the plotter in use.
PLTS (?) {i}	The PLTS command sets or queries the plot speed. If i=0 fast plot speed is used, if i=1 slow plot speed is used.
PNTR (?) {i}	The PNTR command sets or queries the trace pen number. The pen number is in the range of 1 to 6.

PNGD (?) {i}	The PNGD command sets or queries the grid pen number. The pen number is in the range of 1 to 6.
PNAL (?) {i}	The PNAL command sets or queries the alphanumeric pen number. The pen number is in the range of 1 to 6.
PNCR (?) {i}	The PNCR command sets or queries the cursor pen number. The pen number is in the range of 1 to 6.
PRNT (?) {i}	The PRNT command sets or queries the printer type. The printer type may be EPSON (i=0), HP (i=1) or File (i=2).

PRINT and PLOT COMMANDS

PRSC	The PRSC command will print the screen display to a printer attached to the rear panel parallel printer port. This function is the same as the [PRINT] key. The printer type needs to be selected before using the PRSC command.
PALL	The PALL command generates a plot of the data displays. Each feature uses the pen assigned in the Setup Plotter menu.
PTRC	The PTRC command plots only the data trace(s).
PCUR	The PCUR command plots only the cursor(s) if they are on.

FRONT PANEL CONTROLS and AUTO FUNCTIONS

STRT	The STRT command starts or resumes a scan (and sweep). This function is the same as pressing the [START/CONT] key. STRT is ignored if a scan is already in progress.
PAUS	The PAUS command pauses a scan. All sweeps in progress also pause. If a scan is already paused, stopped or done, then this command is ignored (the scan is not reset).
REST	The REST command resets a scan. The REST command can be sent at any time - any scan in progress, paused or not, will be reset. This command will erase the data buffer. All swept parameters are reset to their start values.
ATRC (?) {i}	The ATRC command selects the active display. The parameter i selects Top (i=0) or Bottom (i=1). If the display is full screen, then it is always the active display.
ASCL	The ASCL command auto scales the active display. This command is just like pressing the [AUTO SCALE] key. Only Bar and Chart displays are affected.
AGAN	The AGAN command performs the Auto Gain function. This command is the same as pressing the [AUTO GAIN] key. Auto Gain may take some time if the time constant is long. Check the command execution in progress bit in the Serial Poll Status Byte (bit 1) to determine when the function is finished.
ARSV	The ARSV command performs the Auto Reserve function. This command is the same as pressing the [AUTO RESERVE] key. Auto Reserve may take some time. Check the command execution in progress bit in the Serial Poll Status Byte (bit 1) to determine when the function is finished.
APHS	The APHS command performs the Auto Phase function. This command is the same as pressing the [AUTO PHASE] key. The outputs will take many time constants to reach their new values. Do not send the APHS command again without waiting the appropriate amount of time.
AOFF i	The AOFF i command automatically offsets X (i=1), Y (i=2) or R (i=3) to zero. The parameter i is required. This command is equivalent to pressing the Auto softkey in the Offset & Expand menu box.
CMAX	The CMAX command is just like pressing the [CURSOR MAX/MIN] key. The cursor will move to the max or min of the data (as set by the CSEK command) on the active chart display. Only effective if the active display is a chart display.

DATA TRANSFER COMMANDS

OUTP ? i

The OUTP? i command **reads the value of X, Y, R or θ** . The parameter i selects X (i=1), Y (i=2), R (i=3) or θ (i=4). Values are returned as ASCII floating point numbers with units of Volts or degrees. For example, the response might be "-1.01026". This command is a query only command.

OUTR ? i

The OUTR? i command **reads the value of trace 1, 2, 3 or 4**. The parameter i selects the trace (i=1, 2, 3 or 4). Values are returned as ASCII floating point numbers with units of the trace (as displayed on the bar graph). For example, the response might be "-1.01026". This command is a query only command.

OAUX? i

The OAUX? command **reads the Aux Input values**. The parameter i selects an Aux Input (1, 2, 3 or 4) and is required. The Aux Input voltages are returned as ASCII strings with units of Volts. The resolution is 1/3 mV. This command is a query only command.

SNAP ? i,j {,k,l,m,n}

The SNAP? command records the values of either 2, 3, 4, 5 or 6 parameters at a single instant. For example, SNAP? is a way to query values of X and Y (or R and θ) which are taken at the same time. This is important when the time constant is very short. Using the OUTP? or OUTR? commands will result in time delays, which may be greater than the time constant, between reading X and Y (or R and θ).

The SNAP? command requires at least two parameters and at most six parameters. The parameters i, j, k, l, m, n select the parameters below.

i,j,k,l,m,n	parameter
1	X
2	Y
3	R
4	
5	Aux In 1
6	Aux In 2
7	Aux In 3
8	Aux In 4
9	Reference Frequency
10	Trace 1
11	Trace 2
12	Trace 3
13	Trace 4

The requested values are returned in a single string with the values separated by commas and in the order in which they were requested. For example, the SNAP?1,2,9,5 will return the values of X, Y, Freq and Aux In 1. These values will be returned in a single string such as "0.951359,0.0253297,1000.00,1.234".

The first value is X, the second is Y, the third is f, and the fourth is Aux In 1.

The values of X and Y are recorded at a single instant. The values of R

and are also recorded at a single instant. Thus reading X,Y OR R, yields a coherent snapshot of the output signal. If X,Y,R and are all read, then the values of X,Y are recorded approximately 10 μ s apart from R, . Thus, the values of X and Y may not yield the exact values of R and from a single SNAP? query.

The values of the Aux Inputs may have an uncertainty of up to 32 μ s. The frequency is computed only every other period or 40 ms, whichever is longer.

The SNAP? command is a query only command. The SNAP? command is used to record various parameters simultaneously, not to transfer data quickly.

SPTS ? i

The SPTS? command queries the number of points stored in Trace i. The parameter i selects a trace (1, 2, 3 or 4) and is required. If Trace i is not stored, then 0 is returned. If the scan is reset, then 0 is returned. Remember, SPTS? returns N where N is the number of points - the points are numbered from 0 (oldest) to N-1 (most recent). The SPTS?i command can be sent at any time, even during a scan. This command is a query only command.

TRCA ? i, j, k

The TRCA? command queries the points stored in Trace i. The values are returned as ASCII floating point numbers with the units of the trace. Multiple points are separated by commas and the final point is followed by a terminator. For example, the response with two points might be "-1.234567e-009,+7.654321e-009,".

The parameter i selects a trace (1, 2, 3 or 4) and is required. If Trace i is not stored, then an error occurs. Points are read from the buffer starting at bin j (j 0). A total of k bins are read (k 1). To read a single point, set k=1. Both j and k are required. If j+k exceeds the number of stored points (as returned by the SPTS? query), then an error occurs. Remember, SPTS? returns N where N is the total number of bins - the TRCA? command numbers the bins from 0 (oldest) to N-1 (most recent).

TRCB ? i, j, k

The TRCB? command queries the points stored in Trace i. The values are returned as IEEE format binary floating point numbers (with the units of the trace). There are 4 bytes per point. Multiple points are not separated by any delimiter. The bytes can be read directly into a floating point array (in most languages).

Do not query the IFC (no command in progress) status bit after sending the TRCB command. This bit will not be set until the transfer is complete.

When using the GPIB interface, EOI is sent with the final byte. The points must be read using a binary transfer (see your GPIB interface card software manual). Make sure that the software is configured to NOT terminate reading upon receipt of a CR or LF.

When using the RS232 interface, the word length must be 8 bits. The points must be read as binary bytes (no checking for linefeeds, carriage returns or other control characters). Most serial interface drivers are designed for ASCII text only and will not work here. In addition, the data

transfer does not pause between bytes. The receiving interface must always be ready to receive the next byte. In general, using binary transfers on the RS232 interface is not recommended.

The parameter *i* selects a trace (1, 2, 3 or 4) and is required. If Trace *i* is not stored, then an error occurs. Points are read from the buffer starting at bin *j* (*j* ≥ 0). A total of *k* bins are read (*k* ≥ 1) for a total transfer of *k**4 bytes. To read a single point, set *k*=1. Both *j* and *k* are required. If *j*+*k* exceeds the number of stored points (as returned by the SPTS? query), then an error occurs. Remember, SPTS? returns *N* where *N* is the total number of bins - the TRCB? command numbers the bins from 0 (oldest) to *N*-1 (most recent).

TRCL ? i, j, k

The TRCL? command queries the points stored in Trace *i*. The values are returned in a non-normalized floating point format (with the units of the trace). There are 4 bytes per point. Multiple points are not separated by any delimiter. The bytes CANNOT be read directly into a floating point array.

Each point consists of four bytes. Byte 0 is the LSB and Byte 3 is the MSB. The format is illustrated below.

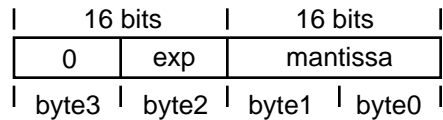

The mantissa is a signed 16 bit integer (-32768 to 32767). The exponent is a signed integer whose value ranges from 0 to 248 (thus byte 3 is always zero). The value of a data point is simply,

$$\text{value} = m \times 2^{(\text{exp}-124)}$$

where *m* is the mantissa and *exp* is the exponent.

The trace data within the SR850 is stored in this format. Data transfers using this format are **faster** than IEEE floating point format. If data transfer speed is important, the TRCL? command should be used.

Do not query the IFC (no command in progress) status bit after sending the TRCL command. This bit will not be set until the transfer is complete.

When using the GPIB interface, EOI is sent with the final byte. The points must be read using a binary transfer (see your GPIB interface card software manual). Make sure that the software is configured to NOT terminate reading upon receipt of a CR or LF.

When using the RS232 interface, the word length must be 8 bits. The points must be read as binary bytes (no checking for linefeeds, carriage returns or other control characters). Most serial interface drivers are designed for ASCII text only and will not work here. In addition, the data transfer does not pause between bytes. The receiving interface must always be ready to receive the next byte. In general, using binary transfers on the RS232 interface is not recommended.

The parameter *i* selects a trace (1, 2, 3 or 4) and is required. If Trace *i* is not stored, then an error occurs. Points are read from the buffer starting at bin *j* (*j* ≥ 0). A total of *k* bins are read (*k* ≥ 1) for a total transfer of *k**4 bytes. To read a single point, set *k*=1. Both *j* and *k* are required. If *j*+*k* exceeds the number of stored points (as returned by the SPTS? query), then an error occurs. Remember, SPTS? returns *N* where *N* is the total number of bins - the TRCB? command numbers the bins from 0 (oldest) to *N*-1 (most recent).

FAST (?) {*i*}

The FAST command sets the fast data transfer mode on and off. The parameter *i* selects:

i=0: Off

i=1: On (DOS programs or other dedicated data collection computers)

i=2: On (Windows Operating System Programs)

When the fast transfer mode is on, whenever data is sampled (during a scan), the values of *X* and *Y* are automatically transmitted over the GPIB interface (this mode is not available over RS232). The sample rate sets the frequency of the data transfers. It is important that the receiving interface be able to keep up with the transfers.

To use the FAST2 mode, a ROM version of 1.08 or higher is required in the SR850. The FAST2 version uses the lock-in transmit queue to buffer the GPIB data being sent to the host. Since the transmit queue can buffer a maximum of 63 *X* and *Y* data pairs, the host can only be diverted for short periods of time (e.g. 120mS at 512Hz sample rate) without causing the lock-in to "time out" and abort the FAST mode data transfer.

The values of *X* and *Y* are transferred as signed integers, 2 bytes long (16 bits). *X* is sent first followed by *Y* for a total of 4 bytes per sample. The values range from -32768 to 32767. The value ±30000 represents ±full scale (i.e. the sensitivity).

Offsets and expands are included in the values of *X* and *Y*. The transferred values are (raw data - offset) x expand. The resulting value must still be a 16 bit integer. The value ±30000 now represents ±full scale divided by the expand factor.

At fast sample rates, it is important that the receiving interface be able to keep up. If the SR850 finds that the interface is not ready to receive a point, then the fast transfer mode is **turned off**.

The fast transfer mode may be turned off with the FAST0 command.

The transfer mode should be turned on (using FAST1 or FAST 2) before a scan is started. Then use the STRD command (see below) to start a scan. After sending the STRD command, immediately make the SR850 a

talker and the controlling interface a listener. Remember, the first transfer will occur with the very first point in the scan. If the scan is started from the front panel or from the trigger input, then make sure that the SR850 is a talker and the controlling interface a listener BEFORE the scan actually starts.

STRD

After using FAST1 or FAST 2 to turn on fast data transfer, use the STRD command to start the scan. STRD starts a scan after a delay of 0.5 sec. This delay allows the controlling interface to place itself in the read mode before the first data points are transmitted. **Do not use the STRT command to start the scan.** See the programming examples at the end of this section.

INTERFACE COMMANDS

- *RST** The *RST command resets the SR850 to its default configurations. The communications setup is not changed. All other modes and settings are set to their default conditions and values. This command takes some time to complete.
- *IDN?** The *IDN? query returns the SR850's device identification string. This string is in the format "Stanford_Research_Systems,SR850,s/n00111,ver1.000". In this example, the serial number is 00111 and the firmware version is 1.000.
- LOCL (?) {i}** The LOCL command sets the local/remote function. If i=0 the SR850 is LOCAL, if i=1 the SR850 will go REMOTE, and if i=2 the SR850 will go into LOCAL LOCKOUT state. The states duplicate the GPIB local/remote states. In the LOCAL state both command execution and keyboard input are allowed. In the REMOTE state command execution is allowed but the keyboard and knob are locked out except for the [HELP] key which returns the SR850 to the LOCAL state. In the LOCAL LOCKOUT state all front panel operation is locked out, including the [HELP] key.
- The LOC/REM indicator is in the status bar at the bottom of the screen.
- OVRM (?) {i}** The OVRM command sets or queries the GPIB Override Remote Yes/No condition. The parameter i selects No (i=0) or Yes (i=1). When Override Remote is set to Yes, then the front panel is not locked out when the unit is in the REMOTE state. The REM indicator will still be on and the [HELP] key will still return the unit to the Local state.
- TRIG** The TRIG command is the software trigger command. This command has the same effect as a trigger at the rear panel trigger input.

STATUS REPORTING COMMANDS

The Status Byte definitions follow this section.

- *CLS** The *CLS command clears all status registers. The status enable registers are **NOT** cleared.
- *ESE (?) {i} {,j}** The *ESE i command sets the **standard event enable register** to the decimal value i (0-255). The *ESE i,j command sets bit i (0-7) to j (0 or 1). The *ESE? command queries the value (0-255) of the status byte enable register. The *ESE? i command queries the value (0 or 1) of bit i.
- *ESR? {i}** The *ESR? command queries the **value of the standard event status byte**. The value is returned as a decimal number from 0 to 255. The *ESR? i command queries the value (0 or 1) of bit i (0-7). Reading the entire byte will clear it while reading bit i will clear just bit i.
- *SRE (?) {i} {,j}** The *SRE i command sets the **serial poll enable register** to the decimal value i (0-255). The *SRE i,j command sets bit i (0-7) to j (0 or 1). The *SRE? command queries the value (0-255) of the serial poll enable register. The *SRE? i command queries the value (0 or 1) of bit i.
- *STB? {i}** The *STB? command queries the **value of the serial poll status byte**. The value is returned as a decimal number from 0 to 255. The *STB? i command queries the value (0 or 1) of bit i (0-7). Reading this byte has no effect on its value.
- *PSC (?) {i}** The *PSC command sets the **value of the power-on status clear bit**. If i=1 the power-on status clear bit is set and all status registers and enable registers are cleared on power up. If i=0 the bit is cleared and the status enable registers maintain their values at power down. This allows a service request to be generated at power up.
- ERRE (?) {i} {,j}** The ERRE i command sets the **error status enable register** to the decimal value i (0-255). The ERRE i,j command sets bit i (0-7) to j (0 or 1). The ERRE? command queries the value (0-255) of the error status enable register. The ERRE? i command queries the value (0 or 1) of bit i.
- ERRS? {i}** The ERRS? command queries the **value of the error status byte**. The value is returned as a decimal number from 0 to 255. The ERRS? i command queries the value (0 or 1) of bit i (0-7). Reading the entire byte will clear it while reading bit i will clear just bit i.
- LIAE (?) {i} {,j}** The LIAE command sets the **lock-in (LIA) status enable register** to the decimal value i (0-255). The LIAE i,j command sets bit i (0-7) to j (0 or 1). The LIAE? command queries the value of the LIA status enable register. The LIAE? i command queries the value (0 or 1) of bit i.
- LIAS? {i}** The LIAS? command queries the **value of the lock-in (LIA) status byte**. The value is returned as a decimal number from 0 to 255. The LIAS? i command queries the value (0 or 1) of bit i (0-7). Reading the entire byte will clear it while reading bit i will clear just bit i.

STATUS BYTE DEFINITIONS

The SR850 reports on its status by means of four status bytes: the Serial Poll Status byte, the Standard Event Status byte, the LIA Status byte, and the Error Status byte.

The status bits are set to 1 when the event or state described in the tables below has occurred or is present.

SERIAL POLL STATUS BYTE	<u>bit</u>	<u>name</u>	<u>usage</u>
	0	SCN	No scan in progress (Stop or Done). A Paused scan is considered to be in progress.
	1	IFC	No command execution in progress.
	2	ERR	An enabled bit in the error status byte has been set.
	3	LIA	An enabled bit in the LIA status byte has been set.
	4	MAV	The interface output buffer is non-empty.
	5	ESB	An enabled bit in the standard status byte has been set.
	6	SRQ	SRQ (service request) has occurred.
	7	Unused	

The ERR, LIA, and ESB bits are set whenever any bit in both their respective status bytes AND enable registers is set. Use the *SRE, *ESE, ERRE and LIAE commands to set enable register bits. The ERR, LIA and ESB bits are not cleared until ALL enabled status bits in the Error, LIA and Standard Event status bytes are cleared (by reading the status bytes or using *CLS).

Using *STB? to read the Serial Poll Status Byte

A bit in the Serial Poll status byte is **NOT** cleared by reading the status byte using *STB?. The bit stays set as long as the status condition exists. This is true even for SRQ. SRQ will be set whenever the same bit in the serial poll status byte AND enable register is set. This is independent of whether a serial poll has occurred to clear the service request.

Using SERIAL POLL

Except for SRQ, a bit in the Serial Poll status byte is **NOT** cleared by polling the status byte. When reading the status byte using a serial poll, the SRQ bit signals that the SR850 is requesting service. The SRQ bit will be set (1) the first time the SR850 is polled following a service request. The serial poll automatically clears the service request. Subsequent serial polls will return SRQ cleared (0) until another service request occurs. Polling the status byte and reading it with *STB? can return different values for SRQ. When polled, SRQ indicates a service request has occurred. When read, SRQ indicates that an enabled status bit is set.

SERVICE REQUESTS (SRQ)

A GPIB service request (SRQ) will be generated whenever a bit in both the Serial Poll Status byte AND Serial Poll Enable register is set. Use *SRE to set bits in the Serial Poll Enable register. A service request is only generated when an enabled Serial Poll Status bit becomes set (changes from 0 to 1). An enabled status bit which becomes set and remains set will generate a single SRQ. If another service request from the same status bit is desired, the requesting status bit must first be cleared. In the case of the ERR, LIA and ESB bits, this means clearing the enabled bits in the ERR, LIA and ESB status bytes (by reading them). Multiple enabled bits in these status bytes will generate a single SRQ. Another SRQ (from ERR, LIA or ESB) can only be generated after clearing the ERR, LIA or ESB bits in the Serial Poll status byte. To clear these bits, ALL enabled bits in the ERR, LIA or ESB status bytes must be cleared.

The controller should respond to the SRQ by performing a serial poll to read the Serial Poll status byte to determine the requesting status bit. Bit 6 (SRQ) will be reset by the serial poll.

For example, to generate a service request when a RESRV overload occurs, bit 0 in the LIA Status Enable register needs to be set (LIAE 0,1 command) and bit 3 in the Serial Poll Enable register must be set (*SRE 3,1 command). When a reserve overload occurs, bit 0 in the LIA Status byte is set. Since bit 0 in the LIA Status byte AND Enable register is set, this ALSO sets bit 3 (LIA) in the Serial Poll Status byte. Since bit 3 in the Serial Poll Status byte AND Enable register is set, an SRQ is generated. Bit 6 (SRQ) in the Serial Poll Status byte is set. Further RESRV overloads will not generate another SRQ until the RESRV overload status bit is cleared. The RESRV status bit is cleared by reading the LIA Status byte (with LIAS?). Presumably, the controller is alerted to the overload via the SRQ, performs a serial poll to clear the SRQ, does something to try to remedy the situation (change gain, experimental parameters, etc.) and then clears the RESRV status bit by reading the LIA status register. A subsequent RESRV overload will then generate another SRQ.

STANDARD EVENT STATUS BYTE

<u>bit</u>	<u>name</u>	<u>usage</u>
0	INP	Set on input queue overflow (too many commands received at once, queues cleared).
1	Unused	
2	QRY	Set on output queue overflow (too many responses waiting to be transmitted, queues cleared).
3	Unused	
4	EXE	Set when a command can not execute correctly or a parameter is out of range.
5	CMD	Set when an illegal command is received.
6	URQ	Set by any key press or knob rotation.
7	PON	Set by power-on.

The bits in this register remain set until cleared by reading them or by the *CLS command.

Remote Programming

LIA STATUS BYTE	<u>bit</u>	<u>name</u>	<u>usage</u>
	0	INPUT/RESRV	Set when an INPUT or RESRV overload is detected.
	1	FILTR	Set when a FILTR overload is detected.
	2	OUTPT	Set when an OUTPT overload is detected.
	3	UNLK	Set when a reference unlock is detected.
	4	RANGE	Set when the detection frequency switches ranges (harmonic x ref. frequency decreases below 199.21 Hz or increases above 203.12 Hz). Time constants above 30 s and Synchronous filtering are turned off in the upper frequency range.
	5	TC	Set when the time constant is changed indirectly, either by changing frequency range, dynamic reserve or filter slope.
	6	TRIG	Set when unit is triggered. Only if samples or scans are triggered.
	7	PLOT	Set when a plot is completed.

The LIA Status bits stay set until cleared by reading or by the *CLS command.

ERROR STATUS BYTE	<u>bit</u>	<u>name</u>	<u>usage</u>
	0	Prn/Plt Error	Set when an error occurs during printing or plotting.
	1	Backup Error	Set at power up when the battery backup has failed.
	2	RAM Error	Set when the RAM Memory test finds an error.
	3	Disk Error	Set when an error occurs during a disk or file operation.
	4	ROM Error	Set when the ROM Memory test finds an error.
	5	GPIB Error	Set when GPIB fast data transfer mode aborted.
	6	DSP Error	Set when the DSP test finds an error.
	7	Math Error	Set when an internal math error occurs.

The Error Status bits stay set until cleared by reading or by the *CLS command.

EXAMPLE PROGRAM 1

Using Microsoft C (v5.1) with the National Instruments GPIB card on the IBM PC.

To successfully interface the SR850 to a PC via the GPIB interface, the instrument, interface card, and interface drivers must all be configured properly. To configure the SR850, the GPIB address must be set in the SYSTEM SETUP menu. The default GPIB address is 8; use this address unless a conflict occurs with other instruments in your system. The SR850 will be set to GPIB address 8 whenever a reset is performed (power on with the [-] key down).

Make sure that you follow all the instructions for installing the GPIB card. The National Instruments card cannot be simply unpacked and put into your computer. To configure the card you must set jumpers and switches on the card to set the I/O address and interrupt levels. You must run the program "IBCONF" to configure the resident GPIB driver for your GPIB card. Please refer to the National Instruments manual for information. In this example, the following options must be set with IBCONF:

```
Device name:          LIA
Device address:      8
Terminate Read on EOS: No (for binary transfers)
```

Once all the hardware and GPIB drivers are configured, use "IBIC". This terminal emulation program allows you to send commands to the SR850 directly from your computer's keyboard. If you cannot talk to the SR850 via "IBIC", then your programs will not run. Use the simple commands provided by National Instruments. Use "IBWRT" and "IBRD" to write and read from the SR850. After you are familiar with these simple commands, you can explore more complex programming commands.

```
/******
```

```
/* Example program using Microsoft C V5.1 and the National Instruments GPIB card.
```

Connect the Sine Out to the A Input with a BNC cable.

Run this program by typing the program name followed by a space and the device name. The device name is the name used in IBCONF to configure the National Instruments driver. For example, if the program is called LIATEST and the above configuration is used, then type LIATEST LIA.

The program will configure the SR850 to sweep the internal oscillator from 10 to 100 Hz in 100 seconds. The line notch (50/60 Hz) filter will be engaged. As the frequency is swept, the response of the notch filter is graphed.

Binary X and Y data will be transferred to the PC during the sweep using the FAST transfer command. After the sweep is complete, the existing magnitude (R) data in the data buffer will be transferred in IEEE floating point format as well as the LIA non-normalized floating point format (faster transfer) */

```
#include <stdio.h>
#include <stdlib.h>
#include <string.h>
#include <math.h>
#include "decl.h"

#define SR850 argv[1]
```

Remote Programming

```
/* function prototypes */

void main(int, char *[]);
void txLia(char *);
void initGpib(char *);
void setupLiaForSweep(void);
void printOutBinaryResults();
void printOutIEEEResults();
void printOutLIAResults();

/* National Instruments Interface Function Prototypes (488.1 Calls - see the National software manual).*/

int  ibfind(char*);
void ibwrt(int,char *,int);
void ibrd(int,char *,unsigned long);
void ibrsp(int,char *);
void ibeos(int,int);
void ibtmo(int,int);

/* global variables */

int  lia;          /* SR850 handle */
int  rxBuf[6600*2]; /* FAST mode data buffer */
float rBuf[6600];  /* Floating point data buffer */

void main(int argc, char *argv[])
{
    int i,x,y,nPts;
    int *ptr;
    char tstr[20];

    if (argc<2) {
        printf("\nUsage: liatest <devName>\n");
        exit(1);
    }
    else
        initGpib(SR850);

    txLia("OUTX1"); /* Set the SR850 to output responses to the GPIB port */
    setupLiaForSweep(); /* Setup the SR850 sweep */

    printf("\nAcquiring Data\n");
    ibtmo(lia,0); /* turn off timeout for lia or set the timeout longer than the scan. The timeout
                  measures the time to transfer the full number of bytes, not the time since the
                  most recent byte is received.*/

    txLia("FAST2;STRD"); /* Turn FAST mode data transfer ON, then start scan using the STRD start
                          after delay command. The STRD command MUST be used if the scan is to be
                          started by this program! Do NOT use STRT. */

    ibrd(lia,(char *)rxBuf,6401L*4L); /* get FAST mode data.
                                       The 100 sec sweep at 64 Hz has 64*100 + 1 points, each point
                                       consists of X (2 bytes) and Y (2 bytes) for a total of 4 bytes. */
}
```

```

printOutBinaryResults();          /* format and print the results */

printf("\n%d bytes received.\nPress <Enter> to continue.",ibcnt);
getch(); printf("\n");

printf("Reading Results in IEEE Binary Format\n");
txLia("SPTS?3");          /* how many points in trace 3 (R) ?*/
ibrd(lia,tstr,20L);        /* get the answer */
sscanf(tstr,"%d",&nPts); /* convert from a string to an int */

sprintf(tstr,"TRCB?3,0,%d",nPts); /* use TRCB to read the points in IEEE floating point format */
ibwrt(lia,tstr,strlen(tstr)); /* note that we cannot use txLia here because the IFC RDY bit will
                               not be set until the transfer is complete! */
ibrd(lia,(char *)rfBuf,(long)nPts*4L); /* read directly into a FLOAT array, 4 bytes per point */

printf ("\nReceived %d bytes in IEEE binary format\n",ibcnt);
printOutIEEEEResults();      /* format and print results */
printf ("Press <Enter> to continue");
getch(); printf("\n");

printf("Reading Results in LIA Binary Format\n");
sprintf(tstr,"TRCL?3,0,%d",nPts); /* use TRCL to read the points in LIA floating point format */
ibwrt(lia,tstr,strlen(tstr)); /* note that we cannot use txLia here because the IFC RDY bit will
                               not be set until the transfer is complete! */
ibrd(lia,(char *)rfBuf,(long)nPts*4L); /* read into FLOAT array but the values are NOT floats! */

printf ("\nReceived %d bytes in LIA binary format\n",ibcnt);
printOutLIAResults();      /* format and print results */
printf ("End of Program");
}

void printOutBinaryResults(void)
{
    /* calculates the first 10 values of R based on the X and Y values takes in FAST mode by the SR850 */

    int i;
    float x,y,r;
    int *ptr;

    printf("\n\n");
    ptr = rxBuf;          /* ptr points to the first X,Y pair of values. X and Y are each integers. */
    for (i=0;i<10;i++) {
        x = (float) (*ptr++) /(float) 30.000; /* 30000 is full scale which is 1 V in this case */
        y = (float) (*ptr++) /(float) 30.000; /* for other scales, multiply by the full scale voltage */
        r = (float) sqrt(x*x + y*y); /* compute R from X and Y */
        printf("%d  %e\n",i,r);
    }
}

void printOutIEEEEResults(void)
{
    /* prints the first 10 values of R transferred in IEEE floating point format by the SR850 */

    int i;

```

```

printf("\n\n");
for (i=0;i<10;i++)
    printf("%d  %e\n",i,rfBuf[i]); /* this is simple since the values are already floats */
}

void printOutLIAResults(void)
{
    /* calculates the first 10 values of R transferred in LIA float format by the SR850 */

    int i,mant,exp;
    int *ptr;
    float val;

    printf("\n\n");
    ptr=(int *) rfBuf; /* ptr points to integers in rfBuf, not floats! */

    for (i=0;i<10;i++) {
        mant = *ptr++; /* first comes the mantissa (16 bits) */
        exp  = *ptr++ - 124; /* then the binary exponent (16 bits) offset by 124 */
        val  = (float) mant * (float) pow(2.0,(double) exp);
        printf("%d  %e\n",i,val);
    }
}

void initGpib(char *devName)
{
    if ((lia=ibfind(devName))<0) {
        printf("\nCannot Find SR850 \n\a");
        exit(1);
    }
}

void txLia(char *str)
{
    char serPol;

    ibwrt(lia,str,strlen(str));
    do {
        ibrsp(lia,&serPol); /* now poll for IFC RDY */
    } while ((serPol&2)==0); /* until the command finishes executing */
}

void setupLiaForSweep(void)
{
    txLia("*RST"); /* initialize the lock-in */

    txLia("FMOD1;SLLM10.;SULM100."); /* set sweep mode and sweep limits */
    txLia("ILIN1"); /* put in the line notch filter */
    txLia("SRAT10;SEND0;SLEN100"); /* set 64 Hz sample rate, stop at end of scan, 100 second
                                     scan length */
    txLia("SMOD0"); /* set single screen */
    txLia("DTYP0,3;DTRC0,3"); /* set chart display, 'R' display */
}

```

```
txLia("DSCL0,.5;DOFF0,.5");      /* set scale from 0 to 1 V */
txLia("DHZS0,11");               /* set 10s/div horizontal */

printf("Scan is Initialized, Press <Enter> to Begin Scan...");
getch();
}
```

EXAMPLE PROGRAM 2

Using Microsoft QUICKBASIC (v4.5) with the National Instruments GPIB card on the IBM PC.

To successfully interface the SR850 to a PC via the GPIB interface, the instrument, interface card, and interface drivers must all be configured properly. To configure the SR850, the GPIB address must be set in the SYSTEM SETUP menu. The default GPIB address is 8; use this address unless a conflict occurs with other instruments in your system. The SR850 will be set to GPIB address 8 whenever a reset is performed (power on with the [-] key down).

Make sure that you follow all the instructions for installing the GPIB card. The National Instruments card cannot be simply unpacked and put into your computer. To configure the card you must set jumpers and switches on the card to set the I/O address and interrupt levels. You must run the program "IBCONF" to configure the resident GPIB driver for your GPIB card. Please refer to the National Instruments manual for information. In this example, the following options must be set with IBCONF:

```
Device name:          LIA
Device address:      8
Terminate Read on EOS: No (For binary transfers)
```

Once all the hardware and GPIB drivers are configured, use "IBIC". This terminal emulation program allows you to send commands to the SR850 directly from your computer's keyboard. If you cannot talk to the SR850 via "IBIC", then your programs will not run. Use the simple commands provided by National Instruments. Use "IBWRT" and "IBRD" to write and read from the SR850. After you are familiar with these simple commands, you can explore more complex programming commands.

Link with the National Basic Library (see the National software manual for more information on making QuickBasic libraries.)

```
' *****
' QuickBASIC 4.0/4.5 SR850 Example Program
'
' The program assumes that a device has been initialized with the device name "LIA"
' The device name is the name used in IBCONF to configure the National Instruments driver.
'
' Connect the Sine Out to the A Input with a BNC cable.
'
' The program will configure the SR850 to sweep the internal oscillator from 10 to 100 Hz in 100 seconds.
' The line notch (50/60 Hz) filter will be engaged. As the frequency is swept, the response of the notch filter
' is graphed.
'
' Binary X and Y data will be transferred to the PC during the sweep using the FAST transfer command.
' After the sweep is complete, the existing magnitude (R) data in the data buffer will be transferred in ASCII
' format as well as the LIA non-normalized floating point format (faster transfer).
' IEEE floating point format can not be used in BASIC since BASIC does not use this format.
'
' use the National Instruments include file
REM $INCLUDE: 'qbdecl4.bas'

DECLARE SUB TXLIA (LIA%, SND$)
DECLARE SUB FINDERR ()
```

Remote Programming

- ' Look for device named "LIA". Use IBCONF to configure the device "LIA" as above.
- ' Assign the device handle to variable LIA%.

```
BDNAME$ = "LIA"  
CALL IBFIND(BDNAME$, LIA%)
```

- ' Check for error on IBFIND call.

```
IF LIA% < 0 THEN CALL FINDERR
```

- ' Reset the device.

```
WRT$ = "*RST"  
CALL TXLIA(LIA%, WRT$)  
CALL IBCLR(LIA%)
```

```
PRINT "The SR850 is reset. Now initialize the scan"  
PRINT "Press <Enter> to continue."  
INPUT a
```

- ' Set the SR850 to output responses to the GPIB port

```
WRT$="OUTX1"  
CALL TXLIA(LIA%, WRT$)
```

- ' Set Internal sweep from 10 to 100 Hz

```
WRT$ = "FMOD1;SLLM10.;SULM100."  
CALL TXLIA(LIA%, WRT$)
```

- ' Turn line notch filter on

```
WRT$ = "ILIN1"  
CALL TXLIA(LIA%, WRT$)
```

- ' Set sample rate to 64 Hz, stop at end, 100 second scan length

```
WRT$ = "SRAT10;SEND0;SLEN100"  
CALL TXLIA(LIA%, WRT$)
```

- ' Set single screen, chart, display R

```
WRT$ = "SMOD0;DTYP0,3;DTRC0,3"  
CALL TXLIA(LIA%, WRT$)
```

- ' Set scale to 0 to 1 V, 10 sec per division

```
WRT$ = "DSCL0,.5;DOFF0,.5;DHZS0,11"  
CALL TXLIA(LIA%, WRT$)
```

```
PRINT "The scan is ready. Now acquire data."  
PRINT "Press <Enter> to continue."  
INPUT a
```

```
DIM RXBUF%(13000)
```

- ' Turn off GPIB timeout or set the timeout longer than the scan. The timeout measures the time to transfer the full number of bytes, not the time since the most recent byte is received.

```
CALL IBTMO(LIA%, 16)
```

- ' Turn FAST mode data transfer ON, then start scan using the STRD start after delay command.

- ' The STRD command must be used if the the scan is to be started by this program!

- ' Do NOT use STRT.

```

WRT$ = "FAST2;STRD"
CALL TXLIA(LIA%, WRT$)

' Get FAST mode data.
' The 100 sec sweep at 64 Hz has 64*100 + 1 points, each point consists of X (2 bytes) and Y (2 bytes)
' for a total of 4 bytes per sample. 6401*4=25604 bytes.
CALL IBRDI(LIA%, RXBUF%(), 25604)

PRINT "Scan Finished."; IBCNT%; "Bytes Received"

' Now print out the first 10 values of R based on the X and Y values

FOR I% = 0 TO 9
' the buffer contains X,Y pairs so move by 2*I% to find the next point.
X = RXBUF%(2 * I%) / 30000!
Y = RXBUF%(2 * I% + 1) / 30000!
' 30000 is full scale (1V in this case). For other scales, multiply by the full scale voltage.
R = SQR((X * X) + (Y * Y))
PRINT "I ="; I%; "
    R ="; R
NEXT I%

PRINT "Now dump the scan as ASCII values"
PRINT "Press <Enter> to continue"
INPUT a

DIM RFBUF(10)
FOR I% = 1 TO 10
RD$ = SPACE$(20)
' Read 1 value of R from buffer position I%-1
WRT$ = "TRCA?3," + STR$(I% - 1) + ",1"
CALL TXLIA(LIA%, WRT$)
CALL IBRD(LIA%, RD$)
' Convert to number and store
RFBUF(I%) = VAL(RD$)
PRINT "I ="; I%; "
    R ="; RFBUF(I%)
NEXT I%

PRINT "Now dump the scan as LIA floating point values"
PRINT "Press <Enter> to continue"
INPUT a

' Read from buffer position 0 a total of 10 points
WRT$ = "TRCL?3,0,10"
' Do not use TXLIA here since the IFC RDY bit will not be cleared until the binary transfer is complete.
CALL IBWRT(LIA%, WRT$)
' Each point is a 4 byte value made up of 2 integers
CALL IBRDI(LIA%, RXBUF%(), 40)

FOR I% = 0 TO 9
' the first integer of each pair is the mantissa
MANTISSA% = RXBUF%(2 * I%)
' the second integer is the exponent offset by 124

```

Remote Programming

```
EXPONENT% = RXBUF%(2 * I% + 1) - 124
'   compute the floating point value
R = MANTISSA% * 2! ^ EXPONENT%
PRINT "I =", I%; "
    R ="; R
NEXT I%

END

SUB FINDERR STATIC
PRINT "IBFIND ERROR"
END SUB

SUB TXLIA (LIA%, SND$)
CALL IBWRT(LIA%, SND$)
'   wait until the command is finished executing
DO
CALL IBRSP(LIA%, SPR%)
LOOP WHILE (SPR% AND 2) <> 2
END SUB
```

Introduction

The performance tests described in this section are designed to verify with a high degree of confidence that the unit is performing within the specifications.

The results of each test may be recorded on the test sheet at the end of this section.

[HARDKEYS]

The keypad consists of five groups of hardkeys. The ENTRY keys are used to enter numeric parameters which have been highlighted by a softkey. The MENU keys select a menu of softkeys. Pressing a menu key will change the menu boxes which are displayed next to the softkeys. Each menu groups together similar parameters and functions. The CONTROL keys start and stop actual data acquisition, select the cursor and toggle the active display. These keys are not in a menu since they are used frequently and while displaying any menu. The SYSTEM keys print the screen to a printer and display help messages. Once again, these keys can be accessed from any menu. The AUTO keys are perform various auto functions and can be accessed from any menu.

Hardkeys are referenced in braces like [HELP].

<Softkeys>

The SR850 has a menu driven user interface. The 6 softkeys to the right of the video display have different functions depending upon the information displayed in the menu boxes along the right edge of the screen. In general, the softkeys have two uses. The first is to toggle a feature on and off or to choose between settings. The second is to highlight a parameter which is then changed using the knob or numeric keypad. In both cases, the softkeys affect the parameters which are displayed adjacent to them.

Softkeys are referenced in brackets like <Ref. Frequency>.

Knob

The knob is used to adjust parameters which have been highlighted using the softkeys. Most numeric entry fields may be adjusted using the knob. In addition, parameters such as sensitivity and time constant use the knob as well. In these cases, the knob function is selected by the softkeys. The [CURSOR] key, which can be pressed at any time, will set the knob function to scrolling the cursor.

Preset

Throughout this section, it will be necessary to preset the lock-in into a known default state. To do this, turn the power off. Turn the power back on while holding down the [] (backspace) key. The unit will perform power up tests and then assume the default settings. Each test generally starts with a preset. This procedure will be referred to as {PRESET}.

Serial Number

If you need to contact Stanford Research Systems, please have the serial number of your unit available. The serial number is printed on a label affixed to the rear panel. The serial number is also displayed on the screen when the unit is powered on.

The serial number can also be displayed by pressing

```
[SYSTEM SETUP]
<Hardware Test >
<More>
<Screen Test>
```

Firmware Revision

The firmware revision code is displayed on the screen when the unit is powered on. The revision code is also displayed with the serial number in the Screen Test described above.

General Installation

POWER

Make sure that the power entry module on the rear panel is set for the AC line voltage in your area and that the correct fuse is installed. The selected AC voltage may be seen through the window on the power entry module. Verify that the line cord is plugged all the way into the power entry module and that the power button on the front panel is pressed in.

SCREEN BRIGHTNESS

If the screen is too dark or too bright, adjust the brightness using the knob at the upper left of the screen. Do not set the brightness higher than necessary.

DISPLAY POSITION

Use the Setup Screen function in the SYSTEM SETUP menu to position the display in the center of the screen.

FAN

The fan in the SR850 is required to cool the unit. Do not block the vents in the chassis or the unit may not operate properly.

Necessary Equipment

The following equipment is necessary to complete the performance tests. The suggested equipment or its equivalent should be used.

1. Frequency Synthesizer

Freq Range	1 Hz to 1 MHz
Freq Accuracy	better than 5 ppm
Amplitude Accuracy	0.2 dB from 1 Hz to 100 kHz
Harmonic Distortion	-65 dBc
Spurious	-55 dBc
TTL SYNC	available

Recommended SRS DS345

2. AC Calibrator

Freq Range	10 Hz to 100 kHz
Amplitude	1 mV to 10 V
Accuracy	0.1%
External phase locking capability	

Recommended Fluke 5200A

3. DC Voltmeter

Range	19.999 V, 4 1/2 digits
Accuracy	0.005%

Recommended Fluke 8840A

4. Feedthrough Terminations

Impedance	50
-----------	----

Warm Up

The lock-in should be turned on and allowed to warm up for at least an hour before any tests are performed. The self test does not require any warm up period.

It is necessary to turn the unit off and on to preset it. As long as the unit is powered on immediately, this will not affect the test results.

The Test Record

Make a copy of the SR850 Performance Test Record at the end of this section. Fill in the results of the tests on this record. This record will allow you to determine whether the tests pass or fail and also to preserve a record of the tests.

If A Test Fails

If a test fails, you should check the settings and connections of any external equipment and, if possible, verify its operation using a DVM, scope or some other piece of test equipment.

After checking the setup, repeat the test from the beginning to make sure that the test was performed correctly.

If the test continues to fail, contact Stanford Research Systems for further instructions. Make sure that you have the unit's serial number and firmware revision code handy. Have the test record on hand as well.

1. Self Tests

The self tests check the lock-in hardware. These are functional tests and do not relate to the specifications. These tests should be run before any of the performance tests.

Note that the Hardware Test menu offers more tests than are required here. Only those tests which require no additional equipment are discussed in this section. The computer interface and disk drive tests are not required but should be periodically checked. See the System Setup menu for more information about those tests.

Setup

No external setup is required for this test.

Procedure

- 1) {PRESET} (Turn on the lock-in with the [] key pressed)
At power up, the RAM, ROM, CLK and DSP tests should all be OK.
- 2) Press the keys in the following sequence:
 - [SYSTEM SETUP]
 - <Hardware Test>
 - <Keypad Test>
Press all of the front panel keys until all of the boxes on the screen are filled in.
Then press any key to exit this screen.
 - <Knob Test>
 - <Speed 2>
Rotate the knob to verify rotation and direction.
 - <Return>
 - <More>
 - <Memory Test>
 - <Main Mem>
 - <Begin Test>
All of the main memory chips should Pass.
 - <Return>
 - <Video Mem>
 - <Begin Test>
All of the video memory chips should Pass.
 - <Return>
 - <Return>
- 3) This completes the functional hardware tests. Enter the results of this test in the test record at the end of this section.

2. DC Offset

This test measures the DC offset of the input.

Setup

Connect a 50 Ω terminator to the A input. This shorts the input so the lock-in's own DC offset will be measured.

Procedure

- 1) {PRESET} (Turn the lock-in off and on with the [] key pressed)
- 2) Press the keys in the following sequence:

[REF/PHASE]
 <Ref. Frequency>
 [1] [ENTER]

[GAIN/TC]
 <Sensitivity>
 Use the knob to select 1 mV.

[DISPLAY/SCALE]
 <Type and Trace>
 Highlight the trace number.
 Use the knob to select trace 3 (R) for the top display.

- 3) Wait at least 10 seconds, then record the reading of R.
- 4) Press

[INPUT]
 <Coupling>
 Select DC coupling.

- 5) Wait 10 seconds, then record the reading of R.
- 6) This completes the DC offset test. Enter the results of this test in the test record at the end of this section.

3. Common Mode Rejection

This test measures the common mode rejection of the lock-in.

Setup

We will use the internal oscillator sine output to provide the signal.

Connect the Sine Out to both the A and B inputs of the lock-in. Use equal length cables from A and B to a BNC TEE. Connect the cable from the Sine Out to the TEE. Do not use any termination.

Procedure

1) {PRESET} (Turn the lock-in off and on with the [] key pressed)

2) Press the keys in the following sequence:

[REF/PHASE]
 <Ref. Frequency>
 [1] [0] [0] [ENTER]

[DISPLAY/SCALE]
 <Type and Trace>
 Highlight the trace number.
 Use the knob to select trace 3 (R) for the top display.

[INPUT/FILTER]
 <Coupling>
 Select DC.

3) The value of R should be 1.000 V (within 2%).

4) Press

[INPUT/FILTER]
 <Source>
 Select A-B.

[GAIN/PHASE]
 <Sensitivity>
 Use the knob to select 200 μ V.

5) Record the value of R.

6) This completes the CMRR measurement test. The common mode rejection is $20\log(1.0/R)$ where R is in Volts. Enter the results of this test in the test record at the end of this section.

4. Amplitude Accuracy and Flatness

This test measures the amplitude accuracy and frequency response.

Setup

We will use the frequency synthesizer to provide an accurate frequency and the AC calibrator to provide a sine wave with an exact amplitude.

Connect the output of the frequency synthesizer to the phase lock input of the calibrator. Connect the output of the AC calibrator to the A input of the lock-in. Be sure to use the appropriate terminations where required. Connect the TTL SYNC output of the synthesizer to the Reference Input of the lock-in.

Set the Synthesizer to:

Function	Sine
Frequency	1 kHz
Amplitude	0.5 Vrms
Offset	off or 0V
Sweep	off
Modulation	none

Set the AC Calibrator to:

Frequency	1 kHz
Amplitude	1.000 Vrms
Voltage	Off
Phase Lock	On
Sense	Internal

Procedure

- 1) {PRESET} (Turn the lock-in off and on with the [] key pressed)
- 2) Press the keys in the following sequence:

[REF/PHASE]

<Ref. Source>

Use the knob to select External.

<Ref. Slope>

Select Rising edge.

[DISPLAY/SCALE]

<Type and Trace>

Highlight the trace number.

Use the knob to select trace 3 (R) for the top display.

[GAIN/TC]

<Filter db/oct>

Select 24 dB/oct.

- 3) Amplitude accuracy is verified at 1 kHz and various sensitivities. For each sensitivity setting in the table below, perform steps 3a through 3c.

<u>Sensitivity</u>	<u>AC Calibrator Amplitude</u>
1 V	1.0000 Vrms
200 mV	200.00 mVrms
100 mV	100.000 mVrms
20 mV	20.000 mVrms
10 mV	10.000 mVrms

Performance Tests

- a) Set the AC calibrator to the amplitude shown in the table.
 - b) Press
 <Sensitivity>
 Use the knob to select the sensitivity from the table.
 - c) Wait for the R reading to stabilize. Record the value of R for each sensitivity.
- 4) Frequency response is checked at frequencies above 1 kHz. The test frequencies are listed below.
- Test Frequencies
- 24 kHz
 - 48 kHz
 - 72 kHz
 - 96 kHz
- a) Set the AC calibrator to 1 kHz and an amplitude of 200.00 mVrms.
 - b) Set the frequency synthesizer to 1 kHz.
 - c) Press
 [GAIN/TC]
 <Sensitivity>
 Use the knob to select 200 mV.
 - d) Set the AC calibrator and frequency synthesizer to the frequency in the table.
 - e) Wait for the R reading to stabilize. Record the value of R.
 - f) Repeat steps 4d and 4e for all of the frequencies listed.
- 5) This completes the amplitude accuracy and frequency response test. Enter the results of this test in the test record at the end of this section.

5. Amplitude Linearity

This test measures the amplitude linearity. This tests how accurately the lock-in measures a signal smaller than full scale.

Setup

We will use the frequency synthesizer to provide an accurate frequency and the AC calibrator to provide a sine wave with an exact amplitude.

Connect the output of the frequency synthesizer to the phase lock input of the calibrator. Connect the output of the AC calibrator to the A input of the lock-in. Be sure to use the appropriate terminations where required. Connect the TTL SYNC output of the synthesizer to the Reference Input of the lock-in.

Set the Synthesizer to:

Function	Sine
Frequency	1 kHz
Amplitude	0.5 Vrms
Offset	off or 0V
Sweep	off
Modulation	none

Set the AC Calibrator to:

Frequency	1 kHz
Amplitude	1.0000 Vrms
Voltage	Off
Phase Lock	On
Sense	Internal

Procedure

- 1) {PRESET} (Turn the lock-in off and on with the [] key pressed)
- 2) Press the keys in the following sequence:

[REF/PHASE]

<Ref. Source>

Use the knob to select External.

<Ref. Slope>

Select Rising edge.

[DISPLAY/SCALE]

<Type and Trace>

Highlight the trace number.

Use the knob to select trace 3 (R) for the top display.

[GAIN/TC]

<Filter db/oct>

Select 24 dB/oct.

[OUTPUT/OFFSET]

<X, Y or R>

Select R offset and expand.

Performance Tests

- 3) For each of the amplitudes listed below, perform steps 3a through 3c.

<u>AC Calibrator Amplitudes</u>	<u>R Output Expand</u>
1.0000 Vrms	1
100.00 mVrms	10
10.000 mVrms	100
4.000 mVrms	250

- a) Set the AC calibrator to the amplitude in the table.
- b) Press the keys in the following sequence:
- <Expand>
 - Highlight the R expand.
 - Enter the R Output Expand from the table.
- c) Wait for the R reading to stabilize. Record the value of R.
- 4) This completes the amplitude linearity test. Enter the results of this test in the test record at the end of this section.

6. Frequency Accuracy

This test measures the frequency accuracy of the lock-in. This tests the accuracy of the frequency counter inside the unit. The counter is used only in external reference mode. The internal oscillator frequency is set by a crystal and has 25 ppm frequency accuracy.

Setup

We will use the frequency synthesizer to provide the reference signal.

Connect the TTL SYNC output of the frequency synthesizer to the Reference input of the lock-in.

Procedure

- 1) {PRESET} (Turn the lock-in off and on with the [] key pressed)
- 2) Set the frequency synthesizer to a frequency of 10 kHz.
- 3) Press the keys in the following sequence:
 - [REF/PHASE]
 - <Ref. Source>
Use the knob to select External.
 - <Ref. Slope>
Select Rising edge.
- 4) The lock-in should be locked to the external reference. The frequency is displayed at the bottom of the screen. Record the frequency reading.
- 5) This completes the frequency accuracy test. Enter the results of this test in the test record at the end of this section.

7. Phase Accuracy

This test measures the phase accuracy of the lock-in. Due to the design of the lock-in, the phase accuracy can be determined by measuring the phase of the internal oscillator Sine Out.

Setup

Connect the Sine Out to the A input of the lock-in using a 1 meter BNC cable. Do not use any termination.

Procedure

- 1) {PRESET} (Turn the lock-in off and on with the [] key pressed)
- 2) Press the keys in the following sequence:

[GAIN/TC]
 <Filter db/oct>
 Select 24 dB/oct.

[INPUT/FILTERS]
 <Coupling>
 Select DC coupling.

[DISPLAY/SCALE]
 <Type and Trace>
 Highlight the trace number.
 Use the knob to select trace 3 (R) for the top display.
 <Top and Bottom>
 Select the Bottom display.
 Use the knob to select trace 4 () for the bottom display.

- 3) The value of R should be 1.000 V ($\pm 2\%$) and the value of ϕ should 0° ($\pm 1^\circ$).
- 4) Phase accuracy is checked at various frequencies. The test frequencies are listed below.

Test Frequencies

10 Hz
 100 Hz
 1 kHz
 10 kHz

- a) Press

[REF/PHASE]
 <Ref. Frequency>
 Enter the frequency from the table.

- b) Wait for the readings to stabilize. Record the value of ϕ .
- c) Repeat steps 4a and 4b for all frequencies in the table.

- 5) This completes the phase accuracy test. Enter the results of this test in the test record at the end of this section.

8. Sine Output Amplitude Accuracy and Flatness

This test measures the amplitude accuracy and frequency response of the internal oscillator Sine Out.

Setup

We will use the lock-in to measure the Sine Out. Connect the Sine Out to the A input of the lock-in.

Procedure

- 1) {PRESET} (Turn the lock-in off and on with the [] key pressed)
- 2) Press the keys in the following sequence:
 - [DISPLAY/SCALE]
 - <Type and Trace>
 - Highlight the trace number.
 - Use the knob to select trace 3 (R) for the top display.
- 3) Amplitude accuracy is verified at 1 kHz using various sensitivities. For each sine amplitude and sensitivity setting in the table below, perform steps 3a through 3b.

<u>Sensitivity</u>	<u>Sine Output Amplitude</u>
1 V	1.000 Vrms
200 mV	0.200 Vrms
50 mV	0.050 Vrms
10 mV	0.010 Vrms

- a) Press
 - [REF/PHASE]
 - <Sine Output>
 - Enter the sine amplitude from the table.
 - [GAIN/TC]
 - <Sensitivity>
 - Use the knob to select the sensitivity from the table.
- b) Wait for the R reading to stabilize. Record the value of R.
- c) Repeat 3a and 3b for each amplitude in the table.
- 4) Frequency response is checked at frequencies above 1 kHz. The sine amplitude is set to 1 Vrms for all frequencies. The test frequencies are listed below.

<u>Test Frequencies</u>
24 kHz
48 kHz
72 kHz
96 kHz

Performance Tests

- c) Press
[GAIN/TC]
<Sensitivity>
Use the knob to select 1 V.
- [REF/PHASE]
<Sine Output>
[1] [ENTER]
- d) Press
<Ref. Frequency>
Enter the frequency from the table.
- e) Wait for the R reading to stabilize. Record the value of R.
- f) Repeat steps 4d and 4e for all of the frequencies listed.
- 5) This completes the sine output amplitude accuracy and frequency response test. Enter the results of this test in the test record at the end of this section.

9. DC Outputs and Inputs

This test measures the DC accuracy of the DC outputs and inputs of the lock-in.

Setup

We will use the digital voltmeter (DVM) to measure the DC outputs of the lock-in. Then we will use one of the outputs to generate a voltage to measure on the DC inputs.

Connect a 50 Ω termination to the A input.

Procedure

- 1) {PRESET} (Turn the lock-in off and on with the [] key pressed)
- 2) Press
[OUTPUT/OFFSET]
- 3) For the CH1 and CH2 outputs, repeat steps 3a through 3e.
 - a) Connect the CH1 (or CH2) output to the DVM. Set the DVM to 19.999 V range.
 - b) Press
<Offset & Expand X, Y, or R>
Select X for CH1 and Y for CH2.
 - c) For each of the offsets in the table below, repeat steps 3d and 3e.

<u>Offsets (%)</u>
-100.00
-50.00
0.00
50.00
100.00

- d) Press
<Offset>
Enter the offset from the table.
 - e) Record the DVM reading.
- 4) Press
[AUX OUTPUTS]
- 5) For each output (1, 2, 3 and 4), repeat steps 5a through 5e.
 - a) Press
<1,2,3,4>
Select the output.
 - b) Connect the selected Aux Output to the DVM.

Performance Tests

c) For each output voltage in the table below, repeat steps 5d and 5e.

Output Voltages

-10.000
-5.000
0.000
5.000
10.000

d) Press

<Voltage>
Enter the voltage from the table.

e) Record the DVM reading.

6) Press

[DISPLAY/SCALE]
<Monitor>
Select Input/Output.

[AUX OUTPUTS]
<1,2,3,4>
Select Aux Out 1.

7) For each Aux Input (1,2,3 and 4), repeat steps 7a through 7d.

a) Connect Aux Out 1 to Aux Input 1,2,3 or 4.

b) For each output voltage in the table above, repeat steps 7c and 7d.

c) Press

<Voltage>
Enter the voltage from the table.

d) Record the Aux Input value from the monitor display at the top of the screen.

8) This completes the DC outputs and inputs test. Enter the results of this test in the test record at the end of this section.

10. Input Noise

This test measures the lock-in input noise.

Setup

Connect a 50 Ω termination to the A input. This grounds the input so the lock-in's own noise is measured.

Procedure

- 1) {PRESET} (Turn the lock-in off and on with the [] key pressed)
- 2) Press the keys in the following sequence:
 - [GAIN/TC]
 - <Sensitivity>
Use the knob to select 100 nV.
 - [TRACE/SCAN]
 - <Trace definition> (second soft key)
Highlight X.
Use the knob to select Xn.
- 3) Wait until the reading of T1 (top display) stabilizes. Record the value of T1.
- 8) This completes the noise test. Enter the results of this test in the test record at the end of this section.

SR850 Performance Test Record

Serial Number _____ Tested By _____
 Firmware Revision _____ Date _____

Equipment Used _____

1. Self Tests

Test	Pass	Fail
Power On Tests	_____	_____
Keypad	_____	_____
Knob	_____	_____
Main Memory	_____	_____
Video Memory	_____	_____

2. DC Offset

Input Coupling	Reading	Upper Limit
AC	_____	0.500 mV
DC	_____	0.500 mV

3. Common Mode Rejection

Frequency	Reading	Upper Limit
100 Hz	_____	30 μ V

4. Amplitude Accuracy and Flatness

Sensitivity	Calibrator Ampl.	Lower Limit	Reading	Upper Limit
1 V	1.0000 Vrms	0.9900 V	_____	1.0100 V
200 mV	200.00 mVrms	198.00 mV	_____	202.00 mV
100 mV	100.000 mVrms	99.00 mV	_____	101.00 mV
20 mV	20.000 mVrms	19.800 mV	_____	20.200 mV
10 mV	10.000 mVrms	9.900 mV	_____	10.100 mV

Sensitivity	Frequency	Lower Limit	Reading	Upper Limit
200 mV	24 kHz	198.00 mV	_____	202.00 mV
200 mV	48 kHz	198.00 mV	_____	202.00 mV
200 mV	72 kHz	198.00 mV	_____	202.00 mV
200 mV	96 kHz	198.00 mV	_____	202.00 mV

SR850 Performance Test Record

5. Amplitude Linearity

<u>Sensitivity</u>	<u>Calibrator Ampl.</u>	<u>Lower Limit</u>	<u>Reading</u>	<u>Upper Limit</u>
1 V	1.0000 Vrms	0.9900 V	_____	1.0100 V
	100.00 mVrms	0.0990 V	_____	0.1010 V
	10.000 mVrms	0.0098 V	_____	0.0102 V
	4.000 mVrms	0.0038 V	_____	0.0042 V

6. Frequency Accuracy

<u>Input Frequency</u>	<u>Lower Limit</u>	<u>Reading</u>	<u>Upper Limit</u>
10 kHz	9.990 kHz	_____	10.010 kHz

7. Phase Accuracy

<u>Frequency</u>	<u>Lower Limit</u>	<u>Reading</u>	<u>Upper Limit</u>
10 Hz	-1.0 deg	_____	+1.0 deg
100 Hz	-1.0 deg	_____	+1.0 deg
1 kHz	-1.0 deg	_____	+1.0 deg
10 kHz	-1.0 deg	_____	+1.0 deg

8. Sine Output Amplitude and Flatness

<u>Sensitivity</u>	<u>Sine Output Ampl.</u>	<u>Lower Limit</u>	<u>Reading</u>	<u>Upper Limit</u>
1 V	1.000 Vrms	0.9800 V	_____	1.0200 V
200 mV	0.200 Vrms	196.00 mV	_____	204.00 mV
50 mV	0.050 Vrms	49.000 mV	_____	51.000 mV
10 mV	0.010 Vrms	9.800 mV	_____	10.200 mV

<u>Sine Ampl.</u>	<u>Frequency</u>	<u>Lower Limit</u>	<u>Reading</u>	<u>Upper Limit</u>
1.000 Vrms	24 kHz	0.9800 V	_____	1.0200 V
	48 kHz	0.9800 V	_____	1.0200 V
	72 kHz	0.9800 V	_____	1.0200 V
	96 kHz	0.9800 V	_____	1.0200 V

9. DC Outputs and Inputs

<u>Output</u>	<u>Offset</u>	<u>Lower Limit</u>	<u>Reading</u>	<u>Upper Limit</u>
CH1	-100.00	9.960 V	_____	10.040 V
	-50.00	4.960 V	_____	5.040 V
	0.00	-0.020 V	_____	0.020 V
	50.00	-5.040 V	_____	-4.960 V
	100.00	-10.040 V	_____	-9.960 V

SR850 Performance Test Record

9. DC Outputs and Inputs (continued)

<u>Output</u>	<u>Offset</u>	<u>Lower Limit</u>	<u>Reading</u>	<u>Upper Limit</u>
CH2	-100.00	9.960 V	_____	10.040 V
	-50.00	4.960 V	_____	5.040 V
	0.00	-0.020 V	_____	0.020 V
	50.00	-5.040 V	_____	-4.960 V
	100.00	-10.040 V	_____	-9.960 V

<u>Output</u>	<u>Voltage</u>	<u>Lower Limit</u>	<u>Reading</u>	<u>Upper Limit</u>
AUX1	-10.000	-10.040 V	_____	-9.960 V
	-5.000	-5.040 V	_____	-4.960 V
	0.000	-0.020 V	_____	0.020 V
	5.000	4.960 V	_____	5.040 V
	10.000	9.960 V	_____	10.040 V

<u>Output</u>	<u>Voltage</u>	<u>Lower Limit</u>	<u>Reading</u>	<u>Upper Limit</u>
AUX2	-10.000	-10.040 V	_____	-9.960 V
	-5.000	-5.040 V	_____	-4.960 V
	0.000	-0.020 V	_____	0.020 V
	5.000	4.960 V	_____	5.040 V
	10.000	9.960 V	_____	10.040 V

<u>Output</u>	<u>Voltage</u>	<u>Lower Limit</u>	<u>Reading</u>	<u>Upper Limit</u>
AUX3	-10.000	-10.040 V	_____	-9.960 V
	-5.000	-5.040 V	_____	-4.960 V
	0.000	-0.020 V	_____	0.020 V
	5.000	4.960 V	_____	5.040 V
	10.000	9.960 V	_____	10.040 V

<u>Output</u>	<u>Voltage</u>	<u>Lower Limit</u>	<u>Reading</u>	<u>Upper Limit</u>
AUX4	-10.000	-10.040 V	_____	-9.960 V
	-5.000	-5.040 V	_____	-4.960 V
	0.000	-0.020 V	_____	0.020 V
	5.000	4.960 V	_____	5.040 V
	10.000	9.960 V	_____	10.040 V

SR850 Performance Test Record

9. DC Outputs and Inputs (continued)

<u>Input</u>	<u>Voltage</u>	<u>Lower Limit</u>	<u>Reading</u>	<u>Upper Limit</u>
AUX1	-10.000	-10.040 V	_____	-9.960 V
	-5.000	-5.040 V	_____	-4.960 V
	0.000	-0.020 V	_____	0.020 V
	5.000	4.960 V	_____	5.040 V
	10.000	9.960 V	_____	10.040 V

<u>Input</u>	<u>Voltage</u>	<u>Lower Limit</u>	<u>Reading</u>	<u>Upper Limit</u>
AUX2	-10.000	-10.040 V	_____	-9.960 V
	-5.000	-5.040 V	_____	-4.960 V
	0.000	-0.020 V	_____	0.020 V
	5.000	4.960 V	_____	5.040 V
	10.000	9.960 V	_____	10.040 V

<u>Input</u>	<u>Voltage</u>	<u>Lower Limit</u>	<u>Reading</u>	<u>Upper Limit</u>
AUX3	-10.000	-10.040 V	_____	-9.960 V
	-5.000	-5.040 V	_____	-4.960 V
	0.000	-0.020 V	_____	0.020 V
	5.000	4.960 V	_____	5.040 V
	10.000	9.960 V	_____	10.040 V

<u>Input</u>	<u>Voltage</u>	<u>Lower Limit</u>	<u>Reading</u>	<u>Upper Limit</u>
AUX4	-10.000	-10.040 V	_____	-9.960 V
	-5.000	-5.040 V	_____	-4.960 V
	0.000	-0.020 V	_____	0.020 V
	5.000	4.960 V	_____	5.040 V
	10.000	9.960 V	_____	10.040 V

10. Input Noise

<u>Frequency</u>	<u>Sensitivity</u>	<u>Reading</u>	<u>Upper Limit</u>
1 kHz	100 nV Min Reserve	_____	8 nV/ Hz

CAUTION

Potentially lethal voltages are present in this instrument. This unit is to be serviced by qualified service personnel only. There are no user serviceable parts inside.

Check the LED at the front edge of the power supply board. The unit is safe only if the LED is OFF. If the LED is ON, then voltages are present within the unit - USE CAUTION.

Use caution when checking circuits with the power on.

Always disconnect the power cord before replacing or servicing any component inside the chassis.

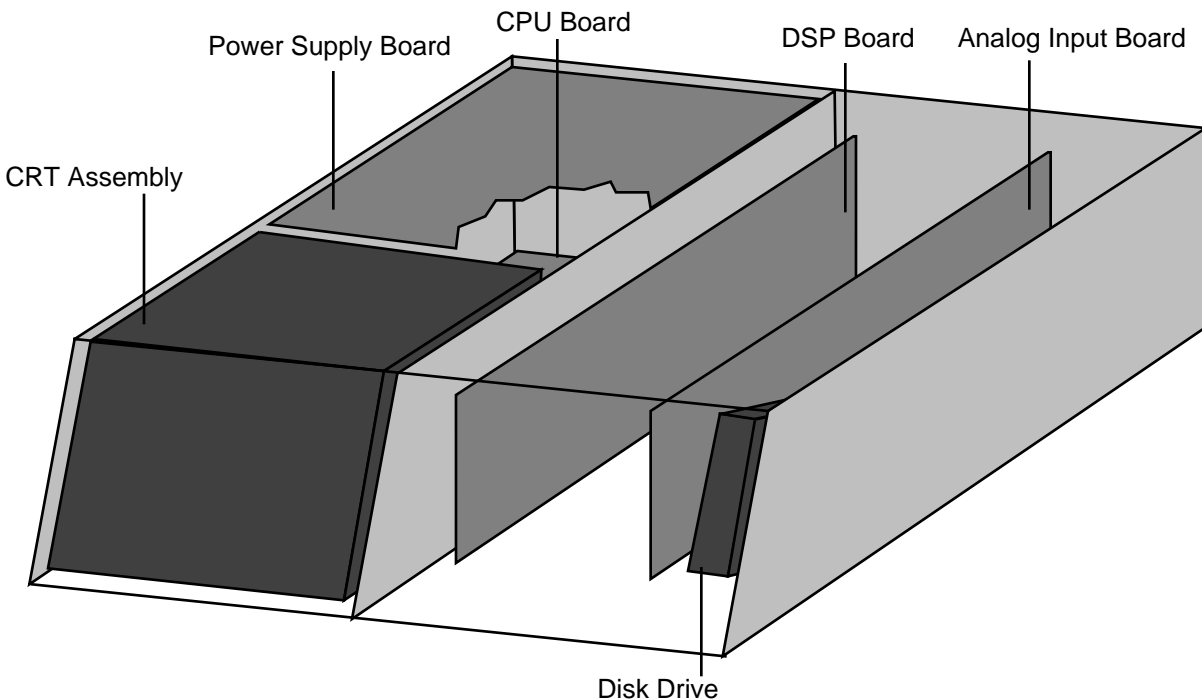

CIRCUIT BOARDS

The SR850 has four main printed circuit board assemblies. The four boards shown above contain most of the active circuitry of the unit. The CRT and video driver circuits are mounted inside the CRT shield assembly. This assembly is replaced as a unit. The front panel circuit board only has keypad contacts printed on it and holds no active components. The DSP and Analog boards are cards mounted in a shielded card cage behind the keypad. The disk drive is mounted on the right hand side panel.

Adjusting the DC Offset and Common Mode Rejection

1. The DC Offset and CMRR adjustments affect each other and must be done together. This procedure requires a 50 Ω terminator, a BNC Tee and a few BNC cables. A small slotted screwdriver is also required to adjust the potentiometers.
2. Turn the unit **ON** while holding the [-] key down. This resets the unit. Let it warm up for at least an hour.
3. Remove the four black screws which secure the top lid. There are two screws on each side. Slide the top lid back about 1/4". Remove the lid by pulling the lid towards the back and upwards. Remove the card cage cover by loosening the two screws at the center edge of the cover.
4. The adjustment pots are on the Analog board on right hand side of the card cage. Remove the magnetic shield cover at the front of the Analog board. Simply pull the shield up using the finger hole.
5. The adjustment pots are shown in the figure.

The **Offset** and **Common Mode** adjustment pots are inside the shield which is mounted on the analog board.

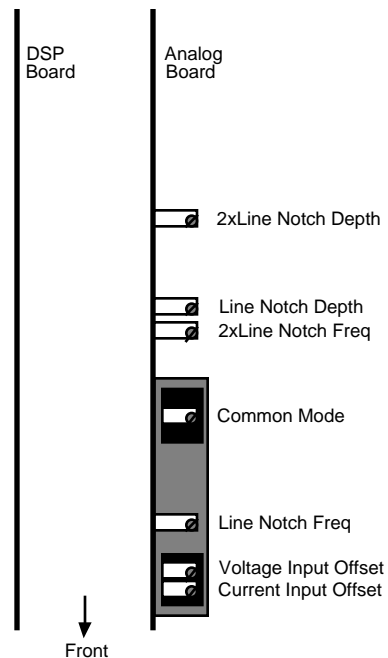

6. Press the following keys to set the frequency and display.

```
[REF/PHASE]
  <Ref. Frequency> Select Reference Frequency
    [1] [ENTER] Enter 1 Hz
[DISPLAY/SCALE]
  <Type/Trace> Select Trace Number for Top display
    [3] [ENTER] Enter 3 to display R
```

7. Connect a 50 Ω termination to the A input. This shorts the input so the lock-in's own DC offset will be measured.

Press

```
[GAIN/TC]
  <Filter dB/oct> twice to select 24 dB/oct
  <Sensitivity>
    Rotate the knob to select 100 mV full scale
```

If the R reading (top display) is less than 1 mV, then proceed to the next step. If the reading is greater than 1 mV, adjust the **Voltage Input Offset** pot until R is less than 1 mV.

8. Press

<Sensitivity>

Rotate the knob to select 1 mV full scale

If the R reading is less than 0.02 mV then proceed to the next step. If the reading is greater than 0.02 mV, adjust the **Voltage Input Offset** pot until R is less than 0.02 mV.

9. Connect the SINE OUT output to both the A and B inputs. Use equal length cables from A and B to a BNC TEE. Connect the cable from SINE OUT to the TEE.

Press

[GAIN/TC]

<Sensitivity>

Rotate the knob to select 1 V full scale

[REF/PHASE]

<Ref. Frequency> Select Reference Frequency

[1] [0] [0] [ENTER] Enter 100 Hz

[INPUT/FILTERS]

<Coupling> Select DC coupling

The R reading (top display) should read 1.00 V ($\pm 2\%$).

Press

<Source> to select A-B

If the R reading is less than 0.001 V, then proceed to the next step. If the reading is greater than 0.001 V, adjust the **Common Mode** pot until R is less than 0.001 V.

Press

[GAIN/TC]

<Sensitivity>

Rotate the knob to select 2 mV full scale

If the R reading is less than 0.2 mV, then proceed to the next step. If the reading is greater than 0.2 mV, adjust the **Common Mode** pot until R is less than 0.02 mV.

Press

[GAIN/TC]

<Sensitivity>

Rotate the knob to select 200 μ V full scale

If the R reading is less than 2 μ V, then proceed to the next step. If the reading is greater than 2 μ V, adjust the **Common Mode** pot until R is less than 2 μ V.

10. The offset needs to be readjusted after adjusting the common mode. Connect a 50 Ω termination to the A input.

Press

[INPUT/FILTERS]

<Source> twice to select A

<Coupling> to select AC

[REF/PHASE]

<Ref. Frequency> Select Reference Frequency

[1] [ENTER] Enter 1 Hz

[GAIN/TC]

<Sensitivity>

Rotate the knob to select 100 mV full scale

If the R reading (top display) is less than 1 mV, then proceed to the next step. If the reading is greater than 1 mV, adjust the **Voltage Input Offset** pot until R is less than 1 mV.

11. Press

<Sensitivity>

Rotate the knob to select 1 mV full scale

If the R reading is less than 0.02 mV then proceed to the next step. If the reading is greater than 0.02 mV, adjust the **Voltage Input Offset** pot until R is less than 0.02 mV.

12. Remove the terminator from the A input. Leave the inputs open to adjust the current input offset.

Press

[INPUT]

<Input Source> Twice to select I

<Grounding> select Ground

<Coupling> select DC

[GAIN/TC]

<Sensitivity>

Rotate the knob to select 100 nA full scale

If the R reading (top display) is less than 1 nA, then proceed to the next step. If the reading is greater than 1 nA, adjust the **Current Input Offset** pot until R is less than 1 nA.

13. Press

<Sensitivity>

Rotate the knob to select 1 nA full scale

If the R reading is less than 0.02 nA then proceed to the next step. If the reading is greater than 0.02 nA, adjust the **Current Input Offset** pot until R is less than 0.02 nA.

14. This completes the offset and common mode adjustment procedure.

15. Turn the unit **OFF**. Replace the magnetic shield at the front of the Analog board and replace the card cage cover. Tighten the two cover screws. Replace the top lid. The lid slides forward and down to engage the clip at the center front. Replace the four black screws to secure the lid.

Adjusting the Notch Filters

1. The Notch filter frequency and depth adjustments must be done together. This procedure requires a BNC cables. A small slotted screwdriver is also required to adjust the potentiometers.
2. Turn the unit **ON** while holding the [-] key down. This resets the unit. Let it warm up for at least an hour.
3. Remove the four black screws which secure the top lid. There are two screws on each side. Slide the top lid back about 1/4". Remove the lid by pulling the lid towards the back and upwards.
4. The adjustment pots are on the Analog board on right hand side of the card cage. The notch filter adjustments are accessible through the card cage vent holes. Do not remove the card cage cover.
5. The adjustment pots are shown in the figure.

The **Notch Frequency** and **Notch Depth** adjustment pots are outside the shield which is mounted on the analog board.

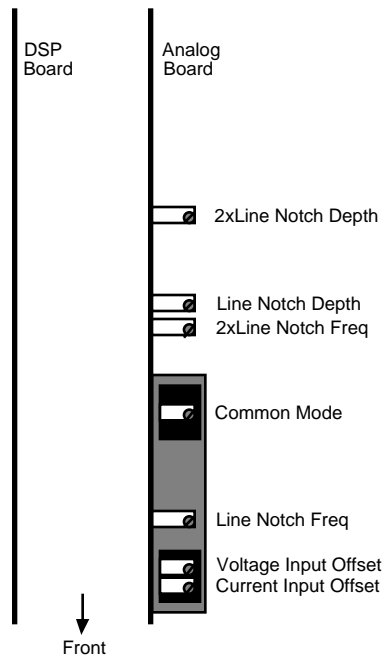

6. Connect the SINE OUT output to the A input with a BNC cable. Press the following keys to set the frequency, display and time constant.

[REF/PHASE]

<Ref. Frequency> Select Reference Frequency

[6] [0] [ENTER] Enter 60 Hz **OR**

[5] [0] [ENTER] Enter 50 Hz

[DISPLAY/SCALE]

<Type/Trace> Select Trace Number for Top display

[3] [ENTER] Enter 3 to display R on the top

<Full/Top/Bottom> to select Bottom display

[4] [ENTER] Enter 4 to display on the bottom

[GAIN/TC]

<Filter dB/oct> twice to select 24 dB/oct

<Synchronous> to select <200 Hz

After the readings are stable, the top display should read 1.00 V ($\pm 2\%$).

Press

[AUTO PHASE]

The bottom display should read 0.0°.

7. Press

[INPUT/FILTERS]

<Line Notches> to select Line

[GAIN/TC]

<Sensitivity>

Rotate the knob to select 50 mV full scale

Adjust the **Line Notch Depth** pot until R (top display) is between 20.0 and 25.0 mV.

Then adjust the **Line Notch Freq** pot to minimize the reading of R **AND** until (bottom display) is EITHER 0° or 180° (within 1°).

8. Now adjust the **Line Notch Depth** pot until R is less than 1.0 mV

9. Press

[INPUT/FILTERS]

<Line Notches> three times to select Out

[GAIN/TC]

<Sensitivity>

Rotate the knob to select 1V full scale

[REF/PHASE]

<Ref. Frequency> Select Reference Frequency

[1] [2] [0] [ENTER] Enter 120 Hz **OR**

[1] [0] [0] [ENTER] Enter 100 Hz

After the readings are stable, the top display should read 1.00 V ($\pm 2\%$).

Press

[AUTO PHASE]

The bottom display should read 0.0°.

10. Press

[INPUT/FILTERS]

<Line Notches> twice to select 2xLine

[GAIN/TC]

<Sensitivity>

Rotate the knob to select 50 mV full scale

Adjust the **2xLine Notch Depth** pot until R (top display) is between 20.0 and 25.0 mV.

Then adjust the **2xLine Notch Freq** pot to minimize the reading of R **AND** until (bottom display) is EITHER 0° or 180° (within 1°).

11. Now adjust the **2xLine Notch Depth** pot until R is less than 1.0 mV

12. This completes the notch filter adjustment procedure.

13. Turn the unit **OFF**. Replace the top lid. The lid slides forward and down to engage the clip at the center front. Replace the four black screws to secure the lid.

CIRCUIT DESCRIPTION

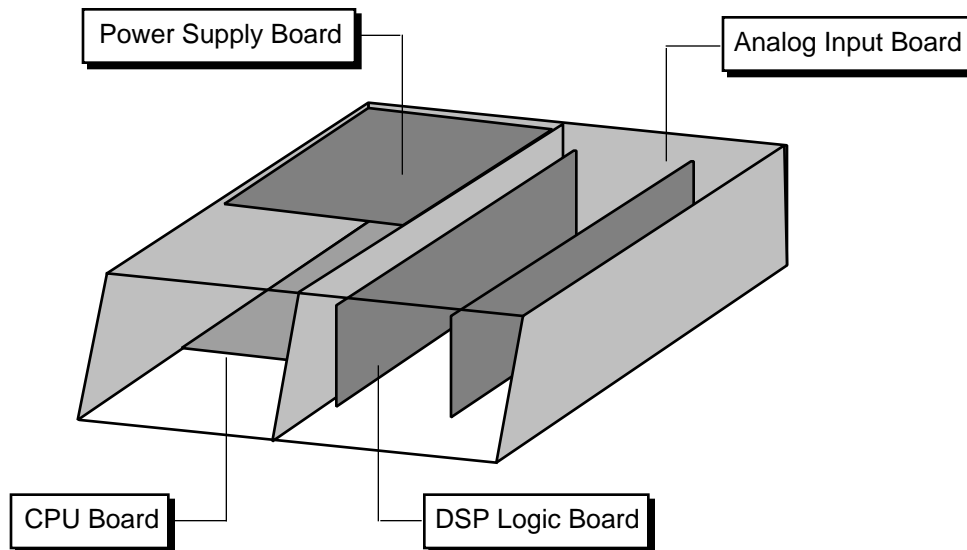

CAUTION

Always disconnect the power cord and wait at least one minute before opening the unit. Dangerous power supply voltages may be present even after the unit has been unplugged.

Check the LED at the front edge of the power supply board. The unit is safe only if the LED is OFF. If the LED is ON, then DO NOT attempt any service on the unit.

This unit is to be serviced by qualified service personnel only. There are no user serviceable parts inside.

VIDEO DRIVER AND CRT

Potentially lethal voltages are present in this circuit. Do not attempt to service the CRT and Video Driver Board. Refer any service problems to the factory.

CIRCUIT BOARDS

The SR850 has four main printed circuit boards. The four boards shown contain most of the active circuitry of the unit. The CRT and video driver board are mounted inside the CRT shield assembly. The front panel circuit board only has keypad contacts printed on it and holds no active components. The rear panel circuit board only provides connections to the BNC connectors on the rear panel.

CPU BOARD

The CPU board contains the microprocessor system. All display, front panel, disk, and computer interfaces are on this board.

MICROPROCESSOR SYSTEM

The microprocessor, U101, is an 80C186 microcontroller which integrates a fast 16 bit processor, counter-timers, interrupt controller, DMA controller, and I/O decoding into a single component.

The 80C186 uses a 24.00 MHz crystal, X101, as its oscillator. The instruction clock cycle is 2 oscillator cycles or 12.0 MHz. The data and lower 16 bits of address are multiplexed on AD0-AD15. U201, U202, U203 latch the address A0-A19 at the beginning of each memory or I/O cycle. U204 and U205 are bidirectional data bus drivers which are active during the data read/write portion of each memory or I/O cycle.

The 80C186 can address 1 Mbyte of memory and 64k of I/O space. The memory is mapped into 4 256kbyte blocks. Each block has 2 sockets, one for the low byte and one for the high byte of data.

U301 and U302 are 128kbyte EPROMS holding the program boot firmware. This memory is mapped at C0000H to FFFFFH (256k). U303 and U304 are 128kbyte data ROMS mapped at 80000H to BFFFFH (256k).

U401-403 are 128kbyte CMOS static RAMs mapped at 00000H to 7FFFFH (512k). U401 and U402 are backed up by the battery. Q401 provides power down RAM protection. This memory is system memory.

4 of the 7 80C186's peripheral chip select strobes are used by peripherals on the CPU board. -PCS0 is decoded into 16 I/O strobes which access the clock, keypad, keyboard, knob, printer port, etc. -PCS1 decodes the disk controller, the GPIB controller, and DMA acknowledge strobes. -PCS2 selects the UART and -PCS3 selects the video graphics controller. Whenever the video controller is accessed, the ARDY line is asserted (U504A) which puts the processor into a wait state. When the video controller acknowledges the data transfer by pulling -Video_Rdy low, the ARDY line is

de-asserted (U805A and U815D) and the processor moves on to the next instruction.

Interrupts generated by peripherals on the CPU board are combined in U505 into a single prioritized interrupt. The highest priority pending interrupt will be encoded on U505's outputs and read via the status port, U608. The UART directly interrupts the processor since it can never be masked.

KEYPAD INTERFACE

The keypad is organized as 8 columns and 8 rows of switch closures. The conductive rubber keys provide the switch closures. U607 strobes the columns and U606 detects the switch closure. The diodes D601 - D608 prevent one column from affecting another. All of the outputs from U607 are set high and U606 is read periodically by the processor. As long as 00H is read, no key is pressed and the strobes are left on. When a non-zero byte is read, then the key strobes are activated individually in order to decode which key is down.

KEYBOARD INTERFACE

The PC keyboard interface uses U603 to convert serial data from the keyboard into a parallel byte for the processor to read. The data format from the keyboard is a leading start bit followed by 8 data bits. U603 is reset by a processor read. When a key is pressed, the bits are shifted into U603. When the start bit appears at the QH output, 7 bits of the data byte are in U603. U601 is the 9th bit of the shift register. When U601 clocks in the start bit, U601 must have the 8 bits of the data. U601 then latches the serial data in U601 and interrupts the processor.

Only keyboards which operate in the PC or 8088 mode will function with this interface.

SPIN KNOB

The knob is an optical encoder buffered by U612. Each transition of its outputs is clocked into U610 or U611 and generates an interrupt at the output of U602A. The processor keeps track of the knob's position continuously.

Circuit Description

SPEAKER

The speaker is driven by a timer on the 80C186. The timer outputs a square wave which is enabled by U602B and drives the speaker through Q705.

CLOCK/CALENDAR

U702 is an MC146818 real time clock chip which keeps track of time and date. The time base is a 32.768 kHz oscillator made by U706. Both U702 and U706 are battery backed up.

PRINTER INTERFACE

The printer interface allows screen displays to be printed to Epson compatible printers. Output data is buffered by U703, an LS octal latch. Output control bits are buffered by the open collector driver U704, and input control bits are discriminated by U705C and U705D.

VIDEO GRAPHICS INTERFACE

The video graphics interface is centered around U810, an HD63484 graphics controller. The HD63484 generates the video sync signals, controls the video memory, and draws graphic primitives such as lines, circles, polygons, etc., and other high level functions. The HD63484 relieves the 80C186 from having to calculate each video image and greatly increases display speed.

U813 and U814 are 32kbyte RAMs which make up the 64k video memory. The video screen is 640H by 480V and requires 38,400 bytes of memory. The remaining memory is used to store patterns, fonts, and other graphic objects. The data and address are multiplexed and U811 and U812 are the address latches.

Data is read 16 bits at a time. When data is required for the display, the 16 bits of data are latched into U804 and U809 which are parallel to serial converters. The video data is then shifted out at 13.5 MHz and synchronized by U806B. U803C blanks the video data except during active display times.

Memory is accessed twice during each display cycle. The first access reads the 16 bits of video data for the current display cycle. The second access is used by the controller for drawing purposes. During the drawing access, data at any

address may be read or written. This allows drawing to take place as fast as possible.

Commands and data are sent from the 80C186 to the HD63484 using a DMA channel. This allows the HD63484 to process commands without having to wait for the 80C186 to send them.

DISK CONTROLLER

U907 is a DP8473 disk controller which integrates all of the functions of the PC interface into a single IC. All motor controls, read and write signals, and data are all controlled by the DP8473. A DMA channel is used to send and receive data from the controller in order to satisfy the disk drive timing.

GPIB INTERFACE

The GPIB (IEEE-488) interface is provided by U902, a TMS9914A controller. U903 and U904 buffer data I/O to the GPIB connector. U902 is programmed to provide an interrupt to the processor whenever there is bus activity addressed to the unit.

RS232 INTERFACE

The SCN2641 UART, U905, provides all of the UART functions as well as baud rate generation. Standard baud rates up to 19.2k can be generated from the 3.6864 MHz clock. U906 buffers the outgoing data and control signals. Incoming signals are received by U705A and U705B. If the host computer asserts DTR, RS232 data output from the unit will cease.

The RS232 port is a DCE and may be connected to a PC using a standard serial cable (not a "null modem" cable).

EXPANSION CONNECTOR

All control of the data acquisition hardware is through the signals on the 30 pin expansion connector.

POWER SUPPLY BOARD

CAUTION: Dangerous voltages are present on this circuit board whenever the instrument is attached to an AC power source and the front panel power switch is "on".

Always disconnect the power cord and wait at least one minute before opening the unit. Check the LED at the front edge of the power supply board. The unit is safe only if the LED is OFF. If the LED is ON, then DO NOT attempt any service on the unit.

UNREGULATED POWER SUPPLIES

A power entry module, with RF line filter, is used to configure the unit for 100, 120, 220, or 240 VAC. The line filter reduces noise from the instrument and reduces the unit's susceptibility to line voltage noise. R1 is an inrush limiter to limit the turn on current and TS1 is a thermal switch which will interrupt the AC line if the heat sink temperature rises to 50°C.

Bridge rectifiers are used to provide unregulated DC at $\pm 22\text{V}$, $\pm 20\text{V}$ and $\pm 8\text{V}$. Schottky diodes are used for all supplies to reduce rectifier losses.

Resistors provide a bleed current on all of the unregulated supply filter capacitors. Because of the large capacitances in this circuit, the time for the voltages to bleed to zero is about a minute after the power is turned off.

POWER SUPPLY REGULATORS

The voltage regulators provide outputs at +5V, -5V, $\pm 15\text{V}$, and $\pm 12\text{V}$. The +5V regulators are designed to operate with a very low drop-out voltage.

U2 is a precision 5.00V reference which is used to set +5V output voltages. This provides very accurate digital power supply outputs.

There are 2 +5V supplies, one to power the CPU board and disk drive (+5V_P), and one to power the DSP Logic Board (+5V_I).

The following description refers to the +5V_P supply but describes the +5V_I supply as well.

The main pass transistor is Q5. The base of this transistor is controlled so that the emitter will provide a low impedance source of 5 VDC. The current gain of Q5 remains large until the collector-emitter voltage drops to about 0.4 VDC, hence the low drop-out voltage of the regulator. The base of Q5 is driven by the emitter of Q6 which is driven by the output of the op amp, U3B. By comparing the output of the regulator to the 5.00V reference, the op amp maintains the regulator's output at 5.00 VDC. The current output from the regulator is measured by the 0.1 Ω resistor R10. If the current exceeds about 2 Amps, then the output of U3A turns on, pulling the sense input of U3B high, thereby turning off the regulator's output.

U6, U7 and U18 are the $\pm 12\text{V}$ regulators. U5 is the -5V regulator. Since these supplies do not need to be accurate, output sensing is not used.

U9 and U10 provide $\pm 20\text{V}$ sources which are not referenced to the digital ground (as are all of the supplies mentioned above). This allows the analog input board to establish a ground at the signal input without digital ground noise.

U1 provides power-up and power-down reset.

The 24 VDC brushless fan speed which cools the heat sink and removes the hot air from the box.

DSP LOGIC BOARD

OVERVIEW

The DSP LOGIC BOARD takes a digital input from the A/D Converter on the Analog Input Board and performs all of the computations related to the measurement before it is displayed on the screen. This includes generating the digital reference sine wave, demodulating the signal, low-pass filtering the results, and offset and expanding the outputs. The internal oscillator sine output and Aux D/A outputs are generated on this board as well. The reference phase lock loop controls the clock of this board whenever the reference mode is external. These functions are implemented within a system comprised of five functional blocks: the Digital Signal Processor (DSP), the DAC Outputs, the Timing Signal Generator, the Reference Clock Generator and the I/O Interface. Through the use of highly efficient algorithms, the system is capable of real-time lock-in operation to 100 kHz with 24 dB/oct filtering on both X and Y as well as providing a synthesized analog sine output.

DSP PROCESSOR

The SR850 utilizes a Motorola 24-bit DSP56001 digital signal processor (U501). The DSP is configured without external memory. The lock-in algorithms run entirely within the internal program and data memory of the DSP itself. The Host processor bus is connected to the main CPU Board via the I/O Interface on the DSP Logic Board. The 80C186 processor on the CPU Board acts as the "host" processor to the DSP. DSP firmware and commands are downloaded from the CPU Board to invoke different operating modes. The DSP also has two dedicated serial ports: one for receiving, and one for transmitting.

REFERENCE CLOCK SOURCE

The clock to the DSP is derived from the timing generator. U120, U121 and U122 are gates which select the clock source for the entire digital board.

When the reference mode is internal, the 30.208 MHz crystal (U111) is used. The A/D inputs and D/A outputs run with a 256 kHz cycle and the DSP performs 59 instructions each cycle (each instruction takes two clocks). The crystal

also sets the internal reference frequency accuracy.

When the reference mode is external, the VCO (voltage controlled oscillator, U110) is used as the system clock. The VCO nominally runs at 30 MHz as well. U105 is a phase comparator. The external reference input, discriminated by U103 (or TTL buffered through U104D) is one of the inputs to the phase comparator. The other input is the internal reference. The DSP always synthesizes a sine wave at the reference frequency. This is the Sine Output. This sine output is discriminated by U209 into a TTL square wave (TTL Sync Out) and is the other input to the phase comparator. The phase lock loop then controls the VCO which is the clock to the DSP. This in turn changes the sine output frequency to maintain frequency lock with the external reference. The DSP is constantly getting external frequency information from the host (based upon counter U622) which allows the DSP to synthesize nearly the correct reference frequency assuming a 30 MHz clock. This keeps the VCO within range at all frequencies.

TIMING GENERATOR

All timing signals for the DSP and Analog boards are derived from the system clock by PALs (U601-604). These PALs generate the clocks for the DACs and A/D converter, the multiplexing signals for the Aux inputs and outputs, etc.

SERIAL CHANNELS

There are two serial data streams from the A/D converter on the Analog Input board which need to be received by the DSP. The digitized input signal is received directly via the DSP's serial input port. The Aux A/D input data is shifted into a pair of serial-to-parallel registers (U502 and U503) and is read via the DSP data bus. Each A/D input channel provides a new sample every 4 μ s.

There are two dual-channel D/A converters on this board for a total of four D/A output channels. Each output channel provides a new output every 4 μ s. This means that 4 output values must be written by the DSP each 4 μ s cycle. The DSP writes to one channel of each D/A converter via its serial

Circuit Description

transmit port each cycle. The transmit port operates at twice the frequency of the receive port. The DSP writes to the other channel of each DAC via a pair of parallel-to-serial registers (U504 and U505).

DAC OUTPUTS

Three of the DAC output channels provide Sine Out, X and Y. The fourth channel is multiplexed into eight slow outputs. Two of these are the front panel CH1 and CH2 outputs when the outputs are proportional to a trace. Four of these are the Aux D/A outputs. The last two are used to provide internal offset trims to the reference and sine discriminators.

The DSP generates sine waves using direct digital synthesis. At each 4 μ s cycle, the DSP calculates the next sine output value based upon the desired reference frequency. This value is output via a DAC and converted to an analog output. This output is a sampled sine wave. To convert this to a smooth, low distortion analog sine wave, the output is filtered to remove frequency components above 100 kHz (U201-203). The filter output is scaled by DAC U206 and output by driver U207. U209 discriminates the zero crossings to provide a TTL square wave at the reference frequency. This is the TTL SYNC out as well as the feedback to the phase lock loop in external reference mode.

I/O INTERFACE TO CPU BOARD

The I/O interface provides the communication pathway between the DSP Logic Board and the main CPU Board. U610 and U613 are buffers for the address and data bus connections. Both buffer chips are enabled only when the CPU Board is writing to the DSP Logic Board. This helps isolate the activity on the CPU Board from affecting circuitry on the DSP Logic Board. U608 and U609 are simple D-type latches used to hold configuration data for the DSP Logic Board. U606 is the main decoder PAL and generates all of the chip selects and strobes needed by the DSP Logic Board.

POWER

The bulk of the digital circuitry, the DSP and the timing PALs and the interface circuits are all powered by +5V from the power supply board. The \pm 22V from the power supply is used to generate

\pm 15V for the op amps. \pm 5.6V for analog switches and op amps is generated from the \pm 15V supplies. The reference and sine discriminators use separate \pm 5V supplies regulated from the \pm 15V supplies as well.

ANALOG INPUT BOARD

OVERVIEW

The Analog Input Board provides the very important link between the user's input signal and the DSP processor. From the front panel BNC, the user's signal passes through a low distortion front-end amplifier, gain stages, notch filters, anti-aliasing filter, and finally an A/D Converter. Once converted to digital form, the input signal is ready to be processed by the Digital Signal Processor.

INPUT AMPLIFIER

The goal of any measurement instrument is to perform some given measurement while affecting the quantities to be measured as little as possible. As such, the input amplifier is often the most critical stage in the entire signal path. The design of the front end input amplifier in the SR850 was driven by an effort to provide optimum performance in the following areas: input voltage noise, input current noise, input capacitance, harmonic distortion, and common mode rejection (CMR). To provide such performance, a FET input differential amplifier with common-mode feedback architecture was chosen. The input signal is first passed through a series of relays to select input mode and input coupling. The input FETs U100A and U100B are extremely low-noise matched FETs. To improve distortion performance, the input FETs are cascoded to maintain a constant drain-source voltage across each FET. This prevents modulation of the drain-source voltage by the input voltage. U109 senses the source voltages and maintains the same voltage at the drains (via FETs U108A and B) with some DC offset determined by resistors N102 and N103. U105 provides common-mode feedback and maintains a constant drain current in each FET. The gain of the front end is fixed. U103 provides the output. The DC offset is adjusted by P101 and the CMR by P102.

GAIN STAGES AND NOTCH FILTERS

Collectively, the front end amplifier and following gain stages provide gain up to about 2000.

The notch filters are simple single stage, inverting band pass filters summing with their inputs to remove 60 Hz or 120 Hz. Each filter has a depth

and frequency adjustment. (60 Hz - depth:P222 and freq:P221 120 Hz - depth:P202 and freq:P201). The 120 Hz notch filter has a configurable gain of either 1 or 3.17.

The notch filters are followed by two gain stages, each configurable up to a gain of 10.

Overloads are sensed at the input amplifier and the final amplifier outputs. Since there is no attenuation in the amplifier chain, this is sufficient.

ANTI-ALIASING FILTER

To prevent aliasing, the input signal passes through a low-pass filter so that all frequency components greater than half the sampling frequency are attenuated by at least 96 dB. This is accomplished with an 8-zero 9-pole elliptical low pass filter. The pass band of this filter is DC to 102kHz. The stopband begins at 154 kHz. Stopband attenuation is nominally 100 dB.

The architecture of the filter is based on a singly terminated passive LC ladder filter. L's are simulated with active gyrators formed by op-amp pairs (U311, U321, U331, U341). Passive LC ladder filters have the special characteristic of being very tolerant of variations in component values. Because no section of the ladder is completely isolated from the other, a change in value of any single component affects the entire ladder. The design of the LC ladder however, is such that the characteristics of the rest of the ladder will shift to account for the change in such a way as to minimize its effect on the ladder. Not only does this loosen the requirement for extremely high accuracy resistors and capacitors, but it also makes the filter extremely stable despite wide temperature variations. As such, the anti-aliasing filter used in the SR850 does not ever require calibration to meet its specifications.

Following the anti-aliasing filter is the signal monitor buffer (U386) and A/D driver stage (U301).

A/D CONVERTER

The SR850 uses a dual channel A/D converter (U407). Each channel samples simultaneously at

Circuit Description

a rate of 256 kHz. One channel is dedicated to the input signal. The other channel reads one of the Aux A/D inputs. The Aux inputs are multiplexed so that each input is read every four cycles. The two digital output streams are buffered by U406 and sent to the DSP board.

I/O INTERFACE

The Analog Input Board communicates with the CPU Board via its I/O Interface. U504 and U506 are simple latches which hold configuration data for the analog board. They are written via the isolated data bus from the DSP board. This data bus is active only when the Analog board is addressed. This prevents noise from the CPU and DSP boards from entering the Analog Board. Timing signals for the A/D Converter are buffered by U406.

POWER

Several voltages are generated on the Analog Input Board locally. $\pm 15V$ is generated for most of the analog IC's. A dedicated $\pm 15V$ supply is also generated for the front-end amplifier. $\pm 5.6V$ is generated for the digital circuitry as well as some of the drivers. The A/D Converter has its own $\pm 5V$ supply.

Power Supply Board Parts List

<u>Ref.</u>	<u>SRS Part No.</u>	<u>Value</u>	<u>Description</u>
C 1	5-00124-526	5600U	Capacitor, Electrolytic, 35V, 20%, Rad
C 2	5-00124-526	5600U	Capacitor, Electrolytic, 35V, 20%, Rad
C 3	5-00228-526	15000U	Capacitor, Electrolytic, 35V, 20%, Rad
C 4	5-00228-526	15000U	Capacitor, Electrolytic, 35V, 20%, Rad
C 5	5-00230-550	47000U	Capacitor, Electrolytic, 10V, 20%, Rad
C 6	5-00229-521	15000U	Capacitor, Electrolytic, 25V, 20%, Rad
C 7	5-00023-529	.1U	Cap, Monolythic Ceramic, 50V, 20%, Z5U
C 8	5-00127-524	2.2U	Capacitor, Tantalum, 50V, 20%, Rad
C 9	5-00038-509	10U	Capacitor, Electrolytic, 50V, 20%, Rad
C 10	5-00027-503	.01U	Capacitor, Ceramic Disc, 50V, 20%, Z5U
C 11	5-00002-501	100P	Capacitor, Ceramic Disc, 50V, 10%, SL
C 12	5-00027-503	.01U	Capacitor, Ceramic Disc, 50V, 20%, Z5U
C 13	5-00002-501	100P	Capacitor, Ceramic Disc, 50V, 10%, SL
C 16	5-00127-524	2.2U	Capacitor, Tantalum, 50V, 20%, Rad
C 17	5-00127-524	2.2U	Capacitor, Tantalum, 50V, 20%, Rad
C 18	5-00127-524	2.2U	Capacitor, Tantalum, 50V, 20%, Rad
C 19	5-00192-542	22U MIN	Cap, Mini Electrolytic, 50V, 20% Radial
C 20	5-00127-524	2.2U	Capacitor, Tantalum, 50V, 20%, Rad
C 21	5-00127-524	2.2U	Capacitor, Tantalum, 50V, 20%, Rad
C 23	5-00192-542	22U MIN	Cap, Mini Electrolytic, 50V, 20% Radial
C 24	5-00127-524	2.2U	Capacitor, Tantalum, 50V, 20%, Rad
C 26	5-00192-542	22U MIN	Cap, Mini Electrolytic, 50V, 20% Radial
C 27	5-00127-524	2.2U	Capacitor, Tantalum, 50V, 20%, Rad
C 28	5-00192-542	22U MIN	Cap, Mini Electrolytic, 50V, 20% Radial
C 29	5-00127-524	2.2U	Capacitor, Tantalum, 50V, 20%, Rad
C 30	5-00192-542	22U MIN	Cap, Mini Electrolytic, 50V, 20% Radial
C 31	5-00127-524	2.2U	Capacitor, Tantalum, 50V, 20%, Rad
C 32	5-00192-542	22U MIN	Cap, Mini Electrolytic, 50V, 20% Radial
C 33	5-00127-524	2.2U	Capacitor, Tantalum, 50V, 20%, Rad
C 34	5-00127-524	2.2U	Capacitor, Tantalum, 50V, 20%, Rad
D 2	3-00391-301	MBR360	Diode
D 3	3-00391-301	MBR360	Diode
D 4	3-00391-301	MBR360	Diode
D 5	3-00391-301	MBR360	Diode
D 6	3-00391-301	MBR360	Diode
D 7	3-00391-301	MBR360	Diode
D 8	3-00391-301	MBR360	Diode
D 9	3-00391-301	MBR360	Diode
D 12	3-00004-301	1N4148	Diode
D 13	3-00004-301	1N4148	Diode
D 15	3-00391-301	MBR360	Diode
D 16	3-00001-301	1N4001	Diode
D 17	3-00001-301	1N4001	Diode
D 18	3-00001-301	1N4001	Diode
D 19	3-00001-301	1N4001	Diode
D 20	3-00001-301	1N4001	Diode

Parts List

<u>Ref.</u>	<u>SRS Part No.</u>	<u>Value</u>	<u>Description</u>
D 30	3-00479-301	MUR410	Diode
D 31	3-00479-301	MUR410	Diode
D 32	3-00479-301	MUR410	Diode
D 33	3-00479-301	MUR410	Diode
D 34	3-00391-301	MBR360	Diode
D 35	3-00391-301	MBR360	Diode
D 36	3-00391-301	MBR360	Diode
D 37	3-00391-301	MBR360	Diode
D 38	3-00001-301	1N4001	Diode
DS1	3-00011-303	RED	LED, T1 Package
JP1	1-00039-116	5 PIN, WHITE	Header, Amp, MTA-156
JP2	1-00116-130	4 PIN DI DISK	Connector, Male
JP3	1-00119-116	3 PIN, WHITE	Header, Amp, MTA-156
JP4	1-00171-130	34 PIN ELH	Connector, Male
JP5	1-00086-130	3 PIN SI	Connector, Male
JP6	1-00086-130	3 PIN SI	Connector, Male
PC1	7-00354-701	4	Printed Circuit Board
Q 3	3-00021-325	2N3904	Transistor, TO-92 Package
Q 4	3-00021-325	2N3904	Transistor, TO-92 Package
Q 5	3-00257-329	TIP41B	Voltage Reg., TO-220 (TAB) Package
Q 6	3-00378-329	TIP102	Voltage Reg., TO-220 (TAB) Package
Q 7	3-00378-329	TIP102	Voltage Reg., TO-220 (TAB) Package
Q 8	3-00257-329	TIP41B	Voltage Reg., TO-220 (TAB) Package
R 3	4-00034-401	10K	Resistor, Carbon Film, 1/4W, 5%
R 4	4-00032-401	100K	Resistor, Carbon Film, 1/4W, 5%
R 5	4-00034-401	10K	Resistor, Carbon Film, 1/4W, 5%
R 6	4-00046-401	2.0M	Resistor, Carbon Film, 1/4W, 5%
R 7	4-00065-401	3.3K	Resistor, Carbon Film, 1/4W, 5%
R 8	4-00021-401	1.0K	Resistor, Carbon Film, 1/4W, 5%
R 9	4-00021-401	1.0K	Resistor, Carbon Film, 1/4W, 5%
R 10	4-00436-409	0.1	Resistor, Wire Wound
R 11	4-00446-407	47.5K	Resistor, Metal Film, 1/8W, 1%, 50PPM
R 12	4-00054-401	200K	Resistor, Carbon Film, 1/4W, 5%
R 13	4-00034-401	10K	Resistor, Carbon Film, 1/4W, 5%
R 14	4-00034-401	10K	Resistor, Carbon Film, 1/4W, 5%
R 15	4-00021-401	1.0K	Resistor, Carbon Film, 1/4W, 5%
R 16	4-00021-401	1.0K	Resistor, Carbon Film, 1/4W, 5%
R 17	4-00436-409	0.1	Resistor, Wire Wound
R 18	4-00770-407	38.3K	Resistor, Metal Film, 1/8W, 1%, 50PPM
R 19	4-00054-401	200K	Resistor, Carbon Film, 1/4W, 5%
R 20	4-00034-401	10K	Resistor, Carbon Film, 1/4W, 5%
R 21	4-00034-401	10K	Resistor, Carbon Film, 1/4W, 5%
R 30	4-00360-401	430	Resistor, Carbon Film, 1/4W, 5%
R 31	4-00048-401	2.2K	Resistor, Carbon Film, 1/4W, 5%
R 32	4-00360-401	430	Resistor, Carbon Film, 1/4W, 5%
R 33	4-00027-401	1.5K	Resistor, Carbon Film, 1/4W, 5%
R 34	4-00027-401	1.5K	Resistor, Carbon Film, 1/4W, 5%
R 35	4-00185-407	4.02K	Resistor, Metal Film, 1/8W, 1%, 50PPM
R 36	4-00185-407	4.02K	Resistor, Metal Film, 1/8W, 1%, 50PPM

<u>Ref.</u>	<u>SRS Part No.</u>	<u>Value</u>	<u>Description</u>
R 37	4-00522-407	243	Resistor, Metal Film, 1/8W, 1%, 50PPM
R 38	4-00517-407	3.57K	Resistor, Metal Film, 1/8W, 1%, 50PPM
R 39	4-00522-407	243	Resistor, Metal Film, 1/8W, 1%, 50PPM
R 40	4-00517-407	3.57K	Resistor, Metal Film, 1/8W, 1%, 50PPM
T 1	1-00152-116	11 PIN, WHITE	Header, Amp, MTA-156
U 1	3-00039-340	74HC14	Integrated Circuit (Thru-hole Pkg)
U 2	3-00319-340	AD586JN	Integrated Circuit (Thru-hole Pkg)
U 3	3-00088-340	LF353	Integrated Circuit (Thru-hole Pkg)
U 4	3-00088-340	LF353	Integrated Circuit (Thru-hole Pkg)
U 5	3-00119-329	7905	Voltage Reg., TO-220 (TAB) Package
U 6	3-00346-329	7812	Voltage Reg., TO-220 (TAB) Package
U 7	3-00346-329	7812	Voltage Reg., TO-220 (TAB) Package
U 8	3-00330-329	7912	Voltage Reg., TO-220 (TAB) Package
U 9	3-00149-329	LM317T	Voltage Reg., TO-220 (TAB) Package
U 10	3-00141-329	LM337T	Voltage Reg., TO-220 (TAB) Package
U 11	3-00114-329	7815	Voltage Reg., TO-220 (TAB) Package
U 12	3-00120-329	7915	Voltage Reg., TO-220 (TAB) Package
Z 0	0-00089-033	4"	Tie
Z 0	0-00186-021	6-32X1-3/8PP	Screw, Panhead Phillips
Z 0	0-00187-021	4-40X1/4PP	Screw, Panhead Phillips
Z 0	0-00231-043	1-32, #4 SHOULD	Washer, nylon
Z 0	0-00246-043	#8 X 1/16	Washer, nylon
Z 0	0-00309-021	8-32X1/4PP	Screw, Panhead Phillips
Z 0	0-00316-003	PLTFM-28	Insulators
Z 0	1-00087-131	2 PIN JUMPER	Connector, Female
Z 0	7-00285-721	PLTFM-21	Machined Part
Z 1	0-00158-070	60MM 24V	Fans, & Hardware

DSP Logic Board Parts List

<u>Ref.</u>	<u>SRS Part No.</u>	<u>Value</u>	<u>Description</u>
C 101	5-00060-512	1.0U	Cap, Stacked Metal Film 50V 5% -40/+85c
C 114	5-00100-517	2.2U	Capacitor, Tantalum, 35V, 20%, Rad
C 117	5-00100-517	2.2U	Capacitor, Tantalum, 35V, 20%, Rad
C 119	5-00259-501	.002U	Capacitor, Ceramic Disc, 50V, 10%, SL
C 120	5-00092-523	1P	Capacitor, Silver Mica, Miniature
C 121	5-00023-529	.1U	Cap, Monolythic Ceramic, 50V, 20%, Z5U
C 130	5-00023-529	.1U	Cap, Monolythic Ceramic, 50V, 20%, Z5U
C 135	5-00002-501	100P	Capacitor, Ceramic Disc, 50V, 10%, SL
C 136	5-00002-501	100P	Capacitor, Ceramic Disc, 50V, 10%, SL
C 137	5-00017-501	47P	Capacitor, Ceramic Disc, 50V, 10%, SL
C 140	5-00053-512	.033U	Cap, Stacked Metal Film 50V 5% -40/+85c
C 141	5-00053-512	.033U	Cap, Stacked Metal Film 50V 5% -40/+85c
C 142	5-00051-512	.015U	Cap, Stacked Metal Film 50V 5% -40/+85c
C 143	5-00121-566	.0047U	Cap, Polyester Film 50V 5% -40/+85c Rad
C 144	5-00056-512	.1U	Cap, Stacked Metal Film 50V 5% -40/+85c
C 150	5-00023-529	.1U	Cap, Monolythic Ceramic, 50V, 20%, Z5U
C 151	5-00023-529	.1U	Cap, Monolythic Ceramic, 50V, 20%, Z5U
C 152	5-00023-529	.1U	Cap, Monolythic Ceramic, 50V, 20%, Z5U

Parts List

<u>Ref.</u>	<u>SRS Part No.</u>	<u>Value</u>	<u>Description</u>
C 153	5-00023-529	.1U	Cap, Monolythic Ceramic, 50V, 20%, Z5U
C 154	5-00023-529	.1U	Cap, Monolythic Ceramic, 50V, 20%, Z5U
C 155	5-00023-529	.1U	Cap, Monolythic Ceramic, 50V, 20%, Z5U
C 156	5-00023-529	.1U	Cap, Monolythic Ceramic, 50V, 20%, Z5U
C 157	5-00023-529	.1U	Cap, Monolythic Ceramic, 50V, 20%, Z5U
C 171	5-00002-501	100P	Capacitor, Ceramic Disc, 50V, 10%, SL
C 173	5-00002-501	100P	Capacitor, Ceramic Disc, 50V, 10%, SL
C 180	5-00038-509	10U	Capacitor, Electrolytic, 50V, 20%, Rad
C 181	5-00038-509	10U	Capacitor, Electrolytic, 50V, 20%, Rad
C 182	5-00100-517	2.2U	Capacitor, Tantalum, 35V, 20%, Rad
C 183	5-00100-517	2.2U	Capacitor, Tantalum, 35V, 20%, Rad
C 202	5-00148-545	1000P - 50V	Capacitor, Monolythic Ceramic, COG, 1%
C 203	5-00148-545	1000P - 50V	Capacitor, Monolythic Ceramic, COG, 1%
C 204	5-00148-545	1000P - 50V	Capacitor, Monolythic Ceramic, COG, 1%
C 205	5-00148-545	1000P - 50V	Capacitor, Monolythic Ceramic, COG, 1%
C 206	5-00148-545	1000P - 50V	Capacitor, Monolythic Ceramic, COG, 1%
C 207	5-00148-545	1000P - 50V	Capacitor, Monolythic Ceramic, COG, 1%
C 210	5-00148-545	1000P - 50V	Capacitor, Monolythic Ceramic, COG, 1%
C 211	5-00003-501	10P	Capacitor, Ceramic Disc, 50V, 10%, SL
C 235	5-00002-501	100P	Capacitor, Ceramic Disc, 50V, 10%, SL
C 236	5-00002-501	100P	Capacitor, Ceramic Disc, 50V, 10%, SL
C 237	5-00016-501	470P	Capacitor, Ceramic Disc, 50V, 10%, SL
C 238	5-00002-501	100P	Capacitor, Ceramic Disc, 50V, 10%, SL
C 254	5-00023-529	.1U	Cap, Monolythic Ceramic, 50V, 20%, Z5U
C 255	5-00023-529	.1U	Cap, Monolythic Ceramic, 50V, 20%, Z5U
C 260	5-00023-529	.1U	Cap, Monolythic Ceramic, 50V, 20%, Z5U
C 261	5-00023-529	.1U	Cap, Monolythic Ceramic, 50V, 20%, Z5U
C 264	5-00023-529	.1U	Cap, Monolythic Ceramic, 50V, 20%, Z5U
C 265	5-00023-529	.1U	Cap, Monolythic Ceramic, 50V, 20%, Z5U
C 280	5-00038-509	10U	Capacitor, Electrolytic, 50V, 20%, Rad
C 281	5-00038-509	10U	Capacitor, Electrolytic, 50V, 20%, Rad
C 282	5-00100-517	2.2U	Capacitor, Tantalum, 35V, 20%, Rad
C 283	5-00100-517	2.2U	Capacitor, Tantalum, 35V, 20%, Rad
C 290	5-00023-529	.1U	Cap, Monolythic Ceramic, 50V, 20%, Z5U
C 301	5-00002-501	100P	Capacitor, Ceramic Disc, 50V, 10%, SL
C 302	5-00002-501	100P	Capacitor, Ceramic Disc, 50V, 10%, SL
C 303	5-00002-501	100P	Capacitor, Ceramic Disc, 50V, 10%, SL
C 305	5-00002-501	100P	Capacitor, Ceramic Disc, 50V, 10%, SL
C 307	5-00002-501	100P	Capacitor, Ceramic Disc, 50V, 10%, SL
C 308	5-00002-501	100P	Capacitor, Ceramic Disc, 50V, 10%, SL
C 309	5-00002-501	100P	Capacitor, Ceramic Disc, 50V, 10%, SL
C 310	5-00002-501	100P	Capacitor, Ceramic Disc, 50V, 10%, SL
C 350	5-00023-529	.1U	Cap, Monolythic Ceramic, 50V, 20%, Z5U
C 351	5-00023-529	.1U	Cap, Monolythic Ceramic, 50V, 20%, Z5U
C 352	5-00023-529	.1U	Cap, Monolythic Ceramic, 50V, 20%, Z5U
C 353	5-00023-529	.1U	Cap, Monolythic Ceramic, 50V, 20%, Z5U
C 381	5-00100-517	2.2U	Capacitor, Tantalum, 35V, 20%, Rad
C 382	5-00100-517	2.2U	Capacitor, Tantalum, 35V, 20%, Rad
C 383	5-00100-517	2.2U	Capacitor, Tantalum, 35V, 20%, Rad

Parts List

<u>Ref.</u>	<u>SRS Part No.</u>	<u>Value</u>	<u>Description</u>
C 384	5-00100-517	2.2U	Capacitor, Tantalum, 35V, 20%, Rad
C 385	5-00100-517	2.2U	Capacitor, Tantalum, 35V, 20%, Rad
C 386	5-00100-517	2.2U	Capacitor, Tantalum, 35V, 20%, Rad
C 387	5-00100-517	2.2U	Capacitor, Tantalum, 35V, 20%, Rad
C 388	5-00100-517	2.2U	Capacitor, Tantalum, 35V, 20%, Rad
C 389	5-00038-509	10U	Capacitor, Electrolytic, 50V, 20%, Rad
C 390	5-00038-509	10U	Capacitor, Electrolytic, 50V, 20%, Rad
C 401	5-00023-529	.1U	Cap, Monolythic Ceramic, 50V, 20%, Z5U
C 402	5-00023-529	.1U	Cap, Monolythic Ceramic, 50V, 20%, Z5U
C 403	5-00023-529	.1U	Cap, Monolythic Ceramic, 50V, 20%, Z5U
C 404	5-00023-529	.1U	Cap, Monolythic Ceramic, 50V, 20%, Z5U
C 406	5-00023-529	.1U	Cap, Monolythic Ceramic, 50V, 20%, Z5U
C 407	5-00023-529	.1U	Cap, Monolythic Ceramic, 50V, 20%, Z5U
C 408	5-00023-529	.1U	Cap, Monolythic Ceramic, 50V, 20%, Z5U
C 409	5-00023-529	.1U	Cap, Monolythic Ceramic, 50V, 20%, Z5U
C 410	5-00021-501	82P	Capacitor, Ceramic Disc, 50V, 10%, SL
C 420	5-00023-529	.1U	Cap, Monolythic Ceramic, 50V, 20%, Z5U
C 421	5-00219-529	.01U	Cap, Monolythic Ceramic, 50V, 20%, Z5U
C 422	5-00023-529	.1U	Cap, Monolythic Ceramic, 50V, 20%, Z5U
C 423	5-00219-529	.01U	Cap, Monolythic Ceramic, 50V, 20%, Z5U
C 424	5-00023-529	.1U	Cap, Monolythic Ceramic, 50V, 20%, Z5U
C 425	5-00219-529	.01U	Cap, Monolythic Ceramic, 50V, 20%, Z5U
C 426	5-00023-529	.1U	Cap, Monolythic Ceramic, 50V, 20%, Z5U
C 427	5-00219-529	.01U	Cap, Monolythic Ceramic, 50V, 20%, Z5U
C 428	5-00023-529	.1U	Cap, Monolythic Ceramic, 50V, 20%, Z5U
C 429	5-00219-529	.01U	Cap, Monolythic Ceramic, 50V, 20%, Z5U
C 430	5-00023-529	.1U	Cap, Monolythic Ceramic, 50V, 20%, Z5U
C 431	5-00219-529	.01U	Cap, Monolythic Ceramic, 50V, 20%, Z5U
C 432	5-00023-529	.1U	Cap, Monolythic Ceramic, 50V, 20%, Z5U
C 433	5-00219-529	.01U	Cap, Monolythic Ceramic, 50V, 20%, Z5U
C 434	5-00023-529	.1U	Cap, Monolythic Ceramic, 50V, 20%, Z5U
C 435	5-00219-529	.01U	Cap, Monolythic Ceramic, 50V, 20%, Z5U
C 450	5-00098-517	10U	Capacitor, Tantalum, 35V, 20%, Rad
C 453	5-00098-517	10U	Capacitor, Tantalum, 35V, 20%, Rad
C 456	5-00098-517	10U	Capacitor, Tantalum, 35V, 20%, Rad
C 459	5-00098-517	10U	Capacitor, Tantalum, 35V, 20%, Rad
C 470	5-00100-517	2.2U	Capacitor, Tantalum, 35V, 20%, Rad
C 471	5-00100-517	2.2U	Capacitor, Tantalum, 35V, 20%, Rad
C 601	5-00027-503	.01U	Capacitor, Ceramic Disc, 50V, 20%, Z5U
C 602	5-00023-529	.1U	Cap, Monolythic Ceramic, 50V, 20%, Z5U
C 603	5-00038-509	10U	Capacitor, Electrolytic, 50V, 20%, Rad
C 604	5-00239-562	680P	Cap., NPO Monolithic Ceramic, 50v, 5% Ra
C 630	5-00033-520	47U	Capacitor, Electrolytic, 16V, 20%, Rad
C 631	5-00033-520	47U	Capacitor, Electrolytic, 16V, 20%, Rad
C 650	5-00225-548	.1U AXIAL	Capacitor, Ceramic, 50V,+80/-20% Z5U AX
C 651	5-00225-548	.1U AXIAL	Capacitor, Ceramic, 50V,+80/-20% Z5U AX
C 652	5-00225-548	.1U AXIAL	Capacitor, Ceramic, 50V,+80/-20% Z5U AX
C 653	5-00225-548	.1U AXIAL	Capacitor, Ceramic, 50V,+80/-20% Z5U AX
C 654	5-00225-548	.1U AXIAL	Capacitor, Ceramic, 50V,+80/-20% Z5U AX

Parts List

<u>Ref.</u>	<u>SRS Part No.</u>	<u>Value</u>	<u>Description</u>
C 655	5-00225-548	.1U AXIAL	Capacitor, Ceramic, 50V,+80/-20% Z5U AX
C 656	5-00225-548	.1U AXIAL	Capacitor, Ceramic, 50V,+80/-20% Z5U AX
C 657	5-00225-548	.1U AXIAL	Capacitor, Ceramic, 50V,+80/-20% Z5U AX
C 658	5-00225-548	.1U AXIAL	Capacitor, Ceramic, 50V,+80/-20% Z5U AX
C 659	5-00225-548	.1U AXIAL	Capacitor, Ceramic, 50V,+80/-20% Z5U AX
C 660	5-00225-548	.1U AXIAL	Capacitor, Ceramic, 50V,+80/-20% Z5U AX
C 661	5-00225-548	.1U AXIAL	Capacitor, Ceramic, 50V,+80/-20% Z5U AX
C 662	5-00225-548	.1U AXIAL	Capacitor, Ceramic, 50V,+80/-20% Z5U AX
C 663	5-00225-548	.1U AXIAL	Capacitor, Ceramic, 50V,+80/-20% Z5U AX
C 664	5-00225-548	.1U AXIAL	Capacitor, Ceramic, 50V,+80/-20% Z5U AX
C 665	5-00225-548	.1U AXIAL	Capacitor, Ceramic, 50V,+80/-20% Z5U AX
C 666	5-00225-548	.1U AXIAL	Capacitor, Ceramic, 50V,+80/-20% Z5U AX
C 667	5-00225-548	.1U AXIAL	Capacitor, Ceramic, 50V,+80/-20% Z5U AX
C 668	5-00225-548	.1U AXIAL	Capacitor, Ceramic, 50V,+80/-20% Z5U AX
C 669	5-00225-548	.1U AXIAL	Capacitor, Ceramic, 50V,+80/-20% Z5U AX
C 670	5-00225-548	.1U AXIAL	Capacitor, Ceramic, 50V,+80/-20% Z5U AX
C 671	5-00225-548	.1U AXIAL	Capacitor, Ceramic, 50V,+80/-20% Z5U AX
CU401	5-00002-501	100P	Capacitor, Ceramic Disc, 50V, 10%, SL
CU402	5-00002-501	100P	Capacitor, Ceramic Disc, 50V, 10%, SL
CX623	5-00225-548	.1U AXIAL	Capacitor, Ceramic, 50V,+80/-20% Z5U AX
D 103	3-00465-301	MV209	Diode
D 104	3-00004-301	1N4148	Diode
D 105	3-00004-301	1N4148	Diode
D 180	3-00004-301	1N4148	Diode
D 181	3-00004-301	1N4148	Diode
D 280	3-00004-301	1N4148	Diode
D 281	3-00004-301	1N4148	Diode
JP301	1-00035-130	20 PIN DIL	Connector, Male
K 101	3-00196-335	HS-212S-5	Relay
K 201	3-00444-335	BS-211-DC5 GF	Relay
L 101	6-00107-606	.8UH	Inductor, Variable
L 601	6-00006-602	33U	Inductor, Radial
N 101	4-00693-421	270X5	Res. Network, SIP, 1/4W,2% (Isolated)
N 102	4-00690-421	3.3KX4	Res. Network, SIP, 1/4W,2% (Isolated)
N 201	4-00693-421	270X5	Res. Network, SIP, 1/4W,2% (Isolated)
N 202	4-00690-421	3.3KX4	Res. Network, SIP, 1/4W,2% (Isolated)
N 301	4-00497-421	1.5KX4	Res. Network, SIP, 1/4W,2% (Isolated)
N 302	4-00692-421	5.6KX4	Res. Network, SIP, 1/4W,2% (Isolated)
N 303	4-00265-421	100X4	Res. Network, SIP, 1/4W,2% (Isolated)
N 304	4-00497-421	1.5KX4	Res. Network, SIP, 1/4W,2% (Isolated)
N 305	4-00692-421	5.6KX4	Res. Network, SIP, 1/4W,2% (Isolated)
N 306	4-00265-421	100X4	Res. Network, SIP, 1/4W,2% (Isolated)
N 420	4-00244-421	10KX4	Res. Network, SIP, 1/4W,2% (Isolated)
N 421	4-00244-421	10KX4	Res. Network, SIP, 1/4W,2% (Isolated)
N 501	4-00463-421	82X4	Res. Network, SIP, 1/4W,2% (Isolated)
N 502	4-00334-425	10KX5	Resistor Network SIP 1/4W 2% (Common)
N 503	4-00333-421	10KX5	Res. Network, SIP, 1/4W,2% (Isolated)
N 601	4-00767-420	270X8	Resistor Network, DIP, 1/4W,2%,8 Ind
N 602	4-00334-425	10KX5	Resistor Network SIP 1/4W 2% (Common)

Parts List

<u>Ref.</u>	<u>SRS Part No.</u>	<u>Value</u>	<u>Description</u>
N 603	4-00463-421	82X4	Res. Network, SIP, 1/4W,2% (Isolated)
N 604	4-00463-421	82X4	Res. Network, SIP, 1/4W,2% (Isolated)
PC1	7-00356-701	L/I DIGITAL	Printed Circuit Board
Q 101	3-00021-325	2N3904	Transistor, TO-92 Package
Q 102	3-00022-325	2N3906	Transistor, TO-92 Package
Q 201	3-00021-325	2N3904	Transistor, TO-92 Package
R 102	4-00022-401	1.0M	Resistor, Carbon Film, 1/4W, 5%
R 103	4-00130-407	1.00K	Resistor, Metal Film, 1/8W, 1%, 50PPM
R 114	4-00056-401	22	Resistor, Carbon Film, 1/4W, 5%
R 115	4-00142-407	100K	Resistor, Metal Film, 1/8W, 1%, 50PPM
R 116	4-00192-407	49.9K	Resistor, Metal Film, 1/8W, 1%, 50PPM
R 117	4-00192-407	49.9K	Resistor, Metal Film, 1/8W, 1%, 50PPM
R 118	4-00193-407	499	Resistor, Metal Film, 1/8W, 1%, 50PPM
R 119	4-00522-407	243	Resistor, Metal Film, 1/8W, 1%, 50PPM
R 120	4-00074-401	33K	Resistor, Carbon Film, 1/4W, 5%
R 121	4-00034-401	10K	Resistor, Carbon Film, 1/4W, 5%
R 130	4-00598-407	127K	Resistor, Metal Film, 1/8W, 1%, 50PPM
R 131	4-00383-407	12.7K	Resistor, Metal Film, 1/8W, 1%, 50PPM
R 132	4-00768-407	1.27K	Resistor, Metal Film, 1/8W, 1%, 50PPM
R 133	4-00204-407	750	Resistor, Metal Film, 1/8W, 1%, 50PPM
R 140	4-00025-401	1.2M	Resistor, Carbon Film, 1/4W, 5%
R 141	4-00598-407	127K	Resistor, Metal Film, 1/8W, 1%, 50PPM
R 142	4-00383-407	12.7K	Resistor, Metal Film, 1/8W, 1%, 50PPM
R 143	4-00768-407	1.27K	Resistor, Metal Film, 1/8W, 1%, 50PPM
R 156	4-00030-401	10	Resistor, Carbon Film, 1/4W, 5%
R 157	4-00030-401	10	Resistor, Carbon Film, 1/4W, 5%
R 170	4-00062-401	270	Resistor, Carbon Film, 1/4W, 5%
R 171	4-00142-407	100K	Resistor, Metal Film, 1/8W, 1%, 50PPM
R 172	4-00105-401	910K	Resistor, Carbon Film, 1/4W, 5%
R 173	4-00292-401	1.1K	Resistor, Carbon Film, 1/4W, 5%
R 174	4-00021-401	1.0K	Resistor, Carbon Film, 1/4W, 5%
R 175	4-00398-407	499K	Resistor, Metal Film, 1/8W, 1%, 50PPM
R 176	4-00130-407	1.00K	Resistor, Metal Film, 1/8W, 1%, 50PPM
R 177	4-00193-407	499	Resistor, Metal Film, 1/8W, 1%, 50PPM
R 178	4-00130-407	1.00K	Resistor, Metal Film, 1/8W, 1%, 50PPM
R 180	4-00781-402	56	Resistor, Carbon Comp, 1/2W, 5%
R 181	4-00781-402	56	Resistor, Carbon Comp, 1/2W, 5%
R 201	4-00177-407	3.48K	Resistor, Metal Film, 1/8W, 1%, 50PPM
R 202	4-00177-407	3.48K	Resistor, Metal Film, 1/8W, 1%, 50PPM
R 203	4-00771-407	66.5	Resistor, Metal Film, 1/8W, 1%, 50PPM
R 204	4-00163-407	2.80K	Resistor, Metal Film, 1/8W, 1%, 50PPM
R 205	4-00409-408	1.210K	Resistor, Metal Film, 1/8W, 0.1%, 25ppm
R 206	4-00409-408	1.210K	Resistor, Metal Film, 1/8W, 0.1%, 25ppm
R 207	4-00467-407	2.43K	Resistor, Metal Film, 1/8W, 1%, 50PPM
R 208	4-00193-407	499	Resistor, Metal Film, 1/8W, 1%, 50PPM
R 209	4-00158-407	2.00K	Resistor, Metal Film, 1/8W, 1%, 50PPM
R 210	4-00409-408	1.210K	Resistor, Metal Film, 1/8W, 0.1%, 25ppm
R 211	4-00409-408	1.210K	Resistor, Metal Film, 1/8W, 0.1%, 25ppm
R 212	4-00746-407	2.05K	Resistor, Metal Film, 1/8W, 1%, 50PPM

Parts List

<u>Ref.</u>	<u>SRS Part No.</u>	<u>Value</u>	<u>Description</u>
R 213	4-00317-407	422	Resistor, Metal Film, 1/8W, 1%, 50PPM
R 214	4-00652-407	1.58K	Resistor, Metal Film, 1/8W, 1%, 50PPM
R 215	4-00409-408	1.210K	Resistor, Metal Film, 1/8W, 0.1%, 25ppm
R 216	4-00409-408	1.210K	Resistor, Metal Film, 1/8W, 0.1%, 25ppm
R 217	4-00523-407	649	Resistor, Metal Film, 1/8W, 1%, 50PPM
R 221	4-00130-407	1.00K	Resistor, Metal Film, 1/8W, 1%, 50PPM
R 222	4-00188-407	4.99K	Resistor, Metal Film, 1/8W, 1%, 50PPM
R 226	4-00782-448	54.9	Resistor, Metal Film, 1W, 1%,
R 227	4-00193-407	499	Resistor, Metal Film, 1/8W, 1%, 50PPM
R 228	4-00704-407	54.9	Resistor, Metal Film, 1/8W, 1%, 50PPM
R 231	4-00519-407	4.75K	Resistor, Metal Film, 1/8W, 1%, 50PPM
R 232	4-00467-407	2.43K	Resistor, Metal Film, 1/8W, 1%, 50PPM
R 237	4-00787-407	768	Resistor, Metal Film, 1/8W, 1%, 50PPM
R 238	4-00031-401	100	Resistor, Carbon Film, 1/4W, 5%
R 239	4-00062-401	270	Resistor, Carbon Film, 1/4W, 5%
R 240	4-00022-401	1.0M	Resistor, Carbon Film, 1/4W, 5%
R 250	4-00772-402	33	Resistor, Carbon Comp, 1/2W, 5%
R 251	4-00772-402	33	Resistor, Carbon Comp, 1/2W, 5%
R 280	4-00781-402	56	Resistor, Carbon Comp, 1/2W, 5%
R 281	4-00781-402	56	Resistor, Carbon Comp, 1/2W, 5%
R 290	4-00071-401	33	Resistor, Carbon Film, 1/4W, 5%
R 301	4-00027-401	1.5K	Resistor, Carbon Film, 1/4W, 5%
R 302	4-00273-401	5.6K	Resistor, Carbon Film, 1/4W, 5%
R 303	4-00027-401	1.5K	Resistor, Carbon Film, 1/4W, 5%
R 304	4-00273-401	5.6K	Resistor, Carbon Film, 1/4W, 5%
R 381	4-00475-407	2.61K	Resistor, Metal Film, 1/8W, 1%, 50PPM
R 382	4-00475-407	2.61K	Resistor, Metal Film, 1/8W, 1%, 50PPM
R 383	4-00706-407	237	Resistor, Metal Film, 1/8W, 1%, 50PPM
R 384	4-00706-407	237	Resistor, Metal Film, 1/8W, 1%, 50PPM
R 385	4-00795-412	24	Resistor, Carbon Film 1/2W 5%
R 386	4-00795-412	24	Resistor, Carbon Film 1/2W 5%
R 387	4-00215-407	909	Resistor, Metal Film, 1/8W, 1%, 50PPM
R 388	4-00215-407	909	Resistor, Metal Film, 1/8W, 1%, 50PPM
R 389	4-00706-407	237	Resistor, Metal Film, 1/8W, 1%, 50PPM
R 390	4-00706-407	237	Resistor, Metal Film, 1/8W, 1%, 50PPM
R 401	4-00234-407	10	Resistor, Metal Film, 1/8W, 1%, 50PPM
R 402	4-00174-407	280	Resistor, Metal Film, 1/8W, 1%, 50PPM
R 450	4-00056-401	22	Resistor, Carbon Film, 1/4W, 5%
R 451	4-00030-401	10	Resistor, Carbon Film, 1/4W, 5%
R 452	4-00056-401	22	Resistor, Carbon Film, 1/4W, 5%
R 453	4-00030-401	10	Resistor, Carbon Film, 1/4W, 5%
R 470	4-00031-401	100	Resistor, Carbon Film, 1/4W, 5%
R 471	4-00031-401	100	Resistor, Carbon Film, 1/4W, 5%
R 503	4-00034-401	10K	Resistor, Carbon Film, 1/4W, 5%
R 601	4-00034-401	10K	Resistor, Carbon Film, 1/4W, 5%
R 602	4-00062-401	270	Resistor, Carbon Film, 1/4W, 5%
R 603	4-00021-401	1.0K	Resistor, Carbon Film, 1/4W, 5%
R 604	4-00034-401	10K	Resistor, Carbon Film, 1/4W, 5%
R 611	4-00062-401	270	Resistor, Carbon Film, 1/4W, 5%

Parts List

<u>Ref.</u>	<u>SRS Part No.</u>	<u>Value</u>	<u>Description</u>
RX623	4-00053-401	200	Resistor, Carbon Film, 1/4W, 5%
T 201	6-00137-601	15MH	Inductor
TP101	1-00143-101	TEST JACK	Vertical Test Jack
TP102	1-00143-101	TEST JACK	Vertical Test Jack
TP103	1-00143-101	TEST JACK	Vertical Test Jack
TP104	1-00143-101	TEST JACK	Vertical Test Jack
TP105	1-00143-101	TEST JACK	Vertical Test Jack
TP106	1-00143-101	TEST JACK	Vertical Test Jack
TP107	1-00143-101	TEST JACK	Vertical Test Jack
TP108	1-00143-101	TEST JACK	Vertical Test Jack
TP201	1-00143-101	TEST JACK	Vertical Test Jack
TP202	1-00143-101	TEST JACK	Vertical Test Jack
TP203	1-00143-101	TEST JACK	Vertical Test Jack
TP204	1-00143-101	TEST JACK	Vertical Test Jack
TP301	1-00143-101	TEST JACK	Vertical Test Jack
TP302	1-00143-101	TEST JACK	Vertical Test Jack
TP303	1-00143-101	TEST JACK	Vertical Test Jack
TP304	1-00143-101	TEST JACK	Vertical Test Jack
TP401	1-00143-101	TEST JACK	Vertical Test Jack
TP402	1-00143-101	TEST JACK	Vertical Test Jack
TP403	1-00143-101	TEST JACK	Vertical Test Jack
TP404	1-00143-101	TEST JACK	Vertical Test Jack
TP501	1-00143-101	TEST JACK	Vertical Test Jack
TP502	1-00143-101	TEST JACK	Vertical Test Jack
U 101	3-00461-340	OPA2604	Integrated Circuit (Thru-hole Pkg)
U 102	3-00461-340	OPA2604	Integrated Circuit (Thru-hole Pkg)
U 103	3-00211-340	LT1016	Integrated Circuit (Thru-hole Pkg)
U 104	3-00262-340	74HC86	Integrated Circuit (Thru-hole Pkg)
U 105	3-00160-340	74HC4046	Integrated Circuit (Thru-hole Pkg)
U 106	3-00402-340	74HC4052	Integrated Circuit (Thru-hole Pkg)
U 107	3-00461-340	OPA2604	Integrated Circuit (Thru-hole Pkg)
U 110	3-00437-340	AD9696KN	Integrated Circuit (Thru-hole Pkg)
U 111	6-00110-621	30.208 MHZ	Crystal Oscillator
U 120	3-00238-340	74F74	Integrated Circuit (Thru-hole Pkg)
U 121	3-00238-340	74F74	Integrated Circuit (Thru-hole Pkg)
U 122	3-00182-340	74HC02	Integrated Circuit (Thru-hole Pkg)
U 180	3-00116-325	78L05	Transistor, TO-92 Package
U 181	3-00122-325	79L05	Transistor, TO-92 Package
U 201	3-00130-340	5532A	Integrated Circuit (Thru-hole Pkg)
U 202	3-00130-340	5532A	Integrated Circuit (Thru-hole Pkg)
U 203	3-00130-340	5532A	Integrated Circuit (Thru-hole Pkg)
U 205	3-00130-340	5532A	Integrated Circuit (Thru-hole Pkg)
U 206	3-00058-340	AD7524	Integrated Circuit (Thru-hole Pkg)
U 207	3-00383-340	LM6321	Integrated Circuit (Thru-hole Pkg)
U 208	3-00461-340	OPA2604	Integrated Circuit (Thru-hole Pkg)
U 209	3-00211-340	LT1016	Integrated Circuit (Thru-hole Pkg)
U 210	3-00262-340	74HC86	Integrated Circuit (Thru-hole Pkg)
U 280	3-00116-325	78L05	Transistor, TO-92 Package
U 281	3-00122-325	79L05	Transistor, TO-92 Package

Parts List

<u>Ref.</u>	<u>SRS Part No.</u>	<u>Value</u>	<u>Description</u>
U 301	3-00087-340	LF347	Integrated Circuit (Thru-hole Pkg)
U 302	3-00087-340	LF347	Integrated Circuit (Thru-hole Pkg)
U 303	3-00088-340	LF353	Integrated Circuit (Thru-hole Pkg)
U 380	3-00149-329	LM317T	Voltage Reg., TO-220 (TAB) Package
U 381	3-00141-329	LM337T	Voltage Reg., TO-220 (TAB) Package
U 382	3-00149-329	LM317T	Voltage Reg., TO-220 (TAB) Package
U 383	3-00141-329	LM337T	Voltage Reg., TO-220 (TAB) Package
U 401	3-00328-340	PCM1700P	Integrated Circuit (Thru-hole Pkg)
U 402	3-00328-340	PCM1700P	Integrated Circuit (Thru-hole Pkg)
U 403	3-00270-340	74HC4051	Integrated Circuit (Thru-hole Pkg)
U 404	3-00385-340	74HC4053	Integrated Circuit (Thru-hole Pkg)
U 501	3-00611-360	DSP56002FC-40	Integrated Circuit (Surface Mount Pkg)
U 502	3-00265-340	74HC595	Integrated Circuit (Thru-hole Pkg)
U 503	3-00265-340	74HC595	Integrated Circuit (Thru-hole Pkg)
U 504	3-00488-340	74HC597	Integrated Circuit (Thru-hole Pkg)
U 505	3-00488-340	74HC597	Integrated Circuit (Thru-hole Pkg)
U 601	3-00495-343	SR850 U601	GAL/PAL, I.C.
U 602	3-00496-343	SR850 U602	GAL/PAL, I.C.
U 603	3-00497-343	SR850 U603	GAL/PAL, I.C.
U 604	3-00498-343	SR850 U604	GAL/PAL, I.C.
U 606	3-00499-343	SR850 U606	GAL/PAL, I.C.
U 608	3-00411-340	74HC273	Integrated Circuit (Thru-hole Pkg)
U 609	3-00411-340	74HC273	Integrated Circuit (Thru-hole Pkg)
U 610	3-00387-340	74HC245	Integrated Circuit (Thru-hole Pkg)
U 611	3-00440-340	74HC573	Integrated Circuit (Thru-hole Pkg)
U 612	3-00440-340	74HC573	Integrated Circuit (Thru-hole Pkg)
U 613	3-00440-340	74HC573	Integrated Circuit (Thru-hole Pkg)
U 614	3-00038-340	74HC139	Integrated Circuit (Thru-hole Pkg)
U 621	3-00441-340	74HC113	Integrated Circuit (Thru-hole Pkg)
U 622	3-00491-340	UPD71054C	Integrated Circuit (Thru-hole Pkg)
U 623	3-00036-340	74HC00	Integrated Circuit (Thru-hole Pkg)
U 630	3-00049-340	74HC74	Integrated Circuit (Thru-hole Pkg)
Z 0	0-00012-007	TO-220	Heat Sinks
Z 0	0-00043-011	4-40 KEP	Nut, Kep
Z 0	0-00373-000	CARD EJECTOR	Hardware, Misc.
Z 0	0-00388-000	RCA PHONO	Hardware, Misc.
Z 0	0-00438-021	4-40X5/16PP	Screw, Panhead Phillips

Analog Input Board Parts List

<u>Ref.</u>	<u>SRS Part No.</u>	<u>Value</u>	<u>Description</u>
C 102	5-00183-535	.1U - 2%	Capacitor, Polypropylene
C 103	5-00183-535	.1U - 2%	Capacitor, Polypropylene
C 104	5-00159-501	6.8P	Capacitor, Ceramic Disc, 50V, 10%, SL
C 106	5-00100-517	2.2U	Capacitor, Tantalum, 35V, 20%, Rad
C 111	5-00023-529	.1U	Cap, Monolythic Ceramic, 50V, 20%, Z5U
C 150	5-00098-517	10U	Capacitor, Tantalum, 35V, 20%, Rad
C 151	5-00098-517	10U	Capacitor, Tantalum, 35V, 20%, Rad
C 152	5-00023-529	.1U	Cap, Monolythic Ceramic, 50V, 20%, Z5U

Parts List

<u>Ref.</u>	<u>SRS Part No.</u>	<u>Value</u>	<u>Description</u>
C 153	5-00023-529	.1U	Cap, Monolythic Ceramic, 50V, 20%, Z5U
C 180	5-00038-509	10U	Capacitor, Electrolytic, 50V, 20%, Rad
C 181	5-00038-509	10U	Capacitor, Electrolytic, 50V, 20%, Rad
C 182	5-00100-517	2.2U	Capacitor, Tantalum, 35V, 20%, Rad
C 183	5-00100-517	2.2U	Capacitor, Tantalum, 35V, 20%, Rad
C 201	5-00060-512	1.0U	Cap, Stacked Metal Film 50V 5% -40/+85c
C 202	5-00060-512	1.0U	Cap, Stacked Metal Film 50V 5% -40/+85c
C 221	5-00060-512	1.0U	Cap, Stacked Metal Film 50V 5% -40/+85c
C 222	5-00060-512	1.0U	Cap, Stacked Metal Film 50V 5% -40/+85c
C 225	5-00007-501	220P	Capacitor, Ceramic Disc, 50V, 10%, SL
C 261	5-00023-529	.1U	Cap, Monolythic Ceramic, 50V, 20%, Z5U
C 281	5-00023-529	.1U	Cap, Monolythic Ceramic, 50V, 20%, Z5U
C 282	5-00023-529	.1U	Cap, Monolythic Ceramic, 50V, 20%, Z5U
C 303	5-00002-501	100P	Capacitor, Ceramic Disc, 50V, 10%, SL
C 311	5-00148-545	1000P - 50V	Capacitor, Monolythic Ceramic, COG, 1%
C 312	5-00148-545	1000P - 50V	Capacitor, Monolythic Ceramic, COG, 1%
C 321	5-00148-545	1000P - 50V	Capacitor, Monolythic Ceramic, COG, 1%
C 322	5-00148-545	1000P - 50V	Capacitor, Monolythic Ceramic, COG, 1%
C 331	5-00148-545	1000P - 50V	Capacitor, Monolythic Ceramic, COG, 1%
C 332	5-00148-545	1000P - 50V	Capacitor, Monolythic Ceramic, COG, 1%
C 341	5-00148-545	1000P - 50V	Capacitor, Monolythic Ceramic, COG, 1%
C 342	5-00148-545	1000P - 50V	Capacitor, Monolythic Ceramic, COG, 1%
C 351	5-00148-545	1000P - 50V	Capacitor, Monolythic Ceramic, COG, 1%
C 361	5-00219-529	.01U	Cap, Monolythic Ceramic, 50V, 20%, Z5U
C 362	0-00772-000	1.5" WIRE	Hardware, Misc.
C 363	5-00022-501	.001U	Capacitor, Ceramic Disc, 50V, 10%, SL
C 371	5-00148-545	1000P - 50V	Capacitor, Monolythic Ceramic, COG, 1%
C 372	5-00148-545	1000P - 50V	Capacitor, Monolythic Ceramic, COG, 1%
C 381	5-00148-545	1000P - 50V	Capacitor, Monolythic Ceramic, COG, 1%
C 382	5-00148-545	1000P - 50V	Capacitor, Monolythic Ceramic, COG, 1%
C 386	5-00013-501	33P	Capacitor, Ceramic Disc, 50V, 10%, SL
C 390	5-00148-545	1000P - 50V	Capacitor, Monolythic Ceramic, COG, 1%
C 391	5-00023-529	.1U	Cap, Monolythic Ceramic, 50V, 20%, Z5U
C 392	5-00023-529	.1U	Cap, Monolythic Ceramic, 50V, 20%, Z5U
C 393	5-00023-529	.1U	Cap, Monolythic Ceramic, 50V, 20%, Z5U
C 394	5-00023-529	.1U	Cap, Monolythic Ceramic, 50V, 20%, Z5U
C 395	5-00023-529	.1U	Cap, Monolythic Ceramic, 50V, 20%, Z5U
C 396	5-00023-529	.1U	Cap, Monolythic Ceramic, 50V, 20%, Z5U
C 397	5-00023-529	.1U	Cap, Monolythic Ceramic, 50V, 20%, Z5U
C 398	5-00023-529	.1U	Cap, Monolythic Ceramic, 50V, 20%, Z5U
C 410	5-00023-529	.1U	Cap, Monolythic Ceramic, 50V, 20%, Z5U
C 411	5-00098-517	10U	Capacitor, Tantalum, 35V, 20%, Rad
C 414	5-00098-517	10U	Capacitor, Tantalum, 35V, 20%, Rad
C 430	5-00100-517	2.2U	Capacitor, Tantalum, 35V, 20%, Rad
C 431	5-00100-517	2.2U	Capacitor, Tantalum, 35V, 20%, Rad
C 456	5-00023-529	.1U	Cap, Monolythic Ceramic, 50V, 20%, Z5U
C 460	5-00023-529	.1U	Cap, Monolythic Ceramic, 50V, 20%, Z5U
C 461	5-00023-529	.1U	Cap, Monolythic Ceramic, 50V, 20%, Z5U
C 462	5-00023-529	.1U	Cap, Monolythic Ceramic, 50V, 20%, Z5U

Parts List

<u>Ref.</u>	<u>SRS Part No.</u>	<u>Value</u>	<u>Description</u>
C 463	5-00023-529	.1U	Cap, Monolythic Ceramic, 50V, 20%, Z5U
C 480	5-00098-517	10U	Capacitor, Tantalum, 35V, 20%, Rad
C 481	5-00098-517	10U	Capacitor, Tantalum, 35V, 20%, Rad
C 482	5-00098-517	10U	Capacitor, Tantalum, 35V, 20%, Rad
C 483	5-00098-517	10U	Capacitor, Tantalum, 35V, 20%, Rad
C 511	5-00100-517	2.2U	Capacitor, Tantalum, 35V, 20%, Rad
C 512	5-00100-517	2.2U	Capacitor, Tantalum, 35V, 20%, Rad
C 513	5-00100-517	2.2U	Capacitor, Tantalum, 35V, 20%, Rad
C 514	5-00100-517	2.2U	Capacitor, Tantalum, 35V, 20%, Rad
C 515	5-00098-517	10U	Capacitor, Tantalum, 35V, 20%, Rad
C 516	5-00023-529	.1U	Cap, Monolythic Ceramic, 50V, 20%, Z5U
C 517	5-00023-529	.1U	Cap, Monolythic Ceramic, 50V, 20%, Z5U
C 520	5-00100-517	2.2U	Capacitor, Tantalum, 35V, 20%, Rad
C 521	5-00100-517	2.2U	Capacitor, Tantalum, 35V, 20%, Rad
C 523	5-00100-517	2.2U	Capacitor, Tantalum, 35V, 20%, Rad
C 524	5-00100-517	2.2U	Capacitor, Tantalum, 35V, 20%, Rad
C 530	5-00100-517	2.2U	Capacitor, Tantalum, 35V, 20%, Rad
C 531	5-00100-517	2.2U	Capacitor, Tantalum, 35V, 20%, Rad
C 540	5-00100-517	2.2U	Capacitor, Tantalum, 35V, 20%, Rad
C 560	5-00100-517	2.2U	Capacitor, Tantalum, 35V, 20%, Rad
C 561	5-00100-517	2.2U	Capacitor, Tantalum, 35V, 20%, Rad
C 562	5-00100-517	2.2U	Capacitor, Tantalum, 35V, 20%, Rad
D 101	3-00489-301	1N5232	Diode
D 180	3-00004-301	1N4148	Diode
D 181	3-00004-301	1N4148	Diode
D 480	3-00004-301	1N4148	Diode
D 481	3-00004-301	1N4148	Diode
J 101	0-00388-000	RCA PHONO	Hardware, Misc.
J 102	0-00388-000	RCA PHONO	Hardware, Misc.
JP201	1-00006-130	2 PIN DI	Connector, Male
JP221	1-00006-130	2 PIN DI	Connector, Male
JP401	1-00184-130	32 PIN DIL	Connector, Male
K 101	3-00196-335	HS-212S-5	Relay
K 102	3-00444-335	BS-211-DC5 GF	Relay
K 103	3-00444-335	BS-211-DC5 GF	Relay
K 104	3-00196-335	HS-212S-5	Relay
K 105	3-00444-335	BS-211-DC5 GF	Relay
L 501	6-00006-602	33U	Inductor, Radial
N 101	4-00560-421	47KX3	Res. Network, SIP, 1/4W,2% (Isolated)
N 102	4-00244-421	10KX4	Res. Network, SIP, 1/4W,2% (Isolated)
N 103	4-00497-421	1.5KX4	Res. Network, SIP, 1/4W,2% (Isolated)
N 261	4-00560-421	47KX3	Res. Network, SIP, 1/4W,2% (Isolated)
N 401	4-00756-421	1.0MX4	Res. Network, SIP, 1/4W,2% (Isolated)
N 402	4-00757-421	220KX4	Res. Network, SIP, 1/4W,2% (Isolated)
N 403	4-00756-421	1.0MX4	Res. Network, SIP, 1/4W,2% (Isolated)
N 404	4-00757-421	220KX4	Res. Network, SIP, 1/4W,2% (Isolated)
N 405	4-00694-421	270X4	Res. Network, SIP, 1/4W,2% (Isolated)
N 406	4-00694-421	270X4	Res. Network, SIP, 1/4W,2% (Isolated)
N 501	4-00758-425	15KX5	Resistor Network SIP 1/4W 2% (Common)

Parts List

<u>Ref.</u>	<u>SRS Part No.</u>	<u>Value</u>	<u>Description</u>
P 101	4-00015-445	100K	Pot, Multi-Turn, Side Adjust
P 102	4-00354-445	20	Pot, Multi-Turn, Side Adjust
P 103	4-00015-445	100K	Pot, Multi-Turn, Side Adjust
P 201	4-00759-445	50	Pot, Multi-Turn, Side Adjust
P 202	4-00760-445	500	Pot, Multi-Turn, Side Adjust
P 221	4-00730-445	100	Pot, Multi-Turn, Side Adjust
P 222	4-00760-445	500	Pot, Multi-Turn, Side Adjust
PC1	7-00355-701	L/I ANALOG	Printed Circuit Board
R 101	4-00021-401	1.0K	Resistor, Carbon Film, 1/4W, 5%
R 102	4-00131-407	1.00M	Resistor, Metal Film, 1/8W, 1%, 50PPM
R 103	4-00306-407	100M	Resistor, Metal Film, 1/8W, 1%, 50PPM
R 104	4-00034-401	10K	Resistor, Carbon Film, 1/4W, 5%
R 106	4-00191-407	49.9	Resistor, Metal Film, 1/8W, 1%, 50PPM
R 107	4-00191-407	49.9	Resistor, Metal Film, 1/8W, 1%, 50PPM
R 108	4-00139-407	10.0M	Resistor, Metal Film, 1/8W, 1%, 50PPM
R 109	4-00139-407	10.0M	Resistor, Metal Film, 1/8W, 1%, 50PPM
R 110	4-00143-407	102K	Resistor, Metal Film, 1/8W, 1%, 50PPM
R 111	4-00689-408	2.150K	Resistor, Metal Film, 1/8W, 0.1%, 25ppm
R 114	4-00217-408	1.000K	Resistor, Metal Film, 1/8W, 0.1%, 25ppm
R 115	4-00735-408	357	Resistor, Metal Film, 1/8W, 0.1%, 25ppm
R 119	4-00217-408	1.000K	Resistor, Metal Film, 1/8W, 0.1%, 25ppm
R 120	4-00735-408	357	Resistor, Metal Film, 1/8W, 0.1%, 25ppm
R 123	4-00143-407	102K	Resistor, Metal Film, 1/8W, 1%, 50PPM
R 124	4-00689-408	2.150K	Resistor, Metal Film, 1/8W, 0.1%, 25ppm
R 125	4-00030-401	10	Resistor, Carbon Film, 1/4W, 5%
R 126	4-00142-407	100K	Resistor, Metal Film, 1/8W, 1%, 50PPM
R 127	4-00142-407	100K	Resistor, Metal Film, 1/8W, 1%, 50PPM
R 129	4-00130-407	1.00K	Resistor, Metal Film, 1/8W, 1%, 50PPM
R 130	4-00192-407	49.9K	Resistor, Metal Film, 1/8W, 1%, 50PPM
R 131	4-00034-401	10K	Resistor, Carbon Film, 1/4W, 5%
R 132	4-00396-407	374K	Resistor, Metal Film, 1/8W, 1%, 50PPM
R 133	4-00059-401	22K	Resistor, Carbon Film, 1/4W, 5%
R 140	4-00030-401	10	Resistor, Carbon Film, 1/4W, 5%
R 141	4-00059-401	22K	Resistor, Carbon Film, 1/4W, 5%
R 150	4-00089-401	56	Resistor, Carbon Film, 1/4W, 5%
R 151	4-00089-401	56	Resistor, Carbon Film, 1/4W, 5%
R 180	4-00030-401	10	Resistor, Carbon Film, 1/4W, 5%
R 181	4-00030-401	10	Resistor, Carbon Film, 1/4W, 5%
R 201	4-00198-407	6.65K	Resistor, Metal Film, 1/8W, 1%, 50PPM
R 202	4-00761-407	287	Resistor, Metal Film, 1/8W, 1%, 50PPM
R 203	4-00762-407	158	Resistor, Metal Film, 1/8W, 1%, 50PPM
R 204	4-00763-407	14.0K	Resistor, Metal Film, 1/8W, 1%, 50PPM
R 205	4-00321-407	1.74K	Resistor, Metal Film, 1/8W, 1%, 50PPM
R 207	4-00380-407	6.34K	Resistor, Metal Film, 1/8W, 1%, 50PPM
R 208	4-00556-407	2.94K	Resistor, Metal Film, 1/8W, 1%, 50PPM
R 221	4-00595-407	13.3K	Resistor, Metal Film, 1/8W, 1%, 50PPM
R 222	4-00663-407	576	Resistor, Metal Film, 1/8W, 1%, 50PPM
R 223	4-00322-407	316	Resistor, Metal Film, 1/8W, 1%, 50PPM
R 224	4-00732-407	28.0K	Resistor, Metal Film, 1/8W, 1%, 50PPM

Parts List

<u>Ref.</u>	<u>SRS Part No.</u>	<u>Value</u>	<u>Description</u>
R 225	4-00321-407	1.74K	Resistor, Metal Film, 1/8W, 1%, 50PPM
R 226	4-00158-407	2.00K	Resistor, Metal Film, 1/8W, 1%, 50PPM
R 227	4-00158-407	2.00K	Resistor, Metal Film, 1/8W, 1%, 50PPM
R 228	4-00158-407	2.00K	Resistor, Metal Film, 1/8W, 1%, 50PPM
R 241	4-00380-407	6.34K	Resistor, Metal Film, 1/8W, 1%, 50PPM
R 242	4-00556-407	2.94K	Resistor, Metal Film, 1/8W, 1%, 50PPM
R 244	4-00380-407	6.34K	Resistor, Metal Film, 1/8W, 1%, 50PPM
R 245	4-00556-407	2.94K	Resistor, Metal Film, 1/8W, 1%, 50PPM
R 246	4-00380-407	6.34K	Resistor, Metal Film, 1/8W, 1%, 50PPM
R 247	4-00556-407	2.94K	Resistor, Metal Film, 1/8W, 1%, 50PPM
R 249	4-00380-407	6.34K	Resistor, Metal Film, 1/8W, 1%, 50PPM
R 252	4-00556-407	2.94K	Resistor, Metal Film, 1/8W, 1%, 50PPM
R 261	4-00138-407	10.0K	Resistor, Metal Film, 1/8W, 1%, 50PPM
R 262	4-00138-407	10.0K	Resistor, Metal Film, 1/8W, 1%, 50PPM
R 299	4-00059-401	22K	Resistor, Carbon Film, 1/4W, 5%
R 301	4-00066-401	3.3M	Resistor, Carbon Film, 1/4W, 5%
R 302	4-00130-407	1.00K	Resistor, Metal Film, 1/8W, 1%, 50PPM
R 303	4-00130-407	1.00K	Resistor, Metal Film, 1/8W, 1%, 50PPM
R 304	4-00158-407	2.00K	Resistor, Metal Film, 1/8W, 1%, 50PPM
R 305	4-00164-407	20.0K	Resistor, Metal Film, 1/8W, 1%, 50PPM
R 306	4-00158-407	2.00K	Resistor, Metal Film, 1/8W, 1%, 50PPM
R 307	4-00217-408	1.000K	Resistor, Metal Film, 1/8W, 0.1%, 25ppm
R 308	4-00217-408	1.000K	Resistor, Metal Film, 1/8W, 0.1%, 25ppm
R 309	4-00130-407	1.00K	Resistor, Metal Film, 1/8W, 1%, 50PPM
R 311	4-00348-407	2.21K	Resistor, Metal Film, 1/8W, 1%, 50PPM
R 312	4-00765-407	56.2	Resistor, Metal Film, 1/8W, 1%, 50PPM
R 313	4-00475-407	2.61K	Resistor, Metal Film, 1/8W, 1%, 50PPM
R 314	4-00748-408	2.000K	Resistor, Metal Film, 1/8W, 0.1%, 25ppm
R 315	4-00748-408	2.000K	Resistor, Metal Film, 1/8W, 0.1%, 25ppm
R 321	4-00467-407	2.43K	Resistor, Metal Film, 1/8W, 1%, 50PPM
R 322	4-00698-407	357	Resistor, Metal Film, 1/8W, 1%, 50PPM
R 323	4-00582-407	2.15K	Resistor, Metal Film, 1/8W, 1%, 50PPM
R 324	4-00748-408	2.000K	Resistor, Metal Film, 1/8W, 0.1%, 25ppm
R 325	4-00748-408	2.000K	Resistor, Metal Film, 1/8W, 0.1%, 25ppm
R 331	4-00159-407	2.10K	Resistor, Metal Film, 1/8W, 1%, 50PPM
R 332	4-00429-407	511	Resistor, Metal Film, 1/8W, 1%, 50PPM
R 333	4-00136-407	1.82K	Resistor, Metal Film, 1/8W, 1%, 50PPM
R 334	4-00748-408	2.000K	Resistor, Metal Film, 1/8W, 0.1%, 25ppm
R 335	4-00748-408	2.000K	Resistor, Metal Film, 1/8W, 0.1%, 25ppm
R 341	4-00137-407	1.91K	Resistor, Metal Film, 1/8W, 1%, 50PPM
R 342	4-00583-407	309	Resistor, Metal Film, 1/8W, 1%, 50PPM
R 343	4-00699-407	1.54K	Resistor, Metal Film, 1/8W, 1%, 50PPM
R 344	4-00748-408	2.000K	Resistor, Metal Film, 1/8W, 0.1%, 25ppm
R 345	4-00748-408	2.000K	Resistor, Metal Film, 1/8W, 0.1%, 25ppm
R 351	4-00200-407	619	Resistor, Metal Film, 1/8W, 1%, 50PPM
R 361	4-00234-407	10	Resistor, Metal Film, 1/8W, 1%, 50PPM
R 363	4-00188-407	4.99K	Resistor, Metal Film, 1/8W, 1%, 50PPM
R 364	4-00164-407	20.0K	Resistor, Metal Film, 1/8W, 1%, 50PPM
R 365	4-00139-407	10.0M	Resistor, Metal Film, 1/8W, 1%, 50PPM

Parts List

<u>Ref.</u>	<u>SRS Part No.</u>	<u>Value</u>	<u>Description</u>
R 371	4-00763-407	14.0K	Resistor, Metal Film, 1/8W, 1%, 50PPM
R 372	4-00700-407	1.62K	Resistor, Metal Film, 1/8W, 1%, 50PPM
R 373	4-00763-407	14.0K	Resistor, Metal Film, 1/8W, 1%, 50PPM
R 374	4-00158-407	2.00K	Resistor, Metal Film, 1/8W, 1%, 50PPM
R 375	4-00158-407	2.00K	Resistor, Metal Film, 1/8W, 1%, 50PPM
R 379	4-00303-407	7.87K	Resistor, Metal Film, 1/8W, 1%, 50PPM
R 381	4-00156-407	16.2K	Resistor, Metal Film, 1/8W, 1%, 50PPM
R 382	4-00202-407	698	Resistor, Metal Film, 1/8W, 1%, 50PPM
R 383	4-00595-407	13.3K	Resistor, Metal Film, 1/8W, 1%, 50PPM
R 384	4-00158-407	2.00K	Resistor, Metal Film, 1/8W, 1%, 50PPM
R 385	4-00158-407	2.00K	Resistor, Metal Film, 1/8W, 1%, 50PPM
R 386	4-00185-407	4.02K	Resistor, Metal Film, 1/8W, 1%, 50PPM
R 387	4-00141-407	100	Resistor, Metal Film, 1/8W, 1%, 50PPM
R 388	4-00021-401	1.0K	Resistor, Carbon Film, 1/4W, 5%
R 389	4-00130-407	1.00K	Resistor, Metal Film, 1/8W, 1%, 50PPM
R 391	4-00030-401	10	Resistor, Carbon Film, 1/4W, 5%
R 392	4-00030-401	10	Resistor, Carbon Film, 1/4W, 5%
R 393	4-00030-401	10	Resistor, Carbon Film, 1/4W, 5%
R 394	4-00030-401	10	Resistor, Carbon Film, 1/4W, 5%
R 395	4-00130-407	1.00K	Resistor, Metal Film, 1/8W, 1%, 50PPM
R 396	4-00138-407	10.0K	Resistor, Metal Film, 1/8W, 1%, 50PPM
R 397	4-00138-407	10.0K	Resistor, Metal Film, 1/8W, 1%, 50PPM
R 398	4-00059-401	22K	Resistor, Carbon Film, 1/4W, 5%
R 430	4-00021-401	1.0K	Resistor, Carbon Film, 1/4W, 5%
R 431	4-00021-401	1.0K	Resistor, Carbon Film, 1/4W, 5%
R 452	4-00141-407	100	Resistor, Metal Film, 1/8W, 1%, 50PPM
R 460	4-00030-401	10	Resistor, Carbon Film, 1/4W, 5%
R 461	4-00030-401	10	Resistor, Carbon Film, 1/4W, 5%
R 462	4-00030-401	10	Resistor, Carbon Film, 1/4W, 5%
R 463	4-00030-401	10	Resistor, Carbon Film, 1/4W, 5%
R 480	4-00108-402	150	Resistor, Carbon Comp, 1/2W, 5%
R 481	4-00108-402	150	Resistor, Carbon Comp, 1/2W, 5%
R 511	4-00475-407	2.61K	Resistor, Metal Film, 1/8W, 1%, 50PPM
R 512	4-00706-407	237	Resistor, Metal Film, 1/8W, 1%, 50PPM
R 513	4-00475-407	2.61K	Resistor, Metal Film, 1/8W, 1%, 50PPM
R 514	4-00706-407	237	Resistor, Metal Film, 1/8W, 1%, 50PPM
R 515	4-00359-402	51	Resistor, Carbon Comp, 1/2W, 5%
R 516	4-00359-402	51	Resistor, Carbon Comp, 1/2W, 5%
R 517	4-00215-407	909	Resistor, Metal Film, 1/8W, 1%, 50PPM
R 518	4-00706-407	237	Resistor, Metal Film, 1/8W, 1%, 50PPM
R 519	4-00215-407	909	Resistor, Metal Film, 1/8W, 1%, 50PPM
R 520	4-00706-407	237	Resistor, Metal Film, 1/8W, 1%, 50PPM
R 540	4-00141-407	100	Resistor, Metal Film, 1/8W, 1%, 50PPM
R 560	4-00056-401	22	Resistor, Carbon Film, 1/4W, 5%
SO101	1-00173-150	8 PIN MACH	Socket, THRU-HOLE
SO102	1-00173-150	8 PIN MACH	Socket, THRU-HOLE
SO108	1-00173-150	8 PIN MACH	Socket, THRU-HOLE
SO361	1-00173-150	8 PIN MACH	Socket, THRU-HOLE
TP101	1-00143-101	TEST JACK	Vertical Test Jack

Parts List

<u>Ref.</u>	<u>SRS Part No.</u>	<u>Value</u>	<u>Description</u>
TP102	1-00143-101	TEST JACK	Vertical Test Jack
TP103	1-00143-101	TEST JACK	Vertical Test Jack
TP104	1-00143-101	TEST JACK	Vertical Test Jack
TP201	1-00143-101	TEST JACK	Vertical Test Jack
TP301	1-00143-101	TEST JACK	Vertical Test Jack
TP302	1-00143-101	TEST JACK	Vertical Test Jack
TP303	1-00143-101	TEST JACK	Vertical Test Jack
TP405	1-00143-101	TEST JACK	Vertical Test Jack
TP406	1-00143-101	TEST JACK	Vertical Test Jack
TP407	1-00143-101	TEST JACK	Vertical Test Jack
TP408	1-00143-101	TEST JACK	Vertical Test Jack
TP501	1-00143-101	TEST JACK	Vertical Test Jack
TP502	1-00143-101	TEST JACK	Vertical Test Jack
TP503	1-00143-101	TEST JACK	Vertical Test Jack
TP504	1-00143-101	TEST JACK	Vertical Test Jack
TP505	1-00143-101	TEST JACK	Vertical Test Jack
TP506	1-00143-101	TEST JACK	Vertical Test Jack
TP507	1-00143-101	TEST JACK	Vertical Test Jack
U 101	3-00494-340	AD645JN	Integrated Circuit (Thru-hole Pkg)
U 102	3-00246-340	NPD5564	Integrated Circuit (Thru-hole Pkg)
U 103	3-00423-340	5534	Integrated Circuit (Thru-hole Pkg)
U 104	3-00143-340	LM393	Integrated Circuit (Thru-hole Pkg)
U 105	3-00461-340	OPA2604	Integrated Circuit (Thru-hole Pkg)
U 106	3-00143-340	LM393	Integrated Circuit (Thru-hole Pkg)
U 108	3-00817-340	NPD5566	Integrated Circuit (Thru-hole Pkg)
U 109	3-00461-340	OPA2604	Integrated Circuit (Thru-hole Pkg)
U 180	3-00118-325	78L15	Transistor, TO-92 Package
U 181	3-00124-325	79L15	Transistor, TO-92 Package
U 201	3-00461-340	OPA2604	Integrated Circuit (Thru-hole Pkg)
U 202	3-00385-340	74HC4053	Integrated Circuit (Thru-hole Pkg)
U 203	3-00423-340	5534	Integrated Circuit (Thru-hole Pkg)
U 204	3-00423-340	5534	Integrated Circuit (Thru-hole Pkg)
U 241	3-00385-340	74HC4053	Integrated Circuit (Thru-hole Pkg)
U 242	3-00423-340	5534	Integrated Circuit (Thru-hole Pkg)
U 243	3-00385-340	74HC4053	Integrated Circuit (Thru-hole Pkg)
U 244	3-00423-340	5534	Integrated Circuit (Thru-hole Pkg)
U 261	3-00143-340	LM393	Integrated Circuit (Thru-hole Pkg)
U 301	3-00130-340	5532A	Integrated Circuit (Thru-hole Pkg)
U 302	3-00385-340	74HC4053	Integrated Circuit (Thru-hole Pkg)
U 303	3-00130-340	5532A	Integrated Circuit (Thru-hole Pkg)
U 304	3-00130-340	5532A	Integrated Circuit (Thru-hole Pkg)
U 305	3-00143-340	LM393	Integrated Circuit (Thru-hole Pkg)
U 311	3-00130-340	5532A	Integrated Circuit (Thru-hole Pkg)
U 321	3-00130-340	5532A	Integrated Circuit (Thru-hole Pkg)
U 331	3-00130-340	5532A	Integrated Circuit (Thru-hole Pkg)
U 341	3-00130-340	5532A	Integrated Circuit (Thru-hole Pkg)
U 361	3-00089-340	LF357	Integrated Circuit (Thru-hole Pkg)
U 362	3-00089-340	LF357	Integrated Circuit (Thru-hole Pkg)
U 371	3-00130-340	5532A	Integrated Circuit (Thru-hole Pkg)

<u>Ref.</u>	<u>SRS Part No.</u>	<u>Value</u>	<u>Description</u>
U 381	3-00130-340	5532A	Integrated Circuit (Thru-hole Pkg)
U 386	3-00423-340	5534	Integrated Circuit (Thru-hole Pkg)
U 391	3-00088-340	LF353	Integrated Circuit (Thru-hole Pkg)
U 401	3-00087-340	LF347	Integrated Circuit (Thru-hole Pkg)
U 402	3-00402-340	74HC4052	Integrated Circuit (Thru-hole Pkg)
U 403	3-00423-340	5534	Integrated Circuit (Thru-hole Pkg)
U 406	3-00155-340	74HC04	Integrated Circuit (Thru-hole Pkg)
U 407	3-00392-340	PCM1750P	Integrated Circuit (Thru-hole Pkg)
U 480	3-00116-325	78L05	Transistor, TO-92 Package
U 481	3-00122-325	79L05	Transistor, TO-92 Package
U 504	3-00411-340	74HC273	Integrated Circuit (Thru-hole Pkg)
U 506	3-00411-340	74HC273	Integrated Circuit (Thru-hole Pkg)
U 508	3-00149-329	LM317T	Voltage Reg., TO-220 (TAB) Package
U 509	3-00141-329	LM337T	Voltage Reg., TO-220 (TAB) Package
U 510	3-00149-329	LM317T	Voltage Reg., TO-220 (TAB) Package
U 511	3-00141-329	LM337T	Voltage Reg., TO-220 (TAB) Package
U 530	3-00195-340	CA3082	Integrated Circuit (Thru-hole Pkg)
Z 0	0-00043-011	4-40 KEP	Nut, Kep
Z 0	0-00187-021	4-40X1/4PP	Screw, Panhead Phillips
Z 0	0-00243-003	TO-220	Insulators
Z 0	0-00373-000	CARD EJECTOR	Hardware, Misc.
Z 0	1-00087-131	2 PIN JUMPER	Connector, Female

CPU Board Parts List

<u>Ref.</u>	<u>SRS Part No.</u>	<u>Value</u>	<u>Description</u>
BT701	6-00001-612	BR-2/3A 2PIN PC	Battery
C 101	5-00177-501	30P	Capacitor, Ceramic Disc, 50V, 10%, SL
C 102	5-00215-501	20P	Capacitor, Ceramic Disc, 50V, 10%, SL
C 103	0-00772-000	1.5" WIRE	Hardware, Misc.
C 501	5-00215-501	20P	Capacitor, Ceramic Disc, 50V, 10%, SL
C 601	5-00033-520	47U	Capacitor, Electrolytic, 16V, 20%, Rad
C 602	5-00012-501	330P	Capacitor, Ceramic Disc, 50V, 10%, SL
C 603	5-00012-501	330P	Capacitor, Ceramic Disc, 50V, 10%, SL
C 701	5-00064-513	.0047U	Capacitor, Mylar/Poly, 50V, 5%, Rad
C 704	5-00012-501	330P	Capacitor, Ceramic Disc, 50V, 10%, SL
C 705	5-00012-501	330P	Capacitor, Ceramic Disc, 50V, 10%, SL
C 706	5-00061-513	.001U	Capacitor, Mylar/Poly, 50V, 5%, Rad
C 801	5-00178-501	62P	Capacitor, Ceramic Disc, 50V, 10%, SL
C 802	5-00178-501	62P	Capacitor, Ceramic Disc, 50V, 10%, SL
C 803	5-00100-517	2.2U	Capacitor, Tantalum, 35V, 20%, Rad
C 804	5-00225-548	.1U AXIAL	Capacitor, Ceramic, 50V,+80/-20% Z5U AX
C 805	5-00100-517	2.2U	Capacitor, Tantalum, 35V, 20%, Rad
C 806	5-00100-517	2.2U	Capacitor, Tantalum, 35V, 20%, Rad
C 807	5-00100-517	2.2U	Capacitor, Tantalum, 35V, 20%, Rad
C 808	5-00100-517	2.2U	Capacitor, Tantalum, 35V, 20%, Rad
C 810	5-00023-529	.1U	Cap, Monolythic Ceramic, 50V, 20%, Z5U
C 811	5-00232-520	470U	Capacitor, Electrolytic, 16V, 20%, Rad
C 901	5-00003-501	10P	Capacitor, Ceramic Disc, 50V, 10%, SL

Parts List

<u>Ref.</u>	<u>SRS Part No.</u>	<u>Value</u>	<u>Description</u>
C 902	5-00003-501	10P	Capacitor, Ceramic Disc, 50V, 10%, SL
C 903	5-00061-513	.001U	Capacitor, Mylar/Poly, 50V, 5%, Rad
C 904	5-00223-513	.027U	Capacitor, Mylar/Poly, 50V, 5%, Rad
C 905	5-00068-513	.047U	Capacitor, Mylar/Poly, 50V, 5%, Rad
C 906	5-00061-513	.001U	Capacitor, Mylar/Poly, 50V, 5%, Rad
C 907	5-00012-501	330P	Capacitor, Ceramic Disc, 50V, 10%, SL
C 908	5-00012-501	330P	Capacitor, Ceramic Disc, 50V, 10%, SL
C 909	5-00178-501	62P	Capacitor, Ceramic Disc, 50V, 10%, SL
C 910	5-00178-501	62P	Capacitor, Ceramic Disc, 50V, 10%, SL
C 1001	5-00225-548	.1U AXIAL	Capacitor, Ceramic, 50V,+80/-20% Z5U AX
C 1002	5-00225-548	.1U AXIAL	Capacitor, Ceramic, 50V,+80/-20% Z5U AX
C 1003	5-00225-548	.1U AXIAL	Capacitor, Ceramic, 50V,+80/-20% Z5U AX
C 1004	5-00225-548	.1U AXIAL	Capacitor, Ceramic, 50V,+80/-20% Z5U AX
C 1005	5-00100-517	2.2U	Capacitor, Tantalum, 35V, 20%, Rad
C 1006	5-00225-548	.1U AXIAL	Capacitor, Ceramic, 50V,+80/-20% Z5U AX
C 1007	5-00225-548	.1U AXIAL	Capacitor, Ceramic, 50V,+80/-20% Z5U AX
C 1008	5-00225-548	.1U AXIAL	Capacitor, Ceramic, 50V,+80/-20% Z5U AX
C 1009	5-00225-548	.1U AXIAL	Capacitor, Ceramic, 50V,+80/-20% Z5U AX
C 1010	5-00225-548	.1U AXIAL	Capacitor, Ceramic, 50V,+80/-20% Z5U AX
C 1011	5-00225-548	.1U AXIAL	Capacitor, Ceramic, 50V,+80/-20% Z5U AX
C 1012	5-00225-548	.1U AXIAL	Capacitor, Ceramic, 50V,+80/-20% Z5U AX
C 1013	5-00225-548	.1U AXIAL	Capacitor, Ceramic, 50V,+80/-20% Z5U AX
C 1014	5-00100-517	2.2U	Capacitor, Tantalum, 35V, 20%, Rad
C 1015	5-00225-548	.1U AXIAL	Capacitor, Ceramic, 50V,+80/-20% Z5U AX
C 1016	5-00225-548	.1U AXIAL	Capacitor, Ceramic, 50V,+80/-20% Z5U AX
C 1017	5-00225-548	.1U AXIAL	Capacitor, Ceramic, 50V,+80/-20% Z5U AX
C 1018	5-00225-548	.1U AXIAL	Capacitor, Ceramic, 50V,+80/-20% Z5U AX
C 1019	5-00225-548	.1U AXIAL	Capacitor, Ceramic, 50V,+80/-20% Z5U AX
C 1020	5-00225-548	.1U AXIAL	Capacitor, Ceramic, 50V,+80/-20% Z5U AX
C 1021	5-00225-548	.1U AXIAL	Capacitor, Ceramic, 50V,+80/-20% Z5U AX
C 1022	5-00225-548	.1U AXIAL	Capacitor, Ceramic, 50V,+80/-20% Z5U AX
C 1023	5-00100-517	2.2U	Capacitor, Tantalum, 35V, 20%, Rad
C 1024	5-00225-548	.1U AXIAL	Capacitor, Ceramic, 50V,+80/-20% Z5U AX
C 1025	5-00225-548	.1U AXIAL	Capacitor, Ceramic, 50V,+80/-20% Z5U AX
C 1026	5-00100-517	2.2U	Capacitor, Tantalum, 35V, 20%, Rad
C 1027	5-00225-548	.1U AXIAL	Capacitor, Ceramic, 50V,+80/-20% Z5U AX
C 1028	5-00225-548	.1U AXIAL	Capacitor, Ceramic, 50V,+80/-20% Z5U AX
C 1029	5-00225-548	.1U AXIAL	Capacitor, Ceramic, 50V,+80/-20% Z5U AX
C 1030	5-00225-548	.1U AXIAL	Capacitor, Ceramic, 50V,+80/-20% Z5U AX
C 1031	5-00225-548	.1U AXIAL	Capacitor, Ceramic, 50V,+80/-20% Z5U AX
C 1032	5-00225-548	.1U AXIAL	Capacitor, Ceramic, 50V,+80/-20% Z5U AX
C 1033	5-00225-548	.1U AXIAL	Capacitor, Ceramic, 50V,+80/-20% Z5U AX
C 1034	5-00225-548	.1U AXIAL	Capacitor, Ceramic, 50V,+80/-20% Z5U AX
C 1035	5-00225-548	.1U AXIAL	Capacitor, Ceramic, 50V,+80/-20% Z5U AX
C 1036	5-00225-548	.1U AXIAL	Capacitor, Ceramic, 50V,+80/-20% Z5U AX
C 1037	5-00225-548	.1U AXIAL	Capacitor, Ceramic, 50V,+80/-20% Z5U AX
C 1038	5-00100-517	2.2U	Capacitor, Tantalum, 35V, 20%, Rad
C 1039	5-00225-548	.1U AXIAL	Capacitor, Ceramic, 50V,+80/-20% Z5U AX
C 1040	5-00225-548	.1U AXIAL	Capacitor, Ceramic, 50V,+80/-20% Z5U AX

Parts List

<u>Ref.</u>	<u>SRS Part No.</u>	<u>Value</u>	<u>Description</u>
C 1041	5-00225-548	.1U AXIAL	Capacitor, Ceramic, 50V,+80/-20% Z5U AX
C 1042	5-00100-517	2.2U	Capacitor, Tantalum, 35V, 20%, Rad
C 1043	5-00225-548	.1U AXIAL	Capacitor, Ceramic, 50V,+80/-20% Z5U AX
C 1044	5-00225-548	.1U AXIAL	Capacitor, Ceramic, 50V,+80/-20% Z5U AX
CU901	5-00114-501	200P	Capacitor, Ceramic Disc, 50V, 10%, SL
D 100	3-00391-301	MBR360	Diode
D 401	3-00004-301	1N4148	Diode
D 601	3-00004-301	1N4148	Diode
D 602	3-00004-301	1N4148	Diode
D 603	3-00004-301	1N4148	Diode
D 604	3-00004-301	1N4148	Diode
D 605	3-00004-301	1N4148	Diode
D 606	3-00004-301	1N4148	Diode
D 607	3-00004-301	1N4148	Diode
D 608	3-00004-301	1N4148	Diode
D 701	3-00203-301	1N5711	Diode
D 702	3-00004-301	1N4148	Diode
D 703	3-00004-301	1N4148	Diode
D 704	3-00004-301	1N4148	Diode
D 705	3-00004-301	1N4148	Diode
D 810	3-00820-301	1N5228B	Diode
JP201	0-00772-000	1.5" WIRE	Hardware, Misc.
JP301	0-00772-000	1.5" WIRE	Hardware, Misc.
JP302	0-00772-000	1.5" WIRE	Hardware, Misc.
JP303	0-00772-000	1.5" WIRE	Hardware, Misc.
JP601	1-00113-100	DIN 5	Connector, Misc.
JP602	1-00207-133	30 PIN DRA	Connector, Male, Right Angle
JP603	0-00772-000	1.5" WIRE	Hardware, Misc.
JP702	1-00083-130	26 PIN DIL	Connector, Male
JP801	1-00035-130	20 PIN DIL	Connector, Male
JP802	0-00772-000	1.5" WIRE	Hardware, Misc.
JP803	1-00086-130	3 PIN SI	Connector, Male
JP901B	1-00209-133	34 PIN DRA	Connector, Male, Right Angle
JP902	1-00238-161	GPIB SHIELDED	Connector, IEEE488, Reverse, R/A, Female
JP903	1-00016-160	RS232 25 PIN D	Connector, D-Sub, Right Angle PC, Female
JP1000	1-00170-130	26 PIN ELH	Connector, Male
JP1002	1-00039-116	5 PIN, WHITE	Header, Amp, MTA-156
N 101	4-00587-425	10KX7	Resistor Network SIP 1/4W 2% (Common)
N 102	4-00334-425	10KX5	Resistor Network SIP 1/4W 2% (Common)
N 501	4-00334-425	10KX5	Resistor Network SIP 1/4W 2% (Common)
N 601	4-00227-425	22KX9	Resistor Network SIP 1/4W 2% (Common)
N 701	4-00270-425	1.0KX5	Resistor Network SIP 1/4W 2% (Common)
N 801	4-00334-425	10KX5	Resistor Network SIP 1/4W 2% (Common)
N 901	4-00221-425	150X5	Resistor Network SIP 1/4W 2% (Common)
N 902	4-00244-421	10KX4	Res. Network, SIP, 1/4W,2% (Isolated)
PC1	7-00809-701	003/015 CONTRLR	Printed Circuit Board
Q 401	3-00026-325	2N5210	Transistor, TO-92 Package
Q 701	3-00022-325	2N3906	Transistor, TO-92 Package
Q 702	3-00021-325	2N3904	Transistor, TO-92 Package

Parts List

<u>Ref.</u>	<u>SRS Part No.</u>	<u>Value</u>	<u>Description</u>
Q 703	3-00021-325	2N3904	Transistor, TO-92 Package
Q 705	3-00022-325	2N3906	Transistor, TO-92 Package
Q 810	3-00022-325	2N3906	Transistor, TO-92 Package
Q 811	3-00021-325	2N3904	Transistor, TO-92 Package
R 401	4-00034-401	10K	Resistor, Carbon Film, 1/4W, 5%
R 402	4-00079-401	4.7K	Resistor, Carbon Film, 1/4W, 5%
R 502	4-00034-401	10K	Resistor, Carbon Film, 1/4W, 5%
R 601	4-00034-401	10K	Resistor, Carbon Film, 1/4W, 5%
R 602	4-00034-401	10K	Resistor, Carbon Film, 1/4W, 5%
R 701	4-00088-401	51K	Resistor, Carbon Film, 1/4W, 5%
R 702	4-00021-401	1.0K	Resistor, Carbon Film, 1/4W, 5%
R 703	4-00034-401	10K	Resistor, Carbon Film, 1/4W, 5%
R 704	4-00034-401	10K	Resistor, Carbon Film, 1/4W, 5%
R 705	4-00034-401	10K	Resistor, Carbon Film, 1/4W, 5%
R 706	4-00034-401	10K	Resistor, Carbon Film, 1/4W, 5%
R 707	4-00063-401	3.0K	Resistor, Carbon Film, 1/4W, 5%
R 710	4-00080-401	47	Resistor, Carbon Film, 1/4W, 5%
R 711	4-00080-401	47	Resistor, Carbon Film, 1/4W, 5%
R 712	4-00021-401	1.0K	Resistor, Carbon Film, 1/4W, 5%
R 713	4-00056-401	22	Resistor, Carbon Film, 1/4W, 5%
R 714	4-00079-401	4.7K	Resistor, Carbon Film, 1/4W, 5%
R 801	4-00022-401	1.0M	Resistor, Carbon Film, 1/4W, 5%
R 802	4-00062-401	270	Resistor, Carbon Film, 1/4W, 5%
R 808	4-00060-401	240	Resistor, Carbon Film, 1/4W, 5%
R 809	4-00081-401	470	Resistor, Carbon Film, 1/4W, 5%
R 810	4-00031-401	100	Resistor, Carbon Film, 1/4W, 5%
R 811	4-00021-401	1.0K	Resistor, Carbon Film, 1/4W, 5%
R 812	4-00021-401	1.0K	Resistor, Carbon Film, 1/4W, 5%
R 813	4-00053-401	200	Resistor, Carbon Film, 1/4W, 5%
R 814	4-00038-401	120	Resistor, Carbon Film, 1/4W, 5%
R 901	4-00273-401	5.6K	Resistor, Carbon Film, 1/4W, 5%
R 904	4-00090-401	560	Resistor, Carbon Film, 1/4W, 5%
R 905	4-00090-401	560	Resistor, Carbon Film, 1/4W, 5%
R 911	4-00022-401	1.0M	Resistor, Carbon Film, 1/4W, 5%
R 912	4-00062-401	270	Resistor, Carbon Film, 1/4W, 5%
R 913	4-00021-401	1.0K	Resistor, Carbon Film, 1/4W, 5%
SO101	1-00108-150	PLCC 68 TH	Socket, THRU-HOLE
SO301	1-00156-150	32 PIN 600 MIL	Socket, THRU-HOLE
SO302	1-00156-150	32 PIN 600 MIL	Socket, THRU-HOLE
SO303	1-00156-150	32 PIN 600 MIL	Socket, THRU-HOLE
SO304	1-00156-150	32 PIN 600 MIL	Socket, THRU-HOLE
SO907	1-00232-150	52 PLCC TH	Socket, THRU-HOLE
U 101	3-00354-360	80C186-12	Integrated Circuit (Surface Mount Pkg)
U 201	3-00340-340	74ALS373	Integrated Circuit (Thru-hole Pkg)
U 202	3-00340-340	74ALS373	Integrated Circuit (Thru-hole Pkg)
U 203	3-00340-340	74ALS373	Integrated Circuit (Thru-hole Pkg)
U 204	3-00341-340	74ALS245	Integrated Circuit (Thru-hole Pkg)
U 205	3-00341-340	74ALS245	Integrated Circuit (Thru-hole Pkg)
U 206	3-00342-340	74ALS138	Integrated Circuit (Thru-hole Pkg)

<u>Ref.</u>	<u>SRS Part No.</u>	<u>Value</u>	<u>Description</u>
U 207	3-00343-340	74ALS32	Integrated Circuit (Thru-hole Pkg)
U 208	3-00344-340	74ALS08	Integrated Circuit (Thru-hole Pkg)
U 401	3-00551-341	128KX8-70	STATIC RAM, I.C.
U 402	3-00551-341	128KX8-70	STATIC RAM, I.C.
U 403	3-00551-341	128KX8-70	STATIC RAM, I.C.
U 404	3-00551-341	128KX8-70	STATIC RAM, I.C.
U 501	3-00342-340	74ALS138	Integrated Circuit (Thru-hole Pkg)
U 502	3-00342-340	74ALS138	Integrated Circuit (Thru-hole Pkg)
U 503	3-00342-340	74ALS138	Integrated Circuit (Thru-hole Pkg)
U 504	3-00049-340	74HC74	Integrated Circuit (Thru-hole Pkg)
U 505	3-00347-340	74LS148	Integrated Circuit (Thru-hole Pkg)
U 506	3-00259-340	74HCT373	Integrated Circuit (Thru-hole Pkg)
U 601	3-00049-340	74HC74	Integrated Circuit (Thru-hole Pkg)
U 602	3-00348-340	74HC20	Integrated Circuit (Thru-hole Pkg)
U 603	3-00265-340	74HC595	Integrated Circuit (Thru-hole Pkg)
U 606	3-00044-340	74HC244	Integrated Circuit (Thru-hole Pkg)
U 607	3-00046-340	74HC374	Integrated Circuit (Thru-hole Pkg)
U 608	3-00044-340	74HC244	Integrated Circuit (Thru-hole Pkg)
U 609	3-00046-340	74HC374	Integrated Circuit (Thru-hole Pkg)
U 610	3-00049-340	74HC74	Integrated Circuit (Thru-hole Pkg)
U 611	3-00049-340	74HC74	Integrated Circuit (Thru-hole Pkg)
U 612	3-00039-340	74HC14	Integrated Circuit (Thru-hole Pkg)
U 701	3-00051-340	74HCU04	Integrated Circuit (Thru-hole Pkg)
U 702	3-00900-340	DS12C887	Integrated Circuit (Thru-hole Pkg)
U 703	3-00300-340	74LS374	Integrated Circuit (Thru-hole Pkg)
U 704	3-00263-340	DS75451N	Integrated Circuit (Thru-hole Pkg)
U 705	3-00110-340	MC1489	Integrated Circuit (Thru-hole Pkg)
U 801	3-00051-340	74HCU04	Integrated Circuit (Thru-hole Pkg)
U 802	3-00171-340	74HC191	Integrated Circuit (Thru-hole Pkg)
U 803	3-00277-340	74HC11	Integrated Circuit (Thru-hole Pkg)
U 804	3-00351-340	74HCT299	Integrated Circuit (Thru-hole Pkg)
U 805	3-00280-340	74HC10	Integrated Circuit (Thru-hole Pkg)
U 806	3-00049-340	74HC74	Integrated Circuit (Thru-hole Pkg)
U 807	3-00274-340	74AC74	Integrated Circuit (Thru-hole Pkg)
U 808	3-00303-340	74HC164	Integrated Circuit (Thru-hole Pkg)
U 809	3-00351-340	74HCT299	Integrated Circuit (Thru-hole Pkg)
U 810	3-00598-340	63484P-98	Integrated Circuit (Thru-hole Pkg)
U 811	3-00046-340	74HC374	Integrated Circuit (Thru-hole Pkg)
U 812	3-00046-340	74HC374	Integrated Circuit (Thru-hole Pkg)
U 813	3-00299-341	32KX8-70L	STATIC RAM, I.C.
U 814	3-00299-341	32KX8-70L	STATIC RAM, I.C.
U 815	3-00262-340	74HC86	Integrated Circuit (Thru-hole Pkg)
U 901	3-00350-340	74ALS04	Integrated Circuit (Thru-hole Pkg)
U 902	3-00645-340	NAT9914BPD	Integrated Circuit (Thru-hole Pkg)
U 903	3-00078-340	DS75160A	Integrated Circuit (Thru-hole Pkg)
U 904	3-00079-340	DS75161A	Integrated Circuit (Thru-hole Pkg)
U 905	3-00247-340	SCN2641	Integrated Circuit (Thru-hole Pkg)
U 906	3-00109-340	MC1488	Integrated Circuit (Thru-hole Pkg)
U 907	3-00596-360	DP8473AV	Integrated Circuit (Surface Mount Pkg)

Parts List

<u>Ref.</u>	<u>SRS Part No.</u>	<u>Value</u>	<u>Description</u>
U 908	3-00040-340	74HC157	Integrated Circuit (Thru-hole Pkg)
X 101	6-00068-620	24.000 MHZ	Crystal
X 801	6-00069-620	13.5168 MHZ	Crystal
X 901	6-00068-620	24.000 MHZ	Crystal
X 902	6-00037-620	3.6864 MHZ	Crystal
Z 0	0-00126-053	3-1/2" #24	Wire #24 UL1007 Strip 1/4x1/4 Tin
Z 0	0-00479-055	1.5"X#30 ORA	Wire, Other
Z 0	1-00136-171	26 COND	Cable Assembly, Ribbon
Z 0	1-00137-165	25 PIN IDC	Connector, D-Sub, Female

Chassis Assembly Parts List

<u>Ref.</u>	<u>SRS Part No.</u>	<u>Value</u>	<u>Description</u>
C 1	5-00219-529	.01U	Cap, Monolythic Ceramic, 50V, 20%, Z5U
C 2	5-00134-529	100P	Cap, Monolythic Ceramic, 50V, 20%, Z5U
C 3	5-00219-529	.01U	Cap, Monolythic Ceramic, 50V, 20%, Z5U
C 4	5-00134-529	100P	Cap, Monolythic Ceramic, 50V, 20%, Z5U
C 5	5-00219-529	.01U	Cap, Monolythic Ceramic, 50V, 20%, Z5U
C 6	5-00134-529	100P	Cap, Monolythic Ceramic, 50V, 20%, Z5U
C 7	5-00219-529	.01U	Cap, Monolythic Ceramic, 50V, 20%, Z5U
C 8	5-00134-529	100P	Cap, Monolythic Ceramic, 50V, 20%, Z5U
C 20	5-00219-529	.01U	Cap, Monolythic Ceramic, 50V, 20%, Z5U
C 21	5-00219-529	.01U	Cap, Monolythic Ceramic, 50V, 20%, Z5U
Z 0	0-00014-002	6J4	Power Entry Hardware
Z 0	0-00025-005	3/8"	Lugs
Z 0	0-00043-011	4-40 KEP	Nut, Kep
Z 0	0-00048-011	6-32 KEP	Nut, Kep
Z 0	0-00079-031	4-40X3/16 M/F	Standoff
Z 0	0-00084-032	36154	Termination
Z 0	0-00089-033	4"	Tie
Z 0	0-00098-042	#6 LOCK	Washer, lock
Z 0	0-00108-054	1" #26	Wire #26 UL1061
Z 0	0-00111-053	1-3/4"#24B	Wire #24 UL1007 Strip 1/4x1/4 Tin
Z 0	0-00112-053	1-3/4"#24R	Wire #24 UL1007 Strip 1/4x1/4 Tin
Z 0	0-00116-050	11-3/4"#18	Wire #18 UL1007 Stripped 3/8x3/8 No Tin
Z 0	0-00122-053	2-1/4" #24	Wire #24 UL1007 Strip 1/4x1/4 Tin
Z 0	0-00123-053	21" #24	Wire #24 UL1007 Strip 1/4x1/4 Tin
Z 0	0-00149-020	4-40X1/4PF	Screw, Flathead Phillips
Z 0	0-00168-023	6-32X5/16R	Screw, Roundhead Phillips
Z 0	0-00187-021	4-40X1/4PP	Screw, Panhead Phillips
Z 0	0-00190-030	#8X1"	Spacer
Z 0	0-00209-021	4-40X3/8PP	Screw, Panhead Phillips
Z 0	0-00210-020	4-40X5/16PF	Screw, Flathead Phillips
Z 0	0-00212-021	6-32X2PP	Screw, Panhead Phillips
Z 0	0-00231-043	1-32, #4 SHOULD	Washer, nylon
Z 0	0-00241-021	4-40X3/16PP	Screw, Panhead Phillips
Z 0	0-00248-026	10-32X3/8TRUSSP	Screw, Black, All Types
Z 0	0-00256-043	#6 SHOULDER	Washer, nylon
Z 0	0-00257-000	HANDLE3	Hardware, Misc.

Parts List

<u>Ref.</u>	<u>SRS Part No.</u>	<u>Value</u>	<u>Description</u>
Z 0	0-00259-021	4-40X1/2"PP	Screw, Panhead Phillips
Z 0	0-00310-010	HEX 3/8-32	Nut, Hex
Z 0	0-00330-050	5-1/2" #18	Wire #18 UL1007 Stripped 3/8x3/8 No Tin
Z 0	0-00331-031	4-40X5/8 F/F	Standoff
Z 0	0-00335-000	FAN GUARD 2	Hardware, Misc.
Z 0	0-00336-027	#4X1/4PP-B	Screw, Sheet Metal
Z 0	0-00337-027	#4X3/8PP-B	Screw, Sheet Metal
Z 0	0-00338-023	2-56X1/4RP	Screw, Roundhead Phillips
Z 0	0-00340-016	F0204	Power Button
Z 0	0-00343-027	#4X1/4PF-B	Screw, Sheet Metal
Z 0	0-00350-053	2-1/4" #24	Wire #24 UL1007 Strip 1/4x1/4 Tin
Z 0	0-00368-053	21" #24	Wire #24 UL1007 Strip 1/4x1/4 Tin
Z 0	0-00369-053	21" #24	Wire #24 UL1007 Strip 1/4x1/4 Tin
Z 0	0-00372-000	BE CU / FFT	Hardware, Misc.
Z 0	0-00377-004	SR760/830/780	Knobs
Z 0	0-00378-004	CAP 760/830/780	Knobs
Z 0	0-00382-000	CARD GUIDE 4.5"	Hardware, Misc.
Z 0	0-00389-000	PHONO PLUG	Hardware, Misc.
Z 0	0-00390-024	1-72X1/4	Screw, Slotted
Z 0	0-00391-010	1-72X5/32X3/64	Nut, Hex
Z 0	0-00394-031	6-32X13/16	Standoff
Z 0	0-00407-032	SOLDR SLV RG174	Termination
Z 0	0-00415-031	4-40X1/2 M/F	Standoff
Z 0	0-00416-020	8-32X1/4PF	Screw, Flathead Phillips
Z 0	0-00417-057	GROMMET STRIP	Grommet
Z 0	0-00418-000	CLIP, CABLE	Hardware, Misc.
Z 0	0-00443-000	SWITCH	Hardware, Misc.
Z 0	0-00466-050	23" #18 BLACK	Wire #18 UL1007 Stripped 3/8x3/8 No Tin
Z 0	0-00467-050	23" #18 RED	Wire #18 UL1007 Stripped 3/8x3/8 No Tin
Z 0	0-00500-000	554808-1	Hardware, Misc.
Z 0	0-00521-048	3" #18	Wire, #18 UL1015 Strip 3/8 x 3/8 No Tin
Z 0	0-00527-050	13" #18	Wire #18 UL1007 Stripped 3/8x3/8 No Tin
Z 0	0-00893-026	8-32X3/8PF	Screw, Black, All Types
Z 0	1-00003-120	BNC	Connector, BNC
Z 0	1-00033-113	5 PIN, 18AWG/OR	Connector, Amp, MTA-156
Z 0	1-00073-120	INSL	Connector, BNC
Z 0	1-00076-171	4 PIN SIL	Cable Assembly, Ribbon
Z 0	1-00110-130	30 PIN DIL	Connector, Male
Z 0	1-00120-113	3 PIN, 18AWG/OR	Connector, Amp, MTA-156
Z 0	1-00131-171	30 COND DIL	Cable Assembly, Ribbon
Z 0	1-00132-171	34 COND	Cable Assembly, Ribbon
Z 0	1-00138-130	5 PIN SI	Connector, Male
Z 0	1-00141-171	5 PIN SIL	Cable Assembly, Ribbon
Z 0	1-00153-113	11 PIN,18AWG/OR	Connector, Amp, MTA-156
Z 0	1-00167-169	14/26 IDC-40 CE	Cable Assembly, Custom
Z 0	1-00168-169	34/60 CE TO IDC	Cable Assembly, Custom
Z 0	1-00180-170	9418	Cable Assembly, Multiconductor
Z 0	1-00181-165	9 PIN STRAIGHT	Connector, D-Sub, Female
Z 0	1-00183-171	20 COND	Cable Assembly, Ribbon

Parts List

<u>Ref.</u>	<u>SRS Part No.</u>	<u>Value</u>	<u>Description</u>
Z 0	1-00206-133	20 PIN DRA	Connector, Male, Right Angle
Z 0	1-00208-133	32 PIN DRA	Connector, Male, Right Angle
Z 0	2-00023-218	DPDT	Switch, Panel Mount, Power, Rocker
Z 0	2-00034-220	ENA1J-B20	SOFTPOT
Z 0	2-00035-222	SAS50B	Thermostat
Z 0	4-00541-435	130V/1200A	Varistor, Zinc Oxide Nonlinear Resistor
Z 0	4-00649-455	100K	Trim Pot, Cond. Plastic, PC Mount
Z 0	4-00681-436	SG240	Thermistor, ICL (Inrush Current Limiter)
Z 0	5-00134-529	100P	Cap, Monolithic Ceramic, 50V, 20%, Z5U
Z 0	6-00004-611	1A 3AG	Fuse
Z 0	6-00076-600	2" SPKR	Misc. Components
Z 0	6-00089-610	PLTFM II	Transformer
Z 0	6-00213-630	2-HOLE	Ferrite Beads
Z 0	7-00124-720	TRANSCOVER2-MOD	Fabricated Part
Z 0	7-00254-721	PLTFM-4	Machined Part
Z 0	7-00270-735	PLTFM-7	Injection Molded Plastic
Z 0	7-00281-720	PLTFM-18	Fabricated Part
Z 0	7-00284-720	PLTFM-20	Fabricated Part
Z 0	7-00286-720	7" CRT SCREEN	Fabricated Part
Z 0	7-00287-721	PLTFM-23	Machined Part
Z 0	7-00289-720	PLTFM-26	Fabricated Part
Z 0	7-00292-720	PLTFM-27	Fabricated Part
Z 0	7-00350-720	PLTFM-29	Fabricated Part
Z 0	7-00392-720	SR770-4	Fabricated Part
Z 0	7-00396-701	PLTFM FP	Printed Circuit Board
Z 0	7-00403-720	SR770-9	Fabricated Part
Z 0	7-00404-720	SR770-10	Fabricated Part
Z 0	7-00406-720	SR770-12	Fabricated Part
Z 0	7-00407-720	SR770-13	Fabricated Part
Z 0	7-00409-720	SR770-15 & 16	Fabricated Part
Z 0	7-00414-720	SR770-17	Fabricated Part
Z 0	7-00420-740	SR850	Keypad, Conductive Rubber
Z 0	7-00421-735	PLTFM-9 THRU 13	Injection Molded Plastic
Z 0	7-00427-711	SR850-5	Rear Panel
Z 0	7-00431-720	SR770-21/22	Fabricated Part
Z 0	7-00432-720	SR770-23	Fabricated Part
Z 0	7-00433-720	SR770-24	Fabricated Part
Z 0	7-00434-721	SR770-25	Machined Part
Z 0	7-00435-720	SR770-26	Fabricated Part
Z 0	7-00436-701	FFT/DSP LI	Printed Circuit Board
Z 0	7-00437-701	FFT/DSP LI	Printed Circuit Board
Z 0	7-00438-701	SR850 RP	Printed Circuit Board
Z 0	7-00458-720	SR850-6	Fabricated Part
Z 0	7-00459-720	SR850-7	Fabricated Part
Z 0	7-00473-720	SR770-27/28/29	Fabricated Part
Z 0	7-00520-709	SR850-12	Lexan Overlay
Z 0	7-00718-720	SR770-33	Fabricated Part
Z 0	8-00034-850	FLOPPY	Disk Drive
Z 0	8-00040-840	7" Z-AXIS	CRT Display

<u>Ref.</u>	<u>SRS Part No.</u>	<u>Value</u>	<u>Description</u>
Z 0	9-00267-917	GENERIC	Product Labels

Miscellaneous Parts List

<u>Ref.</u>	<u>SRS Part No.</u>	<u>Value</u>	<u>Description</u>
U 301	3-00450-342	27C010-120	EPROM/PROM, I.C.
U 302	3-00450-342	27C010-120	EPROM/PROM, I.C.
U 303	3-00450-342	27C010-120	EPROM/PROM, I.C.
U 304	3-00450-342	27C010-120	EPROM/PROM, I.C.
Z 0	0-00089-033	4"	Tie
Z 0	0-00159-000	FAN GUARD	Hardware, Misc.
Z 0	0-00179-000	RIGHT FOOT	Hardware, Misc.
Z 0	0-00180-000	LEFT FOOT	Hardware, Misc.
Z 0	0-00185-021	6-32X3/8PP	Screw, Panhead Phillips
Z 0	0-00187-021	4-40X1/4PP	Screw, Panhead Phillips
Z 0	0-00204-000	REAR FOOT	Hardware, Misc.
Z 0	0-00223-029	6-32X3/8TR PH	Screw, Truss Phillips
Z 0	0-00248-026	10-32X3/8TRUSSP	Screw, Black, All Types
Z 0	0-00259-021	4-40X1/2"PP	Screw, Panhead Phillips
Z 0	0-00315-021	6-32X7/16 PP	Screw, Panhead Phillips
Z 0	1-00182-171	32 COND	Cable Assembly, Ribbon
Z 0	1-00183-171	20 COND	Cable Assembly, Ribbon
Z 0	7-00147-720	BAIL	Fabricated Part
Z 0	7-00394-720	SR770-6	Fabricated Part
Z 0	7-00395-720	SR770-7	Fabricated Part
Z 0	7-00402-720	SR770-8	Fabricated Part
Z 0	7-00405-720	SR770-11	Fabricated Part
Z 0	7-00408-720	SR770-14	Fabricated Part

NOTICE: Schematics may not show current part numbers or values. Refer to parts list for current part numbers or values.