



# OMEN by HP 15 Laptop PC

## Maintenance and Service Guide

© Copyright 2018, 2019 HP Development Company, L.P.

Bluetooth is a trademark owned by its proprietor and used by HP Inc. under license. DisplayPort and the DisplayPort logo are trademarks owned by the Video Electronics Standards Association (VESA) in the United States and other countries. Intel, Core, Optane and Thunderbolt are trademarks of Intel Corporation in the U.S. and other countries. Miracast is a trademark of Wi-Fi Alliance. SDHC, SDXC, and microSD are trademarks or registered trademarks of SD-3C LLC. NVIDIA, Optimus, and GeForce are trademarks and/or registered trademarks of NVIDIA Corporation in the U.S. and other countries. Windows is either a registered trademark or trademark of Microsoft Corporation in the United States and/or other countries.

The information contained herein is subject to change without notice. The only warranties for HP products and services are set forth in the express warranty statements accompanying such products and services. Nothing herein should be construed as constituting an additional warranty. HP shall not be liable for technical or editorial errors or omissions contained herein.

Third Edition: May 2019

First Edition: May 2018

Document Part Number: L31592-003

## Product notice

This guide describes features that are common to most models. Some features may not be available on your computer.

Not all features are available in all editions or versions of Windows. Systems may require upgraded and/or separately purchased hardware, drivers, software or BIOS update to take full advantage of Windows functionality. Windows 10 is automatically updated, which is always enabled. ISP fees may apply and additional requirements may apply over time for updates. Go to <http://www.microsoft.com> for details.

To access the latest user guides, go to <http://www.hp.com/support>, and follow the instructions to find your product. Then select **User Guides**.

## Software terms

By installing, copying, downloading, or otherwise using any software product preinstalled on this computer, you agree to be bound by the terms of the HP End User License Agreement (EULA). If you do not accept these license terms, your sole remedy is to return the entire unused product (hardware and software) within 14 days for a full refund subject to the refund policy of your seller.

For any further information or to request a full refund of the price of the computer, please contact your seller.

## Important Notice about Customer Self-Repair Parts

---

 **CAUTION:** Your computer includes Customer Self-Repair parts and parts that should only be accessed by an authorized service provider. See Chapter 5, "Removal and replacement procedures for Customer Self-Repair parts," for details. Accessing parts described in Chapter 6, "Removal and replacement procedures for authorized service provider only parts," can damage the computer or void your warranty.

---





## Safety warning notice

---

 **WARNING!** To reduce the possibility of heat-related injuries or of overheating the device, do not place the device directly on your lap or obstruct the device air vents. Use the device only on a hard, flat surface. Do not allow another hard surface, such as an adjoining optional printer, or a soft surface, such as pillows or rugs or clothing, to block airflow. Also, do not allow the AC adapter to contact the skin or a soft surface, such as pillows or rugs or clothing, during operation. The device and the AC adapter comply with the user-accessible surface temperature limits defined by applicable safety standards.

---



---

# Table of contents

<b>1 Product description .....</b>	<b>1</b>
Model numbers: 15-dc1000~15-dc1999, 15t-dc100 .....	1
Model numbers: 15-dc0000~15-dc0999, 15t-dc000 .....	5
<b>2 Getting to know your computer .....</b>	<b>13</b>
Right side .....	13
Left side .....	14
Rear .....	15
Display .....	16
Keyboard area .....	17
Touchpad .....	17
Lights .....	18
Button .....	19
Special keys .....	20
Bottom .....	21
Labels .....	21
<b>3 Illustrated parts catalog .....</b>	<b>23</b>
Computer major components .....	23
Display assembly subcomponents .....	26
Miscellaneous parts .....	27
<b>4 Removal and replacement procedures preliminary requirements .....</b>	<b>29</b>
Tools required .....	29
Service considerations .....	29
Plastic parts .....	29
Cables and connectors .....	29
Drive handling .....	30
Workstation guidelines .....	30
Electrostatic discharge information .....	30
Generating static electricity .....	31
Preventing electrostatic damage to equipment .....	31
Personal grounding methods and equipment .....	32
Grounding the work area .....	32
Recommended materials and equipment .....	32
Packaging and transporting guidelines .....	33

<b>5 Removal and replacement procedures for Customer Self-Repair parts .....</b>	<b>34</b>
Component replacement procedures .....	34
Preparation for disassembly .....	34
Base enclosure .....	34
Hard drive (HDD) .....	37
Solid-state drive (SSD) .....	39
Memory modules .....	40
WLAN module .....	42
<b>6 Removal and replacement procedures for authorized service provider parts .....</b>	<b>44</b>
Component replacement procedures .....	44
Battery .....	45
Speakers .....	46
Smart card board .....	47
Fans .....	48
Power connector cable .....	50
Audio board .....	51
USB board .....	52
System board .....	53
Heat sink .....	56
Touchpad board .....	59
Power button board .....	61
Display assembly .....	62
Keyboard/top cover .....	68
<b>7 Using Setup Utility (BIOS) .....</b>	<b>69</b>
Starting Setup Utility (BIOS) .....	69
Updating Setup Utility (BIOS) .....	69
Determining the BIOS version .....	69
Downloading a BIOS update .....	70
<b>8 Using HP PC Hardware Diagnostics .....</b>	<b>71</b>
Using HP PC Hardware Diagnostics Windows (select products only) .....	71
Downloading HP PC Hardware Diagnostics Windows .....	71
Downloading the latest HP PC Hardware Diagnostics Windows version .....	72
Downloading HP Hardware Diagnostics Windows by product name or number (select products only) .....	72
Installing HP PC Hardware Diagnostics Windows .....	72
Using HP PC Hardware Diagnostics UEFI .....	72
Starting HP PC Hardware Diagnostics UEFI .....	73

Downloading HP PC Hardware Diagnostics UEFI to a USB flash drive .....	73
Downloading the latest HP PC Hardware Diagnostics UEFI version .....	73
Downloading HP PC Hardware Diagnostics UEFI by product name or number (select products only) .....	73
Using Remote HP PC Hardware Diagnostics UEFI settings (select products only) .....	74
Downloading Remote HP PC Hardware Diagnostics UEFI .....	74
Downloading the latest Remote HP PC Hardware Diagnostics UEFI version .....	74
Downloading Remote HP PC Hardware Diagnostics UEFI by product name or number .....	74
Customizing Remote HP PC Hardware Diagnostics UEFI settings .....	74
<b>9 Backing up, restoring, and recovering .....</b>	<b>76</b>
Backing up information and creating recovery media .....	76
Using Windows tools .....	76
Using the HP Cloud Recovery Download Tool to create recovery media (select products only) .....	76
Restoring and recovery .....	77
Restoring, resetting, and refreshing using Windows tools .....	77
Recovering using HP Recovery media .....	77
Changing the computer boot order .....	77
<b>10 Specifications .....</b>	<b>78</b>
<b>11 Power cord set requirements .....</b>	<b>79</b>
Requirements for all countries .....	79
Requirements for specific countries and regions .....	80
<b>12 Recycling .....</b>	<b>82</b>
<b>Index .....</b>	<b>83</b>



# 1 Product description

## Model numbers: 15-dc1000~15-dc1999, 15t-dc100

**Table 1-1 Product components and their descriptions**

Category	Details
<b>Product Name</b>	OMEN by HP 15 Laptop PC
	Model Number (Service Tag Down): 15-dc1000~15-dc1999
	CTO Model: 15t-dc100
<b>Processor</b>	<b>Intel® 8th generation Intel Core® i7 processors</b>
	Intel Core i7-9750H (2.6 GHz, turbo up to 4.5 GHz), 2666 MHz/9 MB L3, hexa core, TDP 45 W (all models)
	Intel Core i7-8750H (2.2 GHz, turbo up to 4.1 GHz), 2666 MHz/12 MB L3, hexa core, TDP 45 W (N18E-G1, N18E-G2)
	<b>Intel 8th generation Intel Core i5 processors</b>
Intel Core i5-9300H (2.4 GHz, turbo up to 4.1 GHz), 2666 MHz/8 MB L3, quad core, TDP 45 W (N17P-G0, N18E-G0, N18E-G1, N18P-G0)	
Intel Core i5-8300H (2.3 GHz, turbo up to 4.0 GHz), 2666 MHz/8 MB L3, quad core, TDP 45 W (N18E-G1)	
<b>Chipset</b>	Intel HM370
<b>Graphics</b>	Supports HD decode, DX12, and HDMI
	Supports FPS (GPU Performance Scaling)
	Supports G-Sync (Internal and External)
	Supports Virtual Reality (VR)
	Mixed Reality (MR) ready
	Minimum hardware configuration rules for enabling MR ready: CPU: Hybrid GPU: Core-i5 or greater; Discrete GPU: Core-i5 or greater; Graphics: Discrete: NVIDIA® GTX 1050 or greater; Display: HDMI 1.4/Display Port 1.2 or greater; Memory: 8 GB DDR4 or greater; Storage: > 10 GB additional free space; Windows Display Driver Model (WDDM) 2.2
	<b>Discrete graphics:</b>
NVIDIA® GeForce® RTX 2070 with up to 8 GB of GDDR6 dedicated video memory (N18E-G2)	
NVIDIA GeForce RTX 2060 with up to 6 GB of GDDR6 dedicated video memory (N18E-G1)	
NVIDIA GeForce GTX 1660Ti with up to 6 GB of GDDR6 dedicated video memory (N18E-G0)	
NVIDIA GeForce GTX 1650 with up to 4 GB of GDDR5 dedicated video memory (N18P-G0)	
NVIDIA GeForce GTX 1050 with up to 4 GB of GDDR5 dedicated video memory (N17P-G0)	
<b>Panel</b>	FHD (1920 × 1080), WLED, antiglare, ultra slim, UWVA, 45% CG, 60 Hz, eDP 1.3, narrow bezel; typical brightness: 220 nits
15.6-inch	

**Table 1-1 Product components and their descriptions (continued)**

Category	Details
	FHD (1920 × 1080), WLED, antiglare, slim, UWVA, 45% CG, 60 Hz, eDP, narrow bezel; typical brightness: 220 nits
	FHD (1920 × 1080), WLED, antiglare, slim, UWVA, 45% CG, eDP 1.2 + PSR, narrow bezel; typical brightness: 250 nits
	FHD (1920 × 1080), WLED, antiglare, ultra slim, UWVA, 72% CG, eDP 1.2 + PSR, narrow bezel; typical brightness: 300 nits
	FHD (1920 × 1080), WLED, antiglare, ultra slim, UWVA, 72% CG, 144 Hz, eDP 1.3 + PSR, narrow bezel; typical brightness: 300 nits
	FHD (1920 × 1080), WLED, antiglare, ultra slim, UWVA, 72% CG, 240 Hz, eDP 1.4 + PSR, G-Sync supportable, narrow bezel; typical brightness: 300 nits
	UHD (3840 × 2160), WLED, antiglare, ultra slim, UWVA, 72% CG, 60 Hz, eDP 1.3 + PSR, narrow bezel; typical brightness: 340 nits
<b>Memory</b>	4 GB (4 GB × 1)
Supports up to 32.0 GB maximum system memory	8 GB (8 GB × 1) or (4 GB × 2)
Two SODIMM slots - customer accessible/upgradeable	12 GB (8 GB × 1 + 4 GB × 1)
DDR4-2666 Dual Channel Support	16 GB (16 GB × 1 or 8 GB × 2)
	32 GB (16 GB × 2)
<b>Storage</b>	Support all 7 mm/7.2 mm/9.5 mm, SATA 2.5-inch hard drives - customer accessible/upgradeable (share the same bracket)
	Support M.2 PCIe/SATA solid-state drive - customer accessible/upgradeable
	Support solid-state drive + hard drive - customer accessible/upgradeable
	Accelerometer/hard drive protection support
	<b>Single hard drive configurations</b>
	1 TB, 7200 rpm, 9.5 mm
	<b>PCIe, NVMe, TLC, M.2, solid-state drive</b>
	256 GB
	512 GB
	<b>Dual storage configurations</b>
	128 GB PCIe NVMe TLC M.2 solid-state drive + 1 TB, 7200 rpm mm hard drive
	256 GB, PCIe, NVMe, TLC, M.2, solid-state drive + 1 TB, 7200 rpm hard drive
	256 GB PCIe, NVMe, TLC, M.2, solid-state drive + 2 TB, 5400 rpm hard drive
	512 GB, PCIe, NVMe, TLC, M.2, solid-state drive + 1 TB, 7200 rpm hard drive
	1 TB PCIe, NVMe, TLC, M.2, solid-state drive + 2 TB, 5400 rpm hard drive
	<b>Intel Optane™ (3D Xpoint) Solution PCIe Gen3 × 2 M.2 solid-state drive</b>
	16 GB (Optane Memory Module) + 512 GB solid-state drive
	32 GB (Optane Memory Module) + 1 TB hard drive
<b>Audio and video</b>	<b>HP Wide Vision HD Camera</b> - indicator LED, USB 2.0, HD BSI sensor, f2.0, WDR, 88° WFOV



**Table 1-1 Product components and their descriptions (continued)**

Category	Details
	Dual array digital microphone with appropriate beam-forming, echo-cancellation, noise-suppression software
	720p by 30 frames per second
	<b>BANG &amp; OLUFSEN</b> audio with OMEN Audio Control Panel
	Supports HP Audio Boost 2.0 (with discrete amplifier)
	Supports DTS Headphone X
	Dual speakers
<b>Ethernet</b>	Integrated 10/100/1000 NIC
<b>Wireless</b>	<b>Integrated wireless options with dual antennas</b>
	Realtek RTL8822BE 802.11ac 2 × 2 Wi-Fi + Bluetooth® 4.2 Combo Adapter (MU-MIMO supported)
	Intel Dual Band Wireless-AC 9560 802.11ac 2 × 2 Wi-Fi + Bluetooth 5 Combo Adapter (non-vPro) (MU-MIMO supported)
	Intel Wi-Fi 6 AX200 ax2 × 2 + Bluetooth 5 (non-vPro) (MU-MIMO supported)
	Wi-Fi BIOS SAR
<b>Internal card expansion</b>	One M.2 slot for WLAN
	One M.2 slot for solid-state drive
<b>Ports</b>	Hot Plug/unplug and auto detect for correct output to wide-aspect vs. standard aspect video
	HP Smart Plug AC adapter (4.0 mm barrel)
	Audio-out (headphone)/Audio-in (microphone) combo jack
	Microphone-in
	High-definition multimedia interface (HDMI) v2.0 supporting: up to 4096 × 2160 @ 60 Hz with HDCP 2.2
	Mini DisplayPort
	RJ-45 (network) connector
	AC Smart Pin adapter plug
	<b>USB 3.0 ports</b>
	3 (1 on the left side ; 1 on the right side; 1 on the rear)
	Support HP Sleep & Charge (rear port only)
	<b>USB Type-C ports*</b>
	USB 3.1 Gen 2 with Thunderbolt™ Gen 3 technology (on the rear)
	USB 3.1 Gen 1 (on the rear)
	*Support data transfer
	*Support DisplayPort™ 1.2 out up to 4096 × 2304 (60 Hz)
	*Support HP Sleep & Charge

**Table 1-1 Product components and their descriptions (continued)**

<b>Category</b>	<b>Details</b>
<b>External media cards</b>	<b>HP Multi-Format Digital Media Card Reader</b>
	Supports SD™/SDHC™/SDXC™
	Push-push insertion/removal
<b>Keyboard/pointing devices</b>	<b>Keyboard</b>
	Full-size backlit 3-coat paint island-style keyboard with numeric keypad
	Full-size backlit 3-coat paint island-style keyboard with numeric keypad; special highlight for WASD keys; supports 26-key NKRO anti-ghosting keys
	<b>Touchpad requirements</b>
	Touchpad with image sensor
	Multitouch gestures enabled
	Support for modern trackpad gestures
	Taps enabled as default
<b>Power requirements</b>	<b>Battery</b>
	4 cell polymer battery - 70 Whr (all models)
	3 cell polymer battery - 52 Whr (N17P-G0, N18P-G0)
	Battery life enhancement
	Supports battery fast charge
	<b>AC adapter</b> (Smart, PFC, slim barrel, 4.5 mm)
	135 W (N17P-G0)
	150 W (N18P-G0)
	200 W (N18E-G0, N18E-G1, N18E-G2)
	<b>Power cord</b>
	1 m premium power cord with sticker label (C5) (N17P-G0, N18P-G0)
1 m premium power cord with sticker label (C13) (N18E-G0, N18E-G1, N18E-G2)	
<b>Security</b>	Trusted platform module (TPM) 2.0
	Mini security lock
<b>Operating system</b>	FreeDOS 2.0
	Windows® 10 Home 64
	Windows 10 Home 64 Web/Kiosk
	Windows 10 Home 64 Advanced
	Windows 10 Home 64 Advanced Web/Kiosk
	Windows 10 Home 64 Advanced Single Language
	Windows 10 Home 64 Chinese Market
	Windows 10 Home 64 High-end Chinese Market

**Table 1-1 Product components and their descriptions (continued)**

Category	Details
	Windows 10 Home 64 Plus
	Windows 10 Home 64 Plus Web/Kiosk
	Windows 10 Home 64 Plus Single Language
	Windows 10 Home 64 Plus Single Language Africa Market PPP
	Windows 10 Home 64 Plus Single Language APAC EM PPP
	Windows 10 Home 64 Plus Single Language India Market PPP
	Windows 10 Home 64 Plus Single Language Indonesia Market PPP
	Windows 10 Home 64 Single Language
	Windows 10 Home 64 Single Language Africa Market PPP
	Windows 10 Home 64 Single Language APAC EM PPP
	Windows 10 Home 64 Single Language India Market PPP
	Windows 10 Home 64 Single Language Indonesia Market PPP
	Windows 10 Pro 64
	Windows 10 Pro 64 Web/Kiosk
<b>Serviceability</b>	<b>End-user replaceable parts</b>
	AC adapter
	Memory
	Hard drive
	Solid-state drive

## Model numbers: 15-dc0000~15-dc0999, 15t-dc000

**Table 1-2 Product components and their descriptions**

Category	Details	GeForce GTX 1070 (N17E-G2)	GeForce GTX 1060 (N17E-G1)	GeForce GTX 1050 Ti (N17P-G1)	GeForce GTX 1050 (N17P-G0)
<b>Product Name</b>	OMEN by HP 15 Laptop PC	√	√	√	√
	Model Number (Service Tag Down): 15-dc0000~15-dc0999	√	√	√	√
	CTO Model: 15t-dc000	√	√	√	√
<b>Processor</b>	<b>Intel 8th generation Intel Core i7 processor</b>	√	√	√	√
	Intel Core i7-8750H (2.2 GHz, turbo up to 4.1 GHz), 2666 MHz/9 MB L3, Hhexa core, TDP 45 W				
	<b>Intel 8th generation Intel Core i5 processor</b>		√	√	√

**Table 1-2 Product components and their descriptions (continued)**

Category	Details	GeForce GTX 1070 (N17E-G2)	GeForce GTX 1060 (N17E-G1)	GeForce GTX 1050 Ti (N17P-G1)	GeForce GTX 1050 (N17P-G0)
	Intel Core i5-8300H (2.3 GHz, turbo up to 4.0 GHz), 2666 MHz/8 MB L3, quad core, TDP 45 W				
<b>Chipset</b>	Intel HM370	√	√	√	√
<b>Graphics</b>	Supports HD decode, DX11, and HDMI	√	√	√	√
	Supports Optimus™			√	√
	Supports FPS (GPU Performance Scaling)	√	√	√	√
	Supports G-Sync (Internal and eExternal)	√	√		
	Limited to N17E GPU				
	Supports Virtual Reality (VR)	√	√		
	Oculus VR rule: >= 8 GB memory + >= 512 GB storage + Win OS + GTX 1070/GTX 1060 only				
Mixed Reality ready	√	√	√	√	
<p>Minimum hardware configuration rules for enabling MR ready: CPU: Hybrid GPU: Core-i5 or greater Discrete GPU: Core-i5 or greater Graphics: Discrete: NVIDIA GTX 1050 or greater Display: HDMI 1.4/Display Port 1.2 or greater Memory: 8 GB DDR4 or greater Storage: &gt; 10 GB additional free space Windows Display Driver Model (WDDM) 2.2 required for supporting MR ready</p>					
<b>Internal graphics</b>					
	Intel UHD Graphics 630			√	√
<b>Discrete graphics</b>					
	NVIDIA N17E-G2 (GeForce GTX 1070) Max-Q with up to 8192 MB of dedicated video memory (256 M × 32 GDDR5 8 Gbps × 8 PCs, 1.5 V/8 Gbps)	√			
	Support G-Sync only. Limited to FHD 144 Hz/UHD 60 Hz panel/Core-i7 CPU.				
	NVIDIA N17E-G1 (GeForce GTX 1060) with up to 6144 MB of dedicated video memory (256 M × 32 GDDR5 8 Gbps × 6 PCs, 1.5 V/8 Gbps)		√		
	Support G-Sync only Limited to FHD 144 Hz/UHD 60 Hz panel/Core-i7 CPU.				
	NVIDIA N17E-G1 (GeForce GTX 1060) with up to 3072 MB of dedicated video memory (128 M × 32 GDDR5 8 Gbps × 6 PCs, 1.5 V/8 Gbps)		√		
	Support Non-G-Sync only, limited to FHD 60Hz panel , Bridge Hynix A die/Micron B die 256 M × 32 1.5(5) V 8 Gbps / 1.35 V 7 Gbps onto GDDR5 256 M × 32 1.5 V 7 Gbps.				
<b>Hybrid graphics</b>					

**Table 1-2 Product components and their descriptions (continued)**

Category	Details	GeForce GTX 1070 (N17E-G2)	GeForce GTX 1060 (N17E-G1)	GeForce GTX 1050 Ti (N17P-G1)	GeForce GTX 1050 (N17P-G0)
	NVIDIA N17P-G1 (GeForce GTX 1050 Ti) with up to 4096 MB of dedicated video memory (256 M × 32 GDDR5 7 Gbps × 4 PCs, 1.5 V/7 Gbps) Support Non-G-Sync only			√	
	NVIDIA N17P-G0 (GeForce GTX 1050) with up to 4096 MB of dedicated video memory (256 M × 32 GDDR5 7 Gbps × 4 PCs, 1.5 V/7 Gbps) Support Non-G-Sync only				√
	NVIDIA N17P-G0 (GeForce GTX 1050) with up to 2048 MB of dedicated video memory (128 M × 32 GDDR5 7 Gbps × 4 PCs, 1.5 V/7 Gbps) Support Non-G-Sync only				√
<b>Panel</b>	FHD (1920 × 1080), WLED, antiglare, slim-flat (3.2 mm), UWVA, 45% CG, 60 Hz, eDP, narrow bezel; typical brightness: 220 nits		√	√	√
15.6-inch	FHD (1920 × 1080) WLED, antiglare, uslim-flat (2.6 mm), UWVA, 72% CG, 144 Hz, eDP + PSR, G-Sync supportable, narrow bezel; typical brightness: 300 nits	√	√	√	√
	UHD (3840 × 2160), WLED, antiglare, uslim-flat (2.6 mm), UWVA, 72% CG, 60 Hz, eDP + PSR, G-Sync supportable, narrow bezel; typical brightness: 340 nits	√	√	√	√
	FHD (1920 × 1080), antiglare, WLED, UWVA 45, 220, eDP, ultraslim, 60 Hz, PRC/KOR, narrow bezel		√	√	√
	UHD (3840 × 2160), antiglare, WLED, UWVA 72, 340, eDP 1.3 + PSR, ultraslim, 60 Hz PRC/KOR, narrow bezel	√	√	√	√
	Microsoft HDR Streaming Capable Brightness: >= 300 nits / Color depth: 8 bits/ iGPU 10-bit HW Decode			√	√
<b>Memory</b>	4 GB (4 GB × 1)	√	√	√	√
Supports up to 32.0 GB maximum system memory	8192 GB (8 GB × 1) 12 MB (8 GB × 1 + 4 GB × 1)	√	√	√	√
Two SODIMM slots - customer accessible/ upgradeable	16384 GB (16 GB × 1 or 8 GB × 2) 32 GB (16 GB × 2)	√	√	√	√
DDR4-2666 Dual Channel Support					
<b>Hard Drives</b>	Support all 7 mm/7.2 mm/9.5 mm, SATA 2.5-inch hard drives - customer accessible/ upgradeable (share the same bracket)	√	√	√	√

**Table 1-2 Product components and their descriptions (continued)**

Category	Details	GeForce GTX 1070 (N17E-G2)	GeForce GTX 1060 (N17E-G1)	GeForce GTX 1050 Ti (N17P-G1)	GeForce GTX 1050 (N17P-G0)
	Support M.2 PCIe/SATA solid-state drive - customer accessible/upgradeable				
	Support solid-state drive + hard drive - customer accessible/upgradeable				
	Accelerometer/hard drive protection support				
	<b>Single hard drive configurations</b>	✓	✓	✓	✓
	1 TB (7200) 9.5 mm/7.2 mm	✓	✓	✓	✓
	<b>PCIe NVMe TLC M.2 solid-state drive</b>	✓	✓	✓	✓
	256 GB	✓	✓	✓	✓
	512 GB	✓	✓	✓	✓
	<b>Dual storage configurations</b>	✓	✓	✓	✓
	128 GB, PCIe, NVMe, TLC, M.2, solid-state drive + 1 TB (7200) 9.5 mm/7.2 mm hard drive	✓	✓	✓	✓
	256 GB, PCIe, NVMe, TLC, M.2, solid-state drive + 1 TB (7200) 9.5 mm/7.2 mm hard drive	✓	✓	✓	✓
	512 GB, PCIe, NVMe, TLC, M.2, solid-state drive + 1 TB (7200) 9.5 mm/7.2 mm hard drive	✓	✓	✓	✓
	256 GB, PCIe, NVMe, TLC, M.2, solid-state drive + 2 TB (5400) 9.5 mm/7.2 mm hard drive	✓	✓	✓	✓
	<b>Intel Optane (3D Xpoint) Solution PCIe Gen3 * 2 M.2 solid-state drive</b>	✓	✓	✓	✓
	16 GB (Optane Memory Module) + 1 TB (7200) 9.5 mm/7.2 mm hard drive				
<b>Audio and video</b>	<b>HP Wide Vision HD Camera</b> - indicator LED, USB 2.0, HD BSI sensor, f2.0, WDR, 88° WFOV	✓	✓	✓	✓
	Dual array digital microphone with appropriate beam-forming, echo-cancellation, noise-suppression software	✓	✓	✓	✓
	720p by 30 frames per second	✓	✓	✓	✓
	<b>BANG &amp; OLUFSEN</b> audio with OMEN Audio Control Panel	✓	✓	✓	✓
	Support HP Audio Boost 2.0 (with discrete amplifier)	✓	✓	✓	✓
	Support Headphone X	✓	✓	✓	✓
	Dual speakers	✓	✓	✓	✓
<b>Ethernet</b>	Integrated 10/100/1000 NIC	✓	✓	✓	✓
<b>Wireless</b>	<b>Integrated Wireless options with dual antennas (M.2/PCIe)</b>	✓	✓	✓	✓

**Table 1-2 Product components and their descriptions (continued)**

Category	Details	GeForce GTX 1070 (N17E-G2)	GeForce GTX 1060 (N17E-G1)	GeForce GTX 1050 Ti (N17P-G1)	GeForce GTX 1050 (N17P-G0)
	Realtek RTL8822BE 802.11ac 2 × 2 Wi-Fi + Bluetooth 4.2 Combo Adapter (MU-MIMO supported)	√	√	√	√
	<b>Integrated Wireless options with dual antennas (M.2/MIPI/BRI)</b>	√	√	√	√
	Intel Dual Band Wireless-AC 9560 802.11ac 2 × 2 Wi-Fi + Bluetooth 5 Combo Adapter (non-vPro) (MU-MIMO supported)	√	√	√	√
	Compatible with Wi-Fi CERTIFIED Miracast™-certified devices	√	√	√	√
<b>Internal card expansion</b>	One M.2 slot for WLAN	√	√	√	√
	One M.2 slot for solid-state drive	√	√	√	√
<b>Ports</b>	Hot Plug/Unplug and auto detect for correct output to wide-aspect vs. standard aspect video	√	√	√	√
	HP Smart Plug AC adapter (4.0 mm barrel)	√	√	√	√
	Audio-out (headphone)/Audio-in (microphone) combo jack	√	√	√	√
	Microphone-in	√	√	√	√
	High-definition multimedia interface (HDMI) v2.0 supporting: up to 4096 × 2160 @ 60 Hz with HDCP 2.2	√	√	√	√
	Mini DisplayPort	√	√	√	√
	RJ-45 (network) jack	√	√	√	√
	AC Smart Pin adapter plug	√	√	√	√
	<b>USB 3.0 ports</b>	√	√	√	√
	3 (1 on the left side; 1 on the right side; 1 on the rear side)				
	Support HP Sleep & Charge (rear port only)				
	<b>USB Type-C ports*</b>	√	√	√	√
	USB 3.1 Gen 2 with Thunderbolt Gen 3 technology (on the rear side)			√	√
	USB 3.1 Gen 1 (on the rear side)	√	√		
	*Support data transfer	√	√	√	√
	*Support DisplayPort 1.2 out up to 4096 × 2304 (60 Hz)				
*Support HP Sleep & Charge					
Support DisplayPort 1.2 out up to 4096 × 2304 (60 Hz)	√	√	√	√	

**Table 1-2 Product components and their descriptions (continued)**

Category	Details	GeForce GTX 1070 (N17E-G2)	GeForce GTX 1060 (N17E-G1)	GeForce GTX 1050 Ti (N17P-G1)	GeForce GTX 1050 (N17P-G0)
	Support HP Sleep & Charge	√	√	√	√
	Intel Thunderbolt 3 SP design	√	√		
<b>External media cards</b>	HP 2-in-1 multiformat Digital Media Reader Slot with push-push technology. Reads data from and writes data to digital memory cards such as micro SD/SDHC/SDXC.	√	√	√	√
<b>Keyboard/pointing devices</b>	<b>Keyboard</b>				
	Full-size backlit 3-coat paint island-style keyboard with numeric key pad, 2-zone lighting, Dragon Red with red backlight	√	√	√	√
	Full-size backlit 3-coat paint island-style keyboard with numeric key pad, 4-zone lighting, white with RGB backlight	√	√	√	√
	Special highlight for WASD keys, support 26-key NKRO Anti-Ghosting keys	√	√	√	√
	<b>Touchpad requirements</b>	√	√	√	√
	Touchpad with image sensor	√	√	√	√
	Multitouch gestures enabled (2-finger scroll, pinch, rotate, 2-finger click, 3-finger flick)	√	√	√	√
	Support for modern trackpad gestures	√	√	√	√
	Taps enabled as default	√	√	√	√
<b>Power requirements</b>	<b>Battery</b>				
	4-cell polymer battery - 70 Whr (4550 mAh)	√	√	√	√
	3-cell polymer battery - 52.5 Whr (4550 mAh)			√	√
	Support battery fast charge	√	√	√	√
	<b>AC adapter</b>				
	135 W AC adapter with power cords				√
	150 W AC adapter with power cords			√	
	200 W AC adapter with power cords	√	√		
	<b>Power cord</b>				
	1 m premium power cord with sticker label (C5) - black			√	√
	For adapter <= 90 W, and worldwide except Japan				
	1 m premium power cord with sticker label (C13)	√	√		
<b>Security</b>	Trusted platform module (TPM) 2.0	√	√	√	√



**Table 1-2 Product components and their descriptions (continued)**

Category	Details	GeForce GTX 1070 (N17E-G2)	GeForce GTX 1060 (N17E-G1)	GeForce GTX 1050 Ti (N17P-G1)	GeForce GTX 1050 (N17P-G0)	
	Mini security cable lock	√	√	√	√	
<b>Operating system</b>	<b>Preinstalled:</b>	√	√	√	√	
	Windows 10					
	Windows 10 Pro	√	√	√	√	
	<b>For developed market (ML)</b>					
	Windows 10 Home ML	√	√	√	√	
	Windows 10 Home Plus ML	√	√	√	√	
	i7 + > 4 GB, or, any CPU + >= 1080 p screen + >= 8 GB					
	<b>For emerging market (EM/SL)</b>					
	Windows 10 Home EM/SL	√	√	√	√	
	Windows 10 Home Plus EM/SL	√	√	√	√	
	i7 + > 4 GB, or, any CPU + >= 1080 p screen + >= 8 GB					
	<b>For China Market</b>					
	CPPP Windows 10 Home High End China Language Edition	√	√	√	√	
	i7 + > 4 GB, or, any CPU + >=1080p screen + >= 8 GB					
	CPPP Windows 10 Home China Language Edition	√	√	√	√	
	i7 + > 4 GB, or, any CPU + >= 1080p screen + >= 8 GB					
	<b>For India Market:</b>					
	Windows 10 Home EM/SL IPPP	√	√	√	√	
	i7 + > 4 GB, or, any CPU + >= 1080p screen + >= 8 GB					
	Windows 10 Home Plus EM/SL IPPP	√	√	√	√	
	i7 + >4 GB, or, any CPU + >= 1080 p screen + >= 8 GB					
<b>For Indonesia Market</b>						
Windows 10 Home Plus EM/SL Indonesia PPP	√	√	√	√		
i7 + > 4 GB, or, any CPU + >= 1080 p screen + >= 8 GB						
Windows 10 Home EM/SL Indonesia PPP	√	√	√	√		
<b>For APAC Market</b>						
Windows 10 Home Plus EM/SL APAC PPP	√	√	√	√		

**Table 1-2 Product components and their descriptions (continued)**

Category	Details	GeForce GTX 1070 (N17E-G2)	GeForce GTX 1060 (N17E-G1)	GeForce GTX 1050 Ti (N17P-G1)	GeForce GTX 1050 (N17P-G0)
	i7 + >4 GB, or, any CPU + >= 1080 p screen + >= 8 GB				
	Windows 10 Home EM/SL APAC PPP	√	√	√	√
	<b>FreeDOS 2.0</b>	√	√	√	√
	Not supported on touch models				
<b>Serviceability</b>	<b>End-user replaceable parts:</b>				
	AC adapter	√	√	√	√
	Memory	√	√	√	√
	Hard drive	√	√	√	√
	Solid-state drive	√	√	√	√



## 2 Getting to know your computer

Your computer features top-rated components. This chapter provides details about your components, where they are located, and how they work.

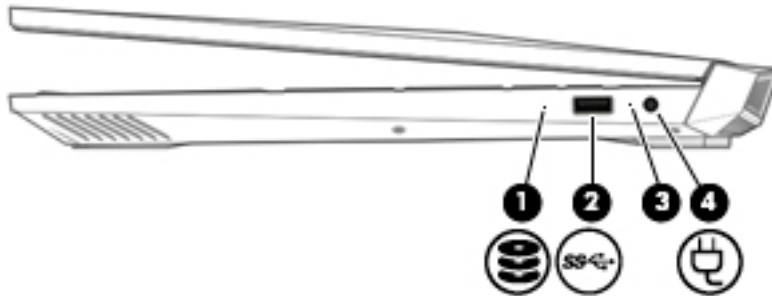
### Right side





**Table 2-1** Right-side components and their descriptions

Component	Description
(1)  Drive light	<ul style="list-style-type: none"><li>Blinking white: The hard drive is being accessed.</li><li>Amber: HP 3D DriveGuard has temporarily parked the hard drive.</li></ul>
(2)  USB SuperSpeed port	Connects a USB device, such as a cell phone, camera, activity tracker, or smartwatch, and provides high-speed data transfer.
(3) AC adapter and battery light	<ul style="list-style-type: none"><li>White: The AC adapter is connected and the battery is fully charged.</li><li>Blinking white: The AC adapter is disconnected and the battery has reached a low battery level.</li><li>Amber: The AC adapter is connected and the battery is charging.</li><li>Off: The battery is not charging.</li></ul>
(4) Power connector	Connects an AC adapter.

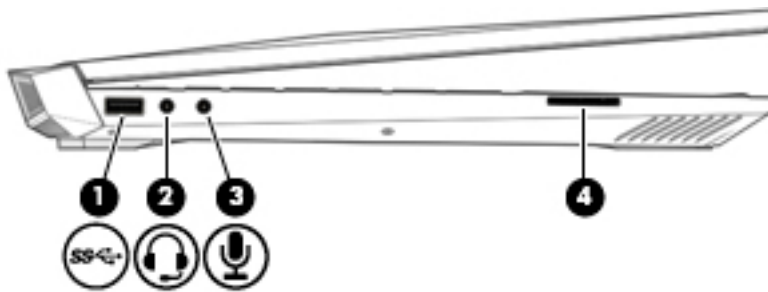
## Left side

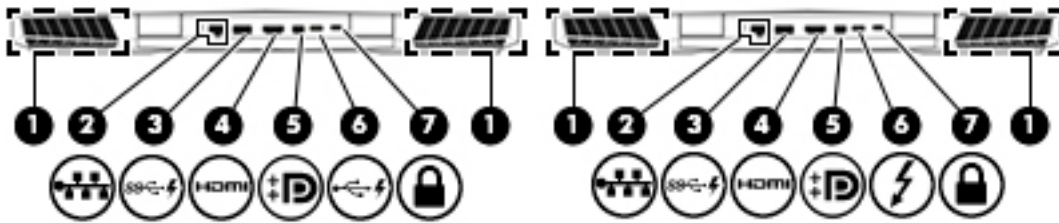

**Table 2-2** Left-side components and their descriptions







Component	Description
(1) 	<p>USB SuperSpeed port</p> <p>Connects a USB device, such as a cell phone, camera, activity tracker, or smartwatch, and provides high-speed data transfer.</p>
(2) 	<p>Audio-out (headphone)/Audio-in (microphone) combo jack</p> <p>Connects optional powered stereo speakers, headphones, earbuds, a headset, or a television audio cable. Also connects an optional headset microphone. This jack does not support optional standalone microphones.</p> <p><b>WARNING!</b> To reduce the risk of personal injury, adjust the volume before putting on headphones, earbuds, or a headset. For additional safety information, see the <i>Regulatory, Safety, and Environmental Notices</i>.</p> <p>To access this guide:</p> <ul style="list-style-type: none"> <li>▲ Type HP Documentation in the taskbar search box, and then select , and then select <b>HP Documentation</b>.</li> </ul> <p><b>NOTE:</b> When a device is connected to the jack, the computer speakers are disabled.</p>
(3) 	<p>Audio-in (microphone) jack</p> <p>Connects an optional computer headset microphone, stereo array microphone, or monaural microphone.</p>
(4)	<p>Memory card reader</p> <p>Reads optional memory cards that enable you to store, manage, share, or access information.</p> <p>To insert a card:</p> <ol style="list-style-type: none"> <li>1. Hold the card label-side up, with connectors facing the computer.</li> <li>2. Insert the card into the memory card reader, and then press in on the card until it is firmly seated.</li> </ol> <p>To remove a card:</p> <ul style="list-style-type: none"> <li>▲ Press in on the card, and then remove it from the memory card reader.</li> </ul>

# Rear

 **NOTE:** Refer to the image that most closely matches your computer.



**Table 2-3** Rear components and their descriptions

Component	Description
(1)	<p>Vents</p> <p>Enable airflow to cool internal components.</p> <p><b>NOTE:</b> The computer fan starts up automatically to cool internal components and prevent overheating. It is normal for the internal fan to cycle on and off during routine operation.</p>
(2)	<p> RJ-45 (network) jack/status lights</p> <p>Connects a network cable.</p> <ul style="list-style-type: none"> <li>White: The network is connected.</li> <li>Amber: Activity is occurring on the network.</li> </ul>
(3)	<p> USB SuperSpeed port with HP Sleep and Charge</p> <p>Connects a USB device, provides high-speed data transfer, and even when the computer is off, charges most products such as a cell phone, camera, activity tracker, or smartwatch.</p>
(4)	<p> HDMI port</p> <p>Connects an optional video or audio device, such as a high-definition television, any compatible digital or audio component, or a high-speed High-Definition Multimedia Interface (HDMI) device.</p>
(5)	<p> Mini Dual-Mode DisplayPort</p> <p>Connects an optional digital display device, such as a high-performance monitor or projector.</p>
(6)	<p> USB Type-C port with HP Sleep and Charge</p> <p>Connects a USB device that has a Type-C connector, and even when the computer is off, charges most products such as a cell phone, camera, activity tracker, or smartwatch.</p> <p>– and –</p> <p>Connects a display device that has a USB Type-C connector, providing DisplayPort output.</p> <p><b>NOTE:</b> Cables and/or adapters (purchased separately) may be required.</p>
(6)	<p> USB Type-C Thunderbolt port with HP Sleep and Charge</p> <p>Connects and charges most USB devices that have a Type-C connector, such as a cell phone, camera, activity tracker, or smartwatch, and provides high-speed data transfer.</p> <p>– and –</p> <p>Connects a display device that has a USB Type-C connector, providing DisplayPort output.</p> <p><b>NOTE:</b> Your computer may also support a Thunderbolt docking station.</p> <p><b>NOTE:</b> Cables and/or adapters (purchased separately) may be required.</p>
(7)	<p>Security cable slot</p> <p>Attaches an optional security cable to the computer.</p>

**Table 2-3 Rear components and their descriptions (continued)**

Component	Description
	<b>NOTE:</b> The security cable is designed to act as a deterrent, but it may not prevent the computer from being mishandled or stolen.

## Display

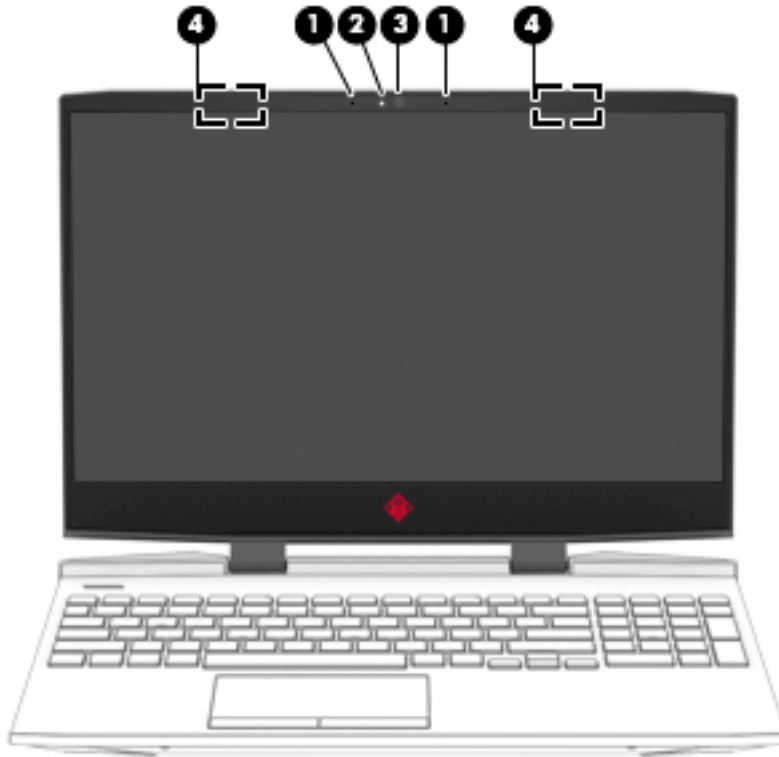

**Table 2-4 Display components and their descriptions**

Component	Description
(1) Internal microphones	Record sound.
(2) Camera light	On: The camera is in use.
(3) Camera	Allows you to video chat, record video, and record still images. Some cameras also allow a facial recognition logon to Windows, instead of a password logon. <b>NOTE:</b> Camera functions vary depending on the camera hardware and software installed on your product.
(4) WLAN antennas*	Send and receive wireless signals to communicate with wireless local area networks (WLANs).

\*The antennas are not visible from the outside of the computer. For optimal transmission, keep the areas immediately around the antennas free from obstructions.

For wireless regulatory notices, see the section of the *Regulatory, Safety, and Environmental Notices* that applies to your country or region.

To access this guide:

- ▲ Type HP Documentation in the taskbar search box, and then select, and then select **HP Documentation**.

# Keyboard area

## Touchpad





**Table 2-5** Touchpad components and their descriptions

Component	Description
(1) Touchpad zone	Reads your finger gestures to move the pointer or activate items on the screen.
(2) Left touchpad button	Functions like the left button on an external mouse.
(3) Right touchpad button	Functions like the right button on an external mouse.

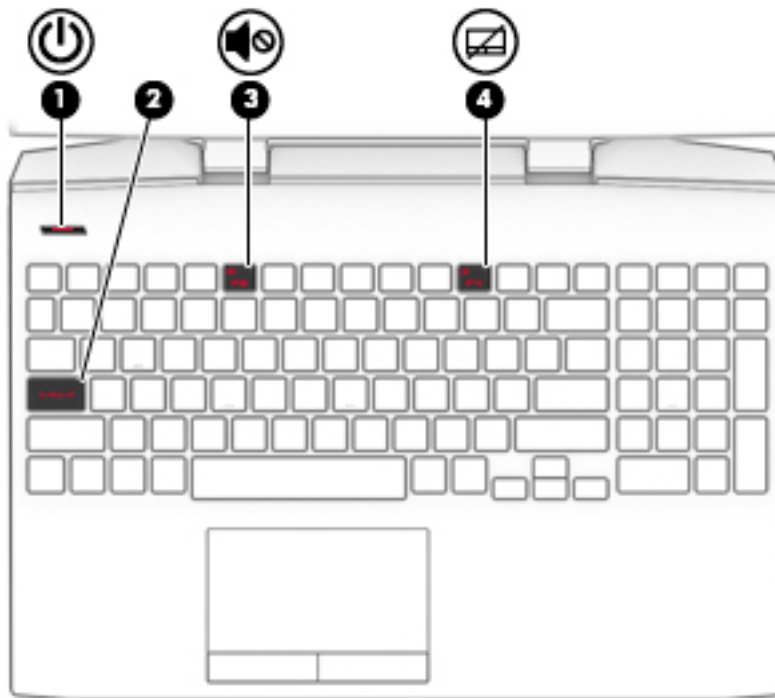
## Lights

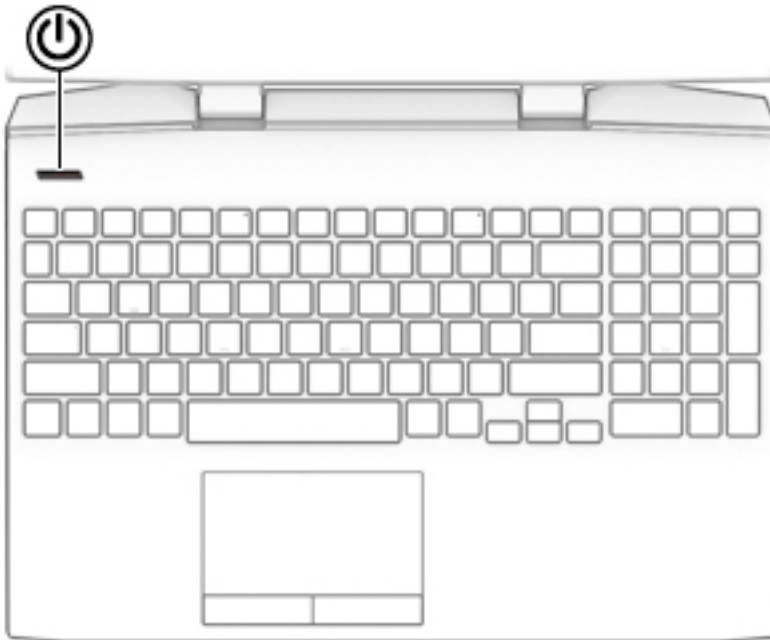

**Table 2-6** Lights and their descriptions



Component	Description
(1)  Power light	<ul style="list-style-type: none"><li>• On: The computer is on.</li><li>• Blinking: The computer is in the Sleep state, a power-saving state. The computer shuts off power to the display and other unneeded components.</li><li>• Off: The computer is off or in Hibernation. Hibernation is a power-saving state that uses the least amount of power.</li></ul>
(2) Caps lock light	On: Caps lock is on, which switches the key input to all capital letters.
(3)  Mute light	<ul style="list-style-type: none"><li>• On: Computer sound is off.</li><li>• Off: Computer sound is on.</li></ul>
(4) Touchpad light	<ul style="list-style-type: none"><li>• On: The touchpad is off.</li><li>• Off: The touchpad is on.</li></ul>



## Button





**Table 2-7** Button and its description

Component	Description
 Power button	<ul style="list-style-type: none"><li>• When the computer is off, press the button to turn on the computer.</li><li>• When the computer is on, press the button briefly to initiate Sleep.</li><li>• When the computer is in the Sleep state, press the button briefly to exit Sleep.</li><li>• When the computer is in Hibernation, press the button briefly to exit Hibernation.</li></ul> <p><b>IMPORTANT:</b> Pressing and holding down the power button results in the loss of unsaved information.</p> <p>If the computer has stopped responding and shutdown procedures are ineffective, press and hold the power button down for at least 5 seconds to turn off the computer.</p> <p>To learn more about your power settings, see your power options:</p> <ul style="list-style-type: none"><li>▲ Right-click the <b>Power</b> icon , and then select <b>Power Options</b>.</li></ul>

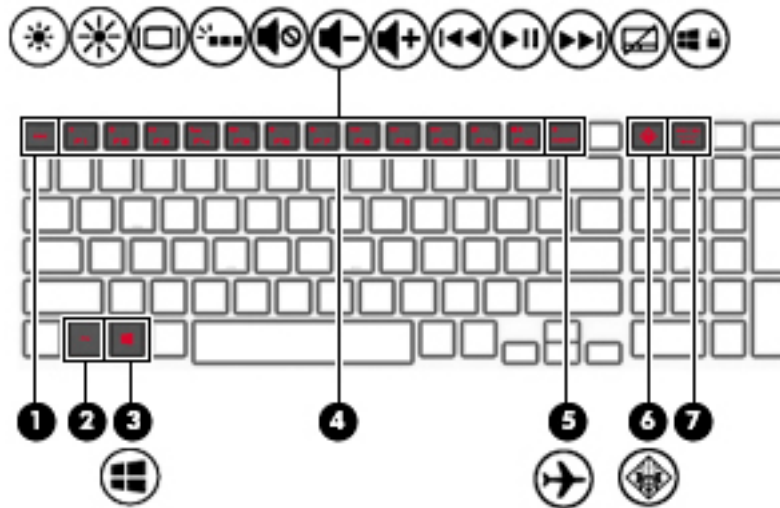
## Special keys



**Table 2-8** Special keys and their descriptions

Component	Description
(1) <span style="margin-left: 20px;">esc key</span>	Displays system information when pressed in combination with the <b>fn</b> key.
(2) <span style="margin-left: 20px;">fn key</span>	Executes specific functions when pressed in combination with another key.
(3)  <span style="margin-left: 20px;">Windows key</span>	Opens the <b>Start</b> menu. <b>NOTE:</b> Pressing the Windows key again will close the <b>Start</b> menu.
(4) <span style="margin-left: 20px;">Action keys</span>	Execute frequently used system functions. <b>NOTE:</b> On select products, the <b>f4</b> action key turns the keyboard backlight feature off or on.
(5)  <span style="margin-left: 20px;">Airplane mode key (also referred to as the wireless button)</span>	Turns the airplane mode and wireless feature on or off. <b>NOTE:</b> A wireless network must be set up before a wireless connection is possible.
(6)  <span style="margin-left: 20px;">OMEN key</span>	Opens the OMEN Command Center software.
(7) <span style="margin-left: 20px;">END/PRT SC key</span>	Turns the END mode on or off. – or – Prints the screen image. ▲ Press and hold the key in combination with the <b>fn</b> key.

# Bottom

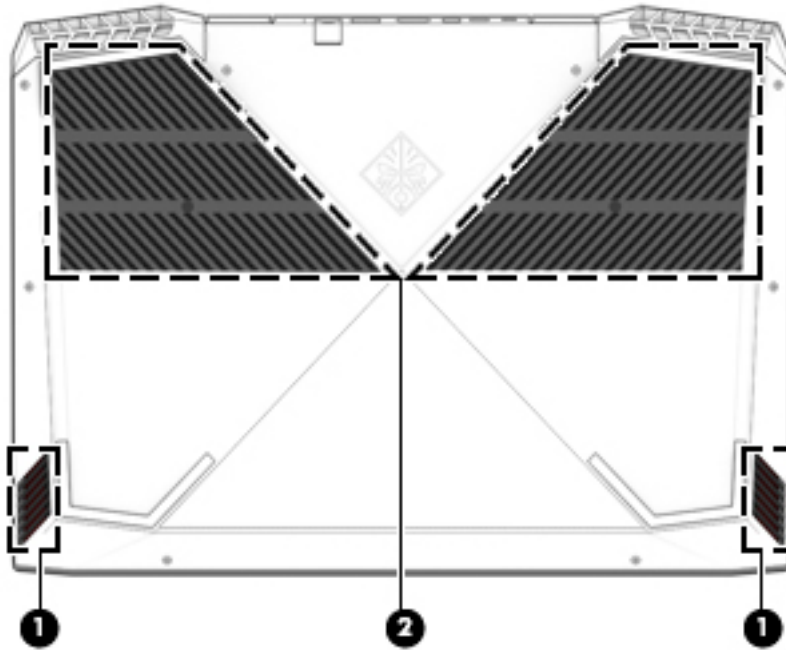

**Table 2-9** Bottom components and their descriptions

Component		Description
(1)	Speakers	Produce sound.
(2)	Vents	Enable airflow to cool internal components.

**NOTE:** The computer fan starts up automatically to cool internal components and prevent overheating. It is normal for the internal fan to cycle on and off during routine operation.

# Labels

The labels affixed to the computer provide information you may need when you troubleshoot system problems or travel internationally with the computer. Labels may be in paper form or imprinted on the product.

**IMPORTANT:** Check the following locations for the labels described in this section: the bottom of the computer, inside the battery bay, under the service door, on the back of the display, or on the bottom of a tablet kickstand.

- Service label—Provides important information to identify your computer. When contacting support, you may be asked for the serial number, the product number, or the model number. Locate this information before you contact support.

Your service label will resemble one of the following examples. Refer to the illustration that most closely matches the service label on your computer.

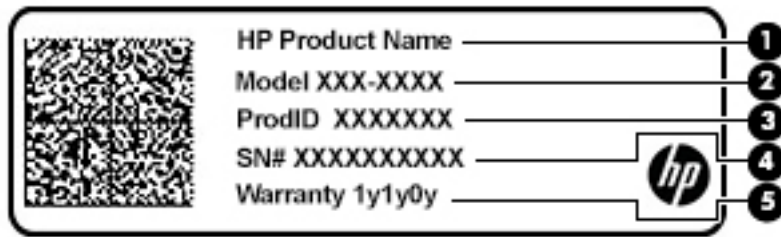

**Table 2-10** Service label components

Component
(1) HP product name
(2) Model number
(3) Product ID
(4) Serial number
(5) Warranty period

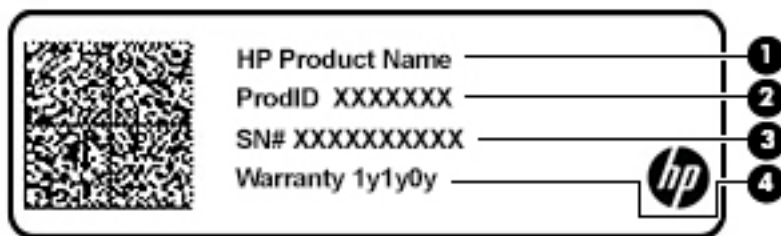

**Table 2-11** Service label components

Component
(1) HP product name
(2) Product ID
(3) Serial number
(4) Warranty period

- Regulatory label(s)—Provide(s) regulatory information about the computer.
- Wireless certification label(s)—Provide(s) information about optional wireless devices and the approval markings for the countries or regions in which the devices have been approved for use.

# 3 Illustrated parts catalog

 **NOTE:** HP continually improves and changes product parts. For complete and current information on supported parts for your computer, go to <http://partsurfer.hp.com>, select your country or region, and then follow the on-screen instructions.

## Computer major components

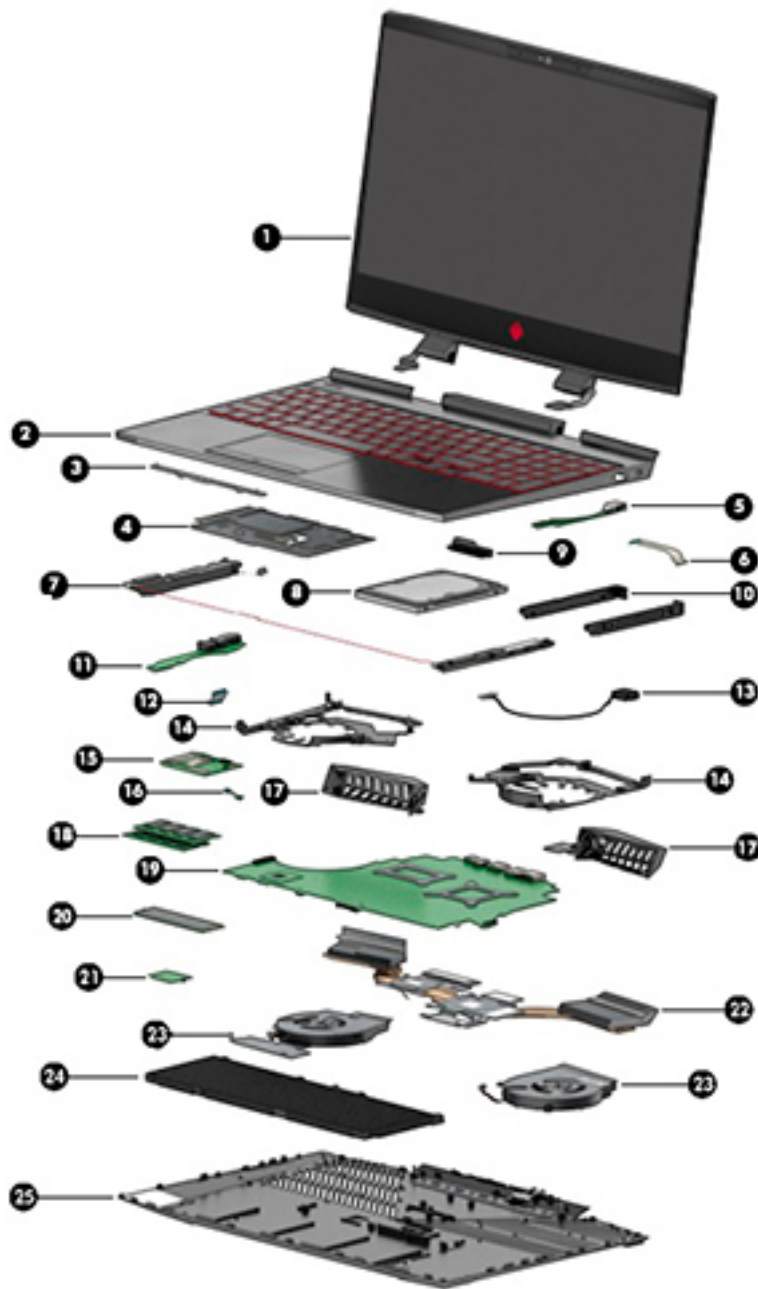

**Table 3-1 Computer major components and their descriptions**

Item	Component	Spare part number
(1)	<b>Display assembly:</b> The display assembly is spared at the subcomponent level only. For more display assembly spare part information, see <a href="#">Display assembly subcomponents on page 26</a> .	
(2)	<b>Keyboard/top cover</b> (includes keyboard cable). For a complete list of keyboard/top covers see <a href="#">Keyboard/top cover on page 68</a> .	
(3)	<b>Touchpad bracket</b>	L24356-001
(4)	<b>Touchpad board</b>	L24355-001
(5)	<b>USB connector board</b> (includes audio jack and USB port)	L24349-001
(6)	<b>USB connector board cable</b>	L24350-001
(7)	<b>Speakers</b> (include left and right speakers and cables)	L24364-001
(8)	<b>Hard drive</b>	
	1 TB, 7200 rpm, 9.5 mm, 2.5 in	766644-001
	2 TB, 5400 rpm, 7 mm, 2.5 in	912487-850
	Hard drive dummy	L24367-001
(9)	<b>Hard drive cable connector</b>	929450-001
(10)	<b>Hard drive brackets</b>	929561-001
(11)	<b>Audio board</b>	L24345-001
	Audio cable, not shown	L24346-001
(12)	<b>Power connector board</b>	L24347-001
(13)	<b>Power connector cable</b> (includes cable and double-sided adhesive)	L24348-001
(14)	<b>Fan support brackets</b> (left and right)	
	N17E/N18E	L24362-001
	N17P/N18P	L24363-001
(15)	<b>Smart card reader board</b>	L24351-001
	Smart card reader cable, not shown	L24352-001
(16)	<b>DC in jack</b>	
	N17P/N18P	L24344-001
	N17E/N18E	L24343-001
(17)	<b>Vent support brackets</b> (left and right), part of the Plastics Kit	L24361-001
(18)	<b>Memory</b>	
	SODIMM 8 GB 2666 MHz 1.2 v DDR4	937236-850
	SODIMM 16 GB 2666 MHz 1.2 v DDR4	937438-850
	SODIMM 4 GB 2666 MHz 1.2 v DDR4	L10598-850
(19)	<b>System board</b> (includes HDMI port, micro-SD card reader slot, USB port, WLAN slot, LVDS slot, DC in slot, and replacement thermal material). For a complete list of system board descriptions see <a href="#">System board on page 53</a> .	
(20)	<b>Solid-state drive</b>	

**Table 3-1 Computer major components and their descriptions (continued)**

<b>Item</b>	<b>Component</b>	<b>Spare part number</b>
	128 GB	L24339-001
	256 GB	L24340-001
	512 GB	L24341-001
	16 GB Optane Memory Module	L24342-001
	32 GB Optane Memory Module + 512 GB solid-state drive	L51797-001
<b>(21)</b>	<b>WLAN module</b>	
	Realtek RTL8822BE 802.11ac 2 × 2 Wi-Fi + Bluetooth 4.2 Combo Adapter (MU-MIMO supported)	915623-001
	Intel Dual Band Wireless-AC 9560 802.11ac 2 × 2 Wi-Fi + Bluetooth 5 Combo Adapter (non-vPro) (MU-MIMO supported)	L22634-001
	Intel Wi-Fi 6 AX200 ax2 × 2 + Bluetooth 5 (non-vPro) (MU-MIMO supported)	L35282-001
<b>(22)</b>	<b>Heat sink</b> (includes replacement thermal material)	
	N17E	L24357-001
	N17P/N18P	L24358-001
	N18E	L51908-001
<b>(23)</b>	<b>Fans</b> (left and right includes replacement thermal material)	
	N17E/N18E	L24359-001
	N17P/N18P	L29081-001
<b>(24)</b>	<b>Battery</b>	
	4 cell 70 Whr 4.55 Ahr LI SR04070XL-PL	917724-855
	3 cell 52 Whr 4.55 Ahr LI SR03052XL-PL	L08855-855
<b>(25)</b>	<b>Base enclosure</b>	
	N17E/N18E	L24353-001
	N17P/N18P	L24354-001

## Display assembly subcomponents

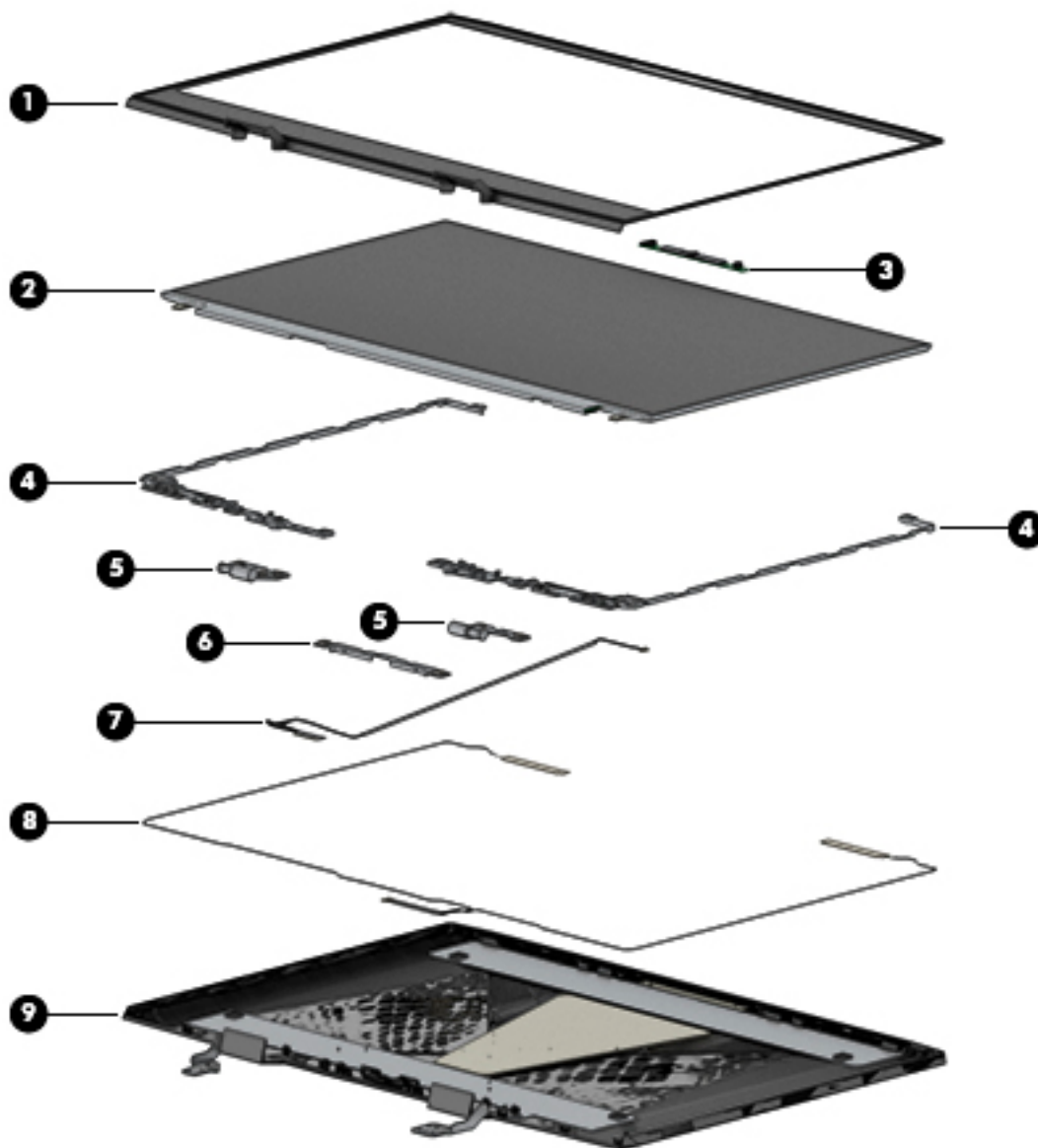

**Table 3-2** Display components and their descriptions

Item	Component	Spare part number
(1)	Display bezel	L24389-001
(2)	Display panel	
	15.6 in, FHD, 60 Hz	L24374-001
	15.6 in, FHD, 144 Hz	L24376-001
	15.6 in, FHD, 60 Hz, 300 nits	L47065-001
	15.6 in, FHD, 240 Hz, 300 nits	L62800-001
	15.6 in, UHD, 60 Hz	L24378-001
(3)	Camera/microphone module (includes double-sided adhesive)	L24391-001



**Table 3-2 Display components and their descriptions (continued)**

Item	Component	Spare part number
(4)	<b>Display hinge</b> (includes left and right display hinges)	L24386-001
(5)	<b>Display hinge bracket</b> , includes display tape	L24387-001
(6)	<b>Display support bracket</b>	L24385-001
(7)	<b>Display panel cable</b> (includes camera/microphone module cable)	
	FHD 60 Hz, 30 pin	L24382-001
	FHD 144 Hz/UHD, 40 pin	L24384-001
	FHD 240 Hz	L63080-001
(8)	<b>WLAN antenna</b> (includes left and right WLAN cables and transceivers)	L24380-001
(9)	<b>Display enclosure/Back cover</b> (includes rubber padding, antenna, and shielding):	
	0.5 mm, for FHD 60 Hz LCD panel	L24379-001
	1.1 mm, for FHD 144 Hz/UHD LCD panel	L32773-001

## Miscellaneous parts

**Table 3-3 Miscellaneous parts and their descriptions**

Component	Spare part number
<b>AC adapter</b>	
150 W PFC SMART 4.5 mm Slim	917649-850
200 W PFC SMART SLIM 4.5 mm	L00818-850
135 W PFC SMART SLIM RC 4.5 mm	L15534-001
135 W PFC SMART SLIM RC 4.5 mm, for Latin America	L15534-101
<b>Miscellaneous Kit</b> , includes system board sponge, power button tape, left and right fan tape, power connector tape, and system board tape	L24372-001
<b>Case</b> , HP 15.6 Chroma Geo Rev sleeve	L07806-101
<b>Display tape</b>	L24392-001
<b>Dongle, USB-C to USB-A</b>	833960-001
<b>HDMI to VGA adapter</b>	701943-001
<b>Power cord</b> (1.00 m)	
For use in Argentina, C13	L22104-001
For use in Argentina, C5	L22106-001
For use in Australia, C13	L22327-001
For use in Australia, C5	L22339-001
For use in Denmark, C13	L22334-001
For use in Denmark, C5	L22322-001

**Table 3-3 Miscellaneous parts and their descriptions (continued)**

<b>Component</b>	<b>Spare part number</b>
For use in Europe, C13	L22333-001
For use in Europe, C5	L22321-001
For use in India, C13	L22624-001
For use in India, C5	L22343-001
For use in Israel, C13	L22335-001
For use in Israel, C5	L22323-001
For use in Italy, C13	L22103-001
For use in Italy, C5	L22105-001
For use in Japan, C13	L22344-001
For use in Japan, C5	L22330-001
For use in North America, C5	L22319-001
For use in North America, C13	L22331-001
For use in the People's Republic of China, C13	L22341-001
For use in the People's Republic of China, C5	L21930-001
For use in South America, C13	L22337-001
For use in South America, C5	L22325-001
For use in South Korea, C13	L22340-001
For use in South Korea, C5	L22328-001
For use in Switzerland, C13	L22336-001
For use in Switzerland, C5	L22324-001
For use in Taiwan, C13	L22342-001
For use in Taiwan, C5	L22329-001
For use in Thailand, C13	L22338-001
For use in Thailand, C5	L22326-001
For use in the United Kingdom, C13	L22332-001
For use in the United Kingdom, C5	L22320-001
<b>Optical drive, USB external DVDRW drive</b>	747080-001
<b>Screw Kit</b>	L24368-001

---

## 4 Removal and replacement procedures preliminary requirements

### Tools required

You will need the following tools to complete the removal and replacement procedures:

- Non-marking, non-conductive pry tool
- Phillips P1 screwdriver

### Service considerations

The following sections include some of the considerations that you must keep in mind during disassembly and assembly procedures.

---

 **NOTE:** As you remove each subassembly from the computer, place the subassembly (and all accompanying screws) away from the work area to prevent damage.

---

### Plastic parts

---

 **IMPORTANT:** Using excessive force during disassembly and reassembly can damage plastic parts.

---

### Cables and connectors

---

 **IMPORTANT:** When servicing the computer, be sure that cables are placed in their proper locations during the reassembly process. Improper cable placement can damage the computer.

---

Cables must be handled with extreme care to avoid damage. Apply only the tension required to unseat or seat the cables during removal and insertion. Handle cables by the connector whenever possible. In all cases, avoid bending, twisting, or tearing cables. Be sure that cables are routed in such a way that they cannot be caught or snagged by parts being removed or replaced. Handle flex cables with extreme care; these cables tear easily.

## Drive handling



**IMPORTANT:** Drives are fragile components that must be handled with care. To prevent damage to the computer, damage to a drive, or loss of information, observe these precautions:

Before removing or inserting a hard drive, shut down the computer. If you are unsure whether the computer is off or in Hibernation, turn the computer on, and then shut it down through the operating system.

Before handling a drive, be sure that you are discharged of static electricity. While handling a drive, avoid touching the connector.

Before removing an optical drive, be sure that a disc is not in the drive and be sure that the optical drive tray is closed.

Handle drives on surfaces covered with at least one inch of shock-proof foam.

Avoid dropping drives from any height onto any surface.

After removing a hard drive or an optical drive, place it in a static-proof bag.

Avoid exposing an internal hard drive to products that have magnetic fields, such as monitors or speakers.

Avoid exposing a drive to temperature extremes or liquids.

If a drive must be mailed, place the drive in a bubble pack mailer or other suitable form of protective packaging and label the package “FRAGILE.”

## Workstation guidelines

Follow these grounding workstation guidelines:

- Cover the workstation with approved static-shielding material.
- Use a wrist strap connected to a properly grounded work surface and use properly grounded tools and equipment.
- Use conductive field service tools, such as cutters, screw drivers, and vacuums.
- When fixtures must directly contact dissipative surfaces, use fixtures made only of static-safe materials.
- Keep the work area free of nonconductive materials, such as ordinary plastic assembly aids and Styrofoam.
- Handle ESD-sensitive components, parts, and assemblies by the case or PCM laminate. Handle these items only at static-free workstations.
- Avoid contact with pins, leads, or circuitry.
- Turn off power and input signals before inserting or removing connectors or test equipment.

## Electrostatic discharge information

A sudden discharge of static electricity from your finger or other conductor can destroy static-sensitive devices or microcircuitry. Often the spark is neither felt nor heard, but damage occurs. An electronic device exposed to electrostatic discharge (ESD) may not appear to be affected at all and can work perfectly throughout a normal cycle. The device may function normally for a while, but it has been degraded in the internal layers, reducing its life expectancy.

Networks built into many integrated circuits provide some protection, but in many cases, the discharge contains enough power to alter device parameters or melt silicon junctions.



**IMPORTANT:** To prevent damage to the device when you are removing or installing internal components, observe these precautions:

Keep components in their electrostatic-safe containers until you are ready to install them.

Before touching an electronic component, discharge static electricity by using the guidelines described in this section.

Avoid touching pins, leads, and circuitry. Handle electronic components as little as possible.

If you remove a component, place it in an electrostatic-safe container.

## Generating static electricity

Note the following:

- Different activities generate different amounts of static electricity.
- Static electricity increases as humidity decreases.

**Table 4-1 Static electricity occurrence based on activity and humidity**

Event	Relative humidity		
	55%	40%	10%
Walking across carpet	7,500 V	15,000 V	35,000 V
Walking across vinyl floor	3,000 V	5,000 V	12,000 V
Motions of bench worker	400 V	800 V	6,000 V
Removing DIPs from plastic tube	400 V	700 V	2,000 V
Removing DIPs from vinyl tray	2,000 V	4,000 V	11,500 V
Removing DIPs from Styrofoam	3,500 V	5,000 V	14,500 V
Removing bubble pack from PCB	7,000 V	20,000 V	26,500 V
Packing PCBs in foam-lined box	5,000 V	11,000 V	21,000 V

Electronic components are then multi-packaged inside plastic tubes, trays, or Styrofoam.



**NOTE:** As little as 700 V can degrade a product.

## Preventing electrostatic damage to equipment

Many electronic components are sensitive to ESD. Circuitry design and structure determine the degree of sensitivity. The following packaging and grounding precautions are necessary to prevent static electricity damage to electronic components.

- To avoid hand contact, transport products in static-safe containers such as tubes, bags, or boxes.
- Protect all electrostatic parts and assemblies with conductive or approved containers or packaging.
- Keep electrostatic-sensitive parts in their containers until they arrive at static-free stations.
- Place items on a grounded surface before removing them from their container.
- Always be properly grounded when touching a sensitive component or assembly.

- Avoid contact with pins, leads, or circuitry.
- Place reusable electrostatic-sensitive parts from assemblies in protective packaging or conductive foam.

## Personal grounding methods and equipment

Use the following equipment to prevent static electricity damage to electronic components:

- **Wrist straps** are flexible straps with a maximum of  $1\text{ M}\Omega \pm 10\%$  resistance in the ground cords. To provide proper ground, a strap must be worn snug against bare skin. The ground cord must be connected and fit snugly into the banana plug connector on the grounding mat or workstation.
- **Heel straps/Toe straps/Boot straps** can be used at standing workstations and are compatible with most types of shoes or boots. On conductive floors or dissipative floor mats, use them on both feet with a maximum of  $1\text{ M}\Omega \pm 10\%$  resistance between the operator and ground.

**Table 4-2 Static shielding protection levels**

Static shielding protection levels	
Method	Voltage
Antistatic plastic	1,500
Carbon-loaded plastic	7,500
Metallized laminate	15,000

## Grounding the work area

To prevent static damage at the work area, use the following precautions:

- Cover the work surface with approved static-dissipative material. Provide a wrist strap connected to the work surface and properly grounded tools and equipment.
- Use static-dissipative mats, foot straps, or air ionizers to give added protection.
- Handle electrostatic sensitive components, parts, and assemblies by the case or PCB laminate. Handle them only at static-free work areas.
- Turn off power and input signals before inserting and removing connectors or test equipment.
- Use fixtures made of static-safe materials when fixtures must directly contact dissipative surfaces.
- Keep work area free of nonconductive materials such as ordinary plastic assembly aids and Styrofoam.
- Use field service tools, such as cutters, screwdrivers, and vacuums, that are conductive.

## Recommended materials and equipment

Materials and equipment that are recommended for use in preventing static electricity include:

- Antistatic tape
- Antistatic smocks, aprons, or sleeve protectors
- Conductive bins and other assembly or soldering aids
- Conductive foam
- Conductive tabletop workstations with ground cord of  $1\text{ M}\Omega \pm 10\%$  resistance
- Static-dissipative table or floor mats with hard tie to ground

- Field service kits
- Static awareness labels
- Wrist straps and footwear straps providing 1 M $\Omega$   $\pm$ 10 resistance
- Material handling packages
- Conductive plastic bags
- Conductive plastic tubes
- Conductive tote boxes
- Opaque shielding bags
- Transparent metallized shielding bags
- Transparent shielding tubes

## Packaging and transporting guidelines

Follow these grounding guidelines when packaging and transporting equipment:

- To avoid hand contact, transport products in static-safe tubes, bags, or boxes.
- Protect ESD-sensitive parts and assemblies with conductive or approved containers or packaging.
- Keep ESD-sensitive parts in their containers until the parts arrive at static-free workstations.
- Place items on a grounded surface before removing items from their containers.
- Always be properly grounded when touching a component or assembly.
- Store reusable ESD-sensitive parts from assemblies in protective packaging or nonconductive foam.
- Use transporters and conveyors made of antistatic belts and roller bushings. Be sure that mechanized equipment used for moving materials is wired to ground and that proper materials are selected to avoid static charging. When grounding is not possible, use an ionizer to dissipate electric charges.

# 5 Removal and replacement procedures for Customer Self-Repair parts

This chapter provides removal and replacement procedures for Customer Self-Repair parts.

 **NOTE:** The Customer Self-Repair program is not available in all locations. Installing a part not supported by the Customer Self-Repair program may void your warranty. Check your warranty to determine if Customer Self-Repair is supported in your location.

## Component replacement procedures

 **NOTE:** Details about your computer, including model, serial number, product key, and length of warranty, are on the service tag at the bottom of your computer. See [Labels on page 21](#) for details.

 **NOTE:** HP continually improves and changes product parts. For complete and current information on supported parts for your computer, go to <http://partsurfer.hp.com>, select your country or region, and then follow the on-screen instructions.

There are as many as 12 screws that must be removed, replaced, and/or loosened when servicing Customer Self-Repair parts. Make special note of each screw size and location during removal and replacement.

## Preparation for disassembly

See [Removal and replacement procedures preliminary requirements on page 29](#) for initial safety procedures.

1. Turn off the computer. If you are unsure whether the computer is off or in Hibernation, turn the computer on, and then shut it down through the operating system.
2. Disconnect the power from the computer by unplugging the power cord from the computer.
3. Disconnect all external devices from the computer.
4. Remove the any smart cards and memory cards.

## Base enclosure

**Table 5-1 Base enclosure description and part number**

Description	Spare part number
<b>Base enclosure</b>	
N17P/N18P	L24354-001
N17E/N18E	L24353-001

Before removing the base enclosure, follow these steps:

- ▲ Prepare the computer for disassembly ([Preparation for disassembly on page 34](#)).

Remove the base enclosure:



1. Turn the computer upside down on a flat surface.
2. Remove the two Phillips 10 mm screws (1).
3. Remove the six Phillips 4 mm screws (2).

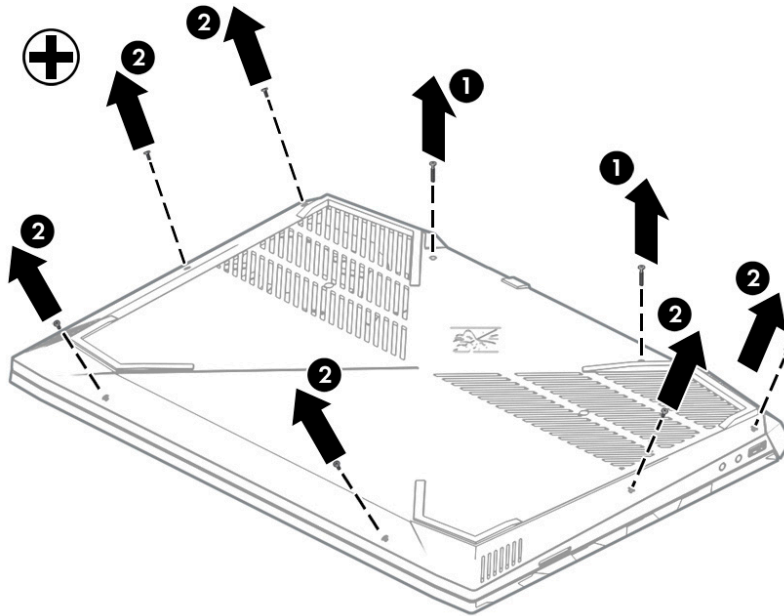

4. Open the display (1) at a 90° angle and then place the display back down.

5. Push in on the top cover (2), and then release the clips (3) securing the base enclosure.

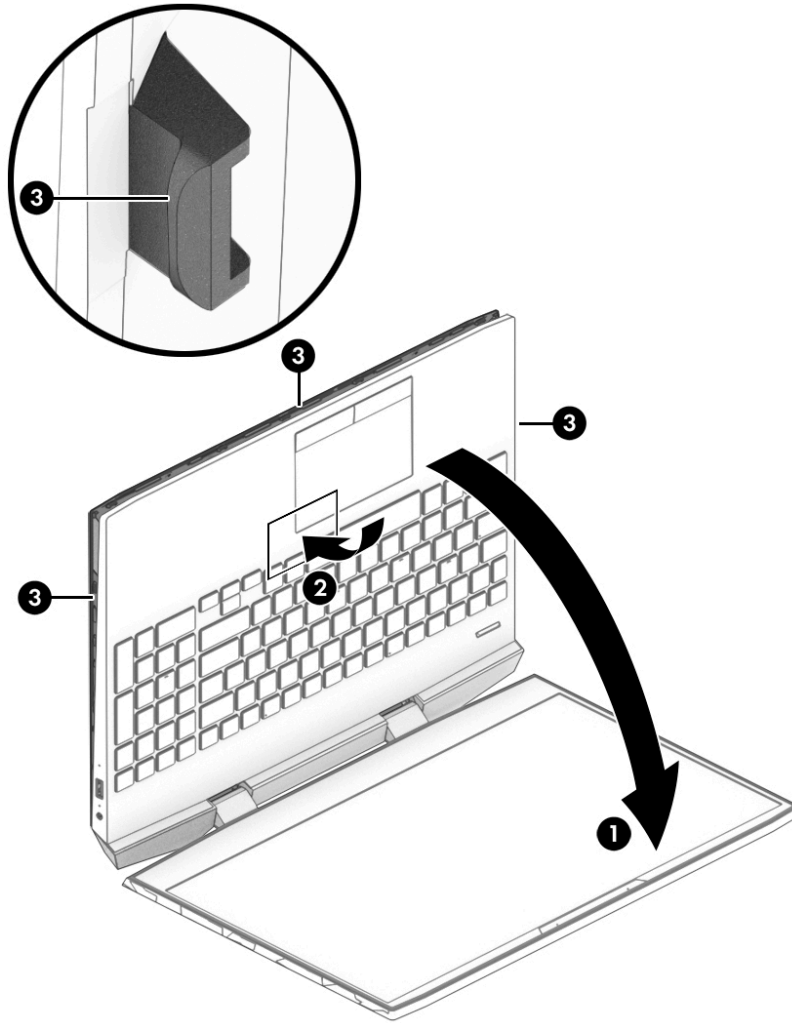

6. Shake the left and right sides (1) to release the base enclosure, and then lift the base enclosure (2) to remove it.

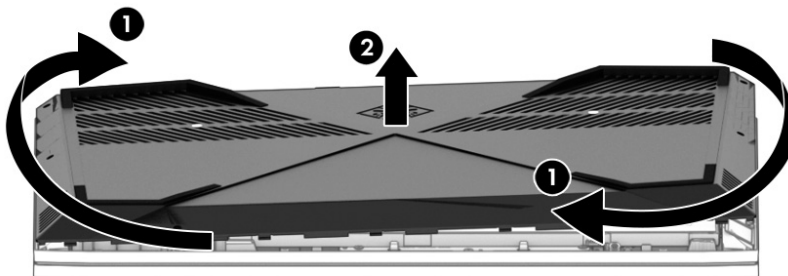

Reverse the removal procedures to install the base enclosure.

## Hard drive (HDD)

**Table 5-2** Hard drive description and part number

Description	Spare part number
<b>Hard drive</b>	
1 TB, 7200 rpm, 9.5 mm, 2.5 in	766644-001
2 TB, 5400 rpm, 7 mm, 2.5 in	912487-850
<b>Hard drive dummy</b>	L24367-001
<b>Hard drive cable connector</b>	929450-001
<b>Hard drive brackets</b>	929561-001

Before removing the hard drive, follow these steps:

1. Prepare the computer for disassembly ([Preparation for disassembly on page 34](#)).
2. Remove the base enclosure (see [Base enclosure on page 34](#)).

Remove the hard drive:

1. Release the HDD cable (1) from the system board.
2. Lift the hard drive release tab (2)
3. Lift the drive (3) to remove it.

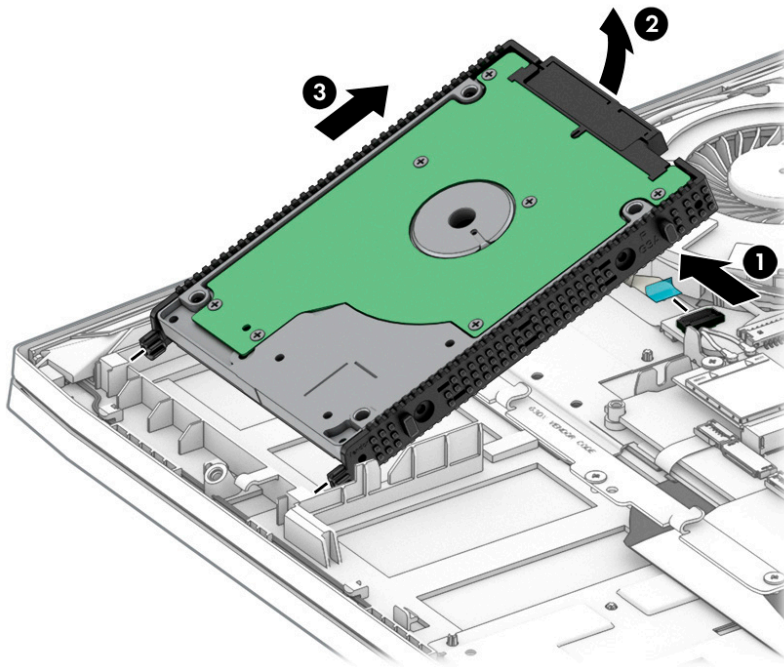

4. If it is necessary to replace the hard drive bracket, remove the brackets **(1)** from the hard drive, and then remove the cable connector **(2)** from the hard drive.

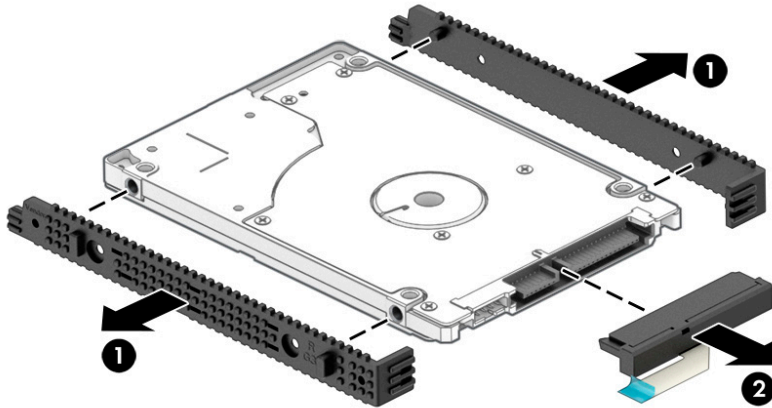

Reverse this procedure to install the hard drive.

## Solid-state drive (SSD)

**Table 5-3 Solid-state drive description and part number**

Description	Spare part number
<b>Solid-state drive</b>	
128 GB	L24339-001
256 GB	L24340-001
512 GB	L24341-001
16 GB Optane Memory Module	L24342-001
32 GB Optane Memory Module + 512 GB solid-state drive	L51797-001

Before removing the solid-state drive, follow these steps:

1. Prepare the computer for disassembly ([Preparation for disassembly on page 34](#)).
2. Remove the base enclosure (see [Base enclosure on page 34](#)).

Remove the solid-state drive:

1. Remove the Phillips M2.0×2.0 screw **(1)** that secures the drive to the system board.
2. Remove the drive by pulling it away from the connector **(2)**.

 **NOTE:** M.2 solid-state drives are designed with notches to prevent incorrect insertion.

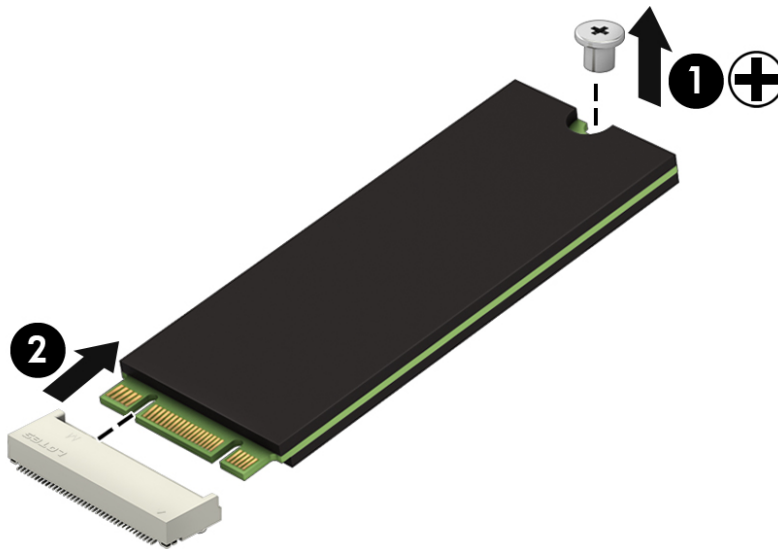

Reverse this procedure to install the solid-state drive.

## Memory modules

 **NOTE:** Primary and expansion memory is installed in a side-by-side configuration in the bottom of the computer.

If only one memory module is installed, it must be installed in the socket labeled “1”.

 **NOTE:** Two additional memory slots are available under the system board. These are not customer self-repair parts.

**Table 5-4 Memory module description and part number**

Description	Spare part number
4 GB, 2666 MHz, 1.2 v, DDR4	L10598-850
8 GB, 2666 MHz, 1.2 v, DDR4	937236-850
16 GB, 2666 MHz, 1.2 v, DDR4	937438-850

 **IMPORTANT:** Before adding new memory, make sure you update the computer to the latest BIOS. Go to [www.hp.com](http://www.hp.com), then select **Support**, and then **Software & drivers** to download the latest BIOS.

**IMPORTANT:** Failure to update the computer to the latest BIOS before installing new memory may result in various system problems.

Before removing the memory module, follow these steps:

1. Shut down the computer. If you are unsure whether the computer is off or in Hibernation, turn the computer on, and then shut it down through the operating system.
2. Disconnect all external devices connected to the computer.
3. Disconnect the power from the computer by first unplugging the power cord from the AC outlet, and then unplugging the AC adapter from the computer.
4. Remove the base enclosure (see [Base enclosure on page 34](#)).

Remove the memory module:

1. Spread the retaining tabs **(1)** on each side of the memory module slot to release the memory module. (The edge of the module opposite the slot rises away from the computer.)

2. Remove the memory module (2) by pulling the module away from the slot at an angle.

 **NOTE:** Memory modules are designed with a notch to prevent incorrect insertion into the memory module slot.

 **NOTE:** The computer uses two memory sockets. The socket labeled “2” houses the expansion memory module and the socket labeled “1” houses the primary memory module. The removal procedure is the same for both memory sockets.

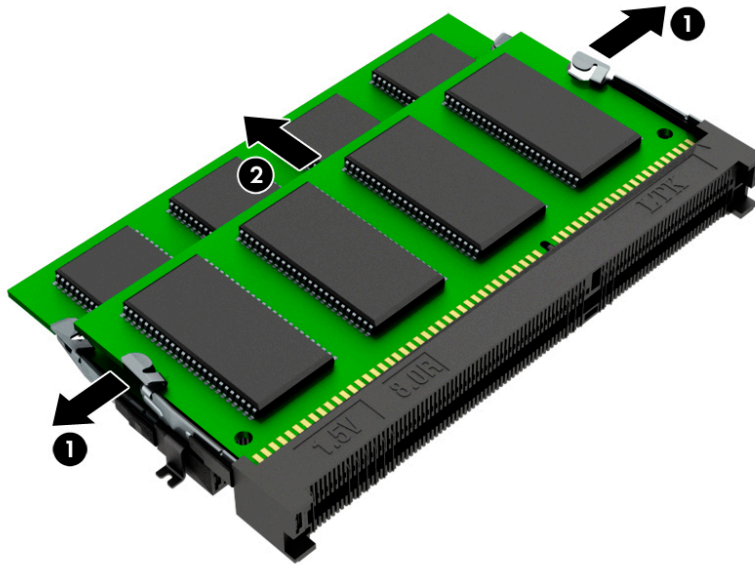

Reverse this procedure to install a memory module.

## WLAN module

**Table 5-5 WLAN module description and part number**

Description	Spare part number
Realtek RTL8822BE 802.11ac 2 × 2 Wi-Fi + Bluetooth 4.2 Combo Adapter (MU-MIMO supported)	915623-001
Intel Dual Band Wireless-AC 9560 802.11ac 2 × 2 Wi-Fi + Bluetooth 5 Combo Adapter (non-vPro) (MU-MIMO supported)	L22634-001
Intel Wi-Fi 6 AX200 ax2 × 2 + Bluetooth 5 (non-vPro) (MU-MIMO supported)	L35282-001



**IMPORTANT:** To prevent an unresponsive system, replace the wireless module only with a wireless module authorized for use in the computer by the governmental agency that regulates wireless devices in your country or region. If you replace the module and then receive a warning message, remove the module to restore device functionality, and then contact support.

Before removing the WLAN module, follow these steps:

1. Shut down the computer. If you are unsure whether the computer is off or in Hibernation, turn the computer on, and then shut it down through the operating system.
2. Disconnect all external devices connected to the computer.
3. Disconnect the power from the computer by first unplugging the power cord from the AC outlet and then unplugging the AC adapter from the computer.
4. Remove the base enclosure (see [Base enclosure on page 34](#)).

To remove the WLAN module:

1. Disconnect the WLAN antenna cables **(1)** from the terminals on the WLAN module.





**NOTE:** The #1 WLAN antenna cable is connected to the WLAN module Main terminal. The #2 WLAN antenna cable is connected to the WLAN module Aux terminal.

2. Remove the Phillips PM2.0 × 3.0 screw **(2)** that secures the WLAN module to the system board. (The WLAN module tilts up.)

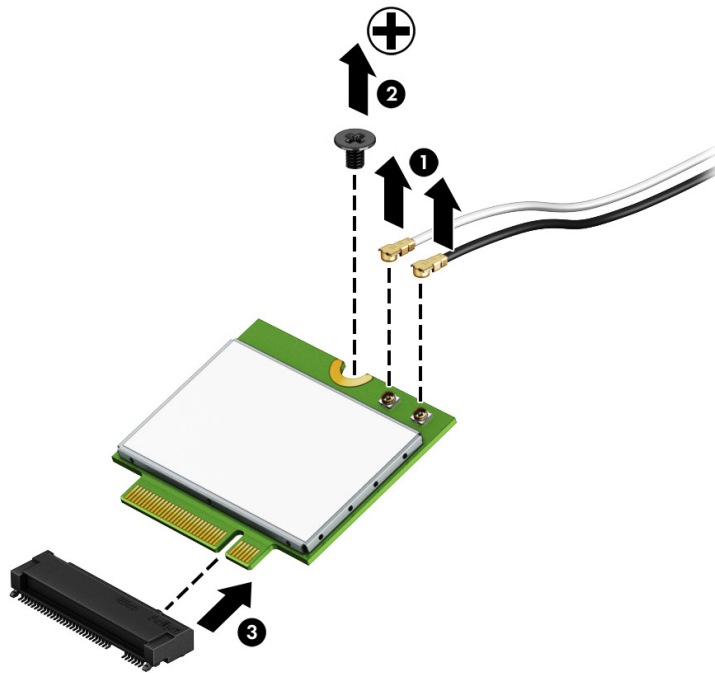

3. Remove the WLAN module by pulling the module away from the slot at an angle (3).



 **NOTE:** If the WLAN antennas are not connected to the terminals on the WLAN module, the protective sleeves must be installed on the antenna connectors, as shown in the following illustration.

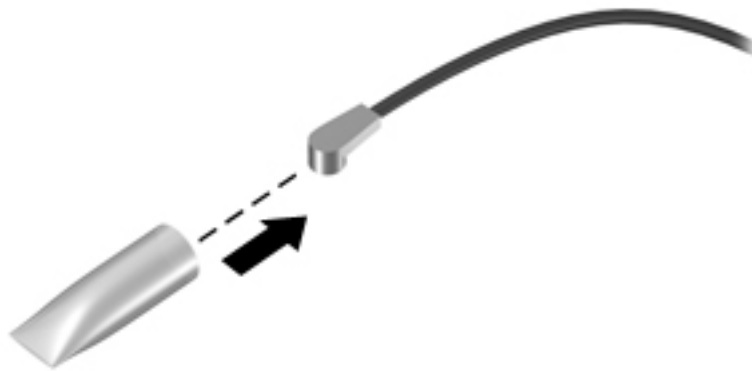

Reverse this procedure to install the WLAN module.

---

## 6 Removal and replacement procedures for authorized service provider parts

This chapter provides removal and replacement procedures for Authorized Service Provider only parts.

 **CAUTION:** Components described in this chapter should only be accessed by an authorized service provider. Accessing these parts can damage the computer or void the warranty.

**CAUTION:** This computer does not have user-replaceable parts. Only HP authorized service providers should perform the removal and replacement procedures described here. Accessing the internal part could damage the computer or void the warranty.

---

### Component replacement procedures

 **NOTE:** Details about your computer, including model, serial number, product key, and length of warranty, are on the service tag at the bottom of your computer. See [Labels on page 21](#) for details.

 **NOTE:** HP continually improves and changes product parts. For complete and current information on supported parts for your computer, go to <http://partsurfer.hp.com>, select your country or region, and then follow the on-screen instructions.

---

There are as many as 47 screws that must be removed, replaced, and/or loosened when servicing Authorized Service Provider only parts. Make special note of each screw size and location during removal and replacement.

# Battery

**Table 6-1 Battery description and part number**

Description	Spare part number
4 cell 70 Whr 4.55 Ahr LI SR04070XL-PL	917724-855
3 cell 52 Whr 4.55 Ahr LI SR03052XL-PL	L08855-855

Before removing the battery, follow these steps:

1. Shut down the computer. If you are unsure whether the computer is off or in Hibernation, turn the computer on, and then shut it down through the operating system.
2. Disconnect all external devices connected to the computer.
3. Disconnect the power from the computer by first unplugging the power cord from the AC outlet, and then unplugging the AC adapter from the computer.
4. Remove the base enclosure (see [Base enclosure on page 34](#)).

Remove the battery:

1. Remove the four Phillip 6 mm screws (1).
2. Lift the battery (2) and then pull the battery (3) forward to remove the battery from the computer.

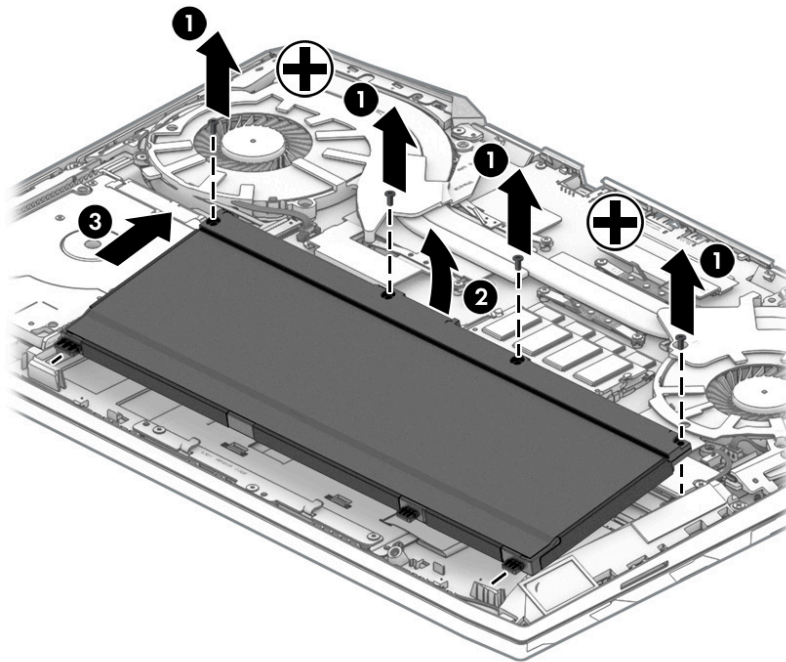

Reverse this procedure to install the battery.

## Speakers

**Table 6-2 Speaker description and part number**

Description	Spare part number
Speaker assembly (includes cable)	L14368-001

Before removing the speaker, follow these steps:

1. Prepare the computer for disassembly ([Preparation for disassembly on page 34](#)).
2. Remove the base enclosure (see [Base enclosure on page 34](#)).
3. Remove the battery (see [Battery on page 45](#)).
4. Remove the hard drive (see [Hard drive \(HDD\) on page 37](#)).
5. Remove the solid-state drive (see [Solid-state drive \(SSD\) on page 39](#)).

Remove the speakers:

1. Disconnect the speaker cable **(1)** from the system board.
2. Remove the two Phillips 6 mm screws **(2)** that secure the speakers to the computer.
3. Release the speaker cable **(3)** from the clips that secure it to the computer.
4. Lift the speakers **(4)** to remove them from the computer.

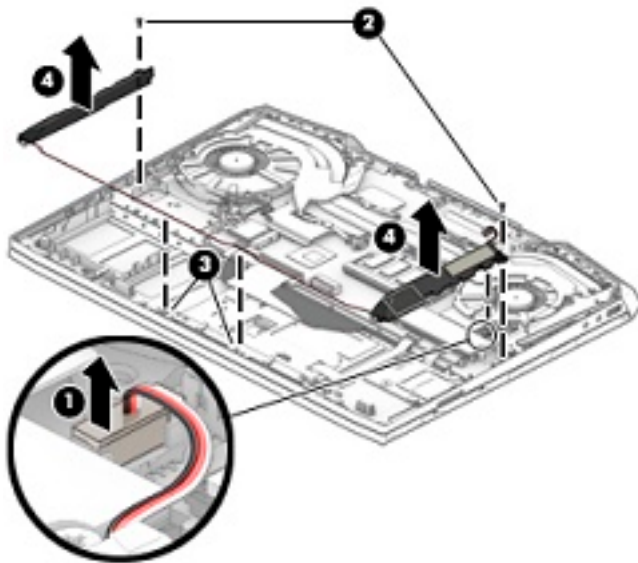

Reverse this procedure to install the speakers.

## Smart card board

**Table 6-3 Smart card board description and part number**

Description	Spare part number
Smart card board	L14374-001

Before removing the card reader, follow these steps:

1. Prepare the computer for disassembly ([Preparation for disassembly on page 34](#)).
2. Remove the base enclosure (see [Base enclosure on page 34](#)).
3. Remove the battery (see [Battery on page 45](#)).
4. Remove the hard drive (see [Hard drive \(HDD\) on page 37](#)).
5. Remove the solid-state drive (see [Solid-state drive \(SSD\) on page 39](#)).



**NOTE:** Before you remove the smart card reader, make sure nothing (memory card or plastic insert) is inserted in the reader.

Remove the smart card reader:

1. Disconnect the smart card reader cable **(1)** from the connector on the system board.
2. Remove the two Phillips screws **(2)** that secure the smart card reader to the computer.
3. Remove the smart card reader from the computer **(3)**.

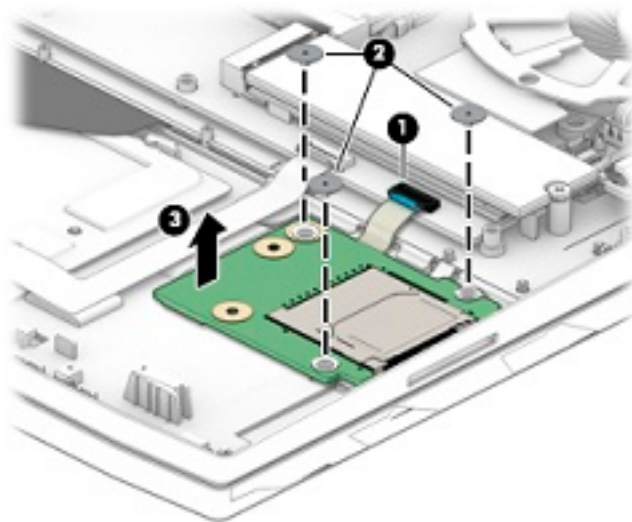

Reverse this procedure to install the smart card reader.

## Fans

**Table 6-4 Fan description and part number**

Description	Spare part number
<b>Fans</b>	
N17E/N18E	L24359-001
N17P/N18P	L29081-001
<b>Fans support brackets</b>	
N17E/N18E	L24362-001
N17P/N18P	L24363-001
<b>Vent support brackets</b>	
	L24361-001

Before removing the fans, follow these steps:

1. Prepare the computer for disassembly ([Preparation for disassembly on page 34](#)).
2. Remove the base enclosure (see [Base enclosure on page 34](#)).
3. Remove the battery (see [Battery on page 45](#)).
4. Remove the hard drive (see [Hard drive \(HDD\) on page 37](#)).
5. Remove the solid-state drive (see [Solid-state drive \(SSD\) on page 39](#)).

Remove the vent support brackets:

1. Release the four Phillips 3 mm flat large head screws (**1**) that secure the brackets to the computer.
2. Rotate the brackets (**2**) down to remove them from the computer.

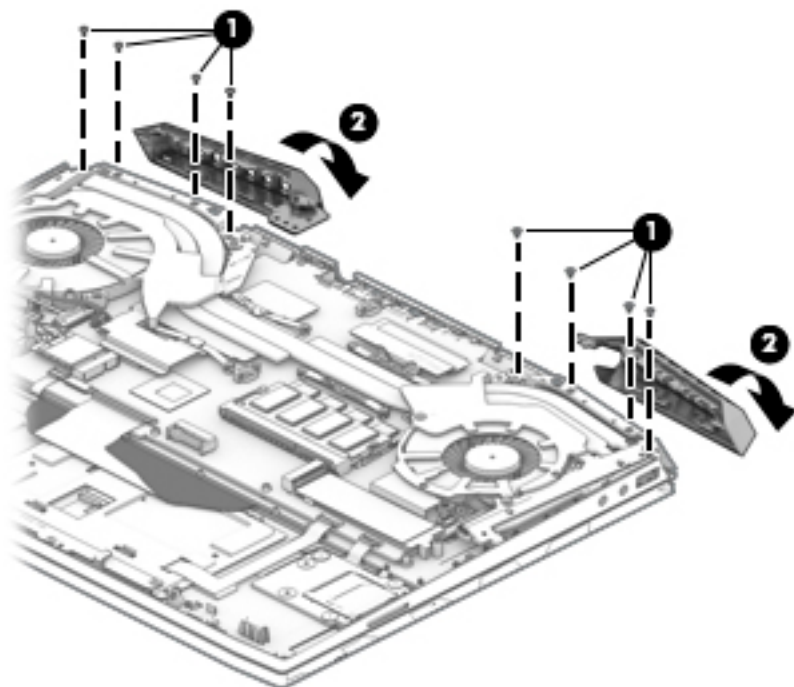

Remove the fan brackets:

1. Release the three screws **(1)** that secure the fan brackets to the computer.
2. Remove the fan brackets **(2)** from the computer.

 **NOTE:** To completely remove the right bracket, disconnect the power connector cable from the system board (see [Power connector cable on page 50](#)).

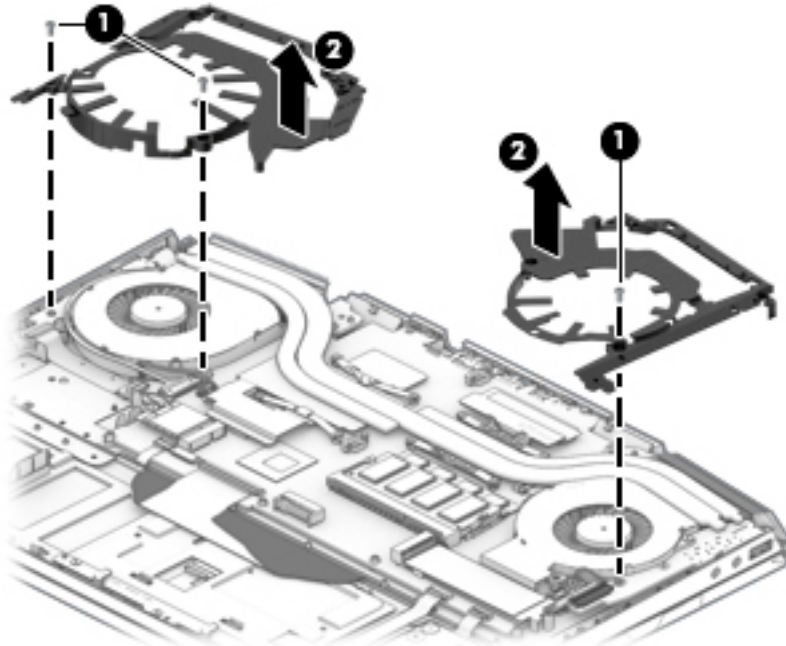

Remove the fans:

1. Disconnect the fan cable **(1)**.
2. Remove the Phillips M5 screws **(2)** that secure the fan to the computer.
3. Remove the fans from the computer **(3)**.

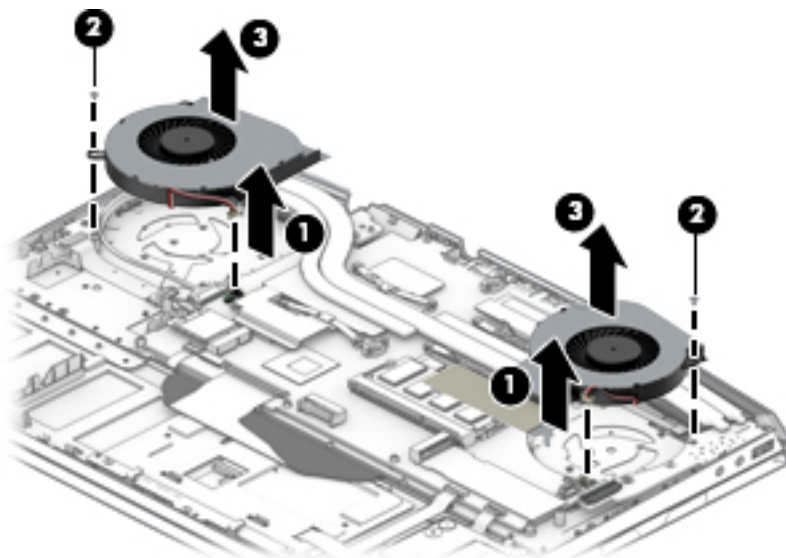

Reverse this procedure to install the fans.

## Power connector cable

**Table 6-5 Power connector cable description and part number**

Description	Spare part number
Power connector cable	L24348-001

Before removing the power connector cable, follow these steps:

1. Prepare the computer for disassembly ([Preparation for disassembly on page 34](#)).
2. Remove the base enclosure (see [Base enclosure on page 34](#)).
3. Remove the battery (see [Battery on page 45](#)).
4. Remove the hard drive (see [Hard drive \(HDD\) on page 37](#)).
5. Remove the solid-state drive (see [Solid-state drive \(SSD\) on page 39](#)).
6. Remove the right fan bracket (see [Fans on page 48](#)).

Remove the power connector cable:

1. Release the connector **(1)** at angle from under the heat sink.
2. Disconnect the power connector cable **(2)** from the connector on the system board.
3. Remove the power connector from the computer **(3)**.

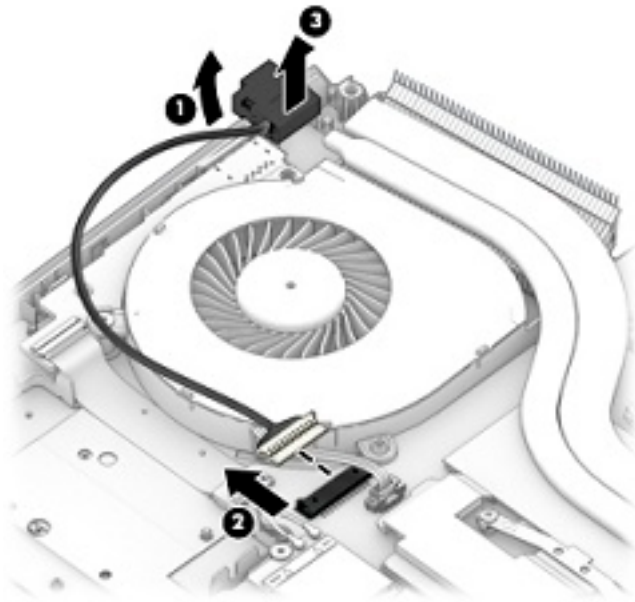

Reverse this procedure to install the power connector cable.



## Audio board

**Table 6-6 Audio board description and part number**

Description	Spare part number
Audio board	L24346-001

Before removing the audio board, follow these steps:

1. Prepare the computer for disassembly ([Preparation for disassembly on page 34](#)).
2. Remove the base enclosure (see [Base enclosure on page 34](#)).
3. Remove the battery (see [Battery on page 45](#)).
4. Remove the hard drive (see [Hard drive \(HDD\) on page 37](#)).
5. Remove the solid-state drive (see [Solid-state drive \(SSD\) on page 39](#)).
6. Remove the left fan (see [Fans on page 48](#)).

Remove the audio board:

1. Disconnect the audio board cable (1) from the connector on the system board.
2. Remove the audio board from the computer (2).

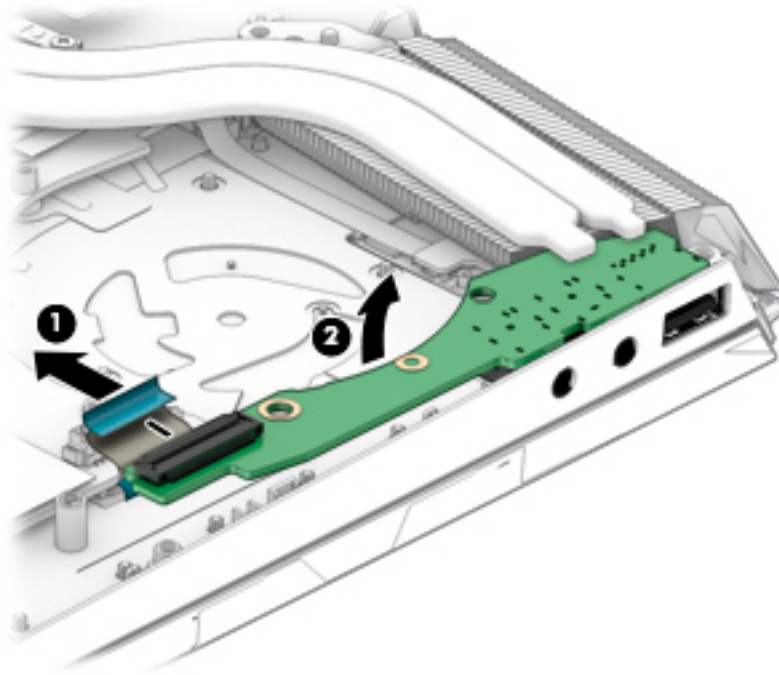

Reverse this procedure to install the audio board.

## USB board

**Table 6-7 USB board description and part number**

Description	Spare part number
USB board	L24349-001
USB board cable	L24350-001

Before removing the USB board, follow these steps:

1. Prepare the computer for disassembly ([Preparation for disassembly on page 34](#)).
2. Remove the base enclosure (see [Base enclosure on page 34](#)).
3. Remove the battery (see [Battery on page 45](#)).
4. Remove the hard drive (see [Hard drive \(HDD\) on page 37](#)).
5. Remove the solid-state drive (see [Solid-state drive \(SSD\) on page 39](#)).
6. Remove the right fan (see [Fans on page 48](#)).

Remove the USB board:

1. Disconnect the USB board cable (1) from the connector on the system board.
2. Remove the USB board from the computer (2).

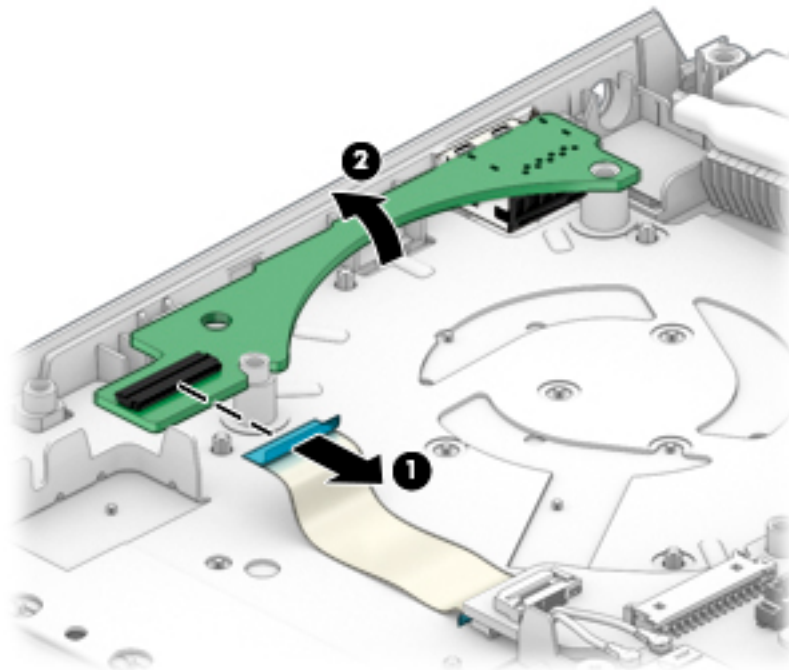

Reverse this procedure to install the USB board.

## System board



**NOTE:** All system board spare part kits include replacement thermal material.

All system boards use the following part numbers:

xxxxxx-001: Non-Windows operating systems

xxxxxx-601: Windows operating system

**Table 6-8 System board description and part number**

Description	Spare part number
<b>Intel Core i7-9750H processor:</b>	
GeForce RTX 2070, 8 GB (G-Sync models)	L51796-xx1
GeForce GTX 1660Ti, 6 GB	L52265-xx1
GeForce GTX 1650, 4 GB	L51791-xx1
GeForce GTX 1050, 4 GB	L58772-xx1
<b>Intel Core i7-8750H processor:</b>	
GeForce RTX 2070, 8 GB (G-Sync models)	L51795-xx1
GeForce RTX 2060, 6 GB	L52266-xx1
GeForce GTX 1050, 4 GB	L24330-xx1
GeForce GTX 1050 Ti, 4 GB	L24331-xx1
GeForce GTX 1060, 3 GB	L24332-xx1
GeForce GTX 1070, 8 GB	L24333-xx1
GeForce GTX 1060, 6 GB	L24334-xx1
GeForce GTX 1060, 6 GB (G-Sync models)	L24335-xx1
GeForce GTX 1050, 2 GB	L24336-xx1
<b>Intel Core i5-9300H processor:</b>	
GeForce GTX 2060, 6 GB	L51794-xx1
GeForce GTX 1660Ti, 6 GB	L51792-xx1
GeForce GTX 1650, 4 GB	L51790-xx1
GeForce GTX 1050, 4 GB	L58771-xx1
<b>Intel Core i5-8300H processor:</b>	
GeForce RTX 2060, 6 GB	L51793-xx1
GeForce GTX 1050, 2 GB	L24327-xx1
GeForce GTX 1050, 4 GB	L24329-xx1
GeForce GTX 1060, 4 GB	L24337-xx1
GeForce GTX 1060, 3 GB	L24338-xx1
GeForce GTX 1060, 6 GB	L25148-xx1

**Table 6-8 System board description and part number (continued)**

Description	Spare part number
GeForce GTX 1060, 3 GB (G-Sync models)	L36478-xx1
GeForce GTX 1060, 6 GB (G-Sync models)	L40551-xx1

Before removing the system board, follow these steps:

1. Prepare the computer for disassembly ([Preparation for disassembly on page 34](#)).
2. Remove the base enclosure (see [Base enclosure on page 34](#)).
3. Remove the battery (see [Battery on page 45](#)).
4. Remove the hard drive (see [Hard drive \(HDD\) on page 37](#)).
5. Remove the solid-state drive (see [Solid-state drive \(SSD\) on page 39](#)).
6. Remove the power connector cable (see [Power connector cable on page 50](#)).
7. Remove the fans (see [Fans on page 48](#)).

When replacing the system board, be sure to remove the following components (as applicable) from the defective system board and install on the replacement system board:

- Heat sink (see [Heat sink on page 56](#))

Remove the system board:

1. Make sure to disconnect the following cables from the system board:
  - (1) Drive cable
  - (2) Power connector cable
  - (3) Fan cable
  - (4) Display cable
  - (5) Fan cable
  - (6) Audio cable
  - (7) Speaker cable
  - (8) Smart card cable
  - (9) Touchpad cable
  - (10) Keyboard cable
  - (11) Backlight cable



**NOTE:** The fan cables were disconnected from the system board when the fans were removed.

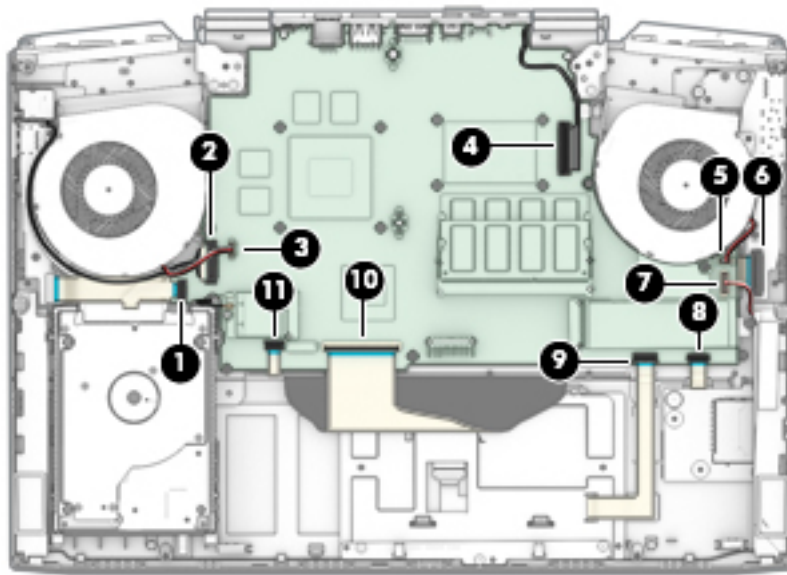

2. Remove the plastic guides (1) and M2.5x4 Phillips head screws (2).

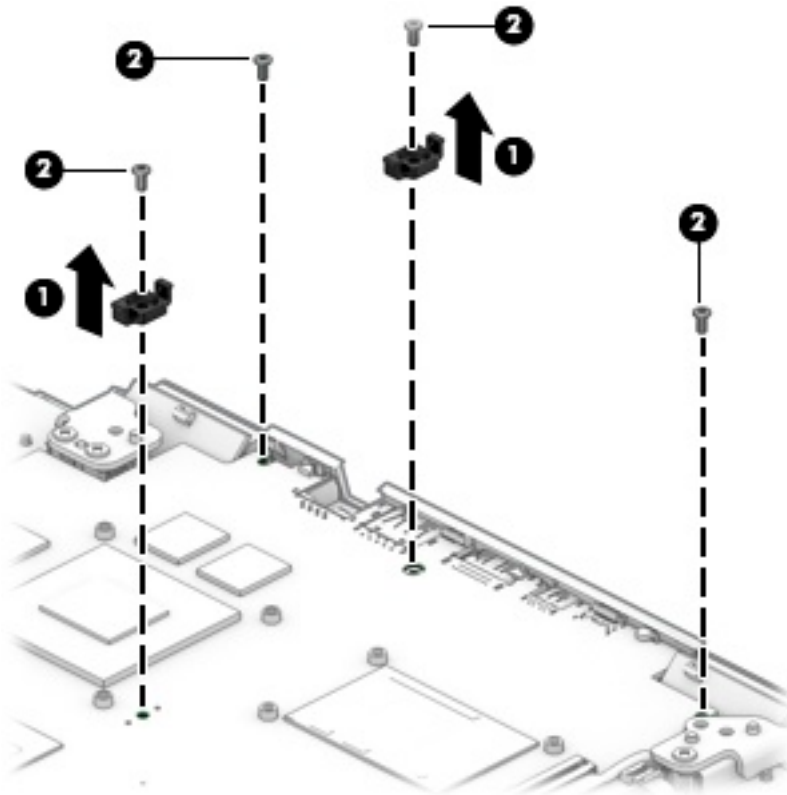

3. Pull the system board (1) up to disengage the connectors, and then remove the system board (2).

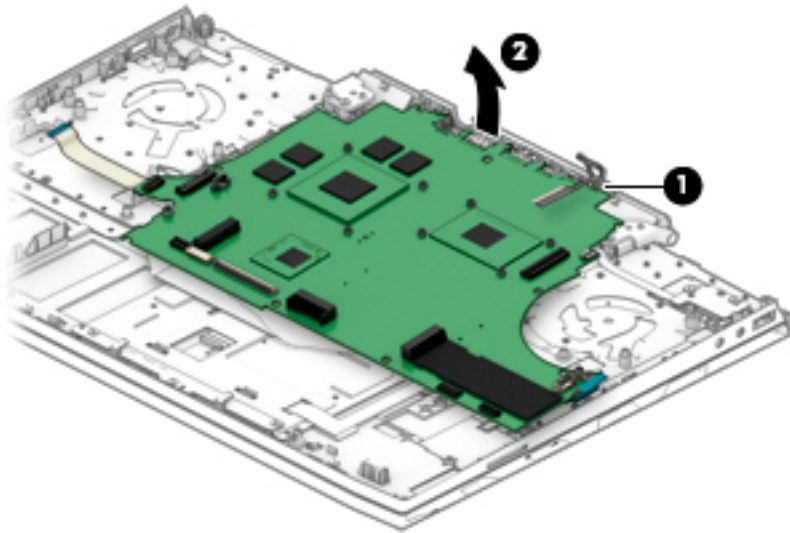

4. Release the USB cable (1), and then disconnect the audio board cable (2) from the bottom of the system board.

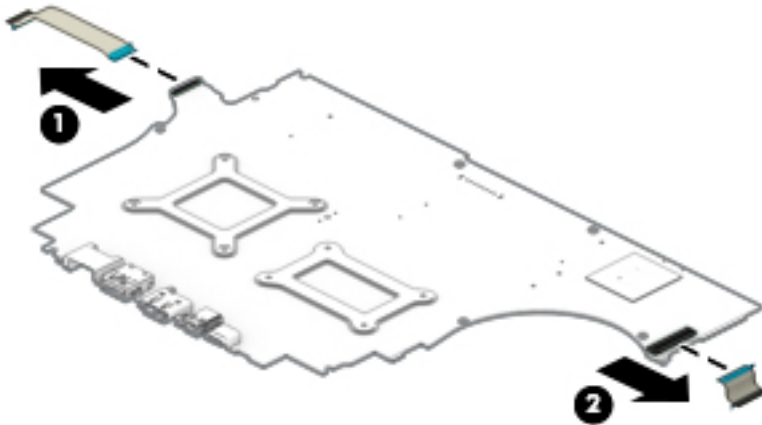

Reverse this procedure to install the system board.

## Heat sink

**Table 6-9 Heat sink description and part number**

Description	Spare part number
<b>Heat sink</b>	
N17E	L24357-001
N17P/N18P	L24358-001
N18E	L51908-001

Before removing the heat sink, follow these steps:

1. Prepare the computer for disassembly ([Preparation for disassembly on page 34](#)).
2. Remove the base enclosure (see [Base enclosure on page 34](#)).
3. Remove the battery (see [Battery on page 45](#)).
4. Remove the hard drive (see [Hard drive \(HDD\) on page 37](#)).
5. Remove the solid-state drive (see [Solid-state drive \(SSD\) on page 39](#)).
6. Remove the power connector cable (see [Power connector cable on page 50](#)).
7. Remove the fans (see [Fans on page 48](#)).

Remove the heat sink:

1. Remove the eight Phillips head screws **(1)** that secure the heat sink to the system board.
2. Remove the heat sink **(2)**.

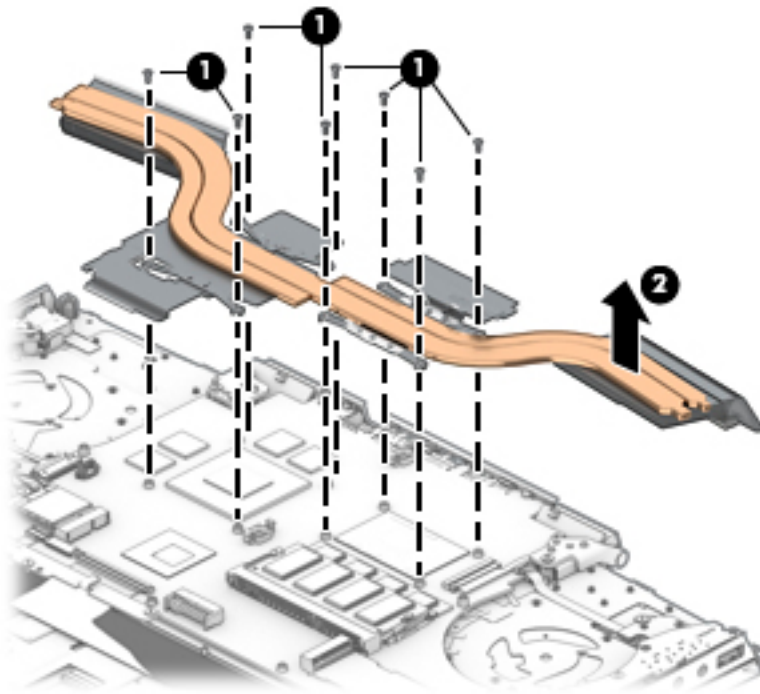

---

 **NOTE:** The thermal material must be thoroughly cleaned from the surfaces of the heat sink and the system board components each time the heat sink is removed. Thermal paste is used on the processor **(1)** and **(3)** and the heat sink section **(2)** and **(4)** that services it.

---

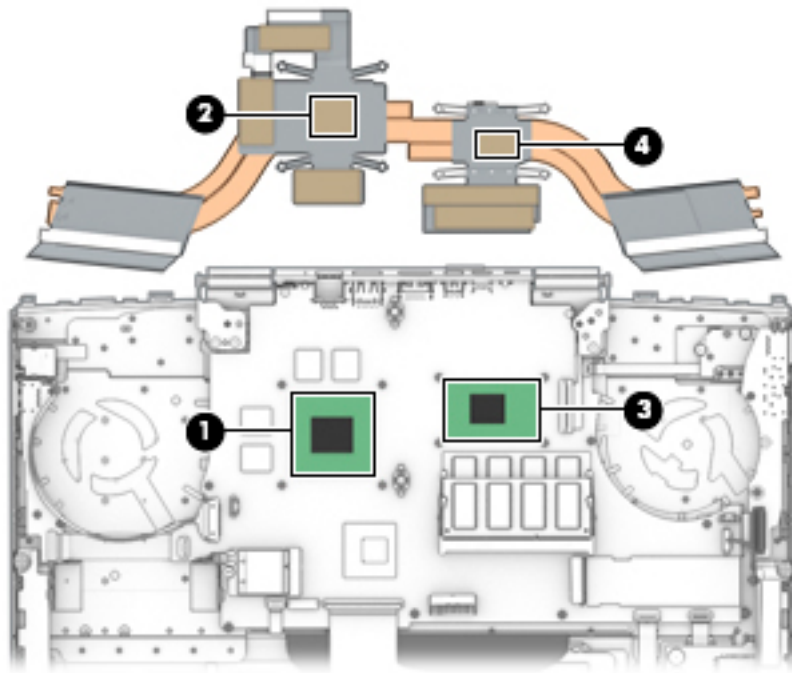

Reverse this procedure to install the heat sink.



## Touchpad board

**Table 6-10** Touchpad board description and part number

Description	Spare part number
Touchpad bracket	L24356-001
Touchpad board	L24355-001

Before removing the touchpad board, follow these steps:

1. Prepare the computer for disassembly ([Preparation for disassembly on page 34](#)).
2. Remove the base enclosure (see [Base enclosure on page 34](#)).
3. Remove the battery (see [Battery on page 45](#)).
4. Remove the hard drive (see [Hard drive \(HDD\) on page 37](#)).
5. Remove the solid-state drive (see [Solid-state drive \(SSD\) on page 39](#)).
6. Release the speaker cables from the touchpad click board bracket (see [Speakers on page 46](#)).

To remove the touchpad board:

1. Remove the three Phillips 5 mm screws **(1)** that secure the touchpad board bracket to the computer.
2. Remove the bracket **(2)** from the computer.

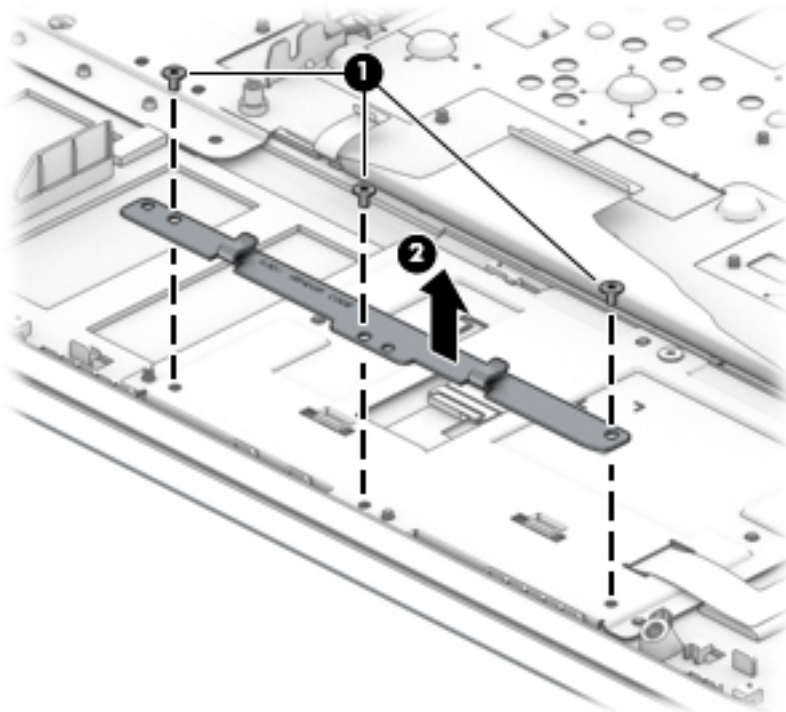

3. Disconnect the touchpad cable **(1)** from the system board.
4. Remove the Phillips screw **(2)** that secures the touchpad click board to the computer, and then release the thermal tape connected to the board.
5. Lift the front of the touchpad board **(3)** to disconnect it from the plastic clips.

6. Release the plastic clips (4) securing the board to the computer, and then remove the board.

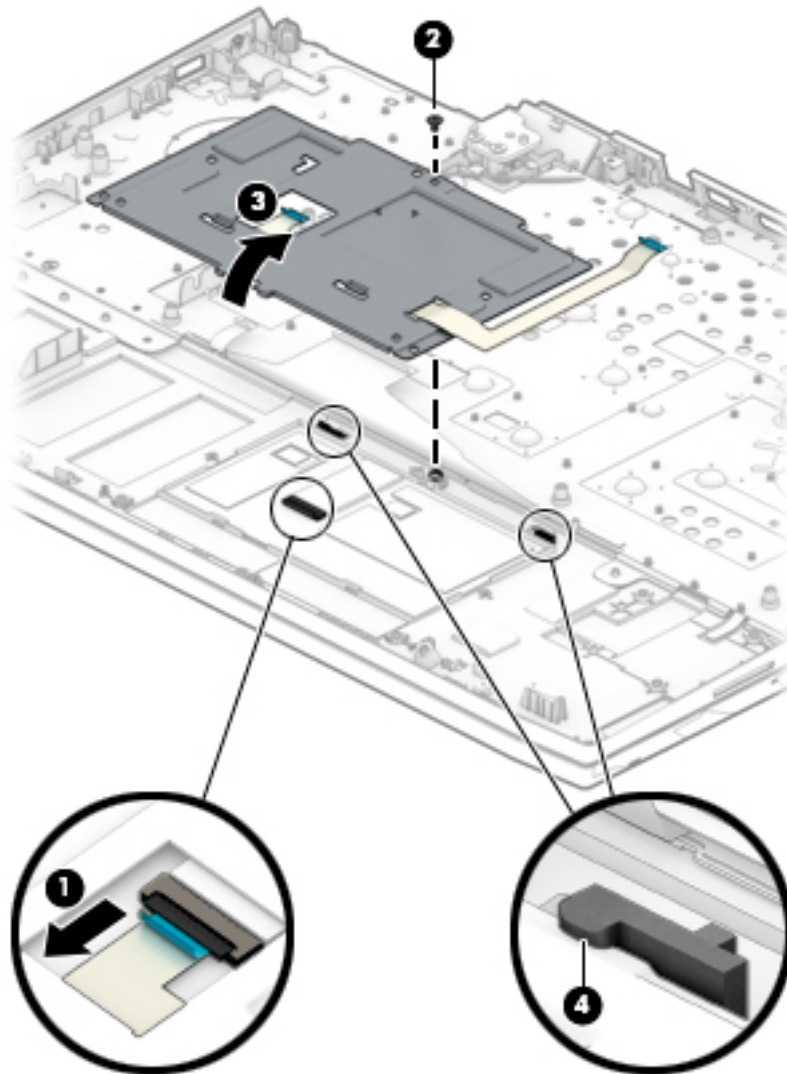

Reverse this procedure to install the touchpad board.

## Power button board

**Table 6-11 Power board button description and part number**

Description	Spare part number
Power button board	L14374-001

Before removing the power button board, follow these steps:

1. Prepare the computer for disassembly ([Preparation for disassembly on page 34](#)).
2. Remove the base enclosure (see [Base enclosure on page 34](#)).
3. Remove the battery (see [Battery on page 45](#)).
4. Remove the hard drive (see [Hard drive \(HDD\) on page 37](#)).
5. Remove the solid-state drive (see [Solid-state drive \(SSD\) on page 39](#)).
6. Remove the power connector cable (see [Power connector cable on page 50](#)).
7. Remove the fans (see [Fans on page 48](#)).
8. Remove the system board (see [System board on page 53](#)).

Remove the power button board:

1. Remove the two Phillips 3 mm screws **(1)** that secure the power button board.
2. Disconnect the power button board cable **(2)**.
3. Remove the power button board **(3)** from the computer.

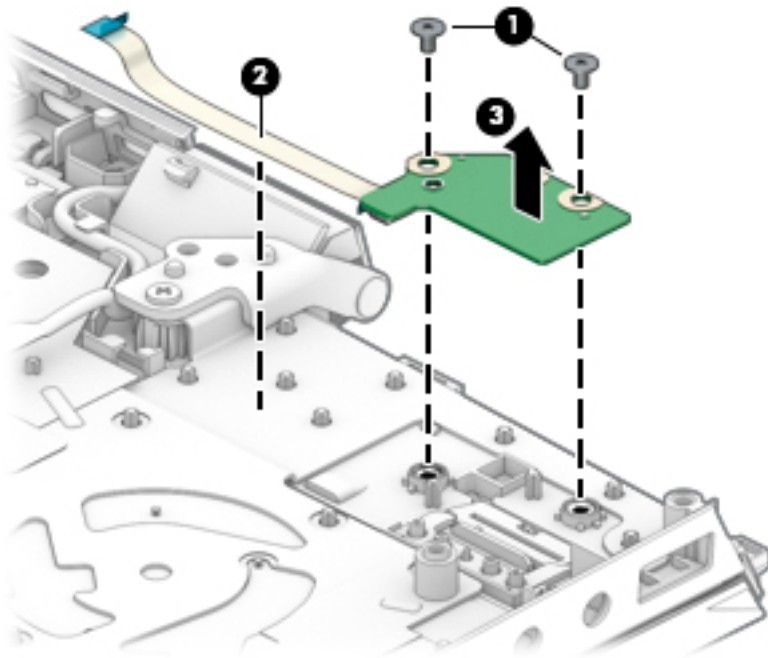

Reverse this procedure to install the power button board.

## Display assembly

 **NOTE:** Display assemblies have spare parts only at the subcomponent level. Additional display assembly spare part information is available at [Display assembly subcomponents on page 26](#).

Before removing the display assembly, follow these steps:

1. Prepare the computer for disassembly ([Preparation for disassembly on page 34](#)).
2. Remove the base enclosure (see [Base enclosure on page 34](#)).
3. Remove the battery (see [Battery on page 45](#)).
4. Remove the hard drive (see [Hard drive \(HDD\) on page 37](#)).
5. Remove the solid-state drive (see [Solid-state drive \(SSD\) on page 39](#)).
6. Remove the power connector cable (see [Power connector cable on page 50](#)).
7. Remove the fans (see [Fans on page 48](#)).
8. Remove the system board (see [System board on page 53](#)).

Remove the display assembly:

1. Remove the three Phillips M2.5 × 5.0 screws **(1)** from the display cable brackets.
2. Position the display hinges **(2)** up.
3. Remove the antenna cables from the clips built into the computer **(3)**.
4. Lift the display assembly **(4)** straight up and remove it.

 **CAUTION:** When installing the display assembly, be sure that the wireless antenna cables are routed and arranged properly.

Failure to properly route the antennas can result in degradation of the computer's wireless performance.

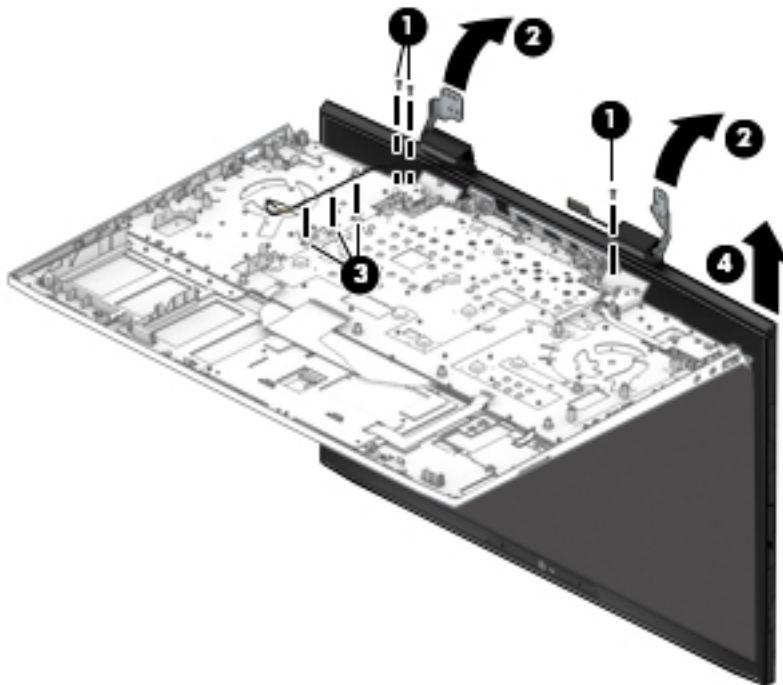

5. To remove the display bezel, flex the top **(1)** of the bezel, the inside edges of the left and right sides **(2)**, and then the bottom **(3)** of the bezel until it disengages from the display enclosure.
6. Remove the display bezel **(4)**.

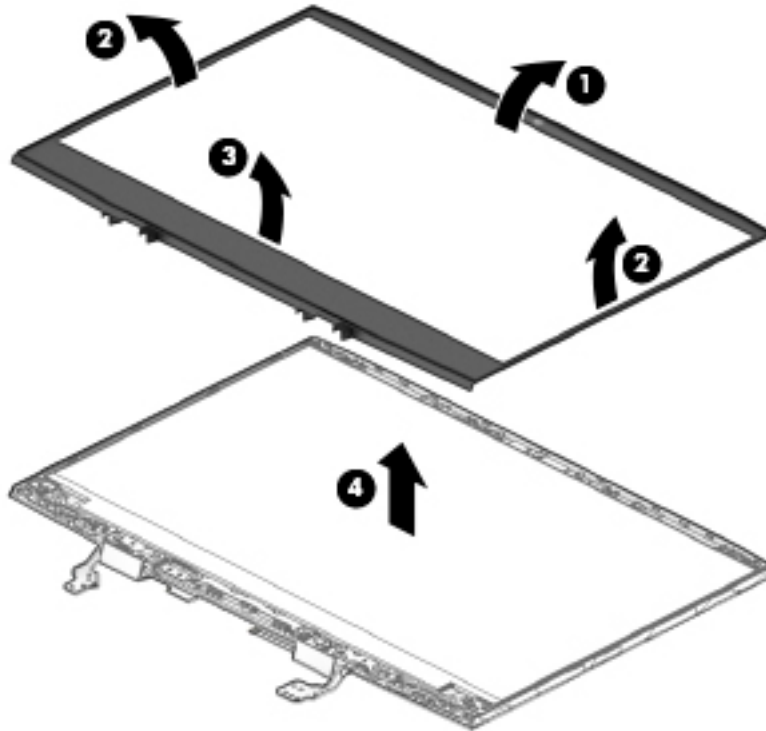

7. To remove the camera module, disconnect the cable **(1)** from the camera module board, and then remove the module **(2)** from the display.

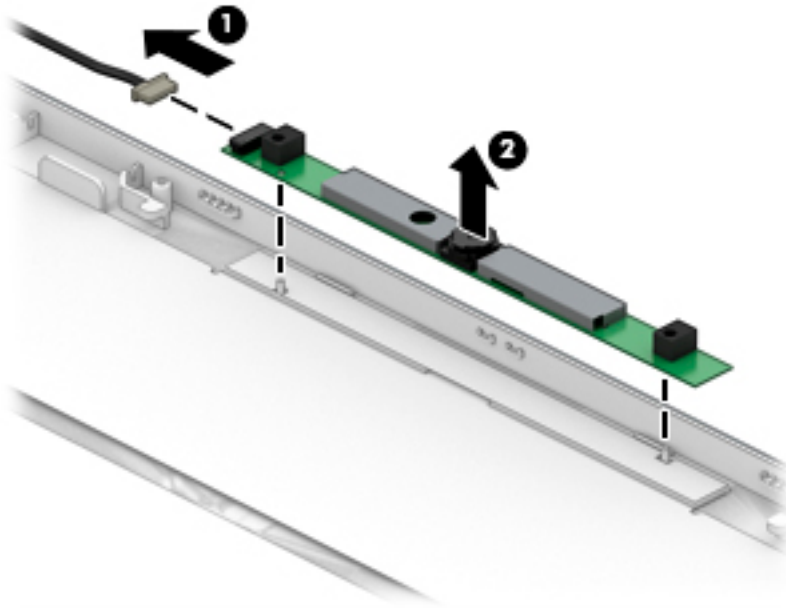

8. If it is necessary to remove the display panel from the enclosure, pull the display adhesive strips **(1)**, and then rotate the panel **(2)** forward.

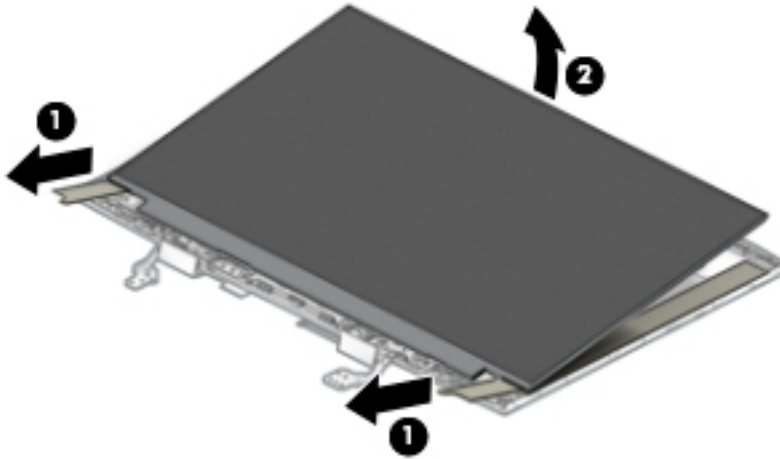

9. On the back of the display panel, lift the tape from atop the connector and then remove the cable **(1)**.
10. Remove the panel **(2)**.

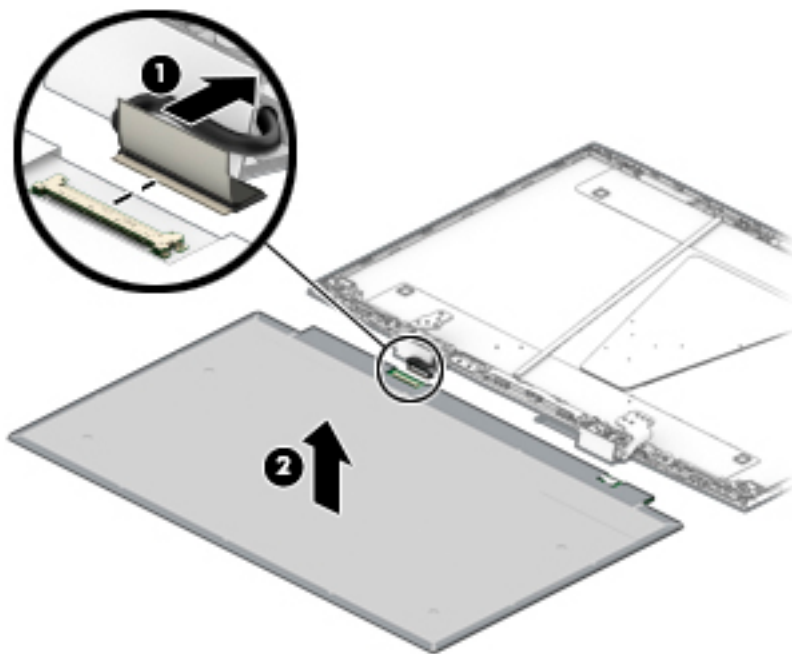

11. If it is necessary to replace the display hinges, remove the four Phillips M2.5x11.0 screws (1) that secure each hinge, and then remove the hinges (2) from the display enclosure.

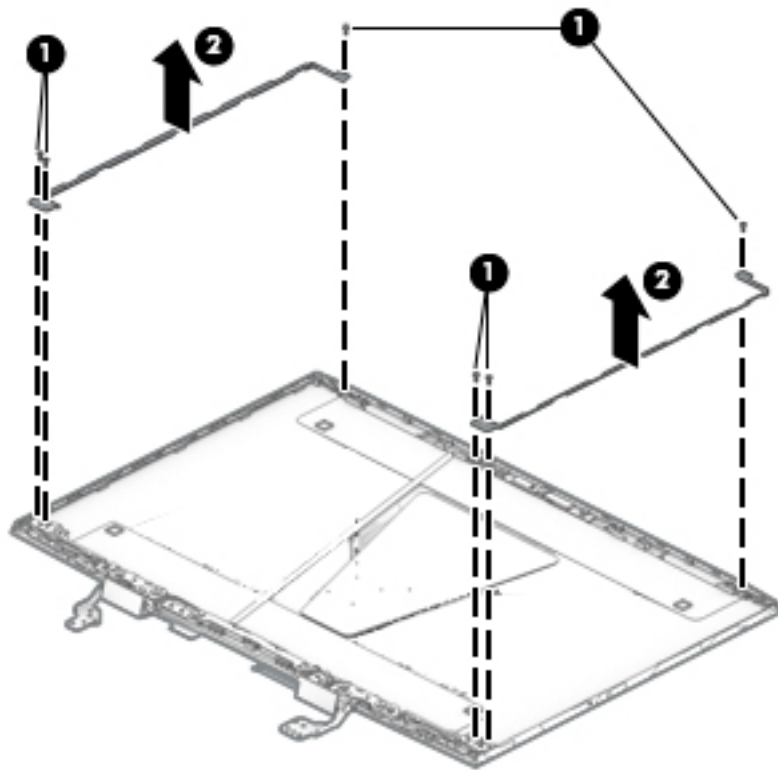

12. If it is necessary to replace the display hinge brackets, remove the six Phillips screws (1) that secure each bracket, and then remove the bracket (2) from the display enclosure.

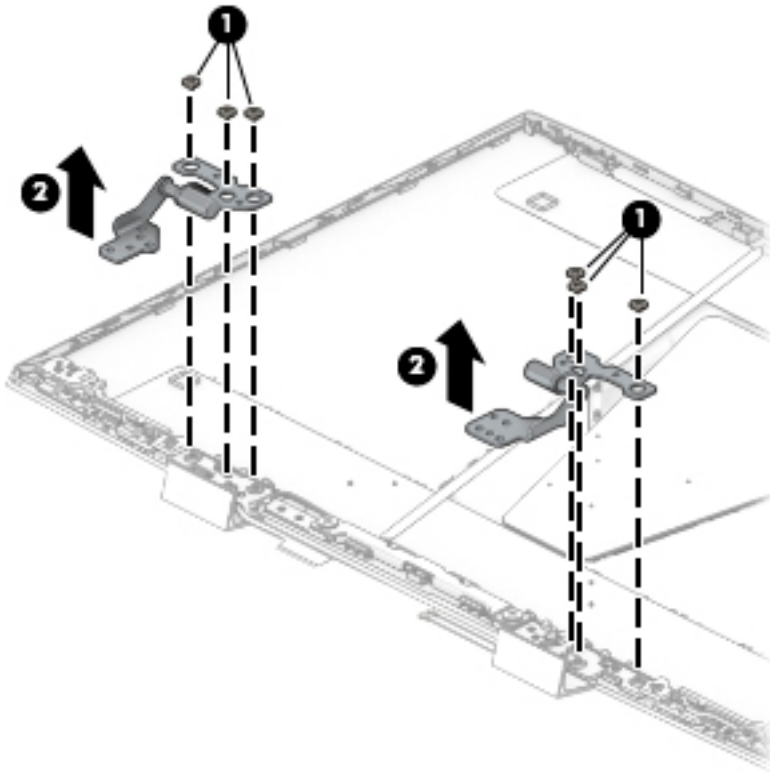

13. If it is necessary to replace the display cable, release the cable from adhesive (1), release the cable from the routing path (2) on the bottom of the display enclosure, and then remove the cable (3).

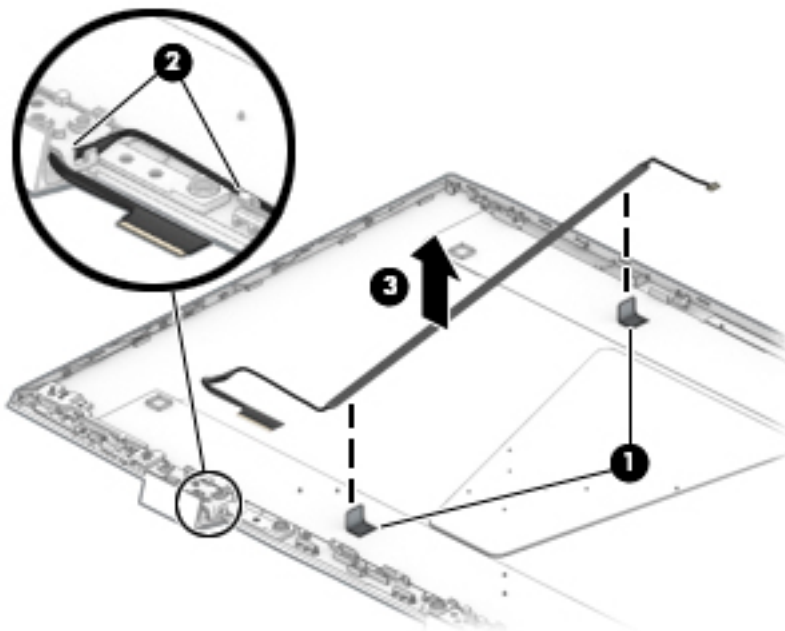



14. If it is necessary to replace the WLAN antenna cables, peel the antennas from the top of the display enclosure **(1)**, remove the antenna cables from the routing path on the bottom of the display enclosure **(2)**, and then remove the antenna cables.

 **NOTE:** The WLAN antennas are included with the display enclosure spare part.

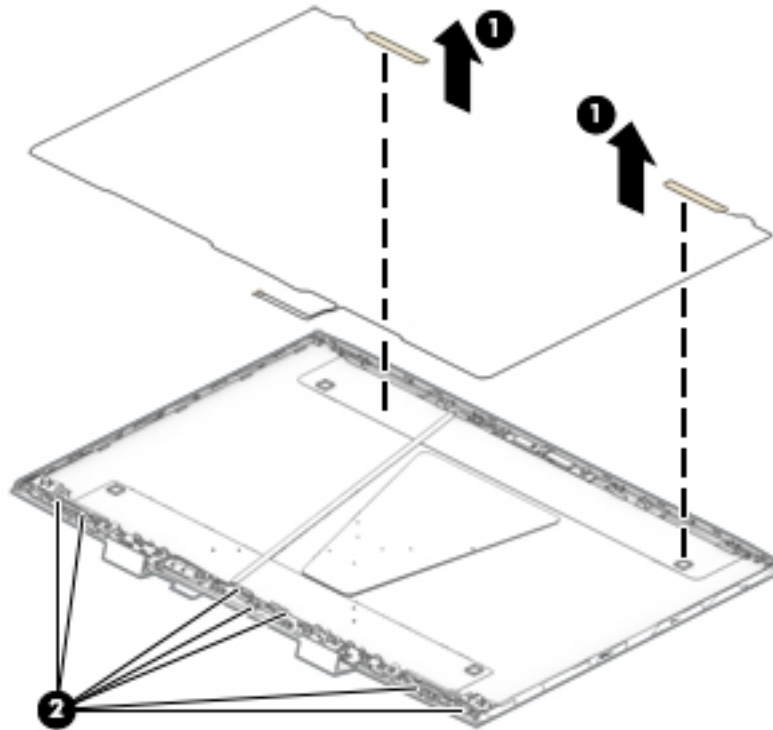

Reverse this procedure to reassemble and install the display assembly.

## Keyboard/top cover

 **NOTE:** The table below lists an XXX extension. The country part number extensions are listed in the next table.

 **NOTE:** The keyboard cable is included.

**Table 6-12 Keyboard description and part number**

Description	Spare part number
Full-size backlit 3-coat paint island-style keyboard with numeric key pad, 2-zone lighting, Dragon Red with red backlight, N17P	L24369-XXX
Full-size backlit 3-coat paint island-style keyboard with numeric key pad, 2-zone lighting, White Legend with RGB backlight, N17P	L24370-XXX
Full-size backlit 3-coat paint island-style keyboard with numeric key pad, 4-zone lighting, white with RGB backlight, N17P	L32770-XXX
Full-size backlit 3-coat paint island-style keyboard with numeric key pad, 2-zone lighting, Dragon Red with red backlight, N17E	L32774-XXX
Full-size backlit 3-coat paint island-style keyboard with numeric key pad, 4-zone lighting, white with RGB backlight, N17E	L32775-XXX

**Table 6-13 Keyboard country part number extensions**

Description	Spare part number extension	Description	Spare part number
For use in Belgium	A41	For use in Portugal	131
For use in Bulgaria	261	For use in Romania	271
For use in Canada	DB1	For use in Russia	251
For use in the Czech Republic and Slovenia	FL1	For use in Saudi Arabia	171
For use in Denmark, Finland, and Norway	DH1	For use in Slovenia	BA1
For use in France	051	For use in South Korea	AD1
For use in Germany	041	For use in Spain	071
For use in Greece	151	For use in Switzerland	BG1
For use in Hungary	211	For use in Taiwan	AB1
For use in Israel	BB1	For use in Thailand	281
For use in Italy	061	For use in Turkey	141
For use in Japan	291	For use in Ukraine	BD1
For use in Latin America	161	For use in the United Kingdom	031
For use in the Netherlands	B31	For use in the United States	001

The keyboard/top cover is what remains when all parts are removed.

# 7 Using Setup Utility (BIOS)

Setup Utility, or Basic Input/Output System (BIOS), controls communication between all the input and output devices on the system (such as disk drives, display, keyboard, mouse, and printer). Setup Utility (BIOS) includes settings for the types of devices installed, the startup sequence of the computer, and the amount of system and extended memory.

 **NOTE:** To start Setup Utility on convertible computers, your computer must be in notebook mode and you must use the keyboard attached to your notebook.

## Starting Setup Utility (BIOS)

 **CAUTION:** Use extreme care when making changes in Setup Utility (BIOS). Errors can prevent the computer from operating properly.

▲ Turn on or restart the computer and quickly press **f10**.

– or –

Turn on or restart the computer, quickly press **esc**, and then press **f10** when the Start menu is displayed.

## Updating Setup Utility (BIOS)

Updated versions of Setup Utility (BIOS) may be available on the HP website.

Most BIOS updates on the HP website are packaged in compressed files called *SoftPaqs*.

Some download packages contain a file named *Readme.txt*, which contains information regarding installing and troubleshooting the file.

## Determining the BIOS version

To decide whether you need to update Setup Utility (BIOS), first determine the BIOS version on your computer.

To reveal the BIOS version information (also known as *ROM date* and *System BIOS*), use one of these options.

- HP Support Assistant
  1. Type `support` in the taskbar search box, and then select the **HP Support Assistant** app.  
– or –  
Select the question mark icon in the taskbar.
  2. Select **My notebook**, and then select **Specifications**.
- Setup Utility (BIOS)
  1. Start Setup Utility (BIOS) (see [Starting Setup Utility \(BIOS\) on page 69](#)).
  2. Select **Main**, and then make note of the BIOS version.
  3. Select **Exit**, select one of the options, and then follow the on-screen instructions.
- In Windows, press **CTRL+Alt+S**.

To check for later BIOS versions, see [Downloading a BIOS update on page 70](#).

## Downloading a BIOS update

---

 **CAUTION:** To reduce the risk of damage to the computer or an unsuccessful installation, download and install a BIOS update only when the computer is connected to reliable external power using the AC adapter. Do not download or install a BIOS update while the computer is running on battery power, docked in an optional docking device, or connected to an optional power source. During the download and installation, follow these instructions:

- Do not disconnect power from the computer by unplugging the power cord from the AC outlet.
- Do not shut down the computer or initiate Sleep.
- Do not insert, remove, connect, or disconnect any device, cable, or cord.

 **NOTE:** If your computer is connected to a network, consult the network administrator before installing any software updates, especially system BIOS updates.

---

1. Type `support` in the taskbar search box, and then select the **HP Support Assistant** app.  
– or –  
Select the question mark icon in the taskbar.
2. Select **Updates**, and then select **Check for updates and messages**.
3. Follow the on-screen instructions.
4. At the download area, follow these steps:
  - a. Identify the most recent BIOS update and compare it to the BIOS version currently installed on your computer. If the update is more recent than your BIOS version, make a note of the date, name, or other identifier. You may need this information to locate the update later, after it has been downloaded to your hard drive.
  - b. Follow the on-screen instructions to download your selection to the hard drive.  
  
Make a note of the path to the location on your hard drive where the BIOS update is downloaded. You will need to access this path when you are ready to install the update.

BIOS installation procedures vary. Follow any instructions that appear on the screen after the download is complete. If no instructions appear, follow these steps:

1. Type `file` in the taskbar search box, and then select **File Explorer**.
2. Select your hard drive designation. The hard drive designation is typically Local Disk (C:).
3. Using the hard drive path you recorded earlier, open the folder that contains the update.
4. Double-click the file that has an `.exe` extension (for example, `filename.exe`).  
  
The BIOS installation begins.
5. Complete the installation by following the on-screen instructions.

---

 **NOTE:** After a message on the screen reports a successful installation, you can delete the downloaded file from your hard drive.

---

# 8 Using HP PC Hardware Diagnostics

## Using HP PC Hardware Diagnostics Windows (select products only)

HP PC Hardware Diagnostics Windows is a Windows-based utility that allows you to run diagnostic tests to determine whether the computer hardware is functioning properly. The tool runs within the Windows operating system in order to diagnose hardware failures.

If HP PC Hardware Diagnostics Windows is not installed on your computer, first you must download and install it. To download HP PC Hardware Diagnostics Windows, see [Downloading HP PC Hardware Diagnostics Windows on page 71](#).

After HP PC Hardware Diagnostics Windows is installed, follow these steps to access it from HP Help and Support or HP Support Assistant.

1. To access HP PC Hardware Diagnostics Windows from HP Help and Support:
  - a. Select the **Start** button, and then select **HP Help and Support**.
  - b. Right-click **HP PC Hardware Diagnostics Windows**, select **More**, and then select **Run as administrator**.

– or –

To access HP PC Hardware Diagnostics Windows from HP Support Assistant:

- a. Type `support` in the taskbar search box, and then select the **HP Support Assistant** app.

– or –

Select the question mark icon in the taskbar.
  - b. Select **Troubleshooting and fixes**.
  - c. Select **Diagnostics**, and then select **HP PC Hardware Diagnostics Windows**.
2. When the tool opens, select the type of diagnostic test you want to run, and then follow the on-screen instructions.



**NOTE:** If you need to stop a diagnostic test at any time, select **Cancel**.

When HP PC Hardware Diagnostics Windows detects a failure that requires hardware replacement, a 24-digit Failure ID code is generated. The screen displays one of the following options:

- A Failure ID link is displayed. Select the link and follow the on-screen instructions.
- A Quick Response (QR) code is displayed. With a mobile device, scan the code and then follow the on-screen instructions.
- Instructions for calling support are displayed. Follow those instructions.

## Downloading HP PC Hardware Diagnostics Windows

- The HP PC Hardware Diagnostics Windows download instructions are provided in English only.
- You must use a Windows computer to download this tool because only .exe files are provided.

## Downloading the latest HP PC Hardware Diagnostics Windows version

To download HP PC Hardware Diagnostics Windows, follow these steps:

1. Go to <http://www.hp.com/go/techcenter/pcdiags>. The HP PC Diagnostics home page is displayed.
2. Select **Download HP Diagnostics Windows**, and then select a location on your computer or a USB flash drive.

The tool is downloaded to the selected location.

## Downloading HP Hardware Diagnostics Windows by product name or number (select products only)

---

 **NOTE:** For some products, it may be necessary to download the software to a USB flash drive by using the product name or number.

---

To download HP PC Hardware Diagnostics Windows by product name or number, follow these steps:

1. Go to <http://www.hp.com/support>.
2. Select **Get software and drivers**, select your type of product, and then enter the product name or number in the search box that is displayed.
3. In the **Diagnostics** section, select **Download**, and then follow the on-screen instructions to select the specific Windows diagnostics version to be downloaded to your computer or USB flash drive.

The tool is downloaded to the selected location.

## Installing HP PC Hardware Diagnostics Windows

To install HP PC Hardware Diagnostics Windows, follow these steps:

- ▲ Navigate to the folder on your computer or the USB flash drive where the .exe file was downloaded, double-click the .exe file, and then follow the on-screen instructions.

## Using HP PC Hardware Diagnostics UEFI

---

 **NOTE:** For Windows 10 S computers, you must use a Windows computer and a USB flash drive to download and create the HP UEFI support environment because only .exe files are provided. For more information, see [Downloading HP PC Hardware Diagnostics UEFI to a USB flash drive on page 73](#).

---

HP PC Hardware Diagnostics UEFI (Unified Extensible Firmware Interface) allows you to run diagnostic tests to determine whether the computer hardware is functioning properly. The tool runs outside the operating system so that it can isolate hardware failures from issues that are caused by the operating system or other software components.

If your PC will not boot into Windows, you can use HP PC Hardware Diagnostics UEFI to diagnose hardware issues.

When HP PC Hardware Diagnostics Windows detects a failure that requires hardware replacement, a 24-digit Failure ID code is generated. For assistance in solving the problem:

- ▲ Select **Get Support**, and then use a mobile device to scan the QR code that displays on the next screen. The HP Customer Support - Service Center page displays, with your Failure ID and product number automatically filled in. Follow the on-screen instructions.

– or –

Contact support, and provide the Failure ID code.

---

 **NOTE:** To start diagnostics on a convertible computer, your computer must be in notebook mode, and you must use the attached keyboard.

 **NOTE:** If you need to stop a diagnostic test, press [esc](#).

---

## Starting HP PC Hardware Diagnostics UEFI

To start HP PC Hardware Diagnostics UEFI, follow these steps:

1. Turn on or restart the computer, and quickly press [esc](#).
2. Press [f2](#).

The BIOS searches three places for the diagnostic tools, in the following order:

- a. Connected USB flash drive

 **NOTE:** To download the HP PC Hardware Diagnostics UEFI tool to a USB flash drive, see [Downloading the latest HP PC Hardware Diagnostics UEFI version on page 73](#).

---

- b. Hard drive

- c. BIOS

3. When the diagnostic tool opens, select a language, select the type of diagnostic test you want to run, and then follow the on-screen instructions.

## Downloading HP PC Hardware Diagnostics UEFI to a USB flash drive

Downloading HP PC Hardware Diagnostics UEFI to a USB flash drive can be useful in the following situations:

- HP PC Hardware Diagnostics UEFI is not included in the preinstall image.
- HP PC Hardware Diagnostics UEFI is not included in the HP Tool partition.
- The hard drive is damaged.

 **NOTE:** The HP PC Hardware Diagnostics UEFI download instructions are provided in English only, and you must use a Windows computer to download and create the HP UEFI support environment because only .exe files are provided.

---

## Downloading the latest HP PC Hardware Diagnostics UEFI version

To download the latest HP PC Hardware Diagnostics UEFI version to a USB flash drive:

1. Go to <http://www.hp.com/go/techcenter/pcdiags>. The HP PC Diagnostics home page is displayed.
2. Select **Download HP Diagnostics UEFI**, and then select **Run**.

## Downloading HP PC Hardware Diagnostics UEFI by product name or number (select products only)

 **NOTE:** For some products, it may be necessary to download the software to a USB flash drive by using the product name or number.

---

To download HP PC Hardware Diagnostics UEFI by product name or number (select products only) to a USB flash drive:

1. Go to <http://www.hp.com/support>.
2. Enter the product name or number, select your computer, and then select your operating system.
3. In the **Diagnostics** section, follow the on-screen instructions to select and download the specific UEFI Diagnostics version for your computer.

## Using Remote HP PC Hardware Diagnostics UEFI settings (select products only)

Remote HP PC Hardware Diagnostics UEFI is a firmware (BIOS) feature that downloads HP PC Hardware Diagnostics UEFI to your computer. It can then execute the diagnostics on your computer, and it may upload results to a preconfigured server. For more information about Remote HP PC Hardware Diagnostics UEFI, go to <http://www.hp.com/go/techcenter/pcdiags>, and then select **Find out more**.

### Downloading Remote HP PC Hardware Diagnostics UEFI



**NOTE:** HP Remote PC Hardware Diagnostics UEFI is also available as a Softpaq that can be downloaded to a server.

### Downloading the latest Remote HP PC Hardware Diagnostics UEFI version

To download the latest Remote HP PC Hardware Diagnostics UEFI version, follow these steps:

1. Go to <http://www.hp.com/go/techcenter/pcdiags>. The HP PC Diagnostics home page is displayed.
2. Select **Download Remote Diagnostics**, and then select **Run**.

### Downloading Remote HP PC Hardware Diagnostics UEFI by product name or number



**NOTE:** For some products, it may be necessary to download the software by using the product name or number.

To download HP Remote PC Hardware Diagnostics UEFI by product name or number, follow these steps:

1. Go to <http://www.hp.com/support>.
2. Select **Get software and drivers**, select your type of product, enter the product name or number in the search box that is displayed, select your computer, and then select your operating system.
3. In the **Diagnostics** section, follow the on-screen instructions to select and download the **Remote UEFI** version for the product.

## Customizing Remote HP PC Hardware Diagnostics UEFI settings

Using the Remote HP PC Hardware Diagnostics setting in Computer Setup (BIOS), you can perform the following customizations:

- Set a schedule for running diagnostics unattended. You can also start diagnostics immediately in interactive mode by selecting **Execute Remote HP PC Hardware Diagnostics**.
- Set the location for downloading the diagnostic tools. This feature provides access to the tools from the HP website or from a server that has been preconfigured for use. Your computer does not require the traditional local storage (such as a disk drive or USB flash drive) to run remote diagnostics.



- Set a location for storing the test results. You can also set the user name and password settings used for uploads.
- Display status information about the diagnostics run previously.

To customize Remote HP PC Hardware Diagnostics UEFI settings, follow these steps:

1. Turn on or restart the computer, and when the HP logo appears, press **f10** to enter Computer Setup.
2. Select **Advanced**, and then select **Settings**.
3. Make your customization selections.
4. Select **Main**, and then **Save Changes and Exit** to save your settings.

Your changes take effect when the computer restarts.

---

# 9 Backing up, restoring, and recovering

This chapter provides information about the following processes, which are standard procedure for most products:

- **Backing up your personal information**—You can use Windows tools to back up your personal information (see [Using Windows tools on page 76](#)).
- **Creating a restore point**—You can use Windows tools to create a restore point (see [Using Windows tools on page 76](#)).
- **Creating recovery media** (select products only)—You can use the HP Cloud Recovery Download Tool (select products only) to create recovery media (see [Using the HP Cloud Recovery Download Tool to create recovery media \(select products only\) on page 76](#)).
- **Restoring and recovery**—Windows offers several options for restoring from backup, refreshing the computer, and resetting the computer to its original state (see [Using Windows tools on page 76](#)).

---

 **IMPORTANT:** If you will be performing recovery procedures on a tablet, the tablet battery must be at least 70% charged before you start the recovery process.

**IMPORTANT:** For a tablet with a detachable keyboard, connect the tablet to the keyboard base before beginning any recovery process.

---

## Backing up information and creating recovery media

### Using Windows tools

---

 **IMPORTANT:** Windows is the only option that allows you to back up your personal information. Schedule regular backups to avoid information loss.

You can use Windows tools to back up personal information and create system restore points and recovery media.

---

 **NOTE:** If computer storage is 32 GB or less, Microsoft System Restore is disabled by default.

For more information and steps, see the Get Help app.

1. Select the **Start** button, and then select the **Get Help** app.
2. Enter the task you want to perform.

---

 **NOTE:** You must be connected to the Internet to access the Get Help app.

---

### Using the HP Cloud Recovery Download Tool to create recovery media (select products only)

You can use the HP Cloud Recovery Download Tool to create HP Recovery media on a bootable USB flash drive.

To download the tool:

- ▲ Go to the Microsoft Store and search for HP Cloud Recovery.

For details, go to <http://www.hp.com/support>, search for HP Cloud Recovery, and then select "HP PCs – Using the Cloud Recovery Tool (Windows 10, 7)."

---

 **NOTE:** If you cannot create recovery media yourself, contact support to obtain recovery discs. Go to <http://www.hp.com/support>, select your country or region, and then follow the on-screen instructions.

---

## Restoring and recovery

### Restoring, resetting, and refreshing using Windows tools

Windows offers several options for restoring, resetting, and refreshing the computer. For details, see [Using Windows tools on page 76](#).

### Recovering using HP Recovery media

HP Recovery media is used to recover the original operating system and software programs that were installed at the factory. On select products, it can be created on a bootable USB flash drive using the HP Cloud Recovery Download Tool. For details, see [Using the HP Cloud Recovery Download Tool to create recovery media \(select products only\) on page 76](#).

---

 **NOTE:** If you cannot create recovery media yourself, contact support to obtain recovery discs. Go to <http://www.hp.com/support>, select your country or region, and then follow the on-screen instructions.

---

To recover your system:

- ▲ Insert the HP Recovery media, and then restart the computer.

### Changing the computer boot order

If your computer does not restart using the HP Recovery media, you can change the computer boot order. This is the order of devices listed in BIOS where the computer looks for startup information. You can change the selection to an optical drive or a USB flash drive, depending on the location of your HP Recovery media.

To change the boot order:

---

 **IMPORTANT:** For a tablet with a detachable keyboard, connect the tablet to the keyboard base before beginning these steps.

---

1. Insert the HP Recovery media.
2. Access the system **Startup** menu.

For computers or tablets with keyboards attached:

- ▲ Turn on or restart the computer or tablet, quickly press **esc**, and then press **f9** for boot options.

For tablets without keyboards:

- ▲ Turn on or restart the tablet, quickly hold down the volume up button, and then select **f9**.

– or –

Turn on or restart the tablet, quickly hold down the volume down button, and then select **f9**.

3. Select the optical drive or USB flash drive from which you want to boot, and then follow the on-screen instructions.

# 10 Specifications

**Table 10-1 Computer specifications**

	Metric	U.S.
<b>Computer dimensions</b>		
Width	<b>360 mm</b>	14.17 in
Depth	<b>263 mm</b>	10.35 in
Height	<b>25 mm</b>	0.98 in
<b>Weight</b>		
SSD+52 W battery+N17P	<b>2.324 kg</b>	5.12 lbs
HD+52W battery+N17P	<b>2.386 kg</b>	5.26 lbs
HD+70W battery+N17P	<b>2.450 kg</b>	5.40 lbs
SSD+70W battery+N17E	<b>2.458 kg</b>	5.42 lbs
HD+70W battery+N17E	<b>2.520 kg</b>	5.56 lbs
<b>Input power</b>		
Operating voltage and current	19.5 V dc @ 6.9 A – 135 W	
	19.5 V dc @ 7.70 A – 150 W	
	19.5 V dc @ 10.3 A – 200 W	
<b>Temperature</b>		
Operating	<b>5°C to 35°C</b>	41°F to 95°F
Nonoperating	<b>-20°C to 60°C</b>	-4°F to 140°F
<b>Relative humidity (noncondensing)</b>		
Operating	10% to 90%	
Nonoperating	5% to 95%	
<b>Maximum altitude (unpressurized)</b>		
Operating	<b>-15 m to 3,048 m</b>	-50 ft to 10,000 ft
Nonoperating	<b>-15 m to 12,192 m</b>	-50 ft to 40,000 ft
<b>NOTE:</b> Applicable product safety standards specify thermal limits for plastic surfaces. The device operates well within this range of temperatures.		

---

# 11 Power cord set requirements

The wide-range input feature of the computer permits it to operate from any line voltage from 100 to 120 V ac, or from 220 to 240 V ac.

The 3-conductor power cord set included with the computer meets the requirements for use in the country or region where the equipment is purchased.

Power cord sets for use in other countries or regions must meet the requirements of the country and region where the computer is used.

## Requirements for all countries

The following requirements are applicable to all countries and regions:

- The length of the power cord set must be at least **1.0 m** (3.3 ft) and no more than **2.0 m** (6.5 ft).
- All power cord sets must be approved by an acceptable accredited agency responsible for evaluation in the country or region where the power cord set will be used.
- The power cord sets must have a minimum current capacity of 10 A and a nominal voltage rating of 125 or 250 V ac, as required by the power system of each country or region.
- The appliance coupler must meet the mechanical configuration of an EN 60 320/IEC 320 Standard Sheet C13 connector for mating with the appliance inlet on the back of the computer.

## Requirements for specific countries and regions

**Table 11-1 Power cord requirements for specific countries and regions**

Country/region	Accredited agency	Applicable note number
Argentina	IRAM	1
Australia	SAA	1
Austria	OVE	1
Belgium	CEBEC	1
Brazil	ABNT	1
Canada	CSA	2
Chile	IMQ	1
Denmark	DEMKO	1
Finland	FIMKO	1
France	UTE	1
Germany	VDE	1
India	ISI	1
Israel	SII	1
Italy	IMQ	1
Japan	JIS	3
The Netherlands	KEMA	1
New Zealand	SANZ	1
Norway	NEMKO	1
The People's Republic of China	CCC	4
Saudi Arabia	SASO	7
Singapore	PSB	1
South Africa	SABS	1
South Korea	KTL	5
Sweden	SEMKO	1
Switzerland	SEV	1
Taiwan	BSMI	6
Thailand	TISI	1
The United Kingdom	ASTA	1
The United States	UL	2

1. The flexible cord must be Type H05VV-F, 3-conductor, 0.75 mm<sup>2</sup> conductor size. Power cord set fittings (appliance coupler and wall plug) must bear the certification mark of the agency responsible for evaluation in the country or region where it will be used.

**Table 11-1 Power cord requirements for specific countries and regions (continued)**

Country/region	Accredited agency	Applicable note number
		2. The flexible cord must be Type SVT/SJT or equivalent, No. 18 AWG, 3-conductor. The wall plug must be a two-pole grounding type with a NEMA 5-15P (15 A, 125 V ac) or NEMA 6-15P (15 A, 250 V ac) configuration. CSA or C-UL mark. UL file number must be on each element.
		3. The appliance coupler, flexible cord, and wall plug must bear a “T” mark and registration number in accordance with the Japanese Dentori Law. The flexible cord must be Type VCR, 3-conductor, 0.75 mm <sup>2</sup> or 1.25 mm <sup>2</sup> conductor size. The wall plug must be a two-pole grounding type with a Japanese Industrial Standard c/o (7 A, 125 V ac) configuration.
		4. The flexible cord must be Type REV, 3-conductor, 0.75 mm <sup>2</sup> conductor size. Power cord set fittings (appliance coupler and wall plug) must bear the CCC certification mark.
		5. The flexible cord must be Type H05VV-F 3-conductor, 0.75 mm <sup>2</sup> conductor size. KTL logo and individual approval number must be on each element. Corset approval number and logo must be printed on a flag label.
		6. The flexible cord must be Type HVCTF 3-conductor, 1.25 mm <sup>2</sup> conductor size. Power cord set fittings (appliance coupler, cable, and wall plug) must bear the BSMI certification mark.
		7. For 127 V ac, the flexible cord must be Type SVT or SJT 3-conductor, 18 AWG, with plug NEMA 5-15P (15 A, 125 V ac), with UL and CSA or C-UL marks. For 240 V ac, the flexible cord must be Type H05VV-F 3-conductor, 0.75 mm <sup>2</sup> or 1.00 mm <sup>2</sup> conductor size, with plug BS 1363/A with BSI or ASTA marks.

---

## 12 Recycling

When a non-rechargeable or rechargeable battery has reached the end of its useful life, do not dispose of the battery in general household waste. Follow the local laws and regulations in your area for battery disposal.

HP encourages customers to recycle used electronic hardware, HP original print cartridges, and rechargeable batteries. For more information about recycling programs, see the HP Web site at <http://www.hp.com/recycle>.



# Index

## A

- AC adapter and battery light, identifying 13
- AC adapter, spare part numbers 27
- action keys
  - identifying 20
- airplane mode key 20
- antenna
  - spare part numbers 27
- audio board
  - removal 51
  - spare part number 24, 51
- audio cable
  - spare part number 24
- audio, product description 2, 8
- audio-in (microphone) jack, identifying 14
- audio-out (headphone)/audio-in (microphone) combo jack, identifying 14

## B

- backup, creating 76
- backups 76
- base enclosure
  - removing 34
  - spare part number 34
- base enclosure, spare part numbers 25
- battery
  - removal 45
  - spare part number 25, 45
- BIOS
  - determining version 69
  - downloading an update 70
  - starting the Setup Utility 69
  - updating 69
- Bluetooth label 22
- boot order, changing 77
- bottom components 21
- buttons
  - left touchpad 17
  - power 19
  - right touchpad 17

## C

- camera
  - identifying 16
- camera light, identifying 16
- camera module
  - removal 63
- caps lock light, identifying 18
- case, spare part number 27
- cautions
  - electrostatic discharge 30
- chipset, product description 1, 6
- components
  - bottom 21
  - display 16
  - keyboard area 17
  - left side 14
  - right side 13
- computer major components 23
- connector board
  - spare part numbers 24
- connector board cable
  - spare part numbers 24
- connector, power 13, 15

## D

- display
  - removal 64
- display assembly
  - removal 62
  - spare part numbers 62
  - subcomponents 26
- display bezel
  - removal 63
  - spare part numbers 26
- display components 16
- display enclosure, spare part number 27
- display hinge bracket
  - spare part number 27
- Display Hinge Kit, spare part number 27
- display panel
  - product description 1, 7
  - spare part numbers 26

- display panel cable
  - spare part number 27
- display support bracket
  - spare part number 27
- display tape, spare part number 27
- dongle, USB-C to USB-A, spare part number 27
- drive light, identifying 13
- Dual-Mode DisplayPort
  - identifying 15

## E

- electrostatic discharge (ESD) 30
  - preventing damage 31
- END key 20
- esc key, identifying 20
- ethernet, product description 3, 8
- external media cards, product description 4, 10

## F

- fan
  - removal 48
  - spare part number 48
- fn key, identifying 20

## G

- graphics, product description 1, 6
- grounding methods 32
- guidelines
  - packaging 33
  - transporting 33
  - workstation 30

## H

- hard drive
  - spare part number 24, 37
- hard drive brackets
  - spare part number 24, 37
- Hard drive cable connector
  - spare part number 24, 37
- hard drive dummy
  - spare part number 24, 37
- hard drives, product description 7

- HDD
  - removal 37
  - spare part numbers 37
- HDMI port
  - identifying 15
- HDMI to VGA adapter, spare part number 27
- heat sink
  - removal 56
  - spare part number 25, 56
- hinge
  - spare part number 27
- HP PC Hardware Diagnostics UEFI
  - downloading 73
  - starting 73
  - using 72
- HP PC Hardware Diagnostics Windows
  - downloading 71
  - installing 72
  - using 71
- HP Recovery Manager
  - correcting boot problems 77
- HP Recovery media
  - recovery 77
- I**
- internal card expansion, product description 3, 9
- internal microphones, identifying 16
- J**
- jacks
  - audio-in (microphone) 14
  - audio-out (headphone)/audio-in (microphone) 14
  - network 15
  - RJ-45 (network) 15
- K**
- keyboard/top cover
  - removal 68
  - spare part numbers 24, 68
- keys
  - action 20
  - airplane mode 20
  - END key 20
  - esc 20
  - fn 20
  - OMEN key 20
- PRT SC 20
- Windows 20
- L**
- labels
  - Bluetooth 22
  - regulatory 22
  - serial number 21
  - service 21
  - wireless certification 22
  - WLAN 22
- left side components 14
- lights
  - AC adapter and battery 13
  - camera 16
  - caps lock 18
  - drive 13
  - power 18
  - RJ-45 (network) status 15
  - touchpad 18
- M**
- memory module
  - removal 40
  - spare part numbers 40
- memory, product description 2, 7
- microphone
  - product description 2, 8
- MicroSD memory card reader, identifying 14
- model name 1, 5
- N**
- network jack, identifying 15
- O**
- OMEN key 20
- operating system, product description 4, 10, 11
- optical drive, spare part number 28
- P**
- packaging guidelines 33
- ports
  - Dual-Mode DisplayPort 15
  - HDMI 15
  - product description 3, 9
  - USB SuperSpeed 13, 14
  - USB SuperSpeed port with HP Sleep and Charge 15
- USB Type-C power connector and Thunderbolt port with HP Sleep and Charge 15
- USB Type-C with HP Sleep and Charge 15
- power button board
  - removal 61
  - spare part number 61
- power button, identifying 19
- power connector
  - identifying 13, 15
- power connector board
  - spare part number 24
- power connector cable
  - removal 50
  - spare part number 24, 50
- power cord
  - requirements for all countries 79
  - requirements for specific countries and regions 80
  - set requirements 79
  - spare part numbers 27
- power lights, identifying 18
- power requirements, product description 4, 10
- processor, product description 1, 5
- product description
  - audio 2, 8
  - chipset 1, 6
  - display panel 1, 7
  - ethernet 3, 8
  - external media cards 4, 10
  - graphics 1, 6
  - hard drives 7
  - internal card expansion 3, 9
  - memory 2, 7
  - microphone 2, 8
  - operating system 4, 10, 11
  - ports 3, 9
  - power requirements 4, 10
  - processors 1, 5
  - product name 1, 5
  - serviceability 5, 12
  - storage 2
  - video 2, 8
  - wireless 3, 8
- product name 1, 5
- product name and number, computer 21

PRT SC key 20

## R

recovery 76  
discs 77  
HP Recovery partition 77  
media 77  
USB flash drive 77  
recovery media  
creating using HP Cloud Recovery  
Download Tool 76  
creating using Windows tools 76  
regulatory information  
regulatory label 22  
wireless certification labels 22  
Remote HP PC Hardware Diagnostics  
UEFI settings  
customizing 74  
using 74  
removal/replacement  
procedures 34, 44  
restoring 76  
right side components 13  
RJ-45 (network) jack, identifying 15  
RJ-45 (network) status lights,  
identifying 15

## S

Screw Kit, spare part number 28  
security cable slot, identifying 15  
serial number, computer 21  
service labels, locating 21  
serviceability, product description  
5, 12  
slots  
memory card reader 14  
security cable 15  
smart card board  
removal 47  
spare part number 47  
solid-state drive  
removal 39  
spare part numbers 39  
speaker  
removal 46  
spare part number 46  
speakers  
identifying 21  
spare part number 24  
special keys, using 20

static electricity 31  
storage, product description 2  
system board  
removal 53  
spare part numbers 24, 53  
system restore point, creating 76

## T

Thunderbolt port with HP Sleep and  
Charge, identifying USB Type-C 15  
touchpad  
removing 59  
spare part number 59  
touchpad board  
spare part numbers 24  
touchpad buttons  
identifying 17  
touchpad click board  
removing 59  
spare part number 59  
touchpad click board bracket  
spare part number 59  
touchpad light 18  
touchpad zone, identifying 17  
transporting guidelines 33  
traveling with the computer 22

## U

USB board  
removal 52  
spare part number 52  
USB SuperSpeed port with HP Sleep  
and Charge, identifying 15  
USB SuperSpeed port, identifying  
13, 14  
USB Type-C port with HP Sleep and  
Charge, identifying 15  
USB Type-C power connector and  
Thunderbolt port with HP Sleep and  
Charge, identifying 15

## V

vents, identifying 15, 21  
video, product description 2, 8

## W

webcam/microphone module  
spare part number 26  
Windows  
backup 76

recovery media 76  
system restore point 76  
Windows key, identifying 20  
Windows tools, using 76  
wireless antenna  
spare part numbers 27  
wireless certification label 22  
wireless, product description 3, 8  
WLAN antenna  
spare part number 27  
WLAN antennas, identifying 16  
WLAN device 22  
WLAN label 22  
WLAN module  
removing 42  
spare part numbers 25  
workstation guidelines 30