

FCC Test Report

FCC ID : 2AJAC-AN520API
Equipment : Araknis Networks 520-series Wi-Fi 6 AX3000
Indoor Wireless Access Point
Model No. : AN-520-AP-I
Brand Name : Araknis Networks
Applicant : Snap One, LLC
Address : 1800 Continental Blvd Suite 200-300 Charlotte,
North Carolina 28273 USA
Standard : 47 CFR FCC Part 15.407
Received Date : Feb. 24, 2022
Tested Date : Apr. 13 ~ Apr. 26, 2022

We, International Certification Corporation, would like to declare that the tested sample has been evaluated and in compliance with the requirement of the above standards. The test results contained in this report refer exclusively to the product. It shall not be reproduced except in full without the written approval of our laboratory.

Reviewed by:

Approved by:



Along Chen / Assistant Manager



Gary Chang / Manager

Table of Contents

1	GENERAL DESCRIPTION	5
1.1	Information.....	5
1.2	Local Support Equipment List	10
1.3	Test Setup Chart	11
1.4	The Equipment List	13
1.5	Test Standards	14
1.6	Reference Guidance	14
1.7	Deviation from Test Standard and Measurement Procedure.....	14
1.8	Measurement Uncertainty	15
2	TEST CONFIGURATION	16
2.1	Testing Facility.....	16
2.2	The Worst Test Modes and Channel Details	17
3	TRANSMITTER TEST RESULTS.....	19
3.1	Emission Bandwidth	19
3.2	Conducted Output Power	20
3.3	Power Spectral Density	22
3.4	Unwanted Emissions	24
3.5	Frequency Stability.....	27
3.6	AC Power Line Conducted Emissions	28
4	TEST LABORATORY INFORMATION	29
Appendix A. Emission Bandwidth		
Appendix B. Conducted Output Power		
Appendix C. Power Spectral Density		
Appendix D. Unwanted Emissions		
Appendix E. Frequency Stability		
Appendix F. AC Power Line Conducted Emissions		

Release Record

Report No.	Version	Description	Issued Date
FR222403AN	Rev. 01	Initial issue	Jun. 09, 2022
FR222403AN	Rev. 02	Adding front end module information.	Jun. 28, 2022

Summary of Test Results

FCC Rules	Test Items	Measured	Result
15.207	AC Power Line Conducted Emissions	[dBuV]: 0.529MHz 41.69 (Margin -4.31dB) - AV	Pass
15.407(b) 15.209	Unwanted Emissions	[dBuV/m at 3m]: 5040.00MHz 53.64 (Margin -0.36dB) - AV	Pass
15.407(a)	Emission Bandwidth	Meet the requirement of limit	Pass
15.407(e)	6dB bandwidth	Meet the requirement of limit	Pass
15.407(a)	Conducted Output Power	Max Power [dBm]: 5150~5250MHz: 26.55 5250~5350MHz: 23.52 5470~5725MHz: 23.89 5725~5850MHz: 26.59	Pass
15.407(a)	Power Spectral Density	Meet the requirement of limit	Pass
15.407(g)	Frequency Stability	Meet the requirement of limit	Pass
15.203	Antenna Requirement	Meet the requirement of limit	Pass

Declaration of Conformity:

The test results with all measurement uncertainty excluded are presented in accordance with the regulation limits or requirements declared by manufacturers.

Comments and Explanations:

The declared of product specification for EUT presented in the report are provided by the manufacturer, and the manufacturer takes all the responsibilities for the accuracy of product specification.

1 General Description

1.1 Information

1.1.1 Specification of the Equipment under Test (EUT)

RF General Information					
Frequency Range (MHz)	IEEE Std. 802.11	Ch. Freq. (MHz)	Channel Number	Transmit Chains (N _{TX})	Data Rate / MCS
5150-5250 5250-5350 5470-5725 5725-5850	a	5180-5240 5260-5320 5500-5720 5745-5825	36-48 [4] 52-64 [4] 100-144 [12] 149-165 [5]	2	6-54 Mbps
5150-5250 5250-5350 5470-5725 5725-5850	n (HT20)	5180-5240 5260-5320 5500-5720 5745-5825	36-48 [4] 52-64 [4] 100-144 [12] 149-165 [5]	2	MCS 0-15
5150-5250 5250-5350 5470-5725 5725-5850	n (HT40)	5190-5230 5270-5310 5510-5710 5755-5795	38-46 [2] 54-62 [2] 102-142 [6] 151-159 [2]	2	MCS 0-15
5150-5250 5250-5350 5470-5725 5725-5850	ac (VHT20)	5180-5240 5260-5320 5500-5720 5745-5825	36-48 [4] 52-64 [4] 100-144 [12] 149-165 [5]	2	MCS 0-9
5150-5250 5250-5350 5470-5725 5725-5850	ac (VHT40)	5190-5230 5270-5310 5510-5710 5755-5795	38-46 [2] 54-62 [2] 102-142 [6] 151-159 [2]	2	MCS 0-9
5150-5250 5250-5350 5470-5725 5725-5850	ac (VHT80)	5210 5290 5530~5690 5775	42 [1] 58 [1] 106-138 [3] 155 [1]	2	MCS 0-9
5150-5350 5470-5725	ac (VHT160)	5250 5570	50 [1] 114 [1]	2	MCS 0-9
5150-5250 5250-5350 5470-5725 5725-5850	ax (HE20)	5180-5240 5260-5320 5500-5720 5745-5825	36-48 [4] 52-64 [4] 100-144 [12] 149-165 [5]	2	MCS 0-11
5150-5250 5250-5350 5470-5725 5725-5850	ax (HE40)	5190-5230 5270-5310 5510-5710 5755-5795	38-46 [2] 54-62 [2] 102-142 [6] 151-159 [2]	2	MCS 0-11
5150-5250 5250-5350 5470-5725 5725-5850	ax (HE80)	5210 5290 5530~5690 5775	42 [1] 58 [1] 106-138 [3] 155 [1]	2	MCS 0-11
5150-5350 5470-5725	ax (HE160)	5250 5570	50 [1] 114 [1]	2	MCS 0-11

Note: OFDM/OFDMA- BPSK, QPSK, 16QAM, 64QAM, 256QAM and 1024QAM modulation.

1.1.2 Antenna Details

Ant. No.	Model	Type	Connector	Operating Frequencies (MHz) / Antenna Gain (dBi)				
				2400~2483.5	5150~5250	5250~5350	5470~5725	5725~5850
1	2.4G-1	PIFA	UFL	5.66	---	---	---	---
2	2.4G-2	PIFA	UFL	6.75	---	---	---	---
3	5G-1	PIFA	UFL	---	4.9	5.1	5.8	5.5
4	5G-2	PIFA	UFL	---	5.1	5	5.25	5.13

1.1.3 Source of Front End Module

Source	2.4 GHz Front End Module	5 GHz Front End Module
Source A	Brand: Kxcomtech Model: KCT8248HE	Brand: Kxcomtech Model: KCT8548HE
Source B	Brand: Qorvo Model: QPF4288ATR13	Brand: Qorvo Model: QPF4588ATR13-5K

1.1.4 Power Supply Type of Equipment under Test (EUT)

Power Supply Type	12V from AC adapter 54V from POE
-------------------	-------------------------------------

Note: The above power supplies are not bundled in market.

1.1.5 Accessories

Accessories		
No.	Equipment	Description
1	RJ45 cable	0.24m non-shielded without core

1.1.6 Channel List

802.11a / n HT20 / ac VHT20 / ax HE20		802.11n HT40 / ac VHT40 / ax HE40	
Channel	Frequency(MHz)	Channel	Frequency(MHz)
36	5180	38	5190
40	5200	46	5230
44	5220	54	5270
48	5240	62	5310
52	5260	102	5510
56	5280	110	5550
60	5300	118	5590
64	5320	126	5630
100	5500	134	5670
104	5520	142	5710
108	5540	151	5755
112	5560	159	5795
116	5580	802.11ac VHT80 / ax HE80	
120	5600	42	5210
124	5620	58	5290
128	5640	106	5530
132	5660	122	5610
136	5680	138	5690
140	5700	155	5775
144	5720	802.11ac VHT160 / ax HE160	
149	5745	50	5250
153	5765	114	5570
157	5785	---	---
161	5805	---	---
165	5825	---	---

1.1.7 Test Tool and Duty Cycle

Test Tool	QPSR, V5.0-00197		
Duty Cycle and Duty Factor	Mode	Duty Cycle (%)	Duty Factor (dB)
	11a	95.58%	0.20
	ax HE20-OFDMA	96.15%	0.17
	ax HE40-OFDMA	85.59%	0.68
	ax HE80-OFDMA	63.13%	2.00
	ax HE160-OFDMA	42.33%	3.73

1.1.8 Power Index of Test Tool

Modulation Mode	Test Frequency (MHz)	Power Index
11a	5180	21.5
11a	5200	21.5
11a	5240	22
11a	5260	17
11a	5300	17
11a	5320	16.5
11a	5500	16
11a	5580	15.5
11a	5700	15
11a	5745	22.5
11a	5785	22
11a	5825	21.5
ax HE20-OFDMA	5180	21.5
ax HE20-OFDMA	5200	21.5
ax HE20-OFDMA	5240	22.5
ax HE20-OFDMA	5260	17.5
ax HE20-OFDMA	5300	17
ax HE20-OFDMA	5320	17
ax HE20-OFDMA	5500	16.5
ax HE20-OFDMA	5580	16
ax HE20-OFDMA	5700	15.5
ax HE20-OFDMA	5745	22.5
ax HE20-OFDMA	5785	21
ax HE20-OFDMA	5825	20.5

Modulation Mode	Test Frequency (MHz)	Power Index
ax HE40-OFDMA	5190	17.5
ax HE40-OFDMA	5230	23.5
ax HE40-OFDMA	5270	20
ax HE40-OFDMA	5310	19.5
ax HE40-OFDMA	5510	19
ax HE40-OFDMA	5590	18.5
ax HE40-OFDMA	5670	18
ax HE40-OFDMA	5755	22.5
ax HE40-OFDMA	5795	22.5
ax HE80-OFDMA	5210	16.5
ax HE80-OFDMA	5290	20.5
ax HE80-OFDMA	5530	19
ax HE80-OFDMA	5610	20
ax HE80-OFDMA	5775	21.5
ax HE160-OFDMA	5250	15
ax HE160-OFDMA	5570	14.5

Modulation Mode	Test Frequency (MHz)	Power Index
11a	5720	15
ax HE20-OFDMA	5720	15.5
ax HE40-OFDMA	5710	18
ax HE80-OFDMA	5690	20

1.2 Local Support Equipment List

Support Equipment List					
No.	Equipment	Brand	Model	FCC ID	Remarks
1	Notebook	DELL	Latitude E5470	DoC	---
2	Adapter	ASIAN POWER DEVICES INC.	WA-36N12FU	---	Remarks: I/P: 100-240V~, 50~60Hz, 0.9A Max. O/P: 12V=3.0A Note 1: Provided by applicant. Note 2: The adapter has 2 models. Model: WA-36N12FU (Undetachable plug) Model: WA-36N12R (Detachable plug)
3	Adapter	ASIAN POWER DEVICES INC.	WA-48B12R	---	Remarks: I/P: 100-240V~, 50~60Hz, 1.5A Max. O/P: 12V=4A 48W Note 1: Provided by applicant. Note 2: The adapter has 2 models. Model: WA-48B12R (Detachable plug) Model: WA-48B12FU (Undetachable plug)
4	POE	EnGenius	EPA5006GAT	---	Remarks: I/P: 100-240V~, 50~60Hz, 0.8A O/P: 54V=0.6A (Provided by applicant.)

1.3 Test Setup Chart

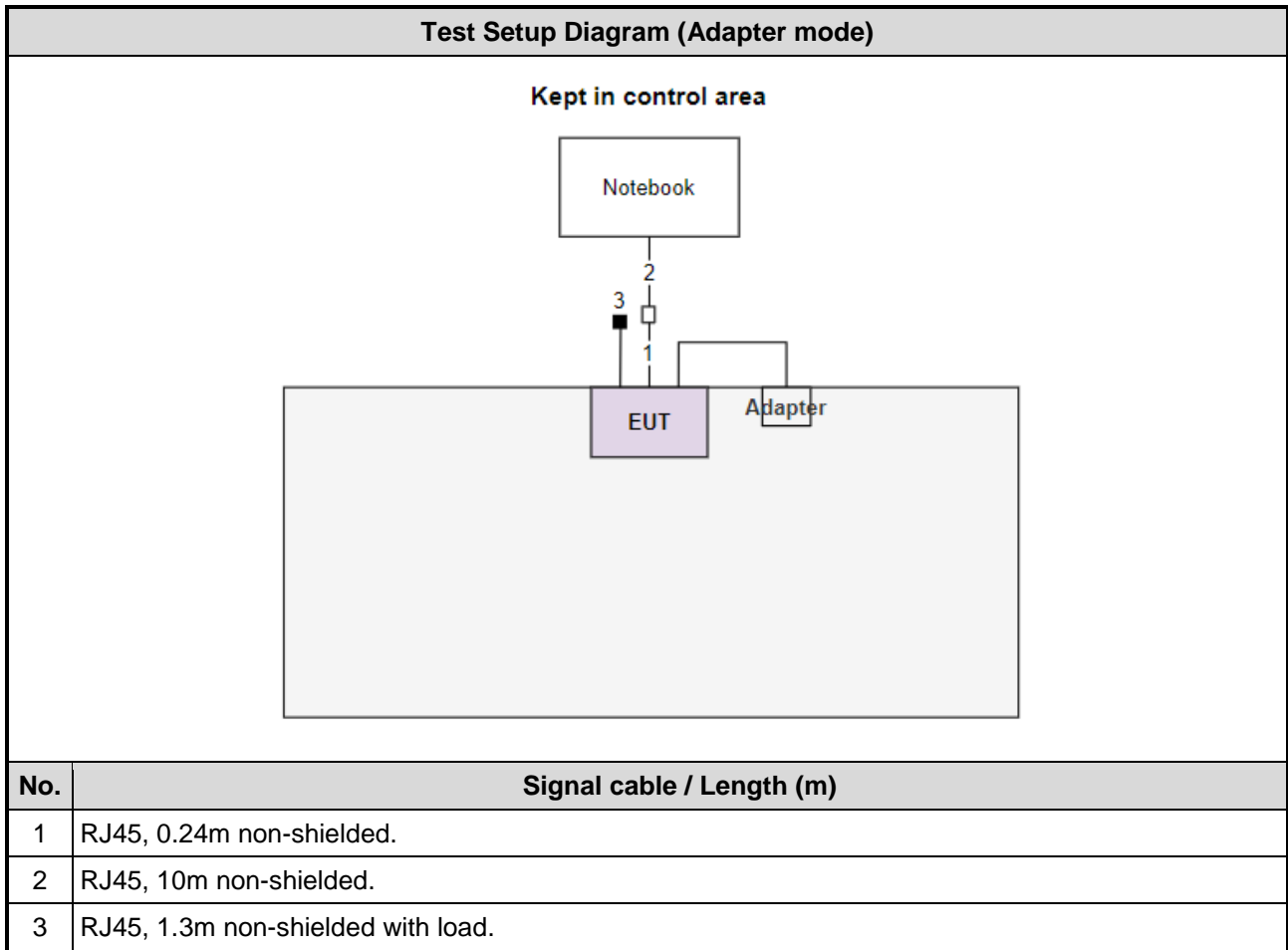

Test Setup Diagram (POE mode)

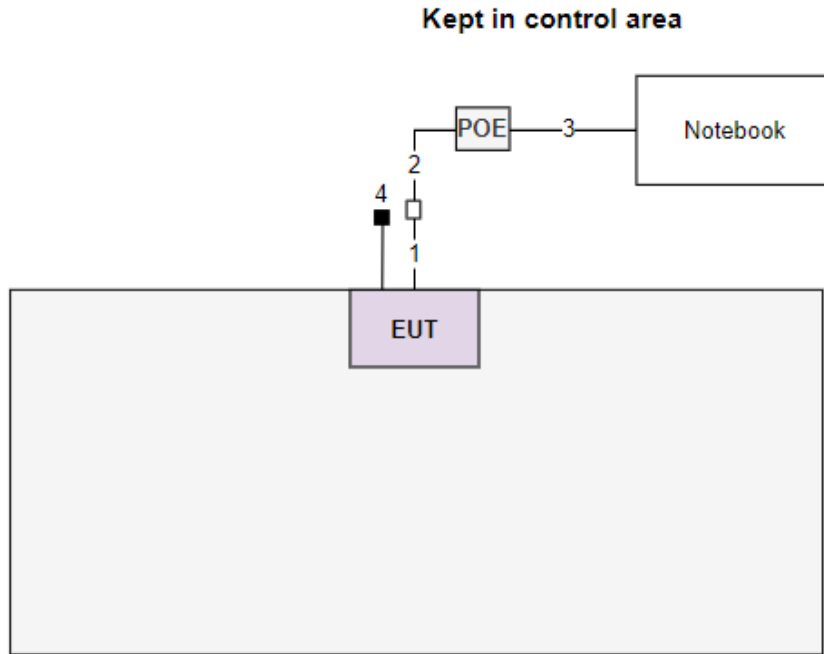

No.	Signal cable / Length (m)
1	RJ45, 0.24m non-shielded.
2	RJ45, 10m non-shielded.
3	RJ45, 1.3m non-shielded.
4	RJ45, 1.3m non-shielded with load.

1.4 The Equipment List

Test Item	Conducted Emission				
Test Site	Conduction room 1 / (CO01-WS)				
Tested Date	Apr. 26, 2022				
Instrument	Brand	Model No.	Serial No.	Calibration Date	Calibration Until
Receiver	R&S	ESR3	101658	Feb. 16, 2022	Feb. 15, 2023
LISN	R&S	ENV216	101295	Jan. 12, 2022	Jan. 11, 2023
LISN (Support Unit)	SCHWARZBECK	NSLK 8127	8127667	Jan .07, 2022	Jan .06, 2023
RF Cable-CON	Woken	CFD200-NL	CFD200-NL-001	Oct. 19, 2021	Oct. 18, 2022
50 ohm terminal (Support Unit)	NA	50	04	May 25, 2021	May 24, 2022
Measurement Software	AUDIX	e3	6.120210k	NA	NA
Note: Calibration Interval of instruments listed above is one year.					

Test Item	Radiated Emission				
Test Site	966 chamber3 / (03CH03-WS)				
Tested Date	Apr. 13 ~ Apr. 22, 2022				
Instrument	Brand	Model No.	Serial No.	Calibration Date	Calibration Until
Receiver	R&S	ESR3	101657	Mar. 15, 2022	Mar. 14, 2023
Spectrum Analyzer	R&S	FSV40	101499	Mar. 08, 2022	Mar. 07, 2023
Loop Antenna	R&S	HFH2-Z2	100330	Nov. 08, 2021	Nov. 07, 2022
Bilog Antenna	SCHWARZBECK	VULB9168	VULB9168-685	May. 06, 2021	May. 05, 2022
Horn Antenna 1G-18G	SCHWARZBECK	BBHA 9120 D	BBHA 9120 D 1206	Dec. 20, 2021	Dec. 19, 2022
Horn Antenna 18G-40G	SCHWARZBECK	BBHA 9170	BBHA 9170508	Jan. 11, 2022	Jan. 10, 2023
Preamplifier	EMC	EMC02325	980187	Jul. 26, 2021	Jul. 25, 2022
Preamplifier	Agilent	83017A	MY39501309	Sep. 06, 2021	Sep. 05, 2022
Preamplifier	EMC	EMC184045B	980192	Jul. 14, 2021	Jul. 13, 2022
Loop Antenna Cable	KOAX KABEL	101354-BW	101354-BW	Oct. 05, 2021	Oct. 04, 2022
LF cable-0.8M	EMC	EMC8D-NM-NM-800	EMC8D-NM-NM-800-001	Sep. 24, 2021	Sep. 23, 2022
LF cable-3M	EMC	EMC8D-NM-NM-3000	131103	Sep. 24, 2021	Sep. 23, 2022
LF cable-13M	EMC	EMC8D-NM-NM-13000	131104	Sep. 24, 2021	Sep. 23, 2022
RF cable-3M	HUBER+SUHNER	SUCOFLEX104	MY22620/4	Sep. 24, 2021	Sep. 23, 2022
RF cable-8M	EMC	EMC104-SM-SM-8000	181107	Sep. 24, 2021	Sep. 23, 2022
Measurement Software	AUDIX	e3	6.120210g	NA	NA
Note: Calibration Interval of instruments listed above is one year.					

Test Item	RF Conducted				
Test Site	(TH01-WS)				
Tested Date	Apr. 19 ~ Apr. 26, 2022				
Instrument	Brand	Model No.	Serial No.	Calibration Date	Calibration Until
Spectrum Analyzer	R&S	FSV40	101910	Apr. 18, 2022	Apr. 17, 2023
Power Meter	Anritsu	ML2495A	1241002	Nov. 07, 2021	Nov. 06, 2022
Power Sensor	Anritsu	MA2411B	1207366	Nov. 07, 2021	Nov. 06, 2022
TEMP&HUMIDITY CHAMBER	GIANT FORCE	GCT-225-40-SP-SD	MAF1212-002	May 25, 2021	May 24, 2022
AC POWER SOURCE	APC	AFC-500W	F312060012	Dec. 03, 2021	Dec. 02, 2022
Measurement Software	Sporton	SENSE-15247_DTS	V5.10	NA	NA
Note: Calibration Interval of instruments listed above is one year.					

1.5 Test Standards

47 CFR FCC Part 15.407
ANSI C63.10-2013

1.6 Reference Guidance

FCC KDB 412172 D01 Determining ERP and EIRP v01r01
FCC KDB 662911 D01 Multiple Transmitter Output v02r01
FCC KDB 789033 D02 General UNII Test Procedures New Rules v02r01

1.7 Deviation from Test Standard and Measurement Procedure

None

1.8 Measurement Uncertainty

The measurement uncertainties given below are based on a 95% confidence level (based on a coverage factor (k=2)).

Measurement Uncertainty	
Parameters	Uncertainty
Bandwidth	±34.130 Hz
Conducted power	±0.808 dB
Frequency error	±1×10 ⁻⁹
Power density	±0.583 dB
Conducted emission	±2.715 dB
AC conducted emission	±2.92 dB
Unwanted Emission ≤ 1GHz	±3.96 dB
Unwanted Emission > 1GHz	±4.51 dB
Time	±0.1%
Temperature	±0.4 °C

2 Test Configuration

2.1 Testing Facility

Test Laboratory	International Certification Corporation
Test Site	CO01-WS, TH01-WS
Address of Test Site	No.3-1, Lane 6, Wen San 3rd St., Kwei Shan Dist., Tao Yuan City 33381, Taiwan (R.O.C.)
Test Site	03CH03-WS
Address of Test Site	No.14-1, Lane 19, Wen San 3rd St., Kwei Shan Dist., Tao Yuan City 333, Taiwan (R.O.C.)

- FCC Designation No.: TW0009
- FCC site registration No.: 207696
- ISED#: 10807C
- CAB identifier: TW2732

2.2 The Worst Test Modes and Channel Details

Non-beamforming mode

Frequency band 5150~5350 MHz / 5470~5725 MHz				
Test item	Modulation Mode	Test Frequency (MHz)	Data Rate	Test Configuration
AC Power Line Conducted Emissions	ax HE40-OFDMA	5230	MCS 0	1, 2
Unwanted Emissions ≤1GHz	ax HE40-OFDMA	5230	MCS 0	1, 2
Unwanted Emissions >1GHz Conducted Output Power Emission Bandwidth Power Spectral Density	11a	5180 / 5200 / 5240 / 5260 / 5300 5320 / 5500 / 5580 / 5700 / 5720	6 Mbps	1
	ax HE20-OFDMA	5180 / 5200 / 5240 / 5260 / 5300 5320 / 5500 / 5580 / 5700 / 5720	MCS 0	
	ax HE40-OFDMA	5190 / 5230 / 5270 / 5310 / 5510 5590 / 5670 / 5710	MCS 0	
	ax HE80-OFDMA	5210 / 5290 / 5530 / 5610 / 5690	MCS 0	
	ax HE160-OFDMA	5250 / 5570	MCS 0	
Frequency Stability	Un-modulation	5320	---	1
Frequency band 5725-5850 MHz				
Test item	Modulation Mode	Test Frequency (MHz)	Data Rate	Test Configuration
AC Power Line Conducted Emissions	11a	5745	6 Mbps	1, 2
Unwanted Emissions ≤1GHz	11a	5745	6 Mbps	1, 2
Unwanted Emissions >1GHz Conducted Output Power Emission Bandwidth 6dB bandwidth Power Spectral Density	11a	5745 / 5785 / 5825	6 Mbps	1
	ax HE20-OFDMA	5745 / 5785 / 5825	MCS 0	
	ax HE40-OFDMA	5755 / 5795	MCS 0	
	ax HE80-OFDMA	5775	MCS 0	
Frequency Stability	Un-modulation	5785	---	1
NOTE:				
1. Source of front end module A and B had been covered during the pretest and found that Source of front end module A was the worst case and was chosen for final test.				
2. Adapter (model: WA-36N12FU) was the worst case and was selected for final testing.				
3. Test configurations are listed as below:				
1) Configuration 1: POE mode				
2) Configuration 2: Adapter mode				

Beamforming mode

Frequency band 5150~5350 MHz / 5470~5725 MHz				
Test item	Modulation Mode	Test Frequency (MHz)	Data Rate	Test Configuration
Conducted Output Power	ax HE20-OFDMA	5180 / 5200 / 5240 / 5260 / 5300 5320 / 5500 / 5580 / 5700 / 5720	MCS 0	---
	ax HE40-OFDMA	5190 / 5230 / 5270 / 5310 / 5510 5590 / 5670 / 5710	MCS 0	
	ax HE80-OFDMA	5210 / 5290 / 5530 / 5610 / 5690	MCS 0	
	ax HE160-OFDMA	5250 / 5570	MCS 0	
Frequency band 5725-5850 MHz				
Test item	Modulation Mode	Test Frequency (MHz)	Data Rate	Test Configuration
Conducted Output Power	ax HE20-OFDMA	5745 / 5785 / 5825	MCS 0	---
	ax HE40-OFDMA	5755 / 5795	MCS 0	
	ax HE80-OFDMA	5775	MCS 0	
NOTE: Adapter (model: WA-36N12FU) was the worst case and was selected for final testing.				

3 Transmitter Test Results

3.1 Emission Bandwidth

3.1.1 Limit of Emission Bandwidth

Within the 5.725-5.85 GHz band, the minimum 6 dB bandwidth of U-NII devices shall be at least 500 kHz.

3.1.2 Test Procedures

26dB Bandwidth

1. Set RBW = approximately 1% of the emission bandwidth.
2. Set the VBW > RBW, Detector = Peak.
3. Trace mode = max hold.
4. Measure the maximum width of the emission that is 26 dB down from the peak of the emission.

Occupied Bandwidth

1. Set RBW = 1 % to 5 % of the OBW.
2. Set VBW \geq 3 RBW.
3. Sample detection and single sweep mode shall be used.
4. Use the 99 % power bandwidth function of the instrument.

6dB Bandwidth

1. Set RBW = 100kHz, VBW = 300kHz.
2. Detector = Peak, Trace mode = max hold.
3. Allow the trace to stabilize.
4. Measure the maximum width of the emission that is constrained by the frequencies associated with the two outermost amplitude points (upper and lower frequencies) that are attenuated by 6 dB relative to the maximum level measured in the fundamental emission.

3.1.3 Test Setup

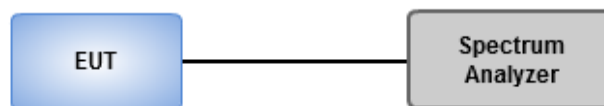

3.1.4 Test Results

Ambient Condition	23-24°C / 67%	Tested By	Aska Huang
--------------------------	---------------	------------------	------------

Refer to Appendix A.

3.2 Conducted Output Power

3.2.1 Limit of Conducted Output Power

Frequency band 5150-5250 MHz	
Operating Mode	Limit
<input type="checkbox"/> Outdoor access point	Conducted Power: 1 W The maximum e.i.r.p. at any elevation angle above 30 degrees as measured from the horizon must not exceed 125 mW (21 dBm)
<input checked="" type="checkbox"/> Indoor access point	Conducted Power: 1 W
<input type="checkbox"/> Fixed point-to-point access points	Conducted Power: 1 W
<input type="checkbox"/> Client devices	Conducted Power: 250 mW

Frequency Band (MHz)	Limit
<input checked="" type="checkbox"/> 5250 ~ 5350	Conducted Power: 250mW or 11dBm+10 log B
<input checked="" type="checkbox"/> 5470 ~ 5725	Conducted Power: 250mW or 11dBm+10 log B
<input checked="" type="checkbox"/> 5725 ~ 5850	Conducted Power: 1 W

Note: "B" is the 26dB emission bandwidth in MHz.

3.2.2 Test Procedures

Method PM-G (Measurement using a gated RF average power meter)

Measurements is performed using a wideband gated RF power meter provided that the gate parameters are adjusted such that the power is measured only when the EUT is transmitting at its maximum power control level. Since the measurement is made only during the ON time of the transmitter, no duty cycle correction factor is required.

Spectrum analyzer (For channel that extends across the 5.725 GHz boundary)

1. Set RBW = 1MHz, VBW = 3MHz, Sweep time = Auto, Detector = RMS.
2. Trace average at least 100 traces in power averaging mode.
3. Compute power by integrating the spectrum across the 26 dB EBW.
4. Add $10 \log(1/X)$, X:duty cycle) if duty cycle is <98%).

3.2.3 Test Setup

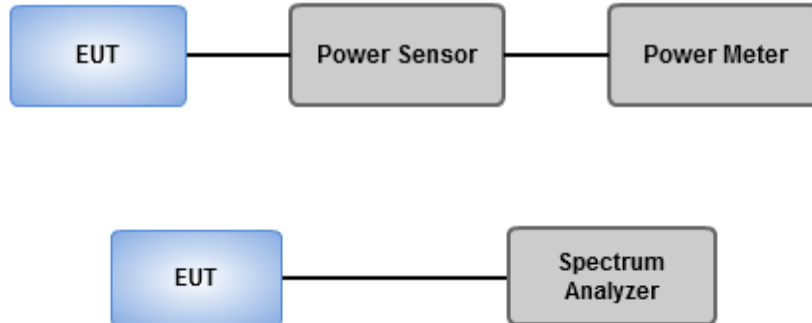

3.2.4 Test Results

Ambient Condition	23-24°C / 67%	Tested By	Aska Huang
--------------------------	---------------	------------------	------------

Refer to Appendix B.

3.3 Power Spectral Density

3.3.1 Limit of Power Spectral Density

Frequency band 5150-5250 MHz		
Operating Mode		Limit
<input type="checkbox"/>	Outdoor access point	17 dBm / MHz
<input checked="" type="checkbox"/>	Indoor access point	17 dBm / MHz
<input type="checkbox"/>	Fixed point-to-point access points	17 dBm / MHz
<input type="checkbox"/>	Client devices	11 dBm / MHz

Frequency Band (MHz)	Limit
<input checked="" type="checkbox"/> 5250 ~ 5350	11 dBm / MHz
<input checked="" type="checkbox"/> 5470 ~ 5725	11 dBm / MHz
<input checked="" type="checkbox"/> 5725 ~ 5850	30 dBm /500 kHz

3.3.2 Test Procedures

For 5150 ~ 5250 MHz / 5250 ~ 5350 MHz / 5470 ~ 5725 MHz

Duty cycle \geq 98 %

1. Set RBW = 1 MHz, VBW = 3 MHz, Sweep time = auto, Detector = RMS.
2. Trace average 100 traces.
3. Use the peak marker function to determine the maximum amplitude level.

Duty cycle < 98 %

1. Set RBW = 1 MHz, VBW = 3 MHz, Detector = RMS.
2. Set sweep time $\geq 10 * (\text{number of points in sweep}) * (\text{total on/off period of the transmitted signal})$.
3. Perform a single sweep.
4. Use the peak marker function to determine the maximum amplitude level.
5. Add $10 \log(1/x)$, where x is the duty cycle.

For 5725 ~ 5850 MHz

Duty cycle \geq 98 %

1. Set RBW = 500 kHz, VBW = 3 MHz, Sweep time = auto, Detector = RMS.
2. Trace average 100 traces.
3. Use the peak marker function to determine the maximum amplitude level.

Duty cycle < 98 %

1. Set RBW = 500 kHz, VBW = 3 MHz, Detector = RMS.
2. Set sweep time $\geq 10 * (\text{number of points in sweep}) * (\text{total on/off period of the transmitted signal})$.
3. Perform a single sweep.
4. Use the peak marker function to determine the maximum amplitude level.
5. Add $10 \log(1/x)$, where x is the duty cycle.

3.3.3 Test Setup

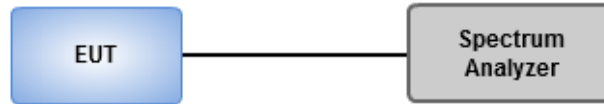

3.3.4 Test Results

Ambient Condition	23-24°C / 67%	Tested By	Aska Huang
--------------------------	---------------	------------------	------------

Refer to Appendix C.

3.4 Unwanted Emissions

3.4.1 Limit of Unwanted Emissions

Restricted Band Emissions Limit			
Frequency Range (MHz)	Field Strength (uV/m)	Field Strength (dBuV/m)	Measure Distance (m)
0.009~0.490	2400/F(kHz)	48.5 - 13.8	300
0.490~1.705	24000/F(kHz)	33.8 - 23	30
1.705~30.0	30	29	30
30~88	100	40	3
88~216	150	43.5	3
216~960	200	46	3
Above 960	500	54	3

Note 1:
Qusai-Peak value is measured for frequency below 1GHz except for 9–90 kHz, 110–490 kHz frequency band. Peak and average value are measured for frequency above 1GHz. The limit on average radio frequency emission is as above table. The limit on peak radio frequency emissions is 20 dB above the maximum permitted average emission limit

Note 2:
Measurements may be performed at a distance other than what is specified provided. When performing measurements at a distance other than that specified, the results shall be extrapolated to the specified distance using an extrapolation factor as below, Frequency at or above 30 MHz: 20 dB/decade Frequency below 30 MHz: 40 dB/decade.

Un-restricted band emissions above 1GHz Limit	
Operating Band	Limit
5.15 - 5.25 GHz	e.i.r.p. -27 dBm [68.2 dBuV/m@3m]
5.25 - 5.35 GHz	e.i.r.p. -27 dBm [68.2 dBuV/m@3m]
5.47 - 5.725 GHz	e.i.r.p. -27 dBm [68.2 dBuV/m@3m]
5.725 - 5.850 GHz	All emissions shall be limited to a level of -27 dBm/MHz at 75 MHz or more above or below the band edge increasing linearly to 10 dBm/MHz at 25 MHz above or below the band edge, and from 25 MHz above or below the band edge increasing linearly to a level of 15.6 dBm/MHz at 5 MHz above or below the band edge, and from 5 MHz above or below the band edge increasing linearly to a level of 27 dBm/MHz at the band edge.

Note 1: Measurements may be performed at a distance other than the limit distance provided they are not performed in the near field and the emissions to be measured can be detected by the measurement equipment. When performing measurements at a distance other than that specified, the results shall be extrapolated to the specified distance using an extrapolation factor of 20 dB/decade (inverse of linear distance for field-strength measurements, inverse of linear distance-squared for power-density measurements).

3.4.2 Test Procedures

1. Measurement is made at a semi-anechoic chamber that incorporates a turntable allowing a EUT rotation of 360°. A continuously-rotating, remotely-controlled turntable is installed at the test site to support the EUT and facilitate determination of the direction of maximum radiation for each EUT emission frequency. The EUT is placed at test table. For emissions testing at or below 1 GHz, the table height is 80 cm above the reference ground plane. For emission measurements above 1 GHz, the table height is 1.5 m
2. Measurement is made with the antenna positioned in both the horizontal and vertical planes of polarization. The measurement antenna is varied in height (1m ~ 4m) above the reference ground plane to obtain the maximum signal strength. Distance between EUT and antenna is 3 m.
3. This investigation is performed with the EUT rotated 360°, the antenna height scanned between 1 m and 4 m, and the antenna rotated to repeat the measurements for both the horizontal and vertical antenna polarizations.

Note:

1. 120kHz measurement bandwidth of test receiver and Quasi-peak detector is for radiated emission below 1GHz.
2. RBW=1MHz, VBW=3MHz and Peak detector is for peak measured value of radiated emission above 1GHz.
3. RBW=1MHz, VBW=1/T and Peak detector is for average measured value of radiated emission above 1GHz.

3.4.3 Test Setup

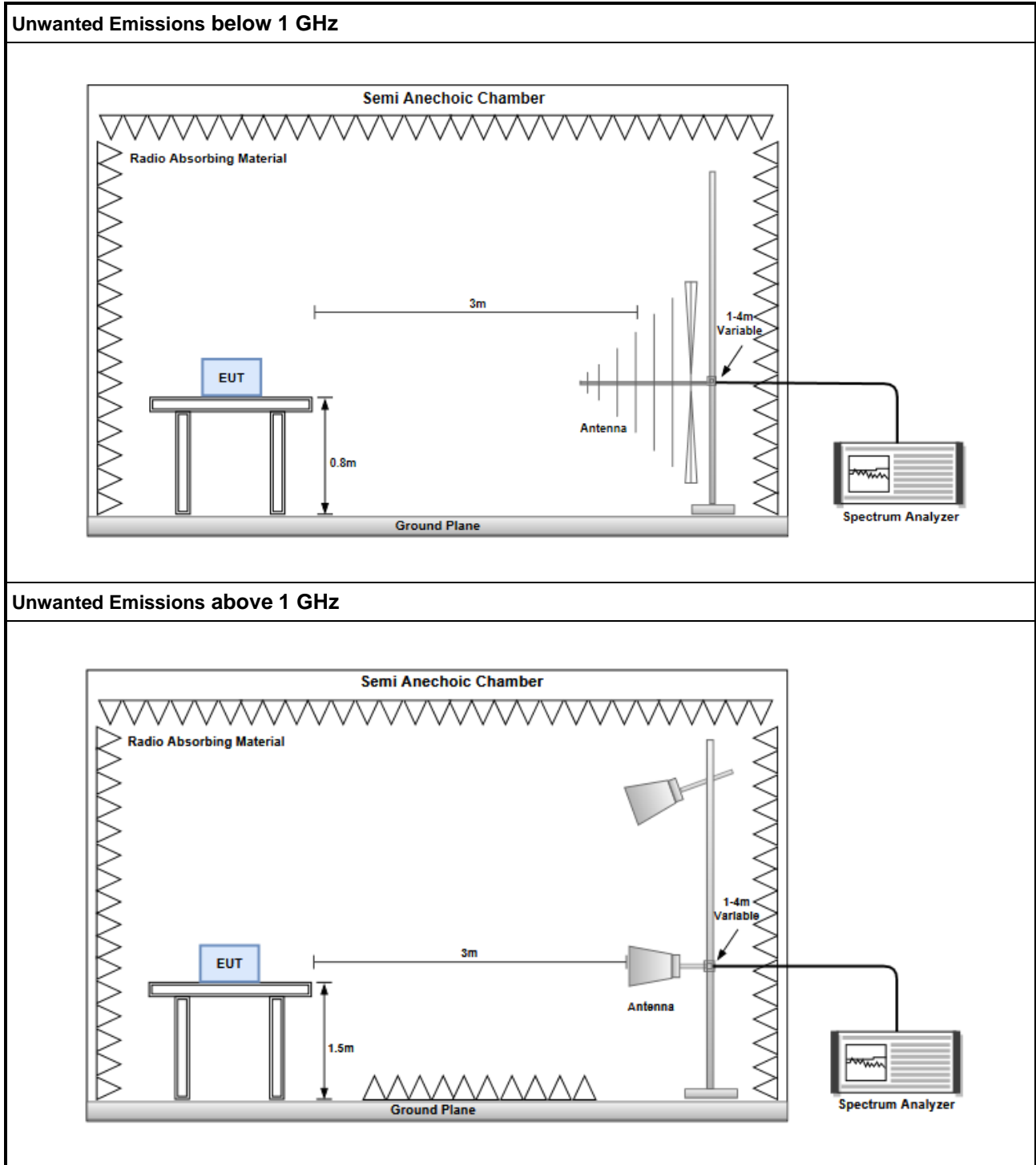

3.4.4 Test Results

Refer to Appendix D.

3.5 Frequency Stability

3.5.1 Limit of Frequency Stability

Manufacturers of U-NII devices are responsible for ensuring frequency stability such that an emission is maintained within the band of operation under all conditions of normal operation as specified in the user's manual.

3.5.2 Test Procedures

1. The EUT is installed in an environment test chamber with external power source.
2. Set the chamber to operate at 20 centigrade and external power source to output at nominal voltage of EUT.
3. A sufficient stabilization period at each temperature is used prior to each frequency measurement.
4. When temperature is stabled, measure the frequency stability.
5. The test shall be performed under normal and extreme condition for temperature and voltage.

3.5.3 Test Setup

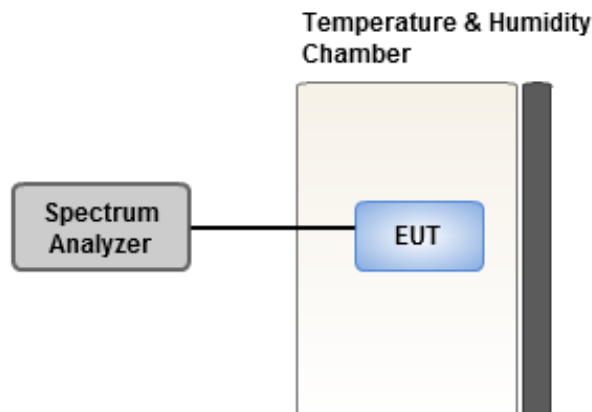

3.5.4 Test Results

Ambient Condition	23-24°C / 67%	Tested By	Aska Huang
--------------------------	---------------	------------------	------------

Refer to Appendix E.

3.6 AC Power Line Conducted Emissions

3.6.1 Limit of AC Power Line Conducted Emissions

Conducted Emissions Limit		
Frequency Emission (MHz)	Quasi-Peak	Average
0.15-0.5	66 - 56 *	56 - 46 *
0.5-5	56	46
5-30	60	50

Note 1: * Decreases with the logarithm of the frequency.

3.6.2 Test Procedures

1. The device is placed on a test table, raised 80 cm above the reference ground plane. The vertical conducting plane is located 40 cm to the rear of the device.
2. The device is connected to line impedance stabilization network (LISN) and other accessories are connected to other LISN. Measured levels of AC power line conducted emission are across the 50 Ω LISN port.
3. AC conducted emission measurements is made over frequency range from 150 kHz to 30 MHz.
4. This measurement was performed with AC 120V/60Hz

3.6.3 Test Setup

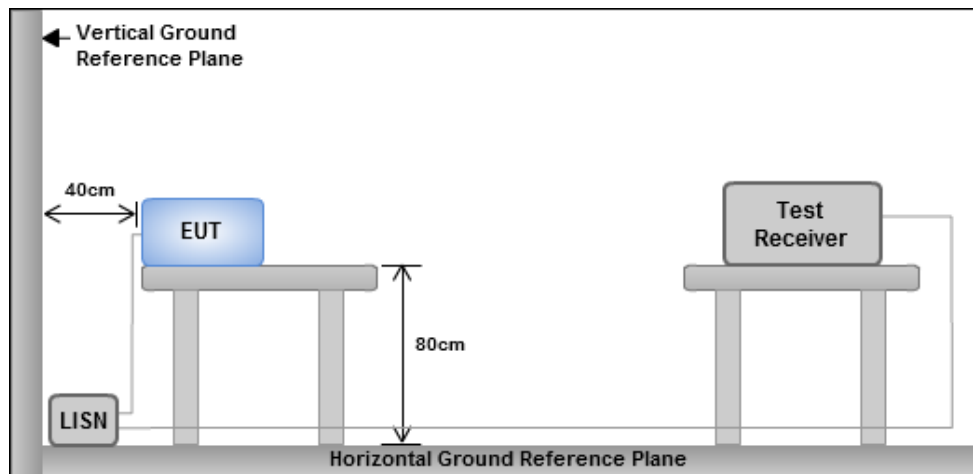

- Note: 1. Support units were connected to second LISN.
 2. Both of LISNs (AMN) are 80 cm from EUT and at least 80 cm from other units and other metal planes

3.6.4 Test Results

Refer to Appendix F.

4 Test laboratory information

Established in 2012, ICC provides foremost EMC & RF Testing and advisory consultation services by our skilled engineers and technicians. Our services employ a wide variety of advanced edge test equipment and one of the widest certification extents in the business.

International Certification Corporation (EMC and Wireless Communication Laboratory), it is our definitive objective is to institute long term, trust-based associations with our clients. The expectation we set up with our clients is based on outstanding service, practical expertise and devotion to a certified value structure. Our passion is to grant our clients with best EMC / RF services by oriented knowledgeable and accommodating staff.

Our Test sites are located at Linkou District and Kwei Shan District. Location map can be found on our website <http://www.icertifi.com.tw>.

Linkou

Tel: 886-2-2601-1640

No.30-2, Ding Fwu Tsuen, Lin Kou
District, New Taipei City, Taiwan
(R.O.C.)

Kwei Shan

Tel: 886-3-271-8666

No.3-1, Lane 6, Wen San 3rd
St., Kwei Shan Dist., Tao Yuan
City 33381, Taiwan (R.O.C.)
No.2-1, Lane 6, Wen San 3rd
St., Kwei Shan Dist., Tao Yuan
City 33381, Taiwan (R.O.C.)

Kwei Shan Site II

Tel: 886-3-271-8640

No.14-1, Lane 19, Wen San 3rd
St., Kwei Shan Dist., Tao Yuan
City 333, Taiwan (R.O.C.)

If you have any suggestion, please feel free to contact us as below information.

Tel: 886-3-271-8666

Fax: 886-3-318-0345

Email: ICC_Service@icertifi.com.tw

==END==



Summary

Mode	Max-N dB (Hz)	Max-OBW (Hz)	ITU-Code	Min-N dB (Hz)	Min-OBW (Hz)
5.15-5.25GHz	-	-	-	-	-
802.11a_Nss1,(6Mbps)_2TX	19.86M	16.312M	16M3D1D	18.99M	16.282M
802.11ax HEW20_Nss1,(MCS0)_2TX-OFDMA	20.94M	18.891M	18M9D1D	20.73M	18.861M
802.11ax HEW40_Nss1,(MCS0)_2TX-OFDMA	40.32M	37.781M	37M8D1D	39.96M	37.601M
802.11ax HEW80_Nss1,(MCS0)_2TX-OFDMA	81.72M	76.882M	76M9D1D	81.48M	76.762M
802.11ax HEW160_Nss1,(MCS0)_2TX-OFDMA	82.4M	78.521M	78M5D1D	81.92M	78.121M
5.25-5.35GHz	-	-	-	-	-
802.11a_Nss1,(6Mbps)_2TX	19.68M	16.312M	16M3D1D	18.96M	16.282M
802.11ax HEW20_Nss1,(MCS0)_2TX-OFDMA	20.97M	18.891M	18M9D1D	20.82M	18.861M
802.11ax HEW40_Nss1,(MCS0)_2TX-OFDMA	40.32M	37.781M	37M8D1D	40.08M	37.721M
802.11ax HEW80_Nss1,(MCS0)_2TX-OFDMA	81.48M	76.882M	76M9D1D	81.24M	76.762M
802.11ax HEW160_Nss1,(MCS0)_2TX-OFDMA	84M	78.521M	78M5D1D	82M	78.121M
5.47-5.725GHz	-	-	-	-	-
802.11a_Nss1,(6Mbps)_2TX	19.8M	16.312M	16M3D1D	14.43M	13.073M
802.11ax HEW20_Nss1,(MCS0)_2TX-OFDMA	21M	18.921M	18M9D1D	15.285M	14.363M
802.11ax HEW40_Nss1,(MCS0)_2TX-OFDMA	40.56M	37.841M	37M8D1D	35.07M	33.653M
802.11ax HEW80_Nss1,(MCS0)_2TX-OFDMA	81.48M	77.001M	77M0D1D	75.375M	72.714M
802.11ax HEW160_Nss1,(MCS0)_2TX-OFDMA	167.04M	155.682M	156MD1D	163.92M	155.202M
5.725-5.85GHz	-	-	-	-	-
802.11a_Nss1,(6Mbps)_2TX	15.12M	16.282M	16M3D1D	2.88M	3.598M
802.11ax HEW20_Nss1,(MCS0)_2TX-OFDMA	18.75M	18.921M	18M9D1D	4.46M	4.638M
802.11ax HEW40_Nss1,(MCS0)_2TX-OFDMA	34.98M	37.841M	37M8D1D	3.76M	4.218M
802.11ax HEW80_Nss1,(MCS0)_2TX-OFDMA	75M	77.001M	77M0D1D	3.96M	4.418M

Max-N dB = Maximum 6dB down bandwidth for 5.725-5.85GHz band / Maximum 26dB down bandwidth for other band;
 Max-OBW = Maximum 99% occupied bandwidth;
 Min-N dB = Minimum 6dB down bandwidth for 5.725-5.85GHz band / Maximum 26dB down bandwidth for other band;
 Min-OBW = Minimum 99% occupied bandwidth



Result

Mode	Result	Limit (Hz)	Port 1-N dB (Hz)	Port 1-OBW (Hz)	Port 2-N dB (Hz)	Port 2-OBW (Hz)
802.11a_Nss1,(6Mbps)_2TX	-	-	-	-	-	-
5180MHz	Pass	Inf	19.53M	16.312M	18.99M	16.312M
5200MHz	Pass	Inf	19.86M	16.312M	19.56M	16.312M
5240MHz	Pass	Inf	19.74M	16.282M	19.47M	16.282M
5260MHz	Pass	Inf	19.47M	16.282M	18.96M	16.282M
5300MHz	Pass	Inf	19.59M	16.312M	19.41M	16.282M
5320MHz	Pass	Inf	19.68M	16.282M	19.44M	16.282M
5500MHz	Pass	Inf	19.68M	16.282M	19.41M	16.312M
5580MHz	Pass	Inf	19.53M	16.282M	19.38M	16.282M
5700MHz	Pass	Inf	19.8M	16.282M	19.5M	16.282M
5720MHz Straddle 5.47-5.725GHz	Pass	Inf	15.165M	13.073M	14.43M	13.088M
5720MHz Straddle 5.725-5.85GHz	Pass	500k	2.88M	3.598M	3.14M	3.698M
5745MHz	Pass	500k	15.06M	16.282M	15M	16.282M
5785MHz	Pass	500k	15.12M	16.282M	15.03M	16.252M
5825MHz	Pass	500k	15.09M	16.282M	14.37M	16.252M
802.11ax HEW20_Nss1,(MCS0)_2TX-OFDMA	-	-	-	-	-	-
5180MHz	Pass	Inf	20.73M	18.861M	20.79M	18.861M
5200MHz	Pass	Inf	20.94M	18.861M	20.94M	18.891M
5240MHz	Pass	Inf	20.85M	18.891M	20.94M	18.891M
5260MHz	Pass	Inf	20.85M	18.891M	20.88M	18.861M
5300MHz	Pass	Inf	20.97M	18.861M	20.82M	18.861M
5320MHz	Pass	Inf	20.85M	18.891M	20.94M	18.861M
5500MHz	Pass	Inf	21M	18.891M	20.73M	18.831M
5580MHz	Pass	Inf	21M	18.891M	20.79M	18.891M
5700MHz	Pass	Inf	20.97M	18.921M	20.82M	18.891M
5720MHz Straddle 5.47-5.725GHz	Pass	Inf	15.285M	14.393M	15.33M	14.363M
5720MHz Straddle 5.725-5.85GHz	Pass	500k	4.46M	4.658M	4.48M	4.638M
5745MHz	Pass	500k	15.03M	18.921M	18.75M	18.921M
5785MHz	Pass	500k	15.06M	18.891M	17.19M	18.891M
5825MHz	Pass	500k	18.63M	18.861M	18.72M	18.921M
802.11ax HEW40_Nss1,(MCS0)_2TX-OFDMA	-	-	-	-	-	-
5190MHz	Pass	Inf	39.96M	37.721M	40.02M	37.601M
5230MHz	Pass	Inf	40.32M	37.721M	40.26M	37.781M
5270MHz	Pass	Inf	40.26M	37.721M	40.32M	37.781M
5310MHz	Pass	Inf	40.08M	37.721M	40.32M	37.721M
5510MHz	Pass	Inf	40.08M	37.781M	40.14M	37.721M
5590MHz	Pass	Inf	40.02M	37.721M	40.08M	37.781M
5670MHz	Pass	Inf	40.14M	37.841M	40.56M	37.721M
5710MHz Straddle 5.47-5.725GHz	Pass	Inf	35.07M	33.653M	35.14M	33.723M
5710MHz Straddle 5.725-5.85GHz	Pass	500k	4.02M	4.218M	3.76M	4.218M
5755MHz	Pass	500k	33.78M	37.841M	32.58M	37.841M
5795MHz	Pass	500k	34.98M	37.841M	34.98M	37.841M



Mode	Result	Limit (Hz)	Port 1-N dB (Hz)	Port 1-OBW (Hz)	Port 2-N dB (Hz)	Port 2-OBW (Hz)
802.11ax HEW80_Nss1,(MCS0)_2TX-OFDMA	-	-	-	-	-	-
5210MHz	Pass	Inf	81.48M	76.882M	81.72M	76.762M
5290MHz	Pass	Inf	81.48M	76.882M	81.24M	76.762M
5530MHz	Pass	Inf	81.48M	77.001M	81.24M	76.762M
5610MHz	Pass	Inf	81.24M	76.882M	81M	77.001M
5690MHz Straddle 5.47-5.725GHz	Pass	Inf	75.375M	72.714M	75.75M	72.714M
5690MHz Straddle 5.725-5.85GHz	Pass	500k	3.96M	4.598M	3.98M	4.418M
5775MHz	Pass	500k	75M	76.762M	73.68M	77.001M
802.11ax HEW160_Nss1,(MCS0)_2TX-OFDMA	-	-	-	-	-	-
5250MHz Straddle 5.15-5.25GHz	Pass	Inf	82.4M	78.121M	81.92M	78.521M
5250MHz Straddle 5.25-5.35GHz	Pass	Inf	84M	78.521M	82M	78.121M
5570MHz	Pass	Inf	167.04M	155.682M	163.92M	155.202M

Port X-N dB = Port X 6dB down bandwidth for 5.725-5.85GHz band / 26dB down bandwidth for other band
 Port X-OBW = Port X 99% occupied bandwidth



802.11a_Nss1,(6Mbps)_2TX

EBW

5180MHz

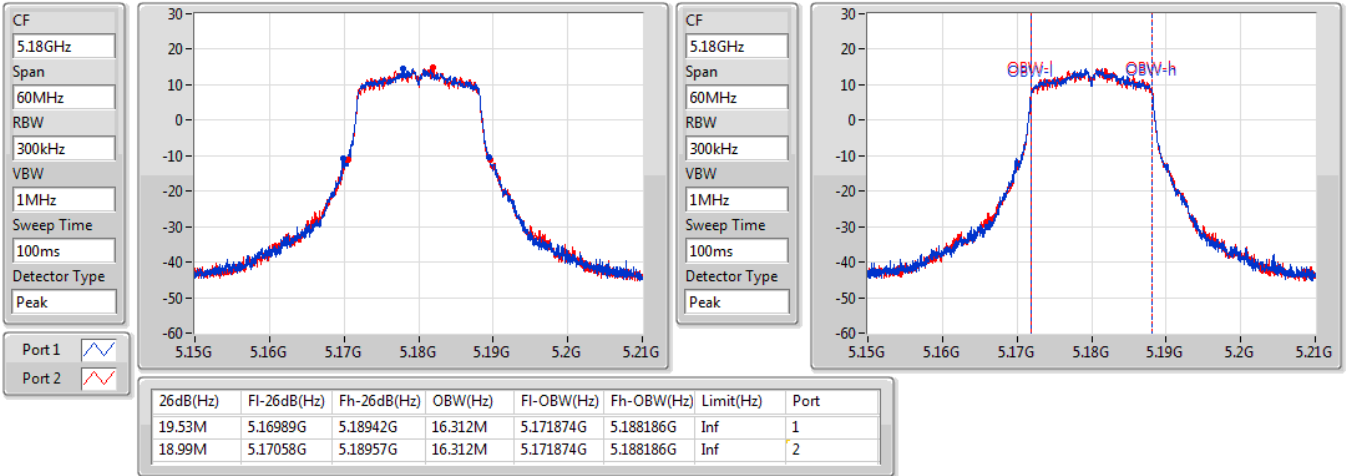

802.11a_Nss1,(6Mbps)_2TX

EBW

5200MHz

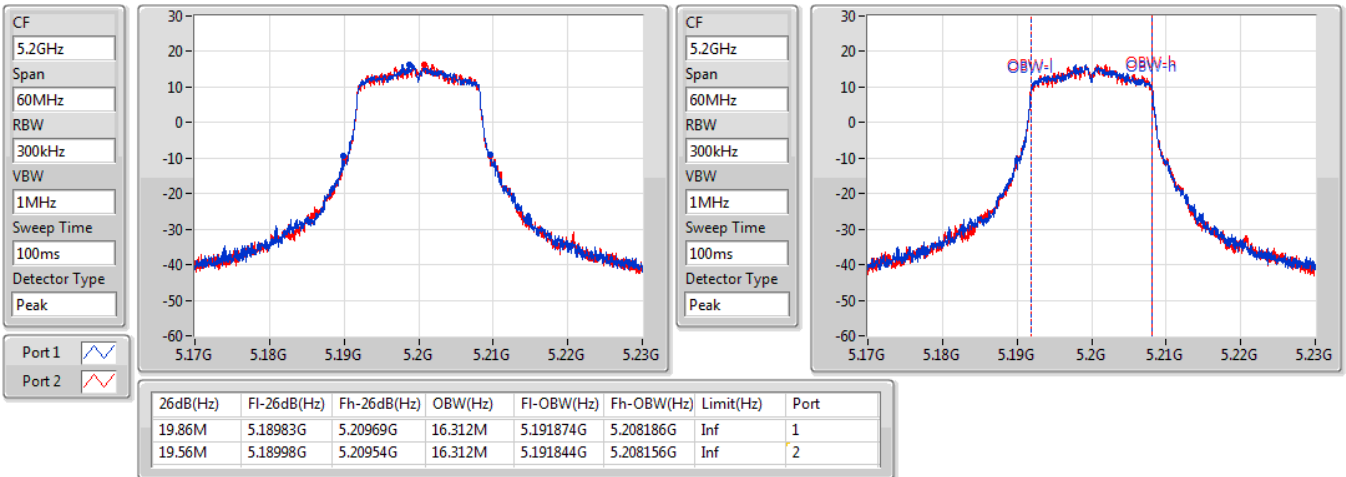



802.11a_Nss1,(6Mbps)_2TX

EBW

5240MHz

CF: 5.24GHz
 Span: 60MHz
 RBW: 300kHz
 VBW: 1MHz
 Sweep Time: 100ms
 Detector Type: Peak

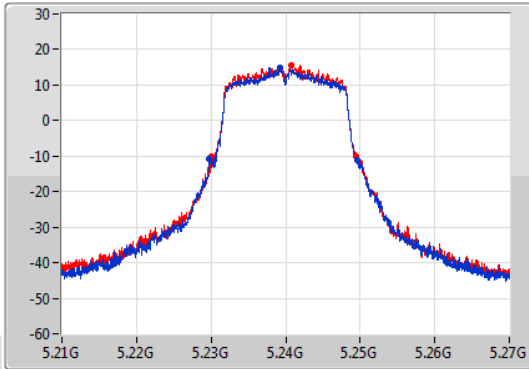

CF: 5.24GHz
 Span: 60MHz
 RBW: 300kHz
 VBW: 1MHz
 Sweep Time: 100ms
 Detector Type: Peak

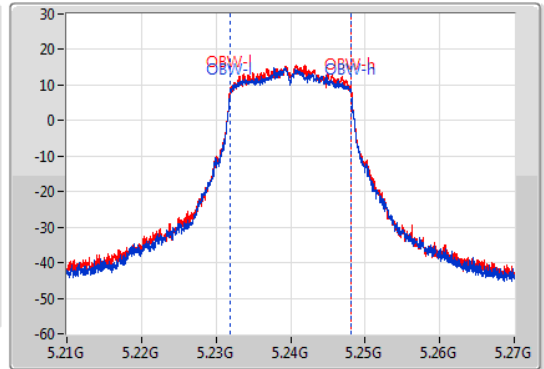

26dB(Hz)	Fl-26dB(Hz)	Fh-26dB(Hz)	OBW(Hz)	Fl-OBW(Hz)	Fh-OBW(Hz)	Limit(Hz)	Port
19.74M	5.2298G	5.24954G	16.282M	5.231874G	5.248156G	Inf	1
19.47M	5.23004G	5.24951G	16.282M	5.231874G	5.248156G	Inf	2

802.11a_Nss1,(6Mbps)_2TX

EBW

5260MHz

CF: 5.26GHz
 Span: 60MHz
 RBW: 300kHz
 VBW: 1MHz
 Sweep Time: 100ms
 Detector Type: Peak

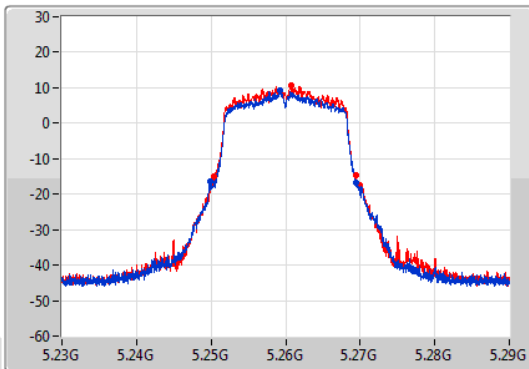

CF: 5.26GHz
 Span: 60MHz
 RBW: 300kHz
 VBW: 1MHz
 Sweep Time: 100ms
 Detector Type: Peak

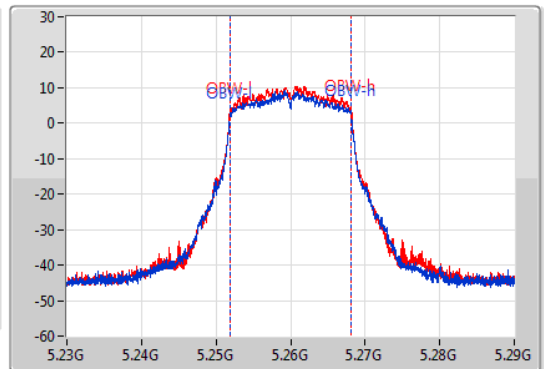

26dB(Hz)	Fl-26dB(Hz)	Fh-26dB(Hz)	OBW(Hz)	Fl-OBW(Hz)	Fh-OBW(Hz)	Limit(Hz)	Port
19.47M	5.24989G	5.26936G	16.282M	5.251874G	5.268156G	Inf	1
18.96M	5.25043G	5.26939G	16.282M	5.251874G	5.268156G	Inf	2



802.11a_Nss1,(6Mbps)_2TX

EBW

5300MHz

CF
5.3GHz

Span
60MHz

RBW
300kHz

VBW
1MHz

Sweep Time
100ms

Detector Type
Peak

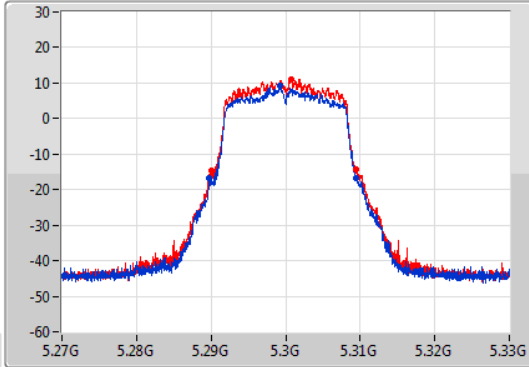

CF
5.3GHz

Span
60MHz

RBW
300kHz

VBW
1MHz

Sweep Time
100ms

Detector Type
Peak

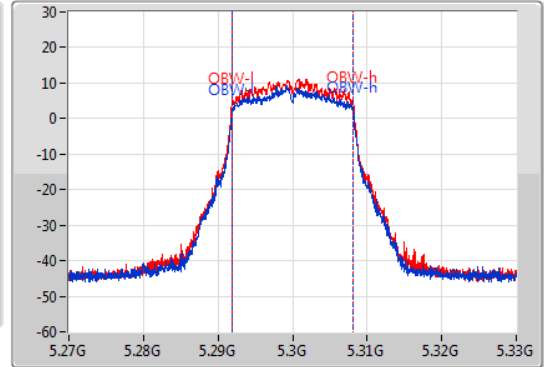

26dB(Hz)	Fl-26dB(Hz)	Fh-26dB(Hz)	OBW(Hz)	Fl-OBW(Hz)	Fh-OBW(Hz)	Limit(Hz)	Port
19.59M	5.2898G	5.30939G	16.312M	5.291874G	5.308186G	Inf	1
19.41M	5.29004G	5.30945G	16.282M	5.291874G	5.308156G	Inf	2

802.11a_Nss1,(6Mbps)_2TX

EBW

5320MHz

CF
5.32GHz

Span
60MHz

RBW
300kHz

VBW
1MHz

Sweep Time
100ms

Detector Type
Peak

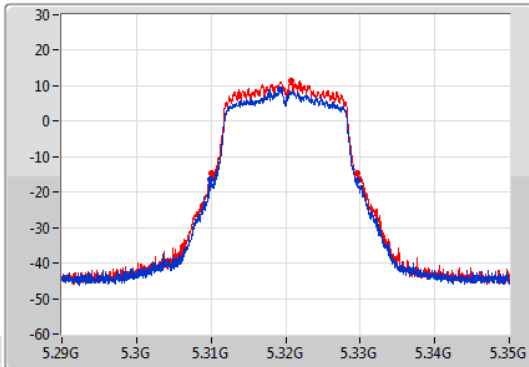

CF
5.32GHz

Span
60MHz

RBW
300kHz

VBW
1MHz

Sweep Time
100ms

Detector Type
Peak

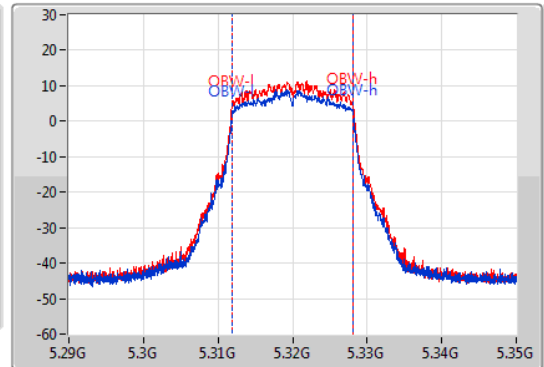

26dB(Hz)	Fl-26dB(Hz)	Fh-26dB(Hz)	OBW(Hz)	Fl-OBW(Hz)	Fh-OBW(Hz)	Limit(Hz)	Port
19.68M	5.30986G	5.32954G	16.282M	5.311874G	5.328156G	Inf	1
19.44M	5.3101G	5.32954G	16.282M	5.311874G	5.328156G	Inf	2



802.11a_Nss1,(6Mbps)_2TX

EBW

5500MHz

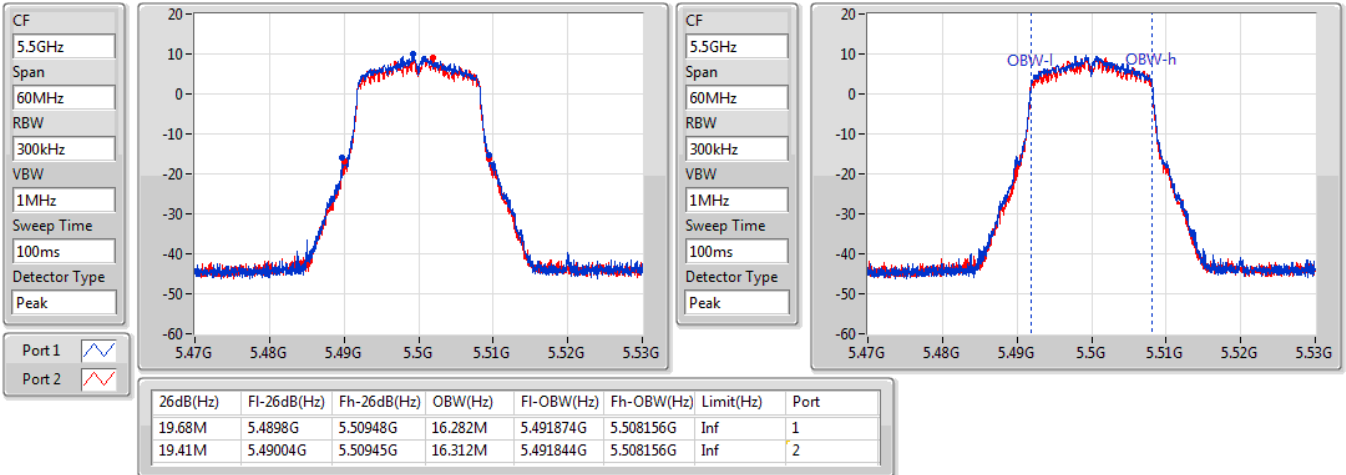

802.11a_Nss1,(6Mbps)_2TX

EBW

5580MHz

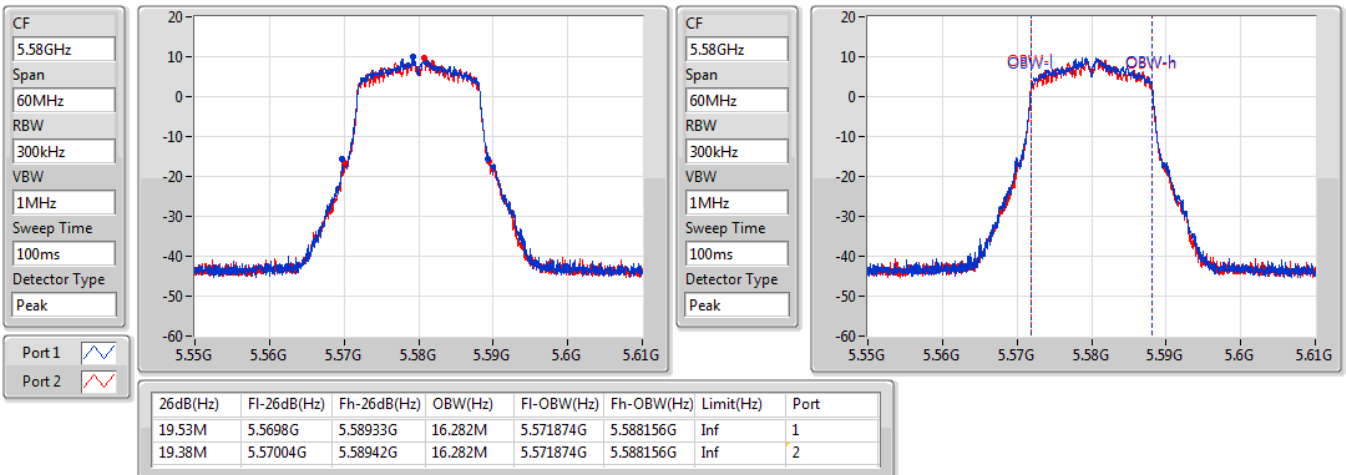



802.11a_Nss1,(6Mbps)_2TX

EBW

5700MHz

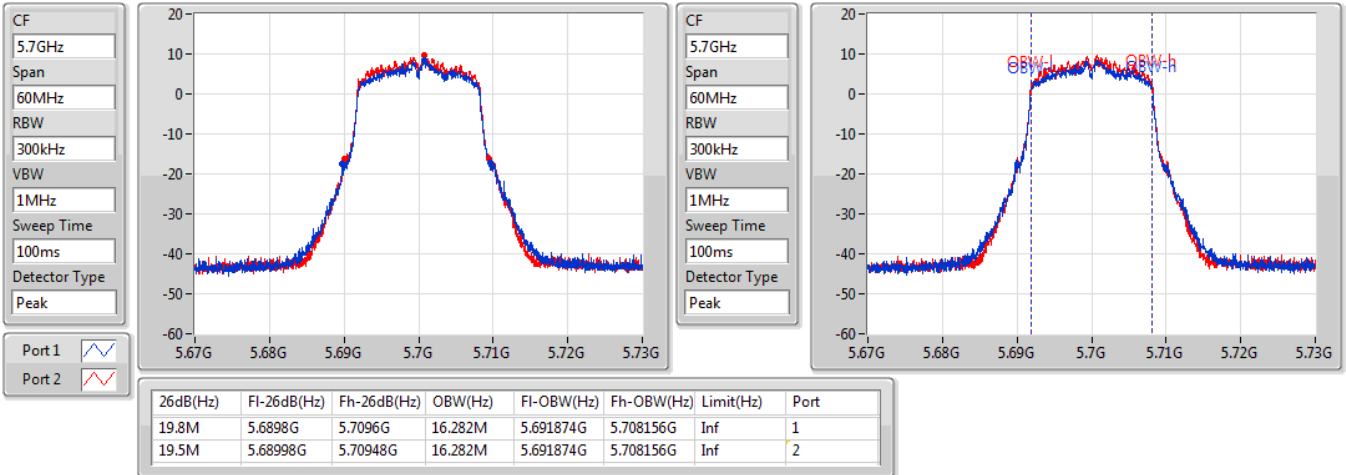

802.11a_Nss1,(6Mbps)_2TX

EBW

5720MHz Straddle 5.47-5.725GHz

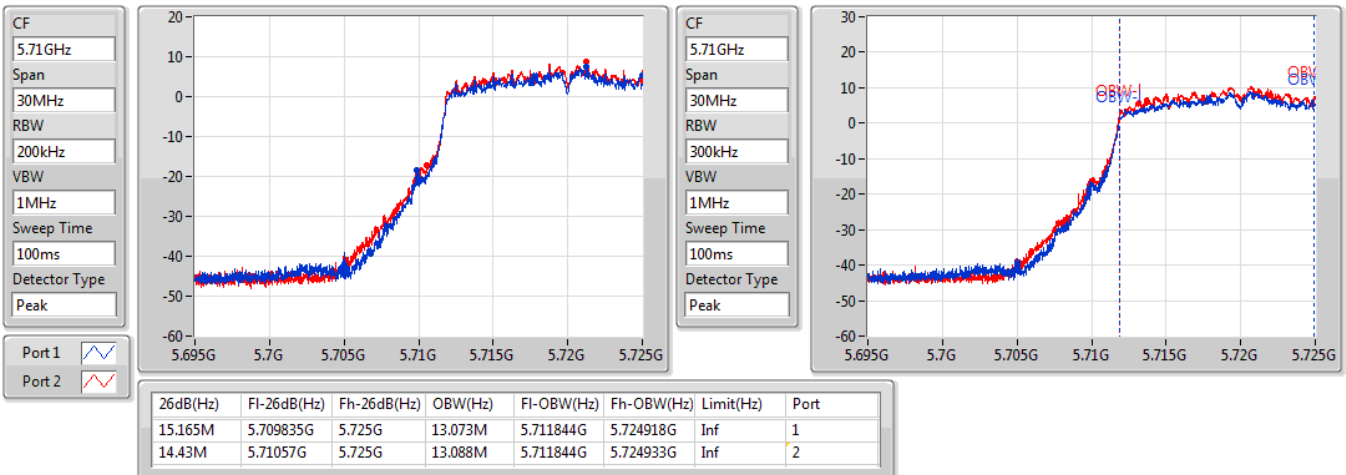

802.11a_Nss1,(6Mbps)_2TX

EBW

5720MHz Straddle 5.725-5.85GHz

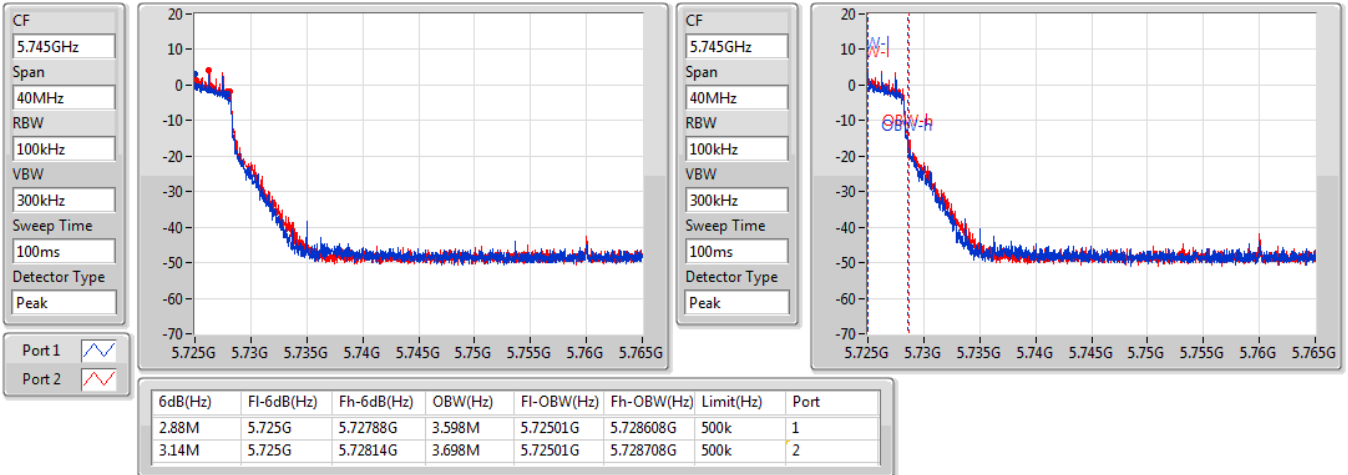

802.11a_Nss1,(6Mbps)_2TX

EBW

5720MHz Straddle 5.725-5.85GHz

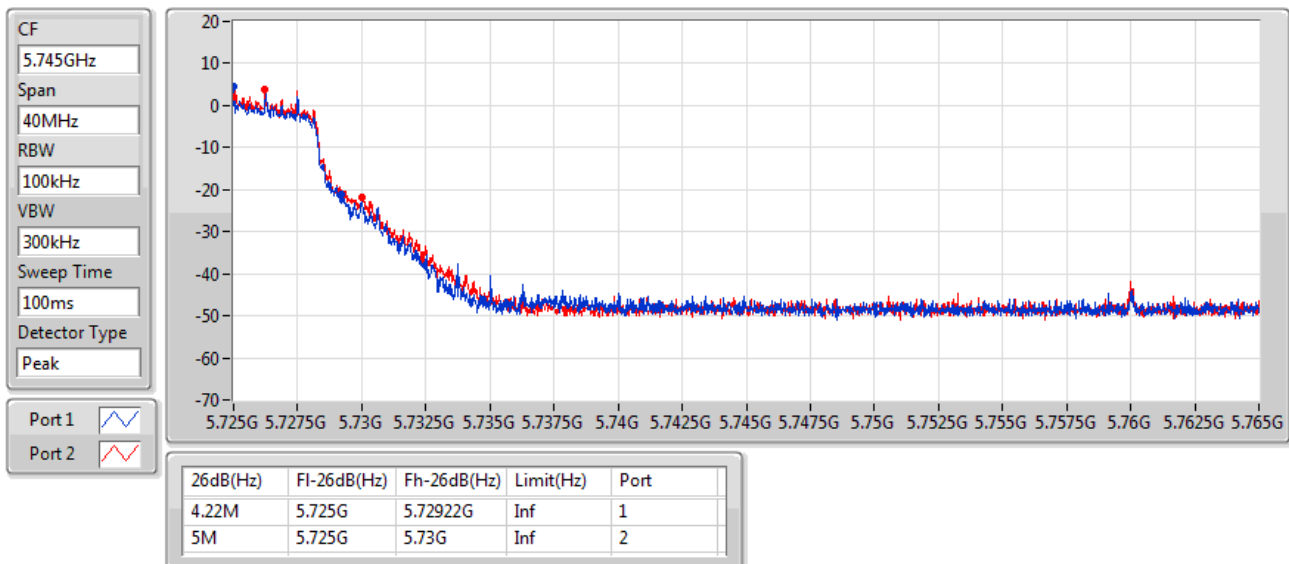



802.11a_Nss1,(6Mbps)_2TX

EBW

5745MHz

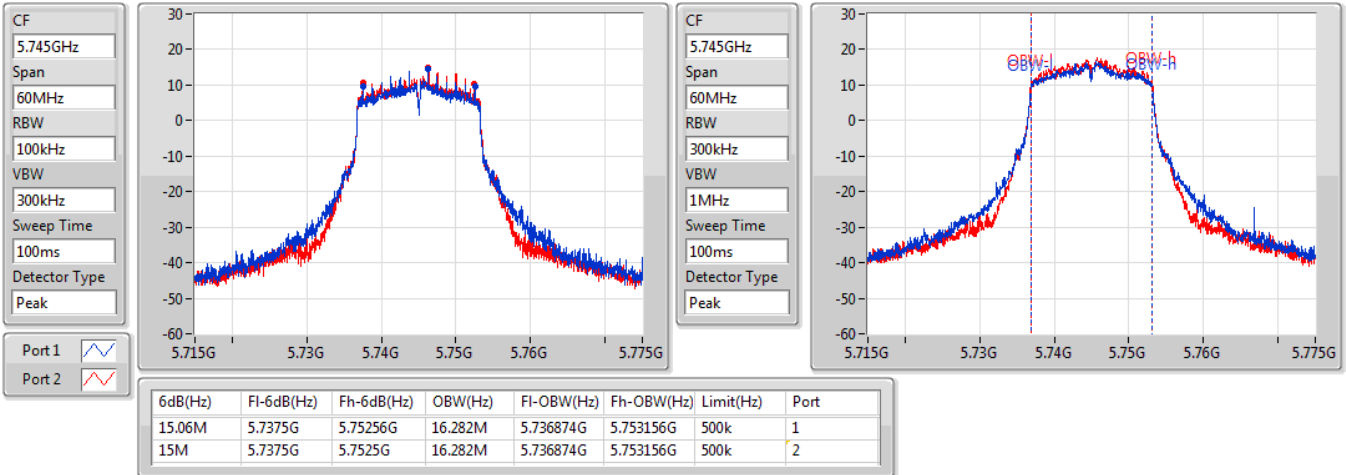

802.11a_Nss1,(6Mbps)_2TX

EBW

5745MHz

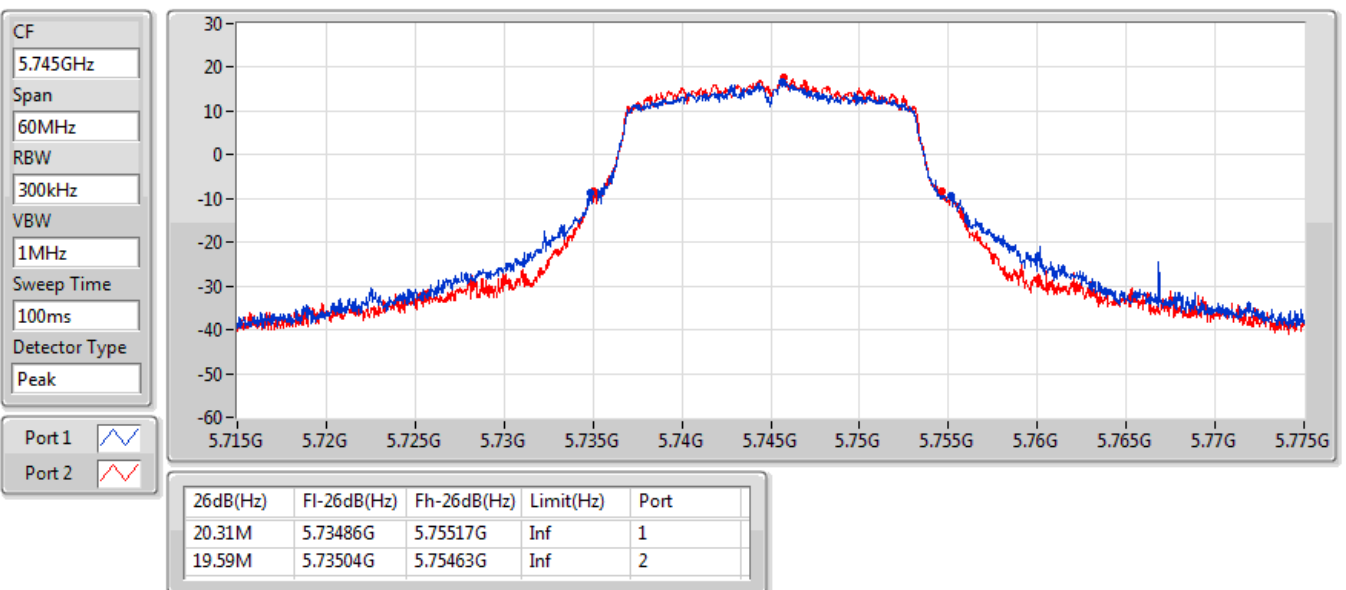



802.11a_Nss1,(6Mbps)_2TX

EBW

5785MHz

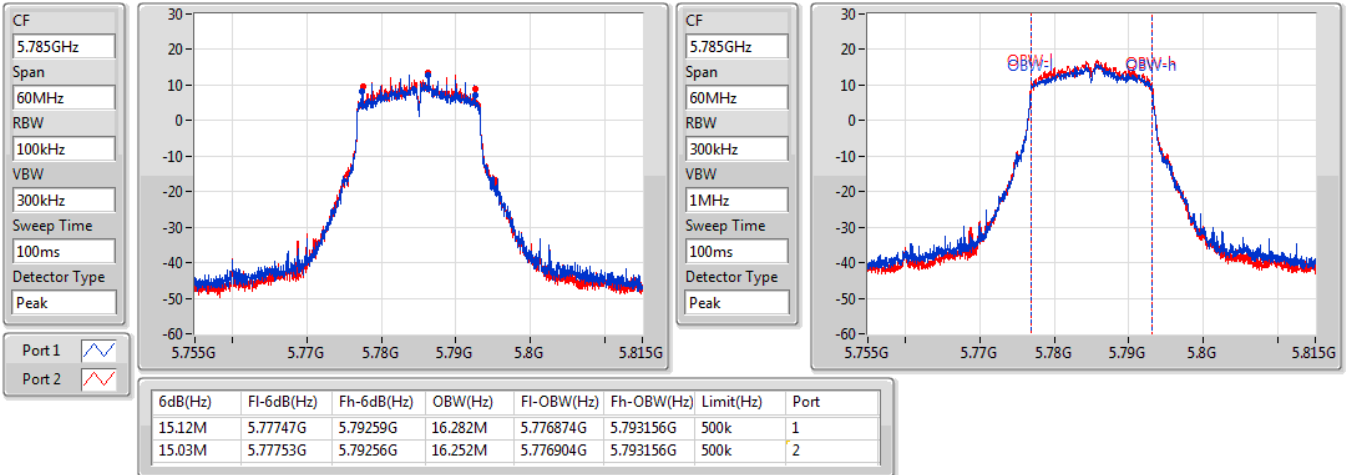

802.11a_Nss1,(6Mbps)_2TX

EBW

5785MHz

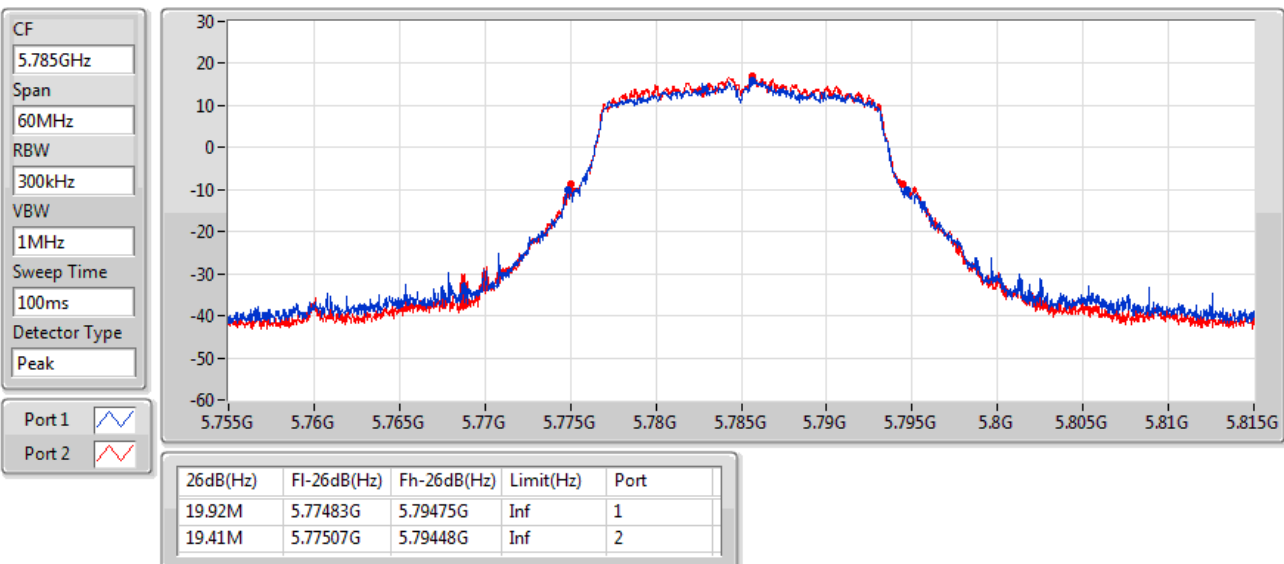

802.11a_Nss1,(6Mbps)_2TX

EBW

5825MHz

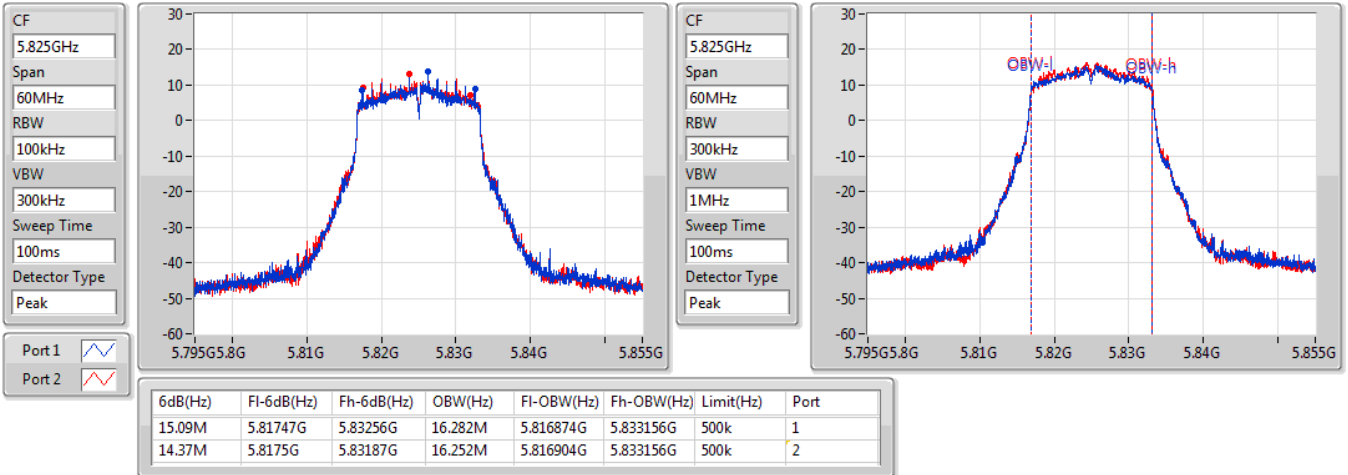

802.11a_Nss1,(6Mbps)_2TX

EBW

5825MHz

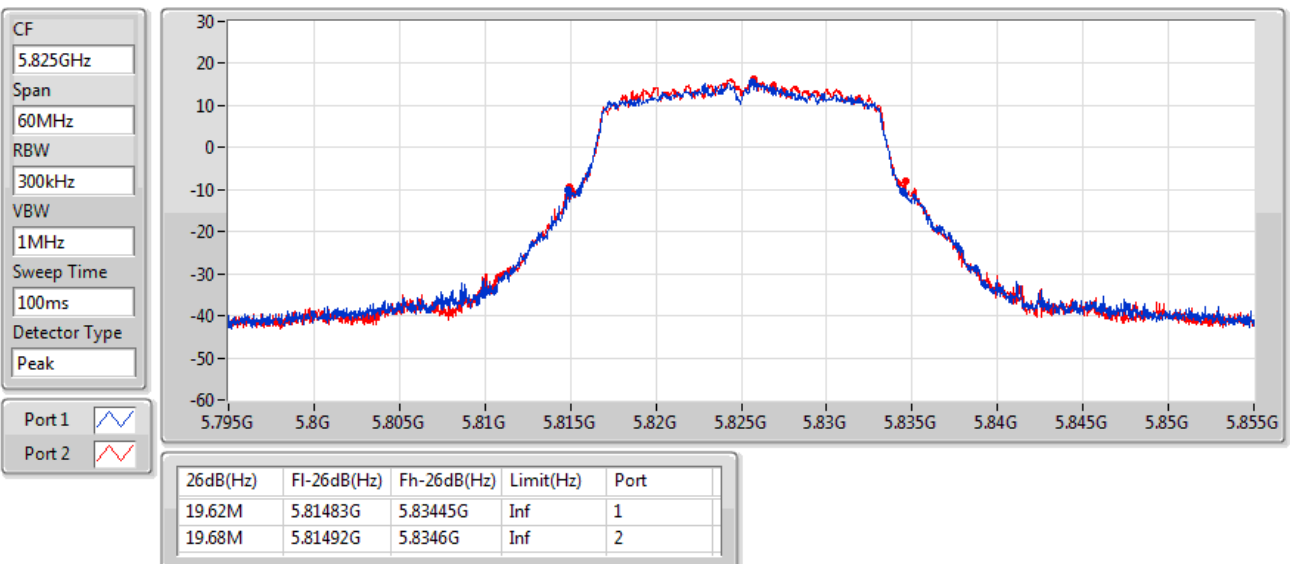



802.11ax HEW20_Nss1,(MCS0)_2TX

EBW

5180MHz

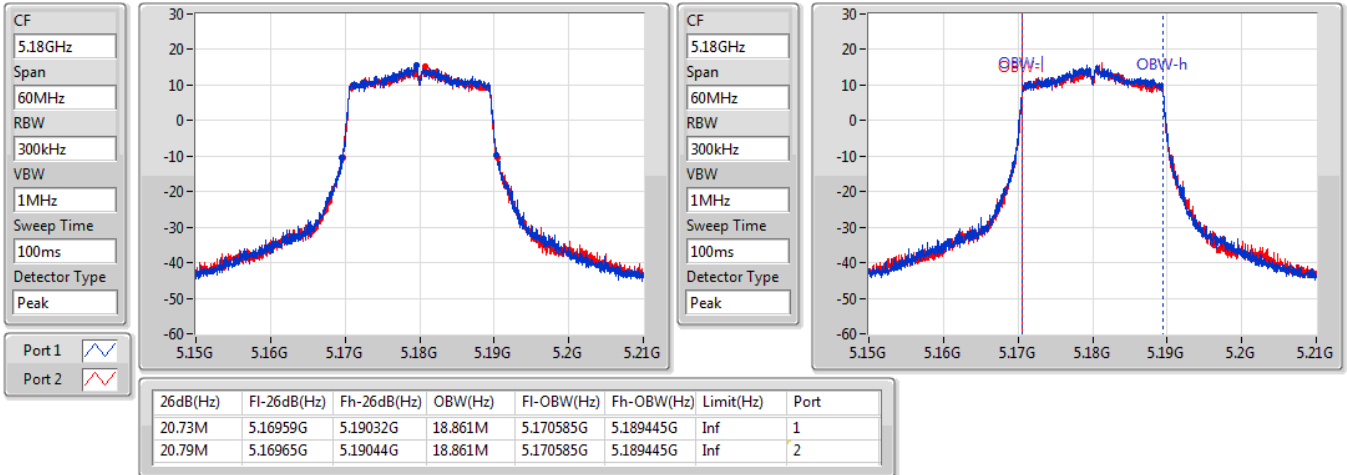

802.11ax HEW20_Nss1,(MCS0)_2TX

EBW

5200MHz

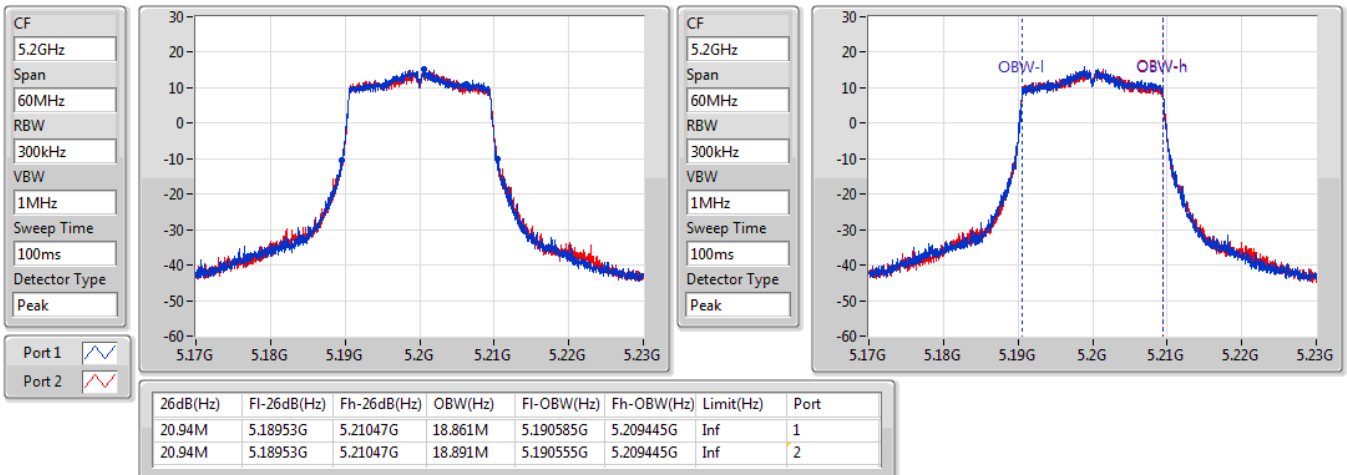



802.11ax HEW20_Nss1,(MCS0)_2TX

EBW

5240MHz

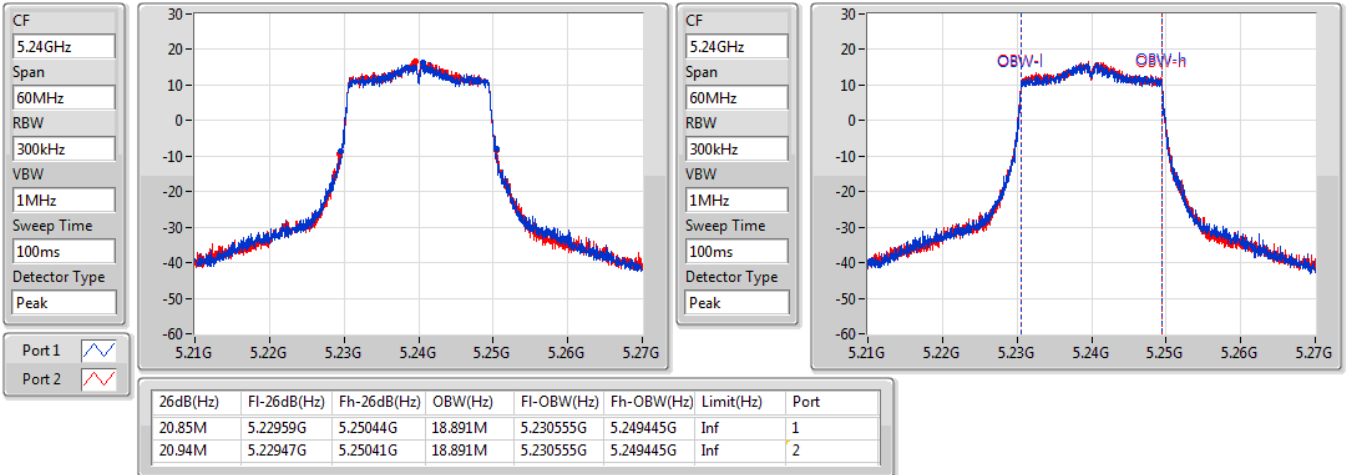

802.11ax HEW20_Nss1,(MCS0)_2TX

EBW

5260MHz

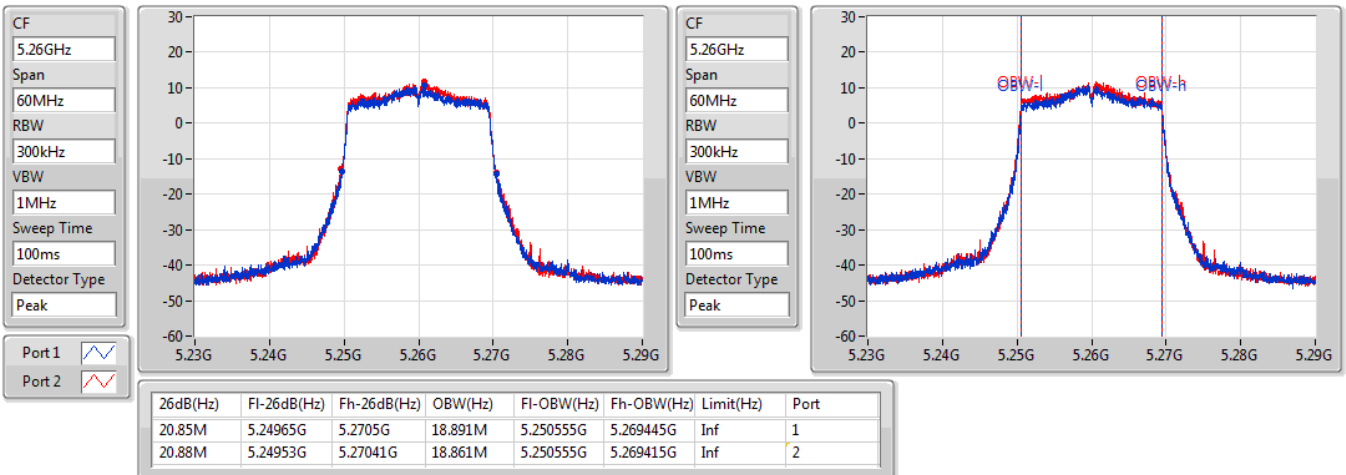



802.11ax HEW20_Nss1,(MCS0)_2TX

EBW

5300MHz

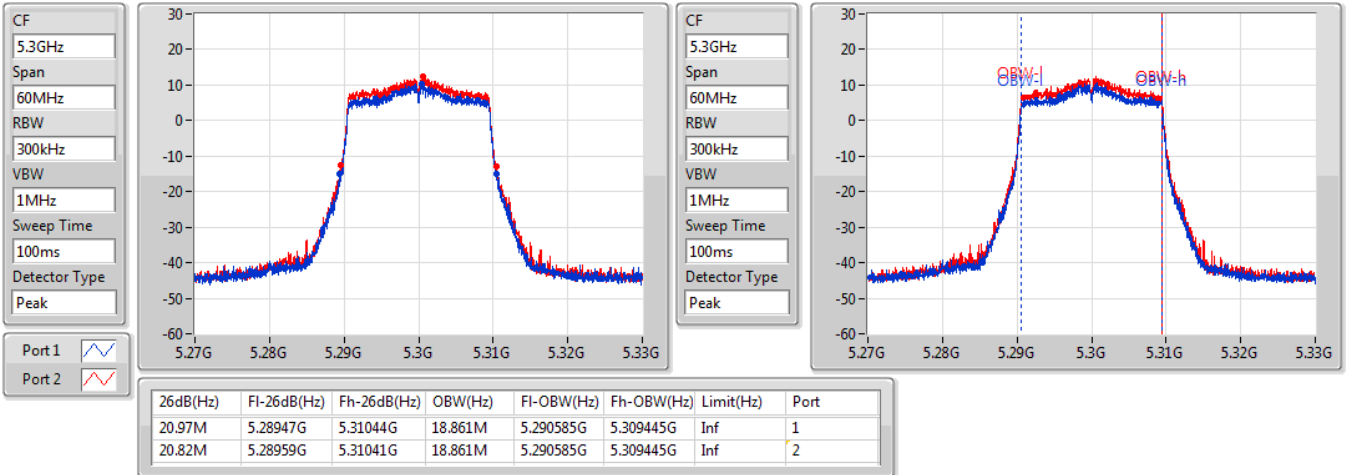

802.11ax HEW20_Nss1,(MCS0)_2TX

EBW

5320MHz

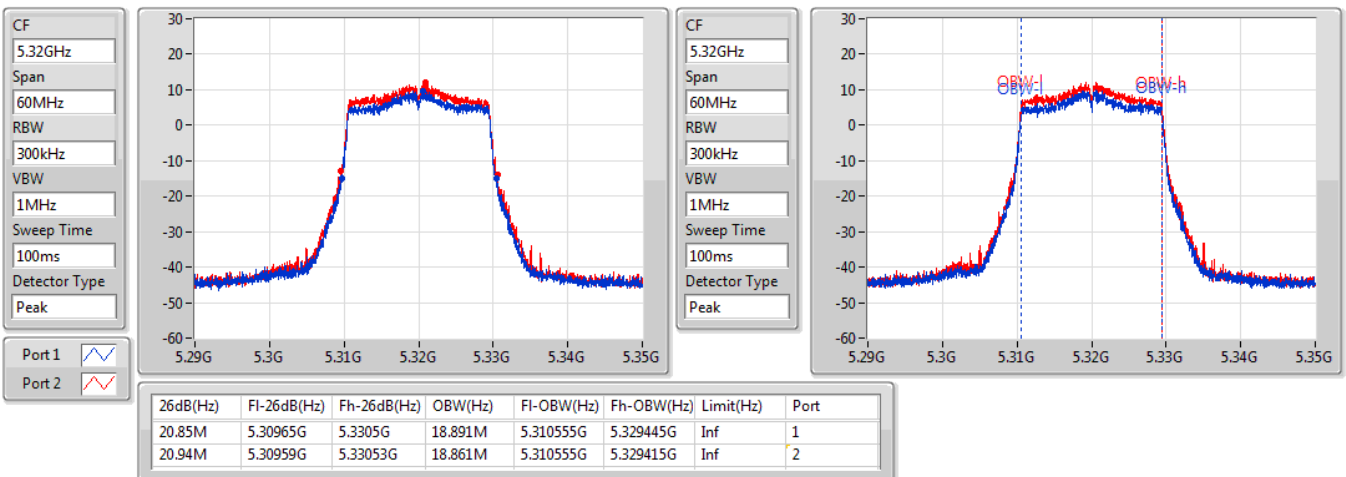



802.11ax HEW20_Nss1,(MCS0)_2TX

EBW

5500MHz

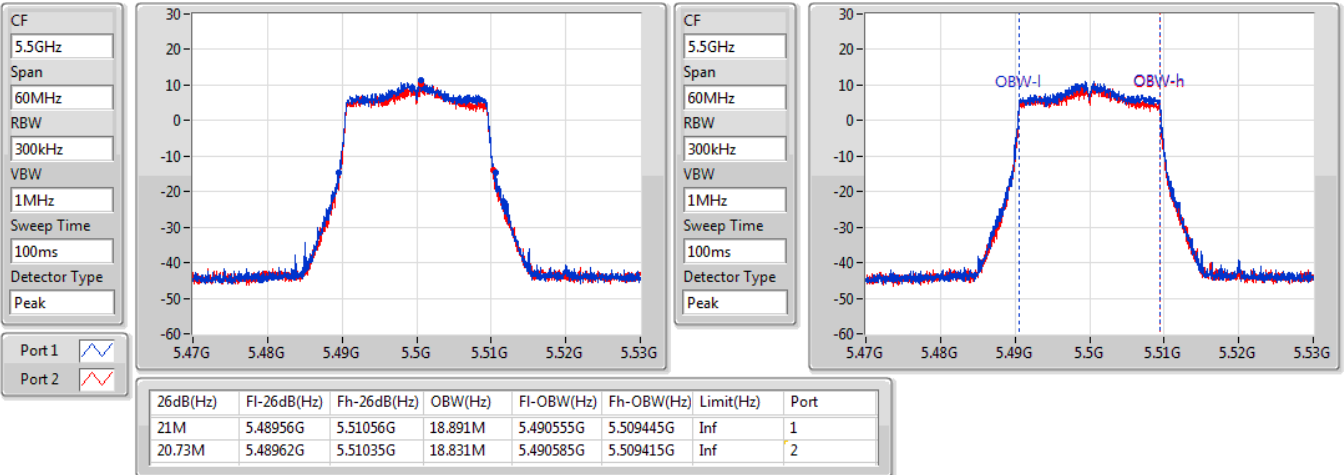

802.11ax HEW20_Nss1,(MCS0)_2TX

EBW

5580MHz

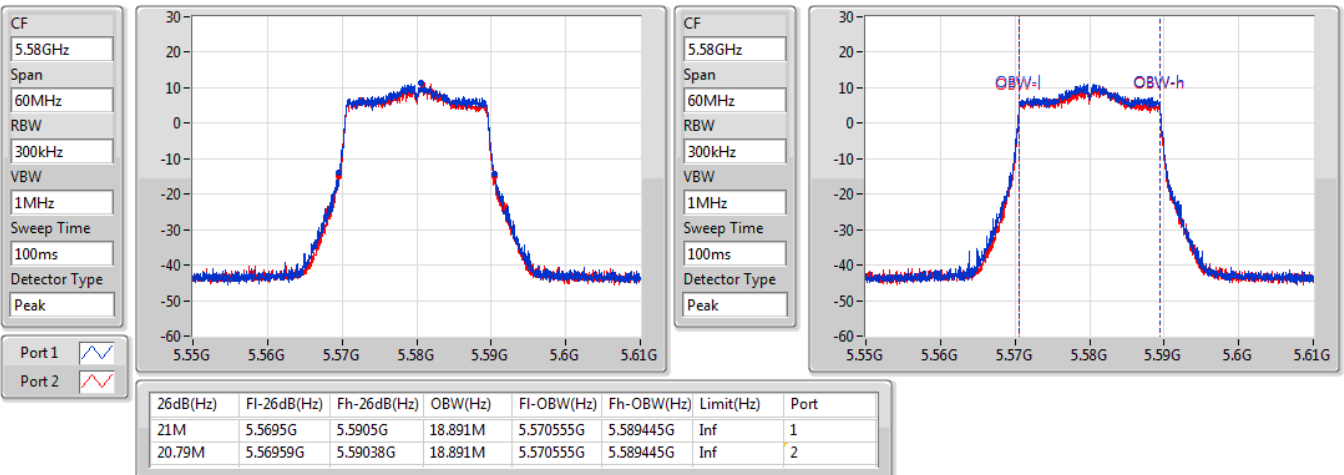



802.11ax HEW20_Nss1,(MCS0)_2TX

EBW

5700MHz

CF
5.7GHz
Span
60MHz
RBW
300kHz
VBW
1MHz
Sweep Time
100ms
Detector Type
Peak

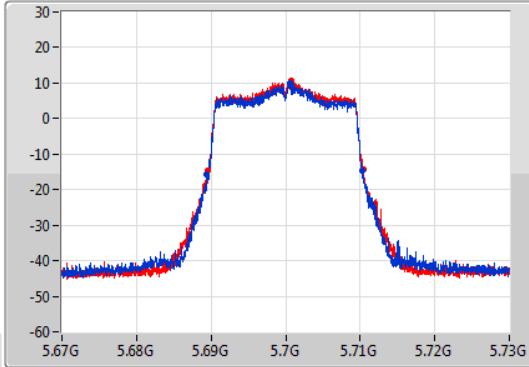

CF
5.7GHz
Span
60MHz
RBW
300kHz
VBW
1MHz
Sweep Time
100ms
Detector Type
Peak

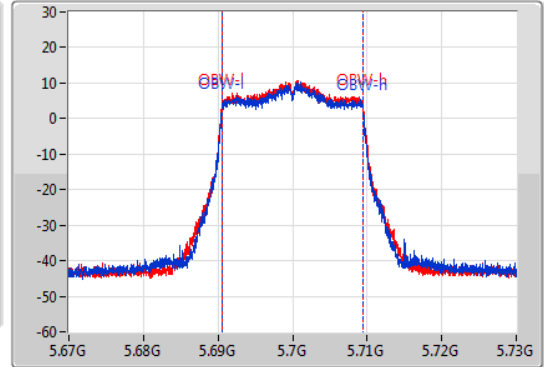

26dB(Hz)	Fl-26dB(Hz)	Fh-26dB(Hz)	OBW(Hz)	Fl-OBW(Hz)	Fh-OBW(Hz)	Limit(Hz)	Port
20.97M	5.68932G	5.71029G	18.921M	5.690525G	5.709445G	Inf	1
20.82M	5.68962G	5.71044G	18.891M	5.690555G	5.709445G	Inf	2

802.11ax HEW20_Nss1,(MCS0)_2TX

EBW

5720MHz Straddle 5.47-5.725GHz

CF
5.71GHz
Span
30MHz
RBW
200kHz
VBW
1MHz
Sweep Time
100ms
Detector Type
Peak

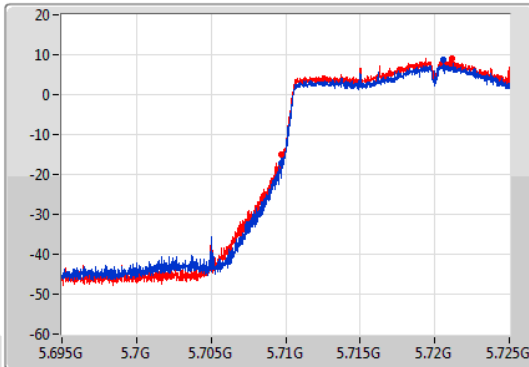

CF
5.71GHz
Span
30MHz
RBW
200kHz
VBW
1MHz
Sweep Time
100ms
Detector Type
Peak

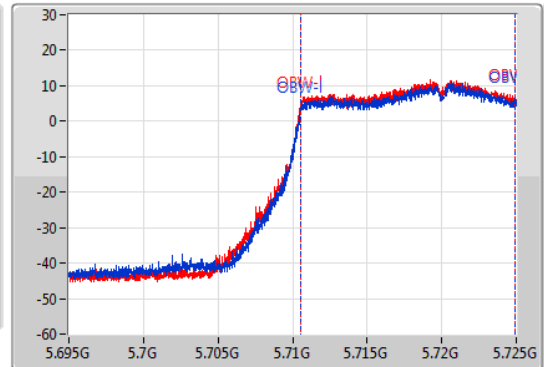

26dB(Hz)	Fl-26dB(Hz)	Fh-26dB(Hz)	OBW(Hz)	Fl-OBW(Hz)	Fh-OBW(Hz)	Limit(Hz)	Port
15.285M	5.709715G	5.725G	14.393M	5.71051G	5.724903G	Inf	1
15.33M	5.70967G	5.725G	14.363M	5.710525G	5.724888G	Inf	2



802.11ax HEW20_Nss1,(MCS0)_2TX

EBW

5720MHz Straddle 5.725-5.85GHz

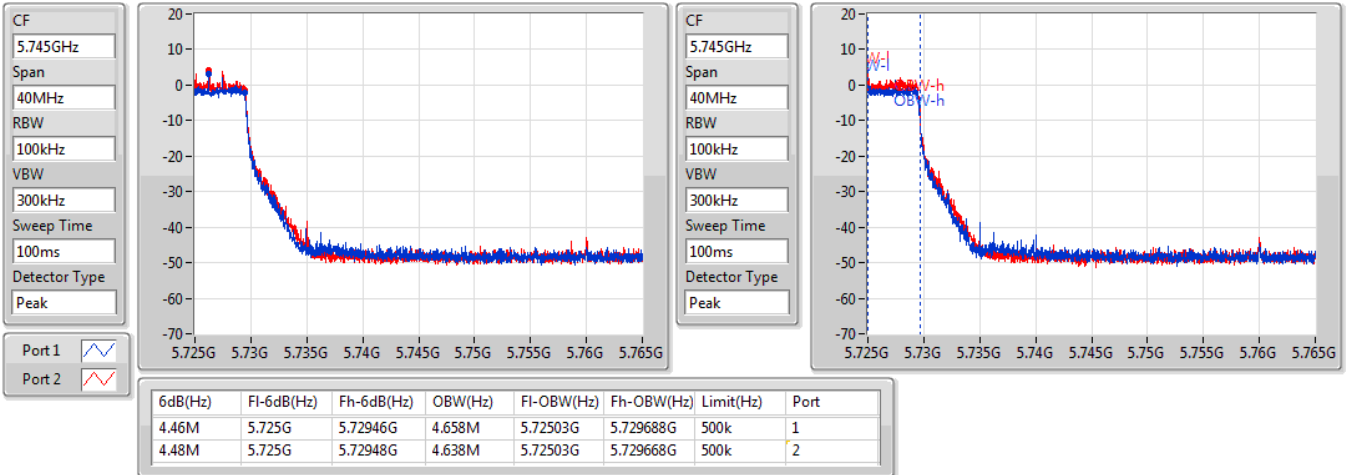

802.11ax HEW20_Nss1,(MCS0)_2TX

EBW

5720MHz Straddle 5.725-5.85GHz

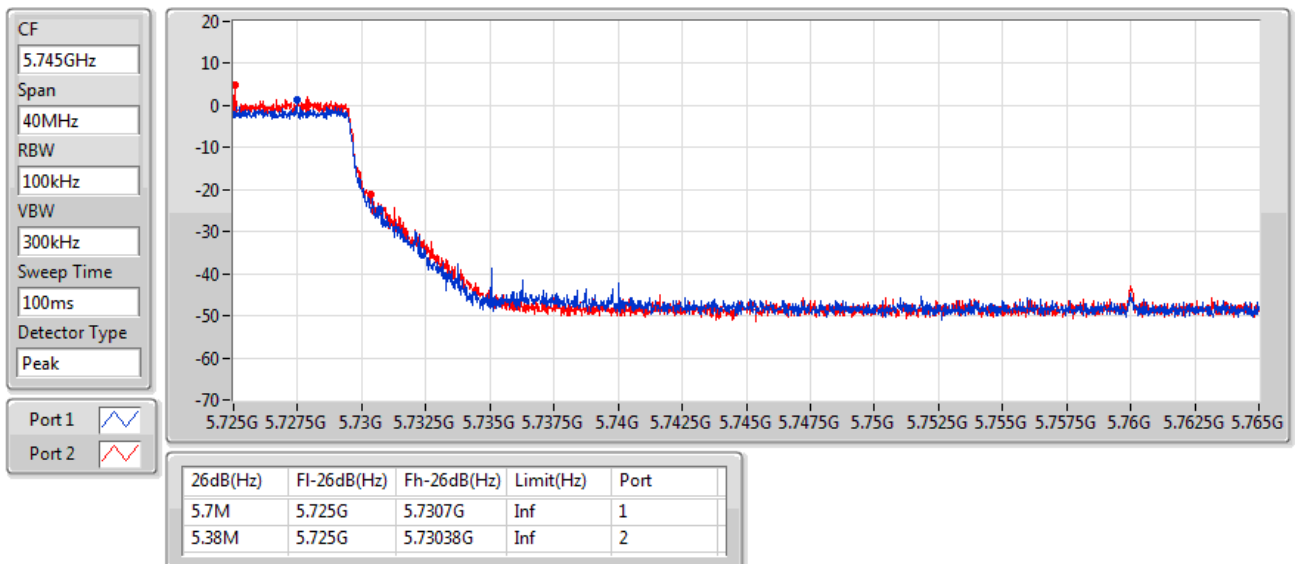



802.11ax HEW20_Nss1,(MCS0)_2TX

EBW

5745MHz

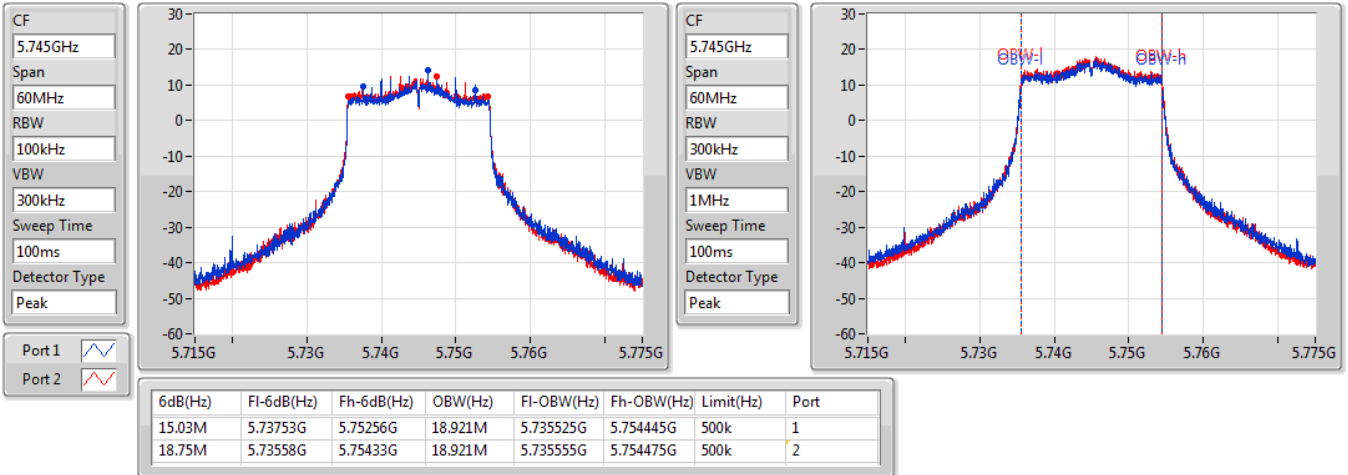

802.11ax HEW20_Nss1,(MCS0)_2TX

EBW

5745MHz

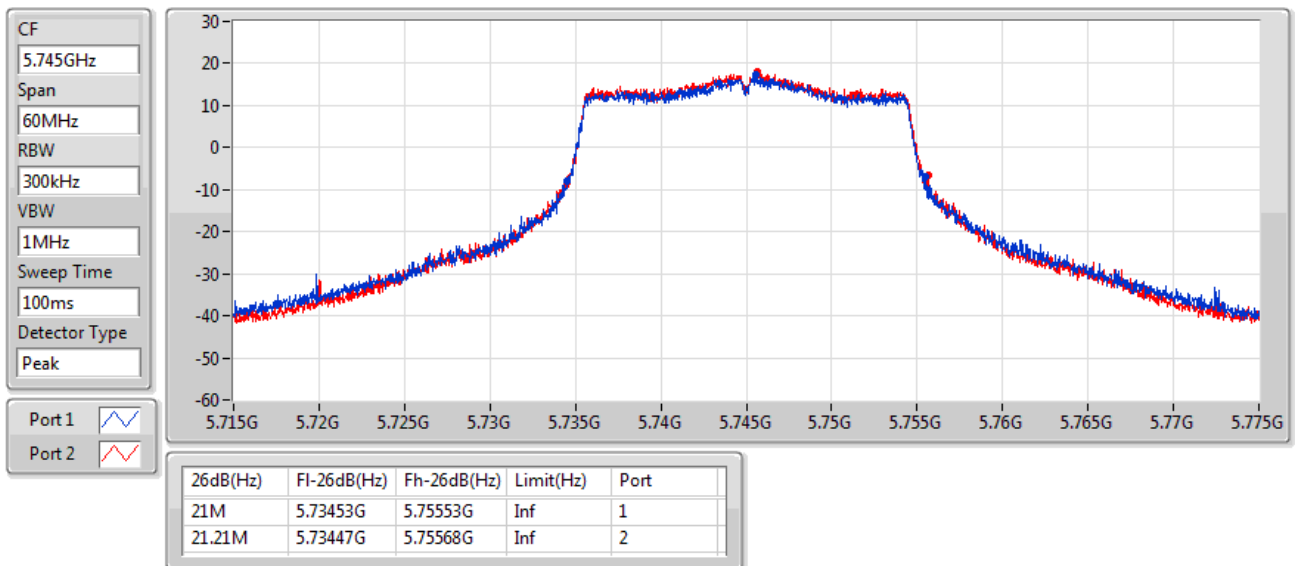

802.11ax HEW20_Nss1,(MCS0)_2TX

EBW

5785MHz

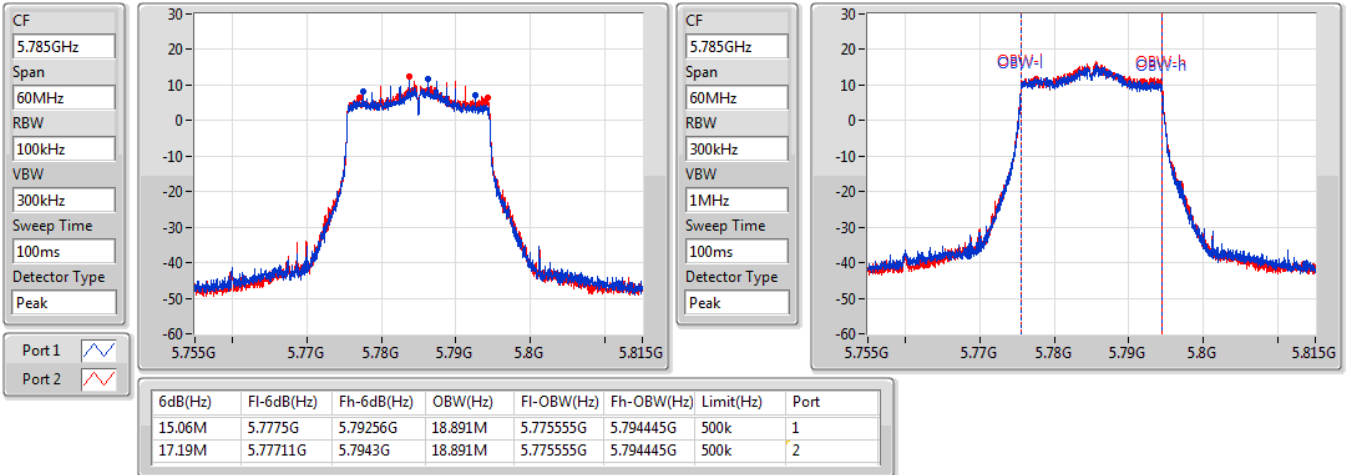

802.11ax HEW20_Nss1,(MCS0)_2TX

EBW

5785MHz

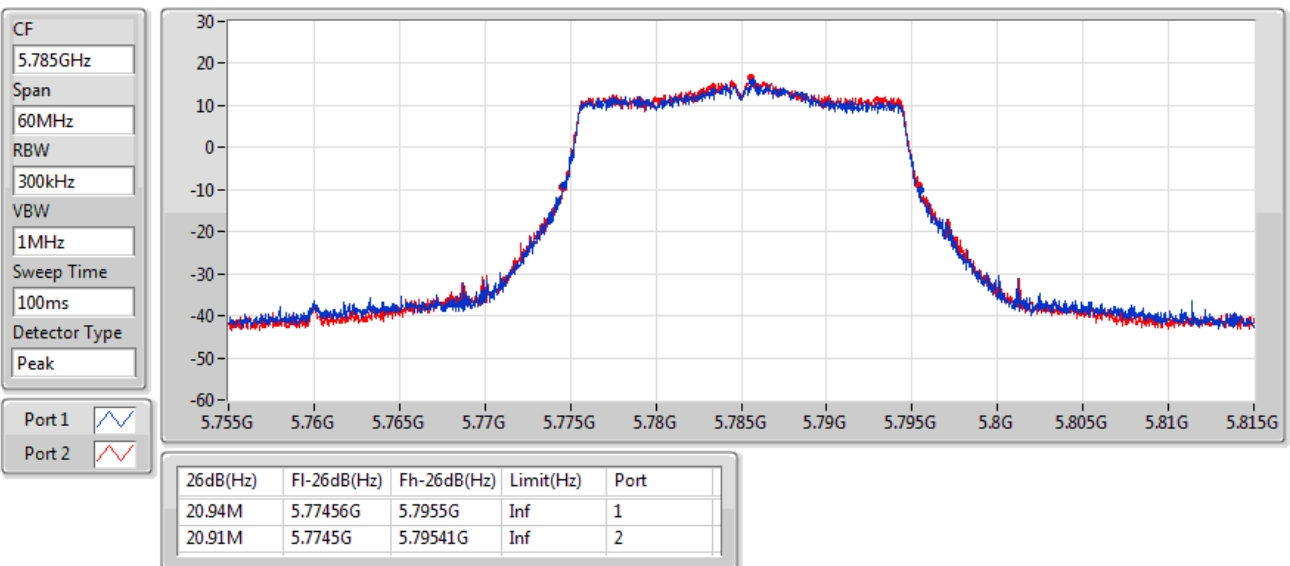



802.11ax HEW20_Nss1,(MCS0)_2TX

EBW

5825MHz

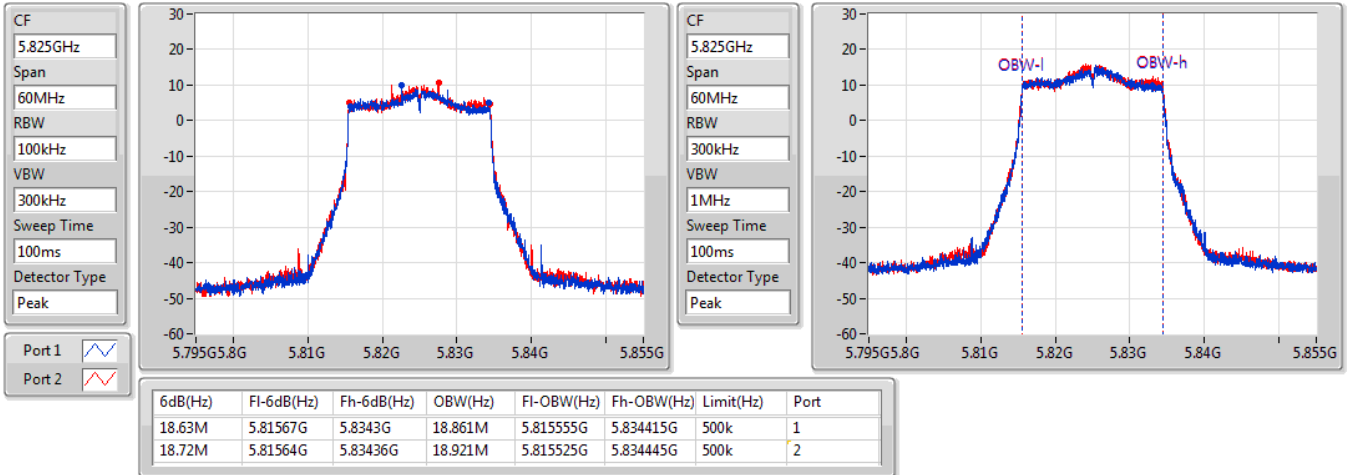

802.11ax HEW20_Nss1,(MCS0)_2TX

EBW

5825MHz

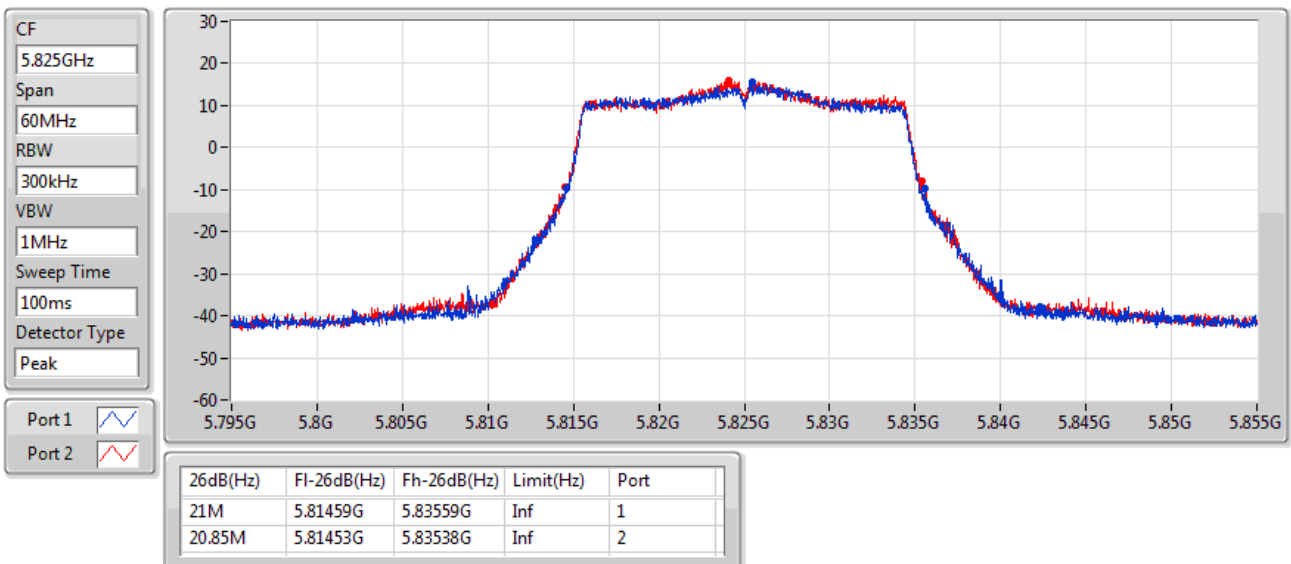



802.11ax HEW40_Nss1,(MCS0)_2TX

EBW

5190MHz

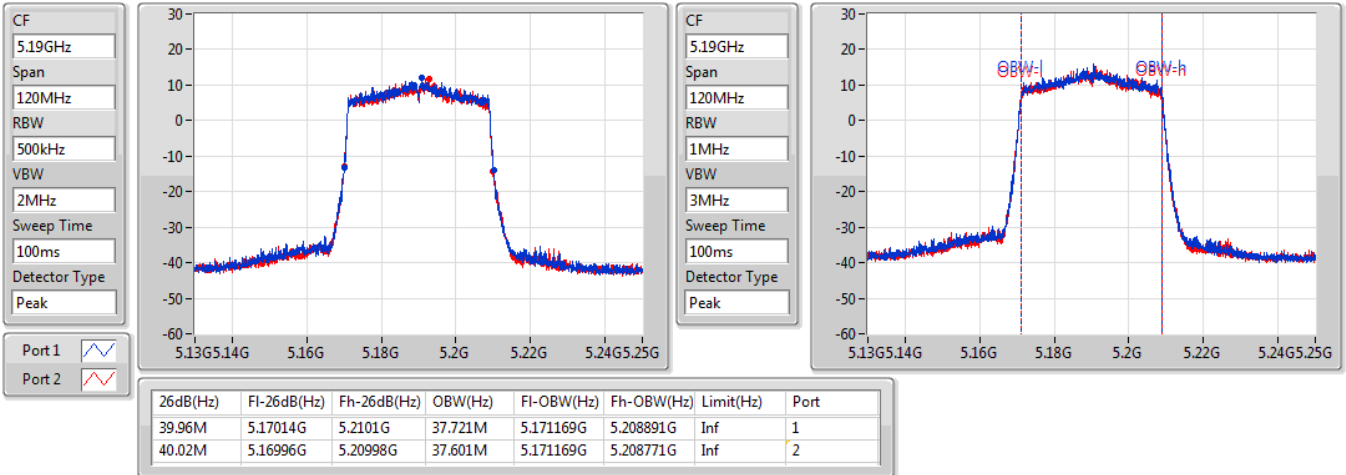

802.11ax HEW40_Nss1,(MCS0)_2TX

EBW

5230MHz

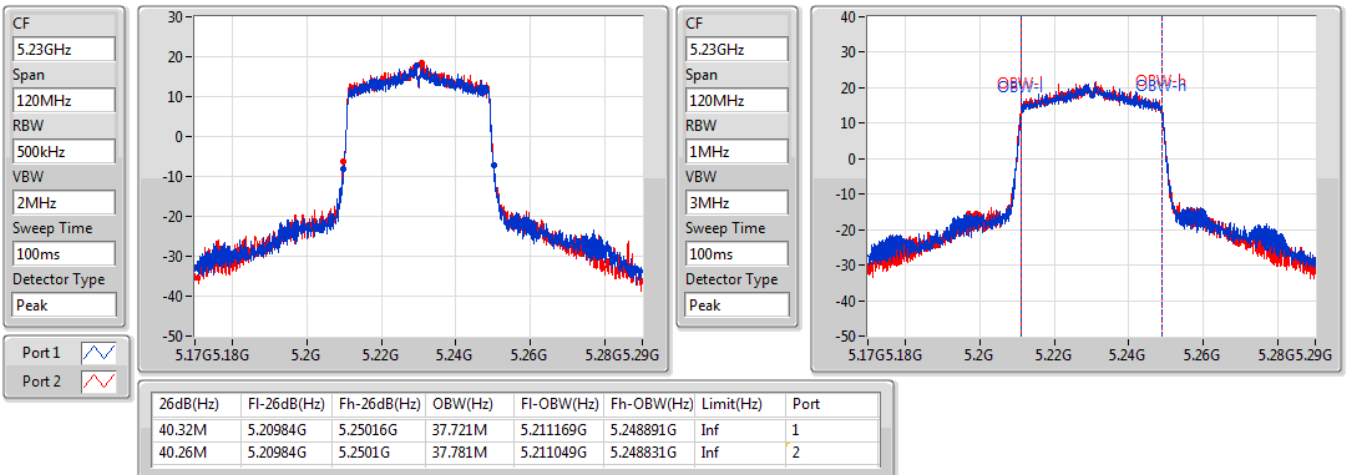



802.11ax HEW40_Nss1,(MCS0)_2TX

EBW

5270MHz

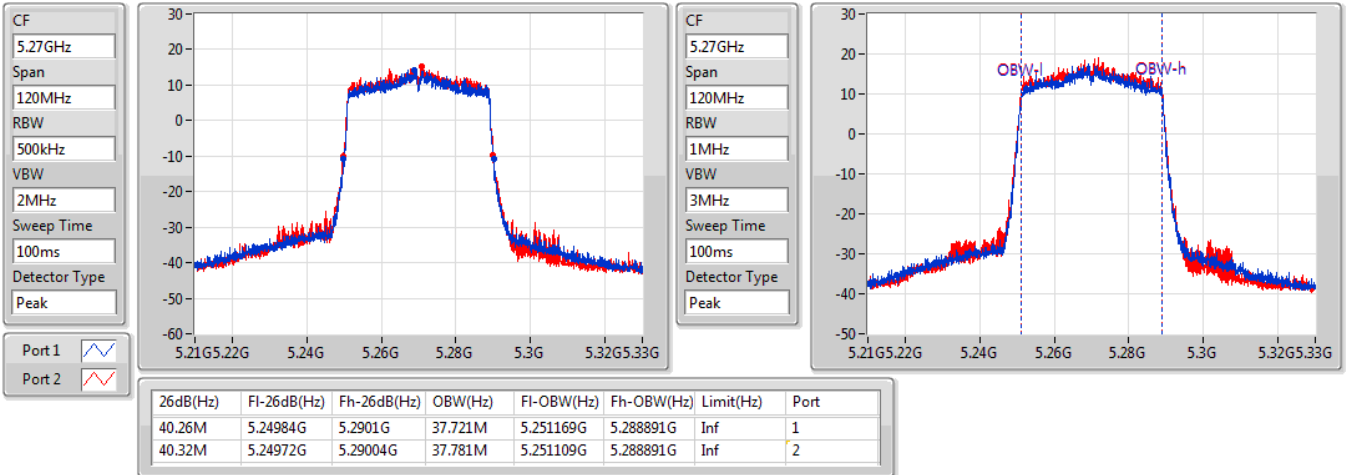

802.11ax HEW40_Nss1,(MCS0)_2TX

EBW

5310MHz

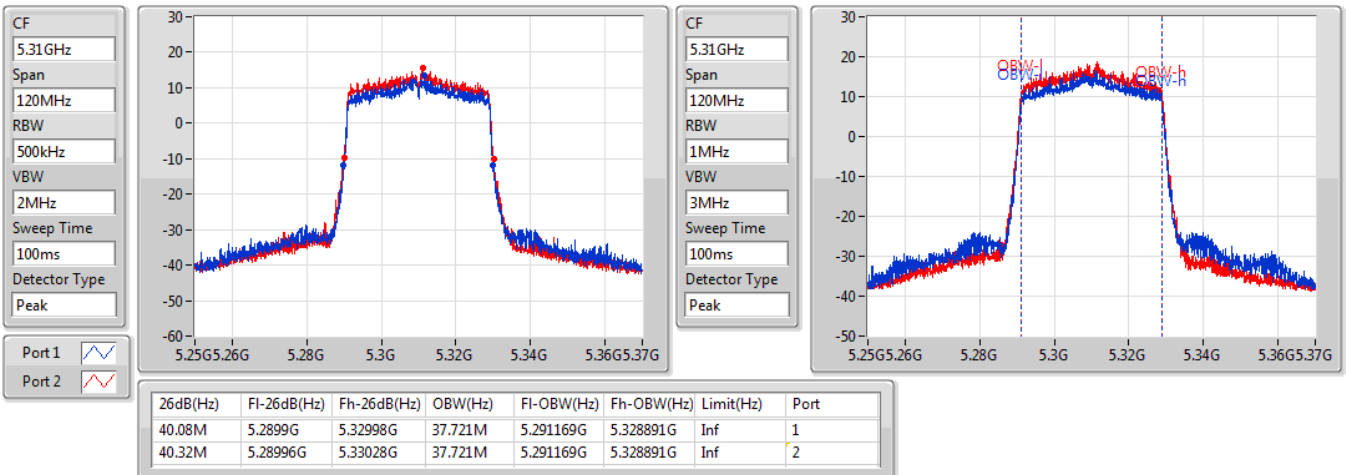



802.11ax HEW40_Nss1,(MCS0)_2TX

EBW

5510MHz

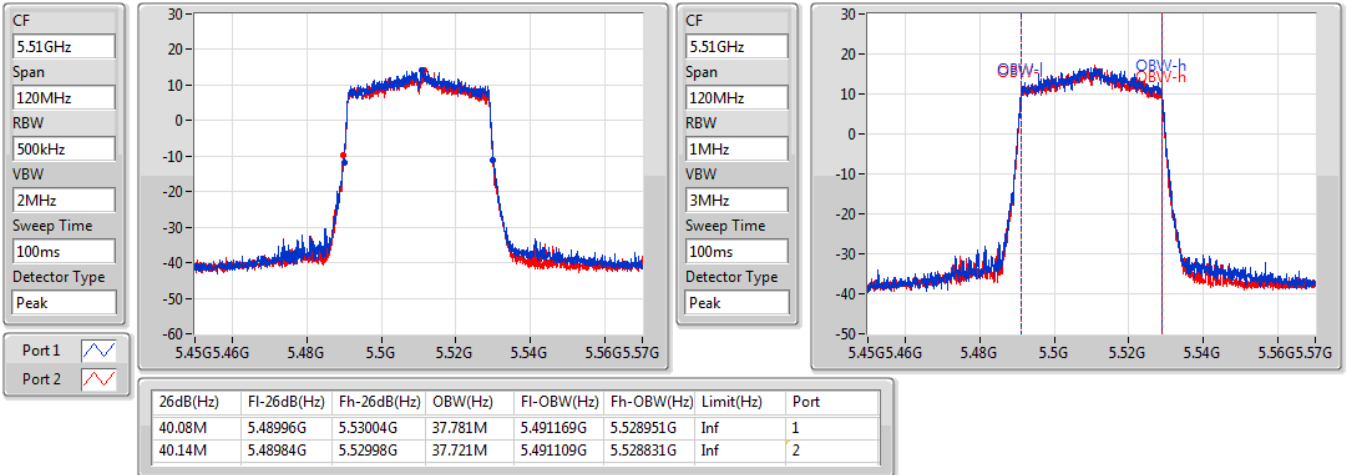

802.11ax HEW40_Nss1,(MCS0)_2TX

EBW

5590MHz

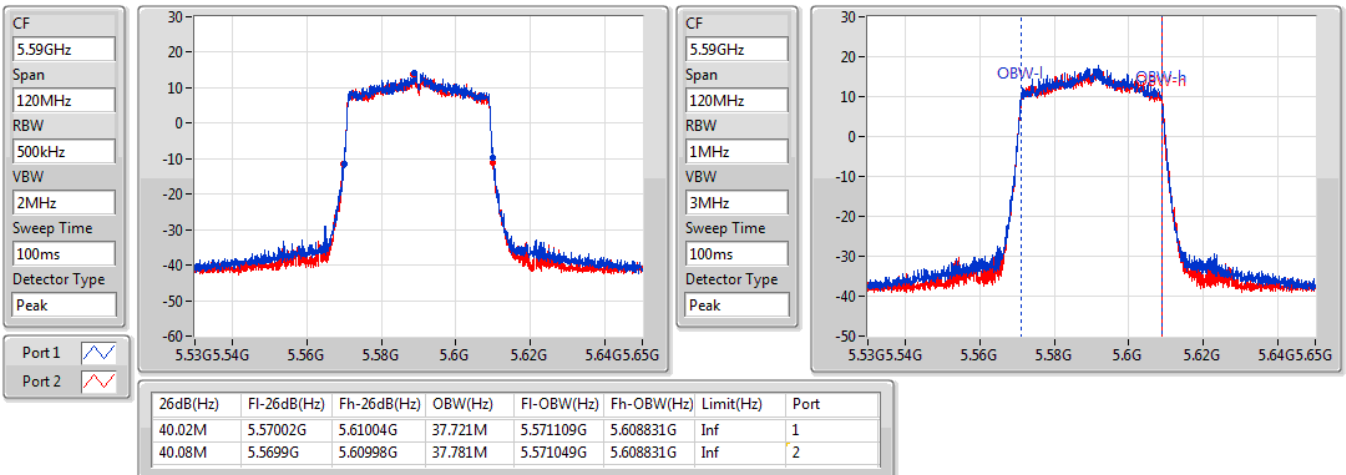



802.11ax HEW40_Nss1,(MCS0)_2TX

EBW

5670MHz

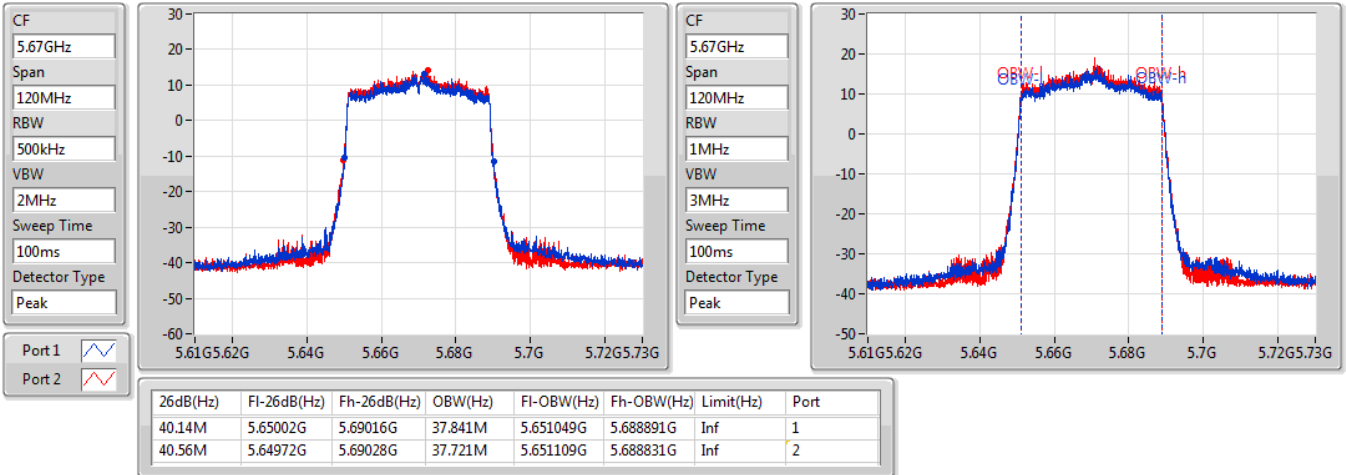

802.11ax HEW40_Nss1,(MCS0)_2TX

EBW

5710MHz Straddle 5.47-5.725GHz

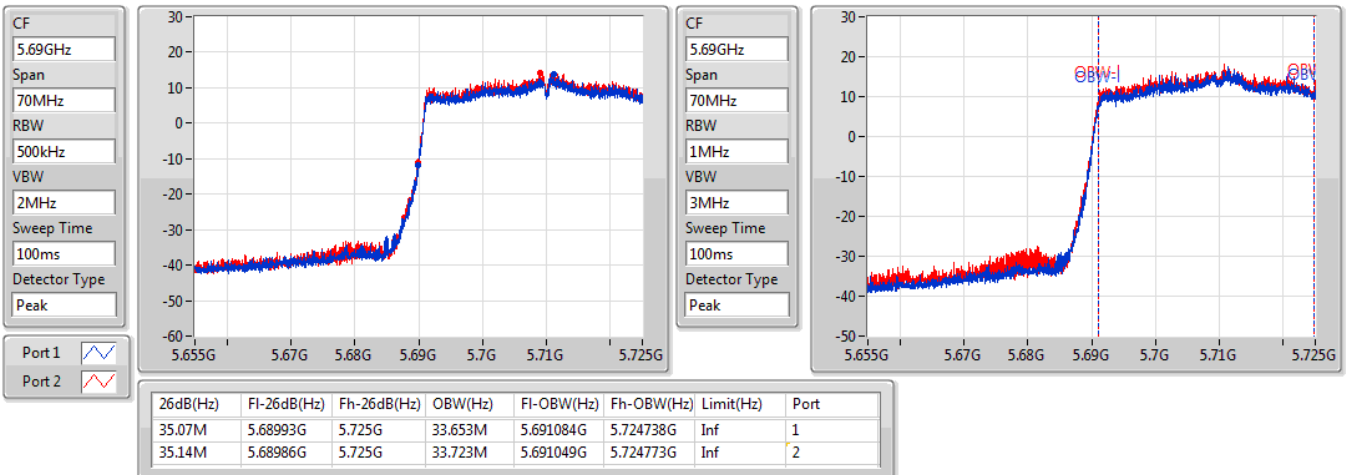



802.11ax HEW40_Nss1,(MCS0)_2TX

EBW

5710MHz Straddle 5.725-5.85GHz

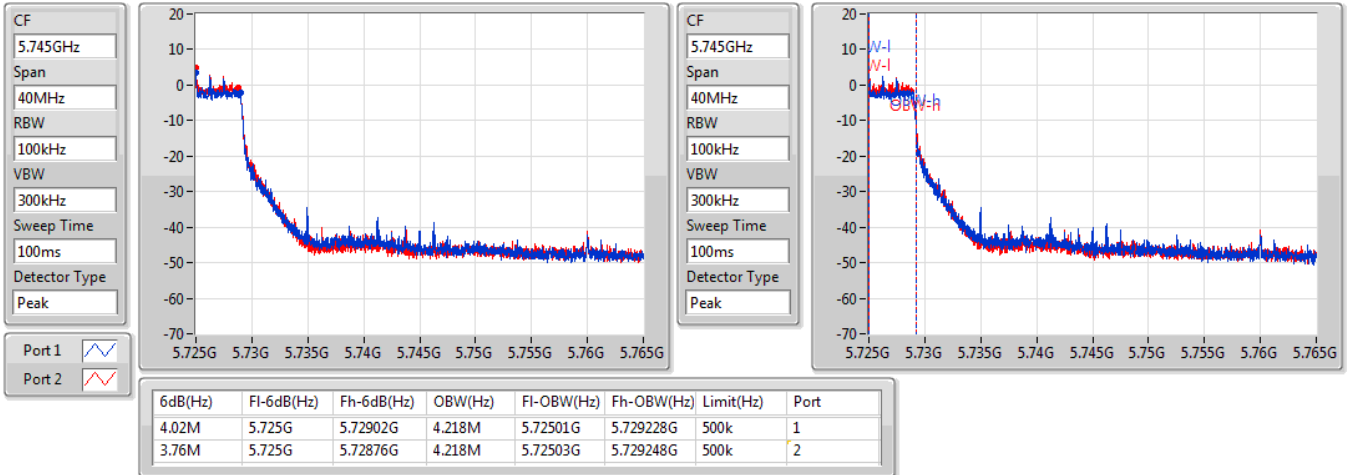

802.11ax HEW40_Nss1,(MCS0)_2TX

EBW

5710MHz Straddle 5.725-5.85GHz

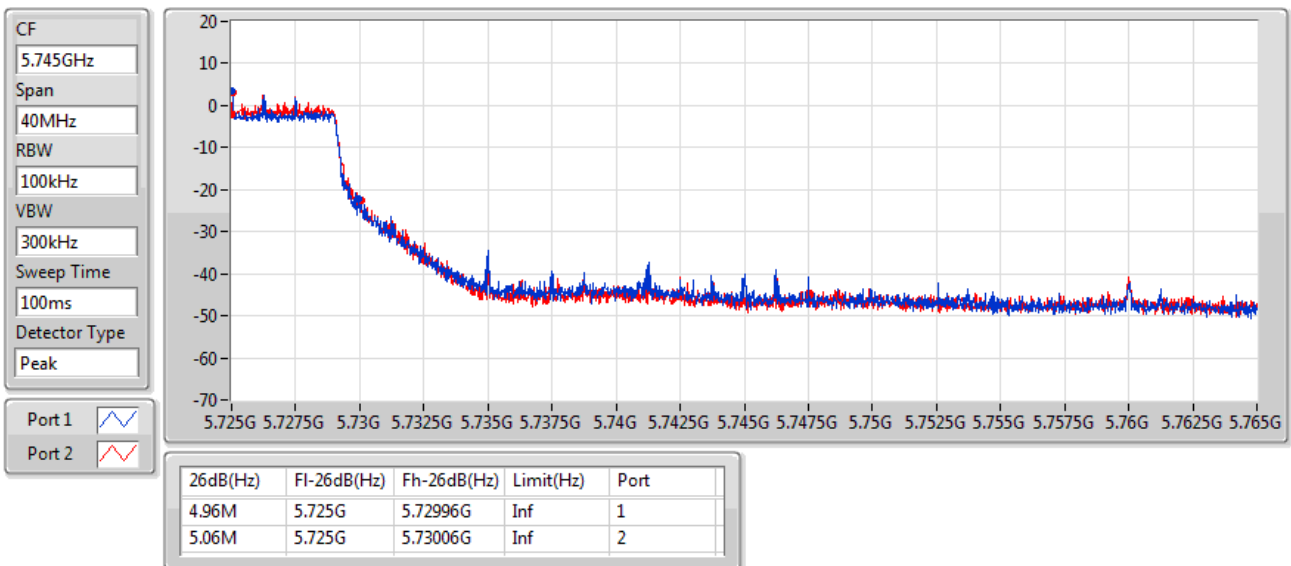



802.11ax HEW40_Nss1,(MCS0)_2TX

EBW

5755MHz

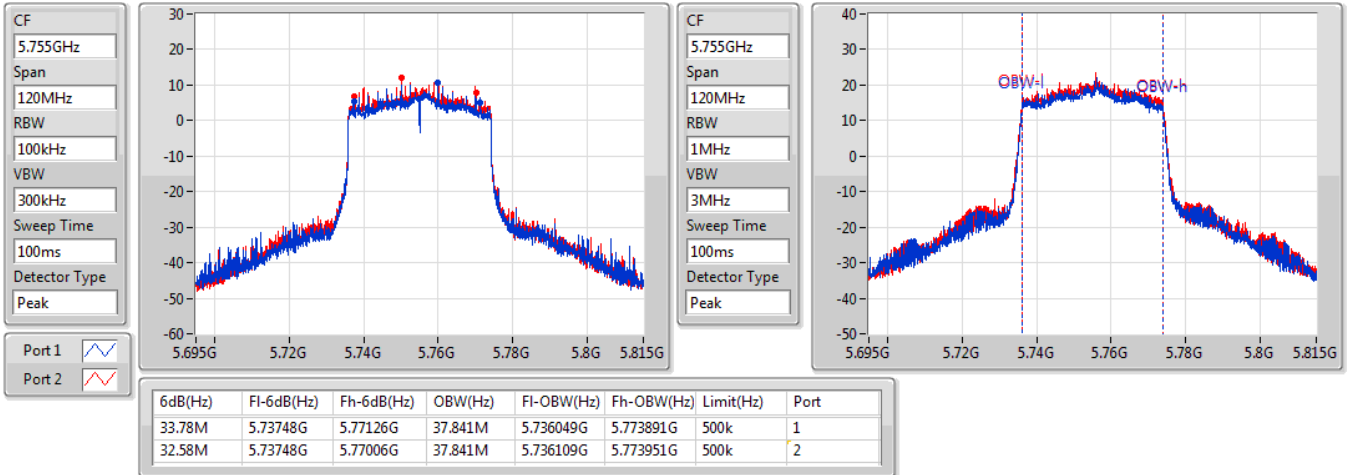

802.11ax HEW40_Nss1,(MCS0)_2TX

EBW

5755MHz

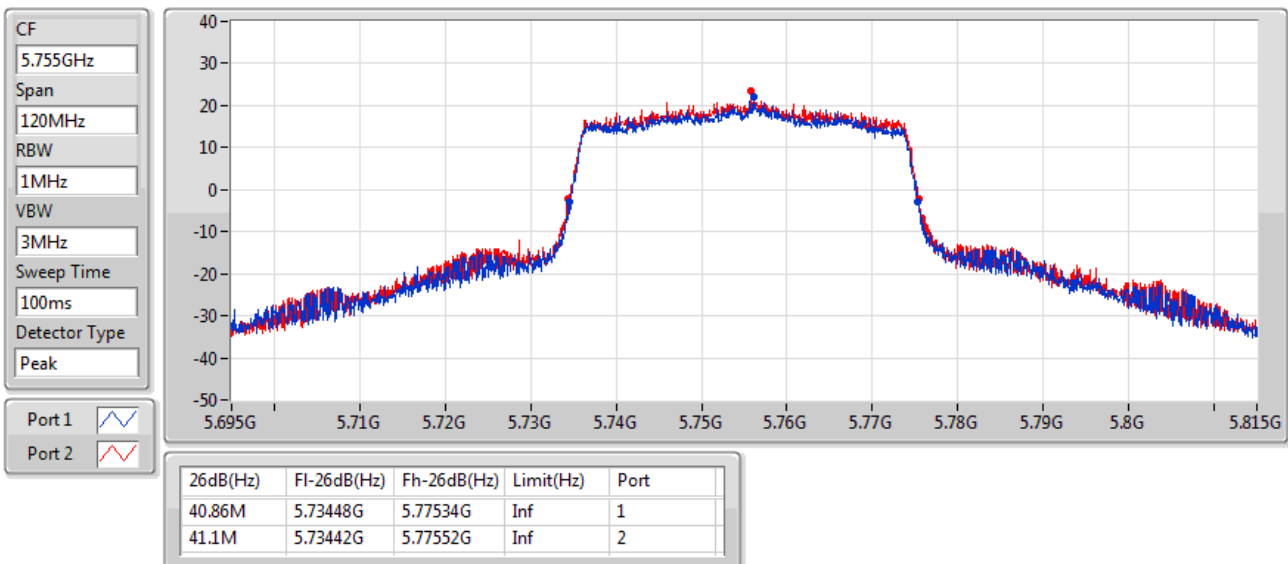

802.11ax HEW40_Nss1,(MCS0)_2TX

EBW

5795MHz

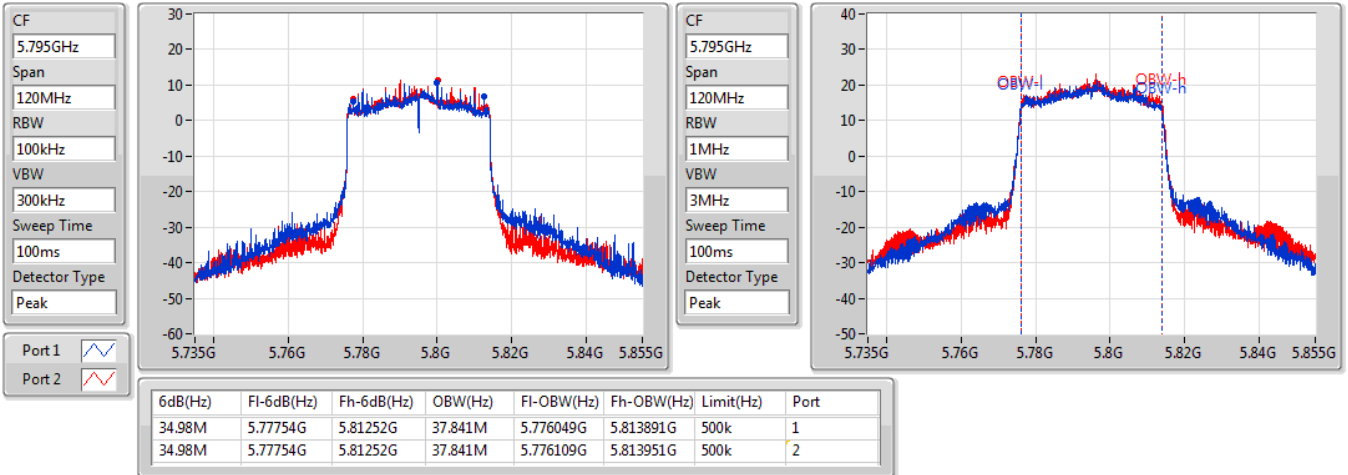

802.11ax HEW40_Nss1,(MCS0)_2TX

EBW

5795MHz

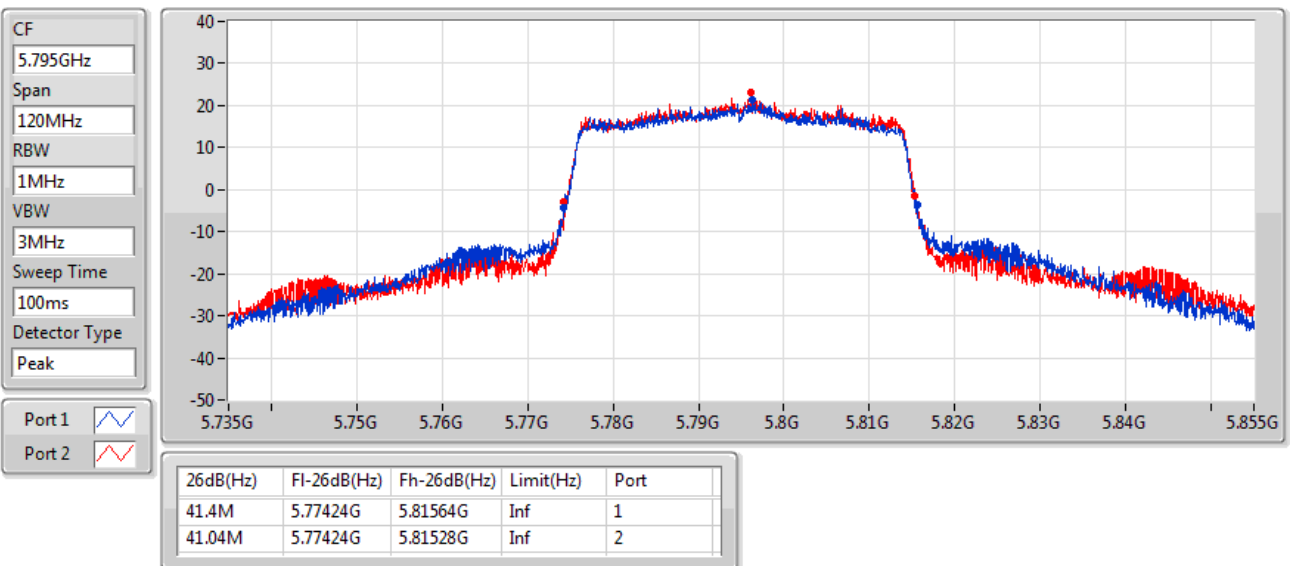



802.11ax HEW80_Nss1,(MCS0)_2TX

EBW

5210MHz

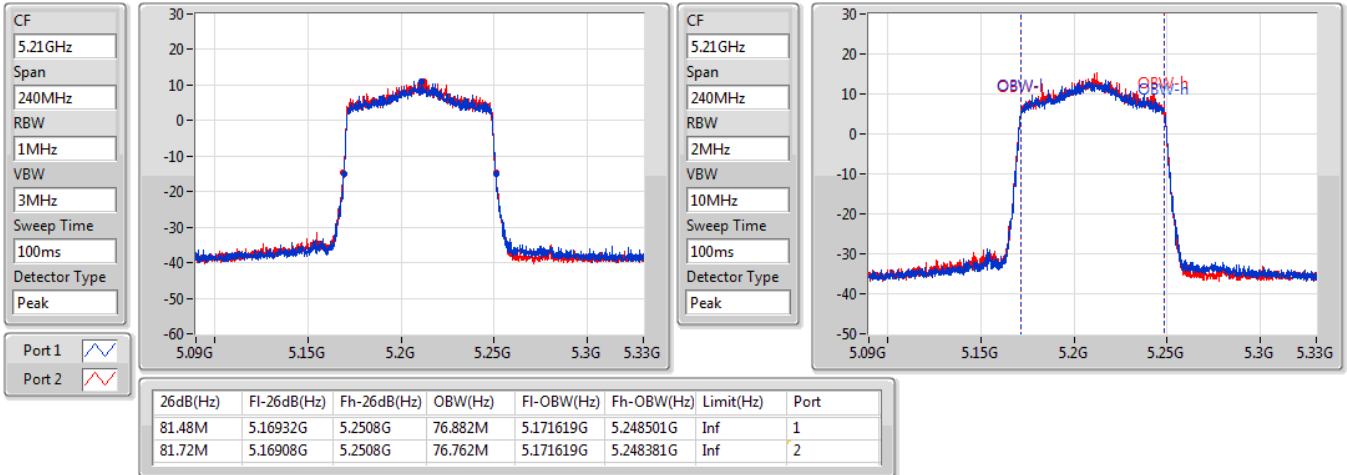

802.11ax HEW80_Nss1,(MCS0)_2TX

EBW

5290MHz

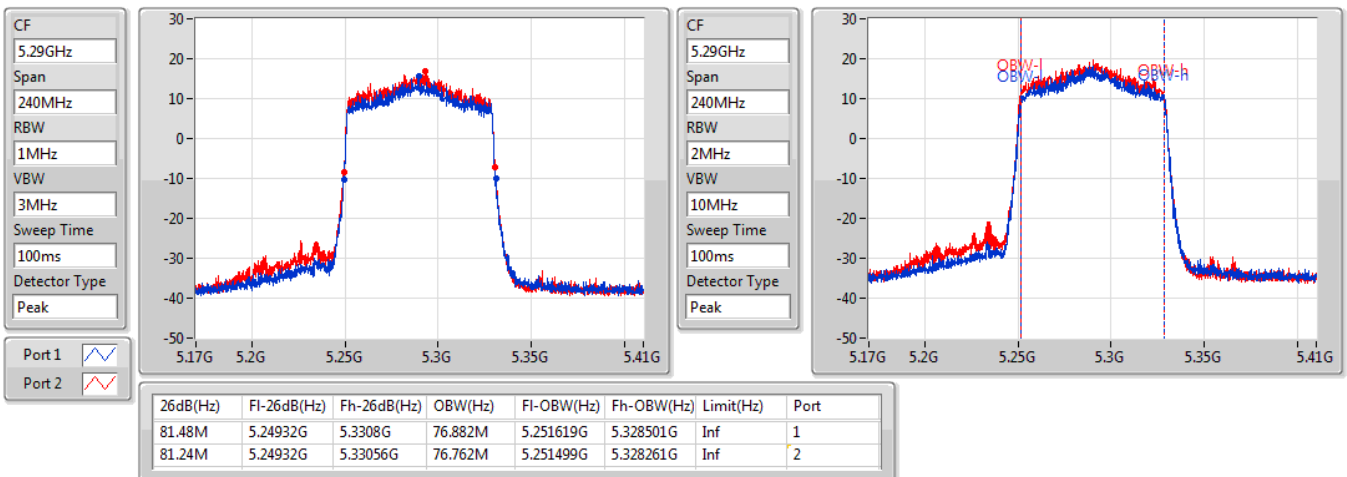



802.11ax HEW80_Nss1,(MCS0)_2TX

EBW

5530MHz

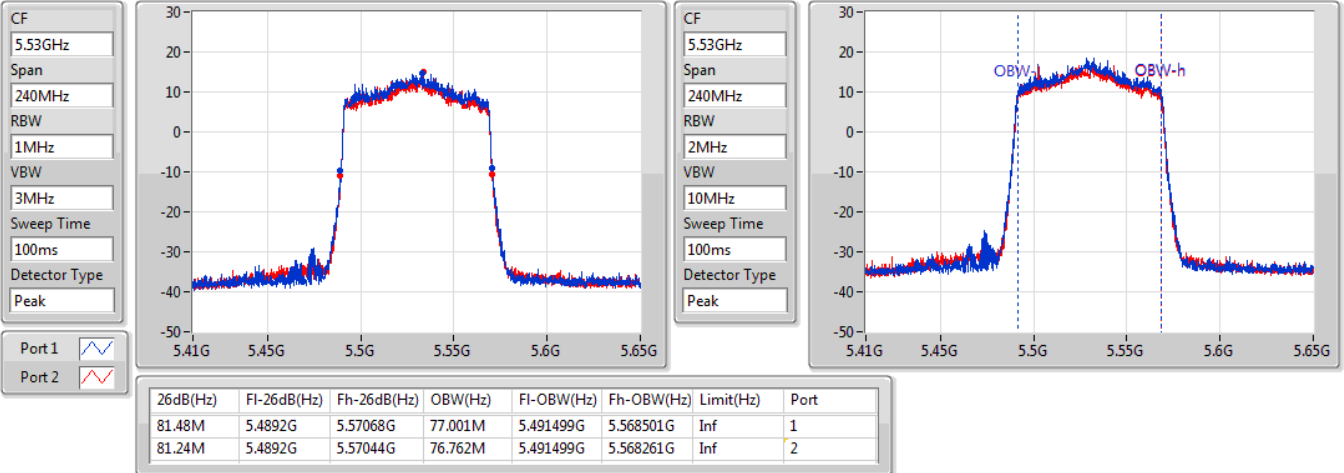

802.11ax HEW80_Nss1,(MCS0)_2TX

EBW

5610MHz

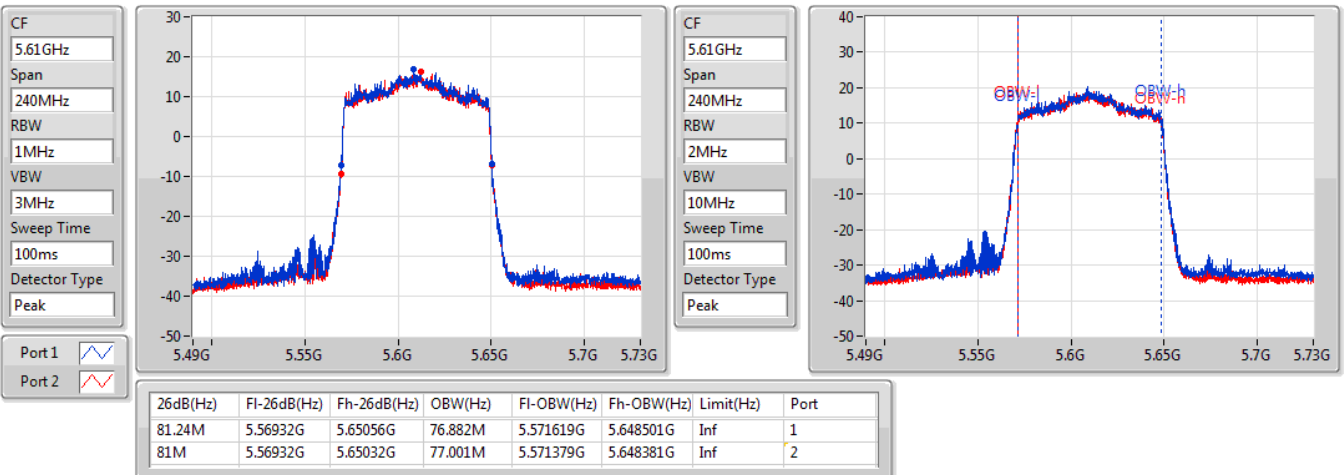



802.11ax HEW80_Nss1,(MCS0)_2TX

EBW

5690MHz Straddle 5.47-5.725GHz

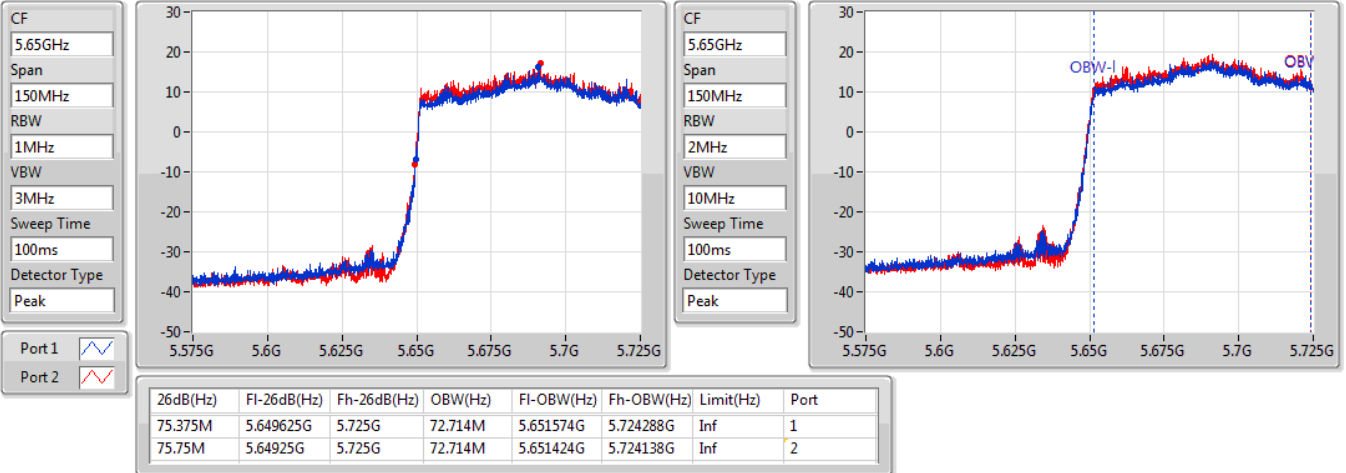

802.11ax HEW80_Nss1,(MCS0)_2TX

EBW

5690MHz Straddle 5.725-5.85GHz

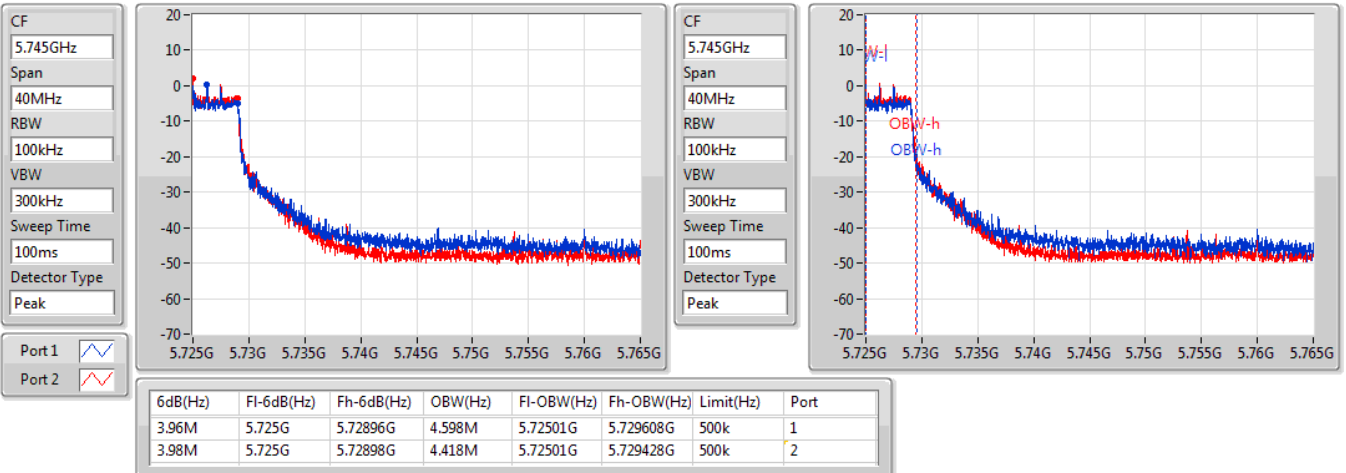



802.11ax HEW80_Nss1,(MCS0)_2TX

EBW

5690MHz Straddle 5.725-5.85GHz

CF
5.745GHz

Span
40MHz

RBW
100kHz

VBW
300kHz

Sweep Time
100ms

Detector Type
Peak

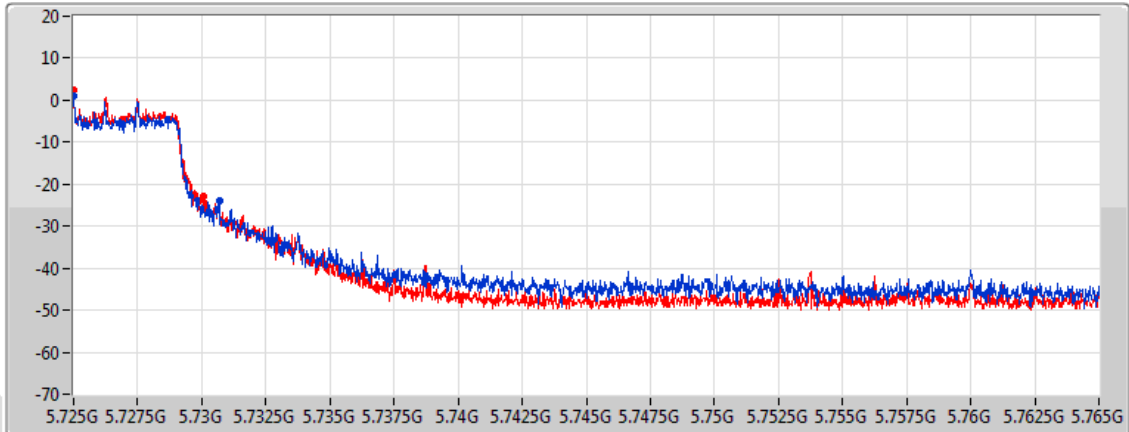

Port 1

Port 2

26dB(Hz)	Fl-26dB(Hz)	Fh-26dB(Hz)	Limit(Hz)	Port
5.68M	5.725G	5.73068G	Inf	1
5.08M	5.725G	5.73008G	Inf	2

802.11ax HEW80_Nss1,(MCS0)_2TX

EBW

5775MHz

CF
5.775GHz

Span
240MHz

RBW
100kHz

VBW
300kHz

Sweep Time
100ms

Detector Type
Peak

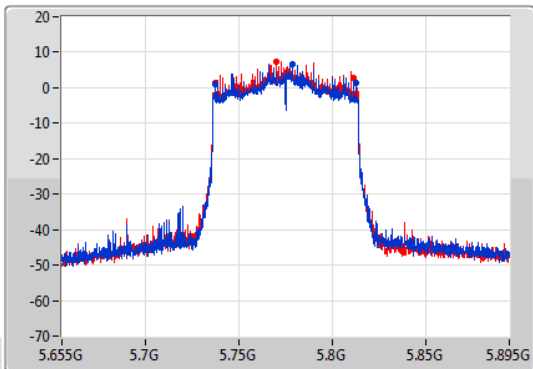

Port 1

Port 2

CF
5.775GHz

Span
240MHz

RBW
2MHz

VBW
10MHz

Sweep Time
100ms

Detector Type
Peak

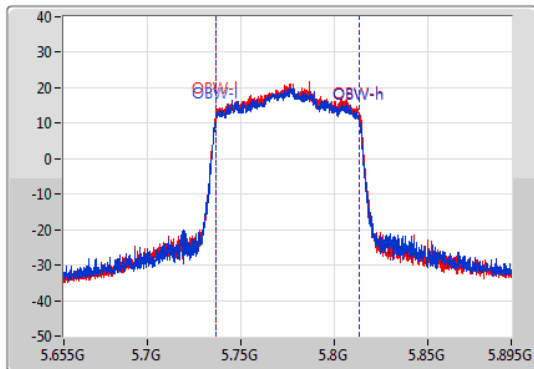

6dB(Hz)	Fl-6dB(Hz)	Fh-6dB(Hz)	OBW(Hz)	Fl-OBW(Hz)	Fh-OBW(Hz)	Limit(Hz)	Port
75M	5.73756G	5.81256G	76.762M	5.736619G	5.813381G	500k	1
73.68M	5.73756G	5.81124G	77.001M	5.736619G	5.813621G	500k	2



802.11ax HEW80_Nss1,(MCS0)_2TX

EBW

5775MHz

CF
5.775GHz

Span
240MHz

RBW
2MHz

VBW
10MHz

Sweep Time
100ms

Detector Type
Peak

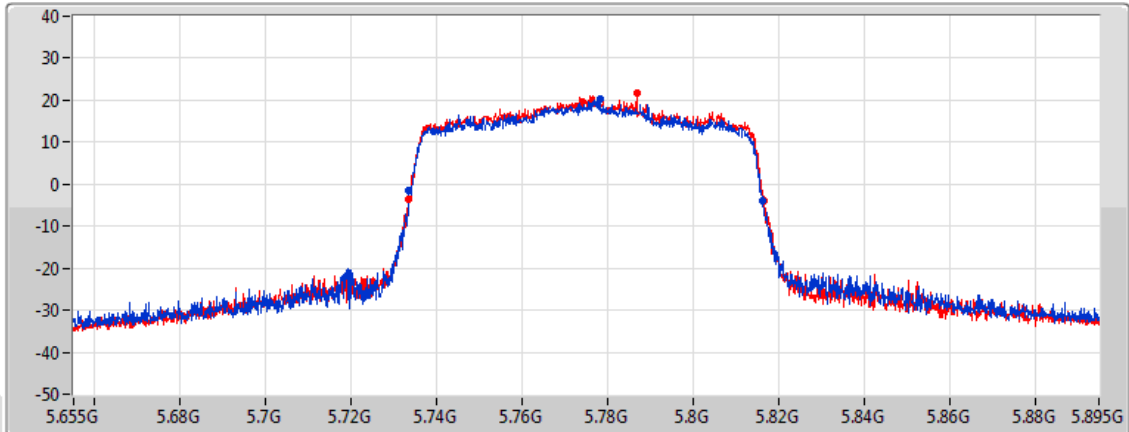

Port 1

Port 2

26dB(Hz)	Fl-26dB(Hz)	Fh-26dB(Hz)	Limit(Hz)	Port
83.04M	5.73336G	5.8164G	Inf	1
83.28M	5.73348G	5.81676G	Inf	2

802.11ax HEW160_Nss1,(MCS0)_2TX

EBW

5250MHz Straddle 5.15-5.25GHz

CF
5.17GHz

Span
160MHz

RBW
2MHz

VBW
10MHz

Sweep Time
100ms

Detector Type
Peak

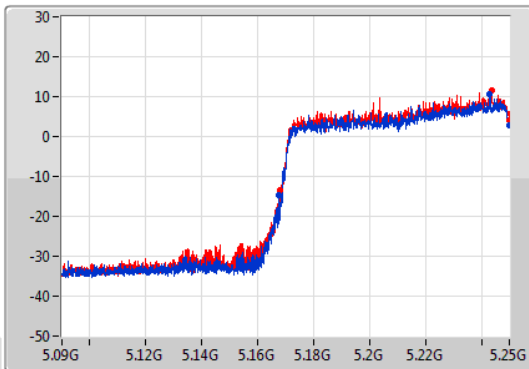

Port 1

Port 2

CF
5.17GHz

Span
160MHz

RBW
3MHz

VBW
10MHz

Sweep Time
100ms

Detector Type
Peak

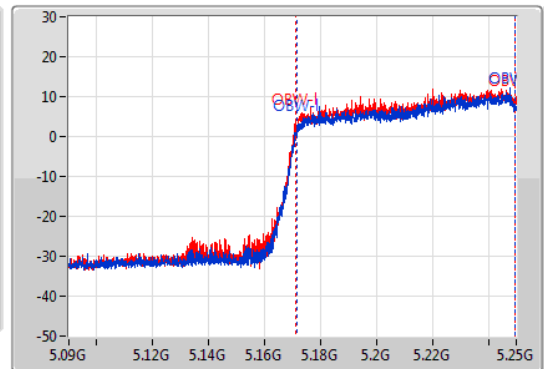

26dB(Hz)	Fl-26dB(Hz)	Fh-26dB(Hz)	OBW(Hz)	Fl-OBW(Hz)	Fh-OBW(Hz)	Limit(Hz)	Port
82.4M	5.1676G	5.25G	78.121M	5.171519G	5.24964G	Inf	1
81.92M	5.16808G	5.25G	78.521M	5.171199G	5.24972G	Inf	2



802.11ax HEW160_Nss1,(MCS0)_2TX

EBW

5250MHz Straddle 5.25-5.35GHz

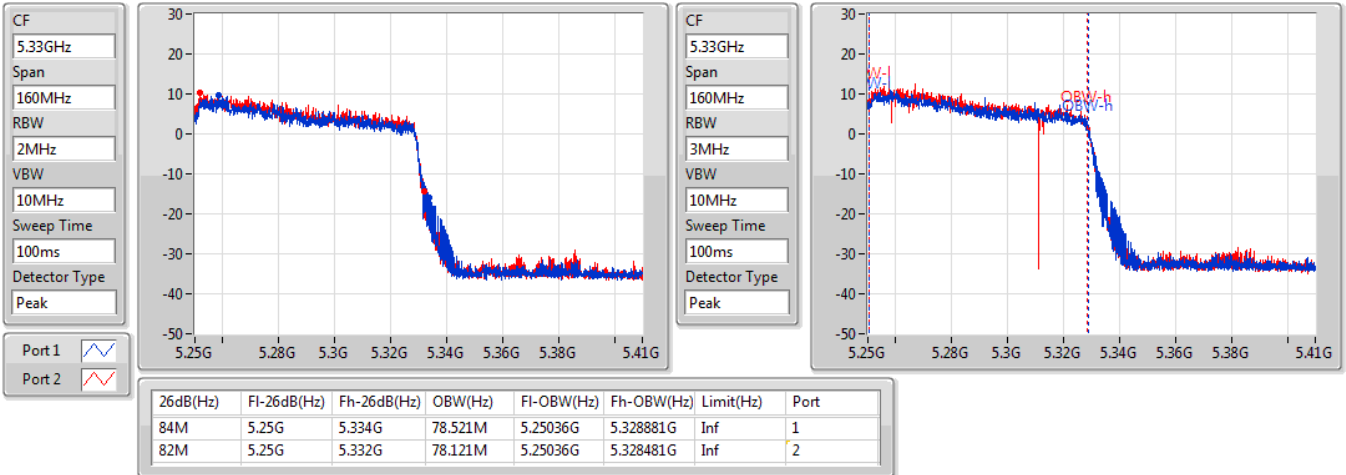

802.11ax HEW160_Nss1,(MCS0)_2TX

EBW

5570MHz

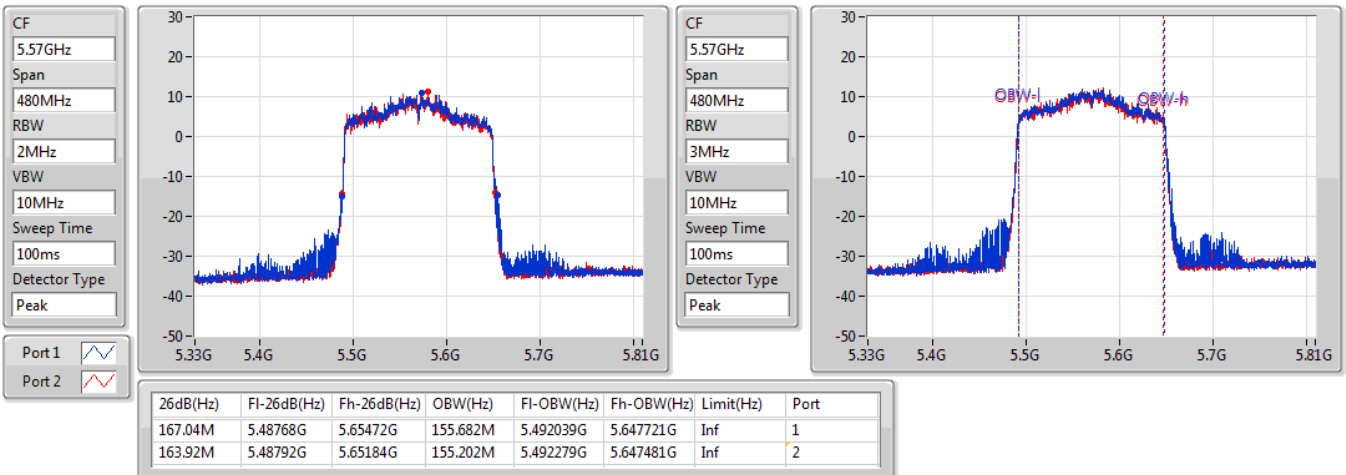



Non-beamforming mode

Summary

Mode	Total Power (dBm)	Total Power (W)	EIRP (dBm)	EIRP (W)
5.15-5.25GHz	-	-	-	-
802.11a_Nss1,(6Mbps)_2TX	25.08	0.32211	30.18	1.04232
802.11ax HEW20_Nss1,(MCS0)_2TX-OFDMA	25.42	0.34834	30.52	1.12720
802.11ax HEW40_Nss1,(MCS0)_2TX-OFDMA	26.55	0.45186	31.65	1.46218
802.11ax HEW80_Nss1,(MCS0)_2TX-OFDMA	18.97	0.07889	24.07	0.25527
802.11ax HEW160_Nss1,(MCS0)_2TX-OFDMA	14.01	0.02518	19.11	0.08147
5.25-5.35GHz	-	-	-	-
802.11a_Nss1,(6Mbps)_2TX	20.02	0.10046	25.12	0.32509
802.11ax HEW20_Nss1,(MCS0)_2TX-OFDMA	20.08	0.10186	25.18	0.32961
802.11ax HEW40_Nss1,(MCS0)_2TX-OFDMA	22.92	0.19588	28.02	0.63387
802.11ax HEW80_Nss1,(MCS0)_2TX-OFDMA	23.52	0.22491	28.62	0.72778
802.11ax HEW160_Nss1,(MCS0)_2TX-OFDMA	13.17	0.02075	18.27	0.06714
5.47-5.725GHz	-	-	-	-
802.11a_Nss1,(6Mbps)_2TX	19.29	0.08492	25.09	0.32285
802.11ax HEW20_Nss1,(MCS0)_2TX-OFDMA	19.50	0.08913	25.30	0.33884
802.11ax HEW40_Nss1,(MCS0)_2TX-OFDMA	22.32	0.17061	28.12	0.64863
802.11ax HEW80_Nss1,(MCS0)_2TX-OFDMA	23.89	0.24491	29.69	0.93111
802.11ax HEW160_Nss1,(MCS0)_2TX-OFDMA	18.27	0.06714	24.07	0.25527
5.725-5.85GHz	-	-	-	-
802.11a_Nss1,(6Mbps)_2TX	26.59	0.45604	32.14	1.63682
802.11ax HEW20_Nss1,(MCS0)_2TX-OFDMA	26.57	0.45394	32.12	1.62930
802.11ax HEW40_Nss1,(MCS0)_2TX-OFDMA	26.55	0.45186	32.10	1.62181
802.11ax HEW80_Nss1,(MCS0)_2TX-OFDMA	25.26	0.33574	30.81	1.20504



Conducted Output Power(Average)

Appendix B

Result

Mode	Result	DG (dBi)	Port 1 (dBm)	Port 2 (dBm)	Total Power (dBm)	Power Limit (dBm)	EIRP (dBm)	EIRP Limit (dBm)
802.11a_Nss1,(6Mbps)_2TX	-	-	-	-	-	-	-	-
5180MHz	Pass	5.10	21.56	21.31	24.45	30.00	29.55	36.00
5200MHz	Pass	5.10	21.39	21.24	24.33	30.00	29.43	36.00
5240MHz	Pass	5.10	21.85	22.28	25.08	30.00	30.18	36.00
5260MHz	Pass	5.10	16.39	17.29	19.87	23.78	24.97	29.78
5300MHz	Pass	5.10	16.03	17.81	20.02	23.88	25.12	29.88
5320MHz	Pass	5.10	15.61	17.32	19.56	23.89	24.66	29.89
5500MHz	Pass	5.80	16.41	15.81	19.13	23.88	24.93	29.88
5580MHz	Pass	5.80	16.57	15.96	19.29	23.87	25.09	29.87
5700MHz	Pass	5.80	15.46	16.24	18.88	23.90	24.68	29.90
5720MHz Straddle 5.47-5.725GHz	Pass	5.80	14.93	16.03	18.53	22.59	24.33	28.59
5720MHz Straddle 5.725-5.85GHz	Pass	5.55	7.46	8.39	10.96	30.00	16.51	36.00
5745MHz	Pass	5.55	23.53	23.63	26.59	30.00	32.14	36.00
5785MHz	Pass	5.55	22.9	23.36	26.15	30.00	31.70	36.00
5825MHz	Pass	5.55	22.83	22.84	25.85	30.00	31.40	36.00
802.11ax HEW20_Nss1,(MCS0)_2TX-OFDMA	-	-	-	-	-	-	-	-
5180MHz	Pass	5.10	21.37	21.05	24.22	30.00	29.32	36.00
5200MHz	Pass	5.10	21.16	21.08	24.13	30.00	29.23	36.00
5240MHz	Pass	5.10	22.25	22.56	25.42	30.00	30.52	36.00
5260MHz	Pass	5.10	16.58	17.51	20.08	24.00	25.18	30.00
5300MHz	Pass	5.10	15.91	17.62	19.86	24.00	24.96	30.00
5320MHz	Pass	5.10	15.83	17.62	19.83	24.00	24.93	30.00
5500MHz	Pass	5.80	16.85	15.97	19.44	24.00	25.24	30.00
5580MHz	Pass	5.80	16.82	16.14	19.50	24.00	25.30	30.00
5700MHz	Pass	5.80	15.69	16.58	19.17	24.00	24.97	30.00
5720MHz Straddle 5.47-5.725GHz	Pass	5.80	15.22	16.34	18.83	22.84	24.63	28.84
5720MHz Straddle 5.725-5.85GHz	Pass	5.55	8.24	9.48	11.91	30.00	17.46	36.00
5745MHz	Pass	5.55	23.26	23.84	26.57	30.00	32.12	36.00
5785MHz	Pass	5.55	21.68	22.1	24.91	30.00	30.46	36.00
5825MHz	Pass	5.55	21.41	21.52	24.48	30.00	30.03	36.00
802.11ax HEW40_Nss1,(MCS0)_2TX-OFDMA	-	-	-	-	-	-	-	-
5190MHz	Pass	5.10	17.33	16.86	20.11	30.00	25.21	36.00
5230MHz	Pass	5.10	23.36	23.71	26.55	30.00	31.65	36.00
5270MHz	Pass	5.10	19.35	20.41	22.92	24.00	28.02	30.00
5310MHz	Pass	5.10	18.58	20.35	22.56	24.00	27.66	30.00
5510MHz	Pass	5.80	19.73	18.85	22.32	24.00	28.12	30.00
5590MHz	Pass	5.80	19.53	19.02	22.29	24.00	28.09	30.00
5670MHz	Pass	5.80	18.22	19.34	21.83	24.00	27.63	30.00
5710MHz Straddle 5.47-5.725GHz	Pass	5.80	18.32	19.18	21.78	24.00	27.58	30.00
5710MHz Straddle 5.725-5.85GHz	Pass	5.55	7	7.97	10.52	30.00	16.07	36.00
5755MHz	Pass	5.55	23.18	23.87	26.55	30.00	32.10	36.00



Conducted Output Power(Average)

Appendix B

Mode	Result	DG (dBi)	Port 1 (dBm)	Port 2 (dBm)	Total Power (dBm)	Power Limit (dBm)	EIRP (dBm)	EIRP Limit (dBm)
5795MHz	Pass	5.55	23.41	23.56	26.50	30.00	32.05	36.00
802.11ax HEW80_Nss1,(MCS0)_2TX-OFDMA	-	-	-	-	-	-	-	-
5210MHz	Pass	5.10	15.75	16.16	18.97	30.00	24.07	36.00
5290MHz	Pass	5.10	19.72	21.17	23.52	24.00	28.62	30.00
5530MHz	Pass	5.80	19.74	18.62	22.23	24.00	28.03	30.00
5610MHz	Pass	5.80	21.05	20.71	23.89	24.00	29.69	30.00
5690MHz Straddle 5.47-5.725GHz	Pass	5.80	19.77	20.74	23.29	24.00	29.09	30.00
5690MHz Straddle 5.725-5.85GHz	Pass	5.55	4.22	5.11	7.70	30.00	13.25	36.00
5775MHz	Pass	5.55	21.96	22.53	25.26	30.00	30.81	36.00
802.11ax HEW160_Nss1,(MCS0)_2TX-OFDMA	-	-	-	-	-	-	-	-
5250MHz Straddle 5.15-5.25GHz	Pass	5.10	10.48	11.47	14.01	30.00	19.11	36.00
5250MHz Straddle 5.25-5.35GHz	Pass	5.10	9.74	10.55	13.17	24.00	18.27	30.00
5570MHz	Pass	5.80	15.52	14.98	18.27	24.00	24.07	30.00

DG = Directional Gain; Port X = Port X output power



802.11a_Nss1,(6Mbps)_2TX

AV Power

5720MHz Straddle 5.47-5.725GHz_TnomVnom

CF
5.71GHz
Span
60MHz
RBW
1MHz
VBW
3MHz
Sweep Time
5ms
Detector Type
RMS
CP BW
30MHz

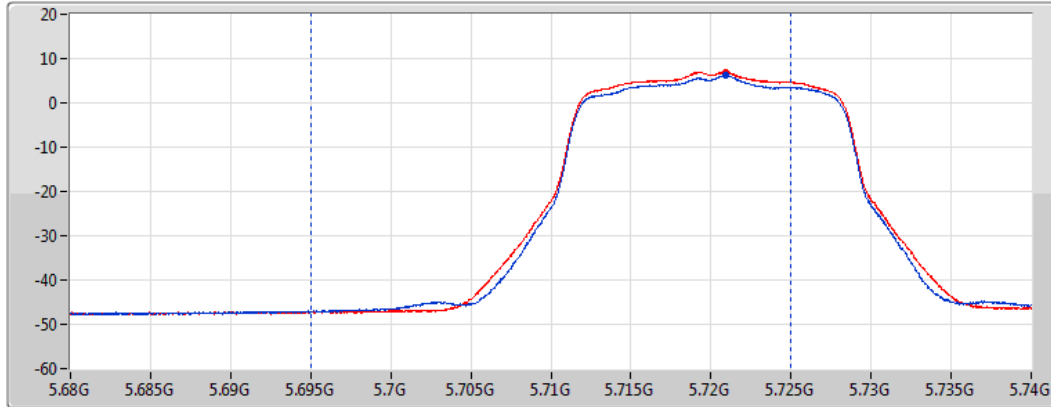

Port 1
Port 2

Sum= Total Power
PX=Port X

Sum(dBm)	P1(dBm)	P2(dBm)
18.53	14.93	16.03

802.11a_Nss1,(6Mbps)_2TX

AV Power

5720MHz Straddle 5.725-5.85GHz_TnomVnom

CF
5.735GHz
Span
40MHz
RBW
1MHz
VBW
3MHz
Sweep Time
5ms
Detector Type
RMS
CP BW
20MHz

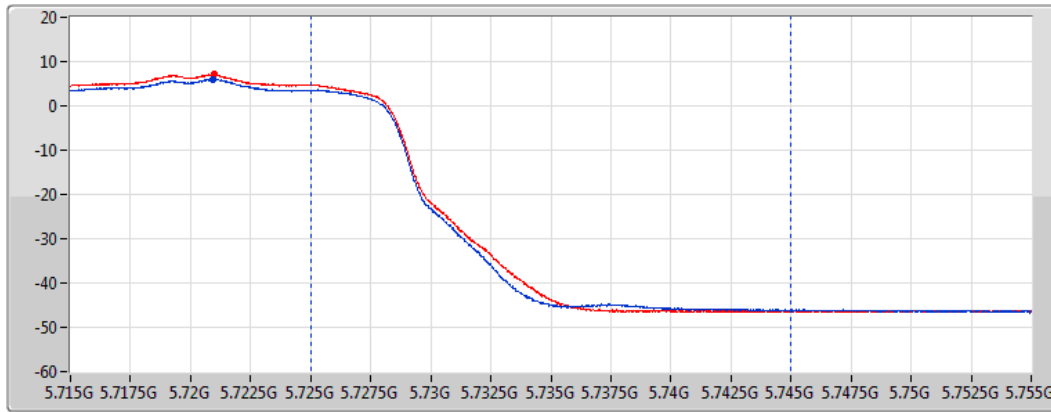

Port 1
Port 2

Sum= Total Power
PX=Port X

Sum(dBm)	P1(dBm)	P2(dBm)
10.96	7.46	8.39



802.11ax HEW20_Nss1,(MCS0)_2TX

AV Power

5720MHz Straddle 5.47-5.725GHz_TnomVnom

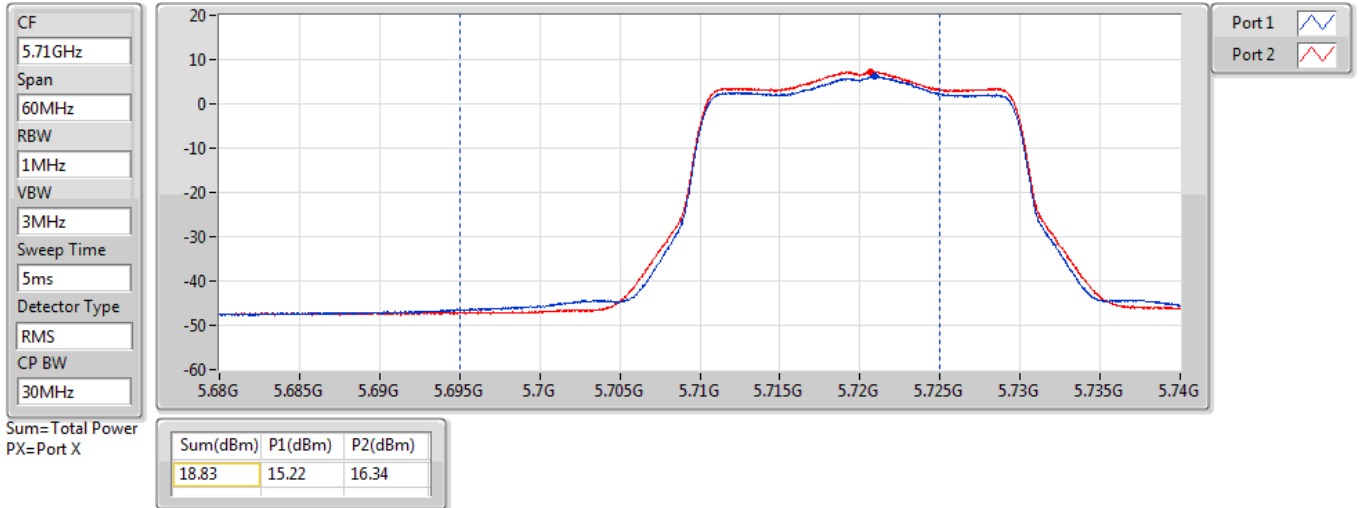

802.11ax HEW20_Nss1,(MCS0)_2TX

AV Power

5720MHz Straddle 5.725-5.85GHz_TnomVnom

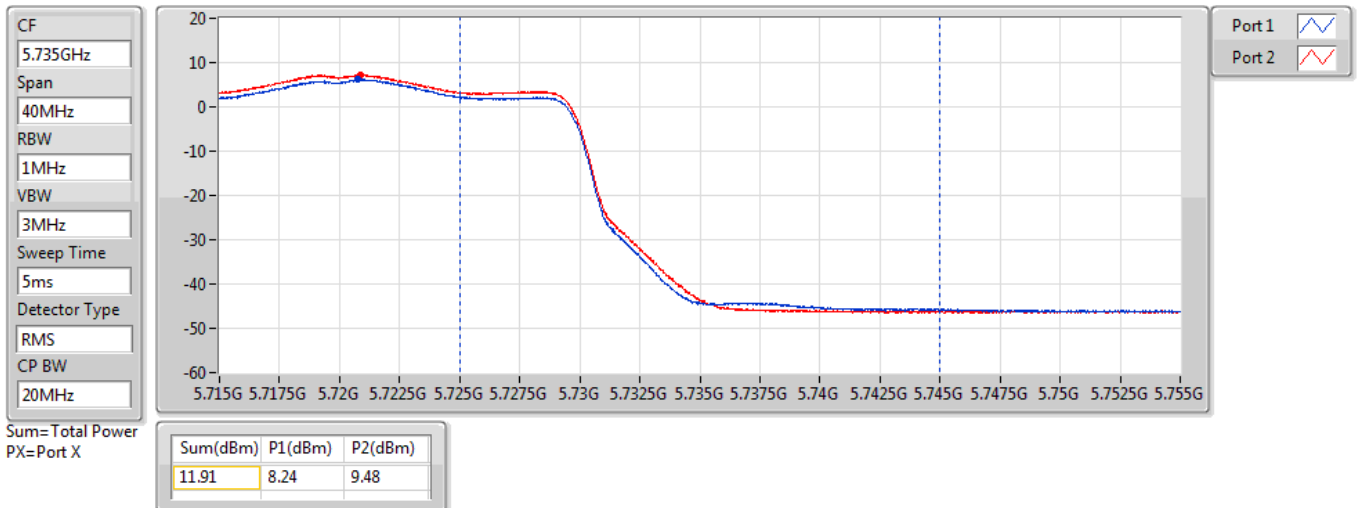



802.11ax HEW40_Nss1,(MCS0)_2TX

AV Power

5710MHz Straddle 5.47-5.725GHz_TnomVnom

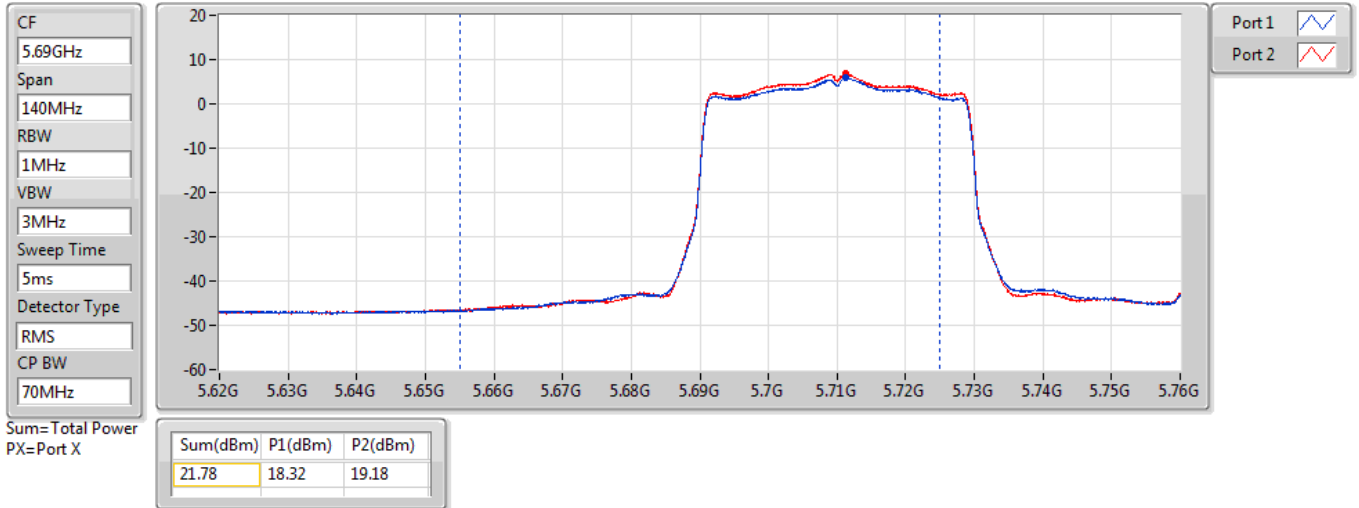

802.11ax HEW40_Nss1,(MCS0)_2TX

AV Power

5710MHz Straddle 5.725-5.85GHz_TnomVnom

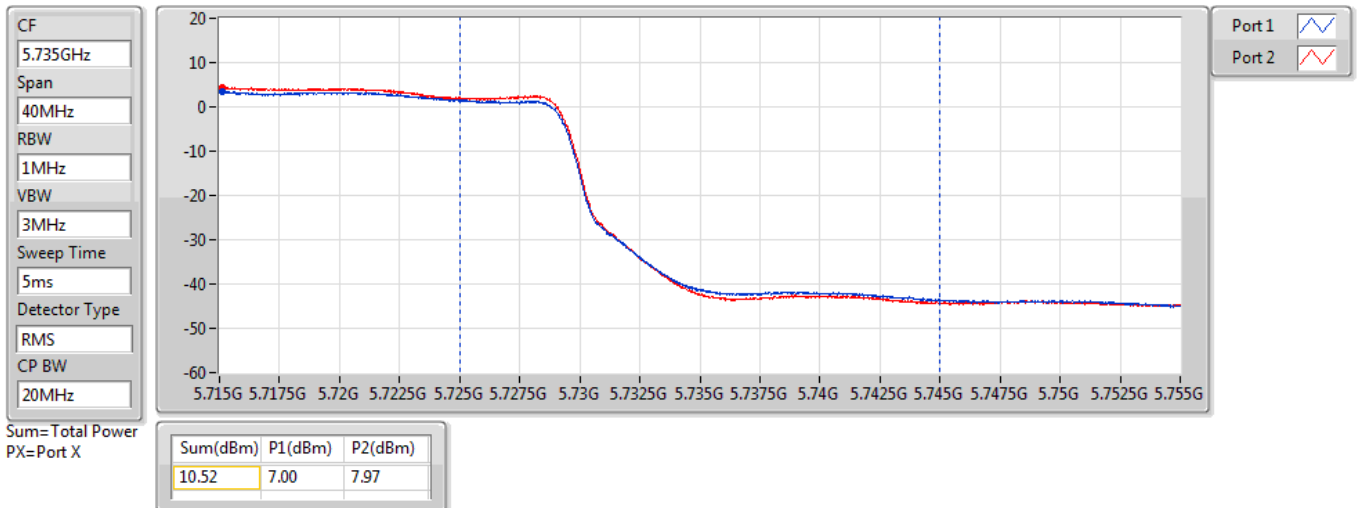



802.11ax HEW80_Nss1,(MCS0)_2TX

AV Power

5690MHz Straddle 5.47-5.725GHz_TnomVnom

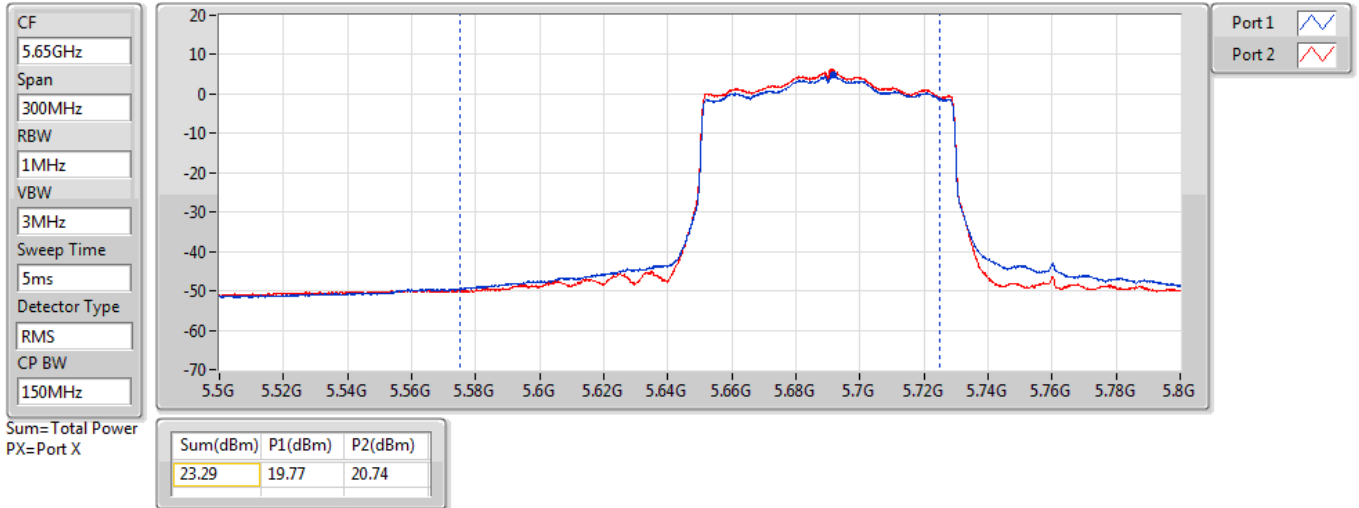

802.11ax HEW80_Nss1,(MCS0)_2TX

AV Power

5690MHz Straddle 5.725-5.85GHz_TnomVnom

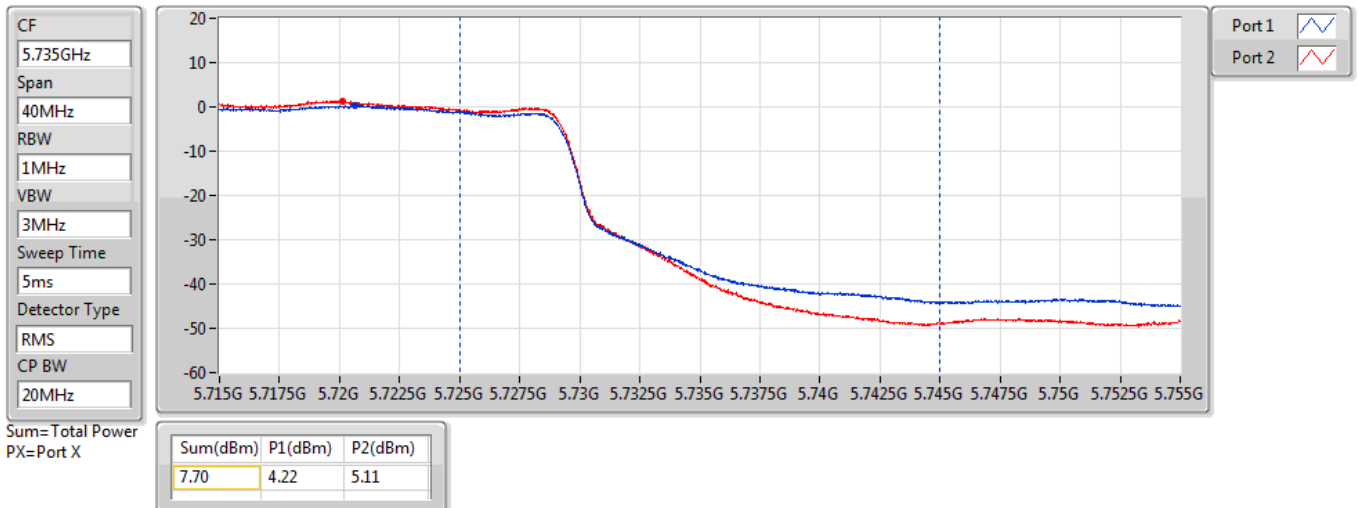



802.11ax HEW160_Nss1,(MCS0)_2TX

AV Power

5250MHz Straddle 5.15-5.25GHz_TnomVnom

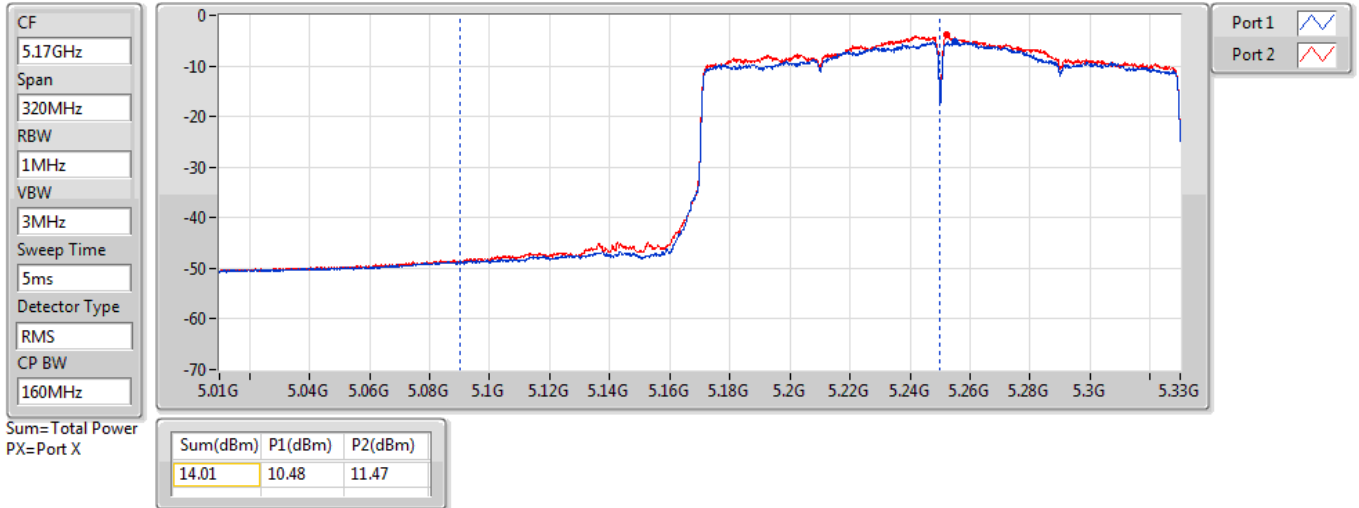

802.11ax HEW160_Nss1,(MCS0)_2TX

AV Power

5250MHz Straddle 5.25-5.35GHz_TnomVnom

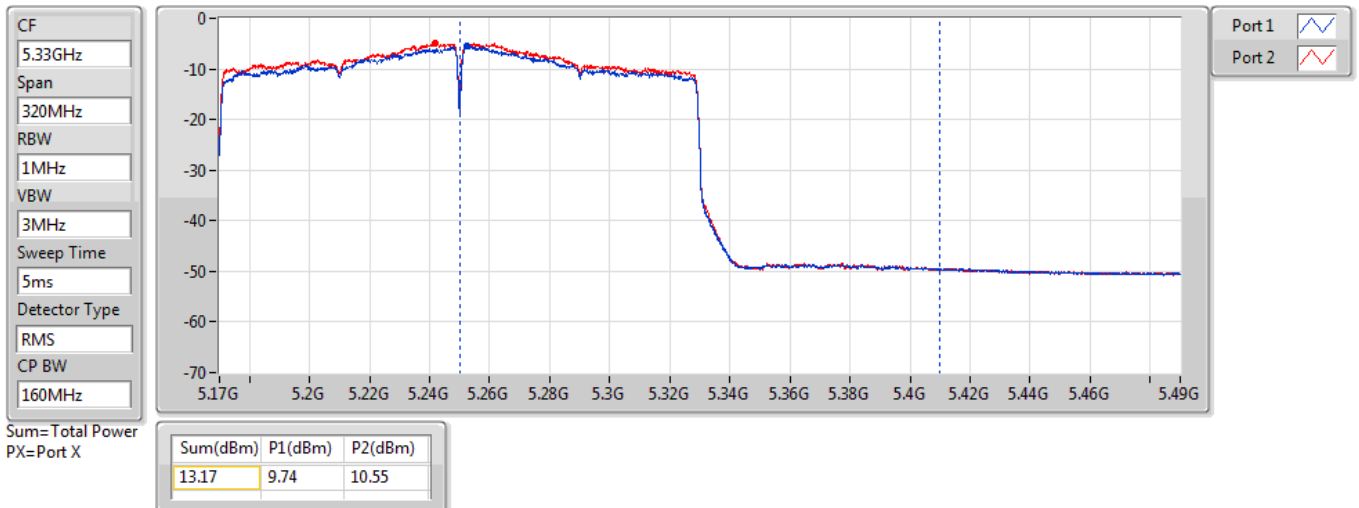



Beamforming mode

Summary

Mode	Total Power (dBm)	Total Power (W)	EIRP (dBm)	EIRP (W)
5.15-5.25GHz	-	-	-	-
802.11ax HEW20-BF_Nss1,(MCS0)_2TX-OFDMA	22.41	0.17418	30.42	1.10154
802.11ax HEW40-BF_Nss1,(MCS0)_2TX-OFDMA	23.54	0.22594	31.55	1.42889
802.11ax HEW80-BF_Nss1,(MCS0)_2TX-OFDMA	15.96	0.03945	23.97	0.24946
802.11ax HEW160-BF_Nss1,(MCS0)_2TX-OFDMA	11.00	0.01259	19.01	0.07962
5.25-5.35GHz	-	-	-	-
802.11ax HEW20-BF_Nss1,(MCS0)_2TX-OFDMA	17.07	0.05093	25.13	0.32584
802.11ax HEW40-BF_Nss1,(MCS0)_2TX-OFDMA	19.91	0.09795	27.97	0.62661
802.11ax HEW80-BF_Nss1,(MCS0)_2TX-OFDMA	20.51	0.11246	28.57	0.71945
802.11ax HEW160-BF_Nss1,(MCS0)_2TX-OFDMA	10.16	0.01038	18.22	0.06637
5.47-5.725GHz	-	-	-	-
802.11ax HEW20-BF_Nss1,(MCS0)_2TX-OFDMA	16.49	0.04457	25.03	0.31842
802.11ax HEW40-BF_Nss1,(MCS0)_2TX-OFDMA	19.31	0.08531	27.85	0.60954
802.11ax HEW80-BF_Nss1,(MCS0)_2TX-OFDMA	20.88	0.12246	29.42	0.87498
802.11ax HEW160-BF_Nss1,(MCS0)_2TX-OFDMA	15.26	0.03357	23.80	0.23988
5.725-5.85GHz	-	-	-	-
802.11ax HEW20-BF_Nss1,(MCS0)_2TX-OFDMA	23.56	0.22699	31.91	1.55239
802.11ax HEW40-BF_Nss1,(MCS0)_2TX-OFDMA	23.54	0.22594	31.89	1.54525
802.11ax HEW80-BF_Nss1,(MCS0)_2TX-OFDMA	22.25	0.16788	30.60	1.14815



Conducted Output Power(Average)

Appendix B

Result

Mode	Result	DG (dBi)	Port 1 (dBm)	Port 2 (dBm)	Total Power (dBm)	Power Limit (dBm)	EIRP (dBm)	EIRP Limit (dBm)
802.11ax HEW20-BF_Nss1,(MCS0)_2TX-OFDMA	-	-	-	-	-	-	-	-
5180MHz	Pass	8.01	18.36	18.04	21.21	27.99	29.22	36.00
5200MHz	Pass	8.01	18.15	18.07	21.12	27.99	29.13	36.00
5240MHz	Pass	8.01	19.24	19.55	22.41	27.99	30.42	36.00
5260MHz	Pass	8.06	13.57	14.5	17.07	21.94	25.13	30.00
5300MHz	Pass	8.06	12.9	14.61	16.85	21.94	24.91	30.00
5320MHz	Pass	8.06	12.82	14.61	16.82	21.94	24.88	30.00
5500MHz	Pass	8.54	13.84	12.96	16.43	21.46	24.97	30.00
5580MHz	Pass	8.54	13.81	13.13	16.49	21.46	25.03	30.00
5700MHz	Pass	8.54	12.68	13.57	16.16	21.46	24.70	30.00
5720MHz Straddle 5.47-5.725GHz	Pass	8.54	12.21	13.33	15.82	21.46	24.36	30.00
5720MHz Straddle 5.725-5.85GHz	Pass	8.35	5.23	6.47	8.90	27.65	17.25	36.00
5745MHz	Pass	8.35	20.25	20.83	23.56	27.65	31.91	36.00
5785MHz	Pass	8.35	18.67	19.09	21.90	27.65	30.25	36.00
5825MHz	Pass	8.35	18.4	18.51	21.47	27.65	29.82	36.00
802.11ax HEW40-BF_Nss1,(MCS0)_2TX-OFDMA	-	-	-	-	-	-	-	-
5190MHz	Pass	8.01	14.32	13.85	17.10	27.99	25.11	36.00
5230MHz	Pass	8.01	20.35	20.7	23.54	27.99	31.55	36.00
5270MHz	Pass	8.06	16.34	17.4	19.91	21.94	27.97	30.00
5310MHz	Pass	8.06	15.57	17.34	19.55	21.94	27.61	30.00
5510MHz	Pass	8.54	16.72	15.84	19.31	21.46	27.85	30.00
5590MHz	Pass	8.54	16.52	16.01	19.28	21.46	27.82	30.00
5670MHz	Pass	8.54	15.21	16.33	18.82	21.46	27.36	30.00
5710MHz Straddle 5.47-5.725GHz	Pass	8.54	15.31	16.17	18.77	21.46	27.31	30.00
5710MHz Straddle 5.725-5.85GHz	Pass	8.35	3.99	4.96	7.51	27.65	15.86	36.00
5755MHz	Pass	8.35	20.17	20.86	23.54	27.65	31.89	36.00
5795MHz	Pass	8.35	20.4	20.5	23.46	27.65	31.81	36.00
802.11ax HEW80-BF_Nss1,(MCS0)_2TX-OFDMA	-	-	-	-	-	-	-	-
5210MHz	Pass	8.01	12.74	13.15	15.96	27.99	23.97	36.00
5290MHz	Pass	8.06	16.71	18.16	20.51	21.94	28.57	30.00
5530MHz	Pass	8.54	16.73	15.61	19.22	21.46	27.76	30.00
5610MHz	Pass	8.54	18.04	17.7	20.88	21.46	29.42	30.00
5690MHz Straddle 5.47-5.725GHz	Pass	8.54	16.76	17.73	20.28	21.46	28.82	30.00
5690MHz Straddle 5.725-5.85GHz	Pass	8.35	1.21	2.1	4.69	27.65	13.04	36.00
5775MHz	Pass	8.35	18.95	19.52	22.25	27.65	30.60	36.00
802.11ax HEW160-BF_Nss1,(MCS0)_2TX-OFDMA	-	-	-	-	-	-	-	-
5250MHz Straddle 5.15-5.25GHz	Pass	8.01	7.47	8.46	11.00	27.99	19.01	36.00
5250MHz Straddle 5.25-5.35GHz	Pass	8.06	6.73	7.54	10.16	21.94	18.22	30.00
5570MHz	Pass	8.54	12.51	11.97	15.26	21.46	23.80	30.00

Port X = Port X output power



Conducted Output Power(Average)

Appendix B

DG = Directional Gain = $10 \log \left[\frac{(10^{G1/20} + 10^{G2/20} + \dots + 10^{GN/20})^2}{N_{ANT}} \right]$;

Ant. No.	Operating Frequencies (MHz) / Antenna Gain (dBi)			
	5150 ~ 5250	5250 ~ 5350	5470 ~ 5725	5725 ~ 5850
1	4.9	5.1	5.8	5.5
2	5.1	5	5.25	5.13
Directional Gain (dBi)	8.01	8.06	8.54	8.33



Summary

Mode	PD (dBm/RBW)	EIRP PD (dBm/RBW)
5.15-5.25GHz	-	-
802.11a_Nss1,(6Mbps)_2TX	14.80	22.81
802.11ax HEW20_Nss1,(MCS0)_2TX-OFDMA	13.88	21.89
802.11ax HEW40_Nss1,(MCS0)_2TX-OFDMA	12.39	20.40
802.11ax HEW80_Nss1,(MCS0)_2TX-OFDMA	1.85	9.86
802.11ax HEW160_Nss1,(MCS0)_2TX-OFDMA	-3.51	4.50
5.25-5.35GHz	-	-
802.11a_Nss1,(6Mbps)_2TX	8.75	16.81
802.11ax HEW20_Nss1,(MCS0)_2TX-OFDMA	8.66	16.72
802.11ax HEW40_Nss1,(MCS0)_2TX-OFDMA	8.84	16.90
802.11ax HEW80_Nss1,(MCS0)_2TX-OFDMA	6.68	14.74
802.11ax HEW160_Nss1,(MCS0)_2TX-OFDMA	-3.89	4.17
5.47-5.725GHz	-	-
802.11a_Nss1,(6Mbps)_2TX	8.36	16.90
802.11ax HEW20_Nss1,(MCS0)_2TX-OFDMA	8.32	16.86
802.11ax HEW40_Nss1,(MCS0)_2TX-OFDMA	8.31	16.85
802.11ax HEW80_Nss1,(MCS0)_2TX-OFDMA	7.22	15.76
802.11ax HEW160_Nss1,(MCS0)_2TX-OFDMA	-2.49	6.05
5.725-5.85GHz	-	-
802.11a_Nss1,(6Mbps)_2TX	14.38	22.73
802.11ax HEW20_Nss1,(MCS0)_2TX-OFDMA	13.74	22.09
802.11ax HEW40_Nss1,(MCS0)_2TX-OFDMA	11.00	19.35
802.11ax HEW80_Nss1,(MCS0)_2TX-OFDMA	7.22	15.57

RBW = 500kHz for 5.725-5.85GHz band / 1MHz for other band;



Result

Mode	Result	DG (dBi)	Port 1 (dBm/RBW)	Port 2 (dBm/RBW)	PD (dBm/RBW)	PD Limit (dBm/RBW)	EIRP PD (dBm/RBW)	EIRP PD Limit (dBm/RBW)
802.11a_Nss1,(6Mbps)_2TX	-	-	-	-	-	-	-	-
5180MHz	Pass	8.01	10.40	10.07	13.11	14.99	21.12	23.00
5200MHz	Pass	8.01	11.92	12.14	14.80	14.99	22.81	23.00
5240MHz	Pass	8.01	10.76	11.40	13.94	14.99	21.95	23.00
5260MHz	Pass	8.06	5.25	6.15	8.57	8.94	16.63	17.00
5300MHz	Pass	8.06	4.87	6.63	8.75	8.94	16.81	17.00
5320MHz	Pass	8.06	4.63	6.41	8.51	8.94	16.57	17.00
5500MHz	Pass	8.54	5.55	4.80	8.07	8.46	16.61	17.00
5580MHz	Pass	8.54	5.63	5.07	8.36	8.46	16.90	17.00
5700MHz	Pass	8.54	4.61	5.48	8.01	8.46	16.55	17.00
5720MHz Straddle 5.47-5.725GHz	Pass	8.54	4.87	5.80	8.35	8.46	16.89	17.00
5720MHz Straddle 5.725-5.85GHz	Pass	8.35	0.56	1.91	4.25	27.65	12.60	36.00
5745MHz	Pass	8.35	10.96	11.86	14.38	27.65	22.73	36.00
5785MHz	Pass	8.35	10.54	11.18	13.82	27.65	22.17	36.00
5825MHz	Pass	8.35	10.01	10.87	13.39	27.65	21.74	36.00
802.11ax HEW20_Nss1,(MCS0)_2TX-OFDMA	-	-	-	-	-	-	-	-
5180MHz	Pass	8.01	9.77	9.66	12.53	14.99	20.54	23.00
5200MHz	Pass	8.01	9.85	9.77	12.59	14.99	20.60	23.00
5240MHz	Pass	8.01	10.83	11.18	13.88	14.99	21.89	23.00
5260MHz	Pass	8.06	5.21	6.26	8.66	8.94	16.72	17.00
5300MHz	Pass	8.06	4.59	6.33	8.43	8.94	16.49	17.00
5320MHz	Pass	8.06	4.41	6.39	8.42	8.94	16.48	17.00
5500MHz	Pass	8.54	5.65	4.63	8.07	8.46	16.61	17.00
5580MHz	Pass	8.54	5.83	5.15	8.32	8.46	16.86	17.00
5700MHz	Pass	8.54	4.73	5.40	8.03	8.46	16.57	17.00
5720MHz Straddle 5.47-5.725GHz	Pass	8.54	4.83	6.03	8.31	8.46	16.85	17.00
5720MHz Straddle 5.725-5.85GHz	Pass	8.35	-0.64	0.60	2.99	27.65	11.34	36.00
5745MHz	Pass	8.35	10.47	10.98	13.74	27.65	22.09	36.00
5785MHz	Pass	8.35	8.90	9.45	12.05	27.65	20.40	36.00
5825MHz	Pass	8.35	8.41	8.97	11.61	27.65	19.96	36.00
802.11ax HEW40_Nss1,(MCS0)_2TX-OFDMA	-	-	-	-	-	-	-	-
5190MHz	Pass	8.01	2.96	2.49	5.62	14.99	13.63	23.00
5230MHz	Pass	8.01	9.12	9.79	12.39	14.99	20.40	23.00
5270MHz	Pass	8.06	5.59	6.40	8.84	8.94	16.90	17.00
5310MHz	Pass	8.06	4.56	6.33	8.38	8.94	16.44	17.00
5510MHz	Pass	8.54	5.58	4.74	8.13	8.46	16.67	17.00
5590MHz	Pass	8.54	5.64	5.30	8.31	8.46	16.85	17.00
5670MHz	Pass	8.54	4.38	5.66	7.92	8.46	16.46	17.00
5710MHz Straddle 5.47-5.725GHz	Pass	8.54	4.60	5.49	8.06	8.46	16.60	17.00
5710MHz Straddle 5.725-5.85GHz	Pass	8.35	-1.30	-0.37	1.91	27.65	10.26	36.00



Mode	Result	DG (dBi)	Port 1 (dBm/RBW)	Port 2 (dBm/RBW)	PD (dBm/RBW)	PD Limit (dBm/RBW)	EIRP PD (dBm/RBW)	EIRP PD Limit (dBm/RBW)
5755MHz	Pass	8.35	7.63	8.47	10.96	27.65	19.31	36.00
5795MHz	Pass	8.35	7.87	8.34	11.00	27.65	19.35	36.00
802.11ax HEW80_Nss1,(MCS0)_2TX-OFDMA	-	-	-	-	-	-	-	-
5210MHz	Pass	8.01	-1.22	-0.77	1.85	14.99	9.86	23.00
5290MHz	Pass	8.06	3.24	4.44	6.68	8.94	14.74	17.00
5530MHz	Pass	8.54	2.91	1.90	5.25	8.46	13.79	17.00
5610MHz	Pass	8.54	4.26	4.34	7.22	8.46	15.76	17.00
5690MHz Straddle 5.47-5.725GHz	Pass	8.54	3.48	4.49	6.97	8.46	15.51	17.00
5690MHz Straddle 5.725-5.85GHz	Pass	8.35	-3.85	-3.36	-0.71	27.65	7.64	36.00
5775MHz	Pass	8.35	3.86	4.64	7.22	27.65	15.57	36.00
802.11ax HEW160_Nss1,(MCS0)_2TX-OFDMA	-	-	-	-	-	-	-	-
5250MHz Straddle 5.15-5.25GHz	Pass	8.01	-6.79	-6.14	-3.51	14.99	4.50	23.00
5250MHz Straddle 5.25-5.35GHz	Pass	8.06	-7.14	-6.46	-3.89	8.94	4.17	17.00
5570MHz	Pass	8.54	-5.45	-5.48	-2.49	8.46	6.05	17.00

RBW = 500kHz for 5.725-5.85GHz band / 1MHz for other band;

PD = trace bin-by-bin of each transmits port summing can be performed maximum power density; Port X = Port X Power Density;

DG = Directional Gain = $10 \log \left[\frac{(10^{G1/20} + 10^{G2/20} + \dots + 10^{GN/20})^2}{N_{ANT}} \right]$;

Ant. No.	Operating Frequencies (MHz) / Antenna Gain (dBi)			
	5150 ~ 5250	5250 ~ 5350	5470 ~ 5725	5725 ~ 5850
1	4.9	5.1	5.8	5.5
2	5.1	5	5.25	5.13
Directional Gain (dBi)	8.01	8.06	8.54	8.33



802.11a_Nss1,(6Mbps)_2TX

PSD

5180MHz

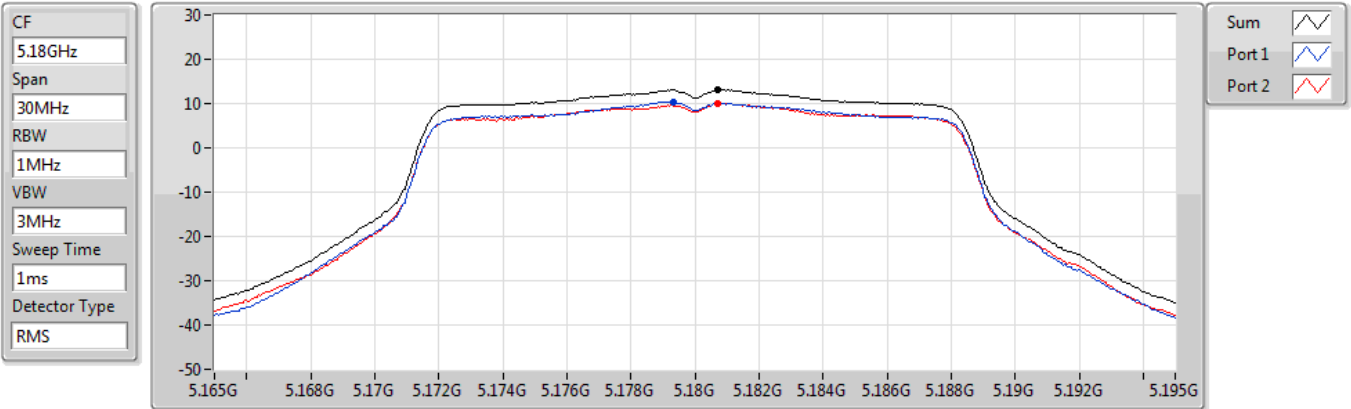

Sum	PD	Port 1	Port 2
(dBm/RBW)	(dBm/RBW)	(dBm/RBW)	(dBm/RBW)
13.11	13.11	10.40	10.07

802.11a_Nss1,(6Mbps)_2TX

PSD

5200MHz

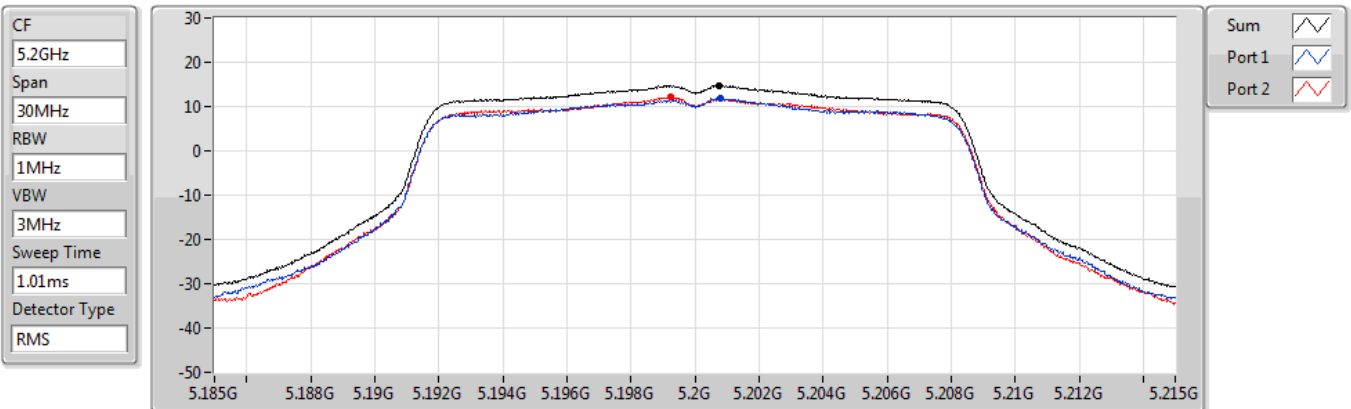

Sum	PD	Port 1	Port 2
(dBm/RBW)	(dBm/RBW)	(dBm/RBW)	(dBm/RBW)
14.80	14.80	11.92	12.14



802.11a_Nss1,(6Mbps)_2TX

PSD

5240MHz

CF
5.24GHz
Span
30MHz
RBW
1MHz
VBW
3MHz
Sweep Time
1.01ms
Detector Type
RMS

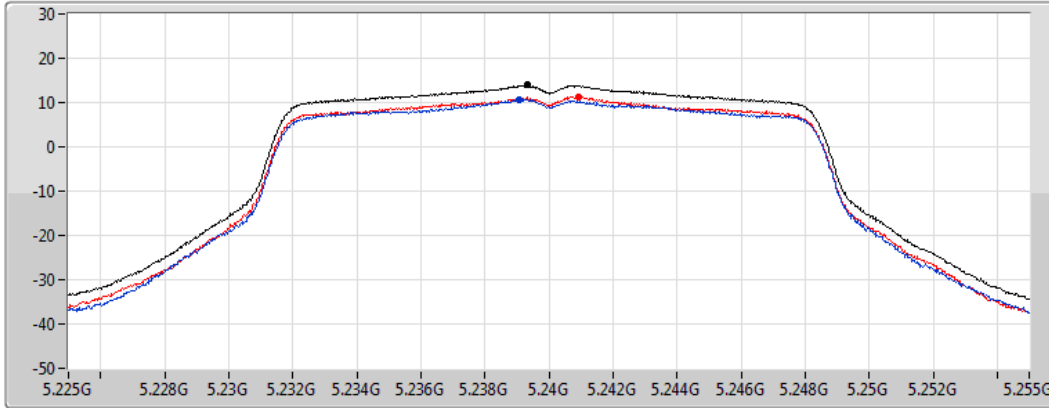

Sum
Port 1
Port 2

Sum	PD	Port 1	Port 2
(dBm/RBW)	(dBm/RBW)	(dBm/RBW)	(dBm/RBW)
13.94	13.94	10.76	11.40

802.11a_Nss1,(6Mbps)_2TX

PSD

5260MHz

CF
5.26GHz
Span
30MHz
RBW
1MHz
VBW
3MHz
Sweep Time
1.01ms
Detector Type
RMS

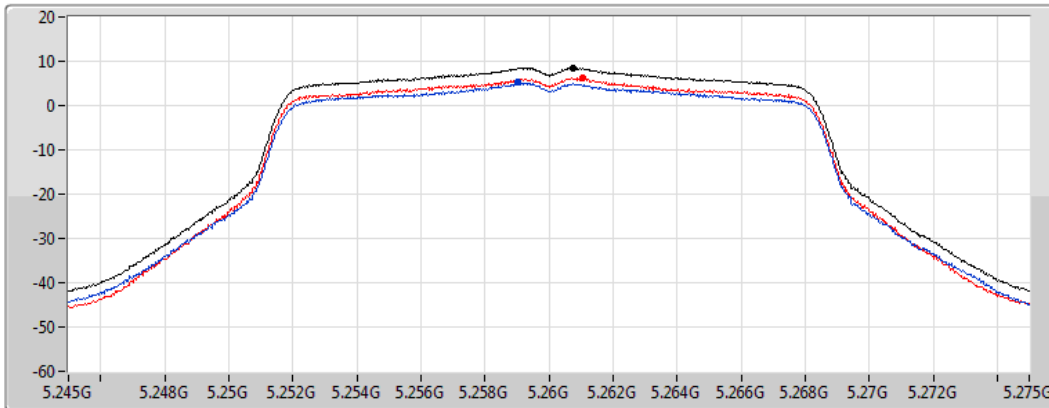

Sum
Port 1
Port 2

Sum	PD	Port 1	Port 2
(dBm/RBW)	(dBm/RBW)	(dBm/RBW)	(dBm/RBW)
8.57	8.57	5.25	6.15



802.11a_Nss1,(6Mbps)_2TX

PSD

5300MHz

CF
5.3GHz
Span
30MHz
RBW
1MHz
VBW
3MHz
Sweep Time
1.01ms
Detector Type
RMS

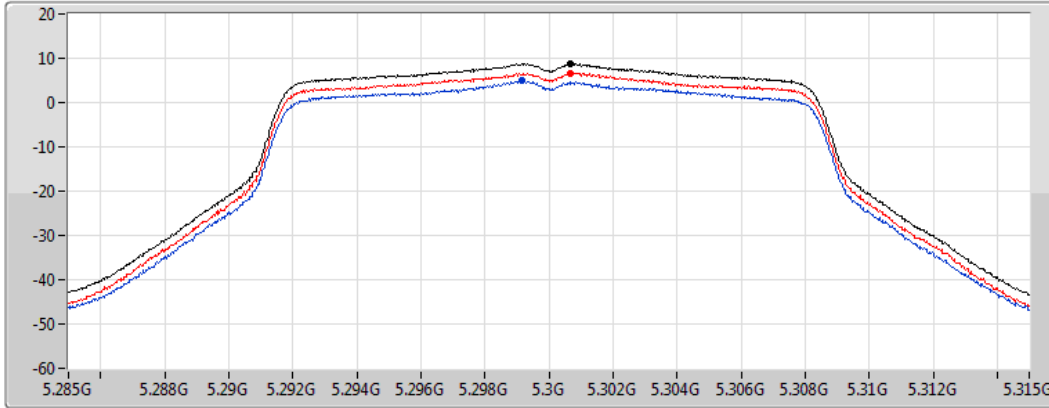

Sum
Port 1
Port 2

Sum	PD	Port 1	Port 2
(dBm/RBW)	(dBm/RBW)	(dBm/RBW)	(dBm/RBW)
8.75	8.75	4.87	6.63

802.11a_Nss1,(6Mbps)_2TX

PSD

5320MHz

CF
5.32GHz
Span
30MHz
RBW
1MHz
VBW
3MHz
Sweep Time
1.01ms
Detector Type
RMS

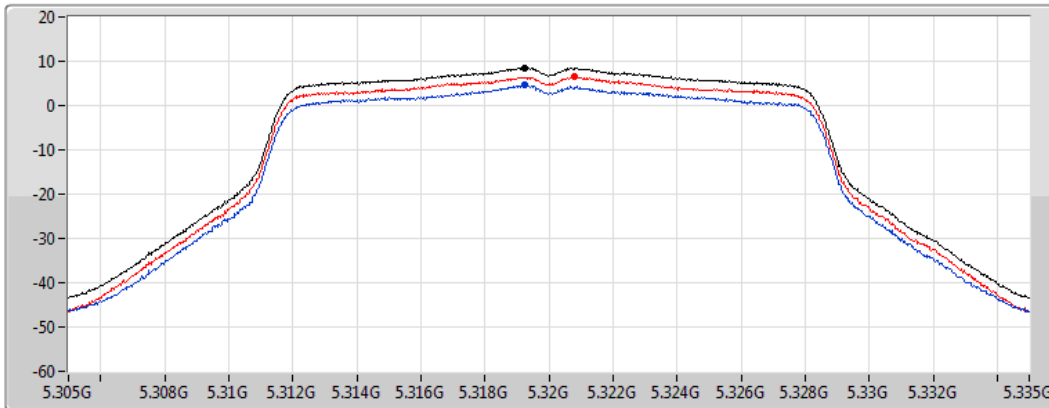

Sum
Port 1
Port 2

Sum	PD	Port 1	Port 2
(dBm/RBW)	(dBm/RBW)	(dBm/RBW)	(dBm/RBW)
8.51	8.51	4.63	6.41



802.11a_Nss1,(6Mbps)_2TX

PSD

5500MHz

CF
5.5GHz
Span
30MHz
RBW
1MHz
VBW
3MHz
Sweep Time
1.01ms
Detector Type
RMS

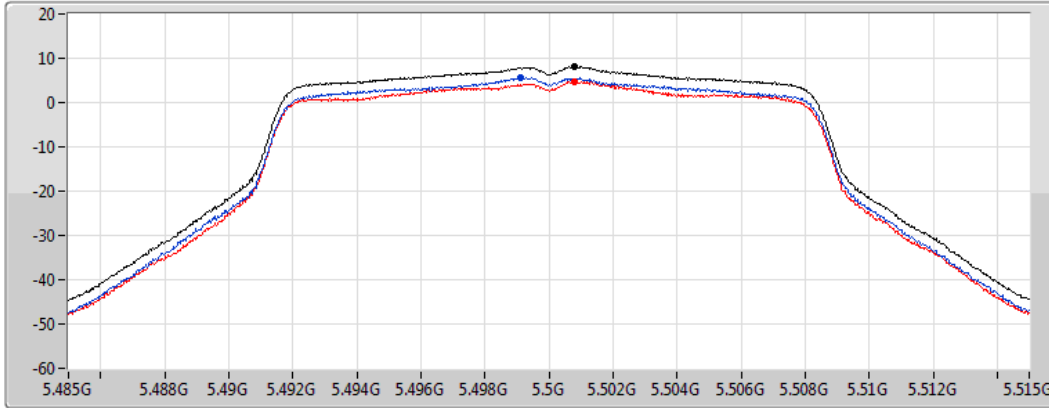

Sum
Port 1
Port 2

Sum	PD	Port 1	Port 2
(dBm/RBW)	(dBm/RBW)	(dBm/RBW)	(dBm/RBW)
8.07	8.07	5.55	4.80

802.11a_Nss1,(6Mbps)_2TX

PSD

5580MHz

CF
5.58GHz
Span
30MHz
RBW
1MHz
VBW
3MHz
Sweep Time
1.01ms
Detector Type
RMS

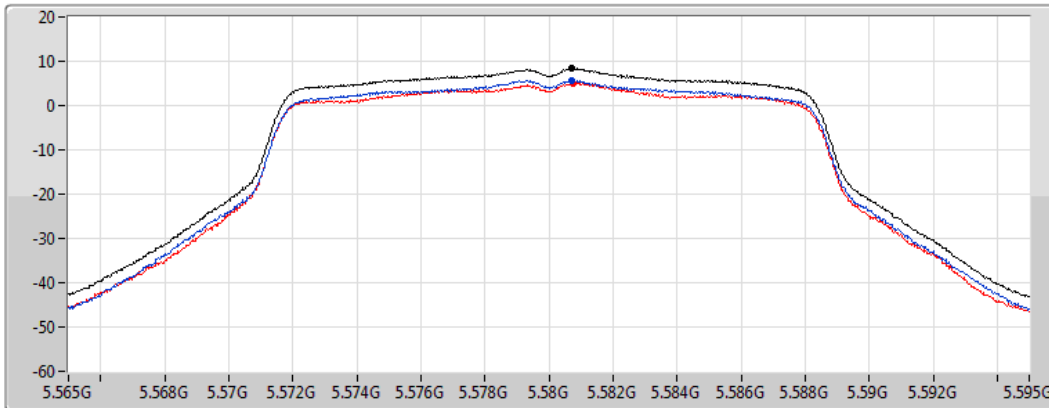

Sum
Port 1
Port 2

Sum	PD	Port 1	Port 2
(dBm/RBW)	(dBm/RBW)	(dBm/RBW)	(dBm/RBW)
8.36	8.36	5.63	5.07



802.11a_Nss1,(6Mbps)_2TX

PSD

5700MHz

CF
5.7GHz
Span
30MHz
RBW
1MHz
VBW
3MHz
Sweep Time
1.01ms
Detector Type
RMS

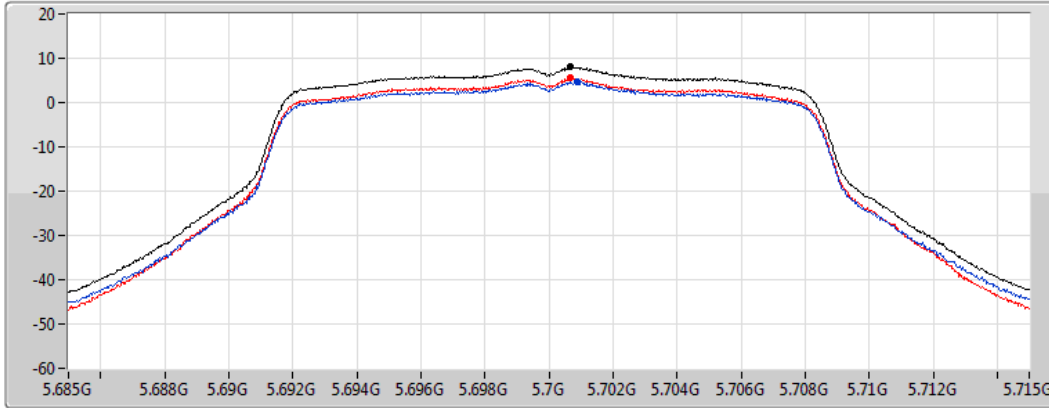

Sum
Port 1
Port 2

Sum	PD	Port 1	Port 2
(dBm/RBW)	(dBm/RBW)	(dBm/RBW)	(dBm/RBW)
8.01	8.01	4.61	5.48

802.11a_Nss1,(6Mbps)_2TX

PSD

5720MHz Straddle 5.47-5.725GHz

CF
5.71GHz
Span
60MHz
RBW
1MHz
VBW
3MHz
Sweep Time
1.01ms
Detector Type
RMS

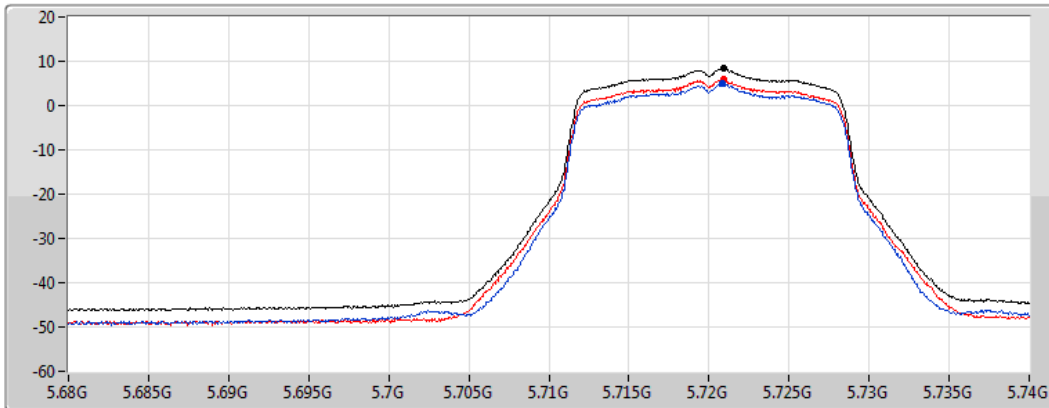

Sum
Port 1
Port 2

Sum	PD	Port 1	Port 2
(dBm/RBW)	(dBm/RBW)	(dBm/RBW)	(dBm/RBW)
8.35	8.35	4.87	5.80



802.11a_Nss1,(6Mbps)_2TX

PSD

5720MHz Straddle 5.725-5.85GHz

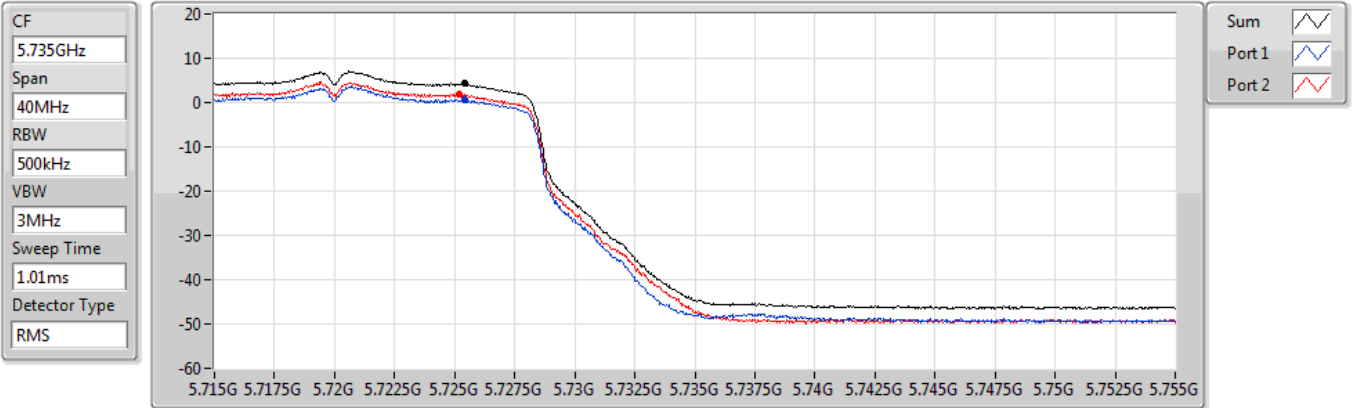

Sum	PD	Port 1	Port 2
(dBm/RBW)	(dBm/RBW)	(dBm/RBW)	(dBm/RBW)
4.25	4.25	0.56	1.91

802.11a_Nss1,(6Mbps)_2TX

PSD

5745MHz

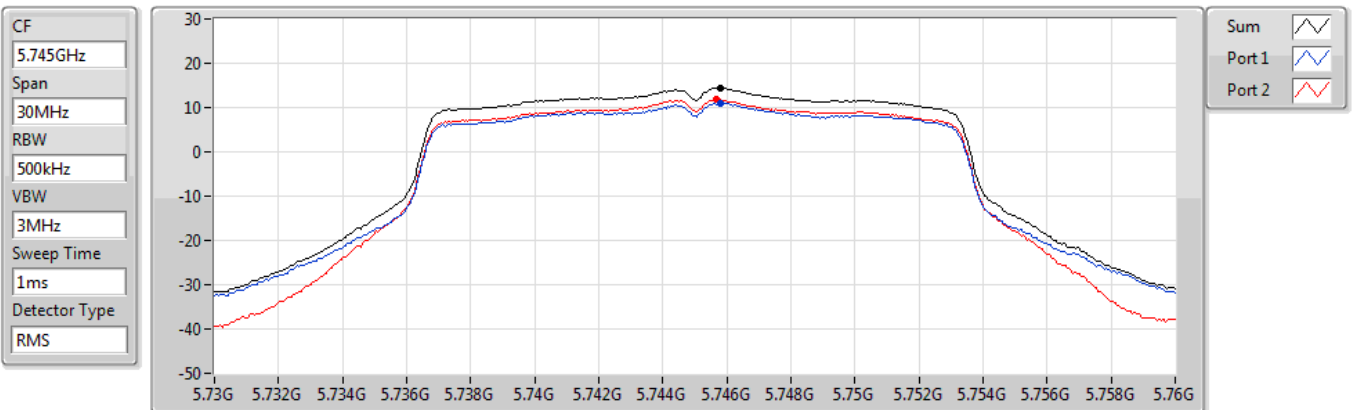

Sum	PD	Port 1	Port 2
(dBm/RBW)	(dBm/RBW)	(dBm/RBW)	(dBm/RBW)
14.38	14.38	10.96	11.86



802.11a_Nss1,(6Mbps)_2TX

PSD

5785MHz

CF
5.785GHz
Span
30MHz
RBW
500kHz
VBW
3MHz
Sweep Time
1ms
Detector Type
RMS

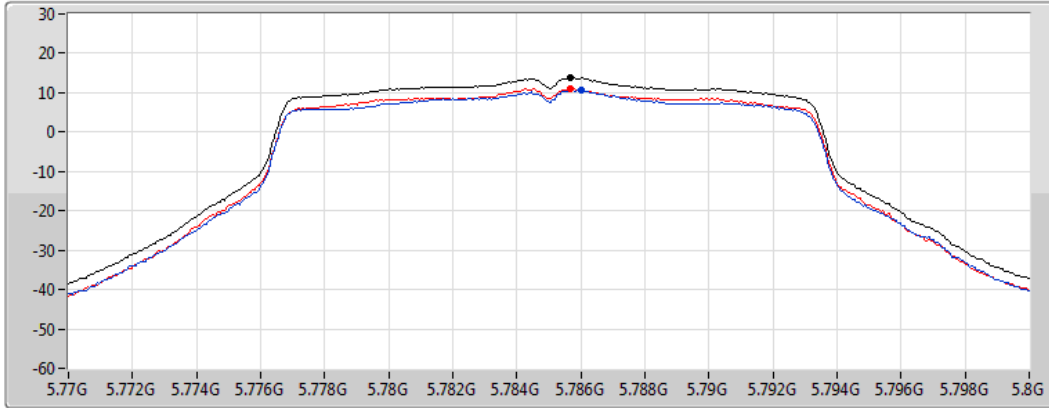

Sum
Port 1
Port 2

Sum	PD	Port 1	Port 2
(dBm/RBW)	(dBm/RBW)	(dBm/RBW)	(dBm/RBW)
13.82	13.82	10.54	11.18

802.11a_Nss1,(6Mbps)_2TX

PSD

5825MHz

CF
5.825GHz
Span
30MHz
RBW
500kHz
VBW
3MHz
Sweep Time
1ms
Detector Type
RMS

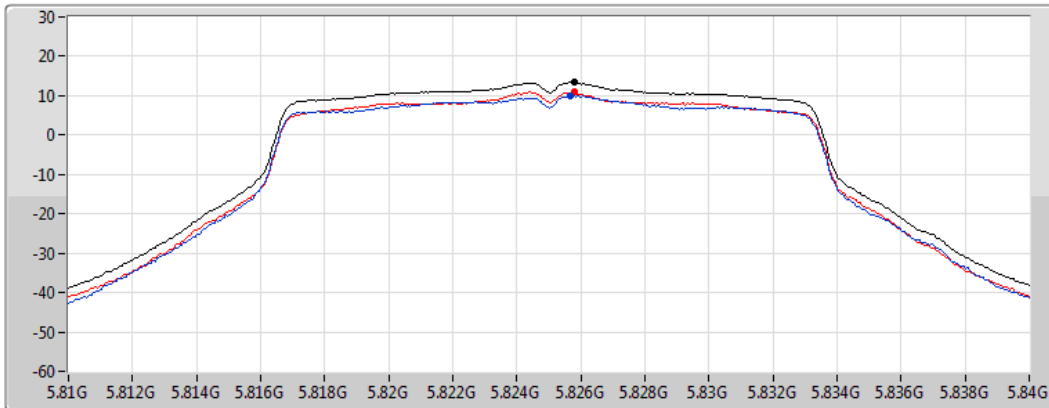

Sum
Port 1
Port 2

Sum	PD	Port 1	Port 2
(dBm/RBW)	(dBm/RBW)	(dBm/RBW)	(dBm/RBW)
13.39	13.39	10.01	10.87



802.11ax HEW20_Nss1,(MCS0)_2TX

PSD

5180MHz

CF
5.18GHz
Span
30MHz
RBW
1MHz
VBW
3MHz
Sweep Time
1ms
Detector Type
RMS

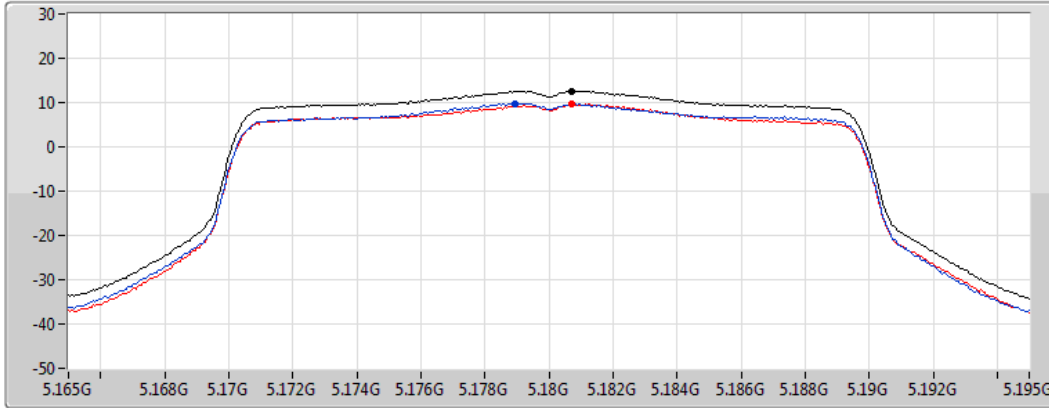

Sum
Port 1
Port 2

Sum	PD	Port 1	Port 2
(dBm/RBW)	(dBm/RBW)	(dBm/RBW)	(dBm/RBW)
12.53	12.53	9.77	9.66

802.11ax HEW20_Nss1,(MCS0)_2TX

PSD

5200MHz

CF
5.2GHz
Span
30MHz
RBW
1MHz
VBW
3MHz
Sweep Time
1.01ms
Detector Type
RMS

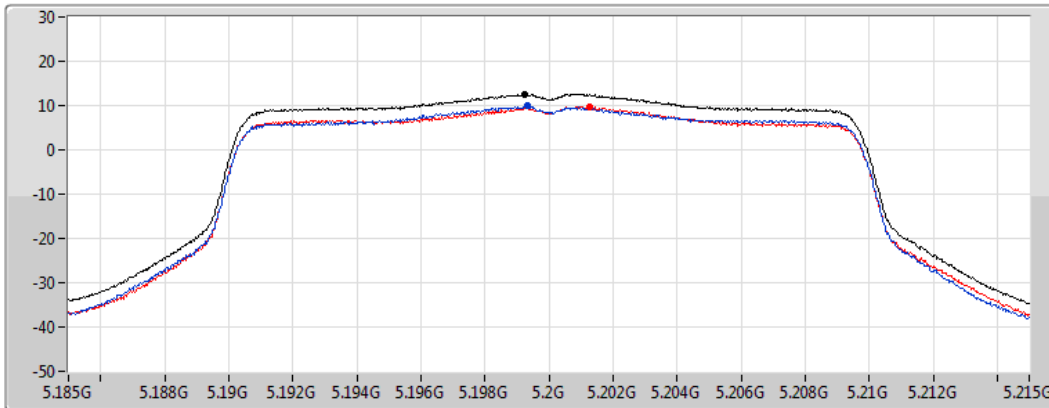

Sum
Port 1
Port 2

Sum	PD	Port 1	Port 2
(dBm/RBW)	(dBm/RBW)	(dBm/RBW)	(dBm/RBW)
12.59	12.59	9.85	9.77



802.11ax HEW20_Nss1,(MCS0)_2TX

PSD

5240MHz

CF
5.24GHz
Span
30MHz
RBW
1MHz
VBW
3MHz
Sweep Time
1.01ms
Detector Type
RMS

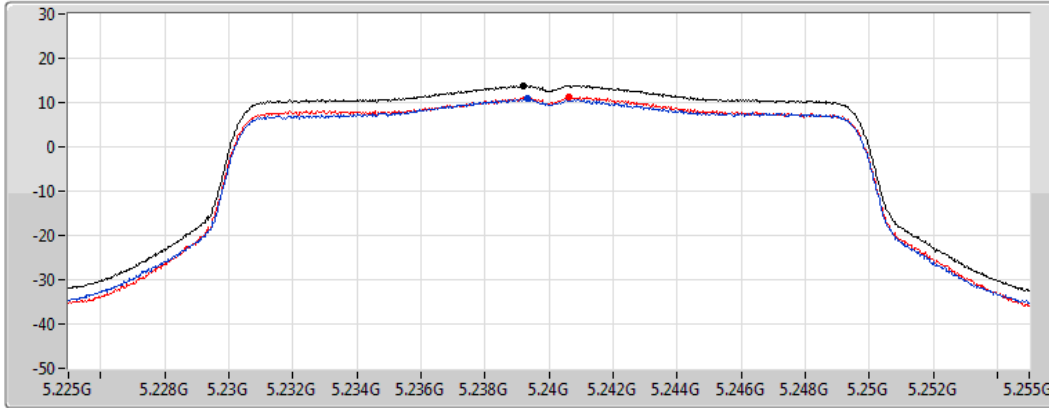

Sum
Port 1
Port 2

Sum	PD	Port 1	Port 2
(dBm/RBW)	(dBm/RBW)	(dBm/RBW)	(dBm/RBW)
13.88	13.88	10.83	11.18

802.11ax HEW20_Nss1,(MCS0)_2TX

PSD

5260MHz

CF
5.26GHz
Span
30MHz
RBW
1MHz
VBW
3MHz
Sweep Time
1.01ms
Detector Type
RMS

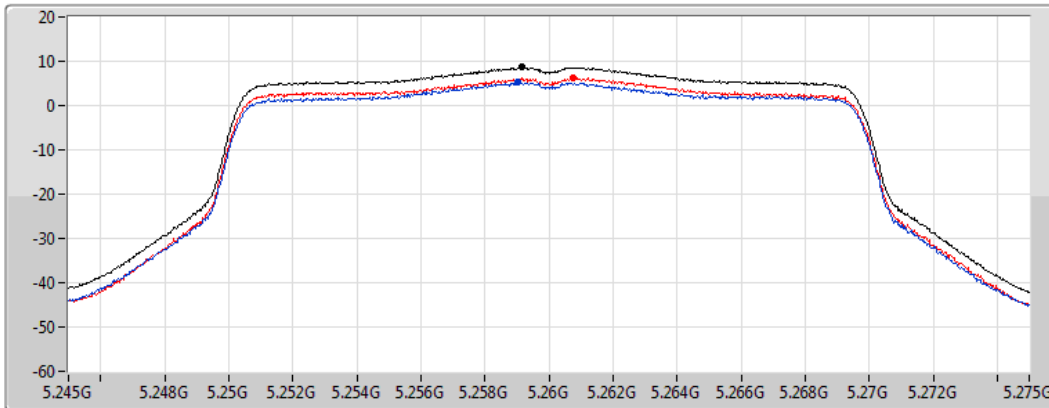

Sum
Port 1
Port 2

Sum	PD	Port 1	Port 2
(dBm/RBW)	(dBm/RBW)	(dBm/RBW)	(dBm/RBW)
8.66	8.66	5.21	6.26



802.11ax HEW20_Nss1,(MCS0)_2TX

PSD

5300MHz

CF
5.3GHz
Span
30MHz
RBW
1MHz
VBW
3MHz
Sweep Time
1.01ms
Detector Type
RMS

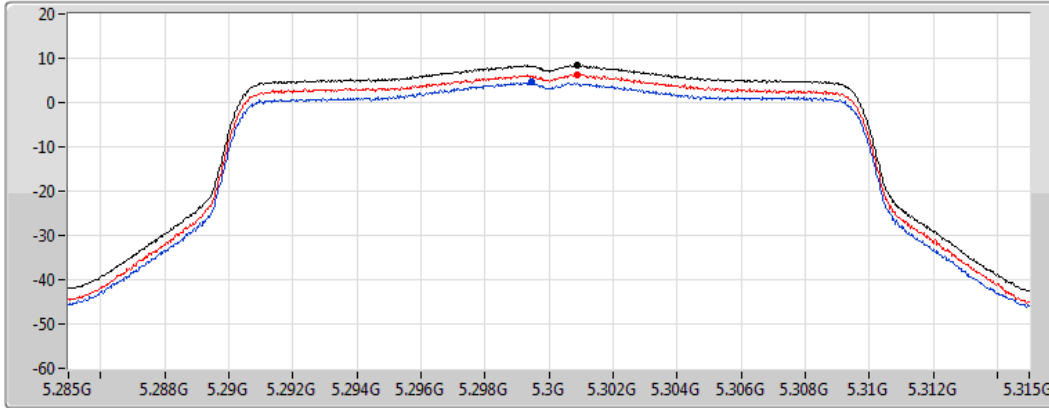

Sum
Port 1
Port 2

Sum	PD	Port 1	Port 2
(dBm/RBW)	(dBm/RBW)	(dBm/RBW)	(dBm/RBW)
8.43	8.43	4.59	6.33

802.11ax HEW20_Nss1,(MCS0)_2TX

PSD

5320MHz

CF
5.32GHz
Span
30MHz
RBW
1MHz
VBW
3MHz
Sweep Time
1.01ms
Detector Type
RMS

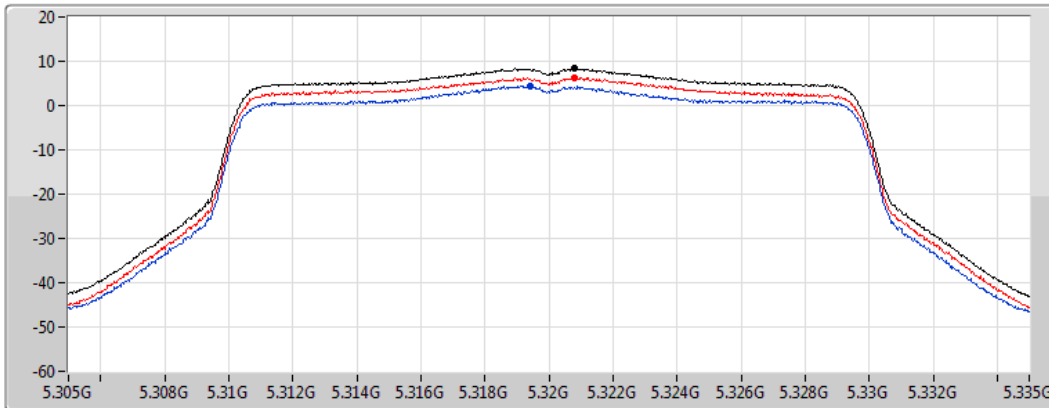

Sum
Port 1
Port 2

Sum	PD	Port 1	Port 2
(dBm/RBW)	(dBm/RBW)	(dBm/RBW)	(dBm/RBW)
8.42	8.42	4.41	6.39



802.11ax HEW20_Nss1,(MCS0)_2TX

PSD

5500MHz

CF
5.5GHz
Span
30MHz
RBW
1MHz
VBW
3MHz
Sweep Time
1.01ms
Detector Type
RMS

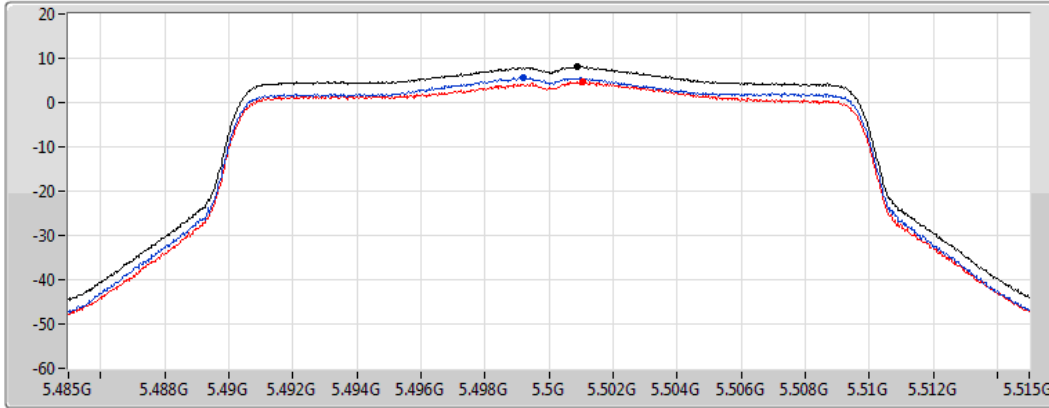

Sum
Port 1
Port 2

Sum	PD	Port 1	Port 2
(dBm/RBW)	(dBm/RBW)	(dBm/RBW)	(dBm/RBW)
8.07	8.07	5.65	4.63

802.11ax HEW20_Nss1,(MCS0)_2TX

PSD

5580MHz

CF
5.58GHz
Span
30MHz
RBW
1MHz
VBW
3MHz
Sweep Time
1.01ms
Detector Type
RMS

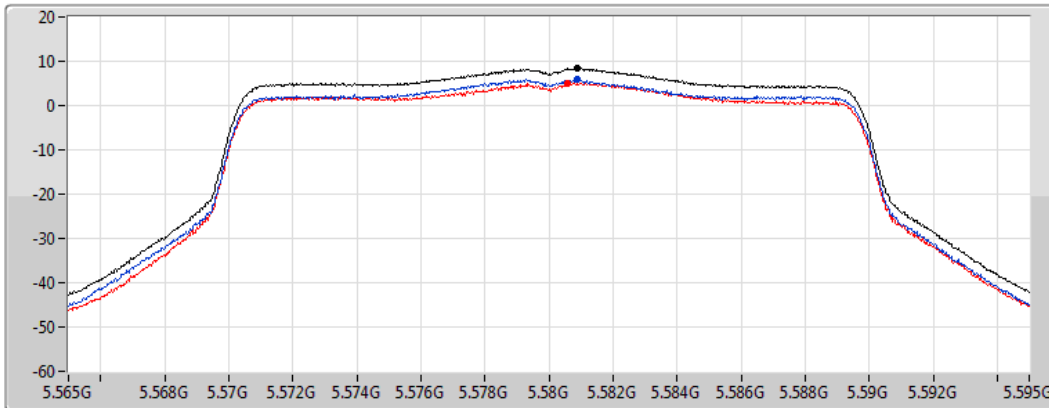

Sum
Port 1
Port 2

Sum	PD	Port 1	Port 2
(dBm/RBW)	(dBm/RBW)	(dBm/RBW)	(dBm/RBW)
8.32	8.32	5.83	5.15



802.11ax HEW20_Nss1,(MCS0)_2TX

PSD

5700MHz

CF
5.7GHz
Span
30MHz
RBW
1MHz
VBW
3MHz
Sweep Time
1.01ms
Detector Type
RMS

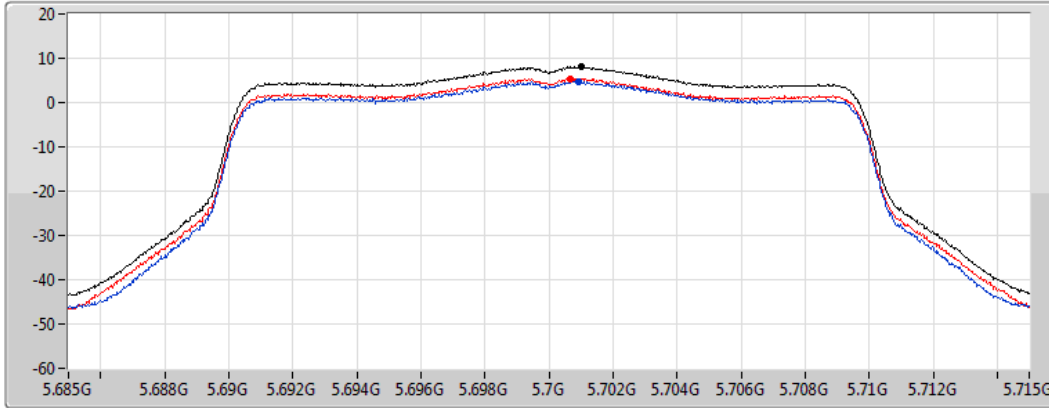

Sum
Port 1
Port 2

Sum	PD	Port 1	Port 2
(dBm/RBW)	(dBm/RBW)	(dBm/RBW)	(dBm/RBW)
8.03	8.03	4.73	5.40

802.11ax HEW20_Nss1,(MCS0)_2TX

PSD

5720MHz Straddle 5.47-5.725GHz

CF
5.71GHz
Span
60MHz
RBW
1MHz
VBW
3MHz
Sweep Time
1.01ms
Detector Type
RMS

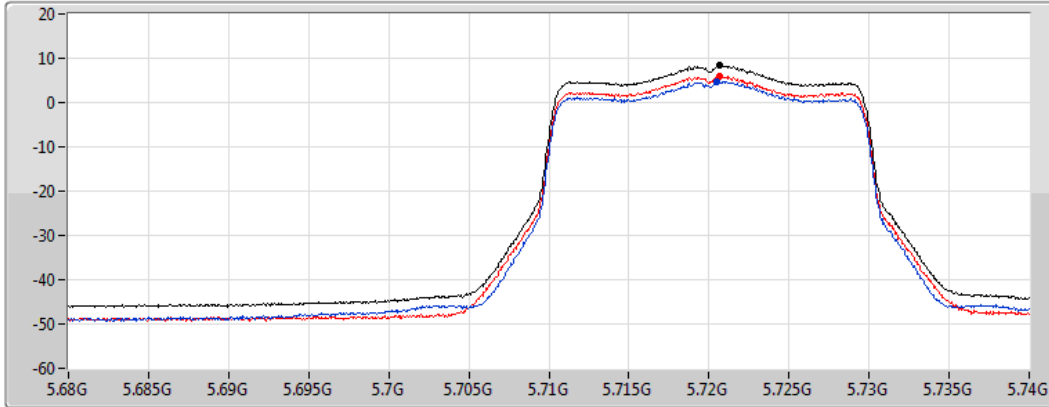

Sum
Port 1
Port 2

Sum	PD	Port 1	Port 2
(dBm/RBW)	(dBm/RBW)	(dBm/RBW)	(dBm/RBW)
8.31	8.31	4.83	6.03



802.11ax HEW20_Nss1,(MCS0)_2TX

PSD

5720MHz Straddle 5.725-5.85GHz

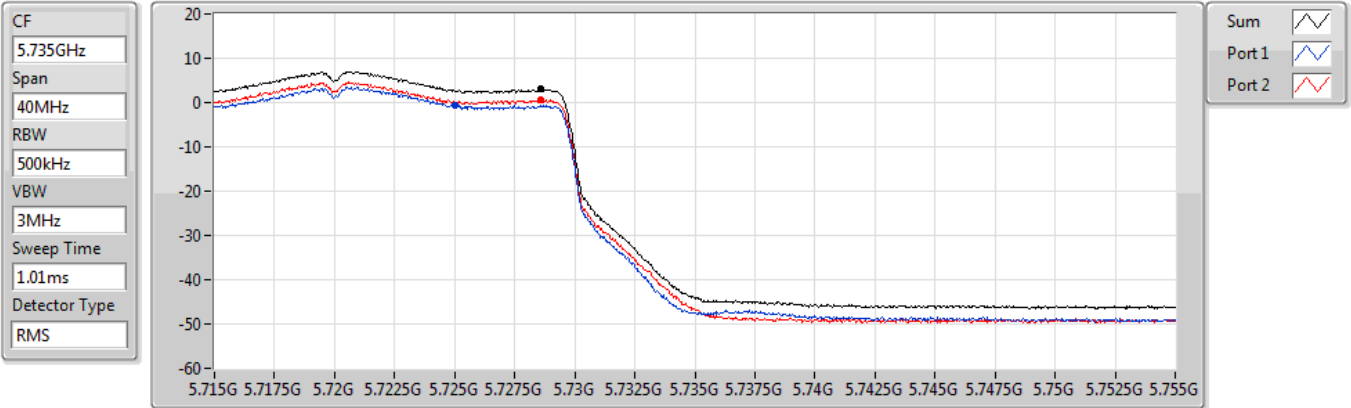

Sum	PD	Port 1	Port 2
(dBm/RBW)	(dBm/RBW)	(dBm/RBW)	(dBm/RBW)
2.99	2.99	-0.64	0.60

802.11ax HEW20_Nss1,(MCS0)_2TX

PSD

5745MHz

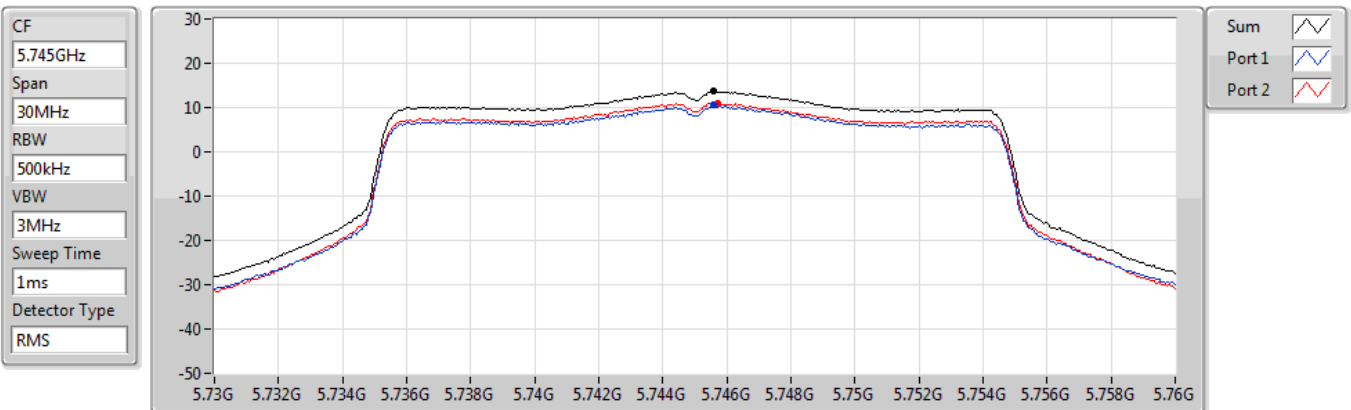

Sum	PD	Port 1	Port 2
(dBm/RBW)	(dBm/RBW)	(dBm/RBW)	(dBm/RBW)
13.74	13.74	10.47	10.98



802.11ax HEW20_Nss1,(MCS0)_2TX

PSD

5785MHz

CF
5.785GHz
Span
30MHz
RBW
500kHz
VBW
3MHz
Sweep Time
1ms
Detector Type
RMS

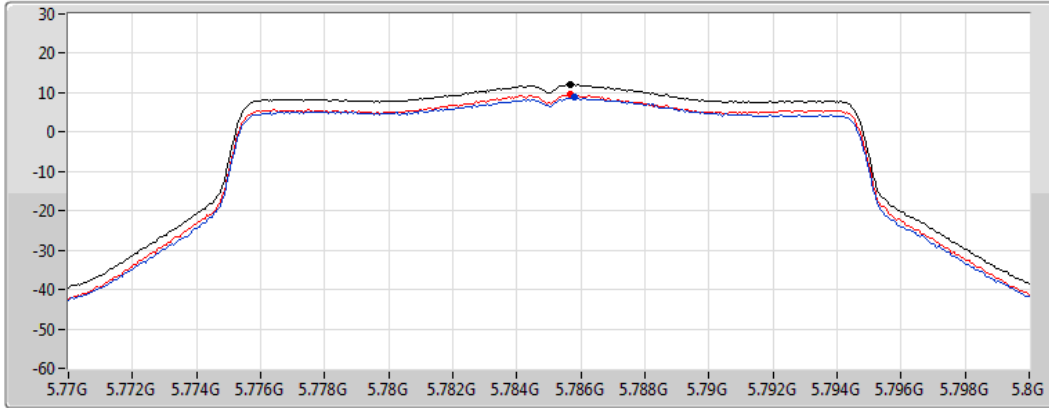

Sum
Port 1
Port 2

Sum	PD	Port 1	Port 2
(dBm/RBW)	(dBm/RBW)	(dBm/RBW)	(dBm/RBW)
12.05	12.05	8.90	9.45

802.11ax HEW20_Nss1,(MCS0)_2TX

PSD

5825MHz

CF
5.825GHz
Span
30MHz
RBW
500kHz
VBW
3MHz
Sweep Time
1ms
Detector Type
RMS

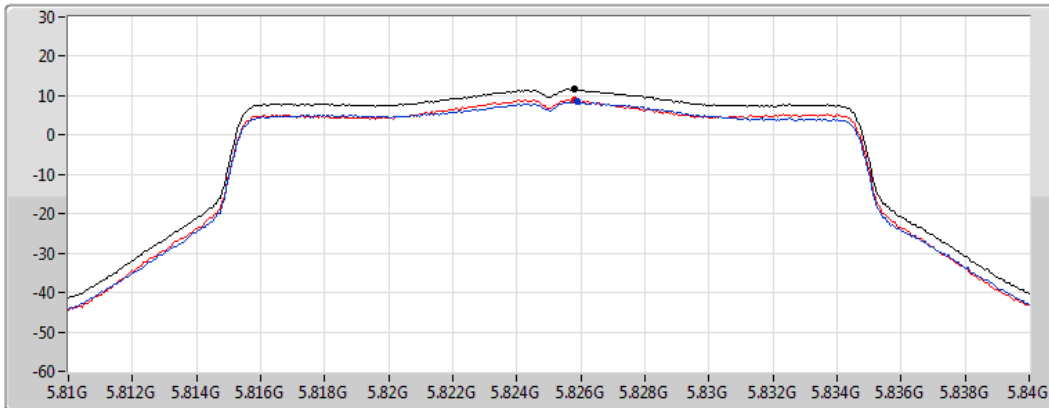

Sum
Port 1
Port 2

Sum	PD	Port 1	Port 2
(dBm/RBW)	(dBm/RBW)	(dBm/RBW)	(dBm/RBW)
11.61	11.61	8.41	8.97



802.11ax HEW40_Nss1,(MCS0)_2TX

PSD

5190MHz

CF
5.19GHz
Span
60MHz
RBW
1MHz
VBW
3MHz
Sweep Time
1ms
Detector Type
RMS

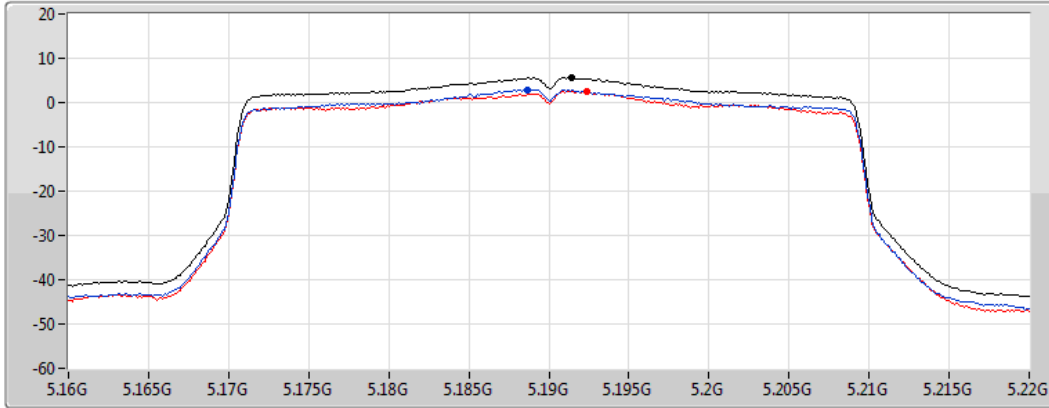

Sum
Port 1
Port 2

Sum	PD	Port 1	Port 2
(dBm/RBW)	(dBm/RBW)	(dBm/RBW)	(dBm/RBW)
5.62	5.62	2.96	2.49

802.11ax HEW40_Nss1,(MCS0)_2TX

PSD

5230MHz

CF
5.23GHz
Span
60MHz
RBW
1MHz
VBW
3MHz
Sweep Time
1.01ms
Detector Type
RMS

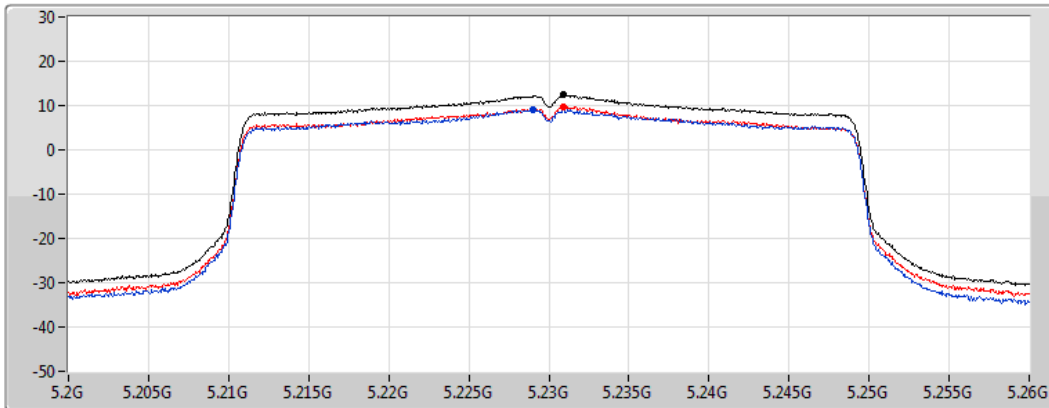

Sum
Port 1
Port 2

Sum	PD	Port 1	Port 2
(dBm/RBW)	(dBm/RBW)	(dBm/RBW)	(dBm/RBW)
12.39	12.39	9.12	9.79



802.11ax HEW40_Nss1,(MCS0)_2TX

PSD

5270MHz

CF
5.27GHz
Span
60MHz
RBW
1MHz
VBW
3MHz
Sweep Time
1.01ms
Detector Type
RMS

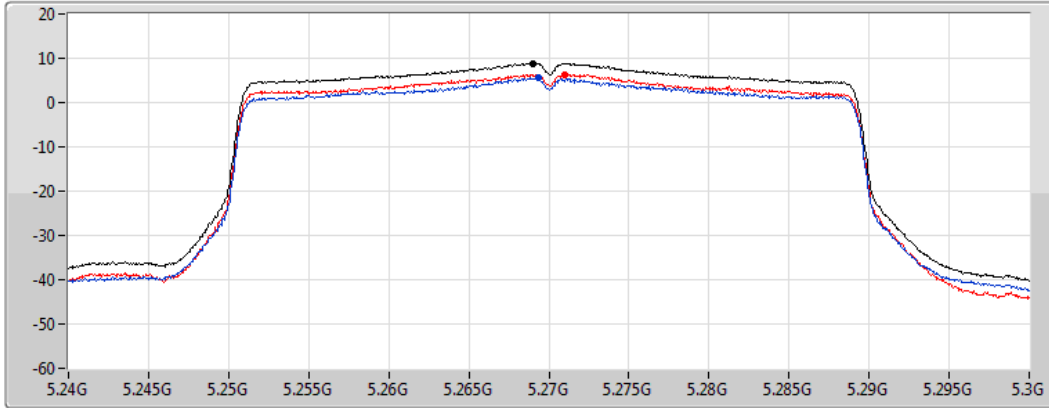

Sum
Port 1
Port 2

Sum	PD	Port 1	Port 2
(dBm/RBW)	(dBm/RBW)	(dBm/RBW)	(dBm/RBW)
8.84	8.84	5.59	6.40

802.11ax HEW40_Nss1,(MCS0)_2TX

PSD

5310MHz

CF
5.31GHz
Span
60MHz
RBW
1MHz
VBW
3MHz
Sweep Time
1.01ms
Detector Type
RMS

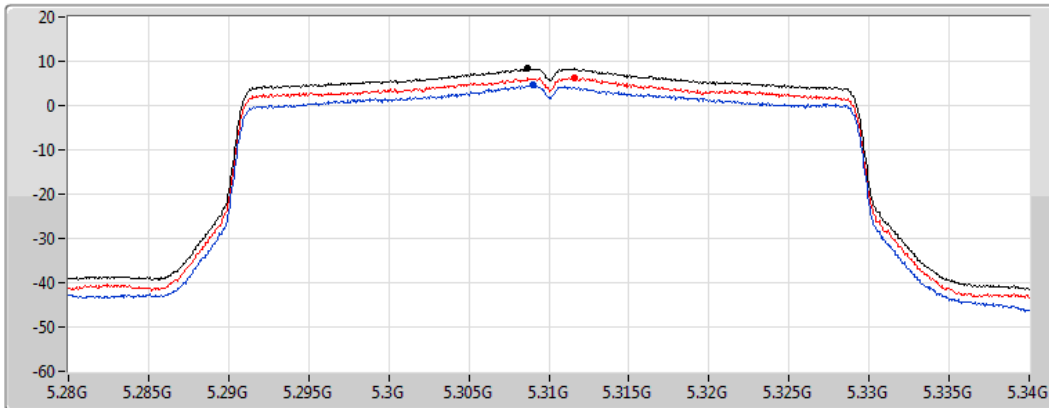

Sum
Port 1
Port 2

Sum	PD	Port 1	Port 2
(dBm/RBW)	(dBm/RBW)	(dBm/RBW)	(dBm/RBW)
8.38	8.38	4.56	6.33



802.11ax HEW40_Nss1,(MCS0)_2TX

PSD

5510MHz

CF
5.51GHz
Span
60MHz
RBW
1MHz
VBW
3MHz
Sweep Time
1.01ms
Detector Type
RMS

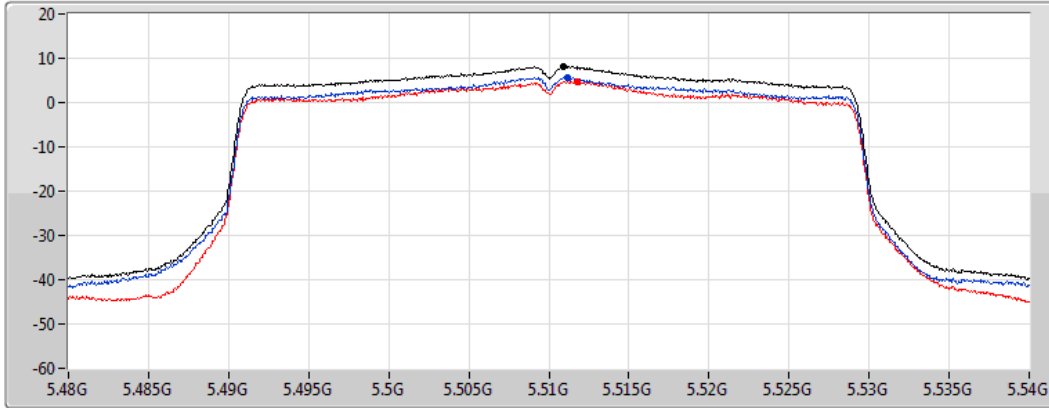

Sum
Port 1
Port 2

Sum	PD	Port 1	Port 2
(dBm/1MHz)	(dBm/1MHz)	(dBm/1MHz)	(dBm/1MHz)
8.13	8.13	5.58	4.74

802.11ax HEW40_Nss1,(MCS0)_2TX

PSD

5590MHz

CF
5.59GHz
Span
60MHz
RBW
1MHz
VBW
3MHz
Sweep Time
1.01ms
Detector Type
RMS

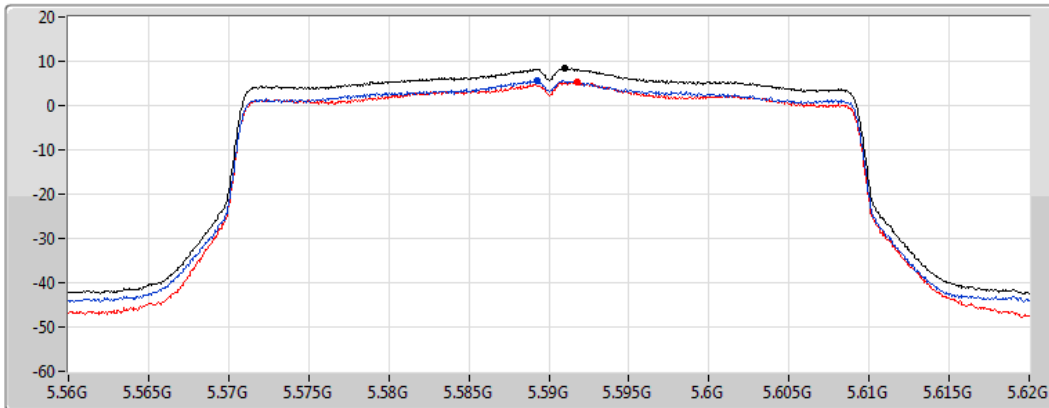

Sum
Port 1
Port 2

Sum	PD	Port 1	Port 2
(dBm/1MHz)	(dBm/1MHz)	(dBm/1MHz)	(dBm/1MHz)
8.31	8.31	5.64	5.30



802.11ax HEW40_Nss1,(MCS0)_2TX

PSD

5670MHz

CF
5.67GHz
Span
60MHz
RBW
1MHz
VBW
3MHz
Sweep Time
1.01ms
Detector Type
RMS

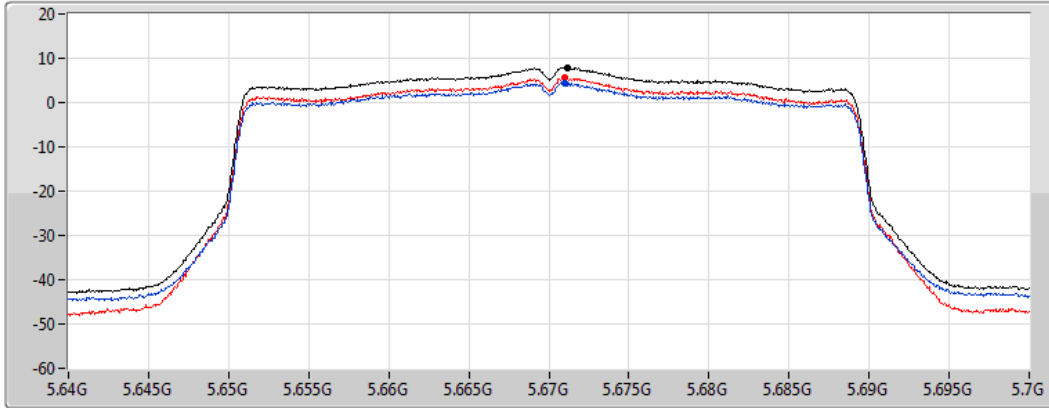

Sum
Port 1
Port 2

Sum	PD	Port 1	Port 2
(dBm/RBW)	(dBm/RBW)	(dBm/RBW)	(dBm/RBW)
7.92	7.92	4.38	5.66

802.11ax HEW40_Nss1,(MCS0)_2TX

PSD

5710MHz Straddle 5.47-5.725GHz

CF
5.69GHz
Span
140MHz
RBW
1MHz
VBW
3MHz
Sweep Time
1.01ms
Detector Type
RMS

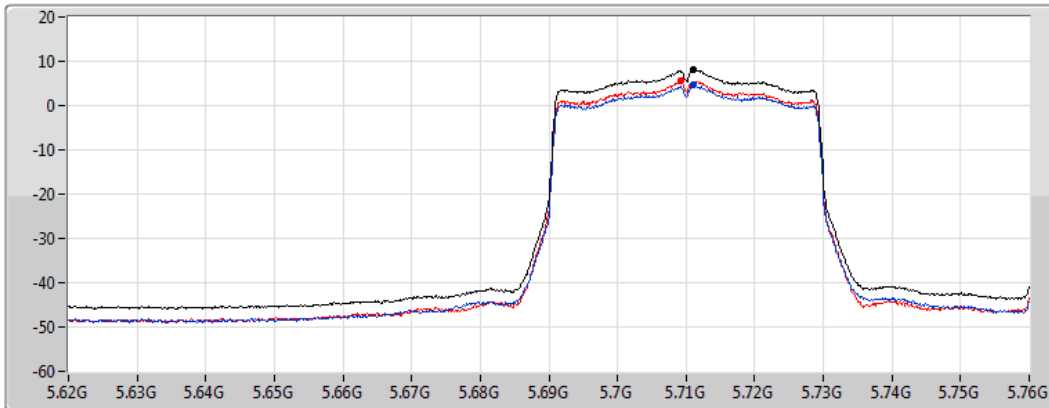

Sum
Port 1
Port 2

Sum	PD	Port 1	Port 2
(dBm/RBW)	(dBm/RBW)	(dBm/RBW)	(dBm/RBW)
8.06	8.06	4.60	5.49



802.11ax HEW40_Nss1,(MCS0)_2TX

PSD

5710MHz Straddle 5.725-5.85GHz

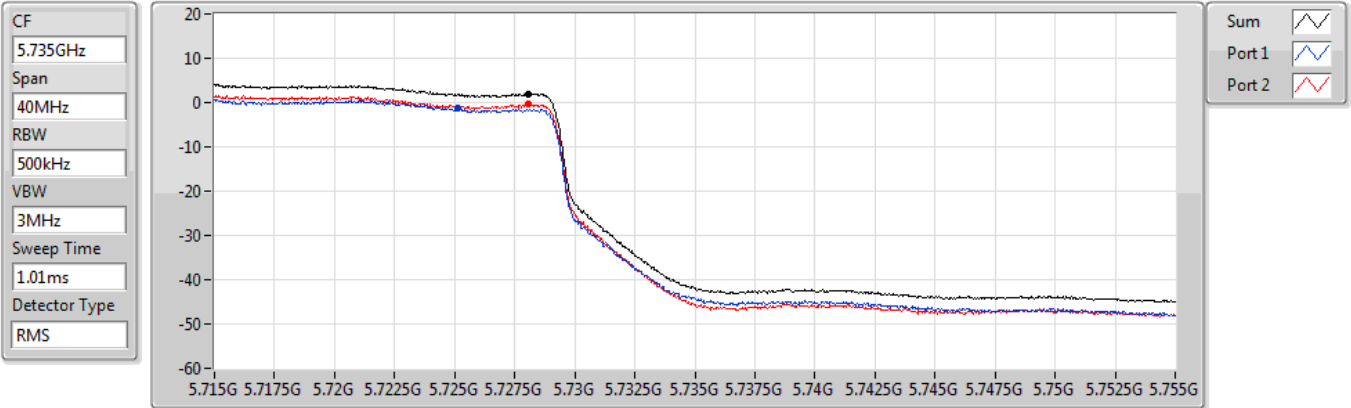

Sum	PD	Port 1	Port 2
(dBm/RBW)	(dBm/RBW)	(dBm/RBW)	(dBm/RBW)
1.91	1.91	-1.30	-0.37

802.11ax HEW40_Nss1,(MCS0)_2TX

PSD

5755MHz

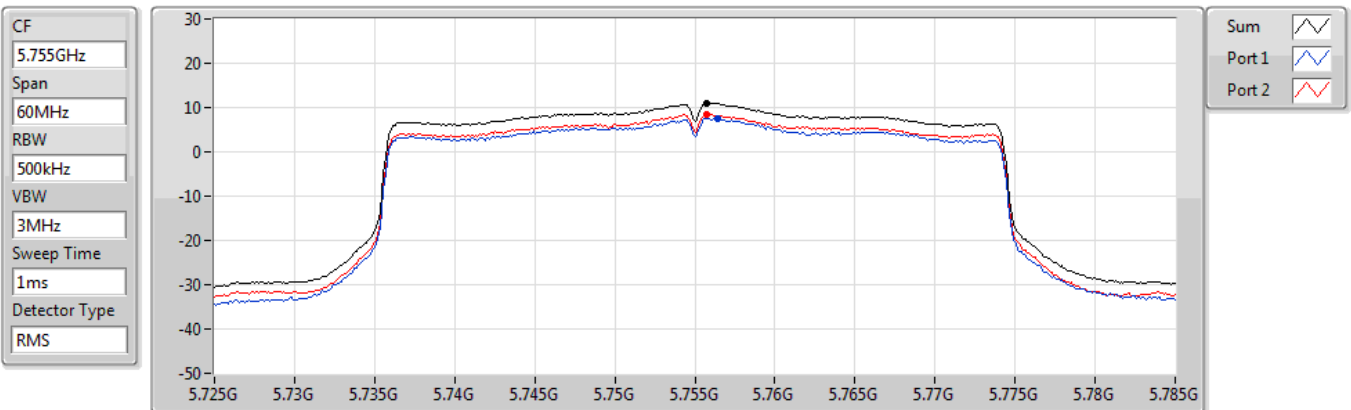

Sum	PD	Port 1	Port 2
(dBm/RBW)	(dBm/RBW)	(dBm/RBW)	(dBm/RBW)
10.96	10.96	7.63	8.47



802.11ax HEW40_Nss1,(MCS0)_2TX

PSD

5795MHz

CF
5.795GHz
Span
60MHz
RBW
500kHz
VBW
3MHz
Sweep Time
1ms
Detector Type
RMS

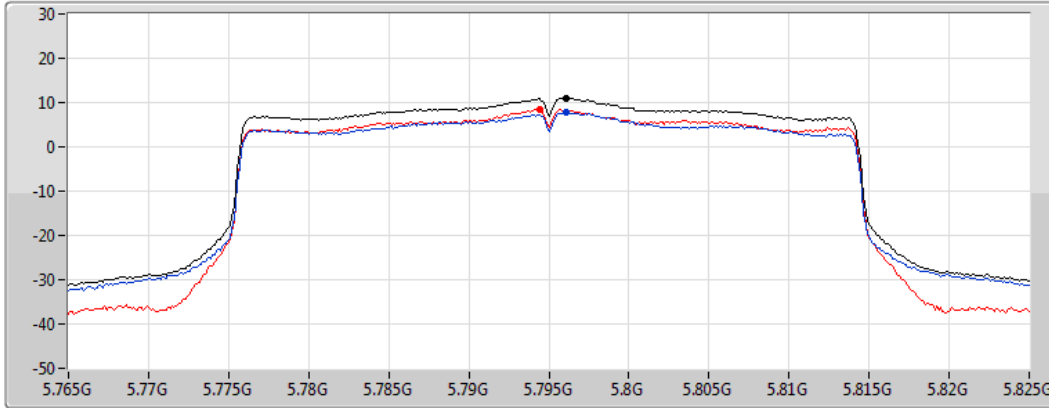

Sum
Port 1
Port 2

Sum	PD	Port 1	Port 2
(dBm/RBW)	(dBm/RBW)	(dBm/RBW)	(dBm/RBW)
11.00	11.00	7.87	8.34

802.11ax HEW80_Nss1,(MCS0)_2TX

PSD

5210MHz

CF
5.21GHz
Span
120MHz
RBW
1MHz
VBW
3MHz
Sweep Time
1ms
Detector Type
RMS

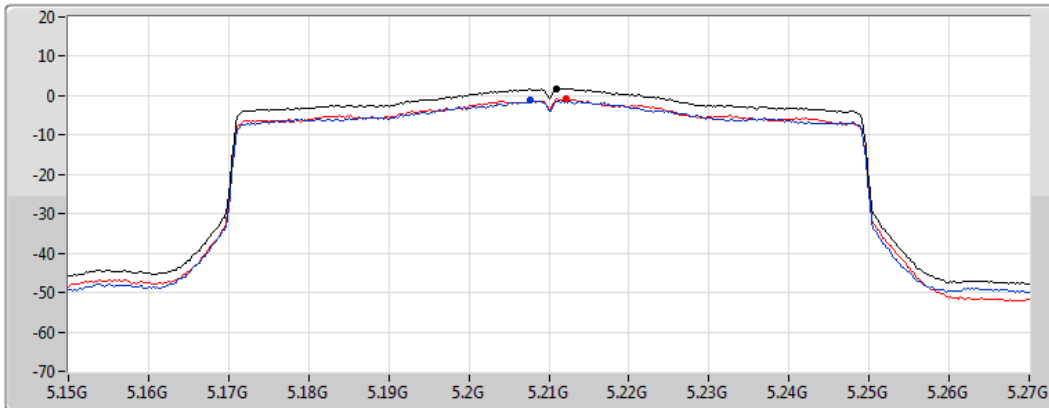

Sum
Port 1
Port 2

Sum	PD	Port 1	Port 2
(dBm/RBW)	(dBm/RBW)	(dBm/RBW)	(dBm/RBW)
1.85	1.85	-1.22	-0.77



802.11ax HEW80_Nss1,(MCS0)_2TX

PSD

5290MHz

CF
5.29GHz
Span
120MHz
RBW
1MHz
VBW
3MHz
Sweep Time
1.01ms
Detector Type
RMS

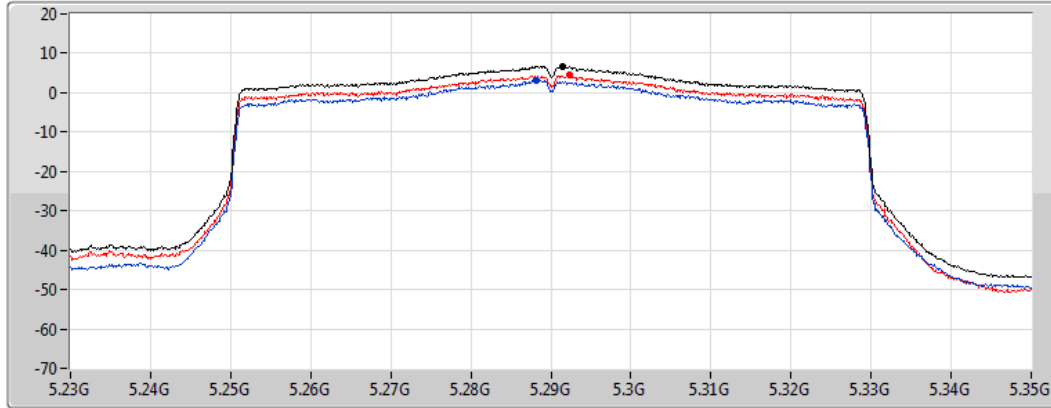

Sum
Port 1
Port 2

Sum	PD	Port 1	Port 2
(dBm/RBW)	(dBm/RBW)	(dBm/RBW)	(dBm/RBW)
6.68	6.68	3.24	4.44

802.11ax HEW80_Nss1,(MCS0)_2TX

PSD

5530MHz

CF
5.53GHz
Span
120MHz
RBW
1MHz
VBW
3MHz
Sweep Time
1ms
Detector Type
RMS

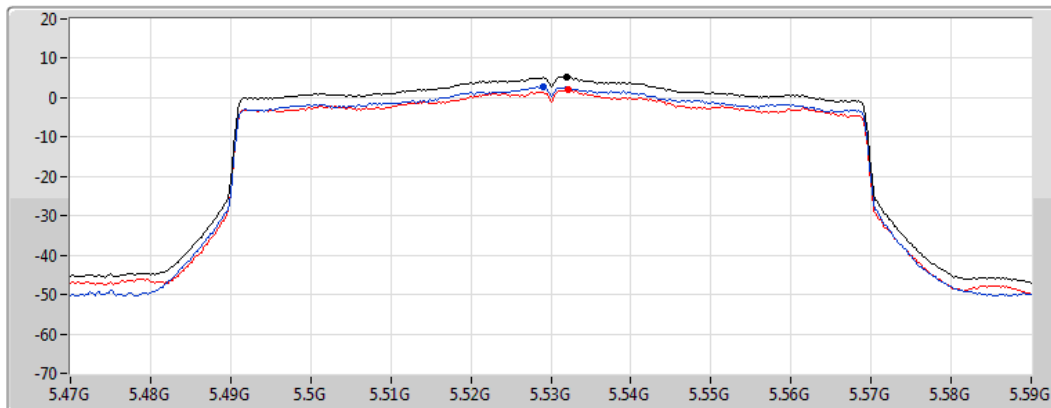

Sum
Port 1
Port 2

Sum	PD	Port 1	Port 2
(dBm/RBW)	(dBm/RBW)	(dBm/RBW)	(dBm/RBW)
5.25	5.25	2.91	1.90



802.11ax HEW80_Nss1,(MCS0)_2TX

PSD

5610MHz

CF
5.61GHz
Span
120MHz
RBW
1MHz
VBW
3MHz
Sweep Time
1.01ms
Detector Type
RMS

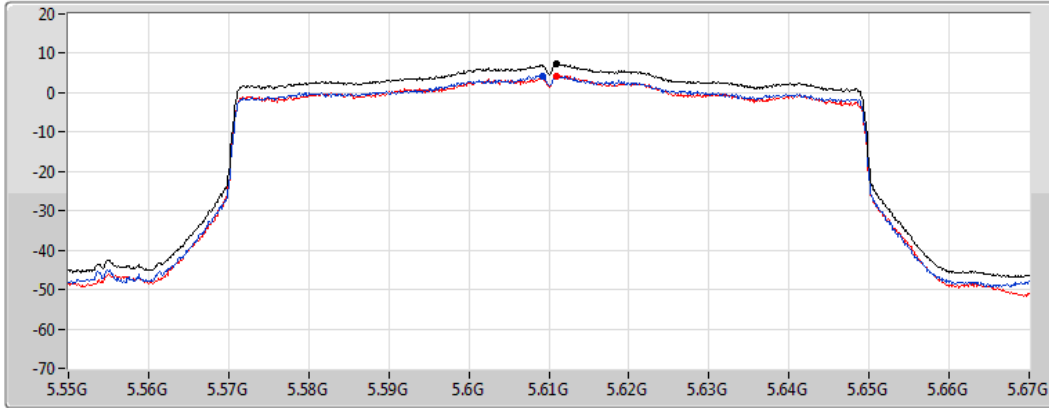

Sum
Port 1
Port 2

Sum	PD	Port 1	Port 2
(dBm/RBW)	(dBm/RBW)	(dBm/RBW)	(dBm/RBW)
7.22	7.22	4.26	4.34

802.11ax HEW80_Nss1,(MCS0)_2TX

PSD

5690MHz Straddle 5.47-5.725GHz

CF
5.65GHz
Span
300MHz
RBW
1MHz
VBW
3MHz
Sweep Time
1.01ms
Detector Type
RMS

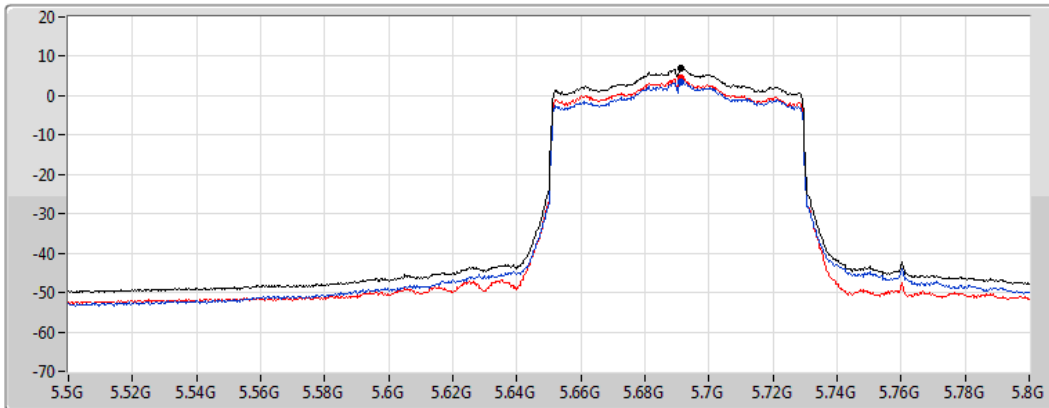

Sum
Port 1
Port 2

Sum	PD	Port 1	Port 2
(dBm/RBW)	(dBm/RBW)	(dBm/RBW)	(dBm/RBW)
6.97	6.97	3.48	4.49



802.11ax HEW80_Nss1,(MCS0)_2TX

PSD

5690MHz Straddle 5.725-5.85GHz

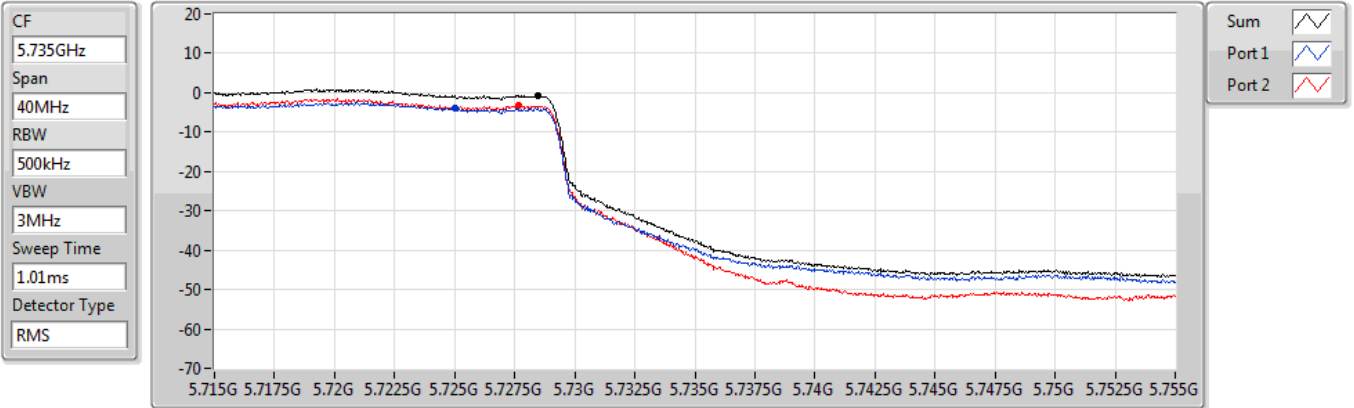

Sum	PD	Port 1	Port 2
(dBm/RBW)	(dBm/RBW)	(dBm/RBW)	(dBm/RBW)
-0.71	-0.71	-3.85	-3.36

802.11ax HEW80_Nss1,(MCS0)_2TX

PSD

5775MHz

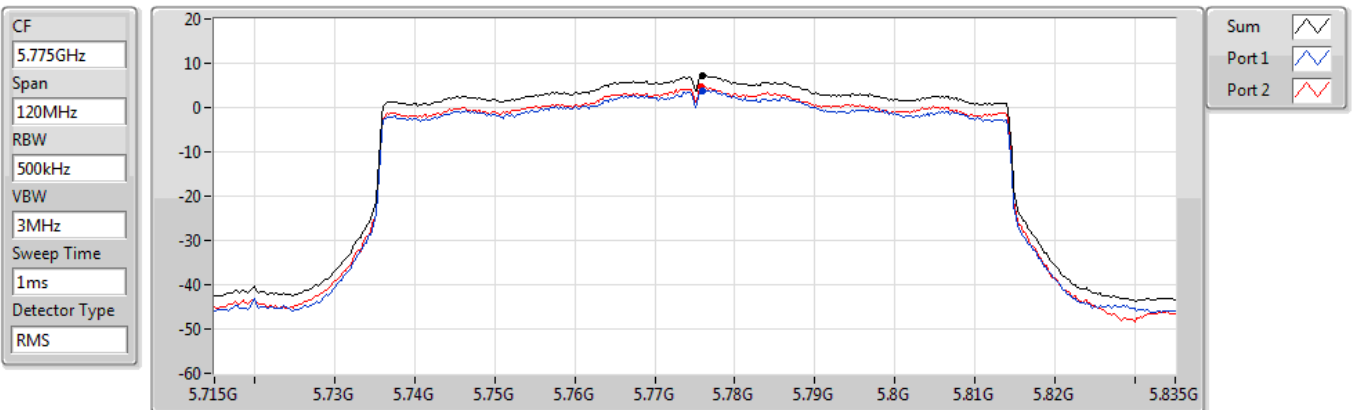

Sum	PD	Port 1	Port 2
(dBm/RBW)	(dBm/RBW)	(dBm/RBW)	(dBm/RBW)
7.22	7.22	3.86	4.64



802.11ax HEW160_Nss1,(MCS0)_2TX

PSD

5250MHz Straddle 5.15-5.25GHz

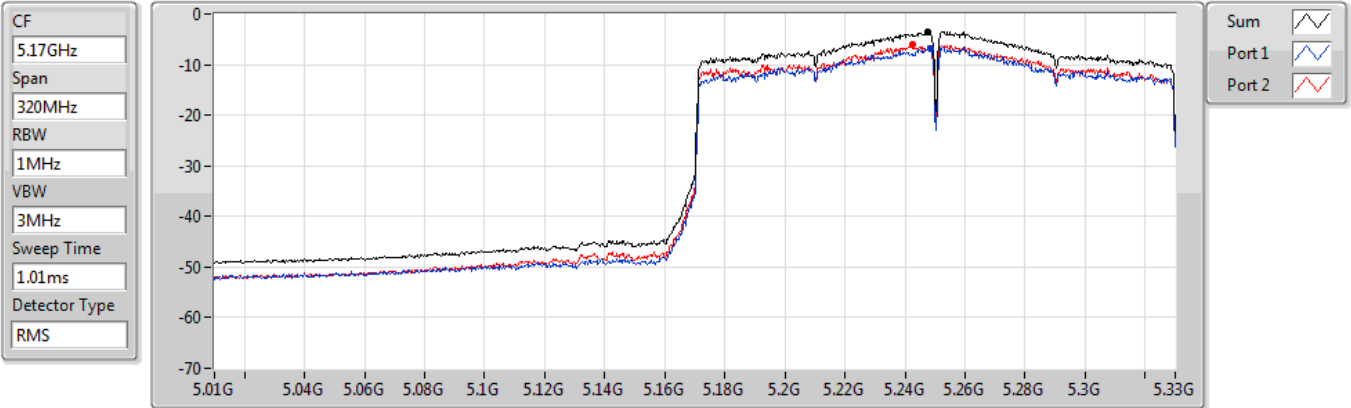

Sum	PD	Port 1	Port 2
(dBm/RBW)	(dBm/RBW)	(dBm/RBW)	(dBm/RBW)
-3.51	-3.51	-6.79	-6.14

802.11ax HEW160_Nss1,(MCS0)_2TX

PSD

5250MHz Straddle 5.25-5.35GHz

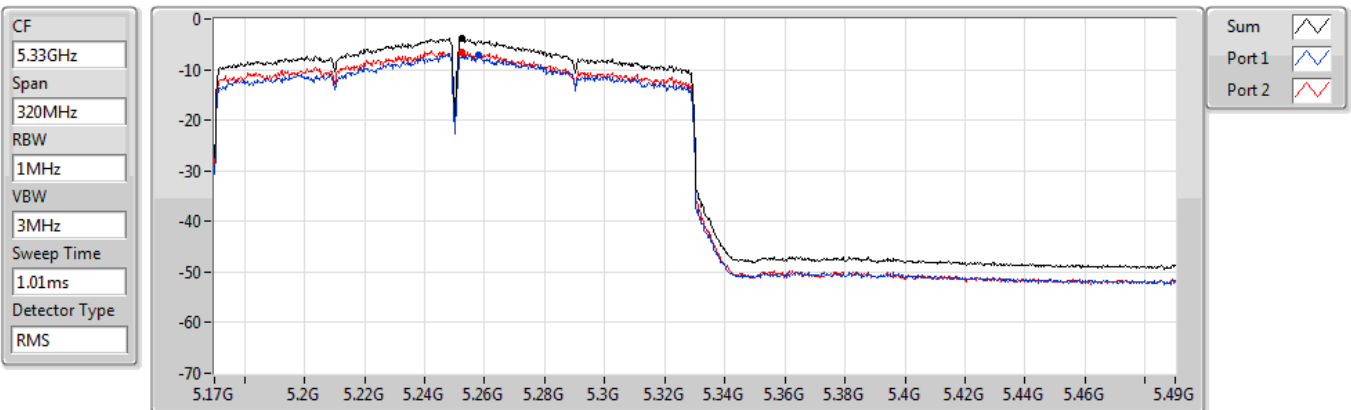

Sum	PD	Port 1	Port 2
(dBm/RBW)	(dBm/RBW)	(dBm/RBW)	(dBm/RBW)
-3.89	-3.89	-7.14	-6.46



802.11ax HEW160_Nss1,(MCS0)_2TX

PSD

5570MHz

CF
5.57GHz
Span
240MHz
RBW
1MHz
VBW
3MHz
Sweep Time
1ms
Detector Type
RMS

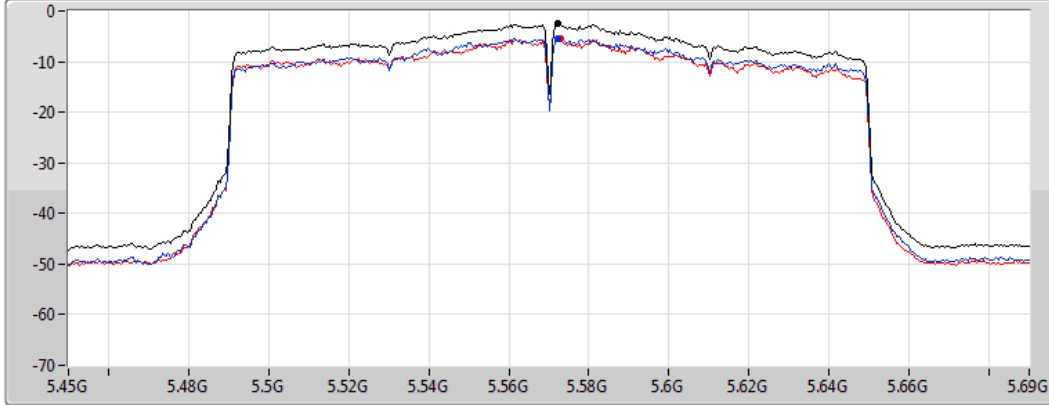

Sum
Port 1
Port 2

Sum	PD	Port 1	Port 2
(dBm/RBW)	(dBm/RBW)	(dBm/RBW)	(dBm/RBW)
-2.49	-2.49	-5.45	-5.48



Adapter mode

Unwanted Emissions (Below 1GHz)

Modulation	ax HE40-OFDMA	Test Freq. (MHz)	5230
Polarization	Horizontal		

Test By :Brad Wu Temperature(°C):24 Humidity(%):63

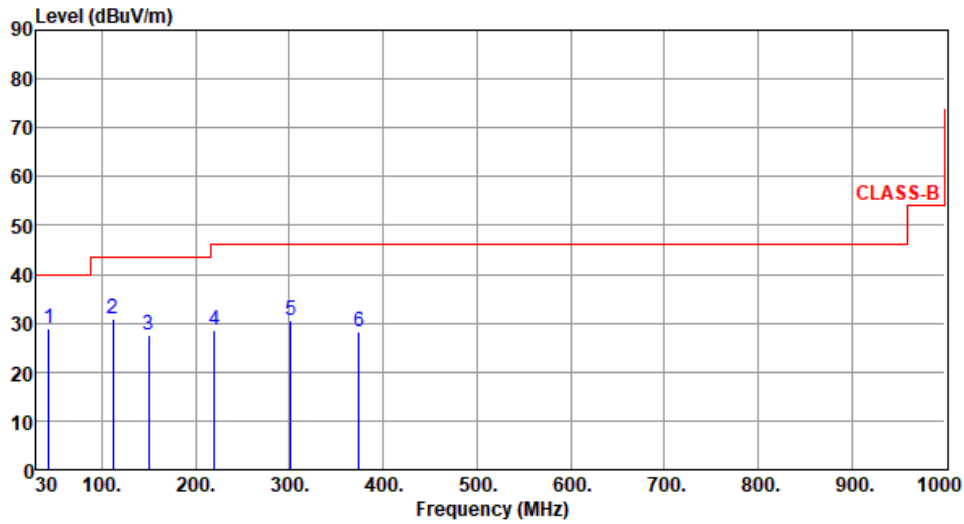

	Freq. MHz	Emission level dBuV/m	Limit dBuV/m	Margin dB	SA reading dBuV	Factor dB/m	Remark	ANT High cm	Turn Table deg
1	43.54	28.96	40.00	-11.04	37.94	-8.98	Peak	---	---
2	111.34	31.05	43.50	-12.45	42.77	-11.72	Peak	---	---
3	149.66	27.53	43.50	-15.97	36.26	-8.73	Peak	---	---
4	220.42	28.71	46.00	-17.29	40.56	-11.85	Peak	---	---
5	301.41	30.54	46.00	-15.46	38.73	-8.19	Peak	---	---
6	374.58	28.09	46.00	-17.91	34.30	-6.21	Peak	---	---

Note 1: Emission Level (dBuV/m) = SA Reading (dBuV) + Factor* (dB/m)

*Factor includes antenna factor , cable loss and amplifier gain

Note 2: Margin (dB) = Emission level (dBuV/m) – Limit (dBuV/m).

Note 3: All spurious emissions below 30MHz are more than 20 dB below the limit.



Modulation	ax HE40-OFDMA	Test Freq. (MHz)	5230
Polarization	Vertical		

Test By :Brad Wu Temperature(°C):24 Humidity(%):63

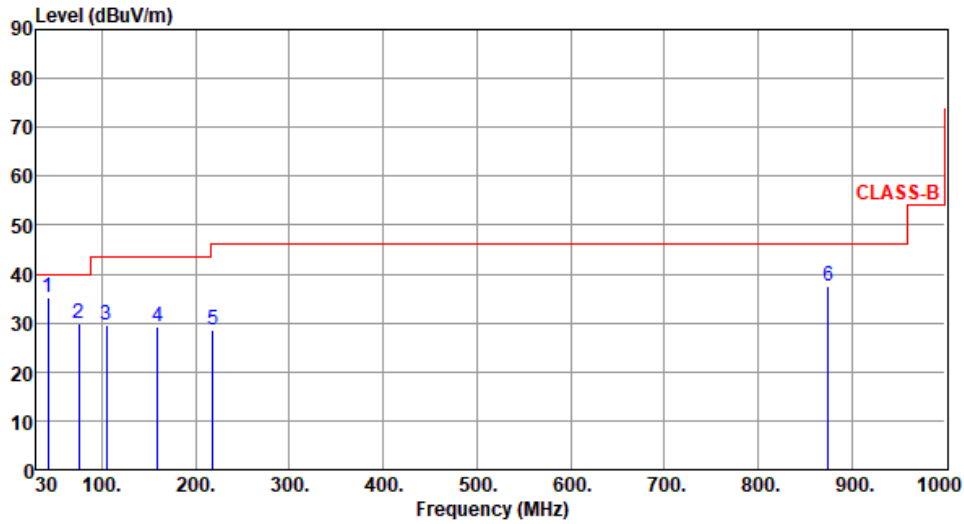

	Freq. MHz	Emission level dBuV/m	Limit dBuV/m	Margin dB	SA reading dBuV	Factor dB/m	Remark	ANT High cm	Turn Table deg
1	42.24	35.31	40.00	-4.69	44.18	-8.87	QP	100	3
2	75.52	29.81	40.00	-10.19	41.90	-12.09	Peak	---	---
3	104.47	29.65	43.50	-13.85	42.33	-12.68	Peak	---	---
4	159.38	29.14	43.50	-14.36	37.53	-8.39	Peak	---	---
5	218.55	28.49	46.00	-17.51	40.32	-11.83	Peak	---	---
6	874.68	37.45	46.00	-8.55	32.96	4.49	Peak	---	---

Note 1: Emission Level (dBuV/m) = SA Reading (dBuV) + Factor* (dB/m)

*Factor includes antenna factor , cable loss and amplifier gain

Note 2: Margin (dB) = Emission level (dBuV/m) – Limit (dBuV/m).

Note 3: All spurious emissions below 30MHz are more than 20 dB below the limit.



Modulation	11a	Test Freq. (MHz)	5745
Polarization	Horizontal		

Test By :Brad Wu Temperature(°C):24 Humidity(%):63

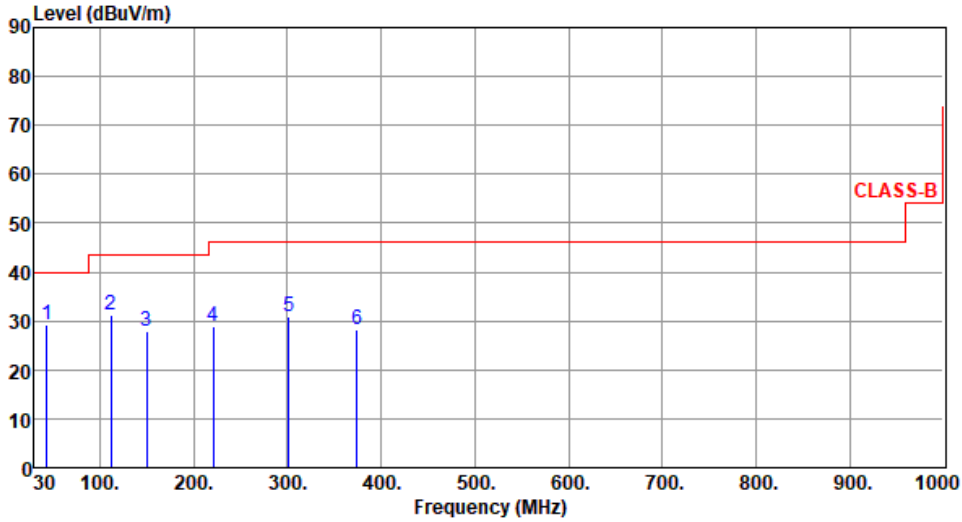

	Freq. MHz	Emission level dBuV/m	Limit dBuV/m	Margin dB	SA reading dBuV	Factor dB/m	Remark	ANT High cm	Turn Table deg
1	43.62	29.14	40.00	-10.86	38.13	-8.99	Peak	---	---
2	111.52	31.24	43.50	-12.26	42.93	-11.69	Peak	---	---
3	150.04	27.85	43.50	-15.65	36.58	-8.73	Peak	---	---
4	220.53	28.96	46.00	-17.04	40.81	-11.85	Peak	---	---
5	301.68	30.92	46.00	-15.08	39.11	-8.19	Peak	---	---
6	374.61	28.25	46.00	-17.75	34.46	-6.21	Peak	---	---

Note 1: Emission Level (dBuV/m) = SA Reading (dBuV) + Factor* (dB/m)

*Factor includes antenna factor , cable loss and amplifier gain

Note 2: Margin (dB) = Emission level (dBuV/m) – Limit (dBuV/m).

Note 3: All spurious emissions below 30MHz are more than 20 dB below the limit.



Modulation	11a	Test Freq. (MHz)	5745
Polarization	Vertical		

Test By :Brad Wu Temperature(°C):24 Humidity(%):63

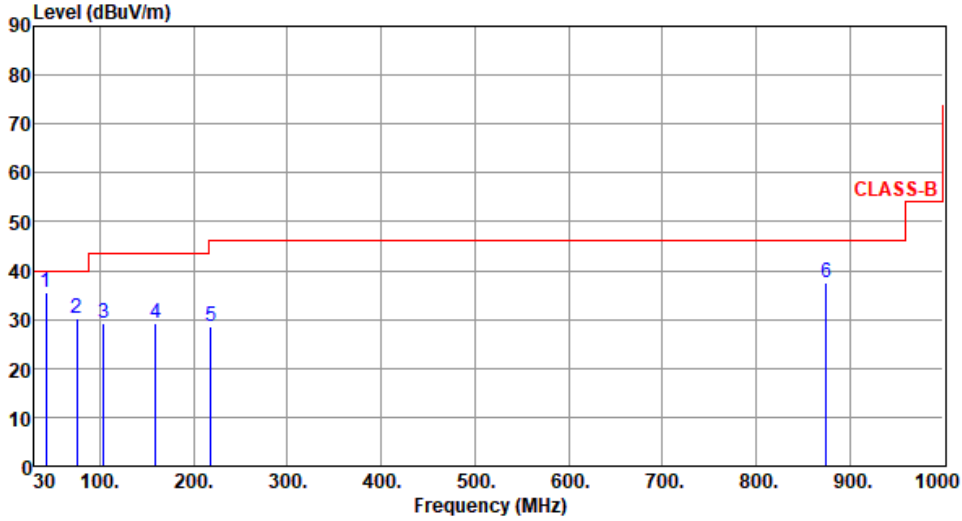

	Freq. MHz	Emission level dBuV/m	Limit dBuV/m	Margin dB	SA reading dBuV	Factor dB/m	Remark	ANT High cm	Turn Table deg
1	42.51	35.48	40.00	-4.52	44.37	-8.89	QP	100	8
2	75.59	30.14	40.00	-9.86	42.25	-12.11	Peak	---	---
3	104.19	29.27	43.50	-14.23	42.03	-12.76	Peak	---	---
4	159.41	29.25	43.50	-14.25	37.64	-8.39	Peak	---	---
5	218.61	28.54	46.00	-17.46	40.37	-11.83	Peak	---	---
6	874.77	37.59	46.00	-8.41	33.10	4.49	Peak	---	---

Note 1: Emission Level (dBuV/m) = SA Reading (dBuV) + Factor* (dB/m)

*Factor includes antenna factor , cable loss and amplifier gain

Note 2: Margin (dB) = Emission level (dBuV/m) – Limit (dBuV/m).

Note 3: All spurious emissions below 30MHz are more than 20 dB below the limit.



POE mode

Unwanted Emissions (Below 1GHz)

Modulation	ax HE40-OFDMA	Test Freq. (MHz)	5230
Polarization	Horizontal		

Test By :Brad Wu Temperature(°C):24 Humidity(%):63

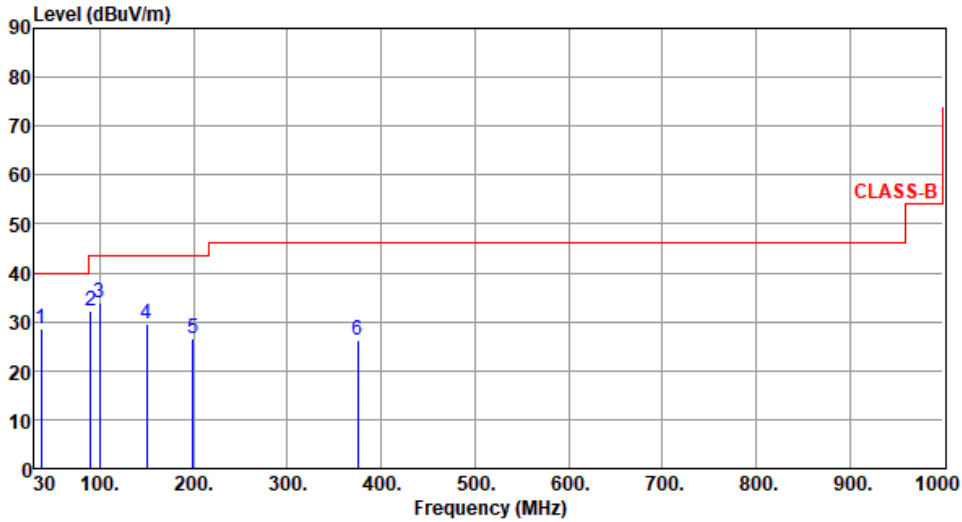

	Freq. MHz	Emission level dBuV/m	Limit dBuV/m	Margin dB	SA reading dBuV	Factor dB/m	Remark	ANT High cm	Turn Table deg
1	36.96	28.55	40.00	-11.45	38.17	-9.62	Peak	---	---
2	90.13	32.21	43.50	-11.29	46.93	-14.72	Peak	---	---
3	99.84	33.96	43.50	-9.54	47.53	-13.57	Peak	---	---
4	149.77	29.68	43.50	-13.82	38.41	-8.73	Peak	---	---
5	199.21	26.72	43.50	-16.78	38.54	-11.82	Peak	---	---
6	375.05	26.35	46.00	-19.65	32.54	-6.19	Peak	---	---

Note 1: Emission Level (dBuV/m) = SA Reading (dBuV) + Factor* (dB/m)

*Factor includes antenna factor , cable loss and amplifier gain

Note 2: Margin (dB) = Emission level (dBuV/m) – Limit (dBuV/m).

Note 3: All spurious emissions below 30MHz are more than 20 dB below the limit.



Modulation	ax HE40-OFDMA	Test Freq. (MHz)	5230
Polarization	Vertical		

Test By :Brad Wu Temperature(°C):24 Humidity(%):63

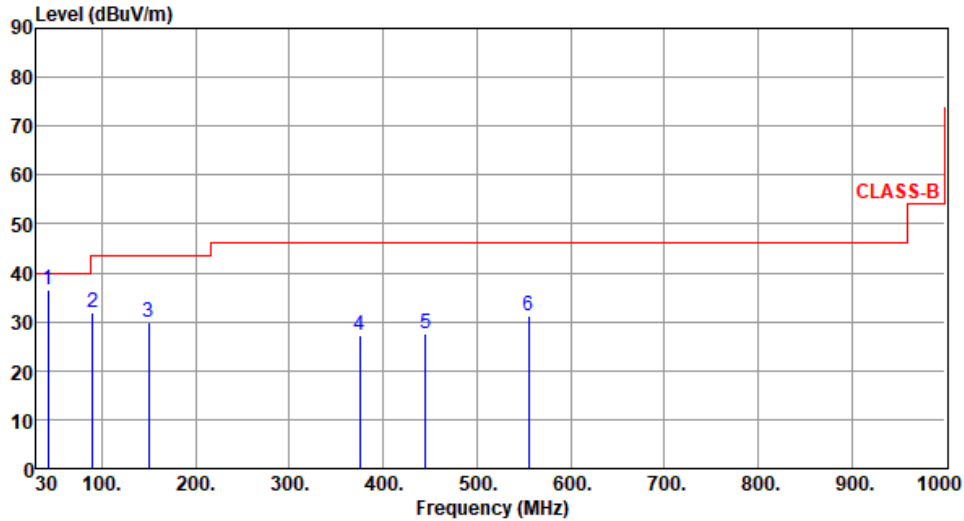

	Freq. MHz	Emission level dBuV/m	Limit dBuV/m	Margin dB	SA reading dBuV	Factor dB/m	Remark	ANT High cm	Turn Table deg
1	42.15	36.55	40.00	-3.45	45.41	-8.86	QP	100	21
2	90.11	31.75	43.50	-11.75	46.47	-14.72	Peak	---	---
3	149.98	29.81	43.50	-13.69	38.54	-8.73	Peak	---	---
4	374.95	27.24	46.00	-18.76	33.44	-6.20	Peak	---	---
5	445.49	27.49	46.00	-18.51	31.35	-3.86	Peak	---	---
6	555.61	31.36	46.00	-14.64	32.98	-1.62	Peak	---	---

Note 1: Emission Level (dBuV/m) = SA Reading (dBuV) + Factor* (dB/m)

*Factor includes antenna factor , cable loss and amplifier gain

Note 2: Margin (dB) = Emission level (dBuV/m) – Limit (dBuV/m).

Note 3: All spurious emissions below 30MHz are more than 20 dB below the limit.



Modulation	11a	Test Freq. (MHz)	5745
Polarization	Horizontal		

Test By :Brad Wu Temperature(°C):24 Humidity(%):63

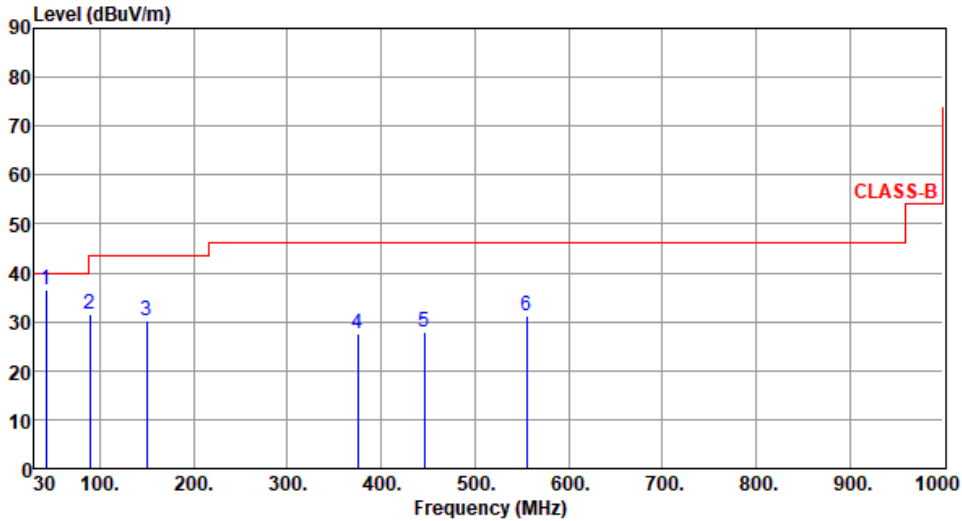

	Freq. MHz	Emission level dBuV/m	Limit dBuV/m	Margin dB	SA reading dBuV	Factor dB/m	Remark	ANT High cm	Turn Table deg
1	42.52	36.55	40.00	-3.45	45.44	-8.89	QP	100	12
2	89.53	31.43	43.50	-12.07	46.14	-14.71	Peak	---	---
3	149.52	30.15	43.50	-13.35	38.88	-8.73	Peak	---	---
4	374.68	27.44	46.00	-18.56	33.65	-6.21	Peak	---	---
5	445.85	27.91	46.00	-18.09	31.76	-3.85	Peak	---	---
6	555.55	31.34	46.00	-14.66	32.96	-1.62	Peak	---	---

Note 1: Emission Level (dBuV/m) = SA Reading (dBuV) + Factor* (dB/m)

*Factor includes antenna factor , cable loss and amplifier gain

Note 2: Margin (dB) = Emission level (dBuV/m) – Limit (dBuV/m).

Note 3: All spurious emissions below 30MHz are more than 20 dB below the limit.



Modulation	11a	Test Freq. (MHz)	5745
Polarization	Vertical		

Test By :Brad Wu Temperature(°C):24 Humidity(%):63

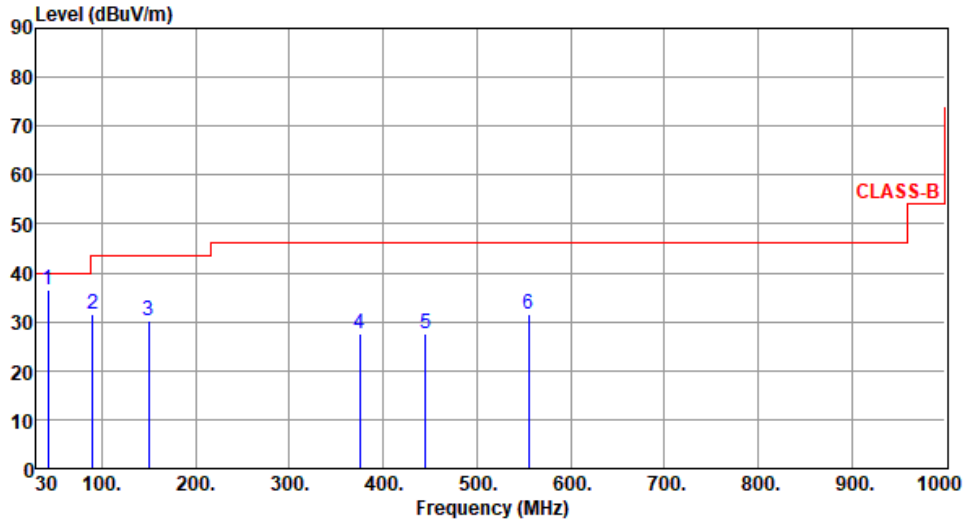

	Freq. MHz	Emission level dBuV/m	Limit dBuV/m	Margin dB	SA reading dBuV	Factor dB/m	Remark	ANT High cm	Turn Table deg
1	42.27	36.65	40.00	-3.35	45.53	-8.88	QP	100	11
2	90.26	31.58	43.50	-11.92	46.32	-14.74	Peak	---	---
3	150.12	30.15	43.50	-13.35	38.87	-8.72	Peak	---	---
4	374.87	27.54	46.00	-18.46	33.74	-6.20	Peak	---	---
5	445.51	27.55	46.00	-18.45	31.41	-3.86	Peak	---	---
6	555.59	31.48	46.00	-14.52	33.10	-1.62	Peak	---	---

Note 1: Emission Level (dBuV/m) = SA Reading (dBuV) + Factor* (dB/m)

*Factor includes antenna factor , cable loss and amplifier gain

Note 2: Margin (dB) = Emission level (dBuV/m) – Limit (dBuV/m).

Note 3: All spurious emissions below 30MHz are more than 20 dB below the limit.



Unwanted Emissions (Above 1GHz) for 11a

Modulation	11a	Test Freq. (MHz)	5180						
Polarization	Horizontal								
Test By :Brad Wu Temperature(°C):23 Humidity(%):65									
	Freq. MHz	Emission level dBUV/m	Limit dBUV/m	Margin dB	SA reading dBUV	Factor dB/m	Remark	ANT High cm	Turn Table deg
1	5040.00	49.22	54.00	-4.78	42.96	6.26	Average	284	289
2	5040.00	60.23	74.00	-13.77	53.97	6.26	Peak	284	289
3	5150.00	45.96	54.00	-8.04	39.65	6.31	Average	276	281
4	5150.00	57.84	74.00	-16.16	51.53	6.31	Peak	276	281
5	10360.00	56.81	68.20	-11.39	42.36	14.45	Peak	100	195
6	15540.00	46.51	54.00	-7.49	30.11	16.40	Average	100	215
7	15540.00	58.42	74.00	-15.58	42.02	16.40	Peak	100	215
8	20720.00	48.16	54.00	-5.84	41.76	6.40	Average	319	182
9	20720.00	61.95	74.00	-12.05	55.55	6.40	Peak	319	182

Note 1: Emission Level (dBUV/m) = SA Reading (dBUV) + Factor* (dB/m)
 *Factor includes antenna factor , cable loss and amplifier gain
 Note 2: Margin (dB) = Emission level (dBUV/m) – Limit (dBUV/m).



Modulation	11a	Test Freq. (MHz)	5180
Polarization	Vertical		

Test By :Brad Wu Temperature(°C):23 Humidity(%):65

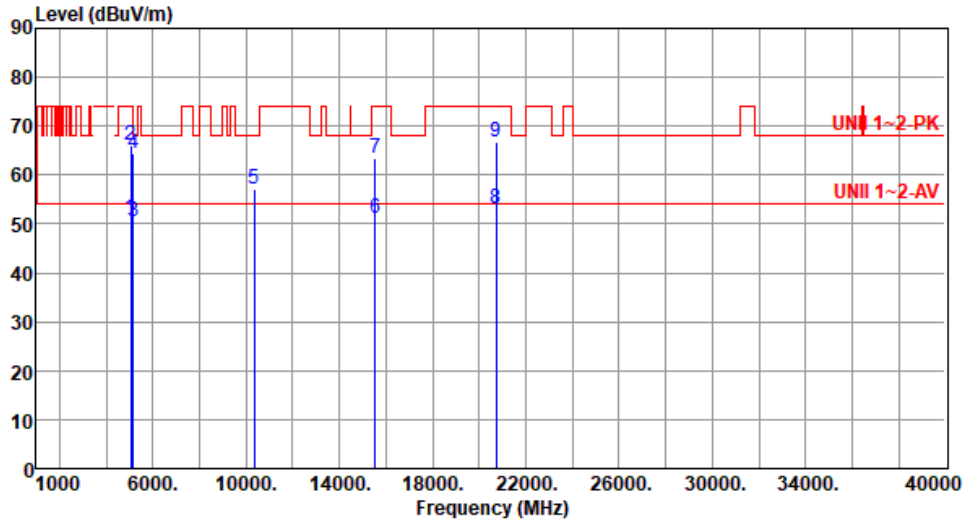

	Freq. MHz	Emission level dBuV/m	Limit dBuV/m	Margin dB	SA reading dBuV	Factor dB/m	Remark	ANT High cm	Turn Table deg
1	5040.00	51.12	54.00	-2.88	44.86	6.26	Average	307	187
2	5040.00	66.22	74.00	-7.78	59.96	6.26	Peak	307	187
3	5150.00	50.32	54.00	-3.68	44.01	6.31	Average	316	182
4	5150.00	64.41	74.00	-9.59	58.10	6.31	Peak	316	182
5	10360.00	57.22	68.20	-10.98	42.77	14.45	Peak	185	41
6	15540.00	51.22	54.00	-2.78	34.82	16.40	Average	301	145
7	15540.00	63.45	74.00	-10.55	47.05	16.40	Peak	301	145
8	20720.00	53.05	54.00	-0.95	46.65	6.40	Average	267	191
9	20720.00	66.64	74.00	-7.36	60.24	6.40	Peak	267	191

Note 1: Emission Level (dBuV/m) = SA Reading (dBuV) + Factor* (dB/m)

*Factor includes antenna factor , cable loss and amplifier gain

Note 2: Margin (dB) = Emission level (dBuV/m) – Limit (dBuV/m).



Modulation	11a	Test Freq. (MHz)	5200
Polarization	Horizontal		

Test By :Akun Chung Temperature(°C):23 Humidity(%):66

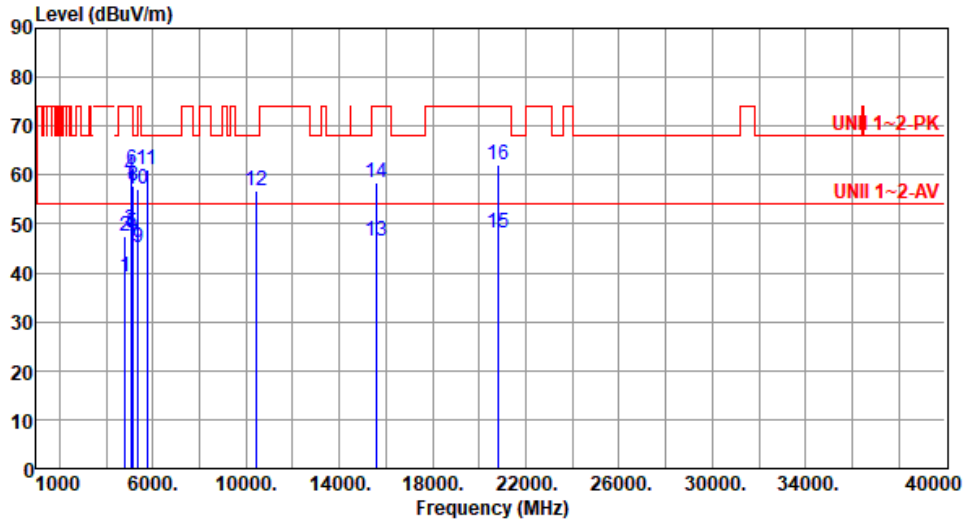

	Freq. MHz	Emission level dBuV/m	Limit dBuV/m	Margin dB	SA reading dBuV	Factor dB/m	Remark	ANT High cm	Turn Table deg
1	4800.00	39.07	54.00	-14.93	33.88	5.19	Average	322	186
2	4800.00	47.58	74.00	-26.42	42.39	5.19	Peak	322	186
3	5040.00	48.82	54.00	-5.18	42.56	6.26	Average	277	281
4	5040.00	59.93	74.00	-14.07	53.67	6.26	Peak	277	281
5	5105.00	48.13	54.00	-5.87	41.66	6.47	Average	303	182
6	5105.00	61.25	74.00	-12.75	54.78	6.47	Peak	303	182
7	5150.00	45.75	54.00	-8.25	39.44	6.31	Average	303	182
8	5150.00	57.79	74.00	-16.21	51.48	6.31	Peak	303	182
9	5350.00	45.12	54.00	-8.88	39.40	5.72	Average	303	182
10	5350.00	57.08	74.00	-16.92	51.36	5.72	Peak	303	182
11	5760.00	61.19	68.20	-7.01	54.55	6.64	Peak	321	293
12	10400.00	56.95	68.20	-11.25	42.47	14.48	Peak	100	200
13	15600.00	46.43	54.00	-7.57	30.49	15.94	Average	100	210
14	15600.00	58.36	74.00	-15.64	42.42	15.94	Peak	100	210
15	20800.00	48.29	54.00	-5.71	41.82	6.47	Average	322	179
16	20800.00	62.02	74.00	-11.98	55.55	6.47	Peak	322	179

Note 1: Emission Level (dBuV/m) = SA Reading (dBuV) + Factor* (dB/m)

*Factor includes antenna factor , cable loss and amplifier gain

Note 2: Margin (dB) = Emission level (dBuV/m) – Limit (dBuV/m).



Modulation	11a	Test Freq. (MHz)	5200
Polarization	Vertical		

Test By : Akun Chung Temperature(°C): 23 Humidity(%): 66

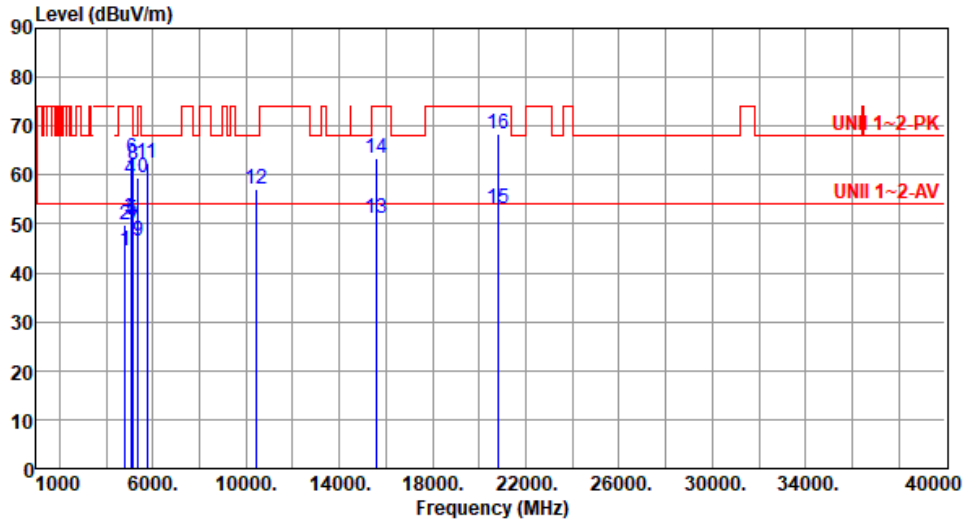

	Freq. MHz	Emission level dBuV/m	Limit dBuV/m	Margin dB	SA reading dBuV	Factor dB/m	Remark	ANT High cm	Turn Table deg
1	4800.00	44.36	54.00	-9.64	39.17	5.19	Average	299	293
2	4800.00	49.97	74.00	-24.03	44.78	5.19	Peak	299	293
3	5040.00	51.06	54.00	-2.94	44.80	6.26	Average	319	172
4	5040.00	59.11	74.00	-14.89	52.85	6.26	Peak	319	172
5	5105.00	50.80	54.00	-3.20	44.33	6.47	Average	322	176
6	5105.00	63.44	74.00	-10.56	56.97	6.47	Peak	322	176
7	5150.00	48.97	54.00	-5.03	42.66	6.31	Average	284	170
8	5150.00	62.19	74.00	-11.81	55.88	6.31	Peak	284	170
9	5350.00	46.38	54.00	-7.62	40.66	5.72	Average	284	170
10	5350.00	59.41	74.00	-14.59	53.69	5.72	Peak	284	170
11	5760.00	62.59	68.20	-5.61	55.95	6.64	Peak	291	158
12	10400.00	57.03	68.20	-11.17	42.55	14.48	Peak	191	46
13	15600.00	51.08	54.00	-2.92	35.14	15.94	Average	297	141
14	15600.00	63.34	74.00	-10.66	47.40	15.94	Peak	297	141
15	20800.00	52.99	54.00	-1.01	46.52	6.47	Average	284	127
16	20800.00	68.29	74.00	-5.71	61.82	6.47	Peak	284	127

Note 1: Emission Level (dBuV/m) = SA Reading (dBuV) + Factor* (dB/m)

*Factor includes antenna factor , cable loss and amplifier gain

Note 2: Margin (dB) = Emission level (dBuV/m) – Limit (dBuV/m).



Modulation	11a	Test Freq. (MHz)	5240
Polarization	Horizontal		

Test By :Brad Wu Temperature(°C):23 Humidity(%):65

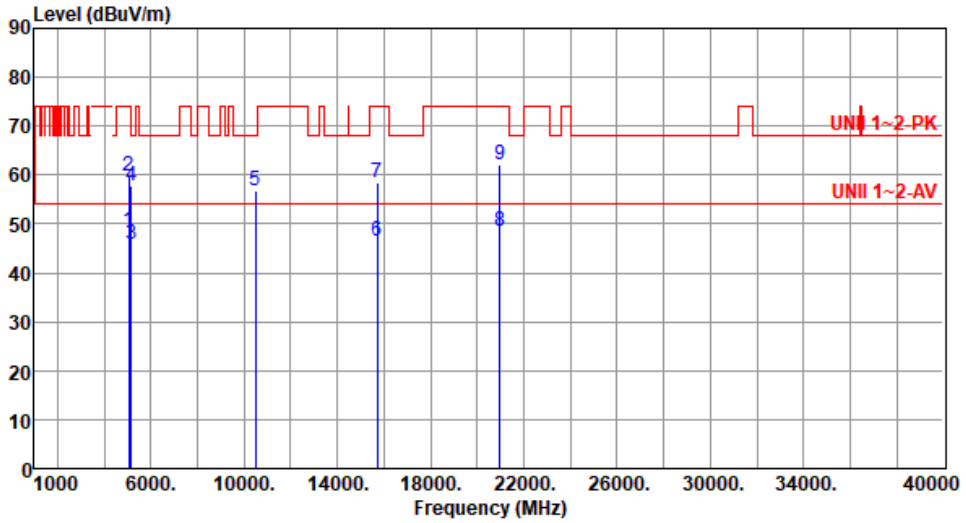

	Freq. MHz	Emission level dBuV/m	Limit dBuV/m	Margin dB	SA reading dBuV	Factor dB/m	Remark	ANT High cm	Turn Table deg
1	5040.00	48.60	54.00	-5.40	42.34	6.26	Average	295	299
2	5040.00	59.79	74.00	-14.21	53.53	6.26	Peak	295	299
3	5150.00	45.92	54.00	-8.08	39.61	6.31	Average	271	292
4	5150.00	57.86	74.00	-16.14	51.55	6.31	Peak	271	292
5	10480.00	56.88	68.20	-11.32	42.25	14.63	Peak	100	185
6	15720.00	46.51	54.00	-7.49	30.56	15.95	Average	100	221
7	15720.00	58.44	74.00	-15.56	42.49	15.95	Peak	100	221
8	20960.00	48.36	54.00	-5.64	41.65	6.71	Average	315	184
9	20960.00	62.19	74.00	-11.81	55.48	6.71	Peak	315	184

Note 1: Emission Level (dBuV/m) = SA Reading (dBuV) + Factor* (dB/m)

*Factor includes antenna factor , cable loss and amplifier gain

Note 2: Margin (dB) = Emission level (dBuV/m) – Limit (dBuV/m).



Modulation	11a	Test Freq. (MHz)	5240
Polarization	Vertical		

Test By :Brad Wu Temperature(°C):23 Humidity(%):65

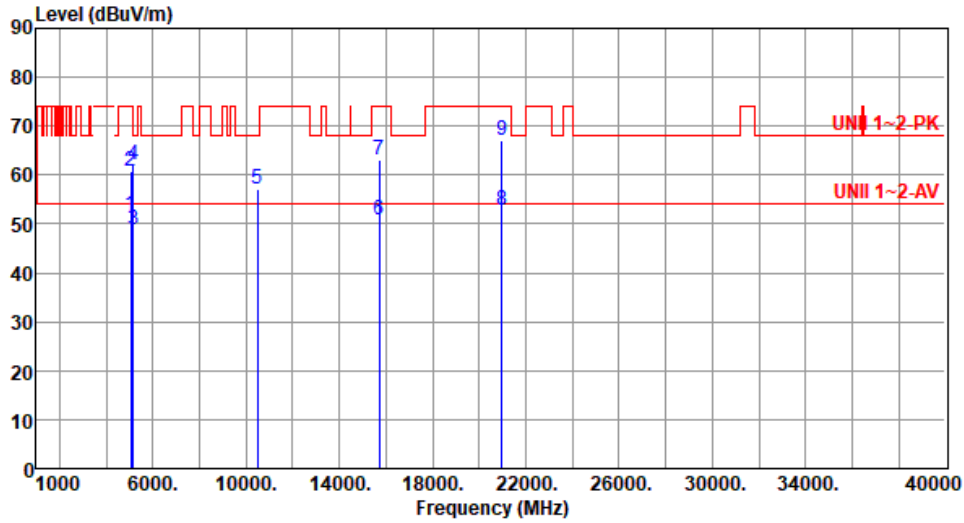

	Freq. MHz	Emission level dBuV/m	Limit dBuV/m	Margin dB	SA reading dBuV	Factor dB/m	Remark	ANT High cm	Turn Table deg
1	5040.00	51.85	54.00	-2.15	45.59	6.26	Average	299	175
2	5040.00	60.82	74.00	-13.18	54.56	6.26	Peak	299	175
3	5150.00	48.88	54.00	-5.12	42.57	6.31	Average	281	176
4	5150.00	62.07	74.00	-11.93	55.76	6.31	Peak	281	176
5	10480.00	57.25	68.20	-10.95	42.62	14.63	Peak	188	51
6	15720.00	50.95	54.00	-3.05	35.00	15.95	Average	300	145
7	15720.00	63.21	74.00	-10.79	47.26	15.95	Peak	300	145
8	20960.00	52.67	54.00	-1.33	45.96	6.71	Average	318	155
9	20960.00	67.01	74.00	-6.99	60.30	6.71	Peak	318	155

Note 1: Emission Level (dBuV/m) = SA Reading (dBuV) + Factor* (dB/m)

*Factor includes antenna factor , cable loss and amplifier gain

Note 2: Margin (dB) = Emission level (dBuV/m) – Limit (dBuV/m).



Modulation	11a	Test Freq. (MHz)	5260
Polarization	Horizontal		

Test By :Brad Wu Temperature(°C):24 Humidity(%):65

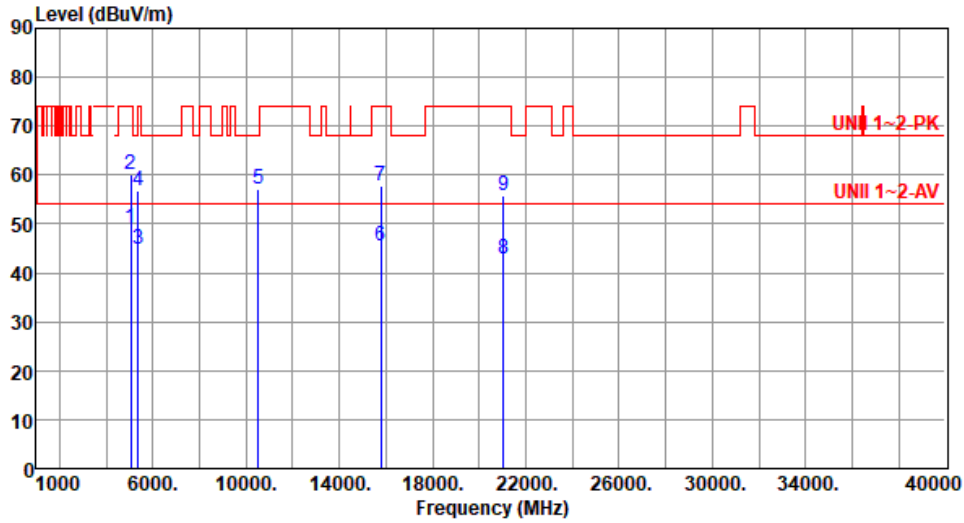

	Freq. MHz	Emission level dBuV/m	Limit dBuV/m	Margin dB	SA reading dBuV	Factor dB/m	Remark	ANT High cm	Turn Table deg
1	5040.00	49.15	54.00	-4.85	42.89	6.26	Average	285	296
2	5040.00	60.14	74.00	-13.86	53.88	6.26	Peak	285	296
3	5350.00	44.81	54.00	-9.19	39.09	5.72	Average	285	296
4	5350.00	56.85	74.00	-17.15	51.13	5.72	Peak	285	296
5	10520.00	57.24	68.20	-10.96	42.57	14.67	Peak	100	165
6	15780.00	45.66	54.00	-8.34	29.80	15.86	Average	100	148
7	15780.00	57.82	74.00	-16.18	41.96	15.86	Peak	100	148
8	21040.00	42.95	54.00	-11.05	36.10	6.85	Average	100	192
9	21040.00	55.63	74.00	-18.37	48.78	6.85	Peak	100	192

Note 1: Emission Level (dBuV/m) = SA Reading (dBuV) + Factor* (dB/m)

*Factor includes antenna factor , cable loss and amplifier gain

Note 2: Margin (dB) = Emission level (dBuV/m) – Limit (dBuV/m).



Modulation	11a	Test Freq. (MHz)	5260						
Polarization	Vertical								
Test By :Brad Wu Temperature(°C):24 Humidity(%):65									
<p>The plot shows a red stepped line representing the emission level across a frequency range from 1000 to 40000 MHz. A horizontal red line at approximately 54 dBuV/m represents the UNII 1-2-AV limit. Several peaks are marked with blue vertical lines and numbered 1 through 9. A red label 'UNII 1-2-PK' is also present on the right side of the plot.</p>									
	Freq.	Emission level	Limit	Margin	SA reading	Factor	Remark	ANT High	Turn Table
	MHz	dBuV/m	dBuV/m	dB	dBuV	dB/m		cm	deg
1	5040.00	52.72	54.00	-1.28	46.46	6.26	Average	294	174
2	5040.00	61.04	74.00	-12.96	54.78	6.26	Peak	294	174
3	5350.00	46.20	54.00	-7.80	40.48	5.72	Average	286	185
4	5350.00	59.01	74.00	-14.99	53.29	5.72	Peak	286	185
5	10520.00	57.41	68.20	-10.79	42.74	14.67	Peak	100	249
6	15780.00	46.52	54.00	-7.48	30.66	15.86	Average	100	247
7	15780.00	58.46	74.00	-15.54	42.60	15.86	Peak	100	247
8	21040.00	45.44	54.00	-8.56	38.59	6.85	Average	282	119
9	21040.00	58.92	74.00	-15.08	52.07	6.85	Peak	282	119

Note 1: Emission Level (dBuV/m) = SA Reading (dBuV) + Factor* (dB/m)
 *Factor includes antenna factor , cable loss and amplifier gain
 Note 2: Margin (dB) = Emission level (dBuV/m) – Limit (dBuV/m).



Modulation	11a	Test Freq. (MHz)	5300						
Polarization	Horizontal								
Test By : Akun Chung Temperature(°C):23 Humidity(%):66									
	Freq. MHz	Emission level dBuV/m	Limit dBuV/m	Margin dB	SA reading dBuV	Factor dB/m	Remark	ANT High cm	Turn Table deg
1	5040.00	49.22	54.00	-4.78	42.96	6.26	Average	280	275
2	5040.00	60.22	74.00	-13.78	53.96	6.26	Peak	280	275
3	5150.00	45.79	54.00	-8.21	39.48	6.31	Average	283	291
4	5150.00	57.89	74.00	-16.11	51.58	6.31	Peak	283	291
5	5350.00	44.92	54.00	-9.08	39.20	5.72	Average	283	291
6	5350.00	56.97	74.00	-17.03	51.25	5.72	Peak	283	291
7	5395.00	45.85	54.00	-8.15	39.66	6.19	Average	283	291
8	5395.00	58.63	74.00	-15.37	52.44	6.19	Peak	283	291
9	10600.00	44.87	54.00	-9.13	30.15	14.72	Average	100	188
10	10600.00	57.00	74.00	-17.00	42.28	14.72	Peak	100	188
11	15900.00	45.81	54.00	-8.19	30.24	15.57	Average	100	155
12	15900.00	57.90	74.00	-16.10	42.33	15.57	Peak	100	155
13	21200.00	43.02	54.00	-10.98	35.85	7.17	Average	100	202
14	21200.00	55.72	74.00	-18.28	48.55	7.17	Peak	100	202

Note 1: Emission Level (dBuV/m) = SA Reading (dBuV) + Factor* (dB/m)

*Factor includes antenna factor , cable loss and amplifier gain

Note 2: Margin (dB) = Emission level (dBuV/m) – Limit (dBuV/m).



Modulation	11a	Test Freq. (MHz)	5300
Polarization	Vertical		

Test By :Akun Chung Temperature(°C):23 Humidity(%):66

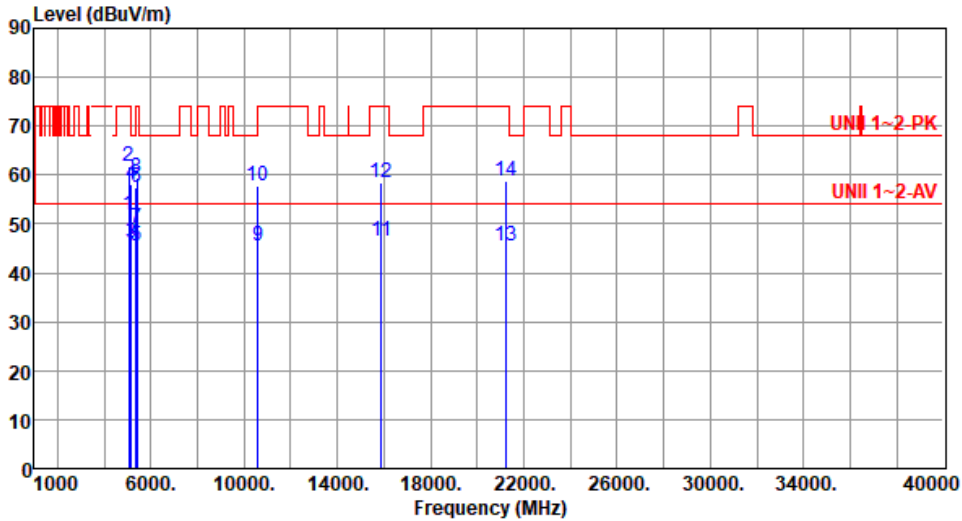

	Freq. MHz	Emission level dBuV/m	Limit dBuV/m	Margin dB	SA reading dBuV	Factor dB/m	Remark	ANT High cm	Turn Table deg
1	5040.00	51.92	54.00	-2.08	45.66	6.26	Average	320	167
2	5040.00	61.93	74.00	-12.07	55.67	6.26	Peak	320	167
3	5150.00	46.00	54.00	-8.00	39.69	6.31	Average	312	150
4	5150.00	58.16	74.00	-15.84	51.85	6.31	Peak	312	150
5	5350.00	45.43	54.00	-8.57	39.71	5.72	Average	312	150
6	5350.00	57.47	74.00	-16.53	51.75	5.72	Peak	312	150
7	5395.00	49.16	54.00	-4.84	42.97	6.19	Average	318	180
8	5395.00	59.35	74.00	-14.65	53.16	6.19	Peak	318	180
9	10600.00	45.61	54.00	-8.39	30.89	14.72	Average	100	247
10	10600.00	57.67	74.00	-16.33	42.95	14.72	Peak	100	247
11	15900.00	46.44	54.00	-7.56	30.87	15.57	Average	100	238
12	15900.00	58.39	74.00	-15.61	42.82	15.57	Peak	100	238
13	21200.00	45.39	54.00	-8.61	38.22	7.17	Average	278	117
14	21200.00	58.83	74.00	-15.17	51.66	7.17	Peak	278	117

Note 1: Emission Level (dBuV/m) = SA Reading (dBuV) + Factor* (dB/m)

*Factor includes antenna factor , cable loss and amplifier gain

Note 2: Margin (dB) = Emission level (dBuV/m) – Limit (dBuV/m).



Modulation	11a	Test Freq. (MHz)	5320
Polarization	Horizontal		

Test By :Brad Wu Temperature(°C):24 Humidity(%):65

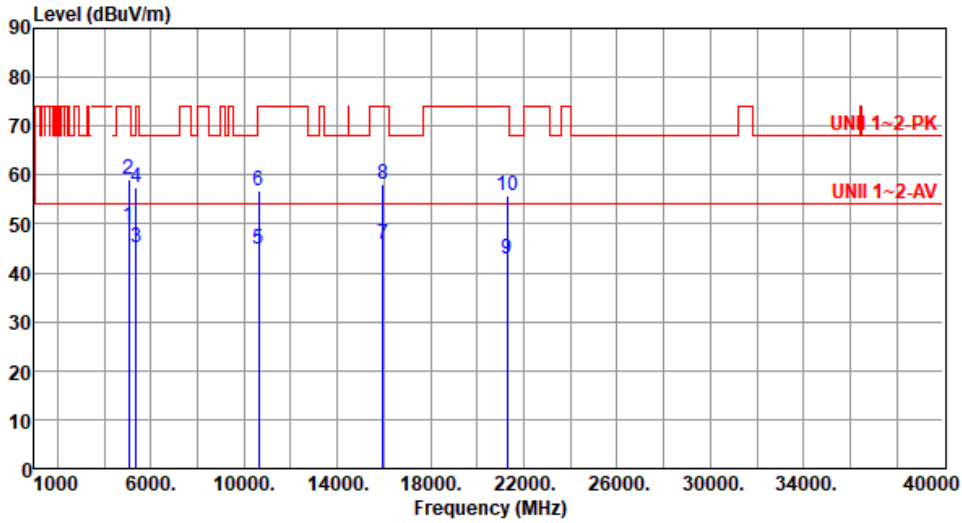

	Freq. MHz	Emission level dBuV/m	Limit dBuV/m	Margin dB	SA reading dBuV	Factor dB/m	Remark	ANT High cm	Turn Table deg
1	5040.00	49.36	54.00	-4.64	43.10	6.26	Average	279	285
2	5040.00	59.28	74.00	-14.72	53.02	6.26	Peak	279	285
3	5350.00	45.21	54.00	-8.79	39.49	5.72	Average	279	285
4	5350.00	57.44	74.00	-16.56	51.72	5.72	Peak	279	285
5	10640.00	44.68	54.00	-9.32	29.82	14.86	Average	100	196
6	10640.00	56.95	74.00	-17.05	42.09	14.86	Peak	100	196
7	15960.00	45.94	54.00	-8.06	30.29	15.65	Average	100	146
8	15960.00	58.02	74.00	-15.98	42.37	15.65	Peak	100	146
9	21280.00	42.98	54.00	-11.02	35.72	7.26	Average	100	204
10	21280.00	55.69	74.00	-18.31	48.43	7.26	Peak	100	204

Note 1: Emission Level (dBuV/m) = SA Reading (dBuV) + Factor* (dB/m)

*Factor includes antenna factor , cable loss and amplifier gain

Note 2: Margin (dB) = Emission level (dBuV/m) – Limit (dBuV/m).



Modulation	11a	Test Freq. (MHz)	5320
Polarization	Vertical		

Test By :Brad Wu Temperature(°C):24 Humidity(%):65

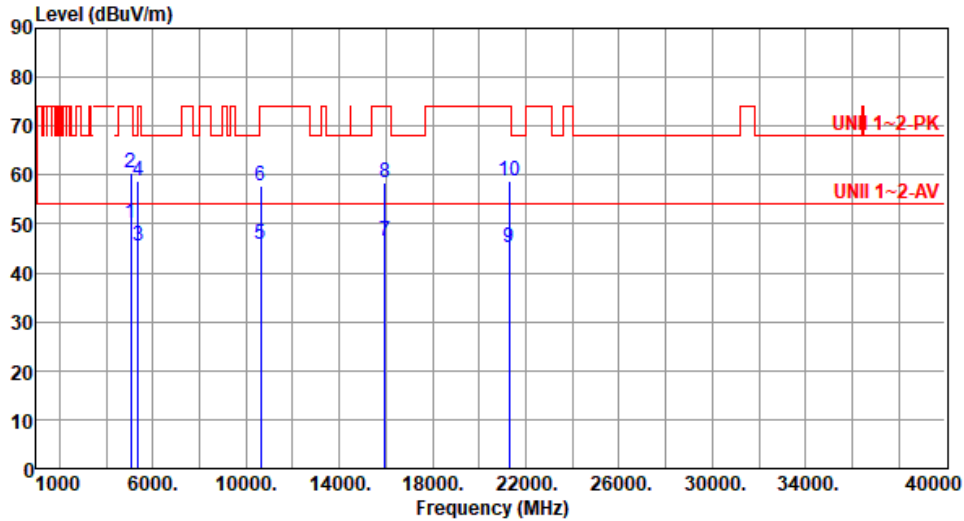

	Freq. MHz	Emission level dBuV/m	Limit dBuV/m	Margin dB	SA reading dBuV	Factor dB/m	Remark	ANT High cm	Turn Table deg
1	5040.00	50.02	54.00	-3.98	43.76	6.26	Average	310	179
2	5040.00	60.31	74.00	-13.69	54.05	6.26	Peak	310	179
3	5350.00	45.51	54.00	-8.49	39.79	5.72	Average	251	157
4	5350.00	58.88	74.00	-15.12	53.16	5.72	Peak	251	157
5	10640.00	45.82	54.00	-8.18	30.96	14.86	Average	100	249
6	10640.00	57.74	74.00	-16.26	42.88	14.86	Peak	100	249
7	15960.00	46.51	54.00	-7.49	30.86	15.65	Average	100	231
8	15960.00	58.42	74.00	-15.58	42.77	15.65	Peak	100	231
9	21280.00	45.26	54.00	-8.74	38.00	7.26	Average	288	115
10	21280.00	58.71	74.00	-15.29	51.45	7.26	Peak	288	115

Note 1: Emission Level (dBuV/m) = SA Reading (dBuV) + Factor* (dB/m)

*Factor includes antenna factor , cable loss and amplifier gain

Note 2: Margin (dB) = Emission level (dBuV/m) – Limit (dBuV/m).



Modulation	11a	Test Freq. (MHz)	5500
Polarization	Horizontal		

Test By :Brad Wu Temperature(°C):24 Humidity(%):65

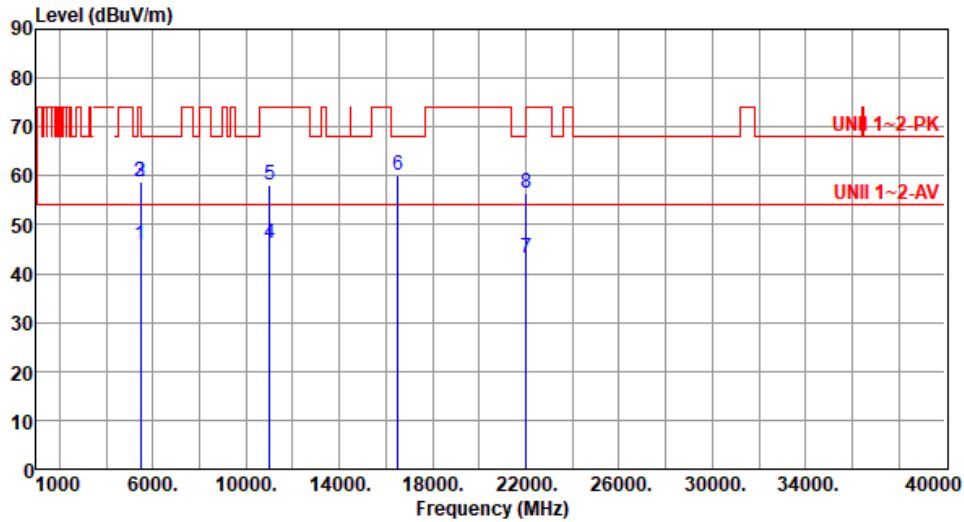

	Freq. MHz	Emission level dBuV/m	Limit dBuV/m	Margin dB	SA reading dBuV	Factor dB/m	Remark	ANT High cm	Turn Table deg
1	5460.00	45.73	54.00	-8.27	39.43	6.30	Average	315	150
2	5460.00	58.74	74.00	-15.26	52.44	6.30	Peak	315	150
3	5470.00	58.86	68.20	-9.34	52.54	6.32	Peak	315	150
4	11000.00	46.07	54.00	-7.93	30.42	15.65	Average	100	257
5	11000.00	58.13	74.00	-15.87	42.48	15.65	Peak	100	257
6	16500.00	60.12	68.20	-8.08	42.66	17.46	Peak	100	216
7	22000.00	43.10	54.00	-10.90	35.45	7.65	Average	320	188
8	22000.00	56.39	68.20	-11.81	48.74	7.65	Peak	320	188

Note 1: Emission Level (dBuV/m) = SA Reading (dBuV) + Factor* (dB/m)

*Factor includes antenna factor , cable loss and amplifier gain

Note 2: Margin (dB) = Emission level (dBuV/m) – Limit (dBuV/m).



Modulation	11a	Test Freq. (MHz)	5500
Polarization	Vertical		

Test By :Brad Wu Temperature(°C):24 Humidity(%):65

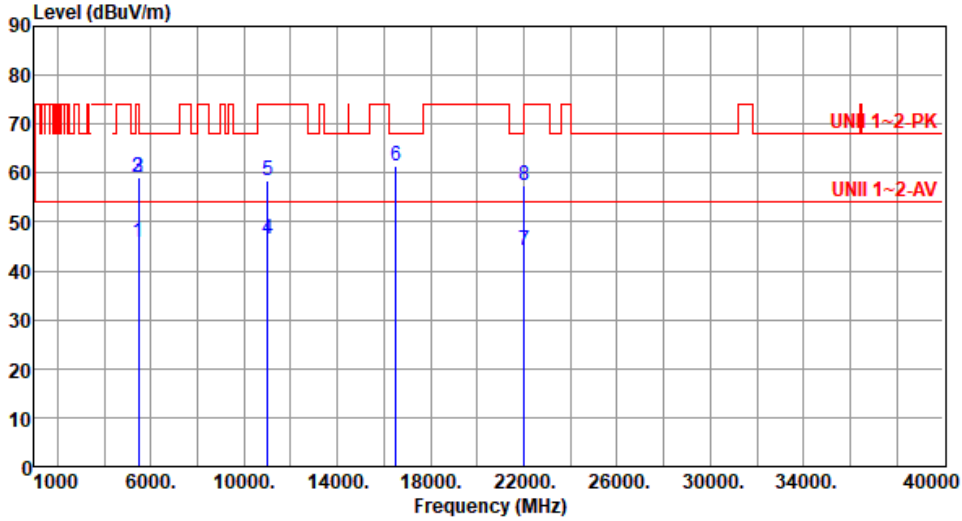

	Freq. MHz	Emission level dBuV/m	Limit dBuV/m	Margin dB	SA reading dBuV	Factor dB/m	Remark	ANT High cm	Turn Table deg
1	5460.00	45.94	54.00	-8.06	39.64	6.30	Average	290	161
2	5460.00	58.98	74.00	-15.02	52.68	6.30	Peak	290	161
3	5470.00	59.28	68.20	-8.92	52.96	6.32	Peak	290	161
4	11000.00	46.57	54.00	-7.43	30.92	15.65	Average	100	166
5	11000.00	58.50	74.00	-15.50	42.85	15.65	Peak	100	166
6	16500.00	61.33	68.20	-6.87	43.87	17.46	Peak	300	150
7	22000.00	44.31	54.00	-9.69	36.66	7.65	Average	277	111
8	22000.00	57.50	68.20	-10.70	49.85	7.65	Peak	277	111

Note 1: Emission Level (dBuV/m) = SA Reading (dBuV) + Factor* (dB/m)

*Factor includes antenna factor , cable loss and amplifier gain

Note 2: Margin (dB) = Emission level (dBuV/m) – Limit (dBuV/m).



Modulation	11a	Test Freq. (MHz)	5580
Polarization	Horizontal		

Test By : Akun Chung Temperature(°C): 23 Humidity(%): 66

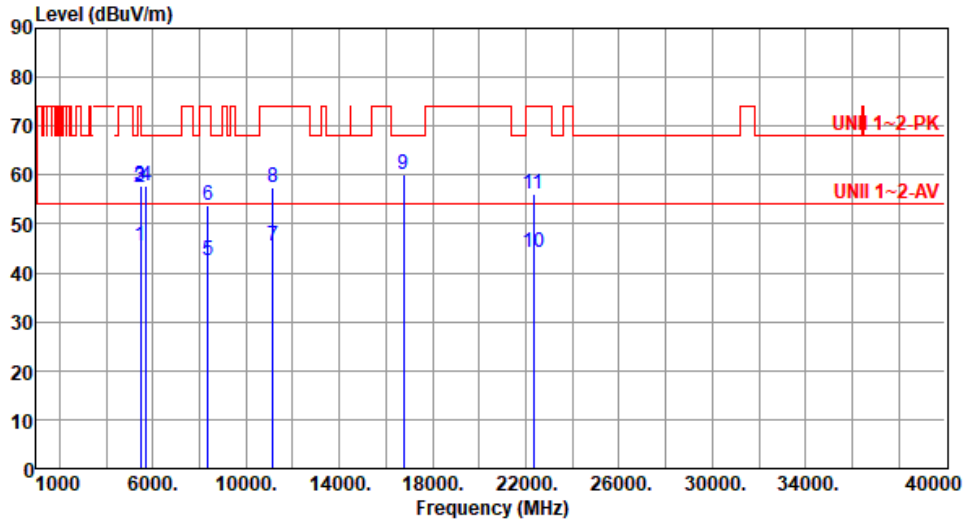

	Freq. MHz	Emission level dBuV/m	Limit dBuV/m	Margin dB	SA reading dBuV	Factor dB/m	Remark	ANT High cm	Turn Table deg
1	5460.00	45.44	54.00	-8.56	39.14	6.30	Average	311	142
2	5460.00	57.54	74.00	-16.46	51.24	6.30	Peak	311	142
3	5470.00	57.65	68.20	-10.55	51.33	6.32	Peak	311	142
4	5725.00	57.87	68.20	-10.33	51.28	6.59	Peak	311	142
5	8370.00	42.38	54.00	-11.62	31.66	10.72	Average	110	170
6	8370.00	53.67	74.00	-20.33	42.95	10.72	Peak	110	170
7	11160.00	45.37	54.00	-8.63	30.22	15.15	Average	100	255
8	11160.00	57.44	74.00	-16.56	42.29	15.15	Peak	100	255
9	16740.00	60.03	68.20	-8.17	42.33	17.70	Peak	100	209
10	22320.00	44.23	54.00	-9.77	35.88	8.35	Average	315	180
11	22320.00	56.23	74.00	-17.77	47.88	8.35	Peak	315	180

Note 1: Emission Level (dBuV/m) = SA Reading (dBuV) + Factor* (dB/m)

*Factor includes antenna factor , cable loss and amplifier gain

Note 2: Margin (dB) = Emission level (dBuV/m) – Limit (dBuV/m).



Modulation	11a	Test Freq. (MHz)	5580
Polarization	Vertical		

Test By :Akun Chung Temperature(°C):23 Humidity(%):66

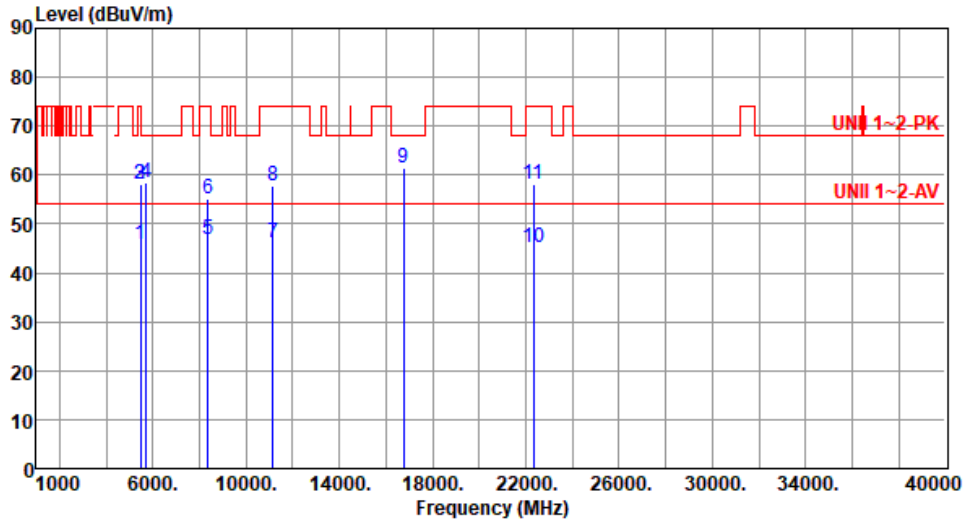

	Freq. MHz	Emission level dBuV/m	Limit dBuV/m	Margin dB	SA reading dBuV	Factor dB/m	Remark	ANT High cm	Turn Table deg
1	5460.00	45.95	54.00	-8.05	39.65	6.30	Average	298	150
2	5460.00	57.95	74.00	-16.05	51.65	6.30	Peak	298	150
3	5470.00	58.01	68.20	-10.19	51.69	6.32	Peak	298	150
4	5725.00	58.31	68.20	-9.89	51.72	6.59	Peak	298	150
5	8370.00	46.68	54.00	-7.32	35.96	10.72	Average	234	133
6	8370.00	55.20	74.00	-18.80	44.48	10.72	Peak	234	133
7	11160.00	46.02	54.00	-7.98	30.87	15.15	Average	315	172
8	11160.00	57.81	74.00	-16.19	42.66	15.15	Peak	315	172
9	16740.00	61.38	68.20	-6.82	43.68	17.70	Peak	300	145
10	22320.00	45.33	54.00	-8.67	36.98	8.35	Average	280	120
11	22320.00	58.23	74.00	-15.77	49.88	8.35	Peak	280	120

Note 1: Emission Level (dBuV/m) = SA Reading (dBuV) + Factor* (dB/m)

*Factor includes antenna factor , cable loss and amplifier gain

Note 2: Margin (dB) = Emission level (dBuV/m) – Limit (dBuV/m).



Modulation	11a	Test Freq. (MHz)	5700
Polarization	Horizontal		

Test By :Brad Wu Temperature(°C):24 Humidity(%):65

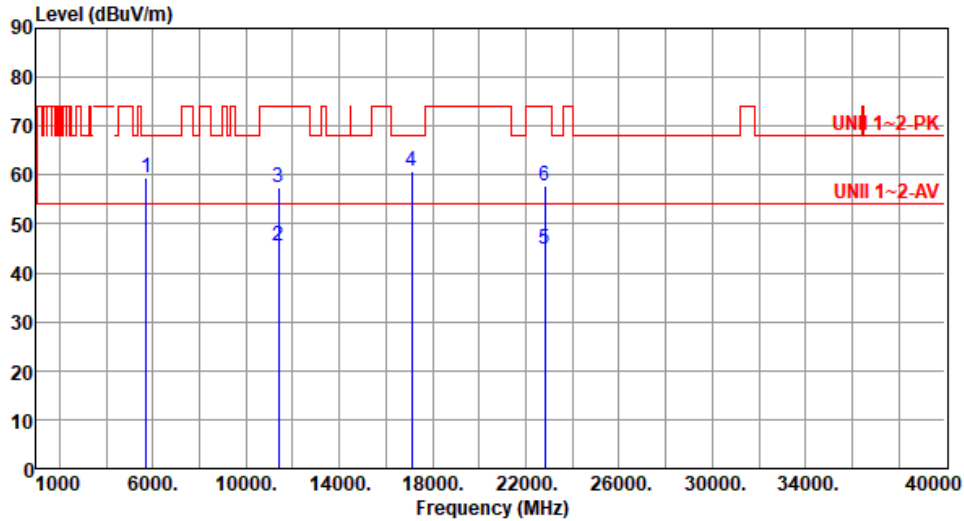

	Freq. MHz	Emission level dBuV/m	Limit dBuV/m	Margin dB	SA reading dBuV	Factor dB/m	Remark	ANT High cm	Turn Table deg
1	5725.00	59.46	68.20	-8.74	52.87	6.59	Peak	308	133
2	11400.00	45.57	54.00	-8.43	30.42	15.15	Average	100	226
3	11400.00	57.60	74.00	-16.40	42.45	15.15	Peak	100	226
4	17100.00	60.85	68.20	-7.35	42.70	18.15	Peak	100	236
5	22800.00	44.97	54.00	-9.03	35.54	9.43	Average	312	182
6	22800.00	57.95	74.00	-16.05	48.52	9.43	Peak	312	182

Note 1: Emission Level (dBuV/m) = SA Reading (dBuV) + Factor* (dB/m)

*Factor includes antenna factor , cable loss and amplifier gain

Note 2: Margin (dB) = Emission level (dBuV/m) – Limit (dBuV/m).



Modulation	11a	Test Freq. (MHz)	5700
Polarization	Vertical		

Test By :Brad Wu Temperature(°C):24 Humidity(%):65

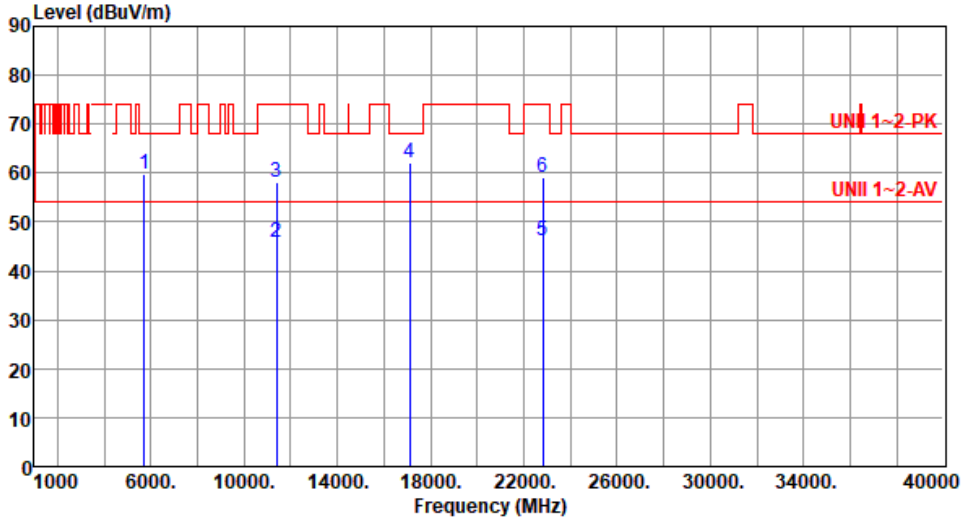

	Freq. MHz	Emission level dBuV/m	Limit dBuV/m	Margin dB	SA reading dBuV	Factor dB/m	Remark	ANT High cm	Turn Table deg
1	5725.00	59.80	68.20	-8.40	53.21	6.59	Peak	283	161
2	11400.00	45.90	54.00	-8.10	30.75	15.15	Average	300	188
3	11400.00	58.00	74.00	-16.00	42.85	15.15	Peak	300	188
4	17100.00	62.02	68.20	-6.18	43.87	18.15	Peak	305	148
5	22800.00	46.28	54.00	-7.72	36.85	9.43	Average	175	116
6	22800.00	59.18	74.00	-14.82	49.75	9.43	Peak	175	116

Note 1: Emission Level (dBuV/m) = SA Reading (dBuV) + Factor* (dB/m)

*Factor includes antenna factor , cable loss and amplifier gain

Note 2: Margin (dB) = Emission level (dBuV/m) – Limit (dBuV/m).



Modulation	11a	Test Freq. (MHz)	5720
Polarization	Horizontal		

Test By : Akun Chung Temperature(°C): 24 Humidity(%): 66

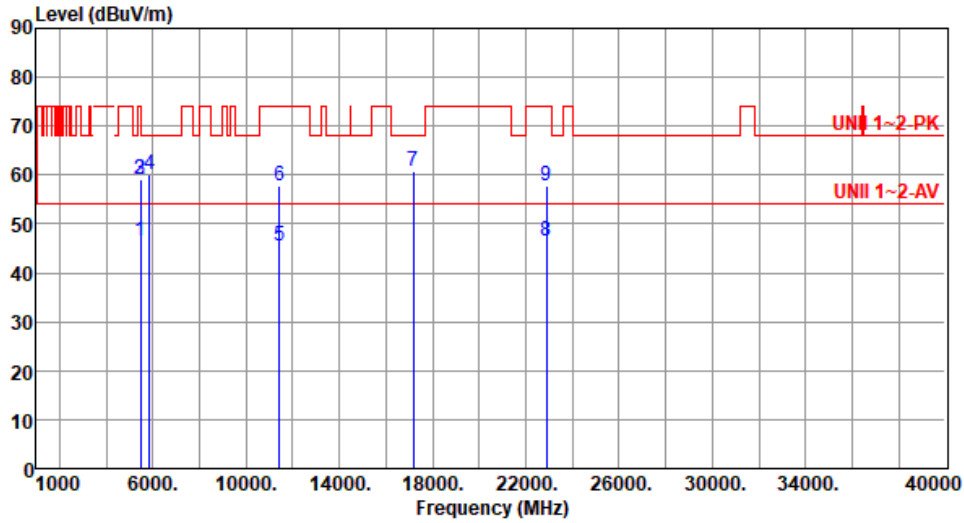

	Freq. MHz	Emission level dBuV/m	Limit dBuV/m	Margin dB	SA reading dBuV	Factor dB/m	Remark	ANT High cm	Turn Table deg
1	5460.00	46.53	54.00	-7.47	40.23	6.30	Average	317	137
2	5460.00	58.95	74.00	-15.05	52.65	6.30	Peak	317	137
3	5470.00	59.00	68.20	-9.20	52.68	6.32	Peak	317	137
4	5850.00	60.02	68.20	-8.18	53.25	6.77	Peak	317	137
5	11440.00	45.50	54.00	-8.50	30.25	15.25	Average	100	241
6	11440.00	57.70	74.00	-16.30	42.45	15.25	Peak	100	241
7	17160.00	60.84	68.20	-7.36	42.69	18.15	Peak	100	243
8	22880.00	46.39	54.00	-7.61	36.87	9.52	Average	313	186
9	22880.00	57.77	74.00	-16.23	48.25	9.52	Peak	313	183

Note 1: Emission Level (dBuV/m) = SA Reading (dBuV) + Factor* (dB/m)

*Factor includes antenna factor , cable loss and amplifier gain

Note 2: Margin (dB) = Emission level (dBuV/m) – Limit (dBuV/m).



Modulation	11a	Test Freq. (MHz)	5720
Polarization	Vertical		

Test By : Akun Chung Temperature(°C): 24 Humidity(%): 66

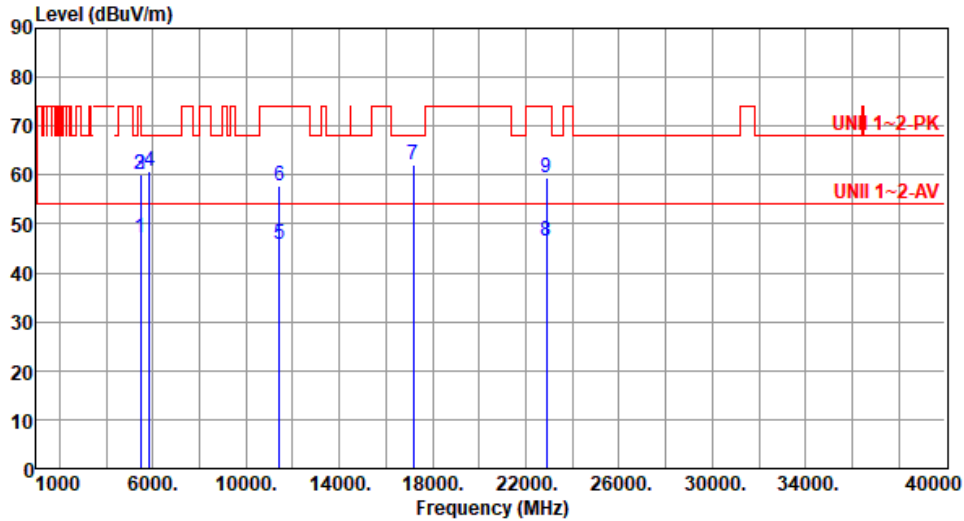

	Freq. MHz	Emission level dBuV/m	Limit dBuV/m	Margin dB	SA reading dBuV	Factor dB/m	Remark	ANT High cm	Turn Table deg
1	5460.00	47.01	54.00	-6.99	40.71	6.30	Average	305	153
2	5460.00	60.04	74.00	-13.96	53.74	6.30	Peak	305	153
3	5470.00	60.10	68.20	-8.10	53.78	6.32	Peak	305	153
4	5850.00	60.64	68.20	-7.56	53.87	6.77	Peak	305	153
5	11440.00	45.98	54.00	-8.02	30.73	15.25	Average	319	175
6	11440.00	57.94	74.00	-16.06	42.69	15.25	Peak	319	175
7	17160.00	62.00	68.20	-6.20	43.85	18.15	Peak	321	150
8	22880.00	46.63	54.00	-7.37	37.11	9.52	Average	271	123
9	22880.00	59.47	74.00	-14.53	49.95	9.52	Peak	271	123

Note 1: Emission Level (dBuV/m) = SA Reading (dBuV) + Factor* (dB/m)

*Factor includes antenna factor , cable loss and amplifier gain

Note 2: Margin (dB) = Emission level (dBuV/m) – Limit (dBuV/m).



Modulation	11a	Test Freq. (MHz)	5745
Polarization	Horizontal		

Test By :Brad Wu Temperature(°C):23 Humidity(%):65

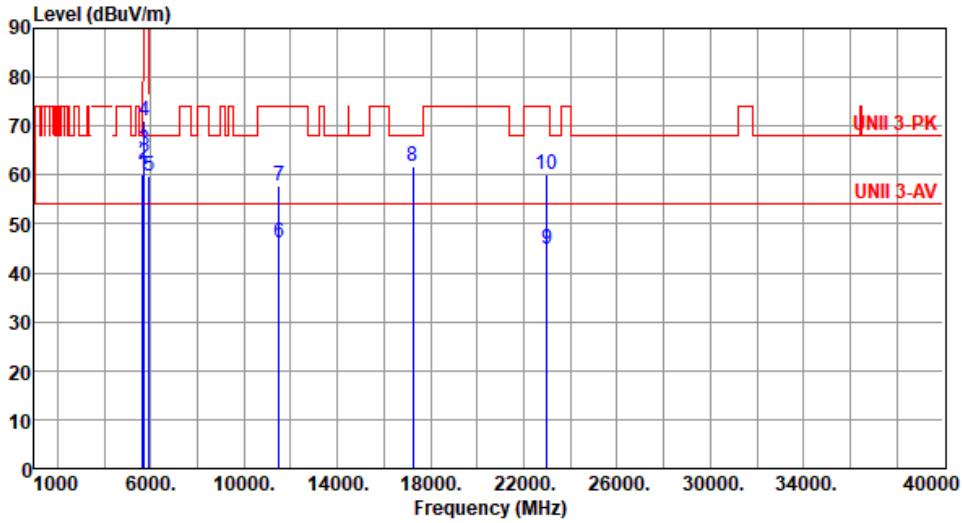

	Freq. MHz	Emission level dBuV/m	Limit dBuV/m	Margin dB	SA reading dBuV	Factor dB/m	Remark	ANT High cm	Turn Table deg
1	5650.00	59.97	68.20	-8.23	53.65	6.32	Peak	320	288
2	5700.00	62.40	105.20	-42.80	55.87	6.53	Peak	320	288
3	5720.00	65.13	110.80	-45.67	58.55	6.58	Peak	320	288
4	5725.00	71.14	122.20	-51.06	64.55	6.59	Peak	320	288
5	5925.00	59.78	68.20	-8.42	52.75	7.03	Peak	320	288
6	11490.00	46.02	54.00	-7.98	30.64	15.38	Average	100	247
7	11490.00	57.85	74.00	-16.15	42.47	15.38	Peak	100	247
8	17235.00	61.83	68.20	-6.37	43.57	18.26	Peak	100	223
9	22980.00	44.73	54.00	-9.27	35.11	9.62	Average	310	181
10	22980.00	60.07	74.00	-13.93	50.45	9.62	Peak	310	188

Note 1: Emission Level (dBuV/m) = SA Reading (dBuV) + Factor* (dB/m)

*Factor includes antenna factor , cable loss and amplifier gain

Note 2: Margin (dB) = Emission level (dBuV/m) – Limit (dBuV/m).



Modulation	11a	Test Freq. (MHz)	5745
Polarization	Vertical		

Test By :Brad Wu Temperature(°C):23 Humidity(%):65

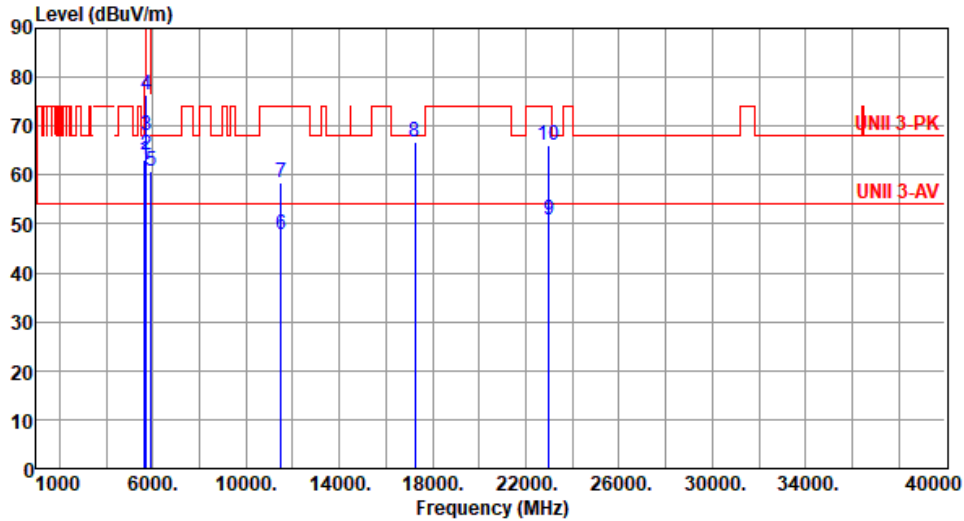

	Freq. MHz	Emission level dBuV/m	Limit dBuV/m	Margin dB	SA reading dBuV	Factor dB/m	Remark	ANT High cm	Turn Table deg
1	5650.00	63.26	68.20	-4.94	56.94	6.32	Peak	291	161
2	5700.00	63.99	105.20	-41.21	57.46	6.53	Peak	291	161
3	5720.00	68.13	110.80	-42.67	61.55	6.58	Peak	291	161
4	5725.00	76.45	122.20	-45.75	69.86	6.59	Peak	291	161
5	5925.00	60.91	68.20	-7.29	53.88	7.03	Peak	291	161
6	11490.00	47.75	54.00	-6.25	32.37	15.38	Average	310	165
7	11490.00	58.36	74.00	-15.64	42.98	15.38	Peak	310	165
8	17235.00	66.79	68.20	-1.41	48.53	18.26	Peak	305	156
9	22980.00	50.89	54.00	-3.11	41.27	9.62	Average	320	177
10	22980.00	66.19	74.00	-7.81	56.57	9.62	Peak	320	177

Note 1: Emission Level (dBuV/m) = SA Reading (dBuV) + Factor* (dB/m)

*Factor includes antenna factor , cable loss and amplifier gain

Note 2: Margin (dB) = Emission level (dBuV/m) – Limit (dBuV/m).



Modulation	11a	Test Freq. (MHz)	5785
Polarization	Horizontal		

Test By :Akun Chung Temperature(°C):23 Humidity(%):66

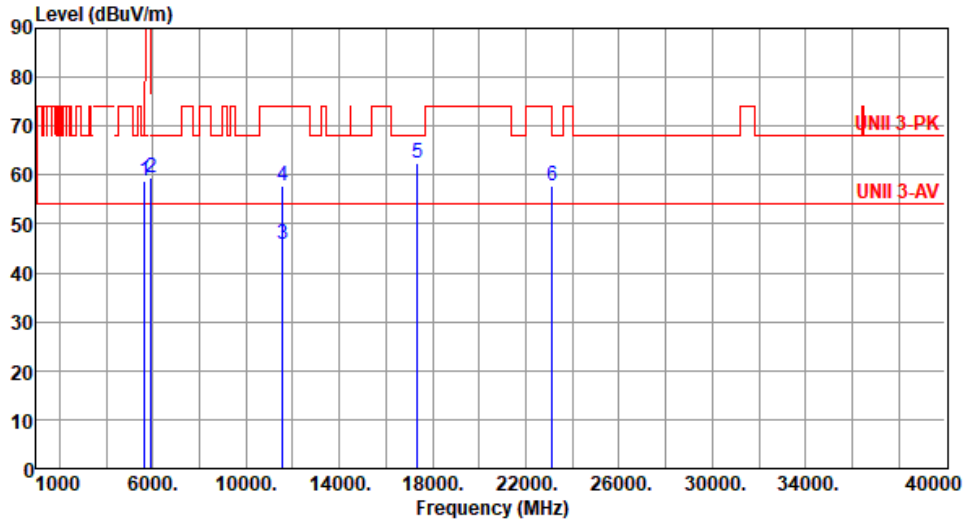

	Freq. MHz	Emission level dBuV/m	Limit dBuV/m	Margin dB	SA reading dBuV	Factor dB/m	Remark	ANT High cm	Turn Table deg
1	5650.00	58.80	68.20	-9.40	52.48	6.32	Peak	319	290
2	5925.00	59.46	68.20	-8.74	52.43	7.03	Peak	319	290
3	11570.00	45.83	54.00	-8.17	30.45	15.38	Average	100	250
4	11570.00	57.88	74.00	-16.12	42.50	15.38	Peak	100	250
5	17355.00	62.45	68.20	-5.75	43.47	18.98	Peak	108	201
6	23140.00	57.92	68.20	-10.28	48.25	9.67	Peak	296	161

Note 1: Emission Level (dBuV/m) = SA Reading (dBuV) + Factor* (dB/m)

*Factor includes antenna factor , cable loss and amplifier gain

Note 2: Margin (dB) = Emission level (dBuV/m) – Limit (dBuV/m).



Modulation	11a	Test Freq. (MHz)	5785
Polarization	Vertical		

Test By :Akun Chung Temperature(°C):23 Humidity(%):66

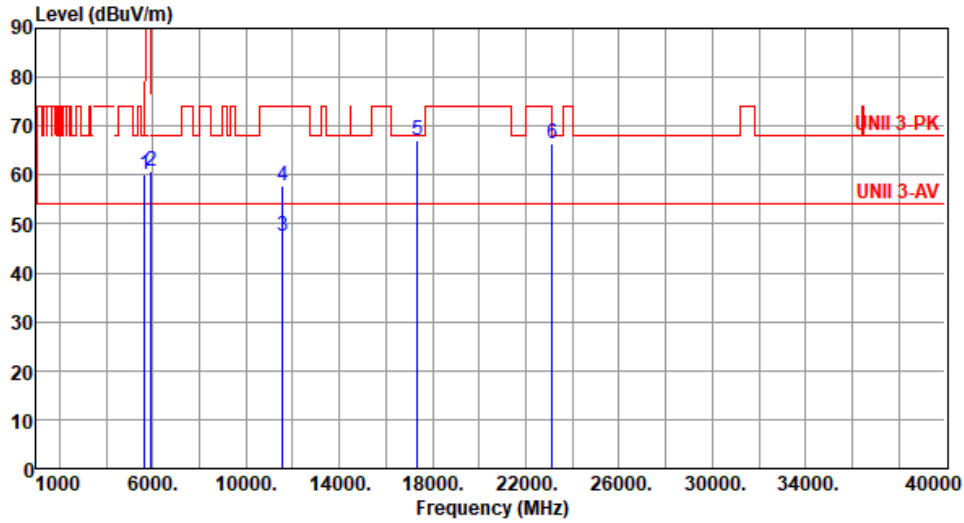

	Freq. MHz	Emission level dBuV/m	Limit dBuV/m	Margin dB	SA reading dBuV	Factor dB/m	Remark	ANT High cm	Turn Table deg
1	5650.00	59.99	68.20	-8.21	53.67	6.32	Peak	311	150
2	5925.00	60.80	68.20	-7.40	53.77	7.03	Peak	311	150
3	11570.00	47.34	54.00	-6.66	31.96	15.38	Average	320	169
4	11570.00	57.94	74.00	-16.06	42.56	15.38	Peak	320	169
5	17355.00	67.19	68.20	-1.01	48.21	18.98	Peak	311	144
6	23140.00	66.40	68.20	-1.80	56.73	9.67	Peak	322	171

Note 1: Emission Level (dBuV/m) = SA Reading (dBuV) + Factor* (dB/m)

*Factor includes antenna factor , cable loss and amplifier gain

Note 2: Margin (dB) = Emission level (dBuV/m) – Limit (dBuV/m).



Modulation	11a	Test Freq. (MHz)	5825
Polarization	Horizontal		

Test By :Brad Wu Temperature(°C):23 Humidity(%):65

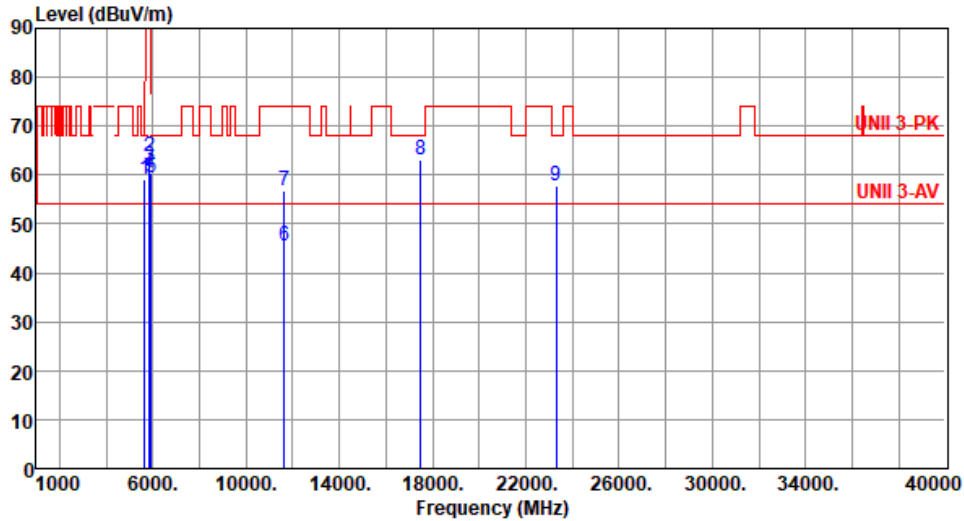

	Freq. MHz	Emission level dBuV/m	Limit dBuV/m	Margin dB	SA reading dBuV	Factor dB/m	Remark	ANT High cm	Turn Table deg
1	5650.00	59.20	68.20	-9.00	52.88	6.32	Peak	305	289
2	5850.00	63.62	122.20	-58.58	56.85	6.77	Peak	305	289
3	5855.00	61.67	110.80	-49.13	54.87	6.80	Peak	305	289
4	5875.00	60.51	105.20	-44.69	53.63	6.88	Peak	305	289
5	5925.00	59.61	68.20	-8.59	52.58	7.03	Peak	305	289
6	11650.00	45.65	54.00	-8.35	30.48	15.17	Average	100	239
7	11650.00	56.64	74.00	-17.36	41.47	15.17	Peak	100	239
8	17475.00	63.07	68.20	-5.13	43.26	19.81	Peak	100	206
9	23300.00	57.80	68.20	-10.40	48.14	9.66	Peak	281	173

Note 1: Emission Level (dBuV/m) = SA Reading (dBuV) + Factor* (dB/m)

*Factor includes antenna factor , cable loss and amplifier gain

Note 2: Margin (dB) = Emission level (dBuV/m) – Limit (dBuV/m).



Modulation	11a	Test Freq. (MHz)	5825						
Polarization	Vertical								
Test By :Brad Wu Temperature(°C):23 Humidity(%):65									
	Freq. MHz	Emission level dBuV/m	Limit dBuV/m	Margin dB	SA reading dBuV	Factor dB/m	Remark	ANT High cm	Turn Table deg
1	5650.00	59.47	68.20	-8.73	53.15	6.32	Peak	312	162
2	5850.00	66.43	122.20	-55.77	59.66	6.77	Peak	312	162
3	5855.00	62.84	110.80	-47.96	56.04	6.80	Peak	312	162
4	5875.00	62.14	105.20	-43.06	55.26	6.88	Peak	312	162
5	5925.00	61.96	68.20	-6.24	54.93	7.03	Peak	312	162
6	11650.00	46.45	54.00	-7.55	31.28	15.17	Average	321	179
7	11650.00	57.02	74.00	-16.98	41.85	15.17	Peak	321	179
8	17475.00	66.20	68.20	-2.00	46.39	19.81	Peak	281	154
9	23300.00	67.18	68.20	-1.02	57.52	9.66	Peak	317	177

Note 1: Emission Level (dBuV/m) = SA Reading (dBuV) + Factor* (dB/m)

*Factor includes antenna factor , cable loss and amplifier gain

Note 2: Margin (dB) = Emission level (dBuV/m) – Limit (dBuV/m).



Unwanted Emissions (Above 1GHz) for ax HE20-OFDMA

Modulation	ax HE20-OFDMA	Test Freq. (MHz)	5180
Polarization	Horizontal		

Test By :Brad Wu Temperature(°C):23 Humidity(%):65

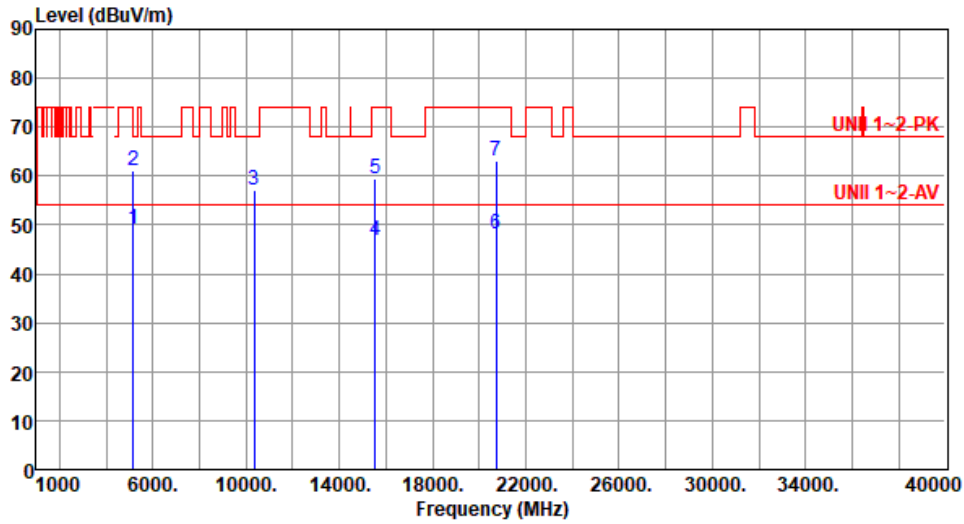

	Freq. MHz	Emission level dBuV/m	Limit dBuV/m	Margin dB	SA reading dBuV	Factor dB/m	Remark	ANT High cm	Turn Table deg
1	5150.00	49.08	54.00	-4.92	42.77	6.31	Average	302	308
2	5150.00	61.16	74.00	-12.84	54.85	6.31	Peak	302	308
3	10360.00	57.03	68.20	-11.17	42.58	14.45	Peak	100	177
4	15540.00	46.79	54.00	-7.21	30.39	16.40	Average	100	217
5	15540.00	59.36	74.00	-14.64	42.96	16.40	Peak	100	217
6	20720.00	48.15	54.00	-5.85	41.75	6.40	Average	318	180
7	20720.00	63.25	74.00	-10.75	56.85	6.40	Peak	318	180

Note 1: Emission Level (dBuV/m) = SA Reading (dBuV) + Factor* (dB/m)
 *Factor includes antenna factor , cable loss and amplifier gain
 Note 2: Margin (dB) = Emission level (dBuV/m) – Limit (dBuV/m).



Modulation	ax HE20-OFDMA	Test Freq. (MHz)	5180
Polarization	Vertical		

Test By :Brad Wu Temperature(°C):23 Humidity(%):65

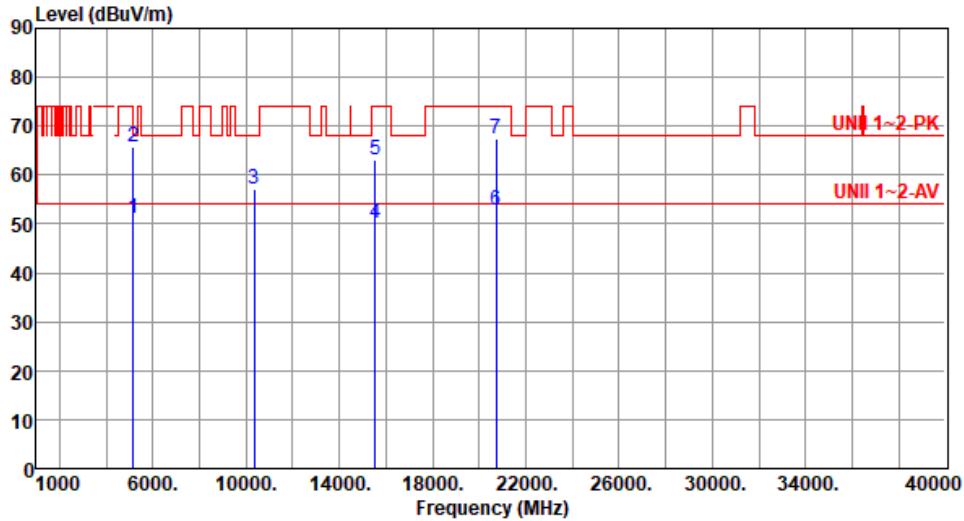

	Freq. MHz	Emission level dBuV/m	Limit dBuV/m	Margin dB	SA reading dBuV	Factor dB/m	Remark	ANT High cm	Turn Table deg
1	5150.00	51.02	54.00	-2.98	44.71	6.31	Average	311	183
2	5150.00	65.91	74.00	-8.09	59.60	6.31	Peak	311	183
3	10360.00	57.00	68.20	-11.20	42.55	14.45	Peak	100	50
4	15540.00	50.28	54.00	-3.72	33.88	16.40	Average	289	155
5	15540.00	63.25	74.00	-10.75	46.85	16.40	Peak	289	155
6	20720.00	52.65	54.00	-1.35	46.25	6.40	Average	320	172
7	20720.00	67.29	74.00	-6.71	60.89	6.40	Peak	320	172

Note 1: Emission Level (dBuV/m) = SA Reading (dBuV) + Factor* (dB/m)

*Factor includes antenna factor , cable loss and amplifier gain

Note 2: Margin (dB) = Emission level (dBuV/m) – Limit (dBuV/m).



Modulation	ax HE20-OFDMA	Test Freq. (MHz)	5200
Polarization	Horizontal		

Test By :Brad Wu Temperature(°C):23 Humidity(%):65

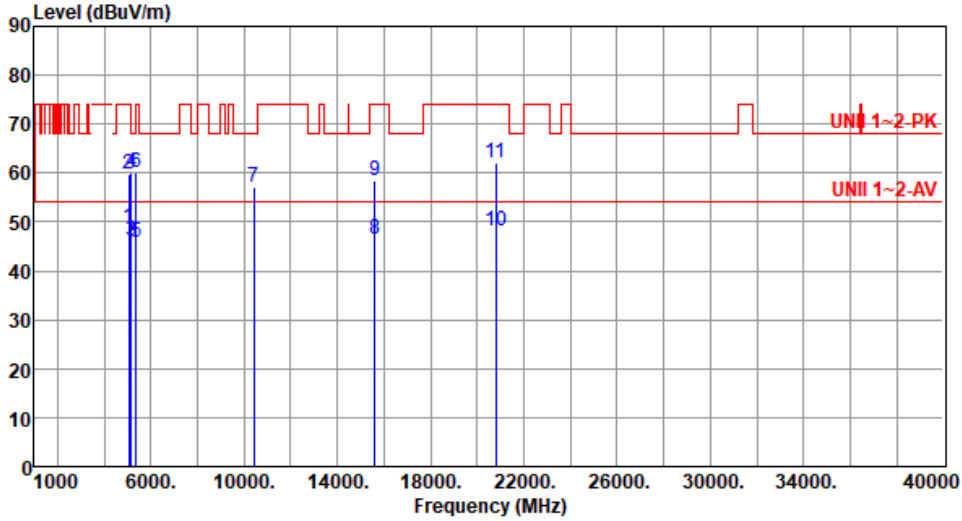

	Freq. MHz	Emission level dBuV/m	Limit dBuV/m	Margin dB	SA reading dBuV	Factor dB/m	Remark	ANT High cm	Turn Table deg
1	5040.00	48.75	54.00	-5.25	42.49	6.26	Average	323	301
2	5040.00	59.82	74.00	-14.18	53.56	6.26	Peak	323	301
3	5150.00	46.30	54.00	-7.70	39.99	6.31	Average	323	301
4	5150.00	60.12	74.00	-13.88	53.81	6.31	Peak	323	301
5	5350.00	45.83	54.00	-8.17	40.11	5.72	Average	323	301
6	5350.00	59.97	74.00	-14.03	54.25	5.72	Peak	323	301
7	10400.00	57.14	68.20	-11.06	42.66	14.48	Peak	100	186
8	15600.00	46.51	54.00	-7.49	30.57	15.94	Average	100	204
9	15600.00	58.45	74.00	-15.55	42.51	15.94	Peak	100	204
10	20800.00	48.15	54.00	-5.85	41.68	6.47	Average	321	181
11	20800.00	62.21	74.00	-11.79	55.74	6.47	Peak	321	181

Note 1: Emission Level (dBuV/m) = SA Reading (dBuV) + Factor* (dB/m)

*Factor includes antenna factor , cable loss and amplifier gain

Note 2: Margin (dB) = Emission level (dBuV/m) – Limit (dBuV/m).



Modulation	ax HE20-OFDMA	Test Freq. (MHz)	5200
Polarization	Vertical		

Test By :Brad Wu Temperature(°C):23 Humidity(%):65

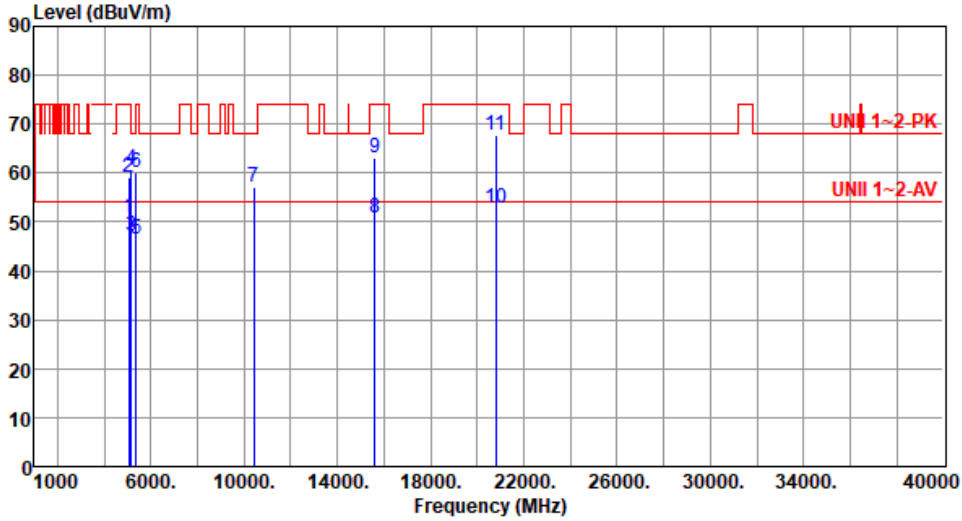

	Freq. MHz	Emission level dBuV/m	Limit dBuV/m	Margin dB	SA reading dBuV	Factor dB/m	Remark	ANT High cm	Turn Table deg
1	5040.00	50.68	54.00	-3.32	44.42	6.26	Average	297	180
2	5040.00	59.24	74.00	-14.76	52.98	6.26	Peak	297	180
3	5150.00	47.13	54.00	-6.87	40.82	6.31	Average	297	180
4	5150.00	60.72	74.00	-13.28	54.41	6.31	Peak	297	180
5	5350.00	46.53	54.00	-7.47	40.81	5.72	Average	297	180
6	5350.00	60.03	74.00	-13.97	54.31	5.72	Peak	297	180
7	10400.00	57.26	68.20	-10.94	42.78	14.48	Peak	188	35
8	15600.00	50.82	54.00	-3.18	34.88	15.94	Average	288	153
9	15600.00	63.05	74.00	-10.95	47.11	15.94	Peak	288	153
10	20800.00	52.92	54.00	-1.08	46.45	6.47	Average	322	169
11	20800.00	67.62	74.00	-6.38	61.15	6.47	Peak	322	169

Note 1: Emission Level (dBuV/m) = SA Reading (dBuV) + Factor* (dB/m)

*Factor includes antenna factor , cable loss and amplifier gain

Note 2: Margin (dB) = Emission level (dBuV/m) – Limit (dBuV/m).



Modulation	ax HE20-OFDMA	Test Freq. (MHz)	5240
Polarization	Horizontal		

Test By :Brad Wu Temperature(°C):23 Humidity(%):65

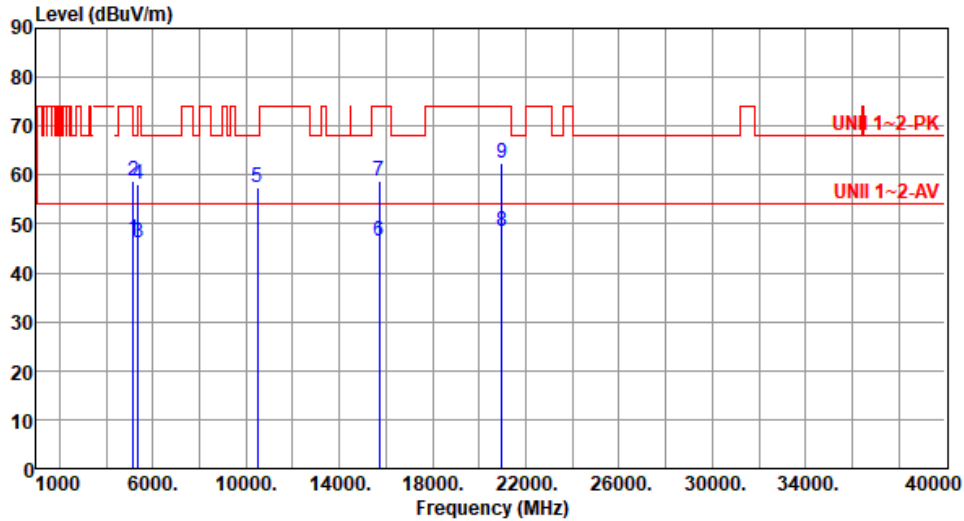

	Freq. MHz	Emission level dBuV/m	Limit dBuV/m	Margin dB	SA reading dBuV	Factor dB/m	Remark	ANT High cm	Turn Table deg
1	5150.00	46.76	54.00	-7.24	40.45	6.31	Average	315	299
2	5150.00	58.76	74.00	-15.24	52.45	6.31	Peak	315	299
3	5350.00	46.05	54.00	-7.95	40.33	5.72	Average	315	299
4	5350.00	58.19	74.00	-15.81	52.47	5.72	Peak	315	299
5	10480.00	57.37	68.20	-10.83	42.74	14.63	Peak	100	192
6	15720.00	46.61	54.00	-7.39	30.66	15.95	Average	100	212
7	15720.00	58.70	74.00	-15.30	42.75	15.95	Peak	100	212
8	20960.00	48.46	54.00	-5.54	41.75	6.71	Average	316	178
9	20960.00	62.57	74.00	-11.43	55.86	6.71	Peak	316	178

Note 1: Emission Level (dBuV/m) = SA Reading (dBuV) + Factor* (dB/m)

*Factor includes antenna factor , cable loss and amplifier gain

Note 2: Margin (dB) = Emission level (dBuV/m) – Limit (dBuV/m).



Modulation	ax HE20-OFDMA	Test Freq. (MHz)	5240
Polarization	Vertical		

Test By :Brad Wu Temperature(°C):23 Humidity(%):65

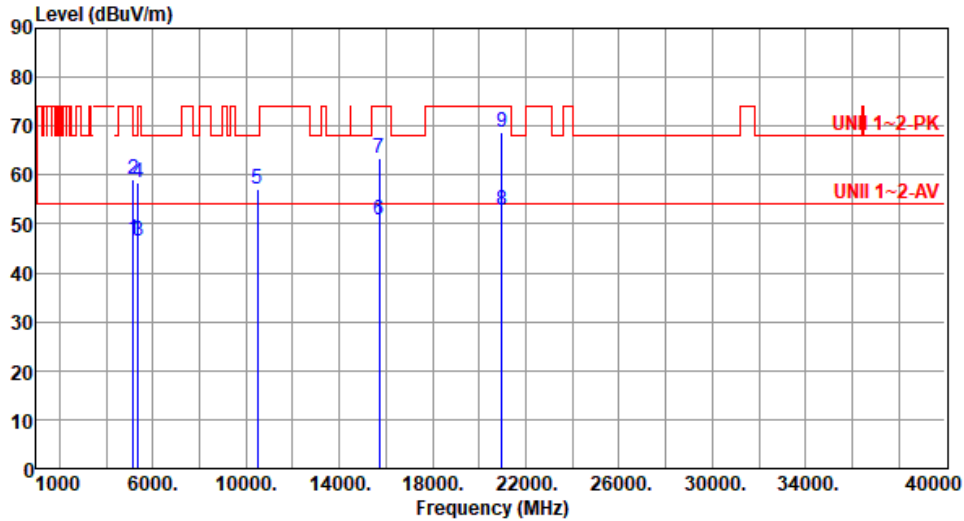

	Freq. MHz	Emission level dBuV/m	Limit dBuV/m	Margin dB	SA reading dBuV	Factor dB/m	Remark	ANT High cm	Turn Table deg
1	5150.00	46.97	54.00	-7.03	40.66	6.31	Average	296	178
2	5150.00	59.01	74.00	-14.99	52.70	6.31	Peak	296	178
3	5350.00	46.44	54.00	-7.56	40.72	5.72	Average	296	178
4	5350.00	58.41	74.00	-15.59	52.69	5.72	Peak	296	178
5	10480.00	57.20	68.20	-11.00	42.57	14.63	Peak	187	36
6	15720.00	50.88	54.00	-3.12	34.93	15.95	Average	285	157
7	15720.00	63.47	74.00	-10.53	47.52	15.95	Peak	285	157
8	20960.00	52.85	54.00	-1.15	46.14	6.71	Average	314	171
9	20960.00	68.70	74.00	-5.30	61.99	6.71	Peak	314	171

Note 1: Emission Level (dBuV/m) = SA Reading (dBuV) + Factor* (dB/m)

*Factor includes antenna factor , cable loss and amplifier gain

Note 2: Margin (dB) = Emission level (dBuV/m) – Limit (dBuV/m).



Modulation	ax HE20-OFDMA	Test Freq. (MHz)	5260
Polarization	Horizontal		

Test By :Akun Chung Temperature(°C):24 Humidity(%):66

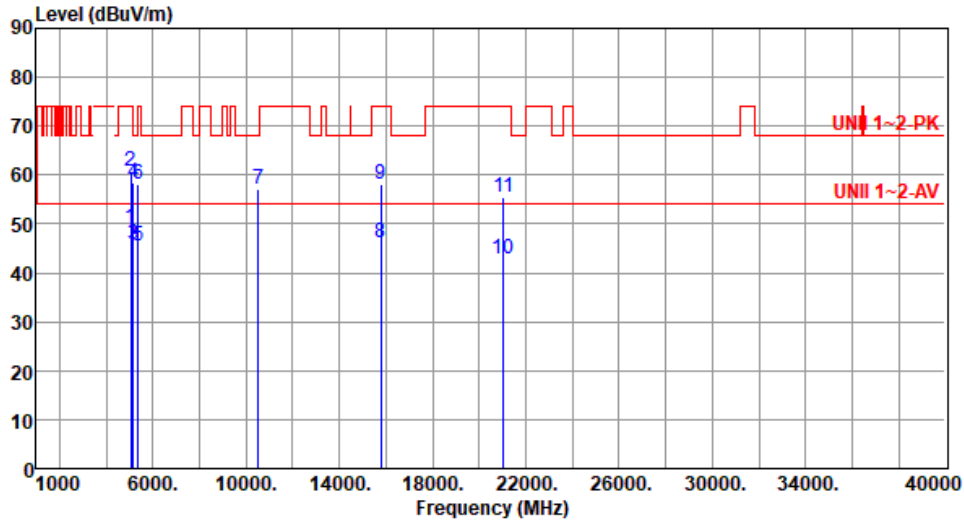

	Freq. MHz	Emission level dBuV/m	Limit dBuV/m	Margin dB	SA reading dBuV	Factor dB/m	Remark	ANT High cm	Turn Table deg
1	5040.00	49.26	54.00	-4.74	43.00	6.26	Average	281	282
2	5040.00	60.82	74.00	-13.18	54.56	6.26	Peak	281	282
3	5150.00	45.76	54.00	-8.24	39.45	6.31	Average	281	282
4	5150.00	58.52	74.00	-15.48	52.21	6.31	Peak	281	282
5	5350.00	45.38	54.00	-8.62	39.66	5.72	Average	281	282
6	5350.00	58.14	74.00	-15.86	52.42	5.72	Peak	281	282
7	10520.00	57.15	68.20	-11.05	42.48	14.67	Peak	100	185
8	15780.00	46.07	54.00	-7.93	30.21	15.86	Average	100	165
9	15780.00	58.11	74.00	-15.89	42.25	15.86	Peak	100	165
10	21040.00	42.96	54.00	-11.04	36.11	6.85	Average	100	211
11	21040.00	55.37	74.00	-18.63	48.52	6.85	Peak	100	211

Note 1: Emission Level (dBuV/m) = SA Reading (dBuV) + Factor* (dB/m)

*Factor includes antenna factor , cable loss and amplifier gain

Note 2: Margin (dB) = Emission level (dBuV/m) – Limit (dBuV/m).



Modulation	ax HE20-OFDMA	Test Freq. (MHz)	5260
Polarization	Vertical		

Test By : Akun Chung Temperature(°C): 24 Humidity(%): 66

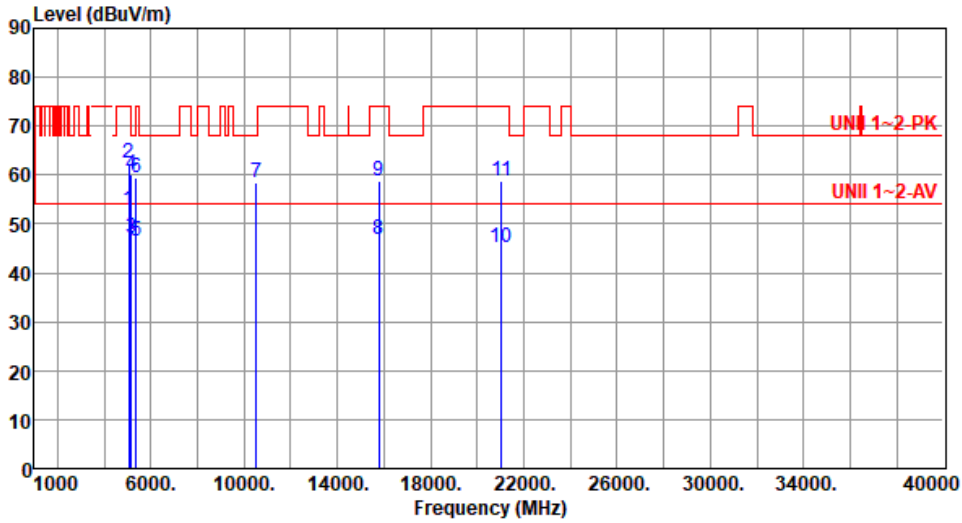

	Freq. MHz	Emission level dBuV/m	Limit dBuV/m	Margin dB	SA reading dBuV	Factor dB/m	Remark	ANT High cm	Turn Table deg
1	5040.00	52.92	54.00	-1.08	46.66	6.26	Average	291	172
2	5040.00	62.50	74.00	-11.50	56.24	6.26	Peak	291	172
3	5150.00	47.19	54.00	-6.81	40.88	6.31	Average	312	175
4	5150.00	60.16	74.00	-13.84	53.85	6.31	Peak	312	175
5	5350.00	46.49	54.00	-7.51	40.77	5.72	Average	312	175
6	5350.00	59.47	74.00	-14.53	53.75	5.72	Peak	312	175
7	10520.00	58.35	68.20	-9.85	43.68	14.67	Peak	100	258
8	15780.00	46.73	54.00	-7.27	30.87	15.86	Average	100	217
9	15780.00	58.82	74.00	-15.18	42.96	15.86	Peak	100	217
10	21040.00	45.18	54.00	-8.82	38.33	6.85	Average	275	123
11	21040.00	58.70	74.00	-15.30	51.85	6.85	Peak	275	123

Note 1: Emission Level (dBuV/m) = SA Reading (dBuV) + Factor* (dB/m)

*Factor includes antenna factor , cable loss and amplifier gain

Note 2: Margin (dB) = Emission level (dBuV/m) – Limit (dBuV/m).



Modulation	ax HE20-OFDMA	Test Freq. (MHz)	5300
Polarization	Horizontal		

Test By :Brad Wu Temperature(°C):23 Humidity(%):65

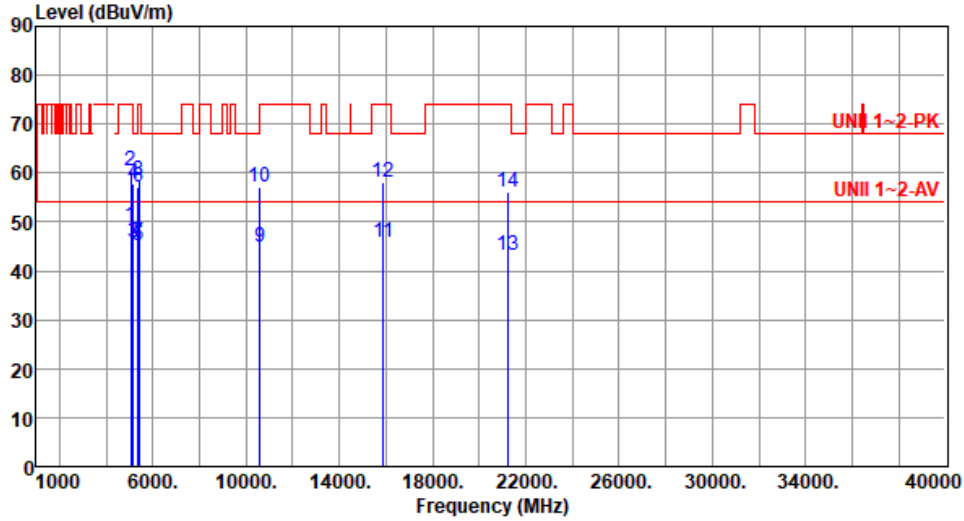

	Freq. MHz	Emission level dBuV/m	Limit dBuV/m	Margin dB	SA reading dBuV	Factor dB/m	Remark	ANT High cm	Turn Table deg
1	5040.00	49.12	54.00	-4.88	42.86	6.26	Average	282	279
2	5040.00	60.28	74.00	-13.72	54.02	6.26	Peak	282	279
3	5150.00	45.82	54.00	-8.18	39.51	6.31	Average	282	279
4	5150.00	57.91	74.00	-16.09	51.60	6.31	Peak	282	279
5	5350.00	45.03	54.00	-8.97	39.31	5.72	Average	282	279
6	5350.00	57.12	74.00	-16.88	51.40	5.72	Peak	282	279
7	5395.00	45.75	54.00	-8.25	39.56	6.19	Average	282	279
8	5395.00	58.46	74.00	-15.54	52.27	6.19	Peak	282	279
9	10600.00	44.96	54.00	-9.04	30.24	14.72	Average	100	186
10	10600.00	57.22	74.00	-16.78	42.50	14.72	Peak	100	186
11	15900.00	45.94	54.00	-8.06	30.37	15.57	Average	100	162
12	15900.00	58.01	74.00	-15.99	42.44	15.57	Peak	100	162
13	21200.00	43.25	54.00	-10.75	36.08	7.17	Average	100	205
14	21200.00	55.96	74.00	-18.04	48.79	7.17	Peak	100	205

Note 1: Emission Level (dBuV/m) = SA Reading (dBuV) + Factor* (dB/m)

*Factor includes antenna factor , cable loss and amplifier gain

Note 2: Margin (dB) = Emission level (dBuV/m) – Limit (dBuV/m).



Modulation	ax HE20-OFDMA	Test Freq. (MHz)	5300
Polarization	Vertical		

Test By :Brad Wu Temperature(°C):23 Humidity(%):65

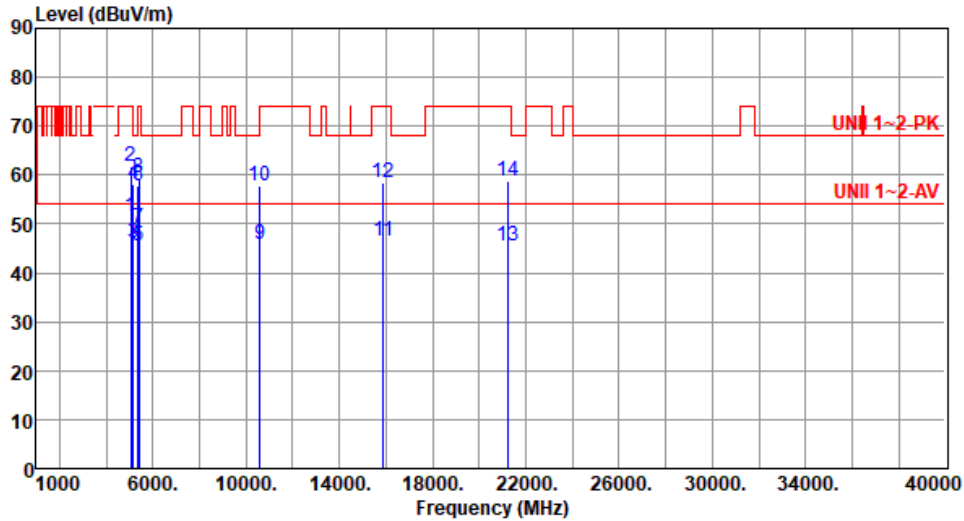

	Freq.	Emission	Limit	Margin	SA	Factor	Remark	ANT	Turn
	MHz	level	dBuV/m	dB	reading	dB/m		High	Table
		dBuV/m			dBuV			cm	deg
1	5040.00	51.35	54.00	-2.65	45.09	6.26	Average	315	165
2	5040.00	61.84	74.00	-12.16	55.58	6.26	Peak	315	165
3	5150.00	46.11	54.00	-7.89	39.80	6.31	Average	295	179
4	5150.00	58.26	74.00	-15.74	51.95	6.31	Peak	295	179
5	5350.00	45.58	54.00	-8.42	39.86	5.72	Average	295	179
6	5350.00	57.62	74.00	-16.38	51.90	5.72	Peak	295	179
7	5395.00	49.28	54.00	-4.72	43.09	6.19	Average	295	179
8	5395.00	59.46	74.00	-14.54	53.27	6.19	Peak	295	179
9	10600.00	45.69	54.00	-8.31	30.97	14.72	Average	100	251
10	10600.00	57.81	74.00	-16.19	43.09	14.72	Peak	100	251
11	15900.00	46.52	54.00	-7.48	30.95	15.57	Average	100	212
12	15900.00	58.46	74.00	-15.54	42.89	15.57	Peak	100	212
13	21200.00	45.46	54.00	-8.54	38.29	7.17	Average	282	119
14	21200.00	58.91	74.00	-15.09	51.74	7.17	Peak	282	119

Note 1: Emission Level (dBuV/m) = SA Reading (dBuV) + Factor* (dB/m)

*Factor includes antenna factor , cable loss and amplifier gain

Note 2: Margin (dB) = Emission level (dBuV/m) – Limit (dBuV/m).



Modulation	ax HE20-OFDMA	Test Freq. (MHz)	5320
Polarization	Horizontal		

Test By :Brad Wu Temperature(°C):23 Humidity(%):65

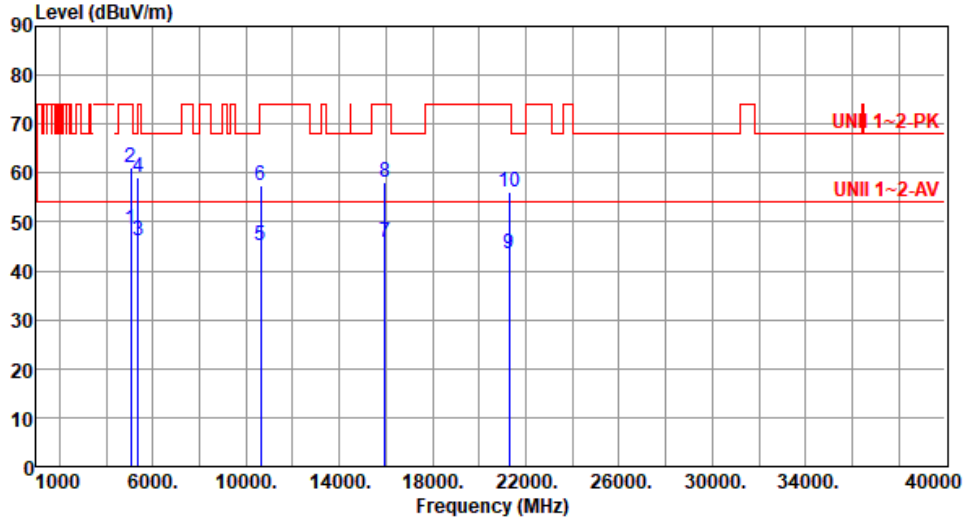

	Freq. MHz	Emission level dBuV/m	Limit dBuV/m	Margin dB	SA reading dBuV	Factor dB/m	Remark	ANT High cm	Turn Table deg
1	5040.00	48.42	54.00	-5.58	42.16	6.26	Average	290	280
2	5040.00	61.15	74.00	-12.85	54.89	6.26	Peak	290	280
3	5350.00	46.02	54.00	-7.98	40.30	5.72	Average	290	280
4	5350.00	59.16	74.00	-14.84	53.44	5.72	Peak	290	280
5	10640.00	45.01	54.00	-8.99	30.15	14.86	Average	100	177
6	10640.00	57.31	74.00	-16.69	42.45	14.86	Peak	100	177
7	15960.00	45.99	54.00	-8.01	30.34	15.65	Average	100	158
8	15960.00	58.13	74.00	-15.87	42.48	15.65	Peak	100	158
9	21280.00	43.40	54.00	-10.60	36.14	7.26	Average	100	209
10	21280.00	56.10	74.00	-17.90	48.84	7.26	Peak	100	209

Note 1: Emission Level (dBuV/m) = SA Reading (dBuV) + Factor* (dB/m)

*Factor includes antenna factor , cable loss and amplifier gain

Note 2: Margin (dB) = Emission level (dBuV/m) – Limit (dBuV/m).



Modulation	ax HE20-OFDMA	Test Freq. (MHz)	5320
Polarization	Vertical		

Test By :Brad Wu Temperature(°C):23 Humidity(%):65

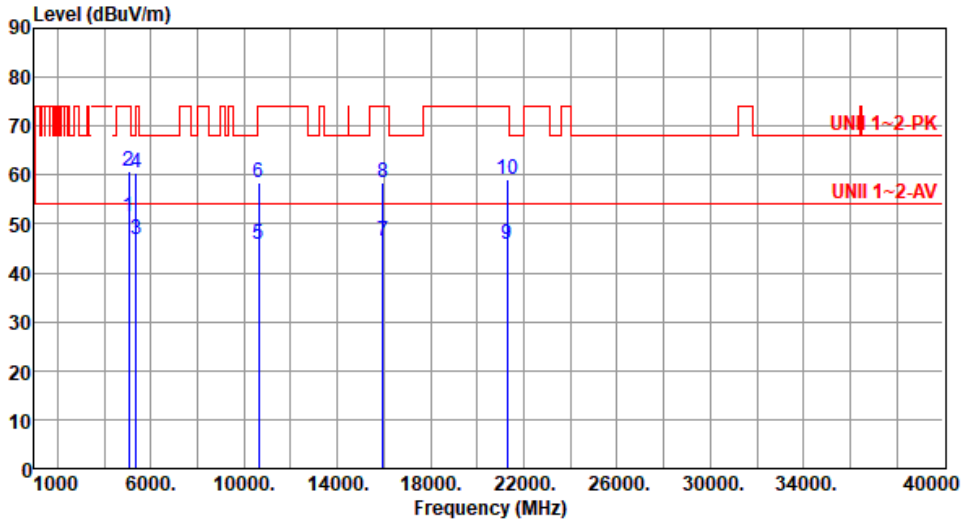

	Freq. MHz	Emission level dBuV/m	Limit dBuV/m	Margin dB	SA reading dBuV	Factor dB/m	Remark	ANT High cm	Turn Table deg
1	5040.00	51.48	54.00	-2.52	45.22	6.26	Average	310	178
2	5040.00	60.88	74.00	-13.12	54.62	6.26	Peak	310	178
3	5350.00	46.93	54.00	-7.07	41.21	5.72	Average	284	177
4	5350.00	60.41	74.00	-13.59	54.69	5.72	Peak	284	177
5	10640.00	45.73	54.00	-8.27	30.87	14.86	Average	100	256
6	10640.00	58.40	74.00	-15.60	43.54	14.86	Peak	100	256
7	15960.00	46.50	54.00	-7.50	30.85	15.65	Average	100	222
8	15960.00	58.43	74.00	-15.57	42.78	15.65	Peak	100	222
9	21280.00	45.88	54.00	-8.12	38.62	7.26	Average	287	126
10	21280.00	59.13	74.00	-14.87	51.87	7.26	Peak	287	126

Note 1: Emission Level (dBuV/m) = SA Reading (dBuV) + Factor* (dB/m)

*Factor includes antenna factor , cable loss and amplifier gain

Note 2: Margin (dB) = Emission level (dBuV/m) – Limit (dBuV/m).



Modulation	ax HE20-OFDMA	Test Freq. (MHz)	5500
Polarization	Horizontal		

Test By :Brad Wu Temperature(°C):23 Humidity(%):65

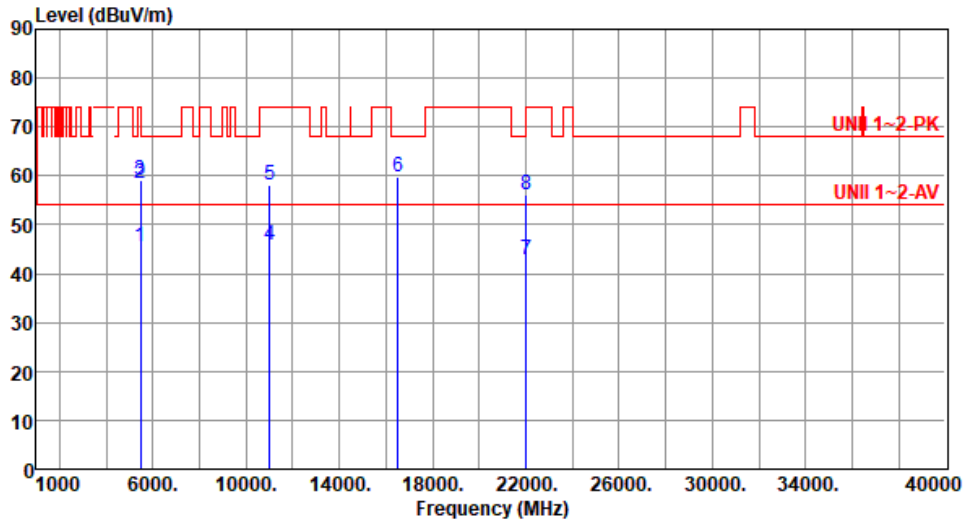

	Freq. MHz	Emission level dBuV/m	Limit dBuV/m	Margin dB	SA reading dBuV	Factor dB/m	Remark	ANT High cm	Turn Table deg
1	5460.00	45.62	54.00	-8.38	39.32	6.30	Average	315	152
2	5460.00	58.54	74.00	-15.46	52.24	6.30	Peak	315	152
3	5470.00	58.95	68.20	-9.25	52.63	6.32	Peak	315	152
4	11000.00	45.92	54.00	-8.08	30.27	15.65	Average	100	260
5	11000.00	58.13	74.00	-15.87	42.48	15.65	Peak	100	260
6	16500.00	59.94	68.20	-8.26	42.48	17.46	Peak	100	225
7	22000.00	42.90	54.00	-11.10	35.25	7.65	Average	318	179
8	22000.00	56.17	68.20	-12.03	48.52	7.65	Peak	318	179

Note 1: Emission Level (dBuV/m) = SA Reading (dBuV) + Factor* (dB/m)

*Factor includes antenna factor , cable loss and amplifier gain

Note 2: Margin (dB) = Emission level (dBuV/m) – Limit (dBuV/m).



Modulation	ax HE20-OFDMA	Test Freq. (MHz)	5500
Polarization	Vertical		

Test By :Brad Wu Temperature(°C):23 Humidity(%):65

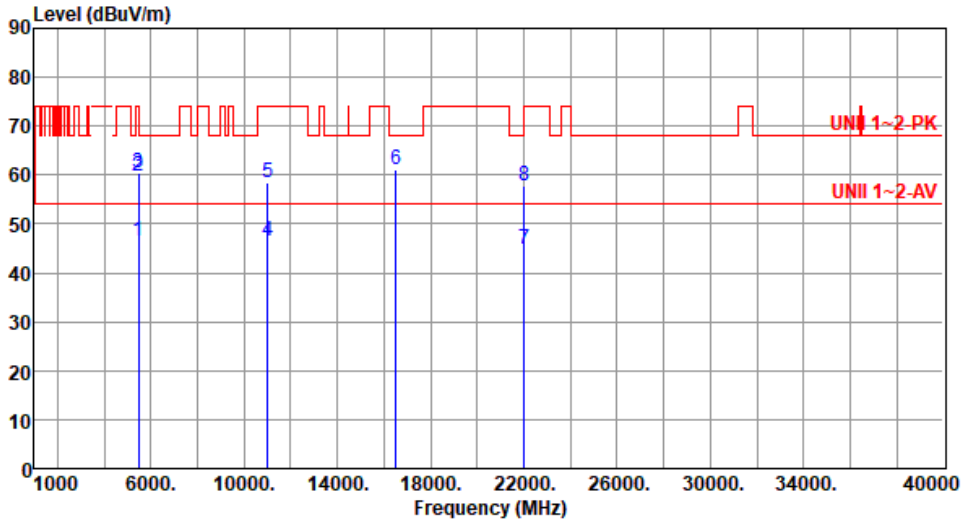

	Freq. MHz	Emission level dBuV/m	Limit dBuV/m	Margin dB	SA reading dBuV	Factor dB/m	Remark	ANT High cm	Turn Table deg
1	5460.00	46.47	54.00	-7.53	40.17	6.30	Average	301	165
2	5460.00	59.65	74.00	-14.35	53.35	6.30	Peak	301	165
3	5470.00	60.34	68.20	-7.86	54.02	6.32	Peak	301	165
4	11000.00	46.53	54.00	-7.47	30.88	15.65	Average	315	183
5	11000.00	58.61	74.00	-15.39	42.96	15.65	Peak	315	183
6	16500.00	61.26	68.20	-6.94	43.80	17.46	Peak	296	160
7	22000.00	44.87	54.00	-9.13	37.22	7.65	Average	281	125
8	22000.00	57.94	68.20	-10.26	50.29	7.65	Peak	281	125

Note 1: Emission Level (dBuV/m) = SA Reading (dBuV) + Factor* (dB/m)

*Factor includes antenna factor , cable loss and amplifier gain

Note 2: Margin (dB) = Emission level (dBuV/m) – Limit (dBuV/m).



Modulation	ax HE20-OFDMA	Test Freq. (MHz)	5580
Polarization	Horizontal		

Test By :Brad Wu Temperature(°C):23 Humidity(%):65

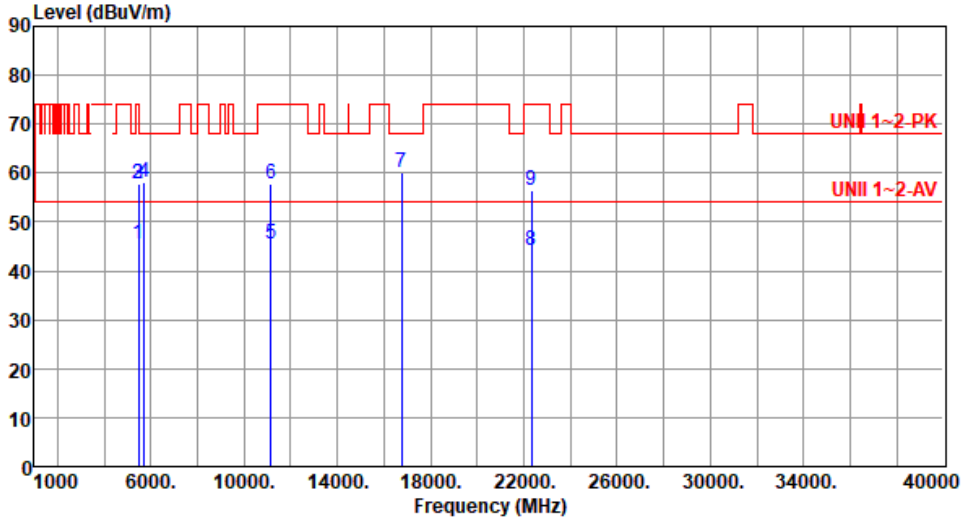

	Freq. MHz	Emission level dBuV/m	Limit dBuV/m	Margin dB	SA reading dBuV	Factor dB/m	Remark	ANT High cm	Turn Table deg
1	5460.00	45.52	54.00	-8.48	39.22	6.30	Average	311	145
2	5460.00	57.62	74.00	-16.38	51.32	6.30	Peak	311	145
3	5470.00	57.91	68.20	-10.29	51.59	6.32	Peak	311	145
4	5725.00	57.96	68.20	-10.24	51.37	6.59	Peak	311	145
5	11160.00	45.49	54.00	-8.51	30.34	15.15	Average	100	256
6	11160.00	57.62	74.00	-16.38	42.47	15.15	Peak	100	256
7	16740.00	60.25	68.20	-7.95	42.55	17.70	Peak	100	214
8	22320.00	44.31	54.00	-9.69	35.96	8.35	Average	311	182
9	22320.00	56.48	74.00	-17.52	48.13	8.35	Peak	311	182

Note 1: Emission Level (dBuV/m) = SA Reading (dBuV) + Factor* (dB/m)

*Factor includes antenna factor , cable loss and amplifier gain

Note 2: Margin (dB) = Emission level (dBuV/m) – Limit (dBuV/m).



Modulation	ax HE20-OFDMA	Test Freq. (MHz)	5580
Polarization	Vertical		

Test By :Brad Wu Temperature(°C):23 Humidity(%):65

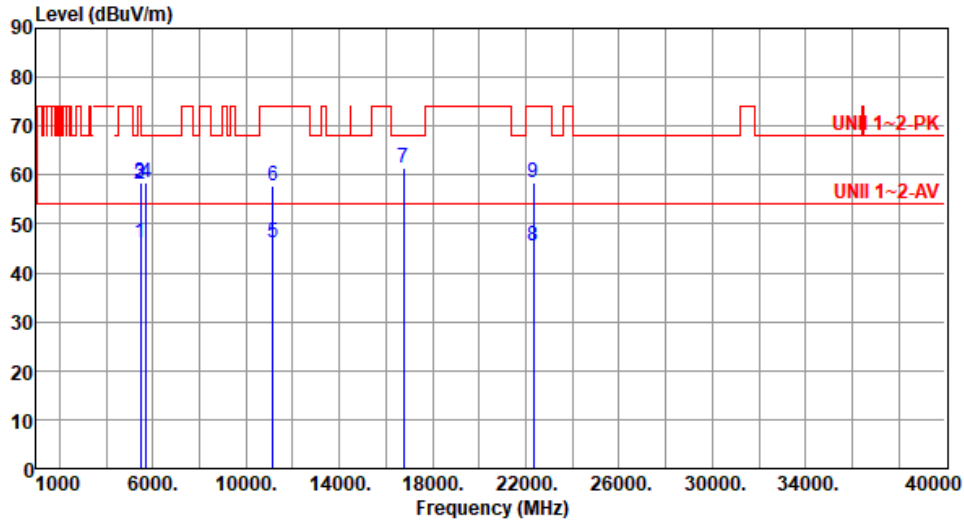

	Freq. MHz	Emission level dBuV/m	Limit dBuV/m	Margin dB	SA reading dBuV	Factor dB/m	Remark	ANT High cm	Turn Table deg
1	5460.00	46.14	54.00	-7.86	39.84	6.30	Average	291	161
2	5460.00	58.02	74.00	-15.98	51.72	6.30	Peak	291	161
3	5470.00	58.29	68.20	-9.91	51.97	6.32	Peak	291	161
4	5725.00	58.46	68.20	-9.74	51.87	6.59	Peak	291	161
5	11160.00	46.13	54.00	-7.87	30.98	15.15	Average	312	179
6	11160.00	57.92	74.00	-16.08	42.77	15.15	Peak	312	179
7	16740.00	61.49	68.20	-6.71	43.79	17.70	Peak	291	158
8	22320.00	45.49	54.00	-8.51	37.14	8.35	Average	275	122
9	22320.00	58.44	74.00	-15.56	50.09	8.35	Peak	275	122

Note 1: Emission Level (dBuV/m) = SA Reading (dBuV) + Factor* (dB/m)

*Factor includes antenna factor , cable loss and amplifier gain

Note 2: Margin (dB) = Emission level (dBuV/m) – Limit (dBuV/m).



Modulation	ax HE20-OFDMA	Test Freq. (MHz)	5700
Polarization	Horizontal		

Test By :Brad Wu Temperature(°C):23 Humidity(%):65

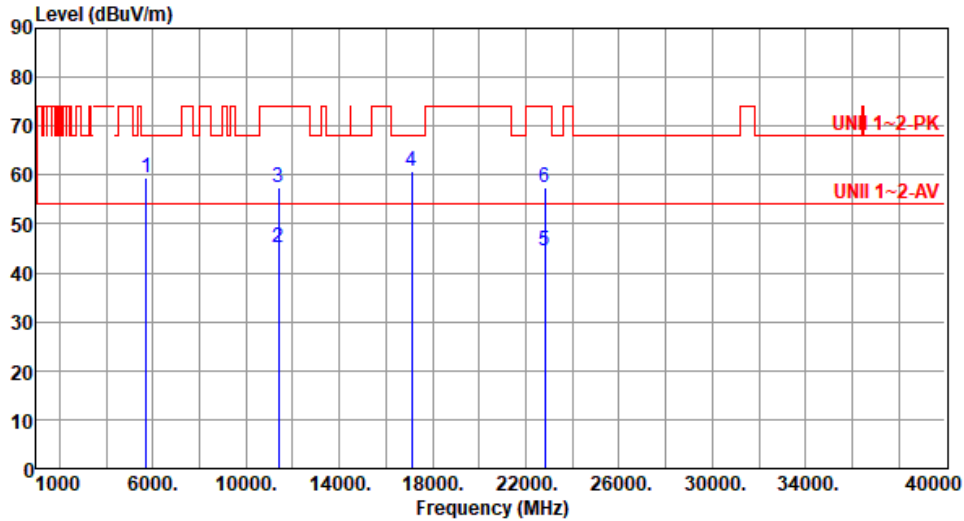

	Freq. MHz	Emission level dBuV/m	Limit dBuV/m	Margin dB	SA reading dBuV	Factor dB/m	Remark	ANT High cm	Turn Table deg
1	5725.00	59.48	68.20	-8.72	52.89	6.59	Peak	318	153
2	11400.00	45.30	54.00	-8.70	30.15	15.15	Average	100	224
3	11400.00	57.57	74.00	-16.43	42.42	15.15	Peak	100	224
4	17100.00	60.65	68.20	-7.55	42.50	18.15	Peak	100	229
5	22800.00	44.58	54.00	-9.42	35.15	9.43	Average	317	184
6	22800.00	57.58	74.00	-16.42	48.15	9.43	Peak	317	184

Note 1: Emission Level (dBuV/m) = SA Reading (dBuV) + Factor* (dB/m)

*Factor includes antenna factor , cable loss and amplifier gain

Note 2: Margin (dB) = Emission level (dBuV/m) – Limit (dBuV/m).



Modulation	ax HE20-OFDMA	Test Freq. (MHz)	5700
Polarization	Vertical		

Test By :Brad Wu Temperature(°C):23 Humidity(%):65

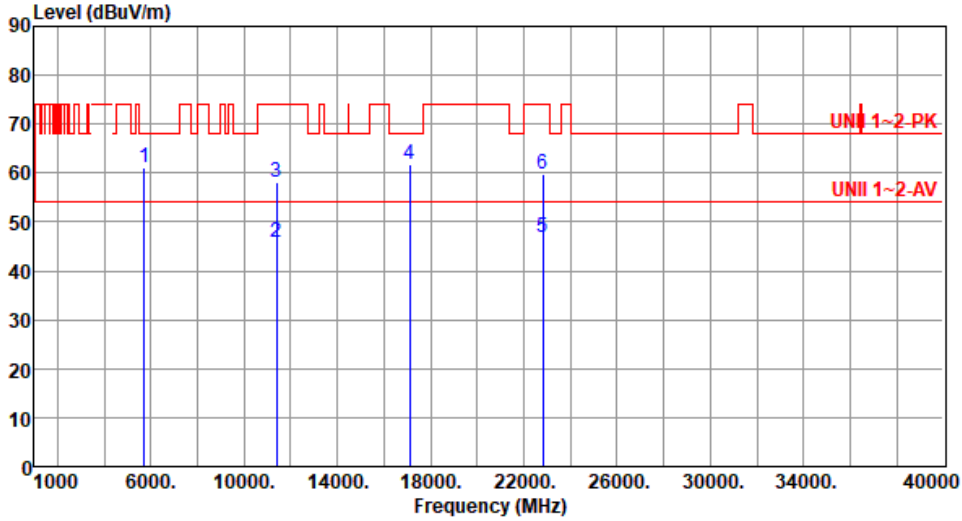

	Freq. MHz	Emission level dBuV/m	Limit dBuV/m	Margin dB	SA reading dBuV	Factor dB/m	Remark	ANT High cm	Turn Table deg
1	5725.00	61.12	68.20	-7.08	54.53	6.59	Peak	309	162
2	11400.00	45.91	54.00	-8.09	30.76	15.15	Average	310	186
3	11400.00	58.04	74.00	-15.96	42.89	15.15	Peak	310	186
4	17100.00	61.80	68.20	-6.40	43.65	18.15	Peak	295	155
5	22800.00	46.82	54.00	-7.18	37.39	9.43	Average	283	124
6	22800.00	59.63	74.00	-14.37	50.20	9.43	Peak	283	124

Note 1: Emission Level (dBuV/m) = SA Reading (dBuV) + Factor* (dB/m)

*Factor includes antenna factor , cable loss and amplifier gain

Note 2: Margin (dB) = Emission level (dBuV/m) – Limit (dBuV/m).



Modulation	ax HE20-OFDMA	Test Freq. (MHz)	5720
Polarization	Horizontal		

Test By :Akun Chung Temperature(°C):24 Humidity(%):66

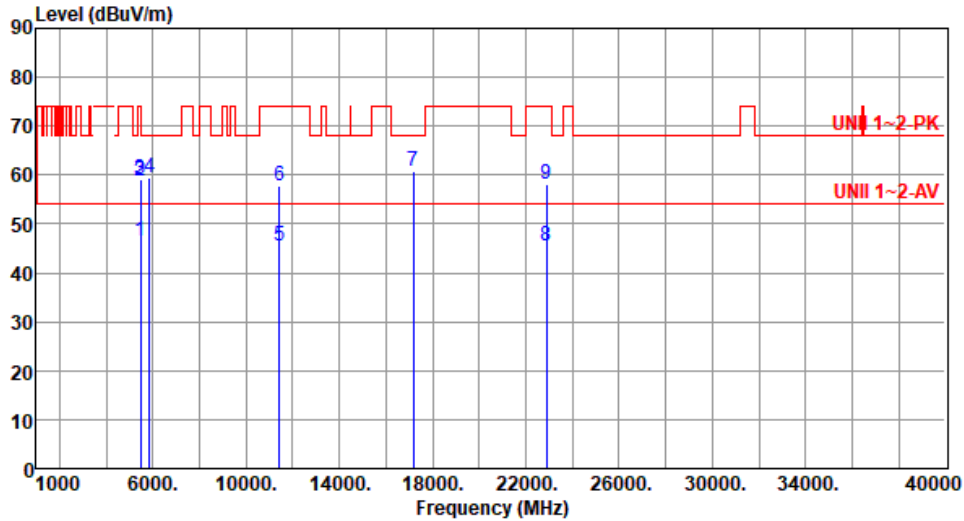

	Freq. MHz	Emission level dBuV/m	Limit dBuV/m	Margin dB	SA reading dBuV	Factor dB/m	Remark	ANT High cm	Turn Table deg
1	5460.00	46.49	54.00	-7.51	40.19	6.30	Average	311	141
2	5460.00	58.75	74.00	-15.25	52.45	6.30	Peak	311	141
3	5470.00	59.17	68.20	-9.03	52.85	6.32	Peak	311	141
4	5850.00	59.36	68.20	-8.84	52.59	6.77	Peak	311	141
5	11440.00	45.60	54.00	-8.40	30.35	15.25	Average	100	257
6	11440.00	57.73	74.00	-16.27	42.48	15.25	Peak	100	257
7	17160.00	60.79	68.20	-7.41	42.64	18.15	Peak	100	223
8	22880.00	45.34	54.00	-8.66	35.82	9.52	Average	306	186
9	22880.00	58.04	74.00	-15.96	48.52	9.52	Peak	306	186

Note 1: Emission Level (dBuV/m) = SA Reading (dBuV) + Factor* (dB/m)

*Factor includes antenna factor , cable loss and amplifier gain

Note 2: Margin (dB) = Emission level (dBuV/m) – Limit (dBuV/m).



Modulation	ax HE20-OFDMA	Test Freq. (MHz)	5720
Polarization	Vertical		

Test By :Akun Chung Temperature(°C):24 Humidity(%):66

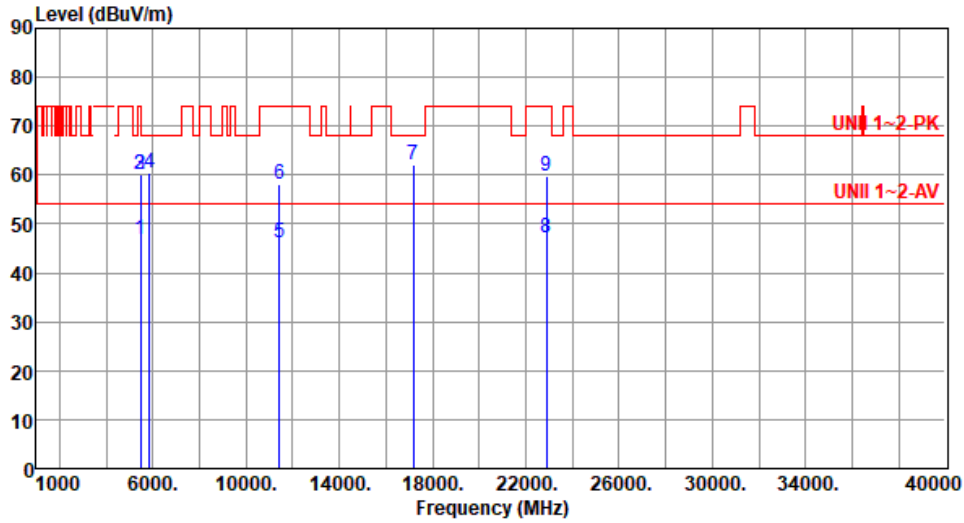

	Freq. MHz	Emission level dBuV/m	Limit dBuV/m	Margin dB	SA reading dBuV	Factor dB/m	Remark	ANT High cm	Turn Table deg
1	5460.00	46.96	54.00	-7.04	40.66	6.30	Average	300	165
2	5460.00	59.98	74.00	-14.02	53.68	6.30	Peak	300	165
3	5470.00	60.02	68.20	-8.18	53.70	6.32	Peak	300	165
4	5850.00	60.52	68.20	-7.68	53.75	6.77	Peak	300	165
5	11440.00	46.08	54.00	-7.92	30.83	15.25	Average	311	174
6	11440.00	58.10	74.00	-15.90	42.85	15.25	Peak	311	174
7	17160.00	62.03	68.20	-6.17	43.88	18.15	Peak	295	163
8	22880.00	47.04	54.00	-6.96	37.52	9.52	Average	283	125
9	22880.00	59.78	74.00	-14.22	50.26	9.52	Peak	283	125

Note 1: Emission Level (dBuV/m) = SA Reading (dBuV) + Factor* (dB/m)

*Factor includes antenna factor , cable loss and amplifier gain

Note 2: Margin (dB) = Emission level (dBuV/m) – Limit (dBuV/m).



Modulation	ax HE20-OFDMA	Test Freq. (MHz)	5745
Polarization	Horizontal		

Test By :Brad Wu Temperature(°C):23 Humidity(%):65

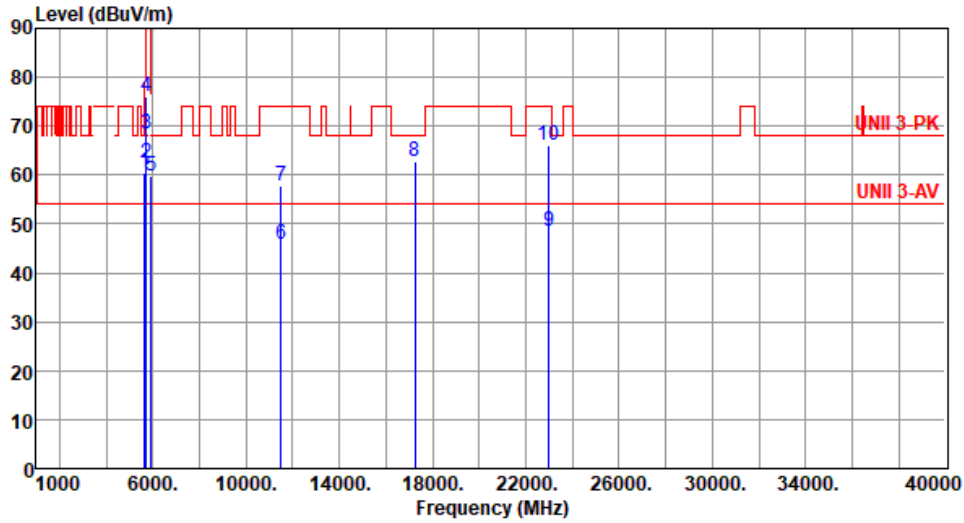

	Freq. MHz	Emission level dBuV/m	Limit dBuV/m	Margin dB	SA reading dBuV	Factor dB/m	Remark	ANT High cm	Turn Table deg
1	5650.00	60.28	68.20	-7.92	53.96	6.32	Peak	308	291
2	5700.00	62.40	105.20	-42.80	55.87	6.53	Peak	308	291
3	5720.00	68.46	110.80	-42.34	61.88	6.58	Peak	308	291
4	5725.00	76.17	122.20	-46.03	69.58	6.59	Peak	308	291
5	5925.00	59.80	68.20	-8.40	52.77	7.03	Peak	308	291
6	11490.00	45.82	54.00	-8.18	30.44	15.38	Average	100	247
7	11490.00	57.84	74.00	-16.16	42.46	15.38	Peak	100	247
8	17235.00	62.80	68.20	-5.40	44.54	18.26	Peak	111	202
9	22980.00	48.44	54.00	-5.56	38.82	9.62	Average	305	157
10	22980.00	66.20	74.00	-7.80	56.58	9.62	Peak	305	157

Note 1: Emission Level (dBuV/m) = SA Reading (dBuV) + Factor* (dB/m)

*Factor includes antenna factor , cable loss and amplifier gain

Note 2: Margin (dB) = Emission level (dBuV/m) – Limit (dBuV/m).



Modulation	ax HE20-OFDMA	Test Freq. (MHz)	5745
Polarization	Vertical		

Test By :Brad Wu Temperature(°C):23 Humidity(%):65

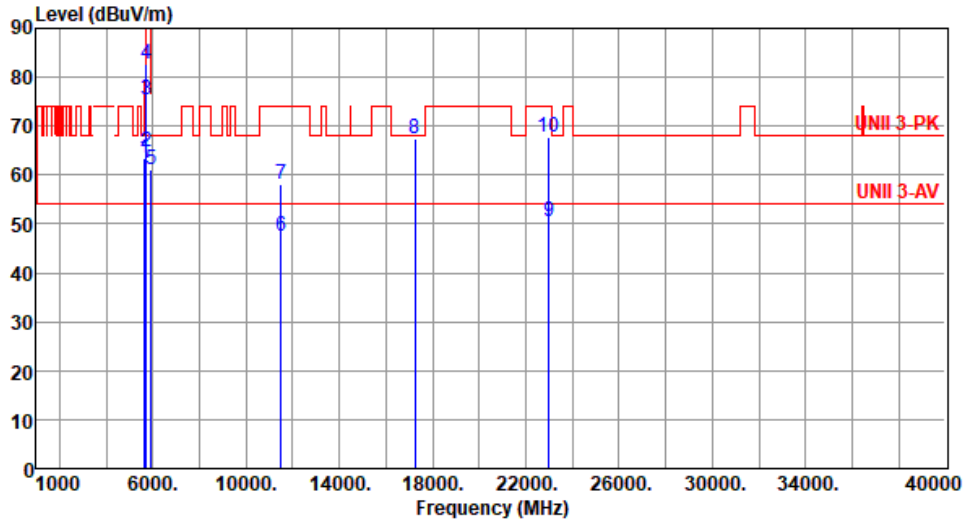

	Freq. MHz	Emission level dBuV/m	Limit dBuV/m	Margin dB	SA reading dBuV	Factor dB/m	Remark	ANT High cm	Turn Table deg
1	5650.00	63.46	68.20	-4.74	57.14	6.32	Peak	289	161
2	5700.00	64.78	105.20	-40.42	58.25	6.53	Peak	289	161
3	5720.00	75.39	110.80	-35.41	68.81	6.58	Peak	289	161
4	5725.00	82.61	122.20	-39.59	76.02	6.59	Peak	289	161
5	5925.00	60.94	68.20	-7.26	53.91	7.03	Peak	289	161
6	11490.00	47.61	54.00	-6.39	32.23	15.38	Average	311	162
7	11490.00	58.25	74.00	-15.75	42.87	15.38	Peak	311	162
8	17235.00	67.45	68.20	-0.75	49.19	18.26	Peak	308	153
9	22980.00	50.55	54.00	-3.45	40.93	9.62	Average	318	176
10	22980.00	67.74	74.00	-6.26	58.12	9.62	Peak	318	176

Note 1: Emission Level (dBuV/m) = SA Reading (dBuV) + Factor* (dB/m)

*Factor includes antenna factor , cable loss and amplifier gain

Note 2: Margin (dB) = Emission level (dBuV/m) – Limit (dBuV/m).



Modulation	ax HE20-OFDMA	Test Freq. (MHz)	5785
Polarization	Horizontal		

Test By :Brad Wu Temperature(°C):23 Humidity(%):65

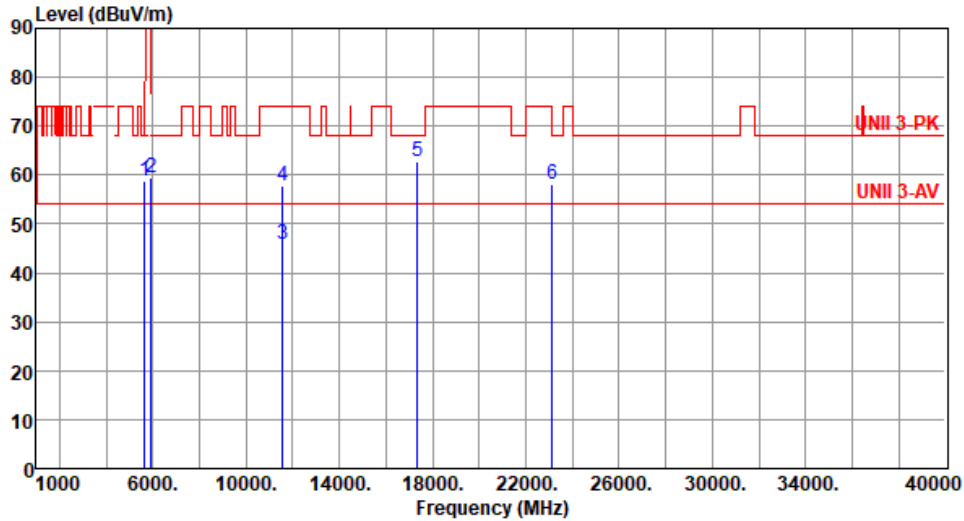

	Freq. MHz	Emission level dBuV/m	Limit dBuV/m	Margin dB	SA reading dBuV	Factor dB/m	Remark	ANT High cm	Turn Table deg
1	5650.00	58.92	68.20	-9.28	52.60	6.32	Peak	321	292
2	5925.00	59.58	68.20	-8.62	52.55	7.03	Peak	321	292
3	11570.00	45.89	54.00	-8.11	30.51	15.38	Average	100	245
4	11570.00	57.91	74.00	-16.09	42.53	15.38	Peak	100	245
5	17355.00	62.63	68.20	-5.57	43.65	18.98	Peak	110	205
6	23140.00	58.25	68.20	-9.95	48.58	9.67	Peak	300	162

Note 1: Emission Level (dBuV/m) = SA Reading (dBuV) + Factor* (dB/m)

*Factor includes antenna factor , cable loss and amplifier gain

Note 2: Margin (dB) = Emission level (dBuV/m) – Limit (dBuV/m).



Modulation	ax HE20-OFDMA	Test Freq. (MHz)	5785
Polarization	Vertical		

Test By :Brad Wu Temperature(°C):23 Humidity(%):65

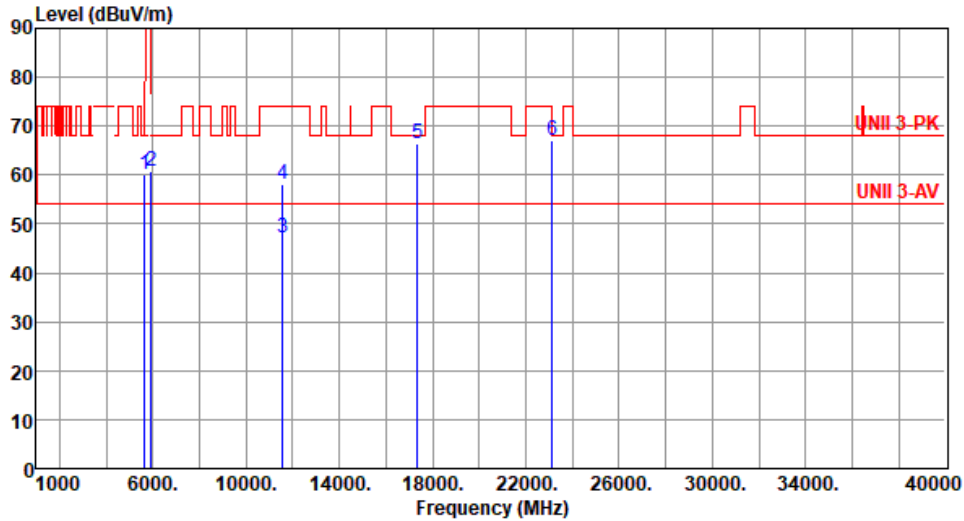

	Freq. MHz	Emission level dBuV/m	Limit dBuV/m	Margin dB	SA reading dBuV	Factor dB/m	Remark	ANT High cm	Turn Table deg
1	5650.00	60.14	68.20	-8.06	53.82	6.32	Peak	301	161
2	5925.00	60.91	68.20	-7.29	53.88	7.03	Peak	301	161
3	11570.00	47.26	54.00	-6.74	31.88	15.38	Average	311	165
4	11570.00	58.14	74.00	-15.86	42.76	15.38	Peak	311	165
5	17355.00	66.41	68.20	-1.79	47.43	18.98	Peak	305	152
6	23140.00	67.12	68.20	-1.08	57.45	9.67	Peak	322	177

Note 1: Emission Level (dBuV/m) = SA Reading (dBuV) + Factor* (dB/m)

*Factor includes antenna factor , cable loss and amplifier gain

Note 2: Margin (dB) = Emission level (dBuV/m) – Limit (dBuV/m).



Modulation	ax HE20-OFDMA	Test Freq. (MHz)	5825
Polarization	Horizontal		

Test By :Brad Wu Temperature(°C):23 Humidity(%):65

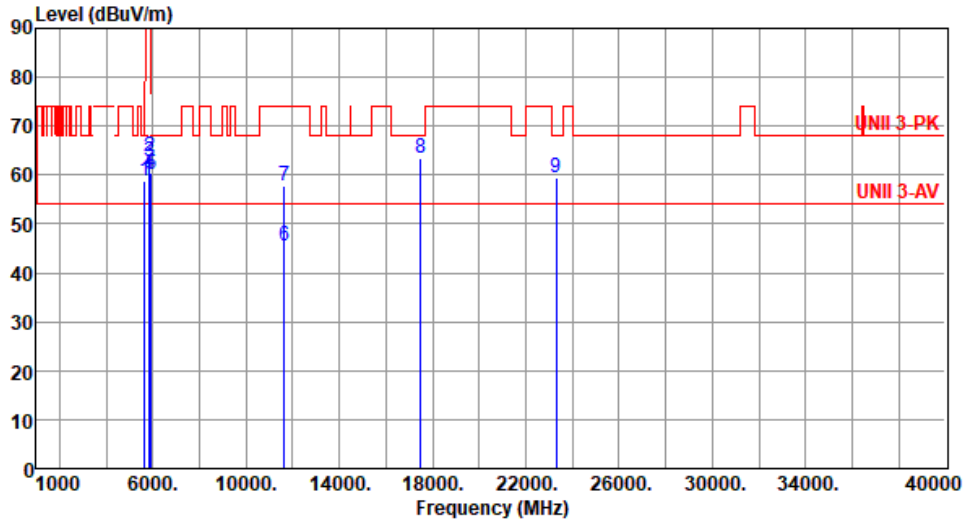

	Freq. MHz	Emission level dBuV/m	Limit dBuV/m	Margin dB	SA reading dBuV	Factor dB/m	Remark	ANT High cm	Turn Table deg
1	5650.00	58.94	68.20	-9.26	52.62	6.32	Peak	312	287
2	5850.00	63.62	122.20	-58.58	56.85	6.77	Peak	312	287
3	5855.00	62.62	110.80	-48.18	55.82	6.80	Peak	312	287
4	5875.00	60.51	105.20	-44.69	53.63	6.88	Peak	312	287
5	5925.00	59.98	68.20	-8.22	52.95	7.03	Peak	312	287
6	11650.00	45.65	54.00	-8.35	30.48	15.17	Average	100	239
7	11650.00	57.67	74.00	-16.33	42.50	15.17	Peak	100	239
8	17475.00	63.58	68.20	-4.62	43.77	19.81	Peak	106	199
9	23300.00	59.51	68.20	-8.69	49.85	9.66	Peak	303	163

Note 1: Emission Level (dBuV/m) = SA Reading (dBuV) + Factor* (dB/m)

*Factor includes antenna factor , cable loss and amplifier gain

Note 2: Margin (dB) = Emission level (dBuV/m) – Limit (dBuV/m).



Modulation	ax HE20-OFDMA	Test Freq. (MHz)	5825						
Polarization	Vertical								
Test By : Brad Wu		Temperature(°C): 23		Humidity(%): 65					
<p>The spectrum plot displays the emission level in dBuV/m across a frequency range from 1000 to 40000 MHz. A red line represents the emission level, showing several peaks. A horizontal red line at approximately 55 dBuV/m is labeled 'UNII 3-AV'. A horizontal red line at approximately 70 dBuV/m is labeled 'UNII 3-PK'. Blue vertical lines with numbers 1 through 9 indicate specific measurement points. The x-axis is labeled 'Frequency (MHz)' and the y-axis is labeled 'Level (dBuV/m)'.</p>									
	Freq. MHz	Emission level dBuV/m	Limit dBuV/m	Margin dB	SA reading dBuV	Factor dB/m	Remark	ANT High cm	Turn Table deg
1	5650.00	60.46	68.20	-7.74	54.14	6.32	Peak	306	163
2	5850.00	66.47	122.20	-55.73	59.70	6.77	Peak	306	163
3	5855.00	65.21	110.80	-45.59	58.41	6.80	Peak	306	163
4	5875.00	62.53	105.20	-42.67	55.65	6.88	Peak	306	163
5	5925.00	61.06	68.20	-7.14	54.03	7.03	Peak	306	163
6	11650.00	46.58	54.00	-7.42	31.41	15.17	Average	325	181
7	11650.00	57.14	74.00	-16.86	41.97	15.17	Peak	325	181
8	17475.00	65.44	68.20	-2.76	45.63	19.81	Peak	285	152
9	23300.00	67.41	68.20	-0.79	57.75	9.66	Peak	316	176
<p>Note 1: Emission Level (dBuV/m) = SA Reading (dBuV) + Factor* (dB/m) *Factor includes antenna factor , cable loss and amplifier gain Note 2: Margin (dB) = Emission level (dBuV/m) – Limit (dBuV/m).</p>									



Unwanted Emissions (Above 1GHz) for ax HE40-OFDMA

Modulation	ax HE40-OFDMA	Test Freq. (MHz)	5190						
Polarization	Horizontal								
Test By :Brad Wu Temperature(°C):23 Humidity(%):65									
	Freq. MHz	Emission level dBuV/m	Limit dBuV/m	Margin dB	SA reading dBuV	Factor dB/m	Remark	ANT High cm	Turn Table deg
1	5040.00	49.79	54.00	-4.21	43.53	6.26	Average	315	144
2	5040.00	61.14	74.00	-12.86	54.88	6.26	Peak	315	144
3	5150.00	48.89	54.00	-5.11	42.58	6.31	Average	315	144
4	5150.00	63.16	74.00	-10.84	56.85	6.31	Peak	315	144
5	15570.00	47.42	54.00	-6.58	31.25	16.17	Average	100	189
6	15570.00	59.12	74.00	-14.88	42.95	16.17	Peak	100	189
7	20760.00	44.16	54.00	-9.84	37.76	6.40	Average	305	206
8	20760.00	58.16	74.00	-15.84	51.76	6.40	Peak	305	206

Note 1: Emission Level (dBuV/m) = SA Reading (dBuV) + Factor* (dB/m)
 *Factor includes antenna factor , cable loss and amplifier gain
 Note 2: Margin (dB) = Emission level (dBuV/m) – Limit (dBuV/m).



Modulation	ax HE40-OFDMA	Test Freq. (MHz)	5190
Polarization	Vertical		

Test By :Brad Wu Temperature(°C):23 Humidity(%):65

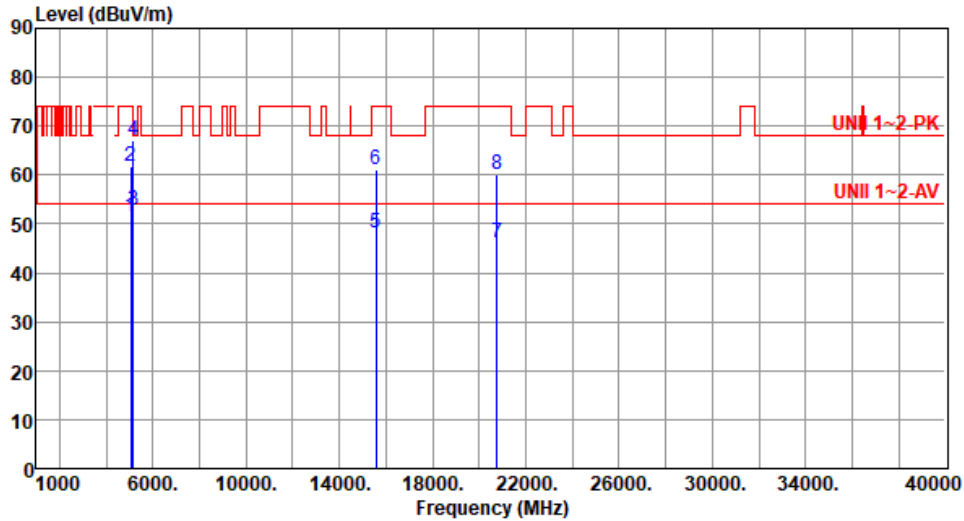

	Freq. MHz	Emission level dBuV/m	Limit dBuV/m	Margin dB	SA reading dBuV	Factor dB/m	Remark	ANT High cm	Turn Table deg
1	5040.00	51.63	54.00	-2.37	45.37	6.26	Average	302	179
2	5040.00	61.81	74.00	-12.19	55.55	6.26	Peak	302	179
3	5150.00	52.72	54.00	-1.28	46.41	6.31	Average	304	180
4	5150.00	67.22	74.00	-6.78	60.91	6.31	Peak	304	180
5	15570.00	48.12	54.00	-5.88	31.95	16.17	Average	305	154
6	15570.00	61.05	74.00	-12.95	44.88	16.17	Peak	305	154
7	20760.00	46.29	54.00	-7.71	39.89	6.40	Average	315	170
8	20760.00	59.99	74.00	-14.01	53.59	6.40	Peak	315	170

Note 1: Emission Level (dBuV/m) = SA Reading (dBuV) + Factor* (dB/m)

*Factor includes antenna factor , cable loss and amplifier gain

Note 2: Margin (dB) = Emission level (dBuV/m) – Limit (dBuV/m).



Modulation	ax HE40-OFDMA	Test Freq. (MHz)	5230
Polarization	Horizontal		

Test By :Brad Wu Temperature(°C):23 Humidity(%):65

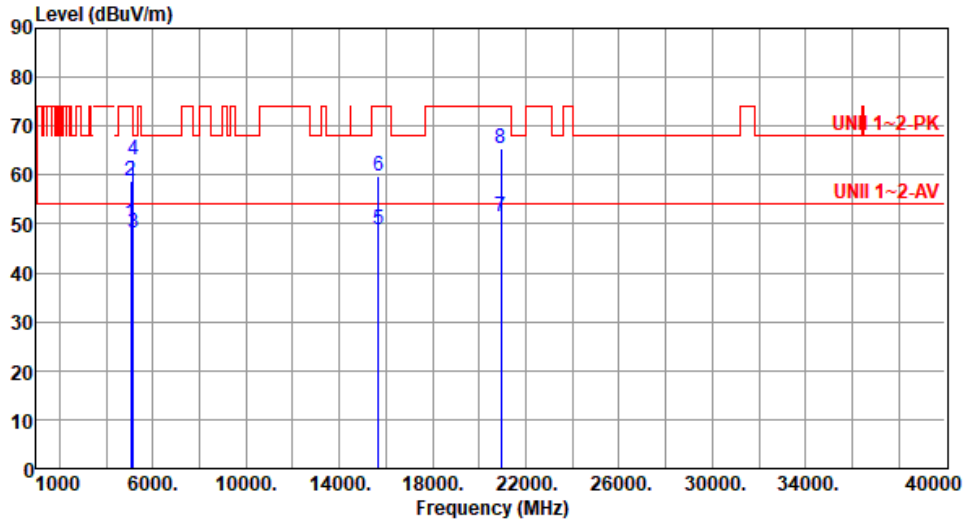

	Freq. MHz	Emission level dBuV/m	Limit dBuV/m	Margin dB	SA reading dBuV	Factor dB/m	Remark	ANT High cm	Turn Table deg
1	5040.00	50.22	54.00	-3.78	43.96	6.26	Average	314	139
2	5040.00	58.68	74.00	-15.32	52.42	6.26	Peak	314	139
3	5150.00	48.18	54.00	-5.82	41.87	6.31	Average	314	139
4	5150.00	63.26	74.00	-10.74	56.95	6.31	Peak	314	139
5	15690.00	48.83	54.00	-5.17	32.85	15.98	Average	100	209
6	15690.00	59.86	74.00	-14.14	43.88	15.98	Peak	100	209
7	20920.00	51.36	54.00	-2.64	44.72	6.64	Average	305	207
8	20920.00	65.39	74.00	-8.61	58.75	6.64	Peak	305	207

Note 1: Emission Level (dBuV/m) = SA Reading (dBuV) + Factor* (dB/m)

*Factor includes antenna factor , cable loss and amplifier gain

Note 2: Margin (dB) = Emission level (dBuV/m) – Limit (dBuV/m).



Modulation	ax HE40-OFDMA	Test Freq. (MHz)	5230
Polarization	Vertical		

Test By :Brad Wu Temperature(°C):23 Humidity(%):65

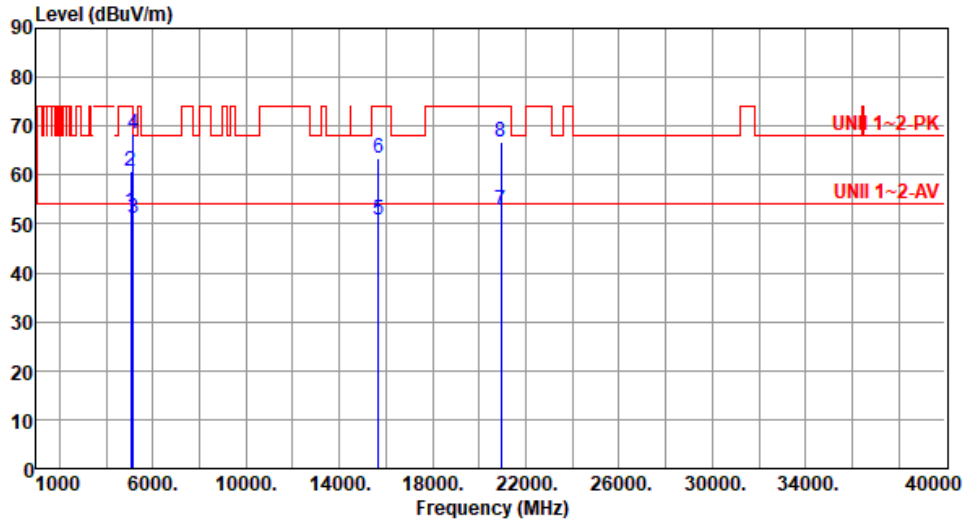

	Freq. MHz	Emission level dBuV/m	Limit dBuV/m	Margin dB	SA reading dBuV	Factor dB/m	Remark	ANT High cm	Turn Table deg
1	5040.00	52.32	54.00	-1.68	46.06	6.26	Average	301	178
2	5040.00	60.76	74.00	-13.24	54.50	6.26	Peak	301	178
3	5150.00	51.03	54.00	-2.97	44.72	6.31	Average	306	181
4	5150.00	68.39	74.00	-5.61	62.08	6.31	Peak	306	181
5	15690.00	50.93	54.00	-3.07	34.95	15.98	Average	296	157
6	15690.00	63.50	74.00	-10.50	47.52	15.98	Peak	296	157
7	20920.00	52.79	54.00	-1.21	46.15	6.64	Average	322	169
8	20920.00	66.71	74.00	-7.29	60.07	6.64	Peak	322	169

Note 1: Emission Level (dBuV/m) = SA Reading (dBuV) + Factor* (dB/m)

*Factor includes antenna factor , cable loss and amplifier gain

Note 2: Margin (dB) = Emission level (dBuV/m) – Limit (dBuV/m).



Modulation	ax HE40-OFDMA	Test Freq. (MHz)	5270
Polarization	Horizontal		

Test By : Akun Chung Temperature(°C): 24 Humidity(%): 66

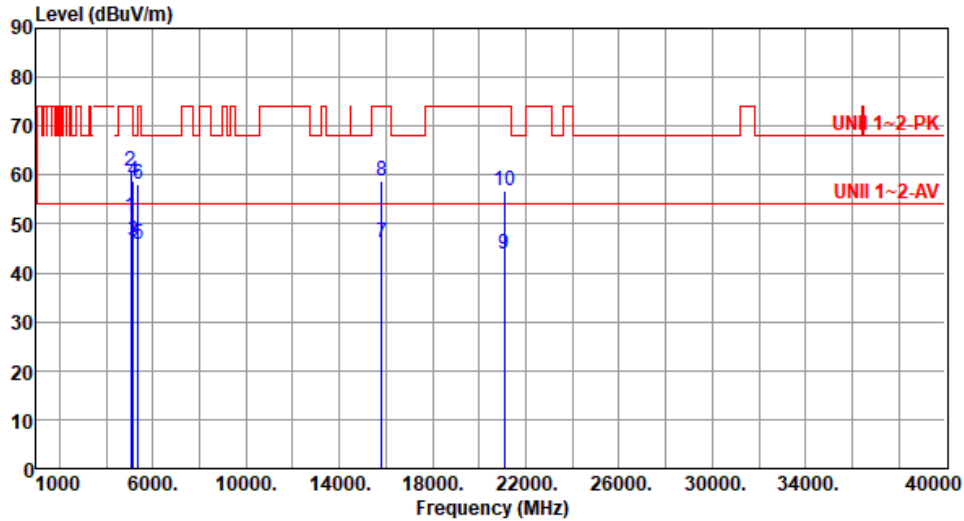

	Freq. MHz	Emission level dBuV/m	Limit dBuV/m	Margin dB	SA reading dBuV	Factor dB/m	Remark	ANT High cm	Turn Table deg
1	5040.00	51.55	54.00	-2.45	45.29	6.26	Average	318	136
2	5040.00	60.74	74.00	-13.26	54.48	6.26	Peak	318	136
3	5150.00	46.56	54.00	-7.44	40.25	6.31	Average	318	136
4	5150.00	58.76	74.00	-15.24	52.45	6.31	Peak	318	136
5	5350.00	45.97	54.00	-8.03	40.25	5.72	Average	318	136
6	5350.00	58.22	74.00	-15.78	52.50	5.72	Peak	318	136
7	15810.00	46.27	54.00	-7.73	30.47	15.80	Average	100	202
8	15810.00	58.67	74.00	-15.33	42.87	15.80	Peak	100	202
9	21080.00	43.78	54.00	-10.22	36.85	6.93	Average	310	210
10	21080.00	56.80	74.00	-17.20	49.87	6.93	Peak	310	210

Note 1: Emission Level (dBuV/m) = SA Reading (dBuV) + Factor* (dB/m)

*Factor includes antenna factor , cable loss and amplifier gain

Note 2: Margin (dB) = Emission level (dBuV/m) – Limit (dBuV/m).



Modulation	ax HE40-OFDMA	Test Freq. (MHz)	5270
Polarization	Vertical		

Test By :Akun Chung Temperature(°C):24 Humidity(%):66

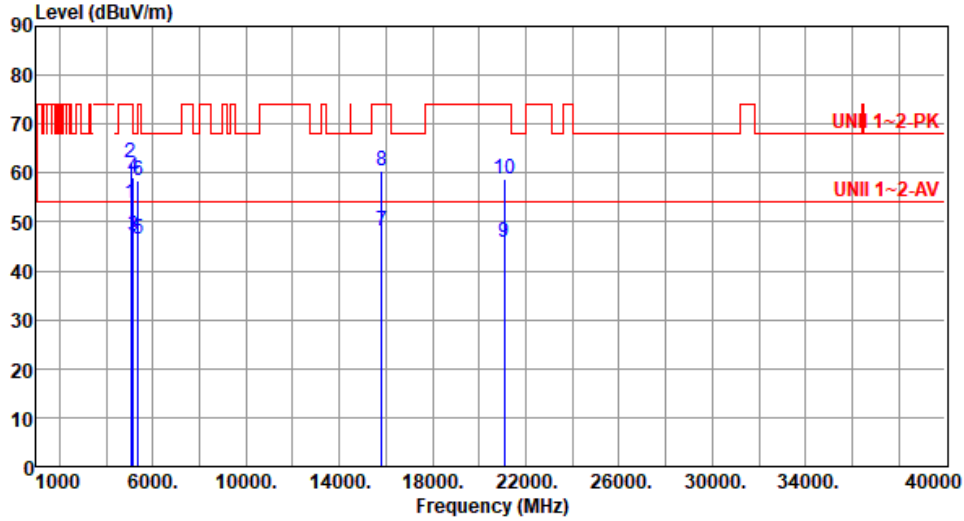

	Freq. MHz	Emission level dBuV/m	Limit dBuV/m	Margin dB	SA reading dBuV	Factor dB/m	Remark	ANT High cm	Turn Table deg
1	5040.00	53.64	54.00	-0.36	47.38	6.26	Average	307	173
2	5040.00	61.95	74.00	-12.05	55.69	6.26	Peak	307	173
3	5150.00	47.09	54.00	-6.91	40.78	6.31	Average	284	179
4	5150.00	59.05	74.00	-14.95	52.74	6.31	Peak	284	179
5	5350.00	46.44	54.00	-7.56	40.72	5.72	Average	284	179
6	5350.00	58.59	74.00	-15.41	52.87	5.72	Peak	284	179
7	15810.00	48.22	54.00	-5.78	32.42	15.80	Average	322	144
8	15810.00	60.45	74.00	-13.55	44.65	15.80	Peak	322	144
9	21080.00	45.89	54.00	-8.11	38.96	6.93	Average	295	122
10	21080.00	58.78	74.00	-15.22	51.85	6.93	Peak	295	122

Note 1: Emission Level (dBuV/m) = SA Reading (dBuV) + Factor* (dB/m)

*Factor includes antenna factor , cable loss and amplifier gain

Note 2: Margin (dB) = Emission level (dBuV/m) – Limit (dBuV/m).



Modulation	ax HE40-OFDMA	Test Freq. (MHz)	5310
Polarization	Horizontal		

Test By :Brad Wu Temperature(°C):23 Humidity(%):65

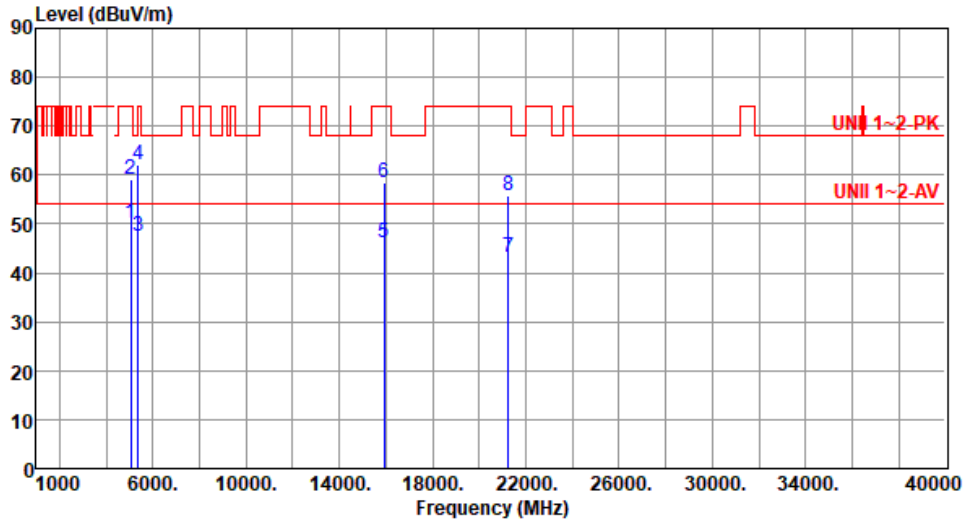

	Freq. MHz	Emission level dBuV/m	Limit dBuV/m	Margin dB	SA reading dBuV	Factor dB/m	Remark	ANT High cm	Turn Table deg
1	5040.00	50.04	54.00	-3.96	43.78	6.26	Average	296	135
2	5040.00	59.15	74.00	-14.85	52.89	6.26	Peak	296	135
3	5350.00	47.50	54.00	-6.50	41.78	5.72	Average	296	135
4	5350.00	62.24	74.00	-11.76	56.52	5.72	Peak	296	135
5	15930.00	46.06	54.00	-7.94	30.44	15.62	Average	100	230
6	15930.00	58.35	74.00	-15.65	42.73	15.62	Peak	100	230
7	21240.00	43.20	54.00	-10.80	35.95	7.25	Average	307	207
8	21240.00	55.83	74.00	-18.17	48.58	7.25	Peak	307	207

Note 1: Emission Level (dBuV/m) = SA Reading (dBuV) + Factor* (dB/m)

*Factor includes antenna factor , cable loss and amplifier gain

Note 2: Margin (dB) = Emission level (dBuV/m) – Limit (dBuV/m).



Modulation	ax HE40-OFDMA	Test Freq. (MHz)	5310
Polarization	Vertical		

Test By :Brad Wu Temperature(°C):23 Humidity(%):65

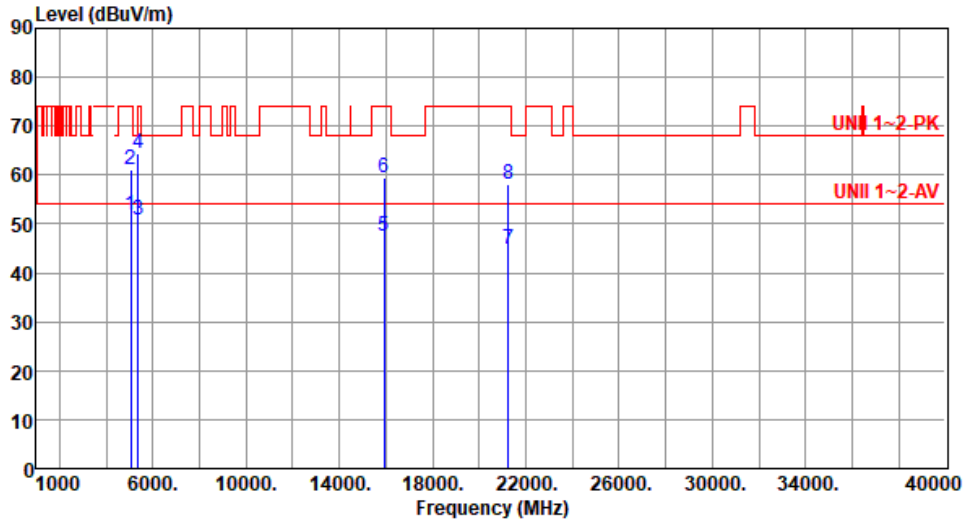

	Freq. MHz	Emission level dBuV/m	Limit dBuV/m	Margin dB	SA reading dBuV	Factor dB/m	Remark	ANT High cm	Turn Table deg
1	5040.00	51.89	54.00	-2.11	45.63	6.26	Average	302	178
2	5040.00	61.03	74.00	-12.97	54.77	6.26	Peak	302	178
3	5350.00	50.84	54.00	-3.16	45.12	5.72	Average	266	158
4	5350.00	64.40	74.00	-9.60	58.68	5.72	Peak	266	158
5	15930.00	47.57	54.00	-6.43	31.95	15.62	Average	315	142
6	15930.00	59.30	74.00	-14.70	43.68	15.62	Peak	315	142
7	21240.00	44.83	54.00	-9.17	37.58	7.25	Average	299	121
8	21240.00	57.99	74.00	-16.01	50.74	7.25	Peak	299	121

Note 1: Emission Level (dBuV/m) = SA Reading (dBuV) + Factor* (dB/m)

*Factor includes antenna factor , cable loss and amplifier gain

Note 2: Margin (dB) = Emission level (dBuV/m) – Limit (dBuV/m).



Modulation	ax HE40-OFDMA	Test Freq. (MHz)	5510
Polarization	Horizontal		

Test By :Brad Wu Temperature(°C):23 Humidity(%):65

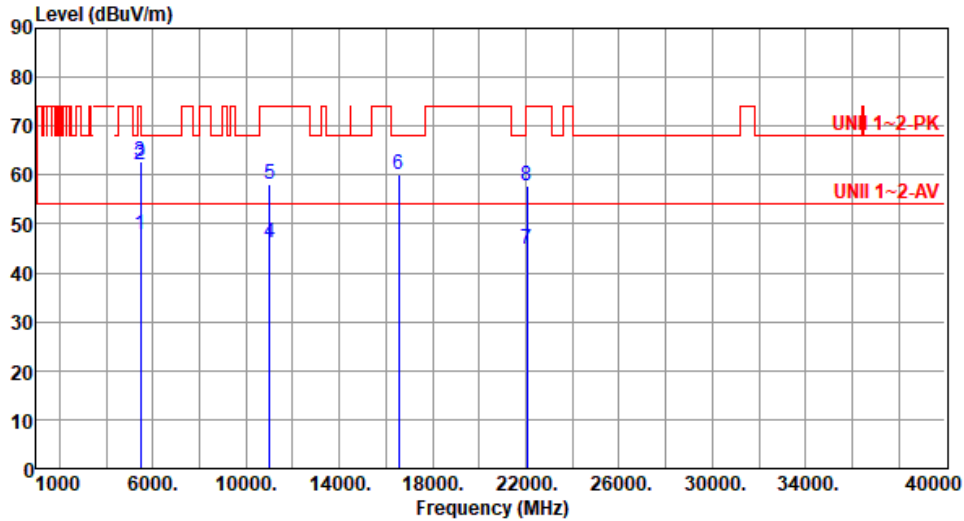

	Freq. MHz	Emission level dBuV/m	Limit dBuV/m	Margin dB	SA reading dBuV	Factor dB/m	Remark	ANT High cm	Turn Table deg
1	5460.00	47.95	54.00	-6.05	41.65	6.30	Average	300	152
2	5460.00	62.14	74.00	-11.86	55.84	6.30	Peak	300	152
3	5470.00	62.90	68.20	-5.30	56.58	6.32	Peak	300	152
4	11020.00	46.05	54.00	-7.95	30.47	15.58	Average	100	207
5	11020.00	58.00	74.00	-16.00	42.42	15.58	Peak	100	207
6	16530.00	60.26	68.20	-7.94	42.96	17.30	Peak	100	203
7	22040.00	44.70	54.00	-9.30	36.95	7.75	Average	309	214
8	22040.00	57.62	74.00	-16.38	49.87	7.75	Peak	309	214

Note 1: Emission Level (dBuV/m) = SA Reading (dBuV) + Factor* (dB/m)

*Factor includes antenna factor , cable loss and amplifier gain

Note 2: Margin (dB) = Emission level (dBuV/m) – Limit (dBuV/m).



Modulation	ax HE40-OFDMA	Test Freq. (MHz)	5510
Polarization	Vertical		

Test By :Brad Wu Temperature(°C):23 Humidity(%):65

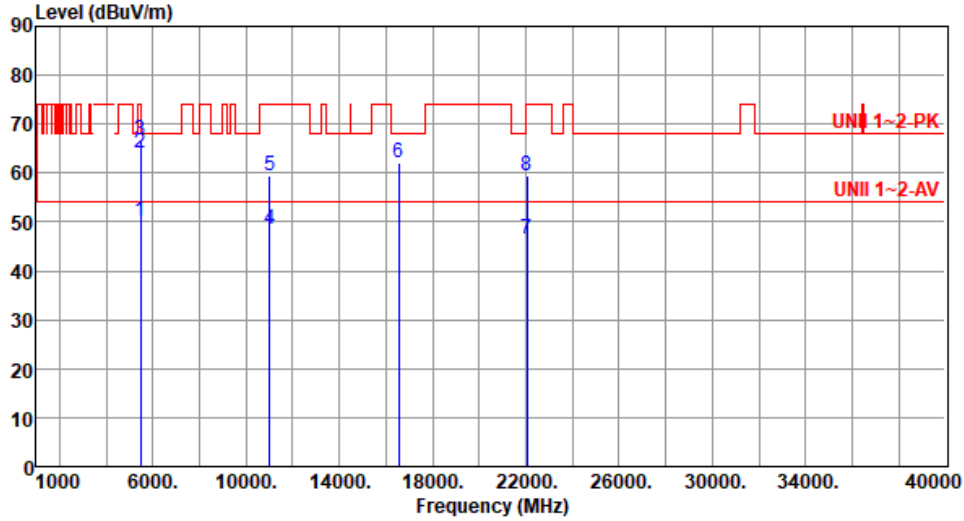

	Freq. MHz	Emission level dBuV/m	Limit dBuV/m	Margin dB	SA reading dBuV	Factor dB/m	Remark	ANT High cm	Turn Table deg
1	5460.00	50.04	54.00	-3.96	43.74	6.30	Average	256	161
2	5460.00	63.93	74.00	-10.07	57.63	6.30	Peak	256	161
3	5470.00	66.77	68.20	-1.43	60.45	6.32	Peak	256	161
4	11020.00	48.33	54.00	-5.67	32.75	15.58	Average	314	158
5	11020.00	59.33	74.00	-14.67	43.75	15.58	Peak	314	158
6	16530.00	62.17	68.20	-6.03	44.87	17.30	Peak	314	152
7	22040.00	46.50	54.00	-7.50	38.75	7.75	Average	274	132
8	22040.00	59.29	74.00	-14.71	51.54	7.75	Peak	274	132

Note 1: Emission Level (dBuV/m) = SA Reading (dBuV) + Factor* (dB/m)

*Factor includes antenna factor , cable loss and amplifier gain

Note 2: Margin (dB) = Emission level (dBuV/m) – Limit (dBuV/m).



Modulation	ax HE40-OFDMA	Test Freq. (MHz)	5590
Polarization	Horizontal		

Test By :Brad Wu Temperature(°C):24 Humidity(%):66

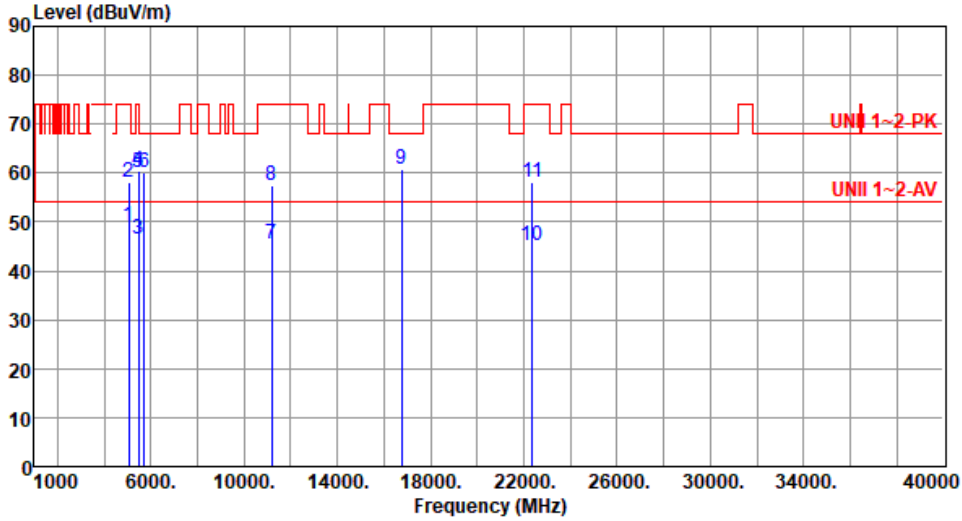

	Freq. MHz	Emission level dBuV/m	Limit dBuV/m	Margin dB	SA reading dBuV	Factor dB/m	Remark	ANT High cm	Turn Table deg
1	5040.00	49.02	54.00	-4.98	42.76	6.26	Average	314	143
2	5040.00	58.04	74.00	-15.96	51.78	6.26	Peak	314	143
3	5460.00	46.55	54.00	-7.45	40.25	6.30	Average	314	143
4	5460.00	60.54	74.00	-13.46	54.24	6.30	Peak	314	143
5	5470.00	59.95	68.20	-8.25	53.63	6.32	Peak	314	143
6	5725.00	60.22	68.20	-7.98	53.63	6.59	Peak	314	143
7	11180.00	45.57	54.00	-8.43	30.47	15.10	Average	100	201
8	11180.00	57.35	74.00	-16.65	42.25	15.10	Peak	100	201
9	16770.00	60.80	68.20	-7.40	42.93	17.87	Peak	100	214
10	22360.00	45.16	54.00	-8.84	36.78	8.38	Average	305	220
11	22360.00	58.24	74.00	-15.76	49.86	8.38	Peak	305	220

Note 1: Emission Level (dBuV/m) = SA Reading (dBuV) + Factor* (dB/m)

*Factor includes antenna factor , cable loss and amplifier gain

Note 2: Margin (dB) = Emission level (dBuV/m) – Limit (dBuV/m).



Modulation	ax HE40-OFDMA	Test Freq. (MHz)	5590
Polarization	Vertical		

Test By :Brad Wu Temperature(°C):24 Humidity(%):66

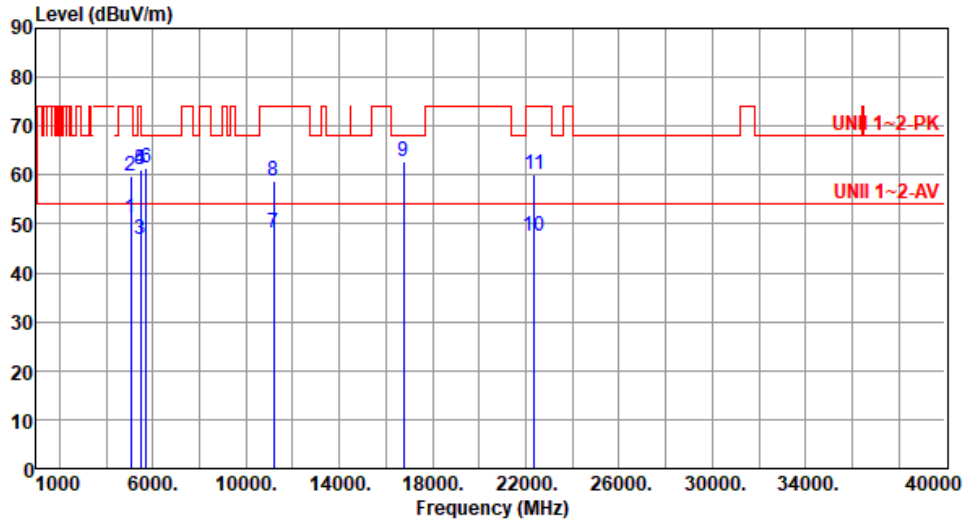

	Freq. MHz	Emission level dBuV/m	Limit dBuV/m	Margin dB	SA reading dBuV	Factor dB/m	Remark	ANT High cm	Turn Table deg
1	5040.00	51.18	54.00	-2.82	44.92	6.26	Average	307	176
2	5040.00	59.93	74.00	-14.07	53.67	6.26	Peak	307	176
3	5460.00	46.97	54.00	-7.03	40.67	6.30	Average	294	154
4	5460.00	61.00	74.00	-13.00	54.70	6.30	Peak	294	154
5	5470.00	61.07	68.20	-7.13	54.75	6.32	Peak	294	154
6	5725.00	61.30	68.20	-6.90	54.71	6.59	Peak	294	154
7	11180.00	48.05	54.00	-5.95	32.95	15.10	Average	322	161
8	11180.00	58.68	74.00	-15.32	43.58	15.10	Peak	322	161
9	16770.00	62.85	68.20	-5.35	44.98	17.87	Peak	315	154
10	22360.00	47.34	54.00	-6.66	38.96	8.38	Average	277	125
11	22360.00	60.14	74.00	-13.86	51.76	8.38	Peak	277	125

Note 1: Emission Level (dBuV/m) = SA Reading (dBuV) + Factor* (dB/m)

*Factor includes antenna factor , cable loss and amplifier gain

Note 2: Margin (dB) = Emission level (dBuV/m) – Limit (dBuV/m).



Modulation	ax HE40-OFDMA	Test Freq. (MHz)	5670
Polarization	Horizontal		

Test By :Brad Wu Temperature(°C):23 Humidity(%):65

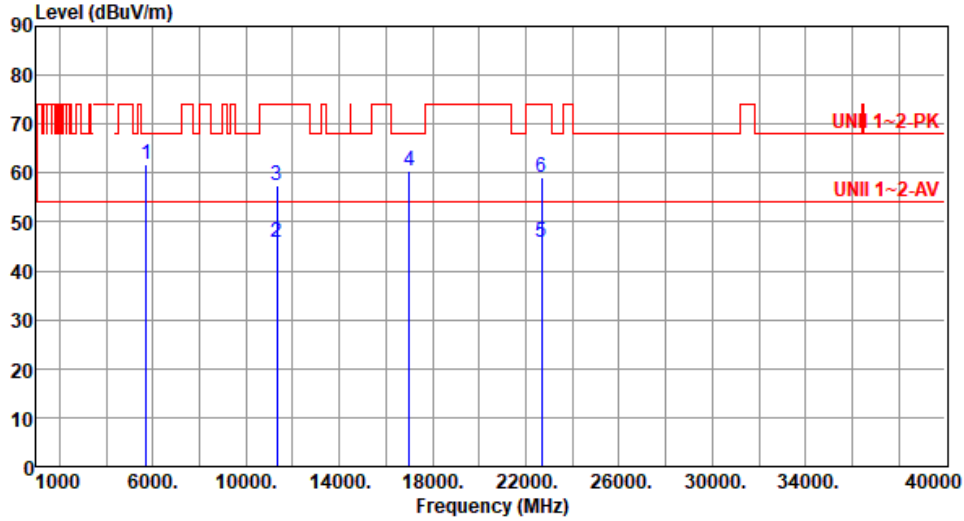

	Freq. MHz	Emission level dBuV/m	Limit dBuV/m	Margin dB	SA reading dBuV	Factor dB/m	Remark	ANT High cm	Turn Table deg
1	5725.00	61.85	68.20	-6.35	55.26	6.59	Peak	308	144
2	11340.00	45.86	54.00	-8.14	30.74	15.12	Average	100	203
3	11340.00	57.57	74.00	-16.43	42.45	15.12	Peak	100	203
4	17010.00	60.36	68.20	-7.84	42.39	17.97	Peak	100	209
5	22680.00	45.89	54.00	-8.11	36.75	9.14	Average	313	208
6	22680.00	58.99	74.00	-15.01	49.85	9.14	Peak	313	208

Note 1: Emission Level (dBuV/m) = SA Reading (dBuV) + Factor* (dB/m)

*Factor includes antenna factor , cable loss and amplifier gain

Note 2: Margin (dB) = Emission level (dBuV/m) – Limit (dBuV/m).



Modulation	ax HE40-OFDMA	Test Freq. (MHz)	5670
Polarization	Vertical		

Test By :Brad Wu Temperature(°C):23 Humidity(%):65

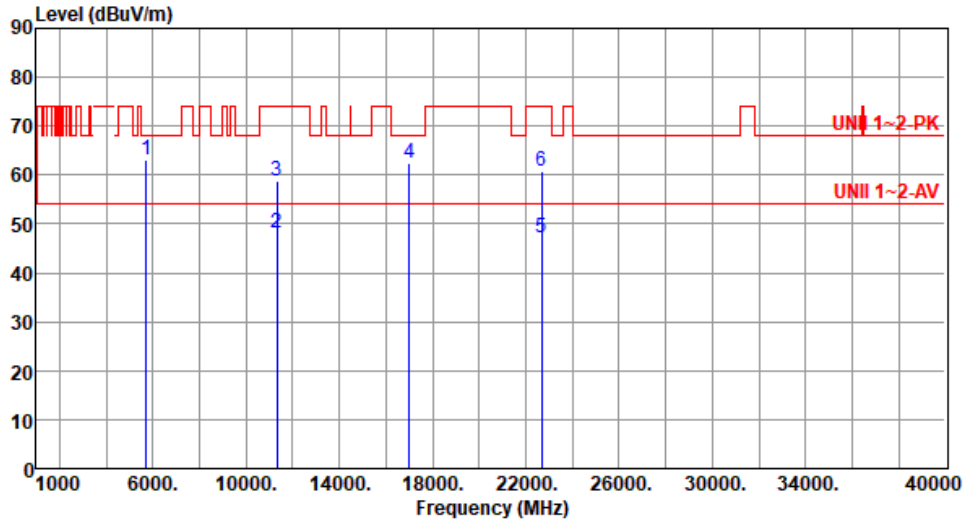

	Freq. MHz	Emission level dBuV/m	Limit dBuV/m	Margin dB	SA reading dBuV	Factor dB/m	Remark	ANT High cm	Turn Table deg
1	5725.00	63.15	68.20	-5.05	56.56	6.59	Peak	258	158
2	11340.00	47.99	54.00	-6.01	32.87	15.12	Average	311	158
3	11340.00	58.87	74.00	-15.13	43.75	15.12	Peak	311	158
4	17010.00	62.52	68.20	-5.68	44.55	17.97	Peak	314	157
5	22680.00	47.28	54.00	-6.72	38.14	9.14	Average	283	129
6	22680.00	60.80	74.00	-13.20	51.66	9.14	Peak	283	129

Note 1: Emission Level (dBuV/m) = SA Reading (dBuV) + Factor* (dB/m)

*Factor includes antenna factor , cable loss and amplifier gain

Note 2: Margin (dB) = Emission level (dBuV/m) – Limit (dBuV/m).



Modulation	ax HE40-OFDMA	Test Freq. (MHz)	5710
Polarization	Horizontal		

Test By : Akun Chung Temperature(°C): 24 Humidity(%): 66

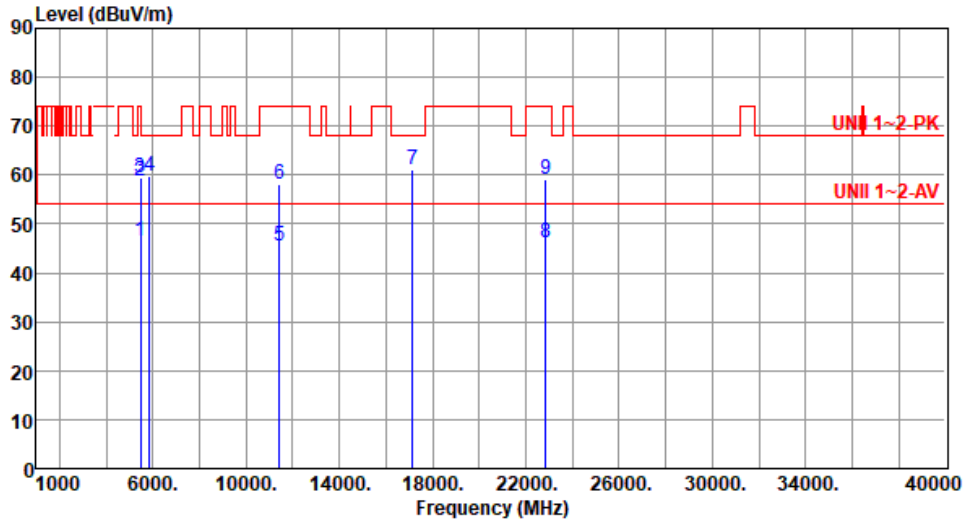

	Freq. MHz	Emission level dBuV/m	Limit dBuV/m	Margin dB	SA reading dBuV	Factor dB/m	Remark	ANT High cm	Turn Table deg
1	5460.00	46.54	54.00	-7.46	40.24	6.30	Average	294	129
2	5460.00	58.76	74.00	-15.24	52.46	6.30	Peak	294	129
3	5470.00	59.57	68.20	-8.63	53.25	6.32	Peak	294	129
4	5850.00	59.62	68.20	-8.58	52.85	6.77	Peak	294	129
5	11420.00	45.62	54.00	-8.38	30.42	15.20	Average	100	200
6	11420.00	58.05	74.00	-15.95	42.85	15.20	Peak	100	200
7	17130.00	61.11	68.20	-7.09	42.96	18.15	Peak	100	196
8	22840.00	46.22	54.00	-7.78	36.75	9.47	Average	306	207
9	22840.00	59.05	74.00	-14.95	49.58	9.47	Peak	306	207

Note 1: Emission Level (dBuV/m) = SA Reading (dBuV) + Factor* (dB/m)

*Factor includes antenna factor , cable loss and amplifier gain

Note 2: Margin (dB) = Emission level (dBuV/m) – Limit (dBuV/m).



Modulation	ax HE40-OFDMA	Test Freq. (MHz)	5710
Polarization	Vertical		

Test By :Akun Chung Temperature(°C):24 Humidity(%):66

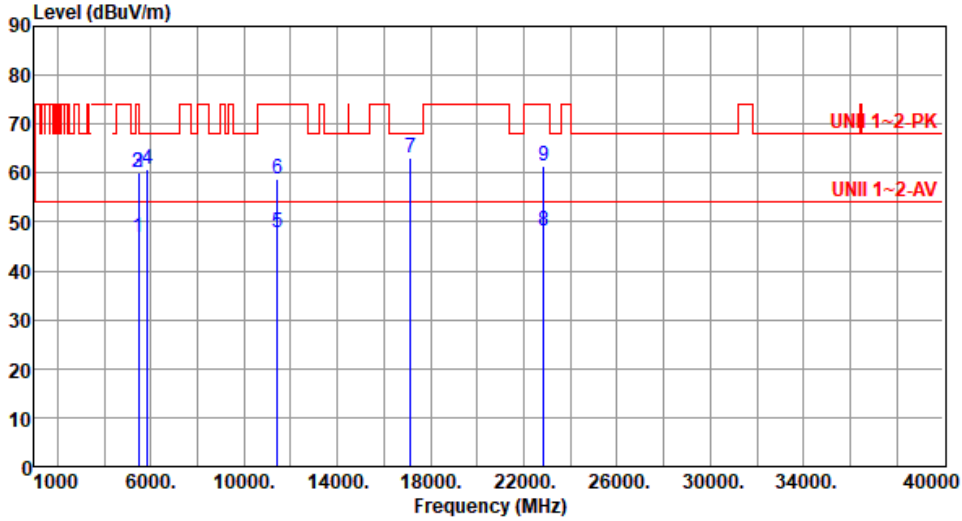

	Freq. MHz	Emission level dBuV/m	Limit dBuV/m	Margin dB	SA reading dBuV	Factor dB/m	Remark	ANT High cm	Turn Table deg
1	5460.00	46.95	54.00	-7.05	40.65	6.30	Average	306	155
2	5460.00	60.00	74.00	-14.00	53.70	6.30	Peak	306	155
3	5470.00	60.07	68.20	-8.13	53.75	6.32	Peak	306	155
4	5850.00	60.65	68.20	-7.55	53.88	6.77	Peak	306	155
5	11420.00	47.95	54.00	-6.05	32.75	15.20	Average	324	158
6	11420.00	58.83	74.00	-15.17	43.63	15.20	Peak	324	158
7	17130.00	63.00	68.20	-5.20	44.85	18.15	Peak	312	160
8	22840.00	48.11	54.00	-5.89	38.64	9.47	Average	286	130
9	22840.00	61.43	74.00	-12.57	51.96	9.47	Peak	286	130

Note 1: Emission Level (dBuV/m) = SA Reading (dBuV) + Factor* (dB/m)

*Factor includes antenna factor , cable loss and amplifier gain

Note 2: Margin (dB) = Emission level (dBuV/m) – Limit (dBuV/m).



Modulation	ax HE40-OFDMA	Test Freq. (MHz)	5755
Polarization	Horizontal		

Test By :Brad Wu Temperature(°C):23 Humidity(%):65

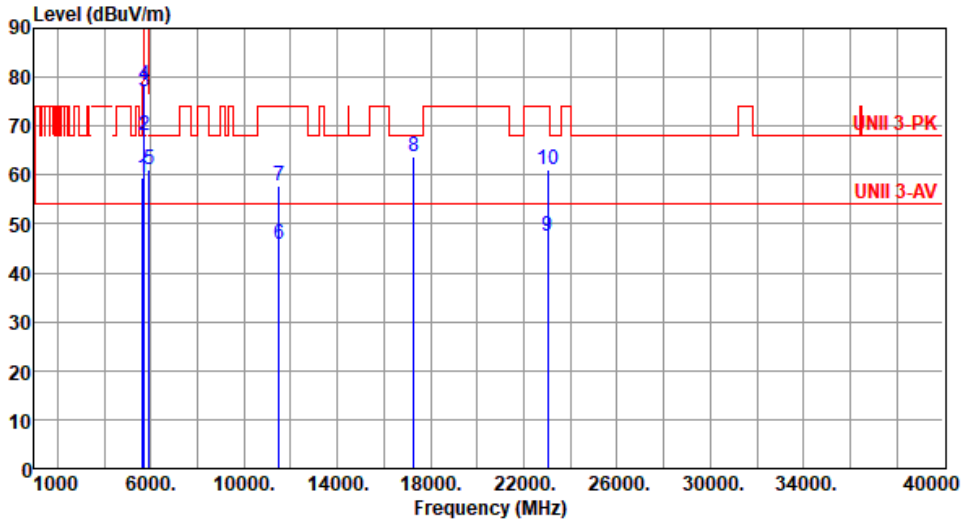

	Freq. MHz	Emission level dBuV/m	Limit dBuV/m	Margin dB	SA reading dBuV	Factor dB/m	Remark	ANT High cm	Turn Table deg
1	5650.00	59.32	68.20	-8.88	53.00	6.32	Peak	300	205
2	5700.00	68.08	105.20	-37.12	61.55	6.53	Peak	300	205
3	5720.00	77.08	110.80	-33.72	70.50	6.58	Peak	300	205
4	5725.00	78.47	122.20	-43.73	71.88	6.59	Peak	300	205
5	5925.00	60.99	68.20	-7.21	53.96	7.03	Peak	300	205
6	11510.00	45.84	54.00	-8.16	30.44	15.40	Average	100	203
7	11510.00	57.80	74.00	-16.20	42.40	15.40	Peak	100	203
8	17265.00	63.81	68.20	-4.39	45.48	18.33	Peak	305	207
9	23020.00	47.39	54.00	-6.61	37.75	9.64	Average	301	212
10	23020.00	61.05	74.00	-12.95	51.41	9.64	Peak	301	212

Note 1: Emission Level (dBuV/m) = SA Reading (dBuV) + Factor* (dB/m)

*Factor includes antenna factor , cable loss and amplifier gain

Note 2: Margin (dB) = Emission level (dBuV/m) – Limit (dBuV/m).



Modulation	ax HE40-OFDMA	Test Freq. (MHz)	5755
Polarization	Vertical		

Test By :Brad Wu Temperature(°C):23 Humidity(%):65

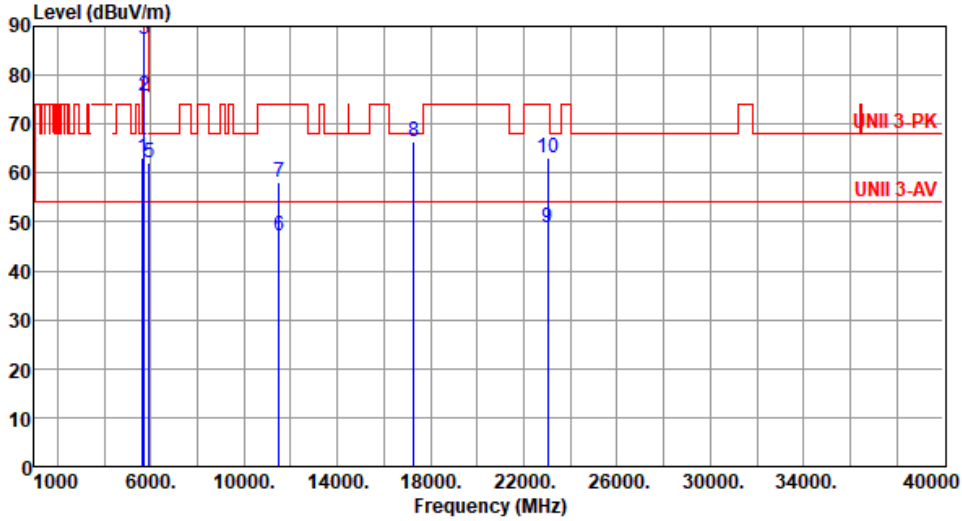

	Freq. MHz	Emission level dBuV/m	Limit dBuV/m	Margin dB	SA reading dBuV	Factor dB/m	Remark	ANT High cm	Turn Table deg
1	5650.00	63.13	68.20	-5.07	56.81	6.32	Peak	299	162
2	5700.00	75.62	105.20	-29.58	69.09	6.53	Peak	299	162
3	5720.00	87.30	110.80	-23.50	80.72	6.58	Peak	299	162
4	5725.00	88.84	122.20	-33.36	82.25	6.59	Peak	299	162
5	5925.00	62.09	68.20	-6.11	55.06	7.03	Peak	299	162
6	11510.00	47.27	54.00	-6.73	31.87	15.40	Average	310	166
7	11510.00	58.24	74.00	-15.76	42.84	15.40	Peak	310	166
8	17265.00	66.26	68.20	-1.94	47.93	18.33	Peak	298	149
9	23020.00	48.75	54.00	-5.25	39.11	9.64	Average	321	178
10	23020.00	63.12	74.00	-10.88	53.48	9.64	Peak	321	178

Note 1: Emission Level (dBuV/m) = SA Reading (dBuV) + Factor* (dB/m)

*Factor includes antenna factor , cable loss and amplifier gain

Note 2: Margin (dB) = Emission level (dBuV/m) – Limit (dBuV/m).



Modulation	ax HE40-OFDMA	Test Freq. (MHz)	5795
Polarization	Horizontal		

Test By :Brad Wu Temperature(°C):23 Humidity(%):65

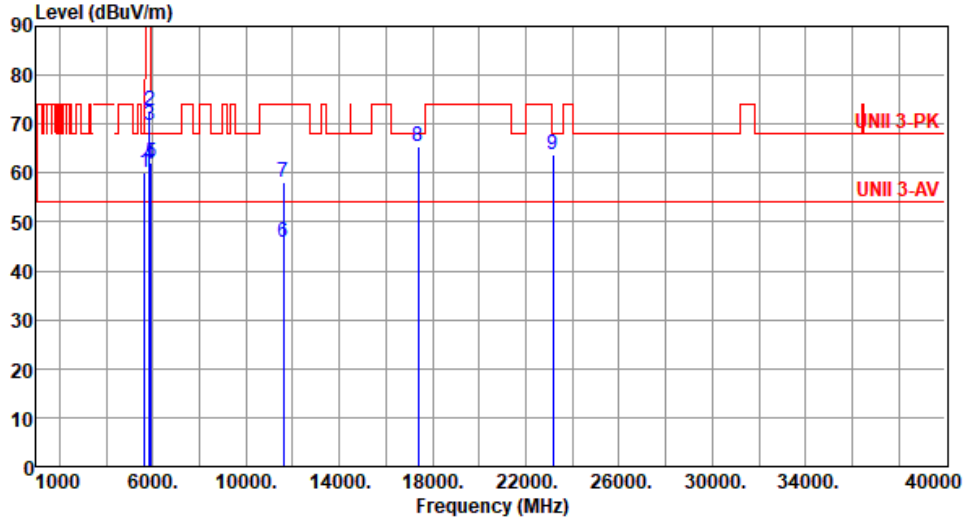

	Freq. MHz	Emission level dBuV/m	Limit dBuV/m	Margin dB	SA reading dBuV	Factor dB/m	Remark	ANT High cm	Turn Table deg
1	5650.00	60.20	68.20	-8.00	53.88	6.32	Peak	299	133
2	5850.00	72.65	122.20	-49.55	65.88	6.77	Peak	299	133
3	5855.00	69.65	110.80	-41.15	62.85	6.80	Peak	299	133
4	5875.00	61.88	105.20	-43.32	55.00	6.88	Peak	299	133
5	5925.00	61.99	68.20	-6.21	54.96	7.03	Peak	299	133
6	11590.00	45.83	54.00	-8.17	30.45	15.38	Average	100	214
7	11590.00	58.18	74.00	-15.82	42.80	15.38	Peak	100	214
8	17385.00	65.54	68.20	-2.66	46.25	19.29	Peak	311	208
9	23180.00	63.64	68.20	-4.56	53.96	9.68	Peak	312	204

Note 1: Emission Level (dBuV/m) = SA Reading (dBuV) + Factor* (dB/m)

*Factor includes antenna factor , cable loss and amplifier gain

Note 2: Margin (dB) = Emission level (dBuV/m) – Limit (dBuV/m).



Modulation	ax HE40-OFDMA	Test Freq. (MHz)	5795
Polarization	Vertical		

Test By :Brad Wu Temperature(°C):23 Humidity(%):65

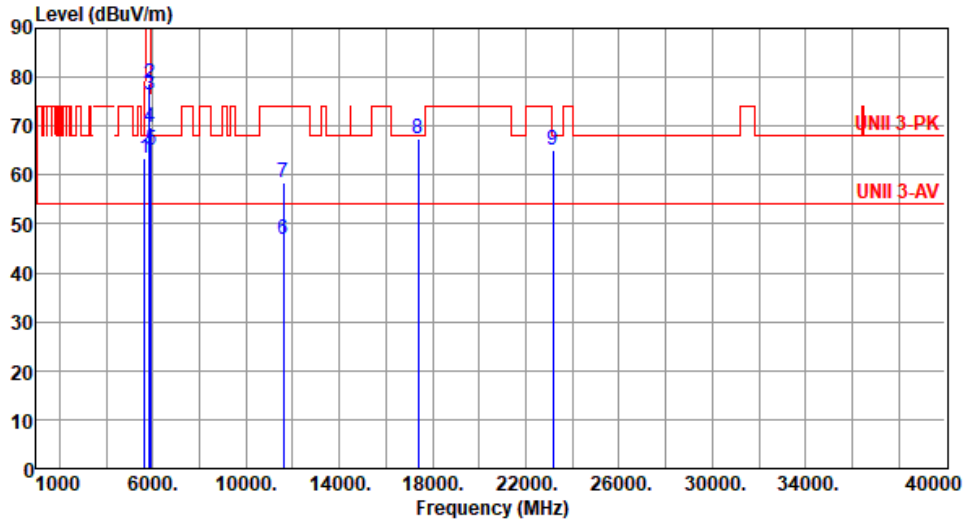

	Freq. MHz	Emission level dBuV/m	Limit dBuV/m	Margin dB	SA reading dBuV	Factor dB/m	Remark	ANT High cm	Turn Table deg
1	5650.00	63.56	68.20	-4.64	57.24	6.32	Peak	302	159
2	5850.00	78.82	122.20	-43.38	72.05	6.77	Peak	302	159
3	5855.00	76.49	110.80	-34.31	69.69	6.80	Peak	302	159
4	5875.00	69.86	105.20	-35.34	62.98	6.88	Peak	302	159
5	5925.00	65.18	68.20	-3.02	58.15	7.03	Peak	302	159
6	11590.00	46.85	54.00	-7.15	31.47	15.38	Average	312	165
7	11590.00	58.36	74.00	-15.64	42.98	15.38	Peak	312	165
8	17385.00	67.39	68.20	-0.81	48.10	19.29	Peak	309	127
9	23180.00	64.96	68.20	-3.24	55.28	9.68	Peak	322	181

Note 1: Emission Level (dBuV/m) = SA Reading (dBuV) + Factor* (dB/m)

*Factor includes antenna factor , cable loss and amplifier gain

Note 2: Margin (dB) = Emission level (dBuV/m) – Limit (dBuV/m).



Unwanted Emissions (Above 1GHz) for ax HE80-OFDMA

Modulation	ax HE80-OFDMA	Test Freq. (MHz)	5210						
Polarization	Horizontal								
Test By :Brad Wu Temperature(°C):23 Humidity(%):65									
	Freq. MHz	Emission level dBuV/m	Limit dBuV/m	Margin dB	SA reading dBuV	Factor dB/m	Remark	ANT High cm	Turn Table deg
1	5150.00	48.19	54.00	-5.81	41.88	6.31	Average	299	155
2	5150.00	62.16	74.00	-11.84	55.85	6.31	Peak	299	155
3	5350.00	45.12	54.00	-8.88	39.40	5.72	Average	299	155
4	5350.00	58.30	74.00	-15.70	52.58	5.72	Peak	299	155
5	15630.00	58.53	74.00	-15.47	42.58	15.95	Peak	100	203
6	20840.00	41.97	54.00	-12.03	35.44	6.53	Average	298	206
7	20840.00	53.78	74.00	-20.22	47.25	6.53	Peak	298	206

Note 1: Emission Level (dBuV/m) = SA Reading (dBuV) + Factor* (dB/m)
 *Factor includes antenna factor , cable loss and amplifier gain
 Note 2: Margin (dB) = Emission level (dBuV/m) – Limit (dBuV/m).



Modulation	ax HE80-OFDMA	Test Freq. (MHz)	5210
Polarization	Vertical		

Test By :Brad Wu Temperature(°C):23 Humidity(%):65

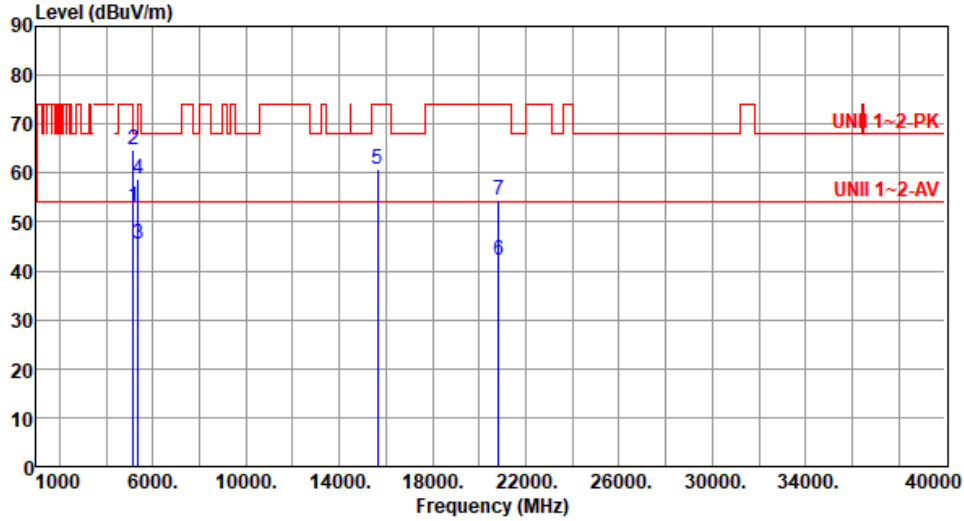

	Freq. MHz	Emission level dBuV/m	Limit dBuV/m	Margin dB	SA reading dBuV	Factor dB/m	Remark	ANT High cm	Turn Table deg
1	5150.00	53.10	54.00	-0.90	46.79	6.31	Average	320	178
2	5150.00	64.86	74.00	-9.14	58.55	6.31	Peak	320	178
3	5350.00	45.37	54.00	-8.63	39.65	5.72	Average	320	178
4	5350.00	58.77	74.00	-15.23	53.05	5.72	Peak	320	178
5	15630.00	60.83	74.00	-13.17	44.88	15.95	Peak	299	155
6	20840.00	42.30	54.00	-11.70	35.77	6.53	Average	294	154
7	20840.00	54.37	74.00	-19.63	47.84	6.53	Peak	294	154

Note 1: Emission Level (dBuV/m) = SA Reading (dBuV) + Factor* (dB/m)

*Factor includes antenna factor , cable loss and amplifier gain

Note 2: Margin (dB) = Emission level (dBuV/m) – Limit (dBuV/m).



Modulation	ax HE80-OFDMA	Test Freq. (MHz)	5290
Polarization	Horizontal		

Test By :Brad Wu Temperature(°C):23 Humidity(%):65

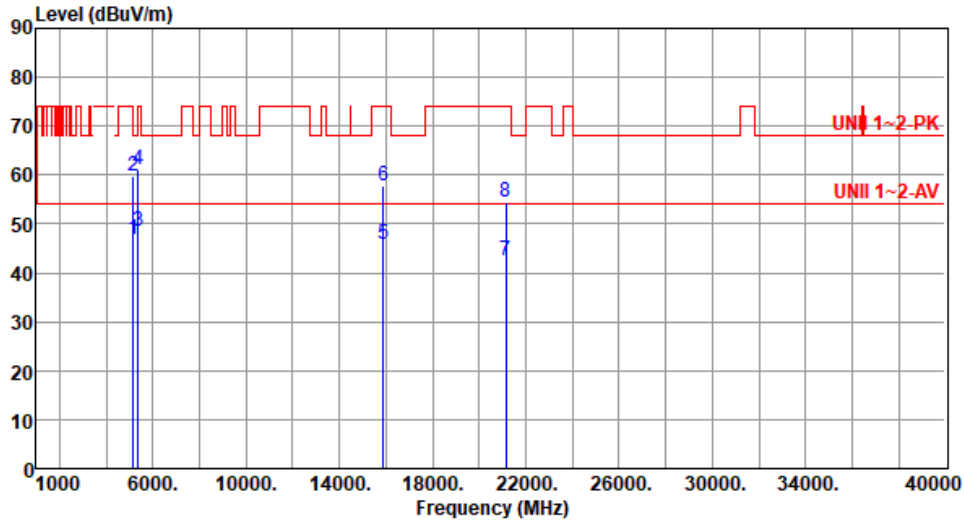

	Freq. MHz	Emission level dBuV/m	Limit dBuV/m	Margin dB	SA reading dBuV	Factor dB/m	Remark	ANT High cm	Turn Table deg
1	5150.00	46.78	54.00	-7.22	40.47	6.31	Average	280	150
2	5150.00	59.86	74.00	-14.14	53.55	6.31	Peak	280	150
3	5350.00	48.57	54.00	-5.43	42.85	5.72	Average	280	150
4	5350.00	61.24	74.00	-12.76	55.52	5.72	Peak	280	150
5	15870.00	45.90	54.00	-8.10	30.25	15.65	Average	100	207
6	15870.00	57.79	74.00	-16.21	42.14	15.65	Peak	100	207
7	21160.00	42.54	54.00	-11.46	35.45	7.09	Average	303	210
8	21160.00	54.34	74.00	-19.66	47.25	7.09	Peak	303	210

Note 1: Emission Level (dBuV/m) = SA Reading (dBuV) + Factor* (dB/m)

*Factor includes antenna factor , cable loss and amplifier gain

Note 2: Margin (dB) = Emission level (dBuV/m) – Limit (dBuV/m).



Modulation	ax HE80-OFDMA	Test Freq. (MHz)	5290
Polarization	Vertical		

Test By :Brad Wu Temperature(°C):23 Humidity(%):65

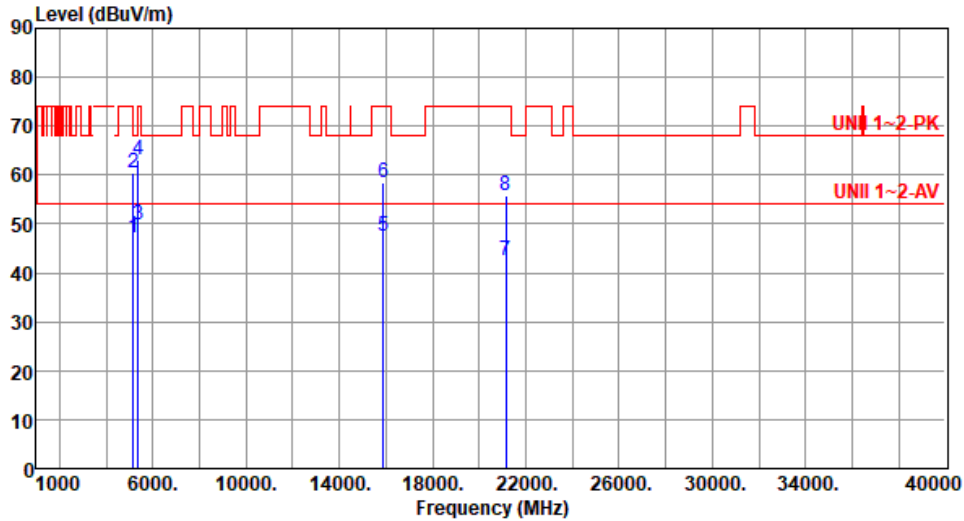

	Freq. MHz	Emission level dBuV/m	Limit dBuV/m	Margin dB	SA reading dBuV	Factor dB/m	Remark	ANT High cm	Turn Table deg
1	5150.00	47.30	54.00	-6.70	40.99	6.31	Average	313	182
2	5150.00	60.34	74.00	-13.66	54.03	6.31	Peak	313	182
3	5350.00	49.69	54.00	-4.31	43.97	5.72	Average	313	182
4	5350.00	63.15	74.00	-10.85	57.43	5.72	Peak	313	182
5	15870.00	47.34	54.00	-6.66	31.69	15.65	Average	298	147
6	15870.00	58.50	74.00	-15.50	42.85	15.65	Peak	298	147
7	21160.00	42.63	54.00	-11.37	35.54	7.09	Average	294	142
8	21160.00	55.94	74.00	-18.06	48.85	7.09	Peak	294	142

Note 1: Emission Level (dBuV/m) = SA Reading (dBuV) + Factor* (dB/m)

*Factor includes antenna factor , cable loss and amplifier gain

Note 2: Margin (dB) = Emission level (dBuV/m) – Limit (dBuV/m).



Modulation	ax HE80-OFDMA	Test Freq. (MHz)	5530
Polarization	Horizontal		

Test By :Brad Wu Temperature(°C):23 Humidity(%):65

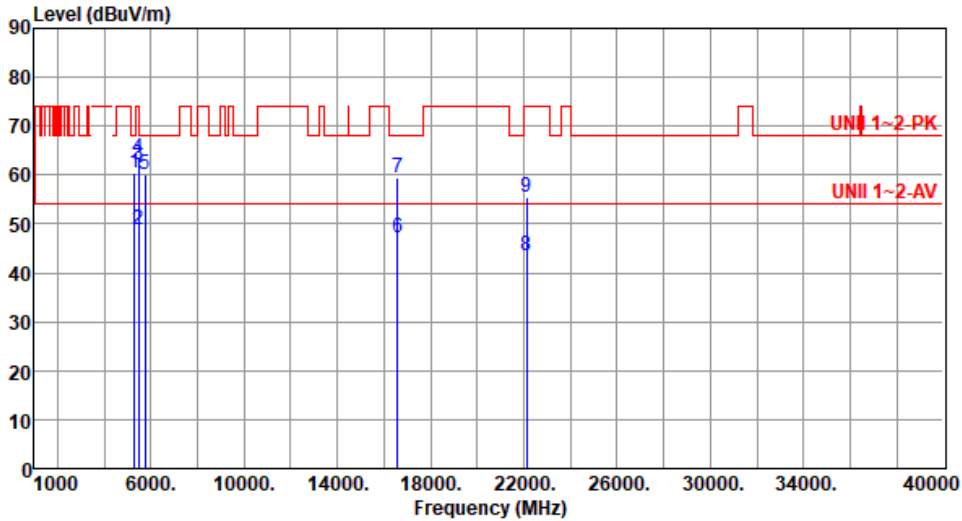

	Freq. MHz	Emission level dBuV/m	Limit dBuV/m	Margin dB	SA reading dBuV	Factor dB/m	Remark	ANT High cm	Turn Table deg
1	5280.00	60.55	68.20	-7.65	54.83	5.72	Peak	299	145
2	5460.00	48.87	54.00	-5.13	42.57	6.30	Average	299	145
3	5460.00	62.17	74.00	-11.83	55.87	6.30	Peak	299	145
4	5470.00	63.31	68.20	-4.89	56.99	6.32	Peak	299	145
5	5760.00	60.24	68.20	-7.96	53.60	6.64	Peak	299	145
6	16590.00	47.22	54.00	-6.78	30.24	16.98	Average	100	205
7	16590.00	59.42	68.20	-8.78	42.44	16.98	Peak	100	205
8	22120.00	43.36	54.00	-10.64	35.41	7.95	Average	302	209
9	22120.00	55.40	74.00	-18.60	47.45	7.95	Peak	302	209

Note 1: Emission Level (dBuV/m) = SA Reading (dBuV) + Factor* (dB/m)

*Factor includes antenna factor , cable loss and amplifier gain

Note 2: Margin (dB) = Emission level (dBuV/m) – Limit (dBuV/m).



Modulation	ax HE80-OFDMA	Test Freq. (MHz)	5530
Polarization	Vertical		

Test By :Brad Wu Temperature(°C):23 Humidity(%):65

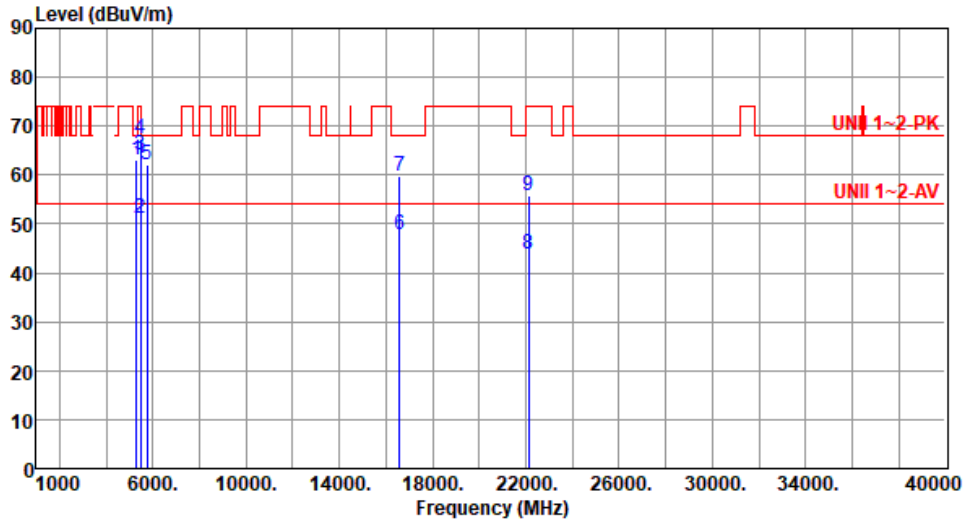

	Freq. MHz	Emission level dBuV/m	Limit dBuV/m	Margin dB	SA reading dBuV	Factor dB/m	Remark	ANT High cm	Turn Table deg
1	5280.00	63.13	68.20	-5.07	57.41	5.72	Peak	314	181
2	5460.00	51.22	54.00	-2.78	44.92	6.30	Average	314	160
3	5460.00	63.95	74.00	-10.05	57.65	6.30	Peak	314	160
4	5470.00	67.56	68.20	-0.64	61.24	6.32	Peak	314	160
5	5760.00	62.16	68.20	-6.04	55.52	6.64	Peak	314	160
6	16590.00	47.66	54.00	-6.34	30.68	16.98	Average	100	155
7	16590.00	59.72	68.20	-8.48	42.74	16.98	Peak	100	155
8	22120.00	43.80	54.00	-10.20	35.85	7.95	Average	315	147
9	22120.00	55.80	74.00	-18.20	47.85	7.95	Peak	315	147

Note 1: Emission Level (dBuV/m) = SA Reading (dBuV) + Factor* (dB/m)

*Factor includes antenna factor , cable loss and amplifier gain

Note 2: Margin (dB) = Emission level (dBuV/m) – Limit (dBuV/m).



Modulation	ax HE80-OFDMA	Test Freq. (MHz)	5610
Polarization	Horizontal		

Test By :Brad Wu Temperature(°C):23 Humidity(%):65

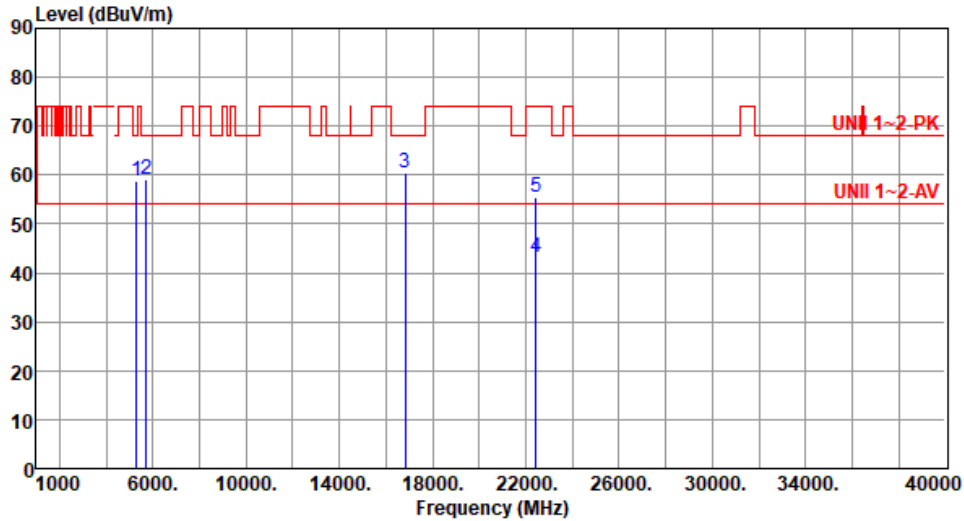

	Freq. MHz	Emission level dBuV/m	Limit dBuV/m	Margin dB	SA reading dBuV	Factor dB/m	Remark	ANT High cm	Turn Table deg
1	5280.00	58.84	68.20	-9.36	53.12	5.72	Peak	295	169
2	5725.00	59.08	68.20	-9.12	52.49	6.59	Peak	295	152
3	16830.00	60.46	68.20	-7.74	42.47	17.99	Peak	100	200
4	22440.00	43.32	54.00	-10.68	34.86	8.46	Average	285	217
5	22440.00	55.41	74.00	-18.59	46.95	8.46	Peak	285	217

Note 1: Emission Level (dBuV/m) = SA Reading (dBuV) + Factor* (dB/m)

*Factor includes antenna factor , cable loss and amplifier gain

Note 2: Margin (dB) = Emission level (dBuV/m) – Limit (dBuV/m).



Modulation	ax HE80-OFDMA	Test Freq. (MHz)	5610
Polarization	Vertical		

Test By :Brad Wu Temperature(°C):23 Humidity(%):65

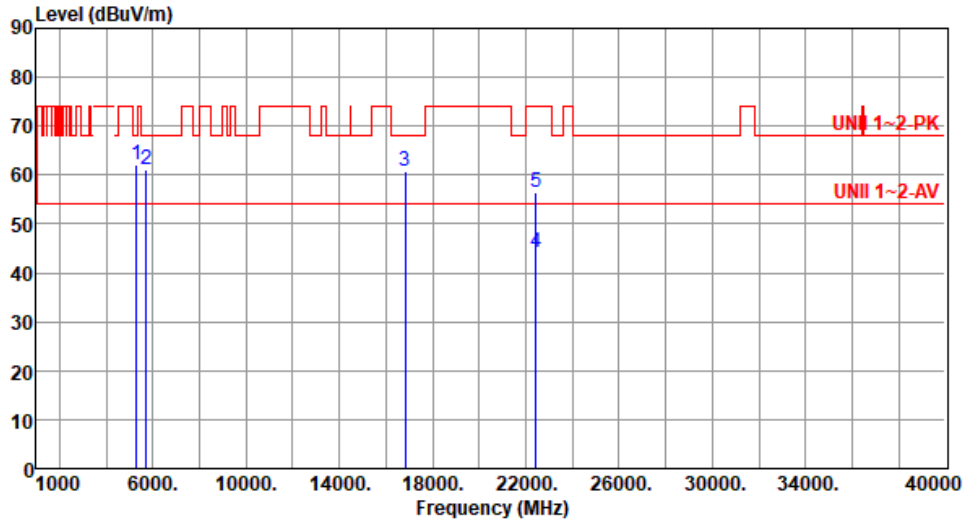

	Freq. MHz	Emission level dBuV/m	Limit dBuV/m	Margin dB	SA reading dBuV	Factor dB/m	Remark	ANT High cm	Turn Table deg
1	5280.00	61.95	68.20	-6.25	56.23	5.72	Peak	315	180
2	5725.00	61.04	68.20	-7.16	54.45	6.59	Peak	315	162
3	16830.00	60.69	68.20	-7.51	42.70	17.99	Peak	100	145
4	22440.00	44.16	54.00	-9.84	35.70	8.46	Average	100	155
5	22440.00	56.32	74.00	-17.68	47.86	8.46	Peak	100	155

Note 1: Emission Level (dBuV/m) = SA Reading (dBuV) + Factor* (dB/m)

*Factor includes antenna factor , cable loss and amplifier gain

Note 2: Margin (dB) = Emission level (dBuV/m) – Limit (dBuV/m).



Modulation	ax HE80-OFDMA	Test Freq. (MHz)	5690
Polarization	Horizontal		

Test By :Akun Chung Temperature(°C):24 Humidity(%):66

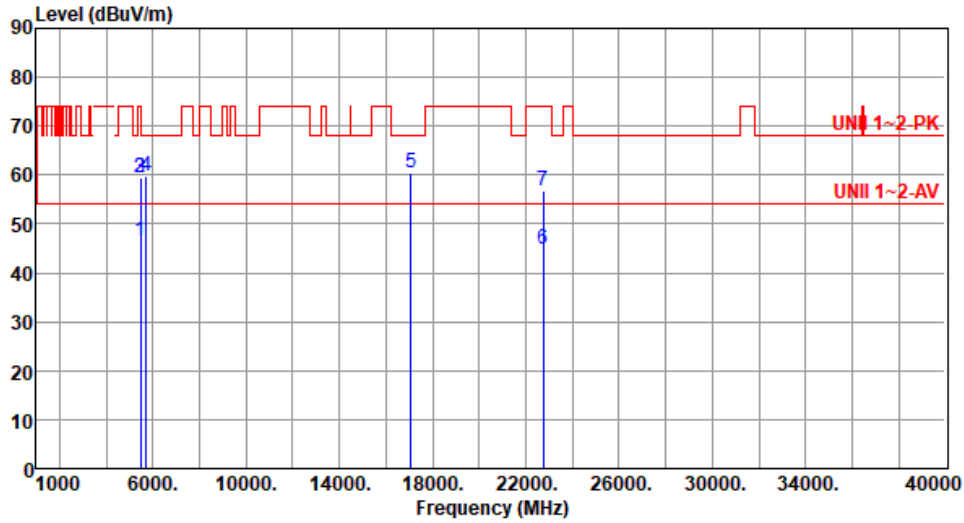

	Freq. MHz	Emission level dBUV/m	Limit dBUV/m	Margin dB	SA reading dBUV	Factor dB/m	Remark	ANT High cm	Turn Table deg
1	5460.00	46.54	54.00	-7.46	40.24	6.30	Average	270	140
2	5460.00	59.54	74.00	-14.46	53.24	6.30	Peak	270	140
3	5470.00	59.57	68.20	-8.63	53.25	6.32	Peak	270	140
4	5725.00	59.79	68.20	-8.41	53.20	6.59	Peak	270	140
5	17070.00	60.49	68.20	-7.71	42.40	18.09	Peak	100	209
6	22760.00	44.81	54.00	-9.19	35.41	9.40	Average	300	208
7	22760.00	56.89	74.00	-17.11	47.49	9.40	Peak	300	208

Note 1: Emission Level (dBUV/m) = SA Reading (dBUV) + Factor* (dB/m)

*Factor includes antenna factor , cable loss and amplifier gain

Note 2: Margin (dB) = Emission level (dBUV/m) – Limit (dBUV/m).



Modulation	ax HE80-OFDMA	Test Freq. (MHz)	5690
Polarization	Vertical		

Test By : Akun Chung Temperature(°C): 24 Humidity(%): 66

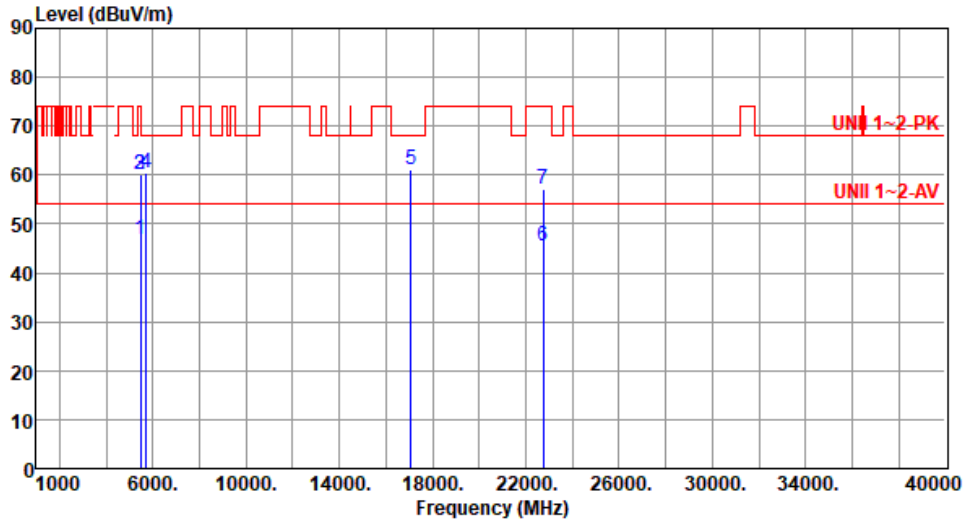

	Freq. MHz	Emission level dBuV/m	Limit dBuV/m	Margin dB	SA reading dBuV	Factor dB/m	Remark	ANT High cm	Turn Table deg
1	5460.00	46.98	54.00	-7.02	40.68	6.30	Average	305	154
2	5460.00	59.96	74.00	-14.04	53.66	6.30	Peak	305	154
3	5470.00	60.14	68.20	-8.06	53.82	6.32	Peak	305	154
4	5725.00	60.54	68.20	-7.66	53.95	6.59	Peak	305	154
5	17070.00	61.04	68.20	-7.16	42.95	18.09	Peak	100	158
6	22760.00	45.35	54.00	-8.65	35.95	9.40	Average	100	147
7	22760.00	57.24	74.00	-16.76	47.84	9.40	Peak	100	147

Note 1: Emission Level (dBuV/m) = SA Reading (dBuV) + Factor* (dB/m)

*Factor includes antenna factor , cable loss and amplifier gain

Note 2: Margin (dB) = Emission level (dBuV/m) – Limit (dBuV/m).



Modulation	ax HE80-OFDMA	Test Freq. (MHz)	5775
Polarization	Horizontal		

Test By :Brad Wu Temperature(°C):23 Humidity(%):65

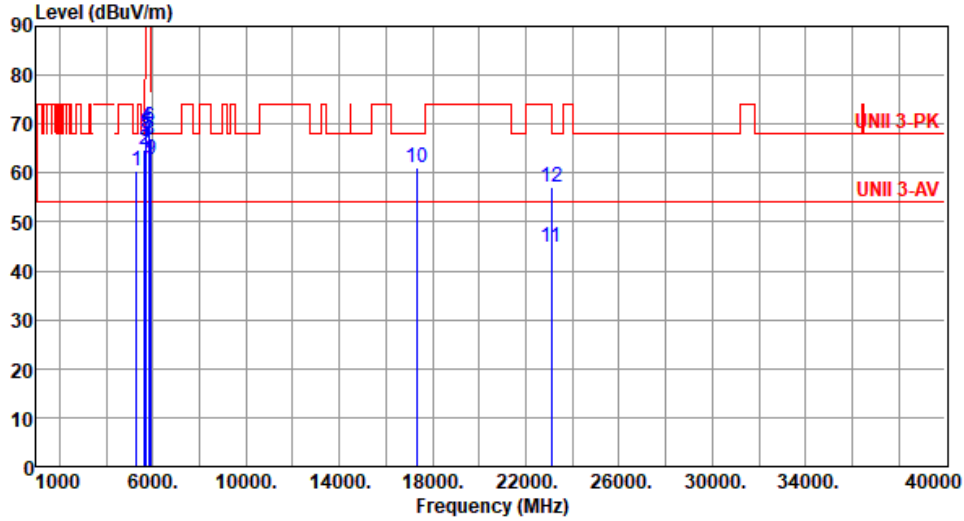

	Freq. MHz	Emission level dBuV/m	Limit dBuV/m	Margin dB	SA reading dBuV	Factor dB/m	Remark	ANT High cm	Turn Table deg
1	5280.00	60.60	68.20	-7.60	54.88	5.72	Peak	300	150
2	5650.00	64.87	68.20	-3.33	58.55	6.32	Peak	300	150
3	5700.00	66.42	105.20	-38.78	59.89	6.53	Peak	300	150
4	5720.00	69.46	110.80	-41.34	62.88	6.58	Peak	300	150
5	5725.00	68.14	122.20	-54.06	61.55	6.59	Peak	300	150
6	5850.00	69.35	122.20	-52.85	62.58	6.77	Peak	300	150
7	5855.00	67.35	110.80	-43.45	60.55	6.80	Peak	300	150
8	5875.00	66.68	105.20	-38.52	59.80	6.88	Peak	300	150
9	5925.00	62.91	68.20	-5.29	55.88	7.03	Peak	300	150
10	17325.00	61.09	68.20	-7.11	42.41	18.68	Peak	100	200
11	23100.00	44.96	54.00	-9.04	35.30	9.66	Average	300	205
12	23100.00	57.16	74.00	-16.84	47.50	9.66	Peak	300	205

Note 1: Emission Level (dBuV/m) = SA Reading (dBuV) + Factor* (dB/m)

*Factor includes antenna factor , cable loss and amplifier gain

Note 2: Margin (dB) = Emission level (dBuV/m) – Limit (dBuV/m).



Modulation	ax HE80-OFDMA	Test Freq. (MHz)	5775
Polarization	Vertical		

Test By :Brad Wu Temperature(°C):23 Humidity(%):65

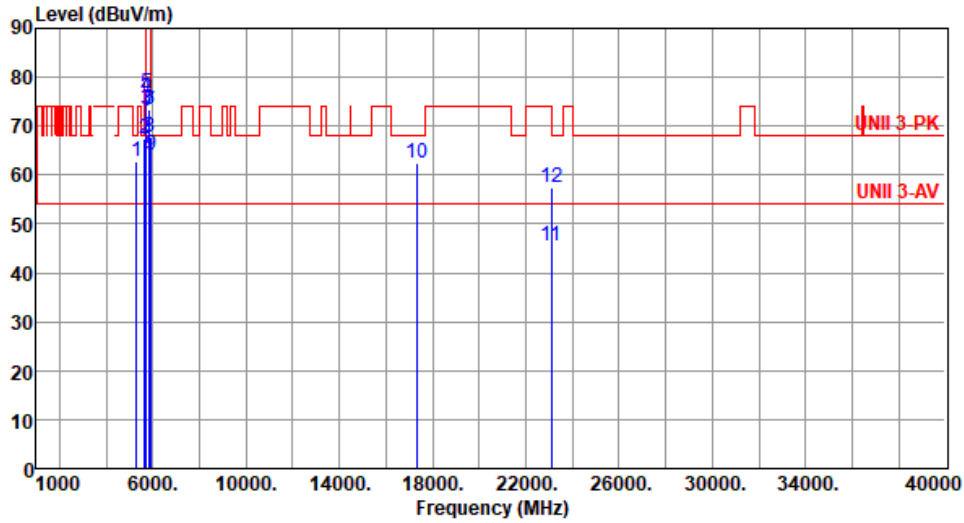

	Freq. MHz	Emission level dBuV/m	Limit dBuV/m	Margin dB	SA reading dBuV	Factor dB/m	Remark	ANT High cm	Turn Table deg
1	5280.00	62.63	68.20	-5.57	56.91	5.72	Peak	316	181
2	5650.00	67.34	68.20	-0.86	61.02	6.32	Peak	316	161
3	5700.00	73.26	105.20	-31.94	66.73	6.53	Peak	316	161
4	5720.00	75.90	110.80	-34.90	69.32	6.58	Peak	316	161
5	5725.00	76.70	122.20	-45.50	70.11	6.59	Peak	316	161
6	5850.00	73.38	122.20	-48.82	66.61	6.77	Peak	316	161
7	5855.00	73.04	110.80	-37.76	66.24	6.80	Peak	316	161
8	5875.00	67.90	105.20	-37.30	61.02	6.88	Peak	316	161
9	5925.00	64.24	68.20	-3.96	57.21	7.03	Peak	316	161
10	17325.00	62.32	68.20	-5.88	43.64	18.68	Peak	100	147
11	23100.00	45.61	54.00	-8.39	35.95	9.66	Average	317	142
12	23100.00	57.61	74.00	-16.39	47.95	9.66	Peak	317	142

Note 1: Emission Level (dBuV/m) = SA Reading (dBuV) + Factor* (dB/m)

*Factor includes antenna factor , cable loss and amplifier gain

Note 2: Margin (dB) = Emission level (dBuV/m) – Limit (dBuV/m).



Modulation	ax HE160-OFDMA	Test Freq. (MHz)	5250
Polarization	Horizontal		

Test By :Akun Chung Temperature(°C):23 Humidity(%):66

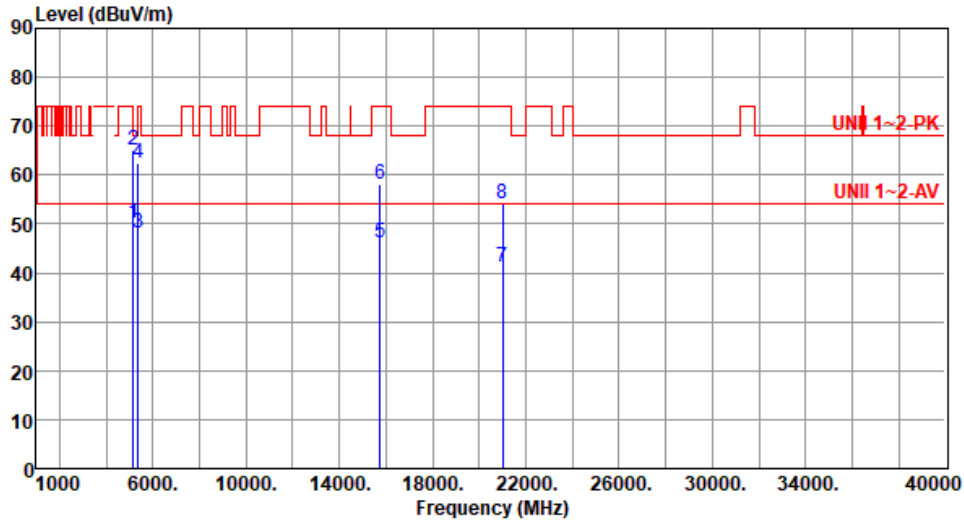

	Freq. MHz	Emission level dBUV/m	Limit dBUV/m	Margin dB	SA reading dBUV	Factor dB/m	Remark	ANT High cm	Turn Table deg
1	5150.00	50.27	54.00	-3.73	43.96	6.31	Average	322	321
2	5150.00	65.16	74.00	-8.84	58.85	6.31	Peak	322	321
3	5350.00	48.22	54.00	-5.78	42.50	5.72	Average	322	321
4	5350.00	62.52	74.00	-11.48	56.80	5.72	Peak	322	321
5	15750.00	46.01	54.00	-7.99	30.10	15.91	Average	100	208
6	15750.00	58.15	74.00	-15.85	42.24	15.91	Peak	100	208
7	21000.00	41.10	54.00	-12.90	34.33	6.77	Average	300	204
8	21000.00	54.12	74.00	-19.88	47.35	6.77	Peak	300	204

Note 1: Emission Level (dBUV/m) = SA Reading (dBUV) + Factor* (dB/m)

*Factor includes antenna factor , cable loss and amplifier gain

Note 2: Margin (dB) = Emission level (dBUV/m) – Limit (dBUV/m).



Modulation	ax HE160-OFDMA	Test Freq. (MHz)	5250
Polarization	Vertical		

Test By : Akun Chung Temperature(°C): 23 Humidity(%): 66

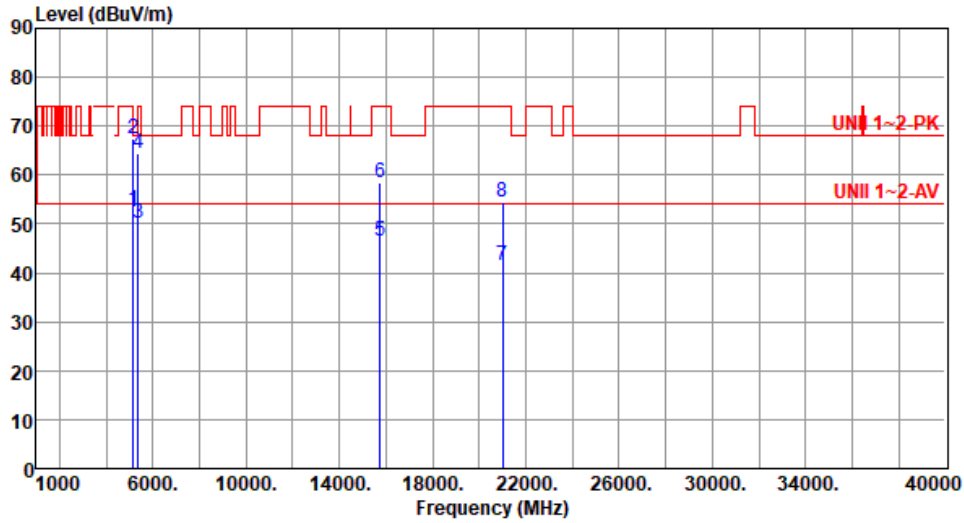

	Freq. MHz	Emission level dBuV/m	Limit dBuV/m	Margin dB	SA reading dBuV	Factor dB/m	Remark	ANT High cm	Turn Table deg
1	5150.00	52.86	54.00	-1.14	46.55	6.31	Average	307	170
2	5150.00	67.29	74.00	-6.71	60.98	6.31	Peak	307	170
3	5350.00	50.27	54.00	-3.73	44.55	5.72	Average	307	170
4	5350.00	64.52	74.00	-9.48	58.80	5.72	Peak	307	170
5	15750.00	46.49	54.00	-7.51	30.58	15.91	Average	100	147
6	15750.00	58.49	74.00	-15.51	42.58	15.91	Peak	100	147
7	21000.00	41.52	54.00	-12.48	34.75	6.77	Average	100	145
8	21000.00	54.46	74.00	-19.54	47.69	6.77	Peak	100	145

Note 1: Emission Level (dBuV/m) = SA Reading (dBuV) + Factor* (dB/m)

*Factor includes antenna factor , cable loss and amplifier gain

Note 2: Margin (dB) = Emission level (dBuV/m) – Limit (dBuV/m).



Modulation	ax HE160-OFDMA	Test Freq. (MHz)	5570
Polarization	Horizontal		

Test By :Brad Wu Temperature(°C):23 Humidity(%):65

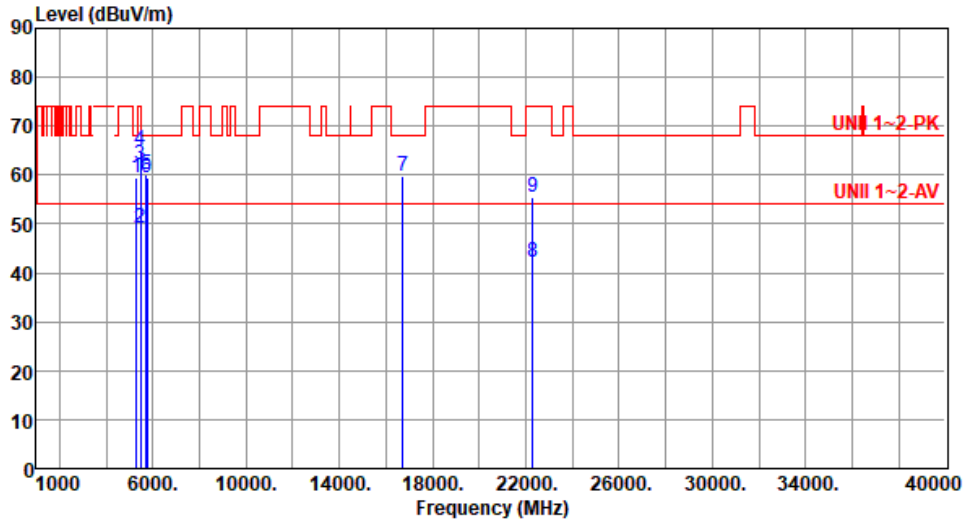

	Freq. MHz	Emission level dBuV/m	Limit dBuV/m	Margin dB	SA reading dBuV	Factor dB/m	Remark	ANT High cm	Turn Table deg
1	5280.00	59.49	68.20	-8.71	53.77	5.72	Peak	304	123
2	5460.00	49.14	54.00	-4.86	42.84	6.30	Average	304	123
3	5460.00	62.17	74.00	-11.83	55.87	6.30	Peak	304	123
4	5470.00	65.17	68.20	-3.03	58.85	6.32	Peak	304	123
5	5725.00	60.09	68.20	-8.11	53.50	6.59	Peak	304	123
6	5760.00	59.44	68.20	-8.76	52.80	6.64	Peak	304	123
7	16710.00	59.63	68.20	-8.57	42.10	17.53	Peak	100	200
8	22280.00	42.11	54.00	-11.89	33.80	8.31	Average	100	208
9	22280.00	55.56	74.00	-18.44	47.25	8.31	Peak	100	208

Note 1: Emission Level (dBuV/m) = SA Reading (dBuV) + Factor* (dB/m)

*Factor includes antenna factor , cable loss and amplifier gain

Note 2: Margin (dB) = Emission level (dBuV/m) – Limit (dBuV/m).



Modulation	ax HE160-OFDMA	Test Freq. (MHz)	5570						
Polarization	Vertical								
Test By :Brad Wu		Temperature(°C):23		Humidity(%):65					
	Freq. MHz	Emission level dBuV/m	Limit dBuV/m	Margin dB	SA reading dBuV	Factor dB/m	Remark	ANT High cm	Turn Table deg
1	5280.00	59.93	68.20	-8.27	54.21	5.72	Peak	292	155
2	5460.00	49.51	54.00	-4.49	43.21	6.30	Average	292	155
3	5460.00	66.40	74.00	-7.60	60.10	6.30	Peak	292	155
4	5470.00	67.77	68.20	-0.43	61.45	6.32	Peak	292	155
5	5725.00	61.33	68.20	-6.87	54.74	6.59	Peak	292	155
6	5760.00	61.27	68.20	-6.93	54.63	6.64	Peak	292	150
7	16710.00	60.11	68.20	-8.09	42.58	17.53	Peak	100	150
8	22280.00	42.91	54.00	-11.09	34.60	8.31	Average	310	155
9	22280.00	56.11	74.00	-17.89	47.80	8.31	Peak	310	155

Note 1: Emission Level (dBuV/m) = SA Reading (dBuV) + Factor* (dB/m)
 *Factor includes antenna factor , cable loss and amplifier gain
 Note 2: Margin (dB) = Emission level (dBuV/m) – Limit (dBuV/m).



Frequency: 5320 MHz	Frequency Drift (ppm)			
Temperature (°C)	0 minute	2 minutes	5 minutes	10 minutes
T20°CVmax	-2.00	-2.43	-2.15	-2.18
T20°CVmin	-1.40	-1.87	-0.82	-1.49
T50°CVnom	-4.28	-3.68	-4.09	-3.87
T40°CVnom	-2.17	-2.06	-2.22	-1.62
T30°CVnom	-2.20	-1.74	-2.34	-2.57
T20°CVnom	-0.21	-0.06	-0.52	-0.08
T10°CVnom	-1.48	-1.63	-0.96	-1.90
T0°CVnom	-0.19	-0.93	-0.65	-0.57
T-10°CVnom	-0.30	-0.47	-0.08	-0.79
T-20°CVnom	0.52	1.16	0.89	0.77
T-30°CVnom	2.77	2.03	2.75	1.80
Vnom [V]: 120	Vmax [V]: 138		Vmin [V]: 102	
Tnom [°C]: 20	Tmax [°C]: 50		Tmin [°C]: -30	

Frequency: 5785 MHz	Frequency Drift (ppm)			
Temperature (°C)	0 minute	2 minutes	5 minutes	10 minutes
T20°CVmax	-1.92	-1.57	-1.72	-1.51
T20°CVmin	-1.30	-1.96	-1.99	-1.30
T50CVnom	-4.15	-3.73	-4.03	-4.16
T40°CVnom	-2.64	-2.42	-2.84	-2.29
T30°CVnom	-1.94	-2.06	-2.49	-2.31
T20°CVnom	-0.48	-1.00	-0.92	-0.81
T10°CVnom	-1.21	-1.50	-0.77	-1.32
T0°CVnom	-1.07	-1.24	-0.98	-0.97
T-10°CVnom	-0.17	-0.10	-0.31	0.22
T-20°CVnom	-0.01	0.15	-0.28	0.17
T-30°CVnom	2.06	1.65	1.59	2.22
Vnom [V]: 120	Vmax [V]: 138		Vmin [V]: 102	
Tnom [°C]: 20	Tmax [°C]: 50		Tmin [°C]: -30	



POE mode

Modulation Mode	ax HE40-OFDMA	Test Freq. (MHz)	5230
Power Phase	Line		

Test by : Joe Liao Temperature: 20°C Humidity: 60%

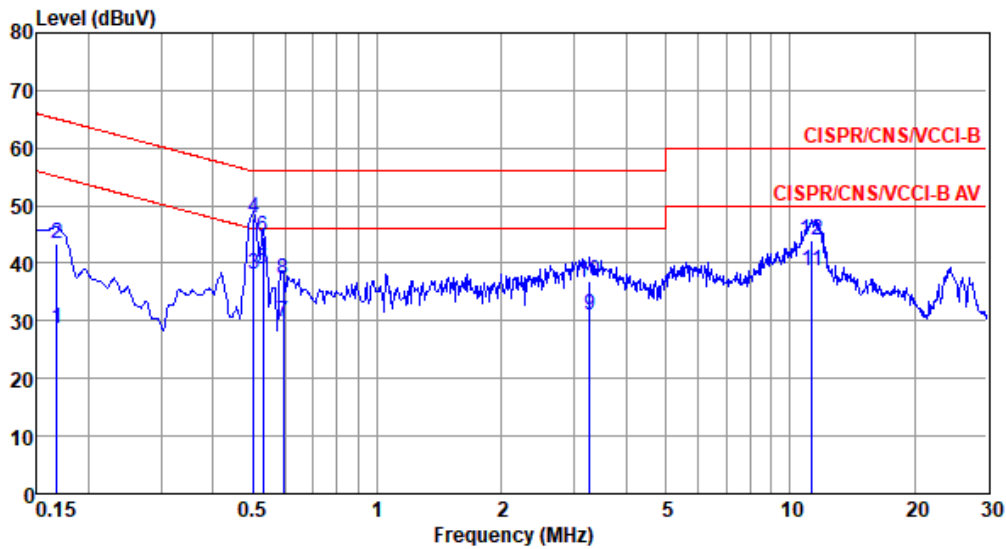

	Freq MHz	Level dBuV	Limit Line dBuV	Over Limit dB	Read Level dBuV	Factor dB	Cable loss dB	Aux dB	Remark
1	0.168	28.72	55.08	-26.36	19.04	9.60	0.08	0.00	Average
2	0.168	43.36	65.08	-21.72	33.68	9.60	0.08	0.00	QP
3	0.502	37.95	46.00	-8.05	28.25	9.60	0.10	0.00	Average
4	0.502	47.71	56.00	-8.29	38.01	9.60	0.10	0.00	QP
5*	0.529	38.88	46.00	-7.12	29.18	9.60	0.10	0.00	Average
6	0.529	44.44	56.00	-11.56	34.74	9.60	0.10	0.00	QP
7	0.592	29.94	46.00	-16.06	20.23	9.60	0.11	0.00	Average
8	0.592	37.24	56.00	-18.76	27.53	9.60	0.11	0.00	QP
9	3.276	30.87	46.00	-15.13	21.03	9.63	0.21	0.00	Average
10	3.276	36.87	56.00	-19.13	27.03	9.63	0.21	0.00	QP
11	11.317	38.61	50.00	-11.39	28.49	9.64	0.48	0.00	Average
12	11.317	43.85	60.00	-16.15	33.73	9.64	0.48	0.00	QP

Note 1: Level (dBuV) = Read Level (dBuV) + LISN Factor (dB) + Cable Loss (dB) + Aux (dB).
 Note 2: Over Limit (dB) = Level (dBuV) – Limit Line (dBuV).



Modulation Mode	ax HE40-OFDMA	Test Freq. (MHz)	5230
Power Phase	Neutral		

Test by : Joe Liao Temperature: 20°C Humidity: 60%

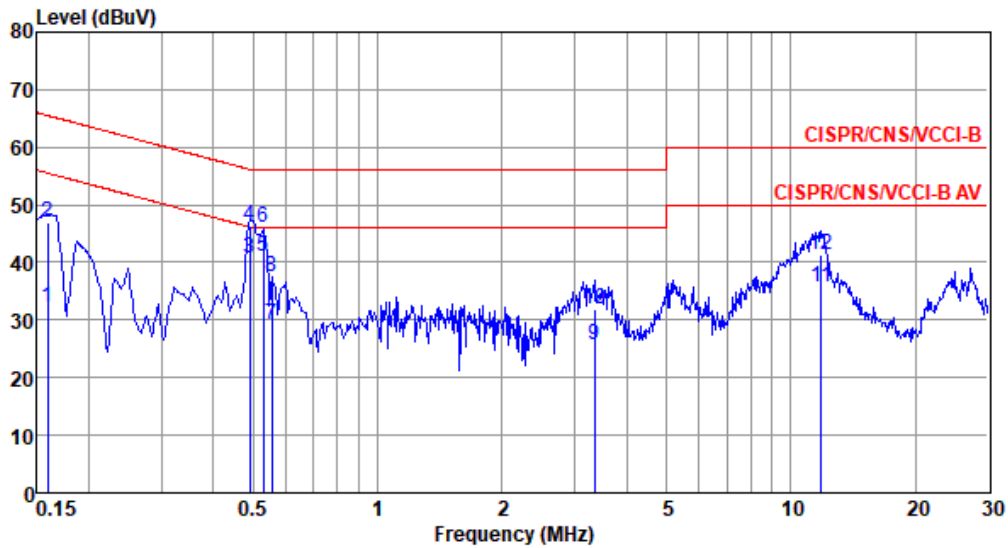

	Freq MHz	Level dBuV	Limit Line dBuV	Over Limit dB	Read Level dBuV	Factor dB	Cable loss dB	Aux dB	Remark
1	0.159	32.20	55.52	-23.32	22.53	9.59	0.08	0.00	Average
2	0.159	47.05	65.52	-18.47	37.38	9.59	0.08	0.00	QP
3	0.491	40.71	46.14	-5.43	31.03	9.58	0.10	0.00	Average
4	0.491	46.43	56.14	-9.71	36.75	9.58	0.10	0.00	QP
5*	0.529	41.08	46.00	-4.92	31.40	9.58	0.10	0.00	Average
6	0.529	46.19	56.00	-9.81	36.51	9.58	0.10	0.00	QP
7	0.555	29.25	46.00	-16.75	19.56	9.58	0.11	0.00	Average
8	0.555	37.61	56.00	-18.39	27.92	9.58	0.11	0.00	QP
9	3.346	25.70	46.00	-20.30	15.88	9.61	0.21	0.00	Average
10	3.346	31.81	56.00	-24.19	21.99	9.61	0.21	0.00	QP
11	11.870	35.79	50.00	-14.21	25.63	9.66	0.50	0.00	Average
12	11.870	41.44	60.00	-18.56	31.28	9.66	0.50	0.00	QP

Note 1: Level (dBuV) = Read Level (dBuV) + LISN Factor (dB) + Cable Loss (dB) + Aux (dB).
 Note 2: Over Limit (dB) = Level (dBuV) - Limit Line (dBuV).



Modulation Mode	11a	Test Freq. (MHz)	5745
Power Phase	Line		

Test by : Joe Liao Temperature: 20°C Humidity: 60%

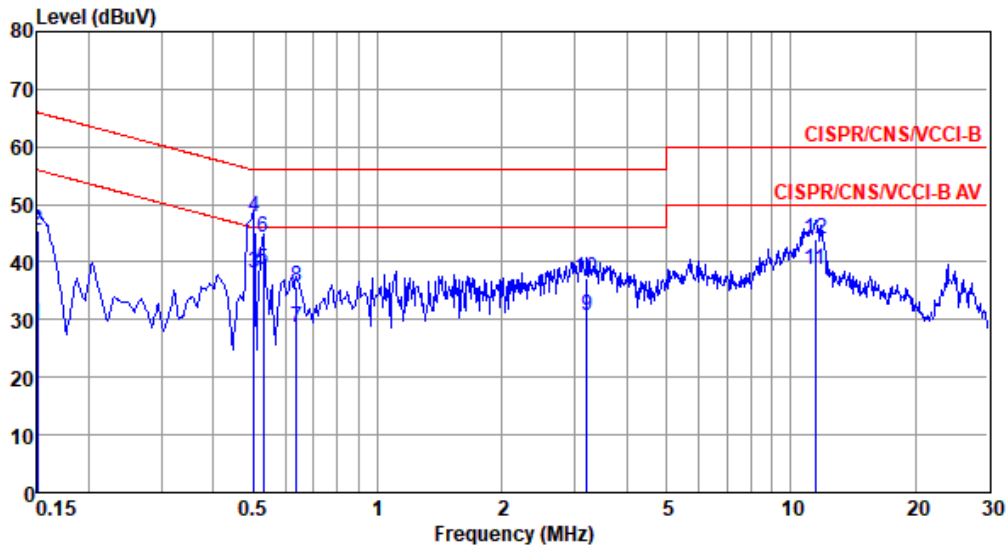

	Freq MHz	Level dBuV	Limit Line dBuV	Over Limit dB	Read Level dBuV	Factor dB	Cable loss dB	Aux dB	Remark
1	0.150	29.27	56.00	-26.73	19.59	9.60	0.08	0.00	Average
2	0.150	45.54	66.00	-20.46	35.86	9.60	0.08	0.00	QP
3	0.502	38.00	46.00	-8.00	28.30	9.60	0.10	0.00	Average
4	0.502	47.75	56.00	-8.25	38.05	9.60	0.10	0.00	QP
5*	0.529	38.77	46.00	-7.23	29.07	9.60	0.10	0.00	Average
6	0.529	44.41	56.00	-11.59	34.71	9.60	0.10	0.00	QP
7	0.637	28.57	46.00	-17.43	18.84	9.61	0.12	0.00	Average
8	0.637	35.75	56.00	-20.25	26.02	9.61	0.12	0.00	QP
9	3.207	30.61	46.00	-15.39	20.77	9.63	0.21	0.00	Average
10	3.207	37.24	56.00	-18.76	27.40	9.63	0.21	0.00	QP
11	11.438	38.62	50.00	-11.38	28.49	9.64	0.49	0.00	Average
12	11.438	43.98	60.00	-16.02	33.85	9.64	0.49	0.00	QP

Note 1: Level (dBuV) = Read Level (dBuV) + LISN Factor (dB) + Cable Loss (dB) + Aux (dB).
 Note 2: Over Limit (dB) = Level (dBuV) – Limit Line (dBuV).



Modulation Mode	11a	Test Freq. (MHz)	5745
Power Phase	Neutral		

Test by : Joe Liao Temperature: 20°C Humidity: 60%

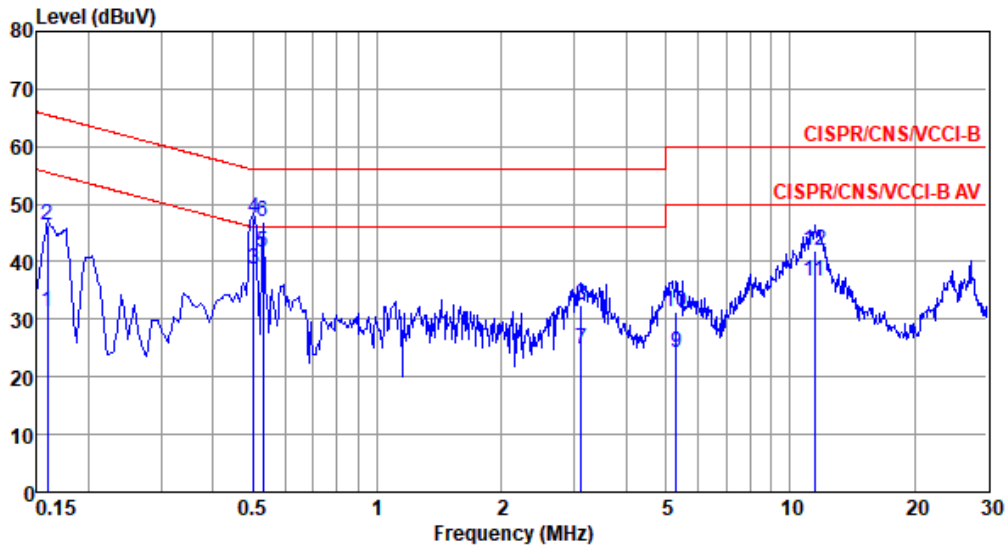

	Freq MHz	Level dBuV	Limit Line dBuV	Over Limit dB	Read Level dBuV	Factor dB	Cable loss dB	Aux dB	Remark
1	0.159	31.43	55.52	-24.09	21.76	9.59	0.08	0.00	Average
2	0.159	46.37	65.52	-19.15	36.70	9.59	0.08	0.00	QP
3	0.502	38.66	46.00	-7.34	28.98	9.58	0.10	0.00	Average
4	0.502	47.43	56.00	-8.57	37.75	9.58	0.10	0.00	QP
5*	0.529	41.69	46.00	-4.31	32.01	9.58	0.10	0.00	Average
6	0.529	47.06	56.00	-8.94	37.38	9.58	0.10	0.00	QP
7	3.123	24.72	46.00	-21.28	14.90	9.61	0.21	0.00	Average
8	3.123	32.44	56.00	-23.56	22.62	9.61	0.21	0.00	QP
9	5.305	24.23	50.00	-25.77	14.33	9.62	0.28	0.00	Average
10	5.305	31.25	60.00	-28.75	21.35	9.62	0.28	0.00	QP
11	11.438	36.52	50.00	-13.48	26.37	9.66	0.49	0.00	Average
12	11.438	41.86	60.00	-18.14	31.71	9.66	0.49	0.00	QP

Note 1: Level (dBuV) = Read Level (dBuV) + LISN Factor (dB) + Cable Loss (dB) + Aux (dB).
 Note 2: Over Limit (dB) = Level (dBuV) – Limit Line (dBuV).



Adapter mode

Modulation Mode	ax HE40-OFDMA	Test Freq. (MHz)	5230
Power Phase	Line		

Test by : Joe Liao Temperature: 20°C Humidity: 60%

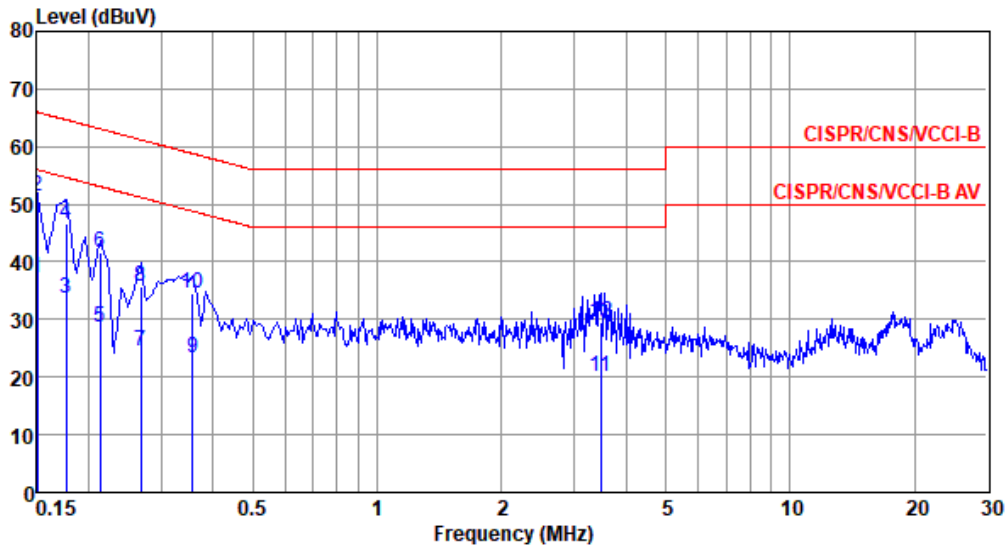

	Freq MHz	Level dBuV	Limit Line dBuV	Over Limit dB	Read Level dBuV	Factor dB	Cable loss dB	Aux dB	Remark
1	0.150	37.16	56.00	-18.84	27.28	9.60	0.08	0.20	Average
2*	0.150	51.45	66.00	-14.55	41.57	9.60	0.08	0.20	QP
3	0.177	33.68	54.64	-20.96	23.78	9.61	0.08	0.21	Average
4	0.177	46.57	64.64	-18.07	36.67	9.61	0.08	0.21	QP
5	0.213	28.76	53.10	-24.34	18.84	9.61	0.08	0.23	Average
6	0.213	41.57	63.10	-21.53	31.65	9.61	0.08	0.23	QP
7	0.267	24.52	51.20	-26.68	14.55	9.61	0.08	0.28	Average
8	0.267	35.58	61.20	-25.62	25.61	9.61	0.08	0.28	QP
9	0.358	23.43	48.78	-25.35	13.41	9.60	0.08	0.34	Average
10	0.358	34.64	58.78	-24.14	24.62	9.60	0.08	0.34	QP
11	3.472	20.03	46.00	-25.97	9.78	9.63	0.21	0.41	Average
12	3.472	29.50	56.00	-26.50	19.25	9.63	0.21	0.41	QP

Note 1: Level (dBuV) = Read Level (dBuV) + LISN Factor (dB) + Cable Loss (dB) + Aux (dB).

Note 2: Over Limit (dB) = Level (dBuV) – Limit Line (dBuV).



Modulation Mode	ax HE40-OFDMA	Test Freq. (MHz)	5230
Power Phase	Neutral		

Test by : Joe Liao Temperature: 20°C Humidity: 60%

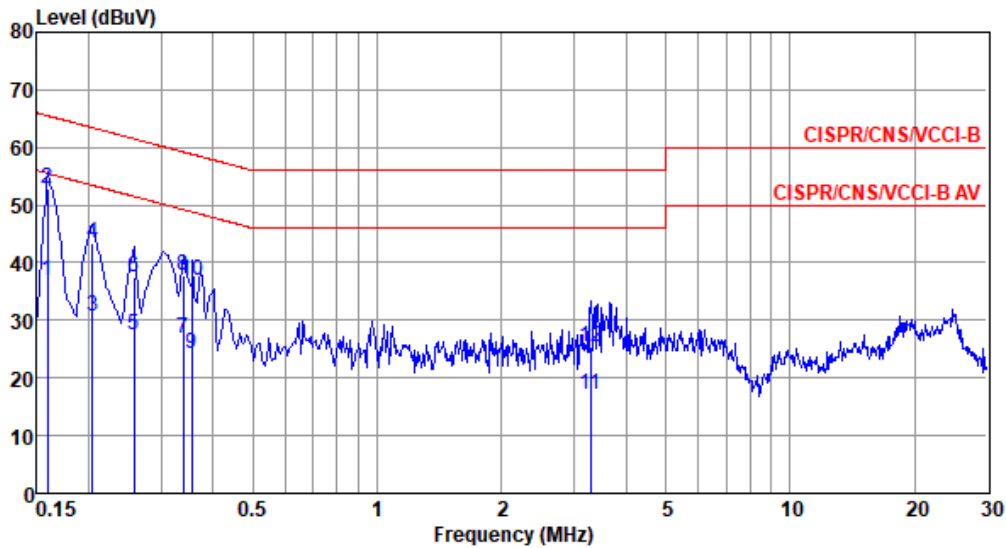

	Freq MHz	Level dBuV	Limit Line dBuV	Over Limit dB	Read Level dBuV	Factor dB	Cable loss dB	Aux dB	Remark
1	0.159	37.00	55.52	-18.52	27.17	9.59	0.08	0.16	Average
2*	0.159	52.80	65.52	-12.72	42.97	9.59	0.08	0.16	QP
3	0.204	30.78	53.45	-22.67	20.93	9.59	0.08	0.18	Average
4	0.204	43.36	63.45	-20.09	33.51	9.59	0.08	0.18	QP
5	0.258	27.37	51.51	-24.14	17.52	9.59	0.08	0.18	Average
6	0.258	37.52	61.51	-23.99	27.67	9.59	0.08	0.18	QP
7	0.339	26.93	49.22	-22.29	17.08	9.58	0.08	0.19	Average
8	0.339	37.65	59.22	-21.57	27.80	9.58	0.08	0.19	QP
9	0.355	24.19	48.84	-24.65	14.34	9.58	0.08	0.19	Average
10	0.355	36.80	58.84	-22.04	26.95	9.58	0.08	0.19	QP
11	3.293	17.05	46.00	-28.95	6.91	9.61	0.21	0.32	Average
12	3.293	25.30	56.00	-30.70	15.16	9.61	0.21	0.32	QP

Note 1: Level (dBuV) = Read Level (dBuV) + LISN Factor (dB) + Cable Loss (dB) + Aux (dB).
 2: Over Limit (dB) = Level (dBuV) – Limit Line (dBuV).



Modulation Mode	11a	Test Freq. (MHz)	5745
Power Phase	Line		

Test by : Joe Liao Temperature: 20°C Humidity: 60%

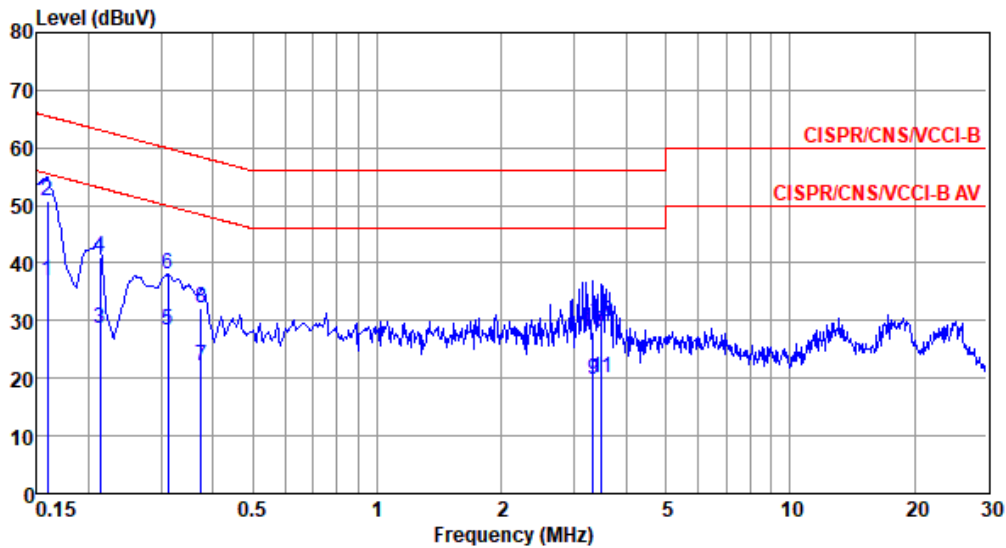

	Freq MHz	Level dBuV	Limit Line dBuV	Over Limit dB	Read Level dBuV	Factor dB	Cable loss dB	Aux dB	Remark
1	0.159	36.85	55.52	-18.67	26.97	9.60	0.08	0.20	Average
2*	0.159	50.90	65.52	-14.62	41.02	9.60	0.08	0.20	QP
3	0.213	28.64	53.10	-24.46	18.72	9.61	0.08	0.23	Average
4	0.213	41.12	63.10	-21.98	31.20	9.61	0.08	0.23	QP
5	0.312	28.26	49.93	-21.67	18.27	9.60	0.08	0.31	Average
6	0.312	37.95	59.93	-21.98	27.96	9.60	0.08	0.31	QP
7	0.375	22.29	48.39	-26.10	12.26	9.60	0.08	0.35	Average
8	0.375	32.14	58.39	-26.25	22.11	9.60	0.08	0.35	QP
9	3.328	19.64	46.00	-26.36	9.39	9.63	0.21	0.41	Average
10	3.328	27.95	56.00	-28.05	17.70	9.63	0.21	0.41	QP
11	3.491	19.98	46.00	-26.02	9.73	9.63	0.21	0.41	Average
12	3.491	29.69	56.00	-26.31	19.44	9.63	0.21	0.41	QP

Note 1: Level (dBuV) = Read Level (dBuV) + LISN Factor (dB) + Cable Loss (dB) + Aux (dB).
 Note 2: Over Limit (dB) = Level (dBuV) - Limit Line (dBuV).



Modulation Mode	11a	Test Freq. (MHz)	5745
Power Phase	Neutral		

Test by : Joe Liao Temperature: 20°C Humidity: 60%

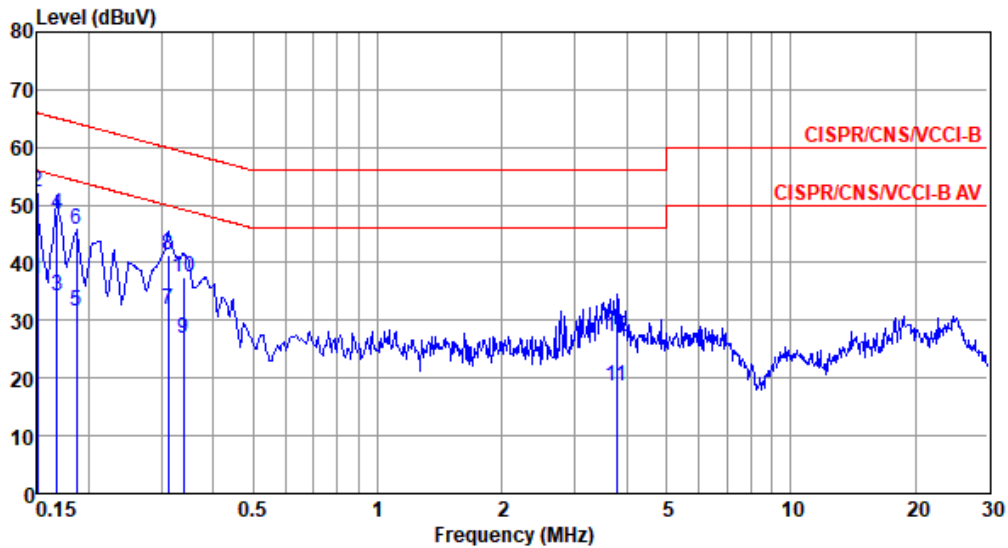

	Freq MHz	Level dBuV	Limit Line dBuV	Over Limit dB	Read Level dBuV	Factor dB	Cable loss dB	Aux dB	Remark
1	0.150	37.10	56.00	-18.90	27.27	9.59	0.08	0.16	Average
2*	0.150	52.29	66.00	-13.71	42.46	9.59	0.08	0.16	QP
3	0.168	34.30	55.08	-20.78	24.46	9.59	0.08	0.17	Average
4	0.168	48.39	65.08	-16.69	38.55	9.59	0.08	0.17	QP
5	0.186	31.65	54.20	-22.55	21.81	9.59	0.08	0.17	Average
6	0.186	45.68	64.20	-18.52	35.84	9.59	0.08	0.17	QP
7	0.312	31.88	49.93	-18.05	22.03	9.58	0.08	0.19	Average
8	0.312	41.44	59.93	-18.49	31.59	9.58	0.08	0.19	QP
9	0.339	26.82	49.22	-22.40	16.97	9.58	0.08	0.19	Average
10	0.339	37.57	59.22	-21.65	27.72	9.58	0.08	0.19	QP
11	3.779	18.52	46.00	-27.48	8.37	9.61	0.21	0.33	Average
12	3.779	27.29	56.00	-28.71	17.14	9.61	0.21	0.33	QP

Note 1: Level (dBuV) = Read Level (dBuV) + LISN Factor (dB) + Cable Loss (dB) + Aux (dB).
 2: Over Limit (dB) = Level (dBuV) – Limit Line (dBuV).