

Use & Care Guide
Manual de Uso y Cuidado
Manuel d'entretien et d'utilisation

Kenmore Elite^{®/MD}

CSV | Max

Cordless Stick Vac

Aspiradora Inalámbrica de Vara

Aspirateur-balai Sans Fil

Model/Modelo/Modèle: DS4090

Vacuum Cleaner Help Line:
1-877-531-7321 (US) / 1-844-608-3081 (CA)
8:00am-5:00pm EST, M-F
www.kenmorefloorcare.com



TABLE OF CONTENTS

Before Using Your New Vacuum Cleaner	2
Packing List	2
Important Safety Instructions.....	3-4
Vacuum Cleaner Warranty	5
Parts and Features.....	6-8
Assembly Instructions	9-10
Operating Instructions	11-12
Vacuum Maintenance and Care.....	13-16
Troubleshooting	17-18
Requesting Assistance Or Service	Back Cover

BEFORE USING YOUR NEW VACUUM CLEANER

Read this Use & Care Guide. It will help you assemble and operate your new Kenmore vacuum cleaner in the safest and most effective way.

For more information about vacuum cleaner care and operation, call the Vacuum Cleaner Help Line at 1-877-531-7321 (US) / 1-844-608-3081 (CA). You will need the complete model and serial numbers when requesting information.

Your vacuum cleaner's model and serial numbers are located on the Model and Serial Number Plate. Use the space below to record the model number and serial number of your new Kenmore vacuum cleaner.

Model No. _____

Serial No. _____

Date of Purchase _____

Keep this book and your sales check (receipt) in a safe place for future reference.

PACKING LIST

Your KENMORE ELITE CORDLESS VACUUM CLEANER is packaged with the following parts and components assembled separately in the carton:

1 Hand Vacuum	1 Wall Mountable Bracket
1 Motorized Nozzle	2 Screws
1 Wand	1 Charging Adapter
1 Combination Tool	1 Manual

IMPORTANT SAFETY INSTRUCTIONS

WARNING!

READ ALL INSTRUCTIONS IN THIS GUIDE BEFORE ASSEMBLING OR USING YOUR VACUUM CLEANER. To reduce the risk of fire, electrical shock, injury to persons or damage when using your vacuum cleaner, follow all safety precautions listed below.

- Use your vacuum only as described in this Use & Care Guide.
- Do not use or charge outdoors or on wet surfaces.
- Do not allow to be used as a toy. Close attention is necessary when used by or near children, pets or plants.
- Use only manufacturer's recommended attachments. Do not use attachments other than those supplied with this vacuum.
- Do not handle charger, including charger plug, and charger terminals with wet hands.
- Do not put any object into openings. Do not use with any opening blocked; keep free of dust, lint, hair, and anything that may reduce air flow.
- Keep hair, loose clothing, fingers, and all parts of body away from openings and moving parts.
- Use extra care when cleaning on stairs.
- Do not use to pick up flammable or combustible liquids, such as gasoline, or use in areas where they may be present.
- Switch off the appliance before connecting the accessories.
- Do not pick up anything that is burning or smoking, such as cigarettes, matches, or hot ashes.
- Do not pick toxic solution such as chlorine bleach, ammonia or drain cleaner.
- Do not use without dust cup and HEPA filter in place.
- Do not charge the unit outdoors.
- Prevent unintentional starting. Ensure the product does not operate before connecting to hand vacuum, picking up or carrying the appliance.
- Do not attempt to charge the appliance with the switch in the on position.
- Do not attempt to use this charging adapter with any other product nor attempt to charge this product with another charging adapter.
- To recharge vacuum, use only Yinli YLS0241AT256080 or Xdroid XZ2560-0800EU charger adapter.
- Do not use an appliance that is damaged or modified. Damaged or modified appliance may exhibit unpredictable behavior resulting in fire, explosion or risk of injury.
- Do not immerse vacuum cleaner, or charging adapter in water or other liquids.
- Always turn the vacuum off before connecting or disconnecting the motorized nozzle.
- Store the cordless vacuum indoors. Put the cordless vacuum away after use to prevent accidents.
- Keep your work area well lit.
- Keep the vacuum moving over the carpet surface at all times to avoid damaging the carpet fibers.
- Do not vacuum up any liquids.
- Do not use in an enclosed space where vapors are present from paint, paint thinner, moth-proofing substances, flammable dust or other explosive or toxic materials.

IMPORTANT SAFETY INSTRUCTIONS

- Do not pick up hard or sharp objects such as glass, nail, screws or coins that could damage the vacuum cleaner.
- To avoid excessive heat and damage to unit or batteries, do not operate the vacuum while charging.
- Do not use extension cords or outlets with inadequate current carrying capacity.
- Do not expose an appliance to fire or excessive temperature. Exposure to fire or temperature above 265°F (130°C) may cause explosion.
- Leaks from battery cells can occur under extreme usage or temperature conditions. If the liquid gets on skin, wash quickly with water. If liquid gets into the eyes, flush them immediately with clean water for a minimum of 10 minutes. Seek medical attention.
- While there is no shock hazard from electrical terminals located on the vacuum, a burn could result from metal objects being inserted into the terminal areas. Vacuum cleaner terminals should always be kept free of objects.
- Store charger indoors in a cool, dry area, not exposed to weather to avoid electrical shock and/or damage to the vacuum cleaner.
- Changes or modifications to this unit not expressly approved by the party responsible for compliance could void the user's authority to operate the equipment.
- Charging improperly or at temperatures outside of the specified range may damage the battery and increase the risk of fire.
- You are responsible for making sure that your vacuum cleaner is not used by anyone who is unable to operate it properly.
- Have servicing performed by a qualified repair person using only identical replacement parts. This will ensure that the safety of the product is maintained.
- Do not modify or attempt to repair the appliance or the battery pack (as applicable) except as indicated in the instructions for use and care.
- **This appliance is designed for household use only!**

NOTICE

This device complies with part 15 of the FCC Rules. Operation is subject to the following two conditions.

1. This device may not cause harmful interference.
2. This device must accept any interference received, including interference that may cause undesired operation.

Product Disposal

This product contains an internal Lithium-ion battery pack formulated from environmentally sensitive materials. This product must be disposed of properly with due care for the environment. Do not dispose of product with household garbage. Consult your local waste authority for information regarding available recycling or disposal options.

SAVE THESE INSTRUCTIONS

Household use only.

VACUUM CLEANER WARRANTY

LIMITED WARRANTY

FOR ONE YEAR from the date of sale this product is warranted against defects in material or workmanship.

WITH PROOF OF SALE a defective product will be replaced free of charge.

The Kenmore brand is used under license. Direct all claims for warranty service to: 1-877-531-7321 (US) / 1-844-608-3081 (CA).

This warranty does not cover filters or belts, which are expendable parts that can wear out from normal use within the warranty period.

This warranty is void if this product is ever used for other than private household purposes.

This warranty gives you specific legal rights, and you may also have other rights which vary from state to state.

Cleva North America, Inc., Greenville SC 29607

PARTS AND FEATURES

It is important to know your vacuum cleaners parts and features to assure its proper and safe use. Review these before using your vacuum.

REPLACEMENT PARTS

Item	Part No.(US)	Part No.(CA)
HEPA Media Filter	561051107	561051107
Pre-Filter Basket	561057103	561057103
Brush Roll	571018102	571018102
2-in-1 Combination Tool	561051104	561051104
Wall Mountable Bracket	571018103	571018103
Screw (2)	551001122	551001122

To order a replacement part, call
1-877-531-7321 (US) /
1-844-608-3081 (CA).

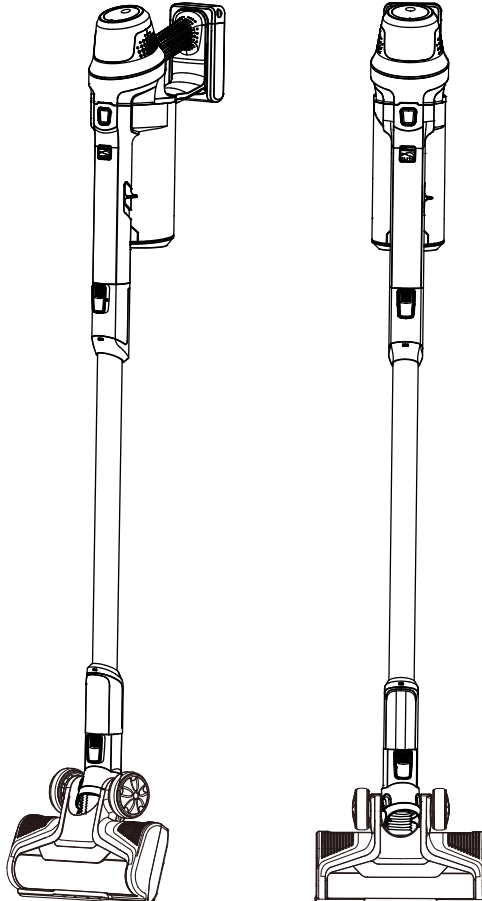

PARTS AND FEATURES

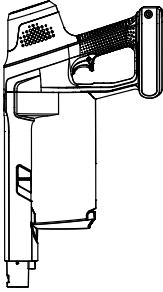

Hand Vacuum



Charging Adapter

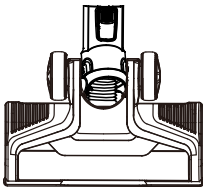

Motorized Nozzle



Wand

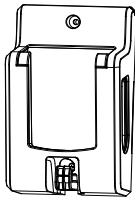

Wall Mountable Bracket



Screw (2)

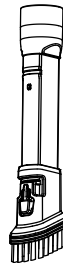

2-in-1 Combination Tool

PARTS AND FEATURES

The motorized nozzle and the combination tool can be inserted into either the hand vacuum or the wand. You will hear a click if the motorized nozzle is installed correctly.

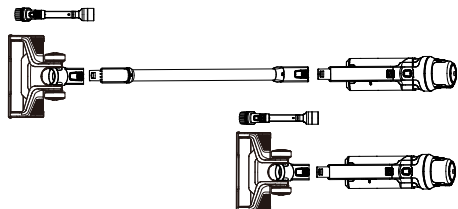

Combination Tool

The combination brush can be used as a crevice tool or as a dusting brush. To use as a dusting brush, simply squeeze the buttons in the side of the tool and shift brush forward.

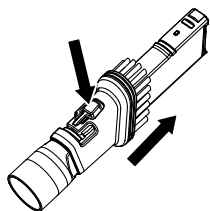

Crevice Tool Mode

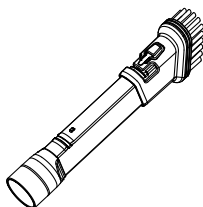

Dusting Brush Mode

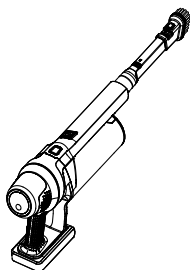
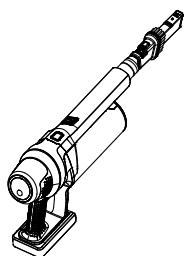

NOTE: For proper electrical contact, always be sure that metal contact surfaces of the motorized nozzle, the wand and the hand vacuum are clean before use.

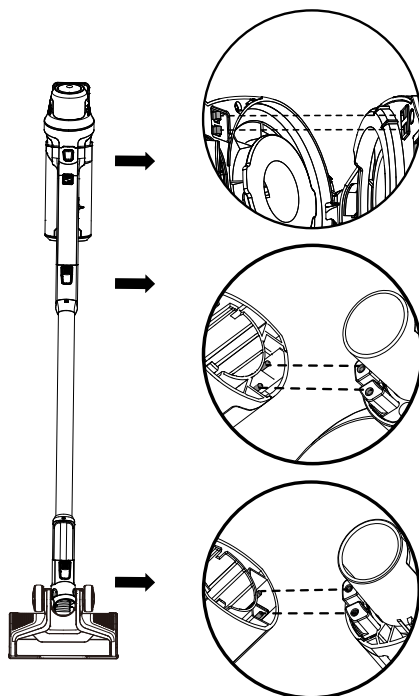

Friction Hold Stoppers

The back of the hand vacuum features two rubber stoppers. When you lean the stick vac against a wall, the stoppers help prevent the unit from slipping down and possibly being damaged.

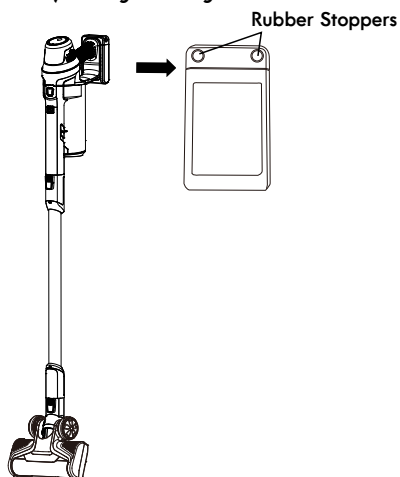

ASSEMBLY INSTRUCTIONS

Before assembling the vacuum cleaner, check the PACKING LIST (Page 2). Use this list to verify that you have received all the components of your new Kenmore Elite CSV Max Cordless Stick Vac.

1. Insert the hand vacuum into the top of the wand until you hear a click.

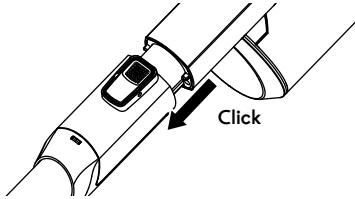

2. Insert the bottom of the wand into the motorized nozzle until you hear a click.

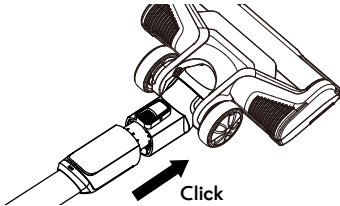

3. Use the 2 screws provided to mount the bracket on the wall, but not to drywall only. Secure the screws to a stud. Mount at a recommended height of 59" and no less than 44" above the floor. Ensure that no plumbing or electrical cables, wires or ductwork are located directly behind the mounting area.

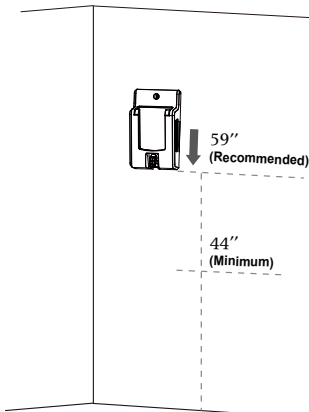

4. Hang the hand vacuum on the wall mount. Align the base of the hand vacuum with the wall mount and slide in as shown in the picture below.

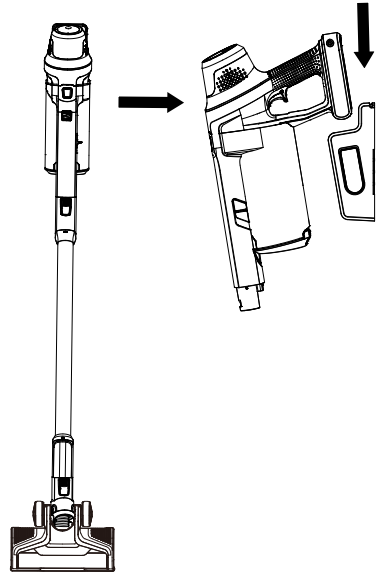

NOTE: To be able to charge vacuum while it is mounted, attach bracket to wall no more than 59" from wall electrical outlet.

CHARGING

WARNING

Before charging make sure the unit is turned OFF.

1. Insert the charging adapter plug into the charging port on the side of the hand vacuum base.
2. Plug the adapter into a wall outlet. The battery indicator will begin to pulse blue.

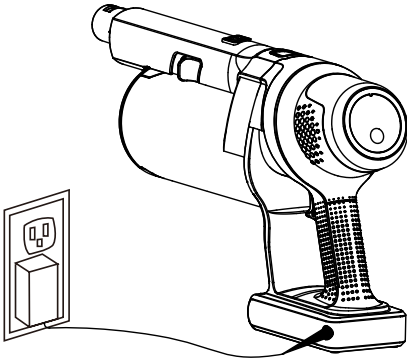

NOTE: The unit can be charged while it is hung on the wall mountable bracket. Attach bracket to wall no more than 59" from a wall electrical outlet.

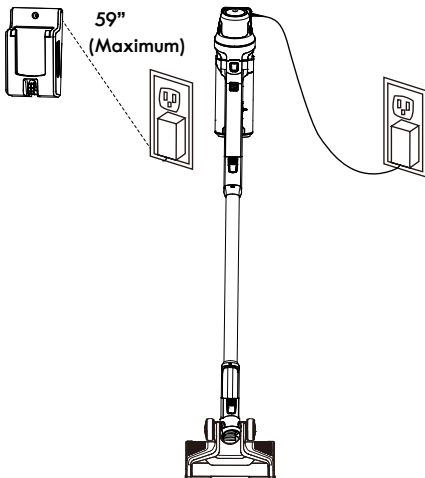

The battery requires approximately 4 hours of charging to regain full capacity. While the unit is charging, the battery indicator ring will pulse blue. When the battery is fully charged, the battery indicator will show a continuous blue light, and turn off after 15 minutes.

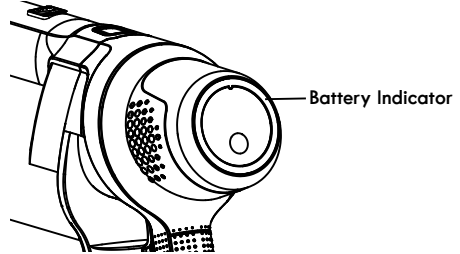

NOTE: Before using stick vacuum for the first time, charge vacuum to full capacity.

NOTE: If the battery indicator does not illuminate when charging, ensure that the charging adapter is plugged in properly to the wall outlet and the charging port on the hand vacuum.

For better battery performance, it is recommended to charge the unit when the battery indicator shows a continuous yellow light during operation, and remove the charging adapter from the unit after the battery is fully charged.

Never charge the batteries in temperatures above 104°F (40°C) or below 39.2°F (4°C). It is normal for the charger to become warm when charging.

OPERATING INSTRUCTIONS

CAUTION

Moving parts! To reduce the risk of personal injury, **DO NOT** touch the brush roll when vacuum is on. Contacting the brush roll while it is rotating can cut, bruise or cause other injuries. Always turn off before servicing. Use caution when operating near children or pets.

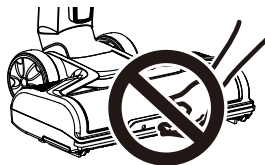

CONTROL BUTTONS

The on/off trigger button is located on the inner side of the hand vacuum handle. The vacuum has two-speed controls, ECO and HIGH. Change speed by pressing the speed change button shown below.

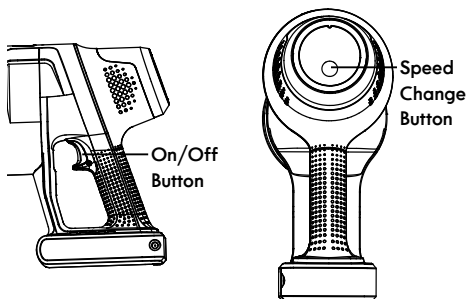

Battery Power Level Indicator

The battery power level indicator lights up to give you an idea of how much battery power remains at any given time.

Battery Power Level Indicator	Battery Capacity
Blue, Continuous	75%~100%
Green, Continuous	50%~74%
Yellow, Continuous	25%~49% (Recharge recommended)
Red, Continuous	10%~24%
Red, Flashing	0~9% (Recharge required)

NOTE: Please remove the battery indicator label before first use.

VACUUM OPERATION

CAUTION

Operate the appliance at room temperature between 39.2°F (4°C) and 104°F (40°C) in order to ensure safe and normal function.

Before vacuuming floors, connect the motorized nozzle to the wand. Then connect the hand vacuum to the wand. The motorized nozzle can be used for cleaning

carpets or rugs, as well as hard floors.

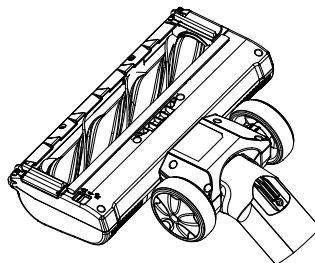

VACUUM OPERATION

To start the vacuum, press the on/off trigger button. Once turned on, the battery level indicator will be lit.

The vacuum starts in the ECO speed position. To switch the speed to HIGH, press the speed change button. Press the speed change button again to switch back to ECO speed.

To turn the vacuum off, press the on/off trigger button again.

When vacuuming on plush carpet, use ECO mode for best performance.

NOTE: When battery power decreases to about 10% remaining, the battery level indicator will start red flashing. The flashing will continue until the unit is charged or is completely out of battery power.

CLEANING WITH THE HAND VACUUM

Easily clean messes on furniture, upholstery, stairs and other hard-to-reach areas with the included combination tool.

1. To detach the hand vacuum, press the wand release button and pull the wand from the hand vacuum.

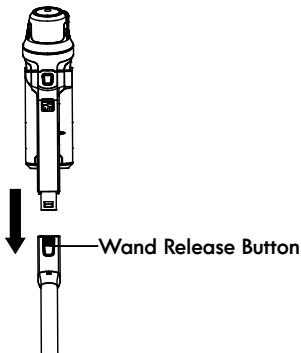

2. Install the combination tool onto the end of the hand vacuum.

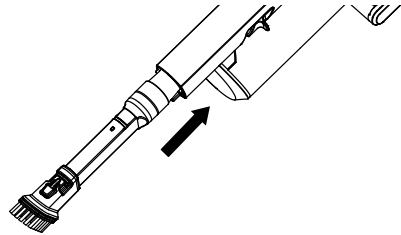

3. When finished cleaning, turn the hand vacuum OFF and remove the combination tool.

VACUUM MAINTENANCE AND CARE

CAUTION

To reduce the risk of electric shock, remove the charging adapter from the unit, and make sure the unit is turned off before any maintenance.

EMPTYING DUST CUP AND CLEANING FILTER

Dust Cup Emptying

For best performance, empty dust cup after every use or once dust reaches max fill line. Never operate the vacuum cleaner without dust cup and filter in place.

Before emptying the dust cup, ensure the vacuum is turned off.

1. Position dust cup lid area of vacuum over a waste receptacle. Press down the dust cup release latch to open dust cup lid and allow cup contents to drop into waste receptacle.

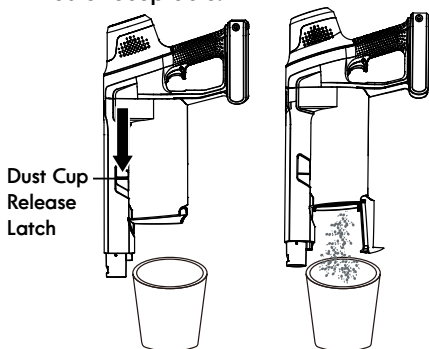

2. Close dust cup lid until you hear a click.

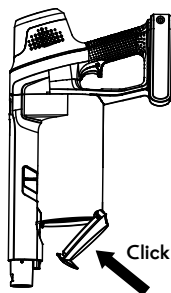

Filter Cleaning

If there is hair wrapped or blocked in the dust cup or the suction power is weak, it is necessary to wash the HEPA media filter and pre-filter basket to clean off accumulated dust or hair.

NOTE: For optimal performance, please check and clean the HEPA Media filter regularly.

WARNING: Do not operate vacuum cleaner without filters in place.

1. With one hand grasped around the handle, press the filter release button to separate the dust cup and filters from the hand vacuum.

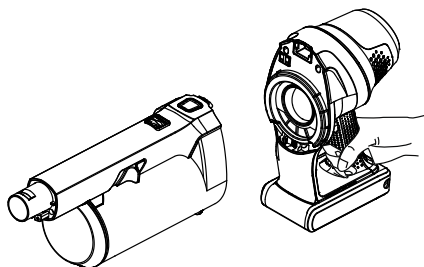
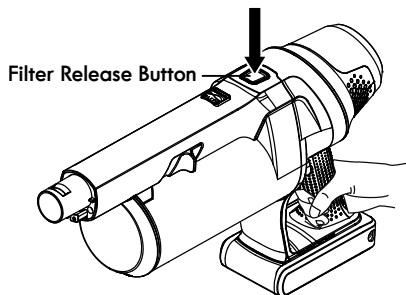

EMPTYING DUST CUP AND CLEANING FILTER

2. Remove the HEPA media filter and pre-filter basket from the dust cup.

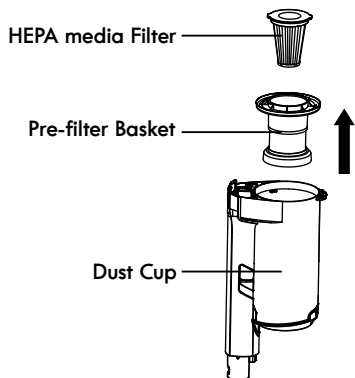

3. Brush loose debris from HEPA media filter and pre-filter basket and then rinse with warm water. Set both filters aside and allow to air dry for 24 hours.

IMPORTANT: The HEPA media filter and pre-filter must dry completely before reuse.

4. Place the pre-filter basket back into the dust cup, then place the HEPA media filter back into the pre-filter basket.

5. To reassemble the dust cup to the hand vacuum, align the tabs on the dust cup with slots in the hand vacuum. Once aligned, attach the dust cup to the hand vacuum until you hear a click.

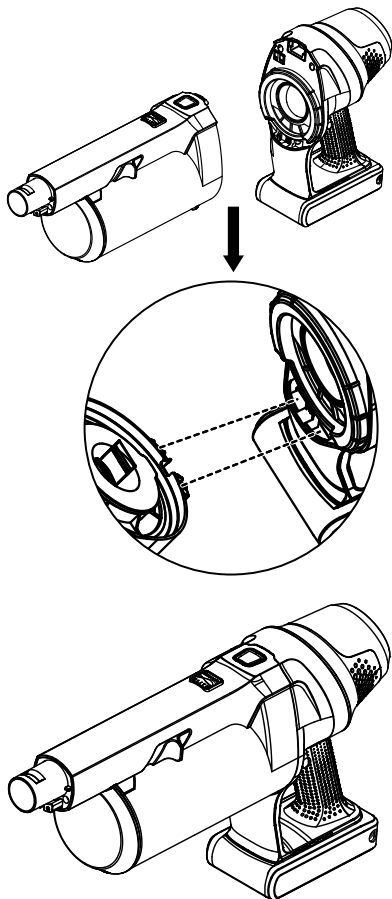

CLEANING THE MOTORIZED NOZZLE & BLOCKAGES

The brush roll may accumulate debris such as strings, hair and fibers. This type of debris can wrap around the brush and diminish its ability to clean effectively.



CAUTION

Risk of injury. Brush may start unexpectedly. Disconnect power nozzle from wand before cleaning or servicing.

Brush Roll Manual Cleaning

1. Make sure the vacuum cleaner is turned off. Remove the wand and the hand vacuum from the motorized nozzle and set aside.
2. Turn the nozzle over to access the brush roll. As shown below, push the tab to the unlock position "□" and hold it. Remove the locking lever.

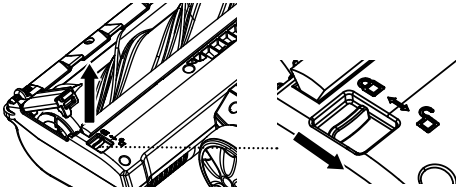

3. With the tab held in the unlock position, lift the brush roll out of the nozzle housing. Clean off debris and anything wrapped around the brush roll. Use a pair of scissors to remove threads, etc. For best performance, clean edges of round end caps of the brush roll and nozzle housing regularly.

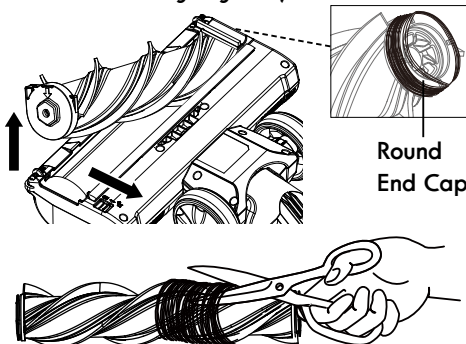

4. Place the brush roll back into the housing. First re-insert the round end cap of the brush roll into the other end of the nozzle housing. Then replace the hexagon end of the brush roll by aligning the end cap as shown and pressing it down into the nozzle housing until a click is heard.

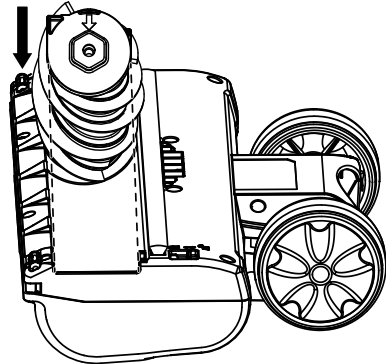

5. Reinstall the locking lever. First insert the tab end of the locking lever into the slot as shown. Then press down the locking lever into place until a click is heard. Make sure the tab is in the lock position.

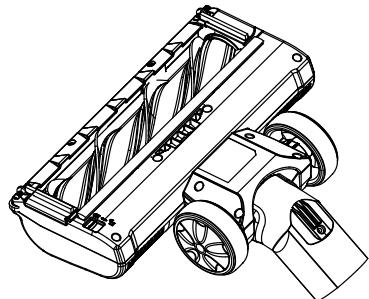
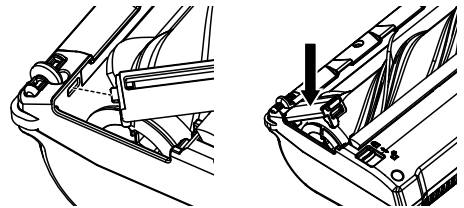

CLEANING THE MOTORIZED NOZZLE & BLOCKAGES

Brush Roll Reset

If the brush roll is blocked or overloaded, the unit will automatically stop power. Switch the unit off and remove the obstruction.

Hose Blockage Removal

1. To clean out the hose, press the wand release button on the motorized nozzle, and pull the motorized nozzle away from the wand.

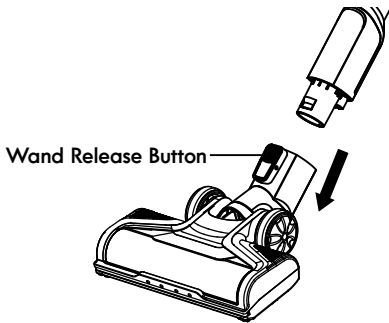

2. Carefully remove any debris or blockage from the inside of the hose. Reattach the motorized nozzle onto the wand.
3. Once the blockage is removed, start the vacuum to ensure air flow through the hose.



CAUTION

Do not use scissors or other sharp objects to remove a blockage from the hose.

NOTE: It is recommended to store the vacuum within a temperature range between 39.2°F (4°C) and 104°F (40°C).

TROUBLESHOOTING

Review the table for solutions to minor performance problems. Any service needed, other than maintenance described in this Use & Care Guide, should be performed by a qualified service dealer.



WARNING

Disconnect electrical supply before performing maintenance to the vacuum cleaner. Failure to do so could result in electrical shock or personal injury.

PROBLEM	POSSIBLE CAUSE	SOLUTION
Vacuum will not power on.	Battery may be depleted.	Charge the battery as instructed on page 10.
	Wrong charger being used.	Be sure to use only the charger supplied with your product.
	Brush roll is jammed.	Remove obstruction. Follow instructions on page 15.
	Hand vacuum or battery is damaged.	Call 1-877-531-7321 (US) / 1-844-608-3081 (CA) for assistance.
Battery indicator does not illuminate when charging the battery.	Charging adapter is not plugged into outlet firmly.	Be sure the charging adapter is plugged in properly to the outlet, and the charging connector is plugged into the charging port of the hand vacuum.
	Dust accumulated on the charging port of the hand vacuum.	Clean off any dust accumulated on the charging port of the hand vacuum.
	No power at electrical outlet.	Check circuit breakers.
	The battery is damaged.	Call 1-877-531-7321 (US) / 1-844-608-3081 (CA) for assistance.
	The battery indicator is damaged.	Call 1-877-531-7321 (US) / 1-844-608-3081 (CA) for assistance.
Battery indicator does not illuminate when using the vacuum.	Battery may be depleted.	Charge the battery as instructed on page 10.
	The battery indicator is damaged.	Call 1-877-531-7321 (US) / 1-844-608-3081 (CA) for assistance.
Battery indicator flashes red and then turns off when using the vacuum.	This indicates an obstruction of brush roll or missing of the filters, which causes the motor protection to trip.	With the unit turned off, check to remove any obstruction in the brush roll or in the motor section, reinstall the filters into place and then re-start. If the unit cannot be re-started, call 1-877-531-7321 (US) / 1-844-608-3081 (CA) for assistance.
	Battery may be depleted.	Charge the battery as instructed on page 10.
Brush roll in the motorized nozzle is not turning.	Brush roll is jammed.	Remove obstruction. Follow instructions on page 15.
	Brush roll is not installed properly.	Remove the brush roll and reinstall as instructed on page 15.

TROUBLESHOOTING

Brush roll in the motorized nozzle is not turning.	Debris accumulates on metal contacts connecting the dust cup and the main body of the hand vacuum.	Remove the debris and reinstall as instructed on page 14.
	The dust cup is installed incorrectly.	Reinstall the dust cup correctly as instructed on page 14.
	The hand vacuum and the wand are not connected into place.	Reinstall the hand vacuum and the wand correctly as instructed on page 9.
	The motorized nozzle and the wand are not connected into place.	Reinstall the motorized nozzle and the wand correctly as instructed on page 15.
	Nozzle motor and brush roll both are not turning.	Check to confirm the above connections are properly made. Re-start the unit. If the nozzle motor and brush roll are still not turning, the nozzle motor may be damaged. Call 1-877-531-7321 (US) / 1-844-608-3081 (CA) for assistance.
	Nozzle motor is spinning, but the brush roll is not rotating.	The belt is broken. Call 1-877-531-7321 (US) / 1-844-608-3081 (CA) for assistance.
Vacuum is not picking up or suction power is weak.	Dust cup is full.	Empty the dust cup.
	Filter needs cleaning.	Follow filter cleaning instructions on page 13-14.
	Filter needs to be replaced.	To purchase parts call 1-877-531-7321 (US) / 1-844-608-3081 (CA).
	Battery may be depleted.	Charge the battery as instructed on page 10.
	Dust cup is not installed well.	Check the dust cup for correct installation and ensure it is snapped firmly in place.
Dust escapes from vacuum.	Filter is missing or installed incorrectly.	Check the filter for correct installation. See page 13-14.
	Filter is damaged and needs to be replaced.	To purchase a replacement filter, call 1-877-531-7321 (US) / 1-844-608-3081 (CA).
	Dust cup is full or is installed incorrectly.	Empty the dust cup container or position the dust cup correctly and snap firmly into place.
	Pre-filter is missing or is installed incorrectly.	Reinstall correctly as instructed on page 13-14.
Vacuum turns off on its own.	Battery may be depleted.	Charge the battery as instructed on page 10.
	Brush roll in the motorized nozzle is jammed or is not installed well causing motor protection system activated.	With the unit turned off, remove the obstruction or re-install the brush roll as instructed on page 15 and then re-start.
	Excessive loading on brush roll brush.	Remove the obstruction and then re-start.
	The suction inlet or hose is blocked or sealed.	Remove the obstruction and then re-start.
	The battery is damaged.	Call 1-877-531-7321 (US) / 1-844-608-3081 (CA) for assistance.